

AO 120 (Rev. 08/10)

TO: Mail Stop 8 Director of the U.S. Patent and Trademark Office P.O. Box 1450 Alexandria, VA 22313-1450	REPORT ON THE FILING OR DETERMINATION OF AN ACTION REGARDING A PATENT OR TRADEMARK
---	--

In Compliance with 35 U.S.C. § 290 and/or 15 U.S.C. § 1116 you are hereby advised that a court action has been filed in the U.S. District Court District of Delaware on the following
 Trademarks or Patents. (the patent action involves 35 U.S.C. § 292.):

DOCKET NO. 15-cv-615-RGA	DATE FILED 7/17/2015	U.S. DISTRICT COURT District of Delaware
PLAINTIFF TQ Delta, LLC		DEFENDANT Time Warner Cable Inc. and Time Warner Cable Enterprises LLC
PATENT OR TRADEMARK NO.	DATE OF PATENT OR TRADEMARK	HOLDER OF PATENT OR TRADEMARK
1 See Attached		
2		
3		
4		
5		

In the above—entitled case, the following patent(s)/ trademark(s) have been included:

DATE INCLUDED 9/9/2015	INCLUDED BY <input checked="" type="checkbox"/> Amendment <input type="checkbox"/> Answer <input type="checkbox"/> Cross Bill <input type="checkbox"/> Other Pleading	
PATENT OR TRADEMARK NO.	DATE OF PATENT OR TRADEMARK	HOLDER OF PATENT OR TRADEMARK
1 US 9,094,268 B2	7/28/2015	TQ Delta, LLC
2		
3		
4		
5		

In the above—entitled case, the following decision has been rendered or judgement issued:

DECISION/JUDGEMENT

CLERK	(BY) DEPUTY CLERK	DATE
-------	-------------------	------

Copy 1—Upon initiation of action, mail this copy to Director Copy 3—Upon termination of action, mail this copy to Director
 Copy 2—Upon filing document adding patent(s), mail this copy to Director Copy 4—Case file copy

	PATENT OR TRADEMARK NO.	DATE OF PATENT OR TRADEMARK	HOLDER OF PATENT OR TRADEMARK
1	US 6,961,369 B1	11/1/2005	TQ Delta, LLC
2	US 8,718,158 B2	5/6/2014	TQ Delta, LLC
3	US 9,014,243 B2	4/21/2015	TQ Delta, LLC
4	US 7,835,430 B2	11/16/2010	TQ Delta, LLC
5	US 8,238,412 B2	8/7/2012	TQ Delta, LLC
6	US 8,432,956 B2	4/30/2013	TQ Delta, LLC
7	US 8,611,404 B2	12/17/2013	TQ Delta, LLC

AO 120 (Rev. 08/10)

TO: Mail Stop 8 Director of the U.S. Patent and Trademark Office P.O. Box 1450 Alexandria, VA 22313-1450	REPORT ON THE FILING OR DETERMINATION OF AN ACTION REGARDING A PATENT OR TRADEMARK
---	---

In Compliance with 35 U.S.C. § 290 and/or 15 U.S.C. § 1116 you are hereby advised that a court action has been filed in the U.S. District Court District of Delaware on the following
 Trademarks or Patents. (the patent action involves 35 U.S.C. § 292.);

DOCKET NO. 15-cv-616-RGA	DATE FILED 7/17/2015	U.S. DISTRICT COURT District of Delaware
PLAINTIFF TQ Delta, LLC		DEFENDANT Verizon Communications Inc., Verizon Services Corp., Verizon Online LLC, Verizon Business Network Services Inc., Verizon Delaware LLC, and Verizon Information Technologies LLC
PATENT OR TRADEMARK NO.	DATE OF PATENT OR TRADEMARK	HOLDER OF PATENT OR TRADEMARK
1 See Attached		
2		
3		
4		
5		

In the above—entitled case, the following patent(s)/trademark(s) have been included:

DATE INCLUDED 9/9/2015	INCLUDED BY <input checked="" type="checkbox"/> Amendment <input type="checkbox"/> Answer <input type="checkbox"/> Cross Bill <input type="checkbox"/> Other Pleading	
PATENT OR TRADEMARK NO.	DATE OF PATENT OR TRADEMARK	HOLDER OF PATENT OR TRADEMARK
1 US 9,094,268 B2	7/28/2015	TQ Delta, LLC
2		
3		
4		
5		

In the above—entitled case, the following decision has been rendered or judgement issued:

DECISION/JUDGEMENT

CLERK	(BY) DEPUTY CLERK	DATE
-------	-------------------	------

Copy 1—Upon initiation of action, mail this copy to Director Copy 3—Upon termination of action, mail this copy to Director
 Copy 2—Upon filing document adding patent(s), mail this copy to Director Copy 4—Case file copy

	PATENT OR TRADEMARK NO.	DATE OF PATENT OR TRADEMARK	HOLDER OF PATENT OR TRADEMARK
1	US 6,961,369 B1	11/1/2005	TQ Delta, LLC
2	US 8,718,158 B2	5/6/2014	TQ Delta, LLC
3	US 9,014,243 B2	4/21/2015	TQ Delta, LLC
4	US 7,835,430 B2	11/16/2010	TQ Delta, LLC
5	US 8,238,412 B2	8/7/2012	TQ Delta, LLC
6	US 8,432,956 B2	4/30/2013	TQ Delta, LLC
7	US 8,611,404 B2	12/17/2013	TQ Delta, LLC

AO 120 (Rev. 08/10)

TO: Mail Stop 8 Director of the U.S. Patent and Trademark Office P.O. Box 1450 Alexandria, VA 22313-1450	REPORT ON THE FILING OR DETERMINATION OF AN ACTION REGARDING A PATENT OR TRADEMARK
---	---

In Compliance with 35 U.S.C. § 290 and/or 15 U.S.C. § 1116 you are hereby advised that a court action has been filed in the U.S. District Court Middle District of Florida, Orlando Division on the following
 Trademarks or Patents. (the patent action involves 35 U.S.C. § 292.):

DOCKET NO. 6:14-cv-1027	DATE FILED 6/26/2014	U.S. DISTRICT COURT Middle District of Florida, Orlando Division
PLAINTIFF Orlando Communications LLC		DEFENDANT LG Electronics, Inc., et al
PATENT OR TRADEMARK NO.	DATE OF PATENT OR TRADEMARK	HOLDER OF PATENT OR TRADEMARK
1 5,687,1296	11/11/1997	James Arthur Proctor, Jr., James Carl Otto
2 6,0009,553	12/28/0199	Dennis Martinez, Thomas Hengeveld, Michael Axford
3		
4		
5		

In the above—entitled case, the following patent(s)/ trademark(s) have been included:

DATE INCLUDED	INCLUDED BY <input type="checkbox"/> Amendment <input type="checkbox"/> Answer <input type="checkbox"/> Cross Bill <input type="checkbox"/> Other Pleading	
PATENT OR TRADEMARK NO.	DATE OF PATENT OR TRADEMARK	HOLDER OF PATENT OR TRADEMARK
1		
2		
3		
4		
5		

In the above—entitled case, the following decision has been rendered or judgement issued:

DECISION/JUDGEMENT Order of Dismissal
--

CLERK Sheryl Loesch	(BY) DEPUTY CLERK R. Olsen	DATE 9/9/2015
------------------------	-------------------------------	------------------

Copy 1—Upon initiation of action, mail this copy to Director Copy 3—Upon termination of action, mail this copy to Director
 Copy 2—Upon filing document adding patent(s), mail this copy to Director Copy 4—Case file copy

AO 120 (Rev. 08/10)

TO: Mail Stop 8 Director of the U.S. Patent and Trademark Office P.O. Box 1450 Alexandria, VA 22313-1450	REPORT ON THE FILING OR DETERMINATION OF AN ACTION REGARDING A PATENT OR TRADEMARK
---	---

In Compliance with 35 U.S.C. § 290 and/or 15 U.S.C. § 1116 you are hereby advised that a court action has been filed in the U.S. District Court Middle District of Florida, Orlando Division on the following
 Trademarks or Patents. (the patent action involves 35 U.S.C. § 292.);

DOCKET NO. 6:14-cv-1026	DATE FILED 6/26/2014	U.S. DISTRICT COURT Middle District of Florida, Orlando Division
PLAINTIFF Orlando Communications LLC		DEFENDANT LG Electronics, Inc., et al
PATENT OR TRADEMARK NO.	DATE OF PATENT OR TRADEMARK	HOLDER OF PATENT OR TRADEMARK
1 5,687,1296	11/11/1997	James Arthur Proctor, Jr., James Carl Otto
2 6,0009,553	12/28/0199	Dennis Martinez, Thomas Hengeveld, Michael Axford
3		
4		
5		

In the above—entitled case, the following patent(s)/ trademark(s) have been included:

DATE INCLUDED	INCLUDED BY <input type="checkbox"/> Amendment <input type="checkbox"/> Answer <input type="checkbox"/> Cross Bill <input type="checkbox"/> Other Pleading	
PATENT OR TRADEMARK NO.	DATE OF PATENT OR TRADEMARK	HOLDER OF PATENT OR TRADEMARK
1		
2		
3		
4		
5		

In the above—entitled case, the following decision has been rendered or judgement issued:

DECISION/JUDGEMENT Order of Dismissal
--

CLERK Sheryl Loesch	(BY) DEPUTY CLERK R. Olsen	DATE 9/9/2015
------------------------	-------------------------------	------------------

Copy 1—Upon initiation of action, mail this copy to Director Copy 3—Upon termination of action, mail this copy to Director
 Copy 2—Upon filing document adding patent(s), mail this copy to Director Copy 4—Case file copy

AO 120 (Rev. 08/10)

TO: Mail Stop 8 Director of the U.S. Patent and Trademark Office P.O. Box 1450 Alexandria, VA 22313-1450	REPORT ON THE FILING OR DETERMINATION OF AN ACTION REGARDING A PATENT OR TRADEMARK
---	--

In Compliance with 35 U.S.C. § 290 and/or 15 U.S.C. § 1116 you are hereby advised that a court action has been filed in the U.S. District Court Middle District of Florida, Orlando Division on the following
 Trademarks or Patents. (the patent action involves 35 U.S.C. § 292.):

DOCKET NO. 6:14-cv-1028	DATE FILED 6/26/2014	U.S. DISTRICT COURT Middle District of Florida, Orlando Division
PLAINTIFF Orlando Communications LLC		DEFENDANT HTC Corporation, et al
PATENT OR TRADEMARK NO.	DATE OF PATENT OR TRADEMARK	HOLDER OF PATENT OR TRADEMARK
1 5,687,1296	11/11/1997	James Arthur Proctor, Jr., James Carl Otto
2 6,0009,553	12/28/0199	Dennis Martinez, Thomas Hengeveld, Michael Axford
3		
4		
5		

In the above—entitled case, the following patent(s)/ trademark(s) have been included:

DATE INCLUDED	INCLUDED BY <input type="checkbox"/> Amendment <input type="checkbox"/> Answer <input type="checkbox"/> Cross Bill <input type="checkbox"/> Other Pleading	
PATENT OR TRADEMARK NO.	DATE OF PATENT OR TRADEMARK	HOLDER OF PATENT OR TRADEMARK
1		
2		
3		
4		
5		

In the above—entitled case, the following decision has been rendered or judgement issued:

DECISION/JUDGEMENT Order of Dismissal
--

CLERK Sheryl Loesch	(BY) DEPUTY CLERK R. Olsen	DATE 9/9/2015
------------------------	-------------------------------	------------------

Copy 1—Upon initiation of action, mail this copy to Director Copy 3—Upon termination of action, mail this copy to Director
 Copy 2—Upon filing document adding patent(s), mail this copy to Director Copy 4—Case file copy

AO 120 (Rev. 08/10)

TO: Mail Stop 8 Director of the U.S. Patent and Trademark Office P.O. Box 1450 Alexandria, VA 22313-1450	REPORT ON THE FILING OR DETERMINATION OF AN ACTION REGARDING A PATENT OR TRADEMARK
---	--

In Compliance with 35 U.S.C. § 290 and/or 15 U.S.C. § 1116 you are hereby advised that a court action has been filed in the U.S. District Court District of Delaware on the following
 Trademarks or Patents. (the patent action involves 35 U.S.C. § 292.);

DOCKET NO.	DATE FILED 7/17/2015	U.S. DISTRICT COURT District of Delaware
PLAINTIFF TQ Delta, LLC		DEFENDANT Verizon Communications Inc., Verizon Services Corp., Verizon Online LLC, Verizon Business Network Services Inc., Verizon Delaware LLC, and Verizon Information Technologies LLC
PATENT OR TRADEMARK NO.	DATE OF PATENT OR TRADEMARK	HOLDER OF PATENT OR TRADEMARK
1 See Attached		
2		
3		
4		
5		

In the above—entitled case, the following patent(s)/ trademark(s) have been included:

DATE INCLUDED	INCLUDED BY <input type="checkbox"/> Amendment <input type="checkbox"/> Answer <input type="checkbox"/> Cross Bill <input type="checkbox"/> Other Pleading	
PATENT OR TRADEMARK NO.	DATE OF PATENT OR TRADEMARK	HOLDER OF PATENT OR TRADEMARK
1		
2		
3		
4		
5		

In the above—entitled case, the following decision has been rendered or judgement issued:

DECISION/JUDGEMENT

CLERK	(BY) DEPUTY CLERK	DATE
-------	-------------------	------

Copy 1—Upon initiation of action, mail this copy to Director Copy 3—Upon termination of action, mail this copy to Director
 Copy 2—Upon filing document adding patent(s), mail this copy to Director Copy 4—Case file copy

	PATENT OR TRADEMARK NO.	DATE OF PATENT OR TRADEMARK	HOLDER OF PATENT OR TRADEMARK
1	US 6,961,369 B1	11/1/2005	TQ Delta, LLC
2	US 8,718,158 B2	5/6/2014	TQ Delta, LLC
3	US 9,014,243 B2	4/21/2015	TQ Delta, LLC
4	US 7,835,430 B2	11/16/2010	TQ Delta, LLC
5	US 8,238,412 B2	8/7/2012	TQ Delta, LLC
6	US 8,432,956 B2	4/30/2013	TQ Delta, LLC
7	US 8,611,404 B2	12/17/2013	TQ Delta, LLC

AO 120 (Rev. 08/10)

TO: Mail Stop 8 Director of the U.S. Patent and Trademark Office P.O. Box 1450 Alexandria, VA 22313-1450	REPORT ON THE FILING OR DETERMINATION OF AN ACTION REGARDING A PATENT OR TRADEMARK
---	---

In Compliance with 35 U.S.C. § 290 and/or 15 U.S.C. § 1116 you are hereby advised that a court action has been filed in the U.S. District Court Delaware on the following
 Trademarks or Patents. (the patent action involves 35 U.S.C. § 292.);

DOCKET NO.	DATE FILED 9/4/2013	U.S. DISTRICT COURT Delaware
PLAINTIFF ROCHE PALO ALTO LLC and GENENTECH, INC.		DEFENDANT WATSON LABORATORIES, INC. – FLORIDA
PATENT OR TRADEMARK NO.	DATE OF PATENT OR TRADEMARK	HOLDER OF PATENT OR TRADEMARK
1 6,083,953	7/4/2000	Roche Palo Alto LLC
2		
3		
4		
5		

In the above—entitled case, the following patent(s)/ trademark(s) have been included:

DATE INCLUDED	INCLUDED BY <input type="checkbox"/> Amendment <input type="checkbox"/> Answer <input type="checkbox"/> Cross Bill <input type="checkbox"/> Other Pleading		
PATENT OR TRADEMARK NO.	DATE OF PATENT OR TRADEMARK	HOLDER OF PATENT OR TRADEMARK	
1			
2			
3			
4			
5			

In the above—entitled case, the following decision has been rendered or judgement issued:

DECISION/JUDGEMENT <p style="text-align: center; font-size: 1.2em;"><i>Dismissed - See Attached</i></p>
--

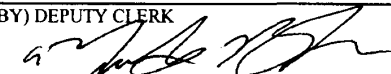
CLERK John A Cerino, Clerk United States District Court 844 N. King Street, Unit 18 Wilmington, DE 19801	(BY) DEPUTY CLERK 	DATE 7/17/15
--	---	-----------------

Copy 1—Upon initiation of action, mail this copy to Director Copy 3—Upon termination of action, mail this copy to Director
 Copy 2—Upon filing document adding patent(s), mail this copy to Director Copy 4—Case file copy

AO 120 (Rev. 3/04)

TO: Mail Stop 8 Director of the U.S. Patent and Trademark Office P.O. Box 1450 Alexandria, VA 22313-1450	REPORT ON THE FILING OR DETERMINATION OF AN ACTION REGARDING A PATENT OR TRADEMARK
--	--

In Compliance with 35 U.S.C. § 290 and/or 15 U.S.C. § 1116 you are hereby advised that a court action has been filed in the U.S. District Court Massachusetts on the following Patents or Trademarks:

DOCKET NO.	DATE FILED 7/17/2015	U.S. DISTRICT COURT Massachusetts
PLAINTIFF BOSTON PROPERTIES LIMITED PARTNERSHIP		DEFENDANT CLAUDETTE MOUSSA, d/b/a Boston Properties Advisors
PATENT OR TRADEMARK NO.	DATE OF PATENT OR TRADEMARK	HOLDER OF PATENT OR TRADEMARK
1 2,527,181	1/8/2002	BOSTON PROPERTIES LIMITED PARTNERSHIP
2		
3		
4		
5		

In the above—entitled case, the following patent(s)/ trademark(s) have been included:

DATE INCLUDED	INCLUDED BY <input checked="" type="checkbox"/> Amendment <input checked="" type="checkbox"/> Answer <input checked="" type="checkbox"/> Cross Bill <input checked="" type="checkbox"/> Other Pleading		
PATENT OR TRADEMARK NO.	DATE OF PATENT OR TRADEMARK	HOLDER OF PATENT OR TRADEMARK	
1			
2			
3			
4			
5			

In the above—entitled case, the following decision has been rendered or judgement issued:

DECISION/JUDGEMENT

CLERK	(BY) DEPUTY CLERK	DATE
-------	-------------------	------

Copy 1—Upon initiation of action, mail this copy to Director Copy 3—Upon termination of action, mail this copy to Director
 Copy 2—Upon filing document adding patent(s), mail this copy to Director Copy 4—Case file copy

AO 120 (Rev. 08/10)

TO: Mail Stop 8 Director of the U.S. Patent and Trademark Office P.O. Box 1450 Alexandria, VA 22313-1450	REPORT ON THE FILING OR DETERMINATION OF AN ACTION REGARDING A PATENT OR TRADEMARK
---	--

In Compliance with 35 U.S.C. § 290 and/or 15 U.S.C. § 1116 you are hereby advised that a court action has been filed in the U.S. District Court Transferred to Delaware from Alabama on the following

Trademarks or Patents. (the patent action involves 35 U.S.C. § 292.);

DOCKET NO. 15-cv-121-RGA	DATE FILED 7/17/2014	U.S. DISTRICT COURT Transferred to Delaware from Alabama
PLAINTIFF ADTRAN, Inc.		DEFENDANT TQ Delta, LLC
PATENT OR TRADEMARK NO.	DATE OF PATENT OR TRADEMARK	HOLDER OF PATENT OR TRADEMARK
1 See Attachment #1		
2		
3		
4		
5		

In the above—entitled case, the following patent(s)/ trademark(s) have been included:

DATE INCLUDED 3/13/2015	INCLUDED BY <input type="checkbox"/> Amendment <input checked="" type="checkbox"/> Answer <input type="checkbox"/> Cross Bill <input type="checkbox"/> Other Pleading	
PATENT OR TRADEMARK NO.	DATE OF PATENT OR TRADEMARK	HOLDER OF PATENT OR TRADEMARK
1 See Attachment #2		
2		
3		
4		
5		

In the above—entitled case, the following decision has been rendered or judgement issued:

DECISION/JUDGEMENT

CLERK	(BY) DEPUTY CLERK	DATE
-------	-------------------	------

Copy 1—Upon initiation of action, mail this copy to Director Copy 3—Upon termination of action, mail this copy to Director
 Copy 2—Upon filing document adding patent(s), mail this copy to Director Copy 4—Case file copy

Attachment #1

Patent or Trademark No.	Date of Patent or Trademark	Holder of Patent or Trademark
1. U.S. 7,453,881 B2	11/18/2008	TQ Delta, LLC
2. U.S. 7,809,028 B2	10/05/2010	TQ Delta, LLC
3. U.S. 7,978,706 B2	7/12/2011	TQ Delta, LLC
4. U.S. 8,422,511 B2	4/16/2013	TQ Delta, LLC
5. U.S. 6,445,730 B1	9/03/2002	TQ Delta, LLC
6. U.S. 7,292,627 B2	11/6/2007	TQ Delta, LLC
7. U.S. 7,451,379 B2	11/11/2008	TQ Delta, LLC
8. U.S. 7,471,721 B2	12/30/2008	TQ Delta, LLC
9. U.S. 7,570,686 B2	8/4/2009	TQ Delta, LLC
10. U.S. 7,831,890 B2	11/09/2010	TQ Delta, LLC
11. U.S. 7,835,430 B2	11/16/2010	TQ Delta, LLC
12. U.S. 7,836,381 B1	11/16/2010	TQ Delta, LLC
13. U.S. 7,844,882 B2	11/30/2010	TQ Delta, LLC
14. U.S. 7,889,784 B2	2/15/2011	TQ Delta, LLC
15. U.S. 7,925,958 B2	04/12/2011	TQ Delta, LLC
16. U.S. 7,978,753 B2	07/12/2011	TQ Delta, LLC
17. U.S. 7,979,778 B2	07/12/2011	TQ Delta, LLC
18. U.S. 8,073,041 B1	12/6/2011	TQ Delta, LLC
19. U.S. 8,090,008 B2	1/3/2012	TQ Delta, LLC
20. U.S. 8,218,610 B2	7/10/2012	TQ Delta, LLC
21. U.S. 8,238,412 B2	08/07/2012	TQ Delta, LLC
22. U.S. 8,276,048 B2	09/25/2012	TQ Delta, LLC
23. U.S. 8,355,427 B2	1/15/2013	TQ Delta, LLC

24. U.S. 8,432,956 B2	4/30/2013	TQ Delta, LLC
25. U.S. 8,437,382 B2	5/7/2013	TQ Delta, LLC
26. U.S. 8,462,835 B2	6/11/2013	TQ Delta, LLC
27. U.S. 8,495,473 B2	7/23/2013	TQ Delta, LLC
28. U.S. 8,516,337 B2	08/20/2013	TQ Delta, LLC

	PATENT OR TRADEMARK NO.	DATE OF PATENT OR TRADEMARK	HOLDER OF PATENT OR TRADEMARK
1	US 7,796,705 B2	9/14/2010	TQ Delta, LLC
2	US 8,335,956 B2	12/18/2012	TQ Delta, LLC
3	US 8,407,546 B2	3/26/2013	TQ Delta, LLC
4	US 8,468,411 B2	6/18/2013	TQ Delta, LLC
5	US 8,645,784 B2	2/4/2014	TQ Delta, LLC
6	US 8,595,577 B2	11/26/2013	TQ Delta, LLC

AO 120 (Rev. 08/10)

TO: Mail Stop 8 Director of the U.S. Patent and Trademark Office P.O. Box 1450 Alexandria, VA 22313-1450	REPORT ON THE FILING OR DETERMINATION OF AN ACTION REGARDING A PATENT OR TRADEMARK
---	--

In Compliance with 35 U.S.C. § 290 and/or 15 U.S.C. § 1116 you are hereby advised that a court action has been filed in the U.S. District Court District of Delaware on the following
 Trademarks or Patents. (the patent action involves 35 U.S.C. § 292.);

DOCKET NO.	DATE FILED 7/18/2014	U.S. DISTRICT COURT District of Delaware
PLAINTIFF TQ Delta, LLC		DEFENDANT ADTRAN, Inc.
PATENT OR TRADEMARK NO.	DATE OF PATENT OR TRADEMARK	HOLDER OF PATENT OR TRADEMARK
1 See Attached		
2 32 Pats		
3		
4		
5		

In the above—entitled case, the following patent(s)/ trademark(s) have been included:

DATE INCLUDED	INCLUDED BY <input type="checkbox"/> Amendment <input type="checkbox"/> Answer <input type="checkbox"/> Cross Bill <input type="checkbox"/> Other Pleading		
PATENT OR TRADEMARK NO.	DATE OF PATENT OR TRADEMARK	HOLDER OF PATENT OR TRADEMARK	
1			
2			
3			
4			
5			

In the above—entitled case, the following decision has been rendered or judgement issued:

DECISION/JUDGEMENT

CLERK	(BY) DEPUTY CLERK	DATE
-------	-------------------	------

Copy 1—Upon initiation of action, mail this copy to Director Copy 3—Upon termination of action, mail this copy to Director
 Copy 2—Upon filing document adding patent(s), mail this copy to Director Copy 4—Case file copy

	PATENT OR TRADEMARK NO.	DATE OF PATENT OR TRADEMARK	HOLDER OF PATENT OR TRADEMARK
1	US 8,090,008 B2	1/3/2012	TQ Delta, LLC
2	US 8,073,041 B1	12/6/2011	TQ Delta, LLC
3	US 7,292,627 B2	11/6/2007	TQ Delta, LLC
4	US 7,471,721 B2	12/30/2008	TQ Delta, LLC
5	US 8,218,610 B2	7/10/2012	TQ Delta, LLC
6	US 8,355,427 B2	1/15/2013	TQ Delta, LLC
7	US 7,453,881 B2	11/18/2008	TQ Delta, LLC
8	US 7,809,028 B2	10/5/2010	TQ Delta, LLC
9	US 7,978,706 B2	7/12/2011	TQ Delta, LLC
10	US 8,422,511 B2	4/16/2013	TQ Delta, LLC
11	US 7,889,784 B2	2/15/2011	TQ Delta, LLC
12	US 7,835,430 B2	11/16/2010	TQ Delta, LLC
13	US 7,570,686 B2	8/4/2009	TQ Delta, LLC
14	US 8,238,412 B2	8/7/2012	TQ Delta, LLC
15	US 8,432,956 B2	4/30/2013	TQ Delta, LLC
16	US 7,451,379 B2	11/11/2008	TQ Delta, LLC
17	US 8,516,337 B2	8/20/2013	TQ Delta, LLC
18	US 7,979,778 B2	7/12/2011	TQ Delta, LLC
19	US 7,925,958 B2	4/12/2011	TQ Delta, LLC
20	US 8,462,835 B2	6/11/2013	TQ Delta, LLC
21	US 8,594,162 B2	11/26/2013	TQ Delta, LLC
22	US 7,978,753 B2	7/12/2011	TQ Delta, LLC
23	US 6,445,730 B1	9/3/2002	TQ Delta, LLC
24	US 8,611,404 B2	12/17/2013	TQ Delta, LLC
25	US 8,437,382 B2	5/7/2013	TQ Delta, LLC
26	US 7,836,381 B1	11/16/2010	TQ Delta, LLC
27	US 7,844,882 B2	11/30/2010	TQ Delta, LLC
28	US 8,276,048 B2	9/25/2012	TQ Delta, LLC
29	US 8,495,473 B2	7/23/2013	TQ Delta, LLC
30	US 8,607,126 B1	12/10/2013	TQ Delta, LLC
31	US 7,831,890 B2	11/9/2010	TQ Delta, LLC
32	US 8,625,660 B2	1/7/2014	TQ Delta, LLC

Birch, Melvin (Akima)

From: ded_nefreply@ded.uscourts.gov
Sent: Wednesday, November 20, 2013 4:56 PM
To: ded_ecf@ded.uscourts.gov
Subject: Activity in Case 1:13-cv-01835-RGA TQ Delta LLC v. Pace Americas Inc.
Patent/Trademark Report to Commissioner

This is an automatic e-mail message generated by the CM/ECF system. Please **DO NOT RESPOND** to this e-mail because the mail box is unattended.

*****NOTE TO PUBLIC ACCESS USERS***** Judicial Conference of the United States policy permits attorneys of record and parties in a case (including pro se litigants) to receive one free electronic copy of all documents filed electronically, if receipt is required by law or directed by the filer. PACER access fees apply to all other users. To avoid later charges, download a copy of each document during this first viewing. However, if the referenced document is a transcript, the free copy and 30 page limit do not apply.

U.S. District Court

District of Delaware

Notice of Electronic Filing

The following transaction was entered by Farnan, Brian on 11/20/2013 at 4:56 PM EST and filed on 11/20/2013

Case Name: TQ Delta LLC v. Pace Americas Inc.

Case Number: 1:13-cv-01835-RGA

Filer:

Document Number: 7

Docket Text:

Report to the Commissioner of Patents and Trademarks for Patent/Trademark Number(s) US 8,090,008 B2; US 8,073,041 B1; US 7,292,627 B2; US 7,471,721 B2; US 8,218,610 B2; US 8,355,427 B2; US 7,453,881 B2; US 7,978,706 B2; US 8,422,511 B2; US 7,889,784 B2; US 7,835,430 B2; US 7,570,686 B2; US 8,238,412 B2; US 8,432,956 B2; US 7,451,379 B2; US 8,516,337 B2; US 7,979,778 B2; US 7,925,958 B2; US 8,462,835 B2; US 7,836,381 B1; US 7,844,882 B2; US 8,276,048 B2; US 8,495,473 B2; US 7,831,890 B2; . (Farnan, Brian)

1:13-cv-01835-RGA Notice has been electronically mailed to:

Brian E. Farnan bfarnan@farnanlaw.com, tfarnan@farnanlaw.com

Michael J. Farnan mfarnan@farnanlaw.com, tfarnan@farnanlaw.com

1:13-cv-01835-RGA Filer will deliver document by other means to:

The following document(s) are associated with this transaction:

AO 120 (Rev. 08/10)

TO: Mail Stop 8 Director of the U.S. Patent and Trademark Office P.O. Box 1450 Alexandria, VA 22313-1450	REPORT ON THE FILING OR DETERMINATION OF AN ACTION REGARDING A PATENT OR TRADEMARK
---	---

In Compliance with 35 U.S.C. § 290 and/or 15 U.S.C. § 1116 you are hereby advised that a court action has been filed in the U.S. District Court District of Delaware on the following

Trademarks or Patents. (the patent action involves 35 U.S.C. § 292.);

DOCKET NO.	DATE FILED 12/9/2013	U.S. DISTRICT COURT District of Delaware
PLAINTIFF TQ Delta, LLC		DEFENDANT ZyXEL Communications Corporation and ZyXEL Communications, Inc.
PATENT OR TRADEMARK NO.	DATE OF PATENT OR TRADEMARK	HOLDER OF PATENT OR TRADEMARK
1 See Attached		
2		
3		
4		
5		

In the above—entitled case, the following patent(s)/ trademark(s) have been included:

DATE INCLUDED	INCLUDED BY <input type="checkbox"/> Amendment <input type="checkbox"/> Answer <input type="checkbox"/> Cross Bill <input type="checkbox"/> Other Pleading	
PATENT OR TRADEMARK NO.	DATE OF PATENT OR TRADEMARK	HOLDER OF PATENT OR TRADEMARK
1		
2		
3		
4		
5		

In the above—entitled case, the following decision has been rendered or judgement issued:

DECISION/JUDGEMENT

CLERK	(BY) DEPUTY CLERK	DATE
-------	-------------------	------

Copy 1—Upon initiation of action, mail this copy to Director Copy 3—Upon termination of action, mail this copy to Director
 Copy 2—Upon filing document adding patent(s), mail this copy to Director Copy 4—Case file copy

PATENT OR TRADEMARK NO.	DATE OF PATENT OR TRADEMARK	HOLDER OF PATENT OR TRADEMARK
1 US 8,090,008 B2	1/3/2012	TQ Delta, LLC
2 US 8,073,041 B1	12/6/2011	TQ Delta, LLC
3 US 7,292,627 B2	11/6/2007	TQ Delta, LLC
4 US 7,471,721 B2	12/30/2008	TQ Delta, LLC
5 US 8,218,610 B2	7/10/2012	TQ Delta, LLC
6. US 8,355,427 B2	1/15/2013	TQ Delta, LLC
7 US 7,453,881 B2	11/18/2008	TQ Delta, LLC
8 US 7,809,028 B2	10/5/2010	TQ Delta, LLC
9 US 7,978,706 B2	7/12/2011	TQ Delta, LLC
10 US 8,422,511 B2	4/16/2013	TQ Delta, LLC
11 US 7,796,705 B2	9/14/2010	TQ Delta, LLC
12 US 7,889,784 B2	2/15/2011	TQ Delta, LLC
13 US 7,835,430 B2	11/16/2010	TQ Delta, LLC
14 US 7,570,686 B2	8/4/2009	TQ Delta, LLC
15 US 8,238,412 B2	8/7/2012	TQ Delta, LLC
16 US 8,432,956 B2	4/30/2013	TQ Delta, LLC
17 US 7,451,379 B2	11/11/2008	TQ Delta, LLC
18 US 8,516,337 B2	8/20/2013	TQ Delta, LLC
19 US 7,979,778 B2	7/12/2011	TQ Delta, LLC
20 US 7,925,958 B2	4/12/2011	TQ Delta, LLC
21 US 8,462,835 B2	6/11/2013	TQ Delta, LLC
22 US 7,978,753 B2	7/12/2011	TQ Delta, LLC
23 US 6,445,730 B1	9/3/2002	TQ Delta, LLC
24 US 8,437,382 B2	5/7/2013	TQ Delta, LLC
25 US 7,836,381 B1	11/16/2010	TQ Delta, LLC
26 US 7,844,882 B2	11/30/2010	TQ Delta, LLC
27 US 8,276,048 B2	9/25/2012	TQ Delta, LLC
28 US 8,495,473 B2	7/23/2013	TQ Delta, LLC
29 US 7,831,890 B2	11/9/2010	TQ Delta, LLC
30 US 8,335,956 B2	12/18/2012	TQ Delta, LLC
31 US 8,468,411 B2	6/18/2013	TQ Delta, LLC
32 US 8,407,546 B2	3/26/2013	TQ Delta, LLC

TO: Mail Stop 8 Director of the U.S. Patent and Trademark Office P.O. Box 1450 Alexandria, VA 22313-1450	REPORT ON THE FILING OR DETERMINATION OF AN ACTION REGARDING A PATENT OR TRADEMARK
---	---

In Compliance with 35 U.S.C. § 290 and/or 15 U.S.C. § 1116 you are hereby advised that a court action has been filed in the U.S. District Court Northern District of Texas, Dallas Division on the following

Trademarks or Patents. (the patent action involves 35 U.S.C. § 292.):

DOCKET NO. 3:12-cv-1462-L	DATE FILED 5/10/2012	U.S. DISTRICT COURT Northern District of Texas, Dallas Division
PLAINTIFF Boulle Ltd		DEFENDANT De Boulle Diamond & Jewelry Inc
PATENT OR TRADEMARK NO.	DATE OF PATENT OR TRADEMARK	HOLDER OF PATENT OR TRADEMARK
1 4,086,050	1/17/2012	Boulle Ltd
2		
3		
4		
5		

In the above—entitled case, the following patent(s)/ trademark(s) have been included:

DATE INCLUDED 12/9/2013	INCLUDED BY <input checked="" type="checkbox"/> Amendment <input type="checkbox"/> Answer <input type="checkbox"/> Cross Bill <input type="checkbox"/> Other Pleading	
PATENT OR TRADEMARK NO.	DATE OF PATENT OR TRADEMARK	HOLDER OF PATENT OR TRADEMARK
1 3,078,625	4/11/2006	De Boulle Diamond & Jewelry Inc
2 3,078,627	4/11/2006	De Boulle Diamond & Jewelry Inc
3		
4		
5		

In the above—entitled case, the following decision has been rendered or judgement issued:

DECISION/JUDGEMENT

CLERK Karen Mitchell	(BY) DEPUTY CLERK s/A. Lowe-Monserrate	DATE 12/10/2013
-------------------------	---	--------------------

Copy 1—Upon initiation of action, mail this copy to Director Copy 3—Upon termination of action, mail this copy to Director
 Copy 2—Upon filing document adding patent(s), mail this copy to Director Copy 4—Case file copy

AO 120 (Rev. 08/10)

TO: Mail Stop 8 Director of the U.S. Patent and Trademark Office P.O. Box 1450 Alexandria, VA 22313-1450	REPORT ON THE FILING OR DETERMINATION OF AN ACTION REGARDING A PATENT OR TRADEMARK
---	--

In Compliance with 35 U.S.C. § 290 and/or 15 U.S.C. § 1116 you are hereby advised that a court action has been filed in the U.S. District Court District of Delaware on the following

Trademarks or Patents. (the patent action involves 35 U.S.C. § 292.);

DOCKET NO.	DATE FILED 11/4/2013	U.S. DISTRICT COURT District of Delaware
PLAINTIFF TQ Delta, LLC		DEFENDANT Pace Americas, Inc.
PATENT OR TRADEMARK NO.	DATE OF PATENT OR TRADEMARK	HOLDER OF PATENT OR TRADEMARK
1 See Attached		
2		
3		
4		
5		

In the above—entitled case, the following patent(s)/ trademark(s) have been included:

DATE INCLUDED	INCLUDED BY <input type="checkbox"/> Amendment <input type="checkbox"/> Answer <input type="checkbox"/> Cross Bill <input type="checkbox"/> Other Pleading	
PATENT OR TRADEMARK NO.	DATE OF PATENT OR TRADEMARK	HOLDER OF PATENT OR TRADEMARK
1		
2		
3		
4		
5		

In the above—entitled case, the following decision has been rendered or judgement issued:

DECISION/JUDGEMENT

CLERK	(BY) DEPUTY CLERK	DATE
-------	-------------------	------

Copy 1—Upon initiation of action, mail this copy to Director Copy 3—Upon termination of action, mail this copy to Director
 Copy 2—Upon filing document adding patent(s), mail this copy to Director Copy 4—Case file copy

PATENT OR TRADEMARK NO.	DATE OF PATENT OR TRADEMARK	HOLDER OF PATENT OR TRADEMARK
1 US 8,090,008 B2	1/3/2012	TQ Delta, LLC
2 US 8,073,041 B1	12/6/2011	TQ Delta, LLC
3 US 7,292,627 B2	11/6/2007	TQ Delta, LLC
4 US 7,471,721 B2	12/30/2008	TQ Delta, LLC
5 US 8,218,610 B2	7/10/2012	TQ Delta, LLC
6. US 8,355,427 B2	1/15/2013	TQ Delta, LLC
7 US 7,453,881 B2	11/18/2008	TQ Delta, LLC
8 US 7,978,706 B2	7/12/2011	TQ Delta, LLC
9 US 8,422,511 B2	4/16/2013	TQ Delta, LLC
10 US 7,889,784 B2	2/15/2011	TQ Delta, LLC
11 US 7,835,430 B2	11/16/2010	TQ Delta, LLC
12 US 7,570,686 B2	8/4/2009	TQ Delta, LLC
13 US 8,238,412 B2	8/7/2012	TQ Delta, LLC
14 US 8,432,956 B2	4/30/2013	TQ Delta, LLC
15 US 7,451,379 B2	11/11/2008	TQ Delta, LLC
16 US 8,516,337 B2	8/20/2013	TQ Delta, LLC
17 US 7,979,778 B2	7/12/2011	TQ Delta, LLC
18 US 7,925,958 B2	4/12/2011	TQ Delta, LLC
19 US 8,462,835 B2	6/11/2013	TQ Delta, LLC

AO 120 (Rev. 08/10)

TO: Mail Stop 8 Director of the U.S. Patent and Trademark Office P.O. Box 1450 Alexandria, VA 22313-1450	REPORT ON THE FILING OR DETERMINATION OF AN ACTION REGARDING A PATENT OR TRADEMARK
---	---

In Compliance with 35 U.S.C. § 290 and/or 15 U.S.C. § 1116 you are hereby advised that a court action has been filed in the U.S. District Court District of Delaware on the following

Trademarks or Patents. (the patent action involves 35 U.S.C. § 292.):

DOCKET NO.	DATE FILED 11/4/2013	U.S. DISTRICT COURT District of Delaware
PLAINTIFF TQ Delta, LLC		DEFENDANT Zhone Technologies, Inc.
PATENT OR TRADEMARK NO.	DATE OF PATENT OR TRADEMARK	HOLDER OF PATENT OR TRADEMARK
1 See Attached		
2		
3		
4		
5		

In the above—entitled case, the following patent(s)/ trademark(s) have been included:

DATE INCLUDED	INCLUDED BY <input type="checkbox"/> Amendment <input type="checkbox"/> Answer <input type="checkbox"/> Cross Bill <input type="checkbox"/> Other Pleading	
PATENT OR TRADEMARK NO.	DATE OF PATENT OR TRADEMARK	HOLDER OF PATENT OR TRADEMARK
1		
2		
3		
4		
5		

In the above—entitled case, the following decision has been rendered or judgement issued:

DECISION/JUDGEMENT

CLERK	(BY) DEPUTY CLERK	DATE
-------	-------------------	------

Copy 1—Upon initiation of action, mail this copy to Director Copy 3—Upon termination of action, mail this copy to Director
Copy 2—Upon filing document adding patent(s), mail this copy to Director Copy 4—Case file copy

	PATENT OR TRADEMARK NO.	DATE OF PATENT OR TRADEMARK	HOLDER OF PATENT OR TRADEMARK
1	US 8,090,008 B2	1/3/2012	TQ Delta, LLC
2	US 8,073,041 B1	12/6/2011	TQ Delta, LLC
3	US 7,292,627 B2	11/6/2007	TQ Delta, LLC
4	US 7,471,721 B2	12/30/2008	TQ Delta, LLC
5	US 8,218,610 B2	7/10/2012	TQ Delta, LLC
6	US 8,355,427 B2	1/15/2013	TQ Delta, LLC
7	US 7,453,881 B2	11/18/2008	TQ Delta, LLC
8	US 7,809,028 B2	10/5/2010	TQ Delta, LLC
9	US 7,978,706 B2	7/12/2011	TQ Delta, LLC
10	US 8,422,511 B2	4/16/2013	TQ Delta, LLC
11	US 7,796,705 B2	9/14/2010	TQ Delta, LLC
12	US 7,889,784 B2	2/15/2011	TQ Delta, LLC
13	US 7,835,430 B2	11/16/2010	TQ Delta, LLC
14	US 7,570,686 B2	8/4/2009	TQ Delta, LLC
15	US 8,238,412 B2	8/7/2012	TQ Delta, LLC
16	US 8,432,956 B2	4/30/2013	TQ Delta, LLC
17	US 7,451,379 B2	11/11/2008	TQ Delta, LLC
18	US 8,516,337 B2	8/20/2013	TQ Delta, LLC
19	US 7,979,778 B2	7/12/2011	TQ Delta, LLC
20	US 7,925,958 B2	4/12/2011	TQ Delta, LLC
21	US 8,462,835 B2	6/11/2013	TQ Delta, LLC
22	US 7,978,753 B2	7/12/2011	TQ Delta, LLC
23	US 6,445,730 B1	9/3/2002	TQ Delta, LLC
24	US 8,437,382 B2	5/7/2013	TQ Delta, LLC



UNITED STATES PATENT AND TRADEMARK OFFICE

UNITED STATES DEPARTMENT OF COMMERCE
United States Patent and Trademark Office
Address: COMMISSIONER FOR PATENTS
P.O. Box 1450
Alexandria, Virginia 22313-1450
www.uspto.gov

APPLICATION NUMBER	FILING OR 371(C) DATE	FIRST NAMED APPLICANT	ATTY. DOCKET NO./TITLE
12/779,660	05/13/2010	David M. Krinsky	6936-2-CON-2-1-1

CONFIRMATION NO. 8981

POA ACCEPTANCE LETTER



OC000000057535126

62574
Jason H. Vick
Sheridan Ross, PC
Suite # 1200
1560 Broadway
Denver, CO 80202

Date Mailed: 11/14/2012

NOTICE OF ACCEPTANCE OF POWER OF ATTORNEY

This is in response to the Power of Attorney filed 11/05/2012.

The Power of Attorney in this application is accepted. Correspondence in this application will be mailed to the above address as provided by 37 CFR 1.33.

/agizaw/

Office of Data Management, Application Assistance Unit (571) 272-4000, or (571) 272-4200, or 1-888-786-0101

Under the Paperwork Reduction Act of 1995, no persons are required to respond to a collection of information unless it displays a valid OMB control number.

POWER OF ATTORNEY TO PROSECUTE APPLICATIONS BEFORE THE USPTO

I hereby revoke all previous powers of attorney given in the application identified in the attached statement under 37 CFR 3.73(c).

I hereby appoint:

 Practitioners associated with Customer Number:

62574

OR Practitioner(s) named below (If more than ten patent practitioners are to be named, then a customer number must be used):

Name	Registration Number	Name	Registration Number

As attorney(s) or agent(s) to represent the undersigned before the United States Patent and Trademark Office (USPTO) in connection with any and all patent applications assigned only to the undersigned according to the USPTO assignment records or assignments documents attached to this form in accordance with 37 CFR 3.73(c).

Please change the correspondence address for the application identified in the attached statement under 37 CFR 3.73(c) to:

 The address associated with Customer Number:

62574

OR

<input type="checkbox"/>	Firm or Individual Name			
	Address			
	City	State	Zip	
	Country			
	Telephone	Email		

Assignee Name and Address: TQ DELTA, LLC
805 Las Cimas Parkway, Suite 240
Austin, Texas 78746**A copy of this form, together with a statement under 37 CFR 3.73(c) (Form PTO/AIA/96 or equivalent) is required to be Filed in each application in which this form is used. The statement under 37 CFR 3.73(c) may be completed by one of The practitioners appointed in this form, and must identify the application in which this Power of Attorney is to be filed.****SIGNATURE of Assignee of Record**

The individual whose signature and title is supplied below is authorized to act on behalf of the assignee

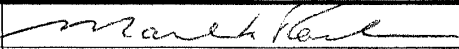
Signature		Date	10/14/12
Name	Mark K. Roche	Telephone	512-609-1810
Title	Managing Director		

This collection of information is required by 37 CFR 1.31, 1.32 and 1.33. The information is required to obtain or retain a benefit by the public which is to file (and by the USPTO to process) an application. Confidentiality is governed by 35 U.S.C. 122 and 37 CFR 1.11 and 1.14. This collection is estimated to take 3 minutes to complete, including gathering, preparing, and submitting the completed application form to the USPTO. Time will vary depending upon the individual case. Any comments on the amount of time you require to complete this form and/or suggestions for reducing this burden, should be sent to the Chief Information Officer, U.S. Patent and Trademark Office, U.S. Department of Commerce, P.O. Box 1450, Alexandria, VA 22313-1450. DO NOT SEND FEES OR COMPLETED FORMS TO THIS ADDRESS. SEND TO: Commissioner for Patents, P.O. Box 1450, Alexandria, VA 22313-1450.

If you need assistance in completing the form, call 1-800-PTO-9199 and select option 2.

Electronic Acknowledgement Receipt

EFS ID:	14147995
Application Number:	12779660
International Application Number:	
Confirmation Number:	8981
Title of Invention:	MULTICARRIER MODULATION MESSAGING FOR POWER LEVEL PER SUBCHANNEL INFORMATION
First Named Inventor/Applicant Name:	David M. Krinsky
Customer Number:	62574
Filer:	Jason Vick/Joanne Vos
Filer Authorized By:	Jason Vick
Attorney Docket Number:	6936-2-CON-2-1-1
Receipt Date:	05-NOV-2012
Filing Date:	13-MAY-2010
Time Stamp:	14:09:47
Application Type:	Utility under 35 USC 111(a)

Payment information:

Submitted with Payment	no
------------------------	----

File Listing:

Document Number	Document Description	File Name	File Size(Bytes)/ Message Digest	Multi Part /.zip	Pages (if appl.)
1		EntityStatus_373c_w_POA.pdf	422470 ec17b2542cc09b6443c2f6df13b90b4fc5bac7cf	yes	4

Multipart Description/PDF files in .zip description		
Document Description	Start	End
Miscellaneous Incoming Letter	1	1
Assignee showing of ownership per 37 CFR 3.73.	2	3
Power of Attorney	4	4
Warnings:		
Information:		
Total Files Size (in bytes):	422470	
<p>This Acknowledgement Receipt evidences receipt on the noted date by the USPTO of the indicated documents, characterized by the applicant, and including page counts, where applicable. It serves as evidence of receipt similar to a Post Card, as described in MPEP 503.</p> <p><u>New Applications Under 35 U.S.C. 111</u> If a new application is being filed and the application includes the necessary components for a filing date (see 37 CFR 1.53(b)-(d) and MPEP 506), a Filing Receipt (37 CFR 1.54) will be issued in due course and the date shown on this Acknowledgement Receipt will establish the filing date of the application.</p> <p><u>National Stage of an International Application under 35 U.S.C. 371</u> If a timely submission to enter the national stage of an international application is compliant with the conditions of 35 U.S.C. 371 and other applicable requirements a Form PCT/DO/EO/903 indicating acceptance of the application as a national stage submission under 35 U.S.C. 371 will be issued in addition to the Filing Receipt, in due course.</p> <p><u>New International Application Filed with the USPTO as a Receiving Office</u> If a new international application is being filed and the international application includes the necessary components for an international filing date (see PCT Article 11 and MPEP 1810), a Notification of the International Application Number and of the International Filing Date (Form PCT/RO/105) will be issued in due course, subject to prescriptions concerning national security, and the date shown on this Acknowledgement Receipt will establish the international filing date of the application.</p>		

IN THE UNITED STATES PATENT AND TRADEMARK OFFICE

In Re the Application of: David M. Krinsky)	Patent No. 8,238,412
)	
Application No.: 12/779,660)	Issued: August 7, 2012
)	
Filed: May 13, 2010)	Examiner: TRAN, Khanh C.
)	
Atty. File No.: 6936-2-CON-2-1-1)	Confirmation No.: 8981
)	

For: MULTICARRIER MODULATION MESSAGING FOR POWER LEVEL PER SUBCHANNEL INFORMATION

ASSERTION OF ENTITLEMENT TO SMALL ENTITY STATUS

Commissioner for Patents
P.O. Box 1450
Alexandria, VA 22313-1450

Madam:

In accordance with MPEP §§ 509.02 and 509.03 AND 37 CFR 1.27, this document is being filed to inform the U.S. Patent Office of the change of status for the above-identified patent from large entity status to small entity status. All fees paid to date have been paid as large entity status. No fees have yet been paid as small entity status. Due to the sale of the referenced patent, the Applicant is now entitled to small entity status.

We respectfully request that small entity status be granted for the above-referenced patent application.

Please contact the undersigned if there are any questions regarding this notification.

Respectfully submitted,

SHERIDAN ROSS P.C.

Date: 5 Nov '12

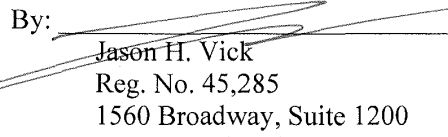
By: 
Jason H. Vick
Reg. No. 45,285
1560 Broadway, Suite 1200
Denver, Colorado 80202
Telephone: 303-863-9700

STATEMENT UNDER 37 CFR 3.73(c)

Applicant/Patent Owner: TQ DELTA, LLC

Application No./Patent No.: 8,238,412 Filed/Issue Date: August 7, 2012

Titled: MULTICARRIER MODULATION MESSAGING FOR POWER LEVEL PER SUBCHANNEL INFORMATION

TQ DELTA, LLC, a Corporation

(Name of Assignee)

(Type of Assignee, e.g., corporation, partnership, university, government agency, etc.)

states that, for the patent application/patent identified above, it is (choose **one** of options 1, 2, 3 or 4 below):

- 1. The assignee of the entire right, title, and interest.
- 2. An assignee of less than the entire right, title, and interest (check applicable box):
 - The extent (by percentage) of its ownership interest is _____%. Additional Statement(s) by the owners holding the balance of the interest **must be submitted** to account for 100% of the ownership interest.
 - There are unspecified percentages of ownership. The other parties, including inventors, who together own the entire right, title and interest are:

[Empty box for additional statements]

Additional Statement(s) by the owner(s) holding the balance of the interest **must be submitted** to account for the entire right, title, and interest.

- 3. The assignee of an undivided interest in the entirety (a complete assignment from one of the joint inventors was made). The other parties, including inventors, who together own the entire right, title, and interest are:

[Empty box for additional statements]

Additional Statement(s) by the owner(s) holding the balance of the interest **must be submitted** to account for the entire right, title, and interest.

- 4. The recipient, via a court proceeding or the like (e.g., bankruptcy, probate), of an undivided interest in the entirety (a complete transfer of ownership interest was made). The certified document(s) showing the transfer is attached.

The interest identified in option 1, 2 or 3 above (not option 4) is evidenced by either (choose **one** of options A or B below):

- A. An assignment from the inventor(s) of the patent application/patent identified above. The assignment was recorded in the United States Patent and Trademark Office at Reel _____, Frame _____, or for which a copy thereof is attached.
- B. A chain of title from the inventor(s), of the patent application/patent identified above, to the current assignee as follows:

1. From: David M. Krinsky and Robert Edmund Pizzano, Jr. To: AWARE, INC.

The document was recorded in the United States Patent and Trademark Office at Reel 012216, Frame 0842, or for which a copy thereof is attached.

2. From: AWARE, INC. To: TQ DELTA, LLC

The document was recorded in the United States Patent and Trademark Office at Reel 029154, Frame 0937, or for which a copy thereof is attached.

[Page 1 of 2]

This collection of information is required by 37 CFR 3.73(b). The information is required to obtain or retain a benefit by the public which is to file (and by the USPTO to process) an application. Confidentiality is governed by 35 U.S.C. 122 and 37 CFR 1.11 and 1.14. This collection is estimated to take 12 minutes to complete, including gathering, preparing, and submitting the completed application form to the USPTO. Time will vary depending upon the individual case. Any comments on the amount of time you require to complete this form and/or suggestions for reducing this burden, should be sent to the Chief Information Officer, U.S. Patent and Trademark Office, U.S. Department of Commerce, P.O. Box 1450, Alexandria, VA 22313-1450. DO NOT SEND FEES OR COMPLETED FORMS TO THIS ADDRESS. **SEND TO: Commissioner for Patents, P.O. Box 1450, Alexandria, VA 22313-1450.**

If you need assistance in completing the form, call 1-800-PTO-9199 and select option 2.

Under the Paperwork Reduction Act of 1995, no persons are required to respond to a collection of information unless it displays a valid OMB control number.

STATEMENT UNDER 37 CFR 3.73(c)

3. From: _____ To: _____

The document was recorded in the United States Patent and Trademark Office at
Reel _____, Frame _____, or for which a copy thereof is attached.

4. From: _____ To: _____

The document was recorded in the United States Patent and Trademark Office at
Reel _____, Frame _____, or for which a copy thereof is attached.

5. From: _____ To: _____

The document was recorded in the United States Patent and Trademark Office at
Reel _____, Frame _____, or for which a copy thereof is attached.

6. From: _____ To: _____

The document was recorded in the United States Patent and Trademark Office at
Reel _____, Frame _____, or for which a copy thereof is attached.

Additional documents in the chain of title are listed on a supplemental sheet(s).

As required by 37 CFR 3.73(c)(1)(i), the documentary evidence of the chain of title from the original owner to the assignee was, or concurrently is being, submitted for recordation pursuant to 37 CFR 3.11.

[NOTE: A separate copy (i.e., a true copy of the original assignment document(s)) must be submitted to Assignment Division in accordance with 37 CFR Part 3, to record the assignment in the records of the USPTO. See MPEP 302.08]

The undersigned (whose title is supplied below) is authorized to act on behalf of the assignee.

Signature

Jason H. Vick
Jason H. Vick

Printed or Typed Name

Date

5 Nov 13
45,285

Title or Registration Number



UNITED STATES PATENT AND TRADEMARK OFFICE

UNITED STATES DEPARTMENT OF COMMERCE
United States Patent and Trademark Office
Address: COMMISSIONER FOR PATENTS
P. O. Box 1450
Alexandria, Virginia 22313-1450
www.uspto.gov

APPLICATION NO.	ISSUE DATE	PATENT NO.	ATTORNEY DOCKET NO.	CONFIRMATION NO.
12/779,660	08/07/2012	8238412	5550-2-CON2-1-1	8981

62574 7590 07/18/2012
Jason H. Vick
Sheridan Ross, PC
Suite # 1200
1560 Broadway
Denver, CO 80202

ISSUE NOTIFICATION

The projected patent number and issue date are specified above.

Determination of Patent Term Adjustment under 35 U.S.C. 154 (b)
(application filed on or after May 29, 2000)

The Patent Term Adjustment is 194 day(s). Any patent to issue from the above-identified application will include an indication of the adjustment on the front page.

If a Continued Prosecution Application (CPA) was filed in the above-identified application, the filing date that determines Patent Term Adjustment is the filing date of the most recent CPA.

Applicant will be able to obtain more detailed information by accessing the Patent Application Information Retrieval (PAIR) WEB site (<http://pair.uspto.gov>).

Any questions regarding the Patent Term Extension or Adjustment determination should be directed to the Office of Patent Legal Administration at (571)-272-7702. Questions relating to issue and publication fee payments should be directed to the Application Assistance Unit (AAU) of the Office of Data Management (ODM) at (571)-272-4200.

APPLICANT(s) (Please see PAIR WEB site <http://pair.uspto.gov> for additional applicants):

David M. Krinsky, Acton, MA;
Robert Edmund Pizzano JR., Stoneham, MA;

The United States represents the largest, most dynamic marketplace in the world and is an unparalleled location for business investment, innovation, and commercialization of new technologies. The USA offers tremendous resources and advantages for those who invest and manufacture goods here. Through SelectUSA, our nation works to encourage and facilitate business investment. To learn more about why the USA is the best country in the world to develop technology, manufacture products, and grow your business, visit SelectUSA.gov.

other known or later developed diagnostic or test information that may be appropriate for the particular communications environment. For example, the exchanged diagnostic and test information can be directed toward specific limitations of the modems, to information relating to the modem installation and deployment environment, or to other diagnostic and test information that can, for example, be determined as needed which may aid in evaluating the cause of a specific failure or problem. Alternatively, the diagnostic and test information can include the loop length and bridged tap length estimations as discussed in copending Attorney Docket No. 081513-000003, filed herewith and incorporated herein by reference in its entirety.

Change(s) applied
to document,
/S.J.W./
5/15/2012

For example, an exemplary embodiment of the invention illustrates the use of the diagnostic link mode in the communication of diagnostic information from the remote terminal (RT) transceiver, e.g., ATU-R, to the central office (CO) transceiver, e.g., ATU-C. Transmission of information from the remote terminal to the central office is important since a typical ADSL service provider is located in the central office and would therefore benefit from the ability to determine problems at the remote terminal without a truckroll. However, it is to be appreciated, that the systems and the methods of this invention will work equally well in communications from the central office to the remote terminal.

These and other features and advantages of this invention are described in or are apparent from the following detailed description of the embodiments.

BRIEF DESCRIPTION OF THE DRAWINGS

The embodiments of the invention will be described in detail, with reference to the following figures wherein:

Fig. 1 is a functional block diagram illustrating an exemplary communications system according to this invention; and

Fig. 2 is a flowchart outlining an exemplary method for communicating diagnostic and test information according to this invention.

DETAILED DESCRIPTION OF THE INVENTION

For ease of illustration the following description will be described in relation to the CO receiving diagnostic and test information from the RT. In the exemplary embodiment, the systems and methods of this invention complete a portion of the normal modem initialization before entering into the diagnostic link mode. The systems and methods of this invention can enter the diagnostic link mode manually, for example, at the direction of a



UNITED STATES PATENT AND TRADEMARK OFFICE

UNITED STATES DEPARTMENT OF COMMERCE
United States Patent and Trademark Office
Address: COMMISSIONER FOR PATENTS
P.O. Box 1450
Alexandria, Virginia 22313-1450
www.uspto.gov

Table with 5 columns: APPLICATION NO., FILING DATE, FIRST NAMED INVENTOR, ATTORNEY DOCKET NO., CONFIRMATION NO. Includes details for application 12/779,660 and associated examiner, art unit, and notification date.

Please find below and/or attached an Office communication concerning this application or proceeding.

The time period for reply, if any, is set in the attached communication.

Notice of the Office communication was sent electronically on above-indicated "Notification Date" to the following e-mail address(es):

jvick@sheridanross.com

Notice of Allowability	Application No.	Applicant(s)	
	12/779,660	KRINSKY ET AL.	
	Examiner	Art Unit	
	KHANH C. TRAN	2611	

-- The MAILING DATE of this communication appears on the cover sheet with the correspondence address--

All claims being allowable, PROSECUTION ON THE MERITS IS (OR REMAINS) CLOSED in this application. If not included herewith (or previously mailed), a Notice of Allowance (PTOL-85) or other appropriate communication will be mailed in due course. **THIS NOTICE OF ALLOWABILITY IS NOT A GRANT OF PATENT RIGHTS.** This application is subject to withdrawal from issue at the initiative of the Office or upon petition by the applicant. See 37 CFR 1.313 and MPEP 1308.

1. This communication is responsive to the IDS and Amendment After Notice of Allowance filed 5/8/2012.
2. An election was made by the applicant in response to a restriction requirement set forth during the interview on ____; the restriction requirement and election have been incorporated into this action.
3. The allowed claim(s) is/are ____.
4. Acknowledgment is made of a claim for foreign priority under 35 U.S.C. § 119(a)-(d) or (f).
 - a) All b) Some* c) None of the:
 1. Certified copies of the priority documents have been received.
 2. Certified copies of the priority documents have been received in Application No. ____ .
 3. Copies of the certified copies of the priority documents have been received in this national stage application from the International Bureau (PCT Rule 17.2(a)).

* Certified copies not received: ____.

Applicant has THREE MONTHS FROM THE "MAILING DATE" of this communication to file a reply complying with the requirements noted below. Failure to timely comply will result in ABANDONMENT of this application.

THIS THREE-MONTH PERIOD IS NOT EXTENDABLE.

5. A SUBSTITUTE OATH OR DECLARATION must be submitted. Note the attached EXAMINER'S AMENDMENT or NOTICE OF INFORMAL PATENT APPLICATION (PTO-152) which gives reason(s) why the oath or declaration is deficient.
 6. CORRECTED DRAWINGS (as "replacement sheets") must be submitted.
 - (a) including changes required by the Notice of Draftsperson's Patent Drawing Review (PTO-948) attached
 - 1) hereto or 2) to Paper No./Mail Date ____.
 - (b) including changes required by the attached Examiner's Amendment / Comment or in the Office action of Paper No./Mail Date ____.
- Identifying indicia such as the application number (see 37 CFR 1.84(c)) should be written on the drawings in the front (not the back) of each sheet. Replacement sheet(s) should be labeled as such in the header according to 37 CFR 1.121(d).**
7. DEPOSIT OF and/or INFORMATION about the deposit of BIOLOGICAL MATERIAL must be submitted. Note the attached Examiner's comment regarding REQUIREMENT FOR THE DEPOSIT OF BIOLOGICAL MATERIAL.

Attachment(s)

- | | |
|---|---|
| <ol style="list-style-type: none"> 1. <input type="checkbox"/> Notice of References Cited (PTO-892) 2. <input type="checkbox"/> Notice of Draftsperson's Patent Drawing Review (PTO-948) 3. <input checked="" type="checkbox"/> Information Disclosure Statements (PTO/SB/08),
Paper No./Mail Date ____ 4. <input type="checkbox"/> Examiner's Comment Regarding Requirement for Deposit of Biological Material | <ol style="list-style-type: none"> 5. <input type="checkbox"/> Notice of Informal Patent Application 6. <input type="checkbox"/> Interview Summary (PTO-413),
Paper No./Mail Date ____ . 7. <input type="checkbox"/> Examiner's Amendment/Comment 8. <input type="checkbox"/> Examiner's Statement of Reasons for Allowance 9. <input checked="" type="checkbox"/> Other <u>PTO-90C.</u> |
|---|---|

/KHANH C TRAN/
Primary Examiner, Art Unit 2611



**UNITED STATES DEPARTMENT OF COMMERCE
U.S. Patent and Trademark Office**

Address : COMMISSIONER FOR PATENTS
P.O. Box 1450
Alexandria, Virginia 22313-1450

APPLICATION NO./ CONTROL NO.	FILING DATE	FIRST NAMED INVENTOR / PATENT IN REEXAMINATION	ATTORNEY DOCKET NO.
12/779,660	13 May, 2010	KRINSKY ET AL.	5550-2-CON2-1-1

Jason H. Vick Sheridan Ross, PC Suite # 1200 1560 Broadway Denver, CO 80202	EXAMINER	
	KHANH C. TRAN	
	ART UNIT	PAPER
	2611	20120627

DATE MAILED:

Please find below and/or attached an Office communication concerning this application or proceeding.

Commissioner for Patents

The IDS and Amendment After Notice of Allowance have been reviewed and entered.

/KCT/

/KHANH C TRAN/
Primary Examiner, Art Unit 2611

PRINTER RUSH

(PTO ASSISTANCE)

Application: <u>12779660</u>	Examiner: <u>Tran</u>	GAU: <u>2611</u>
From: <u>Natarsha Horne</u>	Location: <u>RTFM</u>	Creation Date: <u>05/09/2012</u>

Tracking #: Week Date:

<u>DOC CODE</u>	<u>DOC DATE</u>	<u>MISCELLANEOUS</u>
<input type="checkbox"/> 1449		<input type="checkbox"/> Continuing Data
<input checked="" type="checkbox"/> IDS	<u>05/08/2012</u>	<input type="checkbox"/> Foreign Priority
<input type="checkbox"/> CLM		<input type="checkbox"/> Document Legibility
<input type="checkbox"/> IIFW/FWCLM		<input type="checkbox"/> Fees
<input type="checkbox"/> SRFW		<input type="checkbox"/> Petition (TC)
<input type="checkbox"/> DRW		<input type="checkbox"/> Other
<input type="checkbox"/> OATH		
<input checked="" type="checkbox"/> 312	<u>05/08/2012</u>	
<input type="checkbox"/> SPEC		

[RUSH] Message:

<p>Please respond to the 5/8/2012, IDS and A.NA</p> <p>Thank you NYH</p>
--

[XRUSH] Response:

<p>The IDS filed 5/8/2012 has been considered.</p> <p>Amendment After Notice of Allowance has been entered.</p> <p style="text-align: right;">Initials: <u>/KCT/</u></p>
--

Examiner: PUBS contacts - for DESIGNS: Don Fairchild, 703-756-1566; for ALL OTHER files: Bernadette Queen, 703-756-1565.
NOTE: This form will be included as part of the official USPTO record with the response document coded as XRUSH.
REV: Oct 11



UNITED STATES PATENT AND TRADEMARK OFFICE

UNITED STATES DEPARTMENT OF COMMERCE
United States Patent and Trademark Office
Address: COMMISSIONER FOR PATENTS
P.O. Box 1450
Alexandria, Virginia 22313-1450
www.uspto.gov

Table with columns: APPLICATION NO., FILING DATE, FIRST NAMED INVENTOR, ATTORNEY DOCKET NO., CONFIRMATION NO., EXAMINER, ART UNIT, PAPER NUMBER, NOTIFICATION DATE, DELIVERY MODE. Includes application details for David M. Krinsky and examiner information for TRAN, KHANH C.

Please find below and/or attached an Office communication concerning this application or proceeding.

The time period for reply, if any, is set in the attached communication.

Notice of the Office communication was sent electronically on above-indicated "Notification Date" to the following e-mail address(es):

jvick@sheridanross.com

Supplemental Notice of Allowability	Application No.	Applicant(s)	
	12/779,660	KRINSKY ET AL.	
	Examiner	Art Unit	
	KHANH C. TRAN	2611	

-- The MAILING DATE of this communication appears on the cover sheet with the correspondence address--

All claims being allowable, PROSECUTION ON THE MERITS IS (OR REMAINS) CLOSED in this application. If not included herewith (or previously mailed), a Notice of Allowance (PTOL-85) or other appropriate communication will be mailed in due course. **THIS NOTICE OF ALLOWABILITY IS NOT A GRANT OF PATENT RIGHTS.** This application is subject to withdrawal from issue at the initiative of the Office or upon petition by the applicant. See 37 CFR 1.313 and MPEP 1308.

1. This communication is responsive to the IDS filed 5/8/2012.
2. An election was made by the applicant in response to a restriction requirement set forth during the interview on ____; the restriction requirement and election have been incorporated into this action.
3. The allowed claim(s) is/are ____.
4. Acknowledgment is made of a claim for foreign priority under 35 U.S.C. § 119(a)-(d) or (f).
 - a) All b) Some* c) None of the:
 1. Certified copies of the priority documents have been received.
 2. Certified copies of the priority documents have been received in Application No. ____.
 3. Copies of the certified copies of the priority documents have been received in this national stage application from the International Bureau (PCT Rule 17.2(a)).

* Certified copies not received: ____.

Applicant has THREE MONTHS FROM THE "MAILING DATE" of this communication to file a reply complying with the requirements noted below. Failure to timely comply will result in ABANDONMENT of this application.
THIS THREE-MONTH PERIOD IS NOT EXTENDABLE.

5. A SUBSTITUTE OATH OR DECLARATION must be submitted. Note the attached EXAMINER'S AMENDMENT or NOTICE OF INFORMAL PATENT APPLICATION (PTO-152) which gives reason(s) why the oath or declaration is deficient.
 6. CORRECTED DRAWINGS (as "replacement sheets") must be submitted.
 - (a) including changes required by the Notice of Draftsperson's Patent Drawing Review (PTO-948) attached
 - 1) hereto or 2) to Paper No./Mail Date ____.
 - (b) including changes required by the attached Examiner's Amendment / Comment or in the Office action of Paper No./Mail Date ____.
- Identifying indicia such as the application number (see 37 CFR 1.84(c)) should be written on the drawings in the front (not the back) of each sheet. Replacement sheet(s) should be labeled as such in the header according to 37 CFR 1.121(d).**
7. DEPOSIT OF and/or INFORMATION about the deposit of BIOLOGICAL MATERIAL must be submitted. Note the attached Examiner's comment regarding REQUIREMENT FOR THE DEPOSIT OF BIOLOGICAL MATERIAL.

Attachment(s)

- | | |
|---|---|
| 1. <input type="checkbox"/> Notice of References Cited (PTO-892) | 5. <input type="checkbox"/> Notice of Informal Patent Application |
| 2. <input type="checkbox"/> Notice of Draftsperson's Patent Drawing Review (PTO-948) | 6. <input type="checkbox"/> Interview Summary (PTO-413),
Paper No./Mail Date ____. |
| 3. <input checked="" type="checkbox"/> Information Disclosure Statements (PTO/SB/08),
Paper No./Mail Date ____ | 7. <input type="checkbox"/> Examiner's Amendment/Comment |
| 4. <input type="checkbox"/> Examiner's Comment Regarding Requirement for Deposit
of Biological Material | 8. <input type="checkbox"/> Examiner's Statement of Reasons for Allowance |
| | 9. <input checked="" type="checkbox"/> Other <u>PTO-90C</u> . |

/KHANH C TRAN/
Primary Examiner, Art Unit 2611



**UNITED STATES DEPARTMENT OF COMMERCE
U.S. Patent and Trademark Office**

Address : COMMISSIONER FOR PATENTS
P.O. Box 1450
Alexandria, Virginia 22313-1450

APPLICATION NO./ CONTROL NO.	FILING DATE	FIRST NAMED INVENTOR / PATENT IN REEXAMINATION	ATTORNEY DOCKET NO.
12/779,660	13 May, 2010	KRINSKY ET AL.	5550-2-CON2-1-1

Jason H. Vick Sheridan Ross, PC Suite # 1200 1560 Broadway Denver, CO 80202		EXAMINER	
		KHANH C. TRAN	
		ART UNIT	PAPER
		2611	20120511

DATE MAILED:

Please find below and/or attached an Office communication concerning this application or proceeding.

Commissioner for Patents

This communication is responsive to the IDS filed 5/8/2012. The IDS has been considered.

/KCT/

/KHANH C TRAN/
Primary Examiner, Art Unit 2611

Substitute for form 1449A/PTO				Complete if Known	
INFORMATION DISCLOSURE STATEMENT BY APPLICANT				Application Number	12/779,660
				Filing Date	May 13, 2010
				First Named Inventor	David M. Krinsky
				Art Unit	2611
				Examiner Name	TRAN, Khanh C.
Sheet	1	of	1	Attorney Docket Number	5550-2-CON-2-1-1

U.S. PATENT DOCUMENTS					
Examiner Initials*	Cite No. ¹	Document Number Number-kind Code ^{2 (if known)}	Publication Date MM-DD-YYYY	Name of Patentee of Applicant of Cited Document	Pages, Columns, Lines, Where Relevant Passages or Relevant Figures Appear

FOREIGN PATENT DOCUMENTS						
Examiner Initials*	Cite No. ¹	Foreign Patent Document Country Code ³ ; Number ⁴ ; Kind Code ^{5 (if known)}	Publication Date MM-DD-YYYY	Name of Patentee or Applicant of Cited Document	Pages, Columns, Lines, Where Relevant Passages or Relevant Figures Appear	T ⁶

OTHER ART (Including Author, Title, Date, Pertinent Pages, etc.)		
Examiner Initials*	Cite No. ¹	
/KCT/	1	Notice of Allowance for Canadian Patent Application No. 2,726,826, dated March 1, 2012 (Attorney Ref. No.: 5550-2-PCA-DIV)

Examiner Signature	/Khanh Tran/ (05/11/2012)	Date Considered	05/11/2012
--------------------	---------------------------	-----------------	------------

*EXAMINER: Initial if reference is considered, whether or not citation is in conformance and not considered. Include copy of this form with next communication to applicant.

ALL REFERENCES CONSIDERED EXCEPT WHERE LINED THROUGH. /KCT/

Substitute for form 1449A/PTO				Complete if Known	
INFORMATION DISCLOSURE STATEMENT BY APPLICANT				Application Number	12/779,660
				Filing Date	May 13, 2010
				First Named Inventor	David M. Krinsky
				Art Unit	2611
				Examiner Name	TRAN, Khanh C.
Sheet	1	of	1	Attorney Docket Number	5550-2-CON-2-1-1

U.S. PATENT DOCUMENTS					
Examiner Initials*	Cite No. ¹	Document Number Number-kind Code ^{2 (if known)}	Publication Date MM-DD-YYYY	Name of Patentee of Applicant of Cited Document	Pages, Columns, Lines, Where Relevant Passages or Relevant Figures Appear

FOREIGN PATENT DOCUMENTS						
Examiner Initials*	Cite No. ¹	Foreign Patent Document Country Code ³ ; Number ⁴ ; Kind Code ^{5 (if known)}	Publication Date MM-DD-YYYY	Name of Patentee or Applicant of Cited Document	Pages, Columns, Lines, Where Relevant Passages or Relevant Figures Appear	T ⁶

OTHER ART (Including Author, Title, Date, Pertinent Pages, etc.)		
Examiner Initials*	Cite No. ¹	
	1	Notice of Allowance for Canadian Patent Application No. 2,726,826, dated March 1, 2012 (Attorney Ref. No.: 5550-2-PCA-DIV)

Examiner Signature		Date Considered	
--------------------	--	-----------------	--

*EXAMINER: Initial if reference is considered, whether or not citation is in conformance and not considered. Include copy of this form with next communication to applicant.

Electronic Patent Application Fee Transmittal

Application Number:	12779660			
Filing Date:	13-May-2010			
Title of Invention:	MULTICARRIER MODULATION MESSAGING FOR POWER LEVEL PER SUBCHANNEL INFORMATION			
First Named Inventor/Applicant Name:	David M. Krinsky			
Filer:	Jason Vick/Joanne Vos			
Attorney Docket Number:	5550-2-CON2-1-1			
Filed as Large Entity				
Utility under 35 USC 111(a) Filing Fees				
Description	Fee Code	Quantity	Amount	Sub-Total in USD(\$)
Basic Filing:				
Pages:				
Claims:				
Miscellaneous-Filing:				
Petition:				
Patent-Appeals-and-Interference:				
Post-Allowance-and-Post-Issuance:				
Extension-of-Time:				

Description	Fee Code	Quantity	Amount	Sub-Total in USD(\$)
Miscellaneous:				
Submission- Information Disclosure Stmt	1806	1	180	180
Total in USD (\$)				180

Electronic Acknowledgement Receipt

EFS ID:	12731863
Application Number:	12779660
International Application Number:	
Confirmation Number:	8981
Title of Invention:	MULTICARRIER MODULATION MESSAGING FOR POWER LEVEL PER SUBCHANNEL INFORMATION
First Named Inventor/Applicant Name:	David M. Krinsky
Customer Number:	62574
Filer:	Jason Vick/Joanne Vos
Filer Authorized By:	Jason Vick
Attorney Docket Number:	5550-2-CON2-1-1
Receipt Date:	08-MAY-2012
Filing Date:	13-MAY-2010
Time Stamp:	17:28:29
Application Type:	Utility under 35 USC 111(a)

Payment information:

Submitted with Payment	yes
Payment Type	Deposit Account
Payment was successfully received in RAM	\$ 180
RAM confirmation Number	4657
Deposit Account	191970
Authorized User	

The Director of the USPTO is hereby authorized to charge indicated fees and credit any overpayment as follows:

Charge any Additional Fees required under 37 C.F.R. Section 1.16 (National application filing, search, and examination fees)

Charge any Additional Fees required under 37 C.F.R. Section 1.17 (Patent application and reexamination processing fees)

Charge any Additional Fees required under 37 C.F.R. Section 1.19 (Document supply fees)

Charge any Additional Fees required under 37 C.F.R. Section 1.21 (Miscellaneous fees and charges)

File Listing:

Document Number	Document Description	File Name	File Size(Bytes)/ Message Digest	Multi Part /.zip	Pages (if appl.)
1		IDS_06.pdf	327594 7cfd26ca15ad51b1082abb5877c3c316f95763	yes	4

Multipart Description/PDF files in .zip description					
Document Description		Start	End		
Transmittal Letter		1	3		
Information Disclosure Statement (IDS) Form (SB08)		4	4		

Warnings:

Information:

2	Non Patent Literature	5550-2-PCA-DIV_NOA_03-01-2012.pdf	167830 76e1c56ff487e8e86d57cad5ea830330e4fea25e	no	1
---	-----------------------	-----------------------------------	--	----	---

Warnings:

Information:

3	Fee Worksheet (SB06)	fee-info.pdf	30650 bfc990f64a775443c85cd25052f65529c821455	no	2
---	----------------------	--------------	--	----	---

Warnings:

Information:

Total Files Size (in bytes):			526074		
-------------------------------------	--	--	--------	--	--

This Acknowledgement Receipt evidences receipt on the noted date by the USPTO of the indicated documents, characterized by the applicant, and including page counts, where applicable. It serves as evidence of receipt similar to a Post Card, as described in MPEP 503.

New Applications Under 35 U.S.C. 111

If a new application is being filed and the application includes the necessary components for a filing date (see 37 CFR 1.53(b)-(d) and MPEP 506), a Filing Receipt (37 CFR 1.54) will be issued in due course and the date shown on this Acknowledgement Receipt will establish the filing date of the application.

National Stage of an International Application under 35 U.S.C. 371

If a timely submission to enter the national stage of an international application is compliant with the conditions of 35 U.S.C. 371 and other applicable requirements a Form PCT/DO/EO/903 indicating acceptance of the application as a national stage submission under 35 U.S.C. 371 will be issued in addition to the Filing Receipt, in due course.

New International Application Filed with the USPTO as a Receiving Office

If a new international application is being filed and the international application includes the necessary components for an international filing date (see PCT Article 11 and MPEP 1810), a Notification of the International Application Number and of the International Filing Date (Form PCT/RO/105) will be issued in due course, subject to prescriptions concerning national security, and the date shown on this Acknowledgement Receipt will establish the international filing date of the application.

IN THE UNITED STATES PATENT AND TRADEMARK OFFICE

In Re the Application of:)	Group Art Unit: 2611
KRINSKY et al.)	Confirmation No.: 8981
Serial No.: 12/779,660)	Examiner: TRAN, Khanh C.
Filed: May 13, 2010)	
Atty. File No.: 5550-2-CON-2-1-1)	
Entitled: "Multicarrier Modulation Messaging for Power Level Per Subchannel Information")	<u>SUPPLEMENTAL</u> <u>INFORMATION DISCLOSURE</u> <u>STATEMENT</u>
)	Electronically Submitted

Commissioner for Patents
P.O. Box 1450
Alexandria, VA 22313-1450

Dear Sir:

The references cited on attached Form PTO-1449 are being called to the attention of the Examiner.

- Copies of the cited non-patent and/or foreign references are enclosed herewith.
- Copies of the cited U.S. patents and/or patent applications are enclosed herewith.
- Copies of the cited U.S. patents/patent application publications are not enclosed in accordance with 37 C.F.R. § 1.98(a).
- Copies of the cited references are not enclosed, in accordance with 37 C.F.R. § 1.98(d), because the references were cited by or submitted to the U.S. Patent and Trademark Office in prior application Serial No. _____ filed _____, which is relied upon for an earlier filing date under 35 U.S.C. § 120.
- To the best of applicants' belief, the pertinence of the foreign-language references are believed to be summarized in the attached English abstracts and/or in the figures, although applicants do not necessarily vouch for the accuracy of the translation.
- Examiner's attention is drawn to the following related applications:
 - Serial No. _____ filed _____ (Attorney Ref. No. _____)
 - Serial No. _____ filed _____ (Attorney Ref. No. _____)
- Other: _____

Submission of the above information is not intended as an admission that any item is citable under the statutes or rules to support a rejection, that any item disclosed represents analogous art, or that those skilled in the art would refer to or recognize the pertinence of any reference without the benefit of hindsight, nor should an inference be

drawn as to the pertinence of the references based on the order in which they are presented. Submission of this statement should not be taken as an indication that a search has been conducted, or that no better art exists.

It is respectfully requested that the cited information be expressly considered during the prosecution of this application and the references made of record therein.

FEES

<input type="checkbox"/>	<p>37 CFR 1.97(b): No fee is believed due in connection with this submission, because the information disclosure statement submitted herewith is satisfied by one of the following conditions ("X" indicates satisfaction):</p> <p><input type="checkbox"/> Within three months of the filing date of a national application other than a continued prosecution application under 37 CFR 1.53(d), or</p> <p><input type="checkbox"/> Within three months of the date of entry of the national stage as set forth in § 1.491 in an international application, or</p> <p><input type="checkbox"/> Before the mailing date of a first Office Action on the merits, or</p> <p><input type="checkbox"/> Before the mailing of a first Office action after the filing of a request for continued examination under 37 CFR 1.114.</p> <p>Although no fee is believed due, if any fee is deemed due in connection with this submission, please charge such fee to Deposit Account 19-1970.</p>
<input type="checkbox"/>	<p>37 CFR 1.97(c): The information disclosure statement transmitted herewith is being filed after all the above conditions (37 CFR 1.97(b)), but before the mailing date of any one of the following conditions:</p> <p>(1) a final action under 37 C.F.R. 1.113, or</p> <p>(2) a notice of allowance under 37 C.F.R. 1.311, or</p> <p>(3) an action that otherwise closes prosecution in the application.</p> <p>This Information Disclosure Statement is accompanied by:</p> <p><input type="checkbox"/> A Certification (below) as specified by 37 C.F.R. 1.97(e). Although no fee is believed due, if any fee is deemed due in connection with this submission, please charge such fee to Deposit Account 19-1970.</p> <p style="text-align: center;">OR</p> <p><input type="checkbox"/> Please charge Deposit Account 19-1970 in the amount of \$180.00 for the fee set forth in 37 C.F.R. 1.17(p) for submission of an information disclosure statement. Please credit any overpayment or charge any underpayment to Deposit Account 19-1970.</p>
<input checked="" type="checkbox"/>	<p>37 CFR 1.97(d): This Information Disclosure Statement is being submitted after the period specified in 37 CFR 1.97(c).</p> <p><input checked="" type="checkbox"/> This information Disclosure Statement includes a Certification (below) as specified by 37 C.F.R. 1.97(e)</p> <p style="text-align: center;">AND</p> <p><input checked="" type="checkbox"/> Applicants hereby requests consideration of the reference(s) disclosed herein. Please charge Deposit Account 19-1970 in the amount of \$180.00 under 37 C.F.R. 1.17(p). Please credit any overpayment or charge any underpayment to Deposit Account 19-1970. Election to pay the fee should not be taken as an indication that applicant(s) cannot execute a certification.</p>

Certification (37 C.F.R. 1.97(e))
(Applicable only if checked)

- The undersigned certifies that:
- Each item of information contained in this information disclosure statement was first cited in any communication from a foreign patent office in a counterpart foreign application not more than three months prior to the filing of this statement. 37 C.F.R. 1.97(e)(1).
 - A copy of the communication from the foreign patent office is enclosed.

OR

- No item of information contained in this information disclosure statement was cited in a communication from a foreign patent office in a counterpart foreign application, and, to the knowledge of the undersigned after making reasonable inquiry, no item of information contained in this Information Disclosure Statement was known to any individual designated in 37 C.F.R. 1.56(c) more than three months prior to the filing of this statement. 37 C.F.R. 1.97(e)(2).

Respectfully submitted,

SHERIDAN ROSS P.C.

By: _____

Jason H. Vick
Registration No. 45,285
1560 Broadway, Suite 1200
Denver, Colorado 80202-5141
(303) 863-9700

Date: 8 May/12

PART B - FEE(S) TRANSMITTAL

**Complete and send this form, together with applicable fee(s), to: Mail Mail Stop ISSUE FEE
 Commissioner for Patents
 P.O. Box 1450
 Alexandria, Virginia 22313-1450
 or Fax (571)-273-2885**

INSTRUCTIONS: This form should be used for transmitting the ISSUE FEE and PUBLICATION FEE (if required). Blocks 1 through 5 should be completed where appropriate. All further correspondence including the Patent, advance orders and notification of maintenance fees will be mailed to the current correspondence address as indicated unless corrected below or directed otherwise in Block 1, by (a) specifying a new correspondence address; and/or (b) indicating a separate "FEE ADDRESS" for maintenance fee notifications.

CURRENT CORRESPONDENCE ADDRESS (Note: Use Block 1 for any change of address)

62574 7590 04/26/2012
Jason H. Vick
 Sheridan Ross, PC
 Suite # 1200
 1560 Broadway
 Denver, CO 80202

Note: A certificate of mailing can only be used for domestic mailings of the Fee(s) Transmittal. This certificate cannot be used for any other accompanying papers. Each additional paper, such as an assignment or formal drawing, must have its own certificate of mailing or transmission.

Certificate of Mailing or Transmission

I hereby certify that this Fee(s) Transmittal is being deposited with the United States Postal Service with sufficient postage for first class mail in an envelope addressed to the Mail Stop ISSUE FEE address above, or being facsimile transmitted to the USPTO (571) 273-2885, on the date indicated below.

_____ (Depositor's name)
_____ (Signature)
_____ (Date)

APPLICATION NO.	FILING DATE	FIRST NAMED INVENTOR	ATTORNEY DOCKET NO.	CONFIRMATION NO.
-----------------	-------------	----------------------	---------------------	------------------

12/779,660	05/13/2010	David M. Krinsky	5550-2-CON2-1-1	8981
------------	------------	------------------	-----------------	------

TITLE OF INVENTION: MULTICARRIER MODULATION MESSAGING FOR POWER LEVEL PER SUBCHANNEL INFORMATION

APPLN. TYPE	SMALL ENTITY	ISSUE FEE DUE	PUBLICATION FEE DUE	PREV. PAID ISSUE FEE	TOTAL FEE(S) DUE	DATE DUE
nonprovisional	NO	\$1740	\$300	\$0	\$2040	07/26/2012

EXAMINER	ART UNIT	CLASS-SUBCLASS
TRAN, KHANH C	2611	375-219000

1. Change of correspondence address or indication of "Fee Address" (37 CFR 1.363).
 Change of correspondence address (or Change of Correspondence Address form PTO/SB/122) attached.
 "Fee Address" indication (or "Fee Address" Indication form PTO/SB/47; Rev 03-02 or more recent) attached. **Use of a Customer Number is required.**

2. For printing on the patent front page, list
 (1) the names of up to 3 registered patent attorneys or agents OR, alternatively,
 (2) the name of a single firm (having as a member a registered attorney or agent) and the names of up to 2 registered patent attorneys or agents. If no name is listed, no name will be printed.
 1 Jason H. Vick
 2 Sheridan Ross, PC
 3 _____

3. ASSIGNEE NAME AND RESIDENCE DATA TO BE PRINTED ON THE PATENT (print or type)

PLEASE NOTE: Unless an assignee is identified below, no assignee data will appear on the patent. If an assignee is identified below, the document has been filed for recordation as set forth in 37 CFR 3.11. Completion of this form is NOT a substitute for filing an assignment.

(A) NAME OF ASSIGNEE: **AWARE, INC.**
 (B) RESIDENCE: (CITY and STATE OR COUNTRY) **Bedford, MA**

Please check the appropriate assignee category or categories (will not be printed on the patent): Individual Corporation or other private group entity Government

4a. The following fee(s) are submitted:

Issue Fee
 Publication Fee (No small entity discount permitted)
 Advance Order - # of Copies _____

4b. Payment of Fee(s): (Please first reapply any previously paid issue fee shown above)

A check is enclosed.
 Payment by credit card. Form PTO-2038 is attached.
 The Director is hereby authorized to charge the required fee(s), any deficiency, or credit any overpayment, to Deposit Account Number 19-1970 (enclose an extra copy of this form).

5. Change in Entity Status (from status indicated above)

a. Applicant claims SMALL ENTITY status. See 37 CFR 1.27. b. Applicant is no longer claiming SMALL ENTITY status. See 37 CFR 1.27(g)(2).

NOTE: The Issue Fee and Publication Fee (if required) will not be accepted from anyone other than the applicant; a registered attorney or agent; or the assignee or other party in interest as shown by the records of the United States Patent and Trademark Office.

Authorized Signature _____ Date 8 Mar '12
 Typed or printed name Jason H. Vick Registration No. 45,285

This collection of information is required by 37 CFR 1.311. The information is required to obtain or retain a benefit by the public which is to file (and by the USPTO to process) an application. Confidentiality is governed by 35 U.S.C. 122 and 37 CFR 1.14. This collection is estimated to take 12 minutes to complete, including gathering, preparing, and submitting the completed application form to the USPTO. Time will vary depending upon the individual case. Any comments on the amount of time you require to complete this form and/or suggestions for reducing this burden, should be sent to the Chief Information Officer, U.S. Patent and Trademark Office, U.S. Department of Commerce, P.O. Box 1450, Alexandria, Virginia 22313-1450. **DO NOT SEND FEES OR COMPLETED FORMS TO THIS ADDRESS. SEND TO: Commissioner for Patents, P.O. Box 1450, Alexandria, Virginia 22313-1450.**

Under the Paperwork Reduction Act of 1995, no persons are required to respond to a collection of information unless it displays a valid OMB control number.

IN THE UNITED STATES PATENT AND TRADEMARK OFFICE

In Re the Application of: David M. Krinsky)
) Group Art Unit: 2611
Application No.: 12/779,660)
) Examiner: TRAN, Khanh C.
Filed: May 13, 2010)
) Confirmation No.: 8981
Atty. File No.: 5550-2-CON-2-1-1)
)

For: MULTICARRIER MODULATION MESSAGING FOR POWER LEVEL PER
SUBCHANNEL INFORMATION

AMENDMENT AFTER ALLOWANCE UNDER
37 C.F.R. 1.312

Commissioner for Patents
P.O. Box 1450
Alexandria, VA 22313-1450

Madam:

Applicants submit this Amendment After Allowance pursuant to 37 C.F.R. 1.312 in response to the Notice of Allowance having a mailing date of April 26, 2012. While Applicants believe that no fees are due with the filing of this response, the undersigned hereby authorizes the charge of any fees deemed necessary to Deposit Account No. 19-1970.

An amendment may be entered after the mailing of a Notice of Allowance but prior to payment of the issue fee upon recommendation of the primary Examiner. Therefore, it is respectfully requested that the above-referenced application be amended as follows:

Amendments to the Specification begin on page 2 of this paper.

Remarks begin on page 3 of this paper.

AMENDMENTS TO THE SPECIFICATION

Please amend the specification as follows:

Please replace lines 6-9 on page 3 of the originally filed application with the following:

the cause of a specific failure or problem. Alternatively, the diagnostic and test information can include the loop length and bridged tap length estimations as discussed in U.S. Patent Application Ser. No. 09/755,172, now U.S. Patent No. 6,865,221 ~~depending Attorney Docket No. 081513-000003~~, filed herewith and incorporated herein by reference in its entirety.

REMARKS

The amendment to the specification displayed herein replaces the Attorney docket number with the application number and issued patent number. No new matter is believed to be introduced by this amendment.

The Commissioner is hereby authorized to charge to deposit account number 19-1970 any fees under 37 CFR § 1.16 and 1.17 that may be required by this paper and to credit any overpayment to that Account. If any extension of time is required in connection with the filing of this paper and has not been separately requested, such extension is hereby petitioned.

Respectfully submitted,

SHERIDAN ROSS P.C.

Date: 8 May 72

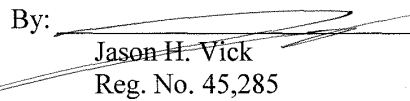
By: 
Jason H. Vick
Reg. No. 45,285
1560 Broadway, Suite 1200
Denver, Colorado 80202
Telephone: 303-863-9700

Electronic Patent Application Fee Transmittal

Application Number:	12779660			
Filing Date:	13-May-2010			
Title of Invention:	MULTICARRIER MODULATION MESSAGING FOR POWER LEVEL PER SUBCHANNEL INFORMATION			
First Named Inventor/Applicant Name:	David M. Krinsky			
Filer:	Jason Vick/Joanne Vos			
Attorney Docket Number:	5550-2-CON2-1-1			
Filed as Large Entity				
Utility under 35 USC 111(a) Filing Fees				
Description	Fee Code	Quantity	Amount	Sub-Total in USD(\$)
Basic Filing:				
Pages:				
Claims:				
Miscellaneous-Filing:				
Petition:				
Patent-Appeals-and-Interference:				
Post-Allowance-and-Post-Issuance:				
Utility Appl issue fee	1501	1	1740	1740
Publ. Fee- early, voluntary, or normal	1504	1	300	300

Description	Fee Code	Quantity	Amount	Sub-Total in USD(\$)
Extension-of-Time:				
Miscellaneous:				
Total in USD (\$)				2040

Electronic Acknowledgement Receipt

EFS ID:	12732484
Application Number:	12779660
International Application Number:	
Confirmation Number:	8981
Title of Invention:	MULTICARRIER MODULATION MESSAGING FOR POWER LEVEL PER SUBCHANNEL INFORMATION
First Named Inventor/Applicant Name:	David M. Krinsky
Customer Number:	62574
Filer:	Jason Vick/Joanne Vos
Filer Authorized By:	Jason Vick
Attorney Docket Number:	5550-2-CON2-1-1
Receipt Date:	08-MAY-2012
Filing Date:	13-MAY-2010
Time Stamp:	18:21:17
Application Type:	Utility under 35 USC 111(a)

Payment information:

Submitted with Payment	yes
Payment Type	Deposit Account
Payment was successfully received in RAM	\$2040
RAM confirmation Number	6297
Deposit Account	191970
Authorized User	

The Director of the USPTO is hereby authorized to charge indicated fees and credit any overpayment as follows:

Charge any Additional Fees required under 37 C.F.R. Section 1.16 (National application filing, search, and examination fees)

Charge any Additional Fees required under 37 C.F.R. Section 1.17 (Patent application and reexamination processing fees)

Charge any Additional Fees required under 37 C.F.R. Section 1.19 (Document supply fees)
 Charge any Additional Fees required under 37 C.F.R. Section 1.20 (Post Issuance fees)
 Charge any Additional Fees required under 37 C.F.R. Section 1.21 (Miscellaneous fees and charges)

File Listing:

Document Number	Document Description	File Name	File Size(Bytes)/ Message Digest	Multi Part /.zip	Pages (if appl.)
1	Issue Fee Payment (PTO-85B)	Issue_Fee_Payment.pdf	157632 027ae45735e5f652c8f42e00a4bf8ab7a5907f62	no	1
Warnings:					
Information:					
2		Amendment_312.pdf	161719 86ca0e72cd810b6682b44755b687b495fddcc851	yes	3
	Multipart Description/PDF files in .zip description				
	Document Description		Start	End	
	Amendment after Notice of Allowance (Rule 312)		1	1	
	Specification		2	2	
Applicant Arguments/Remarks Made in an Amendment		3	3		
Warnings:					
Information:					
3	Fee Worksheet (SB06)	fee-info.pdf	32172 7edc74214d6e10674f37d567363ca671b3ed0d4	no	2
Warnings:					
Information:					
Total Files Size (in bytes):			351523		

This Acknowledgement Receipt evidences receipt on the noted date by the USPTO of the indicated documents, characterized by the applicant, and including page counts, where applicable. It serves as evidence of receipt similar to a Post Card, as described in MPEP 503.

New Applications Under 35 U.S.C. 111

If a new application is being filed and the application includes the necessary components for a filing date (see 37 CFR 1.53(b)-(d) and MPEP 506), a Filing Receipt (37 CFR 1.54) will be issued in due course and the date shown on this Acknowledgement Receipt will establish the filing date of the application.

National Stage of an International Application under 35 U.S.C. 371

If a timely submission to enter the national stage of an international application is compliant with the conditions of 35 U.S.C. 371 and other applicable requirements a Form PCT/DO/EO/903 indicating acceptance of the application as a national stage submission under 35 U.S.C. 371 will be issued in addition to the Filing Receipt, in due course.

New International Application Filed with the USPTO as a Receiving Office

If a new international application is being filed and the international application includes the necessary components for an international filing date (see PCT Article 11 and MPEP 1810), a Notification of the International Application Number and of the International Filing Date (Form PCT/RO/105) will be issued in due course, subject to prescriptions concerning national security, and the date shown on this Acknowledgement Receipt will establish the international filing date of the application.



UNITED STATES PATENT AND TRADEMARK OFFICE

UNITED STATES DEPARTMENT OF COMMERCE
United States Patent and Trademark Office
Address: COMMISSIONER FOR PATENTS
P.O. Box 1450
Alexandria, Virginia 22313-1450
www.uspto.gov

NOTICE OF ALLOWANCE AND FEE(S) DUE

62574 7590 04/26/2012
Jason H. Vick
Sheridan Ross, PC
Suite # 1200
1560 Broadway
Denver, CO 80202

EXAMINER
TRAN, KHANH C

ART UNIT PAPER NUMBER
2611

DATE MAILED: 04/26/2012

Table with 5 columns: APPLICATION NO., FILING DATE, FIRST NAMED INVENTOR, ATTORNEY DOCKET NO., CONFIRMATION NO.
12/779,660 05/13/2010 David M. Krinsky 5550-2-CON2-1-1 8981

TITLE OF INVENTION: MULTICARRIER MODULATION MESSAGING FOR POWER LEVEL PER SUBCHANNEL INFORMATION

Table with 7 columns: APPLN. TYPE, SMALL ENTITY, ISSUE FEE DUE, PUBLICATION FEE DUE, PREV. PAID ISSUE FEE, TOTAL FEE(S) DUE, DATE DUE
nonprovisional NO \$1740 \$300 \$0 \$2040 07/26/2012

THE APPLICATION IDENTIFIED ABOVE HAS BEEN EXAMINED AND IS ALLOWED FOR ISSUANCE AS A PATENT. PROSECUTION ON THE MERITS IS CLOSED. THIS NOTICE OF ALLOWANCE IS NOT A GRANT OF PATENT RIGHTS. THIS APPLICATION IS SUBJECT TO WITHDRAWAL FROM ISSUE AT THE INITIATIVE OF THE OFFICE OR UPON PETITION BY THE APPLICANT. SEE 37 CFR 1.313 AND MPEP 1308.

THE ISSUE FEE AND PUBLICATION FEE (IF REQUIRED) MUST BE PAID WITHIN THREE MONTHS FROM THE MAILING DATE OF THIS NOTICE OR THIS APPLICATION SHALL BE REGARDED AS ABANDONED. THIS STATUTORY PERIOD CANNOT BE EXTENDED. SEE 35 U.S.C. 151. THE ISSUE FEE DUE INDICATED ABOVE DOES NOT REFLECT A CREDIT FOR ANY PREVIOUSLY PAID ISSUE FEE IN THIS APPLICATION. IF AN ISSUE FEE HAS PREVIOUSLY BEEN PAID IN THIS APPLICATION (AS SHOWN ABOVE), THE RETURN OF PART B OF THIS FORM WILL BE CONSIDERED A REQUEST TO REAPPLY THE PREVIOUSLY PAID ISSUE FEE TOWARD THE ISSUE FEE NOW DUE.

HOW TO REPLY TO THIS NOTICE:

I. Review the SMALL ENTITY status shown above.

If the SMALL ENTITY is shown as YES, verify your current SMALL ENTITY status:

- A. If the status is the same, pay the TOTAL FEE(S) DUE shown above.
B. If the status above is to be removed, check box 5b on Part B - Fee(s) Transmittal and pay the PUBLICATION FEE (if required) and twice the amount of the ISSUE FEE shown above, or

If the SMALL ENTITY is shown as NO:

- A. Pay TOTAL FEE(S) DUE shown above, or
B. If applicant claimed SMALL ENTITY status before, or is now claiming SMALL ENTITY status, check box 5a on Part B - Fee(s) Transmittal and pay the PUBLICATION FEE (if required) and 1/2 the ISSUE FEE shown above.

II. PART B - FEE(S) TRANSMITTAL, or its equivalent, must be completed and returned to the United States Patent and Trademark Office (USPTO) with your ISSUE FEE and PUBLICATION FEE (if required). If you are charging the fee(s) to your deposit account, section "4b" of Part B - Fee(s) Transmittal should be completed and an extra copy of the form should be submitted. If an equivalent of Part B is filed, a request to reapply a previously paid issue fee must be clearly made, and delays in processing may occur due to the difficulty in recognizing the paper as an equivalent of Part B.

III. All communications regarding this application must give the application number. Please direct all communications prior to issuance to Mail Stop ISSUE FEE unless advised to the contrary.

IMPORTANT REMINDER: Utility patents issuing on applications filed on or after Dec. 12, 1980 may require payment of maintenance fees. It is patentee's responsibility to ensure timely payment of maintenance fees when due.

PART B - FEE(S) TRANSMITTAL

Complete and send this form, together with applicable fee(s), to: **Mail Stop ISSUE FEE
Commissioner for Patents
P.O. Box 1450
Alexandria, Virginia 22313-1450**
or **Fax (571)-273-2885**

INSTRUCTIONS: This form should be used for transmitting the ISSUE FEE and PUBLICATION FEE (if required). Blocks 1 through 5 should be completed where appropriate. All further correspondence including the Patent, advance orders and notification of maintenance fees will be mailed to the current correspondence address as indicated unless corrected below or directed otherwise in Block 1, by (a) specifying a new correspondence address; and/or (b) indicating a separate "FEE ADDRESS" for maintenance fee notifications.

CURRENT CORRESPONDENCE ADDRESS (Note: Use Block 1 for any change of address)

Note: A certificate of mailing can only be used for domestic mailings of the Fee(s) Transmittal. This certificate cannot be used for any other accompanying papers. Each additional paper, such as an assignment or formal drawing, must have its own certificate of mailing or transmission.

62574 7590 04/26/2012
Jason H. Vick
Sheridan Ross, PC
Suite # 1200
1560 Broadway
Denver, CO 80202

Certificate of Mailing or Transmission

I hereby certify that this Fee(s) Transmittal is being deposited with the United States Postal Service with sufficient postage for first class mail in an envelope addressed to the Mail Stop ISSUE FEE address above, or being facsimile transmitted to the USPTO (571) 273-2885, on the date indicated below.

	(Depositor's name)
	(Signature)
	(Date)

APPLICATION NO.	FILING DATE	FIRST NAMED INVENTOR	ATTORNEY DOCKET NO.	CONFIRMATION NO.
12/779,660	05/13/2010	David M. Krinsky	5550-2-CON2-1-1	8981

TITLE OF INVENTION: MULTICARRIER MODULATION MESSAGING FOR POWER LEVEL PER SUBCHANNEL INFORMATION

APPLN. TYPE	SMALL ENTITY	ISSUE FEE DUE	PUBLICATION FEE DUE	PREV. PAID ISSUE FEE	TOTAL FEE(S) DUE	DATE DUE
nonprovisional	NO	\$1740	\$300	\$0	\$2040	07/26/2012

EXAMINER	ART UNIT	CLASS-SUBCLASS
TRAN, KHANH C	2611	375-219000

<p>1. Change of correspondence address or indication of "Fee Address" (37 CFR 1.363).</p> <p><input type="checkbox"/> Change of correspondence address (or Change of Correspondence Address form PTO/SB/122) attached.</p> <p><input type="checkbox"/> "Fee Address" indication (or "Fee Address" Indication form PTO/SB/47; Rev 03-02 or more recent) attached. Use of a Customer Number is required.</p>	<p>2. For printing on the patent front page, list</p> <p>(1) the names of up to 3 registered patent attorneys or agents OR, alternatively, 1 _____</p> <p>(2) the name of a single firm (having as a member a registered attorney or agent) and the names of up to 2 registered patent attorneys or agents. If no name is listed, no name will be printed. 2 _____</p> <p>3 _____</p>
---	---

3. ASSIGNEE NAME AND RESIDENCE DATA TO BE PRINTED ON THE PATENT (print or type)

PLEASE NOTE: Unless an assignee is identified below, no assignee data will appear on the patent. If an assignee is identified below, the document has been filed for recordation as set forth in 37 CFR 3.11. Completion of this form is NOT a substitute for filing an assignment.

(A) NAME OF ASSIGNEE _____ (B) RESIDENCE: (CITY and STATE OR COUNTRY) _____

Please check the appropriate assignee category or categories (will not be printed on the patent) : Individual Corporation or other private group entity Government

<p>4a. The following fee(s) are submitted:</p> <p><input type="checkbox"/> Issue Fee</p> <p><input type="checkbox"/> Publication Fee (No small entity discount permitted)</p> <p><input type="checkbox"/> Advance Order - # of Copies _____</p>	<p>4b. Payment of Fee(s): (Please first reapply any previously paid issue fee shown above)</p> <p><input type="checkbox"/> A check is enclosed.</p> <p><input type="checkbox"/> Payment by credit card. Form PTO-2038 is attached.</p> <p><input type="checkbox"/> The Director is hereby authorized to charge the required fee(s), any deficiency, or credit any overpayment, to Deposit Account Number _____ (enclose an extra copy of this form).</p>
---	--

5. Change in Entity Status (from status indicated above)

a. Applicant claims SMALL ENTITY status. See 37 CFR 1.27. b. Applicant is no longer claiming SMALL ENTITY status. See 37 CFR 1.27(g)(2).

NOTE: The Issue Fee and Publication Fee (if required) will not be accepted from anyone other than the applicant; a registered attorney or agent; or the assignee or other party in interest as shown by the records of the United States Patent and Trademark Office.

Authorized Signature _____ Date _____

Typed or printed name _____ Registration No. _____

This collection of information is required by 37 CFR 1.311. The information is required to obtain or retain a benefit by the public which is to file (and by the USPTO to process) an application. Confidentiality is governed by 35 U.S.C. 122 and 37 CFR 1.14. This collection is estimated to take 12 minutes to complete, including gathering, preparing, and submitting the completed application form to the USPTO. Time will vary depending upon the individual case. Any comments on the amount of time you require to complete this form and/or suggestions for reducing this burden, should be sent to the Chief Information Officer, U.S. Patent and Trademark Office, U.S. Department of Commerce, P.O. Box 1450, Alexandria, Virginia 22313-1450. DO NOT SEND FEES OR COMPLETED FORMS TO THIS ADDRESS. SEND TO: Commissioner for Patents, P.O. Box 1450, Alexandria, Virginia 22313-1450.

Under the Paperwork Reduction Act of 1995, no persons are required to respond to a collection of information unless it displays a valid OMB control number.



UNITED STATES PATENT AND TRADEMARK OFFICE

UNITED STATES DEPARTMENT OF COMMERCE
United States Patent and Trademark Office
Address: COMMISSIONER FOR PATENTS
P.O. Box 1450
Alexandria, Virginia 22313-1450
www.uspto.gov

Table with 5 columns: APPLICATION NO., FILING DATE, FIRST NAMED INVENTOR, ATTORNEY DOCKET NO., CONFIRMATION NO. Includes details for application 12/779,660 filed 05/13/2010 by David M. Krinsky.

Determination of Patent Term Adjustment under 35 U.S.C. 154 (b)

(application filed on or after May 29, 2000)

The Patent Term Adjustment to date is 250 day(s). If the issue fee is paid on the date that is three months after the mailing date of this notice and the patent issues on the Tuesday before the date that is 28 weeks (six and a half months) after the mailing date of this notice, the Patent Term Adjustment will be 250 day(s).

If a Continued Prosecution Application (CPA) was filed in the above-identified application, the filing date that determines Patent Term Adjustment is the filing date of the most recent CPA.

Applicant will be able to obtain more detailed information by accessing the Patent Application Information Retrieval (PAIR) WEB site (http://pair.uspto.gov).

Any questions regarding the Patent Term Extension or Adjustment determination should be directed to the Office of Patent Legal Administration at (571)-272-7702. Questions relating to issue and publication fee payments should be directed to the Customer Service Center of the Office of Patent Publication at 1-(888)-786-0101 or (571)-272-4200.

Privacy Act Statement

The Privacy Act of 1974 (P.L. 93-579) requires that you be given certain information in connection with your submission of the attached form related to a patent application or patent. Accordingly, pursuant to the requirements of the Act, please be advised that: (1) the general authority for the collection of this information is 35 U.S.C. 2(b)(2); (2) furnishing of the information solicited is voluntary; and (3) the principal purpose for which the information is used by the U.S. Patent and Trademark Office is to process and/or examine your submission related to a patent application or patent. If you do not furnish the requested information, the U.S. Patent and Trademark Office may not be able to process and/or examine your submission, which may result in termination of proceedings or abandonment of the application or expiration of the patent.

The information provided by you in this form will be subject to the following routine uses:

1. The information on this form will be treated confidentially to the extent allowed under the Freedom of Information Act (5 U.S.C. 552) and the Privacy Act (5 U.S.C. 552a). Records from this system of records may be disclosed to the Department of Justice to determine whether disclosure of these records is required by the Freedom of Information Act.
2. A record from this system of records may be disclosed, as a routine use, in the course of presenting evidence to a court, magistrate, or administrative tribunal, including disclosures to opposing counsel in the course of settlement negotiations.
3. A record in this system of records may be disclosed, as a routine use, to a Member of Congress submitting a request involving an individual, to whom the record pertains, when the individual has requested assistance from the Member with respect to the subject matter of the record.
4. A record in this system of records may be disclosed, as a routine use, to a contractor of the Agency having need for the information in order to perform a contract. Recipients of information shall be required to comply with the requirements of the Privacy Act of 1974, as amended, pursuant to 5 U.S.C. 552a(m).
5. A record related to an International Application filed under the Patent Cooperation Treaty in this system of records may be disclosed, as a routine use, to the International Bureau of the World Intellectual Property Organization, pursuant to the Patent Cooperation Treaty.
6. A record in this system of records may be disclosed, as a routine use, to another federal agency for purposes of National Security review (35 U.S.C. 181) and for review pursuant to the Atomic Energy Act (42 U.S.C. 218(c)).
7. A record from this system of records may be disclosed, as a routine use, to the Administrator, General Services, or his/her designee, during an inspection of records conducted by GSA as part of that agency's responsibility to recommend improvements in records management practices and programs, under authority of 44 U.S.C. 2904 and 2906. Such disclosure shall be made in accordance with the GSA regulations governing inspection of records for this purpose, and any other relevant (i.e., GSA or Commerce) directive. Such disclosure shall not be used to make determinations about individuals.
8. A record from this system of records may be disclosed, as a routine use, to the public after either publication of the application pursuant to 35 U.S.C. 122(b) or issuance of a patent pursuant to 35 U.S.C. 151. Further, a record may be disclosed, subject to the limitations of 37 CFR 1.14, as a routine use, to the public if the record was filed in an application which became abandoned or in which the proceedings were terminated and which application is referenced by either a published application, an application open to public inspection or an issued patent.
9. A record from this system of records may be disclosed, as a routine use, to a Federal, State, or local law enforcement agency, if the USPTO becomes aware of a violation or potential violation of law or regulation.

Notice of Allowability	Application No.	Applicant(s)	
	12/779,660	KRINSKY ET AL.	
	Examiner	Art Unit	
	KHANH C. TRAN	2611	

-- The MAILING DATE of this communication appears on the cover sheet with the correspondence address--

All claims being allowable, PROSECUTION ON THE MERITS IS (OR REMAINS) CLOSED in this application. If not included herewith (or previously mailed), a Notice of Allowance (PTOL-85) or other appropriate communication will be mailed in due course. **THIS NOTICE OF ALLOWABILITY IS NOT A GRANT OF PATENT RIGHTS.** This application is subject to withdrawal from issue at the initiative of the Office or upon petition by the applicant. See 37 CFR 1.313 and MPEP 1308.

1. This communication is responsive to the Amendment filed on 3/20/2012.
2. An election was made by the applicant in response to a restriction requirement set forth during the interview on ____; the restriction requirement and election have been incorporated into this action.
3. The allowed claim(s) is/are 44-64 that have been renumbered as claims 1-21, respectively.
4. Acknowledgment is made of a claim for foreign priority under 35 U.S.C. § 119(a)-(d) or (f).
 - a) All b) Some* c) None of the:
 1. Certified copies of the priority documents have been received.
 2. Certified copies of the priority documents have been received in Application No. ____.
 3. Copies of the certified copies of the priority documents have been received in this national stage application from the International Bureau (PCT Rule 17.2(a)).

* Certified copies not received: ____.

Applicant has THREE MONTHS FROM THE "MAILING DATE" of this communication to file a reply complying with the requirements noted below. Failure to timely comply will result in ABANDONMENT of this application.

THIS THREE-MONTH PERIOD IS NOT EXTENDABLE.

5. A SUBSTITUTE OATH OR DECLARATION must be submitted. Note the attached EXAMINER'S AMENDMENT or NOTICE OF INFORMAL PATENT APPLICATION (PTO-152) which gives reason(s) why the oath or declaration is deficient.
 6. CORRECTED DRAWINGS (as "replacement sheets") must be submitted.
 - (a) including changes required by the Notice of Draftsperson's Patent Drawing Review (PTO-948) attached
 - 1) hereto or 2) to Paper No./Mail Date ____.
 - (b) including changes required by the attached Examiner's Amendment / Comment or in the Office action of Paper No./Mail Date ____.
- Identifying indicia such as the application number (see 37 CFR 1.84(c)) should be written on the drawings in the front (not the back) of each sheet. Replacement sheet(s) should be labeled as such in the header according to 37 CFR 1.121(d).**
7. DEPOSIT OF and/or INFORMATION about the deposit of BIOLOGICAL MATERIAL must be submitted. Note the attached Examiner's comment regarding REQUIREMENT FOR THE DEPOSIT OF BIOLOGICAL MATERIAL.

Attachment(s)

- | | |
|--|---|
| <ol style="list-style-type: none"> 1. <input type="checkbox"/> Notice of References Cited (PTO-892) 2. <input type="checkbox"/> Notice of Draftsperson's Patent Drawing Review (PTO-948) 3. <input type="checkbox"/> Information Disclosure Statements (PTO/SB/08),
Paper No./Mail Date ____ 4. <input type="checkbox"/> Examiner's Comment Regarding Requirement for Deposit of Biological Material | <ol style="list-style-type: none"> 5. <input type="checkbox"/> Notice of Informal Patent Application 6. <input type="checkbox"/> Interview Summary (PTO-413),
Paper No./Mail Date ____. 7. <input type="checkbox"/> Examiner's Amendment/Comment 8. <input type="checkbox"/> Examiner's Statement of Reasons for Allowance 9. <input type="checkbox"/> Other ____. |
|--|---|

/KHANH C TRAN/
Primary Examiner, Art Unit 2611

1. The Amendment filed on 3/20/2012 has been entered. Claims 44-64 are still pending in this Office action.

2. Claims 44-64 have been renumbered as claims 1-21, respectively.

Response to Arguments

3. Applicant's arguments, see Applicants' Remarks, filed 3/20/2012, with respect to claims 44-64 have been fully considered and are persuasive. The rejection of claims 44-64 has been withdrawn after Applicants filed Terminal Disclaimers to overcome the outstanding Double Patenting Rejection.

Conclusion

4. Any inquiry concerning this communication or earlier communications from the examiner should be directed to KHANH C. TRAN whose telephone number is (571)272-3007. The examiner can normally be reached on Monday - Friday from 08:00 AM - 05:00 PM.

If attempts to reach the examiner by telephone are unsuccessful, the examiner's supervisor, Shuwang Liu can be reached on 571-272-3036. The fax phone number for the organization where this application or proceeding is assigned is 571-273-8300.

Information regarding the status of an application may be obtained from the Patent Application Information Retrieval (PAIR) system. Status information for published applications may be obtained from either Private PAIR or Public PAIR. Status information for unpublished applications is available through Private PAIR only. For more information about the PAIR system, see <http://pair-direct.uspto.gov>. Should you have questions on access to the Private PAIR system, contact the Electronic Business Center (EBC) at 866-217-9197 (toll-free). If you would like assistance from a USPTO Customer Service Representative or access to the automated information system, call 800-786-9199 (IN USA OR CANADA) or 571-272-1000.

KCT

*/KHANH C TRAN/
Primary Examiner, Art Unit 2611*

Index of Claims 	Application/Control No. 12779660	Applicant(s)/Patent Under Reexamination KRINSKY ET AL.
	Examiner KHANH C TRAN	Art Unit 2611

✓	Rejected	-	Cancelled	N	Non-Elected	A	Appeal
=	Allowed	÷	Restricted	I	Interference	O	Objected

Claims renumbered in the same order as presented by applicant
 CPA
 T.D.
 R.1.47

CLAIM		DATE					
Final	Original	03/11/2012	04/18/2012				
	1	-	-				
	2	-	-				
	3	-	-				
	4	-	-				
	5	-	-				
	6	-	-				
	7	-	-				
	8	-	-				
	9	-	-				
	10	-	-				
	11	-	-				
	12	-	-				
	13	-	-				
	14	-	-				
	15	-	-				
	16	-	-				
	17	-	-				
	18	-	-				
	19	-	-				
	20	-	-				
	21	-	-				
	22	-	-				
	23	-	-				
	24	-	-				
	25	-	-				
	26	-	-				
	27	-	-				
	28	-	-				
	29	-	-				
	30	-	-				
	31	-	-				
	32	-	-				
	33	-	-				
	34	-	-				
	35	-	-				
	36	-	-				

Index of Claims 	Application/Control No. 12779660	Applicant(s)/Patent Under Reexamination KRINSKY ET AL.
	Examiner KHANH C TRAN	Art Unit 2611

✓	Rejected	-	Cancelled	N	Non-Elected	A	Appeal
=	Allowed	÷	Restricted	I	Interference	O	Objected

<input type="checkbox"/> Claims renumbered in the same order as presented by applicant		<input type="checkbox"/> CPA		<input checked="" type="checkbox"/> T.D.		<input type="checkbox"/> R.1.47	
CLAIM		DATE					
Final	Original	03/11/2012	04/18/2012				
	37	-	-				
	38	-	-				
	39	-	-				
	40	-	-				
	41	-	-				
	42	-	-				
	43	-	-				
1	44	✓	=				
2	45	O	=				
3	46	✓	=				
4	47	O	=				
5	48	✓	=				
6	49	O	=				
7	50	✓	=				
8	51	O	=				
9	52	✓	=				
10	53	O	=				
11	54	✓	=				
12	55	O	=				
13	56	✓	=				
14	57	✓	=				
15	58	✓	=				
16	59	✓	=				
17	60	✓	=				
18	61	✓	=				
19	62	✓	=				
20	63	✓	=				
21	64	✓	=				



UNITED STATES PATENT AND TRADEMARK OFFICE

UNITED STATES DEPARTMENT OF COMMERCE
 United States Patent and Trademark Office
 Address: COMMISSIONER FOR PATENTS
 P.O. Box 1450
 Alexandria, Virginia 22313-1450
 www.uspto.gov

BIB DATA SHEET

CONFIRMATION NO. 8981

SERIAL NUMBER 12/779,660	FILING or 371(c) DATE 05/13/2010 RULE	CLASS 375	GROUP ART UNIT 2611	ATTORNEY DOCKET NO. 5550-2-CON2-1-1		
APPLICANTS David M. Krinsky, Acton, MA; Robert Edmund Pizzano JR., Stoneham, MA; ** CONTINUING DATA ***** This application is a CON of 12/477,742 06/03/2009 PAT 7,835,430 YES which is a CON of 10/619,691 07/16/2003 PAT 7,570,686 YES which is a DIV of 09/755,173 01/08/2001 PAT 6,658,052 YES which claims benefit of 60/224,308 08/10/2000 YES and claims benefit of 60/174,865 01/07/2000 YES ** FOREIGN APPLICATIONS ***** /KCT/ ** IF REQUIRED, FOREIGN FILING LICENSE GRANTED ** 05/25/2010						
Foreign Priority claimed <input type="checkbox"/> Yes <input checked="" type="checkbox"/> No 35 USC 119(a-d) conditions met <input type="checkbox"/> Yes <input type="checkbox"/> No Verified and Acknowledged <u>/KHANH C TRAN/</u> Examiner's Signature		<input type="checkbox"/> Met after Allowance KCT Initials	STATE OR COUNTRY MA	SHEETS DRAWINGS 2	TOTAL CLAIMS 21 12	INDEPENDENT CLAIMS 15 6
ADDRESS Jason H. Vick Sheridan Ross, PC Suite # 1200 1560 Broadway Denver, CO 80202 UNITED STATES						
TITLE Multicarrier Modulation Messaging for Power Level Per Subchannel Information						
FILING FEE RECEIVED 3782	FEES: Authority has been given in Paper No. _____ to charge/credit DEPOSIT ACCOUNT No. _____ for following:		<input type="checkbox"/> All Fees <input type="checkbox"/> 1.16 Fees (Filing) <input type="checkbox"/> 1.17 Fees (Processing Ext. of time) <input type="checkbox"/> 1.18 Fees (Issue) <input type="checkbox"/> Other _____ <input type="checkbox"/> Credit			

Issue Classification 	Application/Control No. 12779660	Applicant(s)/Patent Under Reexamination KRINSKY ET AL.
	Examiner KHANH C TRAN	Art Unit 2611

ORIGINAL						INTERNATIONAL CLASSIFICATION															
CLASS			SUBCLASS			CLAIMED					NON-CLAIMED										
375			219			H	O	4	B	1 / 38 (2006.01.01)											
CROSS REFERENCE(S)																					
CLASS	SUBCLASS (ONE SUBCLASS PER BLOCK)																				

Claims renumbered in the same order as presented by applicant
 CPA
 T.D.
 R.1.47

Final	Original	Final	Original	Final	Original	Final	Original	Final	Original	Final	Original	Final	Original	Final	Original
-	1	-	17	-	33	6	49								
-	2	-	18	-	34	7	50								
-	3	-	19	-	35	8	51								
-	4	-	20	-	36	9	52								
-	5	-	21	-	37	10	53								
-	6	-	22	-	38	11	54								
-	7	-	23	-	39	12	55								
-	8	-	24	-	40	13	56								
-	9	-	25	-	41	14	57								
-	10	-	26	-	42	15	58								
-	11	-	27	-	43	16	59								
-	12	-	28	1	44	17	60								
-	13	-	29	2	45	18	61								
-	14	-	30	3	46	19	62								
-	15	-	31	4	47	20	63								
-	16	-	32	5	48	21	64								

NONE	Total Claims Allowed:	
(Assistant Examiner)	(Date)	21
/KHANH C TRAN/ Primary Examiner. Art Unit 2611	(Date)	O.G. Print Claim(s) 1
(Primary Examiner)	(Date)	O.G. Print Figure 1

Search Notes 	Application/Control No. 12779660	Applicant(s)/Patent Under Reexamination KRINSKY ET AL.
	Examiner KHANH C TRAN	Art Unit 2611

SEARCHED			
Class	Subclass	Date	Examiner
375	222, 224-225, 227, 220, 284	4/18/2012	KCT
370	241, 252, 282		KCT
379	22.02, 22.04, 27.01, 27.03		KCT

SEARCH NOTES		
Search Notes	Date	Examiner
Update Searches on Parent Cases US Patent 7,835,430 B2 & US Patent 7,889,784 B2	3/11/2012	KCT
Update Double Patenting Searches		KCT

INTERFERENCE SEARCH			
Class	Subclass	Date	Examiner
375	all subclasses previously cited	4/18/2012	KCT
370	all subclasses previously cited		KCT
379	all subclasses previously cited		KCT

	/KHANH C TRAN/ Primary Examiner.Art Unit 2611
--	--

Application Number 	Application/Control No. 12/779,660	Applicant(s)/Patent under Reexamination KRINSKY ET AL.	
Document Code - DISQ		Internal Document – DO NOT MAIL	

TERMINAL DISCLAIMER	<input checked="" type="checkbox"/> APPROVED	<input type="checkbox"/> DISAPPROVED
Date Filed : 3/20/12	This patent is subject to a Terminal Disclaimer	

Approved/Disapproved by:

Felicia D. Roberts - 2 TDs approved with this filing date:

1. 7,889,784
2. 7,835,430

IN THE UNITED STATES PATENT AND TRADEMARK OFFICE

In Re the Application of: David M. Krinsky)	Group Art Unit: 2611
)	
Application No.: 12/779,660)	Examiner: TRAN, Khanh C.
)	
Filed: May 13, 2010)	Confirmation No.: 8981
)	
Atty. File No.: 5550-2-CON-2-1-1)	
)	

For: MULTICARRIER MODULATION MESSAGING FOR POWER LEVEL PER
SUBCHANNEL INFORMATION

AMENDMENT AND RESPONSE

Commissioner for Patents
P.O. Box 1450
Alexandria, VA 22313-1450

Madam:

Applicants submit this Amendment and Response to address the Office Action having a mailing date of March 19, 2012. Please credit any overpayment or charge any underpayment to Deposit Account No. 19-1970.

Please amend the above-identified patent application as follows:

Amendments to the Claims are shown in the listing of claims which begins on page 2 of this paper.

Remarks begin on page 9 of this paper.

AMENDMENTS TO THE CLAIMS:

This listing of claims will replace all prior versions, and listings, of claims in the application.

Listing of Claims:

1. – 43. (Cancelled)

44. (Previously Presented) A transceiver capable of transmitting test information over a communication channel using multicarrier modulation comprising:

a transmitter portion capable of transmitting a message, wherein the message comprises one or more data variables that represent the test information, wherein bits in the message are modulated onto DMT symbols using Quadrature Amplitude Modulation (QAM) with more than 1 bit per subchannel and wherein at least one data variable of the one or more data variables comprises an array representing power level per subchannel information.

45. (Previously Presented) The transceiver of claim 44, wherein the power level per subchannel information is based on a Reverb signal.

46. (Previously Presented) A transceiver capable of receiving test information over a communication channel using multicarrier modulation comprising:

a receiver portion capable of receiving a message, wherein the message comprises one or more data variables that represent the test information, wherein bits in the message were modulated onto DMT symbols using Quadrature Amplitude Modulation (QAM) with more than 1 bit per subchannel and wherein at least one data variable of the one or more data variables comprises an array representing power level per subchannel information.

47. (Previously Presented) The transceiver of claim 46, wherein the power level per subchannel information is based on a Reverb signal.

48. (Previously Presented) In a transceiver capable of transmitting test information over a communication channel using multicarrier modulation, a method comprising:

transmitting a message, wherein the message comprises one or more data variables that represent the test information, wherein bits in the message are modulated onto DMT symbols using Quadrature Amplitude Modulation (QAM) with more than 1 bit per subchannel and wherein at least one data variable of the one or more data variables comprises an array representing power level per subchannel information.

49. (Previously Presented) The method of claim 48, wherein the power level per subchannel information is based on a Reverb signal.

50. (Previously Presented) In a transceiver capable of receiving test information over a communication channel using multicarrier modulation, a method comprising:

receiving a message, wherein the message comprises one or more data variables that represent the test information, wherein bits in the message were modulated onto DMT symbols using Quadrature Amplitude Modulation (QAM) with more than 1 bit per subchannel and wherein at least one data variable of the one or more data variables comprises an array representing power level per subchannel information.

51. (Previously Presented) The method of claim 50, wherein the power level per subchannel information is based on a Reverb signal.

52. (Previously Presented) A non-transitory computer-readable information storage media having stored thereon instructions that, if executed, cause a transceiver to perform a method comprising:

transmitting a message, wherein the message comprises one or more data variables that represent the test information, wherein bits in the message are modulated onto DMT symbols using Quadrature Amplitude Modulation (QAM) with more than 1 bit per subchannel and wherein at least one data variable of the one or more data variables comprises an array representing power level per subchannel information.

53. (Previously Presented) The media of claim 52, wherein the power level per subchannel information is based on a Reverb signal.

54. (Previously Presented) A non-transitory computer-readable information storage media having stored thereon instructions that, if executed, cause a transceiver to perform a method comprising:

receiving a message, wherein the message comprises one or more data variables that represent the test information, wherein bits in the message were modulated onto DMT symbols using Quadrature Amplitude Modulation (QAM) with more than 1 bit per subchannel and wherein at least one data variable of the one or more data variables comprises an array representing power level per subchannel information.

55. (Previously Presented) The media of claim 54, wherein the power level per subchannel information is based on a Reverb signal.

56. (Previously Presented) A communications system for DSL service comprising a first DSL transceiver capable of transmitting test information over a communication channel using multicarrier modulation and a second DSL transceiver capable of receiving the test information over the communication channel using multicarrier modulation comprising:

a transmitter portion of the first transceiver capable of transmitting a message, wherein the message comprises one or more data variables that represent the test information, wherein bits in the message are modulated onto DMT symbols using Quadrature Amplitude Modulation (QAM) with more than 1 bit per subchannel and wherein at least one data variable of the one or more data variables comprises an array representing Signal to Noise ratio per subchannel during Showtime information; and

a receiver portion of the second transceiver capable of receiving the message, wherein the message comprises the one or more data variables that represent the test information, wherein the bits in the message were modulated onto the DMT symbols using Quadrature Amplitude Modulation (QAM) with more than 1 bit per subchannel and wherein the at least one data variable of the one or more data variables comprises the array representing Signal to Noise ratio per subchannel during Showtime information.

57. (Previously Presented) In a communications system for DSL service with a first DSL transceiver capable of transmitting test information over a communication channel using

multicarrier modulation and a second DSL transceiver capable of receiving the test information over the communication channel using multicarrier modulation, a method comprising:

transmitting a message from the first transceiver, wherein the message comprises one or more data variables that represent the test information, wherein bits in the message are modulated onto DMT symbols using Quadrature Amplitude Modulation (QAM) with more than 1 bit per subchannel and wherein at least one data variable of the one or more data variables comprises an array representing Signal to Noise ratio per subchannel during Showtime information; and

receiving the message at the second transceiver, wherein the message comprises the one or more data variables that represent the test information, wherein the bits in the message were modulated onto the DMT symbols using Quadrature Amplitude Modulation (QAM) with more than 1 bit per subchannel and wherein the at least one data variable of the one or more data variables comprises the array representing Signal to Noise ratio per subchannel during Showtime information.

58. (Previously Presented) One or more non-transitory computer-readable information storage media having stored thereon instructions that, if executed, cause a communications system for DSL service to perform a method comprising:

transmitting a message from a first transceiver, wherein the message comprises one or more data variables that represent the test information, wherein bits in the message are modulated onto DMT symbols using Quadrature Amplitude Modulation (QAM) with more than 1 bit per subchannel and wherein at least one data variable of the one or more data variables comprises an array representing Signal to Noise ratio per subchannel during Showtime information; and

receiving the message at a second transceiver, wherein the message comprises the one or more data variables that represent the test information, wherein the bits in the message were modulated onto the DMT symbols using Quadrature Amplitude Modulation (QAM) with more than 1 bit per subchannel and wherein the at least one data variable of the one or more data variables comprises the array representing Signal to Noise ratio per subchannel during Showtime information.

59. (Previously Presented) A communications system for DSL service comprising a first DSL transceiver capable of transmitting test information over a communication channel using multicarrier modulation and a second DSL transceiver capable of receiving the test information over the communication channel using multicarrier modulation comprising:

a transmitter portion capable of transmitting a message, wherein the message comprises one or more data variables that represent the test information, wherein bits in the message are modulated onto DMT symbols using Quadrature Amplitude Modulation (QAM) with more than 1 bit per subchannel and wherein at least one data variable of the one or more data variables comprises an array representing frequency domain received idle channel noise information; and

a receiver portion capable of receiving the message, wherein the message comprises the one or more data variables that represent the test information, wherein the bits in the message were modulated onto the DMT symbols using Quadrature Amplitude Modulation (QAM) with more than 1 bit per subchannel and wherein at least one data variable of the one or more data variables comprises the array representing frequency domain received idle channel noise information.

60. (Previously Presented) In a communications system for DSL service with a first DSL transceiver capable of transmitting test information over a communication channel using multicarrier modulation and a second DSL transceiver capable of receiving the test information over the communication channel using multicarrier modulation, a method comprising:

transmitting a message, wherein the message comprises one or more data variables that represent the test information, wherein bits in the message are modulated onto DMT symbols using Quadrature Amplitude Modulation (QAM) with more than 1 bit per subchannel and wherein at least one data variable of the one or more data variables comprises an array representing frequency domain received idle channel noise information; and

receiving the message, wherein the message comprises the one or more data variables that represent the test information, wherein the bits in the message were modulated onto the DMT symbols using Quadrature Amplitude Modulation (QAM) with more than 1 bit per subchannel and wherein the at least one data variable of the one or more data variables comprises the array representing frequency domain received idle channel noise information.

61. (Previously Presented) One or more non-transitory computer-readable information storage media having stored thereon instructions that, if executed, cause a communications system for DSL service to perform a method comprising:

transmitting a message, wherein the message comprises one or more data variables that represent the test information, wherein bits in the message are modulated onto DMT symbols using Quadrature Amplitude Modulation (QAM) with more than 1 bit per subchannel and wherein at least one data variable of the one or more data variables comprises an array representing frequency domain received idle channel noise information; and

receiving the message, wherein the message comprises the one or more data variables that represent the test information, wherein the bits in the message were modulated onto the DMT symbols using Quadrature Amplitude Modulation (QAM) with more than 1 bit per subchannel and wherein the at least one data variable of the one or more data variables comprises the array representing frequency domain received idle channel noise information.

62. (Previously Presented) A communications system for DSL service comprising a first DSL transceiver capable of transmitting test information over a communication channel using multicarrier modulation and a second DSL transceiver capable of receiving the test information over the communication channel using multicarrier modulation comprising:

a transmitter portion capable of transmitting a message, wherein the message comprises one or more data variables that represent the test information, wherein bits in the message are modulated onto DMT symbols using Quadrature Amplitude Modulation (QAM) with more than 1 bit per subchannel and wherein at least one data variable of the one or more data variables comprises an array representing power level per subchannel information; and

a receiver portion capable of receiving the message, wherein the message comprises the one or more data variables that represent the test information, wherein bits in the message were modulated onto DMT symbols using Quadrature Amplitude Modulation (QAM) with more than 1 bit per subchannel and wherein at least one data variable of the one or more data variables comprises an array representing power level per subchannel information.

63. (Previously Presented) In a communications system for DSL service with a first DSL transceiver capable of transmitting test information over a communication channel using

multicarrier modulation and a second DSL transceiver capable of receiving the test information over the communication channel using multicarrier modulation, a method comprising:

transmitting a message, wherein the message comprises one or more data variables that represent the test information, wherein bits in the message are modulated onto DMT symbols using Quadrature Amplitude Modulation (QAM) with more than 1 bit per subchannel and wherein at least one data variable of the one or more data variables comprises an array representing power level per subchannel information; and

receiving the message, wherein the message comprises the one or more data variables that represent the test information, wherein the bits in the message were modulated onto DMT symbols using Quadrature Amplitude Modulation (QAM) with more than 1 bit per subchannel and wherein at least one data variable of the one or more data variables comprises an array representing power level per subchannel information.

64. (Previously Presented) One or more non-transitory computer-readable information storage media having stored thereon instructions that, if executed, cause a communications system for DSL service to perform a method comprising:

transmitting a message, wherein the message comprises one or more data variables that represent the test information, wherein bits in the message are modulated onto DMT symbols using Quadrature Amplitude Modulation (QAM) with more than 1 bit per subchannel and wherein at least one data variable of the one or more data variables comprises an array representing power level per subchannel information; and

receiving the message, wherein the message comprises the one or more data variables that represent the test information, wherein the bits in the message were modulated onto DMT symbols using Quadrature Amplitude Modulation (QAM) with more than 1 bit per subchannel and wherein at least one data variable of the one or more data variables comprises an array representing power level per subchannel information.

REMARKS

Applicant requests reconsideration of this application based on the Terminal Disclaimers filed herewith.

The Examiner is thanked for the indication that claims 45, 47, 49, 51, 53 and 55 contain allowable subject matter.

In order to overcome the outstanding double patenting rejections, attached hereto are two Terminal Disclaimers. Based thereon, withdrawal of the rejections is respectfully requested.

With all rejections having been overcome, Applicant respectfully submits the application is in condition for allowance. A prompt Notice of Allowance is respectfully solicited.

Should the Examiner believe anything further is desirable in order to place the application in even better condition for allowance, the Examiner is encouraged to contact Applicants undersigned representative at the telephone number listed below.

The Commissioner is hereby authorized to charge to deposit account number 19-1970 any fees under 37 CFR § 1.16 and 1.17 that may be required by this paper and to credit any overpayment to that Account. If any extension of time is required in connection with the filing of this paper and has not been separately requested, such extension is hereby petitioned.

Respectfully submitted,

SHERIDAN ROSS P.C.

Date: 20 Nov '12

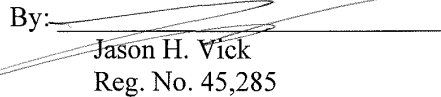
By: 
Jason H. Vick
Reg. No. 45,285
1560 Broadway, Suite 1200
Denver, Colorado 80202
Telephone: 303-863-9700

Under the Paperwork Reduction Act of 1995, no persons are required to respond to a collection of information unless it displays a valid OMB control number.

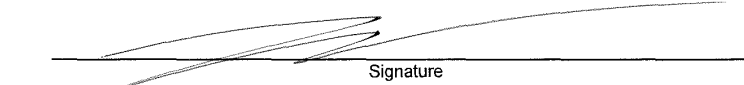
TERMINAL DISCLAIMER TO OBTAIN A DOUBLE PATENTING REJECTION OVER A "PRIOR" PATENT	Docket Number (Optional) 5550-2-CON-2-1-1
<p>In re Application of: David M. Krinsky Application No.: 12/779,660 Filed: May 13, 2010 For: Multicarrier Modulation Messaging for Power Level Per Subchannel Information</p>	
<p>The owner*, <u>AWARE, INC.</u>, of <u>100</u> percent interest in the instant application hereby disclaims, except as provided below, the terminal part of the statutory term of any patent granted on the instant application which would extend beyond the expiration date of the full statutory term of prior patent No. <u>7,889,784</u> as the term of said prior patent is presently shortened by any terminal disclaimer. The owner hereby agrees that any patent so granted on the instant application shall be enforceable only for and during such period that it and the prior patent are commonly owned. This agreement runs with any patent granted on the instant application and is binding upon the grantee, its successors or assigns.</p>	
<p>In making the above disclaimer, the owner does not disclaim the terminal part of the term of any patent granted on the instant application that would extend to the expiration date of the full statutory term of the prior patent, "as the term of said prior patent is presently shortened by any terminal disclaimer," in the event that said prior patent later: expires for failure to pay a maintenance fee; is held unenforceable; is found invalid by a court of competent jurisdiction; is statutorily disclaimed in whole or terminally disclaimed under 37 CFR 1.321; has all claims canceled by a reexamination certificate; is reissued; or is in any manner terminated prior to the expiration of its full statutory term as presently shortened by any terminal disclaimer.</p>	
<p>Check either box 1 or 2 below, if appropriate.</p>	
<p>1. <input type="checkbox"/> For submissions on behalf of a business/organization (e.g., corporation, partnership, university, government agency, etc.), the undersigned is empowered to act on behalf of the business/organization.</p>	
<p>I hereby declare that all statements made herein of my own knowledge are true and that all statements made on information and belief are believed to be true; and further that these statements were made with the knowledge that willful false statements and the like so made are punishable by fine or imprisonment, or both, under Section 1001 of Title 18 of the United States Code and that such willful false statements may jeopardize the validity of the application or any patent issued thereon.</p>	
<p>2. <input checked="" type="checkbox"/> The undersigned is an attorney or agent of record. Reg. No. <u>45,285</u></p>	
	<u>20 Mar '12</u> Date
<u>Jason H. Vick</u> Typed or printed name	
<u>303-863-9700</u> Telephone Number	
<p><input checked="" type="checkbox"/> Terminal disclaimer fee under 37 CFR 1.20(d) included.</p>	
<p>WARNING: Information on this form may become public. Credit card information should not be included on this form. Provide credit card information and authorization on PTO-2038.</p>	
<p>*Statement under 37 CFR 3.73(b) is required if terminal disclaimer is signed by the assignee (owner). Form PTO/SB/96 may be used for making this certification. See MPEP § 324.</p>	

This collection of information is required by 37 CFR 1.321. The information is required to obtain or retain a benefit by the public which is to file (and by the USPTO to process) an application. Confidentiality is governed by 35 U.S.C. 122 and 37 CFR 1.11 and 1.14. This collection is estimated to take 12 minutes to complete, including gathering, preparing, and submitting the completed application form to the USPTO. Time will vary depending upon the individual case. Any comments on the amount of time you require to complete this form and/or suggestions for reducing this burden, should be sent to the Chief Information Officer, U.S. Patent and Trademark Office, U.S. Department of Commerce, P.O. Box 1450, Alexandria, VA 22313-1450. DO NOT SEND FEES OR COMPLETED FORMS TO THIS ADDRESS. SEND TO: Commissioner for Patents, P.O. Box 1450, Alexandria, VA 22313-1450.

If you need assistance in completing the form, call 1-800-PTO-9199 and select option 2.

Under the Paperwork Reduction Act of 1995, no persons are required to respond to a collection of information unless it displays a valid OMB control number.

**TERMINAL DISCLAIMER TO OBTAIN A DOUBLE PATENTING
REJECTION OVER A "PRIOR" PATENT**Docket Number (Optional)
5550-2-CON-2-1-1

In re Application of: David M. Krinsky

Application No.: 12/779,660

Filed: May 13, 2010

For: Multicarrier Modulation Messaging for Power Level Per Subchannel Information

The owner*, AWARE, INC., of 100 percent interest in the instant application hereby disclaims, except as provided below, the terminal part of the statutory term of any patent granted on the instant application which would extend beyond the expiration date of the full statutory term of **prior patent** No. 7,835,430 as the term of said **prior patent** is presently shortened by any terminal disclaimer. The owner hereby agrees that any patent so granted on the instant application shall be enforceable only for and during such period that it and the **prior patent** are commonly owned. This agreement runs with any patent granted on the instant application and is binding upon the grantee, its successors or assigns.

In making the above disclaimer, the owner does not disclaim the terminal part of the term of any patent granted on the instant application that would extend to the expiration date of the full statutory term of the **prior patent**, "as the term of said **prior patent** is presently shortened by any terminal disclaimer," in the event that said **prior patent** later:

- expires for failure to pay a maintenance fee;
- is held unenforceable;
- is found invalid by a court of competent jurisdiction;
- is statutorily disclaimed in whole or terminally disclaimed under 37 CFR 1.321;
- has all claims canceled by a reexamination certificate;
- is reissued; or
- is in any manner terminated prior to the expiration of its full statutory term as presently shortened by any terminal disclaimer.

Check either box 1 or 2 below, if appropriate.

1. For submissions on behalf of a business/organization (e.g., corporation, partnership, university, government agency, etc.), the undersigned is empowered to act on behalf of the business/organization.

I hereby declare that all statements made herein of my own knowledge are true and that all statements made on information and belief are believed to be true; and further that these statements were made with the knowledge that willful false statements and the like so made are punishable by fine or imprisonment, or both, under Section 1001 of Title 18 of the United States Code and that such willful false statements may jeopardize the validity of the application or any patent issued thereon.

2. The undersigned is an attorney or agent of record. Reg. No. 45,285

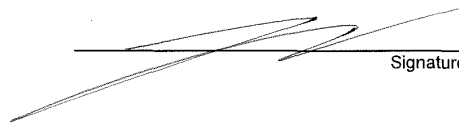
 Signature 20 May '12
Date

Jason H. Vick
 Typed or printed name

303-863-9700
Telephone Number

- Terminal disclaimer fee under 37 CFR 1.20(d) included.

WARNING: Information on this form may become public. Credit card information should not be included on this form. Provide credit card information and authorization on PTO-2038.

*Statement under 37 CFR 3.73(b) is required if terminal disclaimer is signed by the assignee (owner).
Form PTO/SB/96 may be used for making this certification. See MPEP § 324.

This collection of information is required by 37 CFR 1.321. The information is required to obtain or retain a benefit by the public which is to file (and by the USPTO to process) an application. Confidentiality is governed by 35 U.S.C. 122 and 37 CFR 1.11 and 1.14. This collection is estimated to take 12 minutes to complete, including gathering, preparing, and submitting the completed application form to the USPTO. Time will vary depending upon the individual case. Any comments on the amount of time you require to complete this form and/or suggestions for reducing this burden, should be sent to the Chief Information Officer, U.S. Patent and Trademark Office, U.S. Department of Commerce, P.O. Box 1450, Alexandria, VA 22313-1450. DO NOT SEND FEES OR COMPLETED FORMS TO THIS ADDRESS. SEND TO: Commissioner for Patents, P.O. Box 1450, Alexandria, VA 22313-1450.

If you need assistance in completing the form, call 1-800-PTO-9199 and select option 2.

Electronic Patent Application Fee Transmittal

Application Number:	12779660			
Filing Date:	13-May-2010			
Title of Invention:	Multicarrier Modulation Messaging for Power Level Per Subchannel Information			
First Named Inventor/Applicant Name:	David M. Krinsky			
Filer:	Jason Vick/Joanne Vos			
Attorney Docket Number:	5550-2-CON2-1-1			
Filed as Large Entity				
Utility under 35 USC 111(a) Filing Fees				
Description	Fee Code	Quantity	Amount	Sub-Total in USD(\$)
Basic Filing:				
Pages:				
Claims:				
Miscellaneous-Filing:				
Petition:				
Patent-Appeals-and-Interference:				
Post-Allowance-and-Post-Issuance:				
Extension-of-Time:				

Description	Fee Code	Quantity	Amount	Sub-Total in USD(\$)
Miscellaneous:				
Statutory or terminal disclaimer	1814	2	160	320
Total in USD (\$)				320

Electronic Acknowledgement Receipt

EFS ID:	12348647
Application Number:	12779660
International Application Number:	
Confirmation Number:	8981
Title of Invention:	Multicarrier Modulation Messaging for Power Level Per Subchannel Information
First Named Inventor/Applicant Name:	David M. Krinsky
Customer Number:	62574
Filer:	Jason Vick/Joanne Vos
Filer Authorized By:	Jason Vick
Attorney Docket Number:	5550-2-CON2-1-1
Receipt Date:	20-MAR-2012
Filing Date:	13-MAY-2010
Time Stamp:	16:00:44
Application Type:	Utility under 35 USC 111(a)

Payment information:

Submitted with Payment	yes
Payment Type	Deposit Account
Payment was successfully received in RAM	\$320
RAM confirmation Number	2793
Deposit Account	191970
Authorized User	

The Director of the USPTO is hereby authorized to charge indicated fees and credit any overpayment as follows:

Charge any Additional Fees required under 37 C.F.R. Section 1.16 (National application filing, search, and examination fees)

Charge any Additional Fees required under 37 C.F.R. Section 1.17 (Patent application and reexamination processing fees)

Charge any Additional Fees required under 37 C.F.R. Section 1.19 (Document supply fees)

Charge any Additional Fees required under 37 C.F.R. Section 1.21 (Miscellaneous fees and charges)

File Listing:

Document Number	Document Description	File Name	File Size(Bytes)/ Message Digest	Multi Part /.zip	Pages (if appl.)
1		AMEND_01.pdf	1131702 5d60e586e283ec9cd587640f57ccfe4a713c2a3e	yes	11

Multipart Description/PDF files in .zip description			
Document Description	Start	End	
Amendment/Req. Reconsideration-After Non-Final Reject	1	1	
Claims	2	8	
Applicant Arguments/Remarks Made in an Amendment	9	9	
Terminal Disclaimer Filed	10	10	
Terminal Disclaimer Filed	11	11	

Warnings:

Information:

2	Fee Worksheet (SB06)	fee-info.pdf	30187 416d097cd1fc33a250f05b184a011ce7299ae9	no	2
---	----------------------	--------------	---	----	---

Warnings:

Information:

Total Files Size (in bytes):	1161889
-------------------------------------	---------

This Acknowledgement Receipt evidences receipt on the noted date by the USPTO of the indicated documents, characterized by the applicant, and including page counts, where applicable. It serves as evidence of receipt similar to a Post Card, as described in MPEP 503.

New Applications Under 35 U.S.C. 111

If a new application is being filed and the application includes the necessary components for a filing date (see 37 CFR 1.53(b)-(d) and MPEP 506), a Filing Receipt (37 CFR 1.54) will be issued in due course and the date shown on this Acknowledgement Receipt will establish the filing date of the application.

National Stage of an International Application under 35 U.S.C. 371

If a timely submission to enter the national stage of an international application is compliant with the conditions of 35 U.S.C. 371 and other applicable requirements a Form PCT/DO/EO/903 indicating acceptance of the application as a national stage submission under 35 U.S.C. 371 will be issued in addition to the Filing Receipt, in due course.

New International Application Filed with the USPTO as a Receiving Office

If a new international application is being filed and the international application includes the necessary components for an international filing date (see PCT Article 11 and MPEP 1810), a Notification of the International Application Number and of the International Filing Date (Form PCT/RO/105) will be issued in due course, subject to prescriptions concerning national security, and the date shown on this Acknowledgement Receipt will establish the international filing date of the application.

Under the Paperwork Reduction Act of 1995, no persons are required to respond to a collection of information unless it displays a valid OMB control number.

PATENT APPLICATION FEE DETERMINATION RECORD Substitute for Form PTO-875					Application or Docket Number 12/779,660	Filing Date 05/13/2010	<input type="checkbox"/> To be Mailed					
APPLICATION AS FILED – PART I					OTHER THAN SMALL ENTITY							
(Column 1)		(Column 2)		SMALL ENTITY <input type="checkbox"/>		OR						
FOR	NUMBER FILED	NUMBER EXTRA	RATE (\$)	FEE (\$)	RATE (\$)	FEE (\$)						
<input type="checkbox"/> BASIC FEE <small>(37 CFR 1.16(a), (b), or (c))</small>	N/A	N/A	N/A		N/A							
<input type="checkbox"/> SEARCH FEE <small>(37 CFR 1.16(k), (l), or (m))</small>	N/A	N/A	N/A		N/A							
<input type="checkbox"/> EXAMINATION FEE <small>(37 CFR 1.16(o), (p), or (q))</small>	N/A	N/A	N/A		N/A							
TOTAL CLAIMS <small>(37 CFR 1.16(i))</small>	minus 20 =	*	X \$ =		OR	X \$ =						
INDEPENDENT CLAIMS <small>(37 CFR 1.16(h))</small>	minus 3 =	*	X \$ =		OR	X \$ =						
<input type="checkbox"/> APPLICATION SIZE FEE <small>(37 CFR 1.16(s))</small>	If the specification and drawings exceed 100 sheets of paper, the application size fee due is \$250 (\$125 for small entity) for each additional 50 sheets or fraction thereof. See 35 U.S.C. 41(a)(1)(G) and 37 CFR 1.16(s).											
<input type="checkbox"/> MULTIPLE DEPENDENT CLAIM PRESENT <small>(37 CFR 1.16(j))</small>												
* If the difference in column 1 is less than zero, enter "0" in column 2.												
APPLICATION AS AMENDED – PART II			OTHER THAN SMALL ENTITY									
(Column 1)		(Column 2)		(Column 3)		SMALL ENTITY		OR		SMALL ENTITY		
AMENDMENT	03/20/2012	CLAIMS REMAINING AFTER AMENDMENT		HIGHEST NUMBER PREVIOUSLY PAID FOR	PRESENT EXTRA	RATE (\$)	ADDITIONAL FEE (\$)	RATE (\$)	ADDITIONAL FEE (\$)			
	Total <small>(37 CFR 1.16(i))</small>	* 21	Minus	** 21	= 0	X \$ =		OR	X \$60=	0		
	Independent <small>(37 CFR 1.16(h))</small>	* 3	Minus	***3	= 0	X \$ =		OR	X \$250=	0		
	<input type="checkbox"/> Application Size Fee <small>(37 CFR 1.16(s))</small>											
	<input type="checkbox"/> FIRST PRESENTATION OF MULTIPLE DEPENDENT CLAIM <small>(37 CFR 1.16(j))</small>											
						TOTAL ADD'L FEE		OR	TOTAL ADD'L FEE	0		
(Column 1)		(Column 2)		(Column 3)		SMALL ENTITY		OR		SMALL ENTITY		
AMENDMENT		CLAIMS REMAINING AFTER AMENDMENT		HIGHEST NUMBER PREVIOUSLY PAID FOR	PRESENT EXTRA	RATE (\$)	ADDITIONAL FEE (\$)	RATE (\$)	ADDITIONAL FEE (\$)			
	Total <small>(37 CFR 1.16(i))</small>	*	Minus	**	=	X \$ =		OR	X \$ =			
	Independent <small>(37 CFR 1.16(h))</small>	*	Minus	***	=	X \$ =		OR	X \$ =			
	<input type="checkbox"/> Application Size Fee <small>(37 CFR 1.16(s))</small>											
	<input type="checkbox"/> FIRST PRESENTATION OF MULTIPLE DEPENDENT CLAIM <small>(37 CFR 1.16(j))</small>											
						TOTAL ADD'L FEE		OR	TOTAL ADD'L FEE			
* If the entry in column 1 is less than the entry in column 2, write "0" in column 3.												
** If the "Highest Number Previously Paid For" IN THIS SPACE is less than 20, enter "20".												
*** If the "Highest Number Previously Paid For" IN THIS SPACE is less than 3, enter "3".												
The "Highest Number Previously Paid For" (Total or Independent) is the highest number found in the appropriate box in column 1.												
						Legal Instrument Examiner: /DONNA PRICE/						

This collection of information is required by 37 CFR 1.16. The information is required to obtain or retain a benefit by the public which is to file (and by the USPTO to process) an application. Confidentiality is governed by 35 U.S.C. 122 and 37 CFR 1.14. This collection is estimated to take 12 minutes to complete, including gathering, preparing, and submitting the completed application form to the USPTO. Time will vary depending upon the individual case. Any comments on the amount of time you require to complete this form and/or suggestions for reducing this burden, should be sent to the Chief Information Officer, U.S. Patent and Trademark Office, U.S. Department of Commerce, P.O. Box 1450, Alexandria, VA 22313-1450. DO NOT SEND FEES OR COMPLETED FORMS TO THIS ADDRESS. **SEND TO: Commissioner for Patents, P.O. Box 1450, Alexandria, VA 22313-1450.**

If you need assistance in completing the form, call 1-800-PTO-9199 and select option 2.



UNITED STATES PATENT AND TRADEMARK OFFICE

UNITED STATES DEPARTMENT OF COMMERCE
United States Patent and Trademark Office
Address: COMMISSIONER FOR PATENTS
P.O. Box 1450
Alexandria, Virginia 22313-1450
www.uspto.gov

Table with columns: APPLICATION NO., FILING DATE, FIRST NAMED INVENTOR, ATTORNEY DOCKET NO., CONFIRMATION NO., EXAMINER, ART UNIT, PAPER NUMBER, NOTIFICATION DATE, DELIVERY MODE. Includes application details for David M. Krinsky and examiner information for TRAN, KHANH C.

Please find below and/or attached an Office communication concerning this application or proceeding.

The time period for reply, if any, is set in the attached communication.

Notice of the Office communication was sent electronically on above-indicated "Notification Date" to the following e-mail address(es):

jvick@sheridanross.com

Office Action Summary	Application No. 12/779,660	Applicant(s) KRINSKY ET AL.	
	Examiner KHANH C. TRAN	Art Unit 2611	

-- The MAILING DATE of this communication appears on the cover sheet with the correspondence address --

Period for Reply

A SHORTENED STATUTORY PERIOD FOR REPLY IS SET TO EXPIRE 3 MONTH(S) OR THIRTY (30) DAYS, WHICHEVER IS LONGER, FROM THE MAILING DATE OF THIS COMMUNICATION.

- Extensions of time may be available under the provisions of 37 CFR 1.136(a). In no event, however, may a reply be timely filed after SIX (6) MONTHS from the mailing date of this communication.
- If NO period for reply is specified above, the maximum statutory period will apply and will expire SIX (6) MONTHS from the mailing date of this communication.
- Failure to reply within the set or extended period for reply will, by statute, cause the application to become ABANDONED (35 U.S.C. § 133). Any reply received by the Office later than three months after the mailing date of this communication, even if timely filed, may reduce any earned patent term adjustment. See 37 CFR 1.704(b).

Status

- 1) Responsive to communication(s) filed on 13 May 2010.
- 2a) This action is **FINAL**. 2b) This action is non-final.
- 3) An election was made by the applicant in response to a restriction requirement set forth during the interview on _____; the restriction requirement and election have been incorporated into this action.
- 4) Since this application is in condition for allowance except for formal matters, prosecution as to the merits is closed in accordance with the practice under *Ex parte Quayle*, 1935 C.D. 11, 453 O.G. 213.

Disposition of Claims

- 5) Claim(s) 44-64 is/are pending in the application.
- 5a) Of the above claim(s) _____ is/are withdrawn from consideration.
- 6) Claim(s) _____ is/are allowed.
- 7) Claim(s) _____ is/are rejected.
- 8) Claim(s) _____ is/are objected to.
- 9) Claim(s) _____ are subject to restriction and/or election requirement.

Application Papers

- 10) The specification is objected to by the Examiner.
- 11) The drawing(s) filed on 13 May 2010 is/are: a) accepted or b) objected to by the Examiner.
Applicant may not request that any objection to the drawing(s) be held in abeyance. See 37 CFR 1.85(a).
Replacement drawing sheet(s) including the correction is required if the drawing(s) is objected to. See 37 CFR 1.121(d).
- 12) The oath or declaration is objected to by the Examiner. Note the attached Office Action or form PTO-152.

Priority under 35 U.S.C. § 119

- 13) Acknowledgment is made of a claim for foreign priority under 35 U.S.C. § 119(a)-(d) or (f).
- a) All b) Some * c) None of:
1. Certified copies of the priority documents have been received.
2. Certified copies of the priority documents have been received in Application No. _____.
3. Copies of the certified copies of the priority documents have been received in this National Stage application from the International Bureau (PCT Rule 17.2(a)).
- * See the attached detailed Office action for a list of the certified copies not received.

Attachment(s)

- | | |
|---|---|
| 1) <input type="checkbox"/> Notice of References Cited (PTO-892) | 4) <input type="checkbox"/> Interview Summary (PTO-413)
Paper No(s)/Mail Date. _____ |
| 2) <input type="checkbox"/> Notice of Draftsperson's Patent Drawing Review (PTO-948) | 5) <input type="checkbox"/> Notice of Informal Patent Application |
| 3) <input checked="" type="checkbox"/> Information Disclosure Statement(s) (PTO/SB/08)
Paper No(s)/Mail Date _____ | 6) <input type="checkbox"/> Other: _____ |

DETAILED ACTION

1. The Preliminary Amendment filed on 1/10/2011 has been entered. Claims 44-64 are still pending in this Office action.

Double Patenting

The nonstatutory double patenting rejection is based on a judicially created doctrine grounded in public policy (a policy reflected in the statute) so as to prevent the unjustified or improper timewise extension of the “right to exclude” granted by a patent and to prevent possible harassment by multiple assignees. A nonstatutory obviousness-type double patenting rejection is appropriate where the conflicting claims are not identical, but at least one examined application claim is not patentably distinct from the reference claim(s) because the examined application claim is either anticipated by, or would have been obvious over, the reference claim(s). See, e.g., *In re Berg*, 140 F.3d 1428, 46 USPQ2d 1226 (Fed. Cir. 1998); *In re Goodman*, 11 F.3d 1046, 29 USPQ2d 2010 (Fed. Cir. 1993); *In re Longi*, 759 F.2d 887, 225 USPQ 645 (Fed. Cir. 1985); *In re Van Ornum*, 686 F.2d 937, 214 USPQ 761 (CCPA 1982); *In re Vogel*, 422 F.2d 438, 164 USPQ 619 (CCPA 1970); and *In re Thorington*, 418 F.2d 528, 163 USPQ 644 (CCPA 1969).

A timely filed terminal disclaimer in compliance with 37 CFR 1.321(c) or 1.321(d) may be used to overcome an actual or provisional rejection based on a nonstatutory double patenting ground provided the conflicting application or patent either is shown to

be commonly owned with this application, or claims an invention made as a result of activities undertaken within the scope of a joint research agreement.

Effective January 1, 1994, a registered attorney or agent of record may sign a terminal disclaimer. A terminal disclaimer signed by the assignee must fully comply with 37 CFR 3.73(b).

1. Claim 44 is rejected on the ground of nonstatutory obviousness-type double patenting as being unpatentable over claim 1 of ***U.S. Patent No. 7,835,430 B2***. Although the conflicting claims are not identical, they are not patentably distinct from each other because application claim defines an invention that is an obvious variation of that of the Patent claim.

Patent claim differs from application claim in that Patent claim recites “*an array representing frequency domain received idle channel noise information*” while application claim recites “*an array representing power level per sub-channel information*”. Because “frequency domain received idle channel noise information” and “power level per subchannel information” are test information, therefore, it would have been obvious for one of ordinary skill in the art at the time the invention was made to modify the Patent claim so that the array representing power level per sub-channel information as claimed in the application claim.

2. Claim 46 is rejected on the ground of nonstatutory obviousness-type double patenting as being unpatentable over claim 2 of ***U.S. Patent No. 7,835,430 B2***.

Although the conflicting claims are not identical, they are not patentably distinct from each other because application claim defines an invention that is an obvious variation of that of the Patent claim.

Patent claim differs from application claim in that Patent claim recites “*an array representing frequency domain received idle channel noise information*” while application claim recites “*an array representing power level per sub-channel information*”. Because “frequency domain received idle channel noise information” and “power level per subchannel information” are test information, therefore, it would have been obvious for one of ordinary skill in the art at the time the invention was made to modify the Patent claim so that the array representing power level per sub-channel information as claimed in the application claim.

3. Claim 48 is rejected on the ground of nonstatutory obviousness-type double patenting as being unpatentable over claim 3 of ***U.S. Patent No. 7,835,430 B2***.

Although the conflicting claims are not identical, they are not patentably distinct from each other because application claim defines an invention that is an obvious variation of that of the Patent claim.

Patent claim differs from application claim in that Patent claim recites “*an array representing frequency domain received idle channel noise information*” while application claim recites “*an array representing power level per sub-channel information*”. Because “frequency domain received idle channel noise information” and “power level per subchannel information” are test information, therefore, it would have

been obvious for one of ordinary skill in the art at the time the invention was made to modify the Patent claim so that the array representing power level per sub-channel information as claimed in the application claim.

4. Claim 50 is rejected on the ground of nonstatutory obviousness-type double patenting as being unpatentable over claim 4 of ***U.S. Patent No. 7,835,430 B2***. Although the conflicting claims are not identical, they are not patentably distinct from each other because application claim defines an invention that is an obvious variation of that of the Patent claim.

Patent claim differs from application claim in that Patent claim recites “*an array representing frequency domain received idle channel noise information*” while application claim recites “*an array representing power level per sub-channel information*”. Because “frequency domain received idle channel noise information” and “power level per subchannel information” are test information, therefore, it would have been obvious for one of ordinary skill in the art at the time the invention was made to modify the Patent claim so that the array representing power level per sub-channel information as claimed in the application claim.

5. Claim 52 is rejected on the ground of nonstatutory obviousness-type double patenting as being unpatentable over claim 5 of ***U.S. Patent No. 7,835,430 B2***. Although the conflicting claims are not identical, they are not patentably distinct from

each other because application claim defines an invention that is an obvious variation of that of the Patent claim.

Patent claim differs from application claim in that Patent claim recites “*an array representing frequency domain received idle channel noise information*” while application claim recites “*an array representing power level per sub-channel information*”. Because “frequency domain received idle channel noise information” and “power level per subchannel information” are test information, therefore, it would have been obvious for one of ordinary skill in the art at the time the invention was made to modify the Patent claim so that the array representing power level per sub-channel information as claimed in the application claim.

6. Claim 54 is rejected on the ground of nonstatutory obviousness-type double patenting as being unpatentable over claim 6 of ***U.S. Patent No. 7,835,430 B2***. Although the conflicting claims are not identical, they are not patentably distinct from each other because application claim defines an invention that is an obvious variation of that of the Patent claim.

Patent claim differs from application claim in that Patent claim recites “*an array representing frequency domain received idle channel noise information*” while application claim recites “*an array representing power level per sub-channel information*”. Because “frequency domain received idle channel noise information” and “power level per subchannel information” are test information, therefore, it would have been obvious for one of ordinary skill in the art at the time the invention was made to

modify the Patent claim so that the array representing power level per sub-channel information as claimed in the application claim.

7. Claim 44 is rejected on the ground of nonstatutory obviousness-type double patenting as being unpatentable over claim 1 of ***U.S. Patent No. 7,889,784 B2***. Although the conflicting claims are not identical, they are not patentably distinct from each other because application claim defines an invention that is an obvious variation of that of the Patent claim.

Patent claim differs from application claim in that Patent claim recites “*an array representing Signal to Noise ratio per sub-channel during Showtime information*” while application claim recites “*an array representing power level per sub-channel information*”. Because “Signal to Noise ratio per sub-channel during Showtime information” and “power level per sub-channel information” are test information, therefore, it would have been obvious for one of ordinary skill in the art at the time the invention was made to modify the Patent claim so that the array representing power level per sub-channel information as claimed in the application claim.

8. Claim 46 is rejected on the ground of nonstatutory obviousness-type double patenting as being unpatentable over claim 2 of ***U.S. Patent No. 7,889,784 B2***. Although the conflicting claims are not identical, they are not patentably distinct from each other because application claim defines an invention that is an obvious variation of that of the Patent claim.

Patent claim differs from application claim in that Patent claim recites “*an array representing Signal to Noise ratio per sub-channel during Showtime information*” while application claim recites “*an array representing power level per sub-channel information*”. Because “Signal to Noise ratio per sub-channel during Showtime information” and “power level per sub-channel information” are test information, therefore, it would have been obvious for one of ordinary skill in the art at the time the invention was made to modify the Patent claim so that the array representing power level per sub-channel information as claimed in the application claim.

9. Claim 48 is rejected on the ground of nonstatutory obviousness-type double patenting as being unpatentable over claim 3 of ***U.S. Patent No. 7,889,784 B2***. Although the conflicting claims are not identical, they are not patentably distinct from each other because application claim defines an invention that is an obvious variation of that of the Patent claim.

Patent claim differs from application claim in that Patent claim recites “*an array representing Signal to Noise ratio per sub-channel during Showtime information*” while application claim recites “*an array representing power level per sub-channel information*”. Because “Signal to Noise ratio per sub-channel during Showtime information” and “power level per sub-channel information” are test information, therefore, it would have been obvious for one of ordinary skill in the art at the time the invention was made to modify the Patent claim so that the array representing power level per sub-channel information as claimed in the application claim.

10. Claim 50 is rejected on the ground of nonstatutory obviousness-type double patenting as being unpatentable over claim 4 of ***U.S. Patent No. 7,889,784 B2***.

Although the conflicting claims are not identical, they are not patentably distinct from each other because application claim defines an invention that is an obvious variation of that of the Patent claim.

Patent claim differs from application claim in that Patent claim recites “*an array representing Signal to Noise ratio per sub-channel during Showtime information*” while application claim recites “*an array representing power level per sub-channel information*”. Because “Signal to Noise ratio per sub-channel during Showtime information” and “power level per sub-channel information” are test information, therefore, it would have been obvious for one of ordinary skill in the art at the time the invention was made to modify the Patent claim so that the array representing power level per sub-channel information as claimed in the application claim.

11. Claim 52 is rejected on the ground of nonstatutory obviousness-type double patenting as being unpatentable over claim 5 of ***U.S. Patent No. 7,889,784 B2***.

Although the conflicting claims are not identical, they are not patentably distinct from each other because application claim defines an invention that is an obvious variation of that of the Patent claim.

Patent claim differs from application claim in that Patent claim recites “*an array representing Signal to Noise ratio per sub-channel during Showtime information*” while application claim recites “*an array representing power level per sub-channel*”

information". Because "Signal to Noise ratio per sub-channel during Showtime information" and "power level per sub-channel information" are test information, therefore, it would have been obvious for one of ordinary skill in the art at the time the invention was made to modify the Patent claim so that the array representing power level per sub-channel information as claimed in the application claim.

12. Claim 54 is rejected on the ground of nonstatutory obviousness-type double patenting as being unpatentable over claim 6 of ***U.S. Patent No. 7,889,784 B2***. Although the conflicting claims are not identical, they are not patentably distinct from each other because application claim defines an invention that is an obvious variation of that of the Patent claim.

Patent claim differs from application claim in that Patent claim recites "*an array representing Signal to Noise ratio per sub-channel during Showtime information*" while application claim recites "*an array representing power level per sub-channel information*". Because "Signal to Noise ratio per sub-channel during Showtime information" and "power level per sub-channel information" are test information, therefore, it would have been obvious for one of ordinary skill in the art at the time the invention was made to modify the Patent claim so that the array representing power level per sub-channel information as claimed in the application claim.

13. Claim 56 is rejected on the ground of nonstatutory obviousness-type double patenting as being unpatentable over claim 1 in view of claim 2 of ***U.S. Patent No.***

7,889,784 B2 because of similar scope. Although the conflicting claims are not identical, they are not patentably distinct from each other because application claim defines an invention that is an obvious variation of that of the Patent claim.

14. Claim 57 is rejected on the ground of nonstatutory obviousness-type double patenting as being unpatentable over claim 3 in view of claim 4 of **U.S. Patent No. 7,889,784 B2** because of similar scope. Although the conflicting claims are not identical, they are not patentably distinct from each other because application claim defines an invention that is an obvious variation of that of the Patent claim.

15. Claim 58 is rejected on the ground of nonstatutory obviousness-type double patenting as being unpatentable over claim 5 in view of claim 6 of **U.S. Patent No. 7,889,784 B2** because of similar scope. Although the conflicting claims are not identical, they are not patentably distinct from each other because application claim defines an invention that is an obvious variation of that of the Patent claim.

16. Claim 59 is rejected on the ground of nonstatutory obviousness-type double patenting as being unpatentable over claim 1 in view of claim 2 of **U.S. Patent No. 7,835,430 B2** because of similar scope. Although the conflicting claims are not identical, they are not patentably distinct from each other because application claim defines an invention that is an obvious variation of that of the Patent claim.

17. Claim 60 is rejected on the ground of nonstatutory obviousness-type double patenting as being unpatentable over claim 3 in view of claim 4 of ***U.S. Patent No. 7,835,430 B2*** because of similar scope. Although the conflicting claims are not identical, they are not patentably distinct from each other because application claim defines an invention that is an obvious variation of that of the Patent claim.

18. Claim 61 is rejected on the ground of nonstatutory obviousness-type double patenting as being unpatentable over claim 5 in view of claim 6 of ***U.S. Patent No. 7,835,430 B2*** because of similar scope. Although the conflicting claims are not identical, they are not patentably distinct from each other because application claim defines an invention that is an obvious variation of that of the Patent claim.

19. Claim 62 is rejected on the ground of nonstatutory obviousness-type double patenting as being unpatentable over claim 1 in view of claim 2 of ***U.S. Patent No. 7,835,430 B2***. Although the conflicting claims are not identical, they are not patentably distinct from each other because application claim defines an invention that is an obvious variation of that of the Patent claim.

Patent claim differs from application claim in that Patent claim recites “*an array representing frequency domain received idle channel noise information*” while application claim recites “*an array representing power level per sub-channel information*”. Because “frequency domain received idle channel noise information” and “power level per sub-channel information” are test information, therefore, it would have

been obvious for one of ordinary skill in the art at the time the invention was made to modify the Patent claim so that the array representing power level per sub-channel information as claimed in the application claim.

20. Claim 63 is rejected on the ground of nonstatutory obviousness-type double patenting as being unpatentable over claim 3 in view of claim 4 of ***U.S. Patent No. 7,835,430 B2***. Although the conflicting claims are not identical, they are not patentably distinct from each other because application claim defines an invention that is an obvious variation of that of the Patent claim.

Patent claim differs from application claim in that Patent claim recites “*an array representing frequency domain received idle channel noise information*” while application claim recites “*an array representing power level per sub-channel information*”. Because “frequency domain received idle channel noise information” and “power level per sub-channel information” are test information, therefore, it would have been obvious for one of ordinary skill in the art at the time the invention was made to modify the Patent claim so that the array representing power level per sub-channel information as claimed in the application claim.

21. Claim 64 is rejected on the ground of nonstatutory obviousness-type double patenting as being unpatentable over claim 5 in view of claim 6 of ***U.S. Patent No. 7,835,430 B2***. Although the conflicting claims are not identical, they are not patentably

distinct from each other because application claim defines an invention that is an obvious variation of that of the Patent claim.

Patent claim differs from application claim in that Patent claim recites “*an array representing frequency domain received idle channel noise information*” while application claim recites “*an array representing power level per sub-channel information*”. Because “frequency domain received idle channel noise information” and “power level per sub-channel information” are test information, therefore, it would have been obvious for one of ordinary skill in the art at the time the invention was made to modify the Patent claim so that the array representing power level per sub-channel information as claimed in the application claim.

Allowable Subject Matter

22. Claims 45, 47, 49, 51, 53 and 55 are objected to as being dependent upon a rejected base claim, but would be allowable if rewritten in independent form including all of the limitations of the base claim and any intervening claims.

Conclusion

23. Any inquiry concerning this communication or earlier communications from the examiner should be directed to KHANH C. TRAN whose telephone number is

Application/Control Number: 12/779,660
Art Unit: 2611

Page 15

(571)272-3007. The examiner can normally be reached on Monday - Friday from 08:00 AM - 05:00 PM.

If attempts to reach the examiner by telephone are unsuccessful, the examiner's supervisor, Shuwang Liu can be reached on 571-272-3036. The fax phone number for the organization where this application or proceeding is assigned is 571-273-8300.

Information regarding the status of an application may be obtained from the Patent Application Information Retrieval (PAIR) system. Status information for published applications may be obtained from either Private PAIR or Public PAIR. Status information for unpublished applications is available through Private PAIR only. For more information about the PAIR system, see <http://pair-direct.uspto.gov>. Should you have questions on access to the Private PAIR system, contact the Electronic Business Center (EBC) at 866-217-9197 (toll-free). If you would like assistance from a USPTO Customer Service Representative or access to the automated information system, call 800-786-9199 (IN USA OR CANADA) or 571-272-1000.

KCT

*/KHANH C TRAN/
Primary Examiner, Art Unit 2611*

Index of Claims 	Application/Control No. 12779660	Applicant(s)/Patent Under Reexamination KRINSKY ET AL.
	Examiner KHANH C TRAN	Art Unit 2611

✓	Rejected	-	Cancelled	N	Non-Elected	A	Appeal
=	Allowed	÷	Restricted	I	Interference	O	Objected

Claims renumbered in the same order as presented by applicant
 CPA
 T.D.
 R.1.47

CLAIM		DATE					
Final	Original	03/11/2012					
	1	-					
	2	-					
	3	-					
	4	-					
	5	-					
	6	-					
	7	-					
	8	-					
	9	-					
	10	-					
	11	-					
	12	-					
	13	-					
	14	-					
	15	-					
	16	-					
	17	-					
	18	-					
	19	-					
	20	-					
	21	-					
	22	-					
	23	-					
	24	-					
	25	-					
	26	-					
	27	-					
	28	-					
	29	-					
	30	-					
	31	-					
	32	-					
	33	-					
	34	-					
	35	-					
	36	-					

Index of Claims 	Application/Control No. 12779660	Applicant(s)/Patent Under Reexamination KRINSKY ET AL.
	Examiner KHANH C TRAN	Art Unit 2611

✓	Rejected	-	Cancelled	N	Non-Elected	A	Appeal
=	Allowed	÷	Restricted	I	Interference	O	Objected

<input type="checkbox"/> Claims renumbered in the same order as presented by applicant			<input type="checkbox"/> CPA			<input type="checkbox"/> T.D.			<input type="checkbox"/> R.1.47		
CLAIM			DATE								
Final	Original	03/11/2012									
	37	-									
	38	-									
	39	-									
	40	-									
	41	-									
	42	-									
	43	-									
	44	✓									
	45	○									
	46	✓									
	47	○									
	48	✓									
	49	○									
	50	✓									
	51	○									
	52	✓									
	53	○									
	54	✓									
	55	○									
	56	✓									
	57	✓									
	58	✓									
	59	✓									
	60	✓									
	61	✓									
	62	✓									
	63	✓									
	64	✓									

Search Notes 	Application/Control No. 12779660	Applicant(s)/Patent Under Reexamination KRINSKY ET AL.
	Examiner KHANH C TRAN	Art Unit 2611

SEARCHED			
Class	Subclass	Date	Examiner

SEARCH NOTES		
Search Notes	Date	Examiner
Update Searches on Parent Cases US Patent 7,835,430 B2 & US Patent 7,889,784 B2	3/11/2012	KCT
Update Double Patenting Searches		KCT

INTERFERENCE SEARCH			
Class	Subclass	Date	Examiner

	/KHANH C TRAN/ Primary Examiner.Art Unit 2611
--	--



UNITED STATES PATENT AND TRADEMARK OFFICE

UNITED STATES DEPARTMENT OF COMMERCE
 United States Patent and Trademark Office
 Address: COMMISSIONER FOR PATENTS
 P.O. Box 1450
 Alexandria, Virginia 22313-1450
 www.uspto.gov

BIB DATA SHEET

CONFIRMATION NO. 8981

SERIAL NUMBER	FILING or 371(c) DATE	CLASS	GROUP ART UNIT	ATTORNEY DOCKET NO.		
12/779,660	05/13/2010	375	2611	5550-2-CON2-1-1		
APPLICANTS David M. Krinsky, Acton, MA; Robert Edmund Pizzano JR., Stoneham, MA;						
** CONTINUING DATA ***** This application is a CON of 12/477,742 06/03/2009 PAT 7,835,430 YES which is a CON of 10/619,691 07/16/2003 PAT 7,570,686 YES which is a DIV of 09/755,173 01/08/2001 PAT 6,658,052 YES which claims benefit of 60/224,308 08/10/2000 YES and claims benefit of 60/174,865 01/07/2000 YES						
** FOREIGN APPLICATIONS ***** NO /KCT/ /KCT/						
** IF REQUIRED, FOREIGN FILING LICENSE GRANTED ** 05/25/2010						
Foreign Priority claimed <input type="checkbox"/> Yes <input checked="" type="checkbox"/> No 35 USC 119(a-d) conditions met <input type="checkbox"/> Yes <input type="checkbox"/> No Verified and Acknowledged <u>/KHANH C TRAN/</u> Examiner's Signature		<input type="checkbox"/> Met after Allowance KCT Initials	STATE OR COUNTRY MA	SHEETS DRAWINGS 2	TOTAL CLAIMS 21 ← 12	INDEPENDENT CLAIMS 15 ← 6
ADDRESS Jason H. Vick Sheridan Ross, PC Suite # 1200 1560 Broadway Denver, CO 80202 UNITED STATES						
TITLE Multicarrier Modulation Messaging for Power Level Per Subchannel Information						
FILING FEE RECEIVED 3782	FEES: Authority has been given in Paper No. _____ to charge/credit DEPOSIT ACCOUNT No. _____ for following:		<input type="checkbox"/> All Fees <input type="checkbox"/> 1.16 Fees (Filing) <input type="checkbox"/> 1.17 Fees (Processing Ext. of time) <input type="checkbox"/> 1.18 Fees (Issue) <input type="checkbox"/> Other _____ <input type="checkbox"/> Credit			

Substitute for form 1449A/PTO				Complete if Known	
INFORMATION DISCLOSURE STATEMENT BY APPLICANT				Application Number	12/779,660
				Filing Date	May 13, 2010
				First Named Inventor	David M. Krinsky
				Art Unit	2611
				Examiner Name	Chayou, Mohammed KHANH C TRAN
				Attorney Docket Number	5550-2-CON-2-1-1
Sheet	1	of	2		

U.S. PATENT DOCUMENTS					
Examiner Initials*	Cite No. ¹	Document Number Number-kind Code ^{2 (if known)}	Publication Date MM-DD-YYYY	Name of Patentee of Applicant of Cited Document	Pages, Columns, Lines, Where Relevant Passages or Relevant Figures Appear
/KCT/	1	13/004254		Krinsky et al. (filed 01-11-2011)	

FOREIGN PATENT DOCUMENTS						
Examiner Initials*	Cite No. ¹	Foreign Patent Document Country Code ³ ; Number ⁴ ; Kind Code ⁵ (if known)	Publication Date MM-DD-YYYY	Name of Patentee or Applicant of Cited Document	Pages, Columns, Lines, Where Relevant Passages or Relevant Figures Appear	T ⁶

OTHER ART (Including Author, Title, Date, Pertinent Pages, etc.)		
Examiner Initials*	Cite No. ¹	
/KCT/	2	Official Action for U.S. Patent Application No. 10/619,691, mailed Oct. 31, 2006 (5550-2-CON-2), 14 pages
/KCT/	3	Official Action for U.S. Patent Application No. 10/619,691, mailed Mar. 30, 2007 (5550-2-CON-2), 11 pages
/KCT/	4	Official Action for U.S. Patent Application No. 10/619,691, mailed Jun. 13, 2008 (5550-2-CON-2), 7 pages
/KCT/	5	Official Action for U.S. Patent Application No. 10/619,691, mailed Oct. 20, 2008 (5550-2-CON-2), 11 pages
/KCT/	6	Notice of Allowance for U.S. Patent Application No. 10/619,691, mailed May 15, 2009 (5550-2-CON-2), 9 pages
/KCT/	7	Notice of Allowance for U.S. Patent Application No. 10/619,691, mailed July 6, 2009 (5550-2-CON-2), 5 pages
/KCT/	8	Official Action for U.S. Patent Application No. 12/779,708, mailed Sep. 29, 2010 (Attorney Ref. No. 5550-2-CON-2-1-2), 6 pages
/KCT/	9	Official Action for U.S. Patent Application No. 12/779,708, mailed Dec. 15, 2010 (Attorney Ref. No. 5550-2-CON-2-1-2), 6 pages
Examiner Signature	/Khanh Tran/ (03/11/2012)	
Date Considered	03/11/2012	

*EXAMINER: Initial if reference is considered, whether or not citation is in conformance and not considered. Include copy of this form with next communication to applicant.

ALL REFERENCES CONSIDERED EXCEPT WHERE LINED THROUGH. /KCT/

Substitute for form 1449A/PTO				Complete if Known	
INFORMATION DISCLOSURE STATEMENT BY APPLICANT				Application Number	12/779,660
				Filing Date	May 13, 2010
				First Named Inventor	David M. Krinsky
				Art Unit	2611
				Examiner Name	Chayou, Mohammad → KHANH C TRAN
				Attorney Docket Number	5550-2-CON-2-1-1
Sheet	2	of	2		

/KCT/	10	Notice of Allowance for U.S. Patent Application No. 12/779,708, mailed Jan. 3, 2011 (Attorney Ref. No. 5550-2-CON-2-1-2), 6 pages
-------	----	---

Examiner Signature	/Khanh Tran/ (03/11/2012)	Date Considered	03/11/2012
--------------------	---------------------------	-----------------	------------

*EXAMINER: Initial if reference is considered, whether or not citation is in conformance and not considered. Include copy of this form with next communication to applicant.

ALL REFERENCES CONSIDERED EXCEPT WHERE LINED THROUGH. /KCT/

Substitute for form 1449A/PTO				Complete if Known	
INFORMATION DISCLOSURE STATEMENT BY APPLICANT				Application Number	12/779,660
				Filing Date	May 13, 2010
				First Named Inventor	David M. Krinsky
				Art Unit	2611
				Examiner Name	Chayou, Mohammad KHANH C TRAN
Sheet	1	of	2	Attorney Docket Number	5550-2-CON-2-1-1

U.S. PATENT DOCUMENTS					
Examiner Initials*	Cite No. ¹	Document Number Number-kind Code ^{2 (if known)}	Publication Date MM-DD-YYYY	Name of Patentee of Applicant of Cited Document	Pages, Columns, Lines, Where Relevant Passages or Relevant Figures Appear
/KCT/	1	5612960	03/18/97	Stevens et al.	

FOREIGN PATENT DOCUMENTS						
Examiner Initials*	Cite No. ¹	Foreign Patent Document Country Code ³ ; Number ⁴ ; Kind Code ^{5 (if known)}	Publication Date MM-DD-YYYY	Name of Patentee or Applicant of Cited Document	Pages, Columns, Lines, Where Relevant Passages or Relevant Figures Appear	T ⁶

OTHER ART (Including Author, Title, Date, Pertinent Pages, etc.)		
Examiner Initials*	Cite No. ¹	
/KCT/	2	ITU-T Recommendation G.992.2, "Splitterless asymmetric digital subscriber line (ADSL) transceivers," International Telecommunication Union, Jun. 1999, 179 pages
/KCT/	3	ITU-T Recommendation G.994.1, "Handshake procedures for digital subscriber line (DSL) transceivers," International Telecommunication Union, Jun. 1999, 56 pages
/KCT/	4	Notice of Acceptance for Australian Patent Application No. 2004203321, dated Aug. 7, 2008 (Attorney Ref. No. 5550-2-PAU-4)
/KCT/	5	Examination Report for Australian Patent Application No. 2009222537, dated Mar. 21, 2011 (Attorney Ref. No. 5550-2-PAU-4-DIV-2)
/KCT/	6	Examination Report for Australian Patent Application No. 2009222537, dated May 27, 2011 (Attorney Ref. No. 5550-2-PAU-4-DIV-2)
/KCT/	7	Communication Under Rule 71(3) EPC for European Patent Application No. EP 06022008, dated Apr. 4, 2011 (Attorney Ref. No. 5550-2-PEP-5)
/KCT/	8	Official Action (including translation) for Japanese Patent Application No. 2001-552611, mailed Mar. 28, 2011 (Attorney Ref. No. 5550-2-PJP)
/KCT/	9	Notice of Allowance for Japanese Patent Application No. 2008-190051, mailed Mar. 14, 2011 (Attorney Ref. No. 5550-2-PJP-DIV)

Examiner Signature	/Khanh Tran/ (03/11/2012)	Date Considered	03/11/2012
--------------------	---------------------------	-----------------	------------

*EXAMINER: Initial if reference is considered, whether or not citation is in conformance and not considered. Include copy of this form with next communication to applicant.

ALL REFERENCES CONSIDERED EXCEPT WHERE LINED THROUGH. /KCT/

Substitute for form 1449A/PTO				Complete if Known	
INFORMATION DISCLOSURE STATEMENT BY APPLICANT				Application Number	12/779,660
				Filing Date	May 13, 2010
				First Named Inventor	David M. Krinsky
				Art Unit	2611
				Examiner Name	Ghayour, Mohammad → KHANH C
Sheet	2	of	2	Attorney Docket Number	5550-2-CON-2-1-1 TRAN

/KCT/	10	Official Action for U.S. Patent Application No. 09/755,173, mailed Jun. 20, 2002 (Attorney Ref. No. 5550-2)
/KCT/	11	Official Action for U.S. Patent Application No. 09/755,173, mailed Sep. 24, 2002 (Attorney Ref. No. 5550-2)
/KCT/	12	Official Action for U.S. Patent Application No. 09/755,173, mailed Mar. 14, 2003 (Attorney Ref. No. 5550-2)
/KCT/	13	Notice of Allowance for U.S. Patent Application No. 09/755,173, mailed Jul. 1, 2003 (Attorney Ref. No. 5550-2)

Examiner Signature	/Khanh Tran/ (03/11/2012)	Date Considered	03/11/2012
--------------------	---------------------------	-----------------	------------

*EXAMINER: Initial if reference is considered, whether or not citation is in conformance and not considered. Include copy of this form with next communication to applicant.

ALL REFERENCES CONSIDERED EXCEPT WHERE LINED THROUGH. /KCT/

Substitute for form 1449A/PTO				Complete if Known	
INFORMATION DISCLOSURE STATEMENT BY APPLICANT				Application Number	12/779,660
				Filing Date	May 13, 2010
				First Named Inventor	David M. Krinsky
				Art Unit	2611
				Examiner Name	Not yet assigned KHANH C. TRAN
Sheet	1	of	4	Attorney Docket Number	5550-2-CON-2-1-1

U.S. PATENT DOCUMENTS					
Examiner Initials*	Cite No. ¹	Document Number Number-kind Code ^{2 (if known)}	Publication Date MM-DD-YYYY	Name of Patentee of Applicant of Cited Document	Pages, Columns, Lines, Where Relevant Passages or Relevant Figures Appear
/KCT/	1	4385384	05/24/83	Rosbury et al.	
	2	4566100	01/21/86	Mizuno et al.	
	3	5128619	07/07/92	Bjork et al.	
	4	5361293	11/01/94	Czerwiec	
	5	5608643	03/04/97	Wichter et al.	
	6	5864602	01/26/99	Needle	
	7	5964891	10/12/99	Caswell et al.	
	8	6073179	06/06/00	Liu et al.	
	9	6075821	06/13/00	Kao et al.	
	10	6175934	01/16/01	Hershey et al.	
	11	6219378	04/17/01	Wu	
	12	6249543	06/19/01	Chow	
	13	6404774	06/11/02	Jenness	
	14	6411678	06/25/02	Tomlinson, Jr. et al.	
	15	6445773	09/03/02	Liang et al.	
	16	6449307	09/10/02	Ishikawa et al.	
	17	6512789	01/28/03	Mirfakhraei	
	18	6631120	10/07/03	Milbrandt	
	19	6633545	10/14/03	Milbrandt	
	20	6636603	10/21/03	Milbrandt	
	21	6658052	12/02/03	Krinsky et al.	
	22	6725176	04/20/04	Long et al.	
	23	7570686	08/04/09	Krinsky et al.	
	24	2009/0238254	09/24/09	Krinsky et al.	
/KCT/	25	12/779708		Krinsky et al. (05-13-2010)	

Examiner Signature	/Khanh Tran/ (03/11/2012)	Date Considered	03/11/2012
--------------------	---------------------------	-----------------	------------

*EXAMINER: Initial if reference is considered, whether or not citation is in conformance and not considered. Include copy of this form with next communication to applicant.

ALL REFERENCES CONSIDERED EXCEPT WHERE LINED THROUGH. /KCT/

Substitute for form 1449A/PTO				Complete if Known	
INFORMATION DISCLOSURE STATEMENT BY APPLICANT				Application Number	12/779,660
				Filing Date	May 13, 2010
				First Named Inventor	David M. Krinsky
				Art Unit	2611
				Examiner Name	Not yet assigned KHANH C TRAN
Sheet	2	of	4	Attorney Docket Number	5550-2-CON-2-1-1

FOREIGN PATENT DOCUMENTS						
Examiner Initials*	Cite No. ¹	Foreign Patent Document Country Code ³ ; Number ⁴ ; Kind Code ⁵ (if known)	Publication Date MM-DD-YYYY	Name of Patentee or Applicant of Cited Document	Pages, Columns, Lines, Where Relevant Passages or Relevant Figures Appear	T ⁶
/KCT/	26	EP 0889615	01/07/99	INTEGRATED TELECOM EXPRESS		
	27	GB 2303032	02/05/97	SAMSUNG ELECTRONICS CO LTD		
	28	JP Hei6(1994)-003956	01/12/94	TELEBIT CORPORATION		(believed to correspond to WO 86/07223 disclosed herein)
	29	JP-A-Hei10(1998)-513622	12/22/98	ADC TELECOMMUNICATIONS INC		(Translated abstract)
	30	JP-A-Hei11(1999)-261665	09/24/99	MATSUSHITA GRAPHIC COMMUNIC		(Translated abstract)
	31	JP-A-Hei11(1999)-317723	11/16/99	MOTOROLA INC		(Translated abstract)
	32	JP-A-Hei11(1999)-508417	07/21/99	ERICSSON TELEFON AB L M		(Translated abstract)
	33	WO 00/64130	10/26/00	TERADYNE INC		
	34	WO 86/07223	12/04/86	TELEBIT CORPORATION		(believed to correspond to JP Hei6(1994)-003956 disclosed herein)
	35	WO 97/01900	01/16/97	ERICSSON AUSTRIA AG		
/KCT/	36	WO 99/020027	04/22/99	Aware		

Examiner Signature	/Khanh Tran/ (03/11/2012)	Date Considered	03/11/2012
--------------------	---------------------------	-----------------	------------

*EXAMINER: Initial if reference is considered, whether or not citation is in conformance and not considered. Include copy of this form with next communication to applicant.

ALL REFERENCES CONSIDERED EXCEPT WHERE LINED THROUGH. /KCT/

Substitute for form 1449A/PTO				Complete if Known	
INFORMATION DISCLOSURE STATEMENT BY APPLICANT				Application Number	12/779,660
				Filing Date	May 13, 2010
				First Named Inventor	David M. Krinsky
				Art Unit	2611
				Examiner Name	Not yet assigned KHANH C. TRAN
				Attorney Docket Number	5550-2-CON-2-1-1
Sheet	3	of	4		

/KCT/	37	WO 99/26375	05/27/99	TEKTRONIX INC		
/KCT/	38	WO 99/63427	12/09/99	GTE LABORATORIES INC		
/KCT/	39	WO 99/67890	12/29/99	PCTEL INC		

OTHER ART (Including Author, Title, Date, Pertinent Pages, etc.)		
Examiner Initials*	Cite No. ¹	
/KCT/	40	Boets P. et al.: "Modeling Aspect of Transmission Line Networks" Proceedings Of The Instrumentation And Measurement Technology Conference, US, New York, IEEE, May 12, 1992, pp. 137-141, XP000343913 ISBN: 0-7803-0640-6
/KCT/	41	Cioffi, John M., ADSL Maintenance with DMT, T1E1.4 ADSL Project, Amati Communications Corporation, December 1, 1992, pages 1-14
/KCT/	42	Lewis L. et al. "Extending Trouble Ticket System to Fault Diagnostics" IEEE Network, IEEE Inc. New York, US, Nov. 1, 1993, pp. 44-51, XP 000575228
/KCT/	43	International Search Report for PCT/US01/00418 dated Jul. 16, 2001; 4 pages (5550-2-PCT)
/KCT/	44	Written Opinion for International (PCT) Patent Application No. PCT/US01/00418, completed March 9, 2002 (5550-2-PCT)
/KCT/	45	International Preliminary Examination Report for International (PCT) Patent Application No. PCT/US01/00418, completed March 9, 2002 (5550-2-PCT)
/KCT/	46	PCT International Search Report dated Oct. 9, 2002 for PCT/US01/41653 (5550-2-PCT-3)
/KCT/	47	Examiner's First Report for Australian Patent Application No. 27669/01, mailed April 2, 2004 (Attorney's Ref. No. 5550-2-PAU)
/KCT/	48	Notice of Acceptance for Australian Patent Application No. 27669/01, mailed August 6, 2004 (Attorney's Ref. No. 5550-2-PAU)
/KCT/	49	Examiner's First Report for Australian Patent Application No. 2004203321, mailed November 16, 2006 (5550-2-PAU4)

Examiner Signature	/Khanh Tran/ (03/11/2012)	Date Considered	03/11/2012
-----------------------	---------------------------	--------------------	------------

*EXAMINER: Initial if reference is considered, whether or not citation is in conformance and not considered. Include copy of this form with next communication to applicant.

ALL REFERENCES CONSIDERED EXCEPT WHERE LINED THROUGH. /KCT/

Substitute for form 1449A/PTO				Complete if Known	
INFORMATION DISCLOSURE STATEMENT BY APPLICANT				Application Number	12/779,660
				Filing Date	May 13, 2010
				First Named Inventor	David M. Krinsky
				Art Unit	2611
				Examiner Name	Not yet assigned KHANH C. TRAN
Sheet	4	of	4	Attorney Docket Number	5550-2-CON-2-1-1

/KCT/	50	Examiner's First Report for Australian Patent Application No. 2008203520, mailed March 9, 2009 (5550-2-PAU4-DIV)
/KCT/	51	Notice of Acceptance for Australian Patent Application No. 2008203520, mailed July 9, 2009 (5550-2-PAU4-DIV)
/KCT/	52	Official Action for Canadian Patent Application No. 2,394,491, mailed November 24, 2009 (Attorney's Ref. No. 5550-2-PCA)
/KCT/	53	Official Action for European Patent Application No. 01901808.4, mailed December 1, 2004 (Attorney's Ref. No. 5550-2-PEP)
/KCT/	54	Official Action for European Patent Application No. 01901808.4, mailed September 14, 2005 (Attorney's Ref. No. 5550-2-PEP)
/KCT/	55	Communication about intention to grant a European patent for European Patent Application No. 01901808.4, mailed May 15, 2006 (Attorney's Ref. No. 5550-2-PEP)
/KCT/	56	European Search Report for European Patent Application No. EP 06022008 completed January 8, 2007 (5550-2-PEP5)
/KCT/	57	Official Action for European Patent Application No. EP 06022008, mailed April 23, 2010 (Attorney's Ref. No. 5550-2-PEP5)
/KCT/	58	Notification of Reasons (including translation) for Refusal for Japanese Patent Application No. 2001-552611, Dispatched Date: December 7, 2009 (Attorney's Ref. No. 5550-2-PJP)
/KCT/	59	Decision to Grant Patent (including translation) For Korean Patent Application No. 10-2002-7008794, dated December 1, 2006 (Attorney's Ref. No. 5550-2-PKR)
/KCT/	60	Official Action for U.S. Patent Application No. 12/477,742, mailed June 8, 2010 (Attorney's Ref. No. 5550-2-CON-2-1)

Examiner Signature	/Khanh Tran/ (03/11/2012)	Date Considered	03/11/2012
--------------------	---------------------------	-----------------	------------

*EXAMINER: Initial if reference is considered, whether or not citation is in conformance and not considered. Include copy of this form with next communication to applicant.

ALL REFERENCES CONSIDERED EXCEPT WHERE LINED THROUGH. /KCT/

Substitute for form 1449A/PTO				Complete if Known	
INFORMATION DISCLOSURE STATEMENT BY APPLICANT				Application Number	12/779,660
				Filing Date	May 13, 2010
				First Named Inventor	David M. Krinsky
				Art Unit	2611
				Examiner Name	Ken, Clish KHANH C TRAN
Sheet	1	of	1	Attorney Docket Number	5550-2-CON-2-1-1

U.S. PATENT DOCUMENTS					
Examiner Initials*	Cite No. ¹	Document Number Number-kind Code ^{2 (if known)}	Publication Date MM-DD-YYYY	Name of Patentee of Applicant of Cited Document	Pages, Columns, Lines, Where Relevant Passages or Relevant Figures Appear

FOREIGN PATENT DOCUMENTS						
Examiner Initials*	Cite No. ¹	Foreign Patent Document Country Code ³ ; Number ⁴ ; Kind Code ^{5 (if known)}	Publication Date MM-DD-YYYY	Name of Patentee or Applicant of Cited Document	Pages, Columns, Lines, Where Relevant Passages or Relevant Figures Appear	T ⁶

OTHER ART (Including Author, Title, Date, Pertinent Pages, etc.)		
Examiner Initials*	Cite No. ¹	
/KCT/	1	Notice of Acceptance for Australian Patent Application No. 2009222537, dated Aug. 25, 2011 (Attorney Ref. No. 5550-2-PAU-4-DIV-2)
/KCT/	2	Official Action for Canadian Patent Application No. 2,726,826, dated Jun. 30, 2011 (Attorney Ref. No. 5550-2-PCA-DIV)

Examiner Signature	/Khanh Tran/ (03/11/2012)	Date Considered	03/11/2012
--------------------	---------------------------	-----------------	------------

*EXAMINER: Initial if reference is considered, whether or not citation is in conformance and not considered. Include copy of this form with next communication to applicant.

ALL REFERENCES CONSIDERED EXCEPT WHERE LINED THROUGH. /KCT/

EAST Search History

EAST Search History (Prior Art)

Ref #	Hits	Search Query	DBs	Default Operator	Plurals	Time Stamp
S1	674	"375"/\$.CCLS. and (channel adj cod\$5) and diversity	US-PGPUB; USPAT	OR	ON	2005/09/09 09:15
S2	230	"375"/\$.CCLS. and ((channel adj cod\$5) same diversity)	US-PGPUB; USPAT	OR	ON	2007/03/27 07:06
S3	1	"6247158".pn.	US-PGPUB; USPAT	OR	ON	2005/09/08 16:58
S4	7	("4577317" "5283780" "5907582" "5909439" "5970085" "6023492" "6049566").PN.	US-PGPUB; USPAT; USOCR	OR	ON	2005/09/08 17:00
S5	1	"6178196".pn.	US-PGPUB; USPAT; USOCR	OR	ON	2005/09/08 17:00
S6	1	"6389063".PN.	US-PGPUB; USPAT	OR	ON	2005/09/09 09:16
S7	1	"6603807".PN.	US-PGPUB; USPAT	OR	ON	2005/09/09 09:16
S8	1	"6359926".PN.	US-PGPUB; USPAT	OR	ON	2005/09/09 09:16
S9	15	"375"/260.CCLS. and ((channel adj cod\$5) same diversity)	US-PGPUB; USPAT	OR	ON	2005/09/15 15:55
S10	1	"6178196".pn.	US-PGPUB; USPAT	OR	ON	2005/09/15 16:00
S11	1	"6693982".pn.	US-PGPUB; USPAT	OR	ON	2005/09/15 16:41
S12	0	cross adj correlated adj base adj band	US-PGPUB; USPAT	OR	ON	2006/02/24 11:01
S13	762	(cross adj correlated) near2 signal	US-PGPUB; USPAT	OR	ON	2005/09/15 16:42
S14	589	(cross adj correlated) near signal	US-PGPUB; USPAT	OR	ON	2005/09/15 16:42
S15	43	S14 with transmit\$5	US-PGPUB; USPAT	OR	ON	2005/09/15 16:50
S16	362	transmitter same diversity same delay	US-PGPUB; USPAT	OR	ON	2005/09/15 16:51
S17	3	transmitter same diversity same (delay adj path)	US-PGPUB; USPAT	OR	ON	2005/09/15 16:51
S18	1196	diversity with delay	US-PGPUB; USPAT	OR	ON	2005/09/15 17:03
S19	139	diversity same (multi adj user)	US-PGPUB; USPAT	OR	ON	2005/09/15 17:04
S20	15	diversity same (plurality adj user) same transmitter	US-PGPUB; USPAT	OR	ON	2005/09/15 17:12
S21	24	diversity same (plurality adj user) same transmission	US-PGPUB; USPAT	OR	ON	2005/09/15 17:06
S22	0	diversity same (plurality adj user)	US-PGPUB; USPAT	OR	ON	2005/09/15

		same (different adj PN)	USPAT			17:11
S23	18	diversity same (plurality adj user) same (PN adi code)	US-PGPUB; USPAT	OR	ON	2005/09/15 17:12
S24	0	diversity same (plurality adj user) same (PN adj code)	US-PGPUB; USPAT	OR	ON	2005/09/15 17:12
S25	34	(plurality adj antenna) same (plurality adj user)	US-PGPUB; USPAT	OR	ON	2005/09/15 17:16
S26	17	(plurality adj antenna) same (plurality adj user) same transmi\$5	US-PGPUB; USPAT	OR	ON	2005/09/15 17:17
S27	0	(plurality adj antenna) same (distinct adj signal)	US-PGPUB; USPAT	OR	ON	2005/09/15 17:18
S28	3	(plurality adj antenna) same (different adj spread adj code)	US-PGPUB; USPAT	OR	ON	2005/09/15 17:18
S29	12	(diversity) same (different adj spread adj code)	US-PGPUB; USPAT	OR	ON	2005/09/15 17:19
S30	0	multiusers same (channel adj coder) same (plurality adj antenna)	US-PGPUB; USPAT	OR	ON	2005/09/16 14:54
S31	3	data same (channel adj coder) same (plurality adj antenna)	US-PGPUB; USPAT	OR	ON	2005/09/16 14:54
S32	1	MIMO same (channel adj coder) same (plurality adj antenna)	US-PGPUB; USPAT	OR	ON	2005/09/16 15:03
S33	3	(MIMO same (channel adj coder)) and (plurality adj antenna)	US-PGPUB; USPAT	OR	ON	2005/09/16 14:56
S34	86	multi adj user adj data	US-PGPUB; USPAT	OR	ON	2005/09/16 14:58
S35	2	S34 and mimo	US-PGPUB; USPAT	OR	ON	2005/09/16 14:56
S36	10	S34 and diversity	US-PGPUB; USPAT	OR	ON	2005/09/16 14:57
S37	0	S34 and (seial adj parallel)	US-PGPUB; USPAT	OR	ON	2005/09/16 14:58
S38	0	S34 and (serial adj parallel)	US-PGPUB; USPAT	OR	ON	2005/09/16 14:58
S39	194399	data same channel coder same (plurality adj antenna)	US-PGPUB; USPAT	OR	ON	2005/09/16 14:59
S40	3	data same (channel adj coder) same (plurality adj antenna)	US-PGPUB; USPAT	OR	ON	2005/09/16 14:59
S41	8	data same (coder) same (plurality adj antenna)	US-PGPUB; USPAT	OR	ON	2005/09/16 15:00
S42	31	data and (channel adj coder) and (plurality adj antenna)	US-PGPUB; USPAT	OR	ON	2005/09/16 15:01
S43	3	(channel adj coder) same MIMO	US-PGPUB; USPAT	OR	ON	2005/09/16 15:02
S44	5	(channel adj coder) same (plurality adj antenna)	US-PGPUB; USPAT	OR	ON	2005/09/16 15:03
S45	66	(encoder) same (plurality adj antenna)	US-PGPUB; USPAT	OR	ON	2005/09/16 15:16
S46	5	"6285720"	US-PGPUB; USPAT	OR	ON	2005/09/16 15:06
S47	13	"375"/\$.ccls. and (multi adj user adj data)	US-PGPUB; USPAT	OR	ON	2005/09/16 15:19
S48	48	"375"/\$.ccls. and ((multi adj user) same TDMA)	US-PGPUB; USPAT	OR	ON	2005/09/16 15:20
S49	9	"375"/\$.ccls. and ((multi adj user)	US-PGPUB;	OR	ON	2005/09/16;

		same FDD)	USPAT			15:21
S50	10	"370"/\$.cls. and ((multi adj user) same FDD)	US-PGPUB; USPAT	OR	ON	2005/09/16 15:22
S51	1	"370"/\$.cls. and ((channel adj encoder) same FDD)	US-PGPUB; USPAT	OR	ON	2005/09/16 15:24
S52	0	"370"/\$.cls. and ((channel adj coder) same FDD)	US-PGPUB; USPAT	OR	ON	2005/09/16 15:24
S53	1	((channel adj coder) same FDD)	US-PGPUB; USPAT	OR	ON	2005/09/16 15:24
S54	0	((channel adj coder) same (multi adj user))	US-PGPUB; USPAT	OR	ON	2005/09/16 15:24
S55	1	((channel adj encoder) same (multi adj user))	US-PGPUB; USPAT	OR	ON	2005/09/16 15:26
S56	16	((spatial adj diversity) same (multi adj user))	US-PGPUB; USPAT	OR	ON	2005/09/16 15:27
S57	99	((spatial adj diversity) and (multi adj user))	US-PGPUB; USPAT	OR	ON	2005/09/16 15:36
S58	3	"6359864"	US-PGPUB; USPAT	OR	ON	2005/09/16 15:31
S59	106	((FDD and CDMA) and (multi adj user))	US-PGPUB; USPAT	OR	ON	2005/09/16 15:31
S60	11	((spatial adj diversity) and (channel adj coder))	US-PGPUB; USPAT	OR	ON	2005/09/16 15:36
S61	5	("5321725" "5784417" "6031474" "6088408" "6473878").PN.	US-PGPUB; USPAT; USOCR	OR	ON	2005/09/16 15:48
S62	38154	data adj source	US-PGPUB; USPAT; USOCR	OR	ON	2005/09/16 15:48
S63	19	S62 with (multi adj user)	US-PGPUB; USPAT; USOCR	OR	ON	2005/09/16 15:53
S64	3	(frequency adj division adj duplex) same (multi adj user) same CDMA	US-PGPUB; USPAT; USOCR	OR	ON	2005/09/16 15:51
S65	5	("5559723" "5905946" "5933457" "6161209" "6615024").PN.	US-PGPUB; USPAT; USOCR	OR	ON	2005/09/16 15:52
S66	0	(multi adj user adj source)	US-PGPUB; USPAT; USOCR	OR	ON	2005/09/16 15:53
S67	25	((multi adj user) near2 source)	US-PGPUB; USPAT; USOCR	OR	ON	2005/09/16 15:53
S68	23266	((multi adj user) near2 source) amd MIMO	US-PGPUB; USPAT; USOCR	OR	ON	2005/09/16 15:53
S69	0	((multi adj user) near2 source) and MIMO	US-PGPUB; USPAT; USOCR	OR	ON	2005/09/16 15:55
S70	1	"6693982".pn.	US-PGPUB; USPAT; USOCR	OR	ON	2005/09/16 16:11
S71	1	"5886967".pn.	US-PGPUB; USPAT; USOCR	OR	ON	2005/09/16 16:11

S72	1	"5886987".pn.	US-PGPUB; USPAT; USOCR	OR	ON	2005/09/16: 16:13
S73	6	(information adj source) near2 (different adj source)	US-PGPUB; USPAT; USOCR	OR	ON	2005/09/16: 16:13
S74	323	"375"/\$.ccls. and (multiple adj access adj interference)	US-PGPUB; USPAT; USOCR	OR	ON	2005/09/16: 16:14
S75	32	"375"/\$.ccls. and (multiple adj access adj interference) and (demultiplex\$5)	US-PGPUB; USPAT; USOCR	OR	ON	2005/09/16: 16:16
S76	7	"375"/\$.ccls. and (multiple adj access adj interference) and (demultiplex\$5) and coder	US-PGPUB; USPAT; USOCR	OR	ON	2005/09/16: 16:14
S77	28	"375"/\$.ccls. and (multiple adj channel) and (channel adj coder)	US-PGPUB; USPAT; USOCR	OR	ON	2005/09/16: 16:16
S78	1	"6741658".pn.	US-PGPUB; USPAT	OR	ON	2005/09/18: 08:43
S79	1	"6898248".pn.	US-PGPUB; USPAT	OR	ON	2005/09/18: 08:44
S80	1	"6359864".pn.	US-PGPUB; USPAT	OR	ON	2006/02/21: 10:50
S81	1	"6310923".pn.	US-PGPUB; USPAT	OR	ON	2006/02/21: 10:50
S82	3	375/267.ccls. and (transmit near (different adj information))	US-PGPUB; USPAT	OR	ON	2006/02/24: 13:52
S83	1	"6693982".pn.	US-PGPUB; USPAT	OR	ON	2006/02/24: 15:16
S84	561	mapper with identif\$8	US-PGPUB; USPAT	OR	ON	2006/02/24: 15:16
S85	71	"375"/\$.ccls. and (mapper with identif\$8)	US-PGPUB; USPAT	OR	ON	2006/02/24: 15:16
S86	1	"6693982".pn.	US-PGPUB; USPAT	OR	ON	2006/02/27: 09:36
S87	171	space adj time adj block adj code	US-PGPUB; USPAT	OR	ON	2006/02/27: 13:37
S88	25	S87 and (spread adj spectrum)	US-PGPUB; USPAT	OR	ON	2006/02/27: 10:11
S89	2	S87 and (spread adj code)	US-PGPUB; USPAT	OR	ON	2006/02/27: 09:36
S90	126	(angle adj diversity)	US-PGPUB; USPAT	OR	ON	2006/02/27: 10:12
S91	0	S87 and S90	US-PGPUB; USPAT	OR	ON	2006/02/27: 10:11
S92	155	space adj time adj diversity	US-PGPUB; USPAT	OR	ON	2006/02/27: 10:12
S93	3	S90 and S92	US-PGPUB; USPAT	OR	ON	2006/02/27: 10:12
S94	3	(angle adj diversity) same (fading adj channel)	US-PGPUB; USPAT	OR	ON	2006/02/27: 10:17
S95	1	(angle adj diversity) same (directed adj antenna adj beam)	US-PGPUB; USPAT	OR	ON	2006/02/27: 10:17

S96	1	((plurality adj antenna) same (code adj rate) same adapt\$8)	US-PGPUB; USPAT	OR	ON	2006/02/27 10:54
S97	4	((plurality adj antenna) same (code adj rate)) and adapt\$8	US-PGPUB; USPAT	OR	ON	2006/02/27 10:55
S98	0	((plurality adj antenna) same (adapt\$8 adj code adj rate))	US-PGPUB; USPAT	OR	ON	2006/02/27 10:55
S99	0	((adaptive adj antenna) same (adapt\$8 adj code adj rate))	US-PGPUB; USPAT	OR	ON	2006/02/27 10:55
S100	0	((adaptive adj antenna) and (adapt\$8 adj code adj rate))	US-PGPUB; USPAT	OR	ON	2006/02/27 15:02
S101	94	((adaptive adj modulation) and (adaptive adj cod\$5))	US-PGPUB; USPAT	OR	ON	2006/02/27 13:11
S102	1	"5383219".pn.	US-PGPUB; USPAT	OR	ON	2006/02/27 13:36
S103	50	S87 and (transmit adj power)	US-PGPUB; USPAT	OR	ON	2006/02/27 13:43
S104	1	"6693982".pn.	US-PGPUB; USPAT	OR	ON	2006/02/27 14:05
S105	5828	channel adj estimat\$5	US-PGPUB; USPAT	OR	ON	2006/02/27 14:05
S106	1751	channel adj estimator	US-PGPUB; USPAT	OR	ON	2006/02/27 14:06
S107	48	S106 same (channel adj equalizer)	US-PGPUB; USPAT	OR	ON	2006/02/27 14:08
S108	3	S107 and (space adj time)	US-PGPUB; USPAT	OR	ON	2006/02/27 14:08
S109	7	375/267.ccls. and recod\$5	US-PGPUB; USPAT	OR	ON	2006/02/27 15:07
S110	3	("5781845" "6067324" "6122260").PN.	US-PGPUB; USPAT; USOCR	OR	ON	2006/02/27 15:06
S111	3	"375"/\$.ccls. and recod\$5 and (MAI)	US-PGPUB; USPAT	OR	ON	2006/02/27 15:08
S112	1	"375"/\$.ccls. and reencod\$5 and (MAI)	US-PGPUB; USPAT	OR	ON	2006/02/27 15:10
S113	7	reencod\$5 and (MAI)	US-PGPUB; USPAT	OR	ON	2006/02/27 15:08
S114	0	"375"/148.ccls. and reencod\$5 and (MAI)	US-PGPUB; USPAT	OR	ON	2006/02/27 15:14
S115	0	"375"/148.ccls. and reencod\$5 and (space adj time adj diversity)	US-PGPUB; USPAT	OR	ON	2006/02/27 15:14
S116	0	"375"/\$.ccls. and reencod\$5 and (space adj time adj diversity)	US-PGPUB; USPAT	OR	ON	2006/02/27 15:14
S117	0	"375"/\$.ccls. and reencod\$5 and ((space adj time) near2 code)	US-PGPUB; USPAT	OR	ON	2006/02/27 15:15
S118	0	"375"/\$.ccls. and reencod\$5 and ((space adj time) with code)	US-PGPUB; USPAT	OR	ON	2006/02/27 15:15
S119	7	"375"/\$.ccls. and (re adj encod\$5) and ((space adj time) with code)	US-PGPUB; USPAT	OR	ON	2006/02/27 15:15
S120	56	375/260.ccls. and Channeliz\$6	US-PGPUB; USPAT	OR	ON	2006/08/10 16:58
S121	180	375/267.ccls. and (space adj time adj cod\$8)	US-PGPUB; USPAT	OR	ON	2006/08/11 11:15
S122	1	"6366888".pn.	US-PGPUB; USPAT	OR	ON	2006/08/11

			USPAT			11:15
S123	3	375/267.ccls. and (non adj interleav\$8)	US-PGPUB; USPAT	OR	ON	2006/08/11 11:17
S124	11	375/260.ccls. and (non adj interleav\$8)	US-PGPUB; USPAT	OR	ON	2006/08/11 11:22
S125	0	"375"/\$.ccls. and ((inner adj cod\$5) same (outer adj cod\$6) same(non adj interleav\$8))	US-PGPUB; USPAT	OR	ON	2006/08/11 11:24
S126	2	"375"/\$.ccls. and ((inner adj cod\$5) same (outer adj cod\$6)) and(non adj interleav\$8)	US-PGPUB; USPAT	OR	ON	2006/08/11 11:24
S127	0	"375"/\$.ccls. and ((outer adj cod\$6) same(non adj interleav\$8))	US-PGPUB; USPAT	OR	ON	2006/08/11 11:25
S128	3	"375"/267.ccls. and ((cod\$6) same(non adj interleav\$8))	US-PGPUB; USPAT	OR	ON	2006/08/11 11:25
S129	2	"375"/267.ccls. and ((transmit\$5) with(non adj interleav\$8))	US-PGPUB; USPAT	OR	ON	2006/08/11 11:27
S130	4	"375"/267.ccls. and ((transmit\$5) with(without adj interleav\$8))	US-PGPUB; USPAT	OR	ON	2006/08/11 11:27
S131	180	"375"/267.ccls. and (space adj time adj cod\$6)	US-PGPUB; USPAT	OR	ON	2006/08/11 11:28
S132	1	"6115427".pn.	US-PGPUB; USPAT	OR	ON	2006/08/16 08:06
S133	1	"6693982".pn.	US-PGPUB; USPAT	OR	ON	2006/08/16 08:06
S134	3	09/393235	US-PGPUB; USPAT	OR	ON	2006/08/16 13:47
S135	353	combin\$3 with serializ\$3	US-PGPUB; USPAT	OR	ON	2006/08/16 13:48
S136	3383513	number of transmitter antennas	US-PGPUB; USPAT	OR	ON	2007/03/20 07:30
S137	1	10/184054	US-PGPUB; USPAT	OR	ON	2007/03/20 09:21
S138	1	10/619691	US-PGPUB; USPAT	OR	ON	2007/03/20 09:37
S139	1	"6636603".pn.	US-PGPUB; USPAT	OR	ON	2007/03/20 09:41
S140	1	"20040202237"	US-PGPUB; USPAT	OR	ON	2007/03/20 15:17
S141	1	09/798727	US-PGPUB; USPAT	OR	ON	2007/03/20 15:17
S142	1	"6745050".pn.	US-PGPUB; USPAT	OR	ON	2007/03/23 08:55
S143	6	("20020097779" "4794556" "4941178" "5668830" "6480557" "RE31943").PN.	US-PGPUB; USPAT; USOCR	OR	OFF	2007/03/23 08:55
S144	695	CDMA same (multi adj user)	US-PGPUB; USPAT; USOCR	OR	OFF	2007/03/23 08:55
S145	374	"375"/\$.ccls. and (CDMA same (multi adj user))	US-PGPUB; USPAT; USOCR	OR	OFF	2007/03/23 08:56
S146	287	"375"/\$.ccls. and (CDMA with (multi adj user))	US-PGPUB; USPAT; USOCR	OR	OFF	2007/03/23 08:56

S147	0	"375"/\$.ccls. and (CDMA with (multi adj user)) and (interference adj cancel\$&)	US-PGPUB; USPAT; USOCR	OR	OFF	2007/03/23 08:57
S148	89	"375"/\$.ccls. and (CDMA with (multi adj user)) and (interference adj cancel\$5)	US-PGPUB; USPAT; USOCR	OR	OFF	2007/03/23 08:57
S149	8	("4134071" "4744093" "5136612" "5164959" "5361219" "5363403" "5481533" "5790590").PN.	US-PGPUB; USPAT; USOCR	OR	OFF	2007/03/23 08:58
S150	14	("5956333").URFN.	USPAT	OR	OFF	2007/03/23 09:01
S151	1	09/326222.app.	US-PGPUB; USPAT; DERWENT; IBM_TDB	OR	OFF	2007/03/23 09:01
S152	11	("4124818" "4992798" "5418814" "5467368" "5566165" "5596600" "5724378" "5956333" "6032026" "6088383" "6229857").PN.	US-PGPUB; USPAT; USOCR	OR	OFF	2007/03/23 09:03
S153	11	"375"/\$.ccls. and (multi adj user adj demodul\$8)	US-PGPUB; USPAT; USOCR	OR	OFF	2007/03/27 11:53
S154	0	"375"/\$.ccls. and (multi adj user) and remodult\$6	US-PGPUB; USPAT; USOCR	OR	OFF	2007/03/23 09:09
S155	23	"375"/\$.ccls. and (multi adj user) and remodulat\$6	US-PGPUB; USPAT; USOCR	OR	OFF	2007/03/23 09:05
S156	0	"370"/\$.ccls. and (multi adj user) and remodult\$6	US-PGPUB; USPAT; USOCR	OR	OFF	2007/03/23 09:09
S157	0	"455"/\$.ccls. and (multi adj user) and remodult\$6	US-PGPUB; USPAT; USOCR	OR	OFF	2007/03/23 09:10
S158	0	"455"/\$.ccls. and (user) and remodult\$6	US-PGPUB; USPAT; USOCR	OR	OFF	2007/03/23 09:10
S159	237	"455"/\$.ccls. and (user) and remodulat\$6	US-PGPUB; USPAT; USOCR	OR	OFF	2007/03/23 09:10
S160	10	"455"/\$.ccls. and (multiuser) and remodulat\$6	US-PGPUB; USPAT; USOCR	OR	OFF	2007/03/23 09:11
S161	30	(multiuser) and remodulat\$6 and CDMA	US-PGPUB; USPAT; USOCR	OR	OFF	2007/03/23 09:14
S162	873	(multiuser) and CDMA	US-PGPUB; USPAT; USOCR	OR	OFF	2007/03/23 09:14
S163	523	"375"/\$.ccls. and (multiuser) and CDMA	US-PGPUB; USPAT; USOCR	OR	OFF	2007/03/23 09:14
S164	299	"375"/\$.ccls. and ((multiuser) same CDMA)	US-PGPUB; USPAT; USOCR	OR	OFF	2007/03/23 09:14
S165	1	"5956333".pn.	US-PGPUB; USPAT	OR	ON	2007/03/26 09:23

S166	1	"5644592".pn.	US-PGPUB; USPAT	OR	ON	2007/03/26 09:30
S167	1	10/184054	US-PGPUB; USPAT	OR	ON	2007/03/26 10:06
S168	1	"6115427".pn.	US-PGPUB; USPAT	OR	ON	2007/03/26 10:28
S169	49	375/267.ccls. and (multiuser)	US-PGPUB; USPAT	OR	ON	2007/03/26 10:32
S170	6	375/260.ccls. and (multiuser same diversity)	US-PGPUB; USPAT	OR	ON	2007/03/26 10:33
S171	2	375/295.ccls. and (multiuser same diversity)	US-PGPUB; USPAT	OR	ON	2007/03/26 10:34
S172	8	375/130.ccls. and (multiuser same diversity)	US-PGPUB; USPAT	OR	ON	2007/03/26 10:38
S173	1	375/299.ccls. and (multiuser same diversity)	US-PGPUB; USPAT	OR	ON	2007/03/26 10:35
S174	16	375/299.ccls. and (multiuser)	US-PGPUB; USPAT	OR	ON	2007/03/26 10:35
S175	41	375/130.ccls. and (multiuser)	US-PGPUB; USPAT	OR	ON	2007/03/26 10:38
S176	13	375/130.ccls. and (multiuser and PN)	US-PGPUB; USPAT	OR	ON	2007/03/26 10:40
S177	355	375/299.ccls.	US-PGPUB; USPAT	OR	ON	2007/03/26 10:40
S178	167	375/299.ccls. and user	US-PGPUB; USPAT	OR	ON	2007/03/26 10:40
S179	10	375/299.ccls. and (user same PN)	US-PGPUB; USPAT	OR	ON	2007/03/26 10:53
S180	708	"375"/\$.ccls. and (multi adj user) and CDMA	US-PGPUB; USPAT	OR	ON	2007/03/26 10:54
S181	294	"375"/\$.ccls. and (multi adj user) and CDMA and diversity	US-PGPUB; USPAT	OR	ON	2007/03/26 10:54
S182	19	"375"/\$.ccls. and ((multi adj user) same CDMA same diversity)	US-PGPUB; USPAT	OR	ON	2007/03/26 10:59
S183	14	"455"/\$.ccls. and ((multi adj user) same CDMA same diversity)	US-PGPUB; USPAT	OR	ON	2007/03/26 11:03
S184	134	"375"/267.ccls. and ((user) same CDMA)	US-PGPUB; USPAT	OR	ON	2007/03/26 11:18
S185	0	"375"/267.ccls. and (variable near3 rate) same (number adj antenna)	US-PGPUB; USPAT	OR	ON	2007/03/26 11:19
S186	9	"375"/267.ccls. and (variable near3 rate) and (number adj antenna)	US-PGPUB; USPAT	OR	ON	2007/03/26 11:19
S187	7	"375"/\$.ccls. and (variable near3 rate) and (number adj antenna) and (variable adj coding adj rate)	US-PGPUB; USPAT	OR	ON	2007/03/26 11:34
S188	1	"6349216".pn.	US-PGPUB; USPAT	OR	ON	2007/03/26 11:35
S189	53	("4041395" "4147985" "4165493" "4348644" "4356458" "4370622" "4442407" "4546313" "4647871" "4827219" "4890062" "4924191" "4985686" "4990866" "4994757" "5060294" "5101172" "5113414" "5119040" "5170496" "5195045" "5220276" "5251330" "5251331"	US-PGPUB; USPAT; USOCR	OR	OFF	2007/03/26 13:31

		"5276912" "5278997" "5300894" "5302914" "5329244" "5339041" "5351016" "5361403" "5408691" "5420536" "5428828" "5483680" "5553318" "5564086" "5589796" "5598127" "5640691" "5673001" "5694433" "5742201" "5880633" "5901346" "5905407" "5907797" "6020787" "6069525" "6141541" "6160449" "6166598").PN.				
S190	1	"6947491".pn.	US-PGPUB; USPAT; USOCR	OR	OFF	2007/03/26 14:03
S191	188	(code adj rate) and (increas\$5 with antenna)	US-PGPUB; USPAT; USOCR	OR	OFF	2007/03/26 14:04
S192	6	(code adj rate) same (increas\$5 with antenna)	US-PGPUB; USPAT; USOCR	OR	OFF	2007/03/26 15:23
S193	243	375/267.ccls. and (close loop adj power adj control)	US-PGPUB; USPAT; USOCR	OR	OFF	2007/03/26 15:23
S194	1986913	375/267.ccls. and multiuser (close loop adj power adj control)	US-PGPUB; USPAT; USOCR	OR	OFF	2007/03/26 15:24
S195	7	375/267.ccls. and multiuser and (close loop adj power adj control)	US-PGPUB; USPAT; USOCR	OR	OFF	2007/03/26 15:24
S196	0	375/267.ccls. and multiuser and (close\$2 adj loop adj power adj control)	US-PGPUB; USPAT; USOCR	OR	OFF	2007/03/26 15:25
S197	1	"6115406".pn.	US-PGPUB; USPAT; USOCR	OR	OFF	2007/03/26 15:25
S198	6	("4901307" "5652764" "5886987" "5952968" "5982327" "5991332").PN.	US-PGPUB; USPAT; USOCR	OR	OFF	2007/03/26 15:31
S199	13	("4835790" "5267262" "5347535" "5412686" "5485486" "5548835" "5559789" "5574983" "5581547" "5590409" "5598404" "5604766" "5646937").PN.	US-PGPUB; USPAT; USOCR	OR	OFF	2007/03/26 15:45
S200	26	("5886987").URFN.	USPAT	OR	OFF	2007/03/26 15:47
S201	13	("4835790" "5267262" "5347535" "5412686" "5485486" "5548835" "5559789" "5574983" "5581547" "5590409" "5598404" "5604766" "5646937").PN.	US-PGPUB; USPAT; USOCR	OR	OFF	2007/03/26 15:57
S202	5	"375"/267.CCLS. and (MIMO and (MAI))	US-PGPUB; USPAT	OR	ON	2007/03/27 07:06
S203	7	"375"/260.CCLS. and (MIMO and (MAI))	US-PGPUB; USPAT	OR	ON	2007/03/27 07:07
S204	30	"375"/\$.CCLS. and (MIMO and (MAI))	US-PGPUB; USPAT	OR	ON	2007/03/27 07:08
S205	18	"370"/\$.CCLS. and (MIMO and (MAI))	US-PGPUB; USPAT	OR	ON	2007/03/27 07:09
S206	7	"455"/\$.CCLS. and (MIMO and (MAI))	US-PGPUB;	OR	ON	2007/03/27

			USPAT			07:09
S207	10	"455"/\$.CCLS. and (OFDM and (MAI))	US-PGPUB; USPAT	OR	ON	2007/03/27 07:12
S208	39	"370"/\$.CCLS. and (OFDM and (MAI))	US-PGPUB; USPAT	OR	ON	2007/03/27 07:10
S209	39	"375"/\$.CCLS. and (OFDM and (MAI))	US-PGPUB; USPAT	OR	ON	2007/03/27 08:04
S210	1	"6115427".pn.	US-PGPUB; USPAT	OR	ON	2007/03/27 08:05
S211	81	(code adj rate) same (number near antenna)	US-PGPUB; USPAT	OR	ON	2007/03/27 08:20
S212	1	"6560295".pn.	US-PGPUB; USPAT	OR	ON	2007/03/27 08:52
S213	387	(space adj time) same CDMA	US-PGPUB; USPAT	OR	ON	2007/03/27 08:53
S214	68	375/267.ccls. and ((space adj time) same CDMA)	US-PGPUB; USPAT	OR	ON	2007/03/27 09:15
S215	2	375/267.ccls. and (compar\$8 with uplink with downlink)	US-PGPUB; USPAT	OR	ON	2007/03/27 09:16
S216	1	375/222.ccls. and (compar\$8 with uplink with downlink)	US-PGPUB; USPAT	OR	ON	2007/03/27 09:21
S217	0	375/222.ccls. and ((compar\$8 with uplink with downlink) same interference)	US-PGPUB; USPAT	OR	ON	2007/03/27 09:21
S218	9	"375"/\$.ccls. and ((compar\$8 with uplink with downlink) same interference)	US-PGPUB; USPAT	OR	ON	2007/03/27 09:22
S219	0	"375"/222.ccls. and (diagnostic adj bit)	US-PGPUB; USPAT; USOCR	OR	OFF	2007/03/27 11:54
S220	0	"375"/222.ccls. and (diagnostic adj tone)	US-PGPUB; USPAT; USOCR	OR	OFF	2007/03/27 11:54
S221	0	"370"/\$.ccls. and (diagnostic adj tone)	US-PGPUB; USPAT; USOCR	OR	OFF	2007/03/27 13:14
S222	19	"370"/\$.ccls. and (diagnostic with tone)	US-PGPUB; USPAT; USOCR	OR	OFF	2007/03/27 13:17
S223	0	375/222.ccls. and (diagnostic adj tone)	US-PGPUB; USPAT	OR	ON	2007/03/27 13:19
S224	0	375/222.ccls. and (diagnostic with tone)	US-PGPUB; USPAT	OR	ON	2007/03/27 13:19
S225	22	375/222.ccls. and (diagnostic with bit)	US-PGPUB; USPAT	OR	ON	2007/03/27 13:26
S226	8	("5889856" "6137839" "6263016" "6374288" "6400759" "6442195" "6477595" "6594306").PN.	US-PGPUB; USPAT; USOCR	OR	OFF	2007/03/27 13:22
S227	0	375/222.ccls. and (diagnostic with DMT)	US-PGPUB; USPAT	OR	ON	2007/03/27 13:43
S228	0	"375"/\$.ccls. and (diagnostic with DMT)	US-PGPUB; USPAT	OR	ON	2007/03/27 13:26
S229	0	"370"/\$.ccls. and (diagnostic with DMT)	US-PGPUB; USPAT	OR	ON	2007/03/27 13:26
S230	0	"370"/\$.ccls. and (diagnostic same	US-PGPUB;	OR	ON	2007/03/27

		DMT)	USPAT			13:27
S231	1	"375"/\$.ccls. and (diagnostic same DMT)	US-PGPUB; USPAT	OR	ON	2007/03/27 13:39
S232	113	"375"/\$.ccls. and (diagnostic same message)	US-PGPUB; USPAT	OR	ON	2007/03/27 13:39
S233	4	"375"/\$.ccls. and (diagnostic same message) and DMT	US-PGPUB; USPAT	OR	ON	2007/03/27 13:41
S234	6	"370"/\$.ccls. and (diagnostic same message) and DMT	US-PGPUB; USPAT	OR	ON	2007/03/27 13:42
S235	0	"370"/\$.ccls. and (diagnostic same DMT)	US-PGPUB; USPAT	OR	ON	2007/03/27 13:42
S236	1	"375"/\$.ccls. and (diagnostic same DMT)	US-PGPUB; USPAT	OR	ON	2007/03/27 13:45
S237	15	(diagnostic same DMT)	US-PGPUB; USPAT	OR	ON	2007/03/27 13:43
S238	1	375/222.ccls. and (diagnostic adj message)	US-PGPUB; USPAT	OR	ON	2007/03/27 13:43
S239	0	375/260.ccls. and (diagnostic adj message) and DMT	US-PGPUB; USPAT	OR	ON	2007/03/27 13:44
S240	0	375/260.ccls. and (diagnostic adj message)	US-PGPUB; USPAT	OR	ON	2007/03/27 13:44
S241	21	375/260.ccls. and (diagnostic)	US-PGPUB; USPAT	OR	ON	2007/03/27 13:44
S242	5	375/260.ccls. and (diagnostic) and DMT	US-PGPUB; USPAT	OR	ON	2007/03/27 13:45
S243	5	375/260.ccls. and (diagnostic) and OFDM	US-PGPUB; USPAT	OR	ON	2007/03/27 13:45
S244	1	"379"/\$.ccls. and (diagnostic same DMT)	US-PGPUB; USPAT	OR	ON	2007/03/27 13:45
S245	5	"379"/\$.ccls. and (diagnostic same bins)	US-PGPUB; USPAT	OR	ON	2007/03/27 13:46
S246	3	"375"/\$.ccls. and (diagnostic same bins)	US-PGPUB; USPAT	OR	ON	2007/03/27 13:46
S247	12	"370"/\$.ccls. and (diagnostic same bins)	US-PGPUB; USPAT	OR	ON	2007/03/27 13:47
S248	3	"370"/\$.ccls. and (bit with diagnostic) and DMT	US-PGPUB; USPAT	OR	ON	2007/03/27 13:48
S249	7	"375"/\$.ccls. and (bit with diagnostic) and DMT	US-PGPUB; USPAT	OR	ON	2007/03/27 13:50
S250	0	"702"/\$.ccls. and (bit with diagnostic) and DMT	US-PGPUB; USPAT	OR	ON	2007/03/27 13:50
S251	0	"370"/249.ccls. and (bit with diagnostic) and DMT	US-PGPUB; USPAT	OR	ON	2007/03/27 13:52
S252	0	"370"/249.ccls. and (diagnostic) and DMT	US-PGPUB; USPAT	OR	ON	2007/03/27 13:52
S253	65	"370"/249.ccls. and (diagnostic)	US-PGPUB; USPAT	OR	ON	2007/03/27 13:52
S254	1	"370"/249.ccls. and (diagnostic adj message)	US-PGPUB; USPAT	OR	ON	2007/03/27 13:52
S255	1	"370"/249.ccls. and (initiat\$5 near2 diagnostic)	US-PGPUB; USPAT	OR	ON	2007/03/27 14:37
S256	0	dianostic same (DMT adj symbol)	US-PGPUB; USPAT	OR	ON	2007/03/27 14:37
S257	0	diagnostic same (DMT adj symbol)	US-PGPUB; USPAT	OR	ON	2007/03/27

			USPAT			14:37
S258	0	"375"/\$.ccls. and (diagnostic same (DMT adj symbol))	US-PGPUB; USPAT	OR	ON	2007/03/27 14:37
S259	9	"375"/\$.ccls. and (diagnostic and (DMT adj symbol))	US-PGPUB; USPAT	OR	ON	2007/03/27 14:57
S260	1	"375"/\$.ccls. and (diagnostic same DMT)	US-PGPUB; USPAT	OR	ON	2007/03/27 14:58
S261	19	"375"/\$.ccls. and (bit near2 diagnostic)	US-PGPUB; USPAT	OR	ON	2007/03/27 15:00
S262	1	"375"/\$.ccls. and (map\$5 with (bit near2 diagnostic))	US-PGPUB; USPAT	OR	ON	2007/03/27 15:00
S263	12	("4566100" "5128619" "5608643" "5864602" "5964891" "6075821" "6188717" "6219378" "6404774" "6411678" "6449307" "6512789").PN.	US-PGPUB; USPAT; USOCR	OR	OFF	2007/03/27 15:07
S264	0	map\$7 with diagnostic with DMT	US-PGPUB; USPAT; USOCR	OR	OFF	2007/03/27 15:08
S265	0	map\$7 with diagnostic with DMT	US-PGPUB; USPAT; IBM_TDB	OR	OFF	2007/03/27 15:09
S266	0	map\$7 with (diagnostic adj bit) with DMT	US-PGPUB; USPAT; IBM_TDB	OR	OFF	2007/03/27 15:09
S267	1	375/260.ccls. and DMT and diagnostic	US-PGPUB; USPAT; IBM_TDB	OR	OFF	2007/03/27 15:13
S268	13	375/222.ccls. and DMT and diagnostic	US-PGPUB; USPAT; IBM_TDB	OR	OFF	2007/03/27 15:10
S269	0	375/260.ccls. and (diagnostic adj bit)	US-PGPUB; USPAT; IBM_TDB	OR	OFF	2007/03/27 15:13
S270	1	"375"/\$.ccls. and (diagnostic adj bit)	US-PGPUB; USPAT; IBM_TDB	OR	OFF	2007/03/27 15:13
S271	1	"379"/\$.ccls. and (diagnostic adj bit)	US-PGPUB; USPAT; IBM_TDB	OR	OFF	2007/03/27 15:14
S272	69	(diagnostic adj bit)	US-PGPUB; USPAT; IBM_TDB	OR	OFF	2007/03/27 15:15
S273	0	(diagnostic adj bit) and DMT	US-PGPUB; USPAT; IBM_TDB	OR	OFF	2007/03/27 15:14
S274	0	(diagnostic adj bit) and multicarrier	US-PGPUB; USPAT; IBM_TDB	OR	OFF	2007/03/27 15:14
S275	0	(diagnostic adj message) and (DMT adj symbol)	US-PGPUB; USPAT; IBM_TDB	OR	OFF	2007/03/27 15:16
S276	1	(diagnostic adj message) and (DMT adj symbol)	US-PGPUB; USPAT; IBM_TDB	OR	OFF	2007/03/27 16:15
S277	4	10/127164	US-PGPUB;	OR	OFF	2007/03/27

			USPAT; IBM_TDB			16:15
S278	44	("20020006169" "20020191709" "20030067995" "3898566" "4878232" "5163181" "5228055" "5249201" "5490172" "5493587" "5579342" "5608760" "5621762" "5636247" "5638404" "5651028" "5727026" "5751705" "5805640" "5822360" "5930678" "5991262" "6009090" "6032029" "6041081" "6125103" "6128351" "6130918" "6175551" "6222873" "6229995" "6236864" "6240141" "6246725" "6294956" "6356606" "6449302" "6504862" "6687511" "6701163" "6931053" "6931079" "6931239" "6931240").PN.	US-PGPUB; USPAT; USOCR	OR	OFF	2007/03/27 16:19
S279	1	"5930678".pn.	US-PGPUB; USPAT; USOCR	OR	OFF	2007/03/27 16:19
S280	0	(diagnostic adj DMT)	US-PGPUB; USPAT	OR	ON	2007/03/28 07:37
S281	29	(diagnostic adj tone)	US-PGPUB; USPAT	OR	ON	2007/03/28 07:37
S282	0	"375"/\$.ccls. and (diagnostic adj tone)	US-PGPUB; USPAT	OR	ON	2007/03/28 07:37
S283	0	"375"/\$.ccls. and (diagnostic near tone)	US-PGPUB; USPAT	OR	ON	2007/03/28 07:37
S284	7	"375"/\$.ccls. and (diagnostic near bits)	US-PGPUB; USPAT	OR	ON	2007/03/28 07:38
S285	0	"375"/\$.ccls. and (diagnos\$6 near DMT)	US-PGPUB; USPAT	OR	ON	2007/03/28 07:38
S286	0	"375"/\$.ccls. and (diagnos\$6 with DMT)	US-PGPUB; USPAT	OR	ON	2007/03/28 07:38
S287	479	"375"/\$.ccls. and (bit with DMT)	US-PGPUB; USPAT	OR	ON	2007/03/28 07:39
S288	207	"375"/\$.ccls. and (bit near3 DMT)	US-PGPUB; USPAT	OR	ON	2007/03/28 07:39
S289	13	"375"/\$.ccls. and (bit near3 DMT) and diagnost\$5	US-PGPUB; USPAT	OR	ON	2007/03/28 07:47
S290	1	"375"/\$.ccls. and (DMT same diagnost\$5)	US-PGPUB; USPAT	OR	ON	2007/03/28 07:47
S291	40	"375"/\$.ccls. and (DMT and diagnost\$5)	US-PGPUB; USPAT	OR	ON	2007/03/28 07:49
S292	43	"375"/222.ccls. and (diagnos\$5 near3 modem)	US-PGPUB; USPAT	OR	ON	2007/03/28 07:50
S293	10	"375"/222.ccls. and (diagnos\$5 near3 modem) and DMT	US-PGPUB; USPAT	OR	ON	2007/03/28 07:56
S294	0	"370"/484.ccls. and (diagnos\$5 near3 modem) and DMT	US-PGPUB; USPAT	OR	ON	2007/03/28 07:52
S295	0	"370"/484.ccls. and (diagnos\$5) and DMT	US-PGPUB; USPAT	OR	ON	2007/03/28 07:52
S296	1	"370"/484.ccls. and (diagnos\$5)	US-PGPUB; USPAT	OR	ON	2007/03/28 07:52
S297	16	"370"/480.ccls. and (diagnos\$5)	US-PGPUB; USPAT	OR	ON	2007/03/28

			USPAT			07:52
S298	11	"375"/222.ccls. and (diagnos\$5 adj mode)	US-PGPUB; USPAT	OR	ON	2007/03/28 08:08
S299	1	"6658052".pn.	US-PGPUB; USPAT	OR	ON	2007/03/28 08:26
S300	96171	(one adj bit)	US-PGPUB; USPAT	OR	ON	2007/03/28 08:27
S301	5	(one adj bit) with (DMT adj symbol)	US-PGPUB; USPAT	OR	ON	2007/03/28 08:28
S302	197	(bit) with (DMT adj symbol)	US-PGPUB; USPAT	OR	ON	2007/03/28 08:28
S303	27	(bit) with (DMT adj symbol) and (diagnos\$7)	US-PGPUB; USPAT	OR	ON	2007/03/28 08:30
S304	0	(bit near test\$5) with (DMT adj symbol)	US-PGPUB; USPAT	OR	ON	2007/03/28 08:31
S305	0	(diagnost near tone) and (DMT adj symbol)	US-PGPUB; USPAT	OR	ON	2007/03/28 08:31
S306	0	(diagnos\$5 near tone) and (DMT adj symbol)	US-PGPUB; USPAT	OR	ON	2007/03/28 08:31
S307	0	(diagnos\$5 near tone) and (DMT)	US-PGPUB; USPAT	OR	ON	2007/03/28 08:31
S308	0	(diagnos\$5 near carrier) and (DMT)	US-PGPUB; USPAT	OR	ON	2007/03/28 08:36
S309	5	diagnos\$5 with (DMT)	US-PGPUB; USPAT	OR	ON	2007/03/28 09:12
S310	106	(Pulse adj width adj modulat\$6) same (FSK)	US-PGPUB; USPAT	OR	ON	2007/03/28 10:04
S311	1	"6633545".pn.	US-PGPUB; USPAT	OR	ON	2007/03/28 10:48
S312	1	10/619691	US-PGPUB; USPAT	OR	ON	2007/03/28 10:48
S313	1	"6633545".pn.	US-PGPUB; USPAT	OR	ON	2007/03/29 09:09
S314	1	"6673179".pn.	US-PGPUB; USPAT	OR	ON	2007/03/29 09:09
S315	1	"6073179".pn.	US-PGPUB; USPAT	OR	ON	2007/03/29 09:10
S316	0	"375"/\$.ccls. and (diagnos\$6 same ((frequency adj domain) with (idle adj channel adj noise)))	US-PGPUB; USPAT	OR	ON	2008/05/27 09:52
S317	0	(diagnos\$6 same ((frequency adj domain) with (idle adj channel adj noise)))	US-PGPUB; USPAT	OR	ON	2008/05/27 09:52
S318	0	(diagnos\$6 and ((frequency adj domain) with (idle adj channel adj noise)))	US-PGPUB; USPAT	OR	ON	2008/05/27 09:52
S319	0	"10619691".pn.	US-PGPUB; USPAT	OR	ON	2008/05/27 10:03
S320	1	"10/619691"	US-PGPUB; USPAT	OR	ON	2008/05/27 10:03
S321	1	"10619691"	US-PGPUB; USPAT	OR	ON	2008/06/08 23:12
S322	0	"375"/\$.ccls. and ((diagnostic adj information) same (DMT adj symbol))	US-PGPUB; USPAT	OR	ON	2008/06/08 23:32

S323	0	"375"/\$.cls. and ((diagnostic) with (DMT adj symbol))	US-PGPUB; USPAT	OR	ON	2008/06/08 23:32
S324	0	"379"/\$.cls. and ((diagnostic) with (DMT adj symbol))	US-PGPUB; USPAT	OR	ON	2008/06/08 23:33
S325	0	"375"/\$.cls. and ((diagnostic) with (DMT))	US-PGPUB; USPAT	OR	ON	2008/06/08 23:33
S326	0	"375"/\$.cls. and ((diagnostic) with (DMT))	US-PGPUB; USPAT; DERWENT; IBM_TDB	OR	ON	2008/06/08 23:33
S327	1	"375"/\$.cls. and ((diagnostic) same (DMT))	US-PGPUB; USPAT; DERWENT; IBM_TDB	OR	ON	2008/06/08 23:33
S328	4	"375"/\$.cls. and ((diagnostic) same (multicarrier))	US-PGPUB; USPAT; DERWENT; IBM_TDB	OR	ON	2008/06/08 23:34
S329	3	"375"/\$.cls. and ((diagnostic adj information) same (multicarrier))	US-PGPUB; USPAT; DERWENT; IBM_TDB	OR	ON	2008/06/08 23:34
S330	26	"375"/222.cls. and ((diagnostic adj information))	US-PGPUB; USPAT; DERWENT; IBM_TDB	OR	ON	2008/06/08 23:35
S331	2	09/925509	US-PGPUB; USPAT	OR	ON	2008/06/09 07:54
S332	12	09/755173	US-PGPUB; USPAT	OR	ON	2008/06/09 07:55
S333	142	idle adj channel adj noise	US-PGPUB; USPAT	OR	ON	2008/06/09 08:08
S334	3	S333 and DMT	US-PGPUB; USPAT	OR	ON	2008/06/09 08:09
S335	2	S333 same (diagnostic)	US-PGPUB; USPAT	OR	ON	2008/06/09 08:11
S336	256150	S333 ande (diagnostic)	US-PGPUB; USPAT	OR	ON	2008/06/09 08:14
S337	20	S333 and (diagnostic)	US-PGPUB; USPAT	OR	ON	2008/06/09 08:14
S338	32	(diagnostic adj symbol)	US-PGPUB; USPAT	OR	ON	2008/06/09 08:21
S339	0	"375"/\$.cls and (diagnostic adj symbol)	US-PGPUB; USPAT	OR	ON	2008/06/09 08:22
S340	0	"370"/\$.cls and (diagnostic adj symbol)	US-PGPUB; USPAT	OR	ON	2008/06/09 08:22
S341	0	"370"/\$.cls with (diagnostic adj symbol)	US-PGPUB; USPAT	OR	ON	2008/06/09 08:22
S342	0	"375"/\$.cls with (diagnostic adj symbol)	US-PGPUB; USPAT	OR	ON	2008/06/09 08:22
S343	0	"375"/\$.cls with (diagnostic same symbol)	US-PGPUB; USPAT	OR	ON	2008/06/09 08:22
S344	0	"370"/\$.cls with (test adj symbol)	US-PGPUB; USPAT	OR	ON	2008/06/09 08:23
S345	0	"370"/\$.cls with (test with symbol)	US-PGPUB; USPAT	OR	ON	2008/06/09 08:23

S346	0	"375"/\$.ccls with (test with symbol)	US-PGPUB; USPAT	OR	ON	2008/06/09 08:23
S347	0	"370"/\$.ccls with (testing with symbol)	US-PGPUB; USPAT	OR	ON	2008/06/09 08:24
S348	5	(test\$6 with (DMT adj symbol))	US-PGPUB; USPAT	OR	ON	2008/06/09 08:24
S349	0	(diagnos\$6 with (DMT adj symbol))	US-PGPUB; USPAT	OR	ON	2008/06/09 08:25
S350	0	(diagnos\$6 same (DMT adj symbol))	US-PGPUB; USPAT	OR	ON	2008/06/09 08:26
S351	646	(map\$7same (DMT adj symbol))	US-PGPUB; USPAT	OR	ON	2008/06/09 08:26
S352	0	((diagnostic) with (DMT adj symbol))	US-PGPUB; USPAT	OR	ON	2008/06/09 08:27
S353	0	((diagnostic) same (DMT adj symbol))	US-PGPUB; USPAT	OR	ON	2008/06/09 08:27
S354	9421	transmit\$7 with diagnostic	US-PGPUB; USPAT	OR	ON	2008/06/09 09:42
S355	185	"375"/\$.ccls. and (transmit\$7 with diagnostic)	US-PGPUB; USPAT	OR	ON	2008/06/09 09:42
S356	79	"375"/\$.ccls. and (transmit\$7 near3 diagnostic)	US-PGPUB; USPAT	OR	ON	2008/06/09 09:42
S357	11	"375"/222.ccls. and (diagnostic adj mode)	US-PGPUB; USPAT	OR	ON	2008/10/06 09:00
S358	4	"375"/222.ccls. and (idle adj channel adj noise)	US-PGPUB; USPAT	OR	ON	2008/10/06 09:15
S359	1	"6658052".pn.	US-PGPUB; USPAT	OR	ON	2008/10/06 09:17
S360	13	"375"/\$.ccls. and modem and (idle adj channel adj noise)	US-PGPUB; USPAT	OR	ON	2008/10/06 09:20
S361	749	(diagnostic with tone)	US-PGPUB; USPAT	OR	ON	2008/10/10 11:04
S362	0	375/222.ccls. and (diagnostic with tone)	US-PGPUB; USPAT	OR	ON	2008/10/10 11:04
S363	0	375/222.ccls. and (diagnostic adj bits)	US-PGPUB; USPAT	OR	ON	2008/10/10 11:04
S364	26	375/222.ccls. and (diagnostic with bits)	US-PGPUB; USPAT	OR	ON	2008/10/10 11:04
S365	0	375/222.ccls. and (diagnostic with DMT)	US-PGPUB; USPAT	OR	ON	2008/10/10 11:07
S366	0	375/222.ccls. and (diagnostic with tone)	US-PGPUB; USPAT	OR	ON	2008/10/10 11:07
S367	10	"375"/\$.ccls. and (diagnostic with tone)	US-PGPUB; USPAT	OR	ON	2008/10/10 11:07
S368	6	(diagnostic with DMT)	US-PGPUB; USPAT	OR	ON	2008/10/10 11:08
S369	6	375/222.ccls. and (diagnostic adj information) and DMT	US-PGPUB; USPAT	OR	ON	2008/10/10 11:09
S370	2	"20020031167"	US-PGPUB; USPAT	OR	ON	2008/10/10 14:18
S371	2	"20010047424"	US-PGPUB; USPAT	OR	ON	2008/10/10 14:21
S372	1	"6697969".pn.	US-PGPUB; USPAT	OR	ON	2008/10/10 14:50

S373	1	"6510162".pn.	US-PGPUB; USPAT	OR	ON	2008/10/10 15:10
S374	1	(upgrad\$7 adj firmware) with (cable adj modem)	US-PGPUB; USPAT	OR	ON	2008/10/10 15:26
S375	1	(upgrad\$7 adj firmware) same (cable adj modem)	US-PGPUB; USPAT	OR	ON	2008/10/10 15:27
S376	0	(upgrad\$7 adj firmware) same (CMTS and TFTP)	US-PGPUB; USPAT	OR	ON	2008/10/10 15:27
S377	1	(upgrad\$7 adj firmware) and (CMTS and TFTP)	US-PGPUB; USPAT	OR	ON	2008/10/10 15:27
S378	932	(upgrad\$7 adj firmware)	US-PGPUB; USPAT	OR	ON	2008/10/10 15:27
S379	29	(upgrad\$7 adj firmware) same modem	US-PGPUB; USPAT	OR	ON	2008/10/10 15:28
S380	1	CMTS and ((upgrad\$7 adj firmware) same modem)	US-PGPUB; USPAT	OR	ON	2008/10/10 15:29
S381	1	CMTS same (upgrad\$7 adj firmware)	US-PGPUB; USPAT	OR	ON	2008/10/10 15:43
S382	282	CMTS same (digital adj subscriber adj line)	US-PGPUB; USPAT	OR	ON	2008/10/10 15:49
S383	186	CMTS with (digital adj subscriber adj line)	US-PGPUB; USPAT	OR	ON	2008/10/10 15:49
S384	28	"375"/\$.cls. and (idle adj channel adj noise)	US-PGPUB; USPAT	OR	ON	2008/10/13 09:07
S385	0	"375"/\$.cls. and (diagnostic same (idle adj channel adj noise))	US-PGPUB; USPAT	OR	ON	2008/10/13 09:12
S386	3	"375"/\$.cls. and (diagnostic and (idle adj channel adj noise))	US-PGPUB; USPAT	OR	ON	2008/10/13 09:12
S387	20	(diagnostic and (idle adj channel adj noise))	US-PGPUB; USPAT	OR	ON	2008/10/13 09:13
S388	1	(diagnostic adj message) and (idle adj channel adj noise)	US-PGPUB; USPAT	OR	ON	2008/10/13 09:15
S389	1	(diagnostic) and (idle adj channel adj noise) and DMT	US-PGPUB; USPAT	OR	ON	2008/10/13 09:15
S390	3	(diagnostic adj mode) and (idle adj channel adj noise)	US-PGPUB; USPAT	OR	ON	2008/10/13 09:15
S391	15	(diagnostic) and (idle adj channel adj noise) and modem	US-PGPUB; USPAT	OR	ON	2008/10/13 09:16
S392	20	(diagnostic) and (idle adj channel adj noise)	US-PGPUB; USPAT	OR	ON	2008/10/13 09:17
S393	1	"6631120".pn.	US-PGPUB; USPAT	OR	ON	2008/10/13 09:27
S394	1	10/619691	US-PGPUB; USPAT	OR	ON	2008/10/13 10:17
S395	12	09/755173	US-PGPUB; USPAT	OR	ON	2008/10/13 10:39
S396	0	09/597926	US-PGPUB; USPAT	OR	ON	2008/10/13 10:44
S397	1	10/619691	US-PGPUB; USPAT	OR	ON	2009/04/28 08:48
S398	1	"6658052".pn.	US-PGPUB; USPAT	OR	ON	2009/04/28 08:52
S399	1353	(diagnostic adj message)	US-PGPUB; USPAT	OR	ON	2009/04/28 08:53

S400	42	(diagnostic adj message) same variables	US-PGPUB; USPAT	OR	ON	2009/04/28 08:53
S401	0	((diagnostic adj message) same variables) and multicarrier	US-PGPUB; USPAT	OR	ON	2009/04/28 08:53
S402	0	((diagnostic adj message) same variables) and DMT	US-PGPUB; USPAT	OR	ON	2009/04/28 08:53
S403	2	((diagnostic adj message) same variables same array)	US-PGPUB; USPAT	OR	ON	2009/04/28 08:54
S404	1	"7251199".pn.	US-PGPUB; USPAT	OR	ON	2009/04/28 09:14
S405	1	11/510121	US-PGPUB; USPAT	OR	ON	2009/04/28 09:31
S406	345	(diagnostic near bits)	US-PGPUB; USPAT	OR	ON	2009/04/29 09:36
S407	0	(diagnostic near bits) same (DMT)	US-PGPUB; USPAT	OR	ON	2009/04/29 09:37
S408	1	(diagnostic near bits) and (DMT near symbol)	US-PGPUB; USPAT	OR	ON	2009/04/29 09:37
S409	1	(diagnostic near bits) same (symbol)	US-PGPUB; USPAT	OR	ON	2009/04/29 09:38
S410	0	375/222.ccls. and ((diagnostic near bits) same DMT)	US-PGPUB; USPAT	OR	ON	2009/04/29 09:39
S411	3	375/222.ccls. and ((diagnostic near bits))	US-PGPUB; USPAT	OR	ON	2009/04/29 09:39
S412	0	375/222.ccls. and ((test near bits) with DMT)	US-PGPUB; USPAT	OR	ON	2009/04/29 09:40
S413	1	375/222.ccls. and ((pattern near bits) with DMT)	US-PGPUB; USPAT	OR	ON	2009/04/29 09:40
S414	2	375/222.ccls. and (diagnostic near message)	US-PGPUB; USPAT	OR	ON	2009/04/29 09:41
S415	13	375/222.ccls. and (diagnostic with messages)	US-PGPUB; USPAT	OR	ON	2009/04/29 09:42
S416	43	375/222.ccls. and (diagnostic with information)	US-PGPUB; USPAT	OR	ON	2009/04/29 09:47
S417	0	375/222.ccls. and ((diagnostic with information) same variables same DMT)	US-PGPUB; USPAT	OR	ON	2009/04/29 09:48
S418	3	375/222.ccls. and ((diagnostic with information) same variables)	US-PGPUB; USPAT	OR	ON	2009/04/29 09:48
S419	0	375/222.ccls. and ((diagnostic with information) same DMT)	US-PGPUB; USPAT	OR	ON	2009/04/29 09:50
S420	9	375/222.ccls. and ((diagnostic with information) and DMT)	US-PGPUB; USPAT	OR	ON	2009/04/29 09:50
S421	0	375/222.ccls. and ((diagnostic with mode) same DMT)	US-PGPUB; USPAT	OR	ON	2009/04/29 09:54
S422	4	375/222.ccls. and ((diagnostic with symbol))	US-PGPUB; USPAT	OR	ON	2009/04/29 09:54
S423	28	375/222.ccls. and ((diagnostic with bits))	US-PGPUB; USPAT	OR	ON	2009/04/29 09:55
S424	3	375/222.ccls. and ((diagnostic with bits)) and (channel near noise)	US-PGPUB; USPAT	OR	ON	2009/04/29 09:55
S425	7	"375"/\$.ccls. and ((diagnostic with bits)) and (channel near noise)	US-PGPUB; USPAT	OR	ON	2009/04/29 09:56
S426	3	"375"/\$.ccls. and ((diagnostic with	US-PGPUB; USPAT	OR	ON	2009/04/29

		symbols)) and (channel near noise)	USPAT			10:02
S427	3	((diagnostic with symbols)) and (channel near noise)	US-PGPUB; USPAT	OR	ON	2009/04/29 10:03
S428	0	((diagnostic with DMT)) and (channel near noise)	US-PGPUB; USPAT	OR	ON	2009/04/29 10:03
S429	188	((diagnostic with information)) and (channel near noise)	US-PGPUB; USPAT	OR	ON	2009/04/29 10:03
S430	3	((diagnostic with information)) same (channel near noise)	US-PGPUB; USPAT	OR	ON	2009/04/29 10:03
S431	0	((diagnostic with DMT)) same (channel near noise)	US-PGPUB; USPAT	OR	ON	2009/04/29 10:04
S432	0	((diagnostic same DMT)) same (channel near noise)	US-PGPUB; USPAT	OR	ON	2009/04/29 10:04
S433	1	"6631130".pn.	US-PGPUB; USPAT	OR	ON	2009/04/29 10:05
S434	1	"6631120".pn.	US-PGPUB; USPAT	OR	ON	2009/04/29 10:06
S435	1	"6788705".pn.	US-PGPUB; USPAT	OR	ON	2009/04/29 10:27
S436	0	(diagonostic with tone)	US-PGPUB; USPAT	OR	ON	2009/05/05 12:00
S437	781	(diagnostic with tone)	US-PGPUB; USPAT	OR	ON	2009/05/05 12:01
S438	10	"375"/\$.cls. and (diagnostic with tone)	US-PGPUB; USPAT	OR	ON	2009/05/05 12:01
S439	158	"375"/\$.cls. and (diagnostic with bits)	US-PGPUB; USPAT	OR	ON	2009/05/05 12:02
S440	11	"375"/\$.cls. and ((diagnostic adj information) with bits)	US-PGPUB; USPAT	OR	ON	2009/05/05 12:02
S441	0	"375"/\$.cls. and (map\$7 same (diagnostic adj information) same bits same tone)	US-PGPUB; USPAT	OR	ON	2009/05/05 12:10
S442	8781	"375"/\$.cls. and (map\$7 same (diagnostic) ssame tone)	US-PGPUB; USPAT	OR	ON	2009/05/05 12:10
S443	0	"375"/\$.cls. and (map\$7 with (diagnostic) with tone)	US-PGPUB; USPAT	OR	ON	2009/05/05 12:10
S444	0	"375"/\$.cls. and (map\$7 with (diagnostic) with DMT)	US-PGPUB; USPAT	OR	ON	2009/05/05 12:10
S445	0	(map\$7 with (diagnostic) with DMT)	US-PGPUB; USPAT	OR	ON	2009/05/05 12:10
S446	0	(map\$7 with (test) with DMT)	US-PGPUB; USPAT	OR	ON	2009/05/05 12:10
S447	0	((diagnostic near bits) with DMT)	US-PGPUB; USPAT	OR	ON	2009/05/05 13:10
S448	0	((diagnostic near bits) same DMT)	US-PGPUB; USPAT	OR	ON	2009/05/05 13:10
S449	2	((diagnostic with bits) same DMT)	US-PGPUB; USPAT	OR	ON	2009/05/05 13:10
S450	0	((diagnostic near bits) same tone)	US-PGPUB; USPAT	OR	ON	2009/05/05 13:11
S451	1	"6658052".pn.	US-PGPUB; USPAT	OR	ON	2009/05/05 13:24
S452	29	"375"/222.cls. and (diagnostic adj information)	US-PGPUB; USPAT	OR	ON	2009/05/05 14:22

S453	1	10/619691	US-PGPUB; USPAT	OR	ON	2009/05/05 14:32
S454	22	(one adj bit) with DMT	US-PGPUB; USPAT	OR	ON	2009/05/05 14:39
S455	13	09/755173	US-PGPUB; USPAT	OR	ON	2009/05/05 14:51
S456	1	"6658052".pn.	US-PGPUB; USPAT	OR	ON	2009/05/05 14:51
S457	1	"6658052".pn.	US-PGPUB; USPAT	OR	ON	2009/05/07 11:23
S458	1	10/619691	US-PGPUB; USPAT	OR	ON	2009/05/07 11:33
S459	1	"6658052".pn.	US-PGPUB; USPAT	OR	ON	2009/05/08 06:38
S460	7	(diagnostic adj information) same (array) same variables	US-PGPUB; USPAT	OR	ON	2009/05/08 06:53
S461	0	"375"/\$.ccls. and ((diagnostic adj information) same (array) same variables)	US-PGPUB; USPAT	OR	ON	2009/05/08 06:53
S462	6	"375"/\$.ccls. and ((diagnostic adj information) same variables)	US-PGPUB; USPAT	OR	ON	2009/05/08 06:53
S463	3	"379"/\$.ccls. and ((diagnostic adj information) same variables)	US-PGPUB; USPAT	OR	ON	2009/05/08 06:54
S464	21	"370"/\$.ccls. and ((diagnostic adj information) same variables)	US-PGPUB; USPAT	OR	ON	2009/05/08 06:54
S465	10	"370"/\$.ccls. and ((diagnostic adj information) same variables) and modems	US-PGPUB; USPAT	OR	ON	2009/05/08 06:55
S466	2	(message with bits with diagnostic) same DMT	US-PGPUB; USPAT	OR	ON	2010/05/27 09:45
S467	0	(message with bits with test) same DMT	US-PGPUB; USPAT	OR	ON	2010/05/27 09:46
S468	0	(message with bits with test\$6) same DMT	US-PGPUB; USPAT	OR	ON	2010/05/27 09:46
S469	9	(message with test\$6) same DMT	US-PGPUB; USPAT	OR	ON	2010/05/27 09:46
S470	5	"375"/\$.ccls. and "370"/\$.ccls. and ((test\$6 with tone) same DMT)	US-PGPUB; USPAT	OR	ON	2010/05/27 09:47
S471	11	((digital with test\$6 with tone) same DMT)	US-PGPUB; USPAT	OR	ON	2010/05/27 10:10
S472	3	"375"/\$.ccls. and "370"/\$.ccls. and ((test\$6 with bit with tone) and DMT)	US-PGPUB; USPAT	OR	ON	2010/05/27 10:11
S473	63	"375"/\$.ccls. and "370"/\$.ccls. and ((modulat\$5 with bit with tone) and DMT)	US-PGPUB; USPAT	OR	ON	2010/05/27 10:12
S474	0	"375"/\$.ccls. and "370"/\$.ccls. and ((modulat\$5 with bits with tone) and (test adj information) and DMT)	US-PGPUB; USPAT	OR	ON	2010/05/27 10:13
S475	2	"375"/\$.ccls. and "370"/\$.ccls. and ((modulat\$5 with bit with tone) and DMT) and (data near variables)	US-PGPUB; USPAT	OR	ON	2010/05/27 10:18
S476	0	"375"/\$.ccls. and "370"/\$.ccls. and ((modulat\$5 with bit with tone with (channel adj noise)) and DMT)	US-PGPUB; USPAT	OR	ON	2010/05/27 10:20
S477	1	"375"/\$.ccls. and "370"/\$.ccls. and	US-PGPUB; USPAT	OR	ON	2010/05/27

		((modulat\$5 with bit with tone) same (channel adj noise)) and DMT	USPAT			10:21
S478	3	((modulat\$5 with bit with tone) same (channel adj noise)) and DMT	US-PGPUB; USPAT	OR	ON	2010/05/27 10:24
S479	1	(send with (channel adj noise)) and DMT	US-PGPUB; USPAT	OR	ON	2010/05/27 10:26
S480	7	(messag\$3 with (channel adj noise)) and DMT	US-PGPUB; USPAT	OR	ON	2010/05/27 10:27
S481	4	(bits with DMT with (channel adj noise)) and DMT	US-PGPUB; USPAT	OR	ON	2010/05/27 10:28
S482	1656	message same variable same test	US-PGPUB; USPAT	OR	ON	2010/06/03 09:44
S483	3	message same variable same test same DMT	US-PGPUB; USPAT	OR	ON	2010/06/03 09:44
S484	0	message same variable same test same QAM	US-PGPUB; USPAT	OR	ON	2010/06/03 09:44
S485	19	(message same variable same test) and DMT	US-PGPUB; USPAT	OR	ON	2010/06/03 09:45
S486	1	"6658052".pn.	US-PGPUB; USPAT	OR	ON	2010/06/03 09:47
S487	1	"6445773".pn.	US-PGPUB; USPAT	OR	ON	2010/06/03 10:48
S488	1	"6075821".pn.	US-PGPUB; USPAT	OR	ON	2010/06/03 11:11
S489	1	12/477742	US-PGPUB; USPAT	OR	ON	2010/06/14 09:18
S490	1	"7570686".pn.	US-PGPUB; USPAT	OR	ON	2010/06/14 09:22
S491	1	"6658052".pn.	US-PGPUB; USPAT	OR	ON	2010/06/14 09:25
S492	18	"375"/\$.ccls. and (diagnostic near message)	US-PGPUB; USPAT	OR	ON	2010/06/14 09:38
S493	2	"375"/\$.ccls. and "379"/\$.ccls. and (diagnostic near message)	US-PGPUB; USPAT	OR	ON	2010/06/14 09:38
S494	2	DMT same (diagnostic near message)	US-PGPUB; USPAT	OR	ON	2010/06/14 09:48
S495	2	DMT and ((diagnostic near message) same (channel adj noise))	US-PGPUB; USPAT	OR	ON	2010/06/14 09:49
S496	3	DMT and ((diagnostic near message) and (channel adj noise))	US-PGPUB; USPAT	OR	ON	2010/06/14 09:49
S497	2	((diagnostic near message) same (channel adj noise))	US-PGPUB; USPAT	OR	ON	2010/06/14 10:00
S498	3	((diagnostic near message) and (channel adj noise))	US-PGPUB; USPAT	OR	ON	2010/06/14 10:02
S499	1	"6445773".pn.	US-PGPUB; USPAT	OR	ON	2010/06/14 10:29
S500	6	"375"/\$.ccls. and (message same test same DMT)	US-PGPUB; USPAT	OR	ON	2010/08/04 10:00
S501	144	"375"/\$.ccls. and (test near message)	US-PGPUB; USPAT	OR	ON	2010/08/04 10:01
S502	0	"375"/\$.ccls. and ((test near message) same DMT)	US-PGPUB; USPAT	OR	ON	2010/08/04 10:01
S503	1	"375"/\$.ccls. and ((test near message) and DMT)	US-PGPUB; USPAT	OR	ON	2010/08/04 10:01

S504	1	"6445773".pn.	US-PGPUB; USPAT	OR	ON	2010/08/04 10:11
S505	8	(DMT with tone) same (channel near noise)	US-PGPUB; USPAT	OR	ON	2010/08/04 10:18
S506	365	(tone with test with information)	US-PGPUB; USPAT	OR	ON	2010/08/04 10:21
S507	15	(tone near test near information)	US-PGPUB; USPAT	OR	ON	2010/08/04 10:21
S508	58	message with (DMT adj symbols)	US-PGPUB; USPAT	OR	ON	2010/08/04 10:30
S509	2	message with (DMT adj symbols) with (channel adj noise)	US-PGPUB; USPAT	OR	ON	2010/08/04 10:30
S510	4	message with (DMT adj symbols) with (noise)	US-PGPUB; USPAT	OR	ON	2010/08/04 10:30
S511	0	(test near2 information) with (DMT adj symbols)	US-PGPUB; USPAT	OR	ON	2010/08/04 10:32
S512	0	(test near information) with (DMT adj symbols)	US-PGPUB; USPAT	OR	ON	2010/08/04 10:32
S513	0	(test with information) with (DMT adj symbols)	US-PGPUB; USPAT	OR	ON	2010/08/04 10:32
S514	0	(test with information) with (DMT adj symbol)	US-PGPUB; USPAT	OR	ON	2010/08/04 10:32
S515	8	(test with information) with (DMT)	US-PGPUB; USPAT	OR	ON	2010/08/04 10:32
S516	1	"6658052".pn.	US-PGPUB; USPAT	OR	ON	2010/08/04 10:35
S517	0	(test near result) with (DMT adj symbols)	US-PGPUB; USPAT	OR	ON	2010/08/04 10:42
S518	0	(test near result) with (DMT adj tine)	US-PGPUB; USPAT	OR	ON	2010/08/04 10:42
S519	0	(test near result) with (DMT adj tone)	US-PGPUB; USPAT	OR	ON	2010/08/04 10:42
S520	295	(test near result) with (tones)	US-PGPUB; USPAT	OR	ON	2010/08/04 10:42
S521	25	(test near result) near (tones)	US-PGPUB; USPAT	OR	ON	2010/08/04 10:43
S522	0	DMT and ((test near result) near (tones))	US-PGPUB; USPAT	OR	ON	2010/08/04 10:43
S523	0	DMT and ((test near result) near (tone))	US-PGPUB; USPAT	OR	ON	2010/08/04 10:43
S524	8	DMT and ((test near result) with (tone))	US-PGPUB; USPAT	OR	ON	2010/08/04 10:44
S525	1	11/911155	US-PGPUB; USPAT	OR	ON	2010/08/11 11:20
S526	1	12/477742	US-PGPUB; USPAT	OR	ON	2010/08/27 10:10
S527	6310	"375"/\$.ccls. and (message with bits wit DMT)	US-PGPUB; USPAT	OR	ON	2010/12/01 14:53
S528	38	"375"/\$.ccls. and (message with bits with DMT)	US-PGPUB; USPAT	OR	ON	2010/12/01 14:53
S529	0	(map with test adj bit) with DMT	US-PGPUB; USPAT	OR	ON	2010/12/07 14:00
S530	2948	(message with test with information)	US-PGPUB; USPAT	OR	ON	2010/12/07 14:02

EAST Search History

S531	3	(message with test with information) same (DMT adj symbol)	US-PGPUB; OR USPAT	ON	2010/12/07 14:03
S532	116	(modulat\$ with bit with (DMT near symbols))	US-PGPUB; OR USPAT	ON	2010/12/09 10:32
S533	12	(modulat\$ with message with bit with (DMT near symbols))	US-PGPUB; OR USPAT	ON	2010/12/09 10:32
S534	0	(modulat\$ with (test near bit) with (DMT near symbols))	US-PGPUB; OR USPAT	ON	2010/12/09 10:39
S535	3	(modulat\$ with (test with bit) with (DMT near symbols))	US-PGPUB; OR USPAT	ON	2010/12/09 10:39
S536	1	"6781513".pn.	US-PGPUB; OR USPAT	ON	2010/12/09 10:46
S537	1	"7043049".pn.	US-PGPUB; OR USPAT	ON	2010/12/09 11:46
S538	1	"5848155".pn.	US-PGPUB; OR USPAT	ON	2010/12/09 14:44
S539	1	11/166540	US-PGPUB; OR USPAT	ON	2010/12/09 14:48

3/11/2012 9:38:14 AM

C:\Users\ktran5\Documents\EAST\Workspaces\12779708.wsp

Substitute for form 1449A/PTO INFORMATION DISCLOSURE STATEMENT BY APPLICANT				Complete if Known	
				Application Number	12/779,660
				Filing Date	May 13, 2010
				First Named Inventor	David M. Krinsky
				Art Unit	2611
				Examiner Name	Chayour, Muhammad → KHANH C TRAN
Sheet	1	of	1	Attorney Docket Number	5550-2-CON-2-1-1

U.S. PATENT DOCUMENTS					
Examiner Initials*	Cite No. ¹	Document Number Number-kind Code ² (if known)	Publication Date MM-DD-YYYY	Name of Patentee or Applicant of Cited Document	Pages, Columns, Lines, Where Relevant Passages or Relevant Figures Appear
/KCT/	1	6781513	08/24/04	Korkosz et al.	

FOREIGN PATENT DOCUMENTS						
Examiner Initials*	Cite No. ¹	Foreign Patent Document Country Code ³ ; Number ⁴ ; Kind Code ⁵ (if known)	Publication Date MM-DD-YYYY	Name of Patentee or Applicant of Cited Document	Pages, Columns, Lines, Where Relevant Passages or Relevant Figures Appear	T ⁶

OTHER ART (Including Author, Title, Date, Pertinent Pages, etc.)		
Examiner Initials*	Cite No. ¹	
/KCT/	2	"Asymmetric Digital Subscriber Line (ADSL) Transceivers," ITU-T G.992.1, Jun. 1999, pp. 91-117, 125, 126, 131, 132
/KCT/	3	Notice of Allowance for Canadian Patent Application No. 2,394,491, dated Jul. 16, 2010 (Attorney Ref. No. 5550-2-PCA)
/KCT/	4	Official Action for European Patent Application No. EP 06022008, mailed Jul. 7, 2010 (Attorney Ref. No. 5550-2-PEP5)
/KCT/	5	Official Action (including translation) for Japanese Patent Application No. 2001-552611, mailed Aug. 2, 2010 (Attorney Ref. No. 5550-2-PJP)
/KCT/	6	Official Action (including translation) for Japanese Patent Application No. 2008-191051, mailed Jul. 26, 2010 (Attorney Ref. No. 5550-2-PJP-DIV)
/KCT/	7	Official Action for U.S. Patent Application No. 12/477,742, mailed Aug. 16, 2010 (Attorney Ref. No. 5550-2-CON-2-1)
/KCT/	8	Notice of Allowability for U.S. Patent Application No. 12/477,742, mailed Sep. 7, 2010 (Attorney Ref. No. 5550-2-CON-2-1)

Examiner Signature	/Khanh Tran/ (03/11/2012)	Date Considered	03/11/2012
--------------------	---------------------------	-----------------	------------

*EXAMINER: Initial if reference is considered, whether or not citation is in conformance and not considered. Include copy of this form with next communication to applicant.

ALL REFERENCES CONSIDERED EXCEPT WHERE LINED THROUGH. /KCT/

Substitute for form 1449A/PTO				Complete if Known	
INFORMATION DISCLOSURE STATEMENT BY APPLICANT				Application Number	12/779,660
				Filing Date	May 13, 2010
				First Named Inventor	David M. Krinsky
				Art Unit	2611
				Examiner Name	Fan, Chieh M.
Sheet	1	of	1	Attorney Docket Number	5550-2-CON-2-1-1

U.S. PATENT DOCUMENTS					
Examiner Initials*	Cite No. ¹	Document Number Number-kind Code ^{2 (if known)}	Publication Date MM-DD-YYYY	Name of Patentee of Applicant of Cited Document	Pages, Columns, Lines, Where Relevant Passages or Relevant Figures Appear

FOREIGN PATENT DOCUMENTS						
Examiner Initials*	Cite No. ¹	Foreign Patent Document Country Code ³ ; Number ⁴ ; Kind Code ^{5 (if known)}	Publication Date MM-DD-YYYY	Name of Patentee or Applicant of Cited Document	Pages, Columns, Lines, Where Relevant Passages or Relevant Figures Appear	T ⁶

OTHER ART (Including Author, Title, Date, Pertinent Pages, etc.)		
Examiner Initials*	Cite No. ¹	
	1	Notice of Acceptance for Australian Patent Application No. 2009222537, dated Aug. 25, 2011 (Attorney Ref. No. 5550-2-PAU-4-DIV-2)
	2	Official Action for Canadian Patent Application No. 2,726,826, dated Jun. 30, 2011 (Attorney Ref. No. 5550-2-PCA-DIV)

Examiner Signature		Date Considered	
--------------------	--	-----------------	--

*EXAMINER: Initial if reference is considered, whether or not citation is in conformance and not considered. Include copy of this form with next communication to applicant.

Electronic Acknowledgement Receipt

EFS ID:	11093009
Application Number:	12779660
International Application Number:	
Confirmation Number:	8981
Title of Invention:	Multicarrier Modulation Messaging for Power Level Per Subchannel Information
First Named Inventor/Applicant Name:	David M. Krinsky
Customer Number:	62574
Filer:	Jason Vick/Amy Duarte
Filer Authorized By:	Jason Vick
Attorney Docket Number:	5550-2-CON2-1-1
Receipt Date:	30-SEP-2011
Filing Date:	13-MAY-2010
Time Stamp:	18:50:25
Application Type:	Utility under 35 USC 111(a)

Payment information:

Submitted with Payment	no
------------------------	----

File Listing:

Document Number	Document Description	File Name	File Size(Bytes)/ Message Digest	Multi Part /.zip	Pages (if appl.)
1		IDS_05.pdf	335261 c69e36dd578be1a7dc864741c2479d7365658284	yes	4

Multipart Description/PDF files in .zip description					
Document Description			Start	End	
Transmittal Letter			1	3	
Information Disclosure Statement (IDS) Form (SB08)			4	4	
Warnings:					
Information:					
2	Non Patent Literature	5550-2-PAU-4-DIV-2_NOA_2011-08-25.pdf	114178 c37e9ded1fad2bc51b89c52910ec41bc550c8108	no	3
Warnings:					
Information:					
3	Non Patent Literature	5550-2-PCA-DIV_OA_2011-06-30.pdf	216248 97416c585f79a12f2fb268156c6bf02d3fc37b	no	2
Warnings:					
Information:					
Total Files Size (in bytes):			665687		
<p>This Acknowledgement Receipt evidences receipt on the noted date by the USPTO of the indicated documents, characterized by the applicant, and including page counts, where applicable. It serves as evidence of receipt similar to a Post Card, as described in MPEP 503.</p> <p><u>New Applications Under 35 U.S.C. 111</u> If a new application is being filed and the application includes the necessary components for a filing date (see 37 CFR 1.53(b)-(d) and MPEP 506), a Filing Receipt (37 CFR 1.54) will be issued in due course and the date shown on this Acknowledgement Receipt will establish the filing date of the application.</p> <p><u>National Stage of an International Application under 35 U.S.C. 371</u> If a timely submission to enter the national stage of an international application is compliant with the conditions of 35 U.S.C. 371 and other applicable requirements a Form PCT/DO/EO/903 indicating acceptance of the application as a national stage submission under 35 U.S.C. 371 will be issued in addition to the Filing Receipt, in due course.</p> <p><u>New International Application Filed with the USPTO as a Receiving Office</u> If a new international application is being filed and the international application includes the necessary components for an international filing date (see PCT Article 11 and MPEP 1810), a Notification of the International Application Number and of the International Filing Date (Form PCT/RO/105) will be issued in due course, subject to prescriptions concerning national security, and the date shown on this Acknowledgement Receipt will establish the international filing date of the application.</p>					

IN THE UNITED STATES PATENT AND TRADEMARK OFFICE

In Re the Application of:)	Group Art Unit: 2611
KRINSKY et al.)	Confirmation No.: 8981
Serial No.: 12/779,660)	Examiner: Fan, Chieh M.
Filed: May 13, 2010)	
Atty. File No.: 5550-2-CON-2-1-1)	
Entitled: "Multicarrier Modulation Messaging for Power Level Per Subchannel Information")	<u>SUPPLEMENTAL</u> <u>INFORMATION DISCLOSURE</u> <u>STATEMENT</u>
)	Electronically Submitted

Commissioner for Patents
P.O. Box 1450
Alexandria, VA 22313-1450

Dear Sir:

The references cited on attached Form PTO-1449 are being called to the attention of the Examiner.

- Copies of the cited non-patent and/or foreign references are enclosed herewith.
- Copies of the cited U.S. patents and/or patent applications are enclosed herewith.
- Copies of the cited U.S. patents/patent application publications are not enclosed in accordance with 37 C.F.R. § 1.98(a).
- Copies of the cited references are not enclosed, in accordance with 37 C.F.R. § 1.98(d), because the references were cited by or submitted to the U.S. Patent and Trademark Office in prior application Serial No. _____ filed _____, which is relied upon for an earlier filing date under 35 U.S.C. § 120.
- To the best of applicants' belief, the pertinence of the foreign-language references are believed to be summarized in the attached English abstracts and/or in the figures, although applicants do not necessarily vouch for the accuracy of the translation.
- Examiner's attention is drawn to the following related applications:
 Serial No. _____ filed _____ (Attorney Ref. No. _____)
 Serial No. _____ filed _____ (Attorney Ref. No. _____)
- Other: _____

Submission of the above information is not intended as an admission that any item is citable under the statutes or rules to support a rejection, that any item disclosed represents analogous art, or that those skilled in the art would refer to or recognize the pertinence of any reference without the benefit of hindsight, nor should an inference be

drawn as to the pertinence of the references based on the order in which they are presented. Submission of this statement should not be taken as an indication that a search has been conducted, or that no better art exists.

It is respectfully requested that the cited information be expressly considered during the prosecution of this application and the references made of record therein.

FEES

<input checked="" type="checkbox"/>	<p>37 CFR 1.97(b): No fee is believed due in connection with this submission, because the information disclosure statement submitted herewith is satisfied by one of the following conditions ("X" indicates satisfaction):</p> <p><input type="checkbox"/> Within three months of the filing date of a national application other than a continued prosecution application under 37 CFR 1.53(d), or</p> <p><input type="checkbox"/> Within three months of the date of entry of the national stage as set forth in § 1.491 in an international application, or</p> <p><input checked="" type="checkbox"/> Before the mailing date of a first Office Action on the merits, or</p> <p><input type="checkbox"/> Before the mailing of a first Office action after the filing of a request for continued examination under 37 CFR 1.114.</p> <p>Although no fee is believed due, if any fee is deemed due in connection with this submission, please charge such fee to Deposit Account 19-1970.</p>
<input type="checkbox"/>	<p>37 CFR 1.97(c): The information disclosure statement transmitted herewith is being filed after all the above conditions (37 CFR 1.97(b)), but before the mailing date of any one of the following conditions:</p> <p>(1) a final action under 37 C.F.R. 1.113, or</p> <p>(2) a notice of allowance under 37 C.F.R. 1.311, or</p> <p>(3) an action that otherwise closes prosecution in the application.</p> <p>This Information Disclosure Statement is accompanied by:</p> <p><input type="checkbox"/> A Certification (below) as specified by 37 C.F.R. 1.97(e). Although no fee is believed due, if any fee is deemed due in connection with this submission, please charge such fee to Deposit Account 19-1970.</p> <p style="text-align: center;">OR</p> <p><input type="checkbox"/> Please charge Deposit Account 19-1970 in the amount of \$180.00 for the fee set forth in 37 C.F.R. 1.17(p) for submission of an information disclosure statement. Please credit any overpayment or charge any underpayment to Deposit Account 19-1970.</p>
<input type="checkbox"/>	<p>37 CFR 1.97(d): This Information Disclosure Statement is being submitted after the period specified in 37 CFR 1.97(c).</p> <p><input type="checkbox"/> This information Disclosure Statement includes a Certification (below) as specified by 37 C.F.R. 1.97(e)</p> <p style="text-align: center;">AND</p> <p><input type="checkbox"/> Applicants hereby requests consideration of the reference(s) disclosed herein. Please charge Deposit Account 19-1970 in the amount of \$180.00 under 37 C.F.R. 1.17(p). Please credit any overpayment or charge any underpayment to Deposit Account 19-1970. Election to pay the fee should not be taken as an indication that applicant(s) cannot execute a certification.</p>

Certification (37 C.F.R. 1.97(e))

(Applicable only if checked)

The undersigned certifies that:

Each item of information contained in this information disclosure statement was first cited in any communication from a foreign patent office in a counterpart foreign application not more than three months prior to the filing of this statement. 37 C.F.R. 1.97(e)(1).

A copy of the communication from the foreign patent office is enclosed.

OR

No item of information contained in this information disclosure statement was cited in a communication from a foreign patent office in a counterpart foreign application, and, to the knowledge of the undersigned after making reasonable inquiry, no item of information contained in this Information Disclosure Statement was known to any individual designated in 37 C.F.R. 1.56(c) more than three months prior to the filing of this statement. 37 C.F.R. 1.97(e)(2).

Respectfully submitted,

SHERIDAN ROSS P.C.

By: _____

Jason H. Vick

Registration No. 45,285

1560 Broadway, Suite 1200

Denver, Colorado 80202-5141

(303) 863-9700

Date: 30 Sept 11

Substitute for form 1449A/PTO				Complete if Known	
INFORMATION DISCLOSURE STATEMENT BY APPLICANT				Application Number	12/779,660
				Filing Date	May 13, 2010
				First Named Inventor	David M. Krinsky
				Art Unit	2611
				Examiner Name	Ghayour, Mohammad H.
Sheet	1	of	2	Attorney Docket Number	5550-2-CON-2-1-1

U.S. PATENT DOCUMENTS					
Examiner Initials*	Cite No. ¹	Document Number Number-kind Code ^{2 (if known)}	Publication Date MM-DD-YYYY	Name of Patentee of Applicant of Cited Document	Pages, Columns, Lines, Where Relevant Passages or Relevant Figures Appear
	1	5612960	03/18/97	Stevens et al.	

FOREIGN PATENT DOCUMENTS						
Examiner Initials*	Cite No. ¹	Foreign Patent Document Country Code ³ ; Number ⁴ ; Kind Code ^{5 (if known)}	Publication Date MM-DD-YYYY	Name of Patentee or Applicant of Cited Document	Pages, Columns, Lines, Where Relevant Passages or Relevant Figures Appear	T ⁶

OTHER ART (Including Author, Title, Date, Pertinent Pages, etc.)		
Examiner Initials*	Cite No. ¹	
	2	ITU-T Recommendation G.992.2, "Splitterless asymmetric digital subscriber line (ADSL) transceivers," International Telecommunication Union, Jun. 1999, 179 pages
	3	ITU-T Recommendation G.994.1, "Handshake procedures for digital subscriber line (DSL) transceivers," International Telecommunication Union, Jun. 1999, 56 pages
	4	Notice of Acceptance for Australian Patent Application No. 2004203321, dated Aug. 7, 2008 (Attorney Ref. No. 5550-2-PAU-4)
	5	Examination Report for Australian Patent Application No. 2009222537, dated Mar. 21, 2011 (Attorney Ref. No. 5550-2-PAU-4-DIV-2)
	6	Examination Report for Australian Patent Application No. 2009222537, dated May 27, 2011 (Attorney Ref. No. 5550-2-PAU-4-DIV-2)
	7	Communication Under Rule 71(3) EPC for European Patent Application No. EP 06022008, dated Apr. 4, 2011 (Attorney Ref. No. 5550-2-PEP-5)
	8	Official Action (including translation) for Japanese Patent Application No. 2001-552611, mailed Mar. 28, 2011 (Attorney Ref. No. 5550-2-PJP)
	9	Notice of Allowance for Japanese Patent Application No. 2008-190051, mailed Mar. 14, 2011 (Attorney Ref. No. 5550-2-PJP-DIV)

Examiner Signature		Date Considered	
--------------------	--	-----------------	--

*EXAMINER: Initial if reference is considered, whether or not citation is in conformance and not considered. Include copy of this form with next communication to applicant.

Substitute for form 1449A/PTO				Complete if Known	
INFORMATION DISCLOSURE STATEMENT BY APPLICANT				Application Number	12/779,660
				Filing Date	May 13, 2010
				First Named Inventor	David M. Krinsky
				Art Unit	2611
				Examiner Name	Ghayour, Mohammad H.
Sheet	2	of	2	Attorney Docket Number	5550-2-CON-2-1-1

	10	Official Action for U.S. Patent Application No. 09/755,173, mailed Jun. 20, 2002 (Attorney Ref. No. 5550-2)
	11	Official Action for U.S. Patent Application No. 09/755,173, mailed Sep. 24, 2002 (Attorney Ref. No. 5550-2)
	12	Official Action for U.S. Patent Application No. 09/755,173, mailed Mar. 14, 2003 (Attorney Ref. No. 5550-2)
	13	Notice of Allowance for U.S. Patent Application No. 09/755,173, mailed Jul. 1, 2003 (Attorney Ref. No. 5550-2)

Examiner Signature		Date Considered	
-----------------------	--	--------------------	--

*EXAMINER: Initial if reference is considered, whether or not citation is in conformance and not considered. Include copy of this form with next communication to applicant.

Electronic Acknowledgement Receipt

EFS ID:	10233482
Application Number:	12779660
International Application Number:	
Confirmation Number:	8981
Title of Invention:	Multicarrier Modulation Messaging for Power Level Per Subchannel Information
First Named Inventor/Applicant Name:	David M. Krinsky
Customer Number:	62574
Filer:	Jason Vick/Amy Duarte
Filer Authorized By:	Jason Vick
Attorney Docket Number:	5550-2-CON2-1-1
Receipt Date:	03-JUN-2011
Filing Date:	13-MAY-2010
Time Stamp:	19:41:16
Application Type:	Utility under 35 USC 111(a)

Payment information:

Submitted with Payment	no
------------------------	----

File Listing:

Document Number	Document Description	File Name	File Size(Bytes)/ Message Digest	Multi Part /.zip	Pages (if appl.)
1	Non Patent Literature	ITU- T_Recommendation_G992_2_0 6-1999.pdf	20989447 720d0b31fca353c8b3c0d1fa8a36d25b83e9e2cc	no	179

Warnings:

Information:

2	Non Patent Literature	ITU- T_Recommendation_G994-1_0 6-1999.pdf	2054195 5cf135f4d19cc6d2da72898847ceaad36de4 64d2	no	56
Warnings:					
Information:					
3	Non Patent Literature	5550-2- PAU-4_NOA_2008-08-07.pdf	161415 8ae89246eb5c72cd735c7e75bf75ff0d03f1 400e	no	2
Warnings:					
Information:					
4	Non Patent Literature	5550-2-PAU-4- DIV-2_OA_03-21-2011.pdf	106842 6f212e59c6e2bad87b6e7e3285e60831a2b 8092e	no	2
Warnings:					
Information:					
5	Non Patent Literature	5550-2-PAU-4- DIV-2_OA_2011-05-27.pdf	103544 62f1a7c8f81b79b09ed09df60207cb31ad0 bff6	no	2
Warnings:					
Information:					
6	Non Patent Literature	5550-2- PEP-5_Communication_713EP C_04-04-2011.pdf	1118938 aa1de93f8b730f2a5ac628b3f1b4dd492d 25ad3	no	24
Warnings:					
Information:					
7	Non Patent Literature	5550-2-PJP- DIV_NOA_03-14-2011.pdf	75106 82d1c244f8a90e4e89ba3665bc16df1c8172 8853	no	3
Warnings:					
Information:					
8	Non Patent Literature	5550-2_OA_2002-06-20.pdf	520919 89434121207e74641356e47c21b645c1957 e7400	no	6
Warnings:					
Information:					
9	Non Patent Literature	5550-2_OA_2002-09-24.pdf	536559 38636095cd805b446dcae8c508b48479faa bdcf1	no	6
Warnings:					
Information:					
10	Non Patent Literature	5550-2_OA_2003-03-14.pdf	576265 3e1fdb159c760036e282d5f8b0147bbadd2 c5155	no	7
Warnings:					
Information:					

11	Non Patent Literature	5550-2_NOA_2003-07-01.pdf	657680 8f8cdd685998e2650cb2293c68432a950407e251	no	7
Warnings:					
Information:					
12	Non Patent Literature	5550-2-PJP_OA_03-28-2011.pdf	114068 48ce0363891e3a5647f4888237ea92b78a70edf9	no	4
Warnings:					
Information:					
13		IDS_04.pdf	372355 033133439fcc3c1f7f9b427b06989b0115aaecd1	yes	5
	Multipart Description/PDF files in .zip description				
	Document Description	Start	End		
	Transmittal Letter	1	3		
	Information Disclosure Statement (IDS) Form (SB08)	4	5		
Warnings:					
Information:					
Total Files Size (in bytes):				27387333	
<p>This Acknowledgement Receipt evidences receipt on the noted date by the USPTO of the indicated documents, characterized by the applicant, and including page counts, where applicable. It serves as evidence of receipt similar to a Post Card, as described in MPEP 503.</p> <p><u>New Applications Under 35 U.S.C. 111</u> If a new application is being filed and the application includes the necessary components for a filing date (see 37 CFR 1.53(b)-(d) and MPEP 506), a Filing Receipt (37 CFR 1.54) will be issued in due course and the date shown on this Acknowledgement Receipt will establish the filing date of the application.</p> <p><u>National Stage of an International Application under 35 U.S.C. 371</u> If a timely submission to enter the national stage of an international application is compliant with the conditions of 35 U.S.C. 371 and other applicable requirements a Form PCT/DO/EO/903 indicating acceptance of the application as a national stage submission under 35 U.S.C. 371 will be issued in addition to the Filing Receipt, in due course.</p> <p><u>New International Application Filed with the USPTO as a Receiving Office</u> If a new international application is being filed and the international application includes the necessary components for an international filing date (see PCT Article 11 and MPEP 1810), a Notification of the International Application Number and of the International Filing Date (Form PCT/RO/105) will be issued in due course, subject to prescriptions concerning national security, and the date shown on this Acknowledgement Receipt will establish the international filing date of the application.</p>					

IN THE UNITED STATES PATENT AND TRADEMARK OFFICE

In Re the Application of:)	Group Art Unit: 2611
KRINSKY et al.)	Confirmation No.: 8981
Serial No.: 12/779,660)	Examiner: Ghayour, Mohammad H.
Filed: May 13, 2010)	
Atty. File No.: 5550-2-CON-2-1-1)	
Entitled: "Multicarrier Modulation Messaging for Power Level Per Subchannel Information")	<u>SUPPLEMENTAL</u> <u>INFORMATION DISCLOSURE</u> <u>STATEMENT</u>
)	Electronically Submitted

Commissioner for Patents
P.O. Box 1450
Alexandria, VA 22313-1450

Dear Sir:

The references cited on attached Form PTO-1449 are being called to the attention of the Examiner.

- Copies of the cited non-patent and/or foreign references are enclosed herewith.
- Copies of the cited U.S. patents and/or patent applications are enclosed herewith.
- Copies of the cited U.S. patents/patent application publications are not enclosed in accordance with 37 C.F.R. § 1.98(a).
- Copies of the cited references are not enclosed, in accordance with 37 C.F.R. § 1.98(d), because the references were cited by or submitted to the U.S. Patent and Trademark Office in prior application Serial No. _____ filed _____, which is relied upon for an earlier filing date under 35 U.S.C. § 120.
- To the best of applicants' belief, the pertinence of the foreign-language references are believed to be summarized in the attached English translations and/or in the figures, although applicants do not necessarily vouch for the accuracy of the translation.
- Examiner's attention is drawn to the following related applications:
 - Serial No. _____ filed _____ (Attorney Ref. No. _____)
 - Serial No. _____ filed _____ (Attorney Ref. No. _____)
- Other: _____

Submission of the above information is not intended as an admission that any item is citable under the statutes or rules to support a rejection, that any item disclosed represents analogous art, or that those skilled in the art would refer to or recognize the pertinence of any reference without the benefit of hindsight, nor should an inference be

drawn as to the pertinence of the references based on the order in which they are presented. Submission of this statement should not be taken as an indication that a search has been conducted, or that no better art exists.

It is respectfully requested that the cited information be expressly considered during the prosecution of this application and the references made of record therein.

FEES

<input checked="" type="checkbox"/>	<p>37 CFR 1.97(b): No fee is believed due in connection with this submission, because the information disclosure statement submitted herewith is satisfied by one of the following conditions ("X" indicates satisfaction):</p> <p><input type="checkbox"/> Within three months of the filing date of a national application other than a continued prosecution application under 37 CFR 1.53(d), or</p> <p><input type="checkbox"/> Within three months of the date of entry into the national stage of an international application as set forth in 37 CFR 1.491 or</p> <p><input checked="" type="checkbox"/> Before the mailing date of a first Office Action on the merits, or</p> <p><input type="checkbox"/> Before the mailing of a first Office action after the filing of a request for continued examination under 37 CFR 1.114.</p> <p>Although no fee is believed due, if any fee is deemed due in connection with this submission, please charge such fee to Deposit Account 19-1970.</p>
<input type="checkbox"/>	<p>37 CFR 1.97(c): The information disclosure statement transmitted herewith is being filed after all the above conditions (37 CFR 1.97(b)), but before the mailing date of one of the following conditions:</p> <p>(1) a final action under 37 C.F.R. 1.113 or</p> <p>(2) a notice of allowance under 37 C.F.R. 1.311, or</p> <p>(3) an action that otherwise closes prosecution in the application.</p> <p>This Information Disclosure Statement is accompanied by:</p> <p><input type="checkbox"/> A Certification (below) as specified by 37 C.F.R. 1.97(e). Although no fee is believed due, if any fee is deemed due in connection with this submission, please charge such fee to Deposit Account 19-1970.</p> <p style="text-align: center;">OR</p> <p><input type="checkbox"/> Please charge Deposit Account 19-1970 in the amount of \$180.00 for the fee set forth in 37 C.F.R. 1.17(p) for submission of an information disclosure statement. Please credit any overpayment or charge any underpayment to Deposit Account 19-1970.</p>
<input type="checkbox"/>	<p>37 CFR 1.97(d): This Information Disclosure Statement is being submitted after the period specified in 37 CFR 1.97(c).</p> <p><input type="checkbox"/> This information Disclosure Statement includes a Certification (below) as specified by 37 C.F.R. 1.97(e)</p> <p style="text-align: center;">AND</p> <p><input type="checkbox"/> Applicants hereby requests consideration of the reference(s) disclosed herein. Please charge Deposit Account 19-1970 in the amount of \$180.00 under 37 C.F.R. 1.17(p). Please credit any overpayment or charge any underpayment to Deposit Account 19-1970. Election to pay the fee should not be taken as an indication that applicant(s) cannot execute a certification.</p>

Certification (37 C.F.R. 1.97(e))
(Applicable only if checked)

- The undersigned certifies that:
- Each item of information contained in this information disclosure statement was first cited in any communication from a foreign patent office in a counterpart foreign application not more than three months prior to the filing of this statement. 37 C.F.R. 1.97(e)(1).
 - A copy of the communication from the foreign patent office is enclosed.
- OR
- No item of information contained in this information disclosure statement was cited in a communication from a foreign patent office in a counterpart foreign application, and, to the knowledge of the undersigned after making reasonable inquiry, no item of information contained in this Information Disclosure Statement was known to any individual designated in 37 C.F.R. 1.56(c) more than three months prior to the filing of this statement. 37 C.F.R. 1.97(e)(2).

Respectfully submitted,

SHERIDAN ROSS P.C.

By: _____

Jason H. Vick
Registration No. 45,285
1560 Broadway, Suite 1200
Denver, Colorado 80202-5141
(303) 863-9700

Date: 3 Jan '11

Substitute for form 1449A/PTO INFORMATION DISCLOSURE STATEMENT BY APPLICANT				Complete if Known		
				Application Number	12/779,660	
				Filing Date	May 13, 2010	
				First Named Inventor	David M. Krinsky	
				Art Unit	2611	
				Examiner Name	Ghayour, Mohammad H.	
Sheet	1	of	2	Attorney Docket Number	5550-2-CON-2-1-1	

U.S. PATENT DOCUMENTS					
Examiner Initials*	Cite No. ¹	Document Number Number-kind Code ^{2 (if known)}	Publication Date MM-DD-YYYY	Name of Patentee of Applicant of Cited Document	Pages, Columns, Lines, Where Relevant Passages or Relevant Figures Appear
	1	13/004254		Krinsky et al. (filed 01-11-2011)	

FOREIGN PATENT DOCUMENTS						
Examiner Initials*	Cite No. ¹	Foreign Patent Document Country Code ³ ; Number ⁴ ; Kind Code ⁵ (if known)	Publication Date MM-DD-YYYY	Name of Patentee or Applicant of Cited Document	Pages, Columns, Lines, Where Relevant Passages or Relevant Figures Appear	T ⁶

OTHER ART (Including Author, Title, Date, Pertinent Pages, etc.)		
Examiner Initials*	Cite No. ¹	
	2	Official Action for U.S. Patent Application No. 10/619,691, mailed Oct. 31, 2006 (5550-2-CON-2), 14 pages
	3	Official Action for U.S. Patent Application No. 10/619,691, mailed Mar. 30, 2007 (5550-2-CON-2), 11 pages
	4	Official Action for U.S. Patent Application No. 10/619,691, mailed Jun. 13, 2008 (5550-2-CON-2), 7 pages
	5	Official Action for U.S. Patent Application No. 10/619,691, mailed Oct. 20, 2008 (5550-2-CON-2), 11 pages
	6	Notice of Allowance for U.S. Patent Application No. 10/619,691, mailed May 15, 2009 (5550-2-CON-2), 9 pages
	7	Notice of Allowance for U.S. Patent Application No. 10/619,691, mailed July 6, 2009 (5550-2-CON-2), 5 pages
	8	Official Action for U.S. Patent Application No. 12/779,708, mailed Sep. 29, 2010 (Attorney Ref. No. 5550-2-CON-2-1-2), 6 pages
	9	Official Action for U.S. Patent Application No. 12/779,708, mailed Dec. 15, 2010 (Attorney Ref. No. 5550-2-CON-2-1-2), 6 pages
Examiner Signature		Date Considered

*EXAMINER: Initial if reference is considered, whether or not citation is in conformance and not considered. Include copy of this form with next communication to applicant.

Substitute for form 1449A/PTO				Complete if Known	
INFORMATION DISCLOSURE STATEMENT BY APPLICANT				Application Number	12/779,660
				Filing Date	May 13, 2010
				First Named Inventor	David M. Krinsky
				Art Unit	2611
				Examiner Name	Ghayour, Mohammad H.
				Attorney Docket Number	5550-2-CON-2-1-1
Sheet	2	of	2		

	10	Notice of Allowance for U.S. Patent Application No. 12/779,708, mailed Jan. 3, 2011 (Attorney Ref. No. 5550-2-CON-2-1-2), 6 pages
--	----	---

Examiner Signature		Date Considered	
-----------------------	--	--------------------	--

*EXAMINER: Initial if reference is considered, whether or not citation is in conformance and not considered. Include copy of this form with next communication to applicant.

Electronic Acknowledgement Receipt

EFS ID:	9642249
Application Number:	12779660
International Application Number:	
Confirmation Number:	8981
Title of Invention:	Multicarrier Modulation Messaging for Power Level Per Subchannel Information
First Named Inventor/Applicant Name:	David M. Krinsky
Customer Number:	62574
Filer:	Jason Vick/Nancy Davis
Filer Authorized By:	Jason Vick
Attorney Docket Number:	5550-2-CON2-1-1
Receipt Date:	11-MAR-2011
Filing Date:	13-MAY-2010
Time Stamp:	15:35:05
Application Type:	Utility under 35 USC 111(a)

Payment information:

Submitted with Payment	no
------------------------	----

File Listing:

Document Number	Document Description	File Name	File Size(Bytes)/ Message Digest	Multi Part /.zip	Pages (if appl.)
1		IDS_03.pdf	419340 <small>9669335233cb3bba7a4ff800f63b473d3be0b30af</small>	yes	5

Multipart Description/PDF files in .zip description					
Document Description			Start	End	
Transmittal Letter			1	3	
Information Disclosure Statement (IDS) Filed (SB/08)			4	5	
Warnings:					
Information:					
2	NPL Documents	5550-2-CON2_OA_10-31-06.pdf	445804	no	14
			827c1498a2c2471307385d437484d38a253000e6		
Warnings:					
Information:					
3	NPL Documents	5550-2-CON2_OA_3-30-07.pdf	360505	no	11
			4ce2475f77d4ada41e93c92148c62342aff556		
Warnings:					
Information:					
4	NPL Documents	5550-2-CON2_OA_6-13-08.pdf	213633	no	7
			ed7c5e64d3a07730a9d7fc9c2afbdccde49ba669		
Warnings:					
Information:					
5	NPL Documents	5550-2-CON2_OA_10-20-08.pdf	359739	no	11
			90f874c16321df138cd6d83e72f2ad7a8e46326f		
Warnings:					
Information:					
6	NPL Documents	5550-2-CON2_NOA_5-15-09.pdf	362420	no	9
			987db7c0dae929d6ae5d51f6d6969fd44979705b		
Warnings:					
Information:					
7	NPL Documents	5550-2-CON2_NOA_7-6-09.pdf	150837	no	5
			0cb7376cb0fb55ea05c0329c1c04eec596e57c1b		
Warnings:					
Information:					
8	NPL Documents	5550-2-CON-2-1-2_OA_9-29-2010.pdf	196746	no	6
			b0dce94939b1cd715782760bf2cab707e9827a6d		
Warnings:					
Information:					

9	NPL Documents	5550-2- CON-2-1-2_OA_12-15-2010.pdf	204798 f1fcd4825b75e45ab00dec267c823f5cd33 0172	no	6
Warnings:					
Information:					
10	NPL Documents	5550-2- CON-2-1-2_NOA_1-3-2011.pdf	227245 601da178e4f6e431bc48647d65982b5b600 6dfcb	no	6
Warnings:					
Information:					
Total Files Size (in bytes):				2941067	
<p>This Acknowledgement Receipt evidences receipt on the noted date by the USPTO of the indicated documents, characterized by the applicant, and including page counts, where applicable. It serves as evidence of receipt similar to a Post Card, as described in MPEP 503.</p> <p><u>New Applications Under 35 U.S.C. 111</u> If a new application is being filed and the application includes the necessary components for a filing date (see 37 CFR 1.53(b)-(d) and MPEP 506), a Filing Receipt (37 CFR 1.54) will be issued in due course and the date shown on this Acknowledgement Receipt will establish the filing date of the application.</p> <p><u>National Stage of an International Application under 35 U.S.C. 371</u> If a timely submission to enter the national stage of an international application is compliant with the conditions of 35 U.S.C. 371 and other applicable requirements a Form PCT/DO/EO/903 indicating acceptance of the application as a national stage submission under 35 U.S.C. 371 will be issued in addition to the Filing Receipt, in due course.</p> <p><u>New International Application Filed with the USPTO as a Receiving Office</u> If a new international application is being filed and the international application includes the necessary components for an international filing date (see PCT Article 11 and MPEP 1810), a Notification of the International Application Number and of the International Filing Date (Form PCT/RO/105) will be issued in due course, subject to prescriptions concerning national security, and the date shown on this Acknowledgement Receipt will establish the international filing date of the application.</p>					

IN THE UNITED STATES PATENT AND TRADEMARK OFFICE

In Re the Application of:)	Group Art Unit: 2611
David M. Krinsky)	Confirmation No.: 8981
Serial No.: 12/779,660)	Examiner: Ghayour, Mohammad H.
Filed: May 13, 2010)	
Atty. File No.: 5550-2-CON-2-1-1)	
Entitled: "MULTICARRIER MODULATION MESSAGING FOR POWER LEVEL PER SUBCHANNEL INFORMATION")	<u>SUPPLEMENTAL</u> <u>INFORMATION DISCLOSURE</u> <u>STATEMENT</u>
)	Electronically Submitted

Commissioner for Patents
P.O. Box 1450
Alexandria, VA 22313-1450

Dear Sir:

The references cited on attached Form PTO-1449 are being called to the attention of the Examiner.

- Copies of the cited non-patent and/or foreign references are enclosed herewith.
- Copies of the cited U.S. patents and/or patent applications are enclosed herewith.
- Copies of the cited U.S. patents/patent application publications are not enclosed in accordance with 37 C.F.R. § 1.98(a).
- Copies of the cited references are not enclosed, in accordance with 37 C.F.R. § 1.98(d), because the references were cited by or submitted to the U.S. Patent and Trademark Office in prior application Serial No. _____ filed _____, which is relied upon for an earlier filing date under 35 U.S.C. § 120.
- To the best of applicants' belief, the pertinence of the foreign-language references are believed to be summarized in the attached English abstracts and in the figures, although applicants do not necessarily vouch for the accuracy of the translation.
- Examiner's attention is drawn to the following related applications:
Serial No. 13/004,254 filed 0-1-11-2011 (Attorney Ref. No. 5550-2-CON-2-1-3)
- Other: _____

Submission of the above information is not intended as an admission that any item is citable under the statutes or rules to support a rejection, that any item disclosed represents analogous art, or that those skilled in the art would refer to or recognize the pertinence of any reference without the benefit of hindsight, nor should an inference be

drawn as to the pertinence of the references based on the order in which they are presented. Submission of this statement should not be taken as an indication that a search has been conducted, or that no better art exists.

It is respectfully requested that the cited information be expressly considered during the prosecution of this application and the references made of record therein.

FEES

<input checked="" type="checkbox"/>	<p>37 CFR 1.97(b): No fee is believed due in connection with this submission, because the information disclosure statement submitted herewith is satisfied by one of the following conditions ("X" indicates satisfaction):</p> <p><input type="checkbox"/> Within three months of the filing date of a national application other than a continued prosecution application under 37 CFR 1.53(d), or</p> <p><input type="checkbox"/> Within three months of the date of entry into the national stage of an international application as set forth in 37 CFR 1.491 or</p> <p><input checked="" type="checkbox"/> Before the mailing date of a first Office Action on the merits, or</p> <p><input type="checkbox"/> Before the mailing of a first Office action after the filing of a request for continued examination under 37 CFR 1.114.</p> <p>Although no fee is believed due, if any fee is deemed due in connection with this submission, please charge such fee to Deposit Account 19-1970.</p>
<input type="checkbox"/>	<p>37 CFR 1.97(e): The information disclosure statement transmitted herewith is being filed after all the above conditions (37 CFR 1.97(b)), but before the mailing date of one of the following conditions:</p> <p>(1) a final action under 37 C.F.R. 1.113 or</p> <p>(2) a notice of allowance under 37 C.F.R. 1.311, or</p> <p>(3) an action that otherwise closes prosecution in the application.</p> <p>This Information Disclosure Statement is accompanied by:</p> <p><input type="checkbox"/> A Certification (below) as specified by 37 C.F.R. 1.97(e). Although no fee is believed due, if any fee is deemed due in connection with this submission, please charge such fee to Deposit Account 19-1970.</p> <p>OR</p> <p><input type="checkbox"/> Please charge Deposit Account 19-1970 in the amount of \$180.00 for the fee set forth in 37 C.F.R. 1.17(p) for submission of an information disclosure statement. Please credit any overpayment or charge any underpayment to Deposit Account 19-1970.</p>
<input type="checkbox"/>	<p>37 CFR 1.97(d): This Information Disclosure Statement is being submitted after the period specified in 37 CFR 1.97(e).</p> <p><input type="checkbox"/> This information Disclosure Statement includes a Certification (below) as specified by 37 C.F.R. 1.97(e)</p> <p>AND</p> <p><input type="checkbox"/> Applicants hereby requests consideration of the reference(s) disclosed herein. Please charge Deposit Account 19-1970 in the amount of \$180.00 under 37 C.F.R. 1.17(p). Please credit any overpayment or charge any underpayment to Deposit Account 19-1970. Election to pay the fee should not be taken as an indication that applicant(s) cannot execute a certification.</p>

Certification (37 C.F.R. 1.97(e))
(Applicable only if checked)

- The undersigned certifies that:
- Each item of information contained in this information disclosure statement was first cited in any communication from a foreign patent office in a counterpart foreign application not more than three months prior to the filing of this statement. 37 C.F.R. 1.97(e)(1).
 - A copy of the communication from the foreign patent office is enclosed.
- OR
- No item of information contained in this information disclosure statement was cited in a communication from a foreign patent office in a counterpart foreign application, and, to the knowledge of the undersigned after making reasonable inquiry, no item of information contained in this Information Disclosure Statement was known to any individual designated in 37 C.F.R. 1.56(c) more than three months prior to the filing of this statement. 37 C.F.R. 1.97(e)(2).

Respectfully submitted,

SHERIDAN ROSS P.C.

By: _____

Jason H. Vick
Registration No. 45,285
1560 Broadway, Suite 1200
Denver, Colorado 80202-5141
(303) 863-9700

Date: 11 Mar '11

IN THE UNITED STATES PATENT AND TRADEMARK OFFICE

In Re the Application of: David M. Krinsky)	Group Art Unit: 2611
)	
Application No.: 12/779,660)	Examiner: GHAYOUR, Mohammad H.
)	
Filed: May 13, 2010)	Confirmation No.: 8981
)	
Atty. File No.: 5550-2-CON2-1-1)	
)	

For: MULTICARRIER MODULATION MESSAGING FOR POWER LEVEL PER
SUBCHANNEL INFORMATION

Commissioner for Patents
P.O. Box 1450
Alexandria, VA 22313

SECOND PRELIMINARY AMENDMENT

Dear Sir:

Prior to the initial review of the above-identified patent application by the Examiner, please enter the following Preliminary Amendment. Although Applicants do not believe that any fees are due based upon the filing of this Preliminary Amendment, please charge any such fees to Deposit Account 19-1970.

Please amend the above-identified patent application as follows:

Amendments to the Claims are shown in the listing of claims which begin on page 2 of this paper.

Remarks begin on page 9 of this paper.

AMENDMENTS TO THE CLAIMS:

This listing of claims will replace all prior versions, and listings, of claims in the application.

Listing of Claims:

1. – 43. (Cancelled)

44. (Previously Presented) A transceiver capable of transmitting test information over a communication channel using multicarrier modulation comprising:

a transmitter portion capable of transmitting a message, wherein the message comprises one or more data variables that represent the test information, wherein bits in the message are modulated onto DMT symbols using Quadrature Amplitude Modulation (QAM) with more than 1 bit per subchannel and wherein at least one data variable of the one or more data variables comprises an array representing power level per subchannel information.

45. (Previously Presented) The transceiver of claim 44, wherein the power level per subchannel information is based on a Reverb signal.

46. (Previously Presented) A transceiver capable of receiving test information over a communication channel using multicarrier modulation comprising:

a receiver portion capable of receiving a message, wherein the message comprises one or more data variables that represent the test information, wherein bits in the message were modulated onto DMT symbols using Quadrature Amplitude Modulation (QAM) with more than 1 bit per subchannel and wherein at least one data variable of the one or more data variables comprises an array representing power level per subchannel information.

47. (Previously Presented) The transceiver of claim 46, wherein the power level per subchannel information is based on a Reverb signal.

48. (Previously Presented) In a transceiver capable of transmitting test information over a communication channel using multicarrier modulation, a method comprising:

transmitting a message, wherein the message comprises one or more data variables that represent the test information, wherein bits in the message are modulated onto DMT symbols using Quadrature Amplitude Modulation (QAM) with more than 1 bit per subchannel and wherein at least one data variable of the one or more data variables comprises an array representing power level per subchannel information.

49. (Previously Presented) The method of claim 48, wherein the power level per subchannel information is based on a Reverb signal.

50. (Previously Presented) In a transceiver capable of receiving test information over a communication channel using multicarrier modulation, a method comprising:

receiving a message, wherein the message comprises one or more data variables that represent the test information, wherein bits in the message were modulated onto DMT symbols using Quadrature Amplitude Modulation (QAM) with more than 1 bit per subchannel and wherein at least one data variable of the one or more data variables comprises an array representing power level per subchannel information.

51. (Previously Presented) The method of claim 50, wherein the power level per subchannel information is based on a Reverb signal.

52. (Previously Presented) A non-transitory computer-readable information storage media having stored thereon instructions that, if executed, cause a transceiver to perform a method comprising:

transmitting a message, wherein the message comprises one or more data variables that represent the test information, wherein bits in the message are modulated onto DMT symbols using Quadrature Amplitude Modulation (QAM) with more than 1 bit per subchannel and wherein at least one data variable of the one or more data variables comprises an array representing power level per subchannel information.

53. (Previously Presented) The media of claim 52, wherein the power level per subchannel information is based on a Reverb signal.

54. (Previously Presented) A non-transitory computer-readable information storage media having stored thereon instructions that, if executed, cause a transceiver to perform a method comprising:

receiving a message, wherein the message comprises one or more data variables that represent the test information, wherein bits in the message were modulated onto DMT symbols using Quadrature Amplitude Modulation (QAM) with more than 1 bit per subchannel and wherein at least one data variable of the one or more data variables comprises an array representing power level per subchannel information.

55. (Previously Presented) The media of claim 54, wherein the power level per subchannel information is based on a Reverb signal.

56. (New) A communications system for DSL service comprising a first DSL transceiver capable of transmitting test information over a communication channel using multicarrier modulation and a second DSL transceiver capable of receiving the test information over the communication channel using multicarrier modulation comprising:

a transmitter portion of the first transceiver capable of transmitting a message, wherein the message comprises one or more data variables that represent the test information, wherein bits in the message are modulated onto DMT symbols using Quadrature Amplitude Modulation (QAM) with more than 1 bit per subchannel and wherein at least one data variable of the one or more data variables comprises an array representing Signal to Noise ratio per subchannel during Showtime information; and

a receiver portion of the second transceiver capable of receiving the message, wherein the message comprises the one or more data variables that represent the test information, wherein the bits in the message were modulated onto the DMT symbols using Quadrature Amplitude Modulation (QAM) with more than 1 bit per subchannel and wherein the at least one data variable of the one or more data variables comprises the array representing Signal to Noise ratio per subchannel during Showtime information.

57. (New) In a communications system for DSL service with a first DSL transceiver capable of transmitting test information over a communication channel using multicarrier

modulation and a second DSL transceiver capable of receiving the test information over the communication channel using multicarrier modulation, a method comprising:

transmitting a message from the first transceiver, wherein the message comprises one or more data variables that represent the test information, wherein bits in the message are modulated onto DMT symbols using Quadrature Amplitude Modulation (QAM) with more than 1 bit per subchannel and wherein at least one data variable of the one or more data variables comprises an array representing Signal to Noise ratio per subchannel during Showtime information; and

receiving the message at the second transceiver, wherein the message comprises the one or more data variables that represent the test information, wherein the bits in the message were modulated onto the DMT symbols using Quadrature Amplitude Modulation (QAM) with more than 1 bit per subchannel and wherein the at least one data variable of the one or more data variables comprises the array representing Signal to Noise ratio per subchannel during Showtime information.

58. (New) One or more non-transitory computer-readable information storage media having stored thereon instructions that, if executed, cause a communications system for DSL service to perform a method comprising:

transmitting a message from a first transceiver, wherein the message comprises one or more data variables that represent the test information, wherein bits in the message are modulated onto DMT symbols using Quadrature Amplitude Modulation (QAM) with more than 1 bit per subchannel and wherein at least one data variable of the one or more data variables comprises an array representing Signal to Noise ratio per subchannel during Showtime information; and

receiving the message at a second transceiver, wherein the message comprises the one or more data variables that represent the test information, wherein the bits in the message were modulated onto the DMT symbols using Quadrature Amplitude Modulation (QAM) with more than 1 bit per subchannel and wherein the at least one data variable of the one or more data variables comprises the array representing Signal to Noise ratio per subchannel during Showtime information.

59. (New) A communications system for DSL service comprising a first DSL transceiver capable of transmitting test information over a communication channel using multicarrier modulation and a second DSL transceiver capable of receiving the test information over the communication channel using multicarrier modulation comprising:

a transmitter portion capable of transmitting a message, wherein the message comprises one or more data variables that represent the test information, wherein bits in the message are modulated onto DMT symbols using Quadrature Amplitude Modulation (QAM) with more than 1 bit per subchannel and wherein at least one data variable of the one or more data variables comprises an array representing frequency domain received idle channel noise information; and

a receiver portion capable of receiving the message, wherein the message comprises the one or more data variables that represent the test information, wherein the bits in the message were modulated onto the DMT symbols using Quadrature Amplitude Modulation (QAM) with more than 1 bit per subchannel and wherein at least one data variable of the one or more data variables comprises the array representing frequency domain received idle channel noise information.

60. (New) In a communications system for DSL service with a first DSL transceiver capable of transmitting test information over a communication channel using multicarrier modulation and a second DSL transceiver capable of receiving the test information over the communication channel using multicarrier modulation, a method comprising:

transmitting a message, wherein the message comprises one or more data variables that represent the test information, wherein bits in the message are modulated onto DMT symbols using Quadrature Amplitude Modulation (QAM) with more than 1 bit per subchannel and wherein at least one data variable of the one or more data variables comprises an array representing frequency domain received idle channel noise information; and

receiving the message, wherein the message comprises the one or more data variables that represent the test information, wherein the bits in the message were modulated onto the DMT symbols using Quadrature Amplitude Modulation (QAM) with more than 1 bit per subchannel and wherein the at least one data variable of the one or more data variables comprises the array representing frequency domain received idle channel noise information.

61. (New) One or more non-transitory computer-readable information storage media having stored thereon instructions that, if executed, cause a communications system for DSL service to perform a method comprising:

transmitting a message, wherein the message comprises one or more data variables that represent the test information, wherein bits in the message are modulated onto DMT symbols using Quadrature Amplitude Modulation (QAM) with more than 1 bit per subchannel and wherein at least one data variable of the one or more data variables comprises an array representing frequency domain received idle channel noise information; and

receiving the message, wherein the message comprises the one or more data variables that represent the test information, wherein the bits in the message were modulated onto the DMT symbols using Quadrature Amplitude Modulation (QAM) with more than 1 bit per subchannel and wherein the at least one data variable of the one or more data variables comprises the array representing frequency domain received idle channel noise information.

62. (New) A communications system for DSL service comprising a first DSL transceiver capable of transmitting test information over a communication channel using multicarrier modulation and a second DSL transceiver capable of receiving the test information over the communication channel using multicarrier modulation comprising:

a transmitter portion capable of transmitting a message, wherein the message comprises one or more data variables that represent the test information, wherein bits in the message are modulated onto DMT symbols using Quadrature Amplitude Modulation (QAM) with more than 1 bit per subchannel and wherein at least one data variable of the one or more data variables comprises an array representing power level per subchannel information; and

a receiver portion capable of receiving the message, wherein the message comprises the one or more data variables that represent the test information, wherein bits in the message were modulated onto DMT symbols using Quadrature Amplitude Modulation (QAM) with more than 1 bit per subchannel and wherein at least one data variable of the one or more data variables comprises an array representing power level per subchannel information.

63. (New) In a communications system for DSL service with a first DSL transceiver capable of transmitting test information over a communication channel using multicarrier

modulation and a second DSL transceiver capable of receiving the test information over the communication channel using multicarrier modulation, a method comprising:

transmitting a message, wherein the message comprises one or more data variables that represent the test information, wherein bits in the message are modulated onto DMT symbols using Quadrature Amplitude Modulation (QAM) with more than 1 bit per subchannel and wherein at least one data variable of the one or more data variables comprises an array representing power level per subchannel information; and

receiving the message, wherein the message comprises the one or more data variables that represent the test information, wherein the bits in the message were modulated onto DMT symbols using Quadrature Amplitude Modulation (QAM) with more than 1 bit per subchannel and wherein at least one data variable of the one or more data variables comprises an array representing power level per subchannel information.

64. (New) One or more non-transitory computer-readable information storage media having stored thereon instructions that, if executed, cause a communications system for DSL service to perform a method comprising:

transmitting a message, wherein the message comprises one or more data variables that represent the test information, wherein bits in the message are modulated onto DMT symbols using Quadrature Amplitude Modulation (QAM) with more than 1 bit per subchannel and wherein at least one data variable of the one or more data variables comprises an array representing power level per subchannel information; and

receiving the message, wherein the message comprises the one or more data variables that represent the test information, wherein the bits in the message were modulated onto DMT symbols using Quadrature Amplitude Modulation (QAM) with more than 1 bit per subchannel and wherein at least one data variable of the one or more data variables comprises an array representing power level per subchannel information.

REMARKS/ARGUMENTS

By this amendment, new claims 56-64 have been added.

Applicant requests examination on the merits.

Applicant believes that the pending claims are in condition for allowance and such disposition is respectfully requested. In the event that a telephone conversation would further prosecution and/or expedite allowance, the Examiner is invited to contact the undersigned.

The Commissioner is hereby authorized to charge to Deposit Account No. 19-1970 any fees under 37 C.F.R. §§ 1.16 and 1.17 that may be required by this paper and to credit any overpayment to that Account. If any extension of time is required in connection with the filing of this paper and has not been separately requested, such extension is hereby Petitioned.

Respectfully submitted,

SHERIDAN ROSS P.C.

By: _____

Jason H. Vick
Registration No. 45,285
1560 Broadway, Suite 1200
Denver, Colorado 80202-5141
(303) 863-9700

Date: 10 Jan '11

Electronic Patent Application Fee Transmittal

Application Number:	12779660
Filing Date:	13-May-2010
Title of Invention:	Multicarrier Modulation Messaging for Power Level Per Subchannel Information
First Named Inventor/Applicant Name:	David M. Krinsky
Filer:	Jason Vick/Joanne Vos
Attorney Docket Number:	5550-2-CON2-1-1

Filed as Large Entity

Utility under 35 USC 111(a) Filing Fees

Description	Fee Code	Quantity	Amount	Sub-Total in USD(\$)
Basic Filing:				
Pages:				
Claims:				
Claims in excess of 20	1202	1	52	52
Independent claims in excess of 3	1201	9	220	1980

Miscellaneous-Filing:

Petition:

Patent-Appeals-and-Interference:

Post-Allowance-and-Post-Issuance:

Description	Fee Code	Quantity	Amount	Sub-Total in USD(\$)
Extension-of-Time:				
Miscellaneous:				
Total in USD (\$)				2032

Electronic Acknowledgement Receipt

EFS ID:	9196041
Application Number:	12779660
International Application Number:	
Confirmation Number:	8981
Title of Invention:	Multicarrier Modulation Messaging for Power Level Per Subchannel Information
First Named Inventor/Applicant Name:	David M. Krinsky
Customer Number:	62574
Filer:	Jason Vick/Joanne Vos
Filer Authorized By:	Jason Vick
Attorney Docket Number:	5550-2-CON2-1-1
Receipt Date:	10-JAN-2011
Filing Date:	13-MAY-2010
Time Stamp:	12:35:03
Application Type:	Utility under 35 USC 111(a)

Payment information:

Submitted with Payment	yes
Payment Type	Deposit Account
Payment was successfully received in RAM	\$2032
RAM confirmation Number	9302
Deposit Account	191970
Authorized User	

The Director of the USPTO is hereby authorized to charge indicated fees and credit any overpayment as follows:

Charge any Additional Fees required under 37 C.F.R. Section 1.16 (National application filing, search, and examination fees)

Charge any Additional Fees required under 37 C.F.R. Section 1.17 (Patent application and reexamination processing fees)

Charge any Additional Fees required under 37 C.F.R. Section 1.19 (Document supply fees)
 Charge any Additional Fees required under 37 C.F.R. Section 1.20 (Post Issuance fees)
 Charge any Additional Fees required under 37 C.F.R. Section 1.21 (Miscellaneous fees and charges)

File Listing:

Document Number	Document Description	File Name	File Size(Bytes)/ Message Digest	Multi Part /.zip	Pages (if appl.)
1		AMEND_PRELIM_02.pdf	869897 4c364fcee15007429c8e9ecd09135b18be9cb8d6	yes	9

Multipart Description/PDF files in .zip description			
Document Description	Start	End	
Preliminary Amendment	1	1	
Claims	2	8	
Applicant Arguments/Remarks Made in an Amendment	9	9	

Warnings:

Information:

2	Fee Worksheet (PTO-875)	fee-info.pdf	31770 fe2beabd0855ca040e35599ed65d366584691ee8	no	2
---	-------------------------	--------------	---	----	---

Warnings:

Information:

Total Files Size (in bytes):	901667
-------------------------------------	--------

This Acknowledgement Receipt evidences receipt on the noted date by the USPTO of the indicated documents, characterized by the applicant, and including page counts, where applicable. It serves as evidence of receipt similar to a Post Card, as described in MPEP 503.

New Applications Under 35 U.S.C. 111

If a new application is being filed and the application includes the necessary components for a filing date (see 37 CFR 1.53(b)-(d) and MPEP 506), a Filing Receipt (37 CFR 1.54) will be issued in due course and the date shown on this Acknowledgement Receipt will establish the filing date of the application.

National Stage of an International Application under 35 U.S.C. 371

If a timely submission to enter the national stage of an international application is compliant with the conditions of 35 U.S.C. 371 and other applicable requirements a Form PCT/DO/EO/903 indicating acceptance of the application as a national stage submission under 35 U.S.C. 371 will be issued in addition to the Filing Receipt, in due course.

New International Application Filed with the USPTO as a Receiving Office

If a new international application is being filed and the international application includes the necessary components for an international filing date (see PCT Article 11 and MPEP 1810), a Notification of the International Application Number and of the International Filing Date (Form PCT/RO/105) will be issued in due course, subject to prescriptions concerning national security, and the date shown on this Acknowledgement Receipt will establish the international filing date of the application.

Under the Paperwork Reduction Act of 1995, no persons are required to respond to a collection of information unless it displays a valid OMB control number.

PATENT APPLICATION FEE DETERMINATION RECORD Substitute for Form PTO-875					Application or Docket Number 12/779,660		Filing Date 05/13/2010		<input type="checkbox"/> To be Mailed			
APPLICATION AS FILED – PART I					OTHER THAN							
(Column 1)			(Column 2)		SMALL ENTITY <input type="checkbox"/>		OR			SMALL ENTITY		
FOR	NUMBER FILED	NUMBER EXTRA	RATE (\$)	FEE (\$)	OR	RATE (\$)	FEE (\$)					
<input type="checkbox"/> BASIC FEE <small>(37 CFR 1.16(a), (b), or (c))</small>	N/A	N/A	N/A			N/A						
<input type="checkbox"/> SEARCH FEE <small>(37 CFR 1.16(k), (l), or (m))</small>	N/A	N/A	N/A			N/A						
<input type="checkbox"/> EXAMINATION FEE <small>(37 CFR 1.16(o), (p), or (q))</small>	N/A	N/A	N/A			N/A						
TOTAL CLAIMS <small>(37 CFR 1.16(i))</small>	minus 20 =	*	X \$ =			X \$ =						
INDEPENDENT CLAIMS <small>(37 CFR 1.16(h))</small>	minus 3 =	*	X \$ =			X \$ =						
<input type="checkbox"/> APPLICATION SIZE FEE <small>(37 CFR 1.16(s))</small>	If the specification and drawings exceed 100 sheets of paper, the application size fee due is \$250 (\$125 for small entity) for each additional 50 sheets or fraction thereof. See 35 U.S.C. 41(a)(1)(G) and 37 CFR 1.16(s).											
<input type="checkbox"/> MULTIPLE DEPENDENT CLAIM PRESENT <small>(37 CFR 1.16(j))</small>												
					TOTAL		TOTAL					
APPLICATION AS AMENDED – PART II					OTHER THAN							
(Column 1)			(Column 2)		SMALL ENTITY		OR			SMALL ENTITY		
AMENDMENT	01/10/2011	CLAIMS REMAINING AFTER AMENDMENT	HIGHEST NUMBER PREVIOUSLY PAID FOR	PRESENT EXTRA	RATE (\$)	ADDITIONAL FEE (\$)	OR	RATE (\$)	ADDITIONAL FEE (\$)			
	Total <small>(37 CFR 1.16(i))</small>	* 21	Minus	** 20	=	1		X \$ =	X \$52=	52		
	Independent <small>(37 CFR 1.16(h))</small>	* 15	Minus	***6	=	9		X \$ =	X \$220=	1980		
	<input type="checkbox"/> Application Size Fee <small>(37 CFR 1.16(s))</small>											
	<input type="checkbox"/> FIRST PRESENTATION OF MULTIPLE DEPENDENT CLAIM <small>(37 CFR 1.16(j))</small>											
					TOTAL ADD'L FEE		TOTAL ADD'L FEE	2032				
AMENDMENT	CLAIMS REMAINING AFTER AMENDMENT	HIGHEST NUMBER PREVIOUSLY PAID FOR	PRESENT EXTRA	RATE (\$)	ADDITIONAL FEE (\$)	OR	RATE (\$)	ADDITIONAL FEE (\$)				
	Total <small>(37 CFR 1.16(i))</small>	*	Minus	**	=		X \$ =	X \$ =				
	Independent <small>(37 CFR 1.16(h))</small>	*	Minus	***	=		X \$ =	X \$ =				
	<input type="checkbox"/> Application Size Fee <small>(37 CFR 1.16(s))</small>											
	<input type="checkbox"/> FIRST PRESENTATION OF MULTIPLE DEPENDENT CLAIM <small>(37 CFR 1.16(j))</small>											
					TOTAL ADD'L FEE		TOTAL ADD'L FEE					
* If the entry in column 1 is less than the entry in column 2, write "0" in column 3. ** If the "Highest Number Previously Paid For" IN THIS SPACE is less than 20, enter "20". *** If the "Highest Number Previously Paid For" IN THIS SPACE is less than 3, enter "3". The "Highest Number Previously Paid For" (Total or Independent) is the highest number found in the appropriate box in column 1.					Legal Instrument Examiner: /VICTORIA BROWN/							

This collection of information is required by 37 CFR 1.16. The information is required to obtain or retain a benefit by the public which is to file (and by the USPTO to process) an application. Confidentiality is governed by 35 U.S.C. 122 and 37 CFR 1.14. This collection is estimated to take 12 minutes to complete, including gathering, preparing, and submitting the completed application form to the USPTO. Time will vary depending upon the individual case. Any comments on the amount of time you require to complete this form and/or suggestions for reducing this burden, should be sent to the Chief Information Officer, U.S. Patent and Trademark Office, U.S. Department of Commerce, P.O. Box 1450, Alexandria, VA 22313-1450. DO NOT SEND FEES OR COMPLETED FORMS TO THIS ADDRESS. **SEND TO: Commissioner for Patents, P.O. Box 1450, Alexandria, VA 22313-1450.**
 If you need assistance in completing the form, call 1-800-PTO-9199 and select option 2.

Substitute for form 1449A/PTO				Complete if Known	
INFORMATION DISCLOSURE STATEMENT BY APPLICANT				Application Number	12/779,660
				Filing Date	May 13, 2010
				First Named Inventor	David M. Krinsky
				Art Unit	2611
				Examiner Name	Ghayour, Mohammad H.
Sheet	1	of	1	Attorney Docket Number	5550-2-CON-2-1-1

U.S. PATENT DOCUMENTS					
Examiner Initials*	Cite No. ¹	Document Number Number-kind Code ^{2 (if known)}	Publication Date MM-DD-YYYY	Name of Patentee of Applicant of Cited Document	Pages, Columns, Lines, Where Relevant Passages or Relevant Figures Appear
	1	6781513	08/24/04	Korkosz et al.	

FOREIGN PATENT DOCUMENTS						
Examiner Initials*	Cite No. ¹	Foreign Patent Document Country Code ³ ; Number ⁴ ; Kind Code ^{5 (if known)}	Publication Date MM-DD-YYYY	Name of Patentee or Applicant of Cited Document	Pages, Columns, Lines, Where Relevant Passages or Relevant Figures Appear	T ⁶

OTHER ART (Including Author, Title, Date, Pertinent Pages, etc.)		
Examiner Initials*	Cite No. ¹	
	2	"Asymmetric Digital Subscriber Line (ADSL) Transceivers," ITU-T G.992.1, Jun. 1999, pp. 91-117, 125, 126, 131, 132
	3	Notice of Allowance for Canadian Patent Application No. 2,394,491, dated Jul. 16, 2010 (Attorney Ref. No. 5550-2-PCA)
	4	Official Action for European Patent Application No. EP 06022008, mailed Jul. 7, 2010 (Attorney Ref. No. 5550-2-PEP5)
	5	Official Action (including translation) for Japanese Patent Application No. 2001-552611, mailed Aug. 2, 2010 (Attorney Ref. No. 5550-2-PJP)
	6	Official Action (including translation) for Japanese Patent Application No. 2008-191051, mailed Jul. 26, 2010 (Attorney Ref. No. 5550-2-PJP-DIV)
	7	Official Action for U.S. Patent Application No. 12/477,742, mailed Aug. 16, 2010 (Attorney Ref. No. 5550-2-CON-2-1)
	8	Notice of Allowability for U.S. Patent Application No. 12/477,742, mailed Sep. 7, 2010 (Attorney Ref. No. 5550-2-CON-2-1)

Examiner Signature		Date Considered	
--------------------	--	-----------------	--

*EXAMINER: Initial if reference is considered, whether or not citation is in conformance and not considered. Include copy of this form with next communication to applicant.

Electronic Acknowledgement Receipt

EFS ID:	8581567
Application Number:	12779660
International Application Number:	
Confirmation Number:	8981
Title of Invention:	Multicarrier Modulation Messaging for Power Level Per Subchannel Information
First Named Inventor/Applicant Name:	David M. Krinsky
Customer Number:	62574
Filer:	Jason Vick/Nancy Davis
Filer Authorized By:	Jason Vick
Attorney Docket Number:	5550-2-CON2-1-1
Receipt Date:	07-OCT-2010
Filing Date:	13-MAY-2010
Time Stamp:	15:46:30
Application Type:	Utility under 35 USC 111(a)

Payment information:

Submitted with Payment	no
------------------------	----

File Listing:

Document Number	Document Description	File Name	File Size(Bytes)/ Message Digest	Multi Part /.zip	Pages (if appl.)
1		IDS_02.pdf	368021 e0993eec72bf38658b485139fbc97c821cd9c226	yes	4

Multipart Description/PDF files in .zip description					
Document Description			Start	End	
Transmittal Letter			1	3	
Information Disclosure Statement (IDS) Filed (SB/08)			4	4	
Warnings:					
Information:					
2	NPL Documents	Asymmetric_digital_subscriber_line_G992-1_pp_91-117_125-26_131-32.pdf	1964875 7f39e2c53e65d003a7fa787f897913ba5801c5e9	no	33
Warnings:					
Information:					
3	NPL Documents	5550-2-PCA_NOA_7-16-2010.pdf	118093 38e44f1143482f8af07b6d19d1137d4db8ba2e8f	no	1
Warnings:					
Information:					
4	NPL Documents	5550-2-PEP-5_OA_7-7-2010.pdf	201750 75445cd31ff7e634d4b646fb759e8ed0ca88f17e	no	7
Warnings:					
Information:					
5	NPL Documents	5550-2-PJP-DIV_OA_7-26-10.pdf	98046 82fd899db7ff646954b8fc12899a361483450913	no	5
Warnings:					
Information:					
6	NPL Documents	5550-2-CON-2-1_OA_8-16-2010.pdf	276638 f1aea1062a745a083380b37983d3e918534d7445	no	9
Warnings:					
Information:					
7	NPL Documents	5550-2-CON-2-1_NOA_9-7-2010.pdf	233606 0ea357de0860423aa38eb68f8db67ed183f368e0	no	6
Warnings:					
Information:					
8	NPL Documents	5550-2-PJP_OA_08-02-2010.pdf	192775 2daacdecdb0b27030faefc5d08a9487b45e0bcff	no	6
Warnings:					
Information:					
Total Files Size (in bytes):			3453804		

This Acknowledgement Receipt evidences receipt on the noted date by the USPTO of the indicated documents, characterized by the applicant, and including page counts, where applicable. It serves as evidence of receipt similar to a Post Card, as described in MPEP 503.

New Applications Under 35 U.S.C. 111

If a new application is being filed and the application includes the necessary components for a filing date (see 37 CFR 1.53(b)-(d) and MPEP 506), a Filing Receipt (37 CFR 1.54) will be issued in due course and the date shown on this Acknowledgement Receipt will establish the filing date of the application.

National Stage of an International Application under 35 U.S.C. 371

If a timely submission to enter the national stage of an international application is compliant with the conditions of 35 U.S.C. 371 and other applicable requirements a Form PCT/DO/EO/903 indicating acceptance of the application as a national stage submission under 35 U.S.C. 371 will be issued in addition to the Filing Receipt, in due course.

New International Application Filed with the USPTO as a Receiving Office

If a new international application is being filed and the international application includes the necessary components for an international filing date (see PCT Article 11 and MPEP 1810), a Notification of the International Application Number and of the International Filing Date (Form PCT/RO/105) will be issued in due course, subject to prescriptions concerning national security, and the date shown on this Acknowledgement Receipt will establish the international filing date of the application.

IN THE UNITED STATES PATENT AND TRADEMARK OFFICE

In Re the Application of:)	Group Art Unit: 2611
David M. Krinsky)	Confirmation No.: 8981
Serial No.: 12/779,660)	Examiner: Ghayour, Mohammad H.
Filed: May 13, 2010)	
Atty. File No.: 5550-2-CON-2-1-1)	
Entitled: "MULTICARRIER MODULATION MESSAGING FOR POWER LEVEL PER SUBCHANNEL INFORMATION")	<u>SUPPLEMENTAL</u> <u>INFORMATION DISCLOSURE</u> <u>STATEMENT</u>
)	Electronically Submitted

Commissioner for Patents
P.O. Box 1450
Alexandria, VA 22313-1450

Dear Sir:

The references cited on attached Form PTO-1449 are being called to the attention of the Examiner.

- Copies of the cited non-patent and/or foreign references are enclosed herewith.
- Copies of the cited U.S. patents and/or patent applications are enclosed herewith.
- Copies of the cited U.S. patents/patent application publications are not enclosed in accordance with 37 C.F.R. § 1.98(a).
- Copies of the cited references are not enclosed, in accordance with 37 C.F.R. § 1.98(d), because the references were cited by or submitted to the U.S. Patent and Trademark Office in prior application Serial No. _____ filed _____, which is relied upon for an earlier filing date under 35 U.S.C. § 120.
- To the best of applicants' belief, the pertinence of the foreign-language references are believed to be summarized in the attached English abstracts and in the figures, although applicants do not necessarily vouch for the accuracy of the translation.
- Examiner's attention is drawn to the following related applications:
 - Serial No. _____ filed _____ (Attorney Ref. No. _____)
 - Serial No. _____ filed _____ (Attorney Ref. No. _____)
- Other: _____

Submission of the above information is not intended as an admission that any item is citable under the statutes or rules to support a rejection, that any item disclosed represents analogous art, or that those skilled in the art would refer to or recognize the pertinence of any reference without the benefit of hindsight, nor should an inference be

drawn as to the pertinence of the references based on the order in which they are presented. Submission of this statement should not be taken as an indication that a search has been conducted, or that no better art exists.

It is respectfully requested that the cited information be expressly considered during the prosecution of this application and the references made of record therein.

FEES

<input checked="" type="checkbox"/>	<p>37 CFR 1.97(b): No fee is believed due in connection with this submission, because the information disclosure statement submitted herewith is satisfied by one of the following conditions ("X" indicates satisfaction):</p> <p><input type="checkbox"/> Within three months of the filing date of a national application other than a continued prosecution application under 37 CFR 1.53(d), or</p> <p><input type="checkbox"/> Within three months of the date of entry into the national stage of an international application as set forth in 37 CFR 1.491 or</p> <p><input checked="" type="checkbox"/> Before the mailing date of a first Office Action on the merits, or</p> <p><input type="checkbox"/> Before the mailing of a first Office action after the filing of a request for continued examination under 37 CFR 1.114.</p> <p>Although no fee is believed due, if any fee is deemed due in connection with this submission, please charge such fee to Deposit Account 19-1970.</p>
<input type="checkbox"/>	<p>37 CFR 1.97(c): The information disclosure statement transmitted herewith is being filed after all the above conditions (37 CFR 1.97(b)), but before the mailing date of one of the following conditions:</p> <p>(1) a final action under 37 C.F.R. 1.113 or</p> <p>(2) a notice of allowance under 37 C.F.R. 1.311, or</p> <p>(3) an action that otherwise closes prosecution in the application.</p> <p>This Information Disclosure Statement is accompanied by:</p> <p><input type="checkbox"/> A Certification (below) as specified by 37 C.F.R. 1.97(c). Although no fee is believed due, if any fee is deemed due in connection with this submission, please charge such fee to Deposit Account 19-1970.</p> <p style="text-align: center;">OR</p> <p><input type="checkbox"/> Please charge Deposit Account 19-1970 in the amount of \$180.00 for the fee set forth in 37 C.F.R. 1.17(p) for submission of an information disclosure statement. Please credit any overpayment or charge any underpayment to Deposit Account 19-1970.</p>
<input type="checkbox"/>	<p>37 CFR 1.97(d): This Information Disclosure Statement is being submitted after the period specified in 37 CFR 1.97(c).</p> <p><input type="checkbox"/> This information Disclosure Statement includes a Certification (below) as specified by 37 C.F.R. 1.97(e)</p> <p style="text-align: center;">AND</p> <p><input type="checkbox"/> Applicants hereby requests consideration of the reference(s) disclosed herein. Please charge Deposit Account 19-1970 in the amount of \$180.00 under 37 C.F.R. 1.17(p). Please credit any overpayment or charge any underpayment to Deposit Account 19-1970. Election to pay the fee should not be taken as an indication that applicant(s) cannot execute a certification.</p>

Certification (37 C.F.R. 1.97(e))
(Applicable only if checked)

- The undersigned certifies that:
- Each item of information contained in this information disclosure statement was first cited in any communication from a foreign patent office in a counterpart foreign application not more than three months prior to the filing of this statement. 37 C.F.R. 1.97(e)(1).
 - A copy of the communication from the foreign patent office is enclosed.

OR

- No item of information contained in this information disclosure statement was cited in a communication from a foreign patent office in a counterpart foreign application, and, to the knowledge of the undersigned after making reasonable inquiry, no item of information contained in this Information Disclosure Statement was known to any individual designated in 37 C.F.R. 1.56(c) more than three months prior to the filing of this statement. 37 C.F.R. 1.97(e)(2).

Respectfully submitted,

SHERIDAN ROSS P.C.

By: _____

Jason H. Vick
Registration No. 45,285
1560 Broadway, Suite 1200
Denver, Colorado 80202-5141
(303) 863-9700

Date: 7 0 5 '10



UNITED STATES PATENT AND TRADEMARK OFFICE

UNITED STATES DEPARTMENT OF COMMERCE
United States Patent and Trademark Office
Address: COMMISSIONER FOR PATENTS
P.O. Box 1450
Alexandria, Virginia 22313-1450
www.uspto.gov

Table with 4 columns: APPLICATION NUMBER (12/779,660), FILING OR 371(C) DATE (05/13/2010), FIRST NAMED APPLICANT (David M. Krinsky), ATTY. DOCKET NO./TITLE (5550-2-CON2-1-1)

CONFIRMATION NO. 8981

PUBLICATION NOTICE



62574
Jason H. Vick
Sheridan Ross, PC
Suite # 1200
1560 Broadway
Denver, CO 80202

Title: Multicarrier Modulation Messaging for Power Level Per Subchannel Information

Publication No. US-2010-0226418-A1

Publication Date: 09/09/2010

NOTICE OF PUBLICATION OF APPLICATION

The above-identified application will be electronically published as a patent application publication pursuant to 37 CFR 1.211, et seq. The patent application publication number and publication date are set forth above.

The publication may be accessed through the USPTO's publically available Searchable Databases via the Internet at www.uspto.gov. The direct link to access the publication is currently http://www.uspto.gov/patft/.

The publication process established by the Office does not provide for mailing a copy of the publication to applicant. A copy of the publication may be obtained from the Office upon payment of the appropriate fee set forth in 37 CFR 1.19(a)(1). Orders for copies of patent application publications are handled by the USPTO's Office of Public Records. The Office of Public Records can be reached by telephone at (703) 308-9726 or (800) 972-6382, by facsimile at (703) 305-8759, by mail addressed to the United States Patent and Trademark Office, Office of Public Records, Alexandria, VA 22313-1450 or via the Internet.

In addition, information on the status of the application, including the mailing date of Office actions and the dates of receipt of correspondence filed in the Office, may also be accessed via the Internet through the Patent Electronic Business Center at www.uspto.gov using the public side of the Patent Application Information and Retrieval (PAIR) system. The direct link to access this status information is currently http://pair.uspto.gov/. Prior to publication, such status information is confidential and may only be obtained by applicant using the private side of PAIR.

Further assistance in electronically accessing the publication, or about PAIR, is available by calling the Patent Electronic Business Center at 1-866-217-9197.

Office of Data Management, Application Assistance Unit (571) 272-4000, or (571) 272-4200, or 1-888-786-0101



UNITED STATES PATENT AND TRADEMARK OFFICE

UNITED STATES DEPARTMENT OF COMMERCE
United States Patent and Trademark Office
Address: COMMISSIONER FOR PATENTS
P.O. Box 1450
Alexandria, Virginia 22313-1450
www.uspto.gov

APPLICATION NUMBER	FILING OR 371(C) DATE	FIRST NAMED APPLICANT	ATTY. DOCKET NO./TITLE
12/779,660	05/13/2010	David M. Krinsky	5550-2-CON2-1-1

CONFIRMATION NO. 8981

POA ACCEPTANCE LETTER



OC00000042171713

62574
Jason H. Vick
Sheridan Ross, PC
Suite # 1200
1560 Broadway
Denver, CO 80202

Date Mailed: 06/21/2010

NOTICE OF ACCEPTANCE OF POWER OF ATTORNEY

This is in response to the Power of Attorney filed 06/11/2010.

The Power of Attorney in this application is accepted. Correspondence in this application will be mailed to the above address as provided by 37 CFR 1.33.

/snguyen/

Office of Data Management, Application Assistance Unit (571) 272-4000, or (571) 272-4200, or 1-888-786-0101

Under the Paperwork Reduction Act of 1996, no persons are required to respond to a collection of information unless it displays a valid OMB control number.

POWER OF ATTORNEY TO PROSECUTE APPLICATIONS BEFORE THE USPTO

I hereby revoke all previous powers of attorney given in the application identified in the attached statement under 37 CFR 3.73(b).

I hereby appoint:

- Practitioners associated with the Customer Number: 62574
- OR
- Practitioner(s) named below (If more than ten patent practitioners are to be named, then a customer number must be used):

Name	Registration Number		Name	Registration Number

as attorney(s) or agent(s) to represent the undersigned before the United States Patent and Trademark Office (USPTO) in connection with any and all patent applications assigned only to the undersigned according to the USPTO assignment records or assignment documents attached to this form in accordance with 37 CFR 3.73(b).

Please change the correspondence address for the application identified in the attached statement under 37 CFR 3.73(b) to:

- The address associated with Customer Number: 62574
- OR

<input type="checkbox"/> Firm or Individual Name			
Address			
City	State	Zip	
Country			
Telephone	Email		

Assignee Name and Address:
 AWARE, INC.
 40 Middlesex Turnpike
 Bedford, MA 07130-1423

A copy of this form, together with a statement under 37 CFR 3.73(b) (Form PTO/SB/96 or equivalent) is required to be filed in each application in which this form is used. The statement under 37 CFR 3.73(b) may be completed by one of the practitioners appointed in this form if the appointed practitioner is authorized to act on behalf of the assignee, and must identify the application in which this Power of Attorney is to be filed.

SIGNATURE of Assignee of Record
 The individual whose signature and title is supplied below is authorized to act on behalf of the assignee

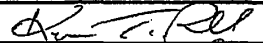
Signature		Date	1/8/09
Name	Kevin C. Russell	Telephone	781-687-335
Title	U.S. General Counsel		

This collection of information is required by 37 CFR 1.31, 1.32 and 1.33. The information is required to obtain or retain a benefit by the public which is to file (and by the USPTO to process) an application. Confidentiality is governed by 35 U.S.C. 122 and 37 CFR 1.11 and 1.14. This collection is estimated to take 3 minutes to complete, including gathering, preparing, and submitting the completed application form to the USPTO. Time will vary depending upon the individual case. Any comments on the amount of time you require to complete this form and/or suggestions for reducing this burden, should be sent to the Chief Information Officer, U.S. Patent and Trademark Office, U.S. Department of Commerce, P.O. Box 1460, Alexandria, VA 22313-1450. DO NOT SEND FEES OR COMPLETED FORMS TO THIS ADDRESS. SEND TO: Commissioner for Patents, P.O. Box 1460, Alexandria, VA 22313-1450.

If you need assistance in completing the form, call 1-800-PTO-9199 and select option 2.

Electronic Acknowledgement Receipt

EFS ID:	7799514
Application Number:	12779660
International Application Number:	
Confirmation Number:	8981
Title of Invention:	Multicarrier Modulation Messaging for Power Level Per Subchannel Information
First Named Inventor/Applicant Name:	David M. Krinsky
Customer Number:	62574
Filer:	Jason Vick/Joanne Vos
Filer Authorized By:	Jason Vick
Attorney Docket Number:	5550-2-CON2-1-1
Receipt Date:	11-JUN-2010
Filing Date:	13-MAY-2010
Time Stamp:	16:52:20
Application Type:	Utility under 35 USC 111(a)

Payment information:

Submitted with Payment	no
------------------------	----

File Listing:

Document Number	Document Description	File Name	File Size(Bytes)/ Message Digest	Multi Part /.zip	Pages (if appl.)
1		Statement_Under_373b_w_PO A.pdf	120118 848a7e8cae3b7eab2e21ff74ede248249885 1e34	yes	2

Multipart Description/PDF files in .zip description		
Document Description	Start	End
Assignee showing of ownership per 37 CFR 3.73(b).	1	1
Power of Attorney	2	2
Warnings:		
Information:		
Total Files Size (in bytes):	120118	
<p>This Acknowledgement Receipt evidences receipt on the noted date by the USPTO of the indicated documents, characterized by the applicant, and including page counts, where applicable. It serves as evidence of receipt similar to a Post Card, as described in MPEP 503.</p> <p><u>New Applications Under 35 U.S.C. 111</u> If a new application is being filed and the application includes the necessary components for a filing date (see 37 CFR 1.53(b)-(d) and MPEP 506), a Filing Receipt (37 CFR 1.54) will be issued in due course and the date shown on this Acknowledgement Receipt will establish the filing date of the application.</p> <p><u>National Stage of an International Application under 35 U.S.C. 371</u> If a timely submission to enter the national stage of an international application is compliant with the conditions of 35 U.S.C. 371 and other applicable requirements a Form PCT/DO/EO/903 indicating acceptance of the application as a national stage submission under 35 U.S.C. 371 will be issued in addition to the Filing Receipt, in due course.</p> <p><u>New International Application Filed with the USPTO as a Receiving Office</u> If a new international application is being filed and the international application includes the necessary components for an international filing date (see PCT Article 11 and MPEP 1810), a Notification of the International Application Number and of the International Filing Date (Form PCT/RO/105) will be issued in due course, subject to prescriptions concerning national security, and the date shown on this Acknowledgement Receipt will establish the international filing date of the application.</p>		

Under the Paperwork Reduction Act of 1995, no persons are required to respond to a collection of information unless it displays a valid OMB control number.

STATEMENT UNDER 37 CFR 3.73(b)

Applicant/Patent Owner: AWARE, INC.

Application No./Patent No.: 12/779,660 Filed/Issue Date: May 13, 2010

Titled: Multicarrier Modulation Messaging for Power Level Per Subchannel Information

AWARE, INC., a Corporation

(Name of Assignee) (Type of Assignee, e.g., corporation, partnership, university, government agency, etc.)

states that it is:

- 1. the assignee of the entire right, title, and interest in;
- 2. an assignee of less than the entire right, title, and interest in (The extent (by percentage) of its ownership interest is _____ %); or
- 3. the assignee of an undivided interest in the entirety of (a complete assignment from one of the joint inventors was made)

the patent application/patent identified above, by virtue of either:

A. An assignment from the inventor(s) of the patent application/patent identified above. The assignment was recorded in the United States Patent and Trademark Office at Reel 012216, Frame 0842, or for which a copy therefore is attached.

OR

B. A chain of title from the inventor(s), of the patent application/patent identified above, to the current assignee as follows:

1. From: _____ To: _____

The document was recorded in the United States Patent and Trademark Office at Reel _____, Frame _____, or for which a copy thereof is attached.

2. From: _____ To: _____

The document was recorded in the United States Patent and Trademark Office at Reel _____, Frame _____, or for which a copy thereof is attached.

3. From: _____ To: _____

The document was recorded in the United States Patent and Trademark Office at Reel _____, Frame _____, or for which a copy thereof is attached.

Additional documents in the chain of title are listed on a supplemental sheet(s).

As required by 37 CFR 3.73(b)(1)(i), the documentary evidence of the chain of title from the original owner to the assignee was, or concurrently is being, submitted for recordation pursuant to 37 CFR 3.11.

[NOTE: A separate copy (i.e., a true copy of the original assignment document(s)) must be submitted to Assignment Division in accordance with 37 CFR Part 3, to record the assignment in the records of the USPTO. See MPEP 302.08]

The undersigned (whose title is supplied below) is authorized to act on behalf of the assignee.



Signature

June 11, 2010

Date

Jason H. Vick

Printed or Typed Name

Attorney for Assignee

Title

This collection of information is required by 37 CFR 3.73(b). The information is required to obtain or retain a benefit by the public which is to file (and by the USPTO to process) an application. Confidentiality is governed by 35 U.S.C. 122 and 37 CFR 1.11 and 1.14. This collection is estimated to take 12 minutes to complete, including gathering, preparing, and submitting the completed application form to the USPTO. Time will vary depending upon the individual case. Any comments on the amount of time you require to complete this form and/or suggestions for reducing this burden, should be sent to the Chief Information Officer, U.S. Patent and Trademark Office, U.S. Department of Commerce, P.O. Box 1450, Alexandria, VA 22313-1450. DO NOT SEND FEES OR COMPLETED FORMS TO THIS ADDRESS. SEND TO: Commissioner for Patents, P.O. Box 1450, Alexandria, VA 22313-1450.

If you need assistance in completing the form, call 1-800-PTO-9199 and select option 2.

Substitute for form 1449A/PTO				Complete if Known	
INFORMATION DISCLOSURE STATEMENT BY APPLICANT				Application Number	12/779,660
				Filing Date	May 13, 2010
				First Named Inventor	David M. Krinsky
				Art Unit	2611
				Examiner Name	Not yet assigned
Sheet	1	of	4	Attorney Docket Number	5550-2-CON-2-1-1

U.S. PATENT DOCUMENTS					
Examiner Initials*	Cite No. ¹	Document Number Number-kind Code ^{2 (if known)}	Publication Date MM-DD-YYYY	Name of Patentee of Applicant of Cited Document	Pages, Columns, Lines, Where Relevant Passages or Relevant Figures Appear
	1	4385384	05/24/83	Rosbury et al.	
	2	4566100	01/21/86	Mizuno et al.	
	3	5128619	07/07/92	Bjork et al.	
	4	5361293	11/01/94	Czerwiec	
	5	5608643	03/04/97	Wichter et al.	
	6	5864602	01/26/99	Needle	
	7	5964891	10/12/99	Caswell et al.	
	8	6073179	06/06/00	Liu et al.	
	9	6075821	06/13/00	Kao et al.	
	10	6175934	01/16/01	Hershey et al.	
	11	6219378	04/17/01	Wu	
	12	6249543	06/19/01	Chow	
	13	6404774	06/11/02	Jenness	
	14	6411678	06/25/02	Tomlinson, Jr. et al.	
	15	6445773	09/03/02	Liang et al.	
	16	6449307	09/10/02	Ishikawa et al.	
	17	6512789	01/28/03	Mirfakhraei	
	18	6631120	10/07/03	Milbrandt	
	19	6633545	10/14/03	Milbrandt	
	20	6636603	10/21/03	Milbrandt	
	21	6658052	12/02/03	Krinsky et al.	
	22	6725176	04/20/04	Long et al.	
	23	7570686	08/04/09	Krinsky et al.	
	24	2009/0238254	09/24/09	Krinsky et al.	
	25	12/779708		Krinsky et al. (05-13-2010)	

Examiner Signature		Date Considered	
--------------------	--	-----------------	--

*EXAMINER: Initial if reference is considered, whether or not citation is in conformance and not considered. Include copy of this form with next communication to applicant.

Substitute for form 1449A/PTO				Complete if Known	
INFORMATION DISCLOSURE STATEMENT BY APPLICANT				Application Number	12/779,660
				Filing Date	May 13, 2010
				First Named Inventor	David M. Krinsky
				Art Unit	2611
				Examiner Name	Not yet assigned
Sheet	2	of	4	Attorney Docket Number	5550-2-CON-2-1-1

FOREIGN PATENT DOCUMENTS						
Examiner Initials*	Cite No. ¹	Foreign Patent Document Country Code ³ ; Number ⁴ ; Kind Code ⁵ (if known)	Publication Date MM-DD-YYYY	Name of Patentee or Applicant of Cited Document	Pages, Columns, Lines, Where Relevant Passages or Relevant Figures Appear	T ⁶
	26	EP 0889615	01/07/99	INTEGRATED TELECOM EXPRESS		
	27	GB 2303032	02/05/97	SAMSUNG ELECTRONICS CO LTD		
	28	JP Hei6(1994)-003956	01/12/94	TELEBIT CORPORATION		(believed to correspond to WO 86/07223 disclosed herein)
	29	JP-A-Hei10(1998)-513622	12/22/98	ADC TELECOMMUNICATIO NS INC		(Translated abstract)
	30	JP-A-Hei11(1999)-261665	09/24/99	MATSUSHITA GRAPHIC COMMUNIC		(Translated abstract)
	31	JP-A-Hei11(1999)-317723	11/16/99	MOTOROLA INC		(Translated abstract)
	32	JP-A-Hei11(1999)-508417	07/21/99	ERICSSON TELEFON AB L M		(Translated abstract)
	33	WO 00/64130	10/26/00	TERADYNE INC		
	34	WO 86/07223	12/04/86	TELEBIT CORPORATION		(believed to correspond to JP Hei6(1994)- 003956 disclosed herein)
	35	WO 97/01900	01/16/97	ERICSSON AUSTRIA AG		
	36	WO 99/020027	04/22/99	Aware		

Examiner Signature		Date Considered	
-----------------------	--	--------------------	--

*EXAMINER: Initial if reference is considered, whether or not citation is in conformance and not considered. Include copy of this form with next communication to applicant.

Substitute for form 1449A/PTO				Complete if Known	
INFORMATION DISCLOSURE STATEMENT BY APPLICANT				Application Number	12/779,660
				Filing Date	May 13, 2010
				First Named Inventor	David M. Krinsky
				Art Unit	2611
				Examiner Name	Not yet assigned
Sheet	3	of	4	Attorney Docket Number	5550-2-CON-2-1-1

	37	WO 99/26375	05/27/99	TEKTRONIX INC		
	38	WO 99/63427	12/09/99	GTE LABORATORIES INC		
	39	WO 99/67890	12/29/99	PCTEL INC		

OTHER ART (Including Author, Title, Date, Pertinent Pages, etc.)		
Examiner Initials*	Cite No. ¹	
	40	Boets P. et al.: "Modeling Aspect of Transmission Line Networks" Proceedings Of The Instrumentation And Measurement Technology Conference, US, New York, IEEE, May 12, 1992, pp. 137-141, XP000343913 ISBN: 0-7803-0640-6
	41	Cioffi, John M., ADSL Maintenance with DMT, T1E1.4 ADSL Project, Amati Communications Corporation, December 1, 1992, pages 1-14
	42	Lewis L. et al. "Extending Trouble Ticket System to Fault Diagnostics" IEEE Network, IEEE Inc. New York, US, Nov. 1, 1993, pp. 44-51, XP 000575228
	43	International Search Report for PCT/US01/00418 dated Jul. 16, 2001; 4 pages (5550-2-PCT)
	44	Written Opinion for International (PCT) Patent Application No. PCT/US01/00418, completed March 9, 2002 (5550-2-PCT)
	45	International Preliminary Examination Report for International (PCT) Patent Application No. PCT/US01/00418, completed March 9, 2002 (5550-2-PCT)
	46	PCT International Search Report dated Oct. 9, 2002 for PCT/US01/41653 (5550-2-PCT-3)
	47	Examiner's First Report for Australian Patent Application No. 27669/01, mailed April 2, 2004 (Attorney's Ref. No. 5550-2-PAU)
	48	Notice of Acceptance for Australian Patent Application No. 27669/01, mailed August 6, 2004 (Attorney's Ref. No. 5550-2-PAU)
	49	Examiner's First Report for Australian Patent Application No. 2004203321, mailed November 16, 2006 (5550-2-PAU4)

Examiner Signature	Date Considered
--------------------	-----------------

*EXAMINER: Initial if reference is considered, whether or not citation is in conformance and not considered. Include copy of this form with next communication to applicant.

Substitute for form 1449A/PTO				Complete if Known	
INFORMATION DISCLOSURE STATEMENT BY APPLICANT				Application Number	12/779,660
				Filing Date	May 13, 2010
				First Named Inventor	David M. Krinsky
				Art Unit	2611
				Examiner Name	Not yet assigned
Sheet	4	of	4	Attorney Docket Number	5550-2-CON-2-1-1

50	Examiner's First Report for Australian Patent Application No. 2008203520, mailed March 9, 2009 (5550-2-PAU4-DIV)
51	Notice of Acceptance for Australian Patent Application No. 2008203520, mailed July 9, 2009 (5550-2-PAU4-DIV)
52	Official Action for Canadian Patent Application No. 2,394,491, mailed November 24, 2009 (Attorney's Ref. No. 5550-2-PCA)
53	Official Action for European Patent Application No. 01901808.4, mailed December 1, 2004 (Attorney's Ref. No. 5550-2-PEP)
54	Official Action for European Patent Application No. 01901808.4, mailed September 14, 2005 (Attorney's Ref. No. 5550-2-PEP)
55	Communication about intention to grant a European patent for European Patent Application No. 01901808.4, mailed May 15, 2006 (Attorney's Ref. No. 5550-2-PEP)
56	European Search Report for European Patent Application No. EP 06022008 completed January 8, 2007 (5550-2-PEP5)
57	Official Action for European Patent Application No. EP 06022008, mailed April 23, 2010 (Attorney's Ref. No. 5550-2-PEP5)
58	Notification of Reasons (including translation) for Refusal for Japanese Patent Application No. 2001-552611, Dispatched Date: December 7, 2009 (Attorney's Ref. No. 5550-2-PJP)
59	Decision to Grant Patent (including translation) For Korean Patent Application No. 10-2002-7008794, dated December 1, 2006 (Attorney's Ref. No. 5550-2-PKR)
60	Official Action for U.S. Patent Application No. 12/477,742, mailed June 8, 2010 (Attorney's Ref. No. 5550-2-CON-2-1)

Examiner Signature		Date Considered	
-----------------------	--	--------------------	--

*EXAMINER: Initial if reference is considered, whether or not citation is in conformance and not considered. Include copy of this form with next communication to applicant.

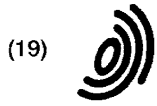

Europäisches Patentamt
 European Patent Office
 Office européen des brevets



(11) EP 0 889 615 A2

(12) EUROPEAN PATENT APPLICATION

(43) Date of publication:
 07.01.1999 Bulletin 1999/01

(51) Int. Cl.⁶: H04L 5/14, H04L 27/26

(21) Application number: 98112040.5

(22) Date of filing: 30.06.1998

(84) Designated Contracting States:
 AT BE CH CY DE DK ES FI FR GB GR IE IT LI LU
 MC NL PT SE
 Designated Extension States:
 AL LT LV MK RO SI

(72) Inventors:
 • Liu, Young Way
 La Mirada, California 90638 (US)
 • Liu, Ming-Kang
 Cupertino, California 95014 (US)
 • Chen, Steve
 San Jose, California 95132 (US)

(30) Priority: 30.06.1997 US 884895

(71) Applicant:
 Integrated Telecom Express
 Santa Clara, California 95051 (US)

(74) Representative:
 Lins, Edgar, Dipl.-Phys. Dr.jur.
 Gramm, Lins & Partner GbR,
 Theodor-Heuss-Strasse 1
 38122 Braunschweig (DE)

(54) Multicarrier transmission with variable data rate

(57) A high speed communications system is provided which uses a selectable, desirable portion of the total available bandwidth of a transmission channel. In a preferred embodiment, the invention is an ADSL compatible modem which selects a sub-set of the available downstream DMT sub-channels based on an evaluation of such sub-channels by appropriate signal processing circuitry. An analog front end (AFE) contains sub-band filtering causes an upstream transceiver to use only this selected number of available sub-channels for down-

stream data transmission. This reduces hardware costs and complexity while still preserving compatibility with applicable ADSL standards and providing a high speed data link. The target data rate of the modem can be further enhanced to the point of achieving full protocol capability by increasing or upgrading the AFEs, and/or the signal processing circuitry in order to increase the number of processable transmitted downstream sub-channels.

FIGURE 6

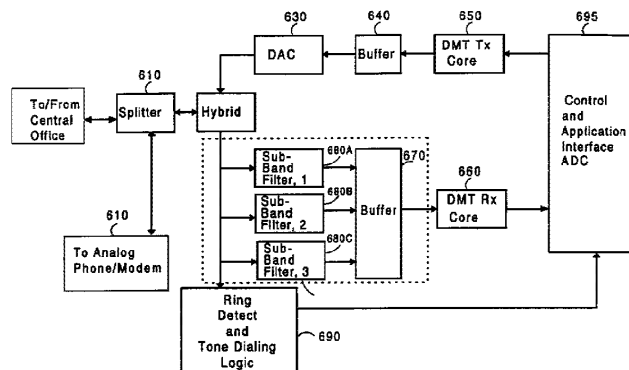

EP 0 889 615 A2

DescriptionFIELD OF THE INVENTION

5 The invention relates generally to an improved high-speed communications system which establishes a data link using only a selectable portion of the total available bandwidth of a channel. The present invention has particular applicability to systems which use rate adaptable techniques such as the discrete multi-tone modulation (DMT) technique and CAP for transmitting data in Digital Subscriber Lines and similar environments. By limiting the data throughput of the link to some adjustable fraction of the total available data rate, the present invention significantly reduces hardware costs and allows a downstream user to configure a data link whose performance is directly controllable by the processing power available to such user. In this manner, the system is completely forward compatible and expandable in functionality, and permits a user to increase throughput to the point of achieving full potential of the available channel bandwidth .

15 BACKGROUND OF THE INVENTION

Remote access and retrieval of data and information are becoming more desirable and common in both consumer and business environments. As data and information transfer is becoming more and more voluminous and complex, using traditional data links such as voice-band modems is too slow in speed. For example, the use of the Internet to locate and access information is increasing daily, but the retrieval of typical graphics, video, audio, and other complex data forms is generally unsatisfyingly slow using conventional voice-band modems. In fact, the slow rate of existing dial-up analog modems frustrates users, and commerce and interaction using the Internet would have been even higher were it not for the unacceptable delays associated with present day access technology. The ability to provide such desired services as video on demand, television (including HDTV, video catalogs, remote CD-ROMs, high-speed LAN access, electronic library viewing, etc., are similarly impeded by the lack of high speed connections.

Since the alternatives to copper line technology have proven unsatisfactory, solutions to the high speed access problem have been focused on improving the performance of voice band modems. Voice band modems operate at the subscriber premises end over a 3 kHz voice band lines and transmit signals through the core switching network, the phone company network treats them exactly like voice signals. These modems presently transmit up to 33.6 kbps over a 2-wire telephone line, even though the practical speed only twenty years ago was 1.2 kbps. The improvement in voice band modems over the past 20 years has resulted from significant advances in algorithms, digital signal processing, and semiconductor technology. Because such modems are limited to voice bandwidth (3.0 kHz), the rate is bound by the Shannon limit, around 30 kbps. A V.34 modem, for example, achieves 10 bits per Hertz of bandwidth, a figure that approaches the theoretical Shannon limits.

35 There is a considerable amount of bandwidth available in copper lines, however, that has gone unused by voice band modems, and this is why a proposal known as Asymmetric Digital Subscriber Line (ADSL) was suggested in the industry as a high-speed protocol/connection alternative. The practical limits on data rate in conventional telephone line lengths (of 24 gauge twisted pair) vary from 1.544 Mbps for an 18,000 foot connection, to 51.840 Mbps for a 1,000 foot connection. Since a large proportion of current telephone subscribers fall within the 18,000 foot coverage range, ADSL can make the current copper wire act like a much "bigger pipe" for sending computer bits and digital information (like movies and TV channels), while still carrying the voice traffic. For example, an ADSL modem can carry information 200 times faster than the typical voice band modem used today.

ADSL is "asymmetric" in that more data goes downstream (to the subscriber) than upstream (back from the subscriber). The reason for this is a combination of cost, demand, and performance. For example, twisted pair wiring coupling increases with the frequency of the signal. If symmetric signals in many pairs are used within a cable, the data rate and line length become significantly limited by the coupling noise. Since the preponderance of target applications for digital subscriber services is asymmetric, asymmetric bit rate is not perceived to be a serious limitation at this time. Therefore, the ADSL standard proposes up to 6 Mbps for downstream, and up to 640 kbps for upstream. For example, video on demand, home shopping, Internet access, remote LAN access, multimedia access, and specialized PC services all feature high data rate demands downstream, to the subscriber, but relatively low data rates demands upstream. The principal advantage is that all of the high speed data operations take place in a frequency band above the voice band, leaving Plain Old Telephone Service (POTS) service independent and undisturbed, even if an ADSL modem fails. ADSL further provides an economical solution for transmission of high bandwidth information over existing copper line infrastructures.

55 Specifically, the proposed standard for ADSL divides the available transmission bandwidth into two parts. At the lower 4 kHz band, ordinary (POTS) is provided. The bulk of the rest bandwidth in the range from 4 kHz to about 1 MHz is for data transmission in the downstream direction, which is defined to be from the exchange to the subscriber. The upstream control channel uses a 160 kHz band in between. The signals in each channel can be extracted with an

appropriate band -pass filter.

A DMT implementation of ADSL uses the entire available 1 MHz range of a copper phone line. It merely splits the signal into 255 separate channels, and each 4 kHz channel can be made to provide a bit rate up to the best present day voice band (33.6 kbs) modems. This results essentially in overall performance which is equivalent to around two hundred V.34 modems used in parallel on the same line. Because each channel can be configured to a different bit rate according to the channel characteristics, it can be seen that DMT is inherently "rate-adaptive" and extremely flexible for interfacing with different subscriber equipment and line conditions.

A number of problems arise, however, in attempting to implement a full scale ADSL transceiver cost-effectively.

First, to achieve this high bit rate transmission over existing telephone subscriber loops, advanced analog front end (AFE) devices, complicated digital signal processing techniques, and high speed complex digital designs are required. As a result, this pushes current technology limits and imposes both high cost and power consumption. For example, AFE devices in modem applications provide the interface between analog wave forms and digital samples for digital hardware/software processing. In high speed modern technologies such as ADSL, AFE devices need to operate at a very high sampling rate and high accuracy. For example, the DMT technology has a spectrum of 1 MHz and requires sampling above 50 MHz if a sigma-delta analog-to-digital (ADC) method is used. This thus requires the state-of-art ADC technology and imposes a high cost for end users.

Second, the time domain signal in ADSL/DMT transmissions is a summation of a large number of carriers modulated by quadrature amplitude modulation (QAM). This typically results in a large peak-to-peak deviation. As a result, even though a high speed AFE is made possible, a large dynamic range and high resolution AFE is required at the same time to minimize quantization errors.

Third, in addition to the high sampling rate and resolution requirement for ADSL AFEs, the other hardware and software in ADSL environment also needs to operate at a much higher speed than current conventional modem counterparts. For example, to implement the DMT technology in software, a custom and dedicated digital signal process (DSP) of a power of several hundred MIPS (millions instructions per second) is required to process many components such as error encoding and decoding, spectrum transforms, timing synchronization, etc. As with the AFE part of the system, this high speed requirement for the signal processing portion of ADSL also results in less flexible, high component costs.

Fourth, requiring a communications device (such as a modem) to fully support the total throughput of a standard such as ADSL may be inefficient in some cases, since many prospective users of high-speed data links may not need to use all the available bandwidth provided by such standards. It is generally more preferable therefore to permit users to throttle or scale the data throughput in a manner they can control, based on their particular application needs, hardware cost budget, etc. For example, a full-scale ADSL system may have the performance level of 200 times conventional V.34 modems, but it is apparent that even a performance improvement of 10 - 20 times than present day available analog modems would be sufficient for many consumer applications, such as Internet access and similar uses. Thus, unlike conventional analog modems, which are available in various speeds varying generally from 14.4 to 56 Kbps, there are no known ADSL modems which offer scalable performance levels to users.

Fifth, in addition to the implementation challenge, the T1E1.4 ADSL standard does not specify the system interface and user model. Although various high level interface to support T1 /E1, ATM, etc. have been described, system integration with high level protocols such as TCP/IP and interface with computer operating systems have not yet been defined. As a result, there is uncertainty how existing and future modem-based applications can work with the ADSL technology. For example, when users run an Internet application which sends and receives data to and from an Internet service provider (ISP), a mutually agreed protocol is required to set up a call and transfer data. Possible protocols available at various levels include ATM (asynchronous transfer mode), TCP/IP, ISDN, and current modem AT commands. Either one of these or a possibly new protocol needs to be defined to facilitate the adoption of ADSL technology.

SUMMARY OF THE INVENTION

An object of the present invention therefore is to provide a communications system which is fully compatible with high speed, rate adaptable protocols such as are used with ADSL, but which system is nevertheless implementable with simpler analog front end receiving/transmitting circuitry and is thus reduced in cost and complexity;

A further object of the present invention is to provide a communications system which is fully compatible with high speed, rate adaptable modulation protocols such as used with ADSL, but which system is nevertheless implementable with simpler digital signal processing circuitry and is thus reduced in cost and complexity;

Another objective of the present invention is to provide a method for transmitting data within a fractional, desirable portion of available bandwidth in a channel by modulating only a limited number of desirable sub-channel data carriers, so that a high speed data link can be achieved that is faster, and has reduced computation and hardware demands;

Yet a further objective of the present invention is to provide a communications system with smaller peak-to-peak deviation in the sub-channels signals, so as to reduce the dynamic range required for the front end ADC, and to mini-

mize quantization errors.

Another objective of the present invention is to provide a high speed communications system having a data throughput that is easily controllable and expandable, so that the performance range of such system can be configured to any fractional percentage of total bandwidth available in a transmission channel, up to and including full bandwidth use of the channel;

A related objective of the present invention is to provide a high speed communications system that is modular so that forward compatible and expandable functionality can be incorporated flexibly and with a minimum of effort on the part of a user of such system;

Yet a further objective is to provide a system that is compatible with high speed protocols used in ADSL, but which is also easily adaptable to support preexisting high level data protocols, including those presently used for controlling high speed voice band modems;

A further object of the present invention is to provide a high speed communications system that self-calibrates its own performance level, based on the processing power available to such system;

Another objective of the present invention is to provide a high speed communications system that permits a user to configure the performance parameters of such system using conventional personal computer hardware, software and operating systems;

A further object of the present invention is to provide an interface between a host operating system and a high speed communications system that provide forward compatible and expandable functionality;

An additional aim of the present invention is to provide an improved system for concurrent control of conventional voice data traffic on a POTS channel, and upstream/downstream communications on separate sub-channels;

These objects and others are accomplished by providing a communications system that permits a host processing device to receive selected data within a narrow bandwidth from an upstream transceiver which can and normally transmits a large bandwidth analog data transmission signal through a connected channel. A channel interface circuit AFE samples the received analog signal to generate a digital signal. Only a limited portion of the bandwidth may be sampled, thus reducing front end complexity. A digital signal processing circuit then extracts the selected data from this limited digital signal, which is significantly easier to process than a full bandwidth digital signal. Feedback information is provided back to the upstream transmitter which causes the upstream transmitter to transmit downstream data thereafter only using the limited bandwidth of the front end, and not the full bandwidth. This feedback information contains information about the channel that suggests to the upstream transmitter that the other bandwidth in the channel is unusable. In this manner, the upstream transceiver is trained to accommodate the lower rate downstream transceiver in a manner that nevertheless preserves protocol integrity.

In a preferred embodiment, the large bandwidth analog data transmission signal is comprised of a number of DMT modulated sub-channels, and an anti-aliasing filter on the front end of the the downstream transceiver ensures that only a limited number of such sub-channels are processed by a DMT signal processing core. The feedback information consists of non-zero SNR information for the selected sub-channels, and a sub-channel blackout "mask" to eliminate the potential use of other sub-channels. The feedback information is sent by way of a front end transmitting circuit which transmits an upstream data transmission using a second frequency range different from the downstream transmission.

One implementation of the aforementioned high speed system is in a personal computer, so that the signal processing can be accomplished using a processor within such computer, which in a preferred embodiment is an X86 compatible processor. Another implementation of the aforementioned high speed system uses a dedicated signal processor for demodulating the selected sub-channels. This cuts down on processing overhead requirements for a host processing system incorporating the system. In such implementations the portion of the downstream data transmission to be processed for data extraction can be configured by a user of such systems, or alternatively, it can be dynamically determined based on an evaluation by the digital signal processing circuit of performance characteristics of different portions of the frequency spectrum within the bandwidth potential of the upstream transceiver.

In another variation, the data rate of a system such as described above can be increased by processing data from an additional second limited frequency bandwidth portion of the total available downstream bandwidth. In a preferred embodiment, this can be done by including a number of anti-aliasing filters in a modular bank as part of the analog front end section, each of which passes a different frequency bandwidth portion. By making the analog front end modular, the data rate of the overall system can be scaled in a controllable and cost-effective fashion. At the same time, each analog front end portion can be operated at a slower sampling clock and smaller dynamic range. This results in a more relaxed speed requirement and smaller quantization noise at a given number of bits per sample.

The present disclosure also includes an interface to an operating system, to facilitate controlling the high speed communications system when it is incorporated in a personal computer system. This interface ensures that the operating system treats such communications system essentially the same as other prior art voice band modems, and in a preferred embodiment, is a device driver for the Windows NT operating shell. Finally, the present disclosure also describes an applications program which permits a user of a personal computer to control the performance characteristics of the high speed communications system by setting certain system parameters when such system is incorpo-

rated in a personal computer system. This program includes an auto calibration routine for setting such system parameters, or alternatively a user of such program can tailor the settings subject to confirmation of the efficacy of such settings based on an evaluation of the processing power available to such user.

5 Although the inventions are described below in a preferred embodiment implementing the ADSL standard, it will be apparent to those skilled in the art the present invention would be beneficially used in any high speed rate-adaptable applications.

10 It should be noted that while some prior art devices also have limited mechanisms for achieving a reduction of nominal or peak transmission speed in a channel, they only activate or implement such mechanisms as a fallback response to a failure in the channel, or because of a transmission rate reduction in the upstream transceiver. Unlike the present invention, such prior art modems, during an initialization process, attempt to establish the highest possible transmission rate achievable by the channel and the upstream transceiver. In other words, any rate reduction imposed by the downstream modem is typically considered an unintended and undesirable side effect of bad channel characteristics, and not a desirable and intentional design target as set forth in the present invention. In addition, the data rate reduction in such modems is accomplished primarily by varying the number of bits per baud (hertz) at a fixed frequency, and not by controlling the overall frequency spectrum of the downstream data transmission. Moreover, in such prior art systems, no effort is made to measure, identify or use an optimal portion of the usable bandwidth or set of transmission sub-channels. Instead, such prior art systems typically use whatever available bandwidth or sub-channels happen to be usable at that instant in time.

15 Similarly, while a fixed 300 baud rate downstream modem can work with an upstream 33kbs rate modem this arrangement is also unlike the present invention. This is because, again, the bandwidth reduction in such prior art device is so large that it is considered commercially unusable by today's standards. Furthermore, the smaller bandwidth modem is not compatible with, and does not support, the higher protocols of the higher bandwidth modem, which is also undesirable from an implementation standpoint. Stated another way, unlike the present invention, the lower end modem limitations of prior art system force the data link to be set up using a low level protocol that does not take advantage of the full capabilities of more advanced protocols.

20 Finally, there is no mechanism for users of either of the prior art systems noted above to expand the functionality of such modems in a controlled, flexible, and modular manner.

BRIEF DESCRIPTION OF THE DRAWINGS

30 Figure 1 is a pictorial depiction of the ADSL/DMT bandwidth allocation for upstream and downstream data in a channel based on frequency division multiplexing (FDM) configuration.
 Figure 1B shows the relationship between a sub-band filter and an analog to digital converter that can be used in an analog front end (AFE) of the present invention ;
 35 Figure 1C is a pictorial depiction of a SNR curve for a typical subscriber loop channel using sub-channel modulation;
 Figures 1D - 1G are mathematical modellings and charts that further explain the underlying physical premises of the present invention based on DMT ;
 Figure 2 is a block diagram of a general implementation of a communications system employing the present invention, adapted for use in an ADSL environment ;
 40 Figure 3A is a block diagram of a dedicated hardware implementation of a communications system employing the present invention, also adapted for use in an ADSL environment;
 Figure 3B is a block diagram of a mixed hardware and software based implementation of a communications system employing the present invention, also adapted for use in an ADSL environment;
 45 Figure 4 is a block diagram depicting the general structure of the data pump device driver used in the mixed implementation shown in Fig. 3;
 Figure 5 is a flowchart depicting the general operation of the control and application interface used in the mixed implementation shown in Fig. 3 ;
 Figure 6 is a block diagram of an implementation of a communications system employing the present invention, also adapted for use in an ADSL environment, in which it is depicted how a user can modularly expand throughput capability by adding additional AFE stages to process a greater percentage of the available bandwidth in the channel.

DETAILED DESCRIPTION OF THE INVENTION

55 While some of the concepts set forth immediately below are well-known, a brief explanation of ADSL technology is provided with reference to Figure 1 to facilitate an understanding of the present invention. As explained above, it is well-known in the art to use DMT to effectuate the ADSL standard. In contrast to most modulation schemes, such as AM/FM

transmissions that use one carrier, DMT uses multiple carriers to transmit data bits. Specifically, T1E1.4 ADSL standards specify an up to 255 channels for downstream transmission from the central office to subscribers and up to 31 channels for upstream transmission from subscribers to the central office. As shown in Figure 1, each carrier has a bandwidth of 4.3125 kHz. The total bandwidth is 1.1 MHz for a total of 255 channels. In the upstream direction, a "pilot" tone in the approximate range of 69 kHz, is used for maintaining timing synchronization. A similar pilot tone is transmitted in the downstream direction in the vicinity of 276 kHz.

Since upstream and downstream transmissions are over the same 2-pair twisted wire, they need to be separated by either echo cancellation (EC) or frequency division multiplexing (FDM). Echo cancellation allows simultaneous transmissions in both directions but requires a complex echo canceler implementation. On the other hand, FDM uses two different frequency bands for separate downstream and upstream transmissions. As shown in Figure 1, the upstream transmission uses subchannels from channel number 6 to 31, and the downstream transmission uses subchannels from channel number 41 to 255. While the remainder of the discussion below focuses on a system employing FDM, it will be appreciated by those skilled in the art that the present invention is adaptable and can be used beneficially with echo-cancellation approaches as well.

As with most communication environments, the transmission bit rates for both upstream and downstream communications in ADSL are not fixed but instead are determined by the quality of the channel. In the present invention, a number of well-known techniques can be used advantageously for setting up the initial data link. In general, these techniques work as follows: during initialization, the channel quality is measured and a certain data rate (typically a number of bits) is assigned for each DMT subchannel; thereafter, a "hand-shaking" process is used to dynamically and adaptively change the bit loadings (and energy levels). The latter is often necessary because (among other things) changes may occur in the overall channel characteristics, changes in the target bit rate may be needed, or new bit distributions in the sub-channels may be required because of degradations in one of the sub-channels.

The quality of the sub-channel response can be measured by the received signal to noise (SNR) ratio. According to the Shannon theorem, the upper limit of the number of bits per unit Hz that can be transmitted is $\log_2(1+SNR)$. Therefore, by measuring the received SNR at the receiver end, one can determine the number of bits allocated for each subchannel modulation. The total data throughput rate achieved by the system, therefore, is simply the sum of all the data rates of all the usable subchannels.

According to the T1 E1.4 ADSL standards, data bits are grouped and processed every 250 μ sec. The number of bits that can be processed over one such time frame is the summation of the bits allocated for each subchannel determined from the previous channel response measurement. For a given number of bits assigned to a certain subchannel, quadrature amplitude modulation (QAM) is used to convert bits to a complex value, which is then modulated by the subchannel carrier at the corresponding frequency.

The above is a merely a brief summary of the general operation of a typical DMT/ADSL communications system. The general circuits used in prior art ADSL systems, the specifics of the bit/energy loading process for the sub-channels, the bit fine tuning process, and the details of the modulation of the sub-channels, are well-known in the art, and will not be discussed at length herein except where such structures or procedures have been modified in accordance with the teachings herein.

The full downstream data throughput of a typical prior art ADSL standard transceiver approaches 6 Mbps, which is more than 200 times the speed of conventional analog modem technology. This requirement was imposed since a large part of the initial motivation to implement ADSL was to achieve high speed multimedia communications and video teleconferencing. Nevertheless, a large number of potential users do not want or need to have such wide bandwidth capability. For example, many potential users of ADSL (or similar high speed loops), including many who are intending to use such links primarily for Internet access, only need to achieve downstream transmission speeds that are in the hundreds of kilobits per second range. This data rate is in fact achievable using only a fraction of the available bandwidth of ADSL. By processing only a fraction of the available bandwidth of the ADSL standard, the present invention permits a limited but extremely useful ADSL modem to be implemented with significantly less expense and complexity than previously possible. At the same time, because the present invention has modular characteristics, the proposed implementation of the present invention affords users an easy path to forward and upward expansion of the overall functionality of their system.

The principle behind this aspect of the present invention is as follows: As shown in Fig. 1B, if the transmission in the channel is restricted to a smaller bandwidth by an anti-aliasing filter 80, according to the Nyquist sampling theorem, the sampling rate of AFE devices (such as ADC 81) that perform analog to digital conversion can be significantly reduced. Specifically, if the total downstream bandwidth is limited to some fractional total B Hz (in a preferred embodiment using DMT in an ADSL environment, B = 20 DMT channels or about 86 kHz) as shown below, we can limit the Nyquist sampling rate to around 180 kHz. This is achievable with ADCs having greatly simplified hardware and reduced performance requirements, in contrast to the full ADSL bandwidth approach, which processes 200 DMT channels or 900 kHz in the case of full ADSL implementation.

The total accumulated bit rate of an ADSL communications system using the present invention can be calculated

as follows. Suppose a total number of k subchannels (out of a total of M possible) are to be supported and each channel is allocated b_k bits for transmission. The total accumulated bit rate (R) is:

$$R = (\sum_{i=1,k} b_i) * 4 \text{ kHz (bits/sec)}$$

5

where 4 kHz is the framing rate defined by T1E1.4 ADSL standards. If $k=20$ channels and the average number of bits per channel is 6, then total bit rate (R) is approximately 480 kbits/sec. It can be seen that this fractional use of the ADSL bandwidth nevertheless provides about 9 times the performance of a conventional analog 56 kbits/sec digital modem. The benefits of this approach of the present invention are apparent. The overall performance and cost of a high speed communications system can be scaled and controlled in direct relationship to the particular needs of particular users. In general, the data rate supportable by (and the relative cost of) any particular implementation of the present invention is generally determined by two factors: (1) the capacity of the AFE; and (2) the capacity of the hardware performing the DMT.

10

The capacity of an AFE is generally measured by the maximum sampling speed it can achieve. As explained above, the sampling speed in turn determines the upper limit of the frequency band B (in kHz) that can be obtained. At the defined channel separation of 4.3125 kHz for ADSL, the total number of subchannels that can be supported is less than or equal to $B/4.3125$. A suitable ADC can be selected, therefore, based on the particular data rate and cost requirements of any particular user.

15

The other factor that limits the number of subchannels (and achievable data rate) is the processing power available for DMT modulation and demodulation routines. For example, a variety of performance levels (achievable data rates) are possible with well-known dedicated signal processing hardware, such as digital signal processors, as discussed in more detail below with reference to Figure 2. Alternatively, as shown in Figure 3, if such routines are implemented primarily by software and run by a host CPU, the required processing power (MIPS) generally increases directly as function of the number of subchannels that need to be processed. This is because, in general, most of the processings are done in serial, or a channel by channel basis. As discussed below in more detail, the present invention makes use of a "calibration" routine for estimating the total available processing power of a users computing system in order to set an upper limit of the total subchannels that can be supported.

20

25

Irrespective of the selection of the particular AFE or signal processing technique used, however, another useful (but not essential) aspect of the present invention is that the sub-channels with the largest signal to noise ratio (SNR) within the passband are selected for data transmission. In other words, in the preferred embodiment of the present invention, those k subchannels within the passband that support the largest number of bits are used for processing. As seen in Fig. 1C, for example, a standard two-wire subscriber line typically has a SNR curve that exhibits extensive attenuation with higher frequencies. It can be seen roughly in this figure that while there are more than 200 sub-channels provided for downstream transmission in ADSL, it is typically the case that 50% of the maximum data rate can be accomplished using only a much smaller percentage (than 50%) of the sub-channels. This fact is especially useful in considering some of the shared/ multi-channel bandwidth embodiments discussed further below.

30

35

The present invention, therefore, permits an implementation for a high speed data communications system that makes use of the best portion of the channel, while still being upwardly compatible and forward expandable. By these terms, it is meant that a system constructed in accordance with the teachings herein is completely compatible with a fully implemented version ADSL DMT modem. Moreover, it will be apparent to those skilled in the art that appropriate modifications specific to the channel and data link protocols and standards can be made so that the present invention can be advantageously employed in non-ADSL environments as well. Upward compatibility and forward expandability refer to the fact that systems constructed with the present teachings can have data rates that are easily upgraded while still preserving and maintaining compatibility with existing standards. For example, lower end users desiring less bandwidth can achieve a satisfactory performance with a minimum of cost, and can then upgrade the performance levels of their systems at later time by suitable (and preferably modular) upgrades of the AFE and signal processing hardware/software.

40

45

A system constructed in accordance with the present teachings is completely compatible with the full ADSL standard because of the following two aspects: According to the rate adaptation feature specified by the T1E1.4 ADSL standards, the bit rate for each sub-channel is determined initially (and preferably dynamically on an ongoing basis) by the sub-channel SNR analysis. Specifically, an ADSL downstream receiver can inform an upstream ADSL transmitter about the quality of the transmission; the receiver can also decide the bit rate for each sub-channel. Therefore, a downstream, partial-channel bandwidth receiver using the present invention can (based on the speed and passband of such receiver) supply an upstream, full-standard ADSL transmitter with information or control signals to effectuate a transmission only in selected sub-channels. In particular, in a preferred embodiment, the upstream ADSL transmitter is provided with SNR information for sub-channels outside the passband that is artificially contrived so as to suggest to the upstream transmitter that these sub-channels are not usable. In this manner, the downstream transmission is limited to a certain number of subchannels within the AFE and signal processing capabilities of the receiver. It can be seen, nev-

55

ertheless, that this scheme is completely transparent to the transmitter, thereby permitting a system built in accordance with the present teachings to be fully compatible with the ADSL standard. While not possible at this time within the ADSL standard, it is apparent that other high-speed data protocols may use a control signal, instead, to provide for express limiting and control of the identity of the sub-channels transmitting information.

5 As the technology improves for AFE devices and DMT implementation, the number of subchannels supported by a system using the present invention can increase. As a result, such systems can upgrade completely to a full T1E1.4 ADSL implementation using a single higher end modular replacement APE devices, or alternatively, a number of lower end modular AFE devices.

10 *GENERAL EMBODIMENT OF PRESENT INVENTION*

The basic structure of the present invention is depicted generally in Fig. 2. In general, the present invention can be embodied in different combinations of hardware and software. The primary difference between these embodiments is the specific implementation of the DMT core. These specific embodiments are described in more detail below with reference to Figs. 3A and 3B.

The structure and operation of ADSL transceivers is well-known in the art, and for that reason the present description primarily details those aspects of such transceivers which are necessary to an understanding of the inventions herein. As seen in Fig. 2, a channel 100 is made of a regular copper wire "loop", and each such loop may have differing electrical properties, transmission lengths (sizes), varying attenuation characteristics, and a number of impairments or interferences. Splitter 210, a conventional and well-known circuit, separates a DMT signal occupying more than 200 sub-channels from a lower end 4 kHz POTS analog signal. The latter can be used for simultaneous voice or conventional analog modem. Hybrid circuit 220 is also well-known in the art, and consists primarily of conventional transformers and isolation circuitry used in a wide variety of high-speed devices interfacing to standard telephone lines. A ring detect logic circuit 290 can also be implemented using accepted techniques, to alert a Control Interface 295 to the existence of a transmission signal originating from an upstream transceiver (not shown).

The full bandwidth signal is either low passed or bandpass limited to a frequency width B by suitable, well-known techniques as it passes through bandpass Filter and Analog/Digital Converter 280, so that only a fraction of the signal in the frequency domain is passed on to Buffer and DMT Receive Core 260. Again, the only important consideration for Subband Filter 280 is that it must constrain the bandwidth of the incoming signal to be $\leq B$, where the sampling rate of the Analog/Digital Converter is $\geq 2B$. This can be accomplished by using well-known filter designs. By suitable selection of circuitry for Filter and ADC 280, the overall system cost and performance can be scaled accordingly. In a preferred embodiment, the signal passed through Filter and ADC 280 occupies a spectrum between approximately 200 and 400 kHz. This selection is based primarily on an expected average performance of a typical two-wire line. It will be apparent to those skilled in the art that different bandpass widths and regions may be more suitable or optimal for other kinds of data links, or other kinds of multi-carrier modulation schemes.

Moreover, in some instances, while it is somewhat more expensive to implement, an adaptive or tunable filter may be substituted, such that the target frequencies of the passband are adjustable uniquely for each new data link. In such cases, the bandpass can be configured to coincide with the sub-channels having the highest achievable SNR, including the subchannels that must be supported for protocol or other system overhead reasons. Also, in some applications, the analog-to-digital conversion may be performed by a digital signal processor, or by the host computer and therefore, the sampling rate can be dynamically controlled and matched to the bandpass target frequency and frequency breadth. This feature, in turn, would assist dynamic scaling of the data throughput based on system computing power and overhead requirements.

Furthermore, in this preferred embodiment, using a multi-carrier approach implementation for ADSL, a pilot tone at 276 kHz must be allowed within the passband. It is apparent that other protocols may require similar pilot tones, and the design of comparable filters to achieve the functionality of Filter and ADC 280 is well within the ordinary skill of one in the art.

DMT Receiver Core 260 is generally responsible for monitoring and measuring the SNR of the sub-channels falling within the frequency range passed by FILTER and ADC 280, and for extracting the original data stream from the numerous sub-carriers. In a preferred embodiment, Control Interface 295 receives system configuration information from a host 298. This information may contain such parameters as target throughput rate R, target error rate, target center frequencies F for FILTER and ADC 280, target frequency width B, etc. By evaluating the SNR and bit capacities of the sub-channels computed by DMT Receiver Core 260, and taking into consideration the target data rate R, Control Interface 295 can select a number k of sub-channels up to and including the total available number M of sub-channels to carry the data stream from the upstream transmitter (not shown). The number of sub-channels that can be used for carrying data is directly related to the bandpass frequency B as described above. In a preferred embodiment, $M = 200+$ (ADSL) and Control Interface 295 will usually configure $k = 20$.

For every sub-channel other than the selected k sub-channels, a "mask" or blackout control/feedback signal is gen-

erated and transmitted by DMT Tx Core 250, Buffer 260 and DAC 230 to the upstream transceiver. This ensures that any subsequent data transmissions by the upstream transceiver only use the selected k sub-channels. This feedback information is provided, therefore, irrespective of the transmitting capacity of the upstream transceiver, and even during times when the channel 100 is capable of supporting more than k sub-channels. In this manner, the present system is perceived by upstream transceiver to be compatible with protocols and performance characteristics of the upstream transceiver, because the upstream transmitter receives feedback information indicating merely that the two systems are connected through a channel with substantial signal attenuation characteristics for data signals outside the k sub-channels. Based on the inherent rate adaptiveness of ADSL and other similar protocols, the upstream transceiver will automatically train itself to use only the k sub-channels predetermined by the downstream transceiver. It should be noted that the DAC 230 and Buffer 240 in the front end transmitting circuit preferably transmit any upstream data transmissions using a second frequency bandwidth different from that of the downstream data transmission. However, this is not necessary in systems using echo-cancellation. Furthermore, in ADSL applications, the size of this bandwidth is considerably smaller, and uses only L sub-channels, where $L < M$. In other xDSL applications, L may be on the same order or larger than M .

Again, while the ADSL standard fixes the data error rate to be 10^{-7} , it is conceivable that other applications of the present invention may tolerate a reduced error rate. For example, if maximum data throughput is required (i.e., the margin is less constrained) then the largest bit capacity sub-channels within B can be selected. Alternatively, if the system is error-performance driven and has more relaxed throughput requirements, then the 20 subchannels with the best margin are selected. A suitable combination of sub-channels can be selected by one skilled in the art based on the particular system requirements which may vary from application to application. Moreover, Controller Interface 295 may optimize the desired sub-channel mix dynamically depending on the type of data transmitted in channel 100. For example, streaming audio or video, or pictorial graphics, may require less integrity and error performance than other kinds of data used by n applications programs running on host 298. The specifics of the structure, operations and techniques used by Controller Interface 295 are not constrained by any requirements of the present invention, and can be implemented in various ways well-known to those skilled in the art.

The operation of the remainder of the circuitry shown in Fig. 2 is also relatively straightforward and not unlike a typical multi-carrier modulation system. Control Interface 295 ensures that DMT Transmit Core 250 performs bit and energy loading only for those sub-carriers necessary to effectuate a selected host throughput rate/error rate combination. As with the circuitry used for Filter ADC 280, the circuitry for performing the functions of DAC 230 can be implemented in programmable form to allow for greater flexibility.

Finally, while not presently supported in ADSL protocols, it is nevertheless possible that the filter in block 280 can be eliminated entirely in some applications when the sub-channel or downstream transmission frequencies can be configured through appropriate handshaking or similar procedures. In other words, if the upstream transmitter can be configured to transmit using only a portion of the bandwidth available in the channel, the advantages of the present invention can still be realized, because the ADC portion of block 280 can still be relatively less complex, since it will be processing at a much slower sampling rate than that required for a full spectrum implementation. Moreover, such an implementation would also yield the same commensurate savings in the DMT processing core, and reduced quantization errors.

Some special features of the present invention include the fact that:

(i) unlike hardware architectures implementing a full T1E1.4 ADSL standard, the present invention uses a filter in the front end. As mentioned earlier, the use of this filter is to allow low speed sampling by the ADC. If suitable handshaking between the upstream and downstream transceivers can be effectuated to generate a reduced downstream transmission, the filter can be eliminated.

(ii) standard ring detection logic is incorporated to support existing modem features;

(ii) DMT Rx core 260 is basically implemented the same way as specified by T1E1.4, but with some important differences, specifically:

[a] due to subband filtering and lower speed sampling, the frequency channels at the output of FFT (not shown) in the DMT Rx Core have a frequency shift

[b] Since not all 256 subchannels are necessarily supported by the DMT Rx Core 260, actual FFT implementation can be smaller, simpler and more cost-effective;

(iv) Control logic 295 permits the system to behave essentially like a conventional analog modem, and is used to support necessary setup tasks such as dialing and handshaking;

(v) The use of limited bandwidth from the downstream channel reduces the need for echo-cancellation circuitry, because there is less need for overlap between the upstream and downstream transmissions, and this further reduces system complexity and cost;

(vi) Because a smaller portion of the spectrum is processed by the present invention, the peak-to-peak deviation of the downstream signal is reduced, and this helps to minimize quantization errors.

DEDICATED HARDWARE BASED EMBODIMENT

5

Figure 3A illustrates an embodiment of the present invention that can be generally described as a dedicated hardware implementation. For the present discussion of Fig. 3A, it can be assumed that those circuits having like numbered references are the same and/or perform the same function as their counterpart in Fig. 2. For example, unless otherwise indicated, there is no material difference between Splitter 210 (Fig. 2) and Splitter 310 (Fig. 3A).

10

In this embodiment, the DMT sub-channel modulation core is implemented completely in dedicated processing hardware. For thin application, DMT Receiver Core 260 typically includes a digital signal processor (DSP) (not shown) and including on-board program ROM (or other suitable memory) for storing executable microcode routines for performing bit, energy and SNR measurements of the carriers in the sub-channels. In such an embodiment, due to the power of the DSP, there is typically no need for processing assistance from a user's host processor 398. This embodiment therefore may be advantageously employed where host processing power limitations are a consideration.

15

A user of a system shown in Fig. 3A can expand the functionality (i.e., data throughput rate and modem features) of such system by upgrading the DMT Receiver Core 260, and where necessary, the AFE 280 as well. The system of Fig. 3A can be incorporated on a typical printed circuit board. By mounting or packaging the circuits used in such blocks in an accessible fashion, they can be replaced or supplemented much in the same way present users of personal computers can upgrade their motherboards to include additional DRAM. One practical alternative, for example, would be to have multiple available slots to accommodate new subband pass filters for passing a greater portion of the downstream transmission to be processed by the DMT core logic. Other practical and simple variations of this approach will be apparent to those skilled in the art.

20

25 PARTIAL SOFTWARE BASED EMBODIMENT

In the above dedicated hardware embodiment, the overall speed (data throughput) can be maximized but with less flexibility for upgrades. This is because upgrades to such a system must take the form of hardware replacements, which can be more costly and difficult for the user to incorporate. On the other hand, as depicted in Fig. 3B, a number of important functions of a communications system can be completely implemented in software, in an analogous fashion to what is commonly described in the art as a "software" modem. In this case, the overall speed of the system depends on the user's processor power available at host 398, and only the AFE portion need be implemented in hardware.

30

The primary differences between the embodiments of Fig. 3A and 3B are the following: (1) implementation of DMT modulation; (2) implementation of the control and handshaking functions; and (3) implementation of the control interface. As seen in Figures 3B and 4, DMT Receive Core 460 and DMT Transmit Core 450 are implemented in a data pump device driver by the host system 398. In a preferred embodiment, host system 398 includes some form of multi-purpose microprocessor (such as an x86 type processor) running a suitable operating system (such as Windows by Microsoft), and is capable of executing suitable low level drivers for the DMT modulation (Fig. 4), as well as high level application software for implementing Control Interface 500 (Fig. 5). Host processor system 398 communicates over a standard bus interface 385 (i.e., a PCI bus) to Front End circuitry 396 for implementing a high speed modem. As with the circuitry in conventional analog modems, this circuitry of the present invention can be effectively incorporated on a PC motherboard (i.e., Bus Interface 385 and Front End Circuitry 396 can be merged so that they are essentially part of host system 398) or on a separate printed circuit board, or as a stand-alone unit physically separated from host 398. While this approach may not provide as much throughput performance, it has the advantage of being less expensive than the pure hardware approach of Fig. 2, and much easier to upgrade.

35

40

45

In the "software" modem implementation of Fig. 3 using a typical PC running Windows, the DMT Tx core 450, Rx Core 460 and Control/Handshaking logic are implemented as a Windows Data Pump Device Driver 400, which consist of DMT routines, associated control and handshaking codes, and an interface to kernel 480.

A more detailed characterization of a portion of host processing system 398 is depicted in Fig. 4, which illustrates a preferred embodiment of a device driver 400 as it would be constituted for a computer operating system shell 480. In the present embodiment, Microsoft Windows NT is considered, but it is understood that other comparable environments may be used, including UNIX, Windows 95, etc. As is well-known, operating system 480 is responsible for supervising and controlling the operation of processing system 398 and all of its associated peripheral devices. Operating system 480 also includes various interactive control and graphical application interfaces (Fig. 5) for permitting a user of processing system 398 to run various applications programs, and to set up, control, configure, monitor and utilize peripheral devices such as disk drives, printers, monitors, modems and the like.

50

55

To assist operating system 480 to interact and control such peripheral devices, it is also well-known to use device drivers, which are essentially low-level hardware routines executed by a host processor and operating system. A device

driver is a memory image file or executable file that contains all the code necessary to instruct a host processor to interface and drive a particular device within a computing system. Device driver 400 acts as an interface between an operating system 480 (in this case, Microsoft Windows NT) and hardware 396. In this case, for example, device driver 400 supports hardware 396 (see Fig. 3B), which is embodied in a typical printed circuit board (or external device). The teachings herein therefore provide for a new device driver that in combination with hardware 396 operates as a "software" modem. In this manner, operating system 480 classifies this combination as an ADSL modem, or in other words, another typical personal computer peripheral device, analogous to conventional voice-band modems.

Generally speaking, device driver 400 works as follows: a user of processing system 398 desiring to establish a data link to a remote site for transmitting/receiving data initiates such link through an application program (Fig. 5). Operating system 480 (Fig. 4) interprets and services this request by passing control of this task to device driver 400, which first generates appropriate instructions for a Device Initialization 440. In a preferred embodiment, Modem card 396 is initialized through Bus Interface 410 using conventional voice band modem control commands, so that the present invention is compatible with preexisting applications programs written for controlling modems using operating system 480. Similarly, therefore, control and data signals are interpreted and transmitted by operating system 480 to a Serial Port Interface 475 so that conventional modem dialing instructions and handshaking signals can be imparted to Modem Card 396 to establish a link through channel 100 to an upstream conventional ADSL transceiver (not shown). As explained above, after suitable handshaking protocols have been completed, the upstream fully compatible ADSL transceiver will begin transmitting data on all available M usable sub-channels. This downstream data is filtered by FILTER/ADC 380 and at this time, information for only N sub-channels ($N \leq M$) is temporarily held in Buffer 370. At or before this same time, an interrupt is generated by bus interface 385 and passed through device driver bus interface 410 to alert Interrupt Service Router 415 to the existence of downstream data requiring processing. Thereafter, DMT Receive Core 460 begins processing the downstream data stream in response to control information from ISR 415. A demultiplexer 465 extracts and correlates the data in the various sub-channels before passing it on to Serial Port Interface 470, and back to Operating System 480. In this manner, Device Driver 400 coordinates with Modem card 396 to effectuate a software modem whose performance is directly correlated to the computing power of a processor contained within the host processing device.

As mentioned earlier, Device Driver 400 also contains control information for configuring the number and selection of sub-channels to be used in the particular data link established through channel 100 with the upstream transceiver during an initialization process. As also mentioned above, this control information may be self-determined by a user of host processing system 398, or alternatively, automatically sensed and monitored by such processing system, based on a computing performance rating for such system determined in a calibration routine. In either event, during the initialization process (and at all times subsequent) the upstream transceiver is induced to use such sub-channels only for the ensuing data transmission. This is accomplished by transmitting SNR information that is interpreted by the upstream transceiver as zero for all but $K \leq N$ of the sub-channels of the driver selection. This data is passed under control of Operating System 480 through Serial Port 475, Framing control 455 and DMT Transmit Core 450 before being sent out to Modem Card 396 and channel 100.

It is understood, of course, that ADSL Modem 396 can also respond to a request from a remote modem for initiating the data link. The process for initializing the link, nevertheless, is essentially the same as that described above. Device driver 400 can also contain control logic for supporting typical dial-up modem operations and control codes from conventional modem application programs typically implemented in voice-band modems, such as setting up Originate/Answer modes, monitoring call progress, performing modem diagnostics, configuring receive/transmit buffer sizes, supporting facsimile transmissions, as well as performing enhanced error control, data compression and flow control between Modem Card 396 and Operating System 480. Device Driver 400 can also support other conventional "always-on" data link connections as desired, such as may be found in typical ethernet network connections, and other dedicated applications.

Given the teachings of the present invention, the general design of the above Data Pump Device Driver 400 is a routine task well within the abilities of one skilled in the art. The specifics of such implementation are not critical or essential to the present inventions, and will vary from application to application according to system designer requirements, so they are not included here. Again, while this embodiment of the present invention is set out in the context of a PC based host processor running Windows, it will be apparent to those skilled in the art that above description is merely an exemplary implementation. The referenced DMT routines, associated control and handshaking codes can be employed in numerous host processing/operating system environments, and in a variety of different coding organizations (high level or low level processing forms) well-known in the

In the preferred embodiment implemented using a standard PC running Windows, Control/Application interface 500 includes Win32 codes which provide standard modem utility functions and interface with Data Pump Device Driver 400. In Fig. 5, a flowchart of the operation of the Control/Application Interface 500 can be seen, which interface is discussed in more detail below.

Another particularly beneficial aspect of the embodiment of Fig. 3B is the provision of a self-determining "perform-

ance" or calibration rating that can be used to determine an optimal or maximum data throughput rate. In other words, the system of Fig. 3B can automatically and adaptively configure a host system 398 to a particular throughput rate based on an evaluation of the available computing power. In a preferred embodiment, the performance rating is determined based on a calibration routine executed by Data Pump Device Driver 400. This routine sets a timer, and counts
 5 how many DMT frames can be processed within the given time; this gives a relative figure of merit for the particular host system in question. For each sub-channel to be added, one DMT frame needs to be processed within a small fraction of 250 μ s. Therefore, by incrementally increasing the sub-channel count, the overall effect on total system processing overhead can be determined. Control/Application Interface 500 provides the user with control to set a threshold of available host power for implementing the high speed link. Based on this threshold of available power (which can be nominally set to 20%) the number of subchannels that can be supported can be gleaned very quickly.
 10

In view of current technology, when DMT processing is implemented in software, the host processing power is more likely to be the limiting factor than the frequency band of the subband filter 80 in Figure 1B. Nevertheless, because host processors (and especially microprocessors) are evolving in performance at a fairly rapid rate, the present invention affords users an opportunity to realize a high speed data link with performance that is controllable, and which improves
 15 whenever there is an upgrade in the host processing system. Since many typical present day personal computer systems have easily accessible and replaceable host processors, users of the present invention can easily and flexibly expand and enhance the throughput and functionality of an ADSL modem.

An example of the flow chart for an ADSL modem application/control program 500 designed in accordance with the present teachings is shown in Fig. 5. With the teachings herein, a user of host processing system 398 can, for the first time, dynamically control a forward compatible and expandable modem, such as an ADSL modem, using modem-control applications software that is analogous to that only previously available for voice band modems. In a preferred embodiment, ADSL Modem Card 396 is automatically detected by Operating System 480 and set up by initialization routine 505 by Modem Device Driver 400. A separate detection routine 510 determines whether or not ADSL Modem Card 396 has been upgraded with an additional AFE (as described generally with reference to Figure 6 below), or alternatively whether a processor used in a host system has changed. The purpose of this step is primarily to determine
 20 whether entries in a Device Parameters Table 560 need to be updated because of changes in computing power, front end capabilities or other parameters that may necessitate a modification of the data throughput characterization of the overall system when used in a communications mode.

A calibration routine 520 is then executed to determine the nominal setup parameters for the overall system in the manner described earlier. The results from this operation are stored in Device Parameter Table 560 where they then become accessible to various application programs that may make use of ADSL Modem Card 396 and Device Driver 400. The information stored in table 560 can include any or all of the following (a) measurements of the computing power available to the host processor; (b) measurements of the number of frames processable by the system within a particular time period; (c) estimations of the expected loading on the processing system based on demands of other
 35 applications programs and peripheral devices; (d) minimum and maximum data throughput estimations and/or targets; (e) data identifying the type of host processor; (f) data identifying the number and type of AFEs in ADSL Modem card 396; (g) estimations and/or target system loading rates available for a datalink (i.e., maximum available processing time to be used by the system during data transmission); (h) data transmit and receive buffer sizes; (i) interrupt or similar priority data for the modem card; (j) estimations and/or target system sub-channel utilization; (k) estimations and/or target system sub-channel bit capacity information; etc. It will be apparent to skilled artisans that the above are just examples of the types of information that may be pertinent to the performance of a high speed communications system, and that other parameters may be considered depending on the environment, application, etc. in which the present invention is used.
 40

After performing Auto Calibration routine 520, the results of the same are presented to the user for acceptance and verification at step 525. At this point, the user can accept the predetermined configuration data at step 526 (i.e., such as proposed maximum and minimum throughput rates, loading rates, etc.) and this would otherwise invoke an end of modem setup routine 590. Should the user not want to accept the recommended parameters, a Manual Configuration routine 530 is executed. At this juncture, various system performance data can be presented to the user for review, along with a list of modifiable system options 532. If for example, the user elects to increase the desired throughput rate,
 50 a Verification routine 540 is then executed to determine whether such rate is reasonably sustainable within the other parameters of the system. If the new proposed configuration data is otherwise acceptable, then the Device Parameter Table 560 is updated, and the setup routine again ends. Otherwise, the user is alerted by a Notification/Suggestion routine 550, which points out the failure of the proposed configuration, and, if possible, makes suggestions to the user for modifying the system options 532 so that overall compliance can be achieved within the performance capability of the host processing system. The program then loops back to Acceptance routine 525, and thereafter the process is repeated until an acceptable configuration has been achieved, and any changes have been incorporated into Device Parameter Table 560.
 55

While some of the operational steps above are described as implemented solely by Operating system 480 and

Device Driver 400, it is understood that such operations occur under direction of modem applications program 500, or in some cases, based on initialization routines executed by the host processing system. Moreover, to simplify the presentation of the present invention, only some of the features that may be implemented are described above, and many other well-known operational steps normally associated with setting up or monitoring modems are omitted.

5 As with the design of the above Data Pump Device Driver 400, the general design of the Control/Application Interface 500 required to accomplish the above functions is a routine task well within the abilities of one skilled in the art given the teachings herein. The specifics of such implementation are not critical or essential to the present inventions, and will vary from application to application according to system designer requirements, so they are not included here. Again, while this embodiment of the present invention is set out in the context of a PC based host processor running
 10 Windows, it will be apparent to those skilled in the art that above description is merely an exemplary implementation. The referenced Control/Application Interface can be employed in numerous host processing/operating system environments, and in a variety of different coding organizations (high level or low level processing forms) well-known in the art.

MULTIPLE AFE AND LOWER SAMPLING SPEED EMBODIMENT

15 Figure 6 illustrates an example of the present invention wherein a user can achieve significantly increased data throughput using multiple low cost, low sampling speed AFEs, generally designated 680A, 680B, 680C, etc. As described above, these AFEs may be in separate, modular form and configured in a bank form so that they can be incorporated conveniently on a printed circuit board (or similar mounting) or integrated in a single IC chip. Each AFE
 20 can be implemented in a fixed hardware configuration, or individually programmed/controlled to pass a certain portion of the downstream data transmission. Assuming suitable processing power is available for DMT modulation/demodulation (either through a dedicated or software implementation as described above in connection with Figs. 3A and 3B) a user of such system can achieve substantially expanded functionality by upgrades having performance characteristics and costs of their choice.

UNDERLYING THEORY OF PRESENT INVENTION FOR ADSL/DMT APPLICATIONS

25 A discussion of the underlying theory supporting the premise of the present invention now follows. In particular, this section shows the mathematical foundation For the use of multiple low speed AFE's to sample a full bandwidth ADSL/DMT signal. It will be apparent to those skilled in the art, after reading this discussion, that the present inventions can be advantageously used in a number of rate adaptable communications environments, including CAP implementations of ADSL.

DMT Transmitter

35 To simplify the present discussion, only a subset of the DMT transmitter is considered, as shown in Figs 1D and 1E. The combined model that includes the channel response and the DMT receiver is shown below, where only one branch of band-pass filtering and sampling is shown for simplicity. To further simplify, the channel response and the SFIR are combined together.

40 In this subsection, we analyze the signal over one band pass filtering process. The result shows that the DMT signals within the band pass can be recovered with the same use of impulse response shortening technique. With use of multiple AFE's that cover different frequency bands, all DMT subchannels can be recovered. IFFT

In an ADSL environment as shown in Fig. 1D, N ($N=512$) frequency domain variables are transformed into the time domain by IFFT block 60

45

$$y_n = \sum_{i=0}^{N-1} x_n e^{j2\pi i n / N}$$

Cyclic Prefix

50 c time domain variables at the end are added to the prefix of the sequence as shown in Fig. 1D by block 70
 $\{z_n\} = \{z_{-c}, z_{-c+1}, \dots, z_{-1}, z_0, z_1, \dots, z_{N-1}\} = \{y_{N-c}, \dots, y_{N-1}, y_0, \dots, y_{N-1}\}$

AFE/DAC

Discrete time domain sequence are converted by AFE 75 to the continuous time domain waveform as follows:

EP 0 889 615 A2

$$z(t) = \sum_{n=-\infty}^{\infty} z_n \rho_{TX}(t-nT_c),$$

5 where $\rho_{TX}(t)$ is the transmitter pulse of the AFE/DAC used, and T_c is the transmitter DAC clock period and equal to

$$T_c = \frac{250 \mu\text{sec}}{N+C}$$

10 according to the DMT ADSL specifications.

Channel

With reference now to Fig. 1E, if the channel impulse response is $h_c(t)$, we have

15

$$u(t) = \sum_{n=-\infty}^{\infty} z_n \rho_{RX}(t-nT_c)$$

20 where $\rho_{RX}(t) = \rho_{TX}(t) \otimes h_c(t)$.

Bandpass Filtering

If the bandpass filter 80 has an impulse response of

25

$$h_{BPF}(t), v(t) = \sum_{n=-\infty}^{\infty} z_n \rho_{BPF}(t-nT_c)$$

30 where $\rho_{BPF}(t) = \rho_{RX}(t) \otimes h_{BPF}(t)$.

AFE/ADC

Let the sampling clock be $T_s = T_c \times L$. This means a slower sampling by a factor of L for AFE 81. Thus,

35

$$w_k = \sum_{n=-\infty}^{\infty} z_n \rho_{BPF}(kT_s - nT_c) = \sum_{n=-\infty}^{\infty} z_n \rho_{BPF}([kL - n]T_c)$$

40 For causal pulse $\rho_{BPF}(t)$, we have

$$w_k = \sum_{n=-\infty}^{\infty} z_n \rho_{BPF}([kL - n]T_c) = \sum_{n=0}^{\infty} z_{kL-n} \rho_{BPF}nT_c$$

45

Shortening FIR (SFIR)

After AFE discrete time sampling, a time domain equalizer (TEQ) called SFIR 82 is used to reduce the combined discrete time impulse response to a duration smaller than c . If the SFIR response is $h_{SFIR}[n]$, we have

50

55

$$\begin{aligned}
 r_k &= \sum_{i=0}^{\infty} w_{k-i} h_{SFIR}[i] \\
 &= \sum_{i=0}^{\infty} \left[\sum_{n=-\infty}^{\infty} z_n p_{BPF}((kL-n-iL)T_c) \right] h_{SFIR}[i] \\
 &= \sum_{n=-\infty}^{\infty} z_n h_{tot}[kL-n] \\
 &= \sum_{n=0}^{\infty} z_{kL-n} h_{tot}[n]
 \end{aligned}$$

where

$$h_{tot}[kL-n] = \sum_{i=0}^{\infty} h_{SFIR}[i] p_{BPF}((kL-n-iL)T_c)$$

20 **Physical Meaning of $h_{tot}[n]$**

If we perform discrete Fourier transform at block 84 for $h_{tot}[n]$, we obtain $H_{tot}[\omega] = H_{SFIR}[L\omega] H_{BPF}[\omega]$ where $H_{SFIR}[L\omega]$ and $H_{BPF}[\omega]$ are the DFT's with period $1/LT_c$ and $1/T_c$, respectively. Their spectra can be illustrated as shown in Fig. 1F for $L=5$.

25 **Dropping Cyclic Prefix**

By dropping the cyclic prefix of length c/L , at block 83 we consider only $s_k = r_k, k=0, \dots, N_1-1$, where $N_1 = N/L$.

30 **FFT**

Performing FFT at block 84 for $s_k, k=0, \dots, (N/L)-1$, one obtains:

$$\begin{aligned}
 q_n &= \sum_{l=0}^{N_1-1} s_l e^{-j2\pi nl / N_1} \\
 &= \sum_{k=0}^{N_1-1} r_k e^{-j2\pi nk / N_1} \\
 &= \sum_{k=0}^{N_1-1} \left(\sum_{i=0}^{\infty} z_{kL-i} h_{tot}[i] \right) e^{-j2\pi nk / N_1} \\
 &= \sum_{k=0}^{N_1-1} \sum_{i=0}^{\infty} z_{kL-i} h_{tot}[i] e^{-j2\pi n(kL-i) / N_1} e^{-j2\pi ni / N_1} \\
 &= \sum_{i=0}^{\infty} \sum_{k=0}^{N_1-1} z_{kL-i} e^{-j2\pi n(kL-i) / N_1} h_{tot}[i] e^{-j2\pi ni / N_1} \\
 &= \sum_{i=0}^c \sum_{k=0}^{N_1-1} z_{kL-i} e^{-j2\pi n(kL-i) / N_1} h_{tot}[i] e^{-j2\pi ni / N_1} \\
 &= \sum_{i=0}^c \sum_{k=0}^{N_1-1} y_{kL-i} e^{-j2\pi n(kL-i) / N_1} h_{tot}[i] e^{-j2\pi ni / N_1}
 \end{aligned}$$

where we assume $h_{tot}[i]$ is only nonzero for $i = 0, \dots, c$. For a given i , let us define

$$l' = \lceil i/L \rceil;$$

5

We can then define $i' = l'L - i$, where $i' = 0, \dots, L-1$. Therefore, $i = l'L - i'$
 From the above definitions, we have

$$\begin{aligned} \sum_{k=0}^{N_1-1} y_{kL-i} e^{-j2\pi n(kL-i)/N_1} &= \sum_{k=0}^{l'-1} y_{kL-i} e^{-j2\pi n(kL-i)/N_1} + \sum_{k=l'}^{N_1-1} y_{kL-i} e^{-j2\pi n(kL-i)/N_1} \\ &= \sum_{k=0}^{l'-1} y_{(k-l')L+i'} e^{-j2\pi n((k-l')L+i')/N_1} + \sum_{k=l'}^{N_1-1} y_{(k-l')L+i'} e^{-j2\pi n((k-l')L+i')/N_1} \\ &= \sum_{k=0}^{l'-1} y_{(k-l'+N_1)L+i'} e^{-j2\pi n((k-l'+N_1)L+i')/N_1} + \sum_{k=0}^{N_1-1-l'} y_{kL+i'} e^{-j2\pi n(kL+i')/N_1} \\ &= \sum_{k=N_1-l'}^{N_1-1} y_{kL+i'} e^{-j2\pi n(kL+i')/N_1} + \sum_{k=0}^{N_1-1-l'} y_{kL+i'} e^{-j2\pi n(kL+i')/N_1} \\ &= \sum_{k=0}^{N_1-1} y_{kL+i'} e^{-j2\pi n(kL+i')/N_1} \end{aligned}$$

25

Therefore,

$$\begin{aligned} q_n &= \sum_{i=0}^c \sum_{k=0}^{N_1-1} y_{kL-i} e^{-j2\pi n(kL-i)/N_1} h_{tot}[i] e^{-j2\pi ni/N_1} \\ &= \sum_{i=0}^c \left[\sum_{k=0}^{N_1-1} y_{kL+i'} e^{-j2\pi n(kL+i')/N_1} \right] h_{tot}[i] e^{-j2\pi ni/N_1} \\ &= \sum_{i=0}^c \left[\sum_{k=0}^{N_1-1} \left(\sum_{l=0}^{N-1} x_l e^{j2\pi(kL+i')l/N} \right) e^{-j2\pi n(kL+i')/N_1} \right] h_{tot}[i] e^{-j2\pi ni/N_1} \\ &= \sum_{i=0}^c \left[\sum_{k=0}^{N_1-1} \sum_{l=0}^{N-1} x_l e^{j2\pi(kL+i')(l-n)/N} \right] h_{tot}[i] e^{-j2\pi ni/N_1} \\ &= \sum_{i=0}^c \left[\sum_{l=0}^{N-1} x_l \sum_{k=0}^{N_1-1} e^{j2\pi(kL+i')(l-n)/N} \right] h_{tot}[i] e^{-j2\pi ni/N_1} \end{aligned}$$

45

Since

$$\sum_{k=0}^{N_1-1} e^{j2\pi(kL+i')(l-n)/N} = 0 \text{ when } (l-n) \neq mN_1,$$

50

we have

$$q_n = N_1 \sum_{i=0}^c \left[\sum_{m=0}^{L-1} x_{mN_1+n} e^{j2\pi i' m/L} \right] h_{tot}[i] e^{-j2\pi ni/N_1}$$

55

Knowing that $h_{tot}[l]$ is zero for $l < 0$ and $l > c$, we have

$$\begin{aligned}
 q_n &= N_1 \sum_{i=0}^c \left[\sum_{m=0}^{L-1} x_{mN_1+n} e^{j2\pi i' m / L} \right] h_{tot}[i] e^{-j2\pi n i / N_1} \\
 &= N_1 \sum_{i=-\infty}^{\infty} \left[\sum_{m=0}^{L-1} x_{mN_1+n} e^{j2\pi i' m / L} \right] h_{tot}[i] e^{-j2\pi n i / N_1} \\
 &= N_1 \sum_{l=-\infty}^{\infty} \sum_{i'=0}^{L-1} \left[\sum_{m=0}^{L-1} x_{mN_1+n} e^{j2\pi i' m / L} \right] h_{tot}[lL - i'] e^{-j2\pi n (lL - i') / N} \\
 &= N_1 \sum_{m=0}^{L-1} x_{mN_1+n} \sum_{i'=0}^{L-1} e^{j2\pi i' m / L} \sum_{l=-\infty}^{\infty} h_{tot}[lL - i'] e^{-j2\pi n (lL - i') / N}
 \end{aligned}$$

Since

$$\begin{aligned}
 \sum_{l=-\infty}^{\infty} h_{tot}[lL - i'] e^{-j2\pi n (lL - i') / N} &= \sum_{l=-\infty}^{\infty} h_{tot}[lL - i'] e^{-j\omega (lL - i') T_c} \Big|_{\omega=2\pi n / NT_c} \\
 &= F \left\{ h_{tot}(t) \sum_l \delta(t - [lL - i'] T_c) \right\} \Big|_{\omega=2\pi n / NT_c} \\
 &= \frac{1}{2\pi} \mathcal{F}_{tot}(\omega) \otimes \left[\frac{2\pi}{LT_c} \sum_l \delta(\omega - \frac{2\pi l}{LT_c}) e^{j2\pi l i' / L} \right] \Big|_{\omega=2\pi n / NT_c} \\
 &= \frac{1}{LT_c} \sum_l \mathcal{F}_{tot}(\frac{2\pi n}{NT_c} - \frac{2\pi l}{LT_c}) e^{j2\pi l i' / L}
 \end{aligned}$$

we have

$$\begin{aligned}
 q_n &= N_1 \sum_{m=0}^{L-1} x_{mN_1+n} \sum_{i'=0}^{L-1} e^{j2\pi i' m / L} \sum_{l=-\infty}^{\infty} h_{tot}[lL - i'] e^{-j2\pi n (lL - i') / N} \\
 &= N_1 \sum_{m=0}^{L-1} x_{mN_1+n} \sum_{i'=0}^{L-1} e^{j2\pi i' m / L} \frac{1}{LT_c} \sum_l \mathbf{H}_{tot}(\frac{2\pi n}{NT_c} - \frac{2\pi l}{LT_c}) e^{j2\pi l i' / L} \\
 &= \frac{N_1}{LT_c} \sum_{m=0}^{L-1} x_{mN_1+n} \sum_l \mathbf{H}_{tot}(\frac{2\pi n}{NT_c} - \frac{2\pi l}{LT_c}) \sum_{i'=0}^{L-1} e^{j2\pi (l+m) i' / L} \\
 &= \frac{N_1}{T_c} \sum_{m=0}^{L-1} x_{mN_1+n} \mathbf{H}_{tot}(\frac{2\pi n}{NT_c} + \frac{2\pi m}{LT_c}) \\
 &= \frac{N_1}{T_c} \sum_{m=0}^{L-1} x_{mN_1+n} \mathbf{H}_{tot}(\frac{2\pi}{NT_c} (mN_1 + n)), \quad n = 0, \dots, N_1 - 1 \\
 &= N_1 \sum_{m=0}^{L-1} x_{mN_1+n} \mathbf{H}_{tot}[mN_1 + n], \quad n = 0, \dots, N_1 - 1
 \end{aligned}$$

where

$$\mathbf{H}_{tot}[n] = \frac{1}{T_c} \mathbf{H}_{tot}(\frac{2\pi}{NT_c} n), \quad \text{for } 0 \leq n < N$$

Relationship between q_n and x_n

As shown in Fig. 1G if $H_{tot}[n]$ is a bandpass filter and nonzero only in the intervals $[k(N/2L), (k+1)(N/2L)]$ and $[(2L-k-1)(N/2L), (2L-k)(N/2L)]$, where $0 \leq k < L$, the possible values of m that

5

$$H_{tot}[m(N/L) + n]$$

10 is nonzero for $0 \leq n < (N/L)$ are as follows.

Even k

If k is even, we can have $m=k/2$ and $0 \leq n < (N/2L)$ so that

15

$$H_{tot}[m(N/L) + n]$$

20

is nonzero over the interval $[k(N/2L), (k+1)(N/2L)]$, and $m=(L-1)-k/2$ and $(N/2L) \leq n < (N/L)$ so that

$$H_{tot}[m(N/L) + n]$$

25

is nonzero over the interval $[(2L-k-1)(N/2L), (2L-k)(N/2L)]$.

Odd k

30 If k is odd, we can have $m=(k-1)/2$ and $(N/2L) \leq n < (N/L)$ so that

$$H_{tot}[m(N/L) + n]$$

35

is nonzero over the interval $[k(N/2L), (k+1)(N/2L)]$, and $m=L-(k-1)/2$ and $0 \leq n < (N/2L)$ so that

$$H_{tot}[m(N/L) + n]$$

40

is nonzero over the interval $[(2L-k-1)(N/2L), (2L-k)(N/2L)]$.

The above discussion is illustrated in Fig. 1G for $L = 3$.

In another variation that can be used in the present invention, similar advantages to those obtained by limiting bandwidth in the received signal in the downstream transceiver can be obtained by also optionally limiting the upstream data rate of the transceiver as well. In other words, the ADSL standard provides for 31 channels in the upstream direction, but many applications do not require this amount of bandwidth. The constraints, requirements and costs associated with the DMT modulation signal processing, and DAC 330 also can be significantly reduced by transmitting only a sub-set of the available 31 sub-channels. The determination of the appropriate sub-channels would be accomplished in essentially the same manner as set forth above, except that the information on upstream sub-channel SNR usually must be determined by the upstream transceiver, and then fed back to the downstream transceiver. To save time and overhead complexity, and given the fact that there is less variation in bit capacity in sub-channels in this frequency band, one approach also would be to simply select a fixed sub-set of such sub-channels-without regard to their actual performance characteristics. In a software modem environment, Control/Application software 500 would provide a user with selectable control to effectuate a restricted upstream transmission on limited sub-channels. Again, with respect to the ADSL standard, the only requirement in this respect is that the upstream pilot tone must also be transmitted to establish a valid data link. An optional limited "upstream" transmission can be effectuated in a variety of ways by the circuitry already described above in connection with Figs. 2 and 3. The exact details of such implementation will be appar-

ent to those of skill in the art given the present teachings.

Although the present invention has been described in terms of a preferred ADSL embodiment, it will be apparent to those skilled in the art that many alterations and modifications may be made to such embodiments without departing from the teachings of the present invention. For example, it is apparent that the present invention would be beneficial used in any xDSL or high speed multi-carrier application environment. Other types of VLSI and ULSI components beyond those illustrated in the foregoing detailed description can be used suitably with the present invention. Accordingly, it is intended that the all such alterations and modifications be included within the scope and spirit of the invention as defined by the following claims.

10 **Claims**

1. A high speed communications system capable of supporting a downstream data transmission from a upstream transceiver using a analog signal consisting of M data carrying signals contained within a bandwidth F, said system comprising:
 - 15 a channel interface circuit for coupling to and receiving said analog signal; and
 - a front end receiving circuit for processing the analog signal and converting it to a digital signal;
 - a processing circuit for extracting N data carrying signals ($N < M$) from the digital signal using a first frequency portion f1 of the digital signal ($f1 < F$).
- 20 2. The system of claim 1, wherein the N data carrying signals are selected by the processing circuit based so as to minimize the amount of processing required to extract the selected data from the digital signal.
3. The system of claim 2, wherein the N data carrying signals can be selected during a initialization process setting up a data link to the upstream transceiver.
4. The system of claim 3, wherein M data carrying signals can be sent by the upstream transmitter during a initialization process, and thereafter, only N data carrying signals are sent.
- 30 5. The system of claim 1, wherein the front end circuit includes: (i) a sub-band filter for passing the first frequency bandwidth portion f1 of said bandwidth F; (ii) and an analog to digital converter.
6. The system of claim 1, wherein the selected data further includes data obtained from an additional second frequency bandwidth portion f2 of said bandwidth F, so that an additional number of data carrying signals P from the M data carrying signals ($N+P < M$) can be processed.
- 35 7. The system of claim 6, further including one or more sub-band filters for passing the first frequency bandwidth portion f1 and second frequency bandwidth portion f2 of said bandwidth F and an analog to digital converter.
- 40 8. The system of claim 7, wherein a target data rate of the system can be increased by processing an additional number of data carrying signals P from the M data carrying signals, where $N+P < M$.
9. The system of claim 1, wherein the selected data to be extracted from the bandpassed data can be controlled by a user of such system.
- 45 10. The system of claim 9, wherein a user of such system can increase a target data rate of the system by modularly augmenting the front end circuit to include additional bandwidth and analog to digital conversion capacity such that an additional number of data carrying signals P from the M data carrying signals ($N+P < M$) can be processed.
- 50 11. The system of claim 1, further including a front end transmitting circuit for transmitting control information to cause said upstream transceiver to transmit downstream data only using the N data carrying signals.
12. The system of claim 11, wherein the control information transmitted to the upstream transceiver includes feedback information indicating that only N of the M data carrying signals are desirable for downstream data transmission, even during times when said channel is capable of supporting more than N data carrying signals.
- 55 13. The system of claim 12, wherein the control information transmitted to the upstream transceiver further includes feedback information indicating that: (i) the system can support any data protocols used by said upstream trans-

ceiver; and (ii) that they are connected through a channel with substantial signal attenuation characteristics for data signals other than the N data carrying signals.

- 5 14. The system of claim 1, further including a front end transmitting circuit for transmitting an upstream data signal using a second frequency bandwidth F2 different from F, and L data carrying signals, and where $L < M$.
15. A high speed communications system for processing an analog data signal from a channel capable of supporting M modulated sub-channels, said system comprising:
- 10 a channel interface circuit for coupling to and receiving said analog data signal from the channel;
- a analog front end circuit for processing the analog data signal and converting it to a digital signal;
- 15 a processing circuit for extracting data from the digital signal, the digital signal including data taken from a number N of said sub-channels, where N is intentionally selected to have a value less than M and where N is negotiated with an upstream transceiver during a initialization procedure.
16. The system of claim 15, where the N sub-channels are initially loaded with bit capacities that are left essentially unchanged unless said channel characteristics vary.
- 20 17. The system of claim 15, wherein the selection of the N sub-channels can be done during the initialization procedure.
18. The system of claim 15, wherein the value of N is based on signal processing capability of the processing circuit.
- 25 19. The system of claim 15, wherein a target data rate of the system can be increased by processing a additional number of sub-channels P from the M sub-channels, and where $N+P < M$.
- 30 20. The system of claim 15 further including a front end transmitting circuit for transmitting control information to cause said upstream diver to transmit downstream data only using the N sub-channels.
- 35 21. The system of claim 15, wherein the upstream transceiver uses discrete multi-tone (DMT) modulation for generating the M modulated sub-channels, and the channel supports asymmetric digital subscriber loop (ADSL) transmission standards.
- 40 22. A high speed communications system for processing an analog data signal from a channel capable of supporting M modulated sub-channels, said system comprising:
- a channel interface circuit for coupling to and receiving said analog data signal from the channel;
- 45 an analog front end circuit for processing the analog data signal and converting it to a digital signal;
- a bus interface circuit for transmitting the digital signal to a host processing device, and for receiving a transmission control signal from the host processing device to cause said upstream transmitter to transmit using only from a number N of said sub-channels, where N is intentionally selected to have a value less than M, and where N is negotiated with a upstream transceiver during a initialization procedure.
- 50 23. The system of claim 22, wherein the value of N is based on signal processing capability of the host processing device.
- 55 24. The system of claim 22, wherein a data rate of the system can be increased by processing an additional number of sub-channels P from the M sub-channels, and where $N+P < M$.
25. The system of claim 22, wherein the upstream transceiver uses discrete multi-tone (DMT) modulation for generating the M modulated sub-channels, and the channel supports asymmetric digital subscriber loop (ADSL) transmission standards.
26. A method of processing a xDSL signal from a digital subscriber loop, said method including the steps of:

negotiating a reduced data rate R' for said signal between a downstream and a upstream transceiver; and

thereafter transmitting said xDSL signal from the upstream transceiver to the downstream transceiver utilizing a number of sub-channels N to effectuate the reduced data rate R', where N is intentionally selected to be less than a maximum number of sub-channels M supported by said digital subscriber loop; wherein the number of sub-channels N is based on signal processing capability available to the downstream transceiver.

5
27. The method of claim 26, wherein the data rate of the system can be increased by processing an additional number of sub-channels P from the M sub-channels, and where $N+P < M$.

10
28. The method of claim 26, wherein the upstream transceiver uses discrete multi-tone (DMT) modulation for generating the M sub-channels.

15
29. The method of claim 26, wherein the reduced data rate R' can be specified by a user operating the downstream transceiver.

20
30. A high speed communications data receiver for communicating through a channel at a data rate X with an upstream transmitter capable of transmitting a data stream at a rate Y ($X < Y$), the receiver comprising:

a channel interface circuit for coupling to and receiving said data stream; and
an analog front end circuit for data sampling the analog signal and converting it to a digital signal; and

25
a processing circuit for extracting selected data from the digital signal, and for generating a transmission control signal for causing said upstream transmitter to transmit at a data rate substantially equal to said data rate X during a data stream transmission; and

wherein data sampling requirements of the analog front end circuit and extracting of the processing circuit are reduced because data sampling and extracting is only performed for a fractional portion of the data stream.

30
31. The system of claim 30, wherein the analog front end circuit further includes one or more sub-band filters for filtering the analog data signal to generate the fractional portion of the data stream that requires data sampling and extracting.

35
32. The system of claim 30, further including a front end transmitting circuit for transmitting the transmission control signal from the processing circuit to cause said upstream transceiver to transmit downstream data only at said data rate X.

40
33. The system of claim 32, wherein the control information transmitted to the upstream transceiver includes feedback information indicating that the maximum downstream data transmission data rate is X, even during times when said channel is capable of supporting more than said data rate X.

34. The system of claim 30, further including a front end transmitting circuit for transmitting an upstream data transmission using a data rate Z, where $Z < Y$.

45
35. The system of claim 30, wherein the ratio of X to Y is approximately .5 or less, and this ratio can be increased through modular additions to the analog front end circuit.

50
36. A high speed communications data receiver for communicating through a channel with an upstream transmitter that is capable of transmitting a data signal with a particular frame rate T and data rate Y, the receiver comprising:

a channel interface circuit for coupling to and receiving said data signal; and
an analog front end circuit for sampling the data signal and converting it to a digital signal; and

55
a processing circuit that: (i) is configurable for processing the digital signal at a data rate $\leq X$ and using said frame rate T, where X is determined for such processing circuit prior to initialization of a data transmission and $X < Y/2$; (ii) generates a transmission control signal for causing said upstream transmitter to transmit at a data rate no greater than X during a data transmission;

wherein signal processing requirements for the processing circuit are reduced because processing is only performed at a fractional rate of the available data rate of said transmission protocol.

37. The system of claim 36, wherein the control information transmitted to the upstream transceiver includes feedback information indicating that the maximum downstream data transmission data rate is X, even during times when said channel is capable of supporting more than said data rate X.
- 5 38. The system of claim 36, wherein the feedback information including the data rate X can be controlled by a user of such system.
39. The system of claim 36, wherein the ratio of X to Y is approximately .2 or less.
- 10 40. A high speed communications system for transmitting digital information in a channel capable of supporting a transmission bandwidth F, said system comprising:
- an upstream data transceiver capable of modulating the digital information to generate an analog data signal data transmission using said transmission bandwidth F; and
- 15 a downstream data transceiver channel interface circuit for coupling to and receiving said analog data signal from the upstream data transceiver through said channel, the downstream data transceiver including:
- (i) a front end receiving circuit for processing the analog data signal and converting it to a digital signal; and
- 20 (ii) a processing circuit for demodulating the digital signal, the digital signal including data from a first frequency bandwidth portion f1 of said bandwidth and for generating feedback information indicating to the upstream transceiver that the bandwidth other than f1 is unsuitable for data transmission; and
- (iii) a front end transmitting circuit for transmitting the feedback information using a second frequency bandwidth portion f2 to cause said upstream transceiver to transmit downstream data only using the first frequency portion f1.
- 25 41. The system of claim 40, wherein the ratio of f1 to F is approximately .5 or less, and this ratio can be increased through modular additions to the front end receiving circuit.
42. The system of claim 40, wherein the feedback information contains intentionally altered channel characteristic information.
- 30 43. The system of claim 41, wherein the feedback information, including the size and location of first frequency portion f1, can be controlled by a user of such system.
- 35 44. A high speed communications data receiver for communicating through a channel at a controllable data rate X with an upstream transmitter capable of transmitting a data signal at a frame rate T, and a data rate Y, where $X/Y < 1/2$, the receiver comprising:
- a channel interface circuit for coupling to and receiving said analog data signal; and
- 40 an analog front end circuit for data sampling the analog signal and converting it to a digital signal; and
- a processing circuit for determining said rate X based on processing capabilities available for extracting data from the digital signal, and for generating a transmission control signal for causing said upstream transmitter to transmit using said frame rate T, and a data rate substantially equal to said data rate X during a data transmission.
- 45 45. The receiver of claim 44, wherein said rate X is determined during a calibration routine.
46. The receiver of claim 45, wherein said calibration routine is executed by a host data processor to determine the capabilities of such processor.
- 50 47. The receiver of claim 44, wherein said rate X is configurable by a user of such receiver based on performance characteristics of a host processor comprising a portion of the processing circuit.
48. The receiver of claim 44, wherein X/Y is approximately .5 or less.
- 55 49. A method for communicating through a channel with an upstream transmitter that is capable of transmitting a data signal at a frame rate T, and a data rate Y, the method comprising the steps of:

- receiving said data signal; and
 sampling the data signal and converting it to a digital signal; and
 processing the digital signal at a data rate $\leq X$ and using said frame rate T, where X is determined prior to initialization of a data transmission and $X < Y/2$; and
 5 generating a transmission control signal for causing said upstream transmitter to transmit at a data rate no greater than X during a data transmission.
50. The method of claim 49, wherein the control information transmitted to the upstream transceiver includes feedback information indicating that the maximum downstream data transmission data rate is X, even during times when said
 10 channel is capable of supporting more than said data rate X.
51. The method of claim 49, wherein the feedback information including the data rate X can be controlled by a user of such system.
- 15 52. The method of claim 49, wherein said rate X is determined during a calibration routine.
53. The method of claim 49, wherein said rate X is configurable by a user of such receiver based on performance characteristics of a host processor comprising a portion of the processing circuit.
- 20 54. A method of operating a high speed communications system that is coupled through a channel to an upstream transceiver operating at a maximum data rate Y using a bandwidth F, said method comprising:
- (a) receiving an analog initialization signal having a bandwidth F from the upstream transceiver through the channel; and
 25 (b) generating a digital signal based on sampling a portion of the analog data transmission signal corresponding to a first frequency bandwidth portion f_1 , where $f_1 < F$; and
 (c) processing the digital signal to extract data from the digital signal such that an effective receiving rate X (where $X < Y$) is achieved by the system;
 (d) generating feedback information pertaining to the channel transmission characteristics indicating to the
 30 upstream transceiver that data rates higher than X should not be used;
 (e) thereafter receiving an analog data signal transmitted by the upstream transceiver to have a bandwidth f_1 ;
 (f) repeating steps (b) and (c).
55. The method of claim 54, further including a step prior to step (a): receiving a control signal from a user of such system for determining the effective receiving rate X.
- 35 56. The method of claim 54, further including a step: determining an optimal bandwidth portion f_1 so as to minimize the amount of processing required to extract the data from the digital signal at the receiving rate X.
- 40 57. A high speed communications transceiver for communicating with an upstream transceiver transmitting an analog data transmission signal using M data carrying signals within a bandwidth F through a channel to said system, said transceiver comprising:
- a channel interface circuit for coupling to and receiving said analog data signal from the channel; and
 45 a front end receiving circuit for sampling the analog data signal and generating a digital signal based on such analog data signal, the digital signal including data from a first frequency bandwidth portion f_1 of said bandwidth F containing N data carrying signals, where $N < M$; and
 a bus interface circuit for transmitting the digital signal to a host processing device; and
 wherein the system's performance, including data rate, can be scaled based on modifications to said front end
 50 receiving circuit or said host processing device so that a the sampling of the analog data signal can be increased, and the first frequency bandwidth portion f_1 can also be expanded.
58. The system of claim 57, wherein the front end receiving circuit includes a filter for passing the first frequency bandwidth portion f_1 of said bandwidth F; (ii) and an analog to digital converter.
- 55 59. The system of claim 58, wherein when the modifications include additional bandpass filters for increasing the first frequency bandwidth portion from f_1 to f_2 , where $F > f_2 > f_1$, the number of data carrying signals is increased from N to $N+P$, where $P = f_2/f_1 * N$, and $N+P < M$.

EP 0 889 615 A2

60. The system of claim 57, wherein the modifications include adding an additional number of front end circuits k in the system each with a bandpass frequency f_1 to result in $N \cdot k$ data carrying signals being included within the digital signal.
- 5 61. The system of claim 57, wherein the first frequency bandwidth portion f_1 is programmable.
62. The system of claim 57, further including a front end transmitting circuit for transmitting control information to cause said upstream transceiver to transmit downstream data only using the N data carrying signals.
- 10 63. The system of claim 62, wherein the control information transmitted to the upstream transceiver includes feedback information from the host processing device indicating to the upstream transceiver that only N of the M data carrying signals are desirable for downstream data transmission, even if said channel is capable of supporting more than N data carrying signals.
- 15 64. The system of claim 63, wherein the front end transmitting circuit transmits an upstream data transmission using a second frequency bandwidth F_2 and L upstream data carrying signals, and where $L < M$.
65. The system of claim 57, further including a host processor circuit in the host processing device for extracting selected data from the N data carrying signals.
- 20 66. The system of claim 65, wherein host processor circuit includes a host microprocessor, a programmable memory coupled to the microprocessor, and a data extraction routine located in the memory which can be executed by the microprocessor.
- 25 67. The system of claim 66, wherein the modifications include upgrading said host processing circuit to include additional signal processing power for processing an additional number of data carrying signals.
68. A method of operating a high speed interface between an upstream transceiver and a host processing device at a target data rate, said method comprising:
- 30 (a) receiving an analog initialization signal having a bandwidth F from the upstream transceiver through a communications channel; and
(b) generating a digital signal based on sampling a portion of the analog initialization signal corresponding to a first frequency bandpass portion f_1 ;
- 35 (c) transmitting the digital signal to said host processing device so that characteristics of data carrying signals contained within first frequency bandpass portion f_1 can be determined, and a number of such data carrying signals can be configured for use by said host processing device to achieve said target data rate; and
(e) generating feedback information indicating to the upstream transceiver that bandwidth other than the first frequency bandpass f_1 should not be used for data transmission; and
- 40 (f) receiving an analog data transmission signal having a bandwidth f_1 from said upstream transceiver; and
(g) generating a digital signal based on sampling the analog data transmission signal; and
(h) transmitting the digital signal to the host processing device so that it can be processed to extract selected data from the data carrying signals;
- 45 (i) when a data rate increase is required, expanding the first frequency bandpass portion f_1 and returning to step (a).
69. The method of claim 68, further including a step of: determining an optimal size and location of first frequency bandpass portion f_1 so as to minimize the amount of processing required by said host processing device to extract the data from the digital signal.
- 50 70. The method of claim 68, wherein the ratio of f_1 to F is approximately .5 or less, and a data rate of such interface is controlled by controlling this ratio.
71. The method of claim 68 wherein the analog data transmission is comprised of M modulated sub-channels within bandwidth F , and the selected data is contained in N of the M sub-channels within first selected frequency bandpass portion f_1 , where $N < M$.
- 55 72. The method of claim 68, further including a step: determining an optimal set of N sub-channels so as to minimize

EP 0 889 615 A2

the amount of processing required to extract the data from the digital signal.

5 73. The method of claim 68, further including a step wherein protocol information pertaining to standards applicable to Asymmetric Digital Subscriber Loops is transmitted by the upstream data transceiver so as to set up a ADSL compatible data link.

10 74. The method of claim 68, wherein during step (i) the first frequency bandpass portion f_1 is increased by the use of additional bandpass filters for increasing the first frequency bandwidth portion from f_1 to f_2 , where $F > f_2 > f_1$, so that the selected data is received at an increased rate equal to approximately f_2/f_1 .

15

20

25

30

35

40

45

50

55

FIGURE 1

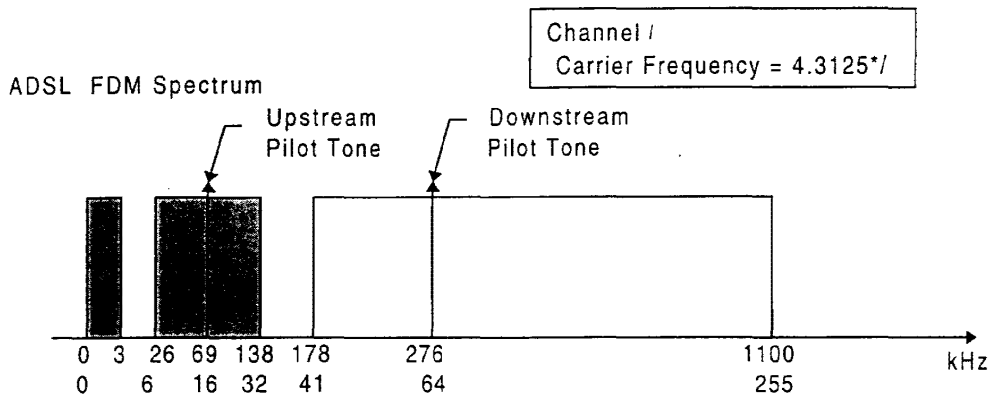

FIGURE 1B

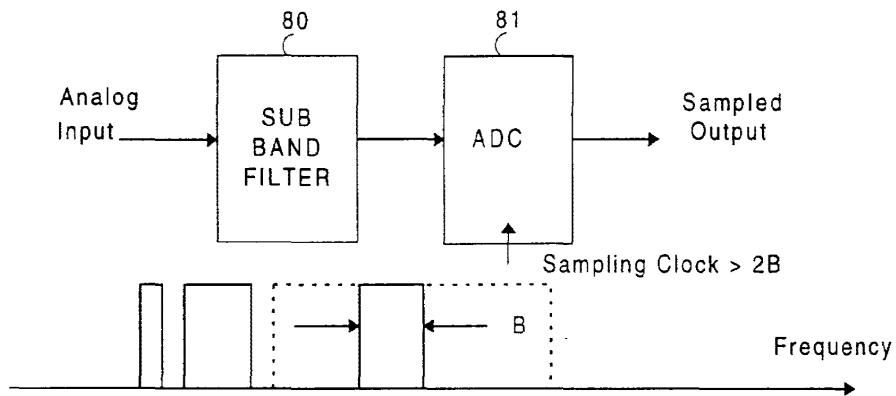

FIGURE 1C

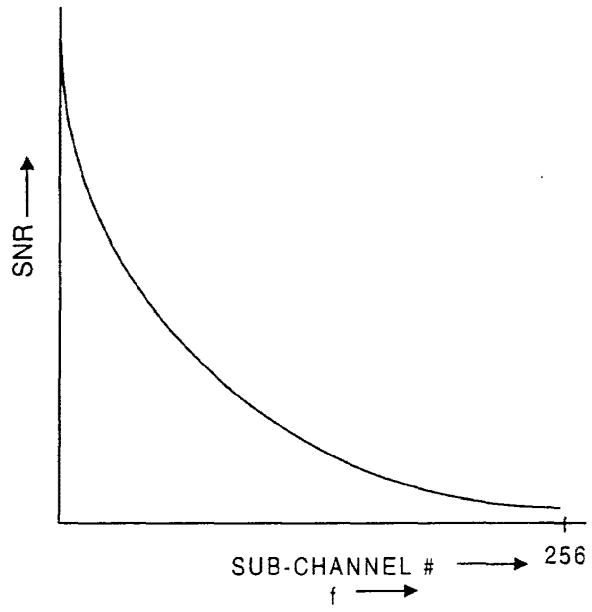

FIGURE 1D

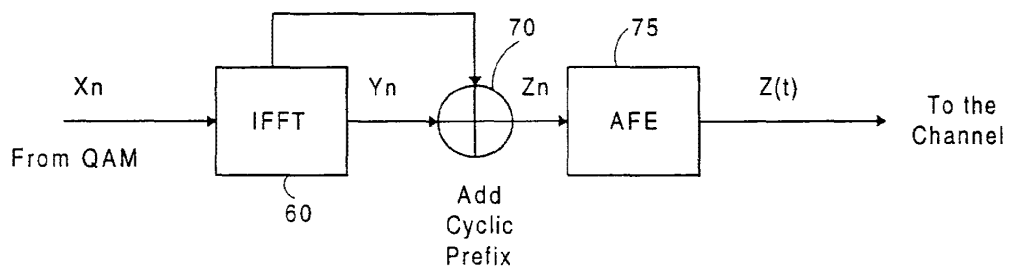

FIGURE 1E

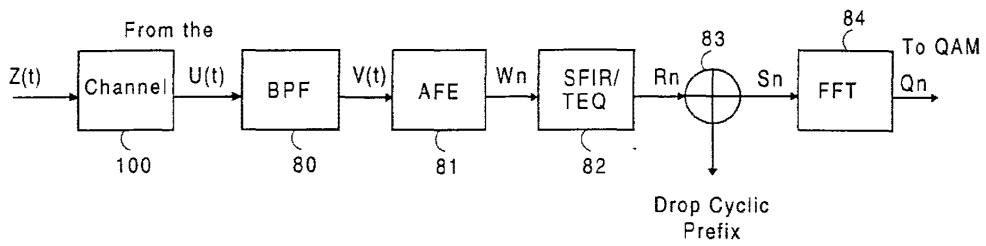

FIGURE 1F

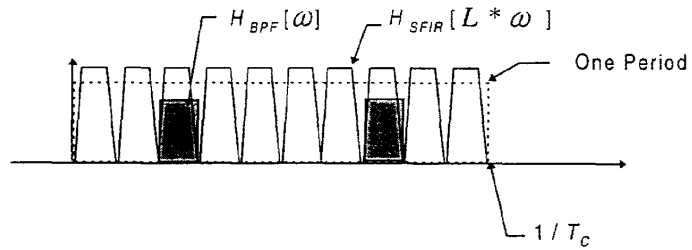

FIGURE 1G

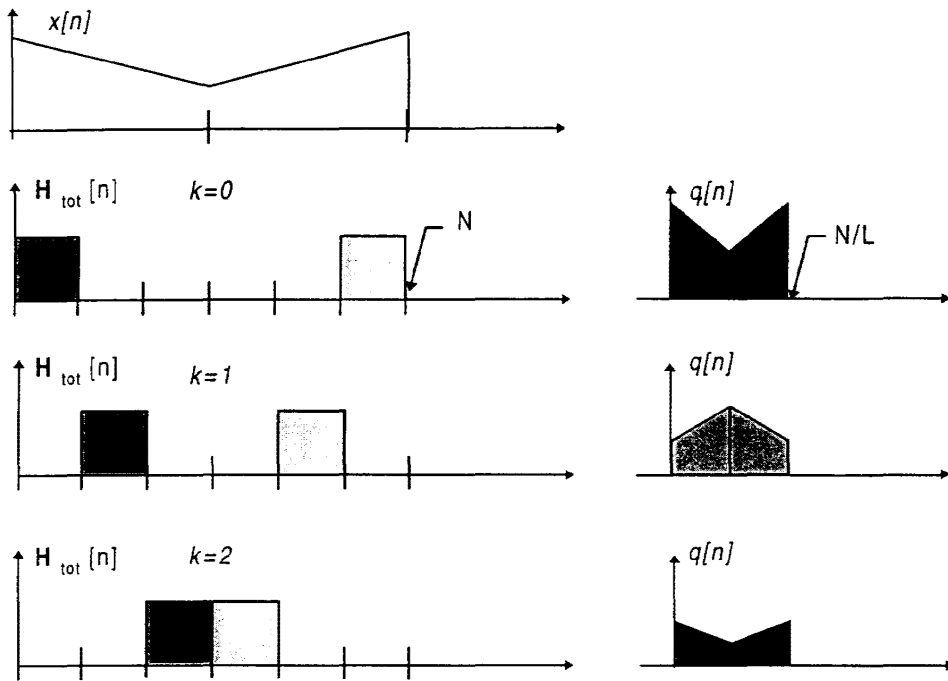

FIGURE 2

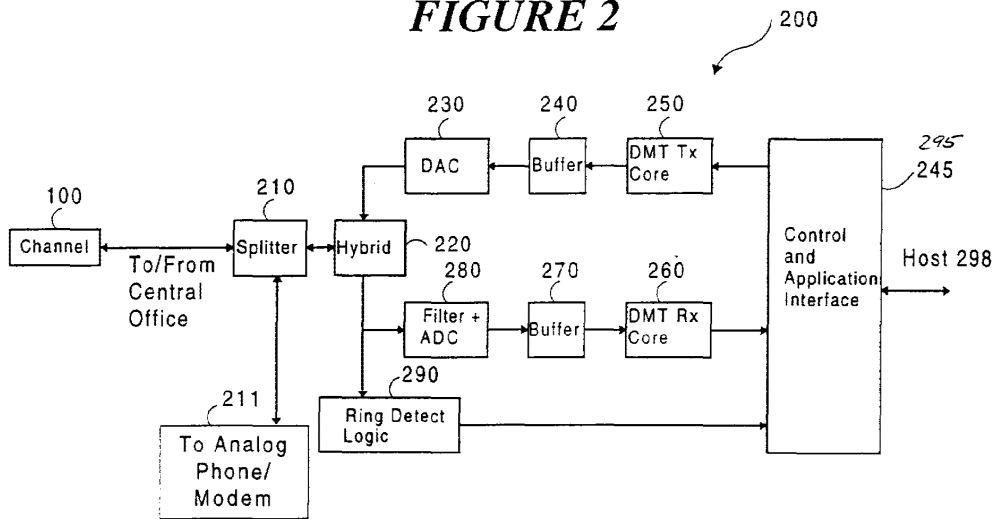

FIGURE 3A

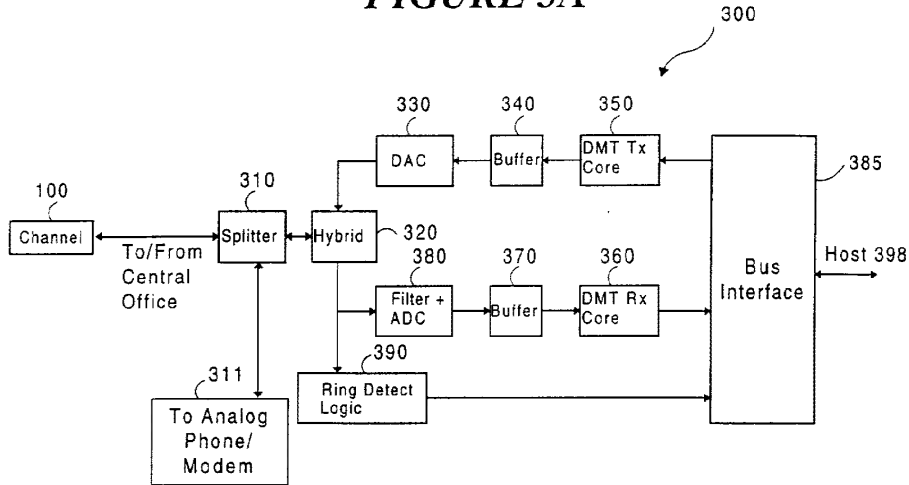

FIGURE 3B

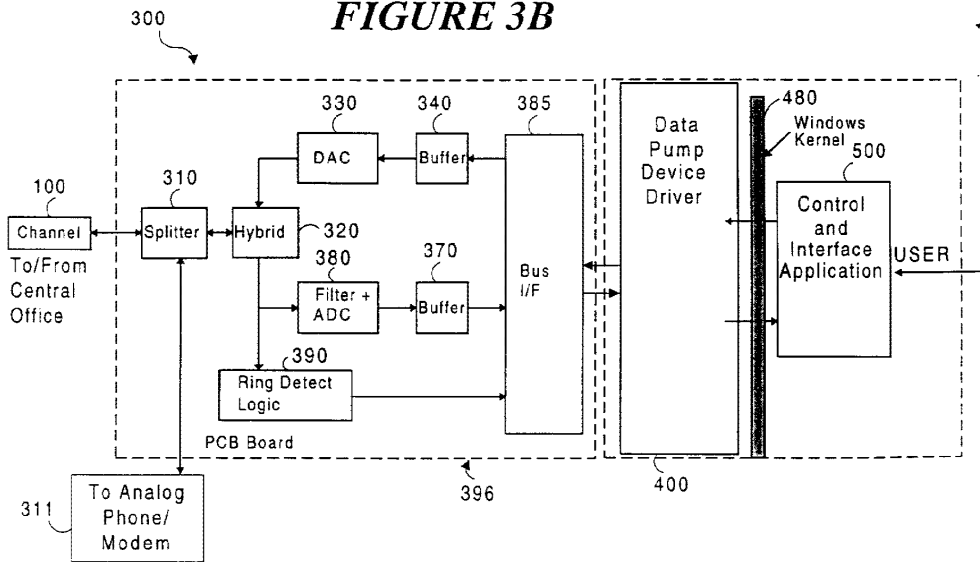

FIGURE 4

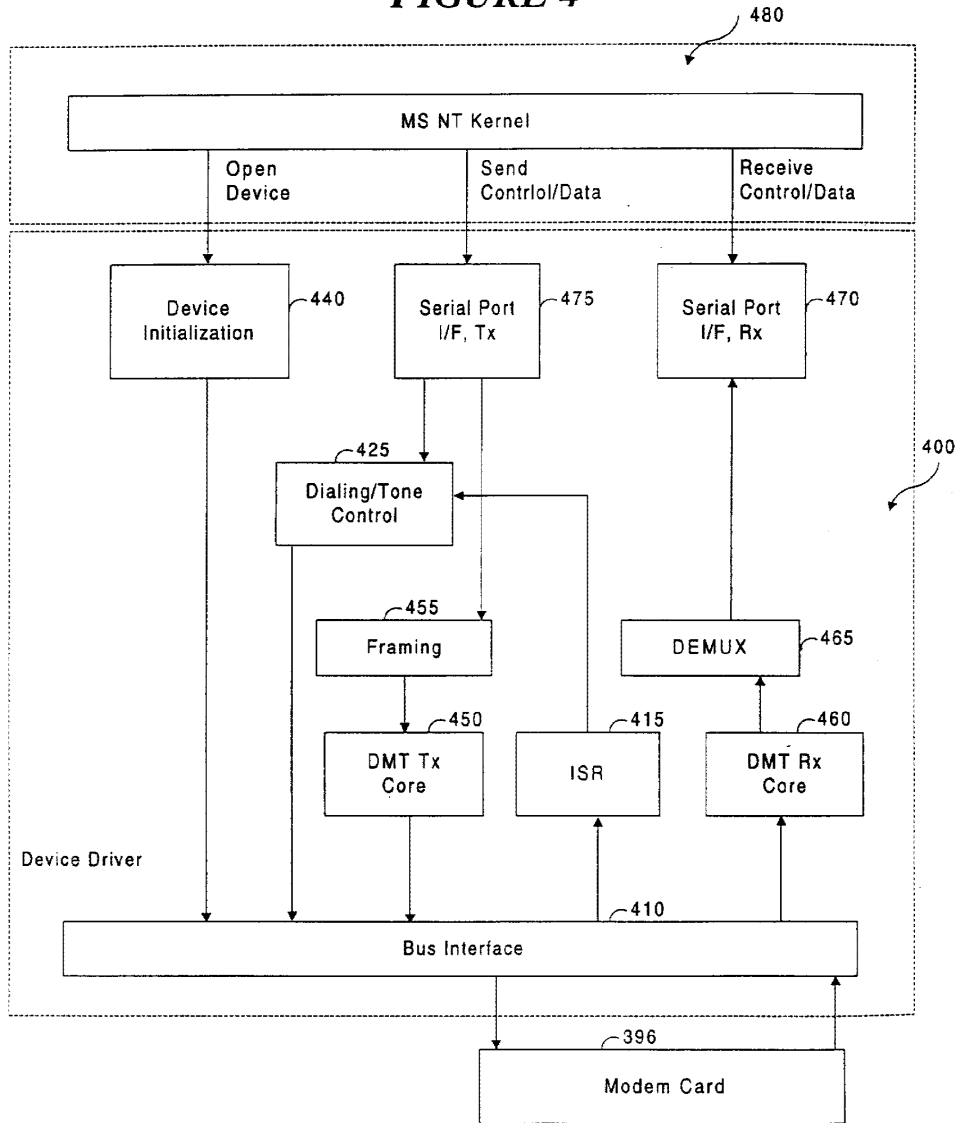

FIGURE 5

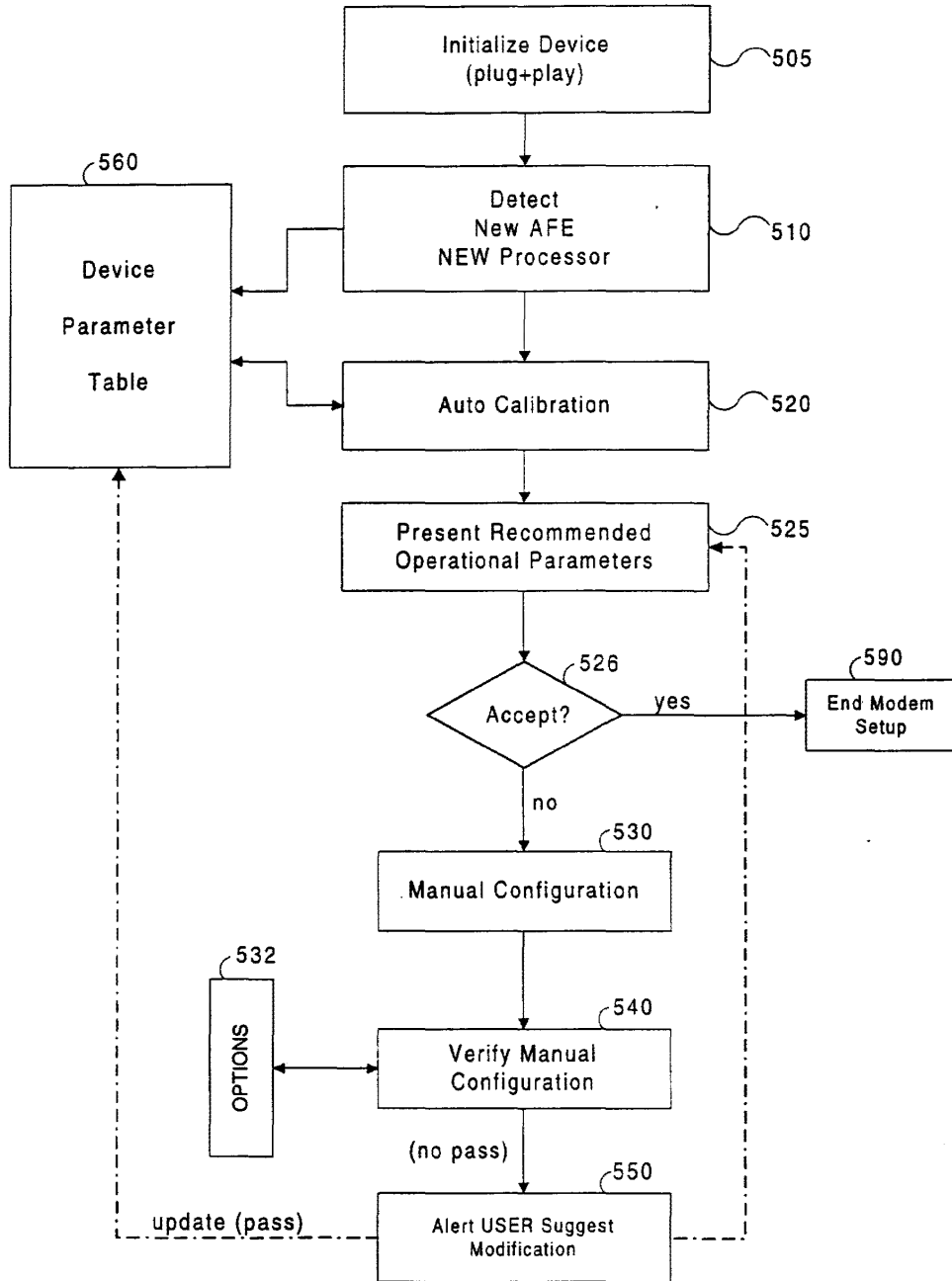
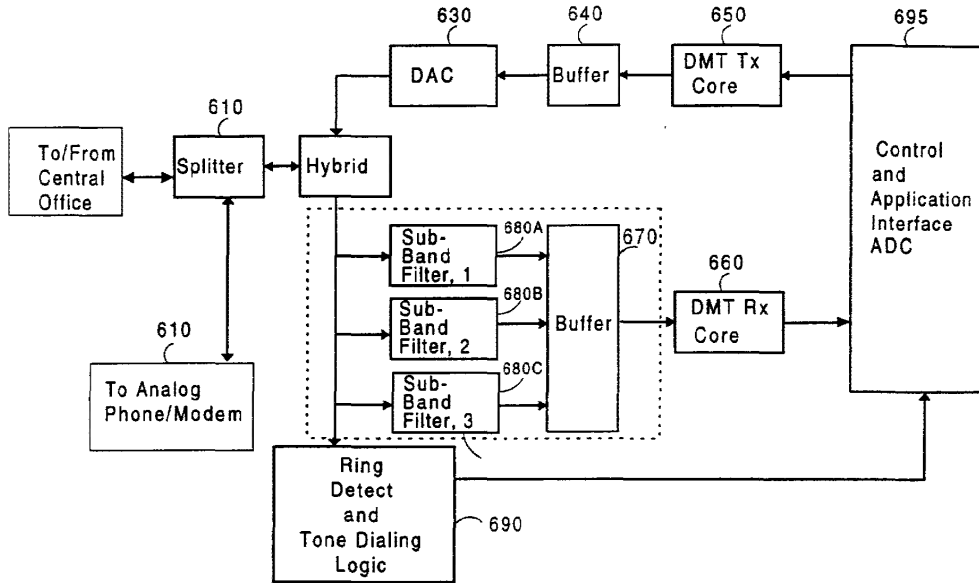

FIGURE 6



(12) **UK Patent Application** (19) **GB** (11) **2 303 032** (13) **A**

(43) Date of A Publication **05.02.1997**

(21) Application No **9613602.3**

(22) Date of Filing **28.06.1996**

(30) Priority Data

(31) **95019065** (32) **30.06.1995** (33) **KR**

(71) Applicant(s)

Samsung Electronics Co Limited

(Incorporated in the Republic of Korea)

**416 Maetan-dong, Paldal-gu, Suwon-City, Kyungki-do,
Republic of Korea**

(72) Inventor(s)

You-sik Chun

(74) Agent and/or Address for Service

**Elkington and Fife
Prospect House, 8 Pembroke Road, SEVENOAKS,
Kent, TN13 1XR, United Kingdom**

(51) INT CL⁶

H04L 5/06

(52) UK CL (Edition O)

H4P PAQ

(56) Documents Cited

None

(58) Field of Search

UK CL (Edition O) H4P PAL PAQ PEM

INT CL⁶ H04L 5/06 27/34

ONLINE:WPI

(54) **Adaptive bit swapping between channels of a discrete multitone system**

(57) An adaptive bit swapping method and device are provided. The method includes the steps of (a) initializing (200) the DMT system to transmit the data via the channel in a steady state; (b) selecting (204) a frame (400) having an inserted sync block from a frame structure of the transmitted data; (c) calculating (210) the signal-to-noise ratios (SNRs) of respective sub-channels of the selected frame; (d) calculating (214) a first difference value between the present representative SNRs calculated in step (c) and the previous representative SNRs of each sub-channel; (e) selecting (216) a maximum value and minimum value among the first difference values of the respective sub-channels; (f) obtaining a second difference value being a difference between the maximum value and the minimum value; (g) determining (218) whether the second difference value is equal to or greater than the predetermined threshold value; and (h) correcting (220) bit and power assigning tables of a transmitter and a receiver if the second difference value is greater than or equal to the threshold value. In addition, the bit and power assigning tables can be corrected accurately since bits and power are swapped using an actually measured SNR.

FIG. 3

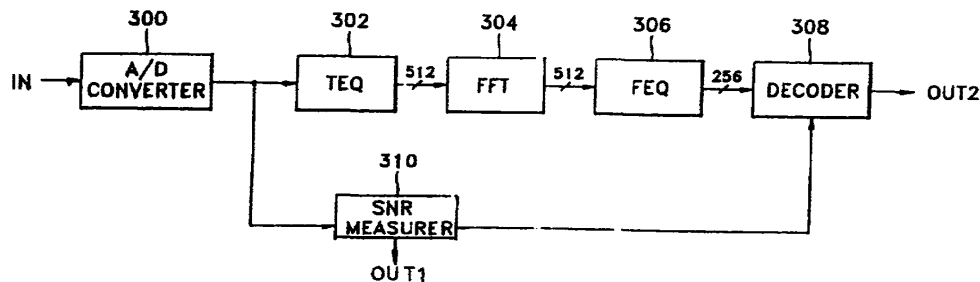

GB 2 303 032 A

FIG. 1 (PRIOR ART)

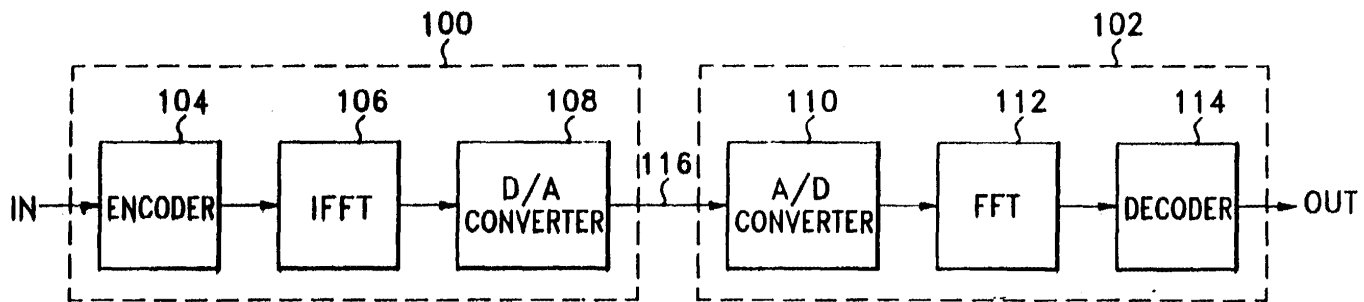

FIG. 2

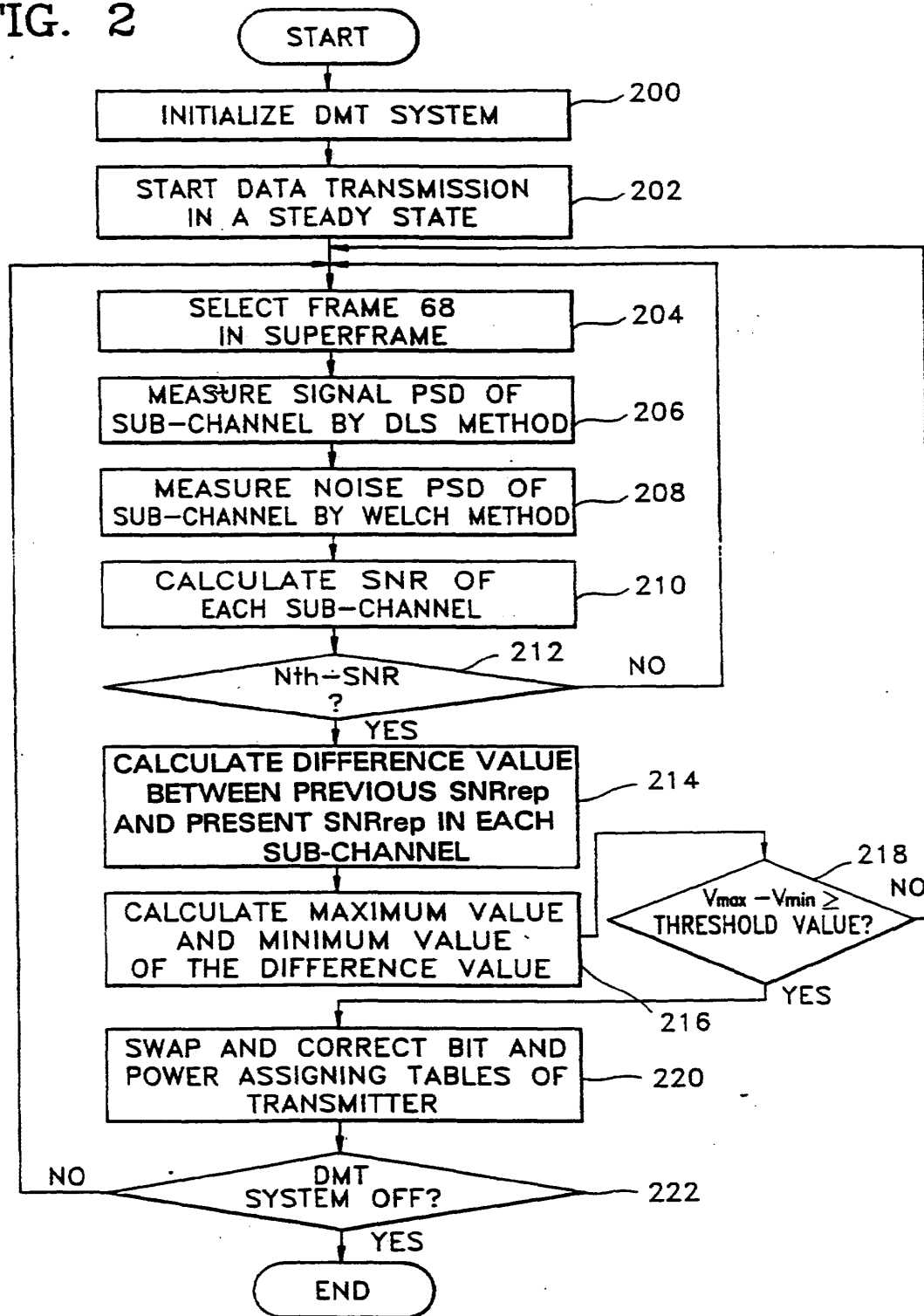

FIG. 3

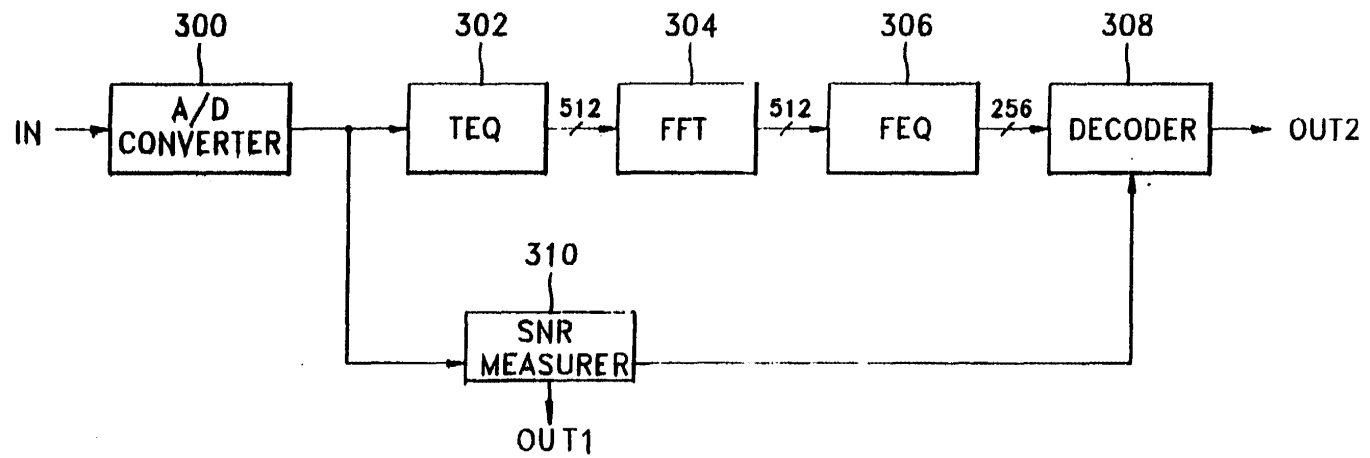
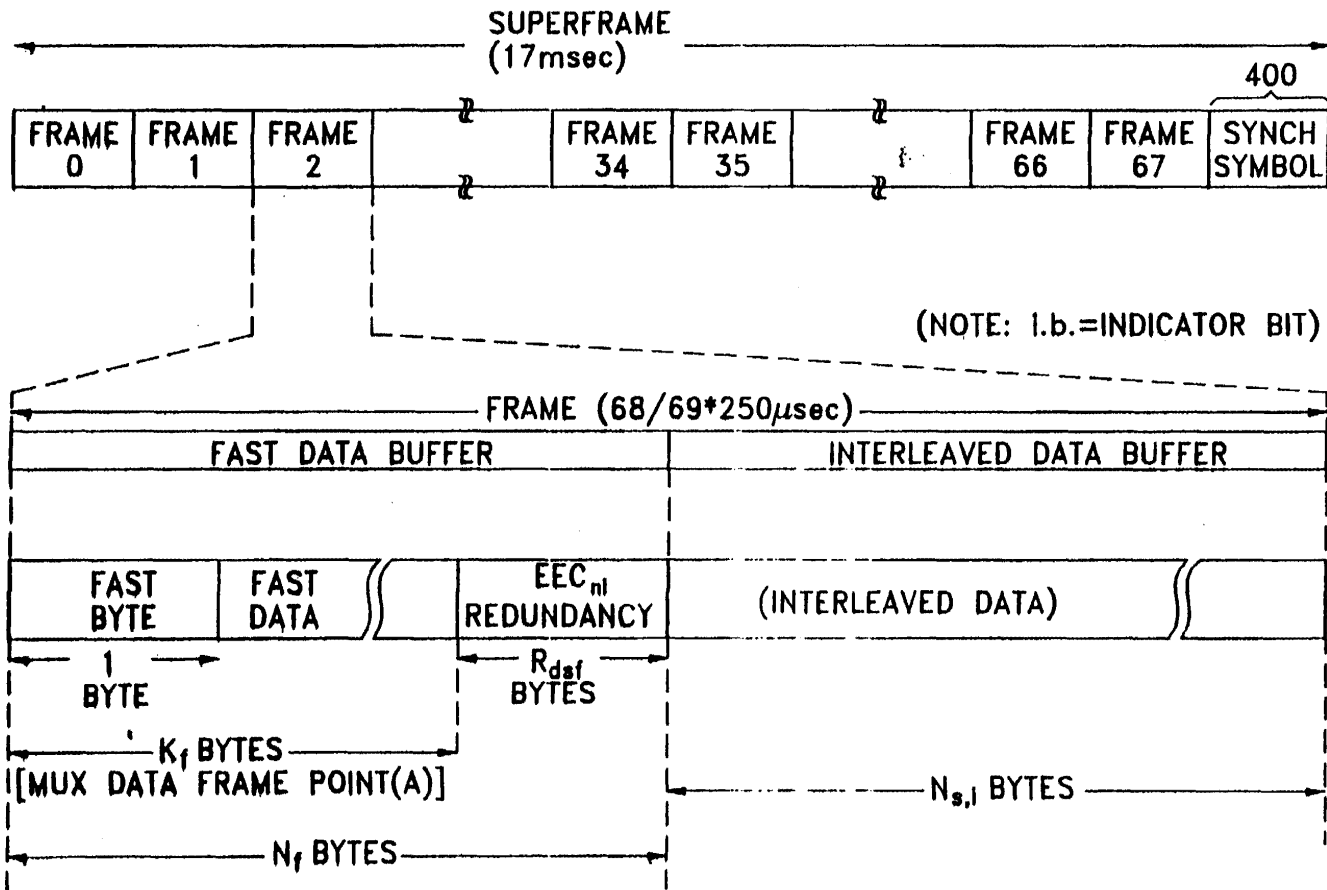

FIG. 4



4/4

**ADAPTIVE BIT SWAPPING METHOD AND DEVICE
FOR DISCRETE MULTITONE SYSTEM**

The present invention relates to a discrete multitone (DMT) system, and more particularly, to an adaptive bit swapping method and device for a DMT system, which adjust
5 the number of bits and power assigned to each sub-channel according to channel characteristics varied during data transmission.

A multicarrier is generally used in a DMT system to
10 use a channel efficiently for transmitting data. Basically in multicarrier modulation, several carrier-modulated waveforms are overlapped to represent an input bit stream. A multicarrier transmission signal is the composite of M independent sub-signals or sub-channels, each having the
15 same bandwidth of 4.3125KHz and respective main frequencies of f_i ($i=1, 2, 3, \dots, M$). These sub-signals are Quadrature Amplitude Modulation (QAM) signals. When data is transmitted at a high speed via an inferior transmission path such as a copper line, the DMT system enables the data
20 to be transmitted at 6Mbps or above, thus offering a good service. In this DMT system using several carriers, the number of bits and power of each channel depending on its signal-to-noise ratio (SNR) are assigned to each sub-channel in the initialization of the system.

25 Changing the number of bits and power assigned to each sub-channel according to its SNR, which is varied without an interruption in a data stream in a data transmission mode, is referred to as bit swapping. Bit swapping is used

in an Asymmetric Digital Subscriber Line (ADSL) service employing the DMT system to reduce an error probability of transmission data.

5 Channel characteristics vary gradually with time in most systems, and frequency response characteristics of an ADSL loop vary gradually with temperature. Therefore, a channel model determined in the initialization of a system should be changed according to the frequency response characteristics.

10 A conventional method for allocating bits to a sub-channel will be described as follows.

A transmitter terminal as well as a receiver terminal by adaption can operate according to the essential concept of a bit allocating method which has been proposed in a dissertation submitted to the Department of Electrical Engineering and the Committee on Graduate Studies of STANFORD University in partial fulfillment of the requirements for the Degree of Doctor of Philosophy, May 15 1993, entitled "BANDWIDTH OPTIMIZED DIGITAL TRANSMISSION TECHNIQUES FOR SPECTRALLY SHAPED CHANNELS WITH IMPULSE NOISE", by Ronald R. Hunt and P.S. Chow. Details of the bit allocating method there described are as follows:

- 20 1. the steady state mean square errors (MSE)'s of all used sub-channels are monitored, where these error values are differences between inputs and outputs of a slicer;
- 25 2. it is determined continuously whether the difference between a maximum error value and a minimum error value is a predetermined threshold value (generally

3dB) or above, and if the difference is the threshold value or above, the procedure goes to the subsequent step;

5 3. the bit number of a value in a bit allocation table for a sub-channel having the maximum error value is decreased by 1, while the bit number of a value in a bit allocation table for a sub-channel having the minimum error value is increased by 1;

 4. the minimum error is doubled, while the maximum error is halved;

10 5. the slicer settings for two sub-channels whose bit values are changed are adjusted; and

 6. the bit swapping information is sent back to a transmission part.

 The initial number of bits allocated to a sub-channel is determined according to an SNR measured during an initialization in an ADSL DMT system. However, the above bit allocation method exhibits the drawback that an incorrect bit swapping may be performed, since an MSE value may be increased due to an error, such as a burst error when data is examined in a reception part, or a frequency-domain equalizer (FEQ) error which can affect MSE in a steady state.

20 To circumvent the above problems, it is first object of the present invention to provide an adaptive bit swapping method for a DMT system in which bits allocated to each sub-channel are swapped in a transmission unit according to an actually measured SNR.

 It is second object of the present invention to

provide an adaptive bit swapping device for a DMT system.

To achieve the first object, there is provided an adaptive bit swapping method in a discrete multitone (DMT) system for an asymmetric digital subscriber line (ADSL) which has a transmitter for encoding and converting data to be transmitted via a channel, and a receiver for restoring the transmitted data to the original form by conversion and decoding, said method comprising the steps of: (a) initializing said DMT system to transmit said data via said channel in a steady state; (b) selecting a frame having an inserted sync block from a frame structure of said transmitted data; (c) calculating the signal-to-noise ratios (SNRs) of respective sub-channels of said selected frame; (d) calculating first difference value between the present representative SNRs calculated in step (c) and the previous representative SNRs of each sub-channel; (e) selecting a maximum value and minimum value among the first difference values of said respective sub-channels; (f) obtaining the second difference value between said maximum value and said minimum value; (g) determining whether said second difference value is equal to or greater than the predetermined threshold value; and (h) correcting bit and power assigning tables of a transmitter and a receiver if said second difference value is greater than or equal to said threshold value.

To achieve the second object, there is provided an adaptive bit swapping device functioning as a receiver for restoring the transmitted data to the original form by

conversion and decoding, said device being included in a discrete multitone (DMT) system for an asymmetric digital subscriber line (ADSL) which has a transmitter for encoding and converting data to be transmitted via a channel, said
5 device comprising: A/D converting means for converting said analogue data signal received via said channel into a digital signal; time-domain equalizing means for receiving said digital signal and reducing a guard band used to remove an interblock interference; fast-Fourier
10 transforming means for receiving the output of said time-domain equalizing means and demodulating said data signal modulated in said transmitter; frequency-domain equalizing means for receiving the output of said fast Fourier transforming means and compensating for a phase error of
15 each sub-channel; SNR measuring means for selecting a frame having an inserted sync block from a frame structure of said transmitted data, calculating the signal-to-noise ratios (SNRs) of respective sub-channels of said selected frame, calculating first difference value between the
20 present representative SNRs calculated above and the previous representative SNRs of each sub-channel, selecting a maximum value and minimum value among the first difference values of said respective sub-channels, obtaining the second difference value between said maximum
25 value and said minimum value, determining whether said second difference value is equal to or greater than the predetermined threshold value and outputting to a transmitter and a receiver the signal used for correcting

bit and power assigning tables of a transmitter and a receiver; and decoding means for receiving the outputs of said SNR measuring means and said frequency-domain equalizing means, resetting a slice value, and decoding said reset slice value.

5

Specific embodiments of the present invention are described in detail below, by way of example, with reference to the attached drawings, in which:

FIG. 1 is a block diagram of a conventional basic DMT system;

10

FIG. 2 is a flow-chart of a bit swapping method for a DMT system according to an embodiment of the present invention;

FIG. 3 is a block diagram of a receiving unit in a DMT system for performing the method of FIG. 2 according to an embodiment of the present invention; and

15

FIG. 4 illustrates the structure of a superframe based on "ADSL standards", which is transmitted in a steady state.

20

An adaptive bit swapping method and device for a DMT system according to an embodiment of the present invention will be described below, with reference to the attached drawings.

A conventional basic DMT system shown in FIG. 1 has a transmitter 100 including an encoder 104, an inverse fast Fourier transformer (IFFT) 106 and a digital/analogue (D/A) converter 108, a receiver 102 including an analogue/digital (A/D) converter 110, a fast Fourier transformer (FFT) 112

25

and a decoder 114, and a transmission path (a transmission channel or a channel) 116. A DMT system for an ADSL transmits a signal via 256 individual channels each having a 4KHz bandwidth. The encoder 104 of the transmitter 100 in the DMT system shown in FIG. 1 simply receives data sequences via an input terminal IN (the accurate number of bits depends on a data rate and an overhead) and allocates the input data sequences to a multitude of sub-channels. The IFFT 106 produces a plurality of time based samples having several real number values from an encoded value. The D/A converter 108 converts a plurality of the received time based samples into an analogue signal suitable for transmission via a copper line, and transmits the analogue signal to the A/D converter 110 via the transmission path 116.

The receiver 102 performs the operations of the transmitter 100 in a reverse order. The receiver 102 consists of three components for performing time recovery, filtering, and channel check functions, respectively.

An adaptive bit swapping device for a DMT system according to an embodiment of the present invention is shown in Fig.3 and includes an A/D converter 300, a time-domain equalizer (TEQ) 302, an FFT 304, a frequency-domain equalizer (FEQ) 306, a decoder 308, and an SNR measurer 310.

Referring to FIG. 2, showing an algorithm for a bit swapping method for a DMT system according to an embodiment of the present invention, when the DMT system is activated

to transmit data, it is initialized with regard to the channel conditions of the transmitter and receiver, in step 200. The initialization is divided into activation & recognition, transceiver training, and channel analysis & exchange. The initialization in the embodiment of the present invention is especially concerned with channel analysis, since the SNR of each sub-channel of a channel formed between the transmitter and the receiver is measured and the number of bits and power are assigned according to the variation in the measured SNR. When the DMT system is placed in a steady state after the initialization, data transmission begins, in step 202.

FIG. 4 illustrates the structure of a superframe of data transmitted in a steady state, which is determined by "ADSL standards". Referring to FIG. 4, a sync(ronization) symbol 400 used to restore the synchronization of the data without reinitialization when the data are affected by an instantaneous interrupt is inserted in a frame 68 of frames 0-68.

In step 204, frame 68 alone is selected after step 202 in the embodiment of the present invention, whereas all frames among the 68 frames shown in FIG. 4 are selected to obtain MSEs in the prior art. In step 206, the signal PSD of each sub-channel is measured by a deterministic least sequence (DLS) method, after step 204. The DLS method indicates that known sequence values received from the transmitter via the channel are accumulated and averaged. A channel response free of random noise can be achieved by

this method, and the signal PSD of each sub-channel can be achieved by fast Fourier transforming the channel response. In step 208, the noise PSD of each sub-channel is measured by a Welch method after step 206. After step 208, the SNR of each sub-channel is obtained from the measured signal PSD and noise PSD in step 210. After step 210, it is determined whether the obtained SNR is the Nth SNR of each sub-channel or not in step 212. Here, N is a predetermined number(50~150). Steps 206-210 should be performed repeatedly for series of N sequent superframes because a plurality of sync frames 68, each pattern of which is known, is needed in order to accurately measure the SNR of each sub-channel.

If N SNRs for each sub-channel are obtained, then firstly, the representative SNR(SNR_{rep}) of each sub-channel is obtained by averaging the N SNRs. Then, the difference value(or first difference value) between the presently obtained SNR_{rep} and the previously obtained SNR_{rep} is calculated for each sub-channel. By a method similar to that described above, all first difference values for all sub-channels are obtained in step 214.

The maximum and the minimum values among the first difference values calculated in step 214 are selected in step 216. After step 216, the second difference value between the maximum value and the minimum value is calculated and it is determined whether the second difference value is a predetermined threshold value(around 3 DB) or not in step 218. If the second difference value is

smaller than the threshold value, the procedure feeds back to step 204, and if it is equal to or greater than the threshold value, the bits and power assigned to a corresponding sub-channel in a transmitter are swapped. That is, the number of bit of a sub-channel having a minimum value is assigned to sub-channel having a maximum value. Thus, the corresponding parameters (a bit number and power table) should be changed to enable a receiver to make an accurate decision, in step 220. In step 222, it is determined whether the DMT system is off after step 220. If it is not off, the procedure feeds back to step 204, and if it is off, the bit swapping method of the present invention ends.

Since the bit swapping only takes place once after at least one superframe has been transmitted (17msec is required for one superframe transmission), a long time is required for the bit swapping. However, even though the channel changes during the time required for the bit swapping, this method can be used because a channel changes very slowly, for example by temperature, etc.

Fig.3 shows a device for performing the above-described method. The A/D converter 300 converts an analogue signal received via an input port IN into a digital signal. The TEQ 302 receives the digital signal from the A/D converter 300 and reduces a guard band used to remove an interblock interference (IBI) produced due to characteristics of a DMT system. For this purpose, a finite impulse response filter (FIR) may be used as the TEQ

302. The FFT 304 receives the signal output from the TEQ
302 and performs a demodulation corresponding to a
modulation of the transmitter. Thus, the FFT 304 serves as
a demodulator corresponding to the IFFT 106 of FIG. 1. The
5 FEQ 306 is a filter for receiving the output of the FFT 304
and compensating for a phase error of each sub-channel.
Meanwhile, the SNR measurer 310 of FIG. 3 receives the
output of the A/D converter 300 and performs the steps 204-
220 described in Fig.2. The SNR measurer 310 can be
10 achieved in terms of software in a digital signal
processor. After processing step 218 shown in Fig.2, the
SNR measurer 310 outputs the control signal for bit
swapping to the transmitter via an output port OUT1 to
correct a bit allocation table at a transmitter, and the
15 measured SNR of each sub-channel is output to the decoder
308. The decoder 308 receives the outputs of the SNR
measurer 310 when frame 68 is input, and the output of the
FEQ 306 when any frame among frames 0 - 67 is input,
decides a slicer value, decodes the reset slicer value, and
20 outputs the decoded value via an output port OUT2.

As described above, in the adaptive bit swapping
method and device of embodiments of the present invention
in the DMT system, the method for comparing SNRs is added
to an SNR measuring method used in a conventional process
25 of initialization. The adaptive bit swapping device
selects only frame 68 from each superframe, thereby
simplifying a conventional complex hardware construction
using all frames. Furthermore, in the adaptive bit swapping

method, more accurate swapping information for changing the number of bit and corresponding power can be transmitted to a transmitter than in the conventional method depending on an MSE, since an actually measured SNR value on a frame 68 is used when the assigned bit number and the assigned quantity of power are changed according to a channel variation.

CLAIMS

1. An adaptive bit swapping method for use in a discrete multitone (DMT) system for an asymmetric digital subscriber line (ADSL) which has a transmitter for encoding and converting data to be transmitted via a channel, and a receiver for restoring the transmitted data to the original form by conversion and decoding, said method comprising the steps of:

5

10

15

20

25

(a) initializing said DMT system to transmit said data via said channel in a steady state;

(b) selecting a frame having an inserted sync block from a frame structure of said transmitted data;

(c) calculating the signal-to-noise ratios (SNRs) of respective sub-channels of said selected frame;

(d) calculating first difference values between the present representative SNRs calculated in step (c) and the previous representative SNRs of each sub-channel;

(e) selecting a maximum value and minimum value among the first difference values of said respective sub-channels;

(f) obtaining a second difference value being a difference between said maximum value and said minimum value;

(g) determining whether said second difference value is equal to or greater than a predetermined threshold value; and

(h) correcting bit and power assigning tables of a transmitter and a receiver if said second difference value

is greater than or equal to said threshold value.

2. An adaptive bit swapping method as claimed in claim 1, wherein said step (a) comprises the steps of:

5 establishing the initial bits and power values of said DMT system; and

starting a transmission of data in a steady state of said DMT system.

3. An adaptive bit swapping method as claimed in claim 1 or claim 2, wherein said step (c) comprises the steps of;

10 measuring the signal power spectrum density (PSD) of each sub-channel by a deterministic least sequence (DLS) method;

15 measuring a noise PSD of each sub-channel by a Welch method; and

calculating said SNR of each sub-channel from said measured signal PSD and said noise PSD.

20 4. An adaptive bit swapping method as claimed in any of claims 1 to 3, wherein said steps (b) and (c) are performed repeatedly a predetermined number of times, and representative SNR value of each sub-channel are calculated making use of said SNRs if the predetermined number of SNRs is obtained for each sub-channel.

25 5. An adaptive bit swapping method as claimed in claim 4, wherein said step (c) comprises the step of;

feeding the procedure back to said step (b), if said predetermined number of SNRs of each sub-channel has not been obtained .

6. An adaptive bit swapping method as claimed in any preceding claim, wherein said step (g) comprises the step of;

5 feeding the procedure back to said step (b), if said second difference value is not greater than or equal to said predetermined threshold value.

7. An adaptive bit swapping device adapted to function as a receiver for restoring transmitted data to its original form by conversion and decoding, said device
10 being adapted for inclusion in a discrete multitone (DMT) system for an asymmetric digital subscriber line (ADSL) which has a transmitter for encoding and converting data to be transmitted via a channel, said device comprising:

A/D converting means for converting said analogue data
15 signal received via said channel into a digital signal;

time-domain equalizing means for receiving said digital signal and reducing a guard band used to remove an interblock interference;

fast-Fourier transforming means for receiving the
20 output of said time-domain equalizing means and demodulating said data signal modulated in said transmitter;

frequency-domain equalizing means for receiving the
25 output of said fast Fourier transforming means and compensating for a phase error of each sub-channel;

SNR measuring means for obtaining the representative SNRs of said respective sub-channels from the output of said A/D converting means using a frame having an inserted

sync symbol from a frame structure of transmitted data,
calculating a first difference values between the previous
representative SNR and present representative SNR for each
sub-channel, comparing a threshold value with a second
5 difference value being a difference between maximum and
minimum value of said first difference values, and
outputting to a transmitter and a receiver the signal used
for correcting a bit allocation table according to the
compared result; and

10 decoding means for receiving the outputs of said SNR
measuring means and said frequency-domain equalizing means,
resetting a slice value, and decoding said reset slice
value.

8. An adaptive bit swapping device adapted to
15 function as a receiver for restoring transmitted data to
its original form by conversion and decoding, said device
being adapted for inclusion in a discrete multitone (DMT)
system for an asymmetric digital subscriber line (ADSL)
which has a transmitter for encoding and converting data to
20 be transmitted via a channel, said device comprising:

A/D converting means for converting said analogue data
signal received via said channel into a digital signal;

25 time-domain equalizing means for receiving said
digital signal and reducing a guard band used to remove an
interblock interference;

fast-Fourier transforming means for receiving the
output of said time-domain equalizing means and
demodulating said data signal modulated in said

transmitter;

frequency-domain equalizing means for receiving the output of said fast Fourier transforming means and compensating for a phase error of each sub-channel;

5 SNR measuring means for selecting a frame having an inserted sync block from a frame structure of said transmitted data, calculating the signal-to-noise ratios (SNRs) of respective sub-channels of said selected frame, calculating first difference values between the present
10 representative SNRs calculated above and the previous representative SNRs of each sub-channel, selecting a maximum value and minimum value among the first difference values of said respective sub-channels, obtaining a second difference value being a difference between said maximum
15 value and said minimum value, determining whether said second difference value is equal to or greater than the predetermined threshold value, and outputting to a transmitter and a receiver the signal used for correcting bit and power assigning tables of a transmitter and a
20 receiver; and

decoding means for receiving the outputs of said SNR measuring means and said frequency-domain equalizing means, resetting a slice value, and decoding said reset slice value.

25 9. An adaptive bit swapping device substantially as herein described with reference to Figure 3 with or without reference to Figures 2 and 4.

10. A discrete multitone (DMT) system for an

asymmetric digital subscriber line (ADSL) which has a transmitter for encoding and converting data to be transmitted via a channel, said system comprising an adaptive bit swapping device as claimed in any of claims 7 to 9.

5

11. An adaptive bit swapping method substantially as herein described with reference to Figure 2 with or without reference to Figures 3 and 4.



Application No: GB 9613602.3
Claims searched: 1-11

Examiner: David Midgley
Date of search: 22 October 1996

Patents Act 1977
Search Report under Section 17

Databases searched:

UK Patent Office collections, including GB, EP, WO & US patent specifications, in:

UK Cl (Ed.O): H4P (PAQ,PAL,PEM)

Int Cl (Ed.6): H04L 5/06,27/34

Other: ONLINE:WPI

Documents considered to be relevant:

Category	Identity of document and relevant passage	Relevant to claims
	NONE	

X	Document indicating lack of novelty or inventive step	A	Document indicating technological background and/or state of the art.
Y	Document indicating lack of inventive step if combined with one or more other documents of same category.	P	Document published on or after the declared priority date but before the filing date of this invention.
&	Member of the same patent family	E	Patent document published on or after, but with priority date earlier than, the filing date of this application.

(19)日本国特許庁 (J P)

(12) 特 許 公 報 (B 2)

(11)特許出願公告番号

特公平6-3956

(24) (44)公告日 平成6年(1994)1月12日

(51)Int.Cl. ⁵	識別記号	庁内整理番号	F I	技術表示箇所
H 0 4 M 11/00	3 0 2	8627-5K		
H 0 4 B 3/04		A 8226-5K		
H 0 4 L 1/00		E 6942-5K		
12/02		8529-5K	H 0 4 L 11/ 02	D
				発明の数 1 (全 15 頁)

(21)出願番号	特願昭61-502770	(71)出願人	999999999 テレビット コーポレイション アメリカ合衆国 95014 カリフォルニア クバーティノ バブロード 10440
(86) (22)出願日	昭和61年(1986)5月5日	(72)発明者	ヒューハートッグス ダーク アメリカ合衆国 95037 カリフォルニア モーガンヒル ローリングヒルズ ドラ イブ 2220
(86)国際出願番号	P C T / U S 8 6 / 0 0 9 8 3	(74)代理人	弁理士 鈴木 弘男
(87)国際公開番号	W O 8 6 / 0 7 2 2 3	審査官	松野 高尚
(87)国際公開日	昭和61年(1986)12月4日		
(65)公表番号	特表昭62-502932		
(43)公表日	昭和62年(1987)11月19日		
(31)優先権主張番号	7 3 6 2 0 0		
(32)優先日	1985年5月20日		
(33)優先権主張国	米国 (U S)		

(54)【発明の名称】 不完全な送信媒体のための総体的なモデム構造体

1

【特許請求の範囲】

【請求項1】各搬送波が複雑さ、即ち1回の変調で送信するビット数の変化するデータエレメントをエンコードした搬送波の集合でデータエレメントをエンコードする形式の、電話線を介してデータを送信する高速モデムにおける搬送波周波数にデータ及び電力を割り当てるシステムにおいて、
上記搬送波周波数の集合に含まれた各々の搬送波周波数に対して等化ノイズ成分を決定する手段と、
各搬送波におけるデータエレメントの複雑さ、即ち1回の変調で送信するビット数を、OとNとの間の整数をnとすれば、n個の情報単位から(n+1)個の情報単位まで増加するに要する余分な電力を決定する手段と、
上記搬送波周波数の集合に含まれたすべての搬送波の余分な電力を次第に電力が増加する順に順序付けする手段

2

と、
この順序付けされた余分な電力に次第に電力が増加する順序で利用可能な電力を割り当てる手段と、
利用可能な電力が尽きる点の値MP (max)を決定する手段と、
割り当てられる電力がその搬送波に対する上記MP (max)に等しくなり且つ割り当てられるデータ単位の数が上記MP (max)に等しいか又はそれより小さい当該搬送波のための余分な電力の数に等しくなるように各搬送波周波数に電力及びデータを割り当てる手段とを具備したことを特徴とするシステム。
【請求項2】上記の順序付け手段は、
任意の余分な電力レベルのテーブルを形成する手段と、
各々の決定された余分な電力レベルの値を上記任意の余分な電力レベルのテーブルの値の1つへと丸めて計算の

煩雑さを減少させる手段とを具備する特許請求の範囲第1項に記載のシステム。

【請求項3】モデムA及びBが電話線によって接続され、等化ノイズを決定する上記の手段は、上記モデムAとBとの間に通信リンクを確立する手段と、

上記モデムA及びBにおける非送信時間インターバル中にラインノイズデータを累積する手段と、

第1の周波数搬送波の集合を上記モデムAからBへと送信する手段とを具備し、各搬送波の振幅は所定の値を有するものであり、

更に、上記第1の周波数搬送波の集合をモデムBで受信する手段と、

モデムBで受信した各搬送波の振幅を測定する手段と、モデムBで測定した振幅を上記所定の振幅と比較して、各搬送波周波数における信号ロス(dB)を決定する手段と、

上記累積したノイズの各搬送波周波数における成分の値(dB)を決定する手段と、

各搬送波周波数における信号ロスを各搬送波周波数におけるノイズ成分に加算して等化ノイズを決定する手段とを具備する特許請求の範囲第2項に記載のシステム。

【発明の詳細な説明】

発明の背景

技術分野

本発明は、一般に、データ通信の分野に関するもので、より詳細には、高速モデムに関する。

従来技術

最近、デジタルデータを直接送信するための特殊設計の電話線が導入されている。しかしながら、膨大な量の電話線はアナログの音声周波数(VF)信号を搬送するように設計されている。モデムは、VF搬送波信号を変調してデジタル情報をVF搬送波信号にエンコードしそしてこれらの信号を復調してこの信号によって保持されたデジタル情報をデコードするのに用いられている。

既存のVF電話線は、モデムの性能を低下すると共に、所望のエラー率以下でデータを送信することのできる速度を制限するような多数の制約がある。これらの制約には、周波数に依存するノイズがVF電話線に存在することや、VF電話線によって周波数に依存する位相遅延が挿入されることや、周波数に依存する信号ロスがあることが含まれる。

一般に、VF電話線の使用可能な帯域は、ゼロより若干上から約4KHzまでである。電話線ノイズの電力スペクトルは、周波数にわたって均一に分布されず、一般的に不定なものである。従って、これまで、VF電話線の使用可能な帯域にわたるノイズスペクトルの分布を測定する方法は皆無である。

更に、周波数に依存する伝播遅延がVF電話線によって誘起される。従って、複雑な多周波数信号の場合は、V

10

20

30

40

50

F電話線により信号の種々の成分間に位相遅延が誘起される。この位相遅延も不定なものであり、送信が行なわれる特定の時間に個々のVF電話線について測定しなければならない。

更に、VF電話線の信号ロスは周波数と共に変化する。等価ノイズは、各搬送波周波数に対して信号ロス成分に追加されるノイズスペクトル成分であり、両成分は、デシベル(dB)で測定される。

一般に、公知のモデムは、満足なエラー率を得るようにデータ速度をダウン方向にシフトすることによって等価ラインノイズ及び信号ロスを補償している。例えば、バラン(Baran)氏の米国特許第4438511号には、ガンダルフ・データ・インク(Gandalf Data Inc.)によって製造されたSM9600スーパー・モデムと称する高速モデムが開示されている。ノイズ障害がある場合、このSM9600は、その送信データ速度を4800bps又は2400bpsに「ギヤシフト」即ち低下させる。バラン氏の特許に開示されたシステムは、64の直角変調された搬送波によってデータを送信する。バラン氏のシステムは、ライン上の大きなノイズ成分の周波数と同じ周波数を有する搬送波の送信を終らせることにより、VFライン上のノイズの周波数依存性を補償するものである。従って、バラン氏のシステムは、VFラインノイズスペクトルの最高点の搬送波周波数で送信を終らせることによりそのスループットを僅かに低下させる。バラン氏のシステムは、本質的に、VFラインノイズスペクトルの分布に基づいて各搬送波信号のゴー/ノー・ゴー判断を行なう。本発明は、バラン氏によって開始された努力を引き継ぐものである。

殆どの公知のシステムは、VFラインによって誘起される周波数依存性の位相遅延を等化システムによって補償するものである。最も大きな位相遅延は、使用可能な帯域の端付近の周波数成分において誘起される。従って、帯域の中心付近の周波数成分は、帯域の外側の周波数成分を捕獲できるように遅延される。等化を行なう場合には、一般に、上記の遅延を実行するための追加回路が必要とされる。

VF電話線を介しての両方向送信に関連した更に別の問題は、出ていく信号と入ってくる信号とで干渉を生じるおそれがあることである。一般に、2つの信号の分離及びアイソレーションは、次の3つの方法の1つで行なわれる。

(a) 別々の信号に対して別々の周波数を使用する周波数マルチプレクシング。この方法は、モデムをベースとする遠隔通信システムに通常用いられるものである。

(b) 別々の信号に対して別々の時間セグメントを使用する時間マルチプレクシング。この方法は、送信器がこれに含まれた全てのデータを送信した後にのみチャンネルを放棄する半二重システムにおいてしばしば使用される。

(c) 直交コードを用いて信号を送信するコードマルチプレクシング。

上記の全てのシステムでは、利用できるスペースが、最初のシステム設計中に固定された一定の割合に基づいて分割される。しかしながら、これらの一定の割合は、各モデムに生じる実際のトラフィックロード（通信負荷）問題に適したものではない。例えば、離れたホストコンピュータに接続されたP Cワークステーションにいる事務員は、10又は20個の文字をタイプし、その応答として全スクリーンを受け取る。この場合、送信側モデムと受信側モデムとの間にチャンネルを等しく割り当てる一定の割合では、P Cワークステーションの事務員にチャンネルを相当過剰に割り当てることになる。従って、実際のトラフィックロード状態の必要性に応じてチャンネル容量を割り当てるモデムがあれば、チャンネル容量の効率的な利用が著しく促進される。

発明の要旨

本発明は、ダイヤル式のV F電話線に使用する高速モデムに関する。このモデムは、多搬送波変調機構を使用しており、全データ送信率を最大にするようにデータ及び電力を種々の搬送波に可変に割り当てる。搬送波間での電力の割当は、割り当てる全電力が指定の限界を越えてはならないという制約を受ける。

好ましい実施例では、上記モデムは、更に、通信リンクの制御権を実際のユーザ要求に応じて2つのモデム（A及びB）間で分担させる可変割当システムを備えている。

本発明の別の特徴は、周波数に依存する位相遅延を補償すると共に記号間の干渉を防止するシステムであって、等化ネットワークを必要としないようなシステムにある。

本発明の1つの特徴によれば、直角振幅変調（QAM）を用いて色々な複雑さ、即ち1回の変調で送信するビット数のデータエレメントが各搬送波にエンコードされる。各搬送波周波数における等価ノイズ成分は、2つのモデム（AとB）との間の通信リンクを経て測定される。

良く知られているように、ビットエラー率（BER）を指定レベル以下に維持すべき場合には、所与の搬送波周波数における所与の複雑さのデータエレメントを送信するに要する電力を、その周波数の等価ノイズ成分が増加した時に、増加しなければならぬ。同様に、データの複雑さ、即ち1回の変調で送信するビット数を増加するためには、信号対雑音比、即ち、S/N比を増加しなければならない。

本発明の一実施例においては、外的なBER及び全利用電力の制約内で全データ率を最大にするようにデータ及び電力が割り当てられる。電力割当システムは、各搬送波における記号率をnからn+1までの情報単位で増加するために余分な所要電力を計算する。次いで、システ

ムは、記号率を1情報単位だけ増加するように最小の追加電力を必要とする搬送波に情報単位を割り当てる。余裕電力は、特に確立された送信リンクの等価ノイズスペクトルの値によって決まるので、電力及びデータの割当は、この特定のリンクについてのノイズを補償するように特に調整される。

本発明の別の特徴によれば、各搬送波における記号の第1の部分は、記号の中をTEとし、この第1部分の中をTPHとすれば、中TE+TPHのガード時間波形を形成するように再送信される。TPHの大きさは、波形の周波数成分について推定される最大位相遅延に等しいか又はそれより大きい。例えば、記号が時間TE内に送信された時間シリーズ $x_0 \cdots x_{n-1}$ によって表わされる場合には、ガード時間波形が時間TE+TPH内に送信された時間シリーズ $x_0 \cdots x_{n-1}$ 、 $x_0 \cdots x_{m-1}$ によって表わされる。mのnに対する比は、TPHのTEに対する比に等しい。

受信モデムにおいては、ガード時間波形の第1周波数成分の時間インターバル T_0 が決定される。中TEのサンプリング周期は、時間 T_0+TPH において開始される。

従って、各搬送波周波数における全記号がサンプリングされ、記号間の干渉が除去される。

本発明の更に別の特徴によれば、モデムAとBとの間での送信リンクの制御の割当は、1つの送信サイクル中に各モデムが送信するパケットの数に対して限界をセットすることによって行なわれる。情報パケットは、1つの波形を構成する搬送波全体においてエンコードされたデータを備えている。又、各モデムは、モデム間の通信リンクを維持するための最小数のパケットを送信するように構成される。従って、1つのモデムが送信すべきデータを有していない場合でも、最小のパケットがタイミングを維持し、他のパラメータが送信される。一方、モデムのデータ量が多い場合には、制限された最大数のパケットNのみを送信してから他のモデムへ制御権を放棄するような制約が課せられる。

実際に、モデムAが少量のデータを有しそしてモデムBが大量のデータを有する場合には、モデムBが殆どの時間中送信リンクの制御権を有することになる。制御権が最初にモデムAに指定された場合には、これが最小数Iのパケットのみを送信する。従って、モデムAは、短い時間中のみ制御権を有する。次いで、制御権はモデムBに指定され、N個のパケットを送信する。Nは非常に大きなものである。再び、制御権はモデムAに指定され、1個のパケットを送信してから制御権をBに戻す。従って、制御権の割当は、I対Nの比に比例する。モデムAのデータ量の送信にL個のパケットが必要とされる場合（ここで、LはIとNとの間の値である）、割当は、LとNの比に比例する。従って、送信リンクの割当は、ユーザの実際の要求に基づいて変化する。

更に、パケットの最大数Nは、各モデムごとと同じである必要はなく、モデムA及びBによって送信されるべきデータの既知の不均衡を受け入れるように変えることができる。

本発明の更に別の特徴によれば、データを決定する前に信号ロス及び周波数オフセットが測定される。追従システムは、測定値からの変化を決定し、これらのずれを補償する。

本発明の更に別の特徴によれば、 T_o の正確な値を決定するシステムが含まれている。このシステムは、時間TAにモデムAから送信される波形に含まれた f_1 及び f_2 の2つのタイミング信号を用いている。時間TAにおける第1と第2のタイミング信号間の相対的な位相はゼロである。

波形は、モデムBに受け取られ、 f_1 のエネルギーを検出することによって受信時間のおおよその推定値 T_{EST} が得られる。この時間 T_{EST} におけるタイミング信号間の相対的な位相を用いて、正確なタイミング基準 T_o が得られる。

図面の簡単な説明

第1図は、本発明に用いられる搬送波周波数全体のグラフ、

第2図は、各搬送波のQAMを示す座標のグラフ、

第3図は、本発明の実施例を示すブロック図、

第4図は、本発明の同期プロセスを示すフローチャート、

第5図は、0, 2, 4, 5, 6ビットデータエレメントに対する座標、例示的な信号対雑音比及び各座標に対する電力レベルを示す一連のグラフ、

第6図は、水充填アルゴリズムを示すグラフ、

第7図は、本発明に用いる水充填アルゴリズムの応用を示すヒストグラム、

第8図は、搬送波周波数全体の周波数成分に対する位相依存周波数遅延の影響を示すグラフ、

第9図は、記号間干渉を防止するために本発明に用いられる波形を示すグラフ、

第10図は、送信された搬送波周波数全体を受信する方法を示すグラフ、

第11図は、変調テンプレートを示す概略図、

第12図は、変調テンプレートの1つの方形の象限を示す概略図、そして

第13図は、本発明のハードウェア実施例を示す概略図である。

好ましい実施例の詳細な説明

本発明は、周波数に依存するラインノイズを補償するように周波数全体における種々の搬送波周波数間で電力を状態に応じて割り当て、周波数に依存する位相遅延を補償するための等化回路の必要性を排除し、変化するチャンネルロード状態を考慮して送信側モデムと受信側モデムとの間でチャンネルを割り当てる二重機構を形成する

ようなモデムに関する。本発明の更に別の特徴は、以下で述べる。

本発明の理解を容易にするために、本発明に用いられる周波数全体及び変調機構を第1図及び第2図について最初に簡単に説明する。次いで、第3図を参照して、本発明の特定の実施例を説明する。最後に、第4図ないし第13図を参照して、本発明の動作及び種々の特徴を説明する。

変調及び全体の構成

10 第1図は、本発明の送信周波数全体10を示す概略図である。これは、使用可能な4KHzのVF帯域にわたって等しく離間された512個の搬送波周波数12を含んでいる。本発明は、各搬送波周波数における位相に拘りないサイン及びコサイン信号を送信するような直角振幅変調(QAM)を用いている。所与の搬送波周波数で送信されるデジタル情報は、その周波数における位相に拘りないサイン及びコサイン信号を振幅変調することによってエンコードされる。

20 QAMシステムは、全ビット率RBでデータを送信する。しかしながら、記号もしくはボーレートRSで示された各搬送波の送信率は、RBの一部分に過ぎない。例えば、データが2つの搬送波間に等しく割り当てられる場合には、 $RS = RB / 2$ となる。

30 好ましい実施例では、0, 2, 4, 5又は6ビットデータエレメントが各搬送波においてエンコードされ、各搬送波の変調は136ミリ秒ごとに変化する。各搬送波について6ビットのRSを仮定すれば、理論的な最大値RBは、22580ビット/秒(bps)となる。搬送波の75%にわたって4ビットのRSを仮定すれば、典型的に実現できるRSは、約11300bpsに等しい。この例示的な高いRSは、ビットエラー率が1エラー/10000送信ビット未満の状態で達成される。

第1図において、複数の垂直線14は、周波数全体を「エポック」と称する時間増分に分割する。エポックは、巾がTEであり、TEの大きさは以下で述べるように決定される。

デジタルデータを種々の搬送波周波数にエンコードするQAMシステムを第2図について説明する。第2図には、第n番目の搬送波に対する4ビット「座標」20が示されている。4ビット数は、16の個々の値をとることができる。この座標における各点は、ベクトル (x_n, y_n) を表わしており、 x_n はサイン信号の振幅である y_n は磁気QAMシステムにおけるコサイン信号の振幅である。付随の文字nは、変調される搬送波を示している。従って、4ビット座標では、4つの個々の y_n の値と、4つの個々の x_n の値とが必要とされる。以下で詳細に述べるように、所与の搬送波周波数で送信されるビットの数を増加するためには、その周波数に等価ノイズ成分があるために、電力を増加することが必要とされる。4ビット送信の場合、受信側のモデムは、 x_n 及

び y_n 振幅係数の4つの考えられる値を弁別できねばならない。この弁別能力は、所与の搬送波周波数に対する信号対雑音比によって左右される。

好ましい実施例では、パケット技術を用いてエラー率が減少される。1つのパケットは、搬送波の変調されたエポックと、エラー検出データとを含んでいる。各パケットは、エラーが生じた場合、修正されるまで繰り返し送信される。或いは又、データの繰り返し送信が所望されないシステムでは、ホワードエラー修正コードを含むエポックが用いられる。

ブロック図

第3図は、本発明の実施例のブロック図である。これについて説明すると、発振側モデム26は、公共のスイッチ式電話線を経て形成された通信リンクの発振端に接続される。通信システムには、通信リンクの応答端に接続された応答モデムも含まれることを理解されたい。以下の説明において、発振モデムの同じ又は同様の部分に対応する応答モデムの部分は、発振モデムの参照番号にプライム（'）記号を付けて示す。

第3図を説明すると、入ってくるデータ流は、モデム26の送信システム28によりデータ入力30に受け取られる。データは、一連のデータビットとしてバッファメモリ32に記憶される。バッファメモリ32の出力は、変調パラメータ発生器34の入力に接続される。変調パラメータ発生器34の出力は、ベクトルテーブルバッファメモリ36に接続され、該バッファメモリ36は変調器40の入力に接続される。変調器40の出力は、時間シーケンスバッファ42に接続され、次いで、該バッファ42は、アナログI/Oインターフェイス44に含まれたデジタル/アナログコンバータ43の入力に接続される。インターフェイス44は、モデムの出力を公共のスイッチ式電話線48に接続する。

受信システム50は、公共のスイッチ式電話線48に接続されてインターフェイス44に含まれたアナログ/デジタルコンバータ(ADC)52を備えている。ADC52の出力は受信時間シリーズバッファ54に接続され、該バッファは、次いで、復調器56の入力に接続される。復調器56の出力は、受信ベクトルテーブルバッファ58に接続され、該バッファは、次いで、デジタルデータ発生器60の入力に接続される。このデジタルデータ発生器60の出力は、受信データビットバッファ62に接続され、該バッファは、出力端子64に接続される。

制御及びスケジューリングユニット66は、変調パラメータ発生器34、ベクトルテーブルバッファ36、復調器56及び受信ベクトルテーブルバッファ58に接続されている。

第3図に示された実施例の機能について概略的に説明する。データを送信する前に、発振モデム26は、応答モデム26'と協働して、各搬送波周波数における等価ノ

イズレベルを測定し、各搬送波周波数で送信されるべきエポック当たりのビット数を決定し、以下で詳細に述べるように、各搬送波周波数に電力を割り当てる。

入ってくるデータは、入力ポート30で受け取られ、入力バッファ32に記憶されるビットシーケンスにフォーマット化される。

変調器34は、上記のQAMシステムを用いて、所与の数のビットを各搬送波周波数のための (x, y, y_n) ベクトルにエンコードする。例えば、周波数 f_n で4つのビットを送信することが決定された場合には、ビット流からの4つのビットが第2図の4ビット座標内の16個の点の1つに変換される。これら座標点の各々は、4つのビットの16個の考えられる組合せの1つに対応する。従って、周波数 n に対するサイン及びコサイン信号の振幅は、ビットシーケンスの4つのビットをエンコードする座標内の点に対応する。 (x_n, y_n) ベクトルは、次いで、ベクトルバッファテーブル36に記憶される。変調器は、周波数全体に含まれた搬送波のための (x_n, y_n) ベクトルのテーブルを受け取り、QAM搬送波周波数の全体を構成する波形を表わすデジタルエンコード化された時間シリーズを形成する。

好ましい実施例では、変調器40は、高速フーリエ変換器(FFT)を備えており、 (x, y) ベクトルをFFT係数として用いて逆FFT演算を実行する。ベクトルテーブルは、512周波数座標の1024個のFFT点を表わす1024の個々の点を含んでいる。逆FFT演算により、QAM全体を表わす1024個の点が時間シリーズで形成される。このデジタルエンコードされた時間シリーズの1024個のエLEMENTは、デジタル時間シリーズバッファ42に記憶される。デジタル時間シリーズは、アナログ/デジタルコンバータ43によりアナログ波形に変換され、インターフェイス46は、公共のスイッチ式電話線48を経て送信するように信号を調整する。

受信システム50について説明すれば、公共のスイッチ式電話線48から受信したアナログ波形は、インターフェイス46によって調整され、アナログ/デジタルコンバータ52に向けられる。アナログ/デジタルコンバータ52は、アナログ波形をデジタルの1024入力時間シリーズテーブルに変換し、これは、受信時間シリーズバッファ54に記憶される。復調器56は、1024入力時間シリーズテーブルを512入力 (x_n, y_n) ベクトルテーブルに変換し、これは、受信ベクトルテーブルバッファ58に記憶される。この変換は、時間シリーズに基づいてFFTを実行することにより行なわれる。各周波数搬送波にエンコードされたビットの数に関する情報は、復調器及びデジタルデータ発生器60に既に記憶されており、従って、受信ベクトルテーブルバッファ58に記憶された (x, y) テーブルは、デジタルデータ発生器60により出力データビットシーケンスに変換

されることに注意されたい。例えば (x_n, y_n) ベクトルが4ビットのシーケンスを表わす場合には、このベクトルがデジタルデータ発生器60により4ビットシーケンスに変換されそして受信データビットバッファ62に記憶される。受信データビットシーケンスは、次いで、出力データ流として出力64へ送られる。

使用するFFT技術の完全な説明は、1975年N. J. のプレントイス・ホール・インク (Prentice-Hall, Inc.) により出版されたラビナ (Rabiner) 氏等の「デジタル信号処理の理論及び応用 (Theory and Applications of Digital Signal Processing)」と題する文献に述べられている。しかしながら、上記したFFT変調技術は、本発明の重要な部分ではない。或いは又、参考としてここに取り上げる前記バランの特性のカラム10、ライン13-70及びカラム11、ライン1-30に述べられたように、搬送波トーンを直接乗算することによって変調を行なうこともできる。更に、バランの特許のカラム12、ライン35-70、カラム13、ライン1-70及びカラム14、ライン1-13に述べられた復調システムと取り替えることもできる。

制御及びスケジュールリングユニット66は、一連の動作を全体的に監視するように維持し、入力及び出力機能を制御する。

等価ノイズの測定

上記したように、各周波数搬送波にエンコードされたデータエレメント及びその周波数搬送波に割り当てられた電力の情報内容は、その搬送波周波数におけるチャンネルノイズ成分の大きさによって左右される。周波数 f_n における等価送信ノイズ成分 $N(f_n)$ は、周波数 f_n における測定した(受信した)ノイズ電力に、周波数 f_n における測定した信号ロスを乗算したものである。等価ノイズはラインごとに変化し、所与のラインにおいても時間ごとに変化する。従って、ここに示すシステムでは、データ送信の直前に $N(f)$ が測定される。

この $N(f)$ を測定して、応答及び発振モデム26と26'との間に通信リンクを確立するために本システムに用いられる同期技術の段階が第4図に示されている。第4図を説明すれば、ステップ1において、発振モデムは応答モデムの番号をダイヤルし、応答モデムはオフ・フックの状態となる。ステップ2において、応答モデムは、次の電力レベルで2つの周波数のエポックを送信する。

(a) 1437. 5Hz: -3dBR

(b) 1687. 5Hz: -3dBR

電力は、基準値Rに対して測定し、好ましい実施例では、0dBR=-9dBmであり、mはミリボルトである。これらのトーンは、以下で詳細に説明するように、タイミング及び周波数オフセットを決定するのに用いられる。次いで、応答モデムは、全部で512の周波数を含む応答コームを-27dBRで送信する。発振モデムは、この

応答コームを受け取り、このコームにおいてFFTを実行する。512個の周波数の電力レベルは指定の値にセットされるので、応答モデム26の制御及びスケジュールリングユニット66は、受信したコードの各周波数に対して (x_n, y_n) 値を比較し、これらの値を、送信された応答コードの電力レベルを表わす (x_n, y_n) 値のテーブルと比較する。この比較により、VF電話線を通しての送信による各周波数の信号ロスが得られる。ステップ3の間に、発振モデム26及び応答モデム26'の両方は、各々のモデムによる送信が行なわれない場合にラインに存在するノイズデータを累積する。次いで、両方のモデムは、累積されたノイズ信号に基づいてFFTを実行し、各搬送波周波数における測定した(受信した)ノイズスペクトル成分値を決定する。多数のノイズエポックを平均化して、測定値の精度を高める。

ステップ4において、発振モデムは、2つの周波数のエポックと、それに続いて、512の周波数の発振コームを、ステップ2について述べたものと同じ電力レベルで送信する。応答モデムは、エポック及び発振コームを受け取り、ステップ2の発振モデムについて述べたように各搬送波周波数におけるタイミング、周波数ずれ及び信号ロスの値を計算する。この点において、発振モデム26は、ノイズ及び信号ロスデータを応答発振方向に送信するように累積しており、一方、応答モデムは、発振応答方向の送信に関連する同じデータを累積している。各モデムは、発振応答方向及び応答発振方向の両方における送信ロス及び受信ノイズに関連したデータを必要とする。それ故、このデータは、同期プロセスの残りのステップに基づいて2つのモデム間で交換される。

ステップ5において、発振モデムは、どの搬送波周波数が標準電力レベルの2ビット送信を応答発振方向に維持するかを示す第1の位相エンコード信号を発生して送信する。標準電力レベルで応答発振方向に2ビットを維持する各成分は、 180° の相対的な位相を有した-28dBR信号として発生される。標準電力レベルで応答発振方向に2ビット送信を維持しない各成分は、 -28 で 0° の相対的位相の信号としてコード化される。応答モデムは、この信号を受信し、どの周波数搬送波が応答発振方向に2ビットの送信を維持するかを決定する。

ステップ6において、応答モデムは、どの搬送波周波数が発振応答方向及び応答発振方向の両方に2ビット送信を維持するかを示す第2の位相エンコード信号を発生し送信する。この信号を発生できるのは、応答モデムが発振応答方向のノイズ及び信号ロスデータを累積しており且つステップ5で発振モデムにより発生された信号において応答発振方向に対して同じデータを受信しているからである。発振モデムによって発生された信号において、2つのビットを両方向に維持する各周波数成分は、 180° の相対的な位相でコード化され、他の全ての成分は、 0° の相対的な位相でコード化される。

これで、2つのモデム間に送信リンクが存在する。一般に、300ないし400個の周波数成分が標準電力レベルの2ビット送信を維持し、これにより、2つのモデム間に約600ビット/エポック率を確立する。ステップ7では、この存在するデータリンクを経て形成される全体的なパケットにおいて応答発振方向に各周波数で維持することのできるビットの数(0-15)及び電力レベル(0-63dB)に関するデータを発振モデムが送信する。従って、ここで、発振及び応答モデムの両方は、応答発振方向の送信に関するデータをもつことになる。各周波数成分に維持することのできるビットの数及び電力レベルを計算するためのステップについて以下に述べる。

ステップ8において、応答モデムは、存在するデータリンクを用いて発振応答方向に各周波数に維持することのできるビットの数及び電力レベルに関するデータを送信する。従って、両モデムは、応答発振及び発振応答の両方向において各周波数成分に維持すべきビットの数及び電力レベルが分かる。

各搬送波周波数における等価ノイズレベル成分の決定に関する上記の説明では、所与のシーケンスの所要のステップが説明された。しかしながら、これらの一連のステップはあまり重要ではなく、多くのステップは同時に行なってもよいし別の順序で行なってもよい。例えば、発振コードに基づくFFTの実行とノイズデータの累積を同時に行なうことができる。又、同期プロセス中に正確なタイミング基準も計算される。このタイミング基準の計算は、各周波数成分に割り当てられたビットの数及び電力レベルを計算する方法を説明した後、詳細に述べる。

送信信号と受信信号との間に7Hzまでの周波数オフセットが存在するのは、一般のVF電話線の障害である。FFTを確実に機能させるためには、このオフセットを補正しなければならない。好ましい実施例では、この補正は、受信信号の真の像及びヒルバート像によりオフセット周波数における直角トーンの片側波帯変調を行なうことによって達成される。同期及び追従アルゴリズムにより、必要な周波数オフセットの推定値が形成される。

電力及びコードの複雑さ、即ち1回の変調で送信するビット数の指定

各搬送波周波数信号にエンコードされた情報は、復調器56により受信チャンネルにおいてデコードされる。チャンネルノイズは、送信信号を歪ませ、復調プロセスの精度を低下させる。例えば、特定の周波数 f_0 に B_0 個のビットがあるという特定の複雑さ、即ち1回の変調で送信するビット数を有するデータエレメントを、等価ノイズレベル成分 N_0 により特徴付けられたVF電話線を経て送信する場合について分析する。一般に、外部システムの条件により、許容できる最大ビットエラー率が決定される。ノイズレベル N_0 及び周波数 f_0 で b_0 個の

ビットを送信する場合には、信号対雑音比が E_b/N_0 以上でなければならない。但し、 E_b は、BERを所与のBER(BER) σ より小さく維持するための信号電力/ビットである。

第5図は、種々の複雑さ、即ち1回の変調で送信するビット数 B の信号に対するQAM座標を示している。各座標に対する例示的な信号対雑音比 E_b/N_0 と、上記の(BER) σ を越えずにこの座標におけるビットの数を送信するに要する電力とが、各座標グラフの横に示されている。

モデムは、公共のスイッチ式電話線に出力される全利用電力が電話会社及び政府機関によって設定された値 P_0 を越えないという制約のもとで作動する。従って、ラインノイズを補償するために信号電力が不定に増加することはない。それ故、所要のBERを維持するためには、ノイズが増加するにつれて、送信信号の複雑さ、即ち1回の変調で送信するビット数を低減しなければならない。

殆どの既存のモデムは、ラインノイズ電力が増加する時に、信号の複雑さ、即ち1回の変調で送信するビット数をダウン方向に任意にギヤシフトする。例えば、1つの公知のモデムは、ビットエラー率が指定の最大値以下に減少されるまで、送信データ率を、9600bpsの最大値から、7200bps、4800bps、2400bps、1200bps、等々の段階で低下させる。従って、信号率は、ノイズを補償するように大きな段階で減少される。バラン氏の特許においては、送信率を減少する方法は、ノイズスペクトルの周波数依存性を考慮するものである。従って、各チャンネルは、プリセットされた数のビットを指定の電力レベルで保持している。各周波数のノイズ成分が測定され、各搬送波周波数で送信すべきであるかどうかについて判断がなされる。従って、バラン氏の特許では、データ率減少機構が、利用できる帯域中にわたるノイズの実際の分布を補償する。

本発明では、各周波数搬送波における信号の複雑さ、即ち1回の変調で送信するビット数及び各周波数搬送波に割り当てられた利用可能な電力の量がラインノイズスペクトルの周波数依存性に応答して変化する。

全周波数内の周波数成分信号に種々のコードの複雑さ、即ち1回の変調で送信するビット数及び電力レベルを指定する本システムは、水充填アルゴリズムに基づくものである。水充填アルゴリズムは、チャンネルを横切る情報の流れを最大にするようにチャンネルの電力を指定する情報理論的な方法である。チャンネルは、ノイズ分布が不均一である形式のもので、送信器は電力の制約を受ける。第6図は、水充填アルゴリズムを目で見て分かるようにするものである。第6図について説明すれば、電力は垂直軸に沿って測定され、周波数は水平軸に沿って測定される。等価ノイズスペクトルは実線60で表わされ、利用可能な電力は、交差斜線領域72によって表わ

される。水充填という名称は、指定電力を表わす或る量の水が充填される山間の一連の谷に等価ノイズ関数が類似していることから付けられたものである。水は谷を満たし、水平面をとる。水充填アルゴリズムの理論的な説明は、1968年、ニューヨーク、J. Wiley and Sons出版の「情報理論及び信頼性のある通信 (Information Theory And Reliable Communication)」と題するガラハー (Gallagher) 氏の文献に述べられている。

水充填理論は、種々のコード (全てエラー修正のためのもの) を用いて達成できる全てのデータ率の最大値として容量が定められ且つ無限の長さであることが最良の傾向であるようなチャンネルの理論的な容量を最大にすることに關するものである点を強調しておく。

本発明による方法は、チャンネルの容量を最大にするものではない。むしろ、本発明の方法は、第1図について上記したように利用可能な電力に制約のあるQAM全体を用いて送信される情報の量を最大にするものである。水充填の考え方の実行は、指定の電力レベルが第2の最低搬送波の等価ノイズレベルに達するまで最低の等価ノイズフロアを有する搬送波に利用可能な電力の増分を割り当てることである。この割当を行なう場合には、512の周波数を走査しなければならない。

次いで、第3の最低チャンネルの等価ノイズレベルに達するまで2つの最低搬送波の間で増分電力が割り当てられる。この割当レベルの場合には、周波数テーブルを何回も走査することが必要で、計算上から非常に複雑である。

本発明の好ましい実施例に用いる電力の割当方法は、次の通りである。

(1) 受信器において等価ノイズを測定しそして送信ロスで乗算することにより送信器におけるシステムノイズを計算する。これらの量を測定するこのプロセスは、第4図を参照し同期について上記で説明した。システムノイズ成分は、各搬送波周波数について計算される。

(2) 各搬送波周波数に対し、色々な複雑さ (ここに示す場合には、0, 2, 4, 5, 及び6) のデータエレメントを送信するに必要な電力レベルを計算する。これは、所要のBER、例えば、1エラー/100000ビットで種々のデータエレメントを送信するに必要な信号対雑音比によって等価ノイズを乗算することにより行なわれる。全BERは、変調された各搬送波の信号エラー率の和である。これらの信号対雑音比は、標準的な基準から得られ、この分野で良く知られている。

(3) 計算された所要の送信電力レベルから、データエレメントの複雑さ、即ち1回の変調で送信するビット数を増加するに必要な余分な電力レベルが決定される。これらの余分な所要の電力レベルは、送信電力の差を、複雑さ、即ち1回の変調で送信するビット数が最も接近し

ているデータエレメントの複雑さ、即ち1回の変調で送信するビット数の量的な差で除算したものである。

(4) 各々のチャンネルについて、余分な所要電力レベル及び量的な差の2カラムテーブルを形成する。それらの単位は、典型的に、各々ワット及びビットで表わされる。

(5) 次第に大きくなる余分な電力に従って上記ステップ4のテーブルを編成することによりヒストグラムを構成する。

10 (6) 利用できる電力が尽きるまで、次第に大きくなる余計な電力に対して利用できる送信電力を順次に指定する。

上記の電力割当方法は、簡単な例によって良く理解できよう。この例に含まれる数値は、オペレーティングシステムにおいて遭遇するパラメータを表わすものではない。

表1は、周波数 f A 及び f B の2つの搬送波 A 及び B に対し、選択されたビット数 N₁ のデータエレメントを送信するための所要電力 P を示している。

搬 送 波 A			
N ₁	N ₂ -N ₁	P	MP(N ₁ ~N ₂)
0	—	0	—
2	2	4	MP(0~2) = 2/ビット
4	2	12	MP(2~4) = 4/ビット
5	1	19	MP(4~5) = 7/ビット
6	1	29	MP(5~6) = 10/ビット

搬 送 波 B			
N ₁	N ₂ -N ₁	P	MP(N ₁ ~N ₂)
0	—	0	—
2	2	6	MP(0~2) = 3/ビット
4	2	18	MP(2~4) = 6/ビット
5	1	29	MP(4~5) = 11/ビット
6	1	44	MP(5~6) = 15/ビット

第1のビット数 N₁ から第2のビット数 N₂ へ複雑さ、即ち1回の変調で送信するビット数を増加するための余分な電力は、次の関係式によって定められる。

$$MP(N_1 \sim N_2) = \frac{P_2 - P_1}{N_2 - N_1}$$

但し、P₂ 及び P₁ は、複雑さ、即ち1回の変調で送信するビット数 N₂ 及び N₁ のデータエレメントを送信するに必要な電力である。N₂ - N₁ は、データエレメントの複雑さ、即ち1回の変調で送信するビット数の量的な差である。BERは、プリセット限界以下に保つように制限されることを理解されたい。

周波数 f A に対する余分な電力は、周波数 f B に対するものよりも少ない。というのは、f B における等価ノイズ N (f B) が f A における等価ノイズ N (f A) より大きいからである。

搬送波A及びBの割当機構に実施について以下に述べる。全ビット数NTが周波数全体にエンコードされるが、搬送波AにもBにもビットが割り当てられていないものと仮定する。例えば、 $N(fA)$ 及び $N(fB)$ は、既にデータを保持しているこれらの搬送波の電力よりも大きい。

この例では、システムは、全データエレメントの複雑さ、即ち1回の変調で送信するビット数を最大量だけ増加するために利用可能な残りの10個の電力単位を搬送波AとBとの間で割り当てる。

NTを2ビットだけ増加するためには、チャンネルAを用いる場合は4単位の電力を割り当てねばならず、チャンネルBを用いる場合は6単位の電力を割り当てねばならない。というのは、両チャンネルに対して $N_1 = 0$ 及び $N_2 = 2$ でありそしてチャンネルAに対して $MP(0 \sim 2) = 2/\text{ビット}$ 、チャンネルBに対して $MP(0 \sim 2) = 3/\text{ビット}$ であるからである。それ故、システムは、4単位の電力を搬送波Aに割り当て、2ビットデータエレメントを搬送波Aにコード化し、全信号の複雑さ、即ち1回の変調で送信するビット数をNTからNT+2に増加し、残りの利用可能な電力単位が6となる。2ビットを更に増加する場合には、搬送波Aに対して $MP(2 \sim 4) = 4/\text{ビット}$ で且つチャンネルBに対して $MP(0 \sim 2) = 3/\text{ビット}$ であるから、電力単位が6つで必要である。それ故、システムは、6単位の電力を搬送波Bに割り当て、2ビットデータエレメントを搬送波Bにエンコードし、全信号の複雑さ、即ち1回の変調で送信するビット数をNT+2からNT+4ビットに増加し、残りの利用可能な電力単位はゼロとなる。

ここで明らかなように、システムは、種々の搬送波周波数の中で電力コストが最低のものを「買い(shopping)」、全データエレメントの複雑さ、即ち1回の変調で送信するビット数を増加させる。

割当システムは、周波数を最初に走査する間に各搬送波に対し最初に表1を形成することによって全部で512個の搬送波全体まで拡張される。

次いで、全ての搬送波に対して計算された余計な所要電力レベルを次第に大きくなる電力に従って編成したヒストグラムが構成される。第7図は、本発明の方法により構成した例示的なヒストグラムを示している。

第7図には、余計な電力の全体的な表が示されていない。むしろ、このヒストグラムは、0.5dBのステップでカウント値が離された64dBの範囲を有するように構成される。ステップとステップとの間の量的な差がカウントとして用いられる。この解決策では若干の丸めエラーが生じるが、作業の長さを著しく低減することができる。ヒストグラムを構成するのに用いる方法は、本発明を実施するのに重要ではない。

ヒストグラムの各カウントは、そのカウントにおける電力値に等しい余分な電力値を有する搬送波の数を表わし

ている整数入力を持している。このヒストグラムは、最低の電力レベルから走査される。各カウントの整数入力は、カウントの数値で乗算され、利用可能な電力から減算される。走査は、利用可能な電力が尽きるまで続けられる。

走査が完了すると、所与のレベルMP(max)より低い全ての余計な電力値が電力及びデータの割当に受け入れられることが決定される。更に、利用可能な電力が余計な電力レベルMP(max)を通して部分的に尽きた場合には、k個の追加搬送波に、MP(max+1)に等しい電力が割り当てられる。

次いで、システムは、種々の搬送波に電力及びデータを割り当てるために再び周波数全体を走査する。各搬送波に割り当てられる電力の量は、MP(max)に等しいか又はそれより小さい当該搬送波に対する余分な電力値の和である。これに加えて、kMP(max+1)の値がそれまで割り当てられていない場合には、MP(max+1)に等しい電力の量が割り当てられる。

タイミング及び位相遅延の補償

受信システムによって(x, y)ベクトルテーブルを再構成する場合には、受信した波形を1024回サンプリングすることが必要である。帯域中は約4KHzであり、従って、ナイキストのサンプリング率は約8000/秒で、サンプル間の時間サンプルオフセットは125マイクロ秒である。従って、全サンプリング時間は128ミリ秒である。同様に、送信FFTは、1024の入力を有する時間シリーズを発生し、記号時間は128ミリ秒である。

サンプリングプロセスでは、サンプリングを開始するためのタイミング基準が必要とされる。このタイミング基準は、同期中に次の方法によって確立される。第4図を参照して定められた同期ステップ中には、発振モデムが時間TESTに応答コームにおける1437.5Hzの周波数成分(第1のタイミング信号)のエネルギーを検出する。上記の時間は、第1のタイミング周波数成分が受信器に到達する正確な時間のおおよその尺度であり、一般に、約2ミリ秒までの精度である。

このおおよその尺度は、次の段階によってその精度が高められる。第1のタイミング信号及び第2のタイミング信号(1687.5Hz)は、エポックマークにおいて相対的な位相がゼロの状態に送信される。

発振モデムは、時間TESTにおいて第1及び第2のタイミング信号の位相を比較する。第1と第2のタイミング信号間に250Hzの周波数差があると、各125マイクロ秒の時間サンプルオフセットに対し2つの信号間に11°の位相ずれが生じる。第1及び第2のタイミング信号は、それらの位置が帯域の中心付近にあるために相対的な位相歪みが僅かである(250マイクロ秒未

満)。従って、2つのタイミングサンプルの位相を比較しそして位相差によって指示された時間サンプリングオ

フセットの個数でTESTを修正することにより、正確なタイミング基準T₀を決定することができる。

サンプリングプロセスをタイミングどりすることに関連した更に別の問題は、周波数に依存した位相遅延がVFラインによって誘起されることである。この位相遅延は、典型的に、VF電話線の場合には、約2ミリ秒或いはそれ以上である。更に、この位相遅延は、4kHzの使用帯域の端付近では著しく悪化する。

第8図は、周波数に依存する位相遅延を受けた後の全周波数の周波数搬送波の分布を示している。第8図を説明すれば、周波数 f_0 、 f_{256} 及び f_{512} に3つの信号90、94、及び92が示されている。長さがTsの2つの記号 x_i 及び y_i は、各周波数において送信される。各記号の中は、不変であることに注意されたい。しかしながら、帯域90及び92の端付近の信号の先縁は、帯域94の中心付近のこれら信号に対して遅延される。

更に、2つの順次に送信されたエポック x_i 及び y_i については、帯域の外端付近にある信号92及び96上の第1記号 x_i の後部が、帯域の中心付近にある記号94上の第2記号 y_i の先端に重畳する。この重畳により、記号間の干渉が生じる。

サンプリングインターバルが所与の時間インターバルTsでサンプリングするように枠付けされる場合には、全周波数における各搬送波の完全なサンプルが得られず、他のエポックからの信号がサンプリングされる。

既存のシステムは、位相修正(等化)回路網を用いて位相歪みを補償すると共に記号間の干渉を防止する。

本発明は、独特なガード時間フォーマットを用いて等化回路網の必要性を排除するものである。このフォーマットが第9図に示されている。

第9図を説明すれば、時間シリーズ x_i 、 y_i 及び z_i によって各々表わされた第1、第2及び第3の送信記号が示されている。第9図に示された波形は、周波数 f の搬送波の1つに変調される。この例では、記号時間Tsが128ミリ秒で、最大位相遅延TPHが8ミリ秒であると仮定される。ガード時間波形は、136ミリ秒のエポックを定める。例えば、第1の波形110(x_i)においては、記号の時間シリーズ $X_0 - X_{1023}$ が最初に送信され、次いで、記号の最初の8ミリ秒 $X_0 - X_{63}$ が繰り返される。

エポックのサンプリングは、ガード時間波形の最後の128ミリ秒に揃えされる(最初に到着する周波数成分によって定められたガード時間エポックの開始に対して)。

この検出プロセスが第10図に示されている。第10図において、帯域の中心付近の f_1 と、帯域の端付近の f_2 とにおける第1及び第2のガード時間波形110及び112が示されている。 f_1 における周波数成分は、受信器に最初に到着する全周波数のうちの成分であり、 f_2

における成分は、最後に到着する成分である。第10図において、 f_2 の第2の波形112は、 f_1 の第1の波形110が受信器に到着する時間 T_0 後の時間 $T_0 + TPH$ (8ミリ秒)に受信器に到着する。この時間 $T_0 + TPH$ に128ミリ秒のサンプリング時間が開始される。従って、 f_2 の全記号 $X_0 - X_{1023}$ がサンプリングされる。その記号の最初の8ミリ秒が再送信されるので、 f_1 の全記号もサンプリングされる。

又、記号間の干渉も排除される。 f_1 の第2記号(y_i)の到着は、(x_i)の最初の8ミリ秒の再送信によって、8ミリ秒遅延される。従って、 f_1 の第2記号の先端は、 f_2 の第1記号の後端と重畳しない。

8ミリ秒のガード時間は、システムの使用可能な時間と帯域巾との積を約6%減少するに過ぎない。この僅かな減少は、必要なガード時間に対して各記号の中が非常に長いことによるものである。

追従

実際に、所与の搬送波については、復調プロセス中に抽出される(x 、 y)ベクトルの大きさが厳密に座標点に入らず、ノイズ及び他のファクタにより各点のまわりに或る程度分布される。従って、信号は、第11図に示された変調テンプレートを用いてデコードされる。

第11図を説明すれば、テンプレートは方形113のグリッドで形成され、方形113の中心には座標点114が設けられている。

第11図において、ベクトル $W = (x_n, y_n)$ は、 f_n におけるサイン及びコサイン信号の復調された振幅を表わしている。 W は、座標点(3, 3)を中心とする方形113内にある。従って、 W は、(3, 3)とデコードされる。

本発明は、同期中に決定された値からの送信ロス、周波数オフセット及びタイミングの変化を決定するように追従を行なうシステムを備えている。

この追従システムは、第11図の復調テンプレートの方形における受信ベクトルの位置を利用するものである。

第12図において、1つの方形が、左下、右上、右上及び左下、各々、115、116、117及び118の4つの象限に分けられており、これらは、各々、速過ぎ、遅過ぎ、大き過ぎ、小さ過ぎを表わしている。これら4つの全ての象限におけるカウントが、或る周波数において或る時間に及ぶものも、或る時間において或る周波数に及ぶものも、互いに等しいか又はほぼ等しい場合には、システムが整列状態にある。即ち、ノイズが唯一の障害である場合には、デコードされたベクトル W に対するエラーの方向がランダムとなる。

しかしながら、送信ロスが0.1dBでも変化する場合に、小さ過ぎるカウントの数が大き過ぎるカウントの数から著しく変化する。同様に、速過ぎるカウントの数と遅過ぎるカウントの数との差が大きい場合には、オフセット周波数の変化によって位相の回転が生じたことを示

21

している。従って、速過ぎ、遅過ぎ及び大き過ぎ、小さ過ぎのカウンタ間の差は、信号ロス及びオフセット周波数の変化に追従するエラー特となる。

本発明は、このエラー特性を用いて、同期中に決定された信号ロス及び周波数オフセットを調整するものである。各周波数に対し、 $\pm 0.1\text{dB}$ 又は $\pm 1.0^\circ$ の調整がエラー特性に基づいて行なわれる。或る実施例では、デコード領域を、速過ぎ、遅過ぎ、大き過ぎ、小さ過ぎという個別の又は重畳するサブ領域に別のやり方で分割するのが好ましい。

更に、タイミング信号の位相は、 T_0 を修正できるように追従される。

チャンネル制御権の指定

本発明は、更に、確立された通信リンクの制御権を発振モデムと応答モデム（各々、A及びBと称する）の間で指定する独特のシステムを具備している。エンコードされた全周波数で構成される各波形は、情報パケットを形成する。

通信リンクの制御権は、最初に、モデムAに指定される。次いで、モデムAは、その入力バッファにおけるデータの量を決定し、I（最小）とN（予め定めた最大）のデータパケットの間で適当に送信を行なう。所定数Nは限界として働き、送信されるパケットの最終的な個数は、入力バッファを空にするに必要なものよりも著しく小さい。一方、モデムAがその入力バッファに殆ど或いは全くデータを有していない場合には、モデムBとの通信を維持するために依然としてI個の情報パケットを送信する。例えば、I個のパケットは、第4図及び同期プロセスについて述べた周波数の発振又は応答コムを含む。

次いで、通信リンクの制御権はモデムBに指定され、該モデムは、モデムAの動作を繰り返す。もちろん、モデムBが最小数Iのパケットを送信する場合には、モデムBが働いていることをモデムAに知らせる。

迅速な文字やエコーや他のユーザ向けの目標を達成するために、2つのモデムの限界Nを同じものにしたり或いはモデム制御のもとでこれらモデムの適用を制限したりする必要はない。

ハードウェアの実施

第13図は、本発明のハードウェア実施例を示すブロック図である。第13図を説明すれば、電子的なデジタルプロセッサ120、アナログI/Oインターフェイス44及びデジタルI/Oインターフェイス122が共通のデータバス124に接続されている。アナログI/Oインターフェイス44は、公共のスイッチ式電話線48を共通のデータバス124にインターフェイスし、デジタルインターフェイス122は、デジタルターミナル装置126を共通のデータバス124にインターフェイスする。

本発明の好ましい実施例では、次の部品が使用される。

22

アナログI/Oインターフェイス44は、高性能の12ビットコーダ・デコーダ（コーデック）及び電話線インターフェイスである。このインターフェイスは、RAM132をアクセスし、監視マイクロプロセッサ128によって制御される。コーデックは、アナログ/デジタルコンバータ、デジタル/アナログコンバータ及び多数のバンドパスフィルタを単一のチップに組み合わされたものである。

デジタルI/Oインターフェイス122は、標準的な25ピンのRS232型コネクタに対する標準的なRS232直列インターフェイスであるか或いはパーソナルコンピュータバスに対する並列インターフェイスである。電子的なデジタルプロセッサ120は、アドレスバス135に接続された監視プロセッサ128と、汎用の数学プロセッサ130と、 $32\text{K} \times 16$ ビットの共用RAMサブシステム132と、リードオンメモリ（ROM）ユニット133とを備えている。

監視マイクロプロセッサ128は、10MHzの68000プロセッサ及び68000プログラムメモリを含む68000データプロセッササブシステムである。 $32\text{K} \times 16$ ビットのプログラムメモリは、ROMユニット133に含まれた多数の低電力高密度のROMチップで構成される。

数学プロセッサ130は、20MHzの320プロセッサ、320プログラムメモリ及び共用RAMシステムのインターフェイスを含む320デジタル信号マイクロプロセッサシステム（DSP）である。ROMユニット133に含まれた2つの高速ROMチップは、 8192×16 ビットのプログラムメモリを構成する。

320システムのプログラムメモリは、変調テーブルのルックアップ、FFT、復調及び上記の他の動作を実行するプログラムを含んでいる。68000プロセッサは、入力及び出力のデジタルデータ流を処理し、320信号プロセッサ及びそれに関連したアナログI/Oへのタスク及びその監視を実行し、そしてそれ自体及びシステムのテストを適宜実行する。

本発明は、特定の実施例について説明した。他の実施例は、今や、当業者に明らかであろう。

特に、搬送波周波数全体は、上記したように制限しなくてもよい。搬送波の数は、2の累乗、例えば、1024でもよいし、他の任意の数でもよい。更に、周波数は、全VF帯域にわたって均一に離間されてなくてもよい。更に、QAM機構は、本発明の実施にとって重要ではない。例えば、AMを使用してもよいが、データ率RBが低下する。

更に、変調テンプレートは方形で構成する必要がない。座標点を取り巻く任意の形状の領域を画成することができる。追従システムは、変調テンプレートの方形を4つの象限に分割したものについて説明した。しかしながら、座標点の周りに画成された任意の領域におけるカウ

ント数の差を追跡することにより所与のパラメータを追跡することができる。

更に、監視マイクロプロセッサ及び汎用の数学プロセッサを含むハードウェア実施例についても説明した。しかしながら、色々な組合わせのICチップを使用することができる。例えば、専用のFFTチップを用いて、変調*

*及び復調動作を実行することができる。

更に、上記で用いた情報単位はビットであった。しかし、本発明は、2進システムに限定されるものではない。

それ故、本発明は、請求の範囲のみによって限定されるものとする。

【第1図】

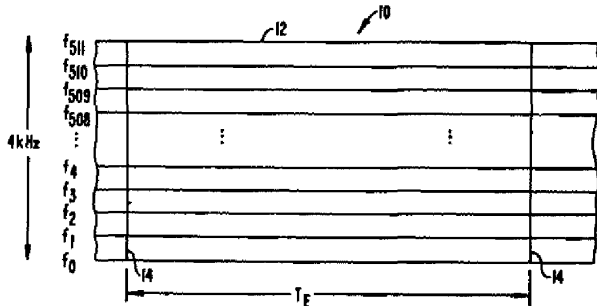

【第2図】

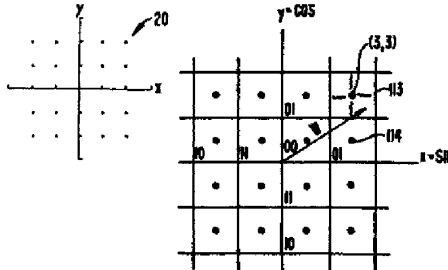

【第11図】

【第3図】

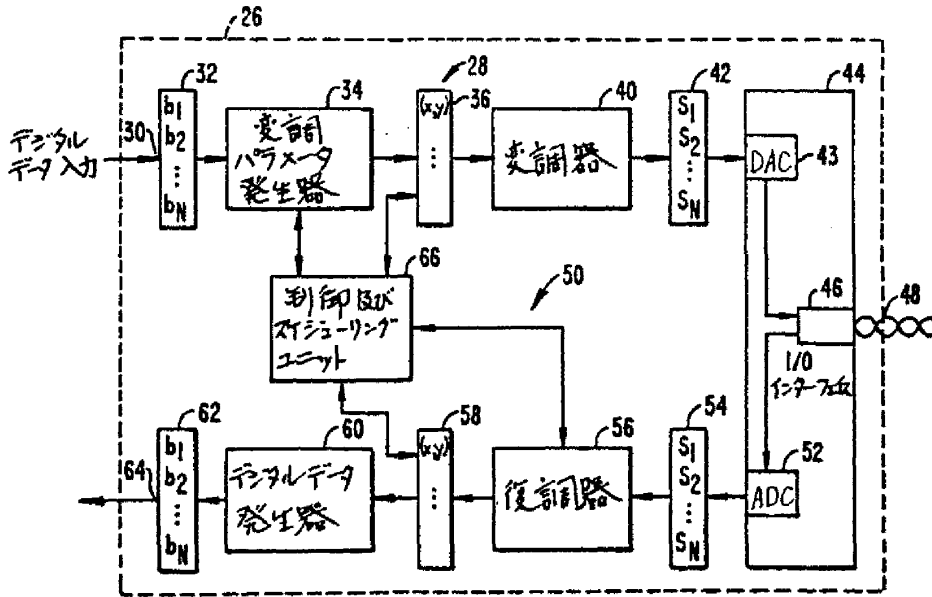

【第9図】

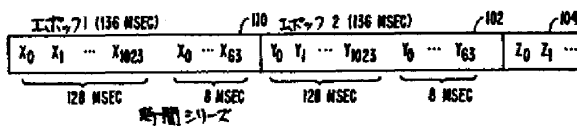

【第4図】

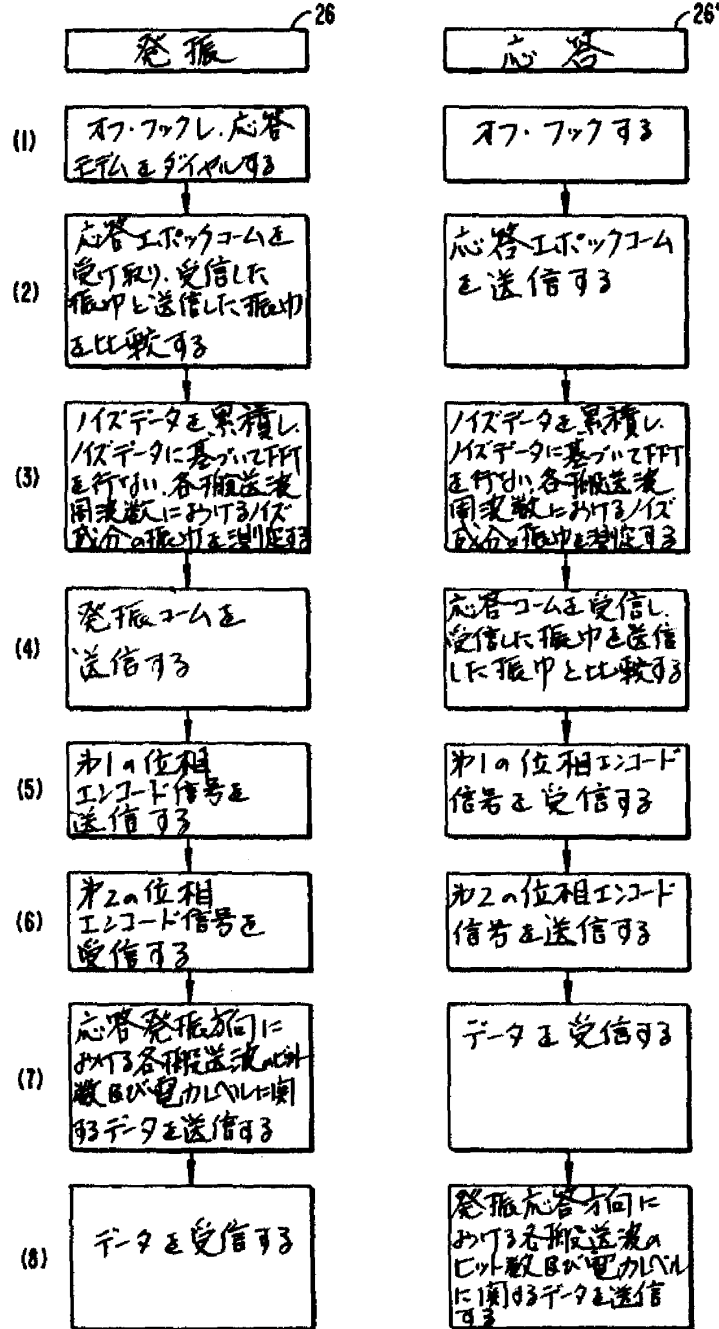

【第5図】

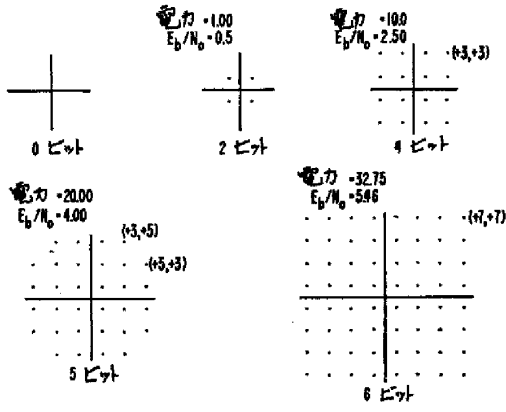

【第6図】

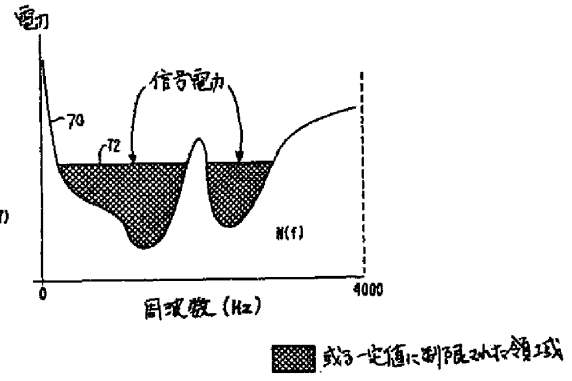

【第7図】

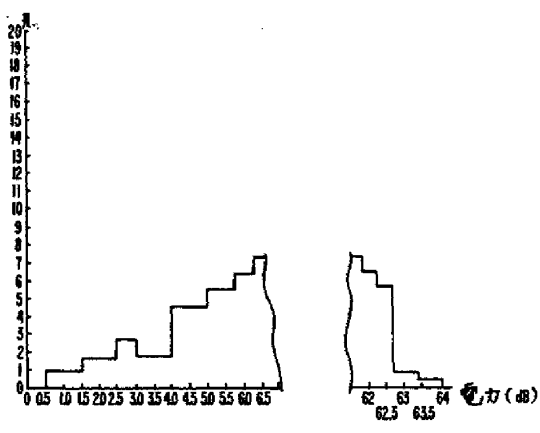

【第10図】

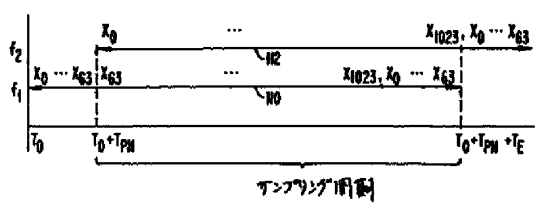

【第8図】

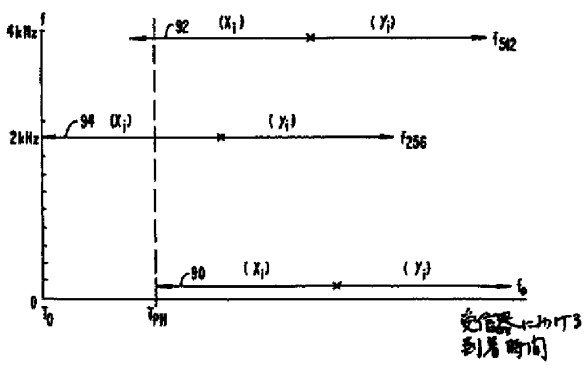

【第12図】

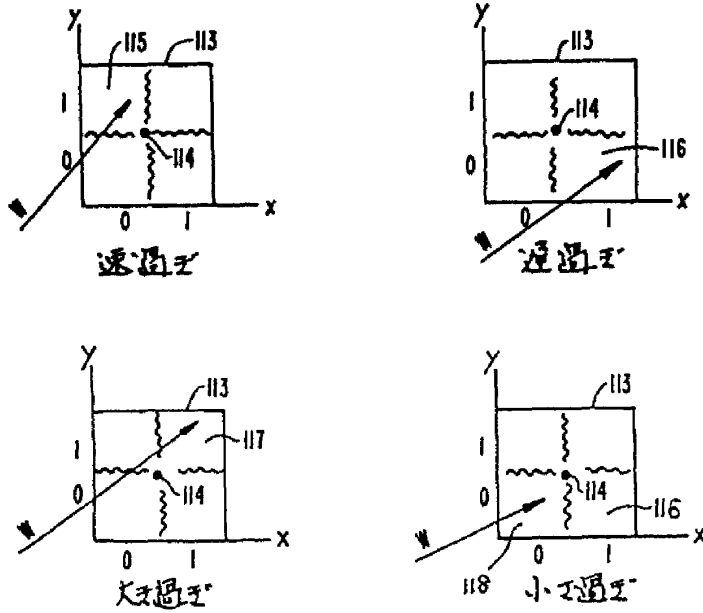

【第13図】

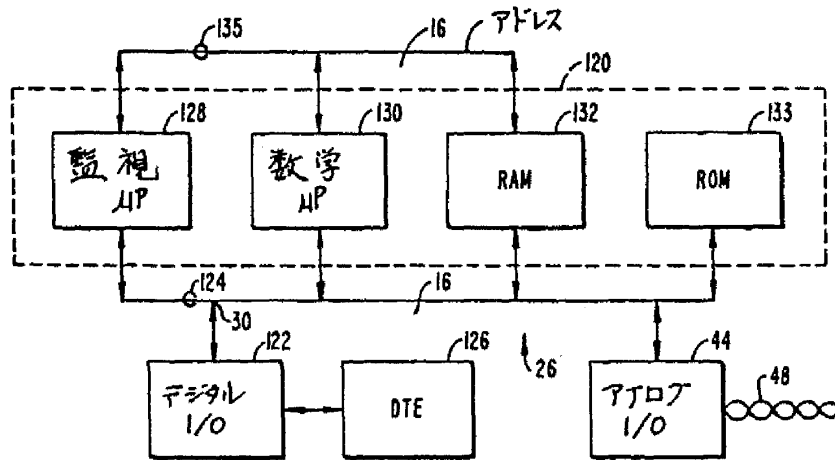

METHOD OF COMMUNICATION CHANNEL MONITORING USING PARITY BITS

Publication number: JP10513622 (T)

Publication date: 1998-12-22

Inventor(s):

Applicant(s):

Classification:

- international: H04N7/16; H04B10/207; H04J3/14; H04J3/16; H04L1/00; H04L1/24; H04L5/02; H04L5/14; H04L25/03; H04L27/26; H04M11/06; H04N7/173; H04L27/00; H04N7/16; H04B10/207; H04J3/14; H04J3/16; H04L1/00; H04L1/24; H04L5/02; H04L5/14; H04L25/03; H04L27/26; H04M11/06; H04N7/173; H04L27/00; (IPC1-7): H04L1/00; H04J3/14; H04J3/16; H04M11/06; H04N7/16

- European: H04N7/173B; H04J3/14; H04L1/00B7B; H04L1/24; H04L5/02Q; H04L5/14T2; H04L25/03E3; H04L27/26M2; H04L27/26M3; H04L27/26M5; H04L27/26M5A1P; H04L27/26M5C3

Application number: JP19960524387T 19960206

Priority number(s): WO1996US01606 19960206; US19950384659 19950206; US19950457295 19950601

Also published as:

WO9624995 (A2)

WO9624995 (A3)

TW409475 (B)

EP0808534 (A2)

CN1193433 (A)

more >>

Abstract not available for JP 10513622 (T)

Abstract of corresponding document: WO 9624995 (A2)

A method for monitoring at least one telephony communication n-bit channel, wherein one of the bits is a parity bit, includes sampling the parity bit of the n-bit channel. A probable bit error rate is derived from the sampling of the parity bit. The probable bit error rate can be compared to a pre-determined bit error rate value to determine if the at least one telephony communication n-bit channel is corrupted. If the at least one telephony communication n-bit channel is corrupted, the at least one telephony communication n-bit channel is re-allocated to an uncorrupted and unallocated telephony communication n-bit channel. Further, at least one unallocated telephony communication channel can be periodically monitored and error data accumulated to indicate the quality thereof.

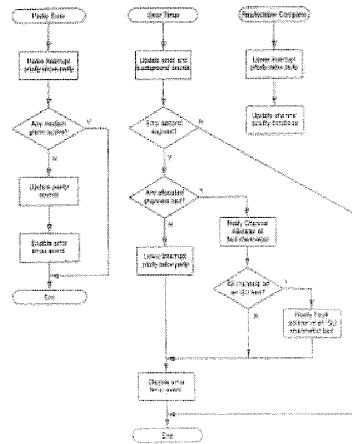

Data supplied from the *espacenet* database — Worldwide

(51)Int.Cl. ⁶	識別記号	F I	
H 0 4 L	1/00	H 0 4 L	1/00 C
H 0 4 J	3/14	H 0 4 J	3/14 Z
	3/16		3/16 Z
H 0 4 M	11/06	H 0 4 M	11/06
H 0 4 N	7/16	H 0 4 N	7/16 Z

審査請求 未請求 予備審査請求 有 (全144頁)

(21)出願番号 特願平8-524387
 (86) (22)出願日 平成8年(1996)2月6日
 (85)翻訳文提出日 平成9年(1997)8月6日
 (86)国際出願番号 PCT/US96/01606
 (87)国際公開番号 WO96/24995
 (87)国際公開日 平成8年(1996)8月15日
 (31)優先権主張番号 08/384,659
 (32)優先日 1995年2月6日
 (33)優先権主張国 米国 (US)
 (31)優先権主張番号 08/457,295
 (32)優先日 1995年6月1日
 (33)優先権主張国 米国 (US)

(71)出願人 エーディーシー テレコミュニケーションズ、インコーポレイティド
 アメリカ合衆国、ミネソタ 55435、ブルーミントン、ウエスト セブンティエイス ストリート 4900
 (72)発明者 アンダーソン、プライアン ディー、
 アメリカ合衆国、ミネソタ 55442、ブリマウス、フィフティース プレイス ノース 11430
 (74)代理人 弁理士 石田 敬 (外3名)

最終頁に続く

(54)【発明の名称】 通信チャンネルをモニタする方法

(57)【要約】

少なくとも1つの電話通信nビットチャンネルをモニタする方法であって、該ビットの1つはパリティビットであり、該nビットチャンネルのパリティビットをサンプリングすることを含む。予想されるビットエラー率は該パリティビットのサンプリングから求められる。該予想されるビットエラー率は、少なくとも1つの電話通信nビットチャンネルがこわれているかどうかを決定するために、予め定められたビットエラー率の値と比較される。もし少なくとも1つの電話通信nビットチャンネルがこわれているならば、該少なくとも1つの電話通信nビットチャンネルは、こわれておらずかつ割当てられていない電話通信nビットチャンネルに再割当てされる。更に、少なくとも1つの割当てられていない電話通信チャンネルが周期的にモニタされ、エラーデータがその品質を示すために累積される。

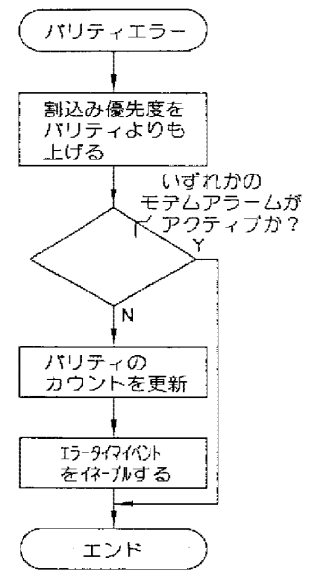

FIG. 29A

【特許請求の範囲】

1. 少なくとも1つの電話通信nビットチャンネルをモニタする方法であって、該ビットの1つがパリティビットであり、

該nビットチャンネルのパリティビットをサンプリングするステップと、

該パリティビットのサンプリングから予想されうるビットエラー率を求めるステップとを具備する方法。

2. 少なくとも1つの割当てられていない電話通信チャンネルに対して、エラーデータを周期的にモニタし累積するステップを更に備えた、請求項1に記載の方法。

3. 少なくとも1つの電話通信nビットチャンネルがこわれているかどうかを決定するために、予想されうるビットエラー率を、予め決定されたビットエラー率の値と比較するステップと、

もし少なくとも1つの電話通信nビットチャンネルがこわれているならば、該少なくとも1つの電話通信nビットチャンネルを、こわれておらずかつ割当てられていない電話通信nビットチャンネルに再割当てするステップとを更に備えた、請求項1に記載の方法。

4. 少なくとも1つの電話通信nビットチャンネルがこわれているかどうかを決定するために、予想されうるビットエラー率を、予め決定されたビットエラー率の値と比較するステップと、

もし該nビットチャンネルがこわれているならば、システム全体の電力を維持している間、該nビットチャンネルの伝送パワーを増加するステップとを更に備えた、請求項1に記載の方法。

5. 少なくとも1つの電話通信nビットチャンネルをモニタする方法であって、該ビットの1つがパリティビットであり、

該nビットチャンネルのパリティビットをサンプリングするステッ

プと、

ある期間に亘って該パリティビットのサンプリングから予想されうるビットエラー率を求めるステップと、

該 n ビットチャネルがこわれているかどうかを決定するために、ある期間に亘って予想されうるビットエラー率を予め定められたビットエラー率の値と比較するステップとからなる方法。

6. 該比較にもとづいて、該 n ビットチャネルから異なる n ビットチャネルに通信を再割当てするステップを更に備える、請求項 5 に記載の方法。

7. 少なくとも 1 つの電話通信 n ビットチャネルが、複数の電話通信の n ビットチャネルの帯域内に含まれており、該帯域が少なくとも 1 つの制御チャネルと関連しており、更に異なる n ビットチャネルが該帯域内に配置されている、請求項 6 に記載の方法。

8. 少なくとも 1 つの電話通信 n ビットチャネルが複数の電話通信 n ビットチャネルの帯域内に含まれており、該帯域は少なくとも 1 つの制御チャネルと関連しており、更に異なる n ビットチャネルが、他の少なくとも 1 つの関連した制御チャネルを有する複数の電話通信 n ビットチャネルの第 2 の帯域に配置されている、請求項 6 に記載の方法。

9. もし該 n ビットチャネルがこわれているならば、システム全体の電力を維持している間、該 n ビットチャネルの伝送パワーを増加するステップを更に備えた、請求項 5 に記載の方法。

10. テーブル内に予想されうるビットエラー率を記憶するステップを更に備え、該テーブルは n ビットチャネル上の将来の通信を割当てするために使用されうる、請求項 5 に記載の方法。

11. もし該チャネルがこわれていないならば、少なくとも 1 つのより長い期間に亘ってパリティビットをサンプリングすることから

少なくとも 1 つの付加的な予想されうるビットエラー率を求めるステップと、

該 n ビットチャネルがこわれているかどうかを決定するために、該少なくとも 1 つの付加的な予想されうるビットエラー率を付加的な予め定められたビットエラー率の値と比較するステップとを更に備えた、請求項 5 に記載の方法。

12. 予め定められたビットエラー率の値は電話通信サービスのためであり、付加的な予め定められたビットエラー率の値は、付加的な電話通信サービスのため

である、請求項11に記載の方法。

13. 電話通信サービスの1つはISDNである、請求項12に記載の方法。

14. もし該nビットチャネルがこわれているならば、システム全体の電力を維持している間、該nビットチャネルの伝送パワーを増加させるステップを更に備えた、請求項11に記載の方法。

15. 該少なくとも1つの付加的な予想されうるビットエラー率と付加的な予め定められたビットエラー率の値との比較にもとづいて、該nビットチャネルから異なるnビットチャネルへ該通信を再割当てするステップを更に備えた、請求項11に記載の方法。

16. 少なくとも1つの電話通信nビットチャネルをモニタする方法であって、該ビットの1つがパリティビットであり、

第1の期間に亘って該nビットチャネルのパリティビットをサンプリングするステップと、

該第1の期間に亘る該パリティビットのサンプリングから予想されうるビットエラー率を求めるステップと、

該nビットチャネルがこわれているかどうかを決定するために該第1の期間に亘っての該予想されうるビットエラー率を予め定められたビットエラー率の値と比較するステップと、

もし該nビットチャネルがこわれていないならば、複数の連続する期間に亘って予想されうるビットエラー率を累積するステップとを備えた方法。

17. 該nビットチャネルがこわれているかどうかを決定するために、該連続する期間に亘っての該累積された予想されうるビットエラー率を、少なくとも1つの付加的な予め定められたビットエラー率の値と比較するステップを更に備えた、請求項16に記載の方法。

18. もし該nビットチャネルがこわれているならば、該nビットチャネルからの通信を第2のnビットチャネルに再割当てするステップを更に備えた、請求項17に記載の方法。

19. もし該nビットチャネルがこわれているならば、システム全体の電力を維

持している間、該 n ビットチャネルの伝送パワーを増加するステップを更に備えた、請求項17に記載の方法。

20. 該予め定められたビットエラー率の値は電話通信サービスと関連しており、また該少なくとも1つの付加的な予め定められたビットエラー率の値は、少なくとも1つの付加的な電話通信サービスと関連している、請求項19に記載の方法。

21. 該電話通信サービスの1つはISDNである、請求項20に記載の方法。

22. もし該 n ビットチャネルがこわれているならば、該 n ビットチャネルから第2の n ビットチャネルに通信を再割当てするステップを更に備えた、請求項16に記載の方法。

23. もし該 n ビットチャネルがこわれているならば、システム全体の電力を維持している間、該 n ビットチャネルの伝送パワーを増加するステップを更に備えた、請求項16に記載の方法。

24. 少なくとも1つの電話通信 n ビットチャネルをモニタする方法であって、該ビットの1つはパリティビットであり、

該 n ビットチャネルのパリティビットをサンプリングするステップと、

第1の期間に亘って該パリティビットをサンプリングすることから予想されうるビットエラー率を求めるステップと、

該 n ビットチャネルがこわれているかどうかを決定するために、該第1の期間に亘っての予想されうるビットエラー率を第1の予め定められたビットエラー率の値と比較するステップと、

第2の期間に亘って該パリティビットをサンプリングすることから予想されうるビットエラー率を求めるステップであって、該第2の期間は該第1の期間より長くされていて該第1の期間と同時に経過するものと、

該 n ビットチャネルがこわれているかどうかを決定するために該第2の期間に亘って該予想されうるビットエラー率を第2の予め定められたビットエラー率の値と比較するステップとを備えた方法。

25. もし該 n ビットチャネルがこわれていなければ、該 n ビットチャネルから

第2のnビットチャンネルに通信を再割当てするステップを更に備えた、請求項24に記載の方法。

26. もし該nビットチャンネルがこわれていれば、システム全体の電力を維持している間、該nビットチャンネルの伝送パワーを増加させるステップを更に備えた、請求項24に記載の方法。

27. テーブル内に該予想されうるビットエラー率を記憶するステップを更に備え、該テーブルはnビットチャンネル上の将来の通信を割当てするために使用される、請求項24に記載の方法。

28. 少なくとも1つの割当てられていない電話通信チャンネルをモニタする方法であって、

該少なくとも1つの割当てられていない電話通信チャンネルを周期的にモニタするステップと、

該少なくとも1つの割当てられていない電話通信チャンネルに対するエラーデータを累積するステップと、

該少なくとも1つの割当てられていない電話通信チャンネルを、該エラーデータにもとづいて、割当てられるのを許容するステップとからなる方法。

29. こわされた電話通信チャンネルから、少なくとも1つの割当てられていない電話通信チャンネルに、電話通信を再割当てするステップを更に備えた、請求項28に記載の方法。

30. 少なくとも1つの割当てられていない電話通信チャンネルを周期的にモニタする方法であって、

遠隔の送信機から、複数ビットの1つがパリティビットであるnビットの信号を送信するステップと、

nビットチャンネルのパリティビットをサンプリングするステップと、

該サンプリングされたパリティビットから予想されうるビットエラー率を求めるステップとを含む、請求項28記載の方法。

31. 割当てられていないチャンネルがパワーダウンされた割当てチャンネルである方法であって、

該チャンネルがモニタされうるように、割当てられていないチャンネル上の遠隔の位置で遠隔のトランスミッタをパワーアップするステップと、

該チャンネルがモニタされた後で該遠隔のトランスミッタをパワーダウンするステップとを更に含む、請求項28に記載の方法。

32. 該チャンネルがこわれているかどうかを決定するために、予想されうるビットエラー率を予め定められたビットエラー率と比較するステップを更に備えた、請求項28に記載の方法。

33. 少なくとも1つの割当てられていない電話通信チャンネルが、

複数の割当てられていない電話通信チャンネルの1つであり、少なくとも或る数の割当てられていない電話通信チャンネルがモニタされる方法であって、このようなモニタリングにもとづいて少なくとも或る数の割当てられていないチャンネルの品質をランク付けするステップを含む、請求項28に記載の方法。

34. 該ランク付けするステップは、高品質のチャンネルをスタンバイチャンネルとしてわきにセットすることを含む、請求項33に記載の方法。

【発明の詳細な説明】

通信チャネルをモニタする方法

発明の分野

本発明は一般的には通信システムの分野に関し、特に本発明は通信チャネルのモニタリングに関する。

発明の背景

最近、家庭とビジネスで見出される2つの情報サービスにはテレビジョン又はビデオサービスおよび電話サービスを含む。他の情報サービスにはデジタルデータ転送を含み、これはしばしば電話サービスに接続されたモデムを用いて達成される。ここでの電話に対するすべての更なる引用には、電話サービスとデジタルデータ転送サービスを含む。

電話とビデオの各信号の特性は異なっており、したがって電話とビデオの各ネットワークは異なる設計がなされる。例えば、電話情報は、ビデオ信号に対する帯域幅と比較したとき、比較的狭い帯域を占有する。更に、電話信号は低周波数であるのに対し、NTSC基準ビデオ信号は50MHzより高いキャリア周波数で伝送される。したがって電話伝送ネットワークはオーディオ周波数で動作する比較的狭い帯域幅システムであり、このシステムは通常壁受側接合ボックスから降下するねじれたワイヤによって顧客にサービスする。他方、ケーブルテレビジョンサービスは広帯域であり、従来の非常に高い周波数のテレビジョン受信器と両立しうる信号を達成するために種々の周波数キャリア混合方法を組み込む。ケーブルテレビジョンシステム又はビデオサービスは典型的には各個々家庭又はビジネスへのシールドされたケーブルサービス接続を通してケーブルテレビジョン会社によって提供される。

電話及びビデオサービスを単一のネットワークに組合せる1つの試みは、“光通信ネットワーク”と題するBalanceへの米国特許4,977,593号に記載されている。Balanceには中央局に配置された光源を有する受動的な光通信網が記載されている。該光源は光ファイバーに沿って時分割多重光信号を送信し、この信号はいくつかの個別的なファイバーをサービスする支所間の一連のスプリッタによって後

で分割される。該ネットワークは同じ光学的経路を介して、デジタル音声データが支所から中央局まで伝送されるのを許容する。更に Balanceは付加的な波長がデジタル多重を介して該ネットワークへ、ケーブルテレビジョンのようなサービスを加えるために利用されうることを示している。

James A.Chiddixと David M.Pangracによる“ファイバー“バックボーン：進化論的なケーブルTVネットワークアーキテクチャに対する提案”と題する1988年NCTAテクニカルペーパーには、ハイブリッド光ファイバー／同軸ケーブルテレビジョン（CATV）システムのアーキテクチャについて記載されている。該アーキテクチャは既存の同軸CATVネットワークで構成する。該アーキテクチャは既存のCATV分配システムにおけるヘッドエンドからいくつかのフィードポイントへの直接的な光ファイバー経路の使用を含む。

“光波伝送ラインを用いたCATV分配ネットワーク”と題するPidgeonに対する米国特許第 5,153,763号には、ヘッドエンドから複数の加入者への広帯域多重チャンネルCATV信号の分配に対するCATVネットワークについて記載されている。ヘッドエンドにおける電気から光へのトランスミッタおよびファイバーノードにおける光から電気へのレシーバは、広帯域CATV電気信号に対応する光信号を放射させ

かつ受信する。光ファイバーノードからの分配は、同軸ケーブルの伝送ラインに沿って電気信号を送信することによって得られる。該システムは、すべての又は一部の広帯域CATV信号を1オクターブより小さい周波数範囲にブロック変換することによって、送信された広帯域CATV信号のひずみを減少させる。“光波伝送ラインを使用したCATV分配ネットワーク”と題する Pidgeonに対する関連米国特許第 5,262,883号には更にひずみを減少させるシステムについて記載されている。

上述の各ネットワークはハイブリッド光ファイバー／コアックスアーキテクチャを含む、種々のアーキテクチャに亘って広帯域ビデオ信号を送信することに対する種々の概念を示している。しかしこれらの参照例のいずれにも電話通信に対するコストのかからないフレキシブルな通信システムについて記載されていない。いくつかの問題は、かかる通信システムにおいて固有のものである。

1つのかかる問題は、使用される帯域幅が割当てられた帯域幅を超えないよう

にトランスポートデータに対して使用される帯域幅を最適化する必要性である。帯域幅の条件は、多対1の通信において特に重要であり、ここでは遠隔のユニットにある多くのトランスミッタが、割当てられた帯域幅を超えないように適応されなければならない。

第2の問題はシステムの電力消費を含む。通信システムはデータのトランスポートに対し遠隔のユニットにおいて用いられる電力を最小にすべきである。その理由は、送受信に対して遠隔のユニットで利用される設備は、システムの伝送メディアに亘って分配される電力によって供給されうるからである。

データの完全さにも配慮されなければならない。内部および外部の干渉は通信の品質を低下させる。内部干渉はシステムに亘ってト

ランスポートされるデータ信号の間に存在する。すなわち共通の通信リンクに亘ってトランスポートされるデータ信号は、それらの間で干渉を経験し、データの完全性を低下させる。外部供給源からのイングレスもまたデータ伝送の完全性に影響を及ぼす。電話通信ネットワークは外部供給源によって発生されるHAM無線のような“ノイズ”の影響を受け易い。このようなノイズは間欠的で強度が変化しうるので、システムに亘ってデータをトランスポートする方法は正確でまたこのようなイングレスの存在を避けるべきである。

これらの問題およびその他については、質の高い通信システムに対する必要性を示す以下の記述から明らかとなるであろう。

発明の概要

多対1の通信システムに固有の問題のいくつかを配慮した、特にイングレスに関して配慮したチャンネルモニタリングの使用について記述される。本発明のモニタ方法は、複数ビットの1つがパリティビットである電話通信nビットチャンネルをモニタする。該nビットチャンネルのパリティビットはサンプリングされ、該パリティビットのサンプリングから予想されうるビットエラー率が求められる。

1実施例では、ある期間に亘る該予想されうるビットエラー率が、該nビットチャンネルがこれわているかどうかを決定するために、最小ビットエラー率を表す予め定められたビットエラー率の値と比較される。こわれたチャンネルは再割当て

されうるか、又は他の実施例では、その崩壊を克服するために該チャネルの伝送パワーが増加されうる。

別の方法の実施例では、該方法は、第1の期間に亘って該nビットチャネルのパリティビットをサンプリングするステップと、該第1の期間に亘るパリティビットのサンプリングから予想されうるビ

ットエラー率を求めるステップと、該第1の期間に亘る該予想されうるビットエラー率を、該nビットチャネルがこわれているかどうかを決定するために予め定められたビットエラー率の値と比較するステップと、もし該nビットチャネルがこわれていなければ複数の連続する期間に亘って予想されうるビットエラー率を累積するステップとをそなえる。

更に他の方法の実施例では、該方法は、該nビットチャネルのパリティビットをサンプリングするステップと、第1の期間に亘る該パリティビットのサンプリングから予想されうるビットエラー率を求めるステップとをそなえる。該第1の期間に亘る該予想されうるビットエラー率は、該nビットチャネルがこわれているかどうかを決定するために、第1の予め定められたビットエラー率の値と比較される。第2の期間に亘るパリティビットのサンプリングから予想されうるビットエラー率が求められる。該第2の期間は該第1の期間より長く、かつ同時に経過する。該nビットチャネルがこわれているかどうかを決定するために、該第2の期間に亘る予想されうるビットエラー率が、第2の予め定められたビットエラー率の値と比較される。

更に他の変形実施例においては、少なくとも1つの割当てられていない電話通信チャネルをモニタする方法は、少なくとも1つの割当てられていない電話通信チャネルを周期的にモニタすることを含む。該少なくとも1つの割当てられていない電話通信チャネルに対するエラーデータは累積され、該少なくとも1つの割当てられていない電話通信チャネルは該エラーデータにもとづいて割当てられる。

。 図面の簡単な説明

図1は、ハイブリッドファイバー／コアックス分配ネットワークを用いた本発明による通信システムのブロック図を示す。

図2は、図1のシステムの別の実施例である。

図3は、図1のシステムのトランスミッタおよびレシーバに関連したホストデジタル端末(HDT)の詳細なブロック図である。

図4は、図3の関連したトランスミッタおよびレシーバのブロック図である。

図5は、図1のシステムの光分配ノードのブロック図である。

図6は、図1のホーム統合サービスユニット(HISU)又はマルチ統合サービスユニット(MISU)のような、統合サービスユニット(ISU)の一般的なブロック図である。

図7A, 7B, 7Cは、図3のHDTに利用されるデータフレーム構造およびフレームシグナリングを示す。

図8は、図3のコアックスマスターユニット(CXMU)のコアックスマスターカード(CXMC)の一般的なブロック図である。

図9Aは、図1のシステムにおける電話トランスポートに対する第1のトランスポート実施例に対するスペクトル割当てを示す。

図9Bは、QAM変調に対するマッピング図を示す。

図9Cは、BPSK変調に対するマッピング図を示す。

図9Dは、図9Aのスペクトル割当てに対するサブバンド図を示す。

図10は、図1のシステムの第1のトランスポート実施例に対するCXMUのマスターコアックスカード(MCC)下り伝送アーキテクチャのブロック図である。

図11は、図1のシステムの第1のトランスポート実施例に対するMISUのコアックストランスポートユニット(CXTU)下りレシーバアーキテクチャのブロック図である。

図12は、図1のシステムの第1のトランスポート実施例に対するHISUのコアックスホームモジュール(CXHM)下りレシーバアーキテクチャのブロック図である。

図13は、図12のCXHM下りレシーバアーキテクチャと関連したCXHM上り伝送アー

キテクチャのブロック図である。

図14は、図11のCXTU下りレシーバアーキテクチャと関連したCXTU上り伝送アーキテクチャのブロック図である。

図15は、図10のMCC下り伝送アーキテクチャと関連したMCC上りレシーバアーキテクチャのブロック図である。

図16は、図1のシステムで使用される獲得物分配ループルーチンのフローチャートである。

図17は、図1のシステムで使用されるトラッキング分配ループ体系ルーチンのフローチャートである。

図18は、図15のMCC上りレシーバアーキテクチャの多相フィルタバンクのマグニチュード応答を示す。

図19は、図18のマグニチュード応答の一部拡大図である。

図20は、図15のMCC上りレシーバアーキテクチャのイングレスフィルタ構成およびFFTのブロック図である。

図21は、図20のイングレスフィルタ構成およびFFTの多相フィルタ構造のブロック図である。

図22Aは、第1のトランスポート実施例の下りレシーバアーキテクチャのキャリア、振幅、タイミング再生ブロックのブロック図である。

図22Bは、第1のトランスポート実施例のMCC上りレシーバアーキテクチャのキャリア、振幅、タイミング、再生ブロックのブロック図である。

図23は、第1のトランスポート実施例のレシーバアーキテクチャ

に対する内部イコライザ動作のブロック図である。

図24は、図1はシステムにおけるトランスポートに対する第2のトランスポート実施例のスペクトル割当てである。

図25は、図1のシステムの第2のトランスポート実施例に対するCXMUのMCCモデムアーキテクチャのブロック図である。

図26は、図1のシステムの第2のトランスポート実施例に対するHISUの加入者モデムアーキテクチャのブロック図である。

図27は、図26の加入者モデムアーキテクチャのモデムのブロック図である。

図28は、図1のシステムで用いられるチャンネルモニタに対するブロック図である。

図29A、29B、29Cは、図28のチャンネルモニタルーチンのエラーモニタ部分に対するフローチャートである。

図29Dは、図29Bに対する別のフローチャートである。

図30は、図28のチャンネルモニタルーチンのバックグラウンドモニタ部分に対するフローチャートである。

図31は、図28のチャンネルモニタルーチンのバックアップ部分に対するフローチャートである。

好適な実施例の詳細な説明

通信システム10は、本発明の図1に示すように、ハイブリッドファイバー・同軸（HFC）分散ネットワーク11上で家庭及びビジネス電話通信サービスを提供するために主として設計されたアクセスプラットフォームである。システム10は、電話やビデオサービスの提供にとって価格的に有効なプラットフォームである。電話サービスは標準的な電話、コンピュータデータ及び／又はテレメトリを含む。加えて、本システムは住居の加入者に対して現存する明

確なサービスに適応するためのフレキシブルプラットフォームである。

ハイブリッドファイバー・同軸分散ネットワーク11は、中央局又はヘッドエンド32から遠隔に配置された分散ノード18（以下、光分散ノード（ODN）と称する）に電話及びビデオサービスを提供するために光ファイバーフィーダラインを利用する。ODN18から、サービスは同軸ネットワークを経て加入者に分散される。HFC基底通信システム10を利用することにより幾つかの利点が存在する。フィーダにインストールされたファイバーを利用することにより、システム10は100の加入者にわってオプトエレクトロニクスの価格をばらまく。分散点から各加入者（「スター」分散アプローチ）に設けられた分離した銅ループを持つ代わりに、システム10は、分散同軸脚部30がサービスのために各家庭及び加入者「タップ」を通るためのバスアプローチを設置する。システム1

0は、非ビデオサービスが、RFスペクトルの専用部分にてより價格的に有効なRFモデム装置を使用して伝送するために変調されることを許容する。最終的に、システム10は、同軸分散リンクが現存するケーブル・レディTVセットを直接駆動することができるので、ビデオサービスが、何ら追加の加入者機器を必要とせずに現存する同軸設備上で担持されることを許容する。

ここで述べるモデムトランスポート・アーキテクチャー、アーキテクチャーの機能性、及びこのようなアーキテクチャーを囲む動作がハイブリッドファイバー・同軸ネットワークよりむしろ分散ネットワークで利用されることは、当業者において明らかである。例えば、機能性は無線システムにおいて実行される。それ故、本発明は添付の請求項に従ってそのようなシステムの使用を企図する。

システム10は、ネットワークインタフェース、同期、DSOG

ルーミング、及び動作、さらに管理、保守及び準備インタフェース(OAM&P)、のような電話トランスポートのための共通の機器機能を備え、さらに、統合サービスユニット100(ISU)のような顧客インタフェース機器へ又はからの情報を担うトランスポートシステムとスイッチングネットワークの間のインタフェースを含むホストデジタル端末12(HDT)を含む。家庭用統合サービスユニット(HISU)68又は多重の居住統合サービスユニットに対向するようなビジネス統合サービスユニットを含む多重ユーザ統合サービスユニット(MISU)66のような、統合サービスユニット(ISU)100は、全ての顧客インタフェース機能及びスイッチされたネットワークへ又はから情報を担うトランスポートシステムへのインタフェースを設置する。本発明のシステムにおいて、HDT12は通常中央局に位置され、ISU100は遠隔の種々の位置に分散されて配置される。HDT12及びISU100は、多対点形態のもとにハイブリッドファイバー・同軸分散ネットワーク11を経て接続される。本発明において、HFC分散ネットワーク11上で情報をトランスポートするために必要とされるモデムの機能性は、HDT12及びISU100の両方におけるインタフェース機器により実行される。このようなモデムの機能性は、直交周波数分割マルチプレックスを利用して実行される。