

AO 120 (Rev. 08/10)

TO: Mail Stop 8 Director of the U.S. Patent and Trademark Office P.O. Box 1450 Alexandria, VA 22313-1450	REPORT ON THE FILING OR DETERMINATION OF AN ACTION REGARDING A PATENT OR TRADEMARK
---	--

In Compliance with 35 U.S.C. § 290 and/or 15 U.S.C. § 1116 you are hereby advised that a court action has been filed in the U.S. District Court District of Delaware on the following
 Trademarks or Patents. (the patent action involves 35 U.S.C. § 292.):

DOCKET NO. 15-cv-615-RGA	DATE FILED 7/17/2015	U.S. DISTRICT COURT District of Delaware	
PLAINTIFF TQ Delta, LLC		DEFENDANT Time Warner Cable Inc. and Time Warner Cable Enterprises LLC	
PATENT OR TRADEMARK NO.	DATE OF PATENT OR TRADEMARK	HOLDER OF PATENT OR TRADEMARK	
1 See Attached			
2			
3			
4			
5			

In the above—entitled case, the following patent(s)/ trademark(s) have been included:

DATE INCLUDED 9/9/2015	INCLUDED BY <input checked="" type="checkbox"/> Amendment <input type="checkbox"/> Answer <input type="checkbox"/> Cross Bill <input type="checkbox"/> Other Pleading		
PATENT OR TRADEMARK NO.	DATE OF PATENT OR TRADEMARK	HOLDER OF PATENT OR TRADEMARK	
1 US 9,094,268 B2	7/28/2015	TQ Delta, LLC	
2			
3			
4			
5			

In the above—entitled case, the following decision has been rendered or judgement issued:

DECISION/JUDGEMENT

CLERK	(BY) DEPUTY CLERK	DATE
-------	-------------------	------

Copy 1—Upon initiation of action, mail this copy to Director Copy 3—Upon termination of action, mail this copy to Director
 Copy 2—Upon filing document adding patent(s), mail this copy to Director Copy 4—Case file copy

COMCAST-1007

Comcast Cable Communications LLC, et. al. v. TQ Delta

Page 1 of 379

	PATENT OR TRADEMARK NO.	DATE OF PATENT OR TRADEMARK	HOLDER OF PATENT OR TRADEMARK
1	US 6,961,369 B1	11/1/2005	TQ Delta, LLC
2	US 8,718,158 B2	5/6/2014	TQ Delta, LLC
3	US 9,014,243 B2	4/21/2015	TQ Delta, LLC
4	US 7,835,430 B2	11/16/2010	TQ Delta, LLC
5	US 8,238,412 B2	8/7/2012	TQ Delta, LLC
6	US 8,432,956 B2	4/30/2013	TQ Delta, LLC
7	US 8,611,404 B2	12/17/2013	TQ Delta, LLC

AO 120 (Rev. 08/10)

TO: Mail Stop 8 Director of the U.S. Patent and Trademark Office P.O. Box 1450 Alexandria, VA 22313-1450	REPORT ON THE FILING OR DETERMINATION OF AN ACTION REGARDING A PATENT OR TRADEMARK
---	--

In Compliance with 35 U.S.C. § 290 and/or 15 U.S.C. § 1116 you are hereby advised that a court action has been filed in the U.S. District Court Middle District of Florida, Orlando Division on the following
 Trademarks or Patents. (the patent action involves 35 U.S.C. § 292.):

DOCKET NO. 6:14-cv-1027	DATE FILED 6/26/2014	U.S. DISTRICT COURT Middle District of Florida, Orlando Division
PLAINTIFF Orlando Communications LLC		DEFENDANT LG Electronics, Inc., et al
PATENT OR TRADEMARK NO.	DATE OF PATENT OR TRADEMARK	HOLDER OF PATENT OR TRADEMARK
1 5,687,1296	11/11/1997	James Arthur Proctor, Jr., James Carl Otto
2 6,0009,553	12/28/0199	Dennis Martinez, Thomas Hengeveld, Michael Axford
3		
4		
5		

In the above—entitled case, the following patent(s)/ trademark(s) have been included:

DATE INCLUDED	INCLUDED BY <input type="checkbox"/> Amendment <input type="checkbox"/> Answer <input type="checkbox"/> Cross Bill <input type="checkbox"/> Other Pleading	
PATENT OR TRADEMARK NO.	DATE OF PATENT OR TRADEMARK	HOLDER OF PATENT OR TRADEMARK
1		
2		
3		
4		
5		

In the above—entitled case, the following decision has been rendered or judgement issued:

DECISION/JUDGEMENT Order of Dismissal
--

CLERK Sheryl Loesch	(BY) DEPUTY CLERK R. Olsen	DATE 9/9/2015
------------------------	-------------------------------	------------------

Copy 1—Upon initiation of action, mail this copy to Director Copy 3—Upon termination of action, mail this copy to Director
 Copy 2—Upon filing document adding patent(s), mail this copy to Director Copy 4—Case file copy

AO 120 (Rev. 08/10)

TO: Mail Stop 8 Director of the U.S. Patent and Trademark Office P.O. Box 1450 Alexandria, VA 22313-1450	REPORT ON THE FILING OR DETERMINATION OF AN ACTION REGARDING A PATENT OR TRADEMARK
---	--

In Compliance with 35 U.S.C. § 290 and/or 15 U.S.C. § 1116 you are hereby advised that a court action has been filed in the U.S. District Court Middle District of Florida, Orlando Division on the following
 Trademarks or Patents. (the patent action involves 35 U.S.C. § 292.):

DOCKET NO. 6:14-cv-1026	DATE FILED 6/26/2014	U.S. DISTRICT COURT Middle District of Florida, Orlando Division
PLAINTIFF Orlando Communications LLC		DEFENDANT LG Electronics, Inc., et al
PATENT OR TRADEMARK NO.	DATE OF PATENT OR TRADEMARK	HOLDER OF PATENT OR TRADEMARK
1 5,687,1296	11/11/1997	James Arthur Proctor, Jr., James Carl Otto
2 6,0009,553	12/28/0199	Dennis Martinez, Thomas Hengeveld, Michael Axford
3		
4		
5		

In the above—entitled case, the following patent(s)/ trademark(s) have been included:

DATE INCLUDED	INCLUDED BY <input type="checkbox"/> Amendment <input type="checkbox"/> Answer <input type="checkbox"/> Cross Bill <input type="checkbox"/> Other Pleading	
PATENT OR TRADEMARK NO.	DATE OF PATENT OR TRADEMARK	HOLDER OF PATENT OR TRADEMARK
1		
2		
3		
4		
5		

In the above—entitled case, the following decision has been rendered or judgement issued:

DECISION/JUDGEMENT Order of Dismissal
--

CLERK Sheryl Loesch	(BY) DEPUTY CLERK R. Olsen	DATE 9/9/2015
------------------------	-------------------------------	------------------

Copy 1—Upon initiation of action, mail this copy to Director Copy 3—Upon termination of action, mail this copy to Director
 Copy 2—Upon filing document adding patent(s), mail this copy to Director Copy 4—Case file copy

AO 120 (Rev. 08/10)

TO: Mail Stop 8 Director of the U.S. Patent and Trademark Office P.O. Box 1450 Alexandria, VA 22313-1450	REPORT ON THE FILING OR DETERMINATION OF AN ACTION REGARDING A PATENT OR TRADEMARK
---	--

In Compliance with 35 U.S.C. § 290 and/or 15 U.S.C. § 1116 you are hereby advised that a court action has been filed in the U.S. District Court District of Delaware on the following

Trademarks or Patents. (the patent action involves 35 U.S.C. § 292.):

DOCKET NO. 15-cv-616-RGA	DATE FILED 7/17/2015	U.S. DISTRICT COURT District of Delaware	
PLAINTIFF TQ Delta, LLC		DEFENDANT Verizon Communications Inc., Verizon Services Corp., Verizon Online LLC, Verizon Business Network Services Inc., Verizon Delaware LLC, and Verizon Information Technologies LLC	
PATENT OR TRADEMARK NO.	DATE OF PATENT OR TRADEMARK	HOLDER OF PATENT OR TRADEMARK	
1 See Attached			
2			
3			
4			
5			

In the above—entitled case, the following patent(s)/ trademark(s) have been included:

DATE INCLUDED 9/9/2015	INCLUDED BY <input checked="" type="checkbox"/> Amendment <input type="checkbox"/> Answer <input type="checkbox"/> Cross Bill <input type="checkbox"/> Other Pleading		
PATENT OR TRADEMARK NO.	DATE OF PATENT OR TRADEMARK	HOLDER OF PATENT OR TRADEMARK	
1 US 9,094,268 B2	7/28/2015	TQ Delta, LLC	
2			
3			
4			
5			

In the above—entitled case, the following decision has been rendered or judgement issued:

DECISION/JUDGEMENT

CLERK	(BY) DEPUTY CLERK	DATE
-------	-------------------	------

Copy 1—Upon initiation of action, mail this copy to Director Copy 3—Upon termination of action, mail this copy to Director
 Copy 2—Upon filing document adding patent(s), mail this copy to Director Copy 4—Case file copy

	PATENT OR TRADEMARK NO.	DATE OF PATENT OR TRADEMARK	HOLDER OF PATENT OR TRADEMARK
1	US 6,961,369 B1	11/1/2005	TQ Delta, LLC
2	US 8,718,158 B2	5/6/2014	TQ Delta, LLC
3	US 9,014,243 B2	4/21/2015	TQ Delta, LLC
4	US 7,835,430 B2	11/16/2010	TQ Delta, LLC
5	US 8,238,412 B2	8/7/2012	TQ Delta, LLC
6	US 8,432,956 B2	4/30/2013	TQ Delta, LLC
7	US 8,611,404 B2	12/17/2013	TQ Delta, LLC

AO 120 (Rev. 08/10)

TO: Mail Stop 8 Director of the U.S. Patent and Trademark Office P.O. Box 1450 Alexandria, VA 22313-1450	REPORT ON THE FILING OR DETERMINATION OF AN ACTION REGARDING A PATENT OR TRADEMARK
---	--

In Compliance with 35 U.S.C. § 290 and/or 15 U.S.C. § 1116 you are hereby advised that a court action has been filed in the U.S. District Court Middle District of Florida, Orlando Division on the following

Trademarks or Patents. (the patent action involves 35 U.S.C. § 292.):

DOCKET NO. 6:14-cv-1028	DATE FILED 6/26/2014	U.S. DISTRICT COURT Middle District of Florida, Orlando Division	
PLAINTIFF Orlando Communications LLC		DEFENDANT HTC Corporation, et al	
PATENT OR TRADEMARK NO.	DATE OF PATENT OR TRADEMARK	HOLDER OF PATENT OR TRADEMARK	
1 5,687,1296	11/11/1997	James Arthur Proctor, Jr., James Carl Otto	
2 6,0009,553	12/28/0199	Dennis Martinez, Thomas Hengeveld, Michael Axford	
3			
4			
5			

In the above—entitled case, the following patent(s)/ trademark(s) have been included:

DATE INCLUDED	INCLUDED BY <input type="checkbox"/> Amendment <input type="checkbox"/> Answer <input type="checkbox"/> Cross Bill <input type="checkbox"/> Other Pleading		
PATENT OR TRADEMARK NO.	DATE OF PATENT OR TRADEMARK	HOLDER OF PATENT OR TRADEMARK	
1			
2			
3			
4			
5			

In the above—entitled case, the following decision has been rendered or judgement issued:

DECISION/JUDGEMENT Order of Dismissal
--

CLERK Sheryl Loesch	(BY) DEPUTY CLERK R. Olsen	DATE 9/9/2015
------------------------	-------------------------------	------------------

Copy 1—Upon initiation of action, mail this copy to Director Copy 3—Upon termination of action, mail this copy to Director
 Copy 2—Upon filing document adding patent(s), mail this copy to Director Copy 4—Case file copy

AO 120 (Rev. 08/10)

TO: Mail Stop 8 Director of the U.S. Patent and Trademark Office P.O. Box 1450 Alexandria, VA 22313-1450	REPORT ON THE FILING OR DETERMINATION OF AN ACTION REGARDING A PATENT OR TRADEMARK
---	--

In Compliance with 35 U.S.C. § 290 and/or 15 U.S.C. § 1116 you are hereby advised that a court action has been filed in the U.S. District Court District of Delaware on the following
 Trademarks or Patents. (the patent action involves 35 U.S.C. § 292.):

DOCKET NO.	DATE FILED 7/17/2015	U.S. DISTRICT COURT District of Delaware
PLAINTIFF TQ Delta, LLC		DEFENDANT Verizon Communications Inc., Verizon Services Corp., Verizon Online LLC, Verizon Business Network Services Inc., Verizon Delaware LLC, and Verizon Information Technologies LLC
PATENT OR TRADEMARK NO.	DATE OF PATENT OR TRADEMARK	HOLDER OF PATENT OR TRADEMARK
1 See Attached		
2		
3		
4		
5		

In the above—entitled case, the following patent(s)/ trademark(s) have been included:

DATE INCLUDED	INCLUDED BY <input type="checkbox"/> Amendment <input type="checkbox"/> Answer <input type="checkbox"/> Cross Bill <input type="checkbox"/> Other Pleading	
PATENT OR TRADEMARK NO.	DATE OF PATENT OR TRADEMARK	HOLDER OF PATENT OR TRADEMARK
1		
2		
3		
4		
5		

In the above—entitled case, the following decision has been rendered or judgement issued:

DECISION/JUDGEMENT

CLERK	(BY) DEPUTY CLERK	DATE
-------	-------------------	------

Copy 1—Upon initiation of action, mail this copy to Director Copy 3—Upon termination of action, mail this copy to Director
 Copy 2—Upon filing document adding patent(s), mail this copy to Director Copy 4—Case file copy

	PATENT OR TRADEMARK NO.	DATE OF PATENT OR TRADEMARK	HOLDER OF PATENT OR TRADEMARK
1	US 6,961,369 B1	11/1/2005	TQ Delta, LLC
2	US 8,718,158 B2	5/6/2014	TQ Delta, LLC
3	US 9,014,243 B2	4/21/2015	TQ Delta, LLC
4	US 7,835,430 B2	11/16/2010	TQ Delta, LLC
5	US 8,238,412 B2	8/7/2012	TQ Delta, LLC
6	US 8,432,956 B2	4/30/2013	TQ Delta, LLC
7	US 8,611,404 B2	12/17/2013	TQ Delta, LLC

AO 120 (Rev. 3/04)

TO: Mail Stop 8 Director of the U.S. Patent and Trademark Office P.O. Box 1450 Alexandria, VA 22313-1450	REPORT ON THE FILING OR DETERMINATION OF AN ACTION REGARDING A PATENT OR TRADEMARK
--	--

In Compliance with 35 U.S.C. § 290 and/or 15 U.S.C. § 1116 you are hereby advised that a court action has been filed in the U.S. District Court Massachusetts on the following Patents or Trademarks:

DOCKET NO.	DATE FILED 7/17/2015	U.S. DISTRICT COURT Massachusetts
PLAINTIFF BOSTON PROPERTIES LIMITED PARTNERSHIP		DEFENDANT CLAUDETTE MOUSSA, d/b/a Boston Properties Advisors
PATENT OR TRADEMARK NO.	DATE OF PATENT OR TRADEMARK	HOLDER OF PATENT OR TRADEMARK
1 2,527,181	1/8/2002	BOSTON PROPERTIES LIMITED PARTNERSHIP
2		
3		
4		
5		

In the above—entitled case, the following patent(s)/ trademark(s) have been included:

DATE INCLUDED	INCLUDED BY <input checked="" type="checkbox"/> Amendment <input checked="" type="checkbox"/> Answer <input checked="" type="checkbox"/> Cross Bill <input checked="" type="checkbox"/> Other Pleading		
PATENT OR TRADEMARK NO.	DATE OF PATENT OR TRADEMARK	HOLDER OF PATENT OR TRADEMARK	
1			
2			
3			
4			
5			

In the above—entitled case, the following decision has been rendered or judgement issued:

DECISION/JUDGEMENT

CLERK	(BY) DEPUTY CLERK	DATE
-------	-------------------	------

Copy 1—Upon initiation of action, mail this copy to Director Copy 3—Upon termination of action, mail this copy to Director
 Copy 2—Upon filing document adding patent(s), mail this copy to Director Copy 4—Case file copy

AO 120 (Rev. 08/10)

TO: Mail Stop 8 Director of the U.S. Patent and Trademark Office P.O. Box 1450 Alexandria, VA 22313-1450	REPORT ON THE FILING OR DETERMINATION OF AN ACTION REGARDING A PATENT OR TRADEMARK
---	---

In Compliance with 35 U.S.C. § 290 and/or 15 U.S.C. § 1116 you are hereby advised that a court action has been filed in the U.S. District Court Delaware on the following
 Trademarks or Patents. (the patent action involves 35 U.S.C. § 292.);

DOCKET NO.	DATE FILED 9/4/2013	U.S. DISTRICT COURT Delaware
PLAINTIFF ROCHE PALO ALTO LLC and GENENTECH, INC.		DEFENDANT WATSON LABORATORIES, INC. – FLORIDA
PATENT OR TRADEMARK NO.	DATE OF PATENT OR TRADEMARK	HOLDER OF PATENT OR TRADEMARK
1 6,083,953	7/4/2000	Roche Palo Alto LLC
2		
3		
4		
5		

In the above—entitled case, the following patent(s)/ trademark(s) have been included:

DATE INCLUDED	INCLUDED BY <input type="checkbox"/> Amendment <input type="checkbox"/> Answer <input type="checkbox"/> Cross Bill <input type="checkbox"/> Other Pleading		
PATENT OR TRADEMARK NO.	DATE OF PATENT OR TRADEMARK	HOLDER OF PATENT OR TRADEMARK	
1			
2			
3			
4			
5			

In the above—entitled case, the following decision has been rendered or judgement issued:

DECISION/JUDGEMENT <i>Dismissed - See Attached</i>

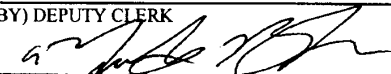
CLERK John A Cerino, Clerk United States District Court 844 N. King Street, Unit 18 Wilmington, DE 19801	(BY) DEPUTY CLERK 	DATE 7/17/15
---	---	-----------------

Copy 1—Upon initiation of action, mail this copy to Director Copy 3—Upon termination of action, mail this copy to Director
 Copy 2—Upon filing document adding patent(s), mail this copy to Director Copy 4—Case file copy

IN THE UNITED STATES PATENT AND TRADEMARK OFFICE

In Re the Application of: Marcos C. Tzannes)	Patent No.: 6,961,369
Application No.: 09/710,310)	Issued: November 1, 2005
Filed: November 9, 2000)	Examiner: NGUYEN, Dung X
Atty. File No.: 6936-47)	Confirmation No.: 5605

For: SYSTEM AND METHOD FOR SCRAMBLING THE PHASE OF THE CARRIERS IN A MULTICARRIER COMMUNICATIONS SYSTEM

**NOTIFICATION OF LOSS OF ENTITLEMENT OF
SMALL ENTITY STATUS UNDER
37 CFR §§ 1.27 (g)(2) and 1.28(c)**

Commissioner for Patents
P.O. Box 1450
Alexandria, VA 22313-1450

Madam:

On November 7, 2012, Applicants filed an Assertion of Entitlement to Small Entity Status in the referenced application. Applicants filed the Assertion in good faith, and paid the fees associated with the application as a small entity in good faith. It was later discovered that the Applicant should not have been entitled to small entity status and the Assertion was established in error.

Pursuant to 37 CFR §§ 1.27(g)(2) and 1.28(c), Applicants are informing the Office that the referenced application is no longer entitled to Small Entity Status.

Furthermore, pursuant to 37 C.F.R. §1.28(c)(1)(2), on December 28, 2012, Applicants submitted a payment of \$2900 at the large entity rate for the 7.5 year maintenance fee and then on January 4, 2013 Applicants requested a refund indicating the payment was made erroneously at the large entity and should have been paid at the small entity rate of \$1450.00. Applicants are now submitting that the referenced patent is no longer a small entity and the 7.5 year maintenance fee should be paid at the large entity rate.

The current fee for the 7.5 year maintenance fee is \$3600. Therefore, the Commissioner is hereby authorized to charge to deposit account number 19-1970 **\$2,150.00** for the deficiency owed.

The Commissioner is also hereby authorized to charge to deposit account number 19-1970 any fees under 37 CFR § 1.16 and 1.17 that may be required by this paper and to credit any overpayment to that Account.

Respectfully submitted,
SHERIDAN ROSS P.C.

Date: March 25, 2013

By: /Jason H. Vick/
Jason H. Vick
Reg. No. 45,285
1560 Broadway, Suite 1200
Denver, Colorado 80202
Telephone: 303-863-9700

Electronic Acknowledgement Receipt

EFS ID:	15346190
Application Number:	09710310
International Application Number:	
Confirmation Number:	5605
Title of Invention:	SYSTEM AND METHOD FOR SCRAMBLING THE PHASE OF THE CARRIERS IN A MULTICARRIER COMMUNICATIONS SYSTEM
First Named Inventor/Applicant Name:	MARCOS C. TZANNES
Customer Number:	62574
Filer:	Jason Vick/Joanne Vos
Filer Authorized By:	Jason Vick
Attorney Docket Number:	6936-47
Receipt Date:	25-MAR-2013
Filing Date:	09-NOV-2000
Time Stamp:	16:30:38
Application Type:	Utility under 35 USC 111(a)

Payment information:

Submitted with Payment	no
------------------------	----

File Listing:

Document Number	Document Description	File Name	File Size(Bytes)/ Message Digest	Multi Part /.zip	Pages (if appl.)
1	Notification of loss of entitlement to small entity status	Loss_of_Entitlement_of_Small Entity_Status.pdf	71478 749200bb867fcaaeef689e4b6373380405a50bb	no	2

Warnings:

Information:

This Acknowledgement Receipt evidences receipt on the noted date by the USPTO of the indicated documents, characterized by the applicant, and including page counts, where applicable. It serves as evidence of receipt similar to a Post Card, as described in MPEP 503.

New Applications Under 35 U.S.C. 111

If a new application is being filed and the application includes the necessary components for a filing date (see 37 CFR 1.53(b)-(d) and MPEP 506), a Filing Receipt (37 CFR 1.54) will be issued in due course and the date shown on this Acknowledgement Receipt will establish the filing date of the application.

National Stage of an International Application under 35 U.S.C. 371

If a timely submission to enter the national stage of an international application is compliant with the conditions of 35 U.S.C. 371 and other applicable requirements a Form PCT/DO/EO/903 indicating acceptance of the application as a national stage submission under 35 U.S.C. 371 will be issued in addition to the Filing Receipt, in due course.

New International Application Filed with the USPTO as a Receiving Office

If a new international application is being filed and the international application includes the necessary components for an international filing date (see PCT Article 11 and MPEP 1810), a Notification of the International Application Number and of the International Filing Date (Form PCT/RO/105) will be issued in due course, subject to prescriptions concerning national security, and the date shown on this Acknowledgement Receipt will establish the international filing date of the application.

IN THE UNITED STATES PATENT AND TRADEMARK OFFICE

In Re the Application of: Marcos C. Tzannes)
Application No.: 09/710,310)
Filed: November 9, 2000)
Atty. File No.: 6936-47)

Patent No.: 6,961,369
Issued: November 1, 2005
Examiner: NGUYEN, Dung X
Confirmation No.: 5605

For: SYSTEM AND METHOD FOR SCRAMBLING THE PHASE OF THE CARRIERS IN
A MULTICARRIER COMMUNICATIONS SYSTEM

**REQUEST FOR REFUND OF MAINTENANCE
FEE UNDER § 37 C.F.R. 1.26**

Commissioner for Patents
P.O. Box 1450
Alexandria, VA 22313-1450

Madam:

This Request for Refund is filed pursuant to 37 U.S.C. 1.26 and MPEP 607.02.

On December 28, 2012, Applicants erroneously paid the 8th year Maintenance Fee payment for the referenced patent as a large entity when it should have been paid as a small entity. On November 7, 2012, Applicants submitted an "Assertion of Entitlement to Small Entity Status" with the USPTO. A copy of the Assertion is attached herewith. Applicants' status is now Small Entity and therefore should have paid \$1450.00 for the 8th year maintenance fee instead of the \$2900.00.

Applicants respectfully request a refund of \$1450.00 in the above-referenced patent.

Applicant respectfully requests that the \$1450.00 be refunded to Deposit Account No. 19-1970 (6936-47).

Respectfully submitted,
SHERIDAN ROSS P.C.

Date: 25 Nov 13

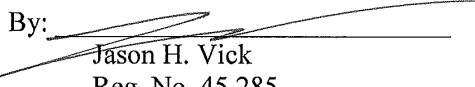
By: 
Jason H. Vick
Reg. No. 45,285
1560 Broadway, Suite 1200
Denver, Colorado 80202
Telephone: 303-863-9700

Electronic Acknowledgement Receipt	
EFS ID:	14170370
Application Number:	09710310
International Application Number:	
Confirmation Number:	5605
Title of Invention:	SYSTEM AND METHOD FOR SCRAMBLING THE PHASE OF THE CARRIERS IN A MULTICARRIER COMMUNICATIONS SYSTEM
First Named Inventor/Applicant Name:	MARCOS C. TZANNES
Customer Number:	181
Filer:	Jason Vick/Joanne Vos
Filer Authorized By:	Jason Vick
Attorney Docket Number:	AWR-017 (457/19)
Receipt Date:	07-NOV-2012
Filing Date:	09-NOV-2000
Time Stamp:	14:16:36
Application Type:	Utility under 35 USC 111(a)

Payment information:

Submitted with Payment	no
------------------------	----

File Listing:

Document Number	Document Description	File Name	File Size(Bytes)/ Message Digest	Multi Part /.zip	Pages (if appl.)
1		EntityStatus_373c_w_POA.pdf	418846 506426549f85e9759490abb4746aadcd5100585c	yes	4

Multipart Description/PDF files in .zip description			
Document Description		Start	End
Miscellaneous Incoming Letter		1	1
Assignee showing of ownership per 37 CFR 3.73.		2	3
Power of Attorney		4	4

Warnings:

Information:

Total Files Size (in bytes):	418846
-------------------------------------	--------

This Acknowledgement Receipt evidences receipt on the noted date by the USPTO of the indicated documents, characterized by the applicant, and including page counts, where applicable. It serves as evidence of receipt similar to a Post Card, as described in MPEP 503.

New Applications Under 35 U.S.C. 111

If a new application is being filed and the application includes the necessary components for a filing date (see 37 CFR 1.53(b)-(d) and MPEP 506), a Filing Receipt (37 CFR 1.54) will be issued in due course and the date shown on this Acknowledgement Receipt will establish the filing date of the application.

National Stage of an International Application under 35 U.S.C. 371

If a timely submission to enter the national stage of an international application is compliant with the conditions of 35 U.S.C. 371 and other applicable requirements a Form PCT/DO/EO/903 indicating acceptance of the application as a national stage submission under 35 U.S.C. 371 will be issued in addition to the Filing Receipt, in due course.

New International Application Filed with the USPTO as a Receiving Office

If a new international application is being filed and the international application includes the necessary components for an international filing date (see PCT Article 11 and MPEP 1810), a Notification of the International Application Number and of the International Filing Date (Form PCT/RO/105) will be issued in due course, subject to prescriptions concerning national security, and the date shown on this Acknowledgement Receipt will establish the international filing date of the application.

IN THE UNITED STATES PATENT AND TRADEMARK OFFICE

In Re the Application of: Marcos C. Tzannes)	Patent No.: 6,961,369
Application No.: 09/710,310)	Issued: November 1, 2005
Filed: November 9, 2000)	Examiner: NGUYEN, Dung X
Atty. File No.: 6936-47)	Confirmation No.: 5605

For: SYSTEM AND METHOD FOR SCRAMBLING THE PHASE OF THE CARRIERS IN A MULTICARRIER COMMUNICATIONS SYSTEM

ASSERTION OF ENTITLEMENT TO SMALL ENTITY STATUS

Commissioner for Patents
P.O. Box 1450
Alexandria, VA 22313-1450

Madam:

In accordance with MPEP §§ 509.02 and 509.03 and 37 CFR 1.27, this document is being filed to inform the U.S. Patent Office of the change of status for the above-identified patent from large entity status to small entity status. All fees paid to date have been paid as large entity status. No fees have yet been paid as small entity status. Due to the sale of the referenced patent, the Applicant is now entitled to small entity status.

We respectfully request that small entity status be granted for the above-referenced patent.

Please contact the undersigned if there are any questions regarding this notification.

Respectfully submitted,

SHERIDAN ROSS P.C.

Date: 7-11-02

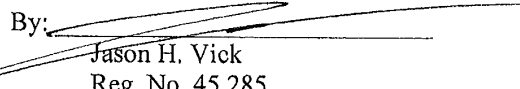
By: 
Jason H. Vick
Reg. No. 45,285
1560 Broadway, Suite 1200
Denver, Colorado 80202
Telephone: 303-863-9700

Under the Paperwork Reduction Act of 1995, no persons are required to respond to a collection of information unless it displays a valid OMB control number.

STATEMENT UNDER 37 CFR 3.73(c)

Applicant/Patent Owner: TQ DELTA, LLC
 Application No./Patent No.: 6,961,369 Filed/Issue Date: November 1, 2005
 Titled: SYSTEM AND METHOD FOR SCRAMBLING THE PHASE OF THE CARRIERS IN A MULTICARRIER COMMUNICATIONS SYSTEM
TQ DELTA, LLC, a Corporation

(Name of Assignee)

(Type of Assignee, e.g., corporation, partnership, university, government agency, etc.)

states that, for the patent application/patent identified above, it is (choose one of options 1, 2, 3 or 4 below):

1. The assignee of the entire right, title, and interest.
2. An assignee of less than the entire right, title, and interest (check applicable box):
- The extent (by percentage) of its ownership interest is ____%. Additional Statement(s) by the owners holding the balance of the interest must be submitted to account for 100% of the ownership interest.
- There are unspecified percentages of ownership. The other parties, including inventors, who together own the entire right, title and interest are:

Additional Statement(s) by the owner(s) holding the balance of the interest must be submitted to account for the entire right, title, and interest.

3. The assignee of an undivided interest in the entirety (a complete assignment from one of the joint inventors was made). The other parties, including inventors, who together own the entire right, title, and interest are:

Additional Statement(s) by the owner(s) holding the balance of the interest must be submitted to account for the entire right, title, and interest.

4. The recipient, via a court proceeding or the like (e.g., bankruptcy, probate), of an undivided interest in the entirety (a complete transfer of ownership interest was made). The certified document(s) showing the transfer is attached.

The interest identified in option 1, 2 or 3 above (not option 4) is evidenced by either (choose one of options A or B below):

- A. An assignment from the inventor(s) of the patent application/patent identified above. The assignment was recorded in the United States Patent and Trademark Office at Reel _____, Frame _____, or for which a copy thereof is attached.
- B. A chain of title from the inventor(s), of the patent application/patent identified above, to the current assignee as follows:

1. From: Marcos C. Tzannes To: AWARE, INC.

The document was recorded in the United States Patent and Trademark Office at
 Reel 010877, Frame 0307, or for which a copy thereof is attached.

2. From: AWARE, INC. To: TQ DELTA, LLC

The document was recorded in the United States Patent and Trademark Office at
 Reel 029154, Frame 0937, or for which a copy thereof is attached.

[Page 1 of 2]

This collection of information is required by 37 CFR 3.73(b). The information is required to obtain or retain a benefit by the public which is to file (and by the USPTO to process) an application. Confidentiality is governed by 35 U.S.C. 122 and 37 CFR 1.11 and 1.14. This collection is estimated to take 12 minutes to complete, including gathering, preparing, and submitting the completed application form to the USPTO. Time will vary depending upon the individual case. Any comments on the amount of time you require to complete this form and/or suggestions for reducing this burden, should be sent to the Chief Information Officer, U.S. Patent and Trademark Office, U.S. Department of Commerce, P.O. Box 1450, Alexandria, VA 22313-1450. DO NOT SEND FEES OR COMPLETED FORMS TO THIS ADDRESS. SEND TO: Commissioner for Patents, P.O. Box 1450, Alexandria, VA 22313-1450.

If you need assistance in completing the form, call 1-800-PTO-9199 and select option 2.

Under the Paperwork Reduction Act of 1995, no persons are required to respond to a collection of information unless it displays a valid OMB control number.

STATEMENT UNDER 37 CFR 3.73(c)

3. From: _____ To: _____

The document was recorded in the United States Patent and Trademark Office at
Reel _____, Frame _____, or for which a copy thereof is attached.

4. From: _____ To: _____

The document was recorded in the United States Patent and Trademark Office at
Reel _____, Frame _____, or for which a copy thereof is attached.

5. From: _____ To: _____

The document was recorded in the United States Patent and Trademark Office at
Reel _____, Frame _____, or for which a copy thereof is attached.

6. From: _____ To: _____

The document was recorded in the United States Patent and Trademark Office at
Reel _____, Frame _____, or for which a copy thereof is attached.

Additional documents in the chain of title are listed on a supplemental sheet(s).

As required by 37 CFR 3.73(c)(1)(i), the documentary evidence of the chain of title from the original owner to the assignee was, or concurrently is being, submitted for recordation pursuant to 37 CFR 3.11.

[NOTE: A separate copy (i.e., a true copy of the original assignment document(s)) must be submitted to Assignment Division in accordance with 37 CFR Part 3, to record the assignment in the records of the USPTO. See MPEP 302.08]

The undersigned (whose title is supplied below) is authorized to act on behalf of the assignee.

Signature _____

Jason H. Vick

Printed or Typed Name

Date 7 Nov '12

45,285

Title or Registration Number

Under the Paperwork Reduction Act of 1995, no persons are required to respond to a collection of information unless it displays a valid OMB control number.

POWER OF ATTORNEY TO PROSECUTE APPLICATIONS BEFORE THE USPTO

I hereby revoke all previous powers of attorney given in the application identified in the attached statement under 37 CFR 3.73(c).

I hereby appoint:

Practitioners associated with Customer Number: 62574

OR

Practitioner(s) named below (If more than ten patent practitioners are to be named, then a customer number must be used):

Name	Registration Number	Name	Registration Number

As attorney(s) or agent(s) to represent the undersigned before the United States Patent and Trademark Office (USPTO) in connection with any and all patent applications assigned only to the undersigned according to the USPTO assignment records or assignments documents attached to this form in accordance with 37 CFR 3.73(c).

Please change the correspondence address for the application identified in the attached statement under 37 CFR 3.73(c) to:

The address associated with Customer Number: 62574

OR

<input type="checkbox"/>	Firm or Individual Name			
	Address			
	City	State	Zip	
	Country			
	Telephone	Email		

Assignee Name and Address: TQ DELTA, LLC
 805 Las Cimas Parkway, Suite 240
 Austin, Texas 78746

A copy of this form, together with a statement under 37 CFR 3.73(c) (Form PTO/AIA/88 or equivalent) is required to be filed in each application in which this form is used. The statement under 37 CFR 3.73(c) may be completed by one of the practitioners appointed in this form, and must identify the application in which this Power of Attorney is to be filed.

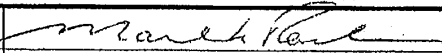
SIGNATURE of Assignee of Record			
The individual whose signature and title is supplied below is authorized to act on behalf of the assignee			
Signature		Date	10/4/12
Name	Mark K. Roche	Telephone	512-609-1810
Title	Managing Director		

This collection of information is required by 37 CFR 1.31, 1.32 and 1.33. The information is required to obtain or retain a benefit by the public which is to file (and by the USPTO to process) an application. Confidentiality is governed by 35 U.S.C. 122 and 37 CFR 1.11 and 1.14. This collection is estimated to take 3 minutes to complete, including gathering, preparing, and submitting the completed application form to the USPTO. Time will vary depending upon the individual case. Any comments on the amount of time you require to complete this form and/or suggestions for reducing this burden, should be sent to the Chief Information Officer, U.S. Patent and Trademark Office, U.S. Department of Commerce, P.O. Box 1450, Alexandria, VA 22313-1450. DO NOT SEND FEES OR COMPLETED FORMS TO THIS ADDRESS. SEND TO: Commissioner for Patents, P.O. Box 1450, Alexandria, VA 22313-1450.

If you need assistance in completing the form, call 1-800-PTO-9199 and select option 2.

Electronic Acknowledgement Receipt

EFS ID:	14614805
Application Number:	09710310
International Application Number:	
Confirmation Number:	5605
Title of Invention:	SYSTEM AND METHOD FOR SCRAMBLING THE PHASE OF THE CARRIERS IN A MULTICARRIER COMMUNICATIONS SYSTEM
First Named Inventor/Applicant Name:	MARCOS C. TZANNES
Customer Number:	62574
Filer:	Jason Vick/Joanne Vos
Filer Authorized By:	Jason Vick
Attorney Docket Number:	6936-47
Receipt Date:	04-JAN-2013
Filing Date:	09-NOV-2000
Time Stamp:	11:34:06
Application Type:	Utility under 35 USC 111(a)

Payment information:

Submitted with Payment	no
------------------------	----

File Listing:

Document Number	Document Description	File Name	File Size(Bytes)/ Message Digest	Multi Part /.zip	Pages (if appl.)
1	Refund Request	Request_for_Refund.pdf	661799 <small>262803071e5f42b1b297684efb61d5a7eba e6857</small>	no	7

Warnings:

Information:

This Acknowledgement Receipt evidences receipt on the noted date by the USPTO of the indicated documents, characterized by the applicant, and including page counts, where applicable. It serves as evidence of receipt similar to a Post Card, as described in MPEP 503.

New Applications Under 35 U.S.C. 111

If a new application is being filed and the application includes the necessary components for a filing date (see 37 CFR 1.53(b)-(d) and MPEP 506), a Filing Receipt (37 CFR 1.54) will be issued in due course and the date shown on this Acknowledgement Receipt will establish the filing date of the application.

National Stage of an International Application under 35 U.S.C. 371

If a timely submission to enter the national stage of an international application is compliant with the conditions of 35 U.S.C. 371 and other applicable requirements a Form PCT/DO/EO/903 indicating acceptance of the application as a national stage submission under 35 U.S.C. 371 will be issued in addition to the Filing Receipt, in due course.

New International Application Filed with the USPTO as a Receiving Office

If a new international application is being filed and the international application includes the necessary components for an international filing date (see PCT Article 11 and MPEP 1810), a Notification of the International Application Number and of the International Filing Date (Form PCT/RO/105) will be issued in due course, subject to prescriptions concerning national security, and the date shown on this Acknowledgement Receipt will establish the international filing date of the application.



UNITED STATES PATENT AND TRADEMARK OFFICE

UNITED STATES DEPARTMENT OF COMMERCE
United States Patent and Trademark Office
Address: COMMISSIONER FOR PATENTS
P.O. Box 1450
Alexandria, Virginia 22313-1450
www.uspto.gov

APPLICATION NUMBER	FILING OR 371(C) DATE	FIRST NAMED APPLICANT	ATTY. DOCKET NO./TITLE
09/710,310	11/09/2000	MARCOS C. TZANNES	AWR-017 (457/19)

CONFIRMATION NO. 5605

POWER OF ATTORNEY NOTICE

181
MILES & STOCKBRIDGE PC
1751 PINNACLE DRIVE
SUITE 500
MCLEAN, VA 22102-3833



Date Mailed: 11/26/2012

/dgbutler/

Office of Data Management, Application Assistance Unit (571) 272-4000, or (571) 272-4200, or 1-888-786-0101



UNITED STATES PATENT AND TRADEMARK OFFICE

UNITED STATES DEPARTMENT OF COMMERCE
United States Patent and Trademark Office
Address: COMMISSIONER FOR PATENTS
P.O. Box 1450
Alexandria, Virginia 22313-1450
www.uspto.gov

APPLICATION NUMBER	FILING OR 371(C) DATE	FIRST NAMED APPLICANT	ATTY. DOCKET NO./TITLE
09/710,310	11/09/2000	MARCOS C. TZANNES	

CONFIRMATION NO. 5605
POA ACCEPTANCE LETTER

62574
Jason H. Vick
Sheridan Ross, PC
Suite # 1200
1560 Broadway
Denver, CO 80202



Date Mailed: 11/26/2012

NOTICE OF ACCEPTANCE OF POWER OF ATTORNEY

This is in response to the Power of Attorney filed 11/07/2012.

The Power of Attorney in this application is accepted. Correspondence in this application will be mailed to the above address as provided by 37 CFR 1.33.

/jtfitzhugh sr/

Office of Data Management, Application Assistance Unit (571) 272-4000, or (571) 272-4200, or 1-888-786-0101



UNITED STATES PATENT AND TRADEMARK OFFICE

UNITED STATES DEPARTMENT OF COMMERCE
United States Patent and Trademark Office
Address: COMMISSIONER FOR PATENTS
P.O. Box 1450
Alexandria, Virginia 22313-1450
www.uspto.gov

APPLICATION NUMBER	FILING OR 371(C) DATE	FIRST NAMED APPLICANT	ATTY. DOCKET NO./TITLE
09/710,310	11/09/2000	MARCOS C. TZANNES	AWR-017 (457/19)

CONFIRMATION NO. 5605

POWER OF ATTORNEY NOTICE

181
MILES & STOCKBRIDGE PC
1751 PINNACLE DRIVE
SUITE 500
MCLEAN, VA 22102-3833



Date Mailed: 11/26/2012

NOTICE REGARDING CHANGE OF POWER OF ATTORNEY

This is in response to the Power of Attorney filed 11/07/2012.

- The Power of Attorney to you in this application has been revoked by the assignee who has intervened as provided by 37 CFR 3.71. Future correspondence will be mailed to the new address of record(37 CFR 1.33).

/jtfitzhugh sr/

Office of Data Management, Application Assistance Unit (571) 272-4000, or (571) 272-4200, or 1-888-786-0101

Under the Paperwork Reduction Act of 1995, no persons are required to respond to a collection of information unless it displays a valid OMB control number.

POWER OF ATTORNEY TO PROSECUTE APPLICATIONS BEFORE THE USPTO

I hereby revoke all previous powers of attorney given in the application identified in the attached statement under 37 CFR 3.73(c).

I hereby appoint:

 Practitioners associated with Customer Number:

62574

OR Practitioner(s) named below (if more than ten patent practitioners are to be named, then a customer number must be used):

Name	Registration Number	Name	Registration Number

As attorney(s) or agent(s) to represent the undersigned before the United States Patent and Trademark Office (USPTO) in connection with any and all patent applications assigned only to the undersigned according to the USPTO assignment records or assignments documents attached to this form in accordance with 37 CFR 3.73(c).

Please change the correspondence address for the application identified in the attached statement under 37 CFR 3.73(c) to:

 The address associated with Customer Number:

62574

OR

<input type="checkbox"/>	Firm or Individual Name			
	Address			
	City	State	Zip	
	Country			
	Telephone	Email		

Assignee Name and Address: TQ DELTA, LLC
805 Las Cimas Parkway, Suite 240
Austin, Texas 78746**A copy of this form, together with a statement under 37 CFR 3.73(c) (Form PTO/AIA/96 or equivalent) is required to be Filed in each application in which this form is used. The statement under 37 CFR 3.73(c) may be completed by one of The practitioners appointed in this form, and must identify the application in which this Power of Attorney is to be filed.****SIGNATURE of Assignee of Record**

The individual whose signature and title is supplied below is authorized to act on behalf of the assignee

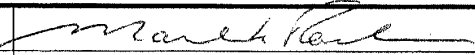
Signature		Date	10/4/12
Name	Mark K. Roche	Telephone	512-609-1810
Title	Managing Director		

This collection of information is required by 37 CFR 1.31, 1.32 and 1.33. The information is required to obtain or retain a benefit by the public which is to file (and by the USPTO to process) an application. Confidentiality is governed by 35 U.S.C. 122 and 37 CFR 1.11 and 1.14. This collection is estimated to take 3 minutes to complete, including gathering, preparing, and submitting the completed application form to the USPTO. Time will vary depending upon the individual case. Any comments on the amount of time you require to complete this form and/or suggestions for reducing this burden, should be sent to the Chief Information Officer, U.S. Patent and Trademark Office, U.S. Department of Commerce, P.O. Box 1450, Alexandria, VA 22313-1450. DO NOT SEND FEES OR COMPLETED FORMS TO THIS ADDRESS. SEND TO: Commissioner for Patents, P.O. Box 1450, Alexandria, VA 22313-1450.

If you need assistance in completing the form, call 1-800-PTO-9199 and select option 2.

Electronic Acknowledgement Receipt

EFS ID:	14170370
Application Number:	09710310
International Application Number:	
Confirmation Number:	5605
Title of Invention:	SYSTEM AND METHOD FOR SCRAMBLING THE PHASE OF THE CARRIERS IN A MULTICARRIER COMMUNICATIONS SYSTEM
First Named Inventor/Applicant Name:	MARCOS C. TZANNES
Customer Number:	181
Filer:	Jason Vick/Joanne Vos
Filer Authorized By:	Jason Vick
Attorney Docket Number:	AWR-017 (457/19)
Receipt Date:	07-NOV-2012
Filing Date:	09-NOV-2000
Time Stamp:	14:16:36
Application Type:	Utility under 35 USC 111(a)

Payment information:

Submitted with Payment	no
------------------------	----

File Listing:

Document Number	Document Description	File Name	File Size(Bytes)/ Message Digest	Multi Part /.zip	Pages (if appl.)
1		EntityStatus_373c_w_POA.pdf	418846 506426549f85e9759490abb4746aadcd51005a5c	yes	4

Multipart Description/PDF files in .zip description		
Document Description	Start	End
Miscellaneous Incoming Letter	1	1
Assignee showing of ownership per 37 CFR 3.73.	2	3
Power of Attorney	4	4
Warnings:		
Information:		
Total Files Size (in bytes):	418846	
<p>This Acknowledgement Receipt evidences receipt on the noted date by the USPTO of the indicated documents, characterized by the applicant, and including page counts, where applicable. It serves as evidence of receipt similar to a Post Card, as described in MPEP 503.</p> <p><u>New Applications Under 35 U.S.C. 111</u> If a new application is being filed and the application includes the necessary components for a filing date (see 37 CFR 1.53(b)-(d) and MPEP 506), a Filing Receipt (37 CFR 1.54) will be issued in due course and the date shown on this Acknowledgement Receipt will establish the filing date of the application.</p> <p><u>National Stage of an International Application under 35 U.S.C. 371</u> If a timely submission to enter the national stage of an international application is compliant with the conditions of 35 U.S.C. 371 and other applicable requirements a Form PCT/DO/EO/903 indicating acceptance of the application as a national stage submission under 35 U.S.C. 371 will be issued in addition to the Filing Receipt, in due course.</p> <p><u>New International Application Filed with the USPTO as a Receiving Office</u> If a new international application is being filed and the international application includes the necessary components for an international filing date (see PCT Article 11 and MPEP 1810), a Notification of the International Application Number and of the International Filing Date (Form PCT/RO/105) will be issued in due course, subject to prescriptions concerning national security, and the date shown on this Acknowledgement Receipt will establish the international filing date of the application.</p>		

IN THE UNITED STATES PATENT AND TRADEMARK OFFICE

In Re the Application of: Marcos C. Tzannes) Patent No.: 6,961,369
Application No.: 09/710,310) Issued: November 1, 2005
Filed: November 9, 2000) Examiner: NGUYEN, Dung X
Atty. File No.: 6936-47) Confirmation No.: 5605

For: SYSTEM AND METHOD FOR SCRAMBLING THE PHASE OF THE CARRIERS IN
A MULTICARRIER COMMUNICATIONS SYSTEM

ASSERTION OF ENTITLEMENT TO SMALL ENTITY STATUS

Commissioner for Patents
P.O. Box 1450
Alexandria, VA 22313-1450

Madam:

In accordance with MPEP §§ 509.02 and 509.03 and 37 CFR 1.27, this document is being filed to inform the U.S. Patent Office of the change of status for the above-identified patent from large entity status to small entity status. All fees paid to date have been paid as large entity status. No fees have yet been paid as small entity status. Due to the sale of the referenced patent, the Applicant is now entitled to small entity status.

We respectfully request that small entity status be granted for the above-referenced patent.

Please contact the undersigned if there are any questions regarding this notification.

Respectfully submitted,

SHERIDAN ROSS P.C.

Date: 7/11/12

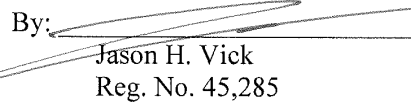
By: 
Jason H. Vick
Reg. No. 45,285
1560 Broadway, Suite 1200
Denver, Colorado 80202
Telephone: 303-863-9700

Under the Paperwork Reduction Act of 1995, no persons are required to respond to a collection of information unless it displays a valid OMB control number.

STATEMENT UNDER 37 CFR 3.73(c)

Applicant/Patent Owner: TQ DELTA, LLC

Application No./Patent No.: 6,961,369 Filed/Issue Date: November 1, 2005

Titled: SYSTEM AND METHOD FOR SCRAMBLING THE PHASE OF THE CARRIERS IN A MULTICARRIER COMMUNICATIONS SYSTEM

TQ DELTA, LLC, a Corporation

(Name of Assignee)

(Type of Assignee, e.g., corporation, partnership, university, government agency, etc.)

states that, for the patent application/patent identified above, it is (choose **one** of options 1, 2, 3 or 4 below):

- 1. The assignee of the entire right, title, and interest.
- 2. An assignee of less than the entire right, title, and interest (check applicable box):
 - The extent (by percentage) of its ownership interest is _____%. Additional Statement(s) by the owners holding the balance of the interest **must be submitted** to account for 100% of the ownership interest.
 - There are unspecified percentages of ownership. The other parties, including inventors, who together own the entire right, title and interest are:

[Empty box for additional statement for option 2]

Additional Statement(s) by the owner(s) holding the balance of the interest **must be submitted** to account for the entire right, title, and interest.

- 3. The assignee of an undivided interest in the entirety (a complete assignment from one of the joint inventors was made). The other parties, including inventors, who together own the entire right, title, and interest are:

[Empty box for additional statement for option 3]

Additional Statement(s) by the owner(s) holding the balance of the interest **must be submitted** to account for the entire right, title, and interest.

- 4. The recipient, via a court proceeding or the like (e.g., bankruptcy, probate), of an undivided interest in the entirety (a complete transfer of ownership interest was made). The certified document(s) showing the transfer is attached.

The interest identified in option 1, 2 or 3 above (not option 4) is evidenced by either (choose **one** of options A or B below):

- A. An assignment from the inventor(s) of the patent application/patent identified above. The assignment was recorded in the United States Patent and Trademark Office at Reel _____, Frame _____, or for which a copy thereof is attached.

- B. A chain of title from the inventor(s), of the patent application/patent identified above, to the current assignee as follows:

1. From: Marcos C. Tzannes To: AWARE, INC.

The document was recorded in the United States Patent and Trademark Office at Reel 010877, Frame 0307, or for which a copy thereof is attached.

2. From: AWARE, INC. To: TQ DELTA, LLC

The document was recorded in the United States Patent and Trademark Office at Reel 029154, Frame 0937, or for which a copy thereof is attached.

This collection of information is required by 37 CFR 3.73(b). The information is required to obtain or retain a benefit by the public which is to file (and by the USPTO to process) an application. Confidentiality is governed by 35 U.S.C. 122 and 37 CFR 1.11 and 1.14. This collection is estimated to take 12 minutes to complete, including gathering, preparing, and submitting the completed application form to the USPTO. Time will vary depending upon the individual case. Any comments on the amount of time you require to complete this form and/or suggestions for reducing this burden, should be sent to the Chief Information Officer, U.S. Patent and Trademark Office, U.S. Department of Commerce, P.O. Box 1450, Alexandria, VA 22313-1450. DO NOT SEND FEES OR COMPLETED FORMS TO THIS ADDRESS. **SEND TO: Commissioner for Patents, P.O. Box 1450, Alexandria, VA 22313-1450.**

If you need assistance in completing the form, call 1-800-PTO-9199 and select option 2.

Under the Paperwork Reduction Act of 1995, no persons are required to respond to a collection of information unless it displays a valid OMB control number.

STATEMENT UNDER 37 CFR 3.73(c)

3. From: _____ To: _____

The document was recorded in the United States Patent and Trademark Office at
Reel _____, Frame _____, or for which a copy thereof is attached.

4. From: _____ To: _____

The document was recorded in the United States Patent and Trademark Office at
Reel _____, Frame _____, or for which a copy thereof is attached.

5. From: _____ To: _____

The document was recorded in the United States Patent and Trademark Office at
Reel _____, Frame _____, or for which a copy thereof is attached.

6. From: _____ To: _____

The document was recorded in the United States Patent and Trademark Office at
Reel _____, Frame _____, or for which a copy thereof is attached.

Additional documents in the chain of title are listed on a supplemental sheet(s).

As required by 37 CFR 3.73(c)(1)(i), the documentary evidence of the chain of title from the original owner to the assignee was, or concurrently is being, submitted for recordation pursuant to 37 CFR 3.11.

[NOTE: A separate copy (i.e., a true copy of the original assignment document(s)) must be submitted to Assignment Division in accordance with 37 CFR Part 3, to record the assignment in the records of the USPTO. See MPEP 302.08]

The undersigned (whose title is supplied below) is authorized to act on behalf of the assignee.

Signature _____

Jason H. Vick

Printed or Typed Name

Date 7 Nov '12

45,285

Title or Registration Number

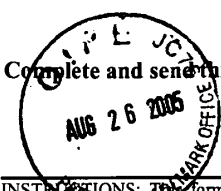

Complete and send this form, together with applicable fee(s), to: Mail

Mail Stop ISSUE FEE
Commissioner for Patents
P.O. Box 1450
Alexandria, Virginia 22313-1450
(703) 746-4000

or Fax

INSTRUCTIONS: This form should be used for transmitting the ISSUE FEE and PUBLICATION FEE (if required). Blocks 1 through 5 should be completed where appropriate. All other correspondence including the Patent, advance orders and notification of maintenance fees will be mailed to the current correspondence address as indicated unless corrected below or directed otherwise in Block 1, by (a) specifying a new correspondence address; and/or (b) indicating a separate "FEE ADDRESS" for maintenance fee notifications.

CURRENT CORRESPONDENCE ADDRESS (Note: Use Block 1 for any change of address)

000181 7590 07/05/2005

MILES & STOCKBRIDGE PC
1751 PINNACLE DRIVE
SUITE 500
MCLEAN, VA 22102-3833

08/30/2005 HDESTA2 00000042 09710310

01 FC:1501 1400.00 OP

Note: A certificate of mailing can only be used for domestic mailings of the Fee(s) Transmittal. This certificate cannot be used for any other accompanying papers. Each additional paper, such as an assignment or formal drawing, must have its own certificate of mailing or transmission.

Certificate of Mailing or Transmission

I hereby certify that this Fee(s) Transmittal is being deposited with the United States Postal Service with sufficient postage for first class mail in an envelope addressed to the Mail Stop ISSUE FEE address above, or being facsimile transmitted to the USPTO (703) 746-4000, on the date indicated below.

	(Depositor's name)
	(Signature)
	(Date)

APPLICATION NO.	FILING DATE	FIRST NAMED INVENTOR	ATTORNEY DOCKET NO.	CONFIRMATION NO.
09/710,310	11/09/2000	MARCOS C. TZANNES	AWR-017 (457/19)	5605

TITLE OF INVENTION: SYSTEM AND METHOD FOR SCRAMBLING THE PHASE OF THE CARRIERS IN A MULTICARRIER COMMUNICATIONS SYSTEM

APPLN. TYPE	SMALL ENTITY	ISSUE FEE	PUBLICATION FEE	TOTAL FEE(S) DUE	DATE DUE
nonprovisional	NO	\$1400	\$0	\$1400	10/05/2005

EXAMINER	ART UNIT	CLASS-SUBCLASS
NGUYEN, DUNG X	2638	375-220000

1. Change of correspondence address or indication of "Fee Address" (37 CFR 1.363).

Change of correspondence address (or Change of Correspondence Address form PTO/SB/122) attached.

"Fee Address" indication (or "Fee Address" Indication form PTO/SB/47; Rev 03-02 or more recent) attached. Use of a Customer Number is required.

2. For printing on the patent front page, list

(1) the names of up to 3 registered patent attorneys or agents OR, alternatively,

(2) the name of a single firm (having as a member a registered attorney or agent) and the names of up to 2 registered patent attorneys or agents. If no name is listed, no name will be printed.

1 Miles & Stockbridge P.C.

2 Jason H. Vick

3 _____

3. ASSIGNEE NAME AND RESIDENCE DATA TO BE PRINTED ON THE PATENT (print or type)

PLEASE NOTE: Unless an assignee is identified below, no assignee data will appear on the patent. If an assignee is identified below, the document has been filed for recordation as set forth in 37 CFR 3.11. Completion of this form is NOT a substitute for filing an assignment.

(A) NAME OF ASSIGNEE

(B) RESIDENCE: (CITY and STATE OR COUNTRY)

Aware, Inc.

Bedford, Massachusetts

Please check the appropriate assignee category or categories (will not be printed on the patent): Individual Corporation or other private group entity Government

4a. The following fee(s) are enclosed:

- Issue Fee
- Publication Fee (No small entity discount permitted)
- Advance Order - # of Copies _____

4b. Payment of Fee(s):

- A check in the amount of the fee(s) is enclosed.
- Payment by credit card. Form PTO-2038 is attached.
- The Director is hereby authorized by charge the required fee(s), or credit any overpayment, to Deposit Account Number 50-1165 (enclose an extra copy of this form).

5. Change in Entity Status (from status indicated above)

- a. Applicant claims SMALL ENTITY status. See 37 CFR 1.27.
- b. Applicant is no longer claiming SMALL ENTITY status. See 37 CFR 1.27(g)(2).

The Director of the USPTO is requested to apply the Issue Fee and Publication Fee (if any) or to re-apply any previously paid issue fee to the application identified above. NOTE: The Issue Fee and Publication Fee (if required) will not be accepted from anyone other than the applicant; a registered attorney or agent; or the assignee or other party in interest as shown by the records of the United States Patent and Trademark Office.

Authorized Signature _____

Date August 25, 2005

Typed or printed name Jason H. Vick

Registration No. 45,285

This collection of information is required by 37 CFR 1.311. The information is required to obtain or retain a benefit by the public which is to file (and by the USPTO to process) an application. Confidentiality is governed by 35 U.S.C. 122 and 37 CFR 1.14. This collection is estimated to take 12 minutes to complete, including gathering, preparing, and submitting the completed application form to the USPTO. Time will vary depending upon the individual case. Any comments on the amount of time you require to complete this form and/or suggestions for reducing this burden, should be sent to the Chief Information Officer, U.S. Patent and Trademark Office, U.S. Department of Commerce, P.O. Box 1450, Alexandria, Virginia 22313-1450. DO NOT SEND FEES OR COMPLETED FORMS TO THIS ADDRESS. SEND TO: Commissioner for Patents, P.O. Box 1450, Alexandria, Virginia 22313-1450.

Under the Paperwork Reduction Act of 1995, no persons are required to respond to a collection of information unless it displays a valid OMB control number.



NOTICE OF ALLOWANCE AND FEE(S) DUE

000181 7590 07/05/2005
MILES & STOCKBRIDGE PC
1751 PINNACLE DRIVE
SUITE 500
MCLEAN, VA 22102-3833

EXAMINER

NGUYEN, DUNG X

ART UNIT PAPER NUMBER

2638

DATE MAILED: 07/05/2005

APPLICATION NO.	FILING DATE	FIRST NAMED INVENTOR	ATTORNEY DOCKET NO.	CONFIRMATION NO.
09/710,310	11/09/2000	MARCOS C. TZANNES	AWR-017 (457/19)	5605

TITLE OF INVENTION: SYSTEM AND METHOD FOR SCRAMBLING THE PHASE OF THE CARRIERS IN A MULTICARRIER COMMUNICATIONS SYSTEM

APPLN. TYPE	SMALL ENTITY	ISSUE FEE	PUBLICATION FEE	TOTAL FEE(S) DUE	DATE DUE
nonprovisional	NO	\$1400	\$0	\$1400	10/05/2005

THE APPLICATION IDENTIFIED ABOVE HAS BEEN EXAMINED AND IS ALLOWED FOR ISSUANCE AS A PATENT. PROSECUTION ON THE MERITS IS CLOSED. THIS NOTICE OF ALLOWANCE IS NOT A GRANT OF PATENT RIGHTS. THIS APPLICATION IS SUBJECT TO WITHDRAWAL FROM ISSUE AT THE INITIATIVE OF THE OFFICE OR UPON PETITION BY THE APPLICANT. SEE 37 CFR 1.313 AND MPEP 1308.

THE ISSUE FEE AND PUBLICATION FEE (IF REQUIRED) MUST BE PAID WITHIN THREE MONTHS FROM THE MAILING DATE OF THIS NOTICE OR THIS APPLICATION SHALL BE REGARDED AS ABANDONED. THIS STATUTORY PERIOD CANNOT BE EXTENDED. SEE 35 U.S.C. 151. THE ISSUE FEE DUE INDICATED ABOVE REFLECTS A CREDIT FOR ANY PREVIOUSLY PAID ISSUE FEE APPLIED IN THIS APPLICATION. THE PTOL-85B (OR AN EQUIVALENT) MUST BE RETURNED WITHIN THIS PERIOD EVEN IF NO FEE IS DUE OR THE APPLICATION WILL BE REGARDED AS ABANDONED.

HOW TO REPLY TO THIS NOTICE:

I. Review the SMALL ENTITY status shown above.

If the SMALL ENTITY is shown as YES, verify your current SMALL ENTITY status:

A. If the status is the same, pay the TOTAL FEE(S) DUE shown above.

B. If the status above is to be removed, check box 5b on Part B - Fee(s) Transmittal and pay the PUBLICATION FEE (if required) and twice the amount of the ISSUE FEE shown above, or

If the SMALL ENTITY is shown as NO:

A. Pay TOTAL FEE(S) DUE shown above, or

B. If applicant claimed SMALL ENTITY status before, or is now claiming SMALL ENTITY status, check box 5a on Part B - Fee(s) Transmittal and pay the PUBLICATION FEE (if required) and 1/2 the ISSUE FEE shown above.

II. PART B - FEE(S) TRANSMITTAL should be completed and returned to the United States Patent and Trademark Office (USPTO) with your ISSUE FEE and PUBLICATION FEE (if required). Even if the fee(s) have already been paid, Part B - Fee(s) Transmittal should be completed and returned. If you are charging the fee(s) to your deposit account, section "4b" of Part B - Fee(s) Transmittal should be completed and an extra copy of the form should be submitted.

III. All communications regarding this application must give the application number. Please direct all communications prior to issuance to Mail Stop ISSUE FEE unless advised to the contrary.

IMPORTANT REMINDER: Utility patents issuing on applications filed on or after Dec. 12, 1980 may require payment of maintenance fees. It is patentee's responsibility to ensure timely payment of maintenance fees when due.

Complete and send this form, together with applicable fee(s), to: **Mail**

**Mail Stop ISSUE FEE
Commissioner for Patents
P.O. Box 1450
Alexandria, Virginia 22313-1450
(703) 746-4000**

or **Fax**

INSTRUCTIONS: This form should be used for transmitting the ISSUE FEE and PUBLICATION FEE (if required). Blocks 1 through 5 should be completed where appropriate. All further correspondence including the Patent, advance orders and notification of maintenance fees will be mailed to the current correspondence address as indicated unless corrected below or directed otherwise in Block 1, by (a) specifying a new correspondence address; and/or (b) indicating a separate "FEE ADDRESS" for maintenance fee notifications.

CURRENT CORRESPONDENCE ADDRESS (Note: Use Block 1 for any change of address)

000181 7590 07/05/2005

**MILES & STOCKBRIDGE PC
1751 PINNACLE DRIVE
SUITE 500
MCLEAN, VA 22102-3833**

Note: A certificate of mailing can only be used for domestic mailings of the Fee(s) Transmittal. This certificate cannot be used for any other accompanying papers. Each additional paper, such as an assignment or formal drawing, must have its own certificate of mailing or transmission.

Certificate of Mailing or Transmission

I hereby certify that this Fee(s) Transmittal is being deposited with the United States Postal Service with sufficient postage for first class mail in an envelope addressed to the Mail Stop ISSUE FEE address above, or being facsimile transmitted to the USPTO (703) 746-4000, on the date indicated below.

(Depositor's name)
(Signature)
(Date)

APPLICATION NO.	FILING DATE	FIRST NAMED INVENTOR	ATTORNEY DOCKET NO.	CONFIRMATION NO.
09/710,310	11/09/2000	MARCOS C. TZANNES	AWR-017 (457/19)	5605

TITLE OF INVENTION: SYSTEM AND METHOD FOR SCRAMBLING THE PHASE OF THE CARRIERS IN A MULTICARRIER COMMUNICATIONS SYSTEM

APPLN. TYPE	SMALL ENTITY	ISSUE FEE	PUBLICATION FEE	TOTAL FEE(S) DUE	DATE DUE
nonprovisional	NO	\$1400	\$0	\$1400	10/05/2005

EXAMINER	ART UNIT	CLASS-SUBCLASS
NGUYEN, DUNG X	2638	375-220000

1. Change of correspondence address or indication of "Fee Address" (37 CFR 1.363).

Change of correspondence address (or Change of Correspondence Address form PTO/SB/122) attached.

"Fee Address" indication (or "Fee Address" Indication form PTO/SB/47; Rev 03-02 or more recent) attached. Use of a Customer Number is required.

2. For printing on the patent front page, list

(1) the names of up to 3 registered patent attorneys or agents OR, alternatively, 1 _____

(2) the name of a single firm (having as a member a registered attorney or agent) and the names of up to 2 registered patent attorneys or agents. If no name is listed, no name will be printed. 2 _____

3 _____

3. ASSIGNEE NAME AND RESIDENCE DATA TO BE PRINTED ON THE PATENT (print or type)

PLEASE NOTE: Unless an assignee is identified below, no assignee data will appear on the patent. If an assignee is identified below, the document has been filed for recordation as set forth in 37 CFR 3.11. Completion of this form is NOT a substitute for filing an assignment.

(A) NAME OF ASSIGNEE _____ (B) RESIDENCE: (CITY and STATE OR COUNTRY) _____

Please check the appropriate assignee category or categories (will not be printed on the patent): Individual Corporation or other private group entity Government

4a. The following fee(s) are enclosed:

Issue Fee

Publication Fee (No small entity discount permitted)

Advance Order - # of Copies _____

4b. Payment of Fee(s):

A check in the amount of the fee(s) is enclosed.

Payment by credit card. Form PTO-2038 is attached.

The Director is hereby authorized by charge the required fee(s), or credit any overpayment, to Deposit Account Number _____ (enclose an extra copy of this form).

5. Change in Entity Status (from status indicated above)

a. Applicant claims SMALL ENTITY status. See 37 CFR 1.27. b. Applicant is no longer claiming SMALL ENTITY status. See 37 CFR 1.27(g)(2).

The Director of the USPTO is requested to apply the Issue Fee and Publication Fee (if any) or to re-apply any previously paid issue fee to the application identified above. NOTE: The Issue Fee and Publication Fee (if required) will not be accepted from anyone other than the applicant; a registered attorney or agent; or the assignee or other party in interest as shown by the records of the United States Patent and Trademark Office.

Authorized Signature _____ Date _____

Typed or printed name _____ Registration No. _____

This collection of information is required by 37 CFR 1.311. The information is required to obtain or retain a benefit by the public which is to file (and by the USPTO to process) an application. Confidentiality is governed by 35 U.S.C. 122 and 37 CFR 1.14. This collection is estimated to take 12 minutes to complete, including gathering, preparing, and submitting the completed application form to the USPTO. Time will vary depending upon the individual case. Any comments on the amount of time you require to complete this form and/or suggestions for reducing this burden, should be sent to the Chief Information Officer, U.S. Patent and Trademark Office, U.S. Department of Commerce, P.O. Box 1450, Alexandria, Virginia 22313-1450. DO NOT SEND FEES OR COMPLETED FORMS TO THIS ADDRESS. SEND TO: Commissioner for Patents, P.O. Box 1450, Alexandria, Virginia 22313-1450.

Under the Paperwork Reduction Act of 1995, no persons are required to respond to a collection of information unless it displays a valid OMB control number.



UNITED STATES PATENT AND TRADEMARK OFFICE

UNITED STATES DEPARTMENT OF COMMERCE
United States Patent and Trademark Office
Address: COMMISSIONER FOR PATENTS
P.O. Box 1450
Alexandria, Virginia 22313-1450
www.uspto.gov

Table with 5 columns: APPLICATION NO., FILING DATE, FIRST NAMED INVENTOR, ATTORNEY DOCKET NO., CONFIRMATION NO.
09/710,310 11/09/2000 MARCOS C. TZANNES AWR-017 (457/19) 5605

000181 7590 07/05/2005
MILES & STOCKBRIDGE PC
1751 PINNACLE DRIVE
SUITE 500
MCLEAN, VA 22102-3833

EXAMINER

NGUYEN, DUNG X

ART UNIT PAPER NUMBER

2638

DATE MAILED: 07/05/2005

Determination of Patent Term Adjustment under 35 U.S.C. 154 (b)
(application filed on or after May 29, 2000)

The Patent Term Adjustment to date is 991 day(s). If the issue fee is paid on the date that is three months after the mailing date of this notice and the patent issues on the Tuesday before the date that is 28 weeks (six and a half months) after the mailing date of this notice, the Patent Term Adjustment will be 991 day(s).

If a Continued Prosecution Application (CPA) was filed in the above-identified application, the filing date that determines Patent Term Adjustment is the filing date of the most recent CPA.

Applicant will be able to obtain more detailed information by accessing the Patent Application Information Retrieval (PAIR) WEB site (http://pair.uspto.gov).

Any questions regarding the Patent Term Extension or Adjustment determination should be directed to the Office of Patent Legal Administration at (571) 272-7702. Questions relating to issue and publication fee payments should be directed to the Customer Service Center of the Office of Patent Publication at (703) 305-8283.

Notice of Allowability	Application No.	Applicant(s)	
	09/710,310	TZANNES, MARCOS C.	
	Examiner	Art Unit	
	Dung X. Nguyen	2631	

-- The MAILING DATE of this communication appears on the cover sheet with the correspondence address--

All claims being allowable, PROSECUTION ON THE MERITS IS (OR REMAINS) CLOSED in this application. If not included herewith (or previously mailed), a Notice of Allowance (PTOL-85) or other appropriate communication will be mailed in due course. **THIS NOTICE OF ALLOWABILITY IS NOT A GRANT OF PATENT RIGHTS.** This application is subject to withdrawal from issue at the initiative of the Office or upon petition by the applicant. See 37 CFR 1.313 and MPEP 1308.

1. This communication is responsive to amendment filed on 07 September 2004.
2. The allowed claim(s) is/are 40 - 51, renumbered as 1 - 12, respectively.
3. The drawings filed on 09 November 2000 are accepted by the Examiner.
4. Acknowledgment is made of a claim for foreign priority under 35 U.S.C. § 119(a)-(d) or (f).
 - a) All b) Some* c) None of the:
 1. Certified copies of the priority documents have been received.
 2. Certified copies of the priority documents have been received in Application No. _____.
 3. Copies of the certified copies of the priority documents have been received in this national stage application from the International Bureau (PCT Rule 17.2(a)).

* Certified copies not received: _____.

Applicant has THREE MONTHS FROM THE "MAILING DATE" of this communication to file a reply complying with the requirements noted below. Failure to timely comply will result in ABANDONMENT of this application.
THIS THREE-MONTH PERIOD IS NOT EXTENDABLE.

5. A SUBSTITUTE OATH OR DECLARATION must be submitted. Note the attached EXAMINER'S AMENDMENT or NOTICE OF INFORMAL PATENT APPLICATION (PTO-152) which gives reason(s) why the oath or declaration is deficient.
 6. CORRECTED DRAWINGS (as "replacement sheets") must be submitted.
 - (a) including changes required by the Notice of Draftsperson's Patent Drawing Review (PTO-948) attached
 - 1) hereto or 2) to Paper No./Mail Date _____.
 - (b) including changes required by the attached Examiner's Amendment / Comment or in the Office action of Paper No./Mail Date _____.
- Identifying Indicia such as the application number (see 37 CFR 1.84(c)) should be written on the drawings in the front (not the back) of each sheet. Replacement sheet(s) should be labeled as such in the header according to 37 CFR 1.121(d).**
7. DEPOSIT OF and/or INFORMATION about the deposit of BIOLOGICAL MATERIAL must be submitted. Note the attached Examiner's comment regarding REQUIREMENT FOR THE DEPOSIT OF BIOLOGICAL MATERIAL.

Attachment(s)

- | | |
|---|---|
| 1. <input type="checkbox"/> Notice of References Cited (PTO-892) | 5. <input type="checkbox"/> Notice of Informal Patent Application (PTO-152) |
| 2. <input type="checkbox"/> Notice of Draftsperson's Patent Drawing Review (PTO-948) | 6. <input checked="" type="checkbox"/> Interview Summary (PTO-413),
Paper No./Mail Date _____. |
| 3. <input type="checkbox"/> Information Disclosure Statements (PTO-1449 or PTO/SB/08),
Paper No./Mail Date _____ | 7. <input checked="" type="checkbox"/> Examiner's Amendment/Comment |
| 4. <input type="checkbox"/> Examiner's Comment Regarding Requirement for Deposit
of Biological Material | 8. <input type="checkbox"/> Examiner's Statement of Reasons for Allowance |
| | 9. <input type="checkbox"/> Other _____. |

KENNETH VANDERPUYE
 PRIMARY EXAMINER

DXN
 June 15, 2005

Response to Arguments

1. Applicant's arguments filed on September 07, 2004 have been fully considered and are persuasive. The Rejection(s) of the Office action filed on March 30, 2004 has been withdrawn. Claims 1 – 39 have been canceled. Claims 40 – 51 have been added.

Examiner's Amendment

2. An examiner's amendment to the record appears below. Should the changes and/or additions be unacceptable to applicant, an amendment may be filed as provided by 37 CFR 1.312. To ensure consideration of such an amendment, it MUST be submitted no later than the payment of the issue fee.

Authorization for this examiner's amendment was given in a telephone interview with Jason H. Vick on June 15, 2005.

IN THE CLAIMS:

Regarding claim 46, the statement of "an array of pseudo-random numbers;" as recited in line 4 has been changed to "A generator generates an array of pseudo-random numbers;".

Allowable Subject Matter

3. **Claims 40 – 51 are allowed, renumbered as 1 – 12, respectively.** The following is an examiner's statement of reasons for allowance:

Regarding to the claimed invention, the prior art of record fails to show or render obvious of a method and its corresponding apparatus of randomizing the phase characteristics of the carriers in a multi-carrier modulation communication utilizing a plurality of QAM-modulated carrier signals, each carrier having a phase characteristic based on a QAM modulation, comprising:

- Generating an array of pseudo-random numbers;
- Determining a phase shift for each carrier signal by multiplying a value from the array of pseudo random numbers with $\pi/m \bmod 2\pi$, where m is an integer, and
- Adding the determined phase shift for each carrier signal to the phase characteristic of each carrier signal.

Any comments considered necessary by applicant must be submitted no later than the payment of the issue fee and, to avoid processing delays, should preferably accompany the issue fee. Such submissions should be clearly labeled "Comments on Statement of Reasons for Allowance."

Contact Information

4. Any inquiry concerning this communication or earlier communications from the examiner should be directed to Dung X. Nguyen whose telephone number is (571) 272-3010. The examiner can normally be reached on Monday through Friday from 8:00 AM to 17:00 PM.

If attempts to reach the examiner by telephone are unsuccessful, the examiner's supervisor, Mr. Vanderpuye Kenneth N. can be reached on (571) 272-3078. The fax phone numbers for this group is (571) 273-3021.

Any inquiry of a general nature or relating to the status of this application or proceeding should be directed to the receptionist whose telephone number is (571) 272-2600.

DXN

June 15, 2005

**KENNETH VANDERPUYE
PRIMARY EXAMINER**

Interview Summary	Application No. 09/710,310	Applicant(s) TZANNES, MARCOS C.	
	Examiner Dung X. Nguyen	Art Unit 2631	

All participants (applicant, applicant's representative, PTO personnel):

(1) Dung X. Nguyen. (3) _____.

(2) Jason H. Vick, the applicant's attorney. (4) _____.

Date of Interview: 15 June 2005.

Type: a) Telephonic b) Video Conference
c) Personal [copy given to: 1) applicant 2) applicant's representative]

Exhibit shown or demonstration conducted: d) Yes e) No.
If Yes, brief description: The statement of "an array of pseudo-random numbers;" as recited in line 4 of claim 46 has been changed to "A generator generates an array of pseudo-random numbers;".

Claim(s) discussed: Claim 46.

Identification of prior art discussed: Claim 46 is a device claim, the statement of "an array of pseudo-random numbers" as recited in line 4 is not appropriated..

Agreement with respect to the claims f) was reached. g) was not reached. h) N/A.

Substance of Interview including description of the general nature of what was agreed to if an agreement was reached, or any other comments: Claim 46 is a device claim, therefore, the statement of "an array of pseudo-random numbers;" as recited in line 4 is not appropriated. The applicant's attorney agrees to change to "A generator generates an array of pseudo-random numbers;" on June 15, 2005.

(A fuller description, if necessary, and a copy of the amendments which the examiner agreed would render the claims allowable, if available, must be attached. Also, where no copy of the amendments that would render the claims allowable is available, a summary thereof must be attached.)

THE FORMAL WRITTEN REPLY TO THE LAST OFFICE ACTION MUST INCLUDE THE SUBSTANCE OF THE INTERVIEW. (See MPEP Section 713.04). If a reply to the last Office action has already been filed, APPLICANT IS GIVEN ONE MONTH FROM THIS INTERVIEW DATE, OR THE MAILING DATE OF THIS INTERVIEW SUMMARY FORM, WHICHEVER IS LATER, TO FILE A STATEMENT OF THE SUBSTANCE OF THE INTERVIEW. See Summary of Record of Interview requirements on reverse side or on attached sheet.

Examiner Note: You must sign this form unless it is an Attachment to a signed Office action.

Examiner's signature, if required

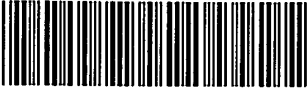
Issue Classification 	Application/Control No.	Applicant(s)/Patent under Reexamination	
	09/710,310	TZANNES, MARCOS C.	
	Examiner	Art Unit	
	Dung X. Nguyen	2631	

ISSUE CLASSIFICATION										
ORIGINAL					CROSS REFERENCE(S)					
CLASS	SUBCLASS				CLASS	SUBCLASS (ONE SUBCLASS PER BLOCK)				
375	220									
INTERNATIONAL CLASSIFICATION										
H	0	4	B	17/00						
				/						
				/						
				/						
				/						

<i>Dung X. Nguyen</i> (Assistant Examiner) (Date) 6/11/05	 KENNETH VANDERPUYE PRIMARY EXAMINER (Primary Examiner) (Date) 6/23/05	Total Claims Allowed: 12 <table border="1" style="width: 100%;"> <tr> <td>O.G. Print Claim(s)</td> <td>O.G. Print Fig.</td> </tr> <tr> <td style="text-align: center;">1</td> <td style="text-align: center;">2</td> </tr> </table>	O.G. Print Claim(s)	O.G. Print Fig.	1	2
O.G. Print Claim(s)	O.G. Print Fig.					
1	2					

<input type="checkbox"/> Claims renumbered in the same order as presented by applicant		<input type="checkbox"/> CPA		<input type="checkbox"/> T.D.		<input type="checkbox"/> R.1.47							
Final	Original	Final	Original	Final	Original	Final	Original						
	1		31		61		91		121		151		181
	2		32		62		92		122		152		182
	3		33		63		93		123		153		183
	4		34		64		94		124		154		184
	5		35		65		95		125		155		185
	6		36		66		96		126		156		186
	7		37		67		97		127		157		187
	8		38		68		98		128		158		188
	9		39		69		99		129		159		189
	10	1	40		70		100		130		160		190
	11	2	41		71		101		131		161		191
	12	3	42		72		102		132		162		192
	13	4	43		73		103		133		163		193
	14	5	44		74		104		134		164		194
	15	6	45		75		105		135		165		195
	16	7	46		76		106		136		166		196
	17	8	47		77		107		137		167		197
	18	9	48		78		108		138		168		198
	19	10	49		79		109		139		169		199
	20	11	50		80		110		140		170		200
	21	12	51		81		111		141		171		201
	22		52		82		112		142		172		202
	23		53		83		113		143		173		203
	24		54		84		114		144		174		204
	25		55		85		115		145		175		205
	26		56		86		116		146		176		206
	27		57		87		117		147		177		207
	28		58		88		118		148		178		208
	29		59		89		119		149		179		209
	30		60		90		120		150		180		210

Search Notes



Application/Control No.

09/710,310

Examiner

Dung X. Nguyen

Applicant(s)/Patent under Reexamination

TZANNES, MARCOS C.

Art Unit

2631

SEARCHED

Class	Subclass	Date	Examiner
Updated		5/23/2005	DXN

INTERFERENCE SEARCHED

Class	Subclass	Date	Examiner
375	220	5/24/2005	DXN

**SEARCH NOTES
(INCLUDING SEARCH STRATEGY)**

	DATE	EXMR
East Text Search	7/23/2005	DXN
Name Inventor Search	5/23/2005	DXN
IEEE Xplore	5/23/2005	DXN
Google Search	5/23/2005	DXN

Index of Claims



Application/Control No.

09/710,310

Examiner

Dung X. Nguyen

Applicant(s)/Patent under Reexamination

TZANNES, MARCOS C.

Art Unit

2631

√	Rejected
=	Allowed

-	(Through numeral) Cancelled
+	Restricted

N	Non-Elected
I	Interference

A	Appeal
O	Objected

Claim		Date					Claim		Date					Claim		Date					
Final	Original	6/15/05					Final	Original						Final	Original						
	1	-					12	51	=						101						
	2	-						52							102						
	3	-						53							103						
	4	-						54							104						
	5	-						55							105						
	6	-						56							106						
	7	-						57							107						
	8	-						58							108						
	9	-						59							109						
	10	-						60							110						
	11	-						61							111						
	12	-						62							112						
	13	-						63							113						
	14	-						64							114						
	15	-						65							115						
	16	-						66							116						
	17	-						67							117						
	18	-						68							118						
	19	-						69							119						
	20	-						70							120						
	21	-						71							121						
	22	-						72							122						
	23	-						73							123						
	24	-						74							124						
	25	-						75							125						
	26	-						76							126						
	27	-						77							127						
	28	-						78							128						
	29	-						79							129						
	30	-						80							130						
	31	-						81							131						
	32	-						82							132						
	33	-						83							133						
	34	-						84							134						
	35	-						85							135						
	36	-						86							136						
	37	-						87							137						
	38	-						88							138						
	39	-						89							139						
1	40	=						90							140						
2	41	=						91							141						
3	42	=						92							142						
4	43	=						93							143						
5	44	=						94							144						
6	45	=						95							145						
7	46	=						96							146						
8	47	=						97							147						
9	48	=						98							148						
10	49	=						99							149						
11	50	=						100							150						



UNITED STATES PATENT AND TRADEMARK OFFICE

COMMISSIONER FOR PATENTS
 UNITED STATES PATENT AND TRADEMARK OFFICE
 WASHINGTON, D.C. 20231
 www.uspto.gov



Bib Data Sheet

SERIAL NUMBER 09/710,310	FILING DATE 11/09/2000 RULE -	CLASS 375	GROUP ART UNIT 2631	ATTORNEY DOCKET NO. AWR-017 (457/19)
------------------------------------	---	---------------------	-------------------------------	--

APPLICANTS
 MARCOS C. TZANNES, ORINDA, CA ;

**** CONTINUING DATA **** *Yes*
 THIS APPLN CLAIMS BENEFIT OF 60/164,134 11/09/1999

**** FOREIGN APPLICATIONS **** *NONE*

IF REQUIRED, FOREIGN FILING LICENSE GRANTED
**** 02/17/2001**

Foreign Priority claimed <input type="checkbox"/> yes <input checked="" type="checkbox"/> no	35 USC 119 (a-d) conditions met <input type="checkbox"/> yes <input checked="" type="checkbox"/> no <input type="checkbox"/> Met after Allowance	STATE OR COUNTRY CA	SHEETS DRAWING 2	TOTAL CLAIMS 39	INDEPENDENT CLAIMS 4
Verified and Acknowledged <i>Simon C. Nguyen</i> Examiner's Signature	<i>DXN</i> Initials				

ADDRESS
 21323

TITLE
 SYSTEM AND METHOD FOR SCRAMBLING THE PHASE OF THE CARRIERS IN A MULTICARRIER COMMUNICATIONS SYSTEM

FILING FEE RECEIVED 1132	FEES: Authority has been given in Paper No. _____ to charge/credit DEPOSIT ACCOUNT No. _____ for following:	<input type="checkbox"/> All Fees <input type="checkbox"/> 1.16 Fees (Filing) <input type="checkbox"/> 1.17 Fees (Processing Ext. of time) <input type="checkbox"/> 1.18 Fees (Issue) <input type="checkbox"/> Other _____ <input type="checkbox"/> Credit
------------------------------------	---	---

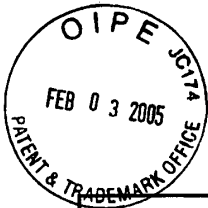

DFW

Approved for use through 07/31/2006 OMB 0651-0035
 U.S. Patent and Trademark Office; U.S. DEPARTMENT OF COMMERCE

Under the Paperwork Reduction Act of 1995, no persons are required to respond to a collection of information unless it displays a valid OMB control number.

CHANGE OF CORRESPONDENCE ADDRESS Application Address to: Commissioner for Patents P.O. Box 1450 Alexandria, VA 22313-1450	Application Number	09/710,310
	Filing Date	November 9, 2000
	First Named Inventor	TZANNES, MARCOS C.
	Art Unit	2631
	Examiner Name	
	Attorney Docket Number	T3653-8962US01

Please change the Correspondence Address for the above-identified patent application to:

The address associated with Customer Number: 000181

OR

<input type="checkbox"/> Firm or Individual Name				
Address				
City		State		Zip
Country				
Telephone	Fax			

This form cannot be used to change the data associated with a Customer Number. To change the data associated with an existing Customer Number use "Request for Customer Number Data Change" (PTO/SB/124).

I am the:

Applicant/Inventor

Assignee of record of the entire interest. Statement under 37 CFR 3.73(b) is enclosed. (Form PTO/SB/96).

Attorney or agent of record. Registration Number: 45,285

Registered practitioner named in the application transmittal letter in an application without an executed oath or declaration. See 37 CFR 1.33(a)(1). Registration Number _____.

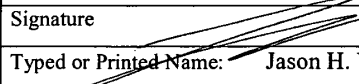
Signature: 

Typed or Printed Name: Jason H. Vick

Date: February 3, 2005 Telephone: (703) 903-9000

NOTE: Signatures of all the inventors or assignees of record of the entire interest or their representative(s) are required. Submit multiple forms if more than one signature is required, see below*.

*Total of 1 forms are submitted.

This collection of information is required by 37 CFR 1.33. The information is required to obtain or retain a benefit by the public which is to file (and by the USPTO to process) an application. Confidentiality is governed by 35 U.S.C. 122 and 37 CFR 1.11 and 1.14. This collection is estimated to 3 minutes to complete, including gathering, preparing, and submitting the completed application form to the USPTO. Time will vary depending upon the individual case. Any comments on the amount of time you require to complete this form and/or suggestions for reducing this burden, should be sent to the Chief Information Officer, U.S. Patent and Trademark Office, U.S. Department of Commerce, P.O. Box 1450, Alexandria, VA 22313-1450. DO NOT SEND FEES OR COMPLETED FORMS TO THIS ADDRESS. SEND TO: Commissioner for Patents, P.O. Box 1450, Alexandria, VA 22313-1450.

09/710,310
 Application or Docket Number
 09/710310

PATENT APPLICATION FEE DETERMINATION RECORD
 Effective October 1, 2000

CLAIMS AS FILED - PART I

		(Column 1)	(Column 2)
TOTAL CLAIMS			
FOR		NUMBER FILED	NUMBER EXTRA
TOTAL CHARGEABLE CLAIMS	39	minus 20=	*
INDEPENDENT CLAIMS	4	minus 3 =	*
MULTIPLE DEPENDENT CLAIM PRESENT <input type="checkbox"/>			

* If the difference in column 1 is less than zero, enter "0" in column 2

CLAIMS AS AMENDED - PART II

		(Column 1)	(Column 2)	(Column 3)
AMENDMENT A		CLAIMS REMAINING AFTER AMENDMENT	HIGHEST NUMBER PREVIOUSLY PAID FOR	PRESENT EXTRA
	Total	12	39	= -
	Independent	4	4	= ✓
FIRST PRESENTATION OF MULTIPLE DEPENDENT CLAIM <input type="checkbox"/>				

		(Column 1)	(Column 2)	(Column 3)
AMENDMENT B		CLAIMS REMAINING AFTER AMENDMENT	HIGHEST NUMBER PREVIOUSLY PAID FOR	PRESENT EXTRA
	Total	.	.	=
	Independent	.	.	=
FIRST PRESENTATION OF MULTIPLE DEPENDENT CLAIM <input type="checkbox"/>				

		(Column 1)	(Column 2)	(Column 3)
AMENDMENT C		CLAIMS REMAINING AFTER AMENDMENT	HIGHEST NUMBER PREVIOUSLY PAID FOR	PRESENT EXTRA
	Total	.	.	=
	Independent	.	.	=
FIRST PRESENTATION OF MULTIPLE DEPENDENT CLAIM <input type="checkbox"/>				

* If the entry in column 1 is less than the entry in column 2, write "0" in column 3.
 ** If the "Highest Number Previously Paid For" IN THIS SPACE is less than 20, enter "20."
 *** If the "Highest Number Previously Paid For" IN THIS SPACE is less than 3, enter "3."
 The "Highest Number Previously Paid For" (Total or Independent) is the highest number found in the appropriate box in column 1.

SMALL ENTITY TYPE OR OTHER THAN SMALL ENTITY

RATE	FEE	OR	RATE	FEE
BASIC FEE	355.00	OR	BASIC FEE	710.00
X\$ 9=		OR	X\$18=	
X40=		OR	X80=	
+135=		OR	+270=	
TOTAL		OR	TOTAL	

SMALL ENTITY TYPE OR OTHER THAN SMALL ENTITY

RATE	ADDITIONAL FEE	OR	RATE	ADDITIONAL FEE
X\$ 9=		OR	X\$18=	
X40=		OR	X80=	
+135=		OR	+270=	
TOTAL ADDIT. FEE		OR	TOTAL ADDIT. FEE	

RATE	ADDITIONAL FEE	OR	RATE	ADDITIONAL FEE
X\$ 9=		OR	X\$18=	
X40=		OR	X80=	
+135=		OR	+270=	
TOTAL ADDIT. FEE		OR	TOTAL ADDIT. FEE	

RATE	ADDITIONAL FEE	OR	RATE	ADDITIONAL FEE
X\$ 9=		OR	X\$18=	
X40=		OR	X80=	
+135=		OR	+270=	
TOTAL ADDIT. FEE		OR	TOTAL ADDIT. FEE	

BEST AVAILABLE COPY

BEST AVAILABLE COPY



Attorney Docket No. T3653-8962US01

IN THE UNITED STATES PATENT AND TRADEMARK OFFICE

In re Patent Application for:

First Inventor: TZANNES, MARCOS C.

Group Art Unit: 2631

Appln. No.: 09/710,310

Examiner: D. Nguyen

For: SYSTEM AND METHOD FOR
SCRAMBLING THE PHASE OF THE
CARRIERS IN A MULTICARRIER
COMMUNICATIONS SYSTEM

Confirmation No.: 5605

* * *

AMENDMENT

Commissioner for Patents
P.O. Box 1450
Alexandria, VA 22313-1450

RECEIVED
SEP 10 2004
Technology Center 2600

Sir:

In response to the Office action dated May 4, 2004, please amend the above-identified application as follows:

Amendments to the Claims begin on page 2 of this paper.

Remarks begin on page 5 of this paper.

AMENDMENTS TO THE CLAIMS

This listing of claims will replace all prior versions and listings of claims in the application.

Listing of Claims:

1 – 39. (Cancelled)

40. (New) In multicarrier modulation communications utilizing a plurality of QAM-modulated carrier signals, each carrier signal having a phase characteristic based on a QAM modulation, a method of randomizing the phase characteristics of the carriers comprising:

generating an array of pseudo-random numbers;

determining a phase shift for each carrier signal by multiplying a value from the array of pseudo-random numbers times $(\pi/m) \bmod 2\pi$, where m is an integer; and

adding the determined phase shift for each carrier signal to the phase characteristic of each carrier signal.

41. (New) The method of claim 40, wherein the method is performed in a multicarrier transmitter.

42. (New) The method of claim 40, wherein the method is performed in a multicarrier receiver.

43. (New) In multicarrier modulation communications utilizing a plurality of QAM-modulated carrier signals, each carrier signal having a phase characteristic

based on a QAM modulation, a system for randomizing the phase characteristics of the carriers comprising:

means for generating an array of pseudo-random numbers;

means for determining a phase shift for each carrier signal by multiplying a value from the array of pseudo-random numbers times $(\pi/m) \bmod 2\pi$, where m is an integer; and

means for adding the determined phase shift for each carrier signal to the phase characteristic of each carrier signal.

44. (New) The system of claim 43, wherein the system is associated with a multicarrier transmitter.

45. (New) The method of claim 43, wherein the system is associated with a multicarrier receiver.

46. (New) In multicarrier modulation device utilizing a plurality of QAM-modulated carrier signals, each carrier signal having a phase characteristic based on a QAM modulation, the device configured to randomize the phase characteristics of the carriers comprising:

an array of pseudo-random numbers;

a modulator adapted to determine a phase shift for each carrier signal by multiplying a value from the array of pseudo-random numbers times $(\pi/m) \bmod 2\pi$, where m is an integer and to add the determined phase shift for each carrier signal to the phase characteristic of each carrier signal.

47. (New) The device of claim 46, wherein the device is a transmitter.

48. (New) The device of claim 46, wherein the device is a receiver.

49. (New) In multicarrier modulation communications utilizing a plurality of QAM-modulated carrier signals, each carrier signal having a phase characteristic based on a QAM modulation, an information storage media having information stored thereon that randomizes the phase characteristics of the carriers comprising:

information that generates an array of pseudo-random numbers;

information that determines a phase shift for each carrier signal by multiplying a value from the array of pseudo-random numbers times $(\pi/m) \bmod 2\pi$, where m is an integer; and

information that adds the determined phase shift for each carrier signal to the phase characteristic of each carrier signal.

50. (New) The media of claim 49, wherein the information operates in a multicarrier transmitter.

51. (New) The media of claim 49, wherein the information operates in a multicarrier receiver.

REMARKS

By this amendment, claims 1-39 have been cancelled without prejudice nor disclaimer nor without concession as to the propriety of the outstanding Office Action in favor of newly added claims 40-51.

In particular, newly added claim 40 recites, *inter alia*, generating an array of pseudo-random numbers, determining a phase shift for each carrier signal by multiplying a value from the array of pseudo-random numbers times $(\pi/m) \bmod 2\pi$, where m is an integer and adding the determined phase shift for each carrier signal to the phase characteristic of each carrier signal.

U.S. Patent No. 5,748,677 to Kumar and U.S. Patent No. 6,704,317 to Dobson were cited with reference to the outstanding 35 U.S.C. § 102(b) and 103(a) rejections. Kumar discloses a reference signal communication method and system and the ability to linearly sum a reference signal 27 with a composite subcarrier signal 20 at 23 to form an overall composite signal 22. Dobson is directed toward a multicarrier LAN modem server.

However, neither of the references teach or suggest randomizing the phase characteristics as recited in independent Claim 40. As will be readily apparent, the remaining claims are also clearly distinguishable from the references of record.

With all outstanding rejections having been overcome, an early notice of allowance is respectfully solicited. Should the Examiner believe anything further is desirable in order to place the application in even better condition for allowance, the Examiner is encouraged to contact Applicant's undersigned representative at the telephone number listed below.

Respectfully submitted,



Jason H. Vick
Registration No. 45,285

Miles & Stockbridge P.C.
1751 Pinnacle Drive
Suite 500
McLean, Virginia 22102-3833
(703) 903-9000

263 / #
41

COMBINED AMENDMENT & PETITION FOR EXTENSION OF TIME UNDER 37 CFR 1.136(a) (Large Entity)	Docket No. T3653-8962US01
---	------------------------------

In Re Application Of: **Marcos C. TZANNES** **SEP 07 2004**

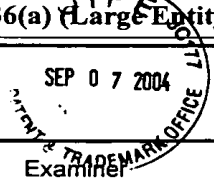

Application No. 09/710,310	Filing Date 11/9/2000	Examiner D. Nguyen	Customer No. 181	Group Art Unit 2631	Confirmation No. 5605
-------------------------------	--------------------------	-----------------------	---------------------	------------------------	--------------------------

Invention: **SYSTEM AND METHOD FOR SCRAMBLING THE PHASE OF THE CARRIERS IN A MULTICARRIER COMMUNICATIONS SYSTEM**

RECEIVED
SEP 10 2004

Technology Center 2600

COMMISSIONER FOR PATENTS:

This is a combined amendment and petition under the provisions of 37 CFR 1.136(a) to extend the period for filing a response to the Office Action of May 4, 2004 in the above-identified application.
Date

The requested extension is as follows (check time period desired):

One month Two months Three months Four months Five months

from: August 4, 2004 until: September 4, 2004
Date *Date*

The fee for the amendment and extension of time has been calculated as shown below:

CLAIMS AS AMENDED						
	CLAIMS REMAINING AFTER AMENDMENT	HIGHEST # PREV. PAID FOR	NUMBER EXTRA CLAIMS PRESENT	RATE		ADDITIONAL FEE
TOTAL CLAIMS	12 -	39 =	0	x \$18.00		\$0.00
INDEP. CLAIMS	4 -	4 =	0	x \$86.00		\$0.00
FEE FOR AMENDMENT						\$0.00
FEE FOR EXTENSION OF TIME						\$110.00
TOTAL FEE FOR AMENDMENT AND EXTENSION OF TIME						\$110.00

09/08/2004 HDEHESS1 00000097 501165 09710310
0. FC:1251 110.00 DA

**COMBINED AMENDMENT & PETITION FOR EXTENSION OF
TIME UNDER 37 CFR 1.136(a) (Large Entity)**

Docket No.
T3653-8962US01

The fee for the amendment and extension of time is to be paid as follows:

- A check in the amount of \$110.00 for the amendment and extension of time is enclosed.
- Please charge Deposit Account No. 50-1165 in the amount of \$110.00
- The Director is hereby authorized to charge payment of the following fees associated with this communication or credit any overpayment to Deposit Account No. 50-1165
 - Any additional filing fees required under 37 C.F.R. 1.16.
 - Any patent application processing fees under 37 CFR 1.17.
- If an additional extension of time is required, please consider this a petition therefor and charge any additional fees which may be required to Deposit Account No. 50-1165
- Payment by credit card. Form PTO-2038 is attached.

WARNING: Information on this form may become public. Credit card information should not be included on this form. Provide credit card information and authorization on PTO-2038.

Signature

Jason H. Vick, Registration No. 45,285
Customer No. 181
Miles & Stockbridge P.C.
1751 Pinnacle Drive, Suite 500
McLean, VA 22102
Telephone: (703) 903-9000

Dated: September 7, 2004

I hereby certify that this correspondence is being deposited with the United States Postal Service with sufficient postage as first class mail in an envelope addressed to the "Commissioner for Patents, P.O. Box 1450, Alexandria, VA 22313-1450" [37 CFR 1.8(a)] o.
(Date)

Signature of Person Mailing Correspondence

Typed or Printed Name of Person Mailing Correspondence

cc: JHV/sys

P28LARGE/REV04



UNITED STATES PATENT AND TRADEMARK OFFICE

UNITED STATES DEPARTMENT OF COMMERCE
United States Patent and Trademark Office
Address: COMMISSIONER FOR PATENTS
P.O. Box 1450
Alexandria, Virginia 22313-1450
www.uspto.gov

APPLICATION NO.	FILING DATE	FIRST NAMED INVENTOR	ATTORNEY DOCKET NO.	CONFIRMATION NO.
09/710,310	11/09/2000	MARCOS C. TZANNES	AWR-017 (457/19)	5605
22204	7590	05/04/2004	EXAMINER	
NIXON PEABODY, LLP 401 9TH STREET, NW SUITE 900 WASHINGTON, DC 20004-2128			NGUYEN, DUNG X	
			ART UNIT	PAPER NUMBER
			2631	

DATE MAILED: 05/04/2004

9

Please find below and/or attached an Office communication concerning this application or proceeding.

Office Action Summary	Application No.	Applicant(s)	
	09/710,310	TZANNES, MARCOS C.	
	Examiner	Art Unit	
	Dung X Nguyen	2631	

-- The MAILING DATE of this communication appears on the cover sheet with the correspondence address --

Period for Reply

A SHORTENED STATUTORY PERIOD FOR REPLY IS SET TO EXPIRE 3 MONTH(S) FROM THE MAILING DATE OF THIS COMMUNICATION.

- Extensions of time may be available under the provisions of 37 CFR 1.136(a). In no event, however, may a reply be timely filed after SIX (6) MONTHS from the mailing date of this communication.
- If the period for reply specified above is less than thirty (30) days, a reply within the statutory minimum of thirty (30) days will be considered timely.
- If NO period for reply is specified above, the maximum statutory period will apply and will expire SIX (6) MONTHS from the mailing date of this communication.
- Failure to reply within the set or extended period for reply will, by statute, cause the application to become ABANDONED (35 U.S.C. § 133). Any reply received by the Office later than three months after the mailing date of this communication, even if timely filed, may reduce any earned patent term adjustment. See 37 CFR 1.704(b).

Status

- 1) Responsive to communication(s) filed on 09 November 2000.
- 2a) This action is **FINAL**.
- 2b) This action is non-final.
- 3) Since this application is in condition for allowance except for formal matters, prosecution as to the merits is closed in accordance with the practice under *Ex parte Quayle*, 1935 C.D. 11, 453 O.G. 213.

Disposition of Claims

- 4) Claim(s) 1 - 39 is/are pending in the application.
 - 4a) Of the above claim(s) _____ is/are withdrawn from consideration.
- 5) Claim(s) _____ is/are allowed.
- 6) Claim(s) 1 - 39 is/are rejected.
- 7) Claim(s) _____ is/are objected to.
- 8) Claim(s) _____ are subject to restriction and/or election requirement.

Application Papers

- 9) The specification is objected to by the Examiner.
- 10) The drawing(s) filed on 25 January 2001 is/are: a) accepted or b) objected to by the Examiner.
 - Applicant may not request that any objection to the drawing(s) be held in abeyance. See 37 CFR 1.85(a).
 - Replacement drawing sheet(s) including the correction is required if the drawing(s) is objected to. See 37 CFR 1.121(d).
- 11) The oath or declaration is objected to by the Examiner. Note the attached Office Action or form PTO-152.

Priority under 35 U.S.C. § 119

- 12) Acknowledgment is made of a claim for foreign priority under 35 U.S.C. § 119(a)-(d) or (f).
 - a) All b) Some * c) None of:
 - 1. Certified copies of the priority documents have been received.
 - 2. Certified copies of the priority documents have been received in Application No. _____.
 - 3. Copies of the certified copies of the priority documents have been received in this National Stage application from the International Bureau (PCT Rule 17.2(a)).

* See the attached detailed Office action for a list of the certified copies not received.

Attachment(s)

- 1) Notice of References Cited (PTO-892)
- 2) Notice of Draftsperson's Patent Drawing Review (PTO-948)
- 3) Information Disclosure Statement(s) (PTO-1449 or PTO/SB/08)
 - Paper No(s)/Mail Date 4, 6.
- 4) Interview Summary (PTO-413)
 - Paper No(s)/Mail Date. _____.
- 5) Notice of Informal Patent Application (PTO-152)
- 6) Other: _____.

DETAILED ACTION

Claim Rejections - 35 USC § 102

1. The following is a quotation of the appropriate paragraphs of 35 U.S.C. 102 that form the basis for the rejections under this section made in this Office action:

A person shall be entitled to a patent unless –

(b) the invention was patented or described in a printed publication in this or a foreign country or in public use or on sale in this country, more than one year prior to the date of application for patent in the United States.

2. **Claims 1, 20, and 37 are rejected** under 35 U.S.C. 102(b) as being anticipated by Kumar (US patent # 5,748,677).

Regarding claim 1, Kumar discloses:

- Associating each carrier signal (column 4, lines 32 – 37 and column 13, lines 39 – 42) with a value determined independently of any input bit value carried by the carrier signal (column 2, line 65 to column 3, line 1);
- Computing a phase shift for each carrier signal based on the value associated with that carrier signal (column 1, lines 51 – 59 and column 5, lines 3 – 11);
- Combining a phase shift computed for each carrier (column 2, lines 5 – 9 and column 4, line 66 to column 5, line 3) with the phase characteristic of that carrier signal (column 1, lines 51 – 59) so as to scramble the phase characteristics of the plurality of carrier signals (column 3, lines 34 – 47).

Regarding claim 20, Kumar discloses:

- Associating each carrier signal (column 4, lines 32 – 37 and column 13, lines 39 – 42) with a value determined independently of any input bit value carried by the carrier signal (column 2, line 65 to column 3, line 1);
- Computing a phase shift for each carrier signal based on the value associated with that carrier signal (column 1, lines 51 – 59 and column 5, lines 3 – 11);

- Demodulating the transmission signal for each carrier signal (column 6, lines 58 – 61, column 2, lines 5 – 9 and column 4, line 66 to column 5, line 3) based on the value associated with that carrier signal (column 13, lines 39 – 45).

Regarding claim 37, the limitations are analyzed in the same manner set forth as claim 1.

Claim Rejections - 35 USC § 103

3. The following is a quotation of 35 U.S.C. 103(a) which forms the basis for all obviousness rejections set forth in this Office action:

(a) A patent may not be obtained though the invention is not identically disclosed or described as set forth in section 102 of this title, if the differences between the subject matter sought to be patented and the prior art are such that the subject matter as a whole would have been obvious at the time the invention was made to a person having ordinary skill in the art to which said subject matter pertains. Patentability shall not be negated by the manner in which the invention was made.

4. **Claims 2 – 19, and 21 – 36, 38, and 39 are rejected** under 35 U.S.C. 103(a) as being unpatentable over by Kumar (US patent # 5,748,677), and further in view of Dobson (US patent # 6,704,317 B1).

Regarding claim 2, Kumar differs from the instant claimed invention that it does not show wherein the apparatus analyzed in claim 1 further comprising modulating bits of the input stream onto the carrier signals having the scrambled phase characteristic to produce a transmission signal with a reduced peak-to-average power ratio.

However, Dobson discloses the modulating bits of the input stream onto the carrier signals (column 3, lines 1 – 5) having the scrambled phase characteristic (column 3, lines 29 – 33) to produce a transmission signal with a reduced peaked-to-average power ratio (column 15, lines 1- 4 and column 11, lines 33 – 34).

Therefore, it would have been obvious to one of ordinary skill in the art at the time of the invention was made to combine Kumar and Dobson to provide the apparatus analyzed in claim 1 further comprising modulating bits of the input stream onto the carrier signals having the scrambled phase characteristic to produce a transmission signal with a reduced peak-to-average power ratio for providing connectivity to devices and networks outside the home (column 1, lines 7 – 14 of Dobson).

Regarding claims 3 and 4, Kumar differs from the instant claimed invention that it does not show wherein the apparatus analyzed in claim 1 further comprising independently deriving and transmitting the value associated with each carrier signal at each transceiver, respectively. But, it discloses that wherein the apparatus analyzed in claim 1 further comprising independently deriving the value associated with each carrier signal (column 4, lines 33 – 37).

However, Dobson discloses that independently deriving and transmitting the value associated with each carrier at each transceiver (column 3, lines 1 – 5 and lines 55 – 58).

Therefore, it would have been obvious to one of ordinary skill in the art at the time of the invention was made to combine Kumar and Dobson to provide the apparatus analyzed in claim 1 further comprising independently deriving the value associated with each carrier signal at each transceiver for providing connectivity to devices and networks outside the home (column 1, lines 7 – 14 of Dobson).

Regarding claim 5, Kumar differs from the instant claimed invention that it does not show wherein the apparatus analyzed in claim 1 further comprising maintaining synchronization between the transceiver using the value associated with each carrier signal. But, it discloses that wherein the apparatus analyzed in claim 1 further comprising maintaining synchronization between the receiver and the transmitter using the value associated with each carrier signal (column 8, lines 28 – 48).

However, Dobson discloses that transmitting the value associated with each carrier at each transceiver (column 3, lines 1 – 5 and lines 55 – 58).

Therefore, it would have been obvious to one of ordinary skill in the art at the time of the invention was made to combine Kumar and Dobson to provide the apparatus analyzed in claim 1 further comprising maintaining synchronization between the transceiver using the value associated with each carrier signal for providing connectivity to devices and networks outside the home (column 1, lines 7 – 14 of Dobson).

Regarding claim 6 and 7, Kumar differs from the instant claimed invention that it does not show wherein the apparatus analyzed in claim 1 further comprising the value varies with each carrier signal or with each DMT symbol, respectively.

However, Dobson discloses that the value varies with each carrier signal or with each DMT symbol, respectively (column 2, lines 36 – 60).

Therefore, it would have been obvious to one of ordinary skill in the art at the time of the invention was made to combine Kumar and Dobson to provide the apparatus analyzed in claim 1 further comprising the value varies with each DMT symbol for providing connectivity to devices and networks outside the home (column 1, lines 7 – 14 of Dobson).

Regarding claim 8, Kumar further discloses that wherein the value is derived from a predetermined parameter (column 14, lines 47 – 51).

Regarding claim 9, Kumar differs from the instant claimed invention that it does not show wherein the predefined parameter is a carrier number.

However, in a digital system, each predetermined sequence must be one and/or zero.

Therefore, it would have been obvious to one of ordinary skill in the art at the time of the invention was made to recognize Kumar to provide the apparatus analyzed in claim 1 further comprising the predefined parameter is a carrier number.

Regarding claim 10, Kumar further discloses wherein the predefined parameter is a symbol count (column 16, lines 58 – 61).

Regarding claims 11 and 12, Kumar differs from the instant claimed invention that it does not show wherein the predefined parameter is a hyperframe count or a superframe count, respectively.

However, since Kumar has disclosed wherein the predefined parameter is a symbol count (column 16, lines 58 – 61), the predefined parameter is a hyperframe count or a superframe count is just a designed choice.

Therefore, it would have been obvious to one of ordinary skill in the art at the time of the invention was made to recognize Kumar to provide the apparatus analyzed in claim 1 further comprising the predefined parameter is a hyperframe count or superframe count for a designed choice.

Regarding claim 13, Kumar discloses wherein the apparatus analyzed in claim 1 further comprising scrambling the bits of the output stream (column 3, lines 31 – 47).

Regarding claim 14, Kumar discloses wherein the apparatus analyzed in claim 1 further comprising a predetermined transmission when the amplitude of the transmission signal exceeds a certain level (column 6, lines 50 – 57).

Regarding claim 15, Kumar inherently discloses wherein the predetermined transmission signal comprises a predetermined pattern of bits (column 6, line 58 to column 7, line 3).

Regarding claim 16, Kumar inherently discloses wherein the predetermined transmission signal comprises a pilot tone (column 6, lines 30 - 33).

Regarding claim 17, Kumar differs from the instant claimed invention that it does not show wherein the pilot tone is used to maintain synchronization between the first transceiver and the second transceiver. But, it discloses that wherein the pilot tone further comprising maintaining synchronization between the receiver and the transmitter using the value associated with each carrier signal (column 8, lines 28 – 48).

However, Dobson discloses that transmitting the value associated with each transceiver (column 3, lines 1 – 5 and lines 55 – 58).

Therefore, it would have been obvious to one of ordinary skill in the art at the time of the invention was made to combine Kumar and Dobson to provide wherein the pilot tone is used to maintain synchronization between the first transceiver and the second transceiver for providing connectivity to devices and networks outside the home (column 1, lines 7 – 14 of Dobson).

Regarding claim 18, Kumar inherently discloses wherein each bit value in the predetermined pattern of bits is a zero value (column 7, lines 10 - 12).

Regarding claim 19, Kumar discloses wherein the predetermined pattern of bits is pseudo-random sequence pattern (column 5, lines 28 - 67).

Regarding claim 21, the limitations are analyzed in the same manner set forth as claim 3.

Regarding claim 22, the limitations are analyzed in the same manner set forth as claim 4.

Regarding claim 23, the limitations are analyzed in the same manner set forth as claim 5.

Regarding claim 24, the limitations are analyzed in the same manner set forth as claim 6

Regarding claim 25, the limitations are analyzed in the same manner set forth as claim 7.

Regarding claim 26, the limitations are analyzed in the same manner set forth as claim 8.

Regarding claim 27, the limitations are analyzed in the same manner set forth as claim 9.

Regarding claim 28, the limitations are analyzed in the same manner set forth as claim 10.

Regarding claim 29, the limitations are analyzed in the same manner set forth as claim 11.

Regarding claim 30, the limitations are analyzed in the same manner set forth as claim 12.

Regarding claim 31, the limitations are analyzed in the same manner set forth as claim 14.

Regarding claim 32, the limitations are analyzed in the same manner set forth as claim 15.

Regarding claim 33, the limitations are analyzed in the same manner set forth as claim 16.

Regarding claim 34, the limitations are analyzed in the same manner set forth as claim 17.

Regarding claim 35, the limitations are analyzed in the same manner set forth as claim 18.

Regarding claim 36, the limitations are analyzed in the same manner set forth as claim 19.

Regarding claim 38, the limitations are analyzed in the same manner set forth as claim 2.

Regarding claim 39, Kumar discloses:

- Receiving over the communication channel a transmission signal (column 14, line 63 to column 15, line 3) comprised a sequence of symbols that each have a bit-value pattern (column 5, lines 28 – 67);
- Comparing the bit-value of each received symbol with a predetermined bit value pattern (column 2, lines 32 – 36, column 9, lines 29 – 41, and column 12, lines 17 – 22);
- Discarding a given one of the received symbols (column 11, lines 64 – 67 and column 18, lines 39 – 42) in the sequence of symbols if the bit-value pattern of that symbol matches (column 9, lines 2 – 6, and column 11, lines 46 – 52) the predetermined bit-value pattern, otherwise demodulating that symbol (column 6, lines 58 – 61, column 7, lines 38 – 42, and column 8, lines 39 – 41).

Kumar differs from the instant claimed invention that it does not show wherein the apparatus analyzed in the instant claimed invention further comparing the each DMT symbol with a predetermined bit-value pattern, discarding it when it has the same value of a predetermined bit-value pattern, otherwise demodulating it.

However, Dobson discloses that the value varies with each carrier signal or with each DMT symbol, respectively (column 2, lines 36 – 60).

Therefore, it would have been obvious to one of ordinary skill in the art at the time of the invention was made to combine Kumar and Dobson to provide the apparatus analyzed in the instant claimed invention further comparing the each DMT symbol with a predetermined bit-value pattern, discarding it when it has the same value of a predetermined bit-value pattern, otherwise demodulating it for providing connectivity to devices and networks outside the home (column 1, lines 7 – 14 of Dobson).

Conclusion

5. The prior art made of record and not relied upon is considered pertinent to applicant's disclosure.

Dobson (US patent # 6,507,585 B1) discloses a multi-carrier adapter device using frequency domain equalizer.

Rhind (US patent # 4,985,900) discloses a non-intrusive channel-impairment analyzer.

Lyon et al. (US patent # 3,955,141) discloses synchronizing circuit for modems in a data communication network.

Contact Information

6. Any inquiry concerning this communication or earlier communications from the examiner should be directed to Dung X. Nguyen whose telephone number is (703) 305-4892. The examiner can normally be reached on Monday through Friday from 8:30 AM to 5:30 PM.

Application/Control Number: 09/710,310
Art Unit: 2631

Page 10

If attempts to reach the examiner by telephone are unsuccessful, the examiner's supervisor, Mr. Ghayour Mohammad H. can be reached on (703) 306-3034. The fax phone numbers for this group is (703) 872-9314.

Any inquiry of a general nature or relating to the status of this application or proceeding should be directed to the receptionist whose telephone number is (703) 305-3800.

DXN

April 15, 2004

A handwritten signature in black ink, consisting of several overlapping, fluid strokes that form a cursive-like shape.

Tle

Notice of References Cited	Application/Control No. 09/710,310	Applicant(s)/Patent Under Reexamination TZANNES, MARCOS C.	
	Examiner Dung X Nguyen	Art Unit 2631	Page 1 of 1

U.S. PATENT DOCUMENTS

*	Document Number Country Code-Number-Kind Code	Date MM-YYYY	Name	Classification
	A US-			
	B US-6,704,317	03-2004	Dobson, William Kurt	370/401
	C US-6,507,585	01-2003	Dobson, William Kurt	370/420
	D US-5,748,677	05-1998	Kumar, Derek D.	375/285
	E US-4,985,900	01-1991	Rhind et al.	375/10
	F US-3,955,141	05-1976	Lyon et al.	325/38 A
	G US-			
	H US-			
	I US-			
	J US-			
	K US-			
	L US-			
	M US-			

FOREIGN PATENT DOCUMENTS

*	Document Number Country Code-Number-Kind Code	Date MM-YYYY	Country	Name	Classification
	N				
	O				
	P				
	Q				
	R				
	S				
	T				

NON-PATENT DOCUMENTS

*	Document Number Country Code-Number-Kind Code	Date MM-YYYY	Country	Name	Classification
	Include as applicable: Author, Title Date, Publisher, Edition or Volume, Pertinent Pages)				
*	U	Provisional application # 60/164,134 filed on 11/09/1999			
	V				
	W				
	X				

*A copy of this reference is not being furnished with this Office action. (See MPEP § 707.05(a).)
Dates in MM-YYYY format are publication dates. Classifications may be US or foreign.

Tle

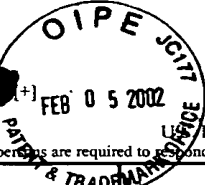

Please type a plus sign (+) inside this box.

PTO/SB/08A (08-00)
Approved for use through 10/31/2002. OMB 0651-0031
Patent and Trademark Office: U.S. DEPARTMENT OF COMMERCE

Under the Paperwork Reduction Act of 1995, no persons are required to respond to a collection of information unless it contains a valid OMB control number.

Substitute for form 1449A/PTO		<i>Complete if Known</i>	
INFORMATION DISCLOSURE STATEMENT BY APPLICANT <i>(use as many sheets as necessary)</i>		Application Number	09/710,310
		Filing Date	November 9, 2000
		First Named Inventor	Marcos C. TZANNES
		Group Art Unit	2631
		Examiner Name	Not yet assigned
		Attorney Docket Number	081513-41
Sheet		of	

U.S. PATENT DOCUMENTS						
Examiner Initials ⁷	Cite No. ¹	U.S. Patent Document		Name of Patentee or Applicant of Cited Document	Date of Publication of Cited Document MM-DD-YYYY	Pages, Columns, Lines, Where Relevant Passages or Relevant Figures Appear
		Number	Kind Code ² <i>(if known)</i>			

RECEIVED
FEB 07 2002

Technology Center 2600

FOREIGN PATENT DOCUMENTS								
Examiner Initials ⁷	Cite No. ¹	Foreign Patent Document			Name of Patentee or Applicant of Cited Document	Date of Publication of Cited Document MM-DD-YYYY	Pages, Columns, Lines, Where Relevant Passages or Relevant Figures Appear	T ⁸
		Office ³	Number ⁴	Kind Code ⁵ <i>(if known)</i>				
<i>DPN</i>		EP	0 584 534	A1	Sandri et al.	03-02-1994		
<i>DPN</i>		GB	2 330 491	A	Baily et al.	04-21-1999		

OTHER PRIOR ART - NON PATENT LITERATURE DOCUMENTS			
Examiner Initials ⁷	Cite No. ¹	Include name of the author (in CAPITAL LETTERS), title of the article (when appropriate), title of the item (book, magazine, journal, serial, symposium, catalog, etc.), date, page(s), volume-issue number(s), publisher, city and/or country where published.	T ²

Examiner Signature	<i>Dmg Xo Nguyen</i>	Date Considered	<i>4/12/2004</i>
--------------------	----------------------	-----------------	------------------

*EXAMINER: Initial if reference considered, whether or not citation is in conformance with MPEP 609. Draw line through citation if not in conformance and not considered. Include copy of this form with next communication to applicant.

¹ Unique citation designation number. ² See attached Kinds of U.S. Patent Documents. ³ Enter Office that issued the document, by the two-letter code (WIPO Standard ST.3). ⁴ For Japanese patent documents, the indication of the year of the reign of the Emperor must precede the serial number of the patent document. ⁵ Kind of document by the appropriate symbols as indicated on the document under WIPO Standard ST.16 if possible. ⁶ Applicant is to place a check mark here if English language Translation is attached.

Burden Hour Statement: This form is estimated to take 2.0 hours to complete. Time will vary depending upon the needs of the individual case. Any comments on the amount of time you are required to complete this form should be sent to the Chief Information Officer, U.S. Patent and Trademark Office, Washington, DC 20231. DO NOT SEND FEES OR COMPLETED FORMS TO THIS ADDRESS. SEND TO: Commissioner for Patents, Washington, DC 20231.

Please type a plus sign (+) inside this box → [+]

4

PTO/SB/08A (08-00)

Approved for use through 10/31/2002. OMB 0651-0031

U.S. Patent and Trademark Office: U.S. DEPARTMENT OF COMMERCE

Under the Paperwork Reduction Act of 1995, no persons are required to respond to a collection of information unless it contains a valid OMB control number.

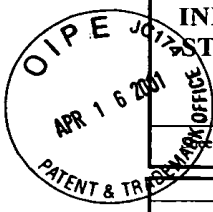

Substitute for form 1449A/PTO		Complete if Known	
INFORMATION DISCLOSURE STATEMENT BY APPLICANT <i>(use as many sheets as necessary)</i>		Application Number	09/710,310
		Filing Date	November 9, 2000
		First Named Inventor	Marcos C. TZANNES
		Group Art Unit	2631
		Examiner Name	Not yet assigned
		Attorney Docket Number	081513-41

U.S. PATENT DOCUMENTS						
Examiner Initials ¹	Cite No. ¹	U.S. Patent Document		Name of Patentee or Applicant of Cited Document	Date of Publication of Cited Document MM-DD-YYYY	Pages, Columns, Lines, Where Relevant Passages or Relevant Figures Appear
		Number	Kind Code ² <i>(if known)</i>			
						RECEIVED APR 17 2001

Technology Center 2600

FOREIGN PATENT DOCUMENTS								
Examiner Initials ¹	Cite No. ¹	Foreign Patent Document			Name of Patentee or Applicant of Cited Document	Date of Publication of Cited Document MM-DD-YYYY	Pages, Columns, Lines, Where Relevant Passages or Relevant Figures Appear	T ⁶
		Office ³	Number ⁴	Kind Code ² <i>(if known)</i>				
JPN		EP	0 719 004	A2	Matsushita Electric Industrial Co., Ltd.	June 26, 1996		
JPN		WO	99/29078		Telia Ab	June 10, 1999		
JPN		WO	98/32065		Fortress Technologies, Inc.	July 23, 1998		
JPN		WO	99/22463		Motorola Inc.	May 6, 1999		

OTHER PRIOR ART - NON PATENT LITERATURE DOCUMENTS			
Examiner Initials ¹	Cite No. ¹	Include name of the author (in CAPITAL LETTERS), title of the article (when appropriate), title of the item (book, magazine, journal, serial, symposium, catalog, etc.), date, page(s), volume-issue number(s), publisher, city and/or country where published.	T ²
JPN		Bauml R. W. et al.: "Reducing The Peak-To-Average Power Ratio Of Multicarrier Modulation By Selected Mapping" Electronics Letters, GB, IEE Stevenage, vol.32, no.22, 24 October 1996, pages 2056-2057, XP000643915 ISSN: 0013-5194.	
JPN		Copy of Annex to Form PCT/ISA/206 for PCT/US00/30958, 23 March 2001.	

Examiner Signature	<i>Dmg X, Nguyen</i>	Date Considered	4/12/2004
--------------------	----------------------	-----------------	-----------

*EXAMINER: Initial if reference considered, whether or not citation is in conformance with MPEP 609. Draw line through citation if not in conformance and not considered. Include copy of this form with next communication to applicant.

¹ Unique citation designation number. ² See attached Kinds of U.S. Patent Documents. ³ Enter Office that issued the document, by the two-letter code (WIPO Standard ST.3). ⁴ For Japanese patent documents, the indication of the year of the reign of the Emperor must precede the serial number of the patent document. ⁵ Kind of document by the appropriate symbols as indicated on the document under WIPO Standard ST.16 if possible. ⁶ Applicant is to place a check mark here if English language Translation is attached.

Burden Hour Statement: This form is estimated to take 2.0 hours to complete. Time will vary depending upon the needs of the individual case. Any comments on the amount of time you are required to complete this form should be sent to the Chief Information Officer, U.S. Patent and Trademark Office, Washington, DC 20231. DO NOT SEND FEES OR COMPLETED FORMS TO THIS ADDRESS. SEND TO: Commissioner for Patents, Washington, DC 20231.

	Type	Hits	Search Text	DBs	Time Stamp	Corrections	Error Definition
1	BRS	1046	bit and (comput\$3 or calculat\$3) and (phase adj1 shift) and scrambl\$3 and associat\$3 and determin\$3 and value	USPAT; US-PGPUB; EPO; DERWENT	2004/04/09 15:40		
2	BRS	326	bit and (comput\$3 or calculat\$3) and (phase adj1 shift) and scrambl\$3 and associat\$3 and determin\$3 and value and (carrier adj signal\$3)	USPAT; US-PGPUB; EPO; DERWENT	2004/04/12 10:34		
3	BRS	41	bit and (comput\$3 or calculat\$3) and (phase adj1 shift) and scrambl\$3 and associat\$3 and determin\$3 and value and (carrier adj signal\$3) and DMT	USPAT; US-PGPUB; EPO; DERWENT	2004/04/12 12:54		
4	IS&R	396	(375/220).CCLS.	USPAT; US-PGPUB; EPO; DERWENT	2004/04/09 15:47		
5	IS&R	843	(375/219).CCLS.	USPAT; US-PGPUB; EPO; DERWENT	2004/04/09 15:47		
6	BRS	1	(bit and (comput\$3 or calculat\$3) and (phase adj1 shift) and scrambl\$3 and associat\$3 and determin\$3 and value and (carrier adj signal\$3) and DMT) and ((375/220).CCLS.)	USPAT; US-PGPUB; EPO; DERWENT	2004/04/09 15:48		
7	BRS	40	bit and (comput\$3 or calculat\$3) and (phase adj1 shift) and scrambl\$3 and associat\$3 and determin\$3 and value and (carrier adj signal\$3) and DMT and (combin\$3 or add\$3 or augment\$3 or sum\$4)	USPAT; US-PGPUB; EPO; DERWENT	2004/04/12 08:30		
8	BRS	4	bit and (comput\$3 or calculat\$3) and (phase adj1 shift) and scrambl\$3 and associat\$3 and determin\$3 and value and (carrier adj signal\$3) and DMT and (combin\$3 or add\$3 or augment\$3 or sum\$4) and wavelet	USPAT; US-PGPUB; EPO; DERWENT	2004/04/12 15:58		
9	IS&R	150	(375/226).CCLS.	USPAT; US-PGPUB; EPO; DERWENT	2004/04/12 12:54		
10	IS&R	541	(375/362).CCLS.	USPAT; US-PGPUB; EPO; DERWENT	2004/04/12 10:33		
11	IS&R	518	(375/327).CCLS.	USPAT; US-PGPUB; EPO; DERWENT	2004/04/12 13:33		
12	BRS	1	bit and (comput\$3 or calculat\$3) and (phase adj1 shift) and scrambl\$3 and associat\$3 and determin\$3 and value and (carrier adj signal\$3) and ((375/226).CCLS.)	USPAT; US-PGPUB; EPO; DERWENT	2004/04/12 10:34		
13	BRS	4	bit and (comput\$3 or calculat\$3) and (phase adj1 shift) and scrambl\$3 and associat\$3 and determin\$3 and value and (carrier adj signal\$3) and ((375/362).CCLS.)	USPAT; US-PGPUB; EPO; DERWENT	2004/04/12 10:35		

	Type	Hits	Search Text	DBs	Time Stamp	Comments	Error Definition
14	BRS	2	bit and (comput\$3 or calculat\$3) and (phase adj1 shift) and scrambl\$3 and associat\$3 and determin\$3 and value and (carrier adj signal\$3) and ((375/327).CCLS.)	USPAT; US-PGPUB; EPO; DERWENT	2004/04/12 10:40		
15	BRS	1161	bit and (comput\$3 or calculat\$3) and (phase adj1 shift) and scrambl\$3 and associat\$3	USPAT; US-PGPUB; EPO; DERWENT	2004/04/12 11:43		
16	IS&R	894	(370/400).CCLS.	USPAT; US-PGPUB; EPO; DERWENT	2004/04/12 12:54		
17	IS&R	2477	(370/401).CCLS.	USPAT; US-PGPUB; EPO; DERWENT	2004/04/12 12:54		
18	BRS	2	bit and (comput\$3 or calculat\$3) and (phase adj1 shift) and scrambl\$3 and associat\$3 and determin\$3 and value and (carrier adj signal\$3) and DMT and ((370/401).CCLS.)	USPAT; US-PGPUB; EPO; DERWENT	2004/04/12 13:33		
19	BRS	1	"20040044942"	USPAT; US-PGPUB; EPO; DERWENT	2004/04/12 13:34		
20	BRS	1	"6704317"	USPAT; US-PGPUB; EPO; DERWENT	2004/04/12 13:34		
21	BRS	19	bit and (comput\$3 or calculat\$3) and (phase adj1 shift) and scrambl\$3 and associat\$3 and determin\$3 and value and (carrier adj signal\$3) and DMT and (combin\$3 or add\$3 or augment\$3 or sum\$4) and discard\$3	USPAT; US-PGPUB; EPO; DERWENT	2004/04/12 16:00		
22	BRS	17	bit and (comput\$3 or calculat\$3) and (phase adj1 shift) and scrambl\$3 and associat\$3 and determin\$3 and value and (carrier adj signal\$3) and DMT and (combin\$3 or add\$3 or augment\$3 or sum\$4) and discard\$3 and match\$3	USPAT; US-PGPUB; EPO; DERWENT	2004/04/12 16:00		



UNITED STATES PATENT AND TRADEMARK OFFICE

COMMISSIONER FOR PATENTS
UNITED STATES PATENT AND TRADEMARK OFFICE
WASHINGTON, D.C. 20231
www.uspto.gov

APPLICATION NUMBER	FILING DATE	FIRST NAMED APPLICANT	ATTY. DOCKET NO./TITLE
09/710,310	11/09/2000	MARCOS C. TZANNES	AWR-017 (457/19)

22204
NIXON PEABODY, LLP
8180 GREENSBORO DRIVE
SUITE 800
MCLEAN, VA 22102

CONFIRMATION NO. 5605



Date Mailed: 05/06/2002

NOTICE REGARDING POWER OF ATTORNEY

This is in response to the Power of Attorney filed 04/29/2002.

The Power of Attorney in this application is accepted. Correspondence in this application will be mailed to the above address as provided by 37 CFR 1.33.

 DAVINA G BUTLER
 2600 (703) 308-9455

OFFICE COPY



UNITED STATES PATENT AND TRADEMARK OFFICE

COMMISSIONER FOR PATENTS
UNITED STATES PATENT AND TRADEMARK OFFICE
WASHINGTON, D.C. 20231
www.uspto.gov

APPLICATION NUMBER	FILING DATE	FIRST NAMED APPLICANT	ATTY. DOCKET NO./TITLE
09/710,310	11/09/2000	MARCOS C. TZANNES	AWR-017 (457/19)

CONFIRMATION NO. 5605

KEVIN RUSSELL
CORPORATE COUNSEL
40 MIDDLESEX TURNPIKE
AWARE, INC.
BEDFORD, MA 01730



Date Mailed: 05/06/2002

NOTICE REGARDING POWER OF ATTORNEY

This is in response to the Power of Attorney filed 04/29/2002.

- The Power of Attorney to you in this application has been revoked by the assignee who has intervned as provided by 37 CFR 3.71. Future correspondence will be mailed to the new address of record(37 CFR 1.33).



 DAVINA G BUTLER
 2600 (703) 308-9455

OFFICE COPY



Please type a plus sign (+) inside this box → [+]

PTO/SB/21 (08-00)

Approved for use through 10/31/2002. OMB 0651-0031
 U.S. Patent and Trademark Office: U.S. DEPARTMENT OF COMMERCE

Under the Paperwork Reduction Act of 1995, no persons are required to respond to a collection of information unless it displays a valid OMB control number.

TRANSMITTAL FORM <i>(to be used for all correspondence after initial filing)</i>	Application Number	09/710,310
	Filing Date	November 9, 2000
	First Named Inventor	Marcos C. Tzannes
	Group Art Unit	2631
	Examiner Name	Not yet assigned
Total Number of Pages in This Submission	Attorney Docket Number	081513-41

ENCLOSURES (check all that apply)		
<input type="checkbox"/> Fee Transmittal Form <input type="checkbox"/> Fee Attached <input type="checkbox"/> Amendment / Reply <input type="checkbox"/> After Final <input type="checkbox"/> Affidavits/declaration(s) <input type="checkbox"/> Extension of Time Request <input type="checkbox"/> Express Abandonment Request <input type="checkbox"/> Information Disclosure Statement <input type="checkbox"/> Certified Copy of Priority Document(s) <input type="checkbox"/> Response to Missing Parts/ Incomplete Application <input type="checkbox"/> Response to Missing Parts under 37 CFR 1.52 or 1.53	<input type="checkbox"/> Assignment Papers (for an Application) <input type="checkbox"/> Drawing(s) <input type="checkbox"/> Licensing-related Papers <input type="checkbox"/> Petition <input type="checkbox"/> Petition to Convert to a Provisional Application <input checked="" type="checkbox"/> Power of Attorney, Revocation Change of Correspondence Address <input type="checkbox"/> Terminal Disclaimer <input type="checkbox"/> Request for Refund <input type="checkbox"/> CD, Number of CD(s) _____	<input type="checkbox"/> After Allowance Communication to Group <input checked="" type="checkbox"/> Other: Statement Under 37 CFR 3.73(b) List of all applications (5 pages)
Remarks	<input checked="" type="checkbox"/> The Commissioner is hereby authorized to charge any additional fees required or credit any overpayments to Deposit Account No. 19-2380 for the above identified docket number.	

RECEIVED
 MAY 01 2002
 Technology Center 2600

SIGNATURE OF APPLICANT, ATTORNEY, OR AGENT	
Firm or Individual name	Jason H. Vick Nixon Peabody LLP 8180 Greensboro Drive Suite 800 McLean, VA 22012
Signature	
Date	April 29, 2002

CERTIFICATE OF MAILING	
I hereby certify that this correspondence is being deposited with the United States Postal Service with sufficient postage as first class mail in an envelope addressed to: Commissioner for Patents, Washington, DC 20231 on this date: 	
Type or printed name	
Signature	Date

Burden Hour Statement: This form is estimated to take 0.2 hours to complete. Time will vary depending upon the needs of the individual case. Any comments on the amount of time you are required to complete this form should be sent to the Chief Information Officer, U.S. Patent and Trademark Office, Washington, DC 20231. **DO NOT SEND FEES OR COMPLETED FORMS TO THIS ADDRESS. SEND TO: Commissioner for Patents, Washington, DC 20231.**



#7
DUBIA
5-3-02

IN THE UNITED STATES PATENT AND TRADEMARK OFFICE

REVOCATION/APPOINTMENT OF POWER OF ATTORNEY

Commissioner for Patents
Washington, D.C. 20231
Sir:

RECEIVED
MAY 01 2002
Technology Center 2600

In the matters listed on the attached sheet (21 U.S. issued patents and 22 U.S. pending patent applications), we hereby revoke all Powers of Attorney heretofore given by us and appoint as our Attorneys the Practitioners at Customer Number 22204 with full power of substitution, association, and revocation, to prosecute said application and to transact all business in the Patent and Trademark Office connected therewith. Furthermore, please change the correspondence address for the cases listed on the attached sheet to Jason H. Vick, NIXON PEABODY LLP, 8180 Greensboro Drive, Suite 800, McLean, VA 22102.

I am the:	
<input type="checkbox"/> Applicant/Inventor.	
<input checked="" type="checkbox"/> Assignee of record of the entire interest. See 37 CFR 3.71. <i>Statement under 37 CFR 3.73(b) is enclosed. (Form PTO/SB/96).</i>	
SIGNATURE of Applicant or Assignee of Record	
Name	Richard P. Moberg
Signature	
Date	8/28/01

RECEIVED

MAY 11 2002

Technology Center 2600

Our Reference	Client Reference	Serial No.	Patent No.	Title	Reel/Frame	Status
081513-21	AWR-005	09/581,400		Multicarrier Transmission System With Low Power Sleep Mode and Rapid-On Capability	011130/0775	Pending
081513-22	AWR-004CN	09/573,816		Method and Apparatus For Varying Power Levels In A Multicarrier Modem	011473/0950	Pending
081513-23	AWR-004CN2	09/597,926		Method and Apparatus For Communicating With Multiple Remote Transceivers	011475/0167	Pending
081513-24	AWR-002C	09/522,870		A Method For Seamlessly Changing Power Modes In An ADSL System	011240/0684	Pending
081513-26	AWR-001	09/663,001		Dynamic Switching Between Active Application Sets	011405/0191	Pending
081513-27	AWR-002B	09/523,086		Method For Synchronizing Seamless Rate Adaptation	011010/0319	Pending
081513-28	AWR-002A	09/522,869		Seamless Rate Adaptive Multicarrier Modulation System And Protocols	011010/0323	Pending
081513-37	AWR-016	09/710,319		Time Diversity Method And Apparatus For Improving Transmission Bit Rate In A Multicarrier System	011395/0718	Pending
081513-38	AWR-006CN	09/421,835		Adaptive Allocation For Variable Bandwidth Multicarrier Communication	8932/0153	Pending
081513-39	AWR-006	08/873,421	6,072,779	Adaptive Allocation For Variable Bandwidth Multicarrier Communication	8932/0153	Issued



NVA189927.1

Our Reference	Client Reference	Serial No.	Patent No.	Title	Reel/Frame	Status
081513-40	AWR-007	09/600,971		Bit Allocation Among Carriers In Multicarrier Communications	011189/0182	Pending
081513-41	AWR-017	09/710,310		A System And Method For Scrambling The Phase of The Carriers in a Multicarrier Communication System	010877/0307	Pending
081513-42	AWR-020	08/804,909	6,252,909	Multicarrier Transmission System Utilizing Channels of Different Bandwidth	010913/0057 011011/0755	Issued
081513-43	AWR-012	09/738,785		Intelligent Rate Option Determination Method Applied To ADSL Transceiver	010771/0652	Pending
081513-44	AWR-019	09/663,758		A Method And A Multicarrier Transceiver With Stored Application Profiles For Supporting Multiple Applications	011171/0341	Pending
081513-62	AWR-021	09/616,954		A System And Method For Transmitting Messages Between Transceivers Using Electromagnetically Coupled Signals	011101/0322	Pending
081513-69	AWR-048	09/774,986		Cache System And Method For Generating Uncached Objects From Cached And Stored Object Components	Recordation of Assignment filed 09/27/2001	Pending
081513-92		60/278,936		Receiver Transparent Q-mode	Recordation of Assignment filed 09/27/2001	Pending
081513-94		60/283,467		Receiver Transparent Q-mode with On-line Reconfiguration	Recordation of Assignment filed 09/27/2001	Pending
081513-97	AWR-014	07/388,384	4,974,187	Modular Digital Signal Processing System	5132/0301	Issued

Our Reference	Client Reference	Serial No.	Patent No.	Title	Reel/Frame	Status
081513-98	AWR-015	07/230,529	4,904,073	Fractal Tilting For Multiple Mirror Optical Devices	4917/0351	Issued
081513-99	AWR-018	08/340,747	5,636,246	Improved Multicarrier Transmission System	7237/0294-0297	Issued
081513-100	AWR-022	08/670,245	5,751,716	Multicarrier Transmission System Adapted For Packet Data Transfer	8949/0229	Issued
081513-101	AWR-023	08/591,831	5,631,610	Single-Side Band Modulation System For Use In Digitally Implemented Multicarrier Transmission System	8301/0162	Issued
081513-102	AWR-024	08/668,575	5,715,280	Method For Partially Modulating And Demodulating Data In A Multicarrier Transmission System	8751/0026	Issued
081513-103	AWR-027	08/876,044	6,021,378	Compression System For Seismic Data	Recordation of Assignment filed 09/28/2001	Issued
081513-104	AWR-026	07/561,449	5,148,498	Image Coding Apparatus And Method Utilizing Separable Transformations	5427/0405-0412	Issued
081513-105	AWR-028	08/661,974	5,832,030	Multicarrier Transmission System Utilizing Channels With Different Error Rates	9137/0328-0330	Issued
081513-106	AWR-029	09/086,198	5,359,627	Channels Codec Apparatus And Method Utilizing Flat Codes	5822/0573-0574	Issued
081513-107	AWR-030	08/307,331	5,606,642	Audio Decompression System Employing Multi-Rate Signal Analysis	6332/0749-0751 6296/0332-0333 6299/0913-0914	Issued

Our Reference	Client Reference	Serial No.	Patent No.	Title	Reel/Frame	Status
081513-108	AWR-032	07/786,722	5,272,530	Method And Apparatus For Coding Motion Pictures Utilizing Motion Compensation	5921/0711-0712	Issued
081513-109	AWR-033	08/002,113	5,583,952	Method And Apparatus For Representing An Image By Iteratively Synthesizing High And Low Frequency Components	5262/0328-0329	Issued
081513-110	AWR-034	07/563,275	5,081,645	Novel Spread Spectrum Codec Apparatus And Method	5446/0763-0770	Issued
081513-111	AWR-035	07/531,468	5,101,446	Method And Apparatus For Coding An Image	5368/0334-0337 5377/0721-0722	Issued
081513-112	AWR-036	07/669,773	5,121,191	Method And Apparatus For Coding Motion Pictures	5753/0821-0828	Issued
081513-113	AWR-037	08/105,796	5,497,398	Multicarrier Transceiver	6673/0631-0634	Issued
081513-114	AWR-038	07/948,147	5,408,580	Audio Compression System Employing Multi-Rate Signal Analysis	6332/0749-0751 6296/0332-0333 6299/0913-0914	Issued
081513-115	AWR-039	08/016,786	5,301,020	Method And Apparatus For Coding Motion Pictures Utilizing Motion Compensation	6457/0215-0216	Issued
081513-116		60/285,054		Forward Model Computation In Single-Ended Time Domain Loop Characterization Using ABCD-matrix Theory of Transmission Lines	Recordation of Assignment filed 09/27/2001	Pending
081513-119		60/287,968		Receiver Transparent Q-mode With On-Line Reconfiguration And Scrambling	Recordation of Assignment filed 09/27/2001	Pending

Our Reference	Client Reference	Serial No.	Patent No.	Title	Reel/Frame	Status
081513-129		60/293,034		Receiver Transparent Q-mode With On-Line Reconfiguration, Scrambling and Q-mode Symbol "Distortion"	Recordation of Assignment filed 09/27/2001	Pending
081513-130		60/293,035		Medley Signal For ADSL	Recordation of Assignment filed 09/27/2001	Pending
081513-133		60/296,697		Variable State Length Initialization	Recordation of Assignment filed 09/27/2001	Pending

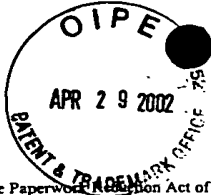

Under the Paperwork Reduction Act of 1995, no persons are required to respond to a collection of information unless it displays a valid OMB control number.

STATEMENT UNDER 37 CFR 3.73(b)

Applicant/Patent Owner: AWARE, Inc.

Application No./Patent No.: See Attached Sheet Filed/Issue Date: See Attached Sheet

Entitled: See Attached Sheet

AWARE, Inc., a corporation
(Name of Assignee) (Type of Assignee, e.g., corporation, partnership, university, government agency, etc.)

states that it is:

- 1. the assignee of the entire right, title, and interest; or
- 2. an assignee of less than the entire right, title and interest.
The extent (by, percentage) of its ownership interest is _____%

in the patent application/patent identified above by virtue of either:

- A. An assignment from the inventor(s) of the patent application/patent identified above. The assignment was recorded in the United States Patent and Trademark Office at Reel See Attached Sheet, Frame See Attached Sheet, or for which a copy thereof is attached.

OR

- B. A chain of title from the inventor(s), of the patent application/patent identified above, to the current assignee as shown below:

- 1. From: _____ To: _____
The document was recorded in the United States Patent and Trademark Office at Reel _____, Frame _____, or for which a copy thereof is attached.
- 2. From: _____ To: _____
The document was recorded in the United States Patent and Trademark Office at Reel _____, Frame _____, or for which a copy thereof is attached.
- 3. From: _____ To: _____
The document was recorded in the United States Patent and Trademark Office at Reel _____, Frame _____, or for which a copy thereof is attached.

Additional documents in the chain of title are listed on a supplemental sheet.

Copies of assignments or other documents in the chain of title are attached.

[NOTE: A separate copy (i.e., the original assignment document or true copy of the original document) must be submitted to Assignment Division in accordance with 37 CFR Part 3, if the assignment is to be recorded in the records of the USPTO. See MPEP 302.08]

The undersigned (whose title is supplied below) is authorized to act on behalf of the assignee.

8/28/01
Date

Richard P. Moberg
Typed or printed name
[Signature]
Signature
Treasurer and CFO of Aware, Inc.
Title

RECEIVED
MAY 01 2002
Technology Center 2600

Burden Hour Statement: This form is estimated to take 0.2 hours to complete. Time will vary depending upon the needs of the individual case. Any comments on the amount of time you are required to complete this form should be sent to the Chief Information Officer, U.S. Patent and Trademark Office, Washington, DC 20231. DO NOT SEND FEES OR COMPLETED FORMS TO THIS ADDRESS. SEND TO: Commissioner for Patents, Washington, DC 20231.

(12) **UK Patent Application** (19) **GB** (11) **2 330 491** (13) **A**

(43) Date of A Publication 21.04.1999

(21) Application No 9721862.2

(22) Date of Filing 15.10.1997

(71) Applicant(s)

British Broadcasting Corporation
(Incorporated in the United Kingdom)
Broadcasting House, LONDON, W1A 1AA,
United Kingdom

(72) Inventor(s)

Stephen Thomas Baily
Richard Harold Evans

(74) Agent and/or Address for Service

Reddie & Grose
16 Theobalds Road, LONDON, WC1X 8PL,
United Kingdom

(51) INT CL⁶
H04J 3/06 , H04L 27/26

(52) UK CL (Edition Q)
H4M MTQX1

(56) Documents Cited
GB 2313527 A EP 0683576 A1 WO 94/08405 A1
US 4574379 A

(58) Field of Search
UK CL (Edition P) H4M MTQA1 MTQA2 MTQA3
MTQX1 MTQX2 MTQX3 , H4P PAL PAPS PSB
INT CL⁶ H04B 7/212 , H04J 3/06 , H04L 7/04 27/26

(54) Abstract Title

Digital broadcast systems

(57) A multi-carrier signal has a regular frame structure and symbol rate and is comprised of contributions from a plurality of different transmitters (2). The contributions from each transmitter are transmitted to a central transmitter (4) in pre-assigned time slots. The received contributions are then re-transmitted as a single signal over a predetermined area of coverage with a dummy symbol inserted at the start of each contribution in the frame for use as a phase reference for demodulating succeeding symbols in that contribution.

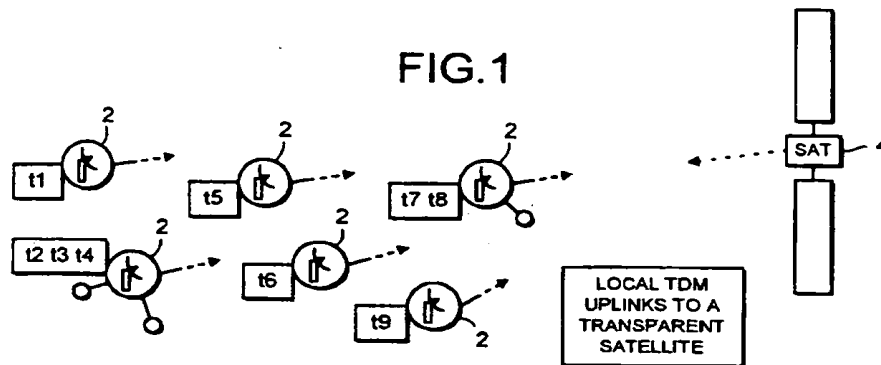

At least one drawing originally filed was informal and the print reproduced here is taken from a later filed formal copy.

BNSDOCID: <GB_2330491A_1_>

GB 2 330 491 A

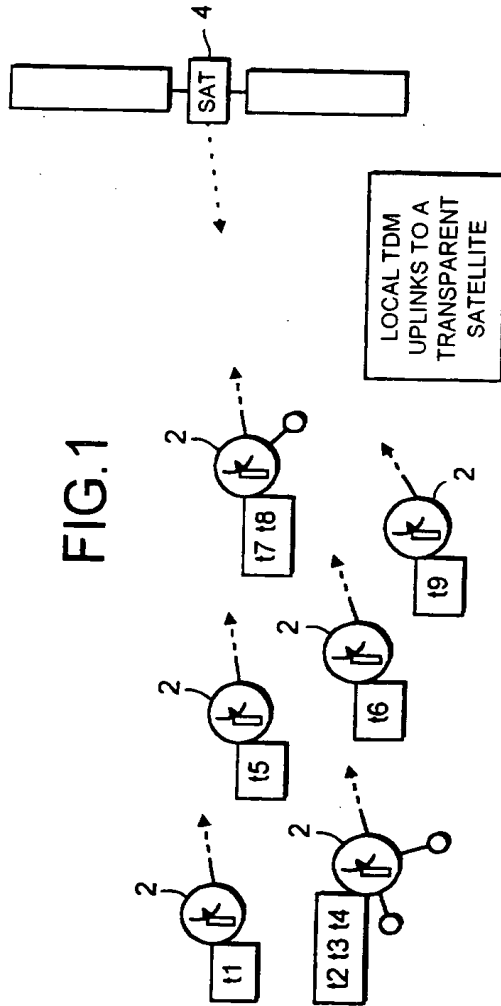

FIG.1

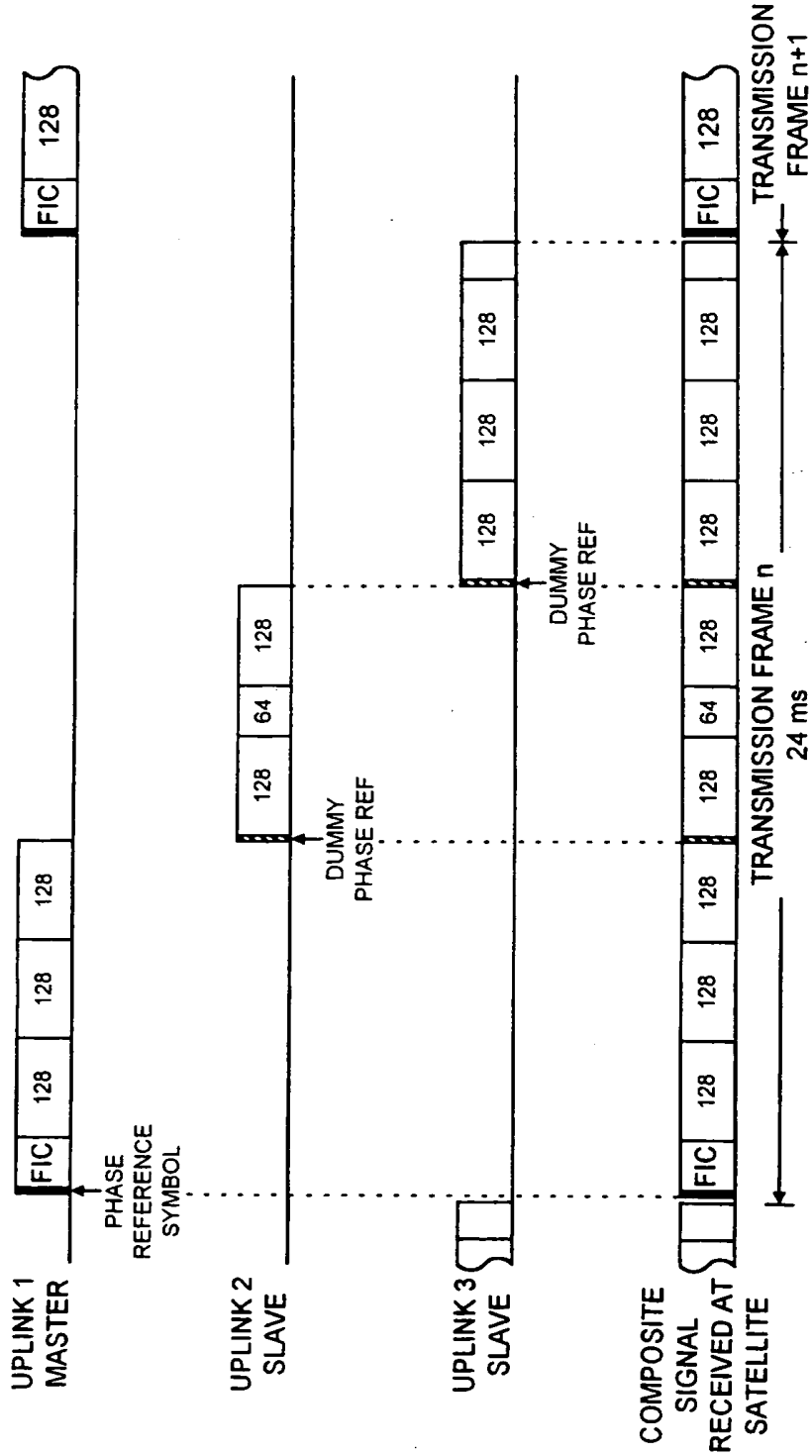

FIG. 2

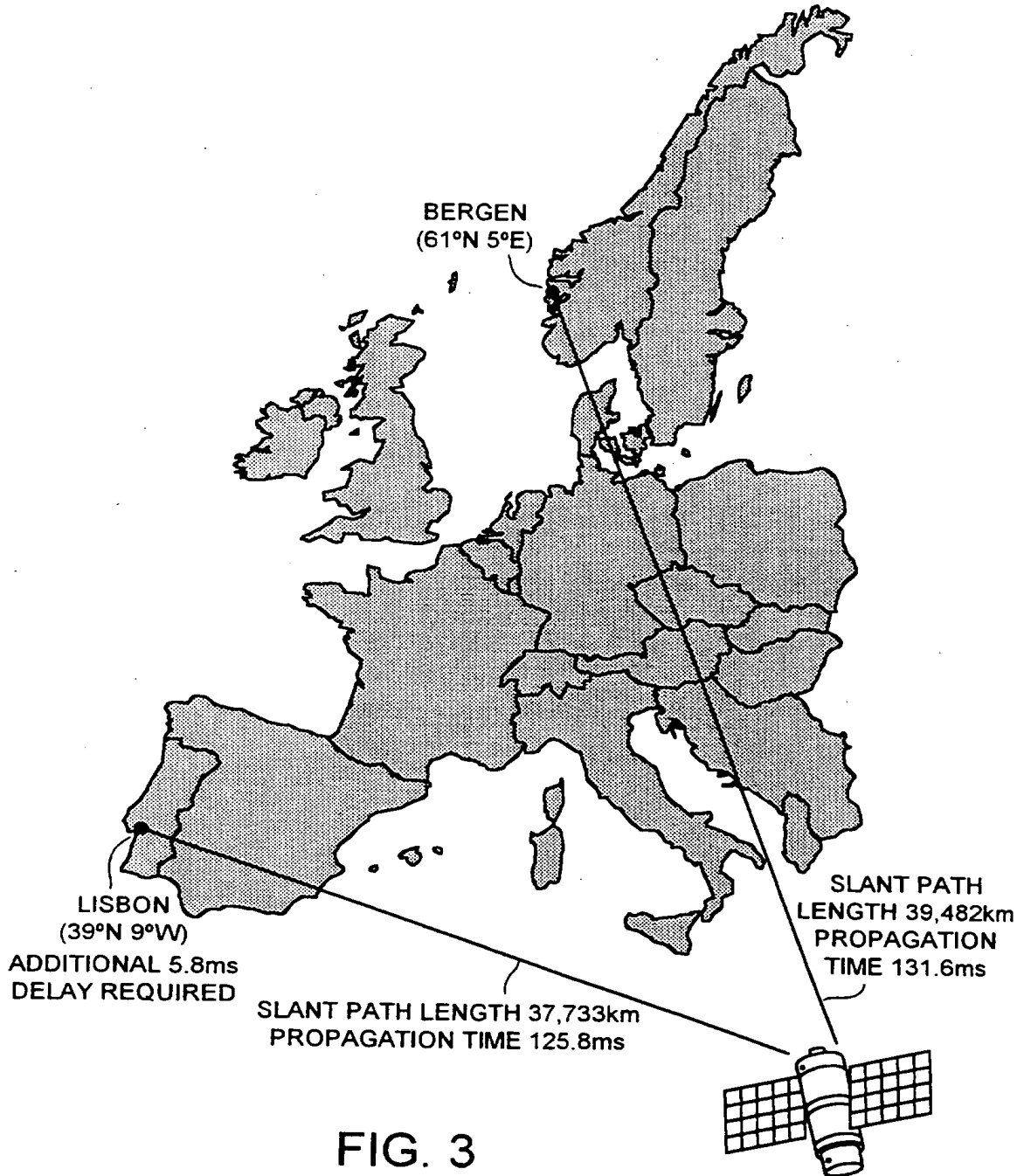
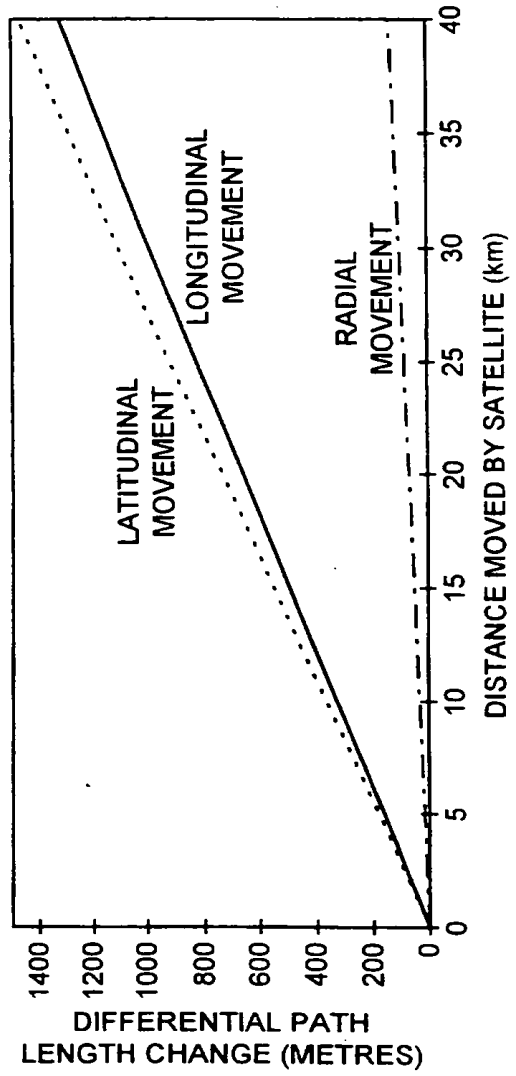
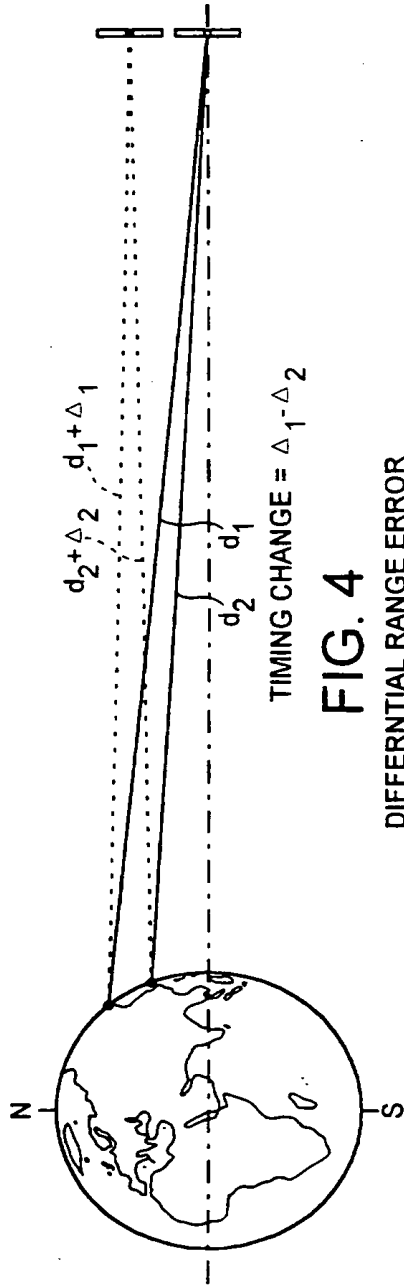
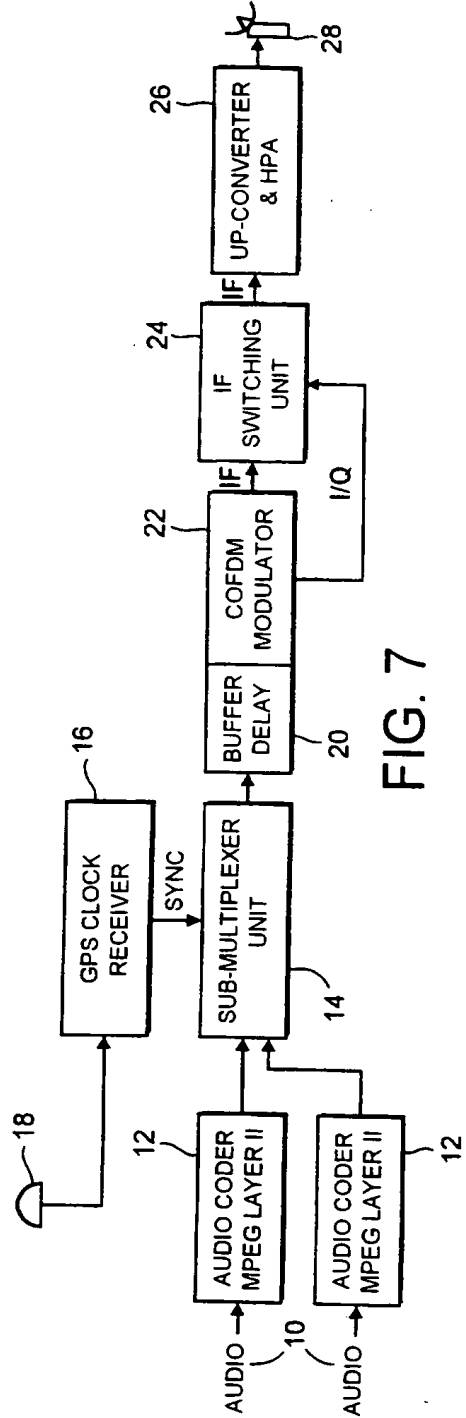
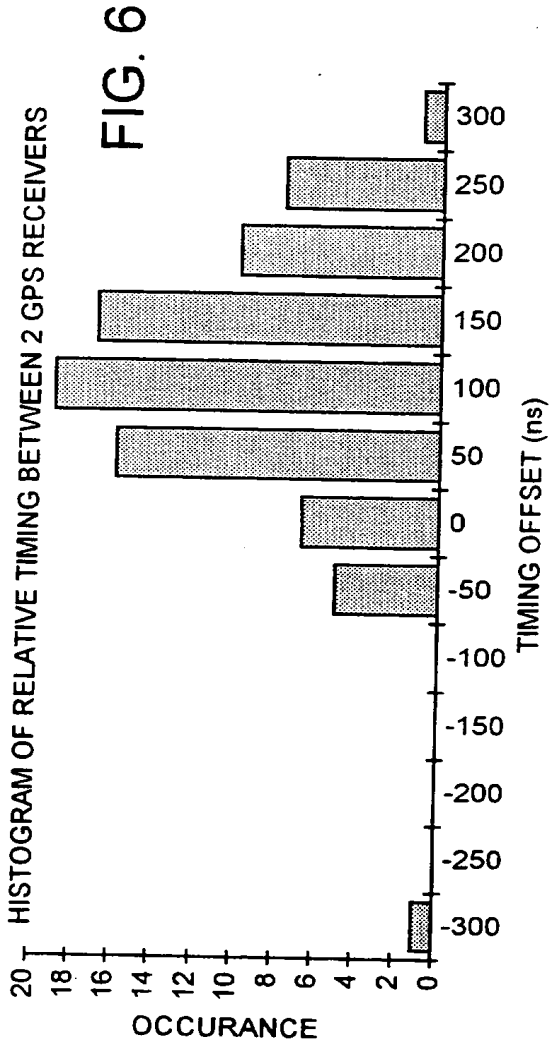

FIG. 3
SLANT PATH LENGTH FROM TWO EUROPEAN CITIES TO EMS





DIGITAL BROADCAST SYSTEMS

This invention relates to digital broadcast systems such as digital audio broadcast (DAB) and in particular to a system which enables digital broadcasts from two or more
5 different broadcasters to be combined in a single broad band transmission.

The Eureka-147 DAB system which has been proposed as a practical implementation of digital audio broadcasting operates by using a coded orthogonal frequency division
10 multiplexed (COFDM) system. In this, a large number of carriers are spread over a broad frequency band to carry digital data. Each carrier is modulated with the data so as to carry two bits of data by using quadrature phase shift keying (QPSK). Groups of these carriers are then
15 transformed to the time domain by a Fast Fourier transform to produce what is known as a DAB symbol. A plurality of these symbols are assembled and between them are able to carry data from a large number of channels. The symbols are transmitted together in a DAB frame or multiplex
20 comprising a series of symbols and which commences and terminates with a null symbol for synchronisation. A typical transmission bandwidth of 1.53 MHz can typically accommodate 5 or 6 channels.

Satellite delivery of digital broadcasts is seen as
25 an attractive option for international broadcasters because it provides coverage of large areas at relatively low costs.

Because a Eureka-147 DAB ensemble carries not just one but several audio channels or other services, several
30 co-operating broadcasters would need to share an ensemble between them. This can be relatively easily accomplished at a national level where there are both national and

local broadcasters by leaving free symbols in national broadcasts into which local broadcasters can insert data. These would typically be combined at a single site and can then be transmitted over the relevant area.

5 Where it is desired to combine broadcasting over a number of different countries, e.g. UK, France, Germany and Austria, and transmit them as a single DAB ensemble over all of those countries, the combination at a single terrestrial uplink site becomes impractical because of the
10 cost of terrestrial data lines.

 One solution is to use a dedicated satellite with an on-board processor to which all the broadcasters transmit. The satellite then combines all the data and produces a single DAB ensemble from this. The problem with this, of
15 course, is that a dedicated satellite has to be launched in order for the system to become operational.

 A preferred embodiment of the present invention provides a system in which a number of different broadcasters each transmit a section of a COFDM ensemble
20 from an uplink site to a conventional satellite in time division multiplex slots. The satellite then amplifies and frequency shifts the received signals before transmitting them over its area of coverage. No on-board processing is involved other than would be used for a,
25 conventional radio transmission. Each uplink site would need to be adequately synchronised to the others so that the resulting composite COFDM signal appeared seamless when transmitted by the satellite. This can easily be achieved using the global position system (GPS).

30 The invention is defined with more precision in the appended claims to which reference should now be made.

The invention will now be described in detail by way of example with reference to the accompanying drawings in which:

5 Figure 1 shows schematically a number of uplink sites transmitting signals to a conventional satellite in time division multiplex (TDM) slots for retransmission over the satellite's area of coverage in an embodiment of the invention;

10 Figure 2 shows schematically the combination of DAB symbols from three different uplink sites in accordance with an embodiment of the invention;

 Figure 3 shows schematically the different slant path lengths from two European cities to a satellite in geostationary orbit;

15 Figure 4 shows the differential range for a satellite in geostationary orbit;

 Figure 5 is a graph showing the relationship between differential path length and the distance moved by the satellite;

20 Figure 6 is a histogram showing relative timings between 2 GPS receivers; and

 Figure 7 is a block diagram of an uplink site of the type shown in Figure 1.

25 It is envisaged that in an embodiment of this invention a multiplexed uplink system would involve two or more uplink sites of the type shown in Figure 1. These can be receiving one or more signals, coding them with COFDM and transmitting them in preassigned time slots to a satellite. Each uplink site provides a portion of the
30 COFDM signal directly to the satellite. The multi carrier nature of the Eureka DAB signal with its frequency and time interleaving means that mapping of a particular bit

pair onto a particular carrier is very complex. Whilst it would be technically possible to identify which carriers are associated with each uplink contribution, it would then be necessary to be able to suppress each carrier on an individual basis. This would be considerably more difficult than switching all of the carriers on and off simultaneously at single symbol boundaries. As will be seen, this is not a severe constraint and greatly simplifies the handover process.

A time division multiplex system of the type embodying the present invention requires a fairly radical rethink of the requirements of the DAB transmission chain. The TDM system requires complete shutdown of the transmitters RF output at frequent and regular intervals. At present there is no structure to enable the COFDM generator to switch off all the carriers at selective times. Inserting zeros into the multiplex is not the solution since the carriers are phase modulated and this would generate a symbol representing a digital zero. Therefore, TDM operation produces a requirement for a 3-stage control of the COFDM transmitter output, a digital one, a digital nought, and a suppressed carrier. This can be done in two ways.

In the first method, the symbols which are not going to be transmitted from the specified uplink are filled with dummy data and the RF output of the COFDM generator is switched off for the duration of the other contributions. As the contributing uplink sources only need to switch at a symbol boundary, this option is relatively simple. A small amount of logic is required to count through the symbols of each frame and switch at the appropriate time.

The second method is to configure the multiplexer and COFDM generator internally to switch off the unwanted carriers for the required time. The configuration is controlled from the multiplexing unit and a new interface
5 to the COFDM generator. A new control mechanism would be required if the multiplexer was to be able to control adequately the COFDM generator. This requires access to the software on both devices.

In the TDM uplink arrangement, the transition points
10 between the separate uplink signals as received at the satellite deserve special consideration. Apart from the problems of synchronisation, there is the problem introduced by the use of differential QPSK modulation. The receivers which are proposed for use with the signal
15 decode each symbol in the ensemble with reference to the phase of the previous symbol (except for the first symbol of every transmission frame which is the fixed reference symbol). This is transmitted by uplink station number 1, the master, and is shown in Figure 2.

20 The other uplink sites are called slaves. Data uplinked by these slave stations cannot be differentially decoded from the beginning because the previous symbol will originate from a different uplink site and will therefore have no useful phase relationship. Because of
25 this, the first symbol of a slave contribution cannot be differentially decoded to provide any useful data. However, its phase state does then become the reference for the second symbol, thereby allowing the remaining symbols from that uplink contribution to be decoded as
30 normal.

To solve this problem, a dummy phase reference symbol is inserted at the start of each slave contribution as shown in Figure 2. The multiplexer can easily be

configured to insert a dummy service component occupying just a single symbol which it fills with random data or any other data. As the system is differentially modulated, the following symbol will be demodulated with reference to the dummy symbol.

The system of Figure 2 shows three multiplex uplink sites carrying contributions of 128 K-bits/s and 64 K-bits/s as part of a TDM arrangement. The lower line of the diagram shows how the dummy phase reference signals inserted by each slave uplink site become part of the overall composite signal received and retransmitted by the satellite.

Loss of the first symbol of each uplink contribution is not a great problem. In Mode III DAB there is a low data-rate per symbol and this means that only 384 bits are lost for each slave uplink. This amounts to just under 0.7% per symbol and an arrangement using 10 geographically separate uplink sites (i.e. one master and nine slaves) would reduce the user capacity by only 6.25%.

Although a transitional dummy phase reference symbol cannot be used to carry any useful data, it may be used for carrying status information between uplink sites (by using a non-standard receiver).

The composite signal transmitted from the satellite will be the combined result of the several different uplink stations. However, it must not exhibit any artefacts of its TDM origination. Three fundamental parameters which must be kept as constant as possible are:

1. synchronisation
2. uplink frequency
3. power level.

The handover between uplinks must not create overlaps or gaps in the signal, the power level must be constant throughout the transmission frame, and the frequency for each uplink must be the same so as not to create any discontinuity. That is to say, the final signal reaching the receiver must appear to be the result of a single transmission chain, rather than the combination of several contributing uplinks.

At the handover point between contributing uplinks, the timing error needs to be accurate to within a fraction of a symbol duration. For Mode III DAB the total symbol duration is 156 microseconds, (which includes a guard interval of 31 μ s). Any "data collision" arising from a mis-aligned uplink would probably cause the loss of some data from both uplinks. In addition, such a data collision would increase the input power to the satellite by 3 dB. Given the finite power capability of a satellite transponder, and the fact that it is likely to be operating close to saturation, this could affect other users of the transponder or even drive the HPA into an overload condition.

A lack of data at the appropriate time could also create problems. In particular, the Eu-147 system uses the null symbol for coarse synchronisation in the time domain, therefore a data gap in the composite signal could be misinterpreted as a null symbol, thereby causing complete synchronisation failure at the receiver, resulting in none of the services on that multiplex being received. Therefore, it is also equally important that a contributing uplink does indeed fill its allocated time-slot.

Various factors must be considered and corrected for to insure that the uplink contributions arrive at the satellite's input antenna at the exact time required.

5 An uplink site suitable for use in the present invention is shown in figure 7. In this particular example the uplink site is combining two local audio signals for uptransmission to a satellite. Each audio signal is first fed to an MPEG audio coder 12. This compresses the audio data. It is next synchronised in a
10 sub-multiplexor unit 14 which receives a synchronising signal from a global positioning system (GPS) clock receiver 16 which receives the GPS signal via an antenna 18. The multiplexor audio signal is then passed to a buffer delay 20 which feeds them at appropriate intervals
15 to a COFDM modulator 22. This produces a frame of COFDM symbols.

These symbols are supplied to an IF switching unit 24. This counts through the earth COFDM symbols in the frame in response to a clock signal which is supplied by
20 the COFDM modulator 22 in its I/Q bus. The switching by the IF switching unit 24 makes sure that only symbols containing data relating to the two audio signals 10 are passed to an upconverter and high power amplifier 26 which then sends them to an antenna 28 for transmission to the
25 satellite of Figure 1.

It will thus be appreciated that the system of Figure 1 comprises six uplink units similar to that of Figure 7. Four of these are handling only one audio signal, one is handling two audio signals and a final one is handling
30 three audio signals. Each will be synchronised by its GPS clock receiver unit 16 and thus will insert audio data in symbols at different time periods to those used by other

uplink stations such that at the satellite a complete frame of data will be received.

If a more sophisticated receiver is used, the dummy symbol could carry other information. The first portion
5 could be used as the phase reference. For example, a specific data pattern could be included. This could then be monitored by the various uplink sites to aid synchronisation of uplink contributions.

The dummy symbol could also be used as a data channel
10 to feed back, to the uplink site providing the first contribution for each frame, information to go into the Fast Information Channel (FIC) which the first transmitter compiles and which describes the structure of the frame. Thus, it describes which symbols contain data for each
15 channel and, clearly, which symbols are dummy symbols.

Thus, the data is fed to the transmitter compiling the FIC via the satellite. No land line is required.

Other data which could be included in the dummy symbol are an audio channel for communication between the
20 uplink sites or additional data for various commercial services.

Furthermore, at each uplink site a receiver can be provided to monitor the timing and frequency of the dummy symbol it transmitted to the satellite. This can then be
25 used to adjust the timing and frequency of the signal provided by the transmitter.

Slant Path Length Compensation

The uplink stations will be located at arbitrary locations on the Earth's surface and will all experience different
30 path lengths to the satellite. In order to create a seamless composite DAB signal the uplink sites with short

path lengths will need compensating delays so that their contributions do not arrive too early.

Given the orbital location of the satellite, and the latitude and longitude of the uplink station, the path
5 length can be readily calculated. Taking a European example, as illustrated in Figure 5:

For a satellite at:	10.2° East
Uplink 1:	Lisbon 39°N 9°W
Uplink 2:	Bergen 61°N 5°E.

10 The nominal difference in the slant path range between the two earth stations and the satellite is 1,749 km, which corresponds to a delay of 5.83 ms.

This could easily be compensated for by delaying the transmission from the Lisbon uplink site (which is closer
15 to the satellite) by an equal amount. (This then allows the placement of the contributing signal at any point in the DAB transmission frame.)

The maximum possible slant path length would be experienced by an earth station on the very edge of the
20 uplink coverage zone where the elevation angle is lowest. It is generally accepted that a minimum earth station antenna elevation angle of 5 degrees is required, and at such a location this gives a maximum possible slant path
length of around 41,130 km (corresponding to a one-way
25 propagation time of 138 ms). On the other hand, the shortest possible slant path distance would be from an earth station exactly at the sub-satellite point at a range of 35786 km, corresponding to a delay of 120 ms. The location of any uplink site can therefore be
30 compensated for using a delay of no more than 18 ms, the

exact figure depending on its geographical location relative to the satellite.

The BBC COFDM generator (CD2M/44) has a built in compensating delay of up to 4 ms, adjustable in increments of 488 ns, while the Marconi-Eddystone COFDM generator can manage a delay of up to 476 ms, adjustable in steps of approximately 1 μ s.

While the difference in the slant path length is the obvious (and major) consideration in synchronising the uplink stations, there are several other factors which affect the accuracy of the timing of each contribution. Some effects will create a common variation in the propagation delay between all the earth stations and the satellite, causing the whole DAB signal to arrive at the incorrect time. Other effects will cause differential errors which adversely change the synchronisation between the uplinked contribution signals.

Although termed "Geostationary", a satellite in GEO orbit will always have a tendency to wander a little, due to the Earth's gravitational irregularities, the influence of the Sun and Moon and solar pressure. These perturbations in the satellite's intended position complicate the uplinking of a TDM based system. As the satellite wanders about, the path length from the geographically separate contributing uplink sites will obviously vary. The normal satellite station keeping tolerance is usually quoted as $\pm 0.05^\circ$ in each plane, corresponding to maintaining the satellite's position within a cube of sides approximately 80 km. This movement can therefore give the calculated slant path length an error of around ± 40 km.

If this path length variation was identical for every uplink site then each uplink contribution would arrive at

the satellite slightly 'early' or 'late' but would maintain its place in the DAB frame. The whole broadcast signal would then arrive a few microseconds 'late' or 'early' but there would be no overall effect on
5 synchronisation between the uplinks.

But, while the path length change between various uplink sites and the satellite is indeed largely the same, any station keeping error will usually create a small but significant differential change in these path lengths,
10 which means a synchronisation error would be introduced between the various signals arriving at the satellite. This is illustrated in Figure 4 where d_1 and d_2 are the original distances from the uplink sites to the satellite, and Δ_1 and Δ_2 are the changes in distance due to orbital
15 drift. If Δ_1 is then different to Δ_2 , then a synchronisation error will be introduced.

Satellite station keeping errors can be resolved into three orthogonal planes - latitudinal - i.e. North/South, longitudinal - i.e. East/West, or radial - i.e. towards or
20 away from the Earth. The magnitude of the differential change varies widely depending on the satellite's plane of movement, the location of the uplink sites and the magnitude of the error in the satellite's station keeping.

The maximum possible differential range would be
25 between two uplinks at the extreme (5° elevation) and opposite edges of a global uplink coverage zone, with the satellite moving in the same plane. This would give a differential timing change of $1 \mu\text{s}/\text{km}$ of satellite movement. In practice, very few uplink sites operate at
30 these extremes and it is likely that most would be within a couple of thousand miles of each other.

Taking the Bergen/Lisbon/EMS example again, the nominal path length difference was shown to be 1,749 km

corresponding to a 5.83 ms fixed delay. Figure 5 shows the differential distance variation between the Bergen and Lisbon uplink paths for variations of the orbital position over the range $\pm 0.05^\circ$ or ± 40 km in each of the three planes.

For a change in the satellite's latitude, Lisbon, being further south than Bergen, experiences a smaller rate of change of path length than Bergen, and at the extremes the error can be ± 1344 metres, corresponding to $\pm 4.5 \mu\text{s}$ (which at $0.06 \mu\text{s}$ is a long way short of the theoretical maximum shown above). For a change in the satellite's longitude a similar magnitude of differential error is experienced, while for a radial change in position, both uplink sites experience very similar changes, resulting in little differential error.

The maximum change in timing would therefore occur when the satellite is at its maximum latitudinal error, and maximum longitudinal error and maximum radial error, combined with two uplink sites located in the same plane as the satellite's positional error. For uplink sites exclusively within Europe and a satellite station-keeping accuracy of $\pm 0.05^\circ$, this would result in a maximum variation of around $\pm 10 \mu\text{s}$, equivalent to ± 3 km. For worldwide uplinking the error could reach ± 20 km ($\pm 67 \mu\text{s}$).

Slant path calculations are generally based on the assumption that the Earth is a uniform sphere. In reality it is an irregular ellipsoid, with a polar radius of 6256.74 km, and an equatorial radius of 6278.12 km, meaning the Earth is slightly 'wider' E-W than it is 'tall' N-S. While slant path length calculations generally use an average figure for the radius, this is not accurate enough for the TDM application. In addition,

the 'radius' of the Earth varies along any circumference due to further irregularities in the geodetic sphere. Therefore, if the Earth is incorrectly assumed to be a regular sphere, then the slant path distance may be in error by perhaps +/- 10 km, equivalent to a timing error of +/- 33 μ s.

Several geodetic models have been proposed to approximate the Earth's shape, with GPS for example using "WGS 84". This enables errors due to ellipsoid geometry to be reduced to just a few metres.

The Earth station's height above sea level can also contribute to a timing error if it is located near the sub-satellite point. Mexico City, the uplink location for our first Eu-147 DAB satellite tests, is at an altitude of around 2 km above sea level.

Each of the contributing uplinks will need to be synchronised to a common time reference. The Global Positioning System (GPS) is a relatively low cost method of global timekeeping and can provide synchronisation to an accuracy of around 1 μ s anywhere in the world. With this application in mind, a pair of GPS based master reference clocks were tested and a histogram produced is shown in Figure 6.

The samples were taken over a period of several weeks, at irregular intervals of at least 15 minutes. As can be seen, there is a distinct fixed offset between the two receivers (an average of 130 ns) but excluding this offset, around 97% of the results show the receivers to be within 175 ns of each other. While the standard GPS specification provides a dithered signal accurate to within +/-340 ns of GPS time/UTC for 95% of the time, the affect of the GPS receiver's flywheel circuitry smooths out the short term phase noise giving a better result.

While the antennas of the two GPS receiver used for the test were located only 0.3 metres apart, the manufacturers claim that similar results would be obtained if the receivers were thousands of miles apart.

5 The effect of the ionosphere varies depending mainly on sunspot activity, time of day, and path length through the ionosphere (which in turn depends on the satellite's elevation angle). The error contribution for the downlink path at 1.5 Ghz is likely to be less than 20 metres and
10 will be common to all contributions. Atmospheric refraction on the uplink paths (typically 14 Ghz) is likely to be less than 1 metre (3 ns) and so will have a negligible affect on any particular uplink contribution.

15 Even a transparent transponder satellite will experience a small throughput delay, due mainly to filtering. This delay will be common to all contributions.

 It has been shown above that there are several factors which will influence the accuracy which is
20 achievable from a slant path distance calculation, and these are summarised in the table below. Some factors only cause an overall delay to the composite signal which is of little importance. Others (marked with a *) create a synchronisation error which may need to be compensated
25 for. The figures given are 'typical worse case' examples.

Parameters:	Distance Error	Time Error
1. Irregular ellipsoid geometry of Earth	10 km	33 μ s
30 2. Height of earth station a.s.l.	2 km	6.7 μ s

3.	Atmospheric refraction (downlink @ 1.5 Ghz)	20 metres	67 ns
4.	Satellite processing delay	1 km	3.3 μ s
5.	Station keeping accuracy of satellite	80 km	266 μ s
	[Differential error due to station keeping]	6 km*	20 μ s*]
6.	Synchronisation clock	300 metres*	1 μ s*
	*Differential errors (creating synchronisation errors)	6.3 km	21 μ s

Therefore, under poor conditions the timing change between two uplink stations in widely separated locations could be double this figure at 42 μ s.

While several factors cause a delay common across all uplinks this can be compensated for with a fixed delay, but the time-varying differential error due to satellite drift and GPS receiver clock error will always remain and, depending on the uplink location, this could be significant. Using DAB transmission Mode III the guard interval is only 31 μ s, and in a hybrid satellite / terrestrial gap filler system, the erosion of the guard interval due to synchronisation errors would be particularly detrimental.

While the fixed components can all be compensated for by using the programmable internal delay of the COFDM generator, the time varying components may need to be eliminated by some form of closed loop control system based on the composite broadcast signal received at each slave uplink site as discussed earlier.

In a single uplink application the up-converter which mixes the signal to its final uplink frequency need not be

particularly stable as the receiver's AFC is capable of compensating for some error. However, in the COFDM uplink multiplexing system, the receiver's AFC and phase reference circuitry operate only on the first symbol of the DAB frame, and therefore only "tune in" to the master station. Switching to a different signal (i.e. a slave contribution) part way through the frame means a step change in the frequency, and any frequency difference gives rise to a loss of ruggedness of the signal. Therefore, each uplink site must employ a highly stable up-converter. The fact that Eu-147 uses differential coding is of benefit here, as it is the phase change between symbols which is important rather than absolute phase. A frequency reference with a short term (1000 seconds) frequency accuracy of <5 in 10^{10} is typically available from GPS clock receives which could assist in frequency matching of all slave stations.

Doppler Shift

Geostationary satellites do not normally create any significant doppler shift of their own due to their fixed orbit (but a mobile terrestrial receiver will experience some doppler shift due to its own velocity unless the satellite is directly overhead). However, doppler shift may be a problem during a repositioning manoeuvre (when compensating for orbital drift), when the satellite may have to move many kilometres in a short period of time.

The frequency shift is caused by two components. The frequency of the uplink transmission (typically at Ku band, 14 Ghz) will appear to be slightly altered, while the frequency of the downlink (broadcast signal) will also change, and in the same direction, compounding the problem. However, because doppler shift is proportional

to frequency, the uplink accounts for around 90% of any frequency change. A fixed frequency error throughout the transmission frame is not a problem as it can be tracked by the AFC circuitry in the consumer's receiver. But in
5 an uplink multiplexing arrangement, the doppler could create a step change in frequency part way through the frame, thereby degrading the quality of the slave contributions.

As the satellite undergoes its repositioning
10 manoeuvre, each uplink signal may experience a different doppler shift, the magnitude of which will vary with the direction of movement of the satellite. The difference between the frequency shifts of the transmissions from the individual uplink sites depends on their geographical
15 separation (in a similar way to the change in time synchronisation with satellite movement).

Again, the frequency change is dependant on the satellite's velocity (i.e. speed and direction) and the geographical location of the uplink sites. The worse case
20 situation would be between two uplinks at the extreme (5° elevation) and opposite edges of a global uplink coverage zone, with the satellite moving in the same plane. This could create a frequency step of approximately $15V$ Hz, where V is the velocity in metres/sec, (however this is a
25 rather extreme and unlikely case). Monitoring the frequency transmitted by the satellite at each uplink site enables automatic feedback control of the uplink transmission to be achieved.

Repositioning is only likely to occur every few weeks
30 and it may be possible to request that it happens at a convenient time of the night when audience figures are low (e.g. 04.00 am).

For a power limited system such as this where the link margin may well be just 2 dB, it is vital that the downlink power budget is maximised, and so the satellite must operate at its optimum power output. This requires
5 that the power level of each contribution to the COFDM transmission frame should be matched to within a fraction of a dB when it arrives at the satellite's input antenna. Gain compensation for incorrect uplink power levels will not be possible at the satellite, and so each uplink site
10 will have the responsibility of ensuring that its own power level matches that of the master station.

The signal levels received at the satellite will depend on several factors - nominal uplink power setting, amplifier efficiency, transmitting antenna misalignment,
15 equipment ageing, satellite receiving antenna gain variation with direction, spreading loss (due to the geographical location of the uplink site). In addition to these "fixed" variables the effect of atmospheric attenuation, and in particular the affects of local rain
20 can change the effective uplink power level by 1 or 2 dB in only a few seconds.

The simplest way of achieving a constant envelope would be to monitor the broadcast signal at each slave site, and adjust the local uplink power as required. This
25 would then take into account all the above variables and can be done automatically with a feedback loop.

MULTIPLEX CONFIGURATION AND THE FAST INFORMATION CHANNEL

In a normal single transmission chain system, the multiplex can be reconfigured dynamically, with the
30 corresponding Multiplex Configuration Information (MCI) being signalled in the Fast Information Channel (FIC). In the TDM uplinking system it is not possible to time

5 multiplex the FIC data and so the master uplink station alone would provide the FIC and hence the MCI. This leads to some limitations in the way the multiplex can be reconfigured. For the multiplex to operate correctly it is essential that the data supplied by the MCI matches the actual configuration transmitted by each of the slave uplink sites.

10 The simplest method is obviously for all parties to agree on a semi-permanent multiplex configuration. The MCI will therefore only need to be changed on the rare occasion when a radical reconfiguration is required, and a suitable scheme could be developed to ensure that all parties complied with the pre-agreed changes.

15 Where a multiplex reconfiguration is limited to an internal change at one uplink site only, so that the capacity transmitted from that site (i.e. the total number of symbols) remained constant, only the master and that particular slave site need to make any changes. However, a multiplex reconfiguration may require a change in the total capacity contributed by a particular site, and this would involve notifying the other affected sites of the impending change.

20 When the total number of symbols per frame transmitted by an uplink is to change, a complication arises. The multiplex reconfiguration is not an instant event due to the affect of the time interleaving process, and to comply thoroughly with the Eu-147 specification, would require that some of the data would continue to originate from the first uplink even after the second uplink had started to contribute to its newly acquired symbol. The mapping of bits onto carriers and the necessary switching is extremely complex and while such a

scheme would not be impossible to implement, the benefits would be perhaps marginal.

It is worth noting that while terrestrial DAB will experience roughly the same change in demand across all services through the day, for satellite DAB the situation is different. The different time zones covered by a single beam could mean that a particular service aimed primarily at the eastern edge of its coverage may require a larger proportion of the multiplex at the peak listening time of the day, and a few hours later may wish to relinquish some of its capacity to an uplink site primarily serving the western edge of the downlink beam as this region approaches its own peak listening time.

One of the disadvantages with any TDMA like scheme is that the transmission equipment must be rated for the peak power levels, even though the average power output may be relatively low. For example, the normal RF power requirement for a DAB uplink, supplying a full multiplex, is typically around 10 Watts. However, the amplifier would need to be backed off by several dB from saturation (to prevent non-linear distortion), and so will need to be rated at around 30 Watts. A single uplink of 128 kbits/s contributing to the 1.152 Mbits/s DAB multiplex will only be operating at 11% duty cycle - in this case with an average power of 1.1 Watts but even so the amplifier used must still be rated at 30 Watts.

For each of the specified DAB operating modes, the carrier spacing is approximately proportional to the transmitting frequency. This means that the affects of oscillator phase noise and doppler shift, which scale with frequency, also remain constant. While for DAB Mode III the carrier spacing of 8 kHz is adequate for the transmitting frequency of around 1.5 Ghz, the uplink

frequency is likely to be several times greater than this, with most uplinks operating at around 6 Ghz (C-band) and 14 Ghz (Ku-band). Any phase noise in the up-converter therefore contributes to a degradation of the DAB signal, and so this component must be carefully chosen.

With any time multiplexed system it is vital that every contributing source is operating correctly synchronised so that it only transmits during its allocated period, otherwise errors will occur. It was pointed out in the section describing timing accuracy that a data collision may not only cause a data loss, and in severe cases may also cause amplifier overload or a reduction in available power for other users of the transponder.

In particular, the first few data bits of every MPEG audio frame carry the very important MPEG header bits used for audio frame synchronisation. This data is mapped into the first symbol of the DAB audio frame, and so even a one symbol overlap due to an incorrect configuration may cause a complete loss of audio for the second contribution. (Although the ETSI standard uses a 16-bit time interleaving process to shuffle the data around between frames, it does not change the relative position of the data within the frame, making the data particularly sensitive to frame rate effects).

In the Eu-147 system, the null symbol is essential for coarse synchronisation in the time domain and so if a slave uplink fault condition creates a gap, this can be misinterpreted as a null symbol, thereby preventing the receiver from acquiring synchronisation, and therefore resulting in non of the services on that multiplex being received.

In the event of a slave uplink being unable to provide a correctly timed signal at the correct frequency and with an appropriate power level it would be wise for it to drop out immediately, and be replaced by the master uplink for the duration of the fault. Therefore the master uplink station needs the flexibility to allow it to cover for fault conditions at any of the slave sites.

The cost of the additional equipment required to implement a time division multiplexed uplink, as described is relatively small. On the top of the usual equipment required for a 'hub' earth station (multiplexer, COFDM generator, upconverter and power amplifier), the only two extra pieces of equipment required for TDM operation are the GPS master clock receiver, costing around £2,000 and an RF switching unit, which if manufactured commercially would cost approximately £2,000.

CLAIMS

1. A method for transmitting a multi-carrier signal having a regular frame structure and symbol rate comprised of contributions from a plurality of different transmitters comprising the steps of:
- 5
- a) transmitting the contributions from each transmitter to a central transmitter in preassigned time slots;
 - b) retransmitting the thus received contributions as a single signal over a predetermined area of coverage; and
 - 10 c) inserting at the start of each contribution a dummy symbol for use as a phase reference for demodulating succeeding symbols in that contribution.
- 15
2. A method according to claim 1 in which the central transmitter comprises a satellite in geostationary orbit and the plurality of transmitters comprise earth based transmitters.
- 20
3. A method according to claim 1 in which the central transmitter comprises a stratospheric platform in geostationary orbit and the plurality of transmitters comprise Earth based transmitters.
- 25
4. A method according to claim 2 or 3 including the step of providing a timing reference signal to each earth based transmitter.
5. A method according to claim 4 in which the step of providing a timing reference comprises detecting a

global timing signal transmitted by a global positioning system (GPS).

5 6. A method according to claim 2 or 3 comprising the step of providing common frequency reference signals to each Earth based transmitter.

7. A method according to any preceding claim including the step of delaying transmission of signals from each Earth station to the satellite in dependence on the position on the Earth's surface of each Earth station.

10 8. A method according to claim 7 including the step of monitoring at each Earth station the COFDM signal from the satellite and adjusting the delay applied to transmissions from the Earth station to compensate for any timing errors caused by other factors.

15 9. A method according to claim 8 in which timing errors are caused by the relative position and velocity of the satellite or stratospheric platform.

20 10. A method according to any preceding claim including the step of monitoring at each transmitter the timing and frequency of the contribution supplied by that transmitter after re-transmission by the central transmitter, and adjusting the timing and frequency of the signal to be transmitted in dependence on the received signal.

25 11. A method according to claim 10 in which the dummy symbol includes a predetermined pattern of data

which are used for monitoring the timing and frequency of signals received at each transmitter.

12. A method according to any preceding claim in which at least part of the dummy symbol is used to
5 transmit data to dedicated receivers.

13. A method according to claim 12 in which the data for dedicated receivers is used as data for voice communication channel between Earth stations.

14. A method according to any preceding claim in
10 which at least part of the dummy symbol is used as a data channel to supply data to the transmitter providing the first contribution in each frame of data for inclusion in an information signal defining the structure of the frame.



Application No: GB 9721862.2
Claims searched: 1 to 14

Examiner: Ken Long
Date of search: 15 April 1998

**Patents Act 1977
Search Report under Section 17**

Databases searched:

UK Patent Office collections, including GB, EP, WO & US patent specifications, in:
UK Cl (Ed.P): H4M (MTQA1-3 & MTQX1-3) & H4P (PAL, PSB & PAPS)
Int Cl (Ed.6): H04J 3/06 H04B 7/212 & H04L (7/04 & 27/26)
Other: NONE

Documents considered to be relevant:

Category	Identity of document and relevant passage	Relevant to claims
A	GB 2313527 A MITSUBISHI	None
A	EP 0683576 A1 HITACHI	None
A	WO 94/08405 A1 MOTOROLA	None
A	US 4574379 AT&T	None

X	Document indicating lack of novelty or inventive step	A	Document indicating technological background and/or state of the art.
Y	Document indicating lack of inventive step if combined with one or more other documents of same category.	P	Document published on or after the declared priority date but before the filing date of this invention.
&	Member of the same patent family	E	Patent document published on or after, but with priority date earlier than, the filing date of this application.

This Page Blank (uspto)

FIG.1

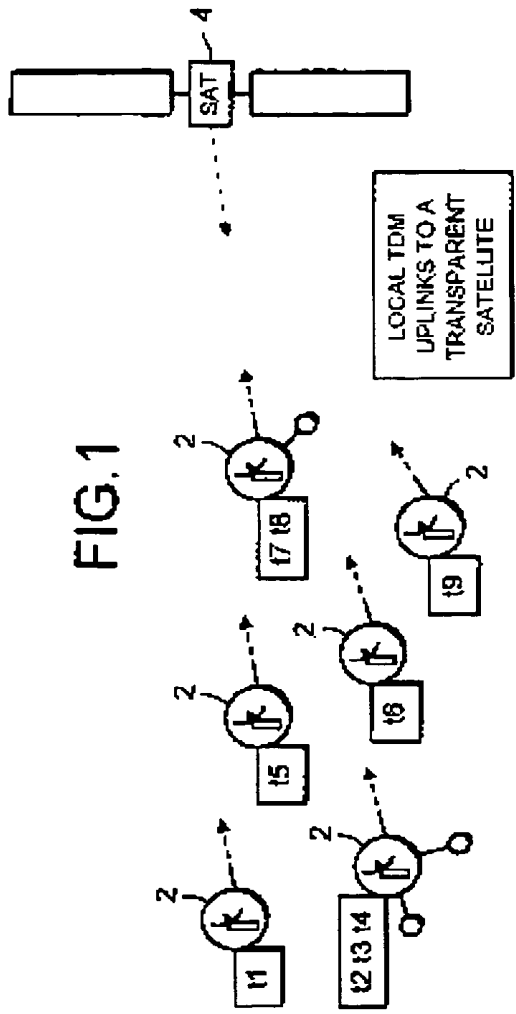

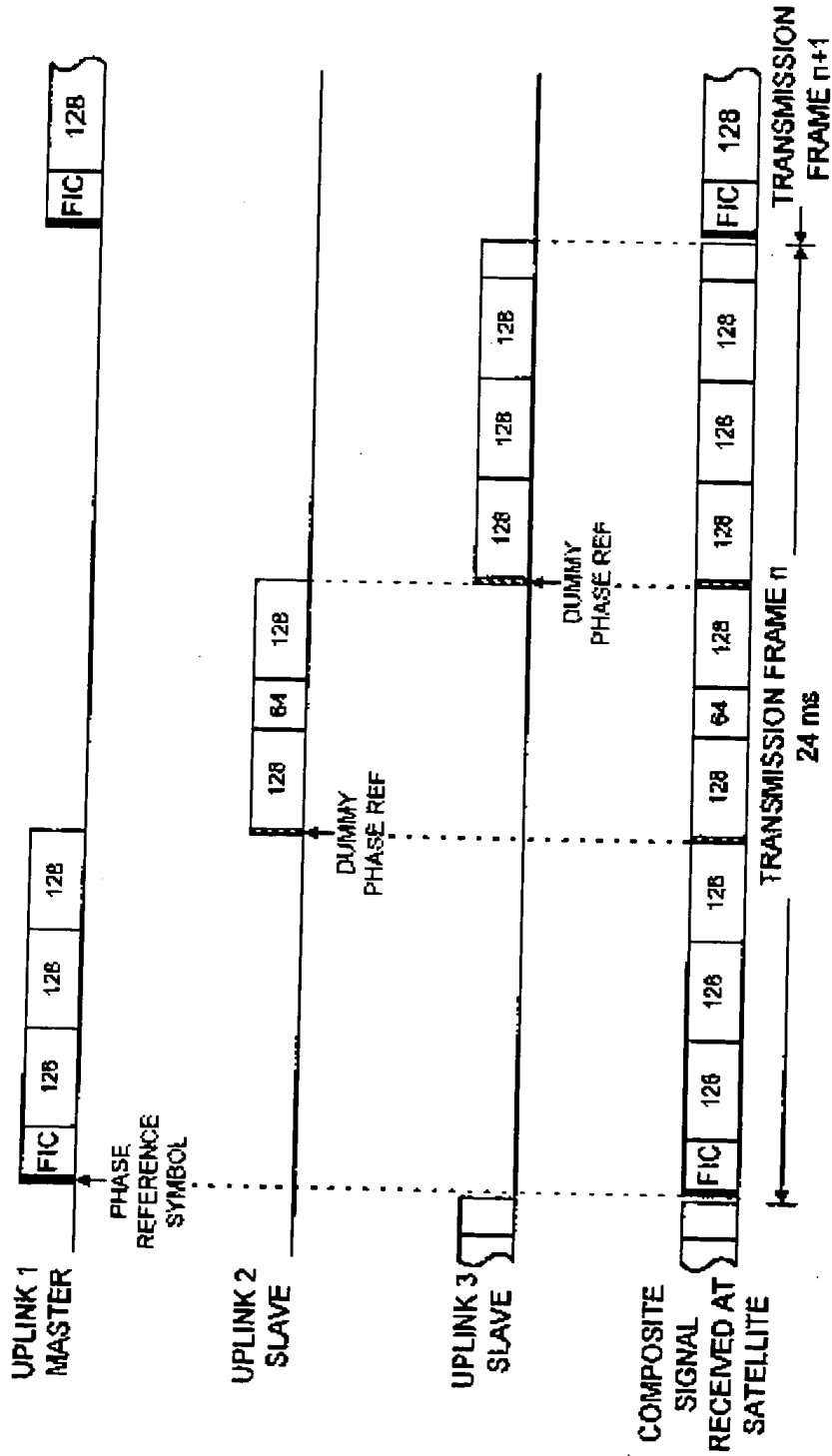

FIG. 2

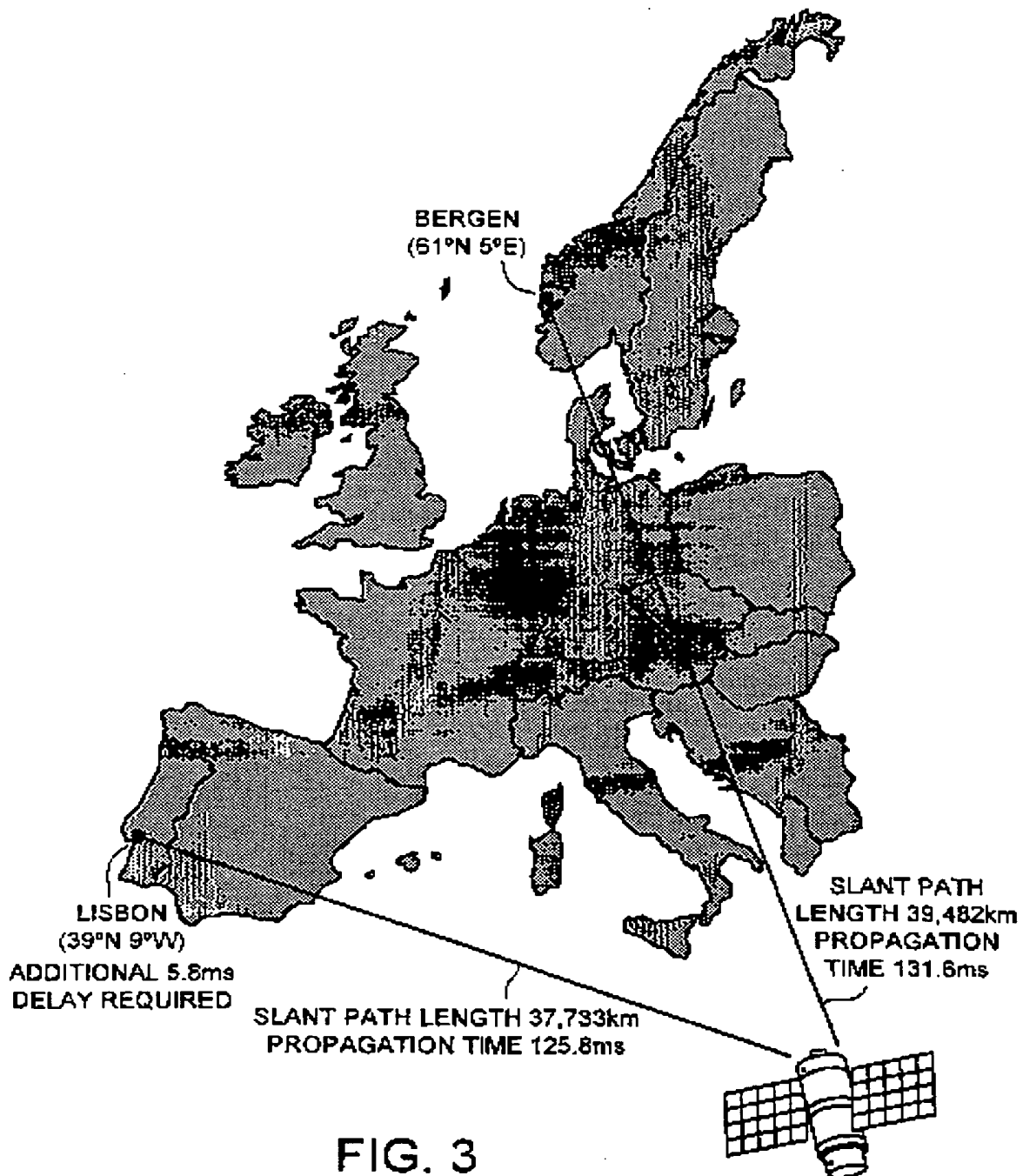

FIG. 3
SLANT PATH LENGTH FROM TWO
EUROPEAN CITIES TO EMS

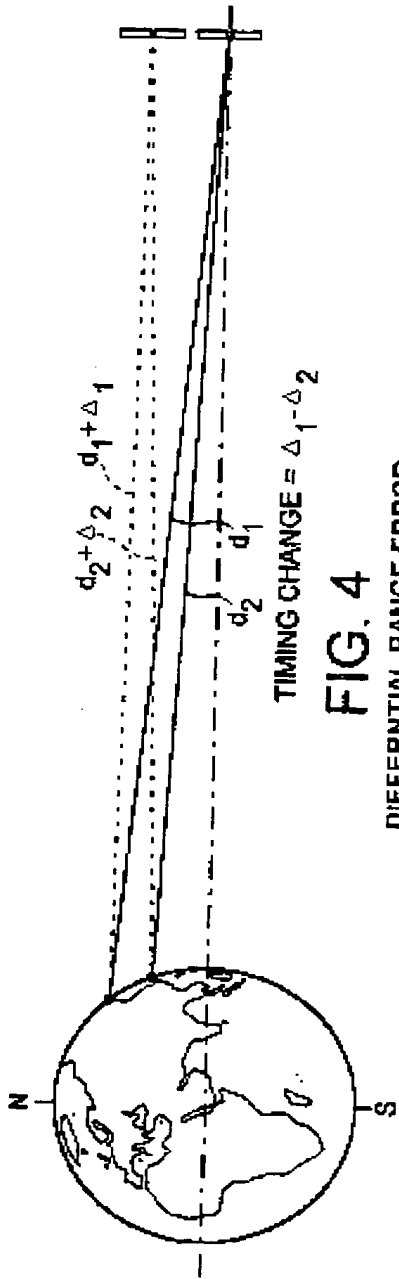

FIG. 4

DIFFERENTIAL RANGE ERROR

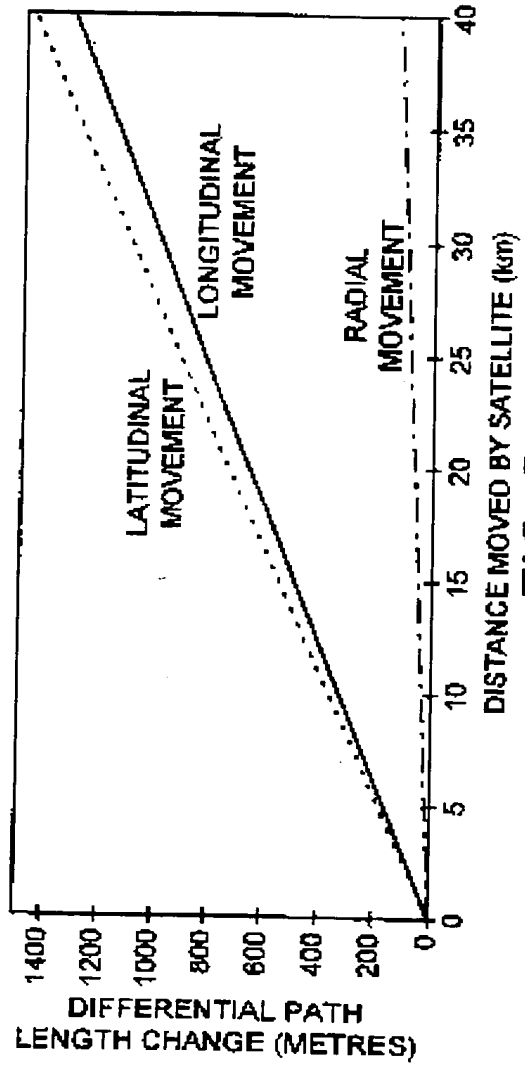
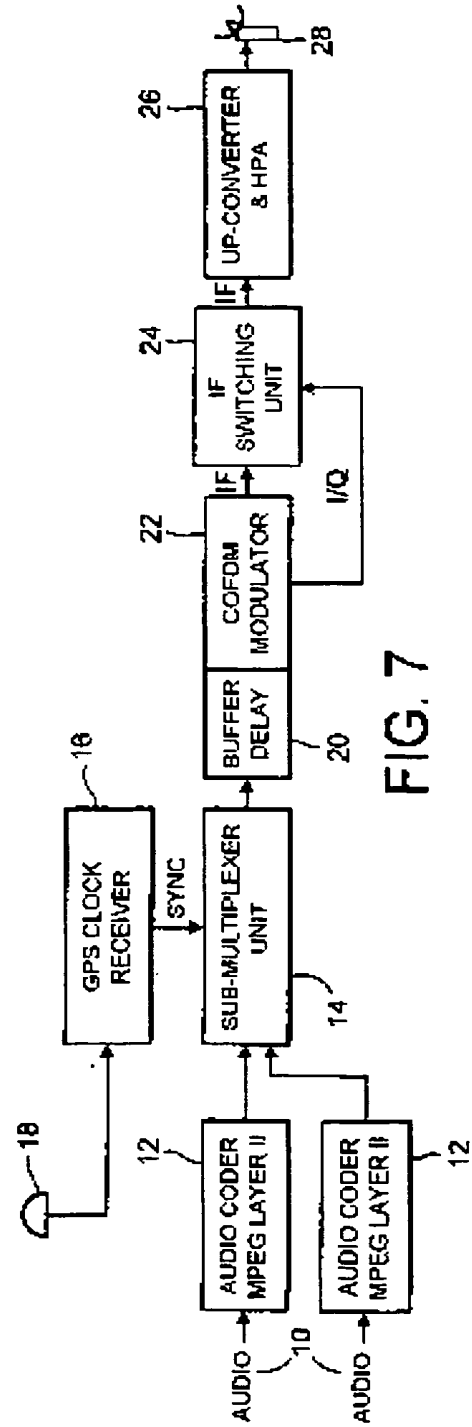
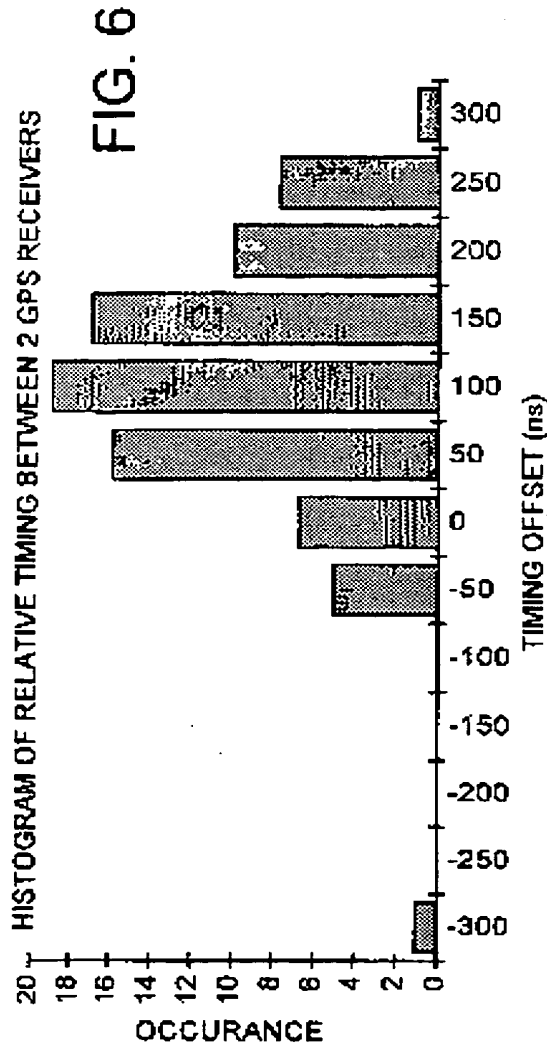

FIG. 5



This Page Blank (uspto)



EUROPEAN PATENT APPLICATION

Application number: **93111722.0**

Int. Cl.5: **H04L 27/34**

Date of filing: **22.07.93**

Priority: **27.07.92 IT MI921819**

Applicant: **ALCATEL ITALIA S.p.A.**
Via L. Bodio, 33/39
I-20158 Milano(IT)

Date of publication of application:
02.03.94 Bulletin 94/09

Inventor: **Sandri, Andrea**
Via Liguria, 6
I-56124 Pisa(IT)

Designated Contracting States:
CH DE ES FR GB LI NL SE

Inventor: **Spalvieri, Arnaldo**
Via La Marca, 40/1
I-60019 Senigallia (AN)(IT)

Representative: **Pohl, Herbert, Dipl.-Ing et al**
Alcatel SEL AG
Patent- und Lizenzwesen
Postfach 30 09 29
D-70449 Stuttgart (DE)

Method and apparatus for reducing the peak power of data sequences.

This application concerns the reduction of the peak power of data sequences, particularly for use in a QAM radio relay system. The peak power reduction leads to fewer problems with non-linear distortion, whether caused by the channel, or by the transmitter power amplifier.

The power reduction is achieved by using a shaping code, which replaces sequences with high power, by sequences with lower power.

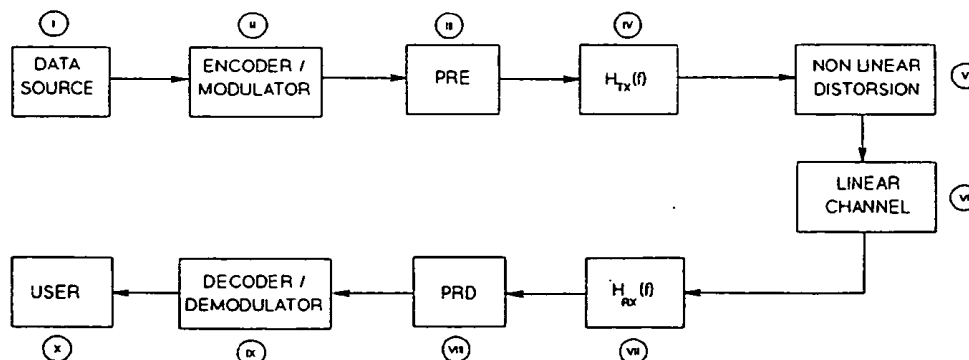

Fig. 1

Background of the invention

The present invention relates to a method of reducing the peak power of the signal at the output of the transmit filter of a digital link, e.g. a microwave one. Such reduction allows to minimize the effects of the transmit channel nonlinearity, including in it eventual nonlinearities of the transmit amplifier.

State of the art

The present digital transmission systems try to obtain high spectral efficiencies through gradually more complex modulation formats. The higher spectral efficiency is counterbalanced by the need of increasing the transmitted power to obtain a prefixed BER (Bit Error Rate: number of wrong bits to total number of bits ratio) value at the receiver. The power delivered by the transmitter generally is limited by the final power amplifier, which has a greatly nonlinear behaviour.

Therefore a serious problem arises with regard to the best exploitation of the nonlinear part of the input-output characteristic of the "channel", including in the latter the final amplifier of the transmitter. At present the problem is faced in one of the following ways (see e.g. the papers of G. Karam, H. Sari, "Analysis of predistortion, equalization and ISI cancellation techniques in digital radio systems with nonlinear transmit amplifier", IEEE Transaction on Communications, vol. 37, n. 12, Dec. 1989):

- 1) data predistortion: one tries to modify the constellation used for driving the nonlinear amplifier through a signal such as to obtain the desired constellation at its output;
- 2) analog signal predistortion: a nonlinear circuit having a characteristic opposite to the one of the above-defined "channel", is inserted in the path of the analog signal;
- 3) channel equalization and nonlinear cancellation of the ISI: the receive equalizer tries to cancel the interferences connected with nonlinearity from the present signal sample (through a suitable nonlinear combination of pre- and post-cursors);
- 4) use of "circular" constellations so as to reduce the ratio between the peak power and the average power of the not-filtered signal.

All the above solutions, under special circumstances, can provide unsatisfactory features. In particular the first three ones are not much efficient in the presence of hard limiter characteristic of the transmitter final amplifier; the last one gives rise to gains anyway slight which can be not sufficient in case of reception filter with very narrow band.

Summary of the invention

It is an object of the invention to individuate a base-band system which - at parity of other conditions - reduces the peak power of the filtered signal, i.e. at the input of the nonlinear channel defined above. It has been found, inter alia, that such reduction is to advantage of radio relay systems links, e.g. allowing the use of smaller antennas or the transmission over longer path sections. The outstanding features of the invention are set forth in the claims while the various aspects and advantages of the invention will become more apparent from the following description (not limiting).

General solution

The basic idea of the invention is based upon the possibility (other conditions such as minimum distance between transmitted points, average transmitted power, etc. being equal) of avoiding transmission of sequences which a high peak power of the filtered signal is associated with, replacing them with more suitable ones (i.e. with a lower peak power of the filtered signal).

The possibility of carrying out this replacement is given by the increasing of the dimension of the alphabet of the transmitted points. In reception the unwanted sequences, suppressed in transmission, are reconstituted in their original form.

By reducing in this way the peak power of the filtered signal it is possible to exploit in a much more efficient manner the nonlinear characteristic of the above-defined "channel".

Fig. 1 illustrates the schematic block diagram of a generic digital transmission system (blocks I, II, IV, V, VI, VII, IX, X) in which blocks II and VIII, subject of this invention, are inserted. In particular, fig. 1 shows:

- the DATA SOURCE (ref. I) which provides the numeric sequence to be transmitted at its output;
- an ENCODER/MODULATOR block (ref. II) which receives at the input the numeric sequence to be transmitted and carries out the standard encoding operations designed for BER reduction (block, convolutional, Trellis Code Modulation, etc., type encoding) and modulation operations, providing at its

- output one of the points of the constellation to be transmitted;
- a PRE block (ref. III), subject of the invention along with block VIII, which eliminates from the transmission the unwanted sequences in terms of peak power of the filtered signal, i.e. of the signal at the output of block IV described below;
- 5 - the transmission filter HTx (f) (ref. IV) which provides at its output the analog signal to be transmitted;
- a NONLINEAR DISTORTION block (ref. V) representing an unwanted nonlinear distortion on the signal path. It can be due to the nonlinear characteristic of the final amplifier of the transmitter (as it happens e.g. in microwave links) or, more in general, to a nonlinear behaviour of the information channel;
- 10 - the information channel proper (ref. VI) identified as "LINEAR CHANNEL", which outputs a signal constituted by the signal at its input added to and/or combined with disturbances of various kind;
- the reception filter HRx (f) (ref. VII) which receives the signal from the transmit channel and carries out a suitable filtering;
- a PRD block (ref. VIII), subject of the invention along with block III, which reconstitutes the signal in its original form containing the unwanted sequences suppressed in transmission by block III;
- 15 - a DECODER/DEMULATOR block (ref. IX) which receives the outgoing signal from block VIII demodulates it and carries out the above-mentioned standard decoding operations, providing the user with the numeric sequence subject of the transmission;
- the USER (ref. X) which receives the numeric sequence.

In an advantageous and therefore preferred embodiment, blocks PRE (III) and PRD (VIII) in accordance with the invention are realized in the form of digital encoders. As an example, fig. 2 shows a block diagram illustrating how it is possible to realize the PRE in case of a radio relay system transmission using a quadrature amplitude modulation (QAM). Let M be the points of the two-dimensional constellation to be transmitted in the conventional case (hereinafter "standard" constellation) and MR be the redundancy points necessary for the encoding (carried out in PRE) subject of the invention; the resulting constellation is composed of (M + MR) points (hereinafter "expanded" constellation).

Typically: $1 < (M + MR)/M < 1.2$.

In fig. 2 there is shown the preferred embodiment of PRE; it includes:

- A delay element T (ref. XIII) which receives as its input the last two-dimensional element of the block of N outgoing two-dimensional symbols from XII and outputs it with a delay equal to one channel symbol interval. Such output will be indicated as "state" of the machine in the following.
- 30 - A map identified as "(M + MR) MAP" (ref. XI) which receives at its input a block of N symbols of the "standard" constellation and provides (M + MR) blocks of N two-dimensional symbols of the "expanded" constellation. Each output block is relative to a particular "state" of the system and represents the best sequence to be transmitted (in the presence of that particular "state" of the machine) in terms of peak power of the filtered signal.
- 35 - A multiplexer "MUX" (ref. XII) having (M + MR) inputs and one output which, on the basis of the "state" at the output of block XIII selects (among the M + MR present at its input) the suitable block of N symbols to be provided at the output.

It remains to be defined what is the meaning of "best sequence in terms of peak power of the filtered signal". According to one particular aspect - even if not limiting - of the invention, the calculation is arranged as follows. Let $h_{TX}(t)$ be the impulse response of the transmission filter IV of fig. 1, T the symbol time, $d^{(k)}$ ($k = 1, 2, \dots, (M + MR)$) the "state" of the system, $C_i = (c_i, c_{i+1}, \dots, c_{N-1})$ the generic block of N two-dimensional symbols, the "weight" w of block $C_i = (c_i, c_{i+1}, \dots, c_{N-1})$ given the state $d^{(k)}$, can be defined as the quantity:

45

$$w(d^{(k)}, C_i) = \max_{-NT \leq t < NT} \left| h_{TX}(t_0 - T) d^{(k)} + \sum_{j=0}^{N-1} h_{TX}(t_0 + jT) c_j \right|^2 \quad (1)$$

50

then meaning that the best sequences C_i (in terms of peak power of the filtered signal) are those having a lower "weight" $w(d^{(k)}, C_i)$.

The PRD can be realized through a circuit quite similar to the one shown in fig. 2 for PRE; its description in terms of block diagram (being within the reach of those skilled in the art, in the light of what has been set forth hereinbefore) will be omitted for conciseness' sake.

55 Reference has been made to specific embodiments represented in figs. 1 and 2 for simplicity and illustrative clearness reasons; therefore it is evident that these are susceptible to those variations, modifications, replacements and the like which, being within the reach of those skilled in the art, naturally

fall within the sphere and the spirit of the scope of the invention.

The following possible variants are here mentioned by way of an example:

- in equation (1) a "state" constituted by several two-dimensional symbols could be envisaged;
- blocks XI and XII of fig. 2 could be replaced by a combinatory algebra, thus transforming the structure of PRE into a convolutional one.
- N could be taken great enough to be able to eliminate in fig. 2 the reaction through block XIII thus transforming the structure of PRE into a "block" structure.

Claims

1. Method of transmitting and receiving numerical signals in which:
 - in transmission, data from a numeric or numerized source are modulated, the modulated signal is filtered and transmitted through a nonlinear channel (where the nonlinearity may be due to the nonlinear characteristic of the final amplifier of the transmitter, or more in general to a nonlinear behaviour of the transmit channel proper),
 - in reception the received signal is filtered and demodulated in order to reconstruct the transmitted numeric sequence
 characterized in that:
 - in transmission, the unwanted sequences in terms of peak power of the filtered signal are eliminated from the modulated signal before filtering and replaced with suitable sequences,
 - in reception, the received and filtered signal is restored in its original form (i.e. containing the unwanted sequences suppressed in transmission) and then sent to the demodulator.
2. Method according to claim 1, characterized in that:
 - the link is a digital, radio relay system link and uses a quadrature amplitude modulation (QAM),
 - the replacement of said sequences is carried out through a base-band digital encoder.
3. Method according to claim 2, characterized in that a "recurring" coding, i.e. using previously transmitted symbols for individuating the symbol to be transmitted, is used.
4. Method according to claim 3, characterized in that the individuation of the sequences to be replaced is carried out on the basis of equation (1) or of relations equivalent thereto.
5. Method substantially as hereinbefore described and represented.
6. System for implementing the method of the preceding claims, including:
 - in transmission, a data source, an encoder/modulator, a transmit filter and a nonlinear amplifier;
 - in reception, a filter and a decoder/demodulator,
 characterized in that:
 - in transmission, an encoder for reducing the peak power of the filtered signal is inserted upstream of the transmit filter,
 - in reception, a decoder for reducing the peak power of the filtered signal is inserted downstream of the receive filter.
7. System according to claim 6, characterized in that the decoder is of "recurrent" type.
8. System according to claim 7, wherein the encoder comprises at least a map and a multiplexer.
9. System according to claim 8, characterized in that the map generates the sequences to be transmitted on the basis of equation (1) or of relations equivalent thereto.

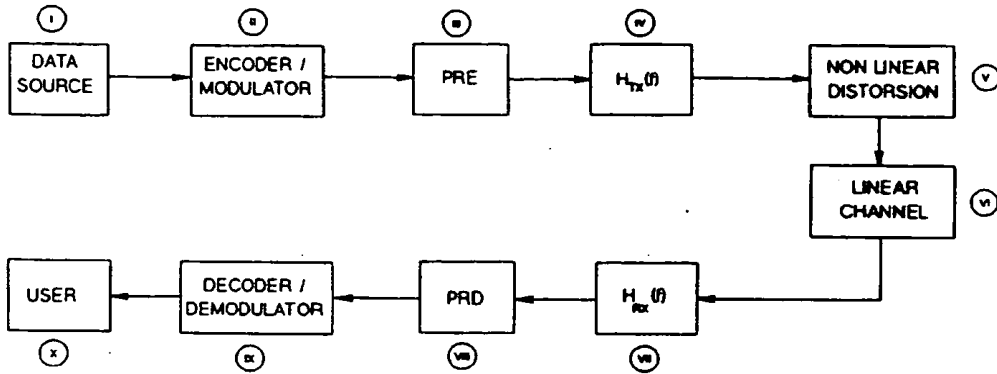

Fig. 1

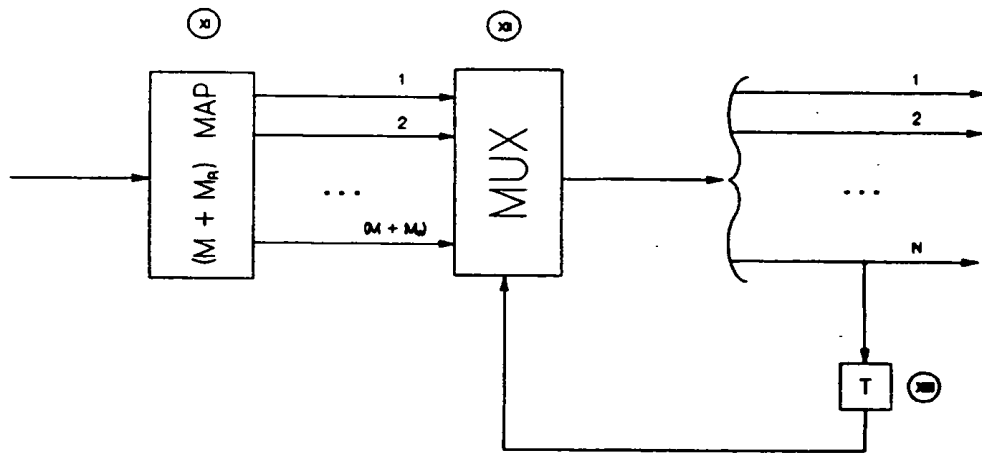

Fig. 2



European Patent
Office

EUROPEAN SEARCH REPORT

Application Number
EP 93 11 1722

DOCUMENTS CONSIDERED TO BE RELEVANT			
Category	Citation of document with indication, where appropriate, of relevant passages	Relevant to claim	CLASSIFICATION OF THE APPLICATION (Int.Cl.5)
X	EP-A-0 383 632 (CODEX) * abstract; figures 1-8,10-13 * * page 2, line 45 - page 3, line 23 * ---	1-4,6-9	H04L27/34
X	IEEE JOURNAL ON SELECTED AREAS IN COMMUNICATION vol. 7, no. 6, August 1989, NEW YORK US pages 941 - 958 FORNEY 'Multidimensional constellations - part II: Voronoi constellations' * abstract; figures 5-7 * * page 950, left column, paragraph 4 - right column, paragraph 3 * ---	1-4,6-9	
X	TRANSACTIONS OF THE IEICE vol. E71, no. 6, June 1988, TOKYO, JP pages 591 - 598 NAKAMURA ET AL. 'A new 90Mbps 68 APSK modem with honeycomb constellation for digital radio relay systems' * figures 11,12 * * page 594, right column, paragraph 3 - page 595, left column, paragraph 2 * ---	1-4,6-9	
A	IEEE International Conference on Communications 1991, 23-27/6/1991, Denver, US; IEEE, New York, US, 1991; pages 1075 - 1079, Soleymani & Kang: "Trellis coding with partially overlapped signal sets" * abstract; figures 1,3,4 * * page 1075, right column, paragraph 2 * * page 1077, left column, paragraph 3 - page 1078, left column, paragraph 1 * --- -/--	1-4,6-9	
The present search report has been drawn up for all claims			
Place of search THE HAGUE		Date of completion of the search 18 November 1993	Examiner SCRIVEN, P
CATEGORY OF CITED DOCUMENTS X : particularly relevant if taken alone Y : particularly relevant if combined with another document of the same category A : technological background O : non-written disclosure P : intermediate document		T : theory or principle underlying the invention E : earlier patent document, but published on, or after the filing date D : document cited in the application L : document cited for other reasons & : member of the same patent family, corresponding document	

EPO FORM ISO 04.81 (P04/01)



European Patent
Office

EUROPEAN SEARCH REPORT

Application Number
EP 93 11 1722

DOCUMENTS CONSIDERED TO BE RELEVANT			
Category	Citation of document with indication, where appropriate, of relevant passages	Relevant to claim	CLASSIFICATION OF THE APPLICATION (Int. Cl.5)
A	IEEE International Conference on Communications 1992; 14-18/6/1992, Chicago, US; IEEE, New York, US, 1992; pages 431 - 1435, Khandani & Kabal: "Using a prefix code for addressing the Voronoi constellations based on lattices D_n and D_n^* " * abstract; figure 3; table 6 * * page 1432, right column, paragraph 2 - page 1433, left column, paragraph 1 * * page 1433, right column, paragraph 2 - page 1434, right column, paragraph 2 *	1-4, 6-9	
X, P	WO-A-92 17971 (BRITISH TELECOMMUNICATIONS) * abstract *	1-4, 6-9	
			TECHNICAL FIELDS SEARCHED (Int. Cl.5)
The present search report has been drawn up for all claims			
Place of search THE HAGUE		Date of completion of the search 18 November 1993	Examiner SCRIVEN, P
CATEGORY OF CITED DOCUMENTS		T : theory or principle underlying the invention E : earlier patent document, but published on, or after the filing date D : document cited in the application I : document cited for other reasons ----- & : member of the same patent family, corresponding document	
X : particularly relevant if taken alone Y : particularly relevant if combined with another document of the same category A : technological background O : non-written disclosure P : intermediate document			

EPO FORM 1500 (01.92) (P/01/93)

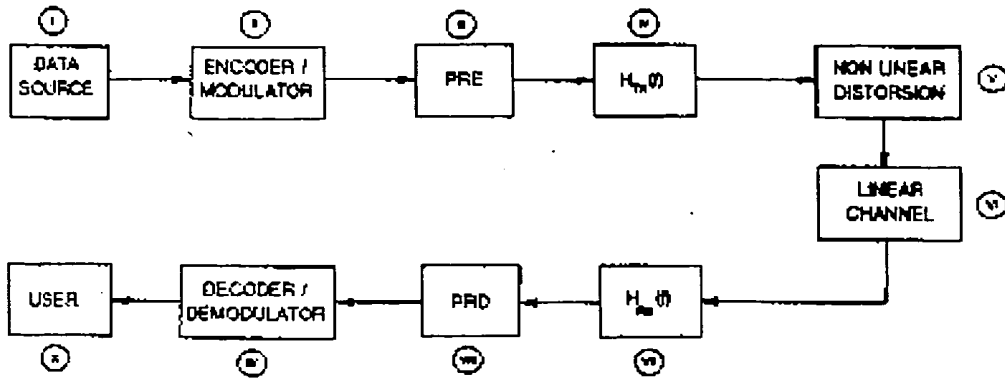

Fig. 1

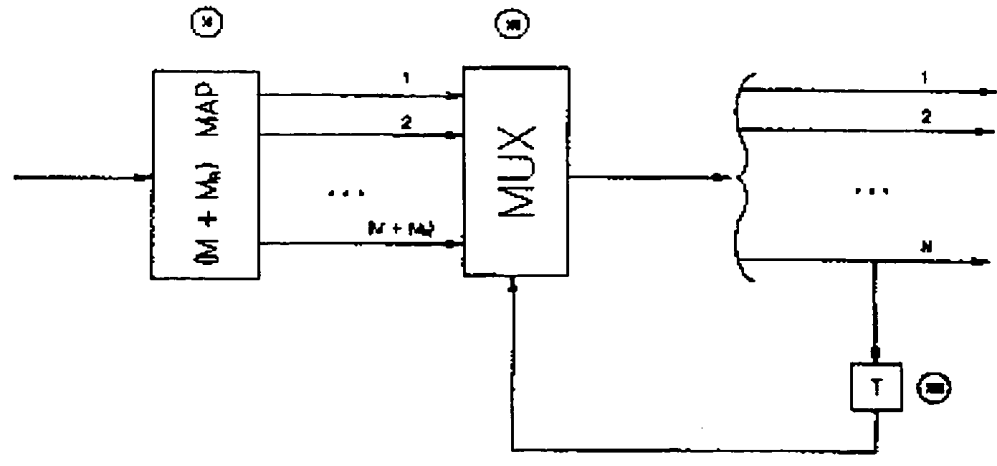

Fig. 2



- 1 - SS

Application No. 09/710,310
Docket No. 081513-41

IN THE UNITED STATES PATENT AND TRADEMARK OFFICE

In re Patent Application of:)
 Marcos C. TZANNES) Examiner
 Serial No. 09/710,310) Group Art Unit: 2631
 Filed: November 9, 2000)
 For: A System And Method For Scrambling The)
 Phase Of The Carriers In A Multicarrier)
 Communications System)

RECEIVED
FEB 07 2002
Technology Center 2600

INFORMATION DISCLOSURE STATEMENT

Commissioner for Patents
Washington, DC 20231

February 5, 2002

Sir:

In accordance with the duty of disclosure as set forth in 37 C.F.R. §1.56, Applicants hereby submit the following information in conformance with 37 C.F.R. §§ 1.97 and 1.98. Pursuant to 37 C.F.R. § 1.98, a copy of each of the documents cited is enclosed.

The documents are being submitted within three (3) months of the filing of this application or entry into the national stage of this application, or before the first Office Action on the merits, whichever is later, therefore no fee or certification is required under 37 C.F.R. § 1.97(b).

It is requested that the accompanying information disclosure statement be considered and made of record in the above-captioned application. To assist the Examiner, the documents are listed on the attached form PTO-1449. It is respectfully requested that an Examiner initialed copy of this form be returned to the undersigned.

The Commissioner is hereby authorized to charge any fees connected with this filing which may be required now, or credit any overpayment to Deposit Account No. 19-2380.

Respectfully submitted,

Jason H. Vick
Registration No. 45,285

NIXON PEABODY LLP
8180 Greensboro Drive, Suite 800
McLean, Virginia 22102

Telephone: (703) 790-9110

#5



UNITED STATES PATENT AND TRADEMARK OFFICE

COMMISSIONER FOR PATENTS
UNITED STATES PATENT AND TRADEMARK OFFICE
WASHINGTON, D.C. 20231
www.uspto.gov

APPLICATION NUMBER	FILING DATE	FIRST NAMED APPLICANT	ATTY. DOCKET NO./TITLE
09/710,310	11/09/2000	MARCOS C. TZANNES	AWR-017 (457/19)

CONFIRMATION NO. 5605



KEVIN RUSSELL
CORPORATE COUNSEL
40 MIDDLESEX TURNPIKE
AWARE, INC.
BEDFORD, MA 01730

Date Mailed: 04/19/2001

NOTICE REGARDING POWER OF ATTORNEY

This is in response to the Power of Attorney filed 02/22/2001.

The Power of Attorney in this application is accepted. Correspondence in this application will be mailed to the above address as provided by 37 CFR 1.33.

~~Customer Service Center~~
~~Initial Patent Examination Division (703) 308-1202~~

OFFICE COPY

#5



UNITED STATES PATENT AND TRADEMARK OFFICE

COMMISSIONER FOR PATENTS
UNITED STATES PATENT AND TRADEMARK OFFICE
WASHINGTON, D.C. 20231
www.uspto.gov

APPLICATION NUMBER	FILING DATE	FIRST NAMED APPLICANT	ATTY. DOCKET NO./TITLE
09/710,310	11/09/2000	MARCOS C. TZANNES	AWR-017 (457/19)

CONFIRMATION NO. 5605

21323
TESTA, HURWITZ & THIBEAULT, LLP
HIGH STREET TOWER
125 HIGH STREET
BOSTON, MA 02110



Date Mailed: 04/19/2001

NOTICE REGARDING POWER OF ATTORNEY

This is in response to the Power of Attorney filed 02/22/2001.

- The Power of Attorney to you in this application has been revoked by the assignee who has intervened as provided by 37 CFR 3.71. Future correspondence will be mailed to the new address of record(37 CFR 1.33).

Customer Service Center
Initial Patent Examination Division (703) 308-1202

OFFICE COPY



(12) **EUROPEAN PATENT APPLICATION**

(43) Date of publication:
 26.06.1996 Bulletin 1996/26

(51) Int. Cl.⁶: **H04L 5/06**

(21) Application number: 95119990.0

(22) Date of filing: 18.12.1995

(84) Designated Contracting States:
DE FR GB NL SE

- Kimura, Tomohiro
 Kawachinagano-shi, Osaka-fu (JP)
- Uno, Yasuhiro
 Osaka-fu, (JP)
- Oue, Hiroshi
 Osaka-fu (JP)

(30) Priority: 20.12.1994 JP 316900/94
 20.03.1995 JP 60732/95

(71) Applicant: **MATSUSHITA ELECTRIC INDUSTRIAL CO., LTD.**
 Kadoma-shi, Osaka-fu, 571 (JP)

(74) Representative: **Altenburg, Udo, Dipl.-Phys. et al**
Patent- und Rechtsanwälte
Bardehle . Pagenberg . Dost . Altenburg .
Frohwitter . Geissler & Partner,
Postfach 86 06 20
81633 München (DE)

(72) Inventors:
 • Hayashino, Hiroshi
 Hyogo-ken, (JP)
 • Harada, Yasuo
 Hyogo-ken, (JP)

(54) **OFDM system with additional protection against multipath effects**

(57) A complex multiplier complex-multiplies a carrier modulation signal group for deciding the phases and amplitudes of a plurality of carriers which are orthogonal to each other on the frequency axis by a complex signal group having a predetermined specific pattern which varies in phase at random. An inverse Fourier transformer performs inverse Fourier transformation on an output of the complex multiplier, for transforming a digital signal which is multiplexed on the frequency axis to an OFDM signal on the time axis. A guard interval insertion part adds front and rear guard intervals to front and rear parts of each symbol of the OFDM signal respectively. The

front and rear guard intervals include data which are identical to those of rear and front end parts of the corresponding symbol respectively. Arithmetic processing which is reverse to that on a transmission side is performed on a receiving side, whereby distortion of received data is removed. Thus, the OFDM signal can be transmitted with no waveform distortion on a data component of each symbol on the frequency axis after Fourier transformation even if a reflected wave is superposed on a direct wave due to a multipath.

FIG. 1

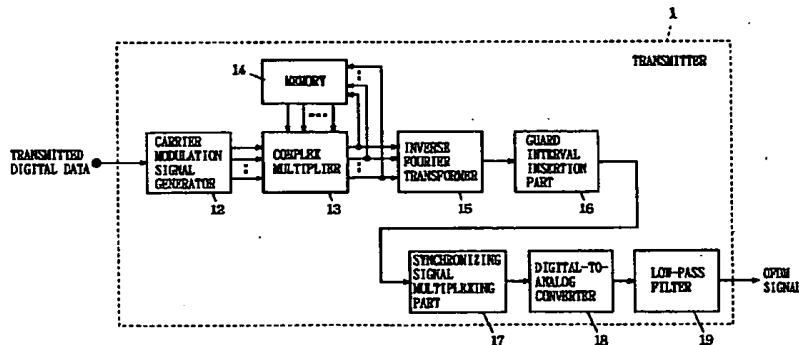

EP 0 719 004 A2

Description

BACKGROUND OF THE INVENTION

Field of the Invention

The present invention relates to an orthogonal frequency division multiplexing (hereinafter referred to as OFDM) transmission method, and more specifically, it relates to a method of transmitting data between a transmission side and a receiving side through a wire or wireless transmission path with an orthogonal frequency division multiplex signal including symbols of prescribed lengths and guard intervals of prescribed lengths which are arranged between the symbols.

Description of the Background Art

As well known in the art, an OFDM transmission system is adapted to divide coded data and sort the same into at least hundreds of carriers, for multiplexing and transmitting the data. In relation to digital sound broadcasting for movable terminals or terrestrial digital television broadcasting, communication through an OFDM signal is recently watched with interest. The OFDM signal can transmit a large quantity of data at a high speed while its characteristics are hardly deteriorated by reflected waves even if no waveform equalizer is provided. Further, this signal hardly causes a crossfire to another service since its signal waveform is close to that of a random noise.

A transmission system employing such an OFDM signal is disclosed in "Suitable for Mobile Receiving of OFDM Digital Broadcasting Employing at least Hundreds of Carriers" by Hajime Fukuchi of the Communications Research Laboratory, the Ministry of Posts and Telecommunications of Japan, "Data Compression and Digital Modulation", Nikkei Electronics Books, issued on October 1, 1993, pp. 207 to 222.

Fig. 13 is a block circuit diagram showing the structure of a conventional transmitter 5 for an OFDM signal which is disclosed in the aforementioned literature, and Fig. 14 illustrates the structure of an OFDM signal which is transmitted from the transmitter 5 shown in Fig. 13. Referring to Fig. 13, the transmitter 5 comprises a serial-to-parallel converter 52, an inverse Fourier transformer 53, a parallel-to-serial converter 54, a digital-to-analog converter 55, and a low-pass filter 56. Referring to Fig. 14, (a), (b) and (c) show direct, reflected and composite waves of the OFDM signal respectively, and (d) shows a time window W.

The serial-to-parallel converter 52 of the transmitter 5 is supplied with an input symbol train. The input symbol train is formed by digitally modulated transmission data, and each transmission symbol includes a plurality of data values. The digital modulation is performed by QPSK (quadrature phase shift keying) modulation or 16 QAM (quadrature amplitude modulation). The serial-to-parallel converter 52 serial-to-parallel converts the input sym-

bol train in every symbol, to obtain a plurality of symbol trains of a lower speed. The degree of parallelism is identical to the number (such as 512, for example, in the range of tens to thousands) of a plurality of carriers, which are orthogonal in phase to each other, employed in the inverse Fourier transformer 53. Due to this operation, the serial-to-parallel converter 52 outputs a group of carrier modulation signals for deciding the amplitudes and phases of the plurality of carriers which are employed in the inverse Fourier transformer 53.

The inverse Fourier transformer 53 allots the carrier modulation signals to the respective carriers which are lined up on the frequency axis in every symbol so that data for one symbol is transformed to a multiplex signal on the frequency axis, and collectively performs inverse Fourier transformation on the signals, thereby transforming the same to a multiplex signal (parallel digital signal in this stage) on the time axis.

The parallel-to-serial converter 54 parallel-to-serial converts the multiplex signal on the time axis, thereby forming a OFDM signal. The digital-to-analog converter 55 converts the OFDM signal to an analog OFDM baseband signal. The low-pass filter 56 limits the band of the OFDM baseband signal, so that no channel-to-channel interference is caused by aliasing.

Following the aforementioned series of operations, the transmitter 5 outputs the OFDM signal including guard intervals G_m and symbols S_m to the transmission path, as shown in Fig. 14. A demodulator (not shown) carries out signal processing which is reverse to that of the modulator 5 on the OFDM signal received through the transmission path, to reproduce an output symbol train which is identical to the input symbol train.

The so-called multipath is caused on the transmission path. Therefore, the receiver receives direct waves of the OFDM signal transmitted from the transmitter and reflected waves which are time-delayed from the direct waves in superposition. If a reflected wave (see (b) in Fig. 14) by the multipath is superposed on a direct wave (see (a) in Fig. 14) in the symbol S_m , for example, an interference part α_m with the guard interval G_m of the reflected wave is caused on a front end part of the symbol S_m of a composite wave (see (c) in Fig. 14), while an interference part β_m with a symbol S_{m-1} of the reflected wave is caused on a front end part of the guard interval G_m . At this time, the interference part β_m which is displaced from the time window W exerts no influence on Fourier transformation of the symbol S_m . However, the interference part α_m is caused in the time window W while the data component of the guard interval G_m is "0", and hence waveform distortion is disadvantageously caused on the data component of each symbol S_m on the frequency axis after the Fourier transformation.

On the other hand, a time delay is caused in the OFDM signal before the same reaches the receiver from the transmitter, due to delay characteristics of the transmission path, deviation in sampling timing resulting from mismatching between clocks of the digital-to-analog converter on the transmission side and an analog-to-dig-

ital converter on the receiving side, and the like. In the receiver, therefore, the time window W must disadvantageously be adjusted on the time axis.

The carrier modulation signals which are outputted from the serial-to-parallel converter 52 may not be out of phase with each other, but may be completely in phase with each other. For example, the carrier modulation signals are completely in phase with each other when a silent state is transmitted in excess of one symbol period in digital sound broadcasting or when a monochromatic picture is transmitted in excess of one symbol period in terrestrial digital television broadcasting. Also in the case of transmitting a sounding state or a multicolor picture, the carrier modulation signals tend to be completely in phase with each other in a digital modulation system such as the QPSK modulation or the 16 QAM, due to a limited number of signal points which are out of phase with each other.

When the carrier modulation signals are completely in phase with each other as described above and these signals are subjected to inverse Fourier transformation, nodes of the respective carriers match with each other on the time axis and addition/increase parts are concentrated to one portion on the time axis, and hence the OFDM signal has an impulsive signal waveform on the time axis, to cause power concentration. Figs. 15(a) to 15(d) show this situation.

Referring to Fig. 15(a), a group of n carrier modulation signals for modulating n carriers which are orthogonal to each other respectively are completely in phase with each other on a complex plane. Referring to Fig. 15(b), the n carriers which are modulated by the n carrier modulation signals shown in Fig. 15(a) are multiplexed on the time axis. When the carrier modulation signals are thus completely in phase with each other, the OFDM signal becomes an impulsive waveform signal. Referring to Fig. 15(c), on the other hand, a group of n carrier modulation signals for modulating n carriers which are orthogonal to each other respectively are at random in phase on a complex plane. Referring to Fig. 15(d), the n carriers which are modulated by the n carrier modulation signals shown in Fig. 15(c) are multiplexed on the time axis. When the carrier modulation signals are thus completely out of phase from each other, the OFDM signal is evenly diffused on the time axis, and becomes a random waveform signal.

As hereinabove described, the OFDM signal has an impulsive waveform to extremely increase the maximum power when the carrier modulation signals are completely in phase with each other, and hence the OFDM signal is disadvantageously readily influenced by nonlinearity of the transmitter, the receiver, a relay amplifier such as a satellite or a CATV included in the transmission path and the like. In this case, the dynamic ranges of the transmitter, the receiver, the relay amplifier and the like may be increased to exert no influences of nonlinearity on the impulsive OFDM signal, while the cost for the transmitter, the receiver, the relay amplifier and the like is disadvantageously increased in this case.

SUMMARY OF THE INVENTION

Accordingly, an object of the present invention is to provide a method of transmitting an OFDM signal which causes no waveform distortion in a data component of each symbol on the frequency axis after Fourier transformation even if a reflected wave is superposed on a direct wave through a multipath, and a transmitter and a receiver therefor.

Another object of the present invention is to provide a method of transmitting an OFDM signal which can readily adjust a time window on the time axis even if a time delay is caused in the OFDM signal before the same reaches a receiving side from a transmission side, and a transmitter and a receiver therefor.

Still another object of the present invention is to provide a method of transmitting an OFDM signal which can reduce an influence of nonlinearity on the OFDM signal in a low-priced structure, and a transmitter and a receiver therefor.

A first aspect of the present invention is directed to a method of transmitting an orthogonal frequency division multiplex signal in every symbol of a prescribed length from a transmission side to a receiving side through a wire or wireless transmission path, and the method comprises:

a first step of transforming a carrier modulation signal group deciding the phases and amplitudes of a plurality of carriers which are orthogonal to each other on the frequency axis to the orthogonal frequency division multiplex signal on the time axis by performing inverse Fourier transformation in every symbol; and

a second step of adding front and rear guard intervals, including data which are identical to those of rear and front end parts of each symbol of the orthogonal frequency division multiplex signal, to front and rear parts of the symbol respectively and transmitting the same to the receiving side.

According to the first aspect of the present invention, as hereinabove described, the front and rear guard intervals including the data which are identical to those of parts of each symbol are added to the front and rear parts of the symbol in transmission of each symbol of the OFDM signal, whereby all data components in a single symbol interval which are lined up on the time axis can be reproduced on the receiving side even if a time window in the Fourier transformation is slightly displaced from the symbol interval of the received signal. Therefore, it is not necessary to correctly coincide the time window with the symbol interval even if a time delay is caused in the OFDM signal before the same reaches the receiving side from the transmission side, whereby the time window can be readily adjusted on the time axis. Even if a symbol interval of a direct wave is superposed with a guard interval of a reflected wave due to a multipath, further, amplitude/phase distortion of each data component appearing on the frequency axis after the Fourier transformation on the receiving side is homogeneous in every symbol. Therefore, such waveform dis-

tortion can be readily removed from data components on the frequency axis of one symbol interval on the receiving side by simple arithmetic processing such as multiplication or addition.

In a preferred embodiment of the aforementioned first aspect, the carrier modulation signal group is complex-multiplied by a reference complex signal group on the frequency axis, so that the complex multiplication result is transformed to an OFDM signal and transmitted to the receiving side. On the receiving side, on the other hand, the OFDM signal which is transmitted from the transmission side is transformed to a receiving carrier modulation signal group so that this receiving carrier modulation signal group is complex-divided by the reference complex signal group on the frequency axis. Even if a time delay is caused in the OFDM signal between the transmission side and the receiving side, therefore, modulated data can be obtained on the receiving side with no influence by the time delay.

As to the reference complex signal group for complex-multiplying the carrier modulation signal group, a result of complex multiplication which is carried out in advance of a constant symbol may be employed with respect to each symbol of the carrier modulation signal group.

Alternatively, the reference complex signal group may be prepared from a complex signal group having a predetermined specific pattern with signals which vary in phase at random. In this case, a complex multiplication result which is obtained in a third step is ordinarily transformed to an OFDM signal, while the reference complex signal group is periodically transformed to an OFDM signal. Thus, the absolute reference phases of the respective signals of the carrier modulation signal group are random values, whereby the OFDM signal obtained by the inverse Fourier transformation can be suppressed from time concentration of power. Thus, it is not necessary to increase the dynamic ranges of the transmitter, the receiver and the transmission path but influences exerted by nonlinearity of the transmitter, the receiver and a relay amplifier on the OFDM signal can be reduced through a low-priced structure.

A second aspect of the present invention is directed to a transmitter for an orthogonal frequency division multiplex signal, which is an apparatus for transmitting the orthogonal frequency division multiplex signal to a receiving side in every symbol of a prescribed length through a wire or wireless transmission path, and the transmitter comprises:

a memory part storing a reference complex signal group;

a complex multiplication part, complex-multiplying a carrier modulation signal group deciding the phases and amplitudes of a plurality of carriers which are orthogonal to each other on the frequency axis, by the reference complex signal group stored in the memory part on the frequency axis, for outputting a transmission carrier modulation signal group;

an inverse Fourier transformation part performing

an inverse Fourier operation on the transmission carrier modulation signal group which is outputted from the complex multiplication part in every symbol thereby transforming the transmission carrier modulation signal group to the orthogonal frequency division multiplex signal on the time axis;

a guard interval addition part adding front and rear guard intervals, including data which are identical to those of rear and front end parts of each symbol of the orthogonal frequency division multiplex signal outputted from the inverse Fourier transformation part, to front and rear parts of the symbol respectively; and

a transmission part transmitting the orthogonal frequency division multiplex signal having the added front and rear guard intervals to the receiving side in every symbol.

In a preferred embodiment of the aforementioned second aspect, the memory part stores a complex multiplication result of the complex multiplication part which is precedent to a constant symbol as the reference complex signal group.

In another preferred embodiment of the aforementioned second aspect, the memory part stores a predetermined complex signal group as the reference complex signal group. On the other hand, the complex multiplication part complex-multiplies the carrier modulation signal group by the reference complex signal group which is stored in the memory part on the frequency axis and outputs the result. Further, the inverse Fourier transformation part ordinarily transforms the complex multiplication result which is outputted from the complex multiplication part to an orthogonal frequency division multiplex signal in every symbol, and periodically transforms the reference complex signal group which is outputted from the memory part to an orthogonal frequency division multiplex signal.

According to the aforementioned second aspect, the memory part may hold an output of a pseudo-noise signal generation part generating a pseudo-noise signal or that of a frequency sweep signal generation part generating a frequency sweep signal as the reference complex signal group.

A third aspect of the present invention is directed to a receiver for an orthogonal frequency division multiplex signal, which is an apparatus for receiving the orthogonal frequency division multiplex signal transmitted from a transmission side in every symbol of a prescribed length through a wire or wireless transmission path, and the receiver comprises:

a Fourier transformation part performing a Fourier transformation operation on the orthogonal frequency division multiplex signal on the time axis in every symbol thereby transforming the orthogonal frequency division multiplex signal to a receiving carrier modulation signal group on the frequency axis;

a memory part storing the receiving carrier modulation signal group which is outputted from the Fourier transformation part in every symbol as a receiving reference complex signal group; and

a complex division part complex-dividing the receiving carrier modulation signal group which is outputted from the Fourier transformation part by the receiving reference complex signal group which is stored in the memory part on the frequency axis.

A fourth aspect of the present invention is directed to a method of transmitting an orthogonal frequency division multiplex signal from a transmission side to a receiving side in every symbol of a prescribed length through a wire or wireless transmission path, and the method comprises:

a first step of forming a carrier modulation signal group for deciding the phases and amplitudes of a plurality of carriers which are orthogonal to each other on the frequency axis in every symbol;

a second step of generating a complex signal group having a predetermined specific pattern with signals varying in phase at random;

a third step of complex-multiplying the carrier modulation signal group by the complex signal group on the frequency axis in every symbol, thereby randomizing phases of respective signals of the carrier modulation signal group; and

a fourth step of ordinarily transforming the carrier modulation signal group having the signals which are randomized in phase in the third step to an orthogonal frequency division multiplex signal on the time axis by inverse Fourier transformation in every symbol, and periodically transforming the complex signal group to an orthogonal frequency division multiplex signal by inverse Fourier transformation, for transmitting the same to the receiving side respectively.

The foregoing and other objects, features, aspects and advantages of the present invention will become more apparent from the following detailed description of the present invention when taken in conjunction with the accompanying drawings.

BRIEF DESCRIPTION OF THE DRAWINGS

Fig. 1 is a block diagram showing the structure of a transmitter 1 according to a first embodiment of the present invention;

Fig. 2 is a block diagram showing the structure of a receiver 2 according to the first embodiment of the present invention;

Fig. 3 illustrates the structure of an OFDM signal which is transmitted from the transmitter 1 shown in Fig. 1;

Fig. 4 illustrates operations of a memory 14 and a complex multiplier 13 shown in Fig. 1;

Fig. 5 illustrates operations of an envelope wave detector 23 and a synchronous reproducer 24 of the receiver 2 with respect to the OFDM signal which is outputted from the transmitter 1 shown in Fig. 1;

Fig. 6 illustrates operations of a memory 26 and a complex divider 27 shown in Fig. 2;

Fig. 7 illustrates comparative results of a simulation for comparing a conventional system and the system

according to the first embodiment with each other in relation to influences exerted by delayed waves by multipaths;

Fig. 8 illustrates results of a simulation for comparing the conventional system and the system according to the first embodiment with each other in relation to influences exerted by time delays through transmission paths etc.;

Fig. 9 is a block diagram showing the structure of a transmitter according to a second embodiment of the present invention;

Fig. 10 illustrates the situation of a complex multiplication of a carrier modulation signal group by a complex signal group in a complex multiplier 13 shown in Fig. 9;

Fig. 11 illustrates operations of a memory 14 and the complex multiplier 13 shown in Fig. 9;

Fig. 12 is a signal structural diagram showing the structure of an OFDM signal which is transmitted from the transmitter shown in Fig. 9;

Fig. 13 is a block diagram showing the structure of a conventional transmitter 5 for an OFDM signal;

Fig. 14 illustrates the structure of the OFDM signal which is transmitted from the transmitter 5 shown in Fig. 13; and

Figs. 15(a) to 15(d) are signal waveform diagrams showing the relations between phase states of carrier modulation signal groups allotted to carriers which are orthogonal to each other and OFDM signals respectively.

DESCRIPTION OF THE PREFERRED EMBODIMENTS

With reference to the drawings, description is now made on embodiments of a method of transmitting an OFDM signal, and a transmitter and a receiver employed therefor according to the present invention.

Fig. 1 is a block diagram showing a transmitter 1 according to a first embodiment of the present invention, Fig. 2 is a block diagram showing the structure of a receiver 2 according to the first embodiment of the present invention, and Fig. 3 illustrates an exemplary structure of an OFDM signal which is employed in the present invention. Referring to Fig. 3, (a) and (b) show direct and reflected waves of the OFDM signal respectively and (c) and (d) show direct and reflected waves of the OFDM signal causing time delays respectively, while (e) shows a time window W.

The transmitter 1 shown in Fig. 1 and the receiver 2 shown in Fig. 2 are connected with each other through a transmission path (not shown) such as a coaxial cable or an optical fiber cable. The transmitter 1 and the receiver 2 are employed in a digital CATV system, for example. The transmitter 1 is adapted to transmit picture data for multiple channels of a television, for example, to the receiver 2 through an OFDM signal.

Referring to Fig. 1, the transmitter 1 comprises a carrier modulation signal generator 12, a complex multiplier

13, a memory 14, an inverse Fourier transformer 15, a guard interval insertion part 16, a synchronizing signal multiplexing part 17, a digital-to-analog converter 18, and a low-pass filter 19.

The carrier modulation signal generator 12 of the transmitter 1 receives transmitted digital data (bit stream signal) to be transmitted to the receiver 2. The carrier modulation signal generator 12 digital-modulates the inputted transmitted digital data and serial-to-parallel converts the same in every symbol interval, thereby converting the data to a carrier modulation signal group including n (512, for example, in the range of tens to thousands) carrier modulation signals for modulating n carriers which are orthogonal to each other. The digital modulation is performed by QPSK modulation or 16 QAM. The carrier modulation signal group in this stage is similar to that outputted from the serial-to-parallel converter 52 (see Fig. 13) of the conventional transmitter. The carrier modulation signal group which is outputted from the carrier modulation signal generator 12 is supplied to the complex multiplier 13. The memory 14 can store such a carrier modulation signal group $D'm$ outputted from the complex multiplier 13 for one symbol. When a carrier modulation signal group Dm is inputted in the complex multiplier 13, the memory 14 outputs a carrier modulation signal group $D'm-1$, which is precedent to one symbol, stored therein to the complex multiplier 13 as a prescribed reference complex signal group. The complex multiplier 13 complex-multiplies the inputted transmission signal group Dm by the reference complex signal group $D'm-1$ which is precedent by one symbol on the frequency axis, thereby forming the following carrier modulation signal group:

$$D'm \quad (D'm = Dm \times D'm-1)$$

Assuming that $Dm[k]_{\text{real}}$ represents the real number part of a k -th ($k = 1, 2, \dots, n$) carrier modulation signal of the carrier modulation signal group, including n carrier modulation signals, which is inputted in the complex multiplier 13 and $Dm[k]_{\text{imag}}$ represents the imaginary number part thereof while $D'm-1[k]_{\text{real}}$ represents the real number part of the k -th carrier modulation signal which is stored in the memory 14 and $D'm-1[k]_{\text{imag}}$ represents the imaginary number part thereof, the complex multiplier 13 carries out multiplication processing as to the real and imaginary number parts of each carrier modulation signal, for outputting:

$$D'm[k]_{\text{real}} = Dm[k]_{\text{real}} \times D'm-1[k]_{\text{real}}$$

$$D'm[k]_{\text{imag}} = Dm[k]_{\text{imag}} \times D'm-1[k]_{\text{imag}}$$

The memory 14 stores the carrier modulation signal $D'm$ (including $D'm[k]_{\text{real}}$ and $D'm[k]_{\text{imag}}$) of the real and imaginary numbers outputted from the complex multiplier 13. As shown in Fig. 4, the memory 14 and the complex multiplier 13 repeatedly execute the aforementioned operations.

The inverse Fourier transformer 15 successively allots the respective carrier modulation signals included in the carrier modulation signal group $D'm$ which is outputted from the complex multiplier 13 to the respective carriers which are lined up on the frequency axis in every symbol interval, collectively performs inverse Fourier transformation thereon, and further performs parallel-to-serial conversion, thereby transforming the carrier modulation signal group multiplexed with the respective data components on the frequency axis to an OFDM signal $D'mt$ multiplexed with the respective data components on the time axis.

The guard interval insertion part 16 temporarily stores the digital OFDM signal $D'mt$ which is outputted from the inverse Fourier transformer 15 in its internal buffer in every symbol interval. Then, the guard interval insertion circuit 16 adds front and rear guard intervals Ghm and Gem to front and rear parts of each symbol S_m (see Fig. 3). Time lengths $tg1$ and $tg2$ of the front and rear guard intervals Ghm and Gem are prescribed in consideration of time difference between direct and indirect waves due to a multipath caused in the transmission path and time delays resulting from sampling deviation between the digital-to-analog converter 18 of the transmitter 1 and an analog-to-digital converter 22 of the receiver 2. Further, the front and rear guard intervals Ghm and Gem include data $D'emt$ and $D'hmt$ which are identical to those of rear and front end parts Sem and Shm of the corresponding symbol S_m respectively. Thus, the substantial symbol length is extended to $tg1 + ts + tg2$. The guard interval insertion part 16 successively outputs the data $D'emt$, $D'm$ and $D'hmt$ through the front guard interval Ghm , the symbol S_m and the rear guard interval Gem .

The synchronizing signal multiplexing part 17 multiplexes a synchronizing signal on the OFDM signal to which the guard intervals are added on the time axis in every symbol in order to indicate the breakpoint of the symbol, and outputs the signal to the digital-to-analog converter 18. The synchronizing signal is formed by a periodically known nonmodulated carrier, a suppression signal etc. with respect to the OFDM signal, as shown at (a) in Fig. 5, for example.

The digital-to-analog converter 18 converts the OFDM signal of the digital data, to which the guard intervals and the synchronizing signal are added, outputted from the synchronizing signal multiplexing part 17 to an analog OFDM baseband signal. The low-pass filter 19 limits the band of the OFDM baseband signal, so that no channel-to-channel interference is caused by aliasing.

As the result of the aforementioned series of operations, the transmitter 1 outputs the OFDM signal including the guard intervals and the synchronizing signal to the transmission path.

Referring to Fig. 2, the receiver 2 comprises a low-pass filter 21, the analog-to-digital converter 22, an envelope detector 23, a synchronous reproducing part 24, a Fourier transformer 25, a memory 26, a complex divider 27, and a transmission data reproducer 28.

The low-pass filter 21 removes unnecessary spectral components of a high-frequency region from the OFDM signal which is received through the transmission path.

In consideration of a time delay Δt caused by the multipath or the delay characteristics of the transmission path, the OFDM signal which is received in the receiver 2 is represented by $ZD'mt$, where Z represents the signal delay as follows:

$$Z = \exp j2\pi f_c \Delta t$$

The analog-to-digital converter 22 converts data $ZD'emt$, $ZD'mt$ and $ZD'hmt$ which are included in the front guard interval Ghm , the symbol S_m and the rear guard interval Gem of the analog OFDM signal respectively to those of a digital OFDM signal.

The envelope detector 23 envelope-detects the OFDM signal, thereby outputting an envelope detection signal shown at (b) in Fig. 5 in every symbol. The synchronous reproducing part 24 outputs a reference timing signal shown at (c) in Fig. 5 in every symbol on the basis of the envelope detection signal outputted from the envelope detector 23. This reference timing signal is inputted in the Fourier transformer 25 and the memory 26.

The Fourier transformer 25 observes the OFDM signal which is outputted from the analog-to-digital converter 22 in synchronization with the reference timing signal through the time window W (see (e) in Fig. 3) of the same length as the symbol length t_s , thereby extracting only necessary data parts of the respective symbols. The Fourier transformer 25 further performs Fourier transformation operations on the extracted data parts, thereby transforming the OFDM signal on the time axis to a receiving carrier modulation signal group on the frequency axis.

The memory 26 stores the receiving carrier modulation signal group which is outputted from the Fourier transformer 25 for one symbol. When the transmitter 1 transmits data $D'm$, the memory 26 stores data $ZD'm$ as corresponding data. The data $ZD'm$ is obtained by adding a time delay Z caused by the multipath or the transmission path to the data $D'm$, as follows:

$$ZD'm = D'm \times \exp j2\pi f_c \Delta t$$

The memory 26 outputs the data $ZD'm$ to the complex divider 27 in synchronization with the reference timing signal. The complex divider 27 establishes synchronization, and then complex-divides data $ZD'm+1$ of a symbol S_{m+1} which is outputted from the Fourier transformer 25 by the data $ZD'm$ held in the memory 26. Namely, the complex divider 27 performs the following operation:

$$ZD'm+1/ZD'm = D'm+1/D'm = D_{m+1}$$

As shown in Fig. 6, the Fourier transformer 25, the memory 26 and the complex divider 27 repeatedly execute the aforementioned operations.

As hereinabove described, a relative time delay is caused between the direct and reflected waves shown at (a) and (b) in Fig. 3, due to the multipath. Further, specific time delays are caused in the direct and reflected waves, due to the difference in sampling timing between the digital-to-analog converter 18 of the transmitter 1 and the analog-to-digital converter 22 of the receiver 2 (see (c) and (d) in Fig. 3). These time delays are not taken into consideration in the Fourier transformer 25 as to the reference timing signal, and hence positions of the receiving side time window W on the time axis are displaced from the symbol intervals of the received signal, as shown at (e) in Fig. 3.

Even if the time window W is displaced from correct symbol intervals in the Fourier transformer 25 of the receiving side, however, the data observed through the time window W include all data $ZD'mt$ on the time axis which must be originally included in one symbol interval since the front and rear guard intervals Ghm and Gem include the data $ZD'emt$ and $ZD'hmt$ respectively. Therefore, the time delays and superposition of the reflected waves appear as uniform amplitude/phase distortion in every data component on the frequency axis. When the time delays and the characteristics of the reflected waves are uniform, the values of the amplitude/phase distortion in the respective symbol intervals are equal to each other. According to this embodiment, the complex divider 27 complex-divides the data $ZD'm+1$ of the symbol S_{m+1} which is outputted from the Fourier transformer 25 by the data $ZD'm$ held in the memory 26, thereby canceling the data delay Z and obtaining the original carrier modulation signal group D_{m+1} with no delay. Namely, the amplitude/phase distortion is canceled by the following operation of the complex divider 27:

$$ZD'm+1/ZD'm = D'm+1/D'm = D_{m+1}$$

Thus, data D_m having no phase/amplitude distortion can be obtained as to each symbol.

According to this embodiment, as hereinabove described, the guard intervals including the data which are identical to those of the front and rear end parts of each symbol are added to the front and rear parts of the symbol respectively for transmitting the data, whereby all data components in one symbol interval which are lined up on the time axis can be reproduced on the receiving side as to both of the direct and reflected waves in the time window W . Therefore, the respective data components appearing on the frequency axis after the Fourier transformation are uniform in amplitude/phase distortion even if the reflected waves are superposed on the direct waves by the multipath to result in superposition of the symbol intervals of the direct waves and the guard intervals of the reflected waves. Therefore, waveform distortion can be readily removed from the receiving carrier modulation signal group on the frequency axis of one symbol interval by executing proper operations (multiplication and division) on the transmission and receiving sides.

According to this embodiment, further, demodulated data can be obtained with no time delay even if a time delay is caused in the OFDM signal between the transmission and receiving sides, by complex-multiplying and complex-dividing the receiving carrier modulation signal group by the prescribed reference complex signal group on the frequency axis. Consequently, it is not necessary to correctly coincide the time window with the symbol interval.

The transmission data reproducer 28 demaps signal points of the receiving carrier modulation signal group D_m which is outputted from the complex divider 27 on a complex plane and decides the signal points, thereby obtaining a receiving digital signal group which is identical in value to the transmission digital signal group of the transmitter 1. As hereinabove described, phase distortion and amplitude distortion are removed from the receiving carrier modulation signal group D_m . Therefore, the transmission data reproducer 28 can correctly and readily determine the original data from the mapping positions on the complex plane.

The inventors have made simulations of comparing the system according to this embodiment with the conventional system with respect to influences exerted by waves delayed by multipaths and those exerted by time axis delays respectively through a calculator. Each simulation was executed on such conditions that the carrier number was 512, only data of a 256-th carrier had an amplitude "1" and a phase "0", and all data of the remaining carriers were "0".

Fig. 7 illustrates the results of the simulation for comparing the system according to this embodiment with the conventional system as to the influences exerted by waves delayed by multipaths. Referring to Fig. 7, (a), (b), (c) and (d) show data distortion states in the case of transforming direct, indirect, composite and composite waves in the conventional system to signals on the frequency axis by Fourier operations respectively. On the other hand, (e), (f), (g) and (h) show data distortion states in the case of converting direct, indirect, composite and composite waves in the system according to this embodiment to signals on the frequency axis by Fourier operations respectively.

In the conventional system, no data is inserted in any guard interval (see $\alpha 1$ at (b) in Fig. 7), and hence an interference part $\alpha 2$ appears in a time window W of the composite wave (see (c) in Fig. 7). When the composite wave is transformed to a signal on the frequency axis by a Fourier operation in the time window W , therefore, the spectrum of the data of the 256-th carrier is spread and the data of the remaining carriers, which must have originally been "0", are distorted. Thus, the transmission data reproducer 28 readily causes an erroneous determination. Further, the transmission data reproducer 28 also readily causes erroneous determinations as to other carriers. In the system according to this embodiment, on the other hand, data are inserted in the guard intervals and hence no influences are exerted on the data of the remaining carriers.

Fig. 8 illustrates the results of the simulation for comparing the system according to this embodiment with the conventional system as to the influences exerted by time delays caused by transmission paths etc. Referring to Fig. 8, (a) shows a spectrum obtained under such conditions that only the data of the 256-th carrier had an amplitude "1" and a phase "0", and (b) shows a signal waveform in the case of transforming the data at (a) to a signal on the time axis by an inverse Fourier operation. Referring to Fig. 8, further, (c) and (d) show data distortion states in the case of transforming composite and composite waves causing time delays in the conventional system to signals on the frequency axis by Fourier operations respectively. On the other hand, (e) and (f) show data distortion states in the case of transforming composite and composite waves causing time delays in the system according to this embodiment to signals on the frequency axis by Fourier operations respectively.

In the conventional system, no data is inserted in any guard interval (see $\alpha 1$ at (c) in Fig. 8), and hence an interference part $\alpha 2$ appears in a time window W of the composite wave, similarly to the case shown at (c) in Fig. 7. When the composite wave is transformed to a signal on the frequency axis by a Fourier operation in the time window W , therefore, the spectrum of the data of the 256-th carrier is spread and the data of the remaining carriers, which must have originally been "0", are distorted, as shown at (d) in Fig. 8. Thus, the transmission data reproducer 28 readily causes erroneous determinations also as to other carriers. In the system according to this embodiment, on the other hand, data are inserted in the guard intervals and hence no influences are exerted on the data of the remaining carriers.

Fig. 9 is a block diagram showing the structure of a transmitter 3 according to a second embodiment of the present invention. In the transmitter 3 shown in Fig. 9, portions corresponding to those of the transmitter 1 shown in Fig. 1 are denoted by the same reference numerals, to omit redundant description. As to the embodiment shown in Fig. 9, it is to be noted that a memory 14 holds an output of a specific pattern generator 31, i.e., a complex signal group D_0 having a predetermined specific pattern with signals which mutually vary in phase at random. Such a complex signal group D_0 can be formed by a pseudo-noise signal generator comprising a PN series pseudo-random signal generator for generating a pseudo-random signal which is at a level between zero and 1 and a multiplier for multiplying the pseudo-random signal by 2π for generating a unit vector signal in a phase having a random value in the range of zero to 2π and an amplitude of 1, for example. Alternatively, the complex signal group D_0 can be formed by a frequency sweep signal generator for generating a known frequency sweep signal in a phase having a random value in the range of zero to 2π .

A complex multiplier 13 complex-multiplies data D_m of each symbol interval by data D_0 on the frequency axis every time data D_m is inputted for forming data $D'm$ ($D'm = D_m \times D_0$), thereby randomizing mutual phases

of respective carrier modulation signals included in a carrier modulation signal group to specific patterns.

Fig. 10 illustrates a complex multiplication operation in the complex multiplier 13. In particular, (a) in Fig. 10 shows arrangement of signal points which can be taken by the carrier modulation signals when 16 QAM is employed as a modulation system, (b) shows a unit vector i whose phase varies at random, and (c) shows a carrier modulation signal whose phase is randomized to a specific pattern.

Referring to (a) in Fig. 10, it is assumed that a carrier modulation signal included in a carrier modulation signal group which is allotted to one carrier is arranged at a signal point A on a complex plane. The signal A has a real number part of 3 and an imaginary number part of 1. It is also assumed that the unit vector i has a phase angle of $3\pi/4$ at this time. A carrier modulation signal A' shown at (c) in Fig. 10 is obtained as the result of a complex multiplication. The carrier modulation signal A' has a real number part of -2.8 and an imaginary number part of 1.4, and takes a signal point which is not present in the arrangement of the 16 QAM. Thus, the phase of the unit vector i varies at random, and hence the complex multiplier 13 outputs a carrier modulation signal group having signals whose phases are mutually randomized to an inverse Fourier transformer 15 even if respective carrier modulation signals included in a carrier modulation signal group which is outputted from a carrier modulation signal generator 12 are in phase with each other.

The complex multiplier 13 repeats such an operation for a prescribed period. Further, the complex multiplier 13 periodically outputs only the data D0. Fig. 11 shows a series of such operations. Assuming that S0 represents a symbol in which the data D0 is inserted, the transmitter 3 periodically outputs the data D0 of the symbol S0 while outputting data Dm of a symbol Sm in other case, as shown in Fig. 12. The inverse Fourier transformer 15 allots the carrier modulation signal group D'm to respective carriers which are lined up on the frequency axis in every symbol, and collectively performs inverse Fourier transformation and parallel-to-serial conversion thereon, thereby converting the same to a digital OFDM signal. Consequently, absolute reference phases of the carrier modulation signal group are at random values in the range of zero to 2π whereby the OFDM signal outputted from the inverse Fourier transformer 15 can be suppressed from power concentration. Thus, it is not necessary to increase the dynamic ranges of the transmitter 3 and a receiver but influences exerted on the OFDM signal by nonlinearity of the transmitter, the receiver, a relay amplifier etc. can be reduced through a low-priced structure. The remaining circuit blocks in the transmitter 3, i.e., those from a guard interval insertion part 16 to a low-pass filter 19, operate similarly to those in the transmitter 1.

The guard interval insertion part 16 inserts a data component D0 which is identical to that of a rear end part of the symbol S0 in a corresponding front guard interval, while inserting a data component which is identical to

that of a front end part of the symbol S0 in a corresponding rear guard interval, similarly to the case of the symbol Sm.

When the transmitter 3 shown in Fig. 9 is employed, a receiver of the same structure as the receiver 2 shown in Fig. 2 can basically be employed. In this case, however, a memory 26 of the receiver stores receiving data ZD0 of a reference complex signal group D0 which is stored in the memory 14 of the transmitter 3.

Also in the embodiment shown in Fig. 9, an effect similar to that of the aforementioned first embodiment can be attained. Namely, amplitude/phase distortion of a receiving carrier modulation signal group appearing on the frequency axis after Fourier transformation is entirely uniform even if reflected waves are superposed on direct waves by a multipath and symbol intervals of the direct waves are superposed with guard intervals of the reflected waves, and can be removed by simple operations (multiplication and division). Further, demodulated data can be obtained with no influence by a time delay even if such a time delay is caused in the OFDM signal between the transmission and receiving sides, whereby a time window can be readily adjusted on the time axis.

While the data are transmitted through wire transmission paths in the aforementioned embodiments, the present invention is not restricted to this but data may alternatively be transmitted through a wireless transmission path. While television picture data for multichannels are carried on the respective carriers in the aforementioned embodiments, picture data for one channel may alternatively be time-shared and sequenced in a parallel manner, to be allotted to respective carriers. Further, voice data, text data or the like may be carried on the respective carriers, in place of the picture data. In addition, the present invention may alternatively be carried out in another system such as LAN or WAN, in place of the CATV.

While the reference complex signal group outputted from the memory 14 is periodically inputted in the inverse Fourier transformer 15 through the complex multiplier 13 in the transmitter 3 shown in Fig. 9, the reference complex signal group may alternatively be directly inputted in the inverse Fourier transformer 15.

While the transmitter 3 shown in Fig. 9 employs the complex signal group D0 including signals having a predetermined specific pattern and phases which mutually vary at random as the reference complex signal group to be included in the carrier modulation signal group, further, the reference complex signal group to be included in the carrier modulation signal group may alternatively be formed by a complex signal group including signals having a predetermined specific pattern which are in phase with each other under a situation causing no power concentration in the OFDM signal. Also in this case, amplitude/phase distortion can be removed by simple operations (multiplication and division), similarly to the first embodiment.

Although the present invention has been described and illustrated in detail, it is clearly understood that the

same is by way of illustration and example only and is not to be taken by way of limitation, the spirit and scope of the present invention being limited only by the terms of the appended claims.

Claims

1. A method of transmitting an orthogonal frequency division multiplex signal from a transmission side to a receiving side in every symbol of a prescribed length through a wire or wireless transmission path, said method comprising:

a first step of transforming a carrier modulation signal group deciding the phases and amplitudes of a plurality of carriers being orthogonal to each other on the frequency axis to said orthogonal frequency division multiplex signal on the time axis by performing inverse Fourier transformation in every symbol; and

a second step of adding front and rear guard intervals, including data being identical to those of rear and front end parts of each symbol of said orthogonal frequency division multiplex signal, to front and rear parts of said symbol respectively and transmitting the same to said receiving side.

2. The method of transmitting an orthogonal frequency division multiplex signal in accordance with claim 1, further comprising a third step of complex-multiplying said carrier modulation signal group by a reference complex signal group on the frequency axis,

said first step being adapted to transform a complex multiplication result being obtained in said third step to said orthogonal frequency division multiplex signal.

3. The method of transmitting an orthogonal frequency division multiplex signal in accordance with claim 2, wherein said third step is adapted to complex-multiply each said carrier modulation group by a result of complex multiplication, being carried out in advance of a constant symbol, serving as said reference complex signal group with respect to each said symbol of said carrier modulation signal group.

4. The method of transmitting an orthogonal frequency division multiplex signal in accordance with claim 2, further comprising a fourth step of generating a complex signal group having a predetermined specific pattern with signals varying in phase at random,

said third step employs said complex signal group being obtained in said fourth step as said reference complex signal group with respect to each said symbol of said carrier modulation signal group, and

said first step ordinarily transforms said complex multiplication result being obtained in said third step to said orthogonal frequency division multiplex signal, while periodically transforming said refer-

ence complex signal group to said orthogonal frequency division multiplex signal.

5. The method of transmitting an orthogonal frequency division multiplex signal in accordance with claim 2, further comprising:

a fifth step of transforming said orthogonal frequency division multiplex signal being transmitted from said transmission side to a receiving carrier modulation signal group corresponding to said carrier modulation signal group in every symbol of said prescribed length, and

a sixth step of complex-dividing said receiving signal group being obtained in said fifth step by a prescribed reference complex signal group on the frequency axis.

6. A transmitter for an orthogonal frequency division multiplex signal, being an apparatus for transmitting said orthogonal frequency division multiplex signal to a receiving side in every symbol of a prescribed length through a wire or wireless transmission path, said transmitter comprising:

memory means storing a reference complex signal group;

complex multiplication means complex-multiplying a carrier modulation signal group deciding the phases and amplitudes of a plurality of carriers being orthogonal to each other on the frequency axis by said reference complex signal group being stored in said memory means on the frequency axis, for outputting a transmission carrier modulation signal group;

inverse Fourier transformation means performing an inverse Fourier operation on said transmission carrier modulation signal group being outputted from said complex multiplication means in every symbol thereby transforming said transmission carrier modulation signal group to said orthogonal frequency division multiplex signal on the time axis;

guard interval addition means adding front and rear guard intervals, including data being identical to those of rear and front end parts of each symbol of said orthogonal frequency division multiplex signal outputted from said inverse Fourier transformation means, to front and rear parts of said symbol respectively; and

transmission means transmitting said orthogonal frequency division multiplex signal having added said front and rear guard intervals to said receiving side in every symbol.

7. The transmitter for an orthogonal frequency division multiplex signal in accordance with claim 6, wherein said memory means stores a complex multiplication result of said complex multiplication means in advance of a constant symbol as said reference complex signal group.

8. The transmitter for an orthogonal frequency division multiplex signal in accordance with claim 6, wherein said memory means stores a predetermined complex signal group as said reference complex signal group,
 said complex multiplication means complex-multiplies said carrier modulation signal group by said reference complex signal group being stored in said memory means on the frequency axis for outputting the same, and
 said inverse Fourier transformation means ordinarily transforms a complex multiplication result being outputted from said complex multiplication means to said orthogonal frequency division multiplex signal in every symbol, while periodically transforming said reference complex signal group being outputted from said memory means to said orthogonal frequency division multiplex signal.
9. The transmitter for an orthogonal frequency division multiplex signal in accordance with claim 8, wherein said memory means holds an output of pseudo-noise signal generation means generating a pseudo-noise signal as said reference complex signal group.
10. The transmitter for an orthogonal frequency division multiplex signal in accordance with claim 8, wherein said memory means holds an output of frequency sweep signal generation means generating a frequency sweep signal as said reference complex signal group.
11. A receiver for an orthogonal frequency division multiplex signal, being an apparatus for receiving said orthogonal frequency division multiplex signal being transmitted from a transmission side in every symbol of a prescribed length through a wire or wireless transmission path, said receiver comprising:
 Fourier transformation means performing a Fourier transformation operation on said orthogonal frequency division multiplex signal on the time axis in every symbol, thereby transforming said orthogonal frequency division multiplex signal to a receiving carrier modulation signal group on the frequency axis;
 memory means storing said receiving carrier modulation signal group being outputted from said Fourier transformation means every constant symbol as a receiving reference complex signal group; and
 complex division means complex-dividing said receiving carrier modulation signal group being outputted from said Fourier transformation means by said receiving reference complex signal group being stored in said memory means on the frequency axis.

12. A method of transmitting an orthogonal frequency division multiplex signal from a transmission side to a receiving side in every symbol of a prescribed length through a wire or wireless transmission path, said method comprising:
 a first step of forming a carrier modulation signal group for deciding the phases and amplitudes of a plurality of carriers being orthogonal to each other in every symbol on the frequency axis;
 a second step of generating a complex signal group having a predetermined specific pattern with signals varying in phase at random;
 a third step of complex-multiplying said carrier modulation signal group by said complex signal group in every symbol on the frequency axis, thereby randomizing the phases of respective signals of said carrier modulation signal group; and
 a fourth step of ordinarily transforming said carrier modulation signal group having said signals being randomized in phase in said third step to said orthogonal frequency division multiplex signal on the time axis by performing inverse Fourier transformation in every symbol while periodically transforming said complex signal group to said orthogonal frequency division multiplex signal by inverse Fourier transformation, for transmitting the same to said receiving side respectively.

FIG. 1

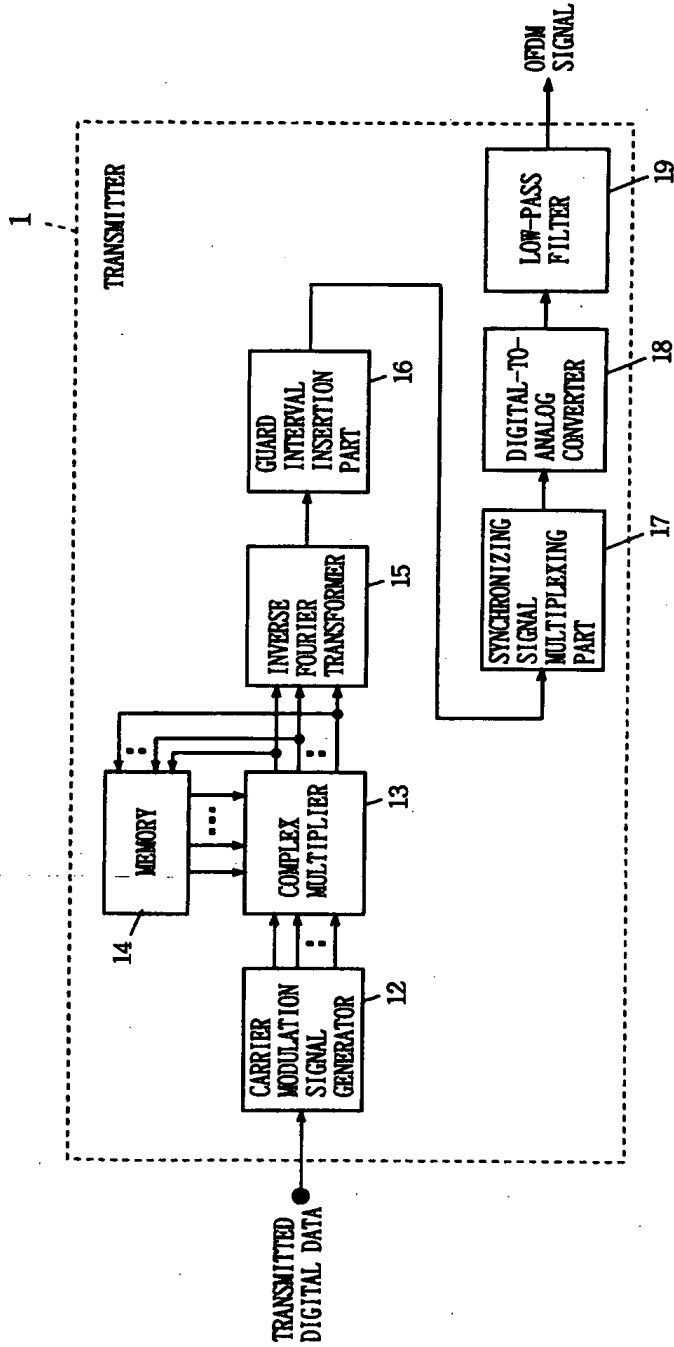

FIG. 2

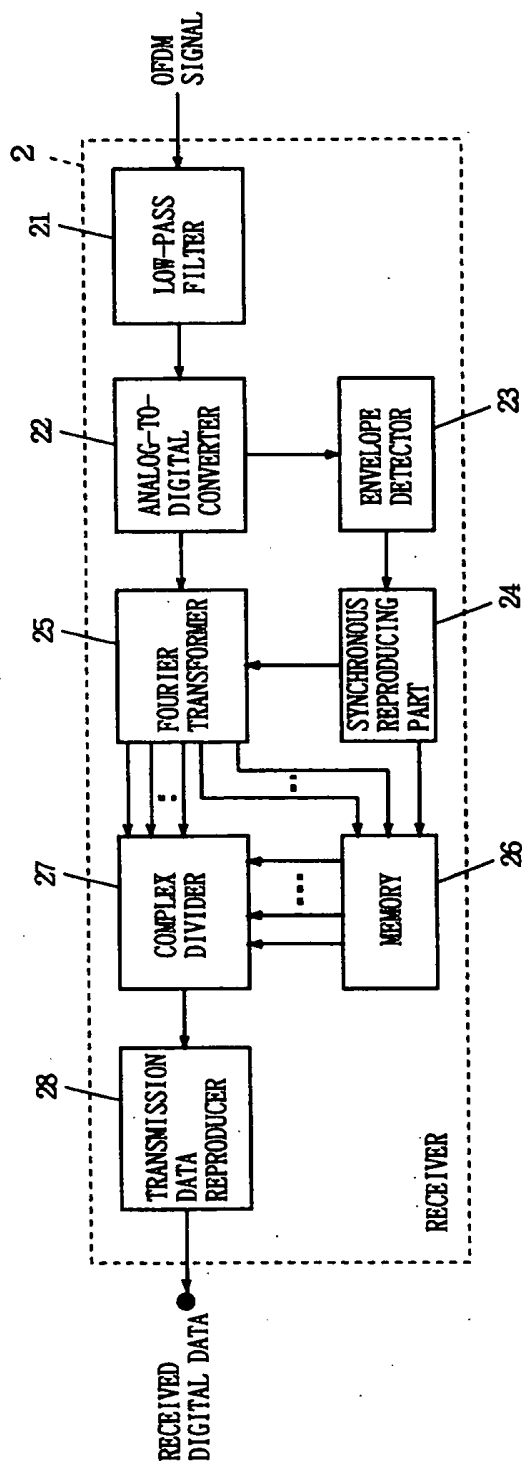

FIG. 3

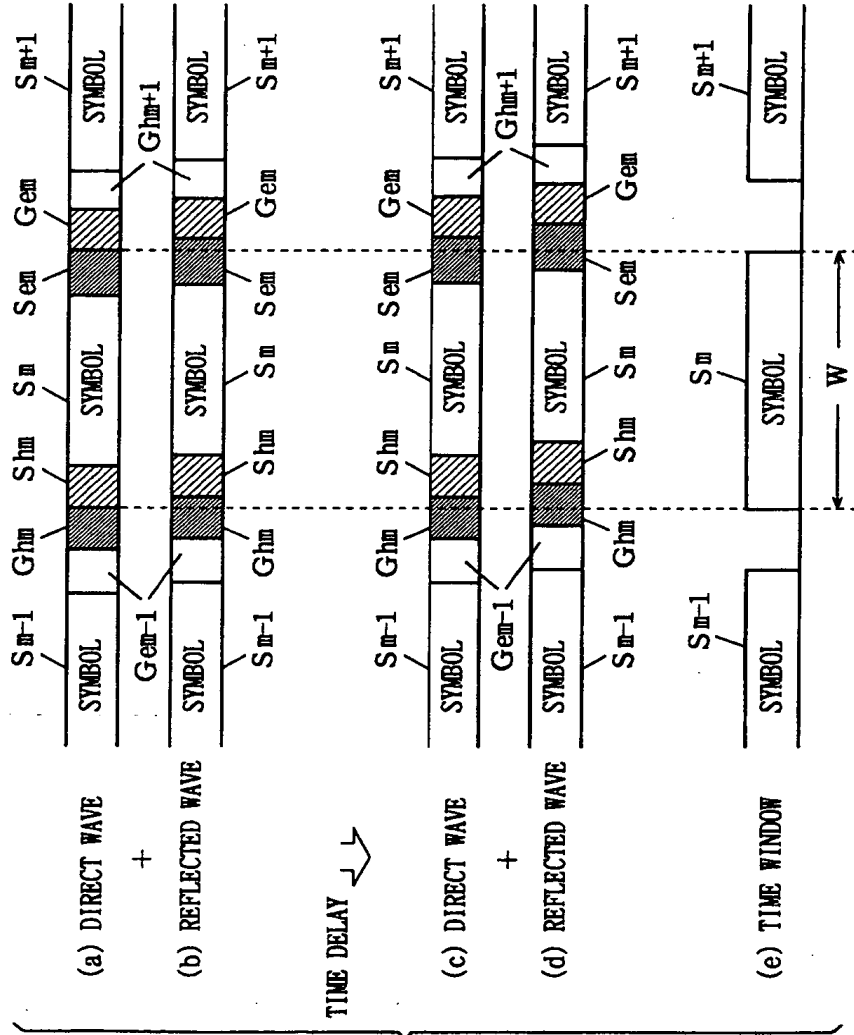

FIG. 4

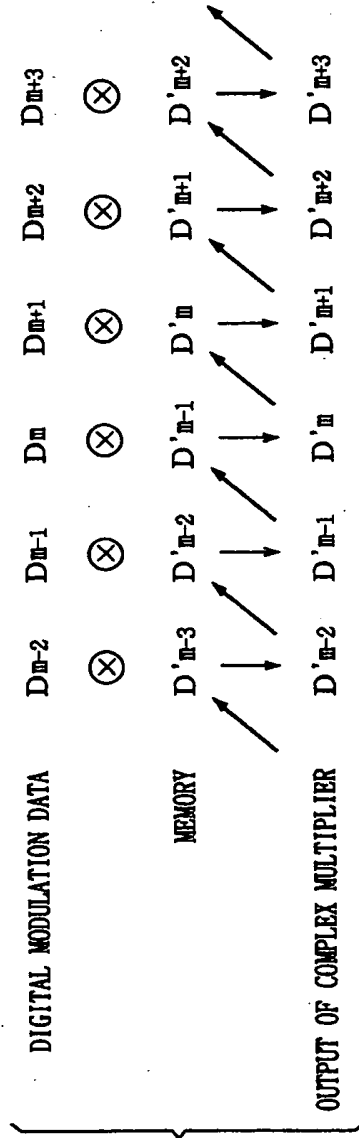

FIG. 5

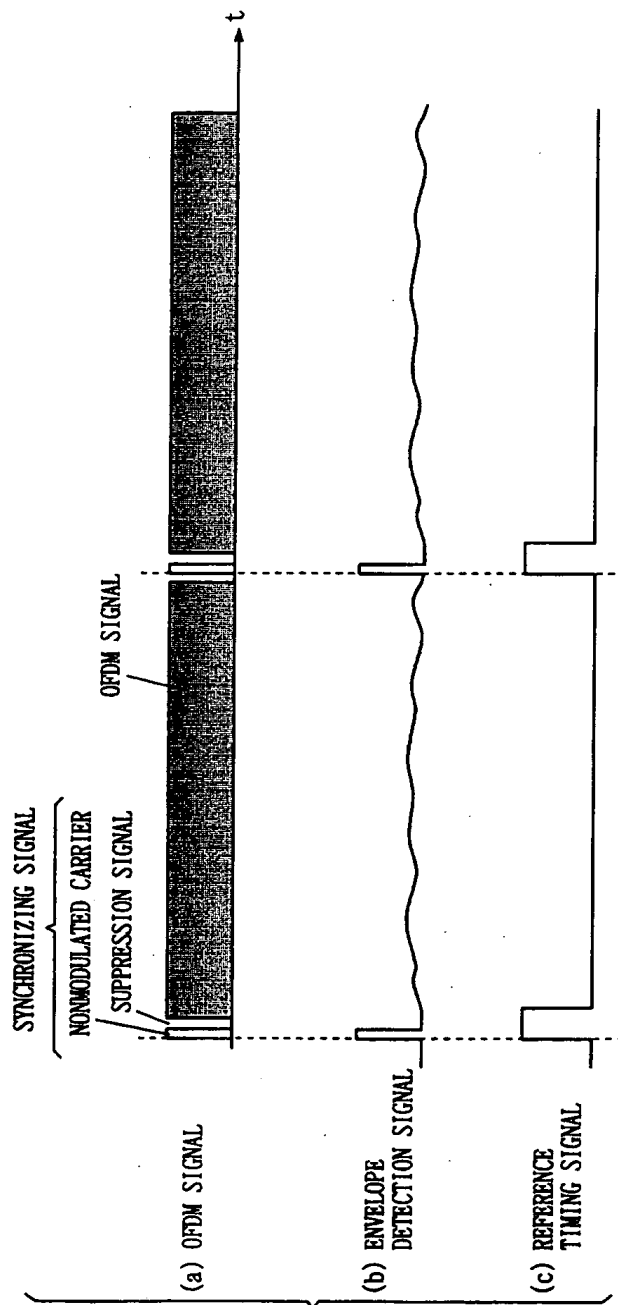

FIG. 6

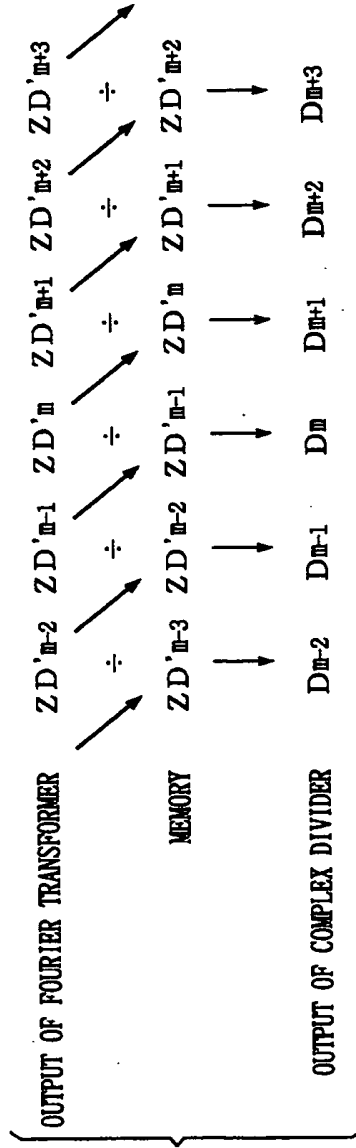

FIG. 7

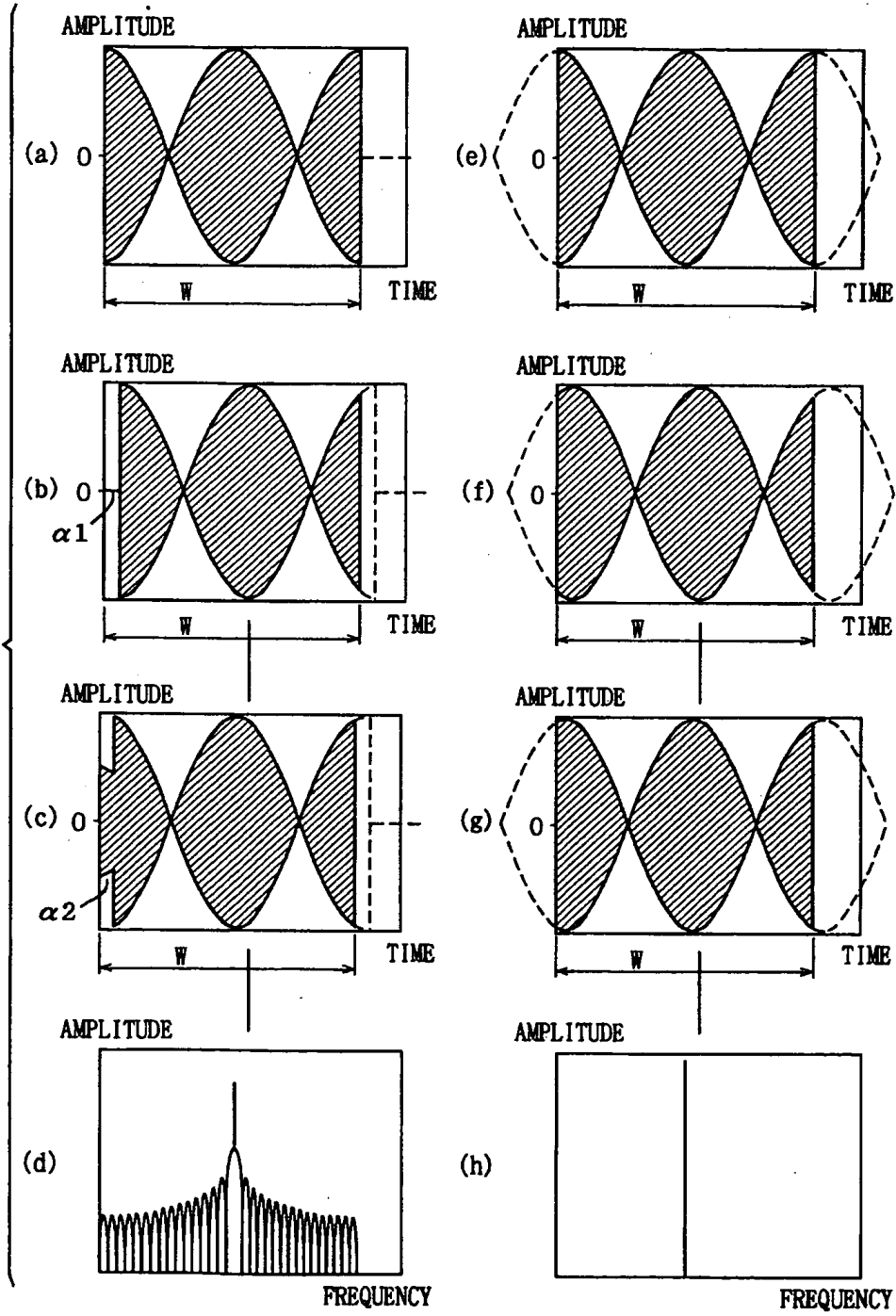

FIG. 8

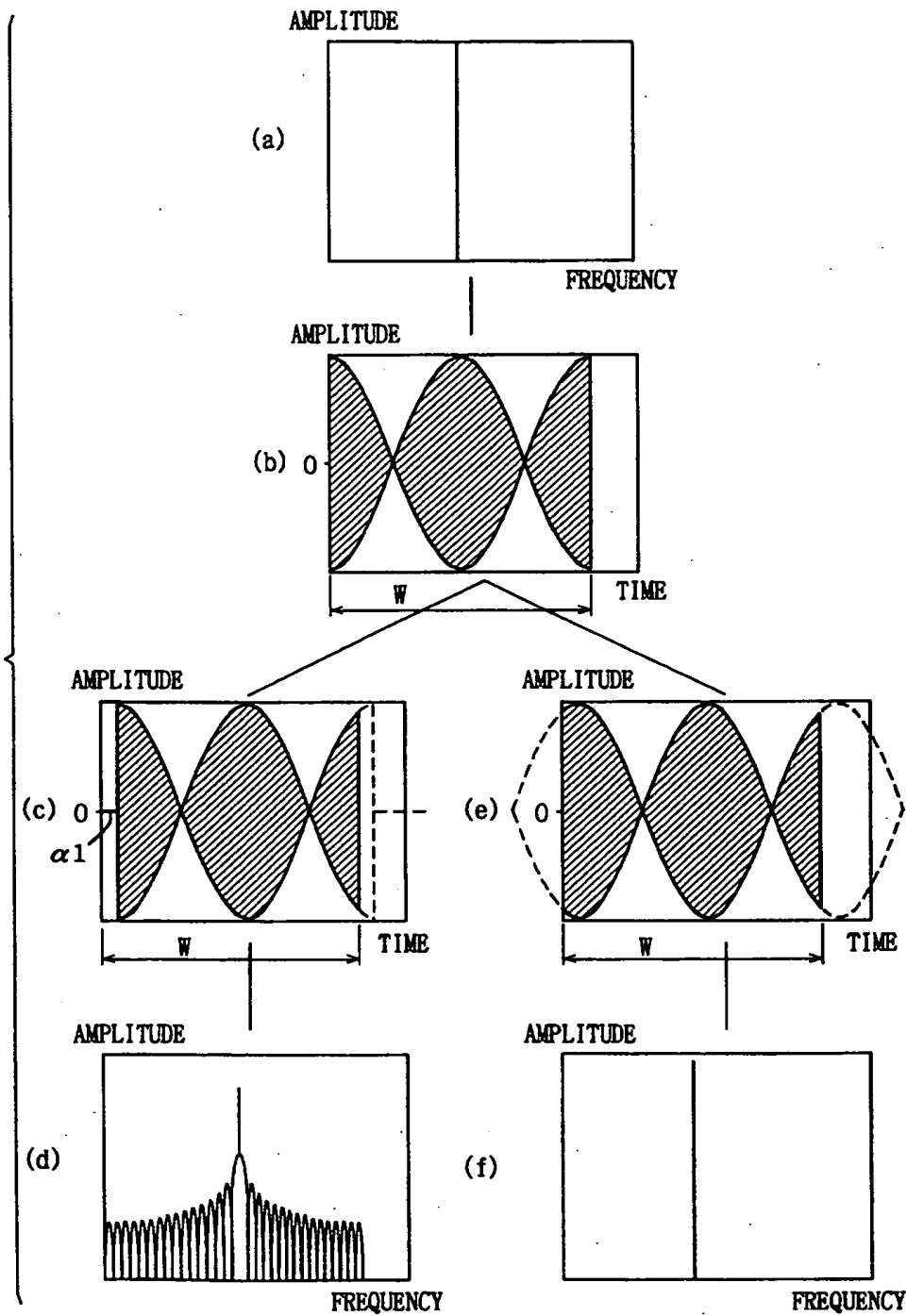

FIG. 9

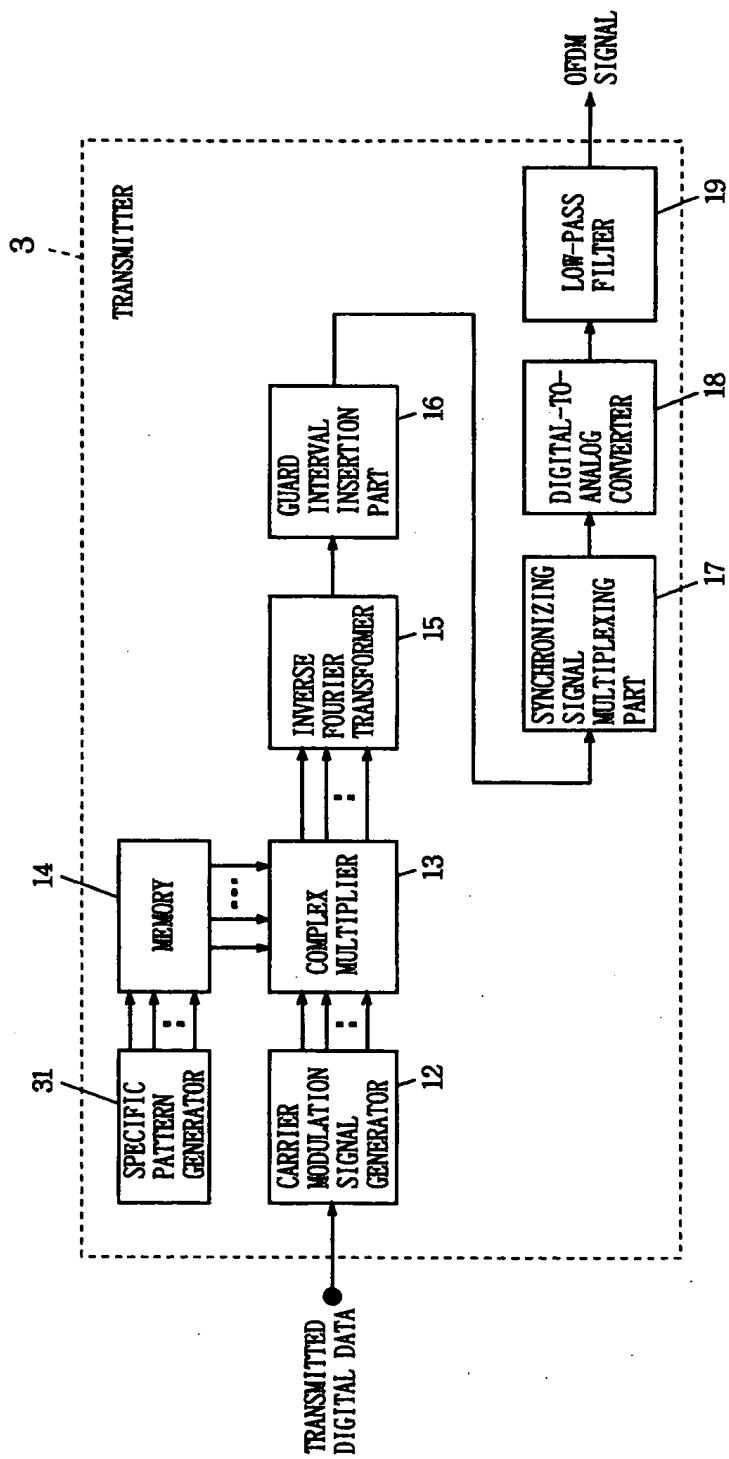

FIG. 10

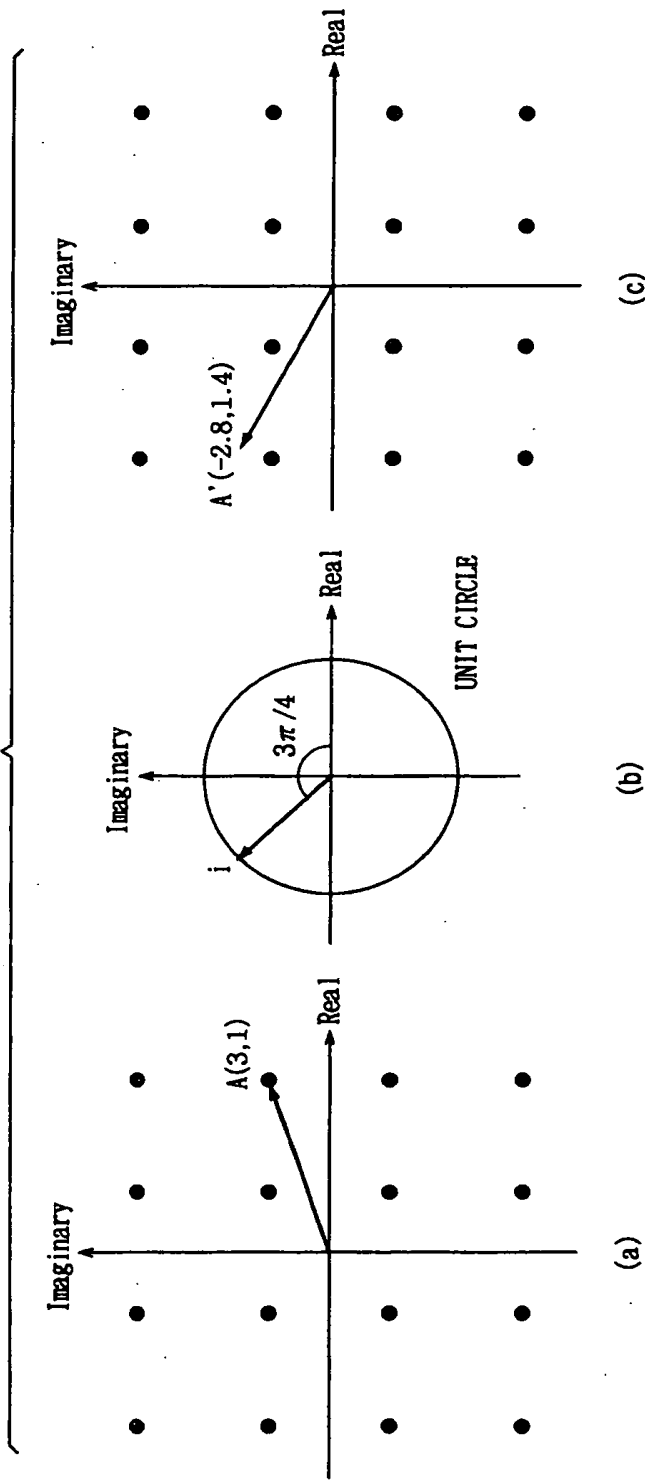

FIG. 11

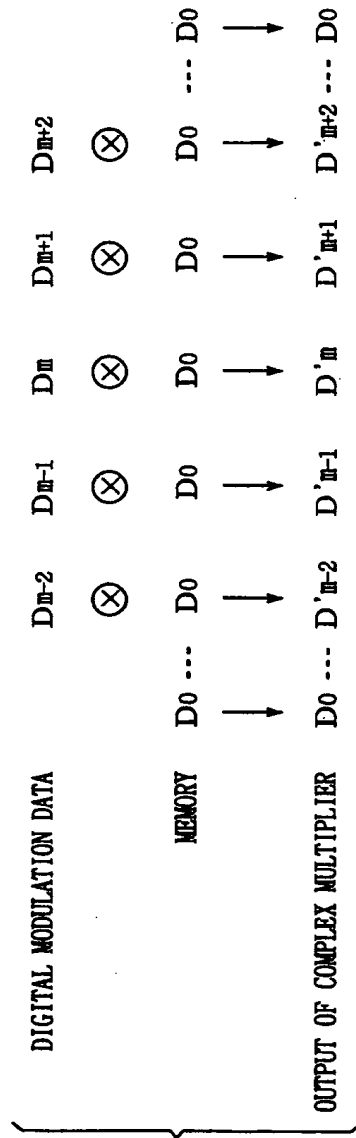

FIG. 12

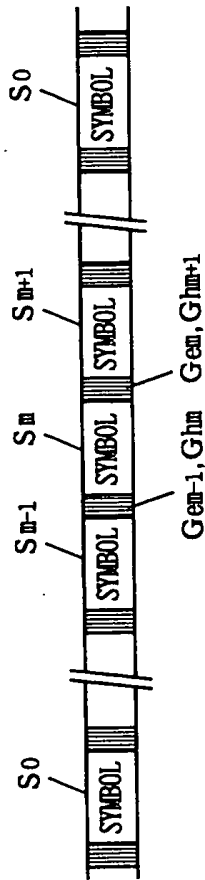

FIG. 13

5 ↘

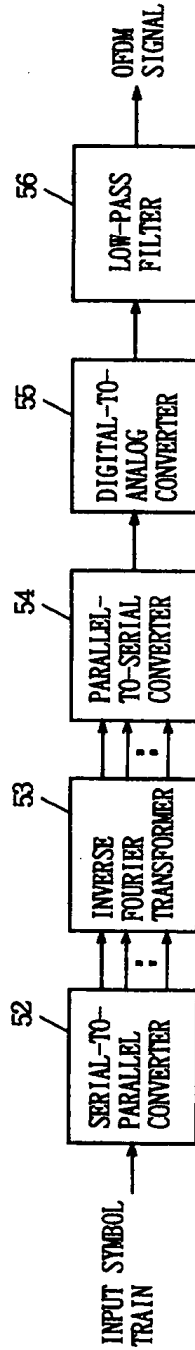
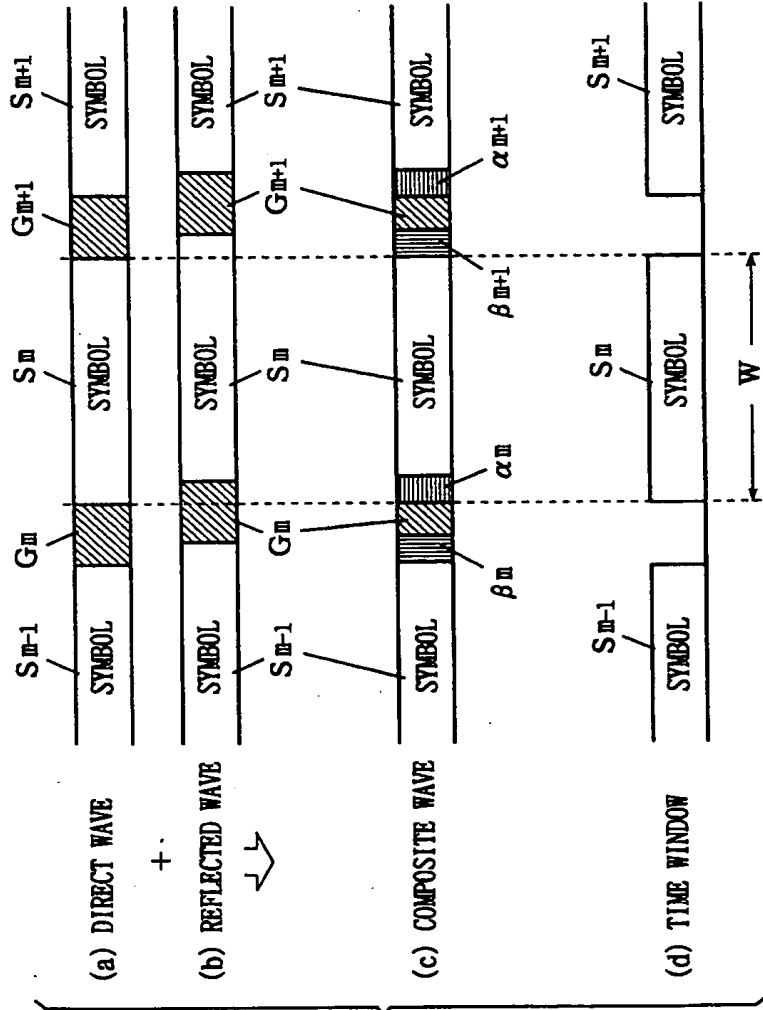

FIG. 14





European Patent Office

EUROPEAN SEARCH REPORT

Application Number
EP 95 11 9990

DOCUMENTS CONSIDERED TO BE RELEVANT			
Category	Citation of document with indication, where appropriate, of relevant passages	Relevant to claim	CLASSIFICATION OF THE APPLICATION (InCl.6)
X	EP 0 610 988 A (PHILIPS ELECTRONICS NV) 17 August 1994 (1994-08-17) * column 1, line 43 - line 46 * * column 8, line 43 - line 45 * * figure 2 *	12	H04L5/06 H04L27/26
A	---	1-11	
X	FAZEL K: "PERFORMANCE OF CONVOLUTIONALLY CODED CDMA/OFDM IN A FREQUENCY-TIME SELECTIVE FADING CHANNEL AND ITS NEAR-FAR RESISTANCE" SERVING HUMANITY THROUGH COMMUNICATIONS. SUPERCOM/ICC, NEW ORLEANS, MAY 1 - 5, 1994, vol. 3, 1 May 1994 (1994-05-01), pages 1438-1442, XP000438734 INSTITUTE OF ELECTRICAL AND ELECTRONICS ENGINEERS * page 1439, column 1, paragraph 2; figure 1 *	12	
A	---	1-11	TECHNICAL FIELDS SEARCHED (InCl.6)
A	MOOSE P H: "DIFFERENTIAL MODULATION AND DEMODULATION OF MULTI-FREQUENCY DIGITAL COMMUNICATIONS SIGNALS" PROCEEDINGS OF THE MILITARY COMMUNICATIONS CONFERENCE. (MILCOM), MONTEREY, SEPT. 30 - OCT. 3, 1990, vol. 1, 30 September 1990 (1990-09-30), pages 273-277, XP000221795 INSTITUTE OF ELECTRICAL AND ELECTRONICS ENGINEERS * page 273, column 2, paragraph 2 * * figure 1 *	1-12	H04L
The present search report has been drawn up for all claims			
Place of search THE HAGUE		Date of completion of the search 8 October 1999	Examiner Orozco Roura, C
CATEGORY OF CITED DOCUMENTS X : particularly relevant if taken alone Y : particularly relevant if combined with another document of the same category A : technological background O : non-written disclosure P : intermediate document		T : theory or principle underlying the invention E : earlier patent document, but published on, or after the filing date D : document cited in the application L : document cited for other reasons & : member of the same patent family, corresponding document	

EPO FORM 1503 03.92 (P/4001)



European Patent Office

EUROPEAN SEARCH REPORT

Application Number
EP 95 11 9990

DOCUMENTS CONSIDERED TO BE RELEVANT			
Category	Citation of document with indication, where appropriate, of relevant passages	Relevant to claim	CLASSIFICATION OF THE APPLICATION (IntCl.6)
X	EP 0 610 988 A (PHILIPS ELECTRONICS NV) 17 August 1994 (1994-08-17) * column 1, line 43 - line 46 * * column 8, line 43 - line 45 * * figure 2 *	12	H04L5/06 H04L27/26
A	---	1-11	
X	FAZEL K: "PERFORMANCE OF CONVOLUTIONALLY CODED CDMA/OFDM IN A FREQUENCY-TIME SELECTIVE FADING CHANNEL AND ITS NEAR-FAR RESISTANCE" SERVING HUMANITY THROUGH COMMUNICATIONS. SUPERCOM/ICC, NEW ORLEANS, MAY 1 - 5, 1994, vol. 3, 1 May 1994 (1994-05-01), pages 1438-1442, XP000438734 INSTITUTE OF ELECTRICAL AND ELECTRONICS ENGINEERS * page 1439, column 1, paragraph 2; figure 1 *	12	
A	---	1-11	TECHNICAL FIELDS SEARCHED (IntCl.6)
A	MOOSE P H: "DIFFERENTIAL MODULATION AND DEMODULATION OF MULTI-FREQUENCY DIGITAL COMMUNICATIONS SIGNALS" PROCEEDINGS OF THE MILITARY COMMUNICATIONS CONFERENCE. (MILCOM), MONTEREY, SEPT. 30 - OCT. 3, 1990, vol. 1, 30 September 1990 (1990-09-30), pages 273-277, XP000221795 INSTITUTE OF ELECTRICAL AND ELECTRONICS ENGINEERS * page 273, column 2, paragraph 2 * * figure 1 *	1-12	H04L
	---	-/--	
The present search report has been drawn up for all claims			
Place of search THE HAGUE		Date of completion of the search 8 October 1999	Examiner Orozco Roura, C
CATEGORY OF CITED DOCUMENTS X : particularly relevant if taken alone Y : particularly relevant if combined with another document of the same category A : technological background O : non-written disclosure P : intermediate document		T : theory or principle underlying the invention E : earlier patent document, but published on, or after the filing date D : document cited in the application L : document cited for other reasons & : member of the same patent family, corresponding document	

EPO FORM 1503 03.82 (P04C01)

ANNEX TO THE EUROPEAN SEARCH REPORT
ON EUROPEAN PATENT APPLICATION NO.

EP 95 11 9990

This annex lists the patent family members relating to the patent documents cited in the above-mentioned European search report. The members are as contained in the European Patent Office EDP file on
The European Patent Office is in no way liable for these particulars which are merely given for the purpose of information.

08-10-1999

Patent document cited in search report	Publication date	Patent family member(s)	Publication date
EP 0610988 A	17-08-1994	FR 2701178 A	05-08-1994
		JP 6318926 A	15-11-1994
		SG 43984 A	14-11-1997
		US 5504775 A	02-04-1996
WO 9519671 A	20-07-1995	SE 501608 C	27-03-1995
		EP 0740868 A	06-11-1996
		SE 9400116 A	27-03-1995
		US 5726973 A	10-03-1998
EP 0701345 A	13-03-1996	JP 8130563 A	21-05-1996
		CN 1130827 A	11-09-1996
GB 2291314 A	17-01-1996	WO 9601535 A	18-01-1996

EPO FORM P0459

For more details about this annex : see Official Journal of the European Patent Office, No. 12/82



European Patent
Office

EUROPEAN SEARCH REPORT

Application Number
EP 95 11 9990

DOCUMENTS CONSIDERED TO BE RELEVANT		
Category	Citation of document with indication, where appropriate, of relevant passages	Relevant to claim
P, X	WO 95 19671 A (ISAKSSON MIKAEL ; TELIA AB (SE)) 20 July 1995 (1995-07-20) * page 13, line 5 * * figure 9 * * figure 10 *	11
E	EP 0 701 345 A (SONY CORP) 13 March 1996 (1996-03-13) * page 8, line 49 - line 52; figure 9 *	1
E	GB 2 291 314 A (BRITISH BROADCASTING CORP) 17 January 1996 (1996-01-17) * page 12, last paragraph - page 13, paragraph 2 *	11
The present search report has been drawn up for all claims		
Place of search	Date of completion of the search	Examiner
THE HAGUE	8 October 1999	Orozco Roura, C
<p>CATEGORY OF CITED DOCUMENTS</p> <p>X : particularly relevant if taken alone Y : particularly relevant if combined with another document of the same category A : technological background O : non-written disclosure P : intermediate document</p> <p>T : theory or principle underlying the invention E : earlier patent document, but published on, or after the filing date D : document cited in the application L : document cited for other reasons & : member of the same patent family, corresponding document</p>		

EPO FORM 1503 03 92 (P/AC/91)



INTERNATIONAL APPLICATION PUBLISHED UNDER THE PATENT COOPERATION TREATY (PCT)

<p>(51) International Patent Classification ⁶ : H04L 27/26</p>	<p>A2</p>	<p>(11) International Publication Number: WO 99/29078 (43) International Publication Date: 10 June 1999 (10.06.99)</p>
<p>(21) International Application Number: PCT/SE98/02193 (22) International Filing Date: 1 December 1998 (01.12.98) (30) Priority Data: 9704497-8 3 December 1997 (03.12.97) SE (71) Applicant (for all designated States except US): TELIA AB (publ) [SE/SE]; Mårbackagatan 11, S-123 86 Farsta (SE). (72) Inventors; and (75) Inventors/Applicants (for US only): NORDSTRÖM, Tomas [SE/SE]; Praktikantvägen 8, S-977 53 Luleå (SE). BAHLENBERG, Gunnar [SE/SE]; Blidvägen 234, S-976 32 Luleå (SE). BENGTSSON, Daniel [SE/SE]; Forskarvägen 36 A, S-977 53 Luleå (SE). HÅKANSSON, Siwert [SE/SE]; Aprilvägen 10, S-177 61 Järfälla (SE). ISAKSSON, Anders [SE/SE]; Elevvägen 1, S-977 25 Luleå (SE). ISAKSSON, Mikael [SE/SE]; Borgmästarevägen 7, S-973 42 Luleå (SE). JOHANSSON, Magnus [SE/SE]; Timmermansgatan 34, S-972 41 Luleå (SE). LJUNGGREN, Lis-Marie [SE/SE]; Praktikantvägen 31, S-977 53 Luleå (SE). LUNDBERG, Hans [SE/SE]; Västra Solgatan 8, S-972 53 Luleå (SE). OLOFSSON, Sven-Rune [SE/SE]; Malmuddsvägen 9, S-972 45 Luleå (SE). OLSSON, Lennart [SE/SE]; Majvägen 39, S-973 31 Luleå (SE).</p>	<p>STEFANSSON, Tomas [SE/SE]; Lulavan 773, S-961 93 Boden (SE). ÖHMAN, Hans [SE/SE]; Fältspatstigen 21, S-977 53 Luleå (SE). ÖKVIST, Göran [SE/SE]; Hagaplan 7, S-974 41 Luleå (SE). (74) Agent: PRAGSTEN, Rolf; Telia Research AB, Vitsandsgatan 9, S-123 86 Farsta (SE). (81) Designated States: EE, JP, LT, LV, NO, US, European patent (AT, BE, CH, CY, DE, DK, ES, FI, FR, GB, GR, IE, IT, LU, MC, NL, PT, SE). Published <i>Without international search report and to be republished upon receipt of that report.</i></p>	

(54) Title: IMPROVEMENTS IN, OR RELATING TO, DATA SCRAMBLERS

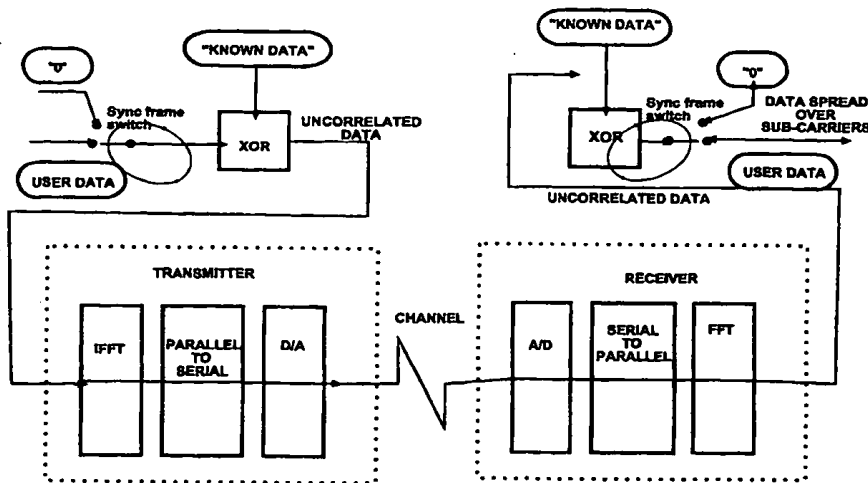

(57) Abstract

The present invention simplifies known data scramblers by making use of the synchronisation frames, normally used for measuring channel characteristics, as a source of pseudo-random data which can be combined with incoming user data. The present invention has particular application to multi-carrier transmission systems which employ DMT, or OFDM. Many of these transmission systems send known data, usually referred to as synchronisation frames, to measure channel characteristics such as signal to noise ratio. The known data contained in a synchronisation frame is selected to have a suitable statistical distribution, e.g. pseudo-random. In the data scrambler of the present invention, user data bits are combined with the known synchronisation frame data using an exclusive-OR function. This results in a statistically and computationally efficient scrambling of the user data.

FOR THE PURPOSES OF INFORMATION ONLY

Codes used to identify States party to the PCT on the front pages of pamphlets publishing international applications under the PCT.

AL	Albania	ES	Spain	LS	Lesotho	SI	Slovenia
AM	Armenia	FI	Finland	LT	Lithuania	SK	Slovakia
AT	Austria	FR	France	LU	Luxembourg	SN	Senegal
AU	Australia	GA	Gabon	LV	Latvia	SZ	Swaziland
AZ	Azerbaijan	GB	United Kingdom	MC	Monaco	TD	Chad
BA	Bosnia and Herzegovina	GE	Georgia	MD	Republic of Moldova	TG	Togo
BB	Barbados	GH	Ghana	MG	Madagascar	TJ	Tajikistan
BE	Belgium	GN	Guinea	MK	The former Yugoslav Republic of Macedonia	TM	Turkmenistan
BF	Burkina Faso	GR	Greece	ML	Mali	TR	Turkey
BG	Bulgaria	HU	Hungary	MN	Mongolia	TT	Trinidad and Tobago
BJ	Benin	IE	Ireland	MR	Mauritania	UA	Ukraine
BR	Brazil	IL	Israel	MW	Malawi	UG	Uganda
BY	Belarus	IS	Iceland	MX	Mexico	US	United States of America
CA	Canada	IT	Italy	NE	Niger	UZ	Uzbekistan
CF	Central African Republic	JP	Japan	NL	Netherlands	VN	Viet Nam
CG	Congo	KE	Kenya	NO	Norway	YU	Yugoslavia
CH	Switzerland	KG	Kyrgyzstan	NZ	New Zealand	ZW	Zimbabwe
CI	Côte d'Ivoire	KP	Democratic People's Republic of Korea	PL	Poland		
CM	Cameroon	KR	Republic of Korea	PT	Portugal		
CN	China	KZ	Kazakistan	RO	Romania		
CU	Cuba	LC	Saint Lucia	RU	Russian Federation		
CZ	Czech Republic	LI	Liechtenstein	SD	Sudan		
DE	Germany	LK	Sri Lanka	SE	Sweden		
DK	Denmark	LR	Liberia	SG	Singapore		
EE	Estonia						

- 1 -

Improvements in, or Relating to, Data Scramblers

5 The present invention relates to data scramblers and descramblers, suitable for use with a multi-carrier transmission system, multi-carrier transmission systems incorporating data scramblers and de-scramblers, and methods for scrambling and descrambling data in multi-carrier transmission systems.

10 Most telecommunications transmission systems are designed to give optimum performance when uncorrelated data is transmitted over them. Unfortunately, user data is not usually uncorrelated and may, for example, include relatively long strings of binary "0"s, or "1"s. If such data is transmitted over a transmission system intended for uncorrelated data, it can result in saturation, i.e. too large a dynamic range, synchronisation drift, etc.. This problem has long been recognised by telecommunications engineers and the conventional solution is to scramble the incoming user data so that it behaves as though it was uncorrelated data.

15 Known data scramblers employ an algorithm to combine user data with a random data string, thereby producing an uncorrelated data stream for transmission.

20 The present invention simplifies known data scramblers by making use of the synchronisation frames, normally used for measuring channel characteristics, as a source of pseudo-random data which can be combined with incoming user data.

25 The present invention has particular application to multi-carrier transmission systems, including copper based transmission systems such as ADSL, VDSL and HDSL which employ DMT, and/or radio based transmission systems employing OFDM. Many of these transmission systems send known data, usually referred to as synchronisation frames, to measure channel characteristics such as signal to noise ratio. The known data contained in a synchronisation frame is selected to have a suitable statistical distribution, e.g. pseudo-random. In a typical DMT

- 2 -

system, used at the present time, the known synchronisation frame data comprises two bits per sub-carrier. In other words, a predetermined 4-QAM signal is transmitted on each sub-carrier.

5 In the present invention, user data bits are combined with the known synchronisation frame data bits, typically the two most significant bits, using an exclusive-OR function. This results in a statistically and computationally efficient scrambling of the user data.

10 According to a first aspect of the present invention, there is provided a data scrambler, for use in a multi-carrier transmission system in which synchronisation frame data is periodically transmitted from a transmitter to a receiver to measure transmission channel characteristics, characterised in that combiner means are provided to combine user data with frame synchronisation data.

Said combiner means may have a XOR function.

15 Said frame synchronisation data is pseudo random.

Said combiner means may be adapted to combine said user data with the two most significant bits of a synchronisation frame.

20 According to a second aspect of the present invention, there is provide a data descrambler, for use in a multi-carrier transmission system in which synchronisation frame data is periodically transmitted from a transmitter to a receiver to measure transmission channel characteristics, and transmitted data is scrambled using a data scrambler as claimed in any of claims 1 to 4, characterised in that combiner means are provided to combine received data with frame synchronisation data.

25 Said combiner means may have a XOR function.

Said frame synchronisation data may be pseudo random.

- 3 -

Said combiner means may be adapted to combine said received data with the two most significant bits of a synchronisation frame.

5 According to a third aspect of the present invention, there is provided a multi-carrier transmission system in which synchronisation frame data is periodically transmitted from a transmitter to a receiver to measure transmission channel characteristics, characterised in that said transmission system incorporates a data scrambler as set forth in any preceding paragraph, connected to said transmitter.

0 Said receiver may be connected to a data descrambler as set forth in any preceding paragraph.

Said multi-carrier transmission system may employ DMT.

Said multi-carrier transmission system may employ OFDM.

Means may be provided for transmitting frame synchronisation data from said data scrambler to said data descrambler.

15 According to a fourth aspect of the present invention, there is provided, in a multi-carrier transmission system in which synchronisation frame data is periodically transmitted from a transmitter to a receiver to measure transmission channel characteristics, a method of scrambling user data prior to transmission, characterised by combining user data with frame synchronisation data.

20 User data may be combined with frame synchronisation data by means of an XOR function.

Said frame synchronisation data may be pseudo random.

Said user data may be combined with the two most significant bits of a synchronisation frame.

- 4 -

5 According to a fifth aspect of the present invention, there is provided, in a multi-carrier transmission system in which synchronisation frame data is periodically transmitted from a transmitter to a receiver to measure transmission channel characteristics, a method of descrambling received data which has been scrambled by a scrambling method as set forth in preceding, characterised by combining received data with frame synchronisation data.

Received data may be combined with frame synchronisation data using an XOR function.

Said frame synchronisation data may be pseudo random.

10 Said received data may be combined with the two most significant bits of a synchronisation frame.

Said multi-carrier transmission system may employ DMT.

Said multi-carrier transmission system may employ OFDM.

15 Embodiments of the invention will now be described, by way of example, with reference to the accompanying drawing, in which:

Figure 1 illustrates data scramblers and descramblers, according to the present invention, in a multi-carrier transmission system

In order to facilitate an understanding of the present invention a glossary of terms used in the description of the present invention is provided below:

20 A/D: Analogue to Digital
ADSL: Asynchronous Digital Subscriber Line
D/A: Digital to Analogue

- 5 -

	DMT:	Digital Multi Tone
	FFT:	Fast Fourier Transform
	HDSL:	High bit rate Digital Subscriber Line
	IFFT:	Inverse Fast Fourier Transform
5	OFDM:	Orthogonal Frequency Division Multiplex
	QAM:	Quadrature Amplitude Modulation
	VDSL:	Very high bit rate Digital Subscriber Line
	XOR:	Exclusive OR

10 Figure 1 shows a transmitter and receiver, in a multi-carrier transmission system, linked by a communications channel. The communications channel may be a copper pair (VDSL etc.), or a radio channel (OFDM). Incoming user data, intended for transmission over the communications channel, is passed via a sync frame switch, to a XOR gate. The sync frame switch permits one of the inputs to the XOR gate to be switched between user data and a string of "0"s. The second
15 input to the XOR gate receives the known synchronisation frame data. When the string of "0"s is passed to the XOR gate, the output from the XOR gate is the synchronisation data, i.e. the "known data" appears at the output of the XOR gate.

20 The incoming user data will almost certainly be far from random, i.e. it will be highly correlated. The incoming user data is combined with the "known data" in the XOR gate. The "known data" is pseudo random, i.e. uncorrelated. The output from the XOR gate will, therefore, also be uncorrelated, i.e. will itself be pseudo-random. This data has the necessary properties to permit good transmission over the transmission channel.

The scrambled data is then passed to the receiver where it is first

- 6 -

5 processed by an Inverse Fast Fourier Transform unit, IFFT, converted from parallel form to serial form, passed to a digital to analogue convertor, D/A, prior to QAM modulation and transmission over the channel. Details of the multiplexing techniques and modulation techniques used in multi-carrier transmission systems will be familiar to those skilled in the art and are not described in detail in this patent specification.

10 The signal received from the transmission channel is demodulated and demultiplexed in the receiver by, inter alia, an A/D convertor, a serial to parallel convertor, and a fast Fourier transform unit FFT. The received data is, of course, scrambled. The received scrambled data is passed to the XOR gate, where it is combined with the "known data", i.e. the same data that was mixed into the signal in the transmitter. The output from the XOR gate will contain the user data, or a string of "0"s depending on the setting of the sync frame switch in the transmitter. The sync frame switch in the receiver is used for synchronisation purposes, i.e. 15 when the receiver is properly synchronised with the transmitter, and a sync frame is transmitted, rather than user data, the output from the XOR gate will be a string of "0"s. Details of transmitter and receiver synchronisation in multi-carrier systems will be well known to those skilled in the art.

20 It should, however, be noted that synchronisation frame data is stored in both the transmitter and receiver, so the receiver always has prior knowledge of the "known data" used by the transmitter.

25 In summary, the present invention scrambles user data by mixing that data with known data normally used in a synchronisation frame, typically the two most significant bits of the synchronisation frame data, using an exclusive-OR function. This results in both statistically and computationally efficient scrambling. Descrambling is achieved by the reverse process, i.e. combining the received scrambled data with the same known data used for scrambling in an exclusive-OR function.

30 The present invention results in a much improved statistical distribution of modulated sub-carriers, in a multi-carrier transmission system, compared to the

case where no scrambling is used for correlated, or null data situations.

As synchronisation data must be present in a multi-carrier receiver and transmitter for use in the synchronisation process, the scrambling technique of the present invention does not increase system complexity.

5 Transmission of the known data is very simple because it only needs to be combined with a string of "0"s.

10 The scrambler of the present invention can be used in all transmission systems that measure channel characteristics by sending known data from transmitter to receiver and use OFDM, DMT, or related multiplexing techniques to spread out the transmitted data over a number of sub-carriers, i.e. multi-carrier transmission techniques.

CLAIMS

- 5 1. A data scrambler, for use in a multi-carrier transmission system in which synchronisation frame data is periodically transmitted from a transmitter to a receiver to measure transmission channel characteristics, characterised in that combiner means are provided to combine user data with frame synchronisation data.
2. A data scrambler, as claimed in claim 1, characterised in that said combiner means has a XOR function.
- 10 3. A data scrambler, as claimed in either claim 1, or claim 2, characterised in that said frame synchronisation data is pseudo random.
4. A data scrambler, as claimed in any previous claim, characterised in that said combiner means is adapted to combine said user data with the two most significant bits of a synchronisation frame.
- 15 5. A data descrambler, for use in a multi-carrier transmission system in which synchronisation frame data is periodically transmitted from a transmitter to a receiver to measure transmission channel characteristics, and transmitted data is scrambled using a data scrambler as claimed in any of claims 1 to 4, characterised in that combiner means are provided to combine received data with frame synchronisation data.
- 20 6. A data descrambler, as claimed in claim 5, characterised in that said combiner means has a XOR function.
7. A data descrambler, as claimed in either claim 5, or claim 6, characterised in that said frame synchronisation data is pseudo random.
- 25 8. A data descrambler, as claimed in any of claims 5 to 7, characterised in that said combiner means is adapted to combine said received data with the two

most significant bits of a synchronisation frame.

- 5 9. A multi-carrier transmission system in which synchronisation frame data is periodically transmitted from a transmitter to a receiver to measure transmission channel characteristics, characterised in that said transmission system incorporates a data scrambler as claimed in any of claims 1 to 4, connected to said transmitter.
- 10 10. A multi-carrier transmission system, as claimed in claim 9, characterised in that said receiver is connected to a data descrambler as claimed in any of claims 5 to 8.
- 10 11. A multi-carrier transmission system, as claimed in claim 10, characterised in that said multi-carrier transmission system employs DMT.
12. A multi-carrier transmission system, as claimed in claim 10, characterised in that said multi-carrier transmission system employs OFDM.
- 15 13. A multi-carrier transmission system, as claimed in any of claims 10 to 12, characterised in that means are provided for transmitting frame synchronisation data from said data scrambler to said data descrambler.
- 20 14. In a multi-carrier transmission system in which synchronisation frame data is periodically transmitted from a transmitter to a receiver to measure transmission channel characteristics, a method of scrambling user data prior to transmission, characterised by combining user data with frame synchronisation data.
15. A method, as claimed in claim 14, characterised by combining user data with frame synchronisation data by mean of an XOR function.
16. A method, as claimed in either claim 14, or claim 15, characterised by said frame synchronisation data being pseudo random.
- 25 17. A method, as claimed in any of claims 14 to 16, characterised by combining

- 10 -

said user data with the two most significant bits of a synchronisation frame.

5 18. In a multi-carrier transmission system in which synchronisation frame data is periodically transmitted from a transmitter to a receiver to measure transmission channel characteristics, a method of descrambling received data which has been scrambled by the method claimed in any of claims 14 to 17, characterised by combining received data with frame synchronisation data.

19. A method, as claimed in claim 18, characterised by combining received data with frame synchronisation data using an XOR function.

10 20. A method, as claimed in either claim 18, or claim 19, characterised by said frame synchronisation data being pseudo random.

21. A method, as claimed in any of claims 18 to 20, characterised by combining said received data with the two most significant bits of a synchronisation frame.

22. A method, as claimed in any of claims 14 to 21, characterised by said multi-carrier transmission system employing DMT.

15 23. A method, as claimed in any of claims 14 to 21, characterised by said multi-carrier transmission system employing OFDM.

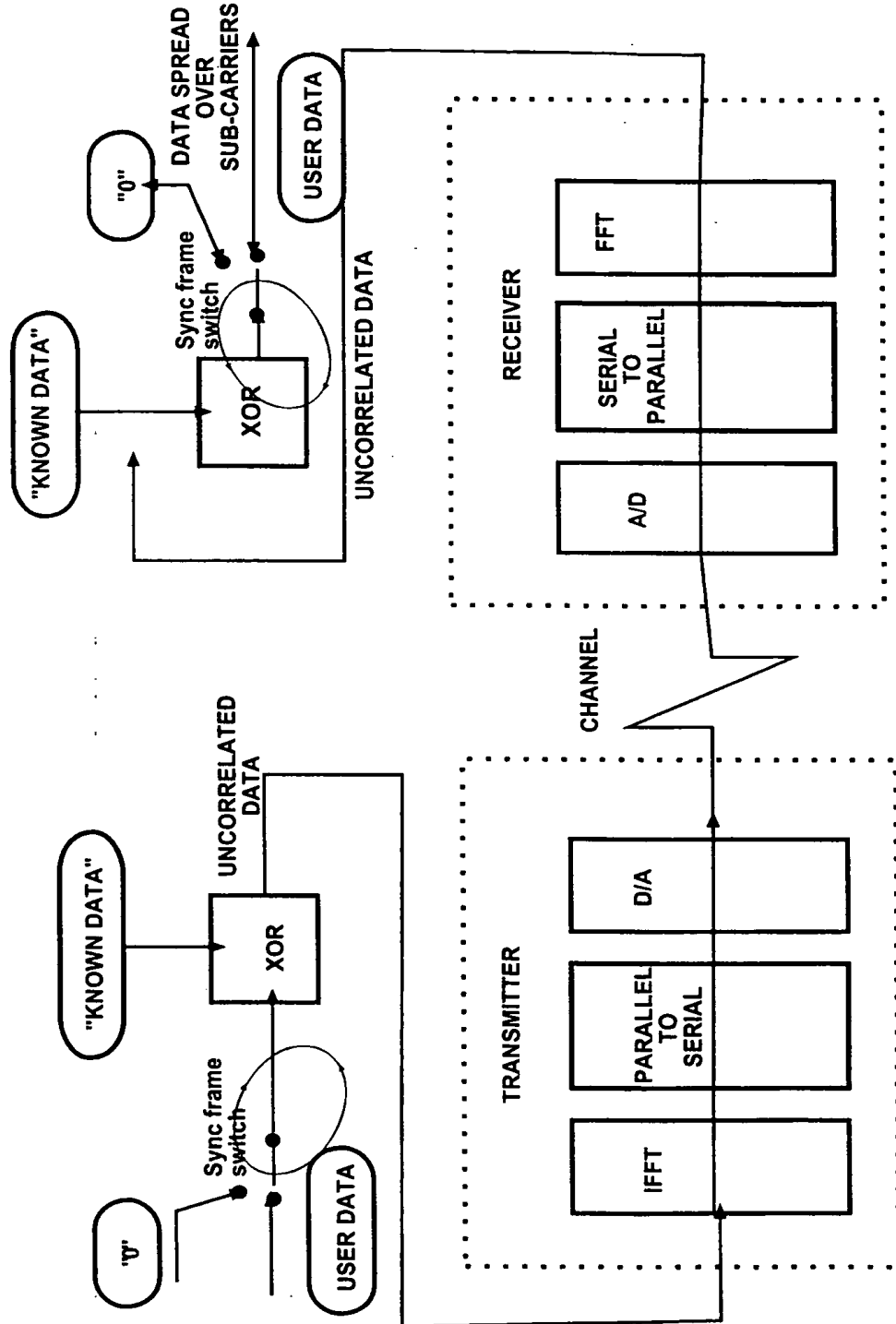

FIGURE 1



INTERNATIONAL APPLICATION PUBLISHED UNDER THE PATENT COOPERATION TREATY (PCT)

<p>(51) International Patent Classification ⁶ : H04L 27/26, 7/08 // H04J 3/12, H04L 5/06</p>	<p>A3</p>	<p>(11) International Publication Number: WO 99/29078 (43) International Publication Date: 10 June 1999 (10.06.99)</p>
<p>(21) International Application Number: PCT/SE98/02193 (22) International Filing Date: 1 December 1998 (01.12.98) (30) Priority Data: 9704497-8 3 December 1997 (03.12.97) SE (71) Applicant (for all designated States except US): TELIA AB (publ) [SE/SE]; Märbackagatan 11, S-123 86 Farsta (SE). (72) Inventors; and (75) Inventors/Applicants (for US only): NORDSTRÖM, Tomas [SE/SE]; Praktikantvägen 8, S-977 53 Luleå (SE). BAHLENBERG, Gunnar [SE/SE]; Blidvägen 234, S-976 32 Luleå (SE). BENGTSSON, Daniel [SE/SE]; Forskarvägen 36 A, S-977 53 Luleå (SE). HÅKANSSON, Siwert [SE/SE]; Aprilvägen 10, S-177 61 Järfälla (SE). ISAKSSON, Anders [SE/SE]; Elefvägen 1, S-977 25 Luleå (SE). ISAKSSON, Mikael [SE/SE]; Borgmästarevägen 7, S-973 42 Luleå (SE). JOHANSSON, Magnus [SE/SE]; Timmermansgatan 34, S-972 41 Luleå (SE). LJUNGGREN, Lis-Marie [SE/SE]; Praktikantvägen 31, S-977 53 Luleå (SE). LUNDBERG, Hans [SE/SE]; Västra Solgatan 8, S-972 53 Luleå (SE). OLOFSSON, Sven-Rune [SE/SE]; Malmuddsvägen 9, S-972 45 Luleå (SE). OLSSON, Lennart [SE/SE]; Majvägen 39, S-973 31 Luleå (SE).</p>	<p>STEFANSSON, Tomas [SE/SE]; Lulavan 773, S-961 93 Boden (SE). ÖHMAN, Hans [SE/SE]; Fältspatstigen 21, S-977 53 Luleå (SE). ÖKVIST, Göran [SE/SE]; Hagaplan 7, S-974 41 Luleå (SE). (74) Agent: PRAGSTEN, Rolf; Telia Research AB, Vitsandsgatan 9, S-123 86 Farsta (SE). (81) Designated States: EE, JP, LT, LV, NO, US, European patent (AT, BE, CH, CY, DE, DK, ES, FI, FR, GB, GR, IE, IT, LU, MC, NL, PT, SE). Published <i>With international search report. Before the expiration of the time limit for amending the claims and to be republished in the event of the receipt of amendments.</i> (88) Date of publication of the international search report: 12 August 1999 (12.08.99)</p>	

(54) Title: IMPROVEMENTS IN, OR RELATING TO, DATA SCRAMBLERS

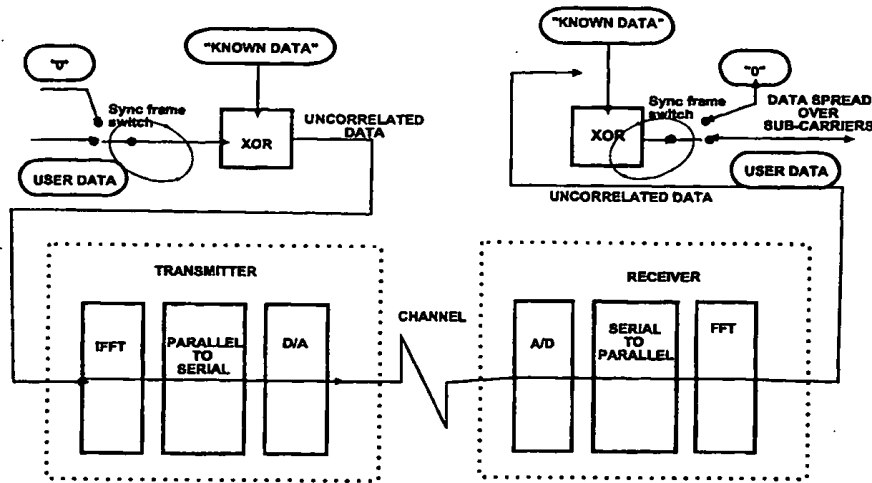

(57) Abstract

The present invention simplifies known data scramblers by making use of the synchronisation frames, normally used for measuring channel characteristics, as a source of pseudo-random data which can be combined with incoming user data. The present invention has particular application to multi-carrier transmission systems which employ DMT, or OFDM. Many of these transmission systems send known data, usually referred to as synchronisation frames, to measure channel characteristics such as signal to noise ratio. The known data contained in a synchronisation frame is selected to have a suitable statistical distribution, e.g. pseudo-random. In the data scrambler of the present invention, user data bits are combined with the known synchronisation frame data using an exclusive-OR function. This results in a statistically and computationally efficient scrambling of the user data.

FOR THE PURPOSES OF INFORMATION ONLY

Codes used to identify States party to the PCT on the front pages of pamphlets publishing international applications under the PCT.

AL	Albania	ES	Spain	LS	Lesotho	SI	Slovenia
AM	Armenia	FI	Finland	LT	Lithuania	SK	Slovakia
AT	Austria	FR	France	LU	Luxembourg	SN	Senegal
AU	Australia	GA	Gabon	LV	Latvia	SZ	Swaziland
AZ	Azerbaijan	GB	United Kingdom	MC	Monaco	TD	Chad
BA	Bosnia and Herzegovina	GE	Georgia	MD	Republic of Moldova	TG	Togo
BB	Barbados	GH	Ghana	MG	Madagascar	TJ	Tajikistan
BE	Belgium	GN	Guinea	MK	The former Yugoslav Republic of Macedonia	TM	Turkmenistan
BF	Burkina Faso	GR	Greece			TR	Turkey
BG	Bulgaria	HU	Hungary	ML	Mali	TT	Trinidad and Tobago
BJ	Benin	IE	Ireland	MN	Mongolia	UA	Ukraine
BR	Brazil	IL	Israel	MR	Mauritania	UG	Uganda
BY	Belarus	IS	Iceland	MW	Malawi	US	United States of America
CA	Canada	IT	Italy	MX	Mexico	UZ	Uzbekistan
CF	Central African Republic	JP	Japan	NE	Niger	VN	Viet Nam
CG	Congo	KE	Kenya	NL	Netherlands	YU	Yugoslavia
CH	Switzerland	KG	Kyrgyzstan	NO	Norway	ZW	Zimbabwe
CI	Côte d'Ivoire	KP	Democratic People's Republic of Korea	NZ	New Zealand		
CM	Cameroon			PL	Poland		
CN	China	KR	Republic of Korea	PT	Portugal		
CU	Cuba	KZ	Kazakstan	RO	Romania		
CZ	Czech Republic	LC	Saint Lucia	RU	Russian Federation		
DE	Germany	LI	Liechtenstein	SD	Sudan		
DK	Denmark	LK	Sri Lanka	SE	Sweden		
EE	Estonia	LR	Liberia	SG	Singapore		

INTERNATIONAL SEARCH REPORT

International application No.

PCT/SE 98/02193

A. CLASSIFICATION OF SUBJECT MATTER		
IPC6: H04L 27/26, H04L 7/08 // H04J 3/12, H04L 5/06 According to International Patent Classification (IPC) or to both national classification and IPC		
B. FIELDS SEARCHED		
Minimum documentation searched (classification system followed by classification symbols)		
IPC6: H04L, H04J, G06F		
Documentation searched other than minimum documentation to the extent that such documents are included in the fields searched		
SE,DK,FI,NO classes as above		
Electronic data base consulted during the international search (name of data base and, where practicable, search terms used)		
WPI, EDOC		
C. DOCUMENTS CONSIDERED TO BE RELEVANT		
Category*	Citation of document, with indication, where appropriate, of the relevant passages	Relevant to claim No.
A	US 4387460 A (PATRICK E. BOUTMY ET AL), 7 July 1983 (07.07.83), column 5, line 26 - column 9, line 60, figures 1-7, claims 1-10 --	1-23
A	WO 9503656 A1 (TELIA AB), 2 February 1995 (02.02.95), page 1, line 7 - line 15; page 4, line 25 - page 6, line 19, figures 1,2, claims 1-7 --	1-23
A	US 5148451 A (SUSUMU OTANI ET AL), 15 Sept 1992 (15.09.92), column 1, line 1 - column 4, line 68, figure 1, claims 1-6 --	1-23
<input checked="" type="checkbox"/> Further documents are listed in the continuation of Box C. <input checked="" type="checkbox"/> See patent family annex.		
<p>* Special categories of cited documents:</p> <p>"A" document defining the general state of the art which is not considered to be of particular relevance</p> <p>"E" earlier document but published on or after the international filing date</p> <p>"L" document which may throw doubts on priority claim(s) or which is cited to establish the publication date of another citation or other special reason (as specified)</p> <p>"O" document referring to an oral disclosure, use, exhibition or other means</p> <p>"P" document published prior to the international filing date but later than the priority date claimed</p> <p>"I" later document published after the international filing date or priority date and not in conflict with the application but cited to understand the principle or theory underlying the invention</p> <p>"X" document of particular relevance: the claimed invention cannot be considered novel or cannot be considered to involve an inventive step when the document is taken alone</p> <p>"Y" document of particular relevance: the claimed invention cannot be considered to involve an inventive step when the document is combined with one or more other such documents, such combination being obvious to a person skilled in the art</p> <p>"&" document member of the same patent family</p>		
Date of the actual completion of the international search		Date of mailing of the international search report
10 June 1999		14 -06- 1999
Name and mailing address of the ISA/ Swedish Patent Office Box 5055, S-102 42 STOCKHOLM Facsimile No. + 46 8 666 02 86		Authorized officer Erik Johannesson/cs Telephone No. + 46 8 782 25 00

Form PCT/ISA/210 (second sheet) (July 1992)

INTERNATIONAL SEARCH REPORT

International application No. PCT/SE 98/02193
--

C (Continuation). DOCUMENTS CONSIDERED TO BE RELEVANT		
Category*	Citation of document, with indication, where appropriate, of the relevant passages	Relevant to claim No.
A	US 4646305 A (STEVEN A. TRETTER ET AL), 24 February 1987 (24.02.87), column 2, line 60 - column 3, line 10; column 5, line 64 - column 6, line 30, figure 1 --	1-23
A	WO 9617455 A1 (TELIA AB), 6 June 1996 (06.06.96), page 4, line 12 - page 6, line 20, claims 1-15 --	1-23
P,A	WO 9829978 A1 (ERICSSON INC.), 9 July 1998 (09.07.98), page 5, line 18 - page 7, line 15, claims 1-11 --	1-23
P,A	WO 9834368 A2 (TELEFONAKTIEBOLAGET LM ERICSSON), 6 August 1998 (06.08.98), claims 1-11 -- -----	1-23

Form PCT/ISA/210 (continuation of second sheet) (July 1992)

INTERNATIONAL SEARCH REPORT
Information on patent family members

03/05/99

International application No.
PCT/SE 98/02193

Patent document cited in search report	Publication date	Patent family member(s)	Publication date
US 4387460 A	07/07/83	NONE	
WO 9503656 A1	02/02/95	EP 0712555 A SE 500986 C SE 9302453 A US 5652772 A	22/05/96 17/10/94 17/10/94 29/07/97
US 5148451 A	15/09/92	AU 627380 B AU 6655090 A CA 2029675 A,C DE 59009714 D,T EP 0427283 A,B JP 2513331 B JP 3153145 A	20/08/92 16/05/91 11/05/91 21/11/96 15/05/91 03/07/96 01/07/91
US 4646305 A	24/02/87	NONE	
WO 9617455 A1	06/06/96	EP 0795239 A SE 502656 C SE 9404121 A	17/09/97 04/12/95 04/12/95
WO 9829978 A1	09/07/98	AU 5623098 A US 5862160 A	31/07/98 19/01/99
WO 9834368 A2	06/08/98	AU 2239097 A AU 5889598 A EP 0883444 A SE 9700308 A	10/09/97 25/08/98 16/12/98 01/08/98

Form PCT/ISA/210 (patent family annex) (July 1992)

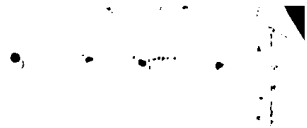

This Page Blank (uspto)



INTERNATIONAL APPLICATION PUBLISHED UNDER THE PATENT COOPERATION TREATY (PCT)

<p>(51) International Patent Classification ⁶ : G06F</p>	<p>A2</p>	<p>(11) International Publication Number: WO 98/32065 (43) International Publication Date: 23 July 1998 (23.07.98)</p>
<p>(21) International Application Number: PCT/US97/24201 (22) International Filing Date: 31 December 1997 (31.12.97) (30) Priority Data: 60/033,995 3 January 1997 (03.01.97) US (71) Applicant: FORTRESS TECHNOLOGIES, INC. [US/US]; Suite 650, 2701 North Rocky Point Drive, Tampa, FL 33607 (US). (72) Inventors: FRIEDMAN, Aharon; Apartment 4208, 2717 Seville Boulevard, Clearwater, FL 34624 (US). BOZOKI, Eva; Apartment 2113, 6161 North Memorial Highway, Tampa, FL 33615 (US). (74) Agents: RUBENSTEIN, Kenneth et al.; Meltzer, Lippe, Goldstein, Wolf & Schlissel, P.C., 190 Willis Avenue, Mineola, NY 11501 (US).</p>	<p>(81) Designated States: AL, AU, BA, BB, BG, BR, CA, CN, CU, CZ, EE, GE, HU, IL, IS, JP, KP, KR, LC, LK, LR, LT, LV, MG, MK, MN, MX, NO, NZ, PL, RO, SG, SI, SK, SL, TR, TT, UA, UZ, VN, YU, ZW, ARIPO patent (GH, GM, KE, LS, MW, SD, SZ, UG, ZW), Eurasian patent (AM, AZ, BY, KG, KZ, MD, RU, TJ, TM), European patent (AT, BE, CH, DE, DK, ES, FI, FR, GB, GR, IE, IT, LU, MC, NL, PT, SE), OAPI patent (BF, BJ, CF, CG, CI, CM, GA, GN, ML, MR, NE, SN, TD, TG).</p> <p>Published <i>Without international search report and to be republished upon receipt of that report.</i></p>	

(54) Title: IMPROVED NETWORK SECURITY DEVICE

(57) Abstract

A network security device is connected between a protected client and a network. The network security device negotiates a session key with any other protected client. Then, all communications between the two clients are encrypted. The inventive device is self-configuring and locks itself to the IP address of its client. Thus, the client cannot change its IP address once set and therefore cannot emulate the IP address of another client. When a packet is transmitted from the protected host, the security device translates the MAC address of the client to its own MAC address before transmitting the packet into the network. Packets addressed to the host, contain the MAC address of the security device. The security device translates its MAC address to the client's MAC address before transmitting the packet to the client.

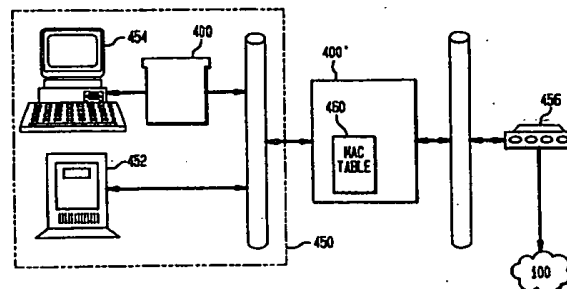
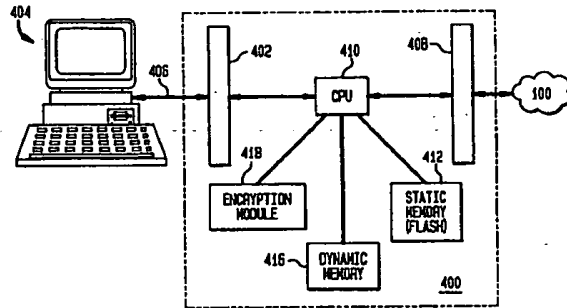

FOR THE PURPOSES OF INFORMATION ONLY

Codes used to identify States party to the PCT on the front pages of pamphlets publishing international applications under the PCT.

AL	Albania	ES	Spain	LS	Lesotho	SI	Slovenia
AM	Armenia	FI	Finland	LT	Lithuania	SK	Slovakia
AT	Austria	FR	France	LU	Luxembourg	SN	Senegal
AU	Australia	GA	Gabon	LV	Latvia	SZ	Swaziland
AZ	Azerbaijan	GB	United Kingdom	MC	Monaco	TD	Chad
BA	Bosnia and Herzegovina	GE	Georgia	MD	Republic of Moldova	TG	Togo
BB	Barbados	GH	Ghana	MG	Madagascar	TJ	Tajikistan
BE	Belgium	GN	Guinea	MK	The former Yugoslav Republic of Macedonia	TM	Turkmenistan
BF	Burkina Faso	GR	Greece			TR	Turkey
BG	Bulgaria	HU	Hungary	ML	Mali	TT	Trinidad and Tobago
BJ	Benin	IE	Ireland	MN	Mongolia	UA	Ukraine
BR	Brazil	IL	Israel	MR	Mauritania	UG	Uganda
BY	Belarus	IS	Iceland	MW	Malawi	US	United States of America
CA	Canada	IT	Italy	MX	Mexico	UZ	Uzbekistan
CF	Central African Republic	JP	Japan	NE	Niger	VN	Viet Nam
CG	Congo	KE	Kenya	NL	Netherlands	YU	Yugoslavia
CH	Switzerland	KG	Kyrgyzstan	NO	Norway	ZW	Zimbabwe
CI	Côte d'Ivoire	KP	Democratic People's Republic of Korea	NZ	New Zealand		
CM	Cameroon		Republic of Korea	PL	Poland		
CN	China	KR	Republic of Korea	PT	Portugal		
CU	Cuba	KZ	Kazakistan	RO	Romania		
CZ	Czech Republic	LC	Saint Lucia	RU	Russian Federation		
DE	Germany	LI	Licchtenstein	SD	Sudan		
DK	Denmark	LK	Sri Lanka	SE	Sweden		
EE	Estonia	LR	Liberia	SG	Singapore		

IMPROVED NETWORK SECURITY DEVICE

Related Application

This patent claims the benefit of U.S. Provisional Patent Application
5 Serial Number 60/033,995 entitled "Improved Network Security Device", filed
on January 3, 1997 for Dr. Aharon Friedman and Dr. Eva Bozoki. This patent
application is directed to improvements in the invention described in U.S. Patent
Application Serial No. 08/529,497 entitled "Network Security Device" and filed
on September 18, 1995. The contents of these two documents are
10 incorporated herein by reference.

Field of the Invention

The present invention is directed to improvements in a network security
device that is connected between a protected computer("the client") and a
15 network and/or a protected local area network (LAN) and a wide area network
(WAN) as well as a method for using the network security device.

Background of the Invention

A. Network Architecture

20 An Internet communications network 100 is depicted in FIG. 1 including five
transmit or backbone networks A,B,C,D, and E and three stub networks R, Y, and
Z. A "backbone" network is an intermediary network which conveys
communicated data from one network to another network. A "stub" network is
a terminal or endpoint network from which communicated data may only initially
25 originate or ultimately be received. Each network, such as the stub network R,
includes one or more interconnected subnetworks I, J, L, and M. As used herein,
the term "subnetwork" refers to a collection of one or more nodes, e.g., (c,w), (d),
(a), (b,x,y), (q,v), (r,z), (s,u), (e,f,g),(h,i),(j,k,l),(m,n), and (o,p), interconnected by
wires and switches for local internodal communication. Each subnetwork may be
30 a local area network (or "LAN"). Each subnetwork has one or more interconnected
nodes which may be host computers ("hosts") u,v,w,x,y,z (indicated by triangles)
or routers a,b,c,d,e,f,g,h,i,j,k,l,m,n,o,p,q,r,s (indicated by squares). A host is an
endpoint node from which communicated data may initially originate or ultimately

be received. A router is a node which serves solely as an intermediary node between two other nodes; the router receives communicated data from one node and retransmits the data to another node. Collectively, backbone networks, stub networks, subnetworks, and nodes are referred to herein as "Internet systems".

5 FIG. 2 shows a block diagram of a host or router node 10. As shown, the node may include a CPU 11, a memory 12 and one or more I/O ports (or network interfaces) 13-1, 13-2, . . . , 13-N connected to a bus 14. Illustratively, each I/O port 13-1, 13-2, . . . , 13-N is connected by wires, optical fibers, and/or switches to the I/O port of another node. The I/O ports 13-1, 13-2, . . . , 13-N are for
10 transmitting communicated data in the form of a bitstream organized into one or more packets to another node and for receiving a packet from another node. If the host 10 is a host computer attached to a subnetwork which is an Ethernet, then the host will have an I/O port which is an Ethernet interface.

A host which initially generates a packet for transmission to another node
15 is called the source node and a host which ultimately receives the packet is called a destination node. Communication is achieved by transferring packets via a sequence of nodes including the source node, zero or more intermediary nodes, and the destination node, in a bucket brigade fashion. For example a packet may be communicated from the node w to the node c, to the node d, to the node b,
20 and to the node x.

An exemplary packet 40 is shown in FIG. 3A having a payload 41 which contains communicated data (i.e., user data) and a header 42 which contains control and/or address information. Typically, the header information is arranged in layers including an IP layer and a physical layer.

25 The IP layer typically includes an IP source address, an IP destination address, a checksum, and a hop count which indicates a number of hops in a multihop network. A physical layer header includes a MAC (Media Access Control) address (hardware address) of the source and a MAC address of the destination.

30 The user data may include a TCP (Transfer Control Protocol) packet including TCP headers or a UDP (User Data Protocol) packet including UDP headers. These protocols control among other things, the packetizing of

information to be transmitted, the reassembly of received packets into the originally transmitted information, and the scheduling of transmission and reception of packets (see e.g., D. Comer, "Internetworking With TCP/IP", Vol. 1 (1991); D. Comer and D. Stevens, "Internetworking With TCP/IP", Vol. 2 (1991)).

5 As seen in FIG. 3B, in an exemplary Internet protocol (IP), each node of the Internet 100 is assigned an Internet address (IP address) which is unique over the entire Internet 100 such as the Internet address 30 for the node y shown in FIG. 3B. See, Information Sciences Institute, RFC 791 "Internet Protocol", September, 1981. The IP addresses are assigned in an hierarchical fashion; the Internet (IP)
10 address 30 of each node contains an address portion 31 indicating the network of the node, an address portion 32 indicating a particular subnetwork of the node, and a host portion 33 which identifies a particular host or router and discriminates between the individual nodes within a particular subnetwork.

In an Internet system 100 which uses the IP protocol, the IP addresses of
15 the source and destination nodes are placed in the packet header 42 (see FIG. 3A) by the source node. A node which receives a packet can identify the source and destination nodes by examining these addresses.

In an Internet system, it is the IP address of a destination that is known, and the physical address (i.e., MAC address) to be placed in the MAC frame header is
20 to be determined. If the destination host is on the same local area subnetwork (and this is easily determined by observing that the network part in both the source and destination IP addresses is the same), then the destination address that is to go into the MAC header destination address field is simply the physical address of the destination host. The MAC destination address may be found by means of the
25 ARP (Address Resolution Protocol) which comprises having the source host broadcast an ARP request packet with the IP address of the destination host and having the destination host respond with its hardware (MAC) address. This MAC address may be placed in the MAC frame (physical layer) headers.

30 B. Encryption Techniques

Eavesdropping in a network, such as the Internet system 100 of FIG. 1, can be thwarted through the use of a message encryption technique. A message

encryption technique employs an encipherment function which utilizes a number referred to as a session key to encipher data (i.e., message content). Only the pair of hosts in communication with each other have knowledge of the session key, so that only the proper hosts, as paired on a particular conversation, can encrypt and

5 decrypt digital signals. Three examples of encipherment functions are (1) the National Bureau of Standards Data Encryption Standard (DES) (see e.g., National Bureau of Standards, "Data Encryption Standard", FIPS-PUB-45, 1977), (2) Fast Encipherment Algorithm (FEAL)(see e.g., Shimizu and S. Miyaguchi, "FEAL-Fast Data Encipherment Algorithm," Systems and Computers in Japan, Vol. 19, No. 7,

10 1988 and S. Miyaguchi, "The FEAL Cipher Family", Proceedings of CRYPTO '90, Santa Barbara, Calif., Aug., 1990); and (3) International Data Encryption Algorithm ("IDEA") (see e.g., X. Lai, "On the Design and Security of Block Ciphers," ETH Series in Information Processing, v.1, Konstanz: Hartung - Gorre Verlag 1992). One way to use an encipherment function is the electronic

15 codebook technique. In this technique a plain text message m is encrypted to produce the cipher text message c using the encipherment function f by the formula $c = f(m, sk)$ where sk is a session key. The message c can only be decrypted with the knowledge of the session key sk to obtain the plain text message $m = f(c, sk)$.

20 Session key agreement between two communicating hosts may be achieved using public key cryptography. (See e.g., U.S. Patent Nos. 5,222,140 and 5,299,263).

Before discussing public key cryptographic techniques, it is useful to provide some background information. Most practical modern cryptography is based on

25 two notorious mathematical problems believed (but not proven) to be hard (i.e., not solvable in polynomial time, on the average). The two problems are known as Factorization and Discrete-Log. The Factorization problem is defined as follows:

Input: N , where $N = pq$ where p and q are large prime numbers

Output: p and/or q .

30 The Discrete-Log problem is defined as follows:

Input: P, g, y , where $y \equiv g^x \pmod{P}$, and P is a large prime number

Output: x .

(The Discrete-Log problem can be similarly defined with a composite modulus $N = pq$).

Based on the Factorization and Discrete-Log problems, some other problems have been defined which correspond to the cracking problems of a cryptographic system.

One system of such a problem which has previously been exploited in cryptography (see, e.g., H.C. Williams, "A Modification of RSA Public-Key Encryption", IEEE Transactions on Information Theory, Vol. IT-26, No. Nov. 6, 1980) is the Modular Square Root problem, which is defined as follows:

10 Input: N, y , where $y \equiv x^2 \pmod{N}$, and $N = pq$, where p and q are large primes
Output: x .

Calculating square roots is easy if p and q are known but hard if p and q are not known. When N is composed of two primes, there are in general four square roots mod N . As used herein, $z \equiv \sqrt{x} \pmod{N}$ is defined to mean that x is the smallest integer whereby $z^2 \equiv x \pmod{N}$.

15 Another problem is known as the Composite Diffie-Hellman (CDH) problem, which is defined as follows:

Input: $N, g, g^x \pmod{N}, g^y \pmod{N}$, where $N \equiv pq$ and p and q are large primes.

Output: $g^{xy} \pmod{N}$.

20 It has been proven mathematically that the Modular Square Root and Composite Diffie-Hellman problems are equally difficult to solve as the above-mentioned factorization problem (see, e.g., M.O. Rabin, "Digitalized Signatures and Public Key Functions as Intractable as Factorization", MIT Laboratory for Computer Science, TR 212, Jan. 1979; Z. Shmueli, "Composite Diffie-Hellman Public Key
25 Generating Schemes Are Hard To Break", Computer Science Department of Technion, Israel, TR 356, Feb. 1985; and K.S. McCurley, "A Key Distribution System Equivalent to Factoring", Journal of Cryptology, Vol. 1, No. 2, 1988, pp. 95-105).

30 In a typical public-key cryptographic system, each user I has a public key P_i (e.g., a modulus N) and a secret key S_i (e.g., the factors p and q). A message to user I is encrypted using a public operation which makes use of the public key known to everybody (e.g., squaring a number mod N). However, this message is

decrypted using a secret operation (e.g., square root mod N) which makes use of the secret key (e.g., the factors p and q).

C. Network Security Devices

5 At present, existing network security products are categorized into two classes: (1) firewalls, such as Janus and ANS, and (2) software products, such as encrypted mail, secured http, one time password, etc.

10 A firewall is a dedicated computer, usually running a Unix operating system. It acts as a filter for incoming and outgoing communications. The firewall is placed as a router between the local area network (LAN) and the outside world. The decision whether to pass a packet is made based on the source and/or destination IP address, and the TCP port number. Some firewalls also have the ability to encrypt data, provided that both sides of the communication employ the same brand of firewall. Some firewalls have a personal authentication feature.

15 Software products are based on the premise that the computer on which they are installed are secure, and protection is only needed outside on the network. Thus, such software products can easily be bypassed by breaking into the computer. A typical scheme is when an intruder implants a "Trojan Horse" on a computer which sends him an unencrypted copy of every transaction. Sometimes, it is even done as a delayed action during the off-hours when the computer is not likely to be supervised.

20 In addition, there are authentication products designed to maintain the integrity of the computer against intrusion. These products are based on the premise that the products are 100% secure. Once the product is compromised, it becomes totally ineffective. Sometimes, careless use by one user may jeopardize all other users of the product.

25 Firewalls are more effective in maintaining network security. However they are very expensive. Their price range is between \$10,000 and \$50,000, plus the price of the hardware. They require a high level of expertise to install and maintain. The most sophisticated and effective firewalls require a specially trained technician or engineer for their maintenance. The special training cost is up to

\$10,000 per person, and the salary adds \$60,000 to \$120,000 or more per annum to the cost.

5 Firewalls have to be constantly maintained, modified, and monitored in order to yield reasonable security. They only cover the TCP part of the Internet Protocol and not the UDP part. Thus, they do not provide security to NFS (Network File Services) and many client/server applications.

10 The firewall is a full service computer which can be logged into for maintenance and monitoring. Thus, it can be broken into. Once a firewall is compromised it loses its effectiveness and becomes a liability rather than a security aid. Firewalls only protect the connection between a LAN and a WAN (Wide Area Network). It does not protect against intrusion into a particular host from within the LAN.

15 In view of the foregoing, it is an object of the present invention to provide a network security device which overcomes the shortcomings of the prior art network security devices.

It is another object of the present invention to provide a hardware device to provide network security for individual hosts attached to a network.

20 It is a further object of the present invention to provide a hardware device to provide network security for a local area network connected to a wide area network.

Summary of the Invention

25 The present invention provides improvements to the Network Security Device described in U.S. Patent Application Serial Number 08/529,497. These improvements include (1) modifications in the device which adapt it to protect a LAN, (2) improved key generation, (3) an improved key exchange algorithm, and (4) improved packet handling procedures which provide double integrity checks.

30 A preferred embodiment of the inventive network security device comprises a first network interface connected to a protected client, a second network interface connected to a portion of a network, and a processing circuit connected to both interfaces.

A communication from the protected client goes from the client, to the first interface, to the processing circuit, to the second interface and into the network. Similarly, a communication received from the network goes from the second interface, to the processing circuit, to the first interface and to the protected client.

A preferred embodiment of the present invention has four keys associated with it:

- (1) a static (permanent) private key;
- (2) dynamic (changing) private key;
- (3) a static public key; and
- (4) a dynamic public key.

In a preferred embodiment, the public keys are exchanged between two network security devices in order to establish a common secret key. The common secret key is the key which is used to encrypt/decrypt all messages between two particular devices. This key should not be transmitted.

The static keys are permanent keys unique to each device. The dynamic keys have a predetermined lifespan and are replaced periodically, such as every 24 hours. Preferably, the static keys are generated using a seed derived from the host's IP address, MAC address of the network interface connected between the protected host and the network security device, and the security device's serial number. Preferably, the dynamic keys are generated using seeds derived from current date and time information.

Packets received from the protected client are encrypted using an encipherment function such as IDEA, FEAL, or DES before being transmitted via the network to a destination. Similarly encrypted packets received from a destination are decrypted. Such encryption and decryption requires a common session key to be possessed jointly by the protected client and the destination (the destination being a protected client of another network security device located someplace else in the network).

The common crypto key (i.e., the common secret key) is obtained using a public key cryptography technique. To aid in the key exchange, the network security device maintains two databases. A static database (SDB) contains

information about secured hosts or nodes in the network. A secured host or node is a host or node that is protected by a network security device. Each entry in the static database contains information about a particular secured host, i.e., the host IP address, time entered in the database, and the host's permanent public key.

5 A dynamic data base (DDB) contains information about secured and unsecured hosts. Each entry in the dynamic database includes a host's IP address, the time that the host's dynamic key was generated, a flag indicating whether or not the host is secured, a flag indicating whether the host is in transition (i.e., in the middle of a key exchange), and a pointer to a common secret session key.

10 The protocol used by the network security device of host i to agree on a common crypto key with a network security device of host j is as follows.

 Consider a communication from host i to host j . The communication arrives at the network security device of host i from host i . The network security device checks if host j is in the dynamic database. If host j is in the dynamic database,
15 it is determined if the dynamic database has a common crypto key for communication between host i and host j . If there is such a common session key, the communication from host i is encrypted using the common crypto key and transmitted to host j . If there is no common crypto key, then host i sends the dynamic part of its public key P_i to host j and host j replies by sending the dynamic
20 part of its public key P_j to host i . The exchange of dynamic parts of the public keys may be encrypted using the static part of the public keys, which may be obtained from the static databases at host i and host j . The common crypto key is then calculated according to a Diffie-Hellman technique.

 Because the dynamic keys of each network security have a particular
25 lifespan, such as 24 hours, there may be a time difference between times when two device's keys expire. Thus, it is possible that one device's dynamic key may expire before the packet is received. One way to prevent this occurrence is to take into account this time difference. The DDB may correct the time difference between the time the packet was sent and the time the packet is received. Also,
30 the DDB time generation entry indicates to the network security device when the other party's dynamic key expires. Thus, when a communication between the

nodes is initiated, it may be determined whether a new dynamic key exchange is warranted, rather than attempting to use an expired common dynamic key.

Note that this assumes that there is an entry for host j in the static database of host i. If there is not, the exchange of dynamic public keys is preceded by an exchange of static public keys and the forming of a database entry for host j in the static database at host i. Moreover, if there is no entry for host j in the dynamic database of host i, such an entry will be generated before the dynamic key exchange.

A packet received by the network security device and the connected host is preferably processed in the following manner. The IP and MAC headers from the packet are copied into a new IP packet. The client host's physical address (e.g., the MAC address of the network interface between the client and the network security device) is replaced with the network security device's MAC address (e.g., the MAC address of the network interface between the network security device and the network). The new IP packet includes a proprietary header and proprietary tail. Information about the packet is stored in the proprietary tail, including check sum information. The data and proprietary tail are then encrypted. The proprietary header is then filled in, including check sum information for the encrypted data. This packet is then transmitted into the network.

This processing method provides a double integrity check. The check sum which was calculated after encryption is checked by the receiver before decryption, providing an integrity test of the encrypted data in transit. The check sum in the proprietary tail was calculated before encryption and checked by the receiver after decryption. This checksum provides a means of strong authentication because the static and dynamic keys used to encrypt the checksum are known only to the two communicating hosts. This check sum will differ if the common secret key is not identical on both sides and also provides an integrity test of the actual data. Note that if the check sum is replaced with a secured hash function, after the packet is encrypted, it becomes a digital signature. It should be noted that encryption takes place at the IP level so that TCP and UDP packets are encoded.

In short, the inventive network security device has a number of significant advantages.

Like a firewall, the inventive network security device is a hardware/software combination in a preferred implementation. However, it is a sealed "box" and cannot be logged into. Hence, it cannot be compromised the way a firewall can. It is much cheaper than a firewall. Thus, each node in the LAN can be equipped with it. This way, it provides protection inside the LAN as well as outside. The network security device works directly at the IP level. It therefore, covers all types of IP protocols and requires no special configuration to different network applications. Thus, the inventive network security device is maintenance free.

Brief Description of the Drawings

The present invention is described with reference to the following figures:

FIG. 1 schematically illustrates an Internet system.

FIG. 2 schematically illustrates the architecture of a host in the network of FIG. 1.

FIGS. 3A and 3B illustrate the format of a packet transmitted in the network of FIG. 1.

FIG. 4A illustrates a network security device for use with a host in the network of FIG. 1 in accordance with an embodiment of the present invention.

FIG. 4B illustrates a network security device for use with a LAN in accordance with an embodiment of the present invention.

FIG. 5 illustrates an entry in a static database maintained by the network security device of FIG. 4.

FIG. 6 illustrates an entry in a dynamic database maintained by the network security device of FIG. 4.

FIG. 7 is a flow chart illustrating an activation method used by the network security device of FIG. 4.

FIG. 8 is a flowchart illustrating a key exchange method used by the network security device of FIG. 4.

FIG. 9 is a flow chart illustrating an IP packet handling algorithm utilized by the network security device of FIG. 4.

FIG. 10 illustrates an IP packet received from a connected host by the network security device and an IP packet transmitted from the network security device into a network.

FIG. 11 is a flowchart illustrating a method of processing the packets of FIG. 5 10.

Detailed Description of the Invention

Overview of the Invention

FIG. 4A schematically illustrates a network security device for protecting a host according to an embodiment of the invention. The security device 400 10 comprises a first interface 402 which is connected to the client host 404. Specifically, the interface 402 is connected to a network interface in the client host 404 (e.g., an interface 13 of Fig. 2) via a cable or wire 406. The security device 400 comprises a second interface 408 which is connected to a portion of a network 100. Illustratively, the interface 408 is connected to an Ethernet so 15 that the interfaces 402, 408 are Ethernet interfaces such as SMC Elite Ultra Interfaces.

FIG. 4B schematically illustrates a network security device 400' for protecting a LAN according to an embodiment of the invention. As seen in FIG. 20 4B, a network security device 400' according to the invention is connected between a LAN 450, such as an Ethernet network (including, for example, a file server 452 and a workstation 454), and a router 456 which routes communications between the LAN 450 and a WAN 100, such as the Internet. As discussed in detail below, several modifications are made in the Network Security 25 Device to adapt it for use in protecting a LAN. As also seen in FIG. 4B, network security devices may be arranged in a cascaded topology. Note that workstation 454 is associated with a network security device 400.

Returning to FIG. 4A, a CPU 410 is connected to the interfaces 402, 408. The CPU is, for example, an Intel 486 DX 62-66 or Pentium. Alternatively, the 30 processing circuit may be implemented as one or more ASICs (Application Specific Integrated Circuits) or a combination of ASICs and a CPU. A static memory 412 (e.g., flash EEPROM) is also connected to the CPU 410 and a dynamic memory

WO 98/32065

416 (e.g., RAM) is connected to the CPU 410. An optional encryption module 418 may be provided to perform encryption and large number arithmetic operations. The encryption unit may be implemented as a programmable logic array. Alternatively, the encryption module 418 may be omitted and its function
5 may be carried out using a software program which is executed by the CPU 410. However, because certain encryption functions are calculation intensive, it may be preferable to separate the encryption functions from other functions of the Network Security Device 400.

The software executed by the CPU 11 preferably has three components: (1)
10 operating system, (2) networking system, and (3) key computation algorithms. The operating system and the networking system may both be part of a Unix-like kernel. The key computation algorithms reside in memory and are signaled into action by the networking system. The operating system is a lobotomized Linux system with all drivers taken out except the RAM,
15 disk, and Ethernet interfaces. The networking system is for communication, key exchange, encryption, configuration, etc. In a preferred embodiment, the key computation software may run independently of the other software. This shifts the computationally intensive task of key computation away from the operating system and networking system.

20 The CPU 410 maintains two databases. One database is a static database (SDB) 412 preferably stored in a permanent memory, such as a Flash ROM 412. FIG. 5 illustrates one entry in the SDB 412. The SDB may have an entry for the client host as well as other hosts. As seen in FIG. 5, the static database entry 500 contains permanent information about the network security device 400 and
25 other secured nodes in the network. The static database entry 500 may include the following information about another secured node: the other node's IP address 502, time that this other node was entered into the database 504, the node's permanent public key 506, and a pointer to the static common key shared by the network security device 400 and the other node's device 508. The static
30 database 500 may also contain the IP address and the serial number of the connected host 510.

A second database is a dynamic database (DDB) 416, which may be stored in a volatile memory, such as a RAM. FIG. 6 illustrates one entry in the DDB 416. As seen in FIG. 6, the dynamic database entry 600 contains information about secured and unsecured nodes, i.e., the other node's IP address 602, the time a last packet was sent from that other node 604, a time the other node's dynamic key was generated 606, a pointer to a common secret key shared with that node, time last updated, a secured flag indicating whether the node is secured (e.g., has its own network security device) 602, and a transition flag indicating whether the node is in transition (i.e., in the middle of a key exchange).

10 Briefly, a preferred embodiment of the present invention operates in the following manner. The interface 402 is put in a promiscuous mode. In this mode, the interface 402 passes all communications from the client host 404 that are sensed on the cable 406 to the CPU 410. The network connection is via the interface 408 which is set to the same IP address as the client 404. The network security device 400 responds to the Address Resolution Protocol by sending its own (rather than the client's) MAC address. This adds a level of security by blocking attempts to bypass the device 400 using the Ethernet protocol.

15 Received communications are checked to see if they are from a secured host. First, the DDB entry 600 is checked to determine if there is a current dynamic common key shared with the node sending the communication. If yes, this key is used to encrypt and decrypt subsequent packets. If no, if these nodes have communicated previously, a dynamic key exchange is performed. If it is the first time these nodes have communicated, a static key exchange is performed to obtain a static dynamic key. This static key is used to encrypt and decrypt the dynamic key exchange communications.

Activation and Initialization

25 In a preferred embodiment, the network security device 400 is a sealed box which cannot be logged into. The network security device 400 senses the IP (and/or MAC) address of the client host 404 and locks itself to it. Once the network security device is locked to the address, the client 404 is prevented by the network security device 400 from changing its IP (and/or MAC) address.

Preferably, before the network security device 400 is placed into service, it is activated. The role of activation is to allow or disallow burning the host's 404 IP address into an entry 500 in the static database 412. As discussed above, the SDB 412 may have an entry 500 for the connected client host.

5 The network security device's serial number (element 510) and the time of activation (element 504) may also be burned into the static database entry 500. As discussed below, these values may be used to generate a seed for the network security device's static private key.

FIG. 7 is a flowchart 700 illustrating a preferred activation method. First,
10 an "activation packet" containing an activation string in the payload may be sent from a connected computer, such as a host 404, through the network security device 400 (step 702). The packet is received by the device 400, which determines whether it has been activated (step 704). If it has not been activated, the IP address and other information are written into the flash memory (step 706),
15 as described above, and an acknowledgment packet is returned to the computer (step 708). The device 400 may also generate a confirmation message for display on a monitor of the connected computer (step 710). The Address Resolution Protocol (ARP) is the protocol which is used to resolve an IP address into a matching Ethernet machine (MAC) address which is the actual address to which
20 the network interface responds. As discussed above, the inventive network security device uses ARP (Address Resolution Protocol) to configure itself and hide the client host. The manner in which the network security device processes an ARP request is described in related application Serial No. 08/529,497, the contents of this description are incorporated herein by reference.

25 Key Calculation

A preferred embodiment of the present invention has four keys associated with it:

- (1) a static (permanent) private key;
- (2) dynamic (changing) private key;
- 30 (3) a static public key; and
- (4) a dynamic public key.

In a preferred embodiment, the private keys are 128 bits long and are known only to that network security device. In a preferred embodiment, the public keys are 512 bits long and are revealed to others. Public keys, as described above, are exchanged between two network security devices in order to establish a 128 bit long common secret key. The common secret key is the key which is used to encrypt/decrypt all messages between two particular devices. The common secret keys should never be transmitted.

In a preferred embodiment, the keys are generated when the device 400 is turned on. As described in detail below, the static keys are permanent keys unique to each device and the dynamic keys have a predetermined lifespan and are replaced periodically, such as every 24 hours.

Static Keys

Keys are generated using a "seed", or number, which is then processed to generate a key. The seed for a randomly generated static private key for a particular network security device 400 is derived from the device's IP-address, MAC-address, serial number, and a time-stamp. The seed may be determined in the following manner:

$$\text{seed} = \text{IP} + \text{MAC}_l + \text{MAC}_h + \text{serial} + \text{time}$$

where:

MAC_l is the low four bytes of the device's six byte MAC address;
MAC_h is the high two bytes of the MAC address.

Using this seed, a private key (preferably 128 bits long), is then randomly generated using a random number generator, such as the GNU Multiple Precision library copyrighted by Free Software Foundation Inc. (1996), Boston, Massachusetts, 02111. If the box is non-activated, the seed is the present time, thus it will be different every time the box is turned-on. On the other hand, for activated boxes, the static private key is a property of the box, it will not change by turning the box on/off.

Dynamic Keys

The dynamic private key is randomly generated at predetermined intervals. For example, dynamic keys may be generated every 24 hours. Preferably, the dynamic keys are derived from a random seed obtained from seconds, minutes,

and hours of the present time. The dynamic secret key may be processed from the seed using a random number generator, such as the GNU Multiple Precision library

Public Keys

5 The static and dynamic public keys are calculated from the private keys according to the equation:

$$X_i \equiv q^{x_i} \pmod{n}$$

where:

X_i is the public key;

10 x_i is the private key;

and q and n prime numbers which are preferably installed in each network security device.

Key Exchanges

The first time a client 404 or LAN 450 sends a message to another network security device, a protocol is executed by which the two devices (i) exchange static public keys (unencrypted), (ii) generate a static common key, and then (iii) exchange dynamic public keys encrypted with their static common key. FIG 8 is a flowchart 800, illustrating the key exchange algorithm.

20 Consider the case where the host client wants to send a communication to a node in the network whose IP = A. When the communication arrives at the network security device of the host client the dynamic data base 416 (DDB) is checked to determine if there is an entry 600 for node A in the dynamic data base (step 702).

Note that the DDB includes an entry for a "secured" flag 612 and a "transition" flag 614. The secured flag indicates the current security status between the two network security devices. Preferably, the secured flag may be in one of five states:

- 0 = unsecured
- 1 = secured
- 30 2 = other party was secured, but now does not respond to dynamic key exchange request (i.e., other party has an entry in the SDB 500 but no current entry in the DDB 600)

3 = the device's dynamic key has expired and must renegotiate all dynamic keys

4 = cannot allocate key storage for the other party's key

The transition flag 614 indicates the status of a key exchange. Preferably, the transition flag maybe in one of four states:

- 0 not in transition
- $i \leq N$ waiting to receive a dynamic public key packet
- $N + 2$ waiting for a dynamic common key calculation
- $-i \geq -N$ waiting for static public key packet
- 10 $-(N + 2)$ waiting for a static common key calculation

where N is the maximum number of tries, and i is the actual number of tries. As discussed in detail below, if there is no entry 600 in the DDB 416, the SDB 412 is searched for an entry 500 corresponding to node A.

The database searches return:

- 15 (i) a transition flag; and
- (ii) and a reference to the entry number in the database.

The "transition" and "secured" flags in the DDB may then be set accordingly. The following table sets out possible outcomes of a DDB/SDB search.

Possible Outcomes of Database Search.

	Need dynamic key	Need static key have nothing to decrypt with	Not asking for any key	Comments
Trans	1	-1	0	

	Need dynamic key	Need static key have nothing to decrypt with	Not asking for any key	Comments
Return	0 -(i + 1)	0	0 -(i + 1) +(i + 1) -(DB size + i + 1)	have nothing to en/decrypt with (no entry in DDB) use st-key to en/decrypt use dyn-key to en/decrypt have st-key in DB, but no dyn-key response (do not encrypt, but use st-key to decrypt)

Where DB size is the number of entries i for node A in the entry number in the dynamic database.

5 Returning to FIG. 8, if there is an entry for node A in the dynamic data base, a check is made to see if a common dynamic key for node A and the protected client has expired (step 803).

If, for example, there is an entry for node A and the secured flag = 1, then node A is secured. Thus, the common dynamic key has not expired and the
10 packet is encrypted using the session key and an encipherment function such as IDEA (step 806).

If the common dynamic key has expired, the dynamic data base entry for the node $IP = A$ has a secured flag = 3 and the transition flag is $i \leq N$ (step 804) which means a key exchange is taking place.

15 The exchange of the dynamic parts of the public keys of the host client and the node with $IP = A$ proceeds as follows. The host client (i.e., the source) sends its dynamic public key and IP address to the node with $IP = A$ (the destination) (step 808) and waits for a reply (step 810). The dynamic public key of the host may be encrypted with the static public key of the node with $IP = A$. The reply is
20 the dynamic public key of the destination node with $IP = A$. This may be encrypted

with the static public key of the host client. Steps 808 and 810 may be repeated several times, such as three times.

5 If no reply is received (step 812) from the destination, the source network security device sets the secured flag to 2 and the transition flag to 0 (step 814) in the DDB entry for the destination. If the packet to be encrypted originated from the host (step 816), the packet may be dropped (step 818). If the packet originated from another party, the network security device may try to decrypt the packet using the static private key (step 820).

10 If a reply is received, the transition flag for the destination node in the DDB entry 600 of the network security device of the host is set to $N + 2$ (step 822), indicating that the common dynamic key is being calculated. Then a common dynamic (crypto) key for the source and destination is calculated by the network security device of the source (step 824) using, for example, a Diffie-Hellman technique as described above. The common session key is then entered into the
15 DDB entry 600 of the source network security device (step 826) and the transition flag for this DDB entry is marked 0 (step 828) because the transition is complete. The secured flag = 1.

The exchange of dynamic public keys and the calculation of a common crypto key assumes that there is an entry for the destination node with $IP = A$ in the static data base 412 (SDB) of the source network security device and in the
20 dynamic data base 416 of the source network security device. That is, that these two network security devices have communicated before. If these entries do not exist (i.e., these two devices have not previously communicated), they may be created prior to the dynamic public key exchange (steps 708-722 described
25 above).

If there is no DDB entry for node $IP = A$ (step 802), an entry is created (step 830), the secured flag = 0, and the transition flag is marked $-i \geq -N$ (step 832). The SDB 500 is checked to determine if the source network security device has an entry for node $IP = A$ (step 834).

30 If there is such an entry, proceed with the dynamic key exchange (steps 808-822), the secured flag is set to 1 and the transition flag is set as described above.

If there is no entry for node A in the SDB, then the network security device 400 sends its static public key in a key-packet to node A and drops the original IP-packet (step 836). The device waits a predetermined time, such as five seconds, for a reply (step 838). Steps 836 and 838 may be repeated several, e.g., three
 5 times. While waiting for a response, the transition flag is $-i \geq -N$. If a reply is received (step 840), an entry is created in the SDB (step 842), the secured flag = 1 and the transition flag is 0. When the static key is received, the network security device calculates a common static key using its static key and a standard Diffie-Hellman technique. The transition flag is set to $-(N+2)$. Once the static
 10 common key is calculated, it is used to encrypt the dynamic key exchange (steps 808-822). The inventive device preferably uses the well-known Diffie-Hellman key exchange protocol.

If no reply is received, the secured flag = 2 and the transition flag in the entry in the DDB is 0 because the transition off (step 814).

15 Both the static and the dynamic key request maybe repeated N_{try} times at not less then t_{expire} time intervals (in a preferred embodiment they are set to 8 tries and 2 ms, respectively). Note that entries in the SDB are burned in and are permanent. Entries in the DDB may be volatile, that is, the entries may be overwritten or lost if the device 400 is turned off.

20 Note that if the second flag for another node is set at either 2, 3, or 4, the network security device will continue to attempt a dynamic key exchange every predetermined period, such as every five minutes.

Expiration of the Dynamic Keys and Synchronization

As indicated above, the dynamic keys have a predetermined lifespan. For
 25 example, new dynamic keys may be generated every 24 hours. When the lifespan expires, all of the dynamic common key entries, which were calculated using an expired dynamic key, for other nodes are incorrect. Thus, all secured flags in the DDB are marked as secured = 3. When the dynamic key of a network security device's 24 hours expires, a new dynamic key is generated. The secured flag is
 30 then changed back to 1 (or 2) when the next packet (sent to or received from that IP-address) initiates a successful dynamic key exchange.

Because the dynamic keys of each network security device have a particular lifespan, such as 24 hours, there may be a time difference between times when two device's keys expire. For example, if two devices in different time zones are both programmed to generate new dynamic keys at midnight, there may be several
5 hours difference between key expiration times. Thus, it is possible that one device's dynamic key may expire during a communication. Also, because Internet communications are connectionless, that is, the receiving party does not have to be connected to the sending party when the packet is transmitted, one or the other party's dynamic key may have expired before the packet is received.

10 One way to prevent this occurrence is to take into account this time difference. Referring back to FIG. 6, the DDB entry 600 contains an entry "time generated" 606, which indicates the time that the other device's dynamic key was generated. This is done by correcting the "time generated" entry by the time difference between the time the packet was sent (the time stamp entry 604 in the
15 DDB entry) and the time the packet is received (the present time).

Also, the time generated 606 entry indicates to the network security device 400 when the other party's dynamic key expires. Thus, when a communication between the nodes is initiated, it may be determined whether a new dynamic key exchange is warranted, rather than attempting to use an expired common dynamic
20 key.

During a dynamic key exchange, one party may have received the other party's dynamic key. The other side, however, may be calculating the common dynamic key and sending dynamic key requests encrypted with the static common key. To avoid having to drop the packet, if a received packet cannot be decrypted
25 with a dynamic key, the device tries to decrypt the packet using the static key. As a result, the packet is dropped only if the packet cannot be decrypted with the static key, that is, if it is an illegal packet.

Receiving a Key Packet

When a network security device receives an IP-packet containing another
30 party's static or dynamic public key (sent either as a reply to a key-request or as an initiation for a key exchange), the public key is extracted from the packet and sent to either the CPU 410 or the encryption module 418 for further processing.

WO 98/32065

There the shared secret-key is calculated from the device's own private key and the other party's just received public key.

As discussed above, these tasks are calculation-intensive, and it may be preferable to provide a separate structure, such as the encryption module 418, so that the throughput of the entire device is not affected.

Packet Processing

Fig. 9 is a flowchart 900 illustrating a packet handling algorithm utilized by the inventive network security device. Illustratively, the packet arrives with the source address IP = C (step 901). The packet may arrive from the connected host at interface 402 or from the network at interface 408.

First consider the case where the packet arrives from the host at interface 402. If the packet carries an ICMP (Internet Control Message Protocol) or IGMP (Internet Gateway Message Protocol) identification (step 902), the packet is passed to the interface 408 without encryption. However, the source MAC address in the packet is translated to the MAC address of interface 408 (step 904). ICMP and IGMP Packets are not addressed to a destination host. Rather these packets are utilized by intermediate entities in the network, e.g., routers, for various functions. The source IP address is checked to make sure that it is the same as the entry burned into the SDB 412 for the connected host. This prevents an adversary from posing as the connected host to gain access to secure communications. This is called preventing "IP spoofing" and is described in detail in U.S. Patent Application Serial No. 08/529,497. The discussion of preventing IP spoofing is incorporated herein by reference.

If the destination to which the packet is addressed is insecure, the packet is dropped (step 906, 908). The device may be in a secured/unsecured mode (special order). In such case the packet will be sent unchanged.

Next, it is determined if the packet contains a part of a message that has been fragmented (step 910). If the packet contains a fragment, the fragments are collected (step 912) and the message is encrypted (step 914). The encryption takes place using the common session key and an encipherment function. If the encrypted message is too long for the particular LAN (step 916), it is fragmented

(step 918). An encrypted packet is then transmitted to interface 408 for transmission into the network 100 (step 920).

An encrypted packet carries a signature in the protocol part of the IP header. This indicates that the packet is encrypted. The IP address of a packet is not encrypted, otherwise the packet could not be routed through the network.

The case where the packet arrives via the network at interface 408 is now considered. If the packet is an ICMP or IGMP packet (step 940) no decryption is necessary and the packet is sent to the first interface 402 (step 942). If the packet is a key exchange packet (step 944) the packet is processed according to the key exchange protocol (step 946). If the packet is not encrypted (step 948) the packet is dropped (step 950). The device may be in a secured/unsecured mode (special order). In such a case the packet will be sent to the client unchanged. If the packet is encrypted but the network security device does not have the key (step 952), the key exchange protocol is carried out (step 954) and the packet is dropped (step 956). If the key is available in the dynamic data base of the network security device, the packet is decrypted (step 958) and sent to interface 402 (step 960).

For packets received from the network the MAC address of the network security device is translated into the MAC address of the client. For packets received from the protected client, the MAC address of the client is translated into the MAC address of the network security device.

Outgoing Packets

As discussed above, the network security device 100 receives an IP-packet on the first interface 402, processes it, and sends it onto network 100 via the second interface 408.

FIG. 10 illustrates an IP packet 1010 (IP_{in}) received from host 404, an IP packet (IP_{out}) 1010 prepared by the network security device 400, and an encrypted IP_{out} packet 1030 transmitted by the second interface 408. As seen in FIG. 10, the IP_{in} packet 1000 includes a MAC header 1002, containing the host's 404 MAC address, an IP header 1004, containing the host's IP address, and a payload 1006 containing data. The IP_{out} packet 1010 includes a MAC header 1012 containing the network security device's MAC address, an IP header 1014 containing the

host's 404 IP address, a proprietary header 1016, a payload 1118 containing the data, and a proprietary tail 1020. Preferably, the data in the payload 1118 is compressed and the proprietary tail 1120 includes packet length, protocol fragment, and checksum information. The encrypted IP_{out} packet 1030 preferably
 5 has everything after the proprietary header 1016 encrypted, including the compressed data 1018 and the proprietary tail 1020.

FIG. 11 is a flowchart 1100 illustrating the processing of IP_{in} and IP_{out}.

- (a) Packet IP_{in} 1000 is received from the host 404 at the first interface 402 (step 1102).
- 10 (b) The IP and MAC headers are copied from IP_{in} to IP_{out} (step 1104).
- (c) The destination MAC address in IP_{in} is replaced by the client's MAC-address (step 1106).
- (d) Skip over the proprietary-header (step 1108).
- (e) Compress the data from IP_{in} to IP_{out} (step 1110). Preferably, the data
 15 is compressed using the LZRW1 compression algorithm.
- (f) Save original length, protocol, frag-info from IP_{in} into the proprietary tail (step 1112).
- (g) In the IP_{out} header, set do not frag = off, and set IP_{out}-protocol = 99 (indicating proprietary protocol) (step 1114).
- 20 (h) Calculate the checksum and save it in the proprietary tail 1120(step 1116).
- (i) Encrypt everything from after the proprietary header until the end of IP_{out} (step 1118).
- (j) Fill the proprietary-header in IP_{out}; set protocol = 191 (encrypted packet) and calculate the header-checksum (step 1120).
 25

Incoming Packets

For incoming packets, steps (b)-(j) are performed in reverse order.

Double Integrity Checks

The method illustrated in FIG. 11 provides a double integrity check. The
 30 checksum in the proprietary-header on the sender's side is calculated after the encryption and checked on the receiver's side before decryption, thus providing an integrity test of the encrypted data in transit.

The checksum in the proprietary-tail on the sender's side is calculated before encryption and checked on the receiver's side after decryption. This checksum provides strong authentication because the static and dynamic keys used to encrypt the checksum are known only by the two communicating devices. (Strong authentication is where one can prove it knows a secret without revealing the secret.) By using a decrypted checksum that agrees with the packet proves the sender and receiver share the same key.

If the encrypted tail checksum is replaced with a secure hash function, such as the well-known MD5 algorithm, after the packet is encrypted, it becomes a digital signature. Where the tail checksum is encrypted with a static common key, it verifies that the dynamic public key originated from the sender, thus authenticating the sender. When the tail checksum is encrypted with a dynamic common key, it also verifies that the packet originated from the sender, authenticating that the packet originated from the sender.

15 Modifications for Use With LANS

Referring again to FIG. 4B, the network security device 400' may be modified to protect a LAN 450 instead of a single host. These modifications are described below. In this illustrative embodiment, the network security device may protect a Class-C LAN having up to 254 clients (i.e., workstations 454, server 20 452, etc.), but other LAN types, such as Class-A and Class-B, are also contemplated by the invention.

During activation, the IP address burned into the flash memory 412 is the Class-C post of the client LAN's IP address. A default MAC address, such as Oxf may also be burned into the flash memory 412. This default MAC address is used 25 in the static key generation. Recall that the MAC address is used in the static key seed generation.

A LAN-type network security device 400' may build a MAC-table 460 which contains its clients' IP and MAC addresses. This table serves two functions. First, it prevents IP spoofing of any of the LAN device's 400' clients. Thus, if a packet 30 is received on the first interface 402 that does not have an IP or MAC address of one of the nodes in the LAN, that packet is dropped.

Second, it facilitates the delivery of packets to clients connected to the LAN 450. This permits packets to be sent from one protected client to another without the packet appearing at the second interface 408.

In short, a unique network security device has been disclosed. Finally, the 5 above described embodiments of the invention are intended to be illustrative only. Numerous alternative embodiments may be devised by those skilled in the art without departing from the scope of the following claims.

CLAIMS

I claim:

1. A network security device configured to protect at least one particular node, the node having a first physical layer address and an Internet address and which communicates via a network, comprising:
- 5
- a. a first interface connected to the at least one particular node and having said first physical layer address of the node;
 - b. a second interface connected to the network and having a second physical layer address, and
 - 10 c. a processing circuit connected to said first and second interfaces, said processing circuit:
 - (1) for a packet received at said first interface from said one particular node and the packet having a header containing a source address that is the Internet address of the at least one particular node and said first physical layer address of said one particular node, the circuit configured to:
 - 15 A. replace the first physical layer address contained in the received packet header with the second physical layer address;
 - 20 B. determine a checksum verifying the packet and saving the determined checksum in the packet; and
 - C. encrypting the packet including the checksum, but leaving the Internet address unencrypted and its position in the packet header unchanged;
 - 25 (2) for a packet received at said second interface from said network and the packet having a header containing a destination address that is the Internet address of the at least one particular node and said second physical layer address of said second interface, the circuit configured to:
 - 30 A. decrypt the packet including a received checksum
 - B. determine if the checksum verifies the packet; and

- 5 C. replace the second physical layer address contained in the received packet header with said first physical layer address of said at least one particular node before said packet is transmitted to the at least one particular node, and leaving the Internet address unencrypted and its position in the packet header unchanged.
- 10 2. The network security device of claim 1, wherein the processing circuit is further configured to:
- a. for a packet received at the first interface:
- (1) determine a second checksum verifying the encrypted packet; and
- (2) save the second checksum in an unencrypted portion of the packet; and
- 15 b. for a packet received at the second interface:
- (1) determine if the second checksum verifies the encrypted packet.
- 20 3. A method for transmitting a packet into a network comprising the steps of:
- a. generating a packet having a header containing a first media access control (MAC) address, an IP address of a destination, and user data,
- b. in a network security device which does no routing and is connected to said network, translating said first MAC address into a second
- 25 MAC address of said network security device,
- c. determining a checksum for the packet and saving the checksum in the packet
- d. encrypting the user data and the checksum, but not the IP address and retaining as unchanged said IP address and its position in said
- 30 header, and
- e. transmitting said packet into said network.

4. The method of claim 3, further comprising the steps of:
- a. determining a second checksum for the packet, including the encrypted user data and checksum;
 - b. saving the second checksum in an unencrypted portion of the packet.
- 5
5. A network security device connected between: (1) a node having an Internet address and (2) a communication network, the device comprising:
- (a) a first interface connected to at least one node, the first interface having a first media access control (MAC) address;
 - 10 (b) a second interface connected to the communication network and having a second MAC address;
 - (c) a processor connected to the first and second interfaces, the processor configured to:
 - 15 (1) receive a packet from the first interface, the packet having a transport layer header, a network layer header, and the first MAC address; the processor configured to:
 - A. replace the first MAC address with the second MAC address in the received packet,
 - B. determine a first checksum verifying the received packet and save the first checksum in the packet;
 - 20 C. encrypt the received transport layer header and the first checksum, and to not encrypt the received network layer header; and to transmit the packet to the second interface; and
 - 25 (2) receive a packet from the second interface, the packet having an encrypted transport layer header and second checksum, an unencrypted network layer header, and the second MAC address; the processor configured to:
 - A. replace the second MAC address with the first MAC address in the received packet;
 - 30 B. decrypt the packet including the transport layer header and the second checksum; and

C. to transmit the packet to the first interface.

6. A method for generating a secret key for a network security device configured to protect at least one host, the secret key being unique to that network security device, the method comprising the steps of:
- 5 a. deriving a seed based on at least one of an Internet protocol (IP) and physical layer address of the at least one host; and
- b. generating a random number based on the seed.
- 10 7. The method of claim 6, wherein the step of deriving the seed further comprises deriving the seed according to:
- $$\text{seed} = \text{IP} + \text{MAC}_l + \text{MAC}_h + \text{serial} + \text{time}$$
- where:
- IP = an IP address for the host;
- 15 MAC_l is a least significant portion of a physical layer address of the host;
- MAC_h is a most significant portion of host's physical layer address;
- serial is a serial number of the network security device; and
- time is a time the seed is derived.
- 20 8. The method of claim 6, wherein the step of generating a random number further comprises supplying the seed to a random number generator and using an output of the random number generator as the secret key.
9. A method for synchronizing a key exchange between a first network security device having a first dynamic key and a second network security device having a second dynamic key, said first and second dynamic keys having a predetermined lifespan and in which at least a first dynamic key of the first network security device may expire before being received by the second network security device, the method comprising:
- 25 a. including with the first dynamic key a time stamp indicating a time that the dynamic key was transmitted and a time that the dynamic key was generated;
- 30

- b. the second network security device receiving the first dynamic key, time stamp, and time the first dynamic key was generated;
- c. maintaining in the second network security device a database containing the received time stamp and time the first dynamic key was generated; and
- 5
- d. determining a difference between a time indicated in the received time stamp and a current time; and
- e. correcting the time that the first dynamic key was generated by the determined difference.
- 10
10. A network security device configured to protect a local area network (LAN) having a plurality of nodes, each node having a physical layer address and an Internet address, the LAN being in communication with a second network, the network security device comprising:
- 15
- a. a first interface connected to the LAN;
- b. a second interface connected to the second network and having a second physical layer address, and
- c. a processing circuit connected to said first and second interfaces, said processing circuit including a table of physical layer and Internet
- 20
- addresses of each of the plurality of nodes in the LAN;
- (1) for a packet received at said first interface from one of the plurality of nodes in the LAN and the packet having a header containing a source address that is the Internet address of the one of the plurality of nodes, a physical layer address of the one of the plurality of nodes, and a destination address, the
- 25
- circuit configured to:
- A. determine if the destination address is an Internet address of another node in the LAN;
- i. if so, transmit the packet to the destination node using the first interface;
- 30
- ii. if not, then replace the first physical layer address contained in the received packet header with the

- second physical layer address; and encrypt the packet leaving the Internet address unencrypted and its position in the packet header unchanged;
- 5 (2) for a packet received at said second interface from said network and the packet having a header containing a destination address that is the Internet address of one of the plurality of nodes and said second physical layer address of said second interface, the circuit configured to:
- 10 A. decrypt the packet;
- B. replace the second physical layer address contained in the received packet header with said physical layer address of said one of the plurality of nodes before the packet is transmitted to the one of the plurality of particular nodes.
- 15 11. The network security device of claim 10, wherein when a packet is received on the first interface, the processing circuit is further configured to compare at least one of the physical layer address and the Internet address in the received packet with the physical layer and Internet addresses in the table
- 20 to determine whether the packet originated from one of the plurality of nodes and, if not, dropping the packet.

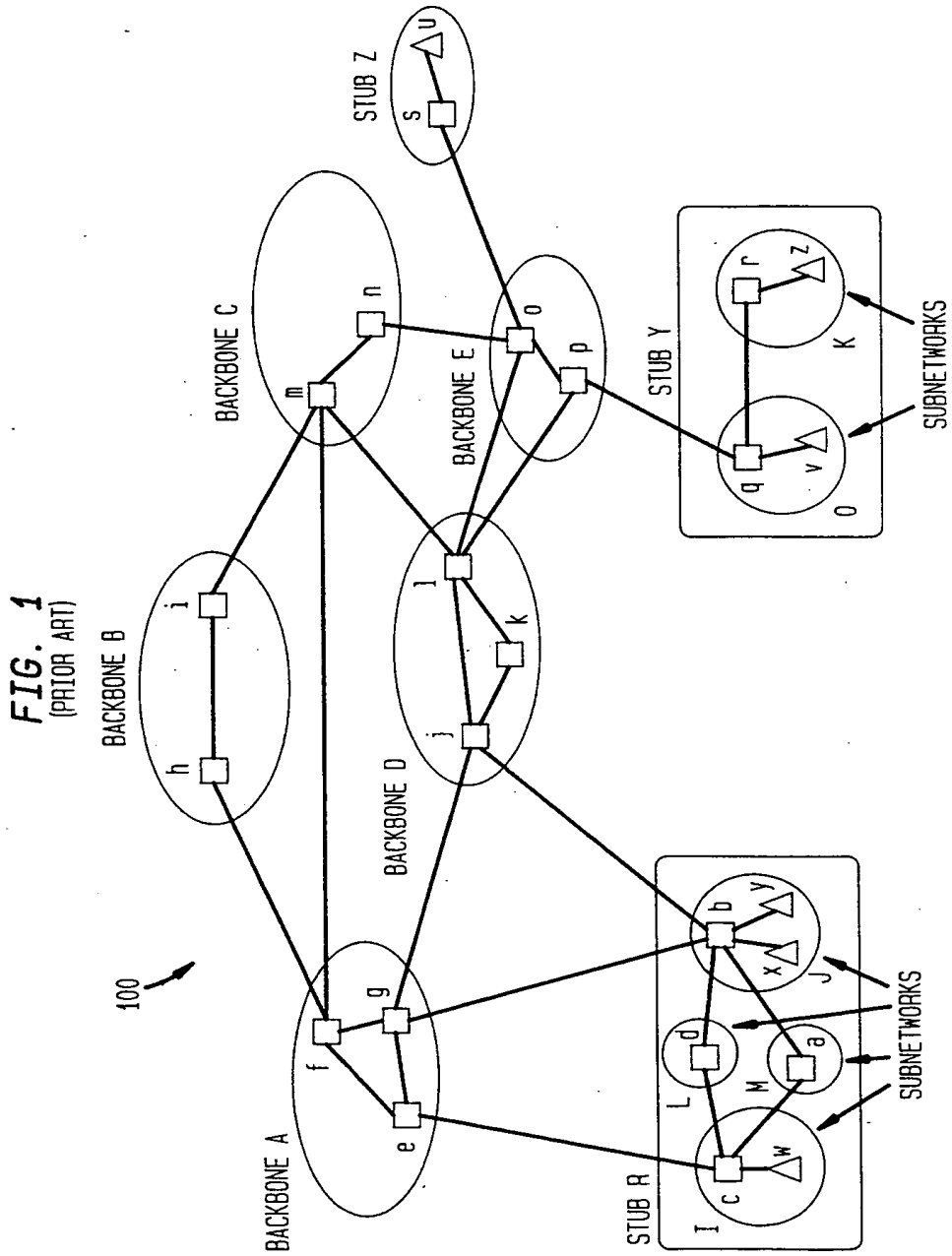

FIG. 1
(PRIOR ART)

100

SUBSTITUTE SHEET (RULE 26)

FIG. 2
(PRIOR ART)

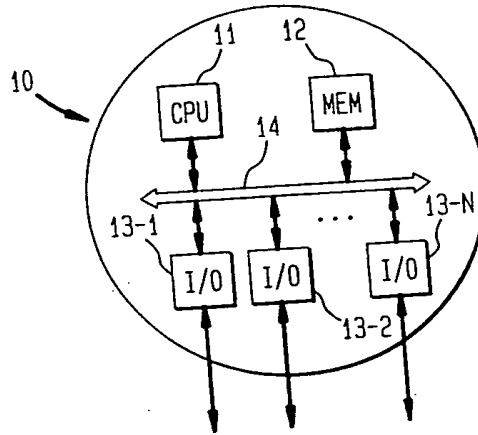

FIG. 3A
(PRIOR ART)

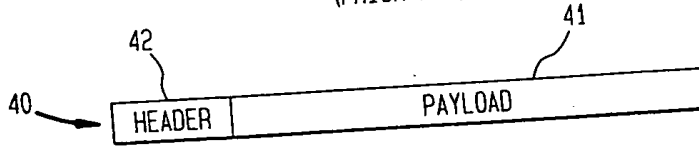
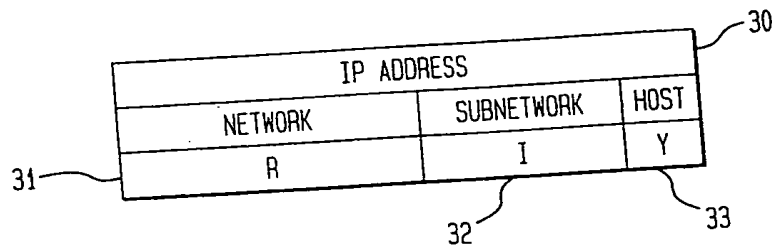

FIG. 3B
(PRIOR ART)



SUBSTITUTE SHEET (RULE 26)

3/9

FIG. 4A

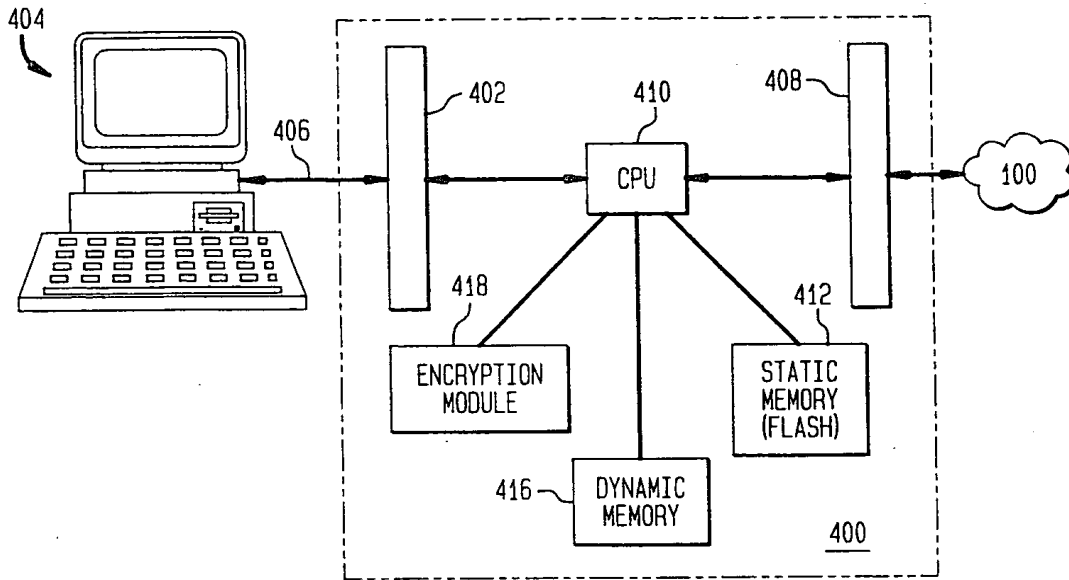
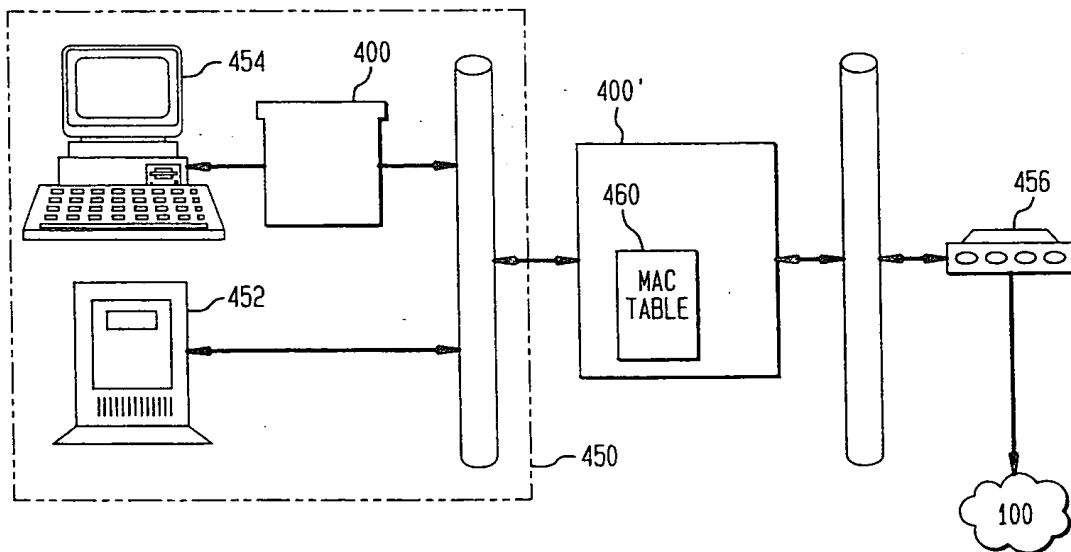

FIG. 4B



SUBSTITUTE SHEET (RULE 26)

FIG. 5

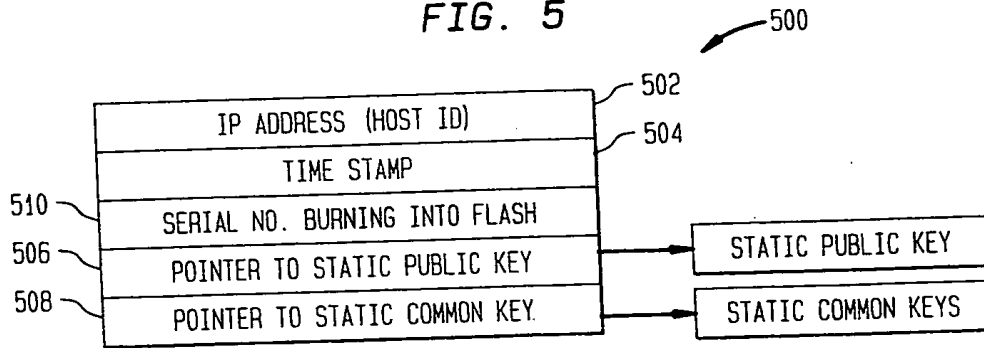
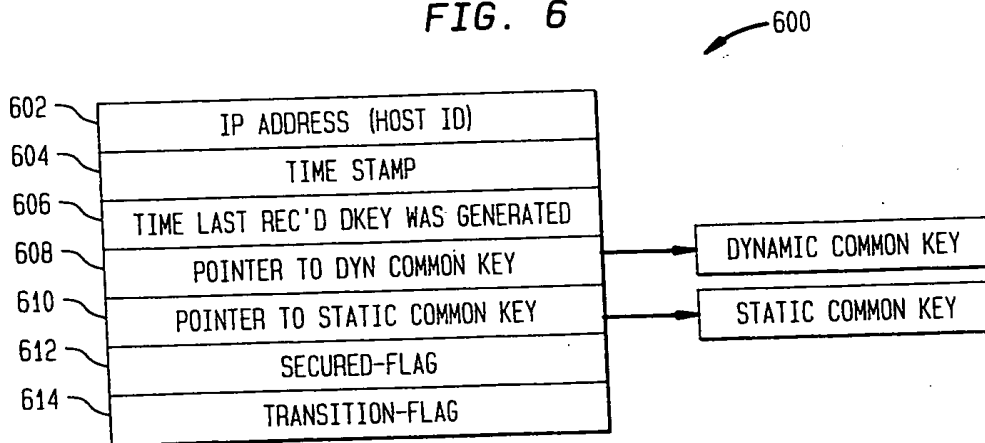

FIG. 6



SUBSTITUTE SHEET (RULE 26)

FIG. 7

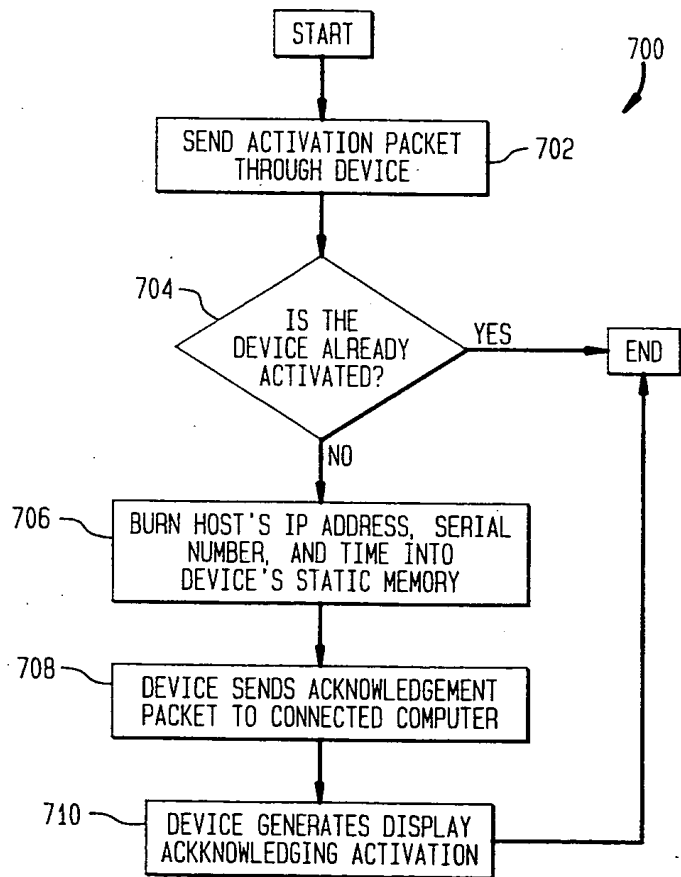
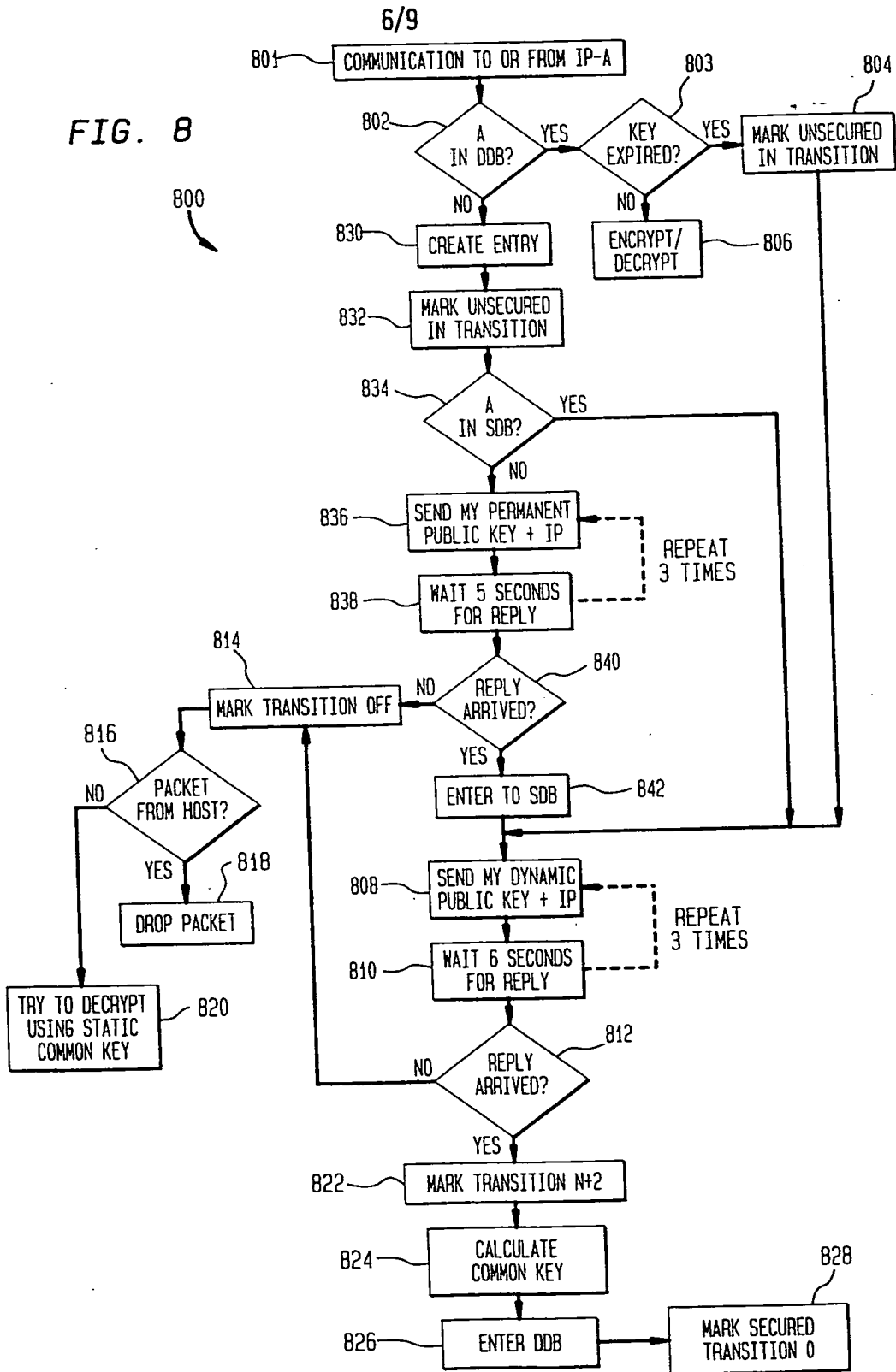
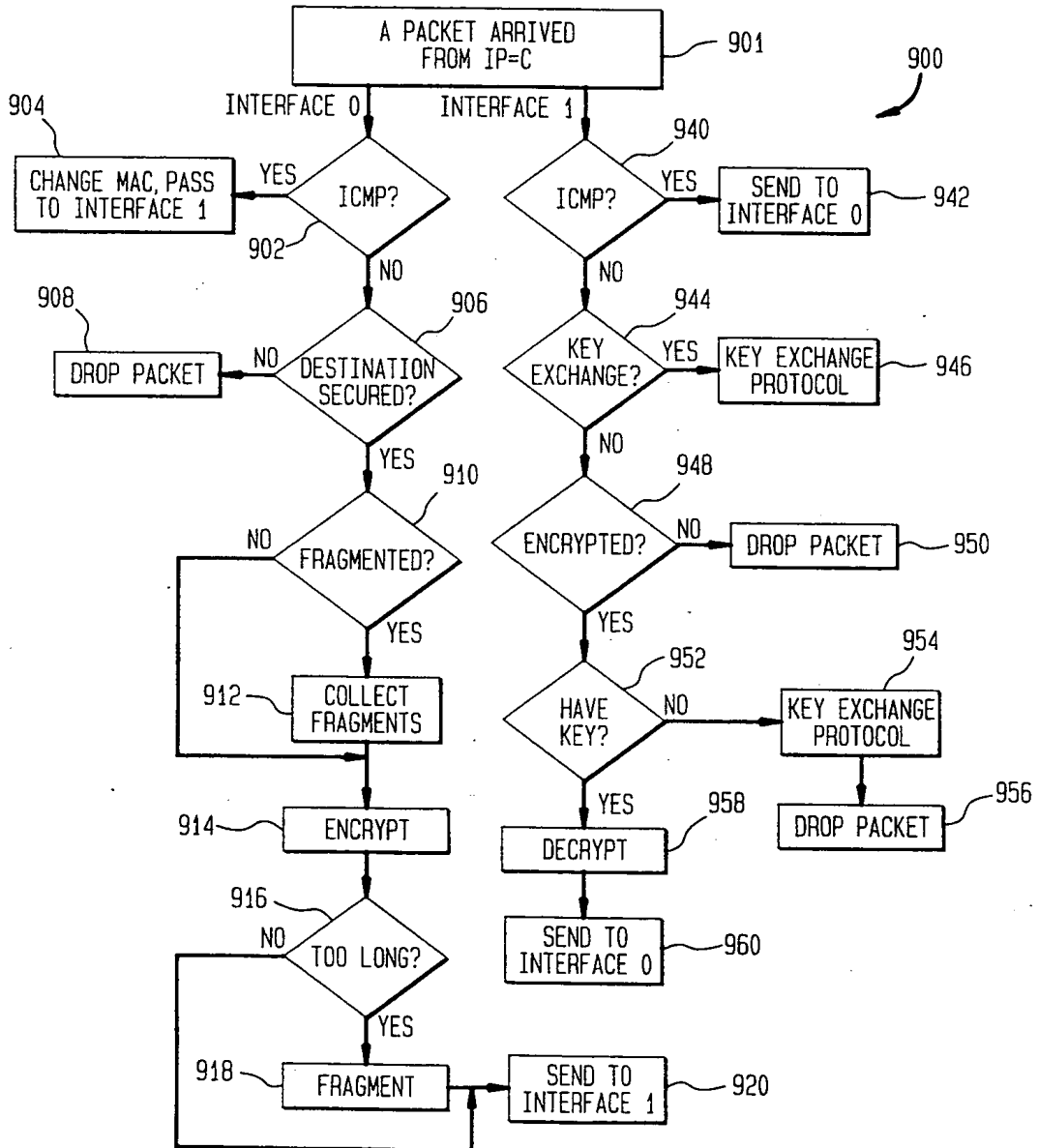

FIG. 8



SUBSTITUTE SHEET (RULE 26)

FIG. 9



SUBSTITUTE SHEET (RULE 26)

FIG. 10

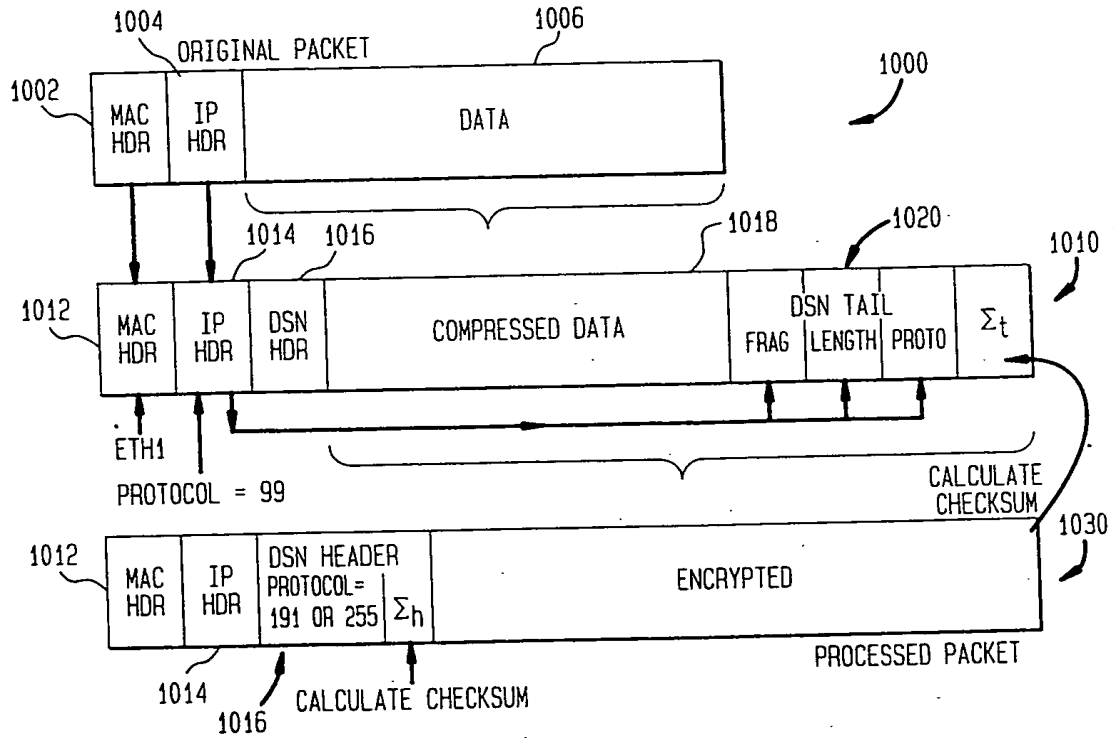

SUBSTITUTE SHEET (RULE 26)

9/9

FIG. 11

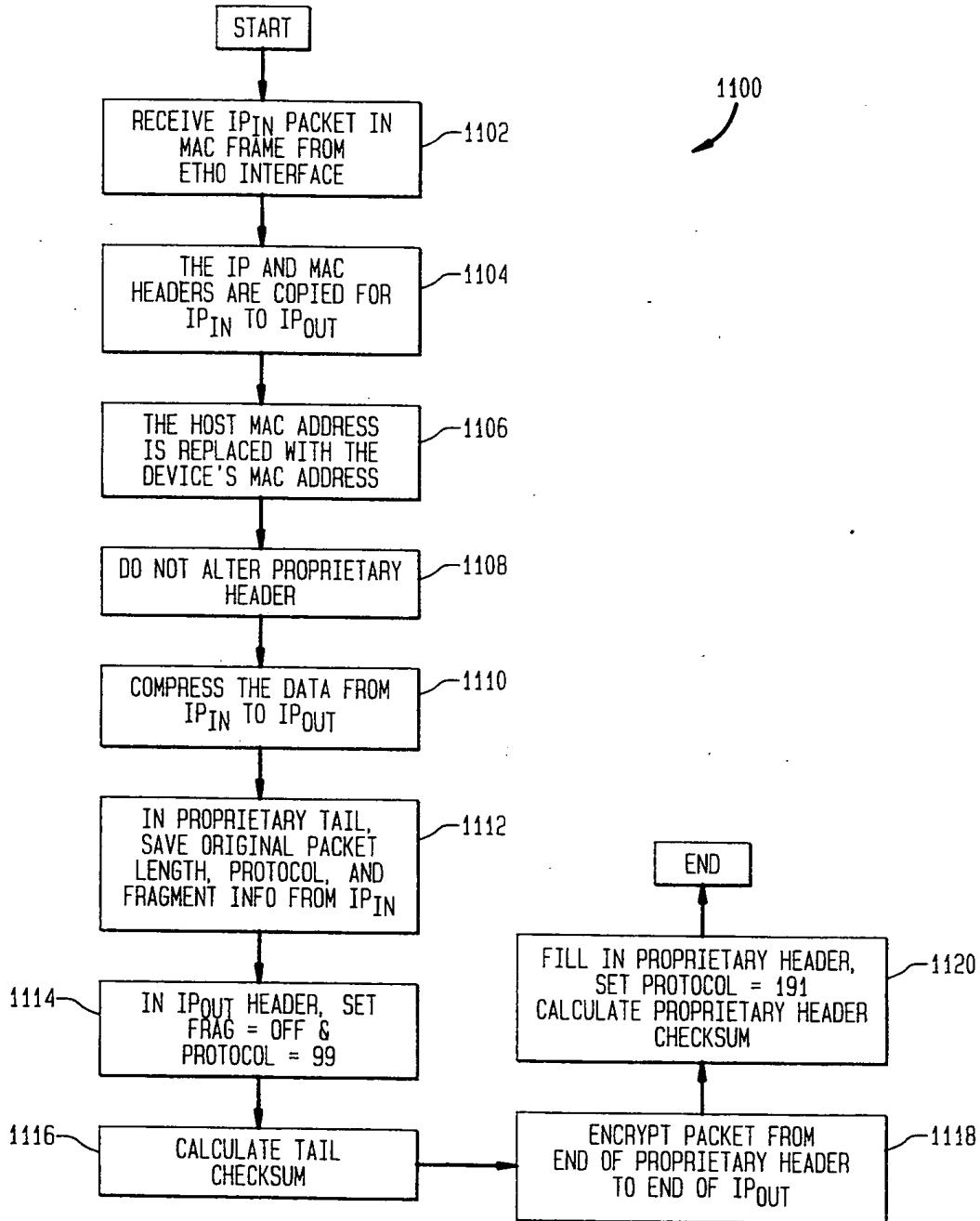

SUBSTITUTE SHEET (RULE 26)

PCT

WORLD INTELLECTUAL PROPERTY ORGANIZATION
International Bureau



INTERNATIONAL APPLICATION PUBLISHED UNDER THE PATENT COOPERATION TREATY (PCT)

(51) International Patent Classification 6 : H04L 12/22, 12/56	A3	(11) International Publication Number: WO 98/32065
		(43) International Publication Date: 23 July 1998 (23.07.98)
(21) International Application Number: PCT/US97/24201	(81) Designated States: AL, AU, BA, BB, BG, BR, CA, CN, CU, CZ, EE, GE, HU, IL, IS, JP, KP, KR, LC, LK, LR, LT, LV, MG, MK, MN, MX, NO, NZ, PL, RO, SG, SI, SK, SL, TR, TT, UA, UZ, VN, YU, ZW, ARIPO patent (GH, GM, KE, LS, MW, SD, SZ, UG, ZW), Eurasian patent (AM, AZ, BY, KG, KZ, MD, RU, TJ, TM), European patent (AT, BE, CH, DE, DK, ES, FI, FR, GB, GR, IE, IT, LU, MC, NL, PT, SE), OAPI patent (BF, BJ, CF, CG, CI, CM, GA, GN, ML, MR, NE, SN, TD, TG).	
(22) International Filing Date: 31 December 1997 (31.12.97)		
(30) Priority Data: 60/033,995 3 January 1997 (03.01.97) US		
(71) Applicant: FORTRESS TECHNOLOGIES, INC. [US/US]; Suite 650, 2701 North Rocky Point Drive, Tampa, FL 33607 (US).	Published <i>With international search report.</i>	
(72) Inventors: FRIEDMAN, Aharon; Apartment 4208, 2717 Seville Boulevard, Clearwater, FL 34624 (US). BOZOKI, Eva; Apartment 2113, 6161 North Memorial Highway, Tampa, FL 33615 (US).	(88) Date of publication of the international search report: 22 October 1998 (22.10.98)	
(74) Agents: RUBENSTEIN, Kenneth et al.; Meltzer, Lippe, Goldstein, Wolf & Schlissel, P.C., 190 Willis Avenue, Mineola, NY 11501 (US).		

(54) Title: IMPROVED NETWORK SECURITY DEVICE

(57) Abstract

A network security device (400) is connected between a protected client (404) and a network(100). The network security device (400) negotiates a session key with an other protected client. Then, all communications between the two clients are encrypted. The inventive device is self-configuring and locks itself to the IP address of its client. Thus, the client cannot change its IP address once set and therefore cannot emulate the IP address of another client. While a packet is transmitted from the protected host, the security device translates the MAC address of the client to its own MAC address before transmitting the packet into the network. Packets addressed to the host contain the MAC address of the security device. The security device translates its MAC address to the client's MAC address before transmitting the packet to the client.

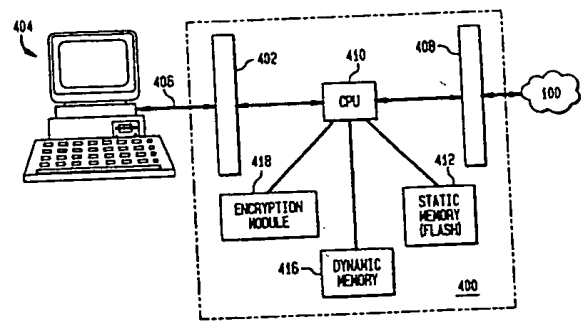

FOR THE PURPOSES OF INFORMATION ONLY

Codes used to identify States party to the PCT on the front pages of pamphlets publishing international applications under the PCT.

AL	Albania	ES	Spain	LS	Lesotho	SI	Slovenia
AM	Armenia	FI	Finland	LT	Lithuania	SK	Slovakia
AT	Austria	FR	France	LU	Luxembourg	SN	Senegal
AU	Australia	GA	Gabon	LV	Latvia	SZ	Swaziland
AZ	Azerbaijan	GB	United Kingdom	MC	Monaco	TD	Chad
BA	Bosnia and Herzegovina	GE	Georgia	MD	Republic of Moldova	TG	Togo
BB	Barbados	GH	Ghana	MG	Madagascar	TJ	Tajikistan
BE	Belgium	GN	Guinea	MK	The former Yugoslav	TM	Turkmenistan
BF	Burkina Faso	GR	Greece		Republic of Macedonia	TR	Turkey
BG	Bulgaria	HU	Hungary	ML	Mali	TT	Trinidad and Tobago
BJ	Benin	IE	Ireland	MN	Mongolia	UA	Ukraine
BR	Brazil	IL	Israel	MR	Mauritania	UG	Uganda
BY	Belarus	IS	Iceland	MW	Malawi	US	United States of America
CA	Canada	IT	Italy	MX	Mexico	UZ	Uzbekistan
CF	Central African Republic	JP	Japan	NE	Niger	VN	Viet Nam
CG	Congo	KE	Kenya	NL	Netherlands	YU	Yugoslavia
CH	Switzerland	KG	Kyrgyzstan	NO	Norway	ZW	Zimbabwe
CI	Côte d'Ivoire	KP	Democratic People's	NZ	New Zealand		
CM	Cameroon		Republic of Korea	PL	Poland		
CN	China	KR	Republic of Korea	PT	Portugal		
CU	Cuba	KZ	Kazakstan	RO	Romania		
CZ	Czech Republic	LC	Saint Lucia	RU	Russian Federation		
DE	Germany	LI	Liechtenstein	SD	Sudan		
DK	Denmark	LK	Sri Lanka	SE	Sweden		
EE	Estonia	LR	Liberia	SG	Singapore		

INTERNATIONAL SEARCH REPORT

International application No.
PCT/US97/24201

A. CLASSIFICATION OF SUBJECT MATTER
 IPC(6) :H04L 12/22, 12/56
 US CL :380/49, 21, 46
 According to International Patent Classification (IPC) or to both national classification and IPC

B. FIELDS SEARCHED
 Minimum documentation searched (classification system followed by classification symbols)
 U.S. : Please See Extra Sheet.

Documentation searched other than minimum documentation to the extent that such documents are included in the fields searched

Electronic data base consulted during the international search (name of data base and, where practicable, search terms used)
 APS-search terms: physical address, checksum, internet address, encrypt?, mac address.

C. DOCUMENTS CONSIDERED TO BE RELEVANT

Category*	Citation of document, with indication, where appropriate, of the relevant passages	Relevant to claim No.
E, A	US 5,757,924 A (FRIEDMAN et al) 26 May 1998 (26.05.98), col. 5, lines 4-44.	1-11
A	US 5,371,868 A (KONING et al) 06 December 1994 (06.12.94), Figure 2b.	1-5, 10-11
A	US 5,386,471 A (BIANCO) 31 January 1995 (31.01.95), col. 2, lines 51-68.	1-5, 10-11
A	US 5,432,850 A (ROTHENBERG) 11 July 1995 (11.07.95), col. 3, lines 46-57.	6-8.
A	US 5,550,984 A (GELB) 27 August 1996 (27.08.96), col. 4, lines 3-26.	1-5, 10-11
A	US 5,351,295 A (PERLMAN et al) 27 September 1994 (27.09.94), col. 2, lines 49-58.	9

Further documents are listed in the continuation of Box C. See patent family annex.

<p>* Special categories of cited documents:</p> <p>*A* document defining the general state of the art which is not considered to be of particular relevance</p> <p>*B* earlier document published on or after the international filing date</p> <p>*L* document which may throw doubts on priority claim(s) or which is cited to establish the publication date of another citation or other special reason (as specified)</p> <p>*O* document referring to an oral disclosure, use, exhibition or other means</p> <p>*P* document published prior to the international filing date but later than the priority date claimed</p>	<p>*T* later document published after the international filing date or priority date and not in conflict with the application but cited to understand the principle or theory underlying the invention</p> <p>*X* document of particular relevance; the claimed invention cannot be considered novel or cannot be considered to involve an inventive step when the document is taken alone</p> <p>*Y* document of particular relevance; the claimed invention cannot be considered to involve an inventive step when the document is combined with one or more other such documents, such combination being obvious to a person skilled in the art</p> <p>*A* document member of the same patent family</p>
Date of the actual completion of the international search 24 JUNE 1998	Date of mailing of the international search report 10 AUG 1998
Name and mailing address of the ISA/US Commissioner of Patents and Trademarks Box PCT Washington, D.C. 20231 Facsimile No. (703) 305-3230	Authorized officer <i>Gilberto Barrón Jr.</i> GILBERTO BARRÓN JR. Telephone No. (703) 305-1830

Form PCT/ISA/210 (second sheet)(July 1992)*

INTERNATIONAL SEARCH REPORT

International application No.
PCT/US97/24201

B. FIELDS SEARCHED

Minimum documentation searched

Classification System: U.S.

380/49, 21, 46, 23, 48

370/389, 392, 469



INTERNATIONAL APPLICATION PUBLISHED UNDER THE PATENT COOPERATION TREATY (PCT)

<p>(51) International Patent Classification ⁶ : H04B 7/005, 7/01, 7/015, 15/00</p>	<p>A1</p>	<p>(11) International Publication Number: WO 99/22463 (43) International Publication Date: 6 May 1999 (06.05.99)</p>
<p>(21) International Application Number: PCT/US98/22801 (22) International Filing Date: 27 October 1998 (27.10.98) (30) Priority Data: 08/959,409 28 October 1997 (28.10.97) US 09/079,535 15 May 1998 (15.05.98) US (71) Applicant: MOTOROLA INC. [US/US]; 1303 East Algonquin Road, Schaumburg, IL 60196 (US). (72) Inventors: GOLDBERG, Steven, Jeffrey; 4409 Foxfire Way, Fort Worth, TX 76133 (US). BUDNIK, Brian, Joseph; 6413 Old Mill Circle, Watauga, TX 76148 (US). SEXTON, Thomas, Aloysius; Apartment 224, 5333 Fossil Creek Boulevard, Fort Worth, TX 76137 (US). CARSELLO, Stephen, Rocco; 8204 Ranier Road, Fort Worth, TX 76137 (US). (74) Agents: BETHARDS, Charles, W. et al.; Motorola Inc., Intellectual Property Dept., 5401 North Beach Street/MS E230, Fort Worth, TX 76137 (US).</p>	<p>(81) Designated States: CA, CN, European patent (AT, BE, CH, CY, DE, DK, ES, FI, FR, GB, GR, IE, IT, LU, MC, NL, PT, SE). Published <i>With international search report. Before the expiration of the time limit for amending the claims and to be republished in the event of the receipt of amendments.</i></p>	

(54) Title: **LIMITING AN INTERVAL OF CARRIER CANCELLATION AND REDUCING ERRORS CAUSED BY INTERSYMBOL INTERFERENCE DURING A SIMULCAST TRANSMISSION**

(57) Abstract

In a messaging system having a plurality of simulcasting base transmitters (104), a plurality of pseudorandom sequence generators (216) are provided (402) for the plurality of base transmitters. The plurality of pseudorandom sequence generators are arranged (403) to ensure that they generate a plurality of pseudorandom sequences having sub-sequences that are different from one another during concurrent transmissions by the plurality of base transmitters. A cancellation-affecting parameter of the plurality of base transmitters is adjusted (404, 406, 408) in accordance with the plurality of pseudorandom sequences during the simulcast transmission from the plurality of base transmitters to limit intervals of carrier cancellation. In addition, a controller (512) controls (1106) at least two transmitters (702) to transmit at least two simulcast signals (902, 904) during a time period. The at least two simulcast signals produce intersymbol interference at a receiver. At least one of the transmitters changes (1108) its output amplitude during a portion of the time period, thereby altering the intersymbol interference during the portion of the time period.

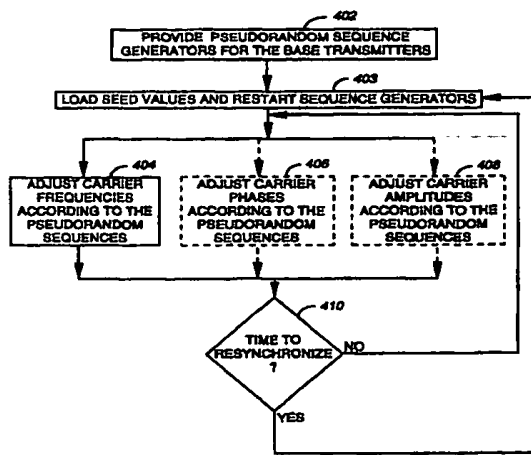

400

FOR THE PURPOSES OF INFORMATION ONLY

Codes used to identify States party to the PCT on the front pages of pamphlets publishing international applications under the PCT.

AL	Albania	ES	Spain	LS	Lesotho	SI	Slovenia
AM	Armenia	FI	Finland	LT	Lithuania	SK	Slovakia
AT	Austria	FR	France	LU	Luxembourg	SN	Senegal
AU	Australia	GA	Gabon	LV	Latvia	SZ	Swaziland
AZ	Azerbaijan	GB	United Kingdom	MC	Monaco	TD	Chad
BA	Bosnia and Herzegovina	GE	Georgia	MD	Republic of Moldova	TG	Togo
BB	Barbados	GH	Ghana	MG	Madagascar	TJ	Tajikistan
BE	Belgium	GN	Guinea	MK	The former Yugoslav Republic of Macedonia	TM	Turkmenistan
BF	Burkina Faso	GR	Greece	ML	Mali	TR	Turkey
BG	Bulgaria	HU	Hungary	MN	Mongolia	TT	Trinidad and Tobago
BJ	Benin	IE	Ireland	MR	Mauritania	UA	Ukraine
BR	Brazil	IL	Israel	MW	Malawi	UG	Uganda
BY	Belarus	IS	Iceland	MX	Mexico	US	United States of America
CA	Canada	IT	Italy	NE	Niger	UZ	Uzbekistan
CF	Central African Republic	JP	Japan	NL	Netherlands	VN	Viet Nam
CG	Congo	KE	Kenya	NO	Norway	YU	Yugoslavia
CH	Switzerland	KG	Kyrgyzstan	NZ	New Zealand	ZW	Zimbabwe
CI	Côte d'Ivoire	KP	Democratic People's Republic of Korea	PL	Poland		
CM	Cameroon	KR	Republic of Korea	PT	Portugal		
CN	China	KZ	Kazakstan	RO	Romania		
CU	Cuba	LC	Saint Lucia	RU	Russian Federation		
CZ	Czech Republic	LI	Liechtenstein	SD	Sudan		
DE	Germany	LK	Sri Lanka	SE	Sweden		
DK	Denmark	LR	Liberia	SG	Singapore		
EE	Estonia						

LIMITING AN INTERVAL OF CARRIER CANCELLATION AND REDUCING ERRORS CAUSED BY INTERSYMBOL INTERFERENCE DURING A SIMULCAST TRANSMISSION

5

Field of the Invention

This invention relates in general to radio communication systems, and more specifically to a method and apparatus in a messaging system
10 for limiting an interval of carrier cancellation and for reducing errors caused by intersymbol interference during a simulcast transmission.

Background of the Invention

15 Radio messaging systems have utilized simulcast transmissions from multiple transmitters for providing radio coverage to large geographic areas. During a simulcast transmission a receiver positioned midway between two transmitters often can receive signals from both transmitters. The resultant instantaneous sum of the two signals
20 depends upon their relative phase, and can be either larger or smaller than either signal alone. For example, if the two signals are substantially equal in amplitude and phase at the receiver, their resultant sum will be about twice the amplitude of either signal alone. If, however, the two signals are substantially equal in amplitude and 180 degrees out of phase,
25 their resultant sum can be so small as to be undetectable by the receiver, due to destructive cancellation of the two signals.

Modern messaging systems utilize forward error correcting codes and bit interleaving to allow messages to be transmitted successfully in the presence of brief fades and noise bursts. Thus, an error-free message
30 can be received even in the presence of intervals of destructive cancellation, provided that the intervals of destructive cancellation are sufficiently brief. To ensure that the intervals of destructive cancellation are sufficiently brief, the prior art messaging systems have employed a technique of permanently offsetting the carrier frequencies of adjacent
35 transmitters with respect to one another by a small, fixed amount, e.g., 15 to 100 Hz.

A problem with the technique of permanently offsetting the carrier frequencies of adjacent transmitters is that it requires additional system

-1-

planning and effort in setting up the radio messaging system.

Furthermore, the technique can cause difficulties when adding new transmitters to an existing system, because the frequency offsets of many of the existing transmitters may have to be readjusted. In addition, some
5 specific frequency offsets between adjacent transmitters, e.g., 200 Hz, are known to cause a higher word error rate, and should be avoided.

Good simulcast transmission has always required some form of delay equalization or launch time synchronization to ensure that the transmissions from different transmitters begin at the same time. For
10 low speed data, having the transmissions begin at the same time has usually been sufficient. For the high speed data which is becoming more prevalent today, having the transmissions begin at the same time is necessary, but not sufficient. The reason is that differential transmission delay introduced in the air links can become a significant fraction of the
15 symbol period when the symbol rate is high. When differential transmission delay becomes a significant fraction of the symbol period, intersymbol interference can occur when two or more simulcast signals arrive at the receiver with similar amplitudes. Such intersymbol interference can cause a high error rate in the received signal.

Thus, what is needed is a method and apparatus for limiting the
20 intervals of destructive cancellation during simulcast transmissions. The method and apparatus preferably will limit the intervals of destructive cancellation without utilizing the prior art technique of permanently offsetting the carrier frequencies of adjacent transmitters with respect to
25 one another.

What is further needed is a method and apparatus that can reduce errors caused by intersymbol interference during a simulcast transmission when two or more simulcast signals are received at similar
30 amplitudes with different transmission delays. The method and apparatus preferably will operate without requiring a custom tuning adjustment during installation and system setup.

Summary of the Invention

35 An aspect of the present invention is a method in a messaging system having a plurality of base transmitters, the method for limiting an interval of carrier cancellation at a reception point during a simulcast

transmission. The method comprises the step of providing a plurality of pseudorandom sequence generators for the plurality of base transmitters, the plurality of pseudorandom sequence generators arranged to ensure that they generate a plurality of pseudorandom sequences having sub-sequences that are different from one another during concurrent transmissions by the plurality of base transmitters. The method further comprises the step of adjusting a cancellation-affecting parameter of the plurality of base transmitters in accordance with the plurality of pseudorandom sequences during the simulcast transmission from the plurality of base transmitters.

Another aspect of the present invention is a base transmitter in a messaging system having a plurality of base transmitters, the base transmitter for limiting an interval of carrier cancellation at a reception point during a simulcast transmission. The base transmitter comprises a transmitter element for transmitting a message, and a processing system coupled to the transmitter element for controlling the transmitter element to transmit the message. The base transmitter further comprises an input interface coupled to the processing system for receiving the message; and a pseudorandom sequence generator coupled to the transmitter element, the pseudorandom sequence generator arranged to ensure that it generates a pseudorandom sequence having sub-sequences that are different from those generated in other ones of the plurality of base transmitters during concurrent transmissions by the plurality of base transmitters. The transmitter element is arranged such that the pseudorandom sequence generator adjusts a cancellation-affecting parameter of the transmitter element in accordance with the pseudorandom sequence during the simulcast transmission from the base transmitter.

A third aspect of the present invention is a method in a messaging system having a plurality of base transmitters, the method for limiting an interval of carrier cancellation at a reception point during a simulcast transmission. The method comprises the step of providing a plurality of pseudorandom sequence generators for the plurality of base transmitters, the plurality of pseudorandom sequence generators arranged to generate a plurality of pseudorandom sequences having sub-sequences that have more than a predetermined probability of being different from one another during concurrent transmissions by the plurality of base

transmitters. A parameter of the plurality of pseudorandom sequences is optimized according to a characteristic of a communication protocol utilized by the messaging system. The method further comprises the step of adjusting a cancellation-affecting parameter of the plurality of base
5 transmitters in accordance with the plurality of pseudorandom sequences during the simulcast transmission from the plurality of base transmitters.

A fourth aspect of the present invention is a method in a wireless communication system for reducing errors caused by intersymbol interference in at least two simulcast signals transmitted during a time
10 period. The at least two simulcast signals are received at similar amplitudes and have different transmission delays with respect to one another. The method comprises the steps of transmitting the at least two simulcast signals from a corresponding at least two transmitters, and changing an output amplitude of at least one of the at least two
15 transmitters during a portion of the time period, thereby altering the intersymbol interference during the portion of the time period.

A fifth aspect of the present invention is a transmitter in a wireless communication system for reducing errors caused by intersymbol interference in at least two simulcast signals transmitted during a time
20 period. The at least two simulcast signals are received by a receiver at similar amplitudes and have different transmission delays with respect to one another. The transmitter comprises a transmitter element for transmitting a first simulcast signal sent simultaneously with at least a second simulcast signal from another transmitter, and a modulator
25 coupled to the transmitter element for changing an output amplitude of the transmitter during a portion of the time period, thereby altering the intersymbol interference at the receiver during the portion of the time period.

A sixth aspect of the present invention is a controller in a wireless communication system for reducing errors caused by intersymbol
30 interference in at least two simulcast signals transmitted during a time period. The at least two simulcast signals are received at similar amplitudes and have different transmission delays with respect to one another. The controller comprises a network interface for receiving a
35 message from a message originator, and a processing system coupled to the network interface for processing the message. The controller further comprises a base station interface coupled to the processing system for

controlling a transmitter to transmit one of the at least two simulcast signals. The processing system is programmed to control the transmitter to change an output amplitude of the transmitter during a portion of the time period, thereby altering the intersymbol interference during the
5 portion of the time period.

Brief Description of the Drawings

FIG. 1 is an electrical block diagram of a messaging system in
10 accordance with the present invention.

FIG. 2 is an electrical block diagram of an exemplary implementation of a base transmitter in accordance with the present invention.

FIG. 3 is a diagram depicting amplitude and relative phase of two carriers offset in frequency in accordance with the present invention.

15 FIG. 4 is a flow chart depicting operation of the messaging system in accordance with the present invention.

FIG. 5 is an electrical block diagram of an exemplary wireless communication system in accordance with the present invention.

20 FIG. 6 is an electrical block diagram of an exemplary controller in accordance with the present invention.

FIG. 7 is an electrical block diagram of an exemplary base station in accordance with the present invention.

FIG. 8 is a timing diagram depicting intersymbol interference in a prior art wireless communication system.

25 FIG. 9 is a timing diagram depicting reduced intersymbol interference in the wireless communication system in accordance with the present invention.

FIG. 10 is an exemplary protocol diagram in accordance with the present invention.

30 FIG. 11 is a flow diagram depicting operation of the exemplary wireless communication system in accordance with the present invention.

Detailed Description of the Drawings

35

Referring to FIG. 1, an electrical block diagram of a messaging system in accordance with the present invention comprises a plurality of

subscriber units 102, which communicate by radio with a fixed portion of the radio system, comprising a plurality of base transmitters 104 and a plurality of controllers 110. The base transmitters 104 are coupled via communication links 106 to the plurality of controllers 110 for control by and communication with the plurality of controllers 110 utilizing well-known techniques. The controllers 110 are coupled to a home controller 120 via communication links 122, 124, and via a conventional communication network 108 for receiving selective call messages from the home controller 120. The home controller 120 and the controllers 110 preferably communicate by utilizing a well-known protocol, e.g., the Telocator Network Paging Protocol (TNPP), the Wireless Messaging transfer protocol (WMtp™), or the InterPaging Networking Protocol (IPNP). It will be appreciated that, alternatively, the home controller 120 and the controller 110 can be collocated. The home controller 120 is preferably coupled via telephone links 126 to a public switched telephone network 112 (PSTN) for receiving the messages from message originators utilizing, for example, a telephone 114 or a personal computer 116 to originate the messages. It will be appreciated that, alternatively, other types of communication networks, e.g., packet switched networks, local area networks, and the Internet can be utilized as well for transporting originated messages to the home controller 120. The hardware of the home controller 120 is preferably similar to the Wireless Messaging Gateway (WMG™) Administrator! paging terminal, while the hardware of the controllers 110 is preferably similar to that of the RF-Conductor!™ message distributor, both manufactured by Motorola, Inc. of Schaumburg, IL. The hardware of the base transmitters 104 is preferably similar to that of the Nucleus® and RF-Orchestra!® transmitters manufactured by Motorola, Inc. It will be appreciated that other similar hardware can be utilized as well for the home controller 120, the controllers 110, and the base transmitters 104. It will be further appreciated that the present invention can be applied to both one-way and two-way selective call messaging systems.

The protocol utilized for transmitting the messages between the base transmitters 104 and the subscriber units 102 is preferably similar to Motorola's well-known FLEX™ family of digital selective call signaling protocols. These protocols utilize well-known error detection and error correction techniques and are therefore tolerant to bit errors occurring during transmission,

provided that the bit errors are not too numerous in any one code word. It will be appreciated that other similar messaging protocols can be used as well.

Referring to FIG. 2, an electrical block diagram depicts an exemplary implementation of the base transmitter 104 in accordance with the present invention. The base transmitter 104 comprises an antenna 204 for emitting a radio signal comprising a message. The base transmitter 104 further comprises a conventional transmitter element 208 coupled to the antenna 204 for transmitting the message, and a processing system 206 coupled to the transmitter element 208 for controlling the transmitter element 208 to transmit the message. The processing system is further coupled to a conventional pseudorandom sequence generator 216, which is also coupled to the transmitter element 208. The pseudorandom sequence generator 216 is arranged to ensure that it generates a pseudorandom sequence having sub-sequences that are different from those generated in other ones of the plurality of base transmitters during concurrent transmissions by the plurality of base transmitters, as described further below. Preferably, the pseudorandom sequence generator 216 is further arranged to provide a pseudorandom sequence identical to that of other base transmitters of the plurality of base transmitters, but initialized, concurrently with the other base transmitters, with a seed value different from that of the other base transmitters. It will be appreciated that, alternatively, the pseudorandom sequence generator 216 can be arranged to provide a pseudorandom sequence that is different from that of other base transmitters 104 of the plurality of base transmitters by, for example, enabling different feedback taps on the pseudorandom sequence generators 216 associated with different base transmitters 104. In addition, the pseudorandom sequence generator 216 preferably has at least a predetermined minimum number of stages, e.g., 20 stages. This preference facilitates allowing the base transmitters 104 to be concurrently initialized with different seed values 226 derived, for example, from the serial number of the base transmitters 104. It also will be appreciated that, alternatively, the pseudorandom sequence generator 216 can be incorporated into the processing system 206, where its functions can be performed in software.

The transmitter element 208 is arranged such that the pseudorandom sequence generator 216 adjusts a cancellation-affecting parameter of the transmitter element 208 in accordance with the

pseudorandom sequence during a simulcast transmission from the base transmitter 104. More specifically, the transmitter element 208 preferably includes a conventional frequency modulator (not shown) coupled to the pseudorandom sequence generator 216 such that the pseudorandom
5 sequence generator 216 adjusts the carrier frequency of the base transmitter 104 in accordance with the pseudorandom sequence. In the simplest case, the pseudorandom sequence generator 216 cooperates with the transmitter element 208 to adjust the carrier frequency of the base transmitter 104 to one of two levels, e.g., ± 50 Hz, about a predetermined
10 nominal carrier frequency. It will be appreciated that, alternatively, the pseudorandom sequence generator 216 and the transmitter element 208 can be arranged to adjust the carrier frequency to one of N predetermined levels in accordance with the pseudorandom sequence, N being an integer greater than unity. It will be further appreciated that,
15 alternatively, the transmitter element 208 can be arranged such that another cancellation-affecting parameter of the base transmitter 104, e.g., the carrier phase or the carrier amplitude, is adjusted in accordance with the pseudorandom sequence, through well-known techniques. It also will be appreciated that, alternatively, the transmitter element 208 can be
20 arranged such that the pseudorandom sequence generator 216 adjusts at least two cancellation-affecting parameters selected from a group of cancellation-affecting parameters consisting of the carrier frequency, the carrier phase, and the carrier amplitude. In addition, it will be appreciated that the pseudorandom sequence may have to be filtered to
25 prevent instantaneous shifts of the cancellation-affecting parameter(s).

Preferably, the pseudorandom sequence generator 216 is further arranged to optimize a parameter of the plurality of pseudorandom sequences according to a characteristic of the communication protocol utilized by the messaging system, such that the intervals of destructive
30 cancellation will exist only long enough to potentially destroy, i.e., change the value of, less than a predetermined number of bits, e.g., two bits, of a given (interleaved) code word, which will fall within the error correction capability of the protocol. This essentially moves the bit errors around, distributing them randomly such that the forward error correction is very
35 likely to correct all the errors caused by the intervals of destructive cancellation.

For example, consider the FLEX protocol, which uses (32,21) BCH code words interleaved such that there are 5 ms intervals between bits corresponding to the same code word. Each block of interleaved code words lasts 160 ms. Consider the case of no dithering and no frequency offsets and a 1 Hz frequency error between two adjacent FM transmitters. The interval of destructive cancellation may last on the order of 100 ms, which will destroy most code word bits (exceeding the forward error correction capability) in 1 or 2 interleaved blocks of the transmission, yet leaving another 4 or 5 interleaved blocks error free. In this condition little benefit is derived from the forward error correction. Now consider the use of pseudorandom frequency dithering in accordance with the present invention, e.g., ± 50 Hz about a nominal frequency, with the duration of each dither set to 7.5 ms, for example. An interval of destructive cancellation lasting 7.5 ms and repeating no more frequently than every 160 ms will destroy, on average, 3/4 bit from each code word. If a random phase difference between two signals generates an interval of destructive cancellation with a probability of 0.1 (as derived further below), then, on average, a destructive phase condition will occur 1.6 times per code word in each block, advantageously allowing a greatly increased benefit from forward error correction coding.

Again referring to FIG. 2, the processing system 206 is further coupled to a conventional clock 202 for generating a timing signal for the base transmitter 104. The accuracy of the timing signal preferably is sufficient to maintain synchronization of the pseudorandom sequence generator 216 within a small time tolerance, e.g., 100 microseconds, between resynchronizations of the pseudorandom sequence generator 216. It will be appreciated that, alternatively, the timing signal can be derived from a Global Positioning Satellite (GPS) receiver. The processing system 206 is also coupled to a conventional input interface 214 for receiving the message via the communication link 106.

The processing system 206 comprises a conventional processor 210 and a conventional memory 212. The memory 212 includes locations for storing messages 222 received through the input interface 214 and, preferably, a pseudorandom sequence seed value 226 derived, for example, from a serial number uniquely assigned by the factory to the base transmitter 104. The memory 212 also includes software elements

for message processing 224 and pseudorandom sequence synchronization 228 in accordance with the present invention.

Referring to FIG. 3, a diagram 300 depicting amplitude (represented by length) and relative phase (θ) of two carriers A1, A2 offset in frequency in accordance with the present invention and received by a receiver at a reception point between two of the base transmitters 104. Assume, for example, that the frequency of the carrier A2 is higher than that of the carrier A1. The result is that the phase of A2 is changing faster with time than that of A1. Periodically, the relative phase θ at the receiver is such that A2 enters the shaded area defined as the zone of destructive cancellation 302. The zone of destructive cancellation 302 preferably is defined, by way of example, to correspond to

$$0.9\pi < \theta < 1.1\pi.$$

15

As θ traverses 2π for each full revolution, one can conclude that for a fixed, nonzero frequency difference between A1 and A2 the probability that A2 is in the zone of destructive cancellation 302 at a randomly chosen instant of time is $P = 0.1$. For a pseudorandomly varied frequency difference between A1 and A2 in accordance with the present invention the probability that A2 is in the zone of destructive cancellation 302 at a randomly chosen instant of time is also $P = 0.1$.

20

The instantaneous power at the receiver is

25

$$P(t) = (A1 + A2\cos(\theta))^2 + (A2\sin(\theta))^2.$$

If $A1 = A2 = 1$, the average power is 2.0. At 0.9π and 1.1π the instantaneous power is approximately 0.1. Thus, within the defined zone of destructive cancellation 302 the instantaneous power is approximately 13 dB or more below the average power. While there is no way to prevent the two carriers A1 and A2 from entering the zone of destructive cancellation 302, it is highly desirable to minimize their stay in the zone, as is advantageously accomplished in accordance with the present invention, as described further below. It will be appreciated that, alternatively, other exemplary ranges of θ can be utilized to define the zone of destructive cancellation 302.

35

FIG. 4 is a flow chart 400 depicting operation of the messaging system in accordance with the present invention. The flow chart 400 begins with providing 402 the pseudorandom sequence generators 216 for the base transmitters 104. After the messaging system is powered up, the processing systems 206 access the seed values 226 corresponding to each of the base transmitters 104. The processing systems 206 then load 403 the seed values 226 and simultaneously restart the pseudorandom sequence generators 216. The restarting of the pseudorandom sequence generators 216 is preferably synchronized by the communication protocol to recur, for example, at the top of each hour. Concurrently restarting the pseudorandom sequence generators 216 periodically in this manner with different seed values 226 advantageously allows identical-sequence pseudorandom sequence generators 216 to be utilized for the base stations, while ensuring that the pseudorandom sequences contain subsequences that are different from one another during concurrent transmissions by the base transmitters 104 (due to the sequences being offset from one another by the different seed values 226). It will be appreciated that, alternatively, the pseudorandom sequence generators 216 can comprise different-sequence pseudorandom sequence generators to ensure that the pseudorandom sequences generated thereby are different from one base transmitter 104 to the next.

Next, the processing systems 206 preferably begin adjusting the carrier frequencies 404 of the corresponding transmitter elements 208 according to the pseudorandom sequences. Alternatively, the processing systems 206 can adjust another cancellation-affecting parameter, such as the carrier phases 406 and/or the carrier amplitudes 408 in addition to, or in lieu of, adjusting the carrier frequencies. For the case of frequency or phase adjustment, the processing systems 206 preferably are programmed to ensure a uniformly distributed phase between 0 and 2π . The processing systems 206 also check 410 whether it is time to resynchronize the pseudorandom sequence generators 216. If so, the flow returns to step 403. If not, the flow returns to the appropriate ones of the adjusting steps 404, 406 and 408.

Simulations in accordance with the present invention have demonstrated that by continuously adjusting a cancellation-affecting parameter of the base stations in accordance with the present invention, the intervals of destructive carrier cancellation advantageously are

limited in length and are randomly dispersed throughout the interleaved transmission blocks of the communication protocol, thereby substantially reducing the word error rate. The simulations have further demonstrated that no other carrier frequency offsetting technique is
5 needed to meet performance objectives. In addition, by randomizing the starting points of the pseudorandom sequences through the use of seed values derived from a random number source, which can include the base station serial numbers, no additional system planning effort is required for adjusting the base stations relative to one another to limit
10 carrier cancellation.

FIG. 5 is an electrical block diagram of an exemplary wireless communication system in accordance with the present invention, comprising a fixed portion 502 including a controller 512 and a plurality of base stations 516, the wireless communication system also including a plurality of receivers
15 522. The base stations 516 preferably communicate with the receivers 522 utilizing conventional radio frequency (RF) signals for sending simulcast transmissions in accordance with the present invention, as will be explained further below. The base stations 516 are coupled by communication links 514 to the controller 512, which controls the base stations 516.

20 The hardware of the controller 512 is preferably a combination of the Wireless Messaging Gateway (WMG™) Administrator! paging terminal, and the RF-Conductor!™ message distributor manufactured by Motorola, Inc., and includes software modified in accordance with the present invention. The base stations 516 comprise a transmitter preferably similar to the RF-Orchestra!
25 transmitter, modified in accordance with the present invention, and can include, in two-way wireless communication systems, the RF-Audience!™ receiver manufactured by Motorola, Inc. The receivers 522 are preferably similar to the Advisor Gold™ and Pagefinder™ wireless communication units, also manufactured by Motorola, Inc. It will be appreciated that other
30 similar hardware can be utilized as well for the controller 512, the base stations 516, and the receivers 522.

Each of the base stations 516 transmits RF signals to the receivers 522 via an antenna 518. The RF signals transmitted by the base stations 516 to the receivers 522 (outbound messages) comprise selective call addresses
35 identifying the receivers 522, and voice and data messages originated by a caller, as well as commands originated by the controller 512 for adjusting operating parameters of the radio communication system.

The controller 512 preferably is coupled by telephone links 501 to a public switched telephone network (PSTN) 510 for receiving selective call message originations therefrom. Selective call originations comprising voice and data messages from the PSTN 510 can be generated, for example, from a
5 conventional telephone 511 or a conventional computer 517 coupled to the PSTN 510. It will be appreciated that, alternatively, other types of communication networks, e.g., packet switched networks, the Internet, and local area networks, can be utilized as well for transporting originated messages to the controller 512.

10 The over-the-air protocol utilized for the transmissions is preferably selected from Motorola's well-known FLEX™ family of digital selective call signaling protocols. These protocols utilize well-known error detection and error correction techniques and are therefore tolerant to bit errors occurring during transmission, provided that the bit errors are not too numerous. It
15 will be appreciated that other suitable protocols can be used as well. It will be further appreciated that, while one embodiment for practicing the present invention is a one-way wireless communication system, the present invention is applicable also to a two-way wireless communication system.

FIG. 6 is an electrical block diagram depicting an exemplary
20 controller 512 in accordance with the present invention. The controller 512 comprises a network interface 618 for receiving a message from a message originator via the telephone links 501. The network interface 618 is coupled to a processing system 610 for controlling and communicating with the network interface 618. The processing system is
25 coupled to a base station interface 604 for controlling and communicating with the base stations 516 via the communication links 514. The processing system 610 is also coupled to a conventional clock 630 for providing a timing signal to the processing system 610. The processing system 610 comprises a conventional computer 612 and a conventional
30 mass medium 614, e.g., a magnetic disk drive, programmed with information and operating software in accordance with the present invention. The mass medium 614 comprises a subscriber database 620, including information about the receivers 522 controlled by the controller 512. The mass medium 614 also includes a message processing element
35 622 for programming the processing system 610 to process messages for the receivers 522 in a conventional manner. In accordance with the present invention, the mass medium 614 also includes a transmitter

output amplitude control element 624 for programming the processing system to control the transmitter 702 (FIG. 7) of the base stations 516 to change an output amplitude of the transmitter 702 during a portion of a time period during which simulcast transmissions are sent, thereby altering the intersymbol interference during the portion of the time period.

FIG. 7 is an electrical block diagram of an exemplary base station 516 in accordance with the present invention. The base station 516 comprises the antenna 518 for radiating a signal comprising a message. The antenna 518 is coupled to a transmitter 702 for transmitting the message. The transmitter 702 preferably comprises a conventional frequency shift keyed (FSK) transmitter element 708 for transmitting a first simulcast signal sent simultaneously with at least a second simulcast signal from another transmitter 702 (as coordinated by the controller 512 through well-known techniques). It will be appreciated that, alternatively, other types of transmitter elements for demodulating other types of modulated signals can be utilized as well for the transmitter element 708. The transmitter 702 further comprises a conventional amplitude modulator 703 coupled to the transmitter element 708 for changing an output amplitude of the transmitter 702 during a portion of the time period of the first simulcast signal, thereby altering the intersymbol interference at the receiver during the portion of the time period. The transmitter 702 is coupled to a processing system 706 for processing the message and for controlling the transmitter 702 in accordance with the present invention. A conventional controller interface 714 preferably is also coupled to the processing system 706 for interfacing with the controller 512 via the communication link 514 through well-known techniques. In addition, a conventional clock 707 is coupled to the processing system 706 for providing a timing signal thereto.

The processing system 706 comprises a conventional processor 710 and a conventional memory 712. The memory 712 comprises software elements and other variables for programming the processing system 706 in accordance with the present invention. The memory 712 includes a transmitter control element 722 for controlling the transmitter 702 through well-known techniques. In addition, the memory 712 includes a message processing element 724 for programming the processing system 706 to process the message in a conventional manner. The memory 712

further comprises a transmitter output amplitude control element 726 for cooperating with the modulator 703 to control the output amplitude of the transmitter 702 in accordance with the present invention, as described further below.

5 FIG. 8 is an exemplary timing diagram 800 depicting intersymbol interference in a prior art wireless communication system. The diagram 800 depicts amplitude versus time of a first signal 802 from a first simulcast transmitter and a second signal 804 from a second simulcast transmitter, the second signal 804 identical to, but delayed with respect to, 10 the first signal 802. When the first and second signals 802, 804 are received by a receiver at nearly the same amplitudes, e.g., less than 4 dB of difference, the received signal 806 can comprise indeterminant areas 808 where the received bit cannot be decoded. When the indeterminant areas 808 occupy more than about 50% of the symbol period (corresponding to a differential delay of 25% of the symbol period), receiver sensitivity begins 15 to be reduced slightly. When the indeterminant areas increase to 100% of the symbol period (corresponding to a differential delay of 50% of the symbol period), receiver sensitivity is reduced to zero.

 FIG. 9 is an exemplary timing diagram 900 depicting reduced intersymbol interference in the wireless communication system in 20 accordance with the present invention. The diagram 900 depicts amplitude versus time of a first signal 902 and a second signal 904. A "nominal" value of the amplitude of the first and second signals is represented by the dashed lines 910. Note that during a portion of the time period of the first and second signals 902, 904, the amplitude is 25 changed above and/or below the nominal value, preferably by adjusting the output amplitude of the transmitter 702 by the modulator 703 under control of the processing system 706, in accordance with the present invention. When the nominal values of the first and second signals 902, 30 904 would be received by a receiver at nearly the same amplitudes, the advantageous effect of changing the output amplitudes of the first and second signals 902, 904 is demonstrated by the decoded signal 906. Note that the indeterminant areas 908 advantageously are reduced in number compared to the diagram 800. The reason for the reduced number of 35 indeterminant areas 908 is that when the amplitudes of the first and second signals 902, 904 are different by more than about 4 dB, receiver

"capture" causes one of the signals to dominate, and the intersymbol interference goes away.

FIG. 10 is an exemplary protocol diagram 1000 in accordance with the present invention. This protocol is used by the controller 912 to
5 communicate to the base station 916 how the transmitter 702 is to change its output amplitude during simulcast transmissions. The diagram 1000 comprises a synchronization portion 1002 for synchronizing the base station 916 with the communications of the controller 912, using well-known techniques. The diagram 1000 further comprises a type indication
10 1004 for indicating the message type, e.g., output amplitude control command. In addition, the diagram 1000 includes a command 1006 for controlling the output amplitude configuration of the base station transmitter 702. This protocol advantageously allows the base station 916 to be reconfigured from time to time with regard to how it changes the
15 output amplitude of its transmissions in accordance with the present invention. As an alternative, the base station 916 can be pre-programmed, either in the field or during manufacture, with fixed instructions as to how the transmitter 702 should change its output amplitude during simulcast transmissions.

20 FIG. 11 is a flow diagram 1100 depicting operation of the exemplary wireless communication system in accordance with the present invention. The diagram 1100 preferably begins with the controller 912 communicating with the base station 916 to control 1102 the transmitter 1102 to change the output amplitude of its transmissions during a portion
25 of the time period of each simulcast transmission. Simulations have shown that relatively small changes in the output amplitude, e.g. about ± 0.5 dB, can produce a sizable, e.g., two to one, improvement in word error rate. Alternatively, the transmitter 1102 can be arranged 1104 during installation and setup, or during manufacture, to change the
30 output amplitude during a portion of the time period of each simulcast transmission. However the transmitter 1102 is programmed, the controller 912 then controls the base stations 916 to send a simulcast transmission. The transmitter 1102 then performs 1106 according to its programmed instructions for changing the output amplitude. Preferably,
35 the transmitter 1102 changes the output amplitude as a predetermined function of time, in synchronism with the symbols transmitted by the transmitter 1102.

In one embodiment, the transmitter 1102 is arranged such that the output amplitude of a central portion of each symbol does not change, while the output amplitude of non-central portions of the symbol do change. This technique exploits the fact that with normally encountered differential delay characteristics, intersymbol interference occurs primarily in the non-central portions of the symbols. In another embodiment, the transmitted signal comprises an error correcting code that can correct a predetermined number of errors in a code block, and the transmitter 1102 changes the output amplitude according to a pseudorandom sequence having a predetermined number of states, e.g., two states, during a transmission of the code block. In this embodiment, it is preferred that the transmitters 1102 in the wireless communication system utilize pseudorandom sequences that are offset from one another, so that different transmitters 1102 do not adjust their output amplitudes identically at every step of the sequence. In yet another embodiment, the transmitter 1102 is arranged to repeat a change to the output amplitude for a number of symbols, wherein the number of symbols is determined from an encoding characteristic employed by the wireless communication system, e.g., the length of an error correcting code block.

Regardless which embodiment in accordance with the present invention is used, an overall objective is to reduce errors due to intersymbol interference. When used with an error correcting code, the present invention often can reduce the number of received errors sufficiently to change an uncorrectable number of errors into a correctable number of errors, thereby advantageously salvaging a message which would otherwise have been corrupted.

Thus, it should be clear from the preceding disclosure that the present invention provides a method and apparatus for limiting the intervals of destructive cancellation during simulcast transmissions. The method and apparatus advantageously limits the intervals of destructive cancellation without utilizing the administratively difficult prior art technique of permanently offsetting the carrier frequencies of adjacent transmitters with respect to one another. In addition, the present invention provides a method and apparatus that advantageously reduces errors caused by intersymbol interference during a simulcast transmission when two or more simulcast signals are received at similar amplitudes with different transmission delays. The method and

apparatus operates without requiring a custom tuning adjustment during installation and system setup.

Many modifications and variations of the present invention are possible in light of the above teachings. Thus, it is to be understood that, within the scope of the appended claims, the invention can be practiced other than as described herein above for the exemplary embodiments.

What is claimed is:

CLAIMS

1. A method in a messaging system having a plurality of base transmitters, the method for limiting an interval of carrier cancellation at a reception point during a simulcast transmission, the method
5 comprising the steps of:

providing a plurality of pseudorandom sequence generators for the plurality of base transmitters, the plurality of pseudorandom sequence generators arranged to ensure that they generate a plurality of
10 pseudorandom sequences having sub-sequences that are different from one another during concurrent transmissions by the plurality of base transmitters; and

adjusting a cancellation-affecting parameter of the plurality of base transmitters in accordance with the plurality of pseudorandom sequences during the simulcast transmission from the plurality of base
15 transmitters.

2. A base transmitter in a messaging system having a plurality of base transmitters, the base transmitter for limiting an interval of carrier
20 cancellation at a reception point during a simulcast transmission, the base transmitter comprising:

a transmitter element for transmitting a message;
a processing system coupled to the transmitter element for
controlling the transmitter element to transmit the message;

25 an input interface coupled to the processing system for receiving the message; and

a pseudorandom sequence generator coupled to the transmitter element, the pseudorandom sequence generator arranged to ensure that it generates a pseudorandom sequence having sub-sequences
30 that are different from those generated in other ones of the plurality of base transmitters during concurrent transmissions by the plurality of base transmitters,

wherein the transmitter element is arranged such that the pseudorandom sequence generator adjusts a cancellation-affecting
35 parameter of the transmitter element in accordance with the pseudorandom sequence during the simulcast transmission from the base transmitter.

3. The base transmitter of claim 2, wherein the transmitter element is further arranged such that the pseudorandom sequence generator adjusts a carrier frequency of the base transmitter.

5

4. The base transmitter of claim 2, wherein the transmitter element is further arranged such that the pseudorandom sequence generator adjusts a carrier phase of the base transmitter.

10

5. The base transmitter of claim 2, wherein the transmitter element is further arranged such that the pseudorandom sequence generator adjusts a carrier amplitude of the base transmitter.

15

6. The base transmitter of claim 2, wherein the transmitter element is further arranged such that the pseudorandom sequence generator adjusts at least two cancellation-affecting parameters selected from a group of cancellation-affecting parameters consisting of a carrier frequency, a carrier phase, and a carrier amplitude.

20

7. The base transmitter of claim 2, wherein the pseudorandom sequence generator is further arranged to optimize a parameter of the plurality of pseudorandom sequences according to a characteristic of a communication protocol utilized by the messaging system.

25

8. The base transmitter of claim 2, wherein the pseudorandom sequence generator is further arranged to provide a pseudorandom sequence identical to that of other base transmitters of the plurality of base transmitters but initialized, concurrently with the other base transmitters, with a seed value different from that of the other base transmitters.

30

9. The base transmitter of claim 2, wherein the pseudorandom sequence generator is further arranged to provide a pseudorandom sequence that is different from that of other base transmitters of the plurality of base transmitters.

35

10. The base transmitter of claim 2, wherein the pseudorandom sequence generator has at least a predetermined minimum number of stages.

5 11. The base transmitter of claim 2,
wherein the transmitter element is further arranged to adjust the cancellation-affecting parameter to one of N predetermined levels in accordance with the pseudorandom sequence, N being an integer greater than unity.

10 12. A method in a messaging system having a plurality of base transmitters, the method for limiting an interval of carrier cancellation at a reception point during a simulcast transmission, the method comprising the steps of:

15 providing a plurality of pseudorandom sequence generators for the plurality of base transmitters, the plurality of pseudorandom sequence generators arranged to generate a plurality of pseudorandom sequences having sub-sequences that have more than a predetermined probability of being different from one another during concurrent
20 transmissions by the plurality of base transmitters, wherein a parameter of the plurality of pseudorandom sequences is optimized according to a characteristic of a communication protocol utilized by the messaging system; and

25 adjusting a cancellation-affecting parameter of the plurality of base transmitters in accordance with the plurality of pseudorandom sequences during the simulcast transmission from the plurality of base transmitters.

13. A method in a wireless communication system for reducing errors caused by intersymbol interference in at least two simulcast signals transmitted during a time period, the at least two simulcast signals
5 received at similar amplitudes and having different transmission delays with respect to one another, the method comprising the steps of:
transmitting the at least two simulcast signals from a corresponding at least two transmitters; and
changing an output amplitude of at least one of the at least
10 two transmitters during a portion of the time period, thereby altering the intersymbol interference during the portion of the time period.

14. A transmitter in a wireless communication system for reducing errors caused by intersymbol interference in at least two simulcast signals
15 transmitted during a time period, the at least two simulcast signals received by a receiver at similar amplitudes and having different transmission delays with respect to one another, the transmitter comprising:
a transmitter element for transmitting a first simulcast signal
20 sent simultaneously with at least a second simulcast signal from another transmitter; and
a modulator coupled to the transmitter element for changing an output amplitude of the transmitter during a portion of the time period, thereby altering the intersymbol interference at the receiver
25 during the portion of the time period.

15. The transmitter of claim 14, wherein the modulator is arranged to change the output amplitude in synchronism with a symbol transmitted from the transmitter.
30

16. The transmitter of claim 14, wherein the modulator is arranged to change the output amplitude as a predetermined function of time.

17. The transmitter of claim 14,
wherein the modulator is arranged to change the output
amplitude in synchronism with a symbol transmitted from the
transmitter, such that the output amplitude of a central portion of the
symbol does not change, while the output amplitude of non-central
portions of the symbol do change.
18. The transmitter of claim 14,
wherein the first simulcast signal comprises an error
correcting code that can correct a predetermined number of errors in a
code block, and
wherein the modulator is arranged to change the output
amplitude according to a pseudorandom sequence having a
predetermined number of states during a transmission of the code block.
19. The transmitter of claim 14, wherein the modulator is arranged
to repeat a change to the output amplitude for a number of symbols,
wherein the number of symbols is determined from an encoding
characteristic employed by the wireless communication system.
20. A controller in a wireless communication system for reducing
errors caused by intersymbol interference in at least two simulcast signals
transmitted during a time period, the at least two simulcast signals
received at similar amplitudes and having different transmission delays
with respect to one another, the controller comprising:
a network interface for receiving a message from a message
originator;
a processing system coupled to the network interface for
processing the message; and
a base station interface coupled to the processing system for
controlling a transmitter to transmit one of the at least two simulcast
signals,
wherein the processing system is programmed to control the
transmitter to change an output amplitude of the transmitter during a
portion of the time period, thereby altering the intersymbol interference
during the portion of the time period.

1/6

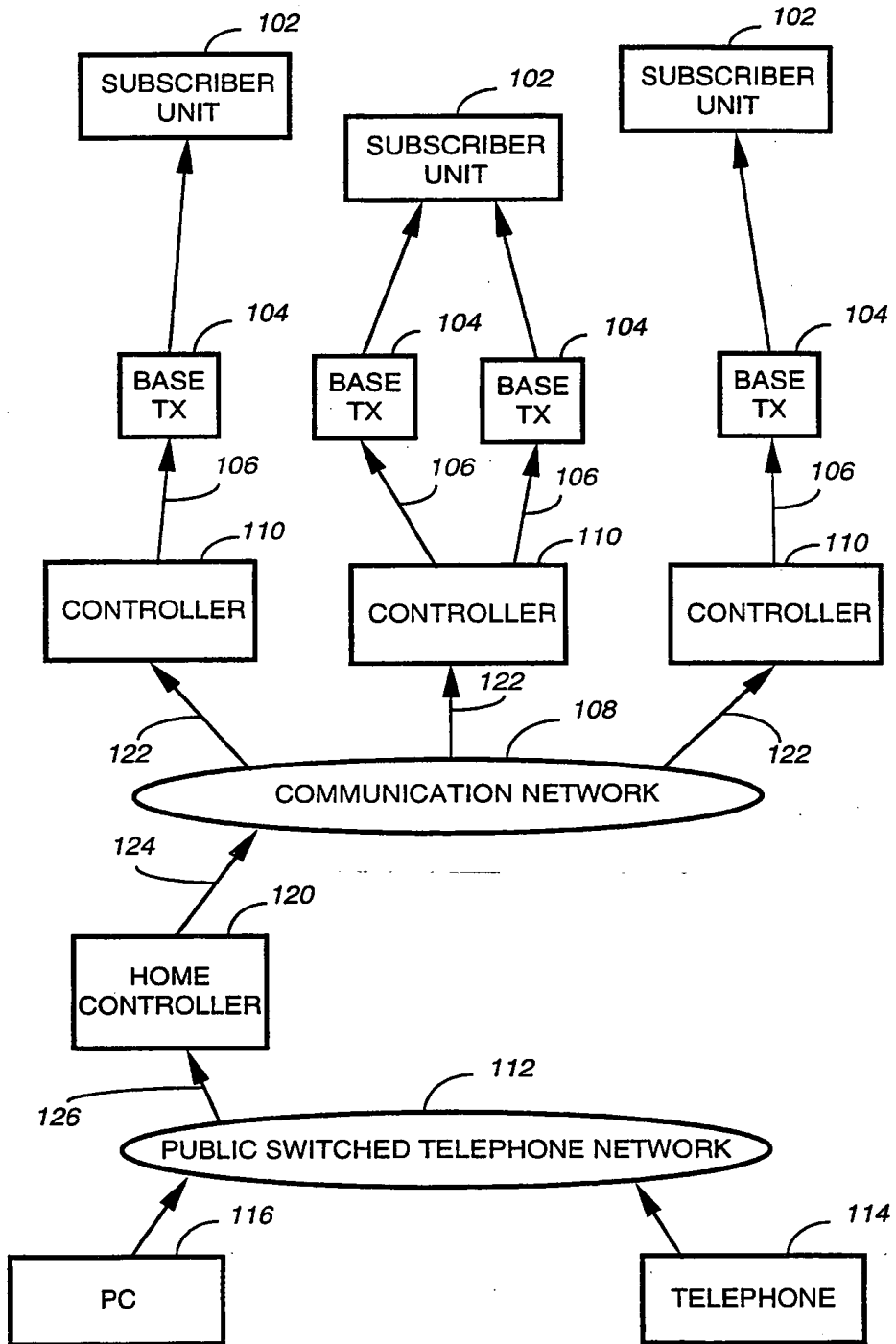
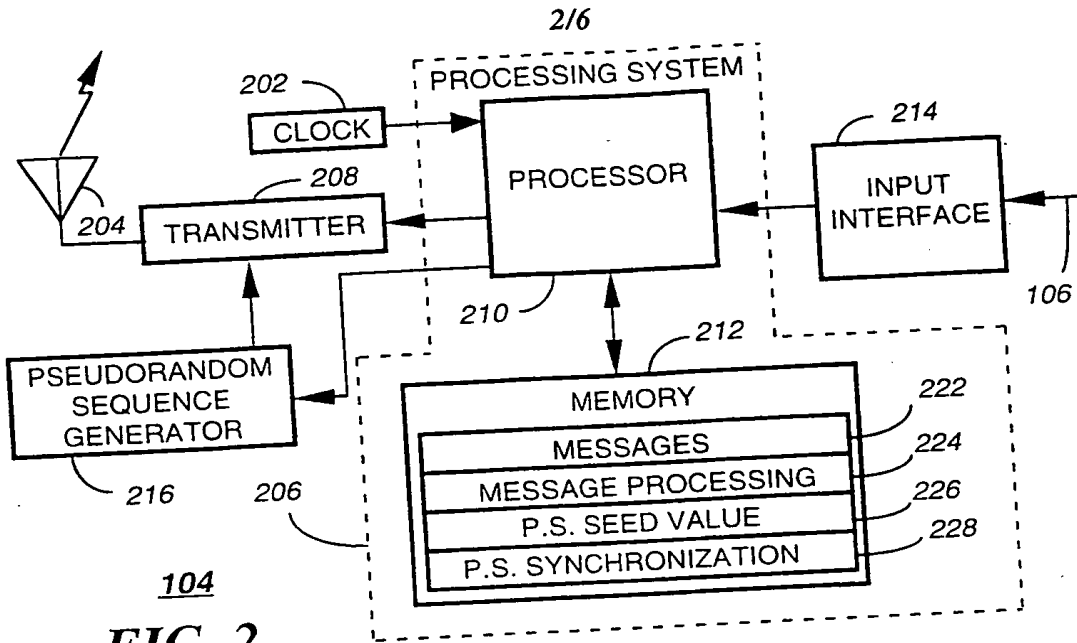
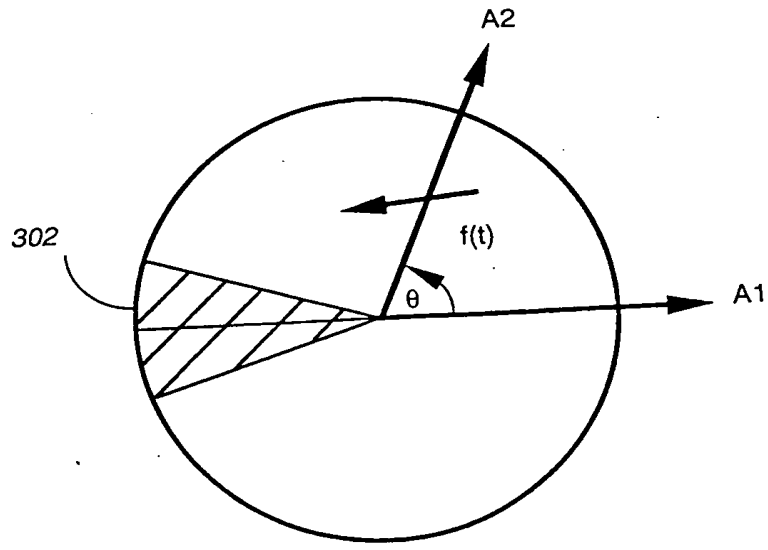

FIG. 1



104
FIG. 2



300
FIG. 3

3/6

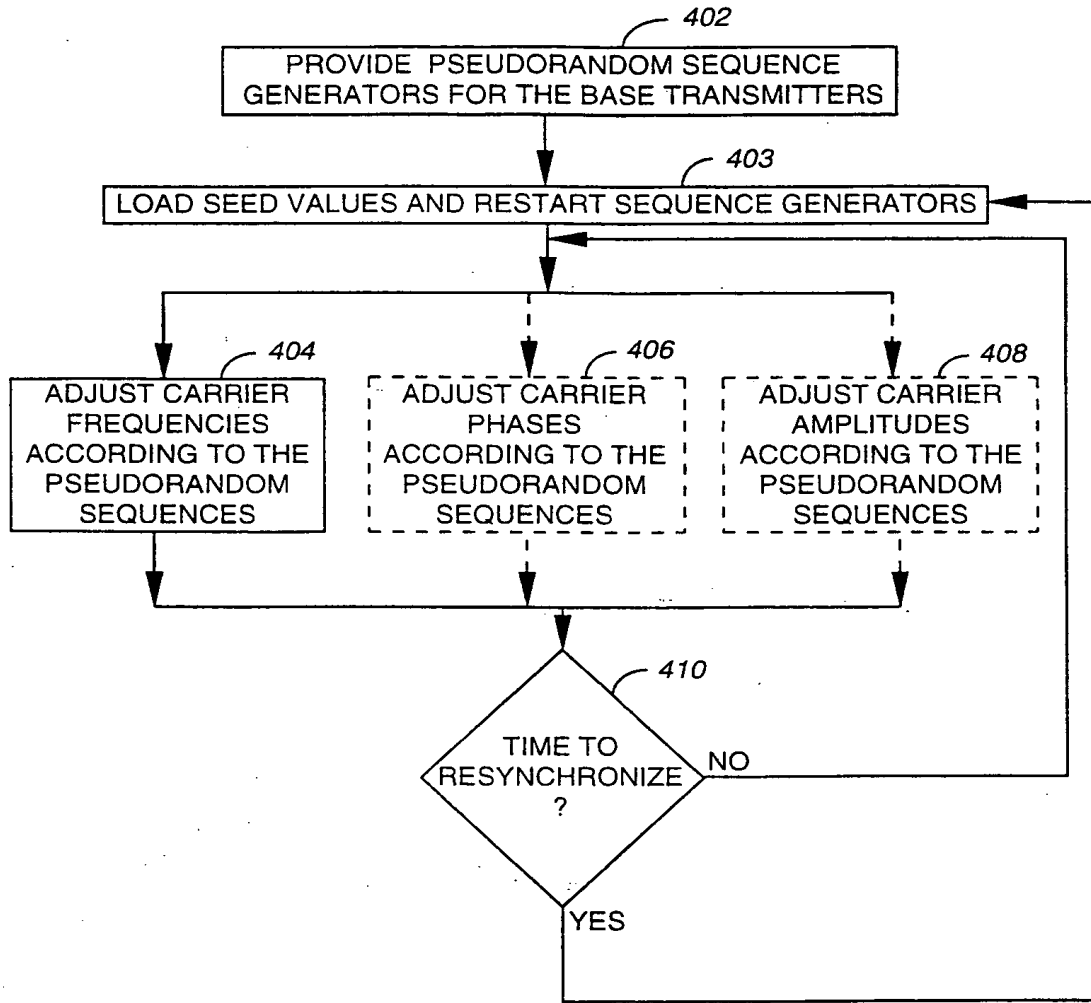

400

FIG. 4

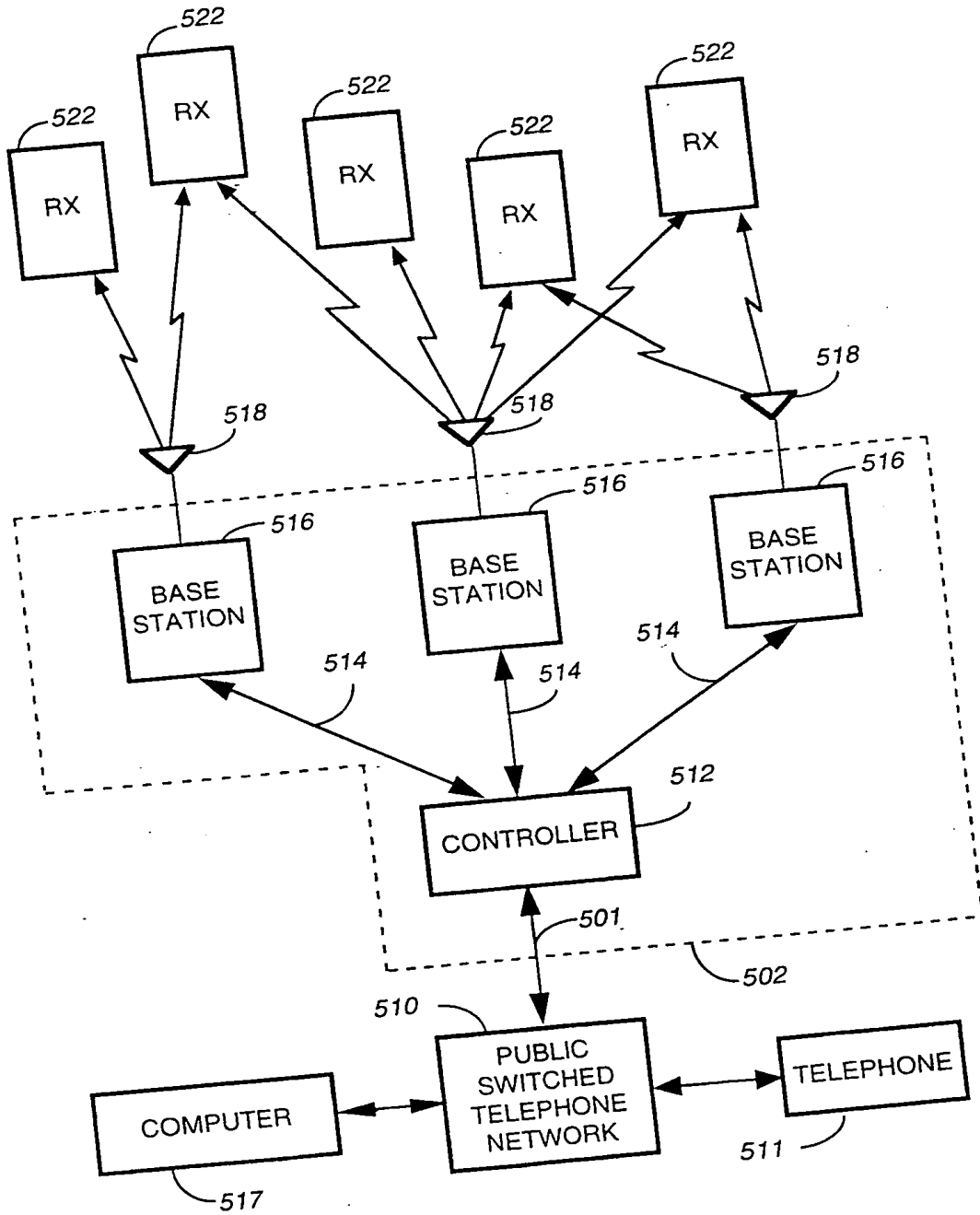
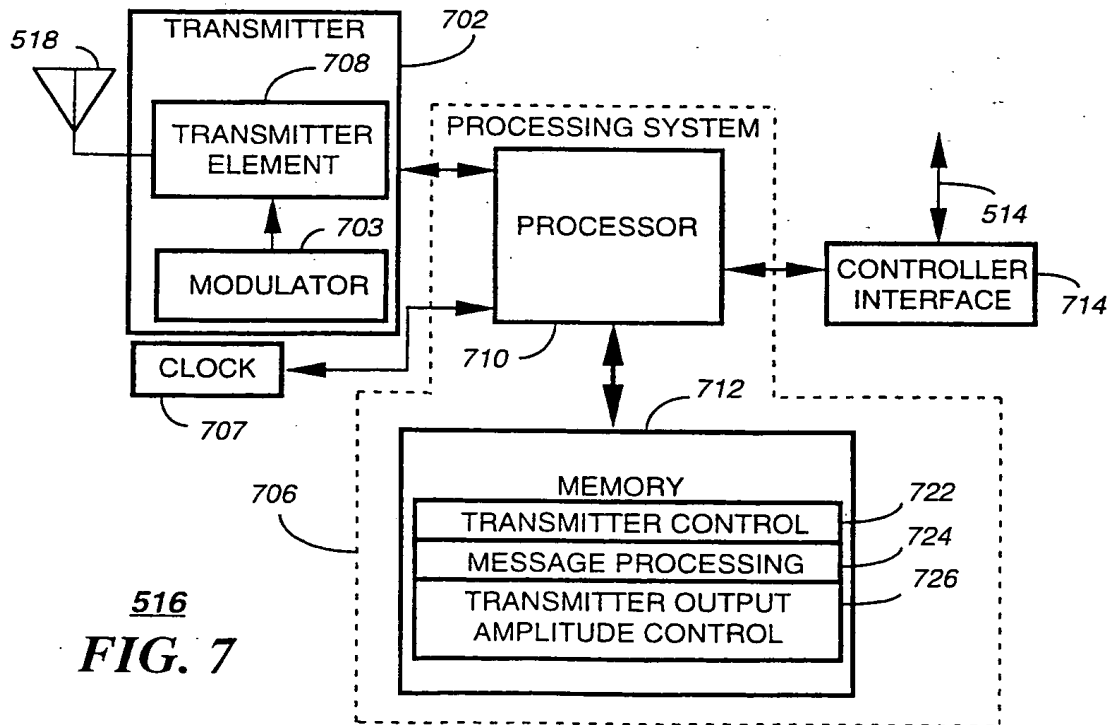
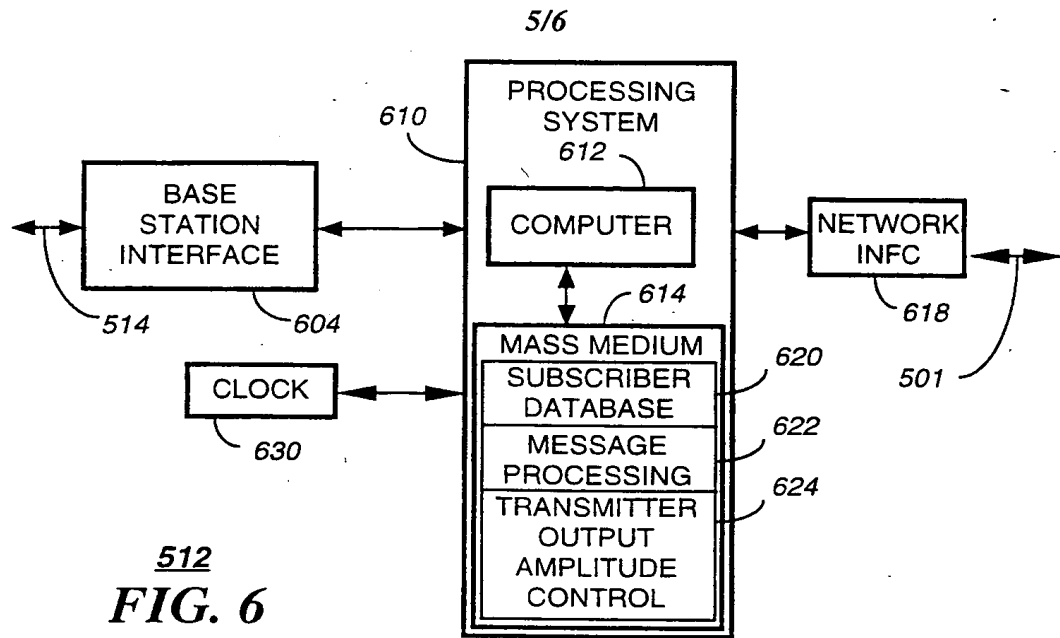

FIG. 5



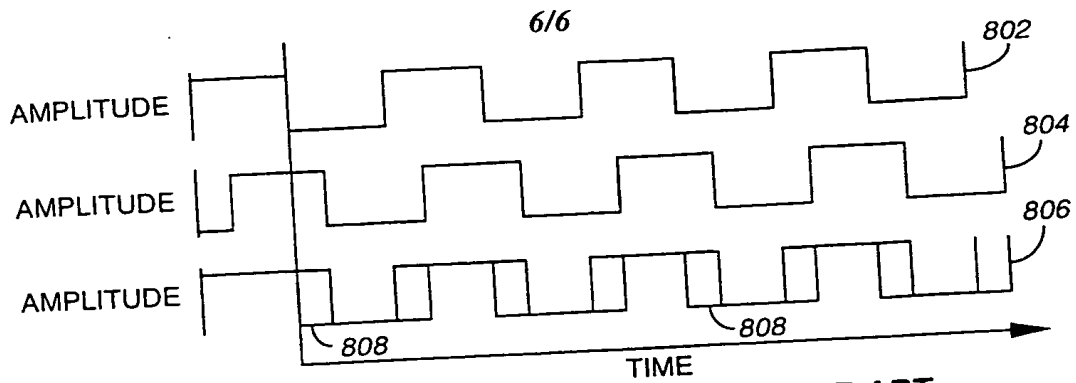

FIG. 8 800 PRIOR ART

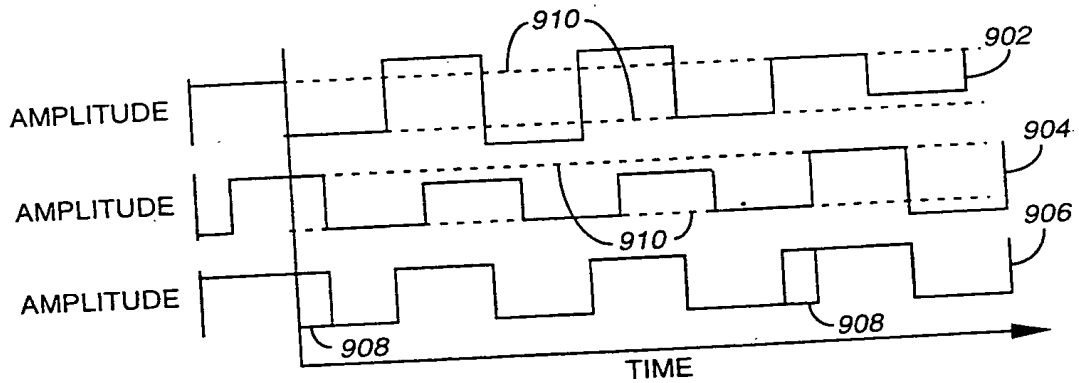

FIG. 9

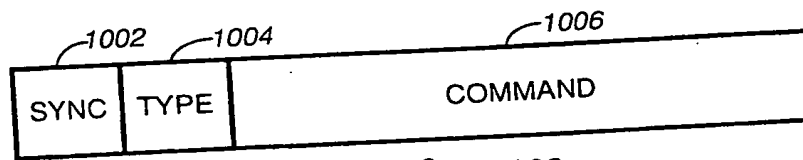

FIG. 10 1000

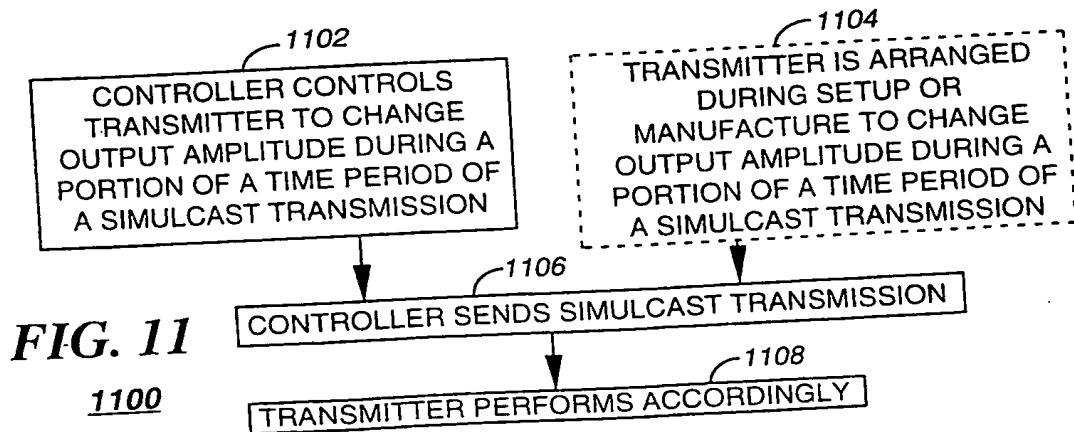

FIG. 11

1100

INTERNATIONAL SEARCH REPORT

International application No.
PCT/US98/22801

A. CLASSIFICATION OF SUBJECT MATTER
IPC(6) :H04B 7/005, 7/01, 7/015, 15/00
US CL : 455/503
According to International Patent Classification (IPC) or to both national classification and IPC

B. FIELDS SEARCHED
Minimum documentation searched (classification system followed by classification symbols)
U.S. : 455/503, 31.1, 31.2, 38.1, 59, 67.6; 340/825.44

Documentation searched other than minimum documentation to the extent that such documents are included in the fields searched

Electronic data base consulted during the international search (name of data base and, where practicable, search terms used)

C. DOCUMENTS CONSIDERED TO BE RELEVANT

Category*	Citation of document, with indication, where appropriate, of the relevant passages	Relevant to claim No.
A	US 5,392,452 A (DAVIS) 21 FEBRUARY 1995, see abstract	1-20
A,P	US 5,802,117 A (GHOSH) 01 SEPTEMBER 1998, see column 4, line 35 through column 9, line 12	1-20
A	US 5,353,307 A (LESTER et al.) 04 OCOTOBER 1994, see abstract.	1-20
A,P	US 5,737,322 A (BURBIDGE et aL.) 07 APRIL 7, 1998, see all	1-20
A	US 5,535,215 A (HIEATT, III) 09 JULY 1996, see figure 2	1-20

Further documents are listed in the continuation of Box C. See patent family annex.

* Special categories of cited documents:	*T* later document published after the international filing date or priority date and not in conflict with the application but cited to understand the principle or theory underlying the invention
A document defining the general state of the art which is not considered to be of particular relevance	*X* document of particular relevance; the claimed invention cannot be considered novel or cannot be considered to involve an inventive step when the document is taken alone
B earlier document published on or after the international filing date	*Y* document of particular relevance; the claimed invention cannot be considered to involve an inventive step when the document is combined with one or more other such documents, such combination being obvious to a person skilled in the art
L document which may throw doubts on priority claim(s) or which is cited to establish the publication date of another citation or other special reason (as specified)	*A* document member of the same patent family
O document referring to an oral disclosure, use, exhibition or other means	
P document published prior to the international filing date but later than the priority date claimed	

Date of the actual completion of the international search 16 DECEMBER 1998	Date of mailing of the international search report 25 FEB 1999
---	---

Name and mailing address of the ISA/US Commissioner of Patents and Trademarks Box PCT Washington, D.C. 20231 Facsimile No. (703) 305-3230	Authorized officer DARNELL R. ARS <i>ARS</i> Telephone No. (703) 306-3015 <i>Hill</i>
---	---

2631
48
08
4/19

IN THE UNITED STATES PATENT AND TRADEMARK OFFICE



International Patent Application of:)
Marcos C. TZANNES)
Serial No. 09/710,310)
Filed: November 9, 2000)
For: A System And Method For Scrambling The)
Phase Of The Carriers In A Multicarrier)
Communications System)

Examiner
Group Art Unit: 2631

RECEIVED
APR 1 7 2001
Technology Center 2600

INFORMATION DISCLOSURE STATEMENT

Commissioner for Patents
Washington, DC 20231

Sir:

In accordance with the duty of disclosure as set forth in 37 C.F.R. §1.56, Applicants hereby submit the following information in conformance with 37 C.F.R. §§ 1.97 and 1.98. Pursuant to 37 C.F.R. § 1.98, a copy of each of the documents cited is enclosed.

The documents are being submitted within three (3) months of the filing of this application or entry into the national stage of this application, or before the first Office Action on the merits, whichever is later, therefore no fee or certification is required under 37 C.F.R. § 1.97(b).

It is requested that the accompanying information disclosure statement be considered and made of record in the above-captioned application. To assist the Examiner, the documents are listed on the attached form PTO-1449. It is respectfully requested that an Examiner initialed copy of this form be returned to the undersigned.

The Commissioner is hereby authorized to charge any fees connected with this filing which may be required now, or credit any overpayment to Deposit Account No. 19-2380.

Respectfully submitted,

Jason H. Vick
Registration No. 45,285

NIXON PEABODY LLP
8180 Greensboro Drive, Suite 800
McLean, Virginia 22102

Telephone: (703) 790-9110



3
2/19

PATENT
Attorney Docket No. AWR-017

IN THE UNITED STATES PATENT AND TRADEMARK OFFICE

APPLICANT: Tzannes
SERIAL NO.: 09/710,310 GROUP NO.: Not Yet Assigned
FILING DATE: November 9, 2000 EXAMINER: Not Yet Assigned
TITLE: A System And Method For Scrambling The Phase Of The Carrier
In A Multicarrier Communications System

RECEIVED
MAR 01 2001
Technology Center 2600

Assistant Commissioner for Patents
Washington, D.C. 20231

REVOCATION OF PRIOR POWERS BY ASSIGNEE OF ENTIRE INTEREST

Sir:

As assignee of record of the entire interest of the above-identified

- application,
- patent,

all powers of attorney previously given are hereby revoked.

Assignee also hereby revokes Powers of Attorney to file and prosecute foreign national patent applications in any and all countries of the world, a regional patent application under the European Patent Convention and/or an international application under the Patent Cooperation Treaty based upon the above-identified application, including a power to meet all designated office requirements for designated states.

In the future, please direct correspondence to:

Kevin Russell
Corporate Counsel
Aware, Inc.
40 Middlesex Turnpike
Bedford, Massachusetts 01730

The assignee of record of the entire interest of the above-identified

application

patent

is

Aware, Inc.

Currently located at

**40 Middlesex Turnpike
Bedford, Massachusetts 01730**

Recorded in PTO on June 5, 2000

Reel No.: 10877

Frame No.: 0307

Recorded herewith

Dated: _____

6/31/01

Respectfully submitted,

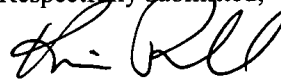

Kevin Russell

Corporate Counsel

Aware, Inc.

40 Middlesex Turnpike

Bedford, Massachusetts 01730



**TRANSMITTAL
FORM**

Application Serial Number	09/710,310
Filing Date	November 9, 2000
First Named Inventor	Tzannes
Group Art Unit	Not yet assigned
Examiner Name	Not yet assigned
Attorney Docket No.	AWR-017
BATCH NO. (after allowance)	Not applicable
Patent No.	Not applicable
Issue Date	Not applicable

RECEIVED
 MAR 01 2001
 Technology Center 2600

ENCLOSURES (check all that apply)

<input type="checkbox"/> Fee Transmittal Form <input type="checkbox"/> Check Attached <input type="checkbox"/> Copy of Fee Transmittal Form <input type="checkbox"/> Amendment/Response <input type="checkbox"/> Preliminary <input type="checkbox"/> After Final <input type="checkbox"/> Affidavits/declaration(s) <input type="checkbox"/> Letter to Official Draftsperson including Drawings [Total Sheets ____] <input type="checkbox"/> Petition for Extension of Time <input type="checkbox"/> Information Disclosure Statement <input type="checkbox"/> Form PTO-1449 <input type="checkbox"/> Copies of IDS Citations <input type="checkbox"/> Certified Copy of Priority Document(s) <input type="checkbox"/> Sequence Listing submission <input type="checkbox"/> Paper Copy/CD <input type="checkbox"/> Computer Readable Copy <input type="checkbox"/> Statement verifying identity of above	<input type="checkbox"/> Copy of Notice to File Missing Parts of Application (PTO-1553) <input type="checkbox"/> Formal Drawing(s) <input type="checkbox"/> Request For Continued Examination (RCE) Transmittal <input checked="" type="checkbox"/> Power of Attorney (Revocation of Prior Powers) <input type="checkbox"/> Terminal Disclaimer <input type="checkbox"/> Executed Declaration and Power of Attorney for Utility or Design Patent Application <input type="checkbox"/> Small Entity Statement <input type="checkbox"/> CD(s) for large table or computer program <input type="checkbox"/> Amendment After Allowance <input type="checkbox"/> Request for Certificate of Correction <input type="checkbox"/> Certificate of Correction (in duplicate)	<input type="checkbox"/> Notice of Appeal to Board of Patent Appeals and Interferences <input type="checkbox"/> Appeal Brief (in triplicate) <input type="checkbox"/> Status Inquiry <input checked="" type="checkbox"/> Return Receipt Postcard <input checked="" type="checkbox"/> Certificate of First Class Mailing under 37 C.F.R. 1.8 <input type="checkbox"/> Certificate of Facsimile Transmission under 37 C.F.R. 1.8 <input type="checkbox"/> Additional Enclosure(s) (please identify below)
---	---	---

CORRESPONDENCE ADDRESS

Direct all correspondence to: Patent Administrator
 Testa, Hurwitz & Thibault, LLP
 High Street Tower
 125 High Street
 Boston, MA 02110
 Tel. No.: (617) 248-7000
 Fax No.: (617) 248-7100

SIGNATURE BLOCK

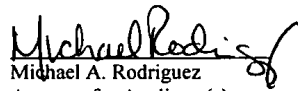
Respectfully submitted,

 Date: February 20, 2001
 Reg. No. 41,274
 Tel. No.: (617) 248-7501
 Fax No.: (617) 248-7100
 Michael A. Rodriguez
 Attorney for Applicant(s)
 Testa, Hurwitz & Thibault, LLP
 High Street Tower
 125 High Street
 Boston, MA 02110

2026125_1

668395



2631

PATENT Attorney Docket No. A-98-017

RECEIVED
MAR 01 2001
Technology Center 2600

IN THE UNITED STATES PATENT AND TRADEMARK OFFICE

APPLICANT(S): Tzannes

SERIAL NO.: 09/710,310 GROUP NO.: Not yet assigned

FILING DATE: November 9, 2000 EXAMINER: Not yet assigned

TITLE: A System And Method For Scrambling The Phase Of The Carriers In A Multicarrier Communications System

CERTIFICATE OF FIRST CLASS MAILING UNDER 37 C.F.R. 1.8

I hereby certify that this correspondence, and any document(s) referred to as enclosed herein, is/are being deposited with the United States Postal Service as first class mail, postage prepaid, in an envelope addressed to the Assistant Commissioner for Patents, Washington, DC 20231 on this 20th day of February, 2001.

Kerri Guglietta
Kerri Guglietta

Assistant Commissioner for Patents
Washington, D.C. 20231

Sir:

Submitted herewith is/are:

Revocation of Prior Powers by Assignee of Entire Interest (2 pages); Transmittal Form (1 page); Certificate of First Class Mailing under 37 C.F.R. 1.8 (1 page); and Return Receipt Postcard.

2026115_1

AP

TRANSMITTAL FORM



Application Serial Number	09/710,310
Filing Date	November 9, 2000
First Named Inventor	Tzannes
Group Art Unit	Not Yet Assigned
Examiner Name	Not Yet Assigned
Attorney Docket No.	AWR-017
BATCH NO. (after allowance)	Not applicable
Patent No.	Not applicable
Issue Date	Not applicable

ENCLOSURES (check all that apply)

<input type="checkbox"/> Fee Transmittal Form <input type="checkbox"/> Check Attached <input type="checkbox"/> Copy of Fee Transmittal Form	<input type="checkbox"/> Copy of Notice to File Missing Parts of Application (PTO-1553) <input checked="" type="checkbox"/> Formal Drawings (2 sheets)	<input type="checkbox"/> Notice of Appeal to Board of Patent Appeals and Interferences <input type="checkbox"/> Appeal Brief (in triplicate)
<input type="checkbox"/> Amendment/Response <input type="checkbox"/> Preliminary <input type="checkbox"/> After Final <input type="checkbox"/> Affidavits/declaration(s) <input type="checkbox"/> Letter to Official Draftsperson including Drawings [Total Sheets ____]	<input type="checkbox"/> Request For Continued Examination (RCE) Transmittal <input type="checkbox"/> Power of Attorney (Revocation of Prior Powers) <input type="checkbox"/> Terminal Disclaimer	<input type="checkbox"/> Status Inquiry <input checked="" type="checkbox"/> Return Receipt Postcard <input checked="" type="checkbox"/> Certificate of First Class Mailing under 37 C.F.R. 1.8 <input type="checkbox"/> Certificate of Facsimile Transmission under 37 C.F.R. 1.8
<input type="checkbox"/> Petition for Extension of Time	<input type="checkbox"/> Executed Declaration and Power of Attorney for Utility or Design Patent Application	<input checked="" type="checkbox"/> Additional Enclosures (please identify below) Transmittal of Formal Drawings (1 page)
<input type="checkbox"/> Information Disclosure Statement <input type="checkbox"/> Form PTO-1449 <input type="checkbox"/> Copies of IDS Citations	<input type="checkbox"/> Small Entity Statement <input type="checkbox"/> CD(s) for large table or computer program	
<input type="checkbox"/> Certified Copy of Priority Document(s)	<input type="checkbox"/> Amendment After Allowance	
<input type="checkbox"/> Sequence Listing submission <input type="checkbox"/> Paper Copy/CD <input type="checkbox"/> Computer Readable Copy <input type="checkbox"/> Statement verifying identity of above	<input type="checkbox"/> Request for Certificate of Correction <input type="checkbox"/> Certificate of Correction (in duplicate)	

CORRESPONDENCE ADDRESS

Direct all correspondence to: Patent Administrator
 Testa, Hurwitz & Thibault, LLP
 High Street Tower
 125 High Street
 Boston, MA 02110
 Tel. No.: (617) 248-7000
 Fax No.: (617) 248-7100

SIGNATURE BLOCK

Respectfully submitted,

 Michael A. Rodriguez
 Atty/Agent for Applicant(s)
 Testa, Hurwitz & Thibault, LLP
 High Street Tower
 125 High Street
 Boston, MA 02110

Date: January 22, 2001
 Reg. No. 41,274
 Tel. No.: (617) 248-7501
 Fax No.: (617) 248-7100

RODRIGUE457\18.2011937_1



PATENT
Attorney Docket No. AWR-017
(457/19)

IN THE UNITED STATES PATENT AND TRADEMARK OFFICE

APPLICANT: Tzannes
SERIAL NO.: 09/710,310 GROUP NO.: Not Yet Assigned
FILING DATE: November 9, 2000 EXAMINER: Not Yet Assigned
TITLE: A System and Method for Scrambling the Phase of the Carriers in
a Multicarrier Communications System

CERTIFICATE OF FIRST CLASS MAILING UNDER 37 C.F.R. 1.8

I hereby certify that this correspondence, and any documents referred to as enclosed herein, are being deposited with the United States Postal Service as first class mail, postage prepaid, in an envelope addressed to: Assistant Commissioner for Patents, Washington, DC 20231 on January 22, 2001.

Kerri M. Guglietta

Assistant Commissioner for Patents
Washington, D.C. 20231

Sir:

Submitted herewith are:

- (1) Transmittal Form (1 page);
- (2) Transmittal of Formal Drawings (1 page);
- (3) Formal Drawings (2 sheets); and
- (4) Return Postcard.

RODRIGUE457\19.2011939_1

04CO
12/27/00
#2

PATENT
Attorney Docket No. AWR-017
(457/19)

IN THE UNITED STATES PATENT AND TRADEMARK OFFICE

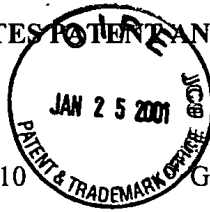

APPLICANT: Tzannes
SERIAL NO.: 09/710,310 GROUP NO.: Not Yet Assigned
FILING DATE: November 9, 2000 EXAMINER: Not Yet Assigned
TITLE: A System and Method for Scrambling the Phase of the Carriers
in a Multicarrier Communications System

Assistant Commissioner for Patents
Washington, D.C. 20231

TRANSMITTAL OF FORMAL DRAWINGS

Sir:

Attached please find the formal drawings for this application - Number of Sheets - 2.

Respectfully submitted,

Date: January 22, 2001
Reg. No. 41,274

Tel. No.: (617) 248-7501
Fax No.: (617) 248-7100

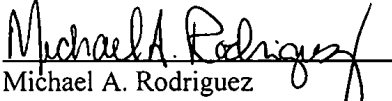
Michael A. Rodriguez
Attorney/Agent for Applicant
TESTA, HURWITZ & THIBEAULT, LLP
High Street Tower
125 High Street
Boston, MA 02110

RODRIGUE457A19.2011938_1

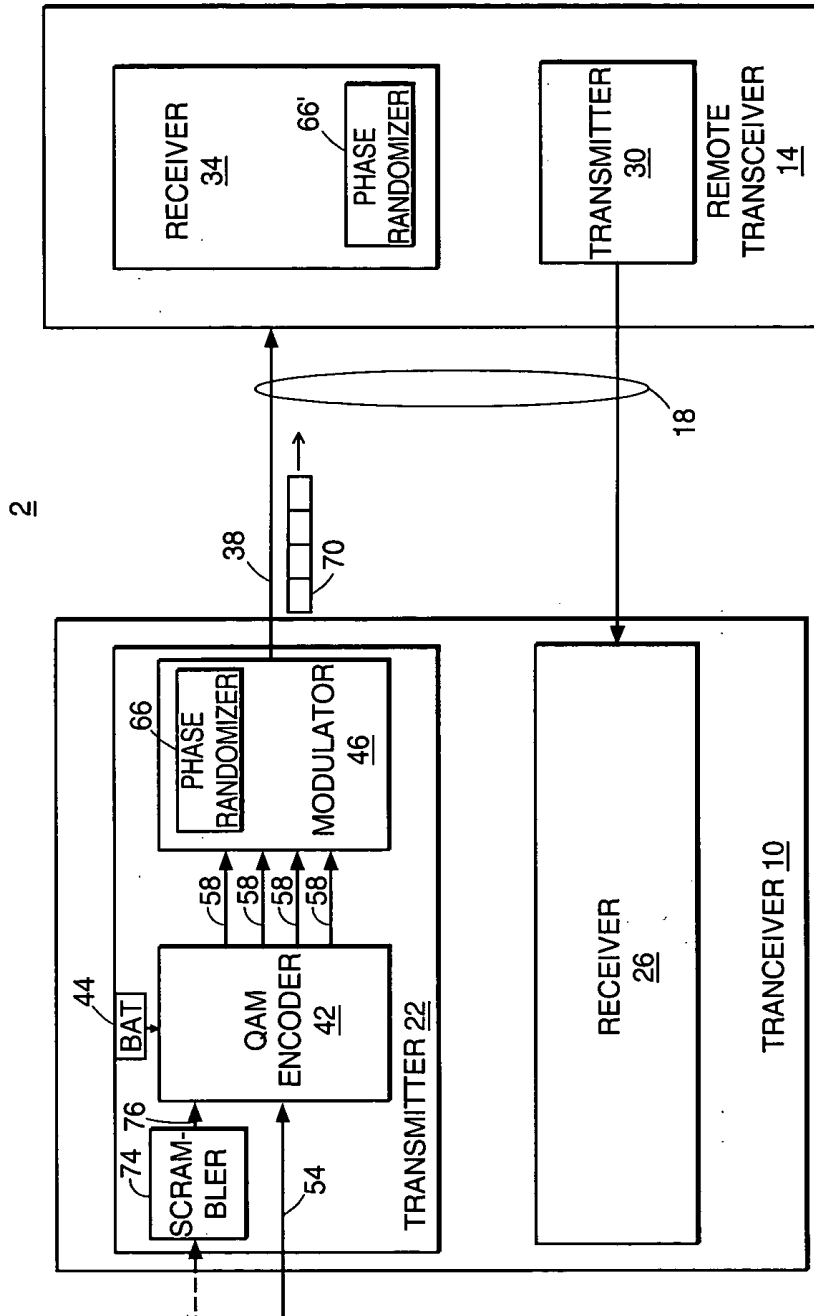

FIG. 1

2/2

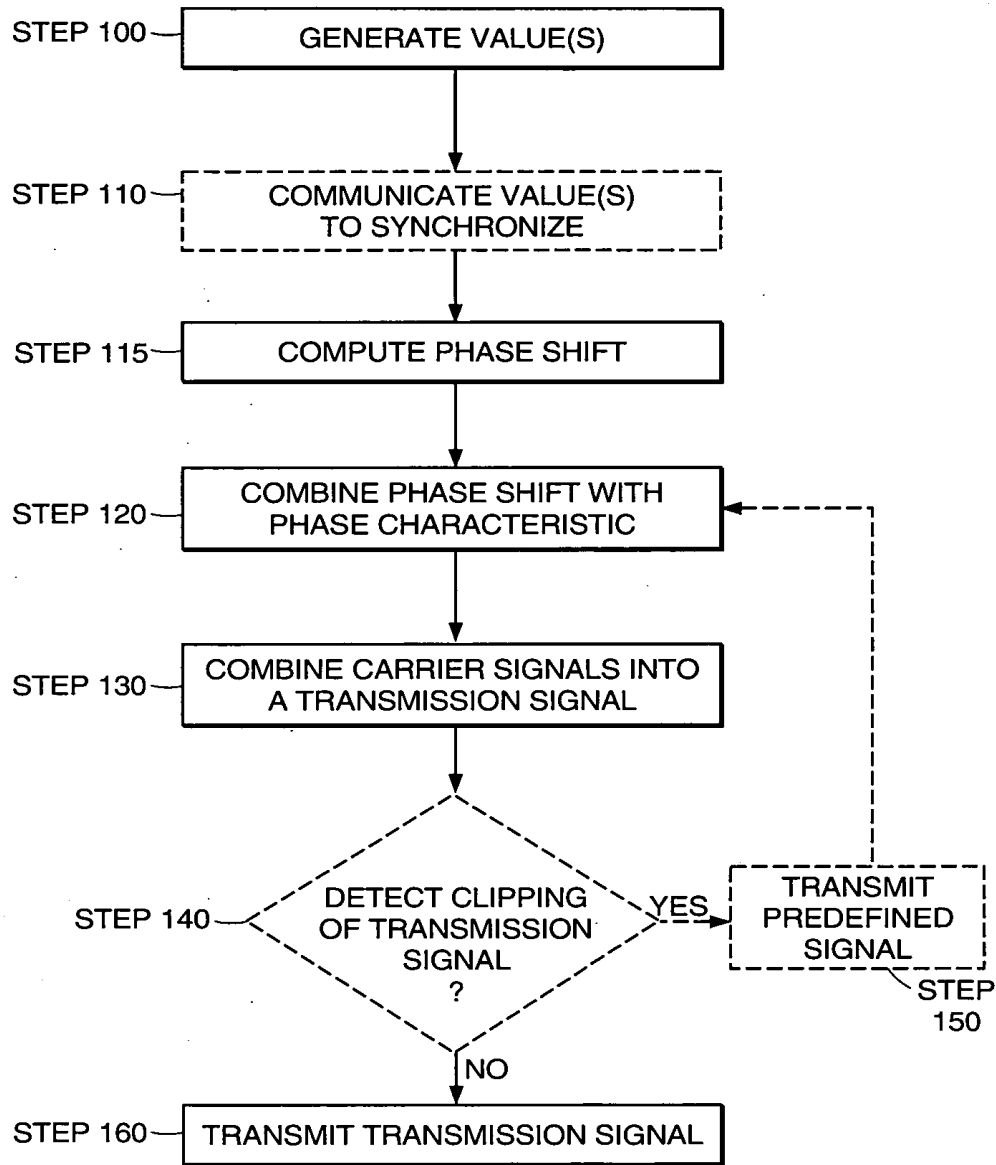

FIG. 2

11-13-00

A

Express Mail Mailing Label No. EM401136836US

11/09/00
13660 U.S. PRO

UTILITY PATENT APPLICATION TRANSMITTAL <small>(Only for new nonprovisional applications under 37 CFR 1.53(b))</small>	Attorney Docket No.	AWR-017 (457/19)
	First Named Inventor	Tzannes
	Title	A System And Method For Scrambling The Phase Of The Carriers In A Multicarrier Communications System

11/09/00
13660 U.S. PRO

APPLICATION ELEMENTS	ADDRESS TO: Box Patent Application Assistant Commissioner for Patents Washington, D.C. 20231
1. <input checked="" type="checkbox"/> Fee Transmittal Form	ACCOMPANYING APPLICATION PARTS
2. <input checked="" type="checkbox"/> Specification and Drawings [Total Pages 27] X - Written Description - (18 pages) X - Claims - (6 pages) X - Abstract - (1 page) X - Sheets of Drawings - (2 sheets) <input type="checkbox"/> Formal <input checked="" type="checkbox"/> Informal	7. <input type="checkbox"/> 37 CFR 3.73(b) Statement (when there is an assignee) <input type="checkbox"/> Power of Attorney
3. <input checked="" type="checkbox"/> Oath or Declaration [Total Pages 3] a. <input checked="" type="checkbox"/> Newly executed (original) b. <input type="checkbox"/> Copy from a prior application (37 CFR 1.63(d)) <i>(for continuation/divisional with Box 17 completed)</i> <i>[Note Box 4 below]</i>	8. <input type="checkbox"/> English Translation Document (if applicable) 9. <input type="checkbox"/> Information Disclosure Statement (IDS)/PTO-1449 <input type="checkbox"/> Copies of IDS Citations
4. <input type="checkbox"/> Incorporation by Reference (usable if Box 3b is checked) The entire Disclosure of the prior application, from which a copy of the oath or declaration is supplied under Box 3b, is considered as being part of the disclosure of the accompanying application and is hereby incorporated by reference therein.	10. <input type="checkbox"/> Preliminary Amendment <input type="checkbox"/> Drawings [Total Sheets] <input type="checkbox"/> Letter to Official Draftsperson Including Drawings [Total Pages]
5. <input type="checkbox"/> Microfiche Computer Program (Appendix)	11. <input checked="" type="checkbox"/> Return Receipt Postcard
6. <input type="checkbox"/> Nucleotide and/or Amino Acid Sequence Submission <input type="checkbox"/> Computer Readable Copy <input type="checkbox"/> Paper Copy (identical to computer copy) <input type="checkbox"/> Statement verifying identity of above copies	12. <input type="checkbox"/> Small Entity Statement(s) <input type="checkbox"/> Statements filed in prior application, (Status still proper and desired) 13. <input type="checkbox"/> Certified Copy of Priority Document(s)
17. <input type="checkbox"/> If a CONTINUING APPLICATION , check appropriate box and supply the requisite information: <input type="checkbox"/> Continuation <input type="checkbox"/> Divisional <input type="checkbox"/> Continuation-in-part (CIP) of prior application Serial No. ____/____. Priority to the above application(s) is claimed under 35 U.S.C. 120. Prior application information: Examiner: ____ Group/Art Unit: ____.	14. <input type="checkbox"/> Deletion of Inventor(s) Signed statement attached deleting inventor(s) named in the prior application. 15. <input checked="" type="checkbox"/> Patent Application Data Entry Form 16. <input type="checkbox"/> Other:
18. <input checked="" type="checkbox"/> Priority - 35 U.S.C. 119 <input checked="" type="checkbox"/> Priority of application Serial No. <u>60/164,134</u> filed on <u>November 9, 1999</u> in <u>United States</u> is claimed under 35 U.S.C. 119. <input type="checkbox"/> The certified copy has been filed in prior U.S. application Serial No. ____/____ on ____. <input type="checkbox"/> The certified copy will follow.	

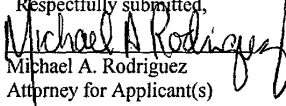
CORRESPONDENCE ADDRESS	SIGNATURE BLOCK
Direct all correspondence to: Patent Administrator Testa, Hurwitz & Thibault, LLP High Street Tower 125 High Street Boston, MA 02110 Tel. No.: (617) 248-7000 Fax No.: (617) 248-7100	Date: November 9, 2000 Reg. No. 41,274 Tel. No.: (617) 248-7501 Fax No.: (617) 248-7100 Respectfully submitted,  Michael A. Rodriguez Attorney for Applicant(s) Testa, Hurwitz & Thibault, LLP High Street Tower 125 High Street Boston, MA 02110

ABRAMSON457/19.1105071

FEE TRANSMITTAL FY 2001	<i>Complete if Known</i>	
	Application Serial Number	Not Yet Assigned
	Filing Date	Herewith
	First Named Inventor	Tzannes
	Group Art Unit	Not Yet Assigned
	Examiner Name	Not Yet Assigned
Attorney Docket No.	AWR-017 (457/19)	

Patent 10310
 09/10/00
 11/09/00

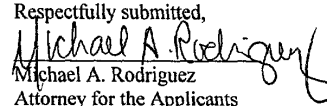
METHOD OF PAYMENT	FEE CALCULATION (continued)																																																																																												
1. <input checked="" type="checkbox"/> Payment Enclosed: <input checked="" type="checkbox"/> Check <input type="checkbox"/> Money Order <input type="checkbox"/> Other	3. ADDITIONAL FEES <table border="1" style="width: 100%; border-collapse: collapse;"> <thead> <tr> <th>Large Entity Fee (\$)</th> <th>Small Entity Fee (\$)</th> <th>Fee Description</th> <th>Fee Paid</th> </tr> </thead> <tbody> <tr><td>130</td><td>65</td><td>Surcharge - late filing fee or oath</td><td></td></tr> <tr><td>50</td><td>25</td><td>Surcharge - late provisional filing fee or cover sheet</td><td></td></tr> <tr><td>130</td><td>130</td><td>Non-English specification</td><td></td></tr> <tr><td>2,520</td><td>2,520</td><td>For filing a request for reexamination</td><td></td></tr> <tr><td>110</td><td>55</td><td>Extension for reply within first month</td><td></td></tr> <tr><td>390</td><td>195</td><td>Extension for reply within second month</td><td></td></tr> <tr><td>890</td><td>445</td><td>Extension for reply within third month</td><td></td></tr> <tr><td>1,390</td><td>695</td><td>Extension for reply within fourth month</td><td></td></tr> <tr><td>1,890</td><td>945</td><td>Extension for reply within fifth month</td><td></td></tr> <tr><td>310</td><td>155</td><td>Notice of Appeal</td><td></td></tr> <tr><td>310</td><td>155</td><td>Filing a brief in support of an appeal</td><td></td></tr> <tr><td>270</td><td>135</td><td>Request for oral hearing</td><td></td></tr> <tr><td>130</td><td>130</td><td>Petitions to the Commissioner</td><td></td></tr> <tr><td>50</td><td>50</td><td>Petitions related to provisional applications</td><td></td></tr> <tr><td>240</td><td>240</td><td>Submission of Information Disclosure Statement (37 CFR 1.97(c))</td><td></td></tr> <tr><td>130</td><td>130</td><td>Submission of Information Disclosure Statement (37 CFR 1.97(d))</td><td></td></tr> <tr><td>710</td><td>355</td><td>Filing a submission after final rejection (37 CFR 1.129(a))</td><td></td></tr> <tr><td>710</td><td>355</td><td>For each additional invention to be examined (37 CFR 1.129(b))</td><td></td></tr> <tr><td></td><td></td><td>Other fee (Specify)</td><td></td></tr> <tr><td></td><td></td><td>Other fee (Specify)</td><td></td></tr> </tbody> </table>	Large Entity Fee (\$)	Small Entity Fee (\$)	Fee Description	Fee Paid	130	65	Surcharge - late filing fee or oath		50	25	Surcharge - late provisional filing fee or cover sheet		130	130	Non-English specification		2,520	2,520	For filing a request for reexamination		110	55	Extension for reply within first month		390	195	Extension for reply within second month		890	445	Extension for reply within third month		1,390	695	Extension for reply within fourth month		1,890	945	Extension for reply within fifth month		310	155	Notice of Appeal		310	155	Filing a brief in support of an appeal		270	135	Request for oral hearing		130	130	Petitions to the Commissioner		50	50	Petitions related to provisional applications		240	240	Submission of Information Disclosure Statement (37 CFR 1.97(c))		130	130	Submission of Information Disclosure Statement (37 CFR 1.97(d))		710	355	Filing a submission after final rejection (37 CFR 1.129(a))		710	355	For each additional invention to be examined (37 CFR 1.129(b))				Other fee (Specify)				Other fee (Specify)									
Large Entity Fee (\$)		Small Entity Fee (\$)	Fee Description	Fee Paid																																																																																									
130		65	Surcharge - late filing fee or oath																																																																																										
50	25	Surcharge - late provisional filing fee or cover sheet																																																																																											
130	130	Non-English specification																																																																																											
2,520	2,520	For filing a request for reexamination																																																																																											
110	55	Extension for reply within first month																																																																																											
390	195	Extension for reply within second month																																																																																											
890	445	Extension for reply within third month																																																																																											
1,390	695	Extension for reply within fourth month																																																																																											
1,890	945	Extension for reply within fifth month																																																																																											
310	155	Notice of Appeal																																																																																											
310	155	Filing a brief in support of an appeal																																																																																											
270	135	Request for oral hearing																																																																																											
130	130	Petitions to the Commissioner																																																																																											
50	50	Petitions related to provisional applications																																																																																											
240	240	Submission of Information Disclosure Statement (37 CFR 1.97(c))																																																																																											
130	130	Submission of Information Disclosure Statement (37 CFR 1.97(d))																																																																																											
710	355	Filing a submission after final rejection (37 CFR 1.129(a))																																																																																											
710	355	For each additional invention to be examined (37 CFR 1.129(b))																																																																																											
		Other fee (Specify)																																																																																											
		Other fee (Specify)																																																																																											
2. <input checked="" type="checkbox"/> The Commissioner is hereby authorized to credit or charge any fee indicated below for this submission to Deposit Account No. 20-0531. <input type="checkbox"/> Required Fees (copy of this sheet enclosed). <input checked="" type="checkbox"/> Additional fee required under 37 CFR 1.16 and 1.17. <input checked="" type="checkbox"/> Overpayment Credit.																																																																																													
FEE CALCULATION																																																																																													
1. FILING FEE <table border="1" style="width: 100%; border-collapse: collapse;"> <thead> <tr> <th>Large Entity Fee (\$)</th> <th>Fee Description</th> <th>Fee Paid</th> </tr> </thead> <tbody> <tr><td>710</td><td>Utility filing fee</td><td>710.00</td></tr> <tr><td>320</td><td>Design filing fee</td><td></td></tr> <tr><td>150</td><td>Provisional filing fee</td><td></td></tr> </tbody> </table> <table border="1" style="width: 100%; border-collapse: collapse;"> <thead> <tr> <th></th> <th>Number Filed</th> <th>Number Extra</th> <th>Rate</th> <th>Amount</th> </tr> </thead> <tbody> <tr> <td>Total Claims</td> <td>39</td> <td>- 20 = 19</td> <td>x \$ 18.00 =</td> <td>342.00</td> </tr> <tr> <td>Independent Claims</td> <td>4</td> <td>- 3 = 1</td> <td>x \$ 80.00 =</td> <td>80.00</td> </tr> <tr> <td colspan="4"><input type="checkbox"/> Multiple Dependent Claim(s), if any</td> <td>\$270.00 =</td> </tr> <tr> <td colspan="4" style="text-align: right;">TOTAL:</td> <td>1132.00</td> </tr> <tr> <td colspan="4" style="text-align: right;">SMALL ENTITY DISCOUNT:</td> <td></td> </tr> <tr> <td colspan="4" style="text-align: right;">SUBTOTAL (1)</td> <td>(\$) 1132.00</td> </tr> </tbody> </table> 2. AMENDMENT CLAIM FEES <table border="1" style="width: 100%; border-collapse: collapse;"> <thead> <tr> <th>Claims Remaining After Amend.</th> <th>Highest No. Previously Paid For</th> <th>Present Extra</th> <th>Rate</th> <th>Fee Paid</th> </tr> </thead> <tbody> <tr> <td>Total</td> <td>-</td> <td>=</td> <td>x \$ 18.00 =</td> <td></td> </tr> <tr> <td>Indep.</td> <td>-</td> <td>=</td> <td>x \$ 80.00 =</td> <td></td> </tr> <tr> <td colspan="4"><input type="checkbox"/> First Presentation of Multiple Dep. Claim</td> <td>+ \$270.00 =</td> </tr> <tr> <td colspan="4" style="text-align: right;">TOTAL:</td> <td>(\$)</td> </tr> <tr> <td colspan="4" style="text-align: right;">SMALL ENTITY DISCOUNT:</td> <td>(\$)</td> </tr> <tr> <td colspan="4" style="text-align: right;">SUBTOTAL (2)</td> <td>(\$)</td> </tr> </tbody> </table>	Large Entity Fee (\$)	Fee Description	Fee Paid	710	Utility filing fee	710.00	320	Design filing fee		150	Provisional filing fee			Number Filed	Number Extra	Rate	Amount	Total Claims	39	- 20 = 19	x \$ 18.00 =	342.00	Independent Claims	4	- 3 = 1	x \$ 80.00 =	80.00	<input type="checkbox"/> Multiple Dependent Claim(s), if any				\$270.00 =	TOTAL:				1132.00	SMALL ENTITY DISCOUNT:					SUBTOTAL (1)				(\$) 1132.00	Claims Remaining After Amend.	Highest No. Previously Paid For	Present Extra	Rate	Fee Paid	Total	-	=	x \$ 18.00 =		Indep.	-	=	x \$ 80.00 =		<input type="checkbox"/> First Presentation of Multiple Dep. Claim				+ \$270.00 =	TOTAL:				(\$)	SMALL ENTITY DISCOUNT:				(\$)	SUBTOTAL (2)				(\$)	<table border="1" style="width: 100%; border-collapse: collapse;"> <tr> <td style="text-align: right;">SUBTOTAL (3)</td> <td>(\$)</td> </tr> <tr> <td style="text-align: right;">SUBTOTAL (1)</td> <td>1132.00</td> </tr> <tr> <td style="text-align: right;">SUBTOTAL (2)</td> <td></td> </tr> <tr> <td style="text-align: right;">SUBTOTAL (3)</td> <td></td> </tr> <tr> <td style="text-align: right;">TOTAL</td> <td>(\$) 1132.00</td> </tr> </table>	SUBTOTAL (3)	(\$)	SUBTOTAL (1)	1132.00	SUBTOTAL (2)		SUBTOTAL (3)		TOTAL	(\$) 1132.00
Large Entity Fee (\$)	Fee Description	Fee Paid																																																																																											
710	Utility filing fee	710.00																																																																																											
320	Design filing fee																																																																																												
150	Provisional filing fee																																																																																												
	Number Filed	Number Extra	Rate	Amount																																																																																									
Total Claims	39	- 20 = 19	x \$ 18.00 =	342.00																																																																																									
Independent Claims	4	- 3 = 1	x \$ 80.00 =	80.00																																																																																									
<input type="checkbox"/> Multiple Dependent Claim(s), if any				\$270.00 =																																																																																									
TOTAL:				1132.00																																																																																									
SMALL ENTITY DISCOUNT:																																																																																													
SUBTOTAL (1)				(\$) 1132.00																																																																																									
Claims Remaining After Amend.	Highest No. Previously Paid For	Present Extra	Rate	Fee Paid																																																																																									
Total	-	=	x \$ 18.00 =																																																																																										
Indep.	-	=	x \$ 80.00 =																																																																																										
<input type="checkbox"/> First Presentation of Multiple Dep. Claim				+ \$270.00 =																																																																																									
TOTAL:				(\$)																																																																																									
SMALL ENTITY DISCOUNT:				(\$)																																																																																									
SUBTOTAL (2)				(\$)																																																																																									
SUBTOTAL (3)	(\$)																																																																																												
SUBTOTAL (1)	1132.00																																																																																												
SUBTOTAL (2)																																																																																													
SUBTOTAL (3)																																																																																													
TOTAL	(\$) 1132.00																																																																																												
CORRESPONDENCE ADDRESS	SIGNATURE BLOCK																																																																																												
Direct all correspondence to: Patent Administrator Testa, Hurwitz & Thibault, LLP High Street Tower-125 High Street Boston, MA 02110 Tel. No.: (617) 248-7000 Fax No.: (617) 248-7100	Respectfully submitted,  Michael A. Rodriguez Attorney for the Applicants Testa, Hurwitz & Thibault, LLP High Street Tower-125 High Street Boston, MA 02110 Date: November 9, 2000 Reg. No.: 41,274 Tel. No.: (617) 248-7501 Fax No.: (617) 248-7100																																																																																												

ABRAMSON457/19.1104944

Inventor Information

Inventor One Given Name :: Marcos
Family Name :: Tzannes
Name Suffix ::
Postal Address Line One :: 121 LaEspiral
Postal Address Line Two ::
City :: Orinda
State/Province :: California
Country :: United States
Postal or Zip Code :: 94563
City of Residence :: Orinda
State/Prov. of Residence :: California
Country of Residence :: United States
Citizenship :: U.S.

Correspondence Information

Correspondence Customer Number :: 021323

Application Information

Title Line One :: A System And Method For Scrambling The Phase Of The Carriers
Title Line Two :: In A Multicarrier Communications System
Total Drawing Sheets :: 2
Formal Drawings :: No
Application Type :: Utility
Docket Number :: AWR-017
Licensed - U S Government Agency ::
Contract Number ::
Grant Number ::
Secrecy Order in Parent Application ::

Representative Information

Representative Customer Number :: 021323

Continuity Information

This application claims the benefit of:
>Application One :: 60/164,134
Filing Date :: November 9, 1999

5

**A System and Method for Scrambling the Phase of the Carriers in a Multicarrier
Communications System**

Related Application

This application claims the benefit of the filing date of copending U.S. Provisional
10 Application, Serial No. 60/164,134, filed November 9, 1999, entitled "A Method For Randomizing
The Phase Of The Carriers In A Multicarrier Communications System To Reduce The Peak To
Average Power Ratio Of The Transmitted Signal," the entirety of which provisional application is
incorporated by reference herein.

15
20
25
30
35
40
45
50
55
60
65
70
75
80
85
90
95
100
105
110
115
120
125
130
135
140
145
150
155
160
165
170
175
180
185
190
195
200
205
210
215
220
225
230
235
240
245
250
255
260
265
270
275
280
285
290
295
300
305
310
315
320
325
330
335
340
345
350
355
360
365
370
375
380
385
390
395
400
405
410
415
420
425
430
435
440
445
450
455
460
465
470
475
480
485
490
495
500

Field of the Invention

This invention relates to communications systems using multicarrier modulation. More
particularly, the invention relates to multicarrier communications systems that lower the peak-to-
average power ratio (PAR) of transmitted signals.

Background of the Invention

20 In a conventional multicarrier communications system, transmitters communicate over a
communication channel using multicarrier modulation or Discrete Multitone Modulation (DMT).
Carrier signals (carriers) or sub-channels spaced within a usable frequency band of the
communication channel are modulated at a symbol (i.e., block) transmission rate of the system. An
input signal, which includes input data bits, is sent to a DMT transmitter, such as a DMT modem.
25 The DMT transmitter typically modulates the phase characteristic, or phase, and amplitude of the

carrier signals using an Inverse Fast Fourier Transform (IFFT) to generate a time domain signal, or transmission signal, that represents the input signal. The DMT transmitter transmits the transmission signal, which is a linear combination of the multiple carriers, to a DMT receiver over the communication channel.

5 The phase and amplitude of the carrier signals of DMT transmission signal can be considered random because the phase and amplitude result from the modulation of an arbitrary sequence of input data bits comprising the transmitted information. Therefore, under the condition that the modulated data bit stream is random, the DMT transmission signal can be approximated as having a Gaussian probability distribution. A bit scrambler is often used in the DMT transmitter to scramble
10 the input data bits before the bits are modulated to assure that the transmitted data bits are random and, consequently, that the modulation of those bits produces a DMT transmission signal with a Gaussian probability distribution.

 With an appropriate allocation of transmit power levels to the carriers or sub-channels, such a system provides a desirable performance. Further, generating a transmission signal with a Gaussian
15 probability distribution is important in order to transmit a transmission signal with a low peak-to-average ratio (PAR), or peak-to-average power ratio. The PAR of a transmission signal is the ratio of the instantaneous peak value (i.e., maximum magnitude) of a signal parameter (e.g., voltage, current, phase, frequency, power) to the time-averaged value of the signal parameter. In DMT
20 systems, the PAR of the transmitted signal is determined by the probability of the random transmission signal reaching a certain peak voltage during the time interval required for a certain number of symbols. An example of the PAR of a transmission signal transmitted from a DMT transmitter is 14.5 dB, which is equivalent to having a $1E-7$ probability of clipping. The PAR of a

In one embodiment, the input bit stream is modulated onto the carrier signals having the substantially scrambled phase characteristic to produce a transmission signal with a reduced peak-to-average power ratio (PAR). The value is derived from a predetermined parameter, such as a random number generator, a carrier number, a DMT symbol count, a superframe count, and a hyperframe count. In another embodiment, a predetermined transmission signal is transmitted when the amplitude of the transmission signal exceeds a certain level.

In another aspect, the invention features a method wherein a value is associated with each carrier signal. The value is determined independently of any input bit value carried by that carrier signal. A phase shift for each carrier signal is computed based on the value associated with that carrier signal. The transmission signal is demodulated using the phase shift computed for each carrier signal.

In another aspect, the invention features a system comprising a phase scrambler that computes a phase shift for each carrier signal based on a value associated with that carrier signal. The phase scrambler also combines the phase shift computed for each carrier signal with the phase characteristic of that carrier signal to substantially scramble the phase characteristic of the carrier signals. In one embodiment, a modulator, in communication with the phase scrambler, modulates bits of an input signal onto the carrier signals having the substantially scrambled phase characteristics to produce a transmission signal with a reduced PAR.

Description of the Drawings

The invention is pointed out with particularity in the appended claims. The advantages of the invention described above, as well as further advantages of the invention, may be better understood

by reference to the following description taken in conjunction with the accompanying drawings, in which:

Fig. 1 is a block diagram of an embodiment of a digital subscriber line communications system including a DMT (discrete multitone modulation) transceiver, in communication with a remote transceiver, having a phase scrambler for substantially scrambling the phase characteristics of carrier signals; and

Fig. 2 is a flow diagram of an embodiment of a process for scrambling the phase characteristics of the carrier signals in a transmission signal.

Detailed Description

10 Fig. 1 shows a digital subscriber line (DSL) communication system 2 including a discrete multitone (DMT) transceiver 10 in communication with a remote transceiver 14 over a communication channel 18 using a transmission signal 38 having a plurality of carrier signals. The DMT transceiver 10 includes a DMT transmitter 22 and a DMT receiver 26. The remote transceiver 14 includes a transmitter 30 and a receiver 34. Although described with respect to discrete multitone modulation, the principles of the invention apply also to other types of multicarrier modulation, such as, but not limited to, orthogonally multiplexed quadrature amplitude modulation (OQAM), discrete wavelet multitone (DWMT) modulation, and orthogonal frequency division multiplexing (OFDM).

The communication channel 18 provides a downstream transmission path from the DMT transmitter 22 to the remote receiver 34, and an upstream transmission path from the remote transmitter 30 to the DMT receiver 26. In one embodiment, the communication channel 18 is a pair of twisted wires of a telephone subscriber line. In other embodiments, the communication channel 18 can be a fiber optic wire, a quad cable, consisting of two pairs of twisted wires, or a quad cable

that is one of a star quad cable, a Dieselhorst-Martin quad cable, and the like. In a wireless communication system wherein the transceivers 10, 14 are wireless modems, the communication channel 18 is the air through which the transmission signal 38 travels between the transceivers 10, 14.

5 By way of example, the DMT transmitter 22 shown in Fig. 1 includes a quadrature amplitude modulation (QAM) encoder 42, a modulator 46, a bit allocation table (BAT) 44, and a phase scrambler 66. The DMT transmitter 22 can also include a bit scrambler 74, as described further below. The remote transmitter 30 of the remote transceiver 14 comprises equivalent components as the DMT transmitter 22. Although this embodiment specifies a detailed description of the DMT
10 transmitter 22, the inventive concepts apply also to the receivers 34, 36 which have similar components to that of the DMT transmitter 22, but perform inverse functions in a reverse order.

The QAM encoder 42 has a single input for receiving an input serial data bit stream 54 and multiple parallel outputs to transmit QAM symbols 58 generated by the QAM encoder 42 from the bit stream 54. In general, the QAM encoder 42 maps the input serial bit-stream 54 in the time
15 domain into parallel QAM symbols 58 in the frequency domain. In particular, the QAM encoder 42 maps the input serial data bit stream 54 into N parallel quadrature amplitude modulation (QAM) constellation points 58, or QAM symbols 58, where N represents the number of carrier signals generated by the modulator 46. The BAT 44 is in communication with the QAM encoder 42 to specify the number of bits carried by each carrier signal. The QAM symbols 58 represent the
20 amplitude and the phase characteristic of each carrier signal.

The modulator 46 provides functionality associated with the DMT modulation and transforms the QAM symbols 58 into DMT symbols 70 each comprised of a plurality of time-

domain samples. The modulator 46 modulates each carrier signal with a different QAM symbol 58. As a result of this modulation, carrier signals have phase and amplitude characteristics based on the QAM symbol 58 and therefore based on the input-bit stream 54. In particular, the modulator 46 uses an inverse fast Fourier transform (IFFT) to change the QAM symbols 58 into a transmission signal 38 comprised of a sequence of DMT symbols 70. The modulator 46 changes the QAM symbols 58 into DMT symbols 70 through modulation of the carrier signals. In another embodiment, the modulator 46 uses the inverse discrete Fourier transform (IDFT) to change the QAM symbols 58 into DMT symbols 70. In one embodiment, a pilot tone is included in the transmission signal 38 to provide a reference signal for coherent demodulation of the carrier signals in the remote receiver 34 during reception of the transmission signal 38.

The modulator 46 also includes a phase scrambler 66 that combines a phase shift computed for each QAM-modulated carrier signal with the phase characteristic of that carrier signal. Combining phase shifts with phase characteristics, in accordance with the principles of the invention, substantially scrambles the phase characteristics of the carrier signals in the transmission signal 38. By scrambling the phase characteristics of the carrier signals, the resulting transmission signal 38 has a substantially minimized peak-to-average (PAR) power ratio. The phase scrambler 66 can be part of or external to the modulator 46. Other embodiments of the phase scrambler 66 include, but are not limited to, a software program that is stored in local memory and is executed on the modulator 46, a digital signal processor (DSP) capable of performing mathematical functions and algorithms, and the like. The remote receiver 34 similarly includes a phase scrambler 66' for use when demodulating carrier signals that have had their phase characteristics adjusted by the phase scrambler 66 of the DMT transceiver 10.

To compute a phase shift for each carrier signal, the phase scrambler 66 associates one or more values with that carrier signal. The phase scrambler 66 determines each value for a carrier signal independently of the QAM symbols 58, and, therefore, independently of the bit value(s) modulated onto the carrier signal. The actual value(s) that the phase scrambler 66 associates with each carrier signal can be derived from one or more predefined parameters, such as a pseudo-random number generator (pseudo-RNG), a DMT carrier number, a DMT symbol count, a DMT superframe count, a DMT hyperframe count, and the like, as described in more detail below. Irrespective of the technique used to produce each value, the same technique is used by the DMT transmitter 22 and the remote receiver 34 so that the value associated with a given carrier signal is known at both ends of the communication channel 18.

The phase scrambler 66 then solves a predetermined equation to compute a phase shift for the carrier signal, using the value(s) associated with that carrier signal as input that effects the output of the equation. Any equation suitable for computing phase shifts can be used to compute the phase shifts. When the equation is independent of the bit values of the input serial bit stream 54, the computed phase shifts are also independent of such bit values.

In one embodiment (shown in phantom), the DMT transmitter 22 includes a bit scrambler 74, which receives the input serial bit stream 54 and outputs data bits 76 that are substantially scrambled. The substantially scrambled bits 76 are then passed to the QAM encoder 42. When the bit scrambler 74 is included in the DMT transmitter 22, the operation of the phase scrambler 66 further assures that the transmission signal 38 has a Gaussian probability distribution and, therefore, a substantially minimized PAR.

Fig. 2 shows embodiments of a process used by the DMT transmitter 22 for adjusting the phase characteristic of each carrier signal and combining these carrier signals to produce the transmission signal 38. The DMT transmitter 22 generates (step 100) a value that is associated with a carrier signal. Because the value is being used to alter the phase characteristics of the carrier signal, both the DMT transmitter 22 and the remote receiver 34 must recognize the value as being associated with the carrier signal. Either the DMT transmitter 22 and the remote receiver 34 independently derive the associated value, or one informs the other of the associated value. For example, in one embodiment the DMT transmitter 22 can derive the value from a pseudo-RNG and then transmit the generated value to the remote receiver 34. In another embodiment, the remote receiver 34 similarly derives the value from the same pseudo-RNG and the same seed as used by the transmitter (i.e., the transmitter pseudo-RNG produces the same series of random numbers as the receiver pseudo-RNG).

As another example, the DMT transmitter 22 and the remote receiver 34 can each maintain a symbol counter for counting DMT symbols. The DMT transmitter 22 increments its symbol counter upon transmitting a DMT symbol; the remote receiver 34 upon receipt. Thus, when the DMT transmitter 22 and the remote receiver 34 both use the symbol count as a value for computing phase shifts, both the DMT transmitter 22 and remote receiver 34 “know” that the value is associated with a particular DMT symbol and with each carrier signal of that DMT symbol.

Values can also be derived from other types of predefined parameters. For example, if the predefined parameter is the DMT carrier number, then the value associated with a particular carrier signal is the carrier number of that signal within the DMT symbol. The number of a carrier signal represents the location of the frequency of the carrier signal relative to the frequency of other carrier

signals within a DMT symbol. For example, in one embodiment the DSL communication system 2 provides 256 carrier signals, each separated by a frequency of 4.3125 kHz and spanning the frequency bandwidth from 0 kHz to 1104 kHz. The DMT transmitter 22 numbers the carrier signals from 0 to 255. Therefore, "DMT carrier number 50" represents the 51st DMT carrier signal which is
5 located at the frequency of 215.625 kHz (i.e., 51 x 4.3125 kHz).

Again, the DMT transmitter 22 and the remote receiver 34 can know the value that is associated with the carrier signal because both the DMT transmitter 22 and the remote receiver 34 use the same predefined parameter (here, the DMT carrier number) to make the value-carrier signal association. In other embodiments (as exemplified above with the transmitter pseudo-RNG), the
10 DMT transmitter 22 can transmit the value to the remote receiver 34 (or vice versa) over the communication channel 18.

In other embodiments, other predefined parameters can be used in conjunction with the symbol count. One example of such a predefined parameter is the superframe count that increments by one every 69 DMT symbols. One exemplary implementation that achieves the superframe
15 counter is to perform a modulo 68 operation on the symbol count. As another example, the DMT transmitter 22 can maintain a hyperframe counter for counting hyperframes. An exemplary implementation of the hyperframe count is to perform a modulo 255 operation on the superframe count. Thus, the hyperframe count increments by one each time the superframe count reaches 255.

Accordingly, it is seen that some predefined parameters produce values that vary from carrier
20 signal to carrier signal. For example, when the predefined parameter is the DMT carrier number, values vary based on the frequency of the carrier signal. As another example, the pseudo-RNG generates a new random value for each carrier signal.

Other predefined parameters produce values that vary from DMT symbol 70 to DMT symbol 70. For example, when the predefined parameter is the symbol count, the superframe count, or hyperframe count, values vary based on the numerical position of the DMT symbol 70 within a sequence of symbols, superframes, or hyperframes. Predefined parameters such as the pseudo-RNG, symbol count, superframe count, and superframe can also be understood to be parameters that vary values over time. Any one or combination of the predefined parameters can provide values for input to the equation that computes a phase shift for a given carrier signal.

In one embodiment, the phase scrambling is used to avoid clipping of the transmission signal on a DMT symbol 70 by DMT symbol 70 basis. In this embodiment, the DMT transmitter 22 uses a value based on a predefined parameter that varies over time, such as the symbol count, to compute the phase shift. It is to be understood that other types of predefined parameters that vary the values associated with carrier signals can be used to practice the principles of the invention. As described above, the transceivers 10, 14 may communicate (step 110) the values to synchronize their use in modulating and demodulating the carrier signals.

The DMT transmitter 22 then computes (step 115) the phase shift that is used to adjust the phase characteristic of each carrier signal. The amount of the phase shift combined with the phase characteristic of each QAM-modulated carrier signal depends upon the equation used and the one or more values associated with that carrier signal.

The DMT transmitter 22 then combines (step 120) the phase shift computed for each carrier signal with the phase characteristic of that carrier signal. By scrambling the phase characteristics of the carrier signals, the phase scrambler 66 reduces (with respect to unscrambled phase characteristics) the combined PAR of the plurality of carrier signals and, consequently, the

transmission signal 38. The following three phase shifting examples, PS #1 – PS #3, illustrate methods used by the phase scrambler 66 to combine a computed phase shift to the phase characteristic of each carrier signal.

Phase Shifting Example #1

5 Phase shifting example #1 (PS #1) corresponds to adjusting the phase characteristic of the QAM-modulated carrier signal associated with a carrier number N by $N \times \frac{\pi}{3}$, modulo (mod) 2π . In this example, a carrier signal having a carrier number N equal to 50 has a phase shift added to the phase characteristic of that carrier signal equal to $50 \times \frac{\pi}{3} \pmod{2\pi} = \frac{2}{3}\pi$. The carrier signal with a carrier number N equal to 51 has a phase shift added to the phase characteristic of that carrier signal equal to $51 \times \frac{\pi}{3} \pmod{2\pi} = \pi$. The carrier signal with a carrier number N equal to 0 has no phase shift added to the phase characteristic of that carrier signal.

Phase Shifting Example #2

15 Phase shifting example #2 (PS #2) corresponds to adjusting the phase characteristic of the QAM-modulated carrier signal associated with a carrier number N by $(N + M) \times \frac{\pi}{4}$, mod 2π , where M is the symbol count. In this example, a carrier signal having a carrier number N equal to 50 on DMT symbol count M equal to 8 has a phase shift added to the phase characteristic of that carrier signal equal to $(50 + 8) \times \frac{\pi}{4} \pmod{2\pi} = \frac{\pi}{2}$. The carrier signal with the same carrier number N equal to 50 on the next DMT symbol count M equal to 9 has a phase shift added to the phase characteristic of that carrier signal equal to $(50 + 9) \times \frac{\pi}{4} \pmod{2\pi} = \frac{3\pi}{4}$.

Phase Shifting Example #3

Phase shifting example #3 (PS #3) corresponds to adjusting the phase characteristic of the QAM-modulated carrier signal associated with a carrier number N by $(X_N) \times \frac{\pi}{6}, \text{ mod } 2\pi$, where X_N is an array of N pseudo-random numbers. In this example, a carrier signal having a carrier number N equal to 5 and X_N equal to [3, 8, 1, 4, 9, 5, ...] has a phase shift added to the phase characteristic of the carrier signal that is equal to $(9) \times \frac{\pi}{6} (\text{mod } 2\pi) = \frac{\pi}{3}$. (Note that 9 is the 5th value in X_N .) The carrier signal with a carrier number N equal to 6 has a phase shift added to the phase characteristic of the carrier signal equal to $(5) \times \frac{\pi}{6} (\text{mod } 2\pi) = \frac{5\pi}{6}$.

It is to be understood that additional and/or different phase shifting techniques can be used by the phase scrambler 66, and that PS #1, #2, and #3 are merely illustrative examples of the principles of the invention. The DMT transmitter 22 then combines (step 130) the carrier signals to form the transmission signal 38. If the transmission signal is not clipped, as described below, the DMT transmitter 22 consequently transmits (step 160) the transmission signal 38 to the remote receiver 34.

Clipping of Transmission Signals

A transmission signal 38 that has high peak values of voltage (i.e., a high PAR) can induce non-linear distortion in the DMT transmitter 22 and the communication channel 18. One form of this non-linear distortion of the transmission signal 38 that may occur is the limitation of the amplitude of the transmission signal 38 (i.e., clipping). For example, a particular DMT symbol 70 clips in the time domain when one or more time domain samples in that DMT symbol 70 are larger than the maximum allowed digital value for the DMT symbols 70. In multicarrier communication

systems when clipping occurs, the transmission signal 38 does not accurately represent the input serial data bit signal 54.

In one embodiment, the DSL communication system 2 avoids the clipping of the transmission signal 38 on a DMT symbol 70 by DMT symbol 70 basis. The DMT transmitter 22
5 detects (step 140) the clipping of the transmission signal 38. If a particular DMT symbol 70 clips in the time domain to produce a clipped transmission signal 38, the DMT transmitter 22 substitutes (step 150) a predefined transmission signal 78 for the clipped transmission signal 38.

The predefined transmission signal 78 has the same duration as a DMT symbol 70 (e.g., 250 ms) in order to maintain symbol timing between the DMT transmitter 22 and the remote receiver 34.
10 The predefined transmission signal 78 is not based on (i.e., independent of) the modulated input data bit stream 54; it is a bit value pattern that is recognized by the remote receiver 34 as a substituted signal. In one embodiment, the predefined transmission signal 78 is a known pseudo-random sequence pattern that is easily detected by the remote receiver 34. In another embodiment, the predefined transmission signal 78 is an “all zeros” signal, which is a zero voltage signal produced at
15 the DMT transmitter 22 output (i.e., zero volts modulated on all the carrier signals). In addition to easy detection by the remote receiver 34, the zero voltage signal reduces the power consumption of the DMT transmitter 22 when delivered by the DMT transmitter 22. Further, a pilot tone is included in the predefined transmission signal 78 to provide a reference signal for coherent demodulation of the carrier signals in the remote receiver 34 during reception of the predefined transmission signal
20 78.

After the remote receiver 34 receives the transmission signal 38, the remote receiver 34 determines if the transmission signal 38 is equivalent to the predefined transmission signal 78. In

one embodiment, when the remote receiver 34 identifies the predefined transmission signal 78, the remote receiver 34 ignores (i.e., discards) the predefined transmission signal 78.

Following the transmission of the predefined transmission signal 78, the phase scrambler 66 shifts (step 120) the phase characteristic of the QAM-modulated carrier signals (based on one of the predefined parameters that varies over time). For example, consider that a set of QAM symbols 58 produces a DMT symbol 70 comprising a plurality of time domain samples, and that one of the time domain samples is larger than the maximum allowed digital value for the DMT symbol 70.

Therefore, because the transmission signal 38 would be clipped when sent to the remote receiver 34, the DMT transmitter 22 sends the predefined transmission signal 78 instead.

After transmission of the predefined transmission signal 78, the DMT transmitter 22 again attempts to send the same bit values that produced the clipped transmission signal 38 in a subsequent DMT symbol 70'. Because the generation of phase shifts in this embodiment is based on values that vary over time, the phase shifts computed for the subsequent DMT symbol 70' are different than those that were previously computed for the DMT symbol 70 with the clipped time domain sample. These different phase shifts are combined to the phase characteristics of the modulated carrier signals to produce carrier signals of the subsequent DMT symbol 70' with different phase characteristics than the carrier signals of the DMT symbol 70 with the clipped time domain sample.

DMT communication systems 2 infrequently produce transmission signals 38 that clip (e.g., approximately one clip every 10^7 time domain samples 70). However, if the subsequent DMT symbol 70' includes a time domain sample that clips, then the predefined transmission signal 78 is again transmitted (step 150) to the remote receiver 34 instead of the clipped transmission signal 38. The clipping time domain sample may be on the same or on a different carrier signal than the

previously clipped DMT symbol 70. The DMT transmitter 22 repeats the transmission of the predefined transmission signal 78 until the DMT transmitter 22 produces a subsequent DMT symbol 70' that is not clipped. When the DMT transmitter 22 produces a DMT symbol 70' that is not clipped, the DTM transmitter 22 transmits (step 160) the transmission signal 38 to the remote receiver 34. The probability of a DMT symbol 70 producing a transmission signal 38 that clips in the time domain depends on the PAR of the transmission signal 38.

For example, the following phase shifting example, PST #4, illustrates the method used by the phase scrambler 66 to combine a different phase shift to the phase characteristic of each carrier signal to avoid the clipping of the transmission signal 38.

10 **Phase Shifting Example #4**

Phase shifting example #4 (PS #4) corresponds to adjusting the phase characteristic of the carrier signal associated with a carrier number N by $\frac{\pi}{3} \times (M + N)$, mod 2π , where M is the DMT symbol count. In this example, if the DMT symbol 70 clips when the DMT symbol count M equals 5, the predefined transmission signal 78 is transmitted instead of the current clipped transmission signal 38. On the following DMT symbol period, the DMT count M equals 6, thereby causing a different set of time domain samples to be generated for the subsequent DMT symbol 70', although the QAM symbols 58 used to produce both DMT symbols 70, 70' are the same.

If this different set of time domain samples (and consequently the transmission signal 38) is not clipped, the DMT transmitter 22 sends the transmission signal 38. If one of the time domain samples in the different set of time domain samples 70 (and consequently the transmission signal 38) is clipped, then the DMT transmitter 22 sends the predefined transmission signal 78 again. The process continues until a DMT symbol 70 is produced without a time domain sample 70 that is

clipped. In one embodiment, the transmitter 22 stops attempting to produce a non-clipped DMT symbol 70' for the particular set of QAM symbols 58 after generating a predetermined number of clipped DMT symbols 70'. At that moment, the transmitter 22 can transmit the most recently produced clipped DMT symbol 70' or the predetermined transmission signal 78.

5 The PAR of the DSL communication system 2 is reduced because the predefined transmission signal 78 is sent instead of the transmission signal 38 when the DMT symbol 70 clips. For example, a DMT communication system 2 that normally has a clipping probability of 10^{-7} for the time domain transmission signal 38 can therefore operate with a 10^{-5} probability of clipping and a lower PAR equal to 12.8 dB (as compared to 14.5 dB). When operating at a 10^{-5} probability of clipping, assuming a DMT symbol 70 has 512 time-domain samples 70, the DMT transmitter 22
10 experiences one clipped DMT symbol 70 out of every $\frac{10^5}{512}$, or 195 DMT symbols 70. This results in the predefined (non-data carrying) transmission signal 78 being transmitted, on average, once every 195 DMT symbols. Although increasing the probability of clipping to 10^{-5} results in approximately a 0.5% (1/195) decrease in throughput, the PAR of the transmission signal 38 is
15 reduced by 1.7 dB, which reduces transmitter complexity in the form of power consumption and component linearity.

While the invention has been shown and described with reference to specific preferred embodiments, it should be understood by those skilled in the art that various changes in form and detail may be made therein without departing from the spirit and scope of the invention as defined
20 by the following claims. For example, although the specification uses DSL to describe the invention, it is to be understood that various form of DSL can be used, e.g., ADSL, VDSL, SDSL, HDSL, HDSL2, or SHDSL. It is also to be understood that the principles of the invention apply to

various types of applications transported over DSL systems (e.g., telecommuting, video conferencing, high speed Internet access, video-on demand).

THESE ARE THE

Claims

What is claimed is:

- 1 1. In a multicarrier modulation system including a first transceiver in communication with a
2 second transceiver using a transmission signal having a plurality of carrier signals for
3 modulating an input bit stream, each carrier signal having a phase characteristic associated
4 with the input bit stream, a method for scrambling the phase characteristics of the carrier
5 signals comprising:
6 associating each carrier signal with a value determined independently of any input bit
7 value carried by that carrier signal;
8 computing a phase shift for each carrier signal based on the value associated with that
9 carrier signal; and
10 combining the phase shift computed for each carrier signal with the phase
11 characteristic of that carrier signal so as to substantially scramble the phase characteristics
12 of the plurality of carrier signals.
- 1 2. The method of claim 1 further comprising modulating bits of the input bit stream onto the
2 carrier signals having the substantially scrambled phase characteristics to produce a
3 transmission signal with a reduced peak-to-average power ratio (PAR).
- 1 3. The method of claim 1 further comprising independently deriving the value associated with
2 each carrier signal at each transceiver.

- 1 4. The method of claim 1 further comprising transmitting the value associated with each carrier
2 signal from one transceiver to the other transceiver.
- 1 5. The method of claim 1 further comprising maintaining synchronization between the
2 transceivers using the value associated with each carrier signal.
- 1 6. The method of claim 1 wherein the value varies with each carrier signal.
- 1 7. The method of claim 1 wherein the value varies with each DMT symbol.
- 1 8. The method of claim 1 wherein the value is derived from a predetermined parameter.
9. The method of claim 8 wherein the predefined parameter is a carrier number.
10. The method of claim 8 wherein the predefined parameter is a symbol count.
11. The method of claim 8 wherein the predefined parameter is a hyperframe count.
12. The method of claim 8 wherein the predefined parameter is a superframe count.
13. The method of claim 1 further comprising scrambling the bits of the input bit stream.
- 1 14. The method of claim 1 further comprising transmitting a predetermined transmission signal
2 when the amplitude of the transmission signal exceeds a certain level.
- 1 15. The method of claim 14 wherein the predetermined transmission signal comprises a
2 predetermined pattern of bits.

- 1 16. The method of claim 14 wherein the predetermined transmission signal comprises a pilot
2 tone.
- 1 17. The method of claim 16 wherein the pilot tone is used to maintain timing synchronization
2 between the first transceiver and the second transceiver.
- 1 18. The method of claim 15 wherein each bit value in the predetermined pattern of bits is a zero
2 value.
- 1 19. The method of claim 15 wherein the predetermined pattern of bits is a pseudo-random
2 sequence pattern.
- 1 20. In a multicarrier modulation system including a first transceiver in communication with a
2 second transceiver using a transmission signal having a plurality of carrier signals for
3 modulating an input bit stream, each carrier signal having a phase characteristic with the
4 input bit stream, a method for scrambling the phase characteristics of the carrier signals
5 comprising:
6 associating each carrier signal with a value determined independently of any input bit
7 value carried by that carrier signal;
8 computing a phase shift for each carrier signal based on the value associated with that
9 carrier signal; and
10 demodulating the transmission signal using the phase shift computed for each carrier
11 signal.

- 1 21. The method of claim 20 further comprising independently deriving the value associated with
2 each carrier signal at each transceiver.
- 1 22. The method of claim 20 further comprising transmitting the value associated with each
2 carrier signal from one transceiver to the other transceiver.
- 1 23. The method of claim 20 further comprising maintaining synchronization between the
2 transceivers using the value associated with each carrier signal.
- 1 24. The method of claim 20 wherein the value varies with each carrier signal.
- 1 25. The method of claim 20 wherein the value varies with each DMT symbol.
- 1 26. The method of claim 20 wherein the value is derived from a predetermined parameter.
- 1 27. The method of claim 26 wherein the predefined parameter is a carrier number.
- 1 28. The method of claim 26 wherein the predefined parameter is a symbol count.
- 1 29. The method of claim 26 wherein the predefined parameter is a hyperframe count.
- 1 30. The method of claim 26 wherein the predefined parameter is a superframe count.
- 1 31. The method of claim 20 further comprising receiving a predetermined transmission when the
2 amplitude of the transmission signal exceeds a certain level.
- 1 32. The method of claim 31 wherein the predetermined transmission signal comprises a
2 predetermined pattern of bits.

1 33. The method of claim 31 wherein the predetermined transmission signal comprises a pilot
2 tone.

1 34. The method of claim 33 wherein the pilot tone is used to maintain timing synchronization
2 between the first transceiver and the second transceiver.

1 35. The method of claim 32 wherein each bit value in the predetermined pattern of bits is a zero
2 value.

1 36. The method of claim 32 wherein the predetermined pattern of bits is a pseudo-random
2 sequence pattern.

1 37. A transceiver for communicating over a communication channel using a transmission signal
2 having a plurality of carrier signals, each carrier signal having a phase characteristic, the
3 transceiver comprising:

4 a phase scrambler computing a phase shift for each carrier signal based on a value
5 associated with that carrier signal and combining the phase shift computed for each carrier
6 signal with the phase characteristic of that carrier signal so as to substantially scramble the
7 phase characteristics of the plurality of carrier signals.

1 38. The transceiver of claim 37 further comprising a modulator in communication with the phase
2 scrambler, the modulator modulating bits of an input signal onto the carrier signals having
3 the substantially scrambled phase characteristics to produce a transmission signal with a
4 reduced PAR.

1 39. In a multicarrier modulation system, a method for communicating over a communication
2 channel, comprising:
3 receiving over the communication channel a transmission signal comprised of a
4 sequence of DMT symbols that each have a bit-value pattern;
5 comparing the bit-value pattern of each received DMT symbol with a predetermined
6 bit value pattern;
7 discarding a given one of the received DMT symbols in the sequence of DMT
8 symbols if the bit-value pattern of that DMT symbol matches the predetermined bit-value
9 pattern, otherwise demodulating that DMT symbol.

10
11
12
13
14
15
16
17
18
19
20
21
22
23
24
25
26
27
28
29
30
31
32
33
34
35
36
37
38
39
40
41
42
43
44
45
46
47
48
49
50

Abstract

A system and method that scrambles the phase characteristic of a carrier signal are described. The scrambling of the phase characteristic of each carrier signal includes associating a value with each carrier signal and computing a phase shift for each carrier signal based on the value associated with that carrier signal. The value is determined independently of any input bit value carried by that carrier signal. The phase shift computed for each carrier signal is combined with the phase characteristic of that carrier signal so as to substantially scramble the phase characteristic of the carrier signals. Bits of an input signal are modulated onto the carrier signals having the substantially scrambled phase characteristic to produce a transmission signal with a reduced PAR.

10
20
30
40
50
60
70
80
90
100
110
120
130
140
150
160
170
180
190
200
210
220
230
240
250
260
270
280
290
300
310
320
330
340
350
360
370
380
390
400

rodrigue/457/17.1102554-2

2
SECRET

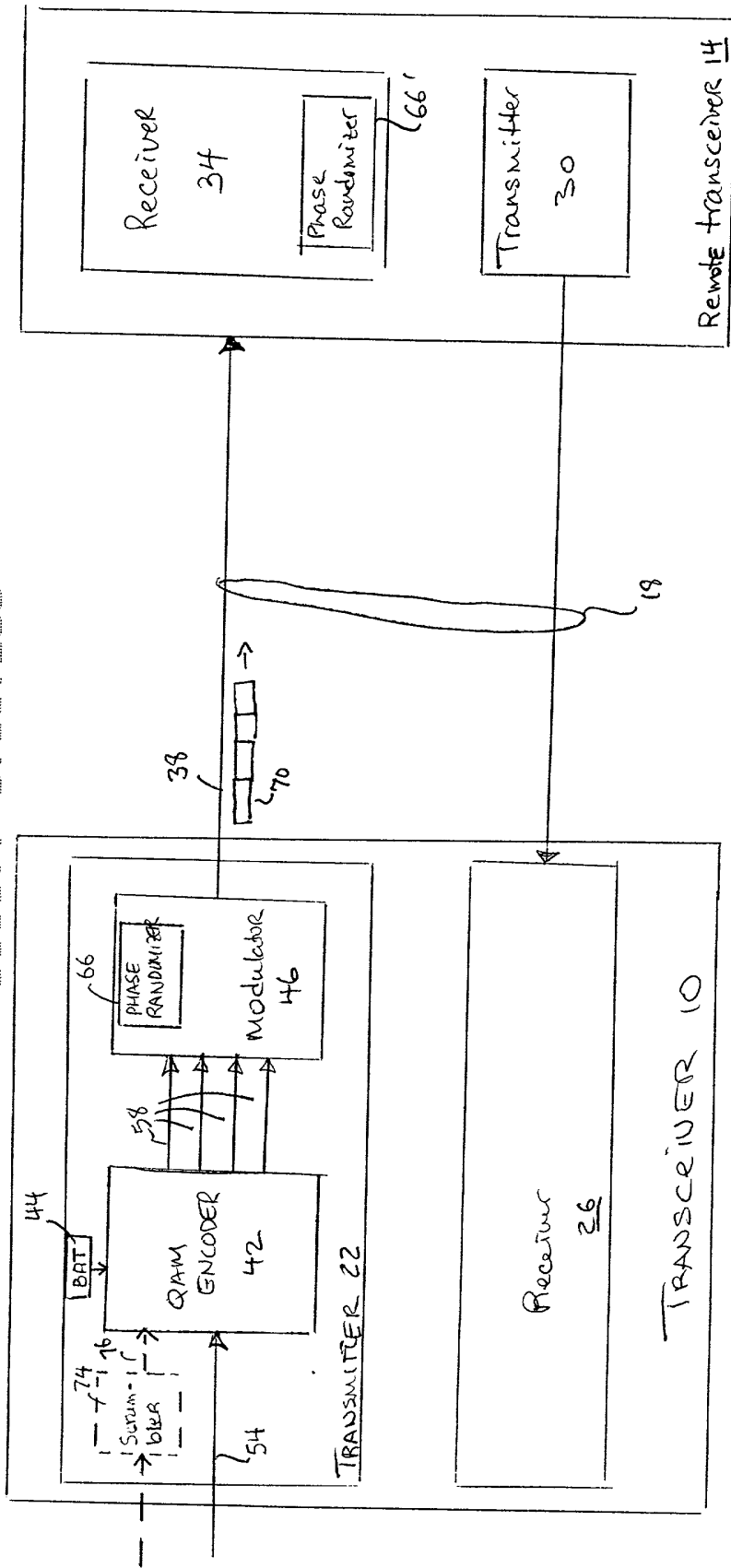

FIG. 1

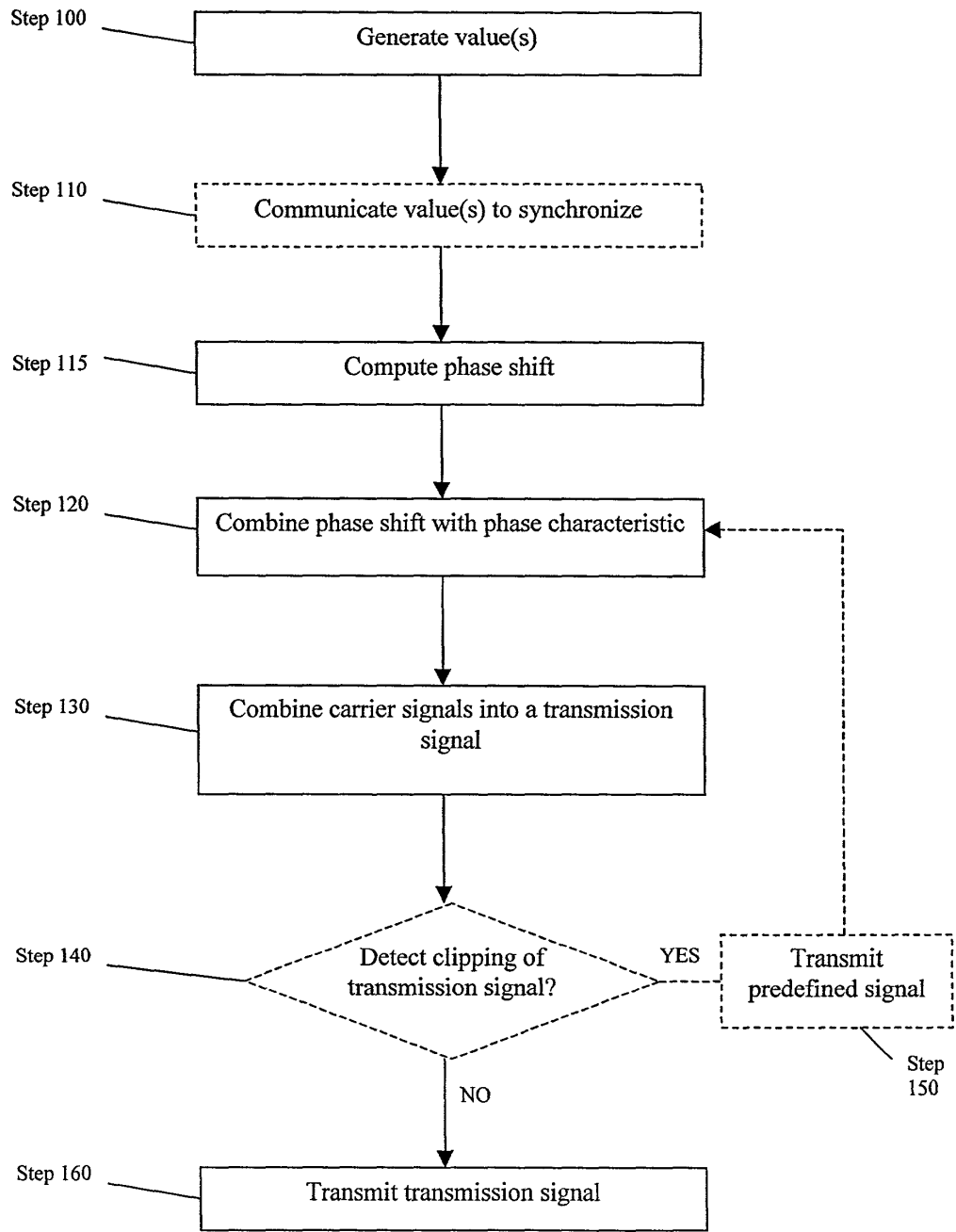

FIG. 2

DECLARATION AND POWER OF ATTORNEY FOR UTILITY OR DESIGN PATENT APPLICATION <input checked="" type="checkbox"/> Declaration <input type="checkbox"/> Declaration Submitted with Submitted after Initial Initial Filing Filing (surcharge 37 CFR 1.16(e) required)	Attorney Docket No.	AWR-017 (457/19)
	First Named Inventor	Tzannes
	COMPLETE IF KNOWN	
	Application Serial Number	Not Yet Assigned
	Filing Date	Herewith
	Group Art Unit	Not Yet Assigned
	Examiner Name	Not Yet Assigned

As a below named inventor, I hereby declare that:

My residence, post office address, and citizenship are as stated below next to my name.

I believe I am the original, first and sole inventor (if only one name is listed below) or an original, first and joint inventor (if plural names are listed below) of the subject matter which is claimed and for which a patent is sought on the invention entitled:

A System And Method For Scrambling The Phase Of The Carriers In A Multicarrier Communications System
(Title of the Invention)

the specification of which

is attached hereto
OR
 was filed on (MM/DD/YYYY) [] as United States Application Serial Number or PCT International Application Number [] and was amended on (MM/DD/YYYY) [] (if applicable).

I hereby state that I have reviewed and understand the contents of the above identified specification, including the claims, as amended by any amendment specifically referred to above.

I acknowledge the duty to disclose to the Patent Office all information known by me to be material to patentability as defined in 37 CFR 1.56.

I hereby claim foreign priority benefits under 35 U.S.C. 119(a)-(d) or 365(b) of any foreign application(s) for patent or inventor's certificate, or 365(a) of any PCT international application which designated at least one country other than the United States of America, listed below and have also identified below, by checking the box, any foreign application for patent or inventor's certificate, or of any PCT international application having a filing date before that of the application on which priority is claimed.

Prior Foreign Application Number(s)	Country	Foreign Filing Date (MM/DD/YYYY)	Priority Not Claimed	Certified Copy Attached?	
				YES	NO
			<input type="checkbox"/>	<input type="checkbox"/>	<input type="checkbox"/>
			<input type="checkbox"/>	<input type="checkbox"/>	<input type="checkbox"/>
			<input type="checkbox"/>	<input type="checkbox"/>	<input type="checkbox"/>
			<input type="checkbox"/>	<input type="checkbox"/>	<input type="checkbox"/>

Additional foreign application numbers are listed on a supplemental priority data sheet attached hereto.

I hereby claim the benefit under 35 U.S.C. 119(e) of any United States provisional application(s) listed below.

Application Serial Number(s)	Filing Date (MM/DD/YYYY)	
60/164,134	11/09/1999	<input type="checkbox"/> Additional provisional application serial numbers are listed on a supplemental priority data sheet attached hereto.

DECLARATION – Utility or Design Patent Application			
I hereby claim the benefit under 35 U.S.C. 120 of any United States application(s), or 365(c), of any PCT international application designating the United States of America, listed below and, insofar as the subject matter of each of the claims of this application is not disclosed in the prior United States or PCT International application in the manner provided by the first paragraph of 35 U.S.C. 112, I acknowledge the duty to disclose information which is material to patentability as defined in 37 CFR 1.56 which became available between the filing date of the prior application and the national or PCT international filing date of this application.			
U.S. Parent Application or PCT Parent Serial Number	Parent Filing Date (MM/DD/YYYY)	Parent Patent Number (if applicable)	
<input type="checkbox"/> Additional U.S. or PCT international application numbers are listed on a supplemental priority data sheet attached hereto.			
As a named inventor, I hereby appoint the following registered practitioners to prosecute this application and to transact all business in the Patent and Trademark Office connected therewith: <input type="checkbox"/> Customer Number → Place Customer Number Bar Code Label Here			
OR <input checked="" type="checkbox"/> Registered practitioner(s) name/registration number listed below			
Name	Registration Number	Name	Registration Number
Steven M. Bauer	31,481	Thomas C. Meyers	36,989
John V. Bianco	36,748	Joseph B. Milstein	42,897
Isabelle A.S. Blundell	43,321	David G. Miranda	42,898
Maureen A. Bresnahan	44,559	Ronda P. Moore	44,244
Michael H. Brodowski	41,640	Indranil Mukerji	P-46,944
Jennifer A. Camacho	43,526	Edmund R. Pitcher	27,829
Joseph A. Capraro, Jr.	36,471	Michael A. Rodriguez	41,274
John J. Cotter	38,116	Jamie H. Rose	45,054
John V. Forcier	42,545	R. Stephen Rosenholm	45,283
Steven J. Frank	33,497	Christopher W. Stamos	35,370
Brian M. Gaff	44,691	Joseph P. Sullivan	45,349
Michael J. Giannetta	42,574	Robert J. Tosti	35,393
Duncan A. Greenhalgh	38,678	Thomas A. Turano	35,722
William G. Guerin	41,047	Michael J. Twomey	38,349
Jonathan A. Harris	44,744	Christine C. Vito	39,061
Ira V. Heffan	41,059	Patrick R.H. Waller	41,418
Danielle L. Herritt	43,670	Daniel A. Wilson	45,508
Douglas J. Kline	35,574	Yin P. Zhang	44,372
John D. Lanza	40,060		
Kurt W. Lockwood	40,704		
<input type="checkbox"/> Additional registered practitioners named on supplemental Registered Practitioner Information sheet attached hereto.			
Direct all correspondence to: <div style="margin-left: 100px;"> Patent Administrator Testa, Hurwitz & Thibault, LLP High Street Tower 125 High Street Boston, MA 02110 Tel. No.: (617) 248-7000 Fax No.: (617) 248-7100 </div>			

I hereby declare that all statements made herein of my own knowledge are true and that all statements made on information and belief are believed to be true; and further that these statements were made with the knowledge that willful false statements and the like so made are punishable by fine or imprisonment, or both, under 18 U.S.C. 1001 and that such willful false statements may jeopardize the validity of the application or any patent issued thereon.

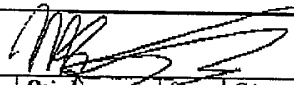
Name of Sole or First Inventor:		<input type="checkbox"/> A petition has been filed for this unsigned inventor						
Given Name (first and middle [if any])				Family Name or Surname				
Marcos C.				Tzannes				
Inventor's Signature					Date		Nov 9, 2000	
Residence	City	Orinda	State	CA	Country	USA	Citizenship	USA
Post Office Address		121 LaEspiral						
P.O. Address (line 2)	City	Orinda	State	CA	ZIP	94563	Country	USA
<input type="checkbox"/> Additional inventors are being named on the _____ supplemental Additional Inventor(s) sheet(s) attached hereto.								
Name of Additional Joint Inventor, if any:		<input type="checkbox"/> A petition has been filed for this unsigned inventor						
Given Name (first and middle [if any])				Family Name or Surname				
Inventor's Signature					Date			
Residence	City		State		Country		Citizenship	
Post Office Address								
P.O. Address (line 2)	City		State		ZIP		Country	
Name of Additional Joint Inventor, if any:		<input type="checkbox"/> A petition has been filed for this unsigned inventor						
Given Name (first and middle [if any])				Family Name or Surname				
Inventor's Signature					Date			
Residence	City		State		Country		Citizenship	
Post Office Address								
P.O. Address (line 2)	City		State		ZIP		Country	

20001109191103565_1

11-13-00

A

Express Mail Mailing Label No. EM401136836US

11/09/00
13660 U.S. PRO

11/09/00
13660 U.S. PRO

UTILITY PATENT APPLICATION TRANSMITTAL <small>(Only for new nonprovisional applications under 37 CFR 1.53(b))</small>	Attorney Docket No.	AWR-017 (457/19)
	First Named Inventor	Tzannes
	Title	A System And Method For Scrambling The Phase Of The Carriers In A Multicarrier Communications System

APPLICATION ELEMENTS	ADDRESS TO: Box Patent Application Assistant Commissioner for Patents Washington, D.C. 20231
1. <input checked="" type="checkbox"/> Fee Transmittal Form	ACCOMPANYING APPLICATION PARTS
2. <input checked="" type="checkbox"/> Specification and Drawings [Total Pages 27] X - Written Description - (18 pages) X - Claims - (6 pages) X - Abstract - (1 page) X - Sheets of Drawings - (2 sheets) <input type="checkbox"/> Formal <input checked="" type="checkbox"/> Informal	7. <input type="checkbox"/> 37 CFR 3.73(b) Statement (when there is an assignee) <input type="checkbox"/> Power of Attorney
3. <input checked="" type="checkbox"/> Oath or Declaration [Total Pages 3] a. <input checked="" type="checkbox"/> Newly executed (original) b. <input type="checkbox"/> Copy from a prior application (37 CFR 1.63(d)) <i>(for continuation/divisional with Box 17 completed)</i> <i>[Note Box 4 below]</i>	8. <input type="checkbox"/> English Translation Document <i>(if applicable)</i> 9. <input type="checkbox"/> Information Disclosure Statement (IDS)/PTO-1449 <input type="checkbox"/> Copies of IDS Citations
4. <input type="checkbox"/> Incorporation by Reference (usable if Box 3b is checked) The entire Disclosure of the prior application, from which a copy of the oath or declaration is supplied under Box 3b, is considered as being part of the disclosure of the accompanying application and is hereby incorporated by reference therein.	10. <input type="checkbox"/> Preliminary Amendment <input type="checkbox"/> Drawings [Total Sheets] <input type="checkbox"/> Letter to Official Draftsperson Including Drawings [Total Pages]
5. <input type="checkbox"/> Microfiche Computer Program <i>(Appendix)</i>	11. <input checked="" type="checkbox"/> Return Receipt Postcard
6. <input type="checkbox"/> Nucleotide and/or Amino Acid Sequence Submission <input type="checkbox"/> Computer Readable Copy <input type="checkbox"/> Paper Copy (identical to computer copy) <input type="checkbox"/> Statement verifying identity of above copies	12. <input type="checkbox"/> Small Entity Statement(s) <input type="checkbox"/> Statements filed in prior application, (Status still proper and desired) 13. <input type="checkbox"/> Certified Copy of Priority Document(s)
14. <input type="checkbox"/> Deletion of Inventor(s) Signed statement attached deleting inventor(s) named in the prior application.	15. <input checked="" type="checkbox"/> Patent Application Data Entry Form
17. <input type="checkbox"/> If a CONTINUING APPLICATION , check appropriate box and supply the requisite information: <input type="checkbox"/> Continuation <input type="checkbox"/> Divisional <input type="checkbox"/> Continuation-in-part (CIP) of prior application Serial No. ____/____. Priority to the above application(s) is claimed under 35 U.S.C. 120. Prior application information: Examiner: _____. Group/Art Unit: _____.	16. <input type="checkbox"/> Other:
18. <input checked="" type="checkbox"/> Priority - 35 U.S.C. 119 <input checked="" type="checkbox"/> Priority of application Serial No. <u>60/164,134</u> filed on <u>November 9, 1999</u> in <u>United States</u> is claimed under 35 U.S.C. 119. <input type="checkbox"/> The certified copy has been filed in prior U.S. application Serial No. ____/____ on ____. <input type="checkbox"/> The certified copy will follow.	

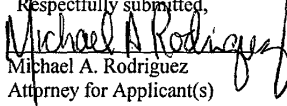
CORRESPONDENCE ADDRESS	SIGNATURE BLOCK
Direct all correspondence to: Patent Administrator Testa, Hurwitz & Thibault, LLP High Street Tower 125 High Street Boston, MA 02110 Tel. No.: (617) 248-7000 Fax No.: (617) 248-7100	Date: November 9, 2000 Reg. No. 41,274 Tel. No.: (617) 248-7501 Fax No.: (617) 248-7100 Respectfully submitted,  Michael A. Rodriguez Attorney for Applicant(s) Testa, Hurwitz & Thibault, LLP High Street Tower 125 High Street Boston, MA 02110

ABRAMSON457/19.1105071

FEE TRANSMITTAL FY 2001	<i>Complete if Known</i>	
	Application Serial Number	Not Yet Assigned
	Filing Date	Herewith
	First Named Inventor	Tzannes
	Group Art Unit	Not Yet Assigned
	Examiner Name	Not Yet Assigned
Attorney Docket No.	AWR-017 (457/19)	

11/09/00
 09/10/310
 10310

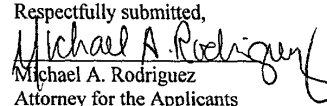
METHOD OF PAYMENT	FEE CALCULATION (continued)																																																																																								
1. <input checked="" type="checkbox"/> Payment Enclosed: <input checked="" type="checkbox"/> Check <input type="checkbox"/> Money Order <input type="checkbox"/> Other	3. ADDITIONAL FEES <table border="1" style="width: 100%; border-collapse: collapse;"> <thead> <tr> <th style="width: 10%;">Large Entity Fee (\$)</th> <th style="width: 10%;">Small Entity Fee (\$)</th> <th style="width: 60%;">Fee Description</th> <th style="width: 20%;">Fee Paid</th> </tr> </thead> <tbody> <tr><td>130</td><td>65</td><td>Surcharge - late filing fee or oath</td><td></td></tr> <tr><td>50</td><td>25</td><td>Surcharge - late provisional filing fee or cover sheet</td><td></td></tr> <tr><td>130</td><td>130</td><td>Non-English specification</td><td></td></tr> <tr><td>2,520</td><td>2,520</td><td>For filing a request for reexamination</td><td></td></tr> <tr><td>110</td><td>55</td><td>Extension for reply within first month</td><td></td></tr> <tr><td>390</td><td>195</td><td>Extension for reply within second month</td><td></td></tr> <tr><td>890</td><td>445</td><td>Extension for reply within third month</td><td></td></tr> <tr><td>1,390</td><td>695</td><td>Extension for reply within fourth month</td><td></td></tr> <tr><td>1,890</td><td>945</td><td>Extension for reply within fifth month</td><td></td></tr> <tr><td>310</td><td>155</td><td>Notice of Appeal</td><td></td></tr> <tr><td>310</td><td>155</td><td>Filing a brief in support of an appeal</td><td></td></tr> <tr><td>270</td><td>135</td><td>Request for oral hearing</td><td></td></tr> <tr><td>130</td><td>130</td><td>Petitions to the Commissioner</td><td></td></tr> <tr><td>50</td><td>50</td><td>Petitions related to provisional applications</td><td></td></tr> <tr><td>240</td><td>240</td><td>Submission of Information Disclosure Statement (37 CFR 1.97(c))</td><td></td></tr> <tr><td>130</td><td>130</td><td>Submission of Information Disclosure Statement (37 CFR 1.97(d))</td><td></td></tr> <tr><td>710</td><td>355</td><td>Filing a submission after final rejection (37 CFR 1.129(a))</td><td></td></tr> <tr><td>710</td><td>355</td><td>For each additional invention to be examined (37 CFR 1.129(b))</td><td></td></tr> <tr><td colspan="3">Other fee (Specify) _____</td><td></td></tr> <tr><td colspan="3">Other fee (Specify) _____</td><td></td></tr> <tr><td colspan="3" style="text-align: right;">SUBTOTAL (3)</td><td style="border: 1px solid black;">(\$)</td></tr> </tbody> </table>	Large Entity Fee (\$)	Small Entity Fee (\$)	Fee Description	Fee Paid	130	65	Surcharge - late filing fee or oath		50	25	Surcharge - late provisional filing fee or cover sheet		130	130	Non-English specification		2,520	2,520	For filing a request for reexamination		110	55	Extension for reply within first month		390	195	Extension for reply within second month		890	445	Extension for reply within third month		1,390	695	Extension for reply within fourth month		1,890	945	Extension for reply within fifth month		310	155	Notice of Appeal		310	155	Filing a brief in support of an appeal		270	135	Request for oral hearing		130	130	Petitions to the Commissioner		50	50	Petitions related to provisional applications		240	240	Submission of Information Disclosure Statement (37 CFR 1.97(c))		130	130	Submission of Information Disclosure Statement (37 CFR 1.97(d))		710	355	Filing a submission after final rejection (37 CFR 1.129(a))		710	355	For each additional invention to be examined (37 CFR 1.129(b))		Other fee (Specify) _____				Other fee (Specify) _____				SUBTOTAL (3)			(\$)
Large Entity Fee (\$)		Small Entity Fee (\$)	Fee Description	Fee Paid																																																																																					
130	65	Surcharge - late filing fee or oath																																																																																							
50	25	Surcharge - late provisional filing fee or cover sheet																																																																																							
130	130	Non-English specification																																																																																							
2,520	2,520	For filing a request for reexamination																																																																																							
110	55	Extension for reply within first month																																																																																							
390	195	Extension for reply within second month																																																																																							
890	445	Extension for reply within third month																																																																																							
1,390	695	Extension for reply within fourth month																																																																																							
1,890	945	Extension for reply within fifth month																																																																																							
310	155	Notice of Appeal																																																																																							
310	155	Filing a brief in support of an appeal																																																																																							
270	135	Request for oral hearing																																																																																							
130	130	Petitions to the Commissioner																																																																																							
50	50	Petitions related to provisional applications																																																																																							
240	240	Submission of Information Disclosure Statement (37 CFR 1.97(c))																																																																																							
130	130	Submission of Information Disclosure Statement (37 CFR 1.97(d))																																																																																							
710	355	Filing a submission after final rejection (37 CFR 1.129(a))																																																																																							
710	355	For each additional invention to be examined (37 CFR 1.129(b))																																																																																							
Other fee (Specify) _____																																																																																									
Other fee (Specify) _____																																																																																									
SUBTOTAL (3)			(\$)																																																																																						
2. <input checked="" type="checkbox"/> The Commissioner is hereby authorized to credit or charge any fee indicated below for this submission to Deposit Account No. 20-0531. <input type="checkbox"/> Required Fees (copy of this sheet enclosed). <input checked="" type="checkbox"/> Additional fee required under 37 CFR 1.16 and 1.17. <input checked="" type="checkbox"/> Overpayment Credit.																																																																																									
FEE CALCULATION																																																																																									
1. FILING FEE <table border="1" style="width: 100%; border-collapse: collapse;"> <thead> <tr> <th style="width: 15%;">Large Entity Fee (\$)</th> <th style="width: 55%;">Fee Description</th> <th style="width: 30%;">Fee Paid</th> </tr> </thead> <tbody> <tr><td>710</td><td>Utility filing fee</td><td style="border: 1px solid black;">710.00</td></tr> <tr><td>320</td><td>Design filing fee</td><td></td></tr> <tr><td>150</td><td>Provisional filing fee</td><td></td></tr> </tbody> </table> <table border="1" style="width: 100%; border-collapse: collapse;"> <thead> <tr> <th style="width: 10%;">Number Filed</th> <th style="width: 10%;">Number Extra</th> <th style="width: 10%;">Rate</th> <th style="width: 10%;">Amount</th> </tr> </thead> <tbody> <tr> <td>Total Claims</td> <td>39 - 20 = <u>19</u></td> <td>x \$ 18.00 =</td> <td>342.00</td> </tr> <tr> <td>Independent Claims</td> <td>4 - 3 = <u>1</u></td> <td>x \$ 80.00 =</td> <td>80.00</td> </tr> <tr> <td colspan="3"><input type="checkbox"/> Multiple Dependent Claim(s), if any</td> <td>\$270.00 =</td> </tr> <tr> <td colspan="3" style="text-align: right;">TOTAL:</td> <td>1132.00</td> </tr> <tr> <td colspan="3" style="text-align: right;">SMALL ENTITY DISCOUNT:</td> <td></td> </tr> <tr> <td colspan="3" style="text-align: right;">SUBTOTAL (1)</td> <td style="border: 1px solid black;">(\$)</td> </tr> </tbody> </table> 2. AMENDMENT CLAIM FEES <table border="1" style="width: 100%; border-collapse: collapse;"> <thead> <tr> <th style="width: 10%;">Claims Remaining After Amend.</th> <th style="width: 10%;">Highest No. Previously Paid For</th> <th style="width: 10%;">Present Extra</th> <th style="width: 10%;">Rate</th> <th style="width: 10%;">Fee Paid</th> </tr> </thead> <tbody> <tr> <td>Total</td> <td>-</td> <td>=</td> <td>x \$ 18.00 =</td> <td></td> </tr> <tr> <td>Indep.</td> <td>-</td> <td>=</td> <td>x \$ 80.00 =</td> <td></td> </tr> <tr> <td colspan="3"><input type="checkbox"/> First Presentation of Multiple Dep. Claim</td> <td>+ \$270.00 =</td> <td></td> </tr> <tr> <td colspan="4" style="text-align: right;">TOTAL:</td> <td style="border: 1px solid black;">(\$)</td> </tr> <tr> <td colspan="4" style="text-align: right;">SMALL ENTITY DISCOUNT:</td> <td style="border: 1px solid black;">(\$)</td> </tr> <tr> <td colspan="4" style="text-align: right;">SUBTOTAL (2)</td> <td style="border: 1px solid black;">(\$)</td> </tr> </tbody> </table>	Large Entity Fee (\$)	Fee Description	Fee Paid	710	Utility filing fee	710.00	320	Design filing fee		150	Provisional filing fee		Number Filed	Number Extra	Rate	Amount	Total Claims	39 - 20 = <u>19</u>	x \$ 18.00 =	342.00	Independent Claims	4 - 3 = <u>1</u>	x \$ 80.00 =	80.00	<input type="checkbox"/> Multiple Dependent Claim(s), if any			\$270.00 =	TOTAL:			1132.00	SMALL ENTITY DISCOUNT:				SUBTOTAL (1)			(\$)	Claims Remaining After Amend.	Highest No. Previously Paid For	Present Extra	Rate	Fee Paid	Total	-	=	x \$ 18.00 =		Indep.	-	=	x \$ 80.00 =		<input type="checkbox"/> First Presentation of Multiple Dep. Claim			+ \$270.00 =		TOTAL:				(\$)	SMALL ENTITY DISCOUNT:				(\$)	SUBTOTAL (2)				(\$)														
Large Entity Fee (\$)	Fee Description	Fee Paid																																																																																							
710	Utility filing fee	710.00																																																																																							
320	Design filing fee																																																																																								
150	Provisional filing fee																																																																																								
Number Filed	Number Extra	Rate	Amount																																																																																						
Total Claims	39 - 20 = <u>19</u>	x \$ 18.00 =	342.00																																																																																						
Independent Claims	4 - 3 = <u>1</u>	x \$ 80.00 =	80.00																																																																																						
<input type="checkbox"/> Multiple Dependent Claim(s), if any			\$270.00 =																																																																																						
TOTAL:			1132.00																																																																																						
SMALL ENTITY DISCOUNT:																																																																																									
SUBTOTAL (1)			(\$)																																																																																						
Claims Remaining After Amend.	Highest No. Previously Paid For	Present Extra	Rate	Fee Paid																																																																																					
Total	-	=	x \$ 18.00 =																																																																																						
Indep.	-	=	x \$ 80.00 =																																																																																						
<input type="checkbox"/> First Presentation of Multiple Dep. Claim			+ \$270.00 =																																																																																						
TOTAL:				(\$)																																																																																					
SMALL ENTITY DISCOUNT:				(\$)																																																																																					
SUBTOTAL (2)				(\$)																																																																																					
CORRESPONDENCE ADDRESS	SIGNATURE BLOCK																																																																																								
Direct all correspondence to: Patent Administrator Testa, Hurwitz & Thibault, LLP High Street Tower-125 High Street Boston, MA 02110 Tel. No.: (617) 248-7000 Fax No.: (617) 248-7100	Respectfully submitted,  Michael A. Rodriguez Attorney for the Applicants Testa, Hurwitz & Thibault, LLP High Street Tower-125 High Street Boston, MA 02110 Date: November 9, 2000 Reg. No.: 41,274 Tel. No.: (617) 248-7501 Fax No.: (617) 248-7100																																																																																								

ABRAMSON457/19.1104944

Inventor Information

Inventor One Given Name :: Marcos
Family Name :: Tzannes
Name Suffix ::
Postal Address Line One :: 121 LaEspiral
Postal Address Line Two ::
City :: Orinda
State/Province :: California
Country :: United States
Postal or Zip Code :: 94563
City of Residence :: Orinda
State/Prov. of Residence :: California
Country of Residence :: United States
Citizenship :: U.S.

Correspondence Information

Correspondence Customer Number :: 021323

Application Information

Title Line One :: A System And Method For Scrambling The Phase Of The Carriers
Title Line Two :: In A Multicarrier Communications System
Total Drawing Sheets :: 2
Formal Drawings :: No
Application Type :: Utility
Docket Number :: AWR-017
Licensed - U S Government Agency ::
Contract Number ::
Grant Number ::
Secrecy Order in Parent Application ::

Representative Information

Representative Customer Number :: 021323

Continuity Information

This application claims the benefit of:
>Application One :: 60/164,134
Filing Date :: November 9, 1999

5

**A System and Method for Scrambling the Phase of the Carriers in a Multicarrier
Communications System**

Related Application

This application claims the benefit of the filing date of copending U.S. Provisional
10 Application, Serial No. 60/164,134, filed November 9, 1999, entitled "A Method For Randomizing
The Phase Of The Carriers In A Multicarrier Communications System To Reduce The Peak To
Average Power Ratio Of The Transmitted Signal," the entirety of which provisional application is
incorporated by reference herein.

15
20
25
30
35
40
45
50
55
60
65
70
75
80
85
90
95
100
105
110
115
120
125
130
135
140
145
150
155
160
165
170
175
180
185
190
195
200
205
210
215
220
225
230
235
240
245
250
255
260
265
270
275
280
285
290
295
300
305
310
315
320
325
330
335
340
345
350
355
360
365
370
375
380
385
390
395
400
405
410
415
420
425
430
435
440
445
450
455
460
465
470
475
480
485
490
495
500

Field of the Invention

This invention relates to communications systems using multicarrier modulation. More
particularly, the invention relates to multicarrier communications systems that lower the peak-to-
average power ratio (PAR) of transmitted signals.

Background of the Invention

20 In a conventional multicarrier communications system, transmitters communicate over a
communication channel using multicarrier modulation or Discrete Multitone Modulation (DMT).
Carrier signals (carriers) or sub-channels spaced within a usable frequency band of the
communication channel are modulated at a symbol (i.e., block) transmission rate of the system. An
input signal, which includes input data bits, is sent to a DMT transmitter, such as a DMT modem.
25 The DMT transmitter typically modulates the phase characteristic, or phase, and amplitude of the

carrier signals using an Inverse Fast Fourier Transform (IFFT) to generate a time domain signal, or transmission signal, that represents the input signal. The DMT transmitter transmits the transmission signal, which is a linear combination of the multiple carriers, to a DMT receiver over the communication channel.

5 The phase and amplitude of the carrier signals of DMT transmission signal can be considered random because the phase and amplitude result from the modulation of an arbitrary sequence of input data bits comprising the transmitted information. Therefore, under the condition that the modulated data bit stream is random, the DMT transmission signal can be approximated as having a Gaussian probability distribution. A bit scrambler is often used in the DMT transmitter to scramble
10 the input data bits before the bits are modulated to assure that the transmitted data bits are random and, consequently, that the modulation of those bits produces a DMT transmission signal with a Gaussian probability distribution.

 With an appropriate allocation of transmit power levels to the carriers or sub-channels, such a system provides a desirable performance. Further, generating a transmission signal with a Gaussian
15 probability distribution is important in order to transmit a transmission signal with a low peak-to-average ratio (PAR), or peak-to-average power ratio. The PAR of a transmission signal is the ratio of the instantaneous peak value (i.e., maximum magnitude) of a signal parameter (e.g., voltage, current, phase, frequency, power) to the time-averaged value of the signal parameter. In DMT
20 systems, the PAR of the transmitted signal is determined by the probability of the random transmission signal reaching a certain peak voltage during the time interval required for a certain number of symbols. An example of the PAR of a transmission signal transmitted from a DMT transmitter is 14.5 dB, which is equivalent to having a $1E-7$ probability of clipping. The PAR of a

In one embodiment, the input bit stream is modulated onto the carrier signals having the substantially scrambled phase characteristic to produce a transmission signal with a reduced peak-to-average power ratio (PAR). The value is derived from a predetermined parameter, such as a random number generator, a carrier number, a DMT symbol count, a superframe count, and a hyperframe count. In another embodiment, a predetermined transmission signal is transmitted when the amplitude of the transmission signal exceeds a certain level.

In another aspect, the invention features a method wherein a value is associated with each carrier signal. The value is determined independently of any input bit value carried by that carrier signal. A phase shift for each carrier signal is computed based on the value associated with that carrier signal. The transmission signal is demodulated using the phase shift computed for each carrier signal.

In another aspect, the invention features a system comprising a phase scrambler that computes a phase shift for each carrier signal based on a value associated with that carrier signal. The phase scrambler also combines the phase shift computed for each carrier signal with the phase characteristic of that carrier signal to substantially scramble the phase characteristic of the carrier signals. In one embodiment, a modulator, in communication with the phase scrambler, modulates bits of an input signal onto the carrier signals having the substantially scrambled phase characteristics to produce a transmission signal with a reduced PAR.

Description of the Drawings

The invention is pointed out with particularity in the appended claims. The advantages of the invention described above, as well as further advantages of the invention, may be better understood

by reference to the following description taken in conjunction with the accompanying drawings, in which:

Fig. 1 is a block diagram of an embodiment of a digital subscriber line communications system including a DMT (discrete multitone modulation) transceiver, in communication with a remote transceiver, having a phase scrambler for substantially scrambling the phase characteristics of carrier signals; and

Fig. 2 is a flow diagram of an embodiment of a process for scrambling the phase characteristics of the carrier signals in a transmission signal.

Detailed Description

10 Fig. 1 shows a digital subscriber line (DSL) communication system 2 including a discrete multitone (DMT) transceiver 10 in communication with a remote transceiver 14 over a communication channel 18 using a transmission signal 38 having a plurality of carrier signals. The DMT transceiver 10 includes a DMT transmitter 22 and a DMT receiver 26. The remote transceiver 14 includes a transmitter 30 and a receiver 34. Although described with respect to discrete multitone modulation, the principles of the invention apply also to other types of multicarrier modulation, such as, but not limited to, orthogonally multiplexed quadrature amplitude modulation (OQAM), discrete wavelet multitone (DWMT) modulation, and orthogonal frequency division multiplexing (OFDM).

The communication channel 18 provides a downstream transmission path from the DMT transmitter 22 to the remote receiver 34, and an upstream transmission path from the remote transmitter 30 to the DMT receiver 26. In one embodiment, the communication channel 18 is a pair of twisted wires of a telephone subscriber line. In other embodiments, the communication channel 18 can be a fiber optic wire, a quad cable, consisting of two pairs of twisted wires, or a quad cable

that is one of a star quad cable, a Dieselhorst-Martin quad cable, and the like. In a wireless communication system wherein the transceivers 10, 14 are wireless modems, the communication channel 18 is the air through which the transmission signal 38 travels between the transceivers 10, 14.

5 By way of example, the DMT transmitter 22 shown in Fig. 1 includes a quadrature amplitude modulation (QAM) encoder 42, a modulator 46, a bit allocation table (BAT) 44, and a phase scrambler 66. The DMT transmitter 22 can also include a bit scrambler 74, as described further below. The remote transmitter 30 of the remote transceiver 14 comprises equivalent components as the DMT transmitter 22. Although this embodiment specifies a detailed description of the DMT
10 transmitter 22, the inventive concepts apply also to the receivers 34, 36 which have similar components to that of the DMT transmitter 22, but perform inverse functions in a reverse order.

The QAM encoder 42 has a single input for receiving an input serial data bit stream 54 and multiple parallel outputs to transmit QAM symbols 58 generated by the QAM encoder 42 from the bit stream 54. In general, the QAM encoder 42 maps the input serial bit-stream 54 in the time
15 domain into parallel QAM symbols 58 in the frequency domain. In particular, the QAM encoder 42 maps the input serial data bit stream 54 into N parallel quadrature amplitude modulation (QAM) constellation points 58, or QAM symbols 58, where N represents the number of carrier signals generated by the modulator 46. The BAT 44 is in communication with the QAM encoder 42 to specify the number of bits carried by each carrier signal. The QAM symbols 58 represent the
20 amplitude and the phase characteristic of each carrier signal.

The modulator 46 provides functionality associated with the DMT modulation and transforms the QAM symbols 58 into DMT symbols 70 each comprised of a plurality of time-

domain samples. The modulator 46 modulates each carrier signal with a different QAM symbol 58. As a result of this modulation, carrier signals have phase and amplitude characteristics based on the QAM symbol 58 and therefore based on the input-bit stream 54. In particular, the modulator 46 uses an inverse fast Fourier transform (IFFT) to change the QAM symbols 58 into a transmission signal 38 comprised of a sequence of DMT symbols 70. The modulator 46 changes the QAM symbols 58 into DMT symbols 70 through modulation of the carrier signals. In another embodiment, the modulator 46 uses the inverse discrete Fourier transform (IDFT) to change the QAM symbols 58 into DMT symbols 70. In one embodiment, a pilot tone is included in the transmission signal 38 to provide a reference signal for coherent demodulation of the carrier signals in the remote receiver 34 during reception of the transmission signal 38.

The modulator 46 also includes a phase scrambler 66 that combines a phase shift computed for each QAM-modulated carrier signal with the phase characteristic of that carrier signal. Combining phase shifts with phase characteristics, in accordance with the principles of the invention, substantially scrambles the phase characteristics of the carrier signals in the transmission signal 38. By scrambling the phase characteristics of the carrier signals, the resulting transmission signal 38 has a substantially minimized peak-to-average (PAR) power ratio. The phase scrambler 66 can be part of or external to the modulator 46. Other embodiments of the phase scrambler 66 include, but are not limited to, a software program that is stored in local memory and is executed on the modulator 46, a digital signal processor (DSP) capable of performing mathematical functions and algorithms, and the like. The remote receiver 34 similarly includes a phase scrambler 66' for use when demodulating carrier signals that have had their phase characteristics adjusted by the phase scrambler 66 of the DMT transceiver 10.

To compute a phase shift for each carrier signal, the phase scrambler 66 associates one or more values with that carrier signal. The phase scrambler 66 determines each value for a carrier signal independently of the QAM symbols 58, and, therefore, independently of the bit value(s) modulated onto the carrier signal. The actual value(s) that the phase scrambler 66 associates with each carrier signal can be derived from one or more predefined parameters, such as a pseudo-random number generator (pseudo-RNG), a DMT carrier number, a DMT symbol count, a DMT superframe count, a DMT hyperframe count, and the like, as described in more detail below. Irrespective of the technique used to produce each value, the same technique is used by the DMT transmitter 22 and the remote receiver 34 so that the value associated with a given carrier signal is known at both ends of the communication channel 18.

The phase scrambler 66 then solves a predetermined equation to compute a phase shift for the carrier signal, using the value(s) associated with that carrier signal as input that effects the output of the equation. Any equation suitable for computing phase shifts can be used to compute the phase shifts. When the equation is independent of the bit values of the input serial bit stream 54, the computed phase shifts are also independent of such bit values.

In one embodiment (shown in phantom), the DMT transmitter 22 includes a bit scrambler 74, which receives the input serial bit stream 54 and outputs data bits 76 that are substantially scrambled. The substantially scrambled bits 76 are then passed to the QAM encoder 42. When the bit scrambler 74 is included in the DMT transmitter 22, the operation of the phase scrambler 66 further assures that the transmission signal 38 has a Gaussian probability distribution and, therefore, a substantially minimized PAR.

Fig. 2 shows embodiments of a process used by the DMT transmitter 22 for adjusting the phase characteristic of each carrier signal and combining these carrier signals to produce the transmission signal 38. The DMT transmitter 22 generates (step 100) a value that is associated with a carrier signal. Because the value is being used to alter the phase characteristics of the carrier signal, both the DMT transmitter 22 and the remote receiver 34 must recognize the value as being associated with the carrier signal. Either the DMT transmitter 22 and the remote receiver 34 independently derive the associated value, or one informs the other of the associated value. For example, in one embodiment the DMT transmitter 22 can derive the value from a pseudo-RNG and then transmit the generated value to the remote receiver 34. In another embodiment, the remote receiver 34 similarly derives the value from the same pseudo-RNG and the same seed as used by the transmitter (i.e., the transmitter pseudo-RNG produces the same series of random numbers as the receiver pseudo-RNG).

As another example, the DMT transmitter 22 and the remote receiver 34 can each maintain a symbol counter for counting DMT symbols. The DMT transmitter 22 increments its symbol counter upon transmitting a DMT symbol; the remote receiver 34 upon receipt. Thus, when the DMT transmitter 22 and the remote receiver 34 both use the symbol count as a value for computing phase shifts, both the DMT transmitter 22 and remote receiver 34 “know” that the value is associated with a particular DMT symbol and with each carrier signal of that DMT symbol.

Values can also be derived from other types of predefined parameters. For example, if the predefined parameter is the DMT carrier number, then the value associated with a particular carrier signal is the carrier number of that signal within the DMT symbol. The number of a carrier signal represents the location of the frequency of the carrier signal relative to the frequency of other carrier

signals within a DMT symbol. For example, in one embodiment the DSL communication system 2 provides 256 carrier signals, each separated by a frequency of 4.3125 kHz and spanning the frequency bandwidth from 0 kHz to 1104 kHz. The DMT transmitter 22 numbers the carrier signals from 0 to 255. Therefore, "DMT carrier number 50" represents the 51st DMT carrier signal which is
5 located at the frequency of 215.625 kHz (i.e., 51 x 4.3125 kHz).

Again, the DMT transmitter 22 and the remote receiver 34 can know the value that is associated with the carrier signal because both the DMT transmitter 22 and the remote receiver 34 use the same predefined parameter (here, the DMT carrier number) to make the value-carrier signal association. In other embodiments (as exemplified above with the transmitter pseudo-RNG), the
10 DMT transmitter 22 can transmit the value to the remote receiver 34 (or vice versa) over the communication channel 18.

In other embodiments, other predefined parameters can be used in conjunction with the symbol count. One example of such a predefined parameter is the superframe count that increments by one every 69 DMT symbols. One exemplary implementation that achieves the superframe
15 counter is to perform a modulo 68 operation on the symbol count. As another example, the DMT transmitter 22 can maintain a hyperframe counter for counting hyperframes. An exemplary implementation of the hyperframe count is to perform a modulo 255 operation on the superframe count. Thus, the hyperframe count increments by one each time the superframe count reaches 255.

Accordingly, it is seen that some predefined parameters produce values that vary from carrier
20 signal to carrier signal. For example, when the predefined parameter is the DMT carrier number, values vary based on the frequency of the carrier signal. As another example, the pseudo-RNG generates a new random value for each carrier signal.

Other predefined parameters produce values that vary from DMT symbol 70 to DMT symbol 70. For example, when the predefined parameter is the symbol count, the superframe count, or hyperframe count, values vary based on the numerical position of the DMT symbol 70 within a sequence of symbols, superframes, or hyperframes. Predefined parameters such as the pseudo-RNG, symbol count, superframe count, and superframe can also be understood to be parameters that vary values over time. Any one or combination of the predefined parameters can provide values for input to the equation that computes a phase shift for a given carrier signal.

In one embodiment, the phase scrambling is used to avoid clipping of the transmission signal on a DMT symbol 70 by DMT symbol 70 basis. In this embodiment, the DMT transmitter 22 uses a value based on a predefined parameter that varies over time, such as the symbol count, to compute the phase shift. It is to be understood that other types of predefined parameters that vary the values associated with carrier signals can be used to practice the principles of the invention. As described above, the transceivers 10, 14 may communicate (step 110) the values to synchronize their use in modulating and demodulating the carrier signals.

The DMT transmitter 22 then computes (step 115) the phase shift that is used to adjust the phase characteristic of each carrier signal. The amount of the phase shift combined with the phase characteristic of each QAM-modulated carrier signal depends upon the equation used and the one or more values associated with that carrier signal.

The DMT transmitter 22 then combines (step 120) the phase shift computed for each carrier signal with the phase characteristic of that carrier signal. By scrambling the phase characteristics of the carrier signals, the phase scrambler 66 reduces (with respect to unscrambled phase characteristics) the combined PAR of the plurality of carrier signals and, consequently, the

transmission signal 38. The following three phase shifting examples, PS #1 – PS #3, illustrate methods used by the phase scrambler 66 to combine a computed phase shift to the phase characteristic of each carrier signal.

Phase Shifting Example #1

5 Phase shifting example #1 (PS #1) corresponds to adjusting the phase characteristic of the QAM-modulated carrier signal associated with a carrier number N by $N \times \frac{\pi}{3}$, modulo (mod) 2π . In this example, a carrier signal having a carrier number N equal to 50 has a phase shift added to the phase characteristic of that carrier signal equal to $50 \times \frac{\pi}{3} \pmod{2\pi} = \frac{2}{3}\pi$. The carrier signal with a carrier number N equal to 51 has a phase shift added to the phase characteristic of that carrier signal equal to $51 \times \frac{\pi}{3} \pmod{2\pi} = \pi$. The carrier signal with a carrier number N equal to 0 has no phase shift added to the phase characteristic of that carrier signal.

Phase Shifting Example #2

15 Phase shifting example #2 (PS #2) corresponds to adjusting the phase characteristic of the QAM-modulated carrier signal associated with a carrier number N by $(N + M) \times \frac{\pi}{4}$, mod 2π , where M is the symbol count. In this example, a carrier signal having a carrier number N equal to 50 on DMT symbol count M equal to 8 has a phase shift added to the phase characteristic of that carrier signal equal to $(50 + 8) \times \frac{\pi}{4} \pmod{2\pi} = \frac{\pi}{2}$. The carrier signal with the same carrier number N equal to 50 on the next DMT symbol count M equal to 9 has a phase shift added to the phase characteristic of that carrier signal equal to $(50 + 9) \times \frac{\pi}{4} \pmod{2\pi} = \frac{3\pi}{4}$.

Phase Shifting Example #3

Phase shifting example #3 (PS #3) corresponds to adjusting the phase characteristic of the QAM-modulated carrier signal associated with a carrier number N by $(X_N) \times \frac{\pi}{6}, \text{ mod } 2\pi$, where X_N is an array of N pseudo-random numbers. In this example, a carrier signal having a carrier number N equal to 5 and X_N equal to [3, 8, 1, 4, 9, 5, ...] has a phase shift added to the phase characteristic of the carrier signal that is equal to $(9) \times \frac{\pi}{6} (\text{mod } 2\pi) = \frac{\pi}{3}$. (Note that 9 is the 5th value in X_N .) The carrier signal with a carrier number N equal to 6 has a phase shift added to the phase characteristic of the carrier signal equal to $(5) \times \frac{\pi}{6} (\text{mod } 2\pi) = \frac{5\pi}{3}$.

It is to be understood that additional and/or different phase shifting techniques can be used by the phase scrambler 66, and that PS #1, #2, and #3 are merely illustrative examples of the principles of the invention. The DMT transmitter 22 then combines (step 130) the carrier signals to form the transmission signal 38. If the transmission signal is not clipped, as described below, the DMT transmitter 22 consequently transmits (step 160) the transmission signal 38 to the remote receiver 34.

Clipping of Transmission Signals

A transmission signal 38 that has high peak values of voltage (i.e., a high PAR) can induce non-linear distortion in the DMT transmitter 22 and the communication channel 18. One form of this non-linear distortion of the transmission signal 38 that may occur is the limitation of the amplitude of the transmission signal 38 (i.e., clipping). For example, a particular DMT symbol 70 clips in the time domain when one or more time domain samples in that DMT symbol 70 are larger than the maximum allowed digital value for the DMT symbols 70. In multicarrier communication

systems when clipping occurs, the transmission signal 38 does not accurately represent the input serial data bit signal 54.

In one embodiment, the DSL communication system 2 avoids the clipping of the transmission signal 38 on a DMT symbol 70 by DMT symbol 70 basis. The DMT transmitter 22
5 detects (step 140) the clipping of the transmission signal 38. If a particular DMT symbol 70 clips in the time domain to produce a clipped transmission signal 38, the DMT transmitter 22 substitutes (step 150) a predefined transmission signal 78 for the clipped transmission signal 38.

The predefined transmission signal 78 has the same duration as a DMT symbol 70 (e.g., 250 ms) in order to maintain symbol timing between the DMT transmitter 22 and the remote receiver 34.
10 The predefined transmission signal 78 is not based on (i.e., independent of) the modulated input data bit stream 54; it is a bit value pattern that is recognized by the remote receiver 34 as a substituted signal. In one embodiment, the predefined transmission signal 78 is a known pseudo-random sequence pattern that is easily detected by the remote receiver 34. In another embodiment, the predefined transmission signal 78 is an “all zeros” signal, which is a zero voltage signal produced at
15 the DMT transmitter 22 output (i.e., zero volts modulated on all the carrier signals). In addition to easy detection by the remote receiver 34, the zero voltage signal reduces the power consumption of the DMT transmitter 22 when delivered by the DMT transmitter 22. Further, a pilot tone is included in the predefined transmission signal 78 to provide a reference signal for coherent demodulation of the carrier signals in the remote receiver 34 during reception of the predefined transmission signal
20 78.

After the remote receiver 34 receives the transmission signal 38, the remote receiver 34 determines if the transmission signal 38 is equivalent to the predefined transmission signal 78. In

one embodiment, when the remote receiver 34 identifies the predefined transmission signal 78, the remote receiver 34 ignores (i.e., discards) the predefined transmission signal 78.

Following the transmission of the predefined transmission signal 78, the phase scrambler 66 shifts (step 120) the phase characteristic of the QAM-modulated carrier signals (based on one of the predefined parameters that varies over time). For example, consider that a set of QAM symbols 58 produces a DMT symbol 70 comprising a plurality of time domain samples, and that one of the time domain samples is larger than the maximum allowed digital value for the DMT symbol 70.

Therefore, because the transmission signal 38 would be clipped when sent to the remote receiver 34, the DMT transmitter 22 sends the predefined transmission signal 78 instead.

After transmission of the predefined transmission signal 78, the DMT transmitter 22 again attempts to send the same bit values that produced the clipped transmission signal 38 in a subsequent DMT symbol 70'. Because the generation of phase shifts in this embodiment is based on values that vary over time, the phase shifts computed for the subsequent DMT symbol 70' are different than those that were previously computed for the DMT symbol 70 with the clipped time domain sample. These different phase shifts are combined to the phase characteristics of the modulated carrier signals to produce carrier signals of the subsequent DMT symbol 70' with different phase characteristics than the carrier signals of the DMT symbol 70 with the clipped time domain sample.

DMT communication systems 2 infrequently produce transmission signals 38 that clip (e.g., approximately one clip every 10^7 time domain samples 70). However, if the subsequent DMT symbol 70' includes a time domain sample that clips, then the predefined transmission signal 78 is again transmitted (step 150) to the remote receiver 34 instead of the clipped transmission signal 38. The clipping time domain sample may be on the same or on a different carrier signal than the

previously clipped DMT symbol 70. The DMT transmitter 22 repeats the transmission of the predefined transmission signal 78 until the DMT transmitter 22 produces a subsequent DMT symbol 70' that is not clipped. When the DMT transmitter 22 produces a DMT symbol 70' that is not clipped, the DTM transmitter 22 transmits (step 160) the transmission signal 38 to the remote receiver 34. The probability of a DMT symbol 70 producing a transmission signal 38 that clips in the time domain depends on the PAR of the transmission signal 38.

For example, the following phase shifting example, PST #4, illustrates the method used by the phase scrambler 66 to combine a different phase shift to the phase characteristic of each carrier signal to avoid the clipping of the transmission signal 38.

10 **Phase Shifting Example #4**

Phase shifting example #4 (PS #4) corresponds to adjusting the phase characteristic of the carrier signal associated with a carrier number N by $\frac{\pi}{3} \times (M + N)$, mod 2π , where M is the DMT symbol count. In this example, if the DMT symbol 70 clips when the DMT symbol count M equals 5, the predefined transmission signal 78 is transmitted instead of the current clipped transmission signal 38. On the following DMT symbol period, the DMT count M equals 6, thereby causing a different set of time domain samples to be generated for the subsequent DMT symbol 70', although the QAM symbols 58 used to produce both DMT symbols 70, 70' are the same.

If this different set of time domain samples (and consequently the transmission signal 38) is not clipped, the DMT transmitter 22 sends the transmission signal 38. If one of the time domain samples in the different set of time domain samples 70 (and consequently the transmission signal 38) is clipped, then the DMT transmitter 22 sends the predefined transmission signal 78 again. The process continues until a DMT symbol 70 is produced without a time domain sample 70 that is

clipped. In one embodiment, the transmitter 22 stops attempting to produce a non-clipped DMT symbol 70' for the particular set of QAM symbols 58 after generating a predetermined number of clipped DMT symbols 70'. At that moment, the transmitter 22 can transmit the most recently produced clipped DMT symbol 70' or the predetermined transmission signal 78.

5 The PAR of the DSL communication system 2 is reduced because the predefined transmission signal 78 is sent instead of the transmission signal 38 when the DMT symbol 70 clips. For example, a DMT communication system 2 that normally has a clipping probability of 10^{-7} for the time domain transmission signal 38 can therefore operate with a 10^{-5} probability of clipping and a lower PAR equal to 12.8 dB (as compared to 14.5 dB). When operating at a 10^{-5} probability of
10 clipping, assuming a DMT symbol 70 has 512 time-domain samples 70, the DMT transmitter 22 experiences one clipped DMT symbol 70 out of every $\frac{10^5}{512}$, or 195 DMT symbols 70. This results in the predefined (non-data carrying) transmission signal 78 being transmitted, on average, once every 195 DMT symbols. Although increasing the probability of clipping to 10^{-5} results in approximately a 0.5% (1/195) decrease in throughput, the PAR of the transmission signal 38 is
15 reduced by 1.7 dB, which reduces transmitter complexity in the form of power consumption and component linearity.

While the invention has been shown and described with reference to specific preferred embodiments, it should be understood by those skilled in the art that various changes in form and detail may be made therein without departing from the spirit and scope of the invention as defined
20 by the following claims. For example, although the specification uses DSL to describe the invention, it is to be understood that various form of DSL can be used, e.g., ADSL, VDSL, SDSL, HDSL, HDSL2, or SHDSL. It is also to be understood that the principles of the invention apply to

Claims

What is claimed is:

- 1 1. In a multicarrier modulation system including a first transceiver in communication with a
2 second transceiver using a transmission signal having a plurality of carrier signals for
3 modulating an input bit stream, each carrier signal having a phase characteristic associated
4 with the input bit stream, a method for scrambling the phase characteristics of the carrier
5 signals comprising:
- 6 associating each carrier signal with a value determined independently of any input bit
7 value carried by that carrier signal;
- 8 computing a phase shift for each carrier signal based on the value associated with that
9 carrier signal; and
- 10 combining the phase shift computed for each carrier signal with the phase
11 characteristic of that carrier signal so as to substantially scramble the phase characteristics
12 of the plurality of carrier signals.
- 1 2. The method of claim 1 further comprising modulating bits of the input bit stream onto the
2 carrier signals having the substantially scrambled phase characteristics to produce a
3 transmission signal with a reduced peak-to-average power ratio (PAR).
- 1 3. The method of claim 1 further comprising independently deriving the value associated with
2 each carrier signal at each transceiver.

- 1 4. The method of claim 1 further comprising transmitting the value associated with each carrier
2 signal from one transceiver to the other transceiver.
- 1 5. The method of claim 1 further comprising maintaining synchronization between the
2 transceivers using the value associated with each carrier signal.
- 1 6. The method of claim 1 wherein the value varies with each carrier signal.
- 1 7. The method of claim 1 wherein the value varies with each DMT symbol.
- 1 8. The method of claim 1 wherein the value is derived from a predetermined parameter.
9. The method of claim 8 wherein the predefined parameter is a carrier number.
10. The method of claim 8 wherein the predefined parameter is a symbol count.
11. The method of claim 8 wherein the predefined parameter is a hyperframe count.
12. The method of claim 8 wherein the predefined parameter is a superframe count.
13. The method of claim 1 further comprising scrambling the bits of the input bit stream.
- 1 14. The method of claim 1 further comprising transmitting a predetermined transmission signal
2 when the amplitude of the transmission signal exceeds a certain level.
- 1 15. The method of claim 14 wherein the predetermined transmission signal comprises a
2 predetermined pattern of bits.

- 1 16. The method of claim 14 wherein the predetermined transmission signal comprises a pilot
2 tone.
- 1 17. The method of claim 16 wherein the pilot tone is used to maintain timing synchronization
2 between the first transceiver and the second transceiver.
- 1 18. The method of claim 15 wherein each bit value in the predetermined pattern of bits is a zero
2 value.
- 1 19. The method of claim 15 wherein the predetermined pattern of bits is a pseudo-random
2 sequence pattern.
- 1 20. In a multicarrier modulation system including a first transceiver in communication with a
2 second transceiver using a transmission signal having a plurality of carrier signals for
3 modulating an input bit stream, each carrier signal having a phase characteristic with the
4 input bit stream, a method for scrambling the phase characteristics of the carrier signals
5 comprising:
6 associating each carrier signal with a value determined independently of any input bit
7 value carried by that carrier signal;
8 computing a phase shift for each carrier signal based on the value associated with that
9 carrier signal; and
10 demodulating the transmission signal using the phase shift computed for each carrier
11 signal.

- 1 21. The method of claim 20 further comprising independently deriving the value associated with
2 each carrier signal at each transceiver.
- 1 22. The method of claim 20 further comprising transmitting the value associated with each
2 carrier signal from one transceiver to the other transceiver.
- 1 23. The method of claim 20 further comprising maintaining synchronization between the
2 transceivers using the value associated with each carrier signal.
- 1 24. The method of claim 20 wherein the value varies with each carrier signal.
- 1 25. The method of claim 20 wherein the value varies with each DMT symbol.
- 1 26. The method of claim 20 wherein the value is derived from a predetermined parameter.
- 1 27. The method of claim 26 wherein the predefined parameter is a carrier number.
- 1 28. The method of claim 26 wherein the predefined parameter is a symbol count.
- 1 29. The method of claim 26 wherein the predefined parameter is a hyperframe count.
- 1 30. The method of claim 26 wherein the predefined parameter is a superframe count.
- 1 31. The method of claim 20 further comprising receiving a predetermined transmission when the
2 amplitude of the transmission signal exceeds a certain level.
- 1 32. The method of claim 31 wherein the predetermined transmission signal comprises a
2 predetermined pattern of bits.

1 33. The method of claim 31 wherein the predetermined transmission signal comprises a pilot
2 tone.

1 34. The method of claim 33 wherein the pilot tone is used to maintain timing synchronization
2 between the first transceiver and the second transceiver.

1 35. The method of claim 32 wherein each bit value in the predetermined pattern of bits is a zero
2 value.

1 36. The method of claim 32 wherein the predetermined pattern of bits is a pseudo-random
2 sequence pattern.

1 37. A transceiver for communicating over a communication channel using a transmission signal
2 having a plurality of carrier signals, each carrier signal having a phase characteristic, the
3 transceiver comprising:

4 a phase scrambler computing a phase shift for each carrier signal based on a value
5 associated with that carrier signal and combining the phase shift computed for each carrier
6 signal with the phase characteristic of that carrier signal so as to substantially scramble the
7 phase characteristics of the plurality of carrier signals.

1 38. The transceiver of claim 37 further comprising a modulator in communication with the phase
2 scrambler, the modulator modulating bits of an input signal onto the carrier signals having
3 the substantially scrambled phase characteristics to produce a transmission signal with a
4 reduced PAR.

1 39. In a multicarrier modulation system, a method for communicating over a communication
2 channel, comprising:
3 receiving over the communication channel a transmission signal comprised of a
4 sequence of DMT symbols that each have a bit-value pattern;
5 comparing the bit-value pattern of each received DMT symbol with a predetermined
6 bit value pattern;
7 discarding a given one of the received DMT symbols in the sequence of DMT
8 symbols if the bit-value pattern of that DMT symbol matches the predetermined bit-value
9 pattern, otherwise demodulating that DMT symbol.

10
11
12
13
14
15
16
17
18
19
20
21
22
23
24
25
26
27
28
29
30
31
32
33
34
35
36
37
38
39
40
41
42
43
44
45
46
47
48
49
50

Abstract

A system and method that scrambles the phase characteristic of a carrier signal are described. The scrambling of the phase characteristic of each carrier signal includes associating a value with each carrier signal and computing a phase shift for each carrier signal based on the value associated
5 with that carrier signal. The value is determined independently of any input bit value carried by that carrier signal. The phase shift computed for each carrier signal is combined with the phase characteristic of that carrier signal so as to substantially scramble the phase characteristic of the carrier signals. Bits of an input signal are modulated onto the carrier signals having the substantially scrambled phase characteristic to produce a transmission signal with a reduced PAR.

10 [patent/457/17.1102554-2](#)

2
SECRET

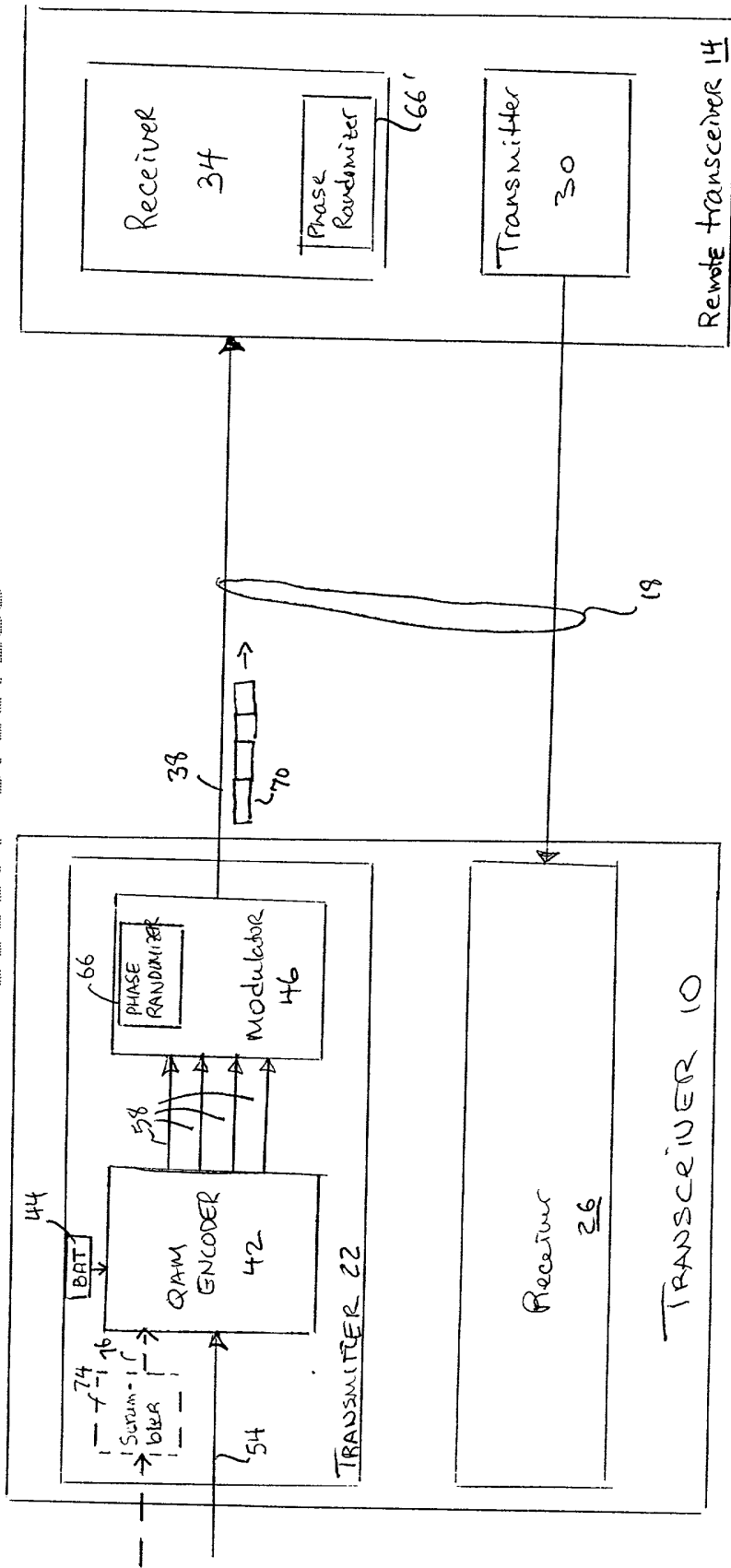

FIG. 1

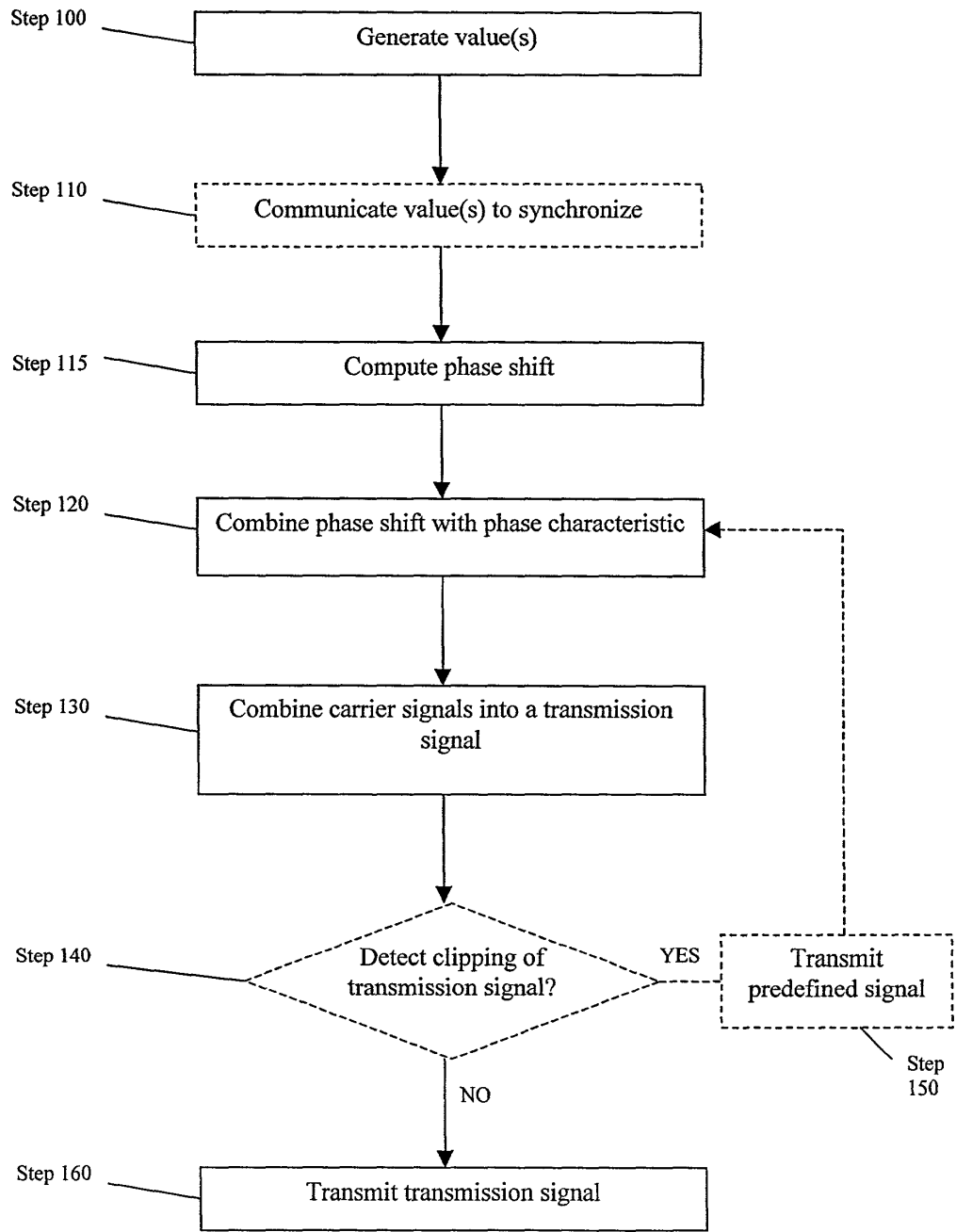

FIG. 2

<p>DECLARATION AND POWER OF ATTORNEY FOR UTILITY OR DESIGN PATENT APPLICATION</p> <p><input checked="" type="checkbox"/> Declaration Submitted with Initial Filing <input type="checkbox"/> Declaration Submitted after Initial Filing (surcharge 37 CFR 1.16(e) required)</p>	Attorney Docket No.	AWR-017 (457/19)
	First Named Inventor	Tzannes
	<i>COMPLETE IF KNOWN</i>	
	Application Serial Number	Not Yet Assigned
	Filing Date	Herewith
	Group Art Unit	Not Yet Assigned
	Examiner Name	Not Yet Assigned

As a below named inventor, I hereby declare that:
 My residence, post office address, and citizenship are as stated below next to my name.
 I believe I am the original, first and sole inventor (if only one name is listed below) or an original, first and joint inventor (if plural names are listed below) of the subject matter which is claimed and for which a patent is sought on the invention entitled:

A System And Method For Scrambling The Phase Of The Carriers In A Multicarrier Communications System
(Title of the Invention)

the specification of which
 is attached hereto
 OR
 was filed on (MM/DD/YYYY) [] as United States Application Serial Number or PCT International Application Number [] and was amended on (MM/DD/YYYY) [] (if applicable).

I hereby state that I have reviewed and understand the contents of the above identified specification, including the claims, as amended by any amendment specifically referred to above.

I acknowledge the duty to disclose to the Patent Office all information known by me to be material to patentability as defined in 37 CFR 1.56.

I hereby claim foreign priority benefits under 35 U.S.C. 119(a)-(d) or 365(b) of any foreign application(s) for patent or inventor's certificate, or 365(a) of any PCT international application which designated at least one country other than the United States of America, listed below and have also identified below, by checking the box, any foreign application for patent or inventor's certificate, or of any PCT international application having a filing date before that of the application on which priority is claimed.

Prior Foreign Application Number(s)	Country	Foreign Filing Date (MM/DD/YYYY)	Priority Not Claimed	Certified Copy Attached?	
				YES	NO
			<input type="checkbox"/>	<input type="checkbox"/>	<input type="checkbox"/>
			<input type="checkbox"/>	<input type="checkbox"/>	<input type="checkbox"/>
			<input type="checkbox"/>	<input type="checkbox"/>	<input type="checkbox"/>
			<input type="checkbox"/>	<input type="checkbox"/>	<input type="checkbox"/>

Additional foreign application numbers are listed on a supplemental priority data sheet attached hereto.

I hereby claim the benefit under 35 U.S.C. 119(e) of any United States provisional application(s) listed below.

Application Serial Number(s)	Filing Date (MM/DD/YYYY)
60/164,134	11/09/1999

Additional provisional application serial numbers are listed on a supplemental priority data sheet attached hereto.

DECLARATION – Utility or Design Patent Application			
I hereby claim the benefit under 35 U.S.C. 120 of any United States application(s), or 365(c), of any PCT international application designating the United States of America, listed below and, insofar as the subject matter of each of the claims of this application is not disclosed in the prior United States or PCT International application in the manner provided by the first paragraph of 35 U.S.C. 112, I acknowledge the duty to disclose information which is material to patentability as defined in 37 CFR 1.56 which became available between the filing date of the prior application and the national or PCT international filing date of this application.			
U.S. Parent Application or PCT Parent Serial Number	Parent Filing Date (MM/DD/YYYY)	Parent Patent Number (if applicable)	
<input type="checkbox"/> Additional U.S. or PCT international application numbers are listed on a supplemental priority data sheet attached hereto.			
As a named inventor, I hereby appoint the following registered practitioners to prosecute this application and to transact all business in the Patent and Trademark Office connected therewith: <input type="checkbox"/> Customer Number → Place Customer Number Bar Code Label Here			
OR <input checked="" type="checkbox"/> Registered practitioner(s) name/registration number listed below			
Name	Registration Number	Name	Registration Number
Steven M. Bauer	31,481	Thomas C. Meyers	36,989
John V. Bianco	36,748	Joseph B. Milstein	42,897
Isabelle A.S. Blundell	43,321	David G. Miranda	42,898
Maureen A. Bresnahan	44,559	Ronda P. Moore	44,244
Michael H. Brodowski	41,640	Indranil Mukerji	P-46,944
Jennifer A. Camacho	43,526	Edmund R. Pitcher	27,829
Joseph A. Capraro, Jr.	36,471	Michael A. Rodriguez	41,274
John J. Cotter	38,116	Jamie H. Rose	45,054
John V. Forcier	42,545	R. Stephen Rosenholm	45,283
Steven J. Frank	33,497	Christopher W. Stamos	35,370
Brian M. Gaff	44,691	Joseph P. Sullivan	45,349
Michael J. Giannetta	42,574	Robert J. Tosti	35,393
Duncan A. Greenhalgh	38,678	Thomas A. Turano	35,722
William G. Guerin	41,047	Michael J. Twomey	38,349
Jonathan A. Harris	44,744	Christine C. Vito	39,061
Ira V. Heffan	41,059	Patrick R.H. Waller	41,418
Danielle L. Herritt	43,670	Daniel A. Wilson	45,508
Douglas J. Kline	35,574	Yin P. Zhang	44,372
John D. Lanza	40,060		
Kurt W. Lockwood	40,704		
<input type="checkbox"/> Additional registered practitioners named on supplemental Registered Practitioner Information sheet attached hereto.			
Direct all correspondence to: <div style="margin-left: 100px;"> Patent Administrator Testa, Hurwitz & Thibault, LLP High Street Tower 125 High Street Boston, MA 02110 Tel. No.: (617) 248-7000 Fax No.: (617) 248-7100 </div>			

I hereby declare that all statements made herein of my own knowledge are true and that all statements made on information and belief are believed to be true; and further that these statements were made with the knowledge that willful false statements and the like so made are punishable by fine or imprisonment, or both, under 18 U.S.C. 1001 and that such willful false statements may jeopardize the validity of the application or any patent issued thereon.

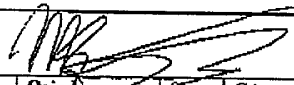
Name of Sole or First Inventor:		<input type="checkbox"/> A petition has been filed for this unsigned inventor						
Given Name (first and middle [if any])				Family Name or Surname				
Marcos C.				Tzannes				
Inventor's Signature					Date		Nov 9, 2000	
Residence	City	Orinda	State	CA	Country	USA	Citizenship	USA
Post Office Address		121 LaEspiral						
P.O. Address (line 2)	City	Orinda	State	CA	ZIP	94563	Country	USA
<input type="checkbox"/> Additional inventors are being named on the _____ supplemental Additional Inventor(s) sheet(s) attached hereto.								
Name of Additional Joint Inventor, if any:		<input type="checkbox"/> A petition has been filed for this unsigned inventor						
Given Name (first and middle [if any])				Family Name or Surname				
Inventor's Signature					Date			
Residence	City		State		Country		Citizenship	
Post Office Address								
P.O. Address (line 2)	City		State		ZIP		Country	
Name of Additional Joint Inventor, if any:		<input type="checkbox"/> A petition has been filed for this unsigned inventor						
Given Name (first and middle [if any])				Family Name or Surname				
Inventor's Signature					Date			
Residence	City		State		Country		Citizenship	
Post Office Address								
P.O. Address (line 2)	City		State		ZIP		Country	

20001109191103565_1

09/710310



Subclass	
Class	
ISSUE CLASSIFICATION	



PATENT NUMBER

U.S. UTILITY Patent Application

O.I.P.E. <i>AK JM¹ CLK</i>	PATENT DATE
--	-------------

APPLICATION NO.	CONT/PRIOR	CLASS	SUBCLASS	ART UNIT	EXAMINER
09/710310	D	375	Z 20	2631	NGUYEN, X. D.

APPLICANTS
MARCOS TZANNES

TITLE
SYSTEM AND METHOD FOR SCRAMBLING THE PHASE OF THE CARRIERS IN A MULTICARRIER COMMUNICATIONS SYSTEM

PTO-2040
12/99

ISSUING CLASSIFICATION							
ORIGINAL		CROSS REFERENCE(S)					
CLASS	SUBCLASS	CLASS	SUBCLASS (ONE SUBCLASS PER BLOCK)				
INTERNATIONAL CLASSIFICATION							

Continued on Issue Slip inside File Jacket

<input type="checkbox"/> TERMINAL DISCLAIMER <input type="checkbox"/> The term of this patent subsequent to _____ (date) has been disclaimed. <input type="checkbox"/> The term of this patent shall not extend beyond the expiration date of U.S. Patent. No. _____ <input type="checkbox"/> The terminal _____ months of this patent have been disclaimed.	DRAWINGS Sheets Drwg. Figs. Drwg. Print Fig.			CLAIMS ALLOWED Total Claims Print Claim for O.G.	
	_____ (Assistant Examiner) _____ (Date)			NOTICE OF ALLOWANCE MAILED	
	_____ (Primary Examiner) _____ (Date)			ISSUE FEE Amount Due Date Paid	
	_____ (Legal Instruments Examiner) _____ (Date)			ISSUE BATCH NUMBER	

WARNING:
The information disclosed herein may be restricted. Unauthorized disclosure may be prohibited by the United States Code Title 35, Sections 122, 181 and 368. Possession outside the U.S. Patent & Trademark Office is restricted to authorized employees and contractors only.

Form PTO-436A
(Rev. 6/99)

FILED WITH: DISK (CRF) FICHE CD-ROM
(Attached in pocket on right inside flap)

(FACE)

Best Available Copy

SEARCHED

Class	Sub.	Date	Exmr.
375	220, 219 226, 227 302	4/12/04	DAN

SEARCH NOTES
(INCLUDING SEARCH STRATEGY)

Consulted with	Date	Exmr.
CHRISTINE TE (7/14)	4/12/04	DAN
East Tex + search	4/14/04	DAN
Inventor Nam Search	4/14/04	DAN

INTERFERENCE SEARCHED

Class	Sub.	Date	Exmr.

(RIGHT OUTSIDE)

1
2
3
4
5
6
00710310-110900
1
2
3
1 3.
2

ISSUE SLIP STAPLE AREA (for additional cross references)

POSITION	INITIALS	ID NO.	DATE
FEE DETERMINATION			
O.I.P.E. CLASSIFIER			
FORMALITY REVIEW	<i>Q</i>	<i>711090</i>	<i>2/17/01</i>
RESPONSE FORMALITY REVIEW			

INDEX OF CLAIMS

- ✓ Rejected
- Allowed
- (Through numeral) ... Canceled
- ⊖ Restricted
- N Non-elected
- I Interference
- A Appeal
- O Objected

Claim	Final	Original	Date
1			
2			
3			
4			
5			
6			
7			
8			
9			
10			
11			
12			
13			
14			
15			
16			
17			
18			
19			
20	✓		
21			
22			
23			
24			
25			
26			
27			
28			
29			
30			
31			
32			
33			
34			
35			
36	✓		
37	✓		
38	✓		
39	✓		
40			
41			
42			
43			
44			
45			
46			
47			
48			
49			
50			

Claim	Final	Original	Date
51			
52			
53			
54			
55			
56			
57			
58			
59			
60			
61			
62			
63			
64			
65			
66			
67			
68			
69			
70			
71			
72			
73			
74			
75			
76			
77			
78			
79			
80			
81			
82			
83			
84			
85			
86			
87			
88			
89			
90			
91			
92			
93			
94			
95			
96			
97			
98			
99			
100			

Claim	Final	Original	Date
101			
102			
103			
104			
105			
106			
107			
108			
109			
110			
111			
112			
113			
114			
115			
116			
117			
118			
119			
120			
121			
122			
123			
124			
125			
126			
127			
128			
129			
130			
131			
132			
133			
134			
135			
136			
137			
138			
139			
140			
141			
142			
143			
144			
145			
146			
147			
148			
149			
150			

If more than 150 claims or 10 actions
staple additional sheet here

(LEFT INSIDE)

Best Available Copy

11-13-00

A

Express Mail Label No. EM401136836US

11/09/00
PTO
11/09/00

UTILITY PATENT APPLICATION TRANSMITTAL <small>(Only for new nonprovisional applications under 37 CFR 1.53(b))</small>	Attorney Docket No.	AWR-017 (457/19)
	First Named Inventor	Tzannes
	Title	A System And Method For Scrambling The Phase Of The Carriers In A Multicarrier Communications System

PTO
11/09/00
11/09/00

APPLICATION ELEMENTS		ADDRESS TO: Box Patent Application Assistant Commissioner for Patents Washington, D.C. 20231	
1. <input checked="" type="checkbox"/> Fee Transmittal Form		ACCOMPANYING APPLICATION PARTS	
2. <input checked="" type="checkbox"/> Specification and Drawings [Total Pages 27] X - Written Description - (18 pages) X - Claims - (6 pages) X - Abstract - (1 page) X - Sheets of Drawings - (2 sheets) <input type="checkbox"/> Formal <input checked="" type="checkbox"/> Informal		7. <input type="checkbox"/> 37 CFR 3.73(b) Statement (when there is an assignee) <input type="checkbox"/> Power of Attorney	
3. <input checked="" type="checkbox"/> Oath or Declaration [Total Pages 3] a. <input checked="" type="checkbox"/> Newly executed (original) b. <input type="checkbox"/> Copy from a prior application (37 CFR 1.63(d)) <i>(for continuation/divisional with Box 17 completed)</i> <i>[Note Box 4 below]</i>		8. <input type="checkbox"/> English Translation Document (if applicable)	
4. <input type="checkbox"/> Incorporation by Reference (usable if Box 3b is checked) The entire Disclosure of the prior application, from which a copy of the oath or declaration is supplied under Box 3b, is considered as being part of the disclosure of the accompanying application and is hereby incorporated by reference therein.		9. <input type="checkbox"/> Information Disclosure Statement (IDS)/PTO-1449 <input type="checkbox"/> Copies of IDS Citations	
5. <input type="checkbox"/> Microfiche Computer Program (Appendix)		10. <input type="checkbox"/> Preliminary Amendment <input type="checkbox"/> Drawings [Total Sheets] <input type="checkbox"/> Letter to Official Draftsperson Including Drawings [Total Pages]	
6. <input type="checkbox"/> Nucleotide and/or Amino Acid Sequence Submission <input type="checkbox"/> Computer Readable Copy <input type="checkbox"/> Paper Copy (identical to computer copy) <input type="checkbox"/> Statement verifying identity of above copies		11. <input checked="" type="checkbox"/> Return Receipt Postcard	
7. <input type="checkbox"/> If a CONTINUING APPLICATION, check appropriate box and supply the requisite information: <input type="checkbox"/> Continuation <input type="checkbox"/> Divisional <input type="checkbox"/> Continuation-in-part (CIP) of prior application Serial No. ____/____. Priority to the above application(s) is claimed under 35 U.S.C. 120. Prior application information: Examiner: ____ Group/Art Unit: ____		12. <input type="checkbox"/> Small Entity Statement(s) <input type="checkbox"/> Statements filed in prior application, (Status still proper and desired)	
18. <input checked="" type="checkbox"/> Priority - 35 U.S.C. 119 <input checked="" type="checkbox"/> Priority of application Serial No. 60/164,134 filed on November 9, 1999 in United States is claimed under 35 U.S.C. 119. <input type="checkbox"/> The certified copy has been filed in prior U.S. application Serial No. ____/____ on ____. <input type="checkbox"/> The certified copy will follow.		13. <input type="checkbox"/> Certified Copy of Priority Document(s)	
14. <input type="checkbox"/> Deletion of Inventor(s) Signed statement attached deleting inventor(s) named in the prior application.		15. <input checked="" type="checkbox"/> Patent Application Data Entry Form	
16. <input type="checkbox"/> Other:		17. <input type="checkbox"/> If a CONTINUING APPLICATION, check appropriate box and supply the requisite information: <input type="checkbox"/> Continuation <input type="checkbox"/> Divisional <input type="checkbox"/> Continuation-in-part (CIP) of prior application Serial No. ____/____. Priority to the above application(s) is claimed under 35 U.S.C. 120. Prior application information: Examiner: ____ Group/Art Unit: ____	
CORRESPONDENCE ADDRESS Direct all correspondence to: Patent Administrator Testa, Hurwitz & Thibault, LLP High Street Tower 125 High Street Boston, MA 02110 Tel. No.: (617) 248-7000 Fax No.: (617) 248-7100		SIGNATURE BLOCK Date: November 9, 2000 Reg. No. 41,274 Tel. No.: (617) 248-7501 Fax No.: (617) 248-7100 Respectfully submitted, Michael A. Rodriguez Michael A. Rodriguez Attorney for Applicant(s) Testa, Hurwitz & Thibault, LLP High Street Tower 125 High Street Boston, MA 02110	

ABRAMSON457/19.1105071

FEE TRANSMITTAL FY 2001	Completed <i>Known</i>	
	Application Serial Number	Not Yet Assigned
	Filing Date	Herewith
	First Named Inventor	Tzannes
	Group Art Unit	Not Yet Assigned
	Examiner Name	Not Yet Assigned
Attorney Docket No.	AWR-017 (457/19)	

11/09/00
 09/11/00
 09/11/00
 09/11/00

METHOD OF PAYMENT 1. <input checked="" type="checkbox"/> Payment Enclosed: <input checked="" type="checkbox"/> Check <input type="checkbox"/> Money Order <input type="checkbox"/> Other 2. <input checked="" type="checkbox"/> The Commissioner is hereby authorized to credit or charge any fee indicated below for this submission to Deposit Account No. 20-0531. <input type="checkbox"/> Required Fees (copy of this sheet enclosed). <input checked="" type="checkbox"/> Additional fee required under 37 CFR 1.16 and 1.17. <input checked="" type="checkbox"/> Overpayment Credit.	FEE CALCULATION (continued) 3. ADDITIONAL FEES <table border="1"> <thead> <tr> <th>Large Entity Fee (\$)</th> <th>Small Entity Fee (\$)</th> <th>Fee Description</th> <th>Fee Paid</th> </tr> </thead> <tbody> <tr><td>130</td><td>65</td><td>Surcharge - late filing fee or oath</td><td></td></tr> <tr><td>50</td><td>25</td><td>Surcharge - late provisional filing fee or cover sheet</td><td></td></tr> <tr><td>130</td><td>130</td><td>Non-English specification</td><td></td></tr> <tr><td>2,520</td><td>2,520</td><td>For filing a request for reexamination</td><td></td></tr> <tr><td>110</td><td>55</td><td>Extension for reply within first month</td><td></td></tr> <tr><td>390</td><td>195</td><td>Extension for reply within second month</td><td></td></tr> <tr><td>890</td><td>445</td><td>Extension for reply within third month</td><td></td></tr> <tr><td>1,390</td><td>695</td><td>Extension for reply within fourth month</td><td></td></tr> <tr><td>1,890</td><td>945</td><td>Extension for reply within fifth month</td><td></td></tr> <tr><td>310</td><td>155</td><td>Notice of Appeal</td><td></td></tr> <tr><td>310</td><td>155</td><td>Filing a brief in support of an appeal</td><td></td></tr> <tr><td>270</td><td>135</td><td>Request for oral hearing</td><td></td></tr> <tr><td>130</td><td>130</td><td>Petitions to the Commissioner</td><td></td></tr> <tr><td>50</td><td>50</td><td>Petitions related to provisional applications</td><td></td></tr> <tr><td>240</td><td>240</td><td>Submission of Information Disclosure Statement (37 CFR 1.97(c))</td><td></td></tr> <tr><td>130</td><td>130</td><td>Submission of Information Disclosure Statement (37 CFR 1.97(d))</td><td></td></tr> <tr><td>710</td><td>355</td><td>Filing a submission after final rejection (37 CFR 1.129(a))</td><td></td></tr> <tr><td>710</td><td>355</td><td>For each additional invention to be examined (37 CFR 1.129(b))</td><td></td></tr> <tr><td colspan="3">Other fee (Specify)</td><td></td></tr> <tr><td colspan="3">Other fee (Specify)</td><td></td></tr> </tbody> </table>	Large Entity Fee (\$)	Small Entity Fee (\$)	Fee Description	Fee Paid	130	65	Surcharge - late filing fee or oath		50	25	Surcharge - late provisional filing fee or cover sheet		130	130	Non-English specification		2,520	2,520	For filing a request for reexamination		110	55	Extension for reply within first month		390	195	Extension for reply within second month		890	445	Extension for reply within third month		1,390	695	Extension for reply within fourth month		1,890	945	Extension for reply within fifth month		310	155	Notice of Appeal		310	155	Filing a brief in support of an appeal		270	135	Request for oral hearing		130	130	Petitions to the Commissioner		50	50	Petitions related to provisional applications		240	240	Submission of Information Disclosure Statement (37 CFR 1.97(c))		130	130	Submission of Information Disclosure Statement (37 CFR 1.97(d))		710	355	Filing a submission after final rejection (37 CFR 1.129(a))		710	355	For each additional invention to be examined (37 CFR 1.129(b))		Other fee (Specify)				Other fee (Specify)			
Large Entity Fee (\$)	Small Entity Fee (\$)	Fee Description	Fee Paid																																																																																		
130	65	Surcharge - late filing fee or oath																																																																																			
50	25	Surcharge - late provisional filing fee or cover sheet																																																																																			
130	130	Non-English specification																																																																																			
2,520	2,520	For filing a request for reexamination																																																																																			
110	55	Extension for reply within first month																																																																																			
390	195	Extension for reply within second month																																																																																			
890	445	Extension for reply within third month																																																																																			
1,390	695	Extension for reply within fourth month																																																																																			
1,890	945	Extension for reply within fifth month																																																																																			
310	155	Notice of Appeal																																																																																			
310	155	Filing a brief in support of an appeal																																																																																			
270	135	Request for oral hearing																																																																																			
130	130	Petitions to the Commissioner																																																																																			
50	50	Petitions related to provisional applications																																																																																			
240	240	Submission of Information Disclosure Statement (37 CFR 1.97(c))																																																																																			
130	130	Submission of Information Disclosure Statement (37 CFR 1.97(d))																																																																																			
710	355	Filing a submission after final rejection (37 CFR 1.129(a))																																																																																			
710	355	For each additional invention to be examined (37 CFR 1.129(b))																																																																																			
Other fee (Specify)																																																																																					
Other fee (Specify)																																																																																					

FEE CALCULATION				
1. FILING FEE				
Large Entity				
Fee (\$)	Fee Description			Fee Paid
710	Utility filing fee			710.00
320	Design filing fee			
150	Provisional filing fee			
	Number Filed	Number Extra	Rate	Amount
Total Claims	39	- 20 = 19	x \$ 18.00 =	342.00
Independent Claims	4	- 3 = 1	x \$ 80.00 =	80.00
<input type="checkbox"/> Multiple Dependent Claim(s), if any				\$270.00 =
TOTAL:				1132.00
SMALL ENTITY DISCOUNT:				
SUBTOTAL (1)				(\$) 1132.00

2. AMENDMENT CLAIM FEES				
Claims Remaining After Amend.	Highest No. Previously Paid For	Present Extra	Rate	Fee Paid
Total	-	=	x \$ 18.00 =	
Indep.	-	=	x \$ 80.00 =	
<input type="checkbox"/> First Presentation of Multiple Dep. Claim				+ \$270.00 =
TOTAL:				(\$)
SMALL ENTITY DISCOUNT:				(\$)
SUBTOTAL (2)				(\$)

SUBTOTAL (3)		(\$)
SUBTOTAL (1)		1132.00
SUBTOTAL (2)		
SUBTOTAL (3)		
TOTAL		(\$) 1132.00

CORRESPONDENCE ADDRESS
Direct all correspondence to: Patent Administrator Testa, Hurwitz & Thibault, LLP High Street Tower-125 High Street Boston, MA 02110 Tel. No.: (617) 248-7000 Fax No.: (617) 248-7100

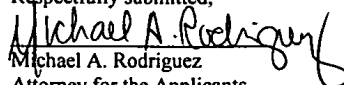
SIGNATURE BLOCK
Date: November 9, 2000 Reg. No.: 41,274 Tel. No.: (617) 248-7501 Fax No.: (617) 248-7100 Respectfully submitted,  Michael A. Rodriguez Attorney for the Applicants Testa, Hurwitz & Thibault, LLP High Street Tower-125 High Street Boston, MA 02110

2
NO. OF PAGES

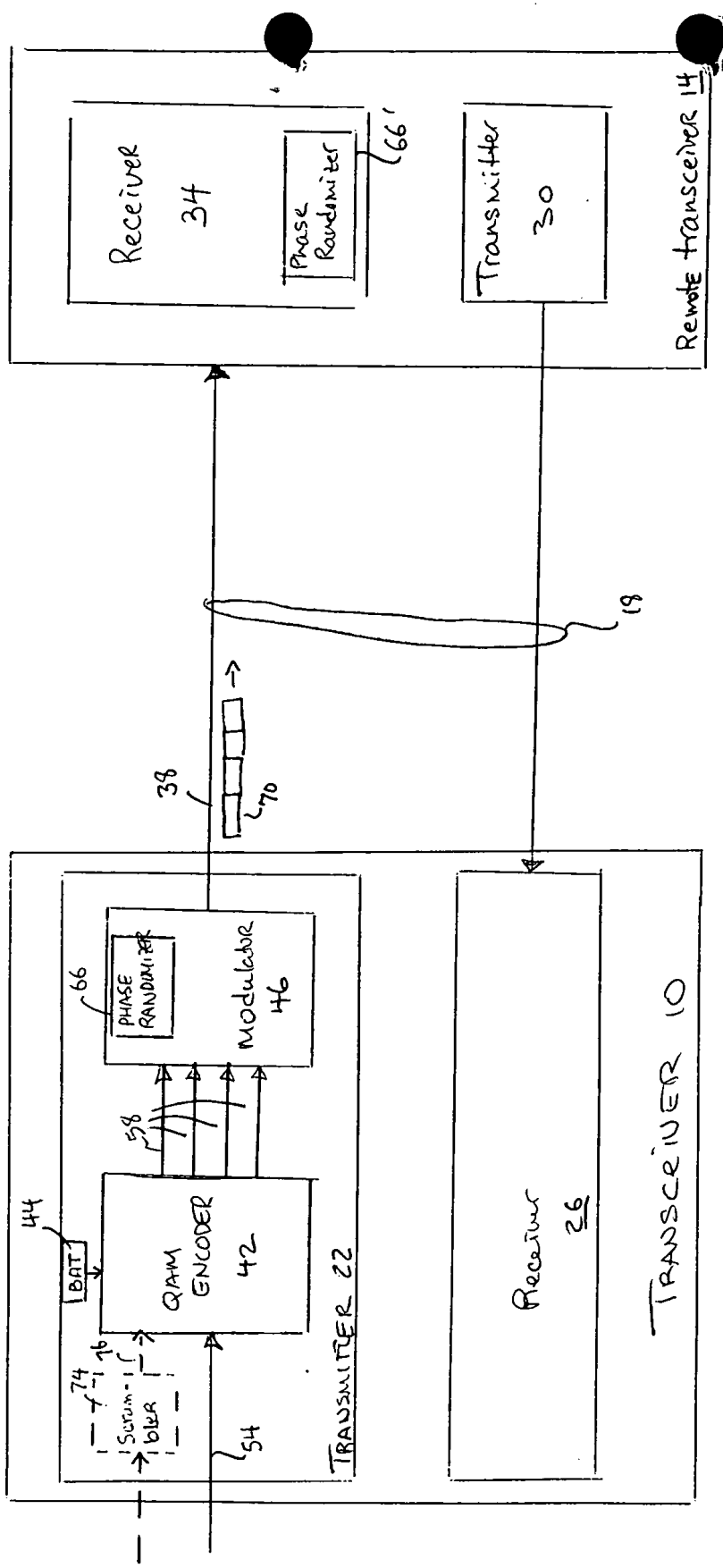

FIG. 1

00001-01201200

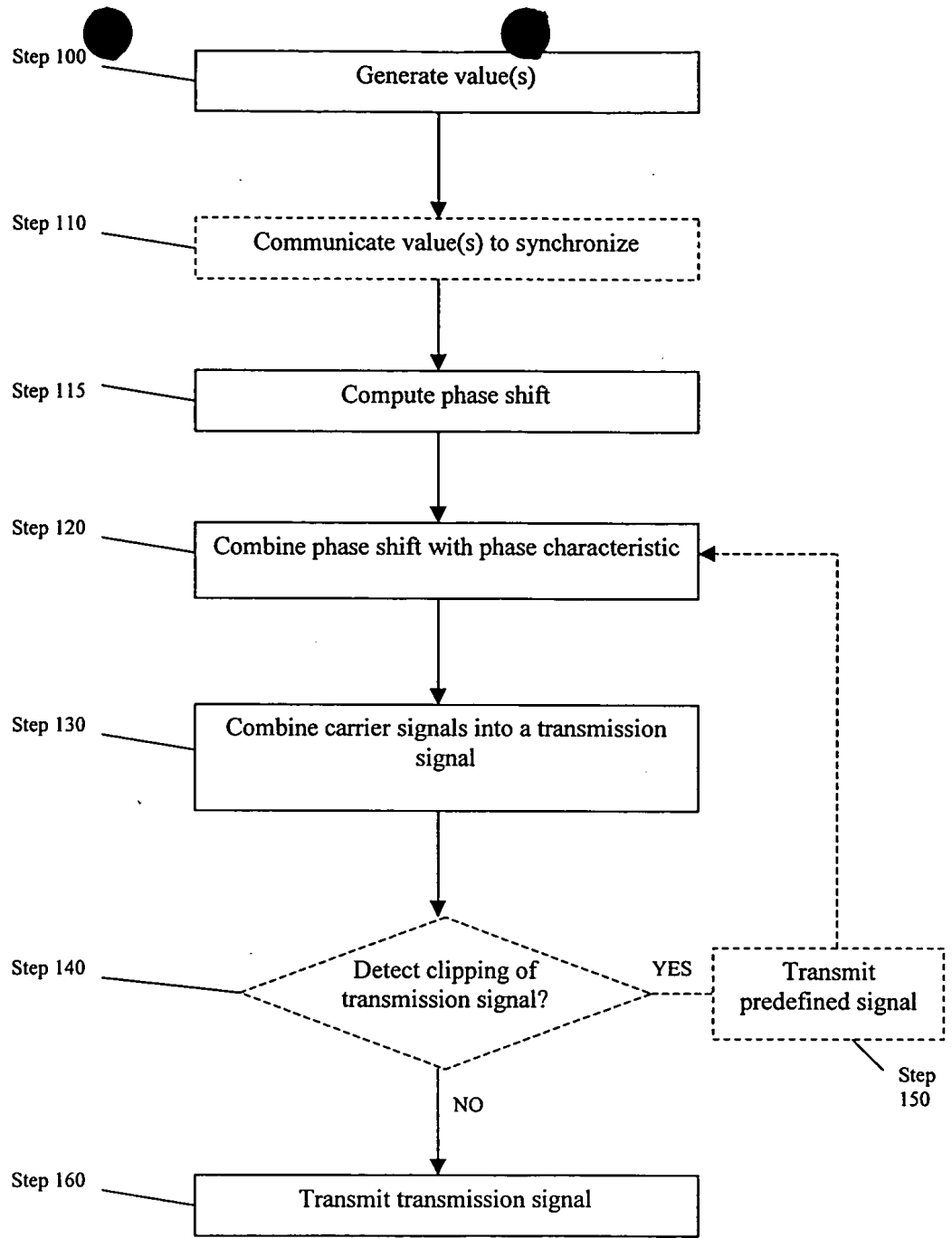

FIG. 2

5

**A System and Method for Scrambling the Phase of the Carriers in a Multicarrier
Communications System**

Related Application

This application claims the benefit of the filing date of copending U.S. Provisional
10 Application, Serial No. 60/164,134, filed November 9, 1999, entitled "A Method For Randomizing
The Phase Of The Carriers In A Multicarrier Communications System To Reduce The Peak To
Average Power Ratio Of The Transmitted Signal," the entirety of which provisional application is
15 incorporated by reference herein.

Field of the Invention

This invention relates to communications systems using multicarrier modulation. More
15 particularly, the invention relates to multicarrier communications systems that lower the peak-to-
average power ratio (PAR) of transmitted signals.

Background of the Invention

20 In a conventional multicarrier communications system, transmitters communicate over a
communication channel using multicarrier modulation or Discrete Multitone Modulation (DMT).
Carrier signals (carriers) or sub-channels spaced within a usable frequency band of the
communication channel are modulated at a symbol (i.e., block) transmission rate of the system. An
input signal, which includes input data bits, is sent to a DMT transmitter, such as a DMT modem.
25 The DMT transmitter typically modulates the phase characteristic, or phase, and amplitude of the

carrier signals using an Inverse Fast Fourier Transform (IFFT) to generate a time domain signal, or transmission signal, that represents the input signal. The DMT transmitter transmits the transmission signal, which is a linear combination of the multiple carriers, to a DMT receiver over the communication channel.

5 The phase and amplitude of the carrier signals of DMT transmission signal can be considered random because the phase and amplitude result from the modulation of an arbitrary sequence of input data bits comprising the transmitted information. Therefore, under the condition that the modulated data bit stream is random, the DMT transmission signal can be approximated as having a Gaussian probability distribution. A bit scrambler is often used in the DMT transmitter to scramble
10 the input data bits before the bits are modulated to assure that the transmitted data bits are random and, consequently, that the modulation of those bits produces a DMT transmission signal with a Gaussian probability distribution.

 With an appropriate allocation of transmit power levels to the carriers or sub-channels, such a system provides a desirable performance. Further, generating a transmission signal with a Gaussian
15 probability distribution is important in order to transmit a transmission signal with a low peak-to-average ratio (PAR), or peak-to-average power ratio. The PAR of a transmission signal is the ratio of the instantaneous peak value (i.e., maximum magnitude) of a signal parameter (e.g., voltage, current, phase, frequency, power) to the time-averaged value of the signal parameter. In DMT
20 systems, the PAR of the transmitted signal is determined by the probability of the random transmission signal reaching a certain peak voltage during the time interval required for a certain number of symbols. An example of the PAR of a transmission signal transmitted from a DMT transmitter is 14.5 dB, which is equivalent to having a $1E-7$ probability of clipping. The PAR of a

In one embodiment, the input bit stream is modulated onto the carrier signals having the substantially scrambled phase characteristic to produce a transmission signal with a reduced peak-to-average power ratio (PAR). The value is derived from a predetermined parameter, such as a random number generator, a carrier number, a DMT symbol count, a superframe count, and a hyperframe count. In another embodiment, a predetermined transmission signal is transmitted when the amplitude of the transmission signal exceeds a certain level.

In another aspect, the invention features a method wherein a value is associated with each carrier signal. The value is determined independently of any input bit value carried by that carrier signal. A phase shift for each carrier signal is computed based on the value associated with that carrier signal. The transmission signal is demodulated using the phase shift computed for each carrier signal.

In another aspect, the invention features a system comprising a phase scrambler that computes a phase shift for each carrier signal based on a value associated with that carrier signal. The phase scrambler also combines the phase shift computed for each carrier signal with the phase characteristic of that carrier signal to substantially scramble the phase characteristic of the carrier signals. In one embodiment, a modulator, in communication with the phase scrambler, modulates bits of an input signal onto the carrier signals having the substantially scrambled phase characteristics to produce a transmission signal with a reduced PAR.

Description of the Drawings

The invention is pointed out with particularity in the appended claims. The advantages of the invention described above, as well as further advantages of the invention, may be better understood

by reference to the following description taken in conjunction with the accompanying drawings, in which:

Fig. 1 is a block diagram of an embodiment of a digital subscriber line communications system including a DMT (discrete multitone modulation) transceiver, in communication with a remote transceiver, having a phase scrambler for substantially scrambling the phase characteristics of carrier signals; and

Fig. 2 is a flow diagram of an embodiment of a process for scrambling the phase characteristics of the carrier signals in a transmission signal.

Detailed Description

100
101
102
103
104
105
106
107
108
109
110
111
112
113
114
115
116
117
118
119
120
121
122
123
124
125
126
127
128
129
130
131
132
133
134
135
136
137
138
139
140
141
142
143
144
145
146
147
148
149
150
151
152
153
154
155
156
157
158
159
160
161
162
163
164
165
166
167
168
169
170
171
172
173
174
175
176
177
178
179
180
181
182
183
184
185
186
187
188
189
190
191
192
193
194
195
196
197
198
199
200
201
202
203
204
205
206
207
208
209
210
211
212
213
214
215
216
217
218
219
220
221
222
223
224
225
226
227
228
229
230
231
232
233
234
235
236
237
238
239
240
241
242
243
244
245
246
247
248
249
250
251
252
253
254
255
256
257
258
259
260
261
262
263
264
265
266
267
268
269
270
271
272
273
274
275
276
277
278
279
280
281
282
283
284
285
286
287
288
289
290
291
292
293
294
295
296
297
298
299
300
301
302
303
304
305
306
307
308
309
310
311
312
313
314
315
316
317
318
319
320
321
322
323
324
325
326
327
328
329
330
331
332
333
334
335
336
337
338
339
340
341
342
343
344
345
346
347
348
349
350
351
352
353
354
355
356
357
358
359
360
361
362
363
364
365
366
367
368
369
370
371
372
373
374
375
376
377
378
379
380
381
382
383
384
385
386
387
388
389
390
391
392
393
394
395
396
397
398
399
400
401
402
403
404
405
406
407
408
409
410
411
412
413
414
415
416
417
418
419
420
421
422
423
424
425
426
427
428
429
430
431
432
433
434
435
436
437
438
439
440
441
442
443
444
445
446
447
448
449
450
451
452
453
454
455
456
457
458
459
460
461
462
463
464
465
466
467
468
469
470
471
472
473
474
475
476
477
478
479
480
481
482
483
484
485
486
487
488
489
490
491
492
493
494
495
496
497
498
499
500

Fig. 1 shows a digital subscriber line (DSL) communication system 2 including a discrete multitone (DMT) transceiver 10 in communication with a remote transceiver 14 over a communication channel 18 using a transmission signal 38 having a plurality of carrier signals. The DMT transceiver 10 includes a DMT transmitter 22 and a DMT receiver 26. The remote transceiver 14 includes a transmitter 30 and a receiver 34. Although described with respect to discrete multitone modulation, the principles of the invention apply also to other types of multicarrier modulation, such as, but not limited to, orthogonally multiplexed quadrature amplitude modulation (OQAM), discrete wavelet multitone (DWMT) modulation, and orthogonal frequency division multiplexing (OFDM).

The communication channel 18 provides a downstream transmission path from the DMT transmitter 22 to the remote receiver 34, and an upstream transmission path from the remote transmitter 30 to the DMT receiver 26. In one embodiment, the communication channel 18 is a pair of twisted wires of a telephone subscriber line. In other embodiments, the communication channel 18 can be a fiber optic wire, a quad cable, consisting of two pairs of twisted wires, or a quad cable

that is one of a star quad cable, a Dieselhorst-Martin quad cable, and the like. In a wireless communication system wherein the transceivers 10, 14 are wireless modems, the communication channel 18 is the air through which the transmission signal 38 travels between the transceivers 10, 14.

5 By way of example, the DMT transmitter 22 shown in Fig. 1 includes a quadrature amplitude modulation (QAM) encoder 42, a modulator 46, a bit allocation table (BAT) 44, and a phase scrambler 66. The DMT transmitter 22 can also include a bit scrambler 74, as described further below. The remote transmitter 30 of the remote transceiver 14 comprises equivalent components as the DMT transmitter 22. Although this embodiment specifies a detailed description of the DMT transmitter 22, the inventive concepts apply also to the receivers 34, 36 which have similar components to that of the DMT transmitter 22, but perform inverse functions in a reverse order.

10
15
20
25
30
35
40
45
50
55
60
65
70
75
80
85
90
95
100
105
110
115
120
125
130
135
140
145
150
155
160
165
170
175
180
185
190
195
200
205
210
215
220
225
230
235
240
245
250
255
260
265
270
275
280
285
290
295
300
305
310
315
320
325
330
335
340
345
350
355
360
365
370
375
380
385
390
395
400
405
410
415
420
425
430
435
440
445
450
455
460
465
470
475
480
485
490
495
500
505
510
515
520
525
530
535
540
545
550
555
560
565
570
575
580
585
590
595
600
605
610
615
620
625
630
635
640
645
650
655
660
665
670
675
680
685
690
695
700
705
710
715
720
725
730
735
740
745
750
755
760
765
770
775
780
785
790
795
800
805
810
815
820
825
830
835
840
845
850
855
860
865
870
875
880
885
890
895
900
905
910
915
920
925
930
935
940
945
950
955
960
965
970
975
980
985
990
995

The QAM encoder 42 has a single input for receiving an input serial data bit stream 54 and multiple parallel outputs to transmit QAM symbols 58 generated by the QAM encoder 42 from the bit stream 54. In general, the QAM encoder 42 maps the input serial bit-stream 54 in the time domain into parallel QAM symbols 58 in the frequency domain. In particular, the QAM encoder 42 maps the input serial data bit stream 54 into N parallel quadrature amplitude modulation (QAM) constellation points 58, or QAM symbols 58, where N represents the number of carrier signals generated by the modulator 46. The BAT 44 is in communication with the QAM encoder 42 to specify the number of bits carried by each carrier signal. The QAM symbols 58 represent the amplitude and the phase characteristic of each carrier signal.

The modulator 46 provides functionality associated with the DMT modulation and transforms the QAM symbols 58 into DMT symbols 70 each comprised of a plurality of time-

domain samples. The modulator 46 modulates each carrier signal with a different QAM symbol 58. As a result of this modulation, carrier signals have phase and amplitude characteristics based on the QAM symbol 58 and therefore based on the input-bit stream 54. In particular, the modulator 46 uses an inverse fast Fourier transform (IFFT) to change the QAM symbols 58 into a transmission signal 38 comprised of a sequence of DMT symbols 70. The modulator 46 changes the QAM symbols 58 into DMT symbols 70 through modulation of the carrier signals. In another embodiment, the modulator 46 uses the inverse discrete Fourier transform (IDFT) to change the QAM symbols 58 into DMT symbols 70. In one embodiment, a pilot tone is included in the transmission signal 38 to provide a reference signal for coherent demodulation of the carrier signals in the remote receiver 34 during reception of the transmission signal 38.

The modulator 46 also includes a phase scrambler 66 that combines a phase shift computed for each QAM-modulated carrier signal with the phase characteristic of that carrier signal. Combining phase shifts with phase characteristics, in accordance with the principles of the invention, substantially scrambles the phase characteristics of the carrier signals in the transmission signal 38. By scrambling the phase characteristics of the carrier signals, the resulting transmission signal 38 has a substantially minimized peak-to-average (PAR) power ratio. The phase scrambler 66 can be part of or external to the modulator 46. Other embodiments of the phase scrambler 66 include, but are not limited to, a software program that is stored in local memory and is executed on the modulator 46, a digital signal processor (DSP) capable of performing mathematical functions and algorithms, and the like. The remote receiver 34 similarly includes a phase scrambler 66' for use when demodulating carrier signals that have had their phase characteristics adjusted by the phase scrambler 66 of the DMT transceiver 10.

To compute a phase shift for each carrier signal, the phase scrambler 66 associates one or more values with that carrier signal. The phase scrambler 66 determines each value for a carrier signal independently of the QAM symbols 58, and, therefore, independently of the bit value(s) modulated onto the carrier signal. The actual value(s) that the phase scrambler 66 associates with each carrier signal can be derived from one or more predefined parameters, such as a pseudo-random number generator (pseudo-RNG), a DMT carrier number, a DMT symbol count, a DMT superframe count, a DMT hyperframe count, and the like, as described in more detail below. Irrespective of the technique used to produce each value, the same technique is used by the DMT transmitter 22 and the remote receiver 34 so that the value associated with a given carrier signal is known at both ends of the communication channel 18.

The phase scrambler 66 then solves a predetermined equation to compute a phase shift for the carrier signal, using the value(s) associated with that carrier signal as input that effects the output of the equation. Any equation suitable for computing phase shifts can be used to compute the phase shifts. When the equation is independent of the bit values of the input serial bit stream 54, the computed phase shifts are also independent of such bit values.

In one embodiment (shown in phantom), the DMT transmitter 22 includes a bit scrambler 74, which receives the input serial bit stream 54 and outputs data bits 76 that are substantially scrambled. The substantially scrambled bits 76 are then passed to the QAM encoder 42. When the bit scrambler 74 is included in the DMT transmitter 22, the operation of the phase scrambler 66 further assures that the transmission signal 38 has a Gaussian probability distribution and, therefore, a substantially minimized PAR.

Fig. 2 shows embodiments of a process used by the DMT transmitter 22 for adjusting the phase characteristic of each carrier signal and combining these carrier signals to produce the transmission signal 38. The DMT transmitter 22 generates (step 100) a value that is associated with a carrier signal. Because the value is being used to alter the phase characteristics of the carrier signal, both the DMT transmitter 22 and the remote receiver 34 must recognize the value as being associated with the carrier signal. Either the DMT transmitter 22 and the remote receiver 34 independently derive the associated value, or one informs the other of the associated value. For example, in one embodiment the DMT transmitter 22 can derive the value from a pseudo-RNG and then transmit the generated value to the remote receiver 34. In another embodiment, the remote receiver 34 similarly derives the value from the same pseudo-RNG and the same seed as used by the transmitter (i.e., the transmitter pseudo-RNG produces the same series of random numbers as the receiver pseudo-RNG).

As another example, the DMT transmitter 22 and the remote receiver 34 can each maintain a symbol counter for counting DMT symbols. The DMT transmitter 22 increments its symbol counter upon transmitting a DMT symbol; the remote receiver 34 upon receipt. Thus, when the DMT transmitter 22 and the remote receiver 34 both use the symbol count as a value for computing phase shifts, both the DMT transmitter 22 and remote receiver 34 “know” that the value is associated with a particular DMT symbol and with each carrier signal of that DMT symbol.

Values can also be derived from other types of predefined parameters. For example, if the predefined parameter is the DMT carrier number, then the value associated with a particular carrier signal is the carrier number of that signal within the DMT symbol. The number of a carrier signal represents the location of the frequency of the carrier signal relative to the frequency of other carrier

signals within a DMT symbol. For example, in one embodiment the DSL communication system 2 provides 256 carrier signals, each separated by a frequency of 4.3125 kHz and spanning the frequency bandwidth from 0 kHz to 1104 kHz. The DMT transmitter 22 numbers the carrier signals from 0 to 255. Therefore, "DMT carrier number 50" represents the 51st DMT carrier signal which is located at the frequency of 215.625 kHz (i.e., 51×4.3125 kHz).

Again, the DMT transmitter 22 and the remote receiver 34 can know the value that is associated with the carrier signal because both the DMT transmitter 22 and the remote receiver 34 use the same predefined parameter (here, the DMT carrier number) to make the value-carrier signal association. In other embodiments (as exemplified above with the transmitter pseudo-RNG), the DMT transmitter 22 can transmit the value to the remote receiver 34 (or vice versa) over the communication channel 18.

In other embodiments, other predefined parameters can be used in conjunction with the symbol count. One example of such a predefined parameter is the superframe count that increments by one every 69 DMT symbols. One exemplary implementation that achieves the superframe counter is to perform a modulo 68 operation on the symbol count. As another example, the DMT transmitter 22 can maintain a hyperframe counter for counting hyperframes. An exemplary implementation of the hyperframe count is to perform a modulo 255 operation on the superframe count. Thus, the hyperframe count increments by one each time the superframe count reaches 255.

Accordingly, it is seen that some predefined parameters produce values that vary from carrier signal to carrier signal. For example, when the predefined parameter is the DMT carrier number, values vary based on the frequency of the carrier signal. As another example, the pseudo-RNG generates a new random value for each carrier signal.

Other predefined parameters produce values that vary from DMT symbol 70 to DMT symbol 70. For example, when the predefined parameter is the symbol count, the superframe count, or hyperframe count, values vary based on the numerical position of the DMT symbol 70 within a sequence of symbols, superframes, or hyperframes. Predefined parameters such as the pseudo-RNG, symbol count, superframe count, and superframe can also be understood to be parameters that vary values over time. Any one or combination of the predefined parameters can provide values for input to the equation that computes a phase shift for a given carrier signal.

In one embodiment, the phase scrambling is used to avoid clipping of the transmission signal on a DMT symbol 70 by DMT symbol 70 basis. In this embodiment, the DMT transmitter 22 uses a value based on a predefined parameter that varies over time, such as the symbol count, to compute the phase shift. It is to be understood that other types of predefined parameters that vary the values associated with carrier signals can be used to practice the principles of the invention. As described above, the transceivers 10, 14 may communicate (step 110) the values to synchronize their use in modulating and demodulating the carrier signals.

The DMT transmitter 22 then computes (step 115) the phase shift that is used to adjust the phase characteristic of each carrier signal. The amount of the phase shift combined with the phase characteristic of each QAM-modulated carrier signal depends upon the equation used and the one or more values associated with that carrier signal.

The DMT transmitter 22 then combines (step 120) the phase shift computed for each carrier signal with the phase characteristic of that carrier signal. By scrambling the phase characteristics of the carrier signals, the phase scrambler 66 reduces (with respect to unscrambled phase characteristics) the combined PAR of the plurality of carrier signals and, consequently, the

transmission signal 38. The following three phase shifting examples, PS #1 – PS #3, illustrate methods used by the phase scrambler 66 to combine a computed phase shift to the phase characteristic of each carrier signal.

Phase Shifting Example #1

5 Phase shifting example #1 (PS #1) corresponds to adjusting the phase characteristic of the QAM-modulated carrier signal associated with a carrier number N by $N \times \frac{\pi}{3}$, modulo (mod) 2π . In this example, a carrier signal having a carrier number N equal to 50 has a phase shift added to the phase characteristic of that carrier signal equal to $50 \times \frac{\pi}{3} \pmod{2\pi} = \frac{2}{3}\pi$. The carrier signal with a carrier number N equal to 51 has a phase shift added to the phase characteristic of that carrier signal equal to $51 \times \frac{\pi}{3} \pmod{2\pi} = \pi$. The carrier signal with a carrier number N equal to 0 has no phase shift added to the phase characteristic of that carrier signal.

Phase Shifting Example #2

10 Phase shifting example #2 (PS #2) corresponds to adjusting the phase characteristic of the QAM-modulated carrier signal associated with a carrier number N by $(N + M) \times \frac{\pi}{4}$, mod 2π , where M is the symbol count. In this example, a carrier signal having a carrier number N equal to 50 on DMT symbol count M equal to 8 has a phase shift added to the phase characteristic of that carrier signal equal to $(50 + 8) \times \frac{\pi}{4} \pmod{2\pi} = \frac{\pi}{2}$. The carrier signal with the same carrier number N equal to 50 on the next DMT symbol count M equal to 9 has a phase shift added to the phase characteristic of that carrier signal equal to $(50 + 9) \times \frac{\pi}{4} \pmod{2\pi} = \frac{3\pi}{4}$.

Phase Shifting Example #3

Phase shifting example #3 (PS #3) corresponds to adjusting the phase characteristic of the QAM-modulated carrier signal associated with a carrier number N by $(X_N) \times \frac{\pi}{6}, \text{ mod } 2\pi$, where X_N is an array of N pseudo-random numbers. In this example, a carrier signal having a carrier number N equal to 5 and X_N equal to [3, 8, 1, 4, 9, 5, ...] has a phase shift added to the phase characteristic of the carrier signal that is equal to $(9) \times \frac{\pi}{6} (\text{mod } 2\pi) = \frac{\pi}{3}$. (Note that 9 is the 5th value in X_N .) The carrier signal with a carrier number N equal to 6 has a phase shift added to the phase characteristic of the carrier signal equal to $(5) \times \frac{\pi}{6} (\text{mod } 2\pi) = \frac{5\pi}{6}$.

It is to be understood that additional and/or different phase shifting techniques can be used by the phase scrambler 66, and that PS #1, #2, and #3 are merely illustrative examples of the principles of the invention. The DMT transmitter 22 then combines (step 130) the carrier signals to form the transmission signal 38. If the transmission signal is not clipped, as described below, the DMT transmitter 22 consequently transmits (step 160) the transmission signal 38 to the remote receiver 34.

Clipping of Transmission Signals

A transmission signal 38 that has high peak values of voltage (i.e., a high PAR) can induce non-linear distortion in the DMT transmitter 22 and the communication channel 18. One form of this non-linear distortion of the transmission signal 38 that may occur is the limitation of the amplitude of the transmission signal 38 (i.e., clipping). For example, a particular DMT symbol 70 clips in the time domain when one or more time domain samples in that DMT symbol 70 are larger than the maximum allowed digital value for the DMT symbols 70. In multicarrier communication

systems when clipping occurs, the transmission signal 38 does not accurately represent the input serial data bit signal 54.

In one embodiment, the DSL communication system 2 avoids the clipping of the transmission signal 38 on a DMT symbol 70 by DMT symbol 70 basis. The DMT transmitter 22 detects (step 140) the clipping of the transmission signal 38. If a particular DMT symbol 70 clips in the time domain to produce a clipped transmission signal 38, the DMT transmitter 22 substitutes (step 150) a predefined transmission signal 78 for the clipped transmission signal 38.

The predefined transmission signal 78 has the same duration as a DMT symbol 70 (e.g., 250 ms) in order to maintain symbol timing between the DMT transmitter 22 and the remote receiver 34.

10 The predefined transmission signal 78 is not based on (i.e., independent of) the modulated input data bit stream 54; it is a bit value pattern that is recognized by the remote receiver 34 as a substituted signal. In one embodiment, the predefined transmission signal 78 is a known pseudo-random sequence pattern that is easily detected by the remote receiver 34. In another embodiment, the predefined transmission signal 78 is an “all zeros” signal, which is a zero voltage signal produced at 15 the DMT transmitter 22 output (i.e., zero volts modulated on all the carrier signals). In addition to easy detection by the remote receiver 34, the zero voltage signal reduces the power consumption of the DMT transmitter 22 when delivered by the DMT transmitter 22. Further, a pilot tone is included in the predefined transmission signal 78 to provide a reference signal for coherent demodulation of the carrier signals in the remote receiver 34 during reception of the predefined transmission signal 20 78.

After the remote receiver 34 receives the transmission signal 38, the remote receiver 34 determines if the transmission signal 38 is equivalent to the predefined transmission signal 78. In

one embodiment, when the remote receiver 34 identifies the predefined transmission signal 78, the remote receiver 34 ignores (i.e., discards) the predefined transmission signal 78.

Following the transmission of the predefined transmission signal 78, the phase scrambler 66 shifts (step 120) the phase characteristic of the QAM-modulated carrier signals (based on one of the predefined parameters that varies over time). For example, consider that a set of QAM symbols 58 produces a DMT symbol 70 comprising a plurality of time domain samples, and that one of the time domain samples is larger than the maximum allowed digital value for the DMT symbol 70. Therefore, because the transmission signal 38 would be clipped when sent to the remote receiver 34, the DMT transmitter 22 sends the predefined transmission signal 78 instead.

10 After transmission of the predefined transmission signal 78, the DMT transmitter 22 again attempts to send the same bit values that produced the clipped transmission signal 38 in a subsequent DMT symbol 70'. Because the generation of phase shifts in this embodiment is based on values that vary over time, the phase shifts computed for the subsequent DMT symbol 70' are different than those that were previously computed for the DMT symbol 70 with the clipped time domain sample. 15 These different phase shifts are combined to the phase characteristics of the modulated carrier signals to produce carrier signals of the subsequent DMT symbol 70' with different phase characteristics than the carrier signals of the DMT symbol 70 with the clipped time domain sample.

DMT communication systems 2 infrequently produce transmission signals 38 that clip (e.g., approximately one clip every 10^7 time domain samples 70). However, if the subsequent DMT symbol 70' includes a time domain sample that clips, then the predefined transmission signal 78 is again transmitted (step 150) to the remote receiver 34 instead of the clipped transmission signal 38. The clipping time domain sample may be on the same or on a different carrier signal than the

previously clipped DMT symbol 70. The DMT transmitter 22 repeats the transmission of the predefined transmission signal 78 until the DMT transmitter 22 produces a subsequent DMT symbol 70' that is not clipped. When the DMT transmitter 22 produces a DMT symbol 70' that is not clipped, the DTM transmitter 22 transmits (step 160) the transmission signal 38 to the remote receiver 34. The probability of a DMT symbol 70 producing a transmission signal 38 that clips in the time domain depends on the PAR of the transmission signal 38.

For example, the following phase shifting example, PST #4, illustrates the method used by the phase scrambler 66 to combine a different phase shift to the phase characteristic of each carrier signal to avoid the clipping of the transmission signal 38.

10 Phase Shifting Example #4

Phase shifting example #4 (PS #4) corresponds to adjusting the phase characteristic of the carrier signal associated with a carrier number N by $\frac{\pi}{3} \times (M + N)$, mod 2π , where M is the DMT symbol count. In this example, if the DMT symbol 70 clips when the DMT symbol count M equals 5, the predefined transmission signal 78 is transmitted instead of the current clipped transmission signal 38. On the following DMT symbol period, the DMT count M equals 6, thereby causing a different set of time domain samples to be generated for the subsequent DMT symbol 70', although the QAM symbols 58 used to produce both DMT symbols 70, 70' are the same.

If this different set of time domain samples (and consequently the transmission signal 38) is not clipped, the DMT transmitter 22 sends the transmission signal 38. If one of the time domain samples in the different set of time domain samples 70 (and consequently the transmission signal 38) is clipped, then the DMT transmitter 22 sends the predefined transmission signal 78 again. The process continues until a DMT symbol 70 is produced without a time domain sample 70 that is

clipped. In one embodiment, the transmitter 22 stops attempting to produce a non-clipped DMT symbol 70' for the particular set of QAM symbols 58 after generating a predetermined number of clipped DMT symbols 70'. At that moment, the transmitter 22 can transmit the most recently produced clipped DMT symbol 70' or the predetermined transmission signal 78.

5 The PAR of the DSL communication system 2 is reduced because the predefined transmission signal 78 is sent instead of the transmission signal 38 when the DMT symbol 70 clips. For example, a DMT communication system 2 that normally has a clipping probability of 10^{-7} for the time domain transmission signal 38 can therefore operate with a 10^{-5} probability of clipping and a lower PAR equal to 12.8 dB (as compared to 14.5 dB). When operating at a 10^{-5} probability of clipping, assuming a DMT symbol 70 has 512 time-domain samples 70, the DMT transmitter 22
10 experiences one clipped DMT symbol 70 out of every $\frac{10^5}{512}$, or 195 DMT symbols 70. This results in the predefined (non-data carrying) transmission signal 78 being transmitted, on average, once every 195 DMT symbols. Although increasing the probability of clipping to 10^{-5} results in approximately a 0.5% (1/195) decrease in throughput, the PAR of the transmission signal 38 is
15 reduced by 1.7 dB, which reduces transmitter complexity in the form of power consumption and component linearity.

While the invention has been shown and described with reference to specific preferred embodiments, it should be understood by those skilled in the art that various changes in form and detail may be made therein without departing from the spirit and scope of the invention as defined
20 by the following claims. For example, although the specification uses DSL to describe the invention, it is to be understood that various form of DSL can be used, e.g., ADSL, VDSL, SDSL, HDSL, HDSL2, or SHDSL. It is also to be understood that the principles of the invention apply to

Claims

What is claimed is:

- 1 1. In a multicarrier modulation system including a first transceiver in communication with a
2 second transceiver using a transmission signal having a plurality of carrier signals for
3 modulating an input bit stream, each carrier signal having a phase characteristic associated
4 with the input bit stream, a method for scrambling the phase characteristics of the carrier
5 signals comprising:
- 6 associating each carrier signal with a value determined independently of any input bit
7 value carried by that carrier signal;
8 computing a phase shift for each carrier signal based on the value associated with that
9 carrier signal; and
10 combining the phase shift computed for each carrier signal with the phase
11 characteristic of that carrier signal so as to substantially scramble the phase characteristics
12 of the plurality of carrier signals.
- 1 2. The method of claim 1 further comprising modulating bits of the input bit stream onto the
2 carrier signals having the substantially scrambled phase characteristics to produce a
3 transmission signal with a reduced peak-to-average power ratio (PAR).
- 1 3. The method of claim 1 further comprising independently deriving the value associated with
2 each carrier signal at each transceiver.

- 1 4. The method of claim 1 further comprising transmitting the value associated with each carrier
2 signal from one transceiver to the other transceiver.
- 1 5. The method of claim 1 further comprising maintaining synchronization between the
2 transceivers using the value associated with each carrier signal.
- 1 6. The method of claim 1 wherein the value varies with each carrier signal.
- 1 7. The method of claim 1 wherein the value varies with each DMT symbol.
- 1 8. The method of claim 1 wherein the value is derived from a predetermined parameter.
9. The method of claim 8 wherein the predefined parameter is a carrier number.
10. The method of claim 8 wherein the predefined parameter is a symbol count.
11. The method of claim 8 wherein the predefined parameter is a hyperframe count.
12. The method of claim 8 wherein the predefined parameter is a superframe count.
13. The method of claim 1 further comprising scrambling the bits of the input bit stream.
- 1 14. The method of claim 1 further comprising transmitting a predetermined transmission signal
2 when the amplitude of the transmission signal exceeds a certain level.
- 1 15. The method of claim 14 wherein the predetermined transmission signal comprises a
2 predetermined pattern of bits.

1 16. The method of claim 14 wherein the predetermined transmission signal comprises a pilot
2 tone.

1 17. The method of claim 16 wherein the pilot tone is used to maintain timing synchronization
2 between the first transceiver and the second transceiver.

1 18. The method of claim 15 wherein each bit value in the predetermined pattern of bits is a zero
2 value.

1 19. The method of claim 15 wherein the predetermined pattern of bits is a pseudo-random
2 sequence pattern.

1 20. In a multicarrier modulation system including a first transceiver in communication with a
2 second transceiver using a transmission signal having a plurality of carrier signals for
3 modulating an input bit stream, each carrier signal having a phase characteristic with the
4 input bit stream, a method for scrambling the phase characteristics of the carrier signals
5 comprising:

6 associating each carrier signal with a value determined independently of any input bit
7 value carried by that carrier signal;

8 computing a phase shift for each carrier signal based on the value associated with that
9 carrier signal; and

10 demodulating the transmission signal using the phase shift computed for each carrier
11 signal.

- 1 21. The method of claim 20 further comprising independently deriving the value associated with
2 each carrier signal at each transceiver.
- 1 22. The method of claim 20 further comprising transmitting the value associated with each
2 carrier signal from one transceiver to the other transceiver.
- 1 23. The method of claim 20 further comprising maintaining synchronization between the
2 transceivers using the value associated with each carrier signal.
- 1 24. The method of claim 20 wherein the value varies with each carrier signal.
- 1 25. The method of claim 20 wherein the value varies with each DMT symbol.
- 1 26. The method of claim 20 wherein the value is derived from a predetermined parameter.
- 1 27. The method of claim 26 wherein the predefined parameter is a carrier number.
- 1 28. The method of claim 26 wherein the predefined parameter is a symbol count.
- 1 29. The method of claim 26 wherein the predefined parameter is a hyperframe count.
- 1 30. The method of claim 26 wherein the predefined parameter is a superframe count.
- 1 31. The method of claim 20 further comprising receiving a predetermined transmission when the
2 amplitude of the transmission signal exceeds a certain level.
- 1 32. The method of claim 31 wherein the predetermined transmission signal comprises a
2 predetermined pattern of bits.

- 1 33. The method of claim 31 wherein the predetermined transmission signal comprises a pilot
2 tone.
- 1 34. The method of claim 33 wherein the pilot tone is used to maintain timing synchronization
2 between the first transceiver and the second transceiver.
- 1 35. The method of claim 32 wherein each bit value in the predetermined pattern of bits is a zero
2 value.
- 1 36. The method of claim 32 wherein the predetermined pattern of bits is a pseudo-random
2 sequence pattern.
- 1 37. A transceiver for communicating over a communication channel using a transmission signal
2 having a plurality of carrier signals, each carrier signal having a phase characteristic, the
3 transceiver comprising:
4 a phase scrambler computing a phase shift for each carrier signal based on a value
5 associated with that carrier signal and combining the phase shift computed for each carrier
6 signal with the phase characteristic of that carrier signal so as to substantially scramble the
7 phase characteristics of the plurality of carrier signals.
- 1 38. The transceiver of claim 37 further comprising a modulator in communication with the phase
2 scrambler, the modulator modulating bits of an input signal onto the carrier signals having
3 the substantially scrambled phase characteristics to produce a transmission signal with a
4 reduced PAR.

1 39. In a multicarrier modulation system, a method for communicating over a communication
2 channel, comprising:
3 receiving over the communication channel a transmission signal comprised of a
4 sequence of DMT symbols that each have a bit-value pattern;
5 comparing the bit-value pattern of each received DMT symbol with a predetermined
6 bit value pattern;
7 discarding a given one of the received DMT symbols in the sequence of DMT
8 symbols if the bit-value pattern of that DMT symbol matches the predetermined bit-value
9 pattern, otherwise demodulating that DMT symbol.

10
11
12
13
14
15
16
17
18
19
20
21
22
23
24
25
26
27
28
29
30
31
32
33
34
35
36
37
38
39
40
41
42
43
44
45
46
47
48
49
50

<p align="center">DECLARATION AND POWER OF ATTORNEY FOR UTILITY OR DESIGN PATENT APPLICATION</p> <p><input checked="" type="checkbox"/> Declaration <input type="checkbox"/> Declaration</p> <p>Submitted with Submitted after Initial</p> <p>Initial Filing Filing (surcharge 37 CFR 1.16(e) required)</p>	Attorney Docket No.	AWR-017 (457/19)
	First Named Inventor	Tzannes
	<i>COMPLETE IF KNOWN</i>	
	Application Serial Number	Not Yet Assigned
	Filing Date	Herewith
	Group Art Unit	Not Yet Assigned
	Examiner Name	Not Yet Assigned

As a below named inventor, I hereby declare that:

My residence, post office address, and citizenship are as stated below next to my name.

I believe I am the original, first and sole inventor (if only one name is listed below) or an original, first and joint inventor (if plural names are listed below) of the subject matter which is claimed and for which a patent is sought on the invention entitled:

A System And Method For Scrambling The Phase Of The Carriers In A Multicarrier Communications System

(Title of the Invention)

the specification of which

is attached hereto
OR
 was filed on [] as United States Application Serial Number or PCT International
(MM/DD/YYYY) Application Number [] and was amended on (MM/DD/YYYY) [] (if applicable).

I hereby state that I have reviewed and understand the contents of the above identified specification, including the claims, as amended by any amendment specifically referred to above.

I acknowledge the duty to disclose to the Patent Office all information known by me to be material to patentability as defined in 37 CFR 1.56.

I hereby claim foreign priority benefits under 35 U.S.C. 119(a)-(d) or 365(b) of any foreign application(s) for patent or inventor's certificate, or 365(a) of any PCT international application which designated at least one country other than the United States of America, listed below and have also identified below, by checking the box, any foreign application for patent or inventor's certificate, or of any PCT international application having a filing date before that of the application on which priority is claimed.

Prior Foreign Application Number(s)	Country	Foreign Filing Date (MM/DD/YYYY)	Priority Not Claimed	Certified Copy Attached?	
				YES	NO
			<input type="checkbox"/>	<input type="checkbox"/>	<input type="checkbox"/>
			<input type="checkbox"/>	<input type="checkbox"/>	<input type="checkbox"/>
			<input type="checkbox"/>	<input type="checkbox"/>	<input type="checkbox"/>
			<input type="checkbox"/>	<input type="checkbox"/>	<input type="checkbox"/>

Additional foreign application numbers are listed on a supplemental priority data sheet attached hereto.

I hereby claim the benefit under 35 U.S.C. 119(e) of any United States provisional application(s) listed below.

Application Serial Number(s)	Filing Date (MM/DD/YYYY)	<input type="checkbox"/> Additional provisional application serial numbers are listed on a supplemental priority data sheet attached hereto.
60/164,134	11/09/1999	

DECLARATION – Utility or Design Patent Application

I hereby claim the benefit under 35 U.S.C. 120 of any United States application(s), or 365(c), of any PCT international application designating the United States of America, listed below and, insofar as the subject matter of each of the claims of this application is not disclosed in the prior United States or PCT International application in the manner provided by the first paragraph of 35 U.S.C. 112, I acknowledge the duty to disclose information which is material to patentability as defined in 37 CFR 1.56 which became available between the filing date of the prior application and the national or PCT international filing date of this application.

U.S. Parent Application or PCT Parent Serial Number	Parent Filing Date (MM/DD/YYYY)	Parent Patent Number (if applicable)

Additional U.S. or PCT international application numbers are listed on a supplemental priority data sheet attached hereto.

As a named inventor, I hereby appoint the following registered practitioners to prosecute this application and to transact all business in the Patent and Trademark Office connected therewith: Customer Number



Place Customer
 Number Bar Code
 Label Here

OR

Registered practitioner(s) name/registration number listed below

Name	Registration Number	Name	Registration Number
Steven M. Bauer	31,481	Thomas C. Meyers	36,989
John V. Bianco	36,748	Joseph B. Milstein	42,897
Isabelle A.S. Blundell	43,321	David G. Miranda	42,898
Maureen A. Bresnahan	44,559	Ronda P. Moore	44,244
Michael H. Brodowski	41,640	Indranil Mukerji	P-46,944
Jennifer A. Camacho	43,526	Edmund R. Pitcher	27,829
Joseph A. Capraro, Jr.	36,471	Michael A. Rodriguez	41,274
John J. Cotter	38,116	Jamie H. Rose	45,054
John V. Forcier	42,545	R. Stephen Rosenholm	45,283
Steven J. Frank	33,497	Christopher W. Stamos	35,370
Brian M. Gaff	44,691	Joseph P. Sullivan	45,349
Michael J. Giannetta	42,574	Robert J. Tosti	35,393
Duncan A. Greenhalgh	38,678	Thomas A. Turano	35,722
William G. Guerin	41,047	Michael J. Twomey	38,349
Jonathan A. Harris	44,744	Christine C. Vito	39,061
Ira V. Heffan	41,059	Patrick R.H. Waller	41,418
Danielle L. Herritt	43,670	Daniel A. Wilson	45,508
Douglas J. Kline	35,574	Yin P. Zhang	44,372
John D. Lanza	40,060		
Kurt W. Lockwood	40,704		

Additional registered practitioners named on supplemental Registered Practitioner Information sheet attached hereto.

Direct all correspondence to:

Patent Administrator
 Testa, Hurwitz & Thibault, LLP
 High Street Tower
 125 High Street
 Boston, MA 02110
 Tel. No.: (617) 248-7000
 Fax No.: (617) 248-7100



UNITED STATES PATENT AND TRADEMARK OFFICE

COMMISSIONER FOR PATENTS
 UNITED STATES PATENT AND TRADEMARK OFFICE
 WASHINGTON, D.C. 20231
 www.uspto.gov



Bib Data Sheet

SERIAL NUMBER 09/710,310	FILING DATE 11/09/2000 RULE -	CLASS 375	GROUP ART UNIT 2631	ATTORNEY DOCKET NO. AWR-017 (457/19)	
APPLICANTS MARCOS C. TZANNES, ORINDA, CA ;					
** CONTINUING DATA ***** <i>Yes</i> <i>DN</i> THIS APPLN CLAIMS BENEFIT OF 60/164,134 11/09/1999					
** FOREIGN APPLICATIONS ***** <i>None</i> *****					
IF REQUIRED, FOREIGN FILING LICENSE GRANTED ** 02/17/2001					
Foreign Priority claimed <input type="checkbox"/> yes <input checked="" type="checkbox"/> no		STATE OR COUNTRY CA	SHEETS DRAWING 2	TOTAL CLAIMS 39	INDEPENDENT CLAIMS 4
35 USC 119 (a-d) conditions met <input type="checkbox"/> yes <input checked="" type="checkbox"/> no <input type="checkbox"/> Met after Allowance					
Verified and Acknowledged <i>Simon K. Nguyen</i> <i>DXN</i> Examiner's Signature Initials					
ADDRESS 21323					
TITLE SYSTEM AND METHOD FOR SCRAMBLING THE PHASE OF THE CARRIERS IN A MULTICARRIER COMMUNICATIONS SYSTEM					
FILING FEE RECEIVED 1132	FEES: Authority has been given in Paper No. _____ to charge/credit DEPOSIT ACCOUNT No. _____ for following:		<input type="checkbox"/> All Fees <input type="checkbox"/> 1.16 Fees (Filing) <input type="checkbox"/> 1.17 Fees (Processing Ext. of time) <input type="checkbox"/> 1.18 Fees (Issue) <input type="checkbox"/> Other _____ <input type="checkbox"/> Credit		

PATENT APPLICATION FEE DETERMINATION RECORD
Effective October 1, 2000

Application or Docket Number

01.710310

CLAIMS AS FILED - PART I

(Column 1) (Column 2)

TOTAL CLAIMS		
FOR	NUMBER FILED	NUMBER EXTRA
TOTAL CHARGEABLE CLAIMS	39 minus 20= *	
INDEPENDENT CLAIMS	4 minus 3 = *	
MULTIPLE DEPENDENT CLAIM PRESENT <input type="checkbox"/>		

* If the difference in column 1 is less than zero, enter "0" in column 2

SMALL ENTITY TYPE OR

OTHER THAN SMALL ENTITY

RATE	FEE	OR	RATE	FEE
BASIC FEE	355.00	OR	BASIC FEE	710.00
X\$ 9=		OR	X\$18=	
X40=		OR	X80=	
+135=		OR	+270=	
TOTAL		OR	TOTAL	

CLAIMS AS AMENDED - PART II

(Column 1) (Column 2) (Column 3)

AMENDMENT A		CLAIMS REMAINING AFTER AMENDMENT		HIGHEST NUMBER PREVIOUSLY PAID FOR	PRESENT EXTRA
	Total	*	Minus	**	=
	Independent	*	Minus	***	=
	FIRST PRESENTATION OF MULTIPLE DEPENDENT CLAIM <input type="checkbox"/>				

SMALL ENTITY OR

OTHER THAN SMALL ENTITY

RATE	ADDITIONAL FEE	OR	RATE	ADDITIONAL FEE
X\$ 9=		OR	X\$18=	
X40=		OR	X80=	
+135=		OR	+270=	
TOTAL ADDIT. FEE		OR	TOTAL ADDIT. FEE	

(Column 1) (Column 2) (Column 3)

AMENDMENT B		CLAIMS REMAINING AFTER AMENDMENT		HIGHEST NUMBER PREVIOUSLY PAID FOR	PRESENT EXTRA
	Total	*	Minus	**	=
	Independent	*	Minus	***	=
	FIRST PRESENTATION OF MULTIPLE DEPENDENT CLAIM <input type="checkbox"/>				

RATE	ADDITIONAL FEE	OR	RATE	ADDITIONAL FEE
X\$ 9=		OR	X\$18=	
X40=		OR	X80=	
+135=		OR	+270=	
TOTAL ADDIT. FEE		OR	TOTAL ADDIT. FEE	

(Column 1) (Column 2) (Column 3)

AMENDMENT C		CLAIMS REMAINING AFTER AMENDMENT		HIGHEST NUMBER PREVIOUSLY PAID FOR	PRESENT EXTRA
	Total	*	Minus	**	=
	Independent	*	Minus	***	=
	FIRST PRESENTATION OF MULTIPLE DEPENDENT CLAIM <input type="checkbox"/>				

RATE	ADDITIONAL FEE	OR	RATE	ADDITIONAL FEE
X\$ 9=		OR	X\$18=	
X40=		OR	X80=	
+135=		OR	+270=	
TOTAL ADDIT. FEE		OR	TOTAL ADDIT. FEE	

* If the entry in column 1 is less than the entry in column 2, write "0" in column 3.
 ** If the "Highest Number Previously Paid For" IN THIS SPACE is less than 20, enter "20."
 *** If the "Highest Number Previously Paid For" IN THIS SPACE is less than 3, enter "3."
 The "Highest Number Previously Paid For" (Total or Independent) is the highest number found in the appropriate box in column 1.

PATENT APPLICATION SERIAL NO. _____

U.S. DEPARTMENT OF COMMERCE
PATENT AND TRADEMARK OFFICE
FEE RECORD SHEET

11/15/2000 JBALINAH 00000032 09710310

01 FC:101	710.00 OP
02 FC:102	80.00 OP
03 FC:103	342.00 OP

PTO-1556
(5/87)

*U.S. GPO: 1999-459-082/19:44

Inventor Information

Inventor One Given Name :: Marcos
Family Name :: Tzannes
Name Suffix ::
Postal Address Line One :: 121 LaEspiral
Postal Address Line Two ::
City :: Orinda
State/Province :: California
Country :: United States
Postal or Zip Code :: 94563
City of Residence :: Orinda
State/Prov. of Residence :: California
Country of Residence :: United States
Citizenship :: U.S.

Correspondence Information

Correspondence Customer Number :: 021323

Application Information

Title Line One :: A System And Method For Scrambling The Phase Of The Carriers
Title Line Two :: In A Multicarrier Communications System
Total Drawing Sheets :: 2
Formal Drawings :: No
Application Type :: Utility
Docket Number :: AWR-017
Licensed - U S Government Agency ::
Contract Number ::
Grant Number ::
Secrecy Order in Parent Application ::

Representative Information

Representative Customer Number :: 021323

Continuity Information

This application claims the benefit of:
>Application One :: 60/164,134
Filing Date :: November 9, 1999