

S E R ⁵mx I E S

USER GUIDE

© Copyright Psion Computers Plc 1999.

All rights reserved. This manual and the programs referred to herein are copyrighted works of Psion Computers PLC, London, England. Reproduction in whole or in part, including utilisation in machines capable of reproduction or retrieval, without the express written permission of the copyright holders is prohibited. Reverse engineering is also prohibited. The information in this document is subject to change without notice. Psion and the Psion logo are registered trademarks, and Psion Series 5mx, Series 5, Series 3mx, Series 3c, Series 3a, Series 3, Siena and PsiWin are trademarks of Psion Computers PLC. Some names referred to are registered trademarks.

© Copyright Symbian Ltd 1999.

All rights reserved. The EPOC machine contains the EPOC operating system and software, and PsiWin 2 contains the EPOC CONNECT software that is the copyrighted work of Symbian Ltd, London, England. EPOC and the EPOC logo are registered trademarks of Symbian Ltd.

The IrDA Feature Trademark is owned by the Infrared Data Association and is used under license therefrom.

© Copyright Monotype Typography Ltd 1997.

All rights reserved. EPOC contains the fonts Arial®, Times New Roman® and Courier, products of Monotype Typography Ltd, Surrey, England.

Arial®, Arial is a trademark of the Monotype Corporation registered in U.S. Patent and Trademark Office and certain other jurisdictions.

Times New Roman®, Times New Roman is a trademark of the Monotype Corporation registered in U.S. Patent and Trademark Office and certain other jurisdictions. Monotype®, Monotype is a trademark of Monotype Typography Limited registered in U.S. Patent and Trademark Office and certain other jurisdictions.

© Lernout & Hauspie Speech Products N.V. 1995.

All rights reserved. International CorrectSpell™ English spelling correction system © 1995 by Lernout & Hauspie Speech Products N.V. All rights reserved. Reproduction or disassembly of embodied algorithms or database prohibited. UK English Concise International Electronic Thesaurus Copyright © 1995 by Lernout & Hauspie Speech Products N.V. All rights reserved. Reproduction or disassembly of embodied programs and databases prohibited.

Part of the software in this product is © Copyright ANT Ltd. 1998. All rights reserved.

Incorporates MPPC® compression from Hi/fn™.

Stac®, LZS®, © 1996, Stac, Inc., © 1994-1996 Microsoft Corporation. Includes one or more U.S. Patents: No. 4701745, 5016009, 5126739, 5146221, and 5414425. Other patents pending.

Incorporates LZS® compression from Hi/fn™. Hi/fn®, LZS®, © 1988-98, Hi/fn. Includes one or more U.S. Patents: No. 4701745, 5016009, 5126739, 5146221, and 5414425. Other patents pending. All notices of Hi/fn's patents shall be made in accordance with 35 U.S.C Sec. 287(a).

Version 1.1, October 1999

Part no. 6105-0053-01

English

FCC Information for the USA

Radio and Television Interference

This equipment radiates radio frequency energy and if not used properly - that is, in strict accordance with the instructions in this manual - may cause interference to radio communications and television reception.

It has been tested and found to comply with the limits for a Class B digital device pursuant to part 15 of the FCC Rules. These are designed to provide reasonable protection against harmful interference in a residential installation. However, there is no guarantee that interference will not occur in a particular installation. If this equipment does cause harmful interference to radio or television reception, which can be determined by turning the equipment off and on, the user is encouraged to try to correct the interference by one or more of the following measures:

- Reorient or relocate the receiving antenna.
- Increase the separation distance between the equipment and the receiver.
- If you are using the equipment with a mains adaptor, plug it into an outlet which is on a different circuit from that to which the receiver is connected.
- Consult an experienced radio/TV technician for help.

Important

This equipment was tested for FCC compliance under conditions that included the use of shielded cables and connectors between it and the peripherals. It is important that you use shielded cable and connectors to reduce the possibility of causing radio and television interference. Shielded cables, suitable for the Series 5 range, can be obtained from an authorised Psion dealer.

If the user modifies the equipment or its peripherals in any way, and these modifications are not approved by Psion, the FCC may withdraw the user's right to operate the equipment.

In the USA

For customers in the USA, the following booklet prepared by the Federal Communications Commission may be of help: "How to Identify and Resolve Radio-TV Interference Problems". This booklet is available from the US Government Printing Office, Washington, DC 20402 Stock No 004-000-00345-4.

Emissions information for Canada

This Class B digital apparatus meets all requirements of the Canadian Interference-Causing Equipment Regulations.

Cet appareil numérique de la classe B respecte toutes les exigences du Règlement sur le matériel brouilleur du Canada.

FCC Declaration of Conformity

Product: Series 5mx

Models: I6M

Have been tested to - and comply with - part 15 of the FCC rules. Operation is subject to the following two conditions:

1. This device may not cause harmful interference.
2. This device must accept any interference received, including interference that may cause undesired operation.

The Product is for home or office use.

Responsible party:

Psion Inc.
150 Baker Avenue,
Concord,
MA 01742, USA.
Tel: +1 508 978 0310
Fax: +1 508 978 9611

Infrared device safety

CLASS I LED PRODUCT

This product includes an Infrared device for transmitting and receiving files from devices supporting the IrDA format. Although this invisible beam is not considered harmful, and complies with EN60825-1 (IEC825-1), we recommend the following precaution: when the Infrared device is transmitting:

- do not stare into the Infrared beam
 - do not view directly with optical instruments
- No parts in the device may be serviced by the user.

CE marking

When used in a residential, commercial or light industrial environment the product and its approved UK and European peripherals fulfil all requirements for CE marking.

CONTENTS

Getting started	1	Files, folders & programs	27
About the Series 5	1	Moving around	27
Where things are	2	Opening files, folders & programs	29
About PsiWin 2	5	Closing programs/files	29
Using this manual	6	Creating new folders	30
Switching on	7	Creating new files	31
Turning on & off	7	Browsing folders	33
The screen	9	Finding files and folders	33
Finding & using the pen	9	Using passwords	35
First steps	10	Changing file attributes	35
Things to do first!	19	Managing folders	36
Things to do next!	23	Checking memory use	37
		Additional disks & programs	38

Word	39	Sheet	55
Entering text	39	Moving around	56
Finding & replacing text	40	Entering information	56
Changing the appearance of text	41	Performing calculations	58
Formatting paragraphs	41	Using ranges	60
Using styles	44	Changing how information is displayed	60
Document outlines	45	Sorting information	61
Information from other programs	47	Changing the number format	62
Spell checking	48	Graphs	63
Creating a new file	49	Printing from Sheet	66
File templates	49	Contacts	67
Saving Word files	51	Adding a contact	67
How the page looks	52	Looking at your contacts	67
Printing	53	Editing & deleting contacts	69
		Contact labels	69
		Exchanging contacts	71
		Printing contacts	71

Agenda 73

Moving around	74
Adding appointments & events	74
Viewing entries	76
Entry symbols	77
Birthdays and anniversaries	77
Reminders for entries - alarms	77
Finding entries and dates	79
Changing and deleting entries	80
Repeating entries	81
Lists and things to do	82
Information from other programs	85
Customising Agenda.....	87
Agenda files	87
Printing Agenda entries	88
Synchronising with a PC Scheduler	89

Email 91

Read this first.....	91
Using Email	91
Managing emails	91
Local folders	92
Writing an email	93
Sending email	95
Receiving email	96
Viewing an email	97
Replying to & forwarding emails	97
Attaching files to messages	99
Disconnecting	100

Calc 101

General calculations	102
Scientific calculations	103
Displaying numbers	109

Jotter	111	Data	127
Adding a note	111	Adding an entry	128
Formatting the text	112	Looking at entries	129
Inserting other information	113	Sorting entries	130
Finding a note	114	Customising Data	130
Deleting entries	114	Finding an entry	131
Customising Jotter	115	Changing or deleting entries	131
Jotter files	116	Customising the database	132
Printing Jotter entries	116	Printing Data entries	133
Time	117	Sketch	135
Using alarms	117	Drawing sketches	136
Using the map	122	Changing a sketch	137
Customising Time	124	Adding text	139
Setting summer time	125	Inserting “clipart”	140
		Printing sketches	141
		Sketch files	141

Spell	143	Bombs- the Series 5 game	155
Spell-checking and correction	143	Programming	157
Using the thesaurus	144	Creating & running OPL programs	157
Solving anagrams	144	Printing	159
Finding missing letters - Xword	145	Setting up the printer	159
Adding words to Spell	146	Selecting the printer model	162
Record	147	Page setup	162
Recording a sound	147	Previewing a document	163
Playing sounds	150	Printing a document	164
Recording voice notes	150	Infrared	165
Playing back a voice note	152	Selecting data to transfer	166
Using voice notes in Record	153	Transferring the information	166
Voice note files	153		

Dialling	169	Security & backups	181
Setting up	170	Troubleshooting	183
Entering phone numbers	171	Appendices	189
Dialling phone numbers	172	Character set	189
Customising the Series 5	173	Specification	191
Creating your own wallpaper	173	Index	193
Recording your own alarms	173		
Customising the System screen	174		

Care & safety	175
Powering the Series 5	176
Changing the batteries	177
Battery safety	179
Prolonging battery life	179

Contents ▲



GETTING STARTED

This manual contains information about the Series 5 and the PC connectivity software PsiWin 2.

About the Series 5

The programs on the Series 5 include:

- **Word**, a word processor for writing letters and other documents.
- **Sheet**, for spreadsheets, tables, and graphs.
- **Contacts**, an address book.
- **Agenda**, a diary program for appointments and lists of things to do.
- **Email**, for sending and receiving email, SMS and fax messages.
- **Calc**, a calculator with general and scientific features.

- **Jotter**, a notebook for jotting down ideas quickly.
- **System**, the Series 5's control centre. You can tap the System icon at any time to move to the System screen.
- **Time**, for alarms and a world map with international times and dialling codes.
- **Data**, a customisable database program.
- **Sketch**, for drawing pictures.
- **Bombs**, a game of logical thinking.
- **Record**, for recording and editing voice memos and sounds.
- **Program**, the editor in which you can create programs using the built-in programming language.
- **Spell**, for checking spelling, thesaurus, solving anagrams and crossword clues.
- **Comms**, for terminal emulation and file transfer.

Where things are

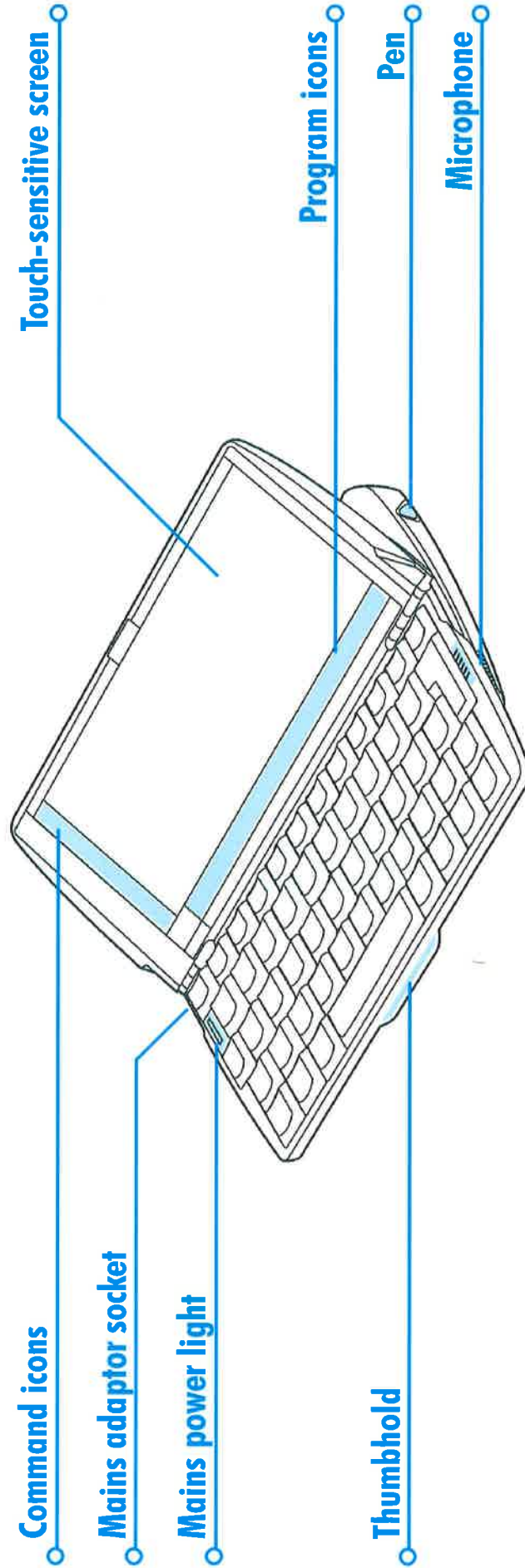

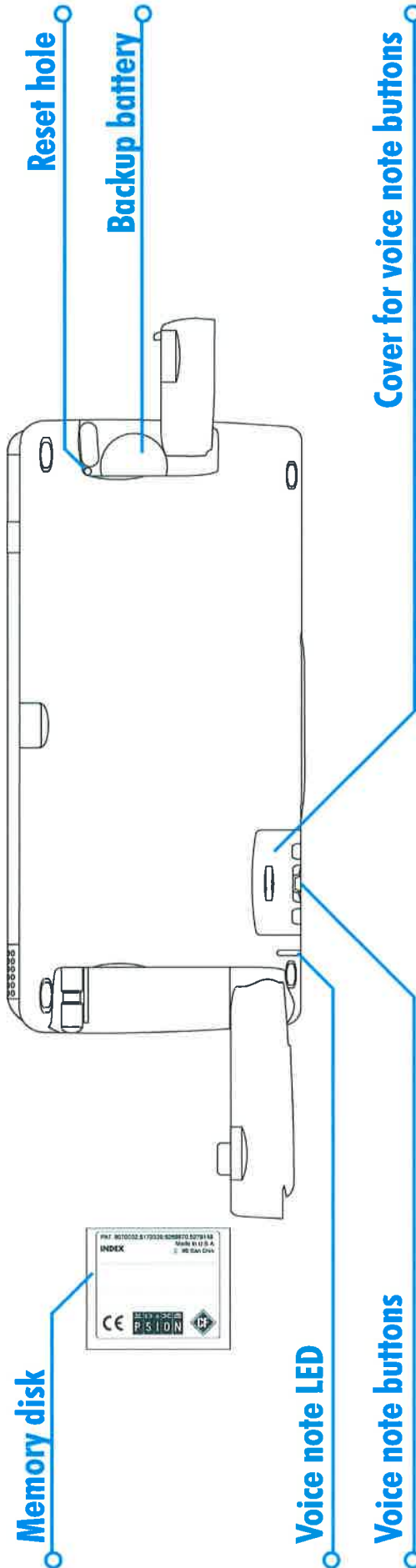

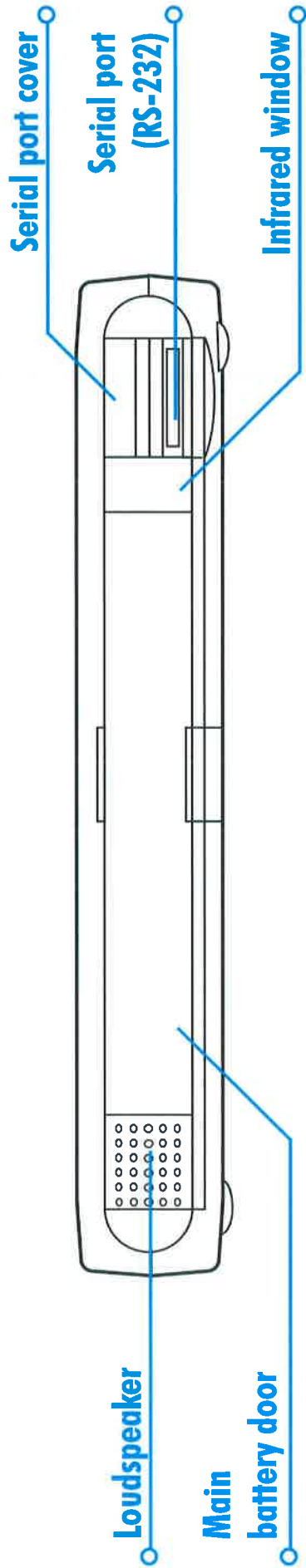

About PsiWin 2

You can use the PC connectivity software PsiWin 2 to integrate the Series 5 with PCs running Windows 95/98 or NT 4.0. By connecting the Series 5 to a PC with a Docking cable and running PsiWin, you can:

- **View your Series 5 files** from Windows Explorer by using the 'My Psion' icon which is added to the PC's Desktop. The 'My Psion' icon gives you access to all of PsiWin's powerful file management facilities for your Series 5 files.
- **Upgrade from an earlier model of Psion handheld computer to a Series 5** as a one-stop process. All your files will be copied from your old Psion (Series 3/3a/3c/3mx or Siena), converted to the Series 5 file formats on the PC, then copied to your Series 5.

- **Drag and drop files** between the Series 5 and the PC in the same way that you would between PC drives, and they will be **automatically converted** to the appropriate file format at the same time.
- **Synchronize Agenda files your address book** on the Series 5 with PC agendas (applications) and contact managers to keep them in step with each other.
- **Back up your Series 5 files** to the PC, then **restore** them from the PC to the Series 5 again should you ever need to.
- **Print files** on your Series 5 to a printer connected directly to your PC, or available to your PC via a network.

Using this manual

This manual gives an overview of all the Series 5 functions and features to give you an idea of what you can do; for more detailed information than is given here, refer to the Series 5 and PsiWin on-line help.

- Read the first part of this chapter to find out how to get the Series 5 ready for use: fit the batteries, switch on, adjust the screen, find and practice with the pen and start using the software.
- Read 'Things to do first!' to find out the essential things to do when you first get your Series 5 - this covers setting the time and date, setting your "home city" (so that the time differences from your home are calculated correctly) and setting owner information and a machine password.

- Move on to 'Things to do next!' for a list of the programs and a brief overview of what else you may want to do when you first use your Series 5 - instructions for using PsiWin to connect to your PC and perform backups and more ideas for customising your Series 5.
- Read the 'Files, folders and programs' chapter for more information about how to enter and manage the information on your Series 5.
- Refer to the 'Troubleshooting' chapter if you have any problems using the Series 5.

Switching on

Fitting the batteries

Before you can use the Series 5 you must fit both sets of batteries, as shown below. **Make sure you fit them the correct way around.** The Series 5 is powered by:

- two AA size Duracell Ultra batteries (supplied). Psion recommend using high power alkaline batteries, such as Duracell Ultra.
- one Lithium CR2032 backup battery (supplied). This preserves your information while you change the main batteries.



Take care when replacing batteries!

You will lose information if you remove both sets of batteries at the same time, or allow both sets of batteries to become completely run down. The Series 5 will warn you when its batteries are getting low, in plenty of time to change them. See the 'Care & safety' chapter for more about battery safety, and details of how to change the batteries.

You can also power the Series 5 from the mains. You should ONLY use Psion approved mains adaptors. Contact your Psion distributor or local Psion retailer for more information.

Turning on & off

- **To switch on:** press the Esc key. When you first do this, you'll see the System screen.

Note: The Series 5 will automatically switch on when an alarm rings, or if you press one of the external voice note buttons.

- **To switch off:** hold down the Fn key and press the Esc key. You can switch off at any time. You do not have to save your information first, as it is automatically saved for you.

Note: If you do not press a key, the Series 5 will automatically switch off after 3 minutes to save battery power. Switch it on again, and you can continue from where you left off.



Can I switch on the Series 5 by tapping the screen?

Yes. You can set up your Series 5 to switch on when you tap the touch-sensitive screen. To do this, open the **Switch on/off** icon from the **Control Panel** in the System screen.

Main batteries

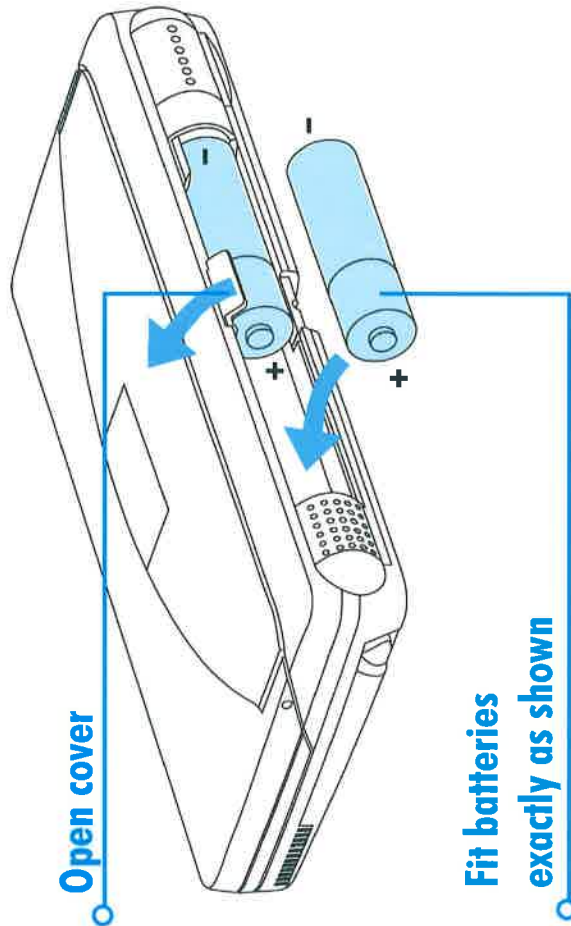

Backup battery

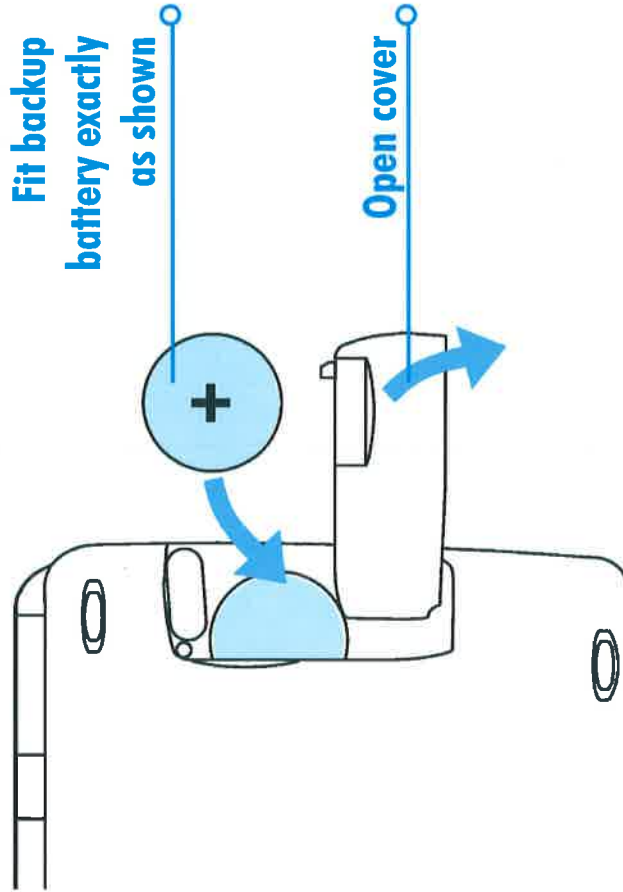

The screen

Adjust the screen contrast by holding down the Fn key and pressing the M (●-) or ' (●+) key.

Change the size of the text on the screen using the **Zoom in** and **Zoom out** commands.

Switch the “backlight” on and off by holding down the Fn key and pressing the Spacebar. You can use the backlight to light up the screen in dim conditions.

Important: Note that the Series 5 uses considerably more battery power when the backlight is on.

Finding & using the pen

The pen is located in a holder at the right, near the back. Press the end of it in gently, and it will pop out. To replace it, push it back in and it will click into place.

Note: If the pen doesn't click into place, see the ‘Troubleshooting’ chapter for more details.

Tap lightly on the screen using the pen. It's OK to use your fingers to tap on the screen, though it is best to use the pen to avoid fingerprints or smudges on the screen. **Do not** tap the

screen with any object that has a sharp tip or you may damage the screen. Don't use any type of ink pen, as the ink may be impossible to remove. See the ‘Care & safety’ chapter for instructions on how to clean the screen.

You can usually tap on an item with the pen to select or change it. For example, you can tap on:

- the program icons, to open a program.
- the command icons, for “shortcuts” to System functions, e.g. the menu bar, Infrared, cutting and pasting, zooming in and out.

Note: If the screen doesn't respond to your taps, you may need to re-calibrate it. You can do this by opening the **Screen** icon from the Control panel.

Most of the things you can do with the pen have an equivalent keyboard combination, so you can use the pen, the keyboard, or a combination of both methods.

First steps

When you first switch on the Series 5, you will see the System screen. This is the “desktop” where you can view your files and folders, and change settings that control how the Series 5 works.

- All the information you enter into the Series 5 is contained in files; their names are displayed in the System screen, beside icons that represent the programs that created them.
- All your files are stored in folders. When you start using the Series 5, the contents of the ‘Documents’ folder is displayed.
- The System screen’s “Title bar” shows you which folder is currently displayed on the screen. When you start you are in the ‘Documents’ folder on the “C (Internal) drive”.

You can have as many folders as you wish, and create folders within other folders. Folders can contain files created in a variety of programs; they are not restricted to files from a single program. See ‘Files, folders & programs’ for details of managing files and folders.

Navigating between files & folders

- Tap on a folder icon to move to that folder, tap on the Close folder icon to close it and move back up a level.
- Tap on a file to select it, tap again to open it. If the filename is displayed in bold, the file is open, and tapping it will move straight to the file.

See ‘Files, folders & programs’ for more information about manipulating files and folders.

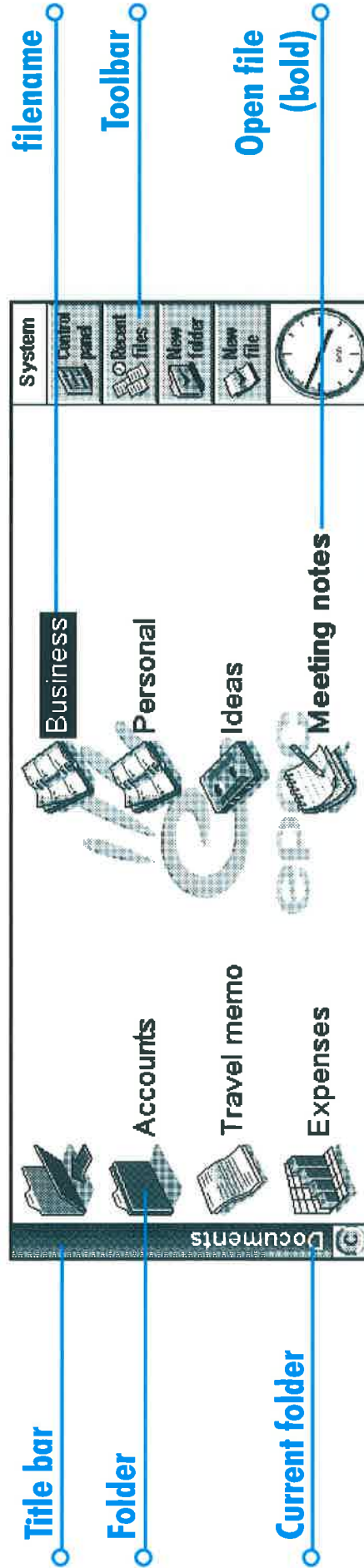

Starting programs

When you open or move to a file, the correct program for this file is started automatically. You can also start programs by tapping on the appropriate “program icon” (the icon in the row of pictures at the bottom of the screen).

- Tap the System icon at any time to move to the System screen.
- Tap on Extras to display the “Extras bar”, which contains more program icons.

You don't have to close one program before opening another, just tap on another program icon, and that program will open too.

You can see what files and programs are open from the System screen by using the **List open files** command from the **File** menu, or by tapping on the name in the top right corner of the screen.

Programs & files

When you run a program, it will usually display the currently open file, or the file that you last looked at. If you want to write a new letter, draw a new picture, create a new database and so on, you'll need to create a new file for the particular program involved.

- **To create a new file:** select the command on the **File** menu. The file will now be created, and the current file will be closed and saved at the same time. You can start entering your information.
- You can also use this command in the System screen to create a new file. Usually, this creates a file using the standard settings; creating a file from within a program creates a file which already has any settings or preferences you have set up in the program.
- It is a good idea to keep related files together in a folder, to make the files easier to find later. See 'Files, folders & programs' for details of how to manage your files and folders.

See the 'Which program to use?' section for more about using the programs.

Entering information

You can enter information and complete tasks using the pen or the keyboard. You can usually select a menu command to perform each task.

- Press the Menu key or tap on the  command icon to see the available commands on the “Menu bar”.
- Tap on the menu names and commands, or use the arrow keys to move around the menus. Tap on commands marked with a ▶ or press the right arrow key to see further commands.

Note: You can press the shortcut key combinations shown next to the commands as a quick way of selecting them, e.g. Ctrl+M, means hold down the Ctrl key and press the M key at the same time.

- A menu command with three dots at the end means that selecting the command will display a “dialog” where you enter more information.
- If a menu command is grey, it means that it’s not currently available; e.g. you cannot “Copy” unless you have first selected something to copy.

Using dialogs

A “dialog” appears when you need to make selections and enter further information. You can move between dialog items by tapping on them, or using the up and down arrow keys. Dialogs contain one or more of the following elements:

Text box: where you just type in your information.

List box: where you select from a number of options. You will see left and right arrows around the current selection; you can change the selection by tapping on the arrows, by pressing the left and right arrow keys, or by typing the first letter of the option you want. You can usually tap in the box or press the Tab key to see a list of the available options.

Check box: where you make a choice between selecting an option or not selecting it. Just tap on the check box, or press the left and right arrow keys to add or remove a tick.

Radio buttons: where you make one choice from a number of options. Just tap on an option, or use the left and right arrow keys to make a selection.

- If a dialog line is grey, it is currently not available, usually because you have to select something else first. For example, if you have not ticked the box to set an alarm for an Agenda entry, the lines to set the alarm time and date are grey. Some dialog lines only appear when another option has been chosen.

Some dialogs comprise a number of “pages”, each page has a “tab” at the top. Tap on the tab or move the highlight to the tab name, to go to that page. You can also move a dialog around the screen by holding the pen on the dialog title bar and dragging it across the screen.

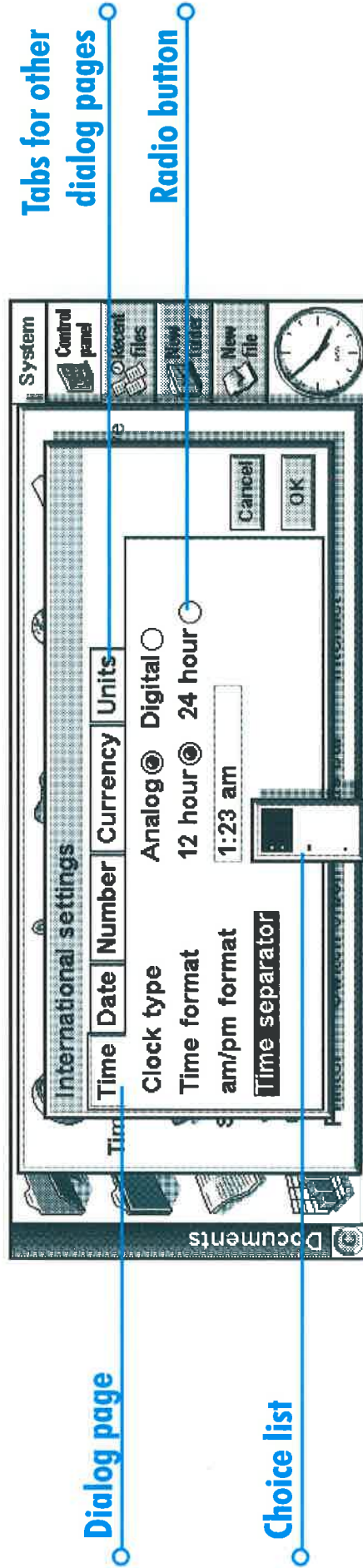

How do I display a calendar?

In most dialogs in which you can type a date, move to the date line then tap again or press Tab to display a calendar.

Today's date is circled, and the date currently displayed in the dialog is highlighted. To select another date, move to the date you want and press Enter. Use the buttons on the top line, or further presses of the Tab key, to display a three month or twelve month calendar. Use the "dog ears" to move between the pages of the calendar.

You can also display a calendar from the Agenda program. See the 'Agenda' chapter for more details.

Dialog buttons

Dialogs may have on-screen buttons. Tap on the button or use the keypress combination under it. Some buttons have a standard keypress equivalent:

- Usually, you can tap the **OK** button or press the Enter key if you want to save information and remove the dialog.
- Tap the **Cancel** button or press the Esc key if you want to remove the dialog without saving the information.
- For dialogs that ask a question, you can tap the **Yes** button or press the 'Y' key for 'yes'; tap the **No** button, press the 'N' key or press the Esc key for 'no'.

Copying information between programs

You can insert information created in one program into a different program. This is known as “inserting” an “object”.

For example, you may want to add a picture to a letter you are writing. To do this, write the letter as normal using the Word program. Then, while in Word, select the menu command to insert a sketch. This will start the Sketch program, where you can create the picture. Close Sketch when you have finished and the picture will be inserted in your letter.

Sometimes the object you insert can be displayed as an icon, perhaps if you insert a large amount of Word text in an Agenda entry. Alternatively, you may prefer to see the actual information added, e.g. a map to view in the Word file.

For example, you may wish to:

- insert tables of figures and graphs from Sheet into a Word file. You can add labels and titles to the graph in Sheet before inserting it in the Word file.
- keep a map of how to find a restaurant as a sketch, perhaps attached to an Agenda entry for the day that you’re going there.
- create a Sketch file of your signature, and insert the signature when you write letters in the Word processor.
- keep handwritten notes and ideas in Sketch. You can then insert them into Jotter or a Word file if necessary.

Displaying Help

You can display help at any time, and from any program. Help information is contained on a series of “help cards” in one large database that looks similar to the databases that you create in the Data program. Help is not specific to the program that you are using; wherever you are, you can just type a “clue” to search for the information you need.

Note: The on-line help contains more detailed information than is included in this manual.

- **To display help:** Hold down Fn and press ‘,’ (comma); the key has “Help” printed on it.
- **To search for help about something:** simply type your clue into the **Find:** box, and press Enter. The display will show a list of Help cards that contain this word, and the first occurrence is highlighted. To move between cards, tap on the **Prev** or **Next** buttons, press Enter, or use the left and right arrow keys.

- **To show help for a particular program:** type the program name followed by an exclamation mark, e.g. type ‘Agenda!’ or ‘Contacts!’ to only show help for these programs.

- **To look through the help text:** drag the scroll bar on the side of the Help card, or use the up and down arrow keys.
- **To print the current Help card:** select **Print** from the **File** menu.
- **To type in another search word:** press Esc, and then type in the word to search for as before. To use one of the last five search words again, tap on the button next to the **Find:** box, or press Tab and select the word you want to use.
- **To return to the program you were using:** tap the **Go back** button on the Toolbar, or tap the program’s icon. You can return to the Help card you were viewing by simply pressing Fn and ‘,’ (comma) again.

Note: You can highlight text in a Help card using the pen or keyboard, and copy it to use in a file of your own. Copy the text by selecting the **Copy** command from the **Edit** menu. Then go to your own file, and paste it in.

Help topic titles
in card browser

Text found
by search

The screenshot shows a help topic card titled "Inserting text (Sketch)". The card content includes: "You can insert text into the sketch.", a note: "Note: Once the text has been inserted you cannot edit or reformat it.", and instructions: "To add text: 1. Tap the Insert text button on the Tools Toolbar, or select Insert text on the Tools menu. 2. Type in the text to insert. Change the" (partially cut off). At the bottom of the card is a search bar containing "Find: insert" and "prev" and "Next" buttons. The card is part of a larger interface with a top navigation bar containing "Help", "Quick find", "Find in all text", "Print", "Go back", and a clock. A list of other help topics is visible on the right side of the card, including "Functions (Sheet)", "Inserting cells, rows & columns", "Inserting objects (Agent)", "Inserting objects (Data)", "Inserting objects (Jotter)", "Inserting objects (Word)", "Inserting page breaks (Table)", "Inserting pictures from gallery", "Inserting text (Sketch)", and "Objects".

Help topic card

Go back without
closing help

Search clue

Things to do first!

This section describes what you need to do to set up your Series 5. You should:

- set the current time and date, so that you can use the Agenda programs and set alarms.
- set your “Home city”, so that the Series 5 can display the correct time differences and dialling codes for other places in the World.

It is also a good idea to:

- enter owner information, so that your Series 5 can be returned if you lose it.
- set a password for your machine, so that other people cannot access your information.

Setting the time, date & the Home city

1. In the System screen, tap on the **Control panel** button on the Toolbar, or select the command from the **Tools** menu.
2. Tap the **Time & date** icon, or move the highlight to it using the arrow keys and press Enter.
3. You will see a “dialog” in which you can set the time and date, your home city and summer times around the world.

Tap the **Time & date** button. Move the highlight in the **Time** and **Date** lines by tapping on the part you want to change, or by using the arrow keys. Type the date or time, press ‘P’ for p.m. or ‘A’ for a.m.

4. Tap on the **OK** button or press the Enter key, and the time and date are saved.
5. Tap the **Home** button.
6. Select your Home city and country. To do this:
 - Start typing in the name of your home city, or tap on the arrow symbols or press the left and right arrow keys until you find the city you want.
 - If your home city is not listed, select a city that is nearby for now (adding a city is described in the ‘Time’ chapter).
7. Tap on the **OK** button or press the Enter key, and your home city is saved. Tap **Close** or press Enter to remove the dialog and return to the Control panel. Press Esc to return to the System screen.

Note: The Series 5 can use a 12 hour clock (midnight is 12:00:00 a.m.) or a 24 hour clock. Refer to the ‘Time’ chapter for details of how to change these settings, and how to adjust the clock for summer time.

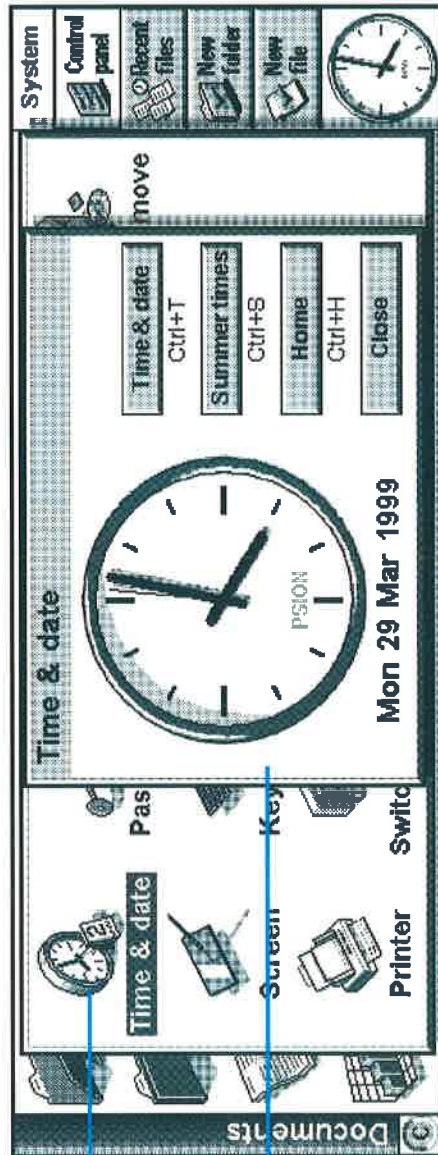

Time & date icon

Time & date dialog

Entering owner information

It is a good idea to type your contact information as “owner information”, so that if you lose your Series 5, it can be returned when found:

1. Select the **Password** icon from the **Control panel** in the System screen, and tap the **Owner info** button in the dialog.
2. Type in your details. The labels provided are suggestions only, you can change them if you want to. It's best not to put your home address, in case your house keys are lost at the same time.

3. Set how you wish the owner information screen to be displayed, i.e.:
 - ‘At switch on’, if you always want to display the screen when switching the machine on.
 - ‘Once per day’, if you only want to see the screen once a day, the first time you switch your machine on each day.
 - ‘Never’, if you never want to display the screen when you switch on.

You can display the owner information at any other time using the **Owner** command on the **Information** menu in the System screen.

Setting a system password

To prevent anyone looking at the files on the Internal disk of the Series 5, set a system password which you must type in before you can use the machine.

To do this:

1. Select the **Password** icon from the **Control panel** in the System screen.
2. Tick the 'Ask for password' box so that your Series 5 requests the password when you switch the machine on.
3. Type the password twice for confirmation. Choose a password that you won't easily forget, but one that won't be easy for someone else to guess. **DON'T FORGET** your password! You will need to enter the password again if you want to change the password settings on your Series 5.

The password is now set. The next time you switch your machine on, you will have to type in the password to access your files.

If you want to switch the password off temporarily, remove the tick from the 'Ask for password' box.

Note: The system password does not protect files stored on Memory disks or files copied to other machines.



Important: don't forget your password!

If you have forgotten the system password then you will have to reset the machine. All the files stored on the internal disk will then be lost.

Things to do next!

This section gives a brief overview of what else you may want to do when your first use your Series 5, including:

- Ideas for how you can use the programs.
- Instructions for using PsiWin to connect to your PC and perform backups to your PC.
- Ideas for customising your Series 5.

Which programs to use?

The first things you wish to do may include:

- **entering appointments, reminders, birthdays and lists of things to do** from your old diary or time planner into the Agenda program. If you use a PC scheduler such as Microsoft Outlook or Lotus Organizer, you can use PsiWin to synchronize the information in your Psion and PC schedules to keep them both up to date.
- **entering names and addresses** from your old address book into the Series 5's Contacts address book. If you also keep names and addresses in a PC scheduler, you can use PsiWin to synchronize your Psion and PC address books so that they are both kept up to date.

- **setting a morning alarm** in the Time program. The Time program also includes a map of the world, and information about cities, world times, and national and international dialling codes.

- **entering a 'work to do list'**. This is best entered as a To-do list in Agenda. You will be able to see outstanding tasks in the Day view, set alarms to remind you to do them and cross out items when you've completed them.

You may also wish to:

- keep a meeting agenda or minutes as a memo or voice note attached to the meeting's entry in Agenda. You can then retrieve the notes by finding the meeting entry.
- keep a record of expenses in the Sheet program. Here you can search for items, add columns of numbers, or calculate totals and tax.
- keep a Data file as a "knowledgebase" of notes about a particular subject. You can keep track of references or products as you find them, and include additional information as attached "voice notes" or sketches.

Connecting the Series 5 to the PC

- Connect the smaller end of the Docking cable to the serial port on the Series 5, and the other end to a serial port at the back of the PC.

Using PsiWin

- Please see the PsiWin documentation for installation instructions. For a floppy disk version of this software, please contact your nearest Psion distributor.
- When you have installed PsiWin on the PC, the 'My Psion' icon will appear on the Windows Desktop. Just click the right mouse button on this icon to see menu options for the things that you can do. PsiWin also adds a number of commands and icons to Windows Explorer for working on Series 5 files. See the PsiWin on-line help for details of how to use PsiWin with the Series 5.

Note: The Comms program that is built into the Series 5 provides terminal emulation and file transfer to other computers. You can use it to connect the Series 5 directly to another computer, or via a modem to access electronic mail systems and bulletin boards.

A detailed User Guide for Comms is included on the PsiWin CD ROM, along with other literature that may be of interest to you.

Backing up to a PC

You can use PsiWin to back up individual files, folders, or all of the Series 5's disk to the PC.



Making regular backups.

It is a good idea to set up an “automatic backup” in PsiWin so that you can make sure your machine is backed up regularly.

Backing up to Memory Disks

You can back up individual files, individual folders or groups of files and folders to a Memory Disk. To back up the files and folders, copy them from the internal disk to a Memory Disk using the **Copy** and **Paste** commands in the System screen.

1. Select the files and folders you want to back up, then select the **Copy** command from the **Edit** menu.
2. Set the current disk to be D (i.e. the Memory disk), and select the folder you want to use for the backup on disk D.
3. Select the **Paste** command from the **Edit** menu.

Exploring the Control panel

- To display the **Control panel**: move to the System screen and tap on the **Control panel** button on the Toolbar, or select the command from the **Tools** menu. Initially, you should set up the **Time & date**, **Screen**, **Switch on/off**, and **Printer** if you intend to use one. You might also like to set up owner information and a password. You may wish to change other settings later.

When you first use your Series 5, you may wish to:

- Use the **International** icon to change settings which may vary from country to country, e.g. the currency and date formats.
- Use the **Switch on/off** icon to control how and when the Series 5 switches on and off. For example, you might like it to switch on when you tap the screen, and off when you close the case.

- Use the **Sound** icon to control the sounds that the Series 5 makes when you press keys, tap the screen and perform other actions.
- Use the **Screen** icon to change the screen contrast and set the backlight and automatic switch off times, or re-calibrate the touch sensitive screen if the Series 5 stops responding to your pen taps.
- Use the **Keyboard** icon to control how long you have to hold a key down before a repeat keypress occurs.
- Use the **Password** icon to set a password on your machine or enter owner information.

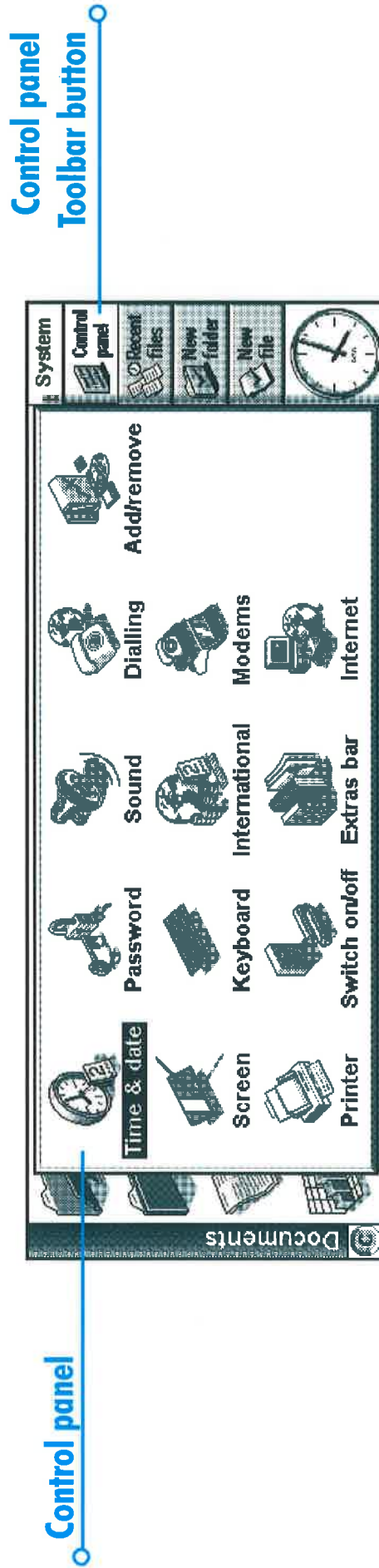

FILES, FOLDERS & PROGRAMS

The System screen is the Series 5's file manager. You will see the System screen the first time you switch the Series 5 on; at other times, just tap the System program icon to move to it.

When you first turn the Series 5 on, the name of the current folder is displayed in the Title at the left of the screen. Files are listed in columns across the screen; the icons beside their names represent the programs which are used to open them.

Moving around

- **To move the highlight between the files and folders on the screen:** tap on the names, or use the arrow keys. If there are more files in the folder than can be displayed on screen, scroll the screen using the left and right arrow keys, or the scroll bar at the bottom of the screen.
You can use a "bookmark" to tag and move to a folder that you often use. Move to the folder and select **Set bookmark** from the **Edit** menu to insert the bookmark. Later you can select **Go to bookmark** from the **Edit** menu to move back to the folder.
- **To view the files on a Memory disk:** change the current disk by tapping the disk ('C') icon in the Title bar and select the disk you want to view, or select the command for disk 'D' from the **Current disk** commands on the **Disk** menu.

Close folder

Files

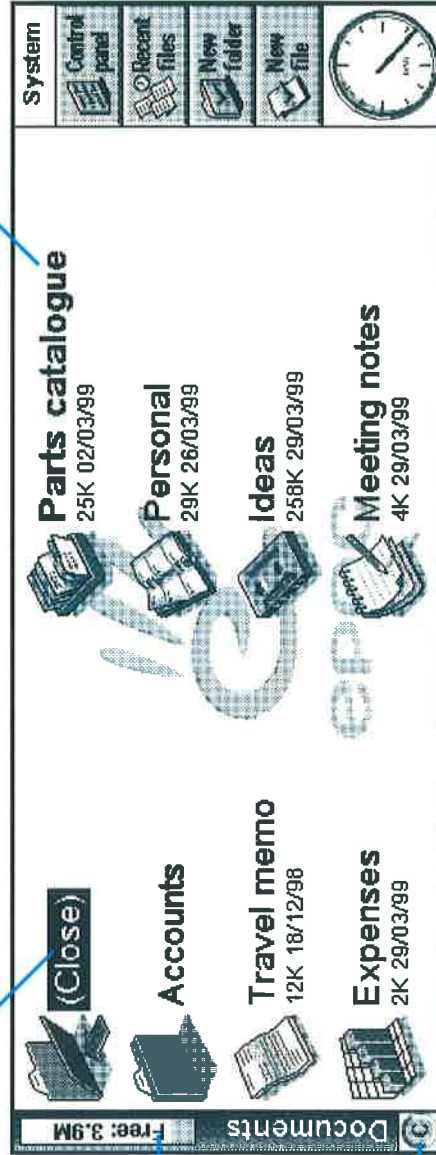

Memory

information

Change disk



Opening files, folders & programs

- **To open a file or folder from the System screen:** tap it twice, or highlight it and press Enter. Files that are currently open have their names displayed in bold on the System screen. Opening a file automatically saves and closes any other file that is currently open in the program.
- **To open two or more files of the same type at the same time:** hold down the Fn key while opening the second file from the System screen. Then tap the program icon to cycle through the open files.
- **To move to a program:** tap the relevant Program icon; tap the Extras icon to display more program icons. If the program is file-based, e.g. Data or Word, the program displays the last file you were looking at. You can start a new file using the **New file** Toolbar button or the command on the **File** menu (see 'Creating new files' later for more details).

Note: If the last file you were looking at has been deleted, moved or renamed, the program automatically looks for a file with a standard filename (e.g. Word, Data, Agenda and so on) in the standard folder, and opens this file instead. It will create a new file if necessary.

Note: Tap on the Extras icon to display additional icons for programs installed on your Series 5. If there are more programs than will fit on the screen, tap the **More** button.



How can I see which files and programs are open?

Select the **List open files** command from the **File** menu, or hold down the Ctrl key and tap the **System** icon. To move to a file or program in the list, highlight it and press the **Go to file** button.

Closing programs/files

- **To close the current folder:** tap on the Close folder icon at the top of the screen, or highlight it and press Enter. When you close all folders in the System screen, you move to the highest level of the disk, called the "root" of the disk.
- **To close a file:** use the **Close** command on the **File** menu, either in the program in which the file is open, or in the System screen. Any changes you have made to the file are automatically saved.

You can also close files or programs by holding down Ctrl and tapping the System icon, then using the **Close file** button in the list of open files and programs.

Creating new folders

You can keep a maximum of 64 items (each file or folder counts as one item) in the “root” (top level) of the Series 5’s internal disk. It’s best to create a number of folders in which to store all your files to prevent the top level of the System screen from becoming too full.

You might want to create some folders for work projects and others for home use. For example, you may create a folder called “House” for files relating to work on your house, and create another folder within the “House” folder called “Letters” for Word files of correspondence. Using folders in this way will also make your files easier to find.

To create a new folder:

1. Move to the folder in which you wish to create the new folder.
2. Select the **New folder** command from the Toolbar or **File** menu, and type in the folder name.

You cannot use the following characters in a folder name: < > : / \ * ?

If you use Series 5 files with a PC, you may wish to create folders that match equivalent folders on your PC. This will make transferring files between the Series 5 and PC easier.

Creating new files

You can create files from the System screen, or from within programs. As a general rule:

- Create a file from the System screen to start with the standard Series 5 settings.
- Create a file from within a program to use the settings that are in use in the file currently open, e.g. labels in a Data file.

To create a file from the System screen:

1. Move to the folder where you wish to keep the file.
2. Select the **Create new** command from the **File** menu, then select **File**.
3. Select the program you wish to use, e.g. Word for a Word document.
4. A filename is suggested. If you do not wish to use this, type a name of your own before pressing the **OK** button.

Note: If you have an existing file already open within the program, and wish to leave it open so that you can refer to both files, hold down the Fn key while pressing the **OK** button.

What names can I use for my files & folders?

You can use most characters in file and folder names including spaces, so it is fine to have folders called, for example, "1997 Purchase Orders and Invoices". The only characters which cannot be used in a file or folder name are / < > : \ * and ?.

The maximum length of a filename is 256 characters, although note that this includes the disk drive letter, and the names of the folders within which the file is contained (known as the "path"). The maximum length of a folder name, including the path, is 252 characters.

This will not generally be a problem, although it means that you may encounter difficulties if you use very long filenames for files which you store in folders which have long names, nested within other folders with long names, and so on. If you do exceed the maximum allowed length, rename a folder or file to a shorter name.

Important:

Note that files are not stored with a filename extension so that an Agenda file, e.g. called '1997', will have the same filename as a Sheet file called '1997'. You **cannot** store two files with the same name in the same folder, even if the files are created using different programs. If you save a file with the same filename as a file already existing in that folder, the original file will be deleted and replaced with the new file.

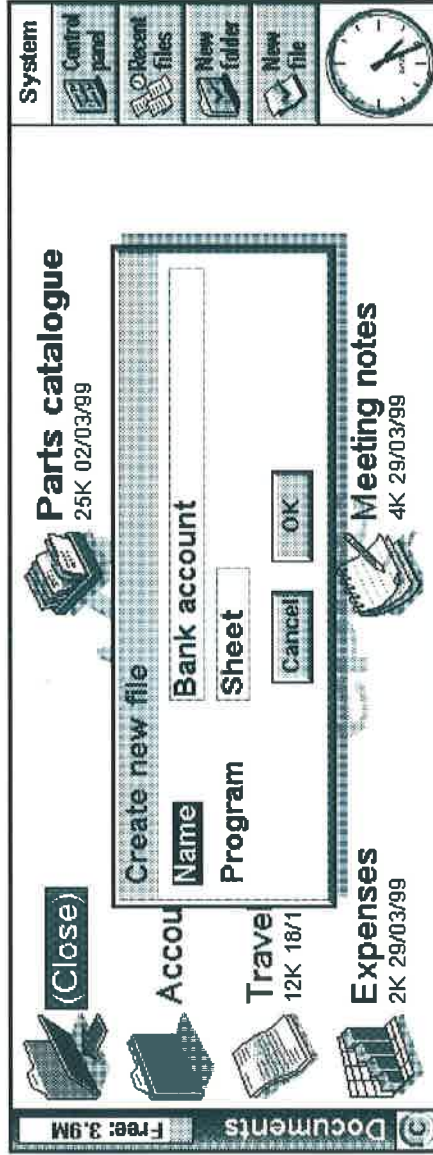

Browsing folders

A quick way to find a file is to use the **Browse folders** command on the **File** menu. This displays a Browser which shows a tree structure of all the files and folders on the current disk. You can also display the Browser by tapping the Title bar or pressing Tab in the System screen.

- **To move between files and folders in the Browser:** use the pen or arrow keys.
- **To “expand” the folder display:** highlight the folder name and tap it again or press Tab. To “collapse” the folder display, tap the folder name twice or press Tab.
- **To create a folder from the Browser:** press the **New folder** button.
- **To rearrange the order of the files in the currently highlighted folder:** press the relevant **Sort by** button.
- **To select a file from the Browser:** highlight the file and press the **OK** button. This selects the file in the System screen from where you can open it, rename it, or copy, move or delete the file.

Note: A quick way of opening a file direct from the Browser is simply to highlight it and press Enter twice.

Finding files and folders

To search for files or folders select **Find files** command on the **Edit** menu.

- If you know the name or part of the name, type it on the **Name** line; leave it blank to find all files and folders.
 - To search only for files used with a specific program, select the program name on the **Program** line; select ‘Any’ to search for all files used with any program.
- Tap **OK** to start the search. This checks all files and folders on the Internal disk and includes a Memory disk if present. The search results appear in a list.
- **To sort the list** by filename, file type, file size or creation date, press the **Sort** button and choose the sorting type required. To sort the list again in reverse order, just select the same sorting type again.
 - **To go to a file or folder:** highlight it and tap it again, or press Enter.

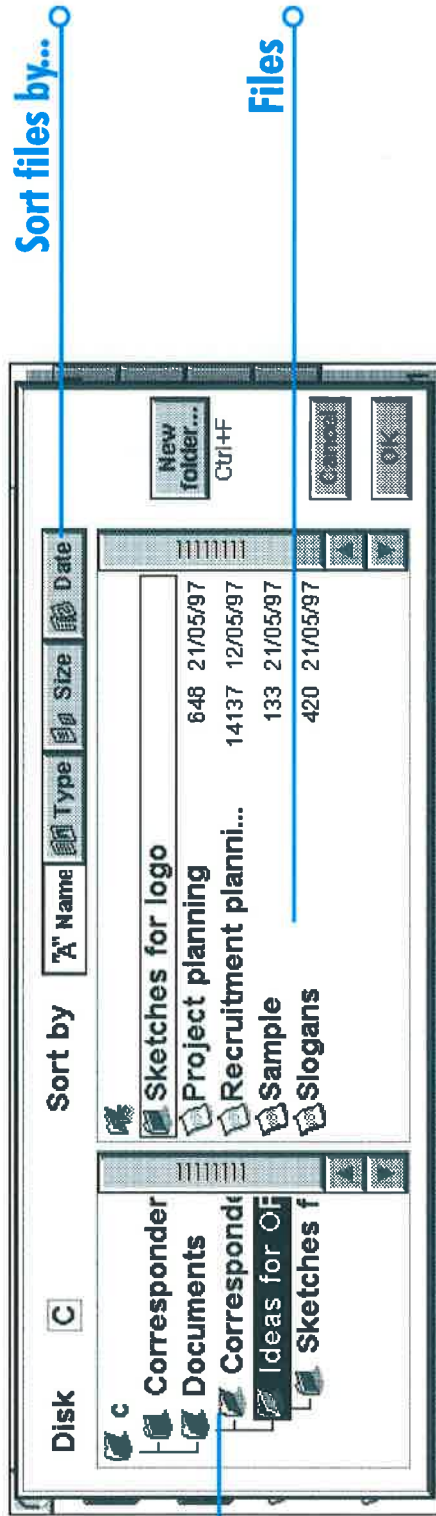

Folders

Files

Using passwords

You can prevent other people from opening your Word and Sheet files by setting a password for each file. For example, you may have a Sheet spreadsheet containing your personal finance details. To set a password on a file:

1. Open the file and select the password command from the **File** menu.
2. Type your password twice for confirmation. Choose a password that you won't easily forget, but one that won't be easy for other people to guess.
3. Press the **OK** button, and the file is saved immediately with the password.

When you want to open the file, you will be asked to type in the password.

Important: don't forget your password!

If you have forgotten the password for a file then you will not be able to open it.

The password on an individual file will protect it if you transfer it to a Memory disk or another machine. If you copy the file, the copy will be protected by the same password. The password also prevents the file being converted to another format and read on a PC.

Changing file attributes

You can prevent a file from being accidentally changed by making it a "read-only" file. To do this, highlight the file in the System screen and select **Properties** from the **File** menu. Then tick the **Read-only** box.

Files that have been created on a PC and then transferred to the Series 5 may also be "read-only" files.

To check whether a file is a "read-only" file, highlight it in the System screen and select **Properties** from the **File** menu.

Note: If you transfer a "read-only" file to another machine, it can be viewed, and the "read-only" attribute can be removed.

Managing folders

To move one or more folders or files from one location to another:

1. First highlight the file(s) or folder(s) to select them. To highlight a consecutive list of files or folders, highlight the first one, hold down the Shift key, and then highlight the last one. To select items that are not consecutive, hold down the Ctrl key and tap each file/folder in turn.
To select all the files/folders in the current folder, use the **Select all** command on the **Edit** menu. To deselect items, press the Esc key.
2. Select the **Cut (move)** command from the **Edit** menu. A dotted line appears round the file/folder icon(s).
3. Go to the disk drive and open the folder into which the highlighted items are to be moved.
4. Select the **Paste** command from the **Edit** menu.

Note: Moving a folder also moves all the files within that folder.

Note: If you move (or rename) your most recently opened Agenda or Data file, you should open it again by selecting it from the System screen, rather than tapping the Agenda or Data program icon. Tapping on the program icon will create a new Agenda or Data file.

- To copy a file or folder, or multiple files/folders to a different folder: follow the earlier instructions, but select the **Copy** as opposed to the **Cut (move)** command from the **Edit** menu.
- To make a copy of a file or folder within the same folder: highlight it on the System screen and select the **Copy** command followed by the **Paste** command. A new file is automatically created for you using the following naming convention (with Word as the example): Word(01), Word(02), etc. You can rename the file or folder later if you wish.
- To copy the entire contents of a disk to a folder on another disk: e.g. to back up the entire contents of your Internal disk ('C') to a backup folder on a Memory disk ('D'), select **Copy disk** from the **Disk** menu.

- **To rename a single file or folder:** highlight it, select **Rename** from the **File** menu, and then type in a new name.
- **To rename a disk:** select **Name disk** from the **Disk** menu.
- **To remove one or more files or folders:** first highlight them and then either press the Del key, or select the **Delete** command from the **File** menu.

Important: If you are deleting folders, remember that the entire contents of the folders (including all the other folders contained within them and all their files) will also be deleted.

Checking memory use

- **To display the amount of memory remaining:** select **Show disk gauge** from the **View** menu to see the amount of free memory in the System screen Title bar. Tap on this gauge, or select the **Disk** command from the **Information** menu to see more detailed information about a selected disk.
- **To see information about total memory usage:** select the **Memory** command from the **Information** menu.

Which files use the most memory?

Certain types of files use more memory than others.

Sound files can become very large, so you should take care to delete unwanted Record and Voice note files so that they do not use up space on the Internal disk.

When recording a sound (either using Record directly or via the voice note buttons), the Series 5 will allow you to continue recording until the 'Time available' runs out. Even if the Time available is zero, the Record program will always leave approximately 100 kilobytes of free memory.

If you find that the amount of free memory is suddenly reduced, it is a good idea to check the size of any Record files. It is also advisable to check the size of the Voice note file in the standard folder. The voice notes you record using the external voice note buttons are stored one after the other in this file.

Agenda files can also become very large. You should tidy your Agenda periodically in order to remove entries; see the 'Agenda' chapter for more details.

What will happen when the memory is full?

When the memory is nearly full, you will see warning dialogs when running programs to indicate that the Series 5's memory is almost full, and there is not enough memory to perform some tasks.

Many of the things you do need just a little free memory in order to work - displaying dialogs, menus, etc. These can fail with a message like 'Memory full'. Don't worry though, the Series 5 will not allow you to use all of the available memory; it will always set aside enough memory for you to close a program or save an open file to a Memory disk.

Files saved on the Internal disk and "open" programs both use memory. So, if the memory is nearly full you should be able to free some memory by closing some programs. You can use the **List open files** command from the **File** menu in the System screen to check which programs are running, and then close the programs or files that you do not need to have open.

You can also delete any unwanted files from the System screen, or move files to a Memory disk or your PC to free more memory.

Additional disks & programs

You can insert Memory disks into the slot on the right hand side of the Series 5. You might use them as additional memory for storing files, or to add more programs to the Series 5.

- **If a Memory disk contains additional programs:** their icons will automatically appear in the Extras bar when you insert the disk. They will be removed from the Extras bar when you take out the disk.

- **To delete all the files on a Memory disk:** put it in the slot, and then select the **Format disk** command from the **Disk** menu; select 'D' as the 'Disk' in the **Format disk** dialog. **Do not format the 'C' disk** - this will remove all the files you have stored on the Series 5's Internal disk, and remove all the preferences and settings that you have set up.

If you wish to run a translated OPL program, locate the file in the System screen, highlight the filename and tap it or press Enter to run it.

Can I run Series 3/3a/3c/3mx programs on a Series 5?

There are no major differences between OPL for Series 3/3a/3c/3mx machines and OPL for the Series 5. If you have written programs in OPL on a Series 3/3a/3c/3mx, you should be able to translate them so that you can run them on a Series 5. Series 3/3a/3c/3mx **applications** (which are not written as OPL programs) **will not run on a Series 5.**



WORD

Word is the word processing program. It has many of the editing and formatting features that you would expect from a fully-featured word processor.

Many types of text formatting, e.g. alignment and font settings, can be applied to individual paragraphs or defined as a paragraph “style”.

Entering text

The text you type always appears at the current cursor location (there is a ▶ marker in the margin to help you find the cursor).

All text after the current cursor position moves to make way for the new text. To delete characters, press Del to delete backwards or hold down Shift and press Del to delete forwards from the cursor.

Top toolbar

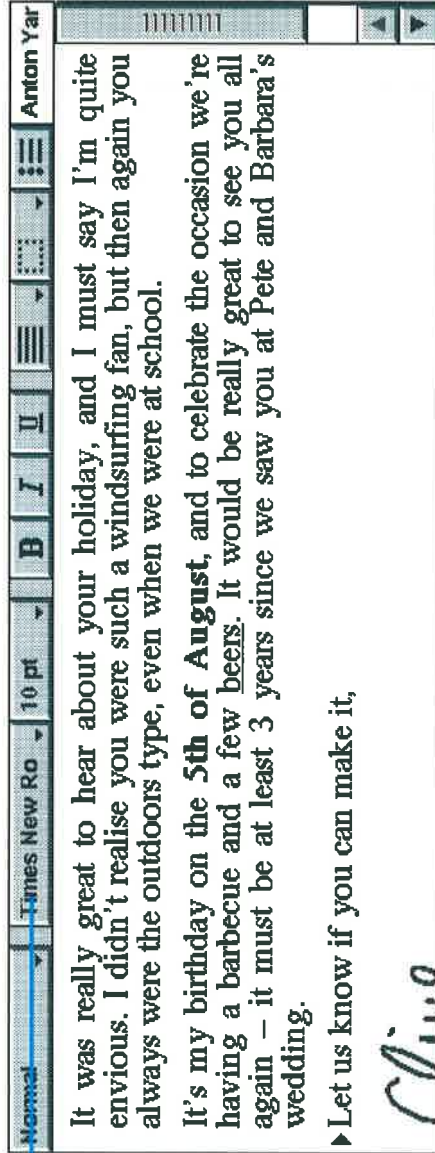

When text reaches the right-hand side of the screen, it automatically “wraps” the text onto the next line. If you want to view your page as it will be printed (“WYSIWYG”), switch off word-wrapping by removing the tick from the command on the **View** menu.

As you might expect, you can apply many commands to sections of text by highlighting them first. To highlight text, drag the pen over it or hold down Shift and use the arrow keys. To select all text in the file, use the command on the **Edit** menu.

- **To remove text:** highlight the text and press Del or select the **Cut** command. If you accidentally delete a section of text, you can replace it by selecting the **Undo delete** command from the **Edit** menu.
- **To copy text without deleting the original:** highlight it and select the **Copy** command from the **Edit** menu. To insert copied text, place the cursor where you want the text to appear and select the **Paste** command from the **Edit** menu.
- **To move a section of text:** highlight it and select the **Cut** command from the **Edit** menu. Place the cursor where you want the text to appear, then select the **Paste** command.

- You can make the text appear larger or smaller on the screen by selecting the **Zoom in** and **Zoom out** commands from the **View** menu. You can also select the **Set zoom** command to set a “custom” zoom level. Note that zooming does not affect printing.

Finding & replacing text

You can search through an entire file for a particular word or phrase and, if you wish, replace it with a different one. The **Find** commands are on the **Edit** menu.

- **To find text:** select the **Find** command and type in the text that you want to find. You can search “down” or “up” through a file - down searches from the current position to the end of the file, and up searches backwards to the beginning of the file. While searching, you can match the whole word, or make the search case sensitive.
- **To find and then replace text:** select the **Replace** command. Type the text that you want to find, as before, and the text that you want to replace it with. You can replace a single occurrence of the chosen text, or all occurrences from this point onwards.





Changing the appearance of text

You can highlight text then apply formatting to it, or select a format to use and then start typing:

- Press the **B** button for bold text, **I** for italics or **U** for underlined text (or use the commands on the **Text** menu).
- Press the button again, or remove the tick from the menu command to remove the effect, or switch it off.
- Use the button on the Top toolbar (e.g. **Times New Roman**) to choose from a list of available fonts. Note that the text that appears on the button will reflect the current font. Use the size button (e.g. **10 pt**) to change the size of text.

You can apply any of these effects, and also set the text position (e.g. for superscript and subscript text), use strikethrough text (crossed out), and change the text colour using the **Font** command on the **Text** menu.

Formatting paragraphs

Many formatting and spacing options can be applied to whole paragraphs. A paragraph may be a single word or title, a standard paragraph of text, or several lines grouped together, e.g. an address.

Each time you press the Enter key you start a new paragraph.

To start a new line without starting a new paragraph (e.g. for an address), hold down Shift and press Enter to insert a “forced line break”.

- To apply formatting to an entire paragraph, e.g. to change the horizontal alignment, place the cursor within the text of the paragraph using the pen or arrow keys, then tap the button or select the menu option. To apply formatting to a number of paragraphs, make sure that the highlight covers at least part of each paragraph. You don't need to highlight all the text in the paragraphs you want to format.

Aligning paragraphs

Alignment changes the horizontal position of paragraphs on the page. You may wish to align the text left or right with the appropriate margin, centre a title, or justify text to align both edges with the margins.

- To change the alignment: select the paragraph(s) to align, then tap  or select the command from the **Paragraph** menu, then select the alignment you want.

Note: Margins are set as part of the file's page setup. See 'How the page looks' later for more information.

Indents & tabs

Indents set the position of a paragraph between the margins, while tabs allow you to line up text on the page.

You can set left, right and first line indents for selected paragraphs by selecting the command from the **Paragraph** menu and entering a measurement (measured from the existing margins) in the boxes. The left indent applies to all lines except the first line, so that you can create a "hanging indent" by applying different left and first line settings.

You can change the standard tab setting, and set up custom tab stops for individual paragraphs by selecting the command from the **Paragraph** menu.

Bullets & symbols

To emphasise paragraphs that are items on a list you can precede each paragraph with a bullet.

- To add a bullet to a paragraph, tap  or select the command from the **Paragraph** menu. Use the menu command to change the bullet format, i.e. the size or colour of the bullet character, or the character to use.

Special characters

You can insert foreign and other special characters in your file by selecting the **Special character** command from the **Insert** menu.





You can also insert non-printing characters which control word wrapping on the screen and in the printed document:

- For a non-breaking space, press Shift and the Spacebar. This will prevent a line breaking at the space.
- For a non-breaking hyphen or “hard hyphen”, press Shift with the - key (i.e. Ctrl+Fn+O). This will prevent a line breaking at the hyphen.

You can use the **View preferences** command on the **Tools** menu to select which non-printing characters are displayed on screen.

Line spacing

When you select a particular font size, Word automatically uses an appropriate line spacing to make sure that there will always be a gap between successive lines of text. You might sometimes wish to override these settings, e.g. in a paragraph with different sizes of text.

- **To set line spacing:** select the command from the **Paragraph** menu and enter a point size. Set the spacing to ‘At least’ to ensure that lines of text never overlap, but will move further apart to accommodate any larger text

appearing on the same line, or ‘Exactly’ to ensure that lines of text are always the same distance apart, even if larger text appears on the same line.

- To insert extra blank space between paragraphs, enter point sizes for the ‘Space above’ and ‘Space below’.

Note: The other lines in this paragraph affect where page breaks occur when the file is printed. See ‘How the page looks’ later.

Paragraph borders

You can draw a border around a paragraph. You can also change the background colour of a paragraph.

- **To draw a border:** select the paragraph(s) then tap  and select from the range of options. Or, use the command on the **Paragraph** menu to apply the borders and set the style and colour for each “side” of the border (i.e. Left, Right, Top or Bottom) and how far you want the border to be from the text. You can also set a background colour.
- Remember to set different background and text colours, otherwise the text will be invisible.

Using styles

A style is a collection of formatting options which can be applied to a whole paragraph using a single command or keypress.

Word has four built-in styles; Normal, Heading 1, Heading 2 and Heading 3.

- **To apply a built-in style:** select the paragraph(s), then tap the **Normal** button on the Top toolbar and select the style you want, e.g. Heading 1. You can also select the **Style gallery** command from the **Paragraph** menu.

Note: The text on this button changes to display the style of the current paragraph.

Style button

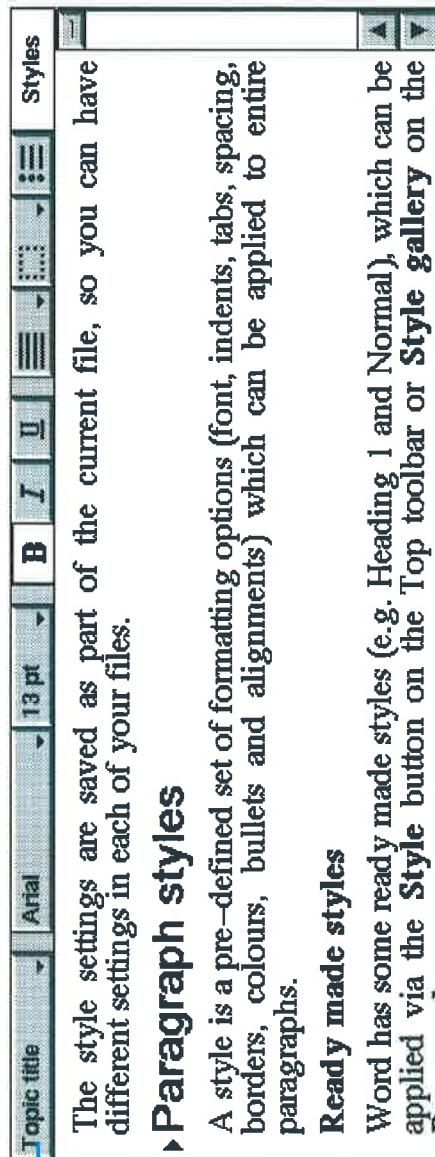



Defining styles

In addition to the built-in styles, you can create your own - either from scratch or by modifying an existing one. Styles are saved with the file, so each Word file can have different style settings.

1. Select the **Style gallery** command from the **Paragraph** menu and select **New** to create your own style, or select **Modify** to change the currently selected style in the list.
2. Press the **Format** button, then modify text and paragraph options as you wish.

If you are creating a new style, you can then name and assign an outline level and shortcut key. Your new style will now appear in the list of paragraph styles for the current file.

To delete a style you have created, select the **Style gallery** command from the **Paragraph** menu, select the style name from the list, and press Delete.

- You cannot delete or rename Word's built-in styles, but you can modify their settings for the current file. The built-in styles in other files will not be affected.

Document outlines

You can view an outline of a document, with one line for each paragraph style which has an "outline level". The standard Heading styles use a sequence of different outline levels: Heading 1 is the highest with outline level 1, Heading 2 has outline level 2 and so on.

You can choose which paragraph styles you want to display in the outline, making it easier for you to see the structure of the document and move between different sections.

Select **Outline** on the **View** menu to see the document structure in outline. You can then:

- expand the outline to include other styles with a lower outline level. Highlight a particular line and tap again or press the right arrow to expand the level. Tap **Open all** to show all of the outline levels. Styles which have an outline level of zero are not shown.
- close the outline to show only the higher outline levels. Highlight a line and tap again or press the left arrow to close one level. Tap **Close all** to only show the highest outline level.
- tap **Done** or press Esc to return to the document.

You can change the outline level for any style so that you can display a document structure including your own headings or other styles. See 'Using styles' earlier for more about creating styles.

Moving around the document outline

You can use the document outline to move quickly to other parts of the document. To do this:

1. Select **Outline** on the **View** menu to display the document structure in outline.
2. Move the cursor to the line representing the section of the document that you want to move to (using the arrow keys to display or hide other levels as necessary).
3. Tap **Go to** or press Enter to return to the document with the cursor at this section in the text.

Document outline levels

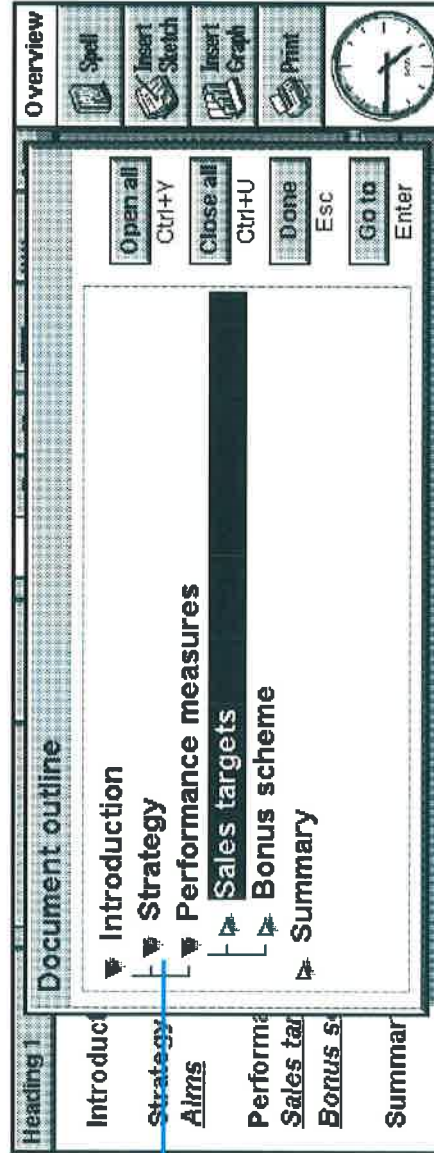



Information from other programs

You can add pictures, graphs, spreadsheets and sounds to your Word files by inserting information created by the other Series 5 programs. When a piece of information is inserted, it is known as an "object".

Inserting an "object"

- To insert a sketch: tap the **Insert Sketch** button in the Toolbar or select the command from the **Insert** menu. A copy of the Sketch program will open where you can create

your picture.

- To insert a table or graph: tap the **Insert Graph** button in the Toolbar or select the command from the **Insert** menu. A copy of the Sheet program will open. Word displays the inserted Sheet object as a graph or a spreadsheet, depending on the view displayed when you close the copy of Sheet.

- To insert a sound or other object: select the **Other object** command, and select from the programs which support this feature, e.g. Record for a sound recording.

Graph inserted from Sheet

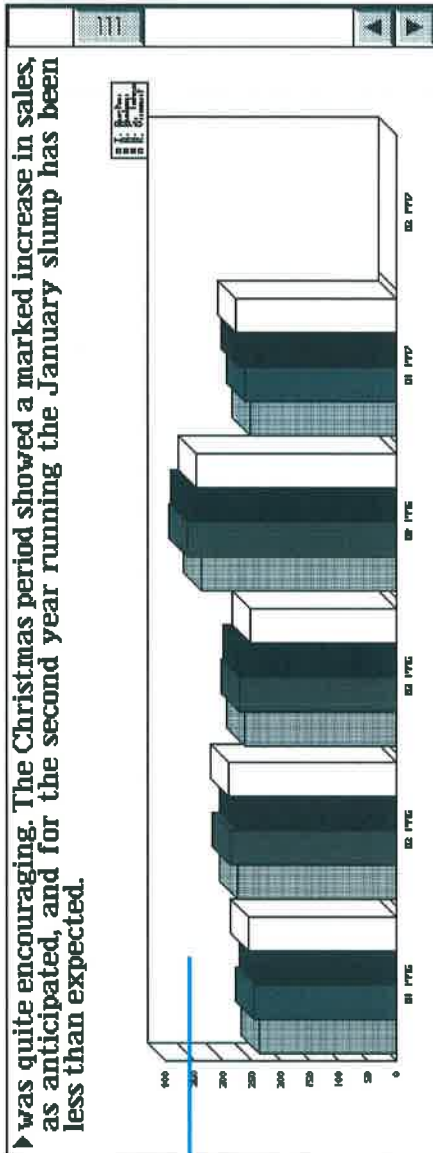

Close the program using the **Done** button at the top of the screen to return to Word.

When you have inserted a sketch, table or graph you can select it, then use the pen to drag one of the “handles” to resize it. You can tap an object to edit it again. You can also format an object to resize it, or crop the edges to control the amount of the object displayed, by highlighting it and using the **Object** commands on the **Edit** menu.

You can also use the **Format object** command to display an object as an icon of the program that created it to save space on screen. To set a preference so that objects are always displayed as icons when first created, use **Object preferences** on the **Tools** menu.

Some objects, e.g. sounds from Record, are always displayed as icons and cannot be formatted. Tapping the icon (or selecting it and pressing Enter) opens a copy of Record so that you can play the sound.

Important: Note that inserting objects into a file causes a considerable increase in file size.

Spell checking

To check the spelling of a Word file, select the command from the **Tools** menu (to check the spelling of a single word or phrase, highlight it first). Spell will display any words that are not found in the Spell dictionary, or included in the Personal dictionary (if applicable). You can then:

- correct the unrecognised word. Type in the correct spelling, or choose from the list of suggested alternatives.
- ignore the word and leave it unchanged in the Word file, or ignore all instances of the word in the file.
- add the word to Spell’s Personal dictionary.

See the ‘Spell’ chapter for more about spell checking.





Creating a new file

To create a new Word file, use the **Create new file** command on the **File** menu in Word or the System screen. If you do this in the Word program you can enter a filename and location and select a “template” for the new file.

File templates

A template is a document design that you can use as a starting point for new documents. The template can include text, paragraph styles and page layout information. When you create a new document using a template, Word copies the information in the template into the new file which you can then change as you require. For example, you can use the standard Fax template to create a fax - the template includes the coversheet text and you can add the fax details and number.

You can select from a number of standard templates. When you open a document using a particular template, you then work on a document based on the template; you don't change the template itself.

Creating a template

If you can't find a suitable built-in template, you can create your own file template. To do this:

1. Create the Word file with the text, styles, page layout, headers, footers, and so on that you want to include in the template. Note that other settings such as the cursor position and printer setup are also stored.

If you want to change an existing template, open a new document using the template and make the changes to this Word file.

2. Select **Save as template** from the **More** commands on the **File** menu.
3. Enter a name for the template. If you are making changes to an existing template, type the original template's name. Word displays templates with (C) or (D) added to the name, according to the disk you use to store the file.

You cannot change the standard built-in templates in Word, although you can use them as a starting point for your own customised templates.

You can use the **Delete template** command (from the **More** commands on the **File** menu) to delete a template you've created. You cannot delete the built-in templates.

Setting the "default" template.

If you create a new Word document from the System screen, Word uses the built-in 'Blank document' template. If you want to start documents in the System screen using a different template, create a template as before but type the name "Normal" for the file. Word will use the 'Normal' template if it exists, otherwise it will use the blank template.

Document template

Fax heading

Fax

▶ To: _____ From: _____
Fax: _____ Fax: _____
Phone: _____ Date: _____
Re: _____ No. pages: _____
CC: _____

Urgent ✓ For review ✓ Please reply ✓ Please comment

Spell
Insert Sketch
Insert Graph
Print

purchase d





Saving Word files

When you edit a Word file you are actually working on a copy of the file stored in memory. When you close Word this file is automatically saved to disk. If you do not specify a filename it will be called Word, and subsequent files will be saved as Word(01), Word(02), and so on. To save a file using a different name, or in a different folder, select the **Save as** command from the **More** commands on the **File** menu.

To create a new Word file, use the command on the **File** menu and enter a filename and folder. The current file is closed and automatically saved.

You can undo all changes since the last “save” using the **Revert to saved** command on the **File** menu. This will re-open the most recently saved version of the file.

Note: If you password-protect a file, it is immediately saved as “password-protected”. If you revert to saved, you will need to enter the password for the file.

How the page looks

When you create a new file, Word uses standard page settings to control how your text will appear when printed. To change the page setup for the current document, select the **Page setup** command from the **Printing** commands on the **File** menu; adjust the paper size, orientation and margins as appropriate.

Page breaks

Word automatically fits text to the paper size and continues on to another page where necessary. If you want to have more control over where new pages start, you can insert your own page breaks and set page breaking options for individual paragraphs.

- To start a new page, place the cursor at the desired point and select the **Page break** command from the **Insert** menu, or hold down Ctrl and press Enter.

To define how Word prints a specific paragraph, place the cursor in the relevant paragraph, or highlight several paragraphs, then select the **Line spacing** command from the **Paragraph** menu. You can select from the following:

- 'Keep together' to prevent a page break within the paragraph.
- 'Keep with next' to ensure that a paragraph always appears on the same page as the paragraph that follows it.
- 'Start new page' to ensure that a paragraph will always appear at the top of a new page.
- 'Allow as widow/orphan' to let a single line at the beginning or end of the paragraph appear on a separate page from the remainder of the paragraph.

You can display where page breaks will occur in a file by selecting the **Paginate** command from the **Tools** menu. The position of each page break is then shown with a dotted line. Note that the dotted lines are not automatically updated if you edit the document further, so you will need to select the **Paginate** command again if you wish to repaginate and update the position of the dotted lines.





Headers, footers & page numbers

Headers and footers are pieces of text (e.g. page numbers or a chapter title) which appear at the top and bottom of each page of a printed file. To add a header or footer, select the **Page setup** command from the **Printing** commands on the **File** menu, and select the Header or Footer page in the dialog. Enter your text in the box and format it as desired.

To insert page numbers, the current time or date, or the file name, press the **Insert** button and select from the options available. Word automatically updates page numbering as you edit your file.

Printing

If you have a printer ready for use with the Series 5, you can print your Word files. You can preview how your printed file will appear on paper and review all your page setup options beforehand.

- To preview your printed document, select the command from the **Printing** commands on the **File** menu. Word paginates your file and displays the first page(s) on screen. You can use the **Setup** options to control the number of pages displayed in the preview and whether or not visible margin lines are shown.
- To print the file, select the command from the **Printing** commands on the **File** menu. You can choose to print the entire file, or only a selection of pages. You can also print multiple copies of the file.

See the 'Printing' chapter for more details.

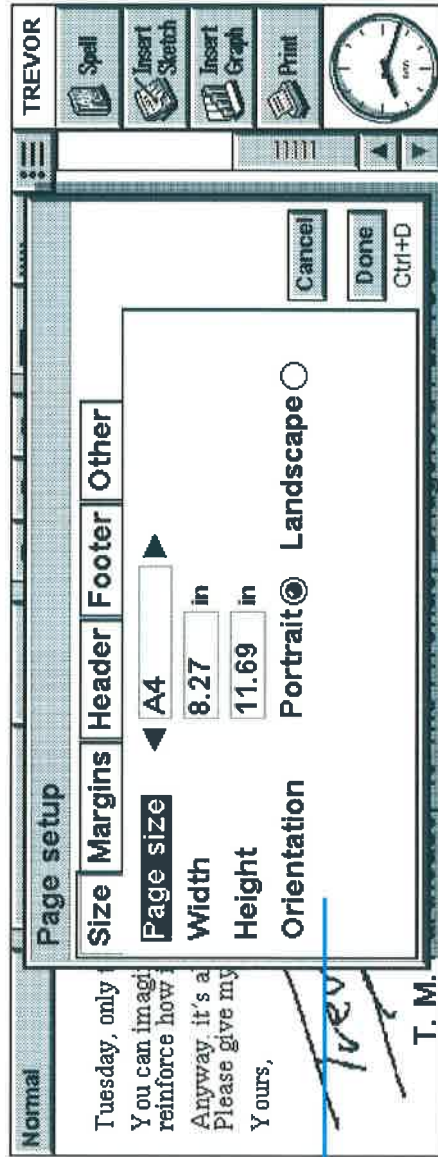

Page setup





SHEET

Sheet is the spreadsheet program. It has many of the features and functions that you would expect from a fully-featured spreadsheet.

You can use Sheet to create worksheets, and use PsiWin to transfer worksheets to and from your PC.

Sheet has two views:

- The Sheet view, where information is displayed in cells on a worksheet. Cells are referred to by their position in the grid of columns and rows, e.g. D3. You can present information in table form in Sheet, and perform calculations based on sets of numbers stored in the worksheet.
- The Graph view, where you can create graphs based on information stored in the worksheet.

Column heading

Univers		10 pt	B	I	U	Σ	f(x)	Portfolio
C6	=SUMPRODUCT(B2:B4,C2:C4)/100							
1	Company	Bought	Price (c)	Date	Price now	Value	Gain	
2	Yarback Holdings	1000	40.4	8/96	391.75	£3917.50	-3.03%	
3	Hodders Ents.	3700	18.25	8/96	55	£2035.00	201.4%	
4	Green-Browning	550	1120.5	8/96	1168	£6424.00	4.24%	
5								
6	Value then	£10878.00			Value now	£12376.50		
7					Total gain	£1498.50		
8					Today:	28-Apr-97		

Row heading

Top toolbar

Moving around

The current cell is indicated by a dark border around a cell. The information you enter in the input line applies to this cell.

- Tap any cell to select it, or use the arrow keys to move around. You can use the scrollbars or the arrow keys to move to other areas of the worksheet. Hold down the Ctrl key and use the arrow keys to move by a whole screen at a time.
- Use the **Find** commands on the **Edit** menu to move to other cells. Use **Find** and **Find next** to move to cells if you know their content, or **Go to** to jump to a specific cell.

Note: You can alter the number of cells displayed by using the zoom commands, or by setting the zoom level using the command on the **View** menu.

Highlight more than one cell to perform actions which apply to an area:

- **To highlight more than one cell:** drag the pen from the first cell in the block to cover the desired cells, or hold down Shift and use the arrow keys.

- **To highlight a whole column or a whole row:** tap the shaded column or row heading, e.g. "C" or "2".
- **To highlight the entire worksheet:** tap the square in the top left corner of the worksheet headings.

Entering information

To enter information in a cell, select it and start typing. You will see the information you are entering on the input line. The first character you type tells Sheet what kind of information the cell will contain:

- **To enter numbers:** begin with a number or with one of these characters: . - + and (.
- **To enter text:** simply type it in. If your text starts with a number, type a ' first, e.g. '24 Longton Road. If you want the text itself to contain a ' at the beginning, type two of them, e.g. "97 sales figures.
- **To enter a formula for a calculation:** begin with a =. For example, to make a given cell display the sum of the contents of cells B1 and B2, type in =B1+B2.
- **To edit the information in a cell:** simply highlight the cell and press Enter. You can then edit the contents on the input line.





- **To enter a date:** type the day, month and year on the input line, separating them with a space or the date separator character as set in the System screen, e.g. 1 Oct 69 or 1 10 69, or 10 1 69 if you use this date format.
- **To enter a time:** type the hour, minutes and seconds, separating them with a colon (or the time separator character as set in the System screen).

You can also change the width of columns and the height of rows, to suit the information contained in them. To do this:

- Drag the right-hand edge of the column heading to adjust its width, and the lower edge of the row heading to adjust its height.
- Use the commands on the **Format** menu to set the height of a row in points and the width of a column in characters.

Note: If you enter more text than can be displayed in the current cell, the information will run over into the next column if that column is empty, so you may want to adjust the column width. If you enter a number that's too long for the cell, you will see a series of # signs in the cell, though the actual number will still be stored.

To freeze panes on the worksheet: type the information you wish to “freeze” in the rows and columns, position the pointer in the cell below the row to freeze, and to the right of the column to freeze (this will often be B2). Tap the  button, or select the command from the **View** menu. The “frozen” panes will stay on screen when scrolling through the rest of the worksheet.

- **To protect the worksheet from changes:** select the **Protection** command from the **Tools** menu.
- **To allow changes to some cells only:** highlight the area you for which you wish to allow changes, select the **Protection** command on the **Tools** menu and remove the tick to “unlock” the highlighted cells. If you then protect the worksheet, changes are only allowed to the cells that are not locked.

Performing calculations

There are two ways to perform calculations:

- Type the calculation into a single cell. When you press Enter or move to another cell, the result will be displayed on the worksheet.
- Use a formula for a calculation; just type the different parts of your calculation in separate cells and note their references, e.g. income in B2 and tax in C2. In a new cell, enter the formula, beginning with a =. Use the cell

references for the components of the calculation rather than the numbers themselves. For example, =C2-(B2*C2). The value displayed in this cell is calculated for whatever values you use in the component cells.

Note: If you have a row or column of cells and want to know their sum, position the pointer in the cell at the end of the row or column and tap the Σ button. Sheet will insert the formula for the sum of the preceding group of cells and calculate the result.

Use = to enter formulae

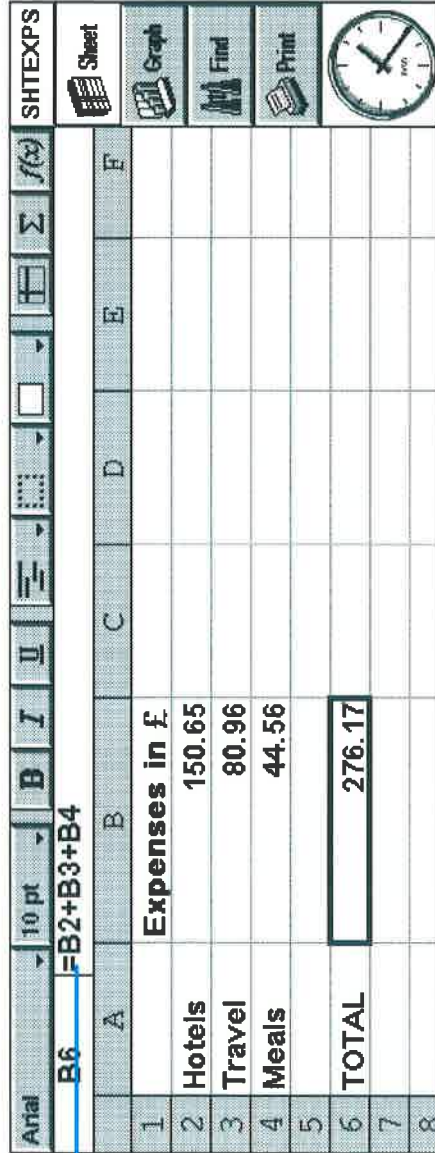

The screenshot shows a spreadsheet application interface. At the top, there is a menu bar with options: Arial, 10 pt, B, I, U, and a formula bar containing =B2+B3+B4. Below the menu bar is a toolbar with icons for Sheet, Graph, Find, Print, and a clock. The main area is a grid with columns A-F and rows 1-8. The data in the grid is as follows:

	A	B	C	D	E	F
1						
2	Hotels	150.65				
3	Travel	80.96				
4	Meals	44.56				
5						
6	TOTAL	276.17				
7						
8						





There are two types of cell reference you can use in a formula:

- Relative references, such as A2. These get updated when copied and moved elsewhere. For example, a reference to cell A2 in a formula in cell B3 will change to B2 if the formula is copied to cell C3.
- Absolute references, such as \$A\$2. These contain a \$ sign in front of the parts of the reference that you don't want to change even if the formula is moved elsewhere. So, \$A\$2 in cell B3 remains \$A\$2 when copied to cell C3.
- You can combine the two types of reference: A\$5 in A6 will become B\$5 when copied to B8.

A formula which contains a reference to its own cell, either directly or indirectly, is called a "circular reference". You can find any circular references in the worksheet using the **Find** commands on the **Edit** menu. You should avoid making circular references as they produce unpredictable results.

Recalculation

Sheet automatically recalculates your worksheet every time you change part of a calculation. You may want to turn this feature off if you are making a large number of changes in the worksheet. To do this:

- Select the **Preferences** command from the **Tools** menu, and set Auto recalculation to off. When Auto recalculation is off, a '+?-' symbol will be displayed at the right end of the input line whenever you need to recalculate manually to update results.

To make Sheet recalculate the worksheet, select the command from the **Tools** menu.

Functions

Sheet has a large number of functions, e.g. mathematical, financial and trigonometric functions, that you can incorporate in your calculations. See the built-in help on the Series 5 for a full list and details of syntax.

- **To use a function in a calculation:** just type it in. Alternatively, tap the function button or select **Function** from the **Insert** menu. Choose the function you require.

Using ranges

A range is a rectangular block of cells. The reference for a range consists of the cell references of the top left and bottom right corners of the block, separated by a colon, e.g. B2:C6. You can use ranges to define areas of the worksheet for applying formatting, creating graphs, or include range references in formulae, e.g. =SUM(B2:C6).



- **To select a range:** highlight all the cells you want to be a part of your range.
- **To use a range in a formula:** highlight the range to be inserted while entering the formula. For example, type “=SUM(“ then drag the highlight to cover the appropriate range, type a “)” and press Enter.

Naming ranges

- **To name a range:** highlight the range and add a name using the **Add name** command from the **Name** commands on the **Insert** menu. You can use this name in sums and formulae, e.g. “=AVERAGE(Bills)”. You can edit the range name using the **Edit name** command.

Changing how information is displayed

You can format the information in the worksheet in a number of ways, e.g. to differentiate the parts of tables and calculations. Formatting is applied to the currently selected cells.

- **To change the alignment of information:** tap  to set the horizontal alignment, or use the command on the **Format** menu to set both the horizontal and the vertical alignment.
- **To change the font:** use the buttons in the Top toolbar to change the font or font size. Alternatively, use the command on the **Format** menu to select the font, font size and other attributes, e.g. bold, superscript, strikethrough etc.
- **To add bold, italic or underline:** use the  buttons, or use the **Font** command as described above.
- **To add a border:** tap  or select the command from the **Format** menu and select a border style for the each side of cell.
- **To add shading:** tap  or select the command on the **Format** menu, and select the shading you want to apply.





Sorting information

You can sort rows in a list based on values in a single column or in several columns. You can also sort columns based on values in rows, if your list is set up that way. In either case, you can sort using more than one row or column. For example, if you want to sort a table based on a 'surname' column, but have more than one entry for each surname, you can also sort again using a 'first name' column.

Sorting from top to bottom

You can sort information in order from highest to lowest value, or into alphabetical order, according to the information in a particular column. Use this type of sorting if you want to change the order of the rows in a table, e.g. to sort entries in a table into the order specified by an 'Amount' column.

To sort from top to bottom:

1. Highlight the range of information that you want to sort. Sheet will only sort information inside this range.
2. Select **Top-to-bottom** from the **Sort** commands on the **Tools** menu.

3. In the dialog, select the column that you want to use to order the rows, and specify the way that you want to sort. Click **Options** if you want to make the sort case sensitive.

Sorting from left to right

You can also sort from left to right. Use this type of sorting if you want to change the order of the columns in a table.

To sort from left to right:

1. Highlight the range of information that you want to sort, rows and columns. Sheet will only sort information inside this range.
2. Select **Left-to-right** from the **Sort** commands on the **Tools** menu.
3. In the dialog, select the row that you want to use to order the columns, and specify the way that you want to sort. Click **Options** if you want to make the sort case sensitive.

Changing the number format

Select the **Number** command from the **Format** menu to change the number format. You can set the formats for the current highlighted range or all cells in the worksheet.

The number formats include general, triad (e.g. 3 000 000) and scientific number display, as well as special formats for displaying text, currency, dates and times, percentages, and also for a format for hiding the contents of cells.

Note: Some settings for the way numbers are displayed, e.g. the thousands separator, are set in the System screen.

The screenshot shows the 'Format' menu with the following options:

- Sample time formats
 - 2/14
 - 02/14/97
 - 14 Feb 97
 - February 14, 1997
 - 02/14/1997 12:00 am
- Number formats
 - General
 - Fixed
 - Scientific
 - 145
 - 145.00
 - 9.32E+04
 - Currency
 - Percent
 - Triad
 - £145.00
 - 17.5%
 - 93,200
- Alignment
 - Left
 - Top
 - Centred
 - Centred
 - Right
 - Bottom

Other menu items include 'Sheet', 'Graph', 'Find', 'Print', and the system date/time '11:15 Thu 8'.





Graphs

You can use Sheet to create, format and print graphs based on information on the worksheet, for example to show annual sales figures, or the distribution of revenue.

You can create many types of graphs including line graphs, bar and column graphs, scatter charts and pie charts, and can add to or alter many aspects of the graph's appearance by tapping on the area of the graph you wish to change.

Creating a graph

To create a graph:

1. Highlight a column or row of numbers in the Sheet view. This will be the first "range" that your graph depicts. You can add other ranges later on to build up your graph.
2. Tap the **Graph** button on the Toolbar to move to the graph view. You will see your graph displayed on the screen.

Use the **Sheet** and **Graph** buttons on the Toolbar to switch between the two views.

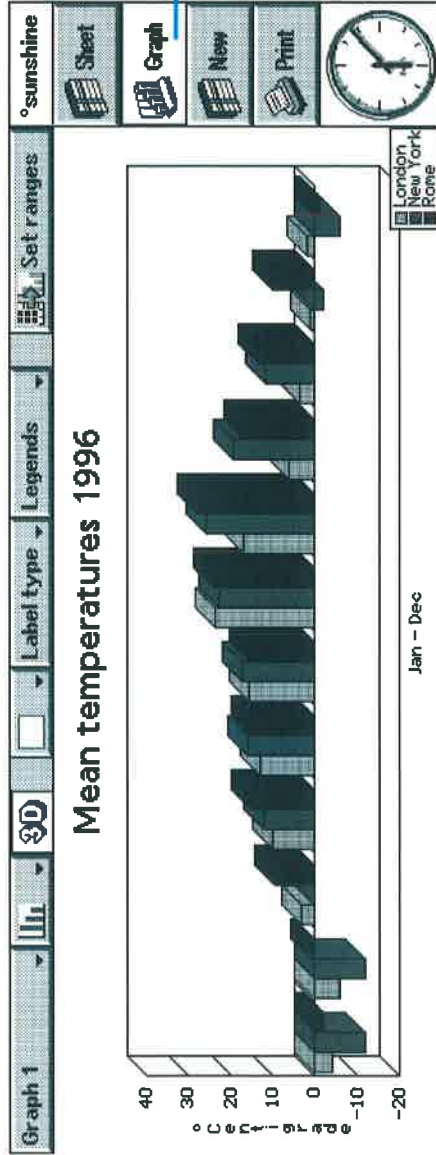

Graph view

Replacing the graph range

When you create a graph, it is set to the range you first specified. It will reflect changes to the data within that range, but will not reflect other ranges you highlight on the worksheet. To replace the current graph range (or ranges) with a new one:

1. In the Sheet view, highlight the new range you want the graph to use.
2. Switch to the Graph view, then press the **Set ranges** button. The new range(s) will replace the old one(s) as the subject of the graph.

Adding a range to a graph

You can add further ranges to graphs to display additional information, e.g. to include a previous year's sales figures as well as the current ones.

- **To add a range to a graph:** select the range you want to add to your graph in the Sheet view, switch to the Graph view and then select the command from the **Ranges** menu.

Graph type & appearance

When you first create a graph, it will be a column graph. Change the type using the  button, or the **Graph settings** command. The graphs types include line graphs, bar and column graphs, scatter graphs and pie charts.

- **To change the graph from 2D to 3D and back:** use the **3D** button on the Top toolbar, or the **Graph settings** command.
- **To change the pattern used for a range:** select the **Change range** command from the **Ranges** menu, then choose the range and the fill colours and styles for each range.
- **To change the background, text and line colours of a graph:** use the Colours and Styles pages in the Graph settings and Change range dialogs.

Note: You can alter many aspects of the graph appearance by tapping on the area of the graph you wish to change.





Adding titles, labels and grid lines

- **To add a title to a graph:** select the **Graph settings** command from the **Graphs** menu and insert the title. You can change the style and font of the title using the **Title font** command on the **Graphs** menu.
- **To add axis titles:** use the **Format X-axis** and **Format Y-axis** commands. You can also use these commands to format the X and Y axes, e.g. to add grid lines, tick marks, add or remove axis labels, alter the axis position and scale, or hide them completely.
- **To add labels to each range:** use the **Change range** command to specify the type of label you want and the cells in which your labels are stored.
- **To add a legend to a graph:** tap the **Legends** button and select the desired position for the legend. Alternatively, use the **Graph settings** command.

Working with more than one graph

You can create more than one graph for a worksheet and switch between them easily.

- **To create a new graph:** highlight the first range for the new graph, then switch to the **Graph** view. Select the **New graph** command from the **Graphs** menu, and specify the settings for the new graph.
- **To switch between the graphs you have created:** tap the **Graph** button on the Top toolbar or use the command on the **Graphs** menu.

Printing from Sheet

You can print a range of pages, the entire worksheet or a graph from Sheet using the **Printing** commands on the **File** menu. You need to set up the page layout and printer first, using the **Page setup** and **Print setup** commands. You can use the **Print preview** command or the **Print** button in the Toolbar to display a preview.

See the 'Printing' chapter for more details.





CONTACTS

You can use the Contacts program to store information about your “contacts”, such as those found in an address book. Each contact includes “labels” for details such as names, addresses, email addresses, telephone and fax numbers.

Adding a contact

You can add contact details in any order. To add a contact:

1. Tap the **New contact** button or select the command from the **File** menu.
2. Type the contact information next to the appropriate labels.
 - Tap on a label or use the arrow keys to move between the boxes. Use the scroll bar to see labels which are not currently displayed.
 - Tap on the page headings to move between the personal and work pages.
3. Tap the **Save** button when you've finished typing in the contact details.

Note: If there is no suitable label for the information you wish to enter, you can add a new label. See 'Contact labels' later.

Looking at your contacts

Contact details are displayed as a single page, with the contacts list shown alongside.

- To sort contacts alphabetically by first name, last name or company name, use the **Sort** button on the Toolbar or the command on the **View** menu.
- To adjust the width of the list and contact details, use **Preferences** on the **Tools** menu.

How do I dial a telephone number?

You can dial a contact's telephone number by selecting the contact and tapping the **Dial** button on the Toolbar. See the 'Dialling' chapter for details of how to dial numbers directly from Contacts and other programs.

Finding contacts

You can find contacts by typing part of the name, or search for text contained anywhere within the contact details.

- To search for a contact by name, simply type the first few letters of the name in the 'Find:' box and press Enter. Only the name and company name are searched.
- To search for text contained anywhere within a contact's details, e.g. text in an address, email or notes label, use the **Find in all text** command on the **Edit** menu.

Search tips.

Type a ? for a single unknown letter or a * for any number of unknown letters (known as "wildcards"), e.g. typing '?ath' would find 'cath' and 'kath', whereas typing '*ath' would also find 'goliath'.

After a search, only those entries including the search text will be displayed. To display all the contact entries again, tap on the 'Find:' box.

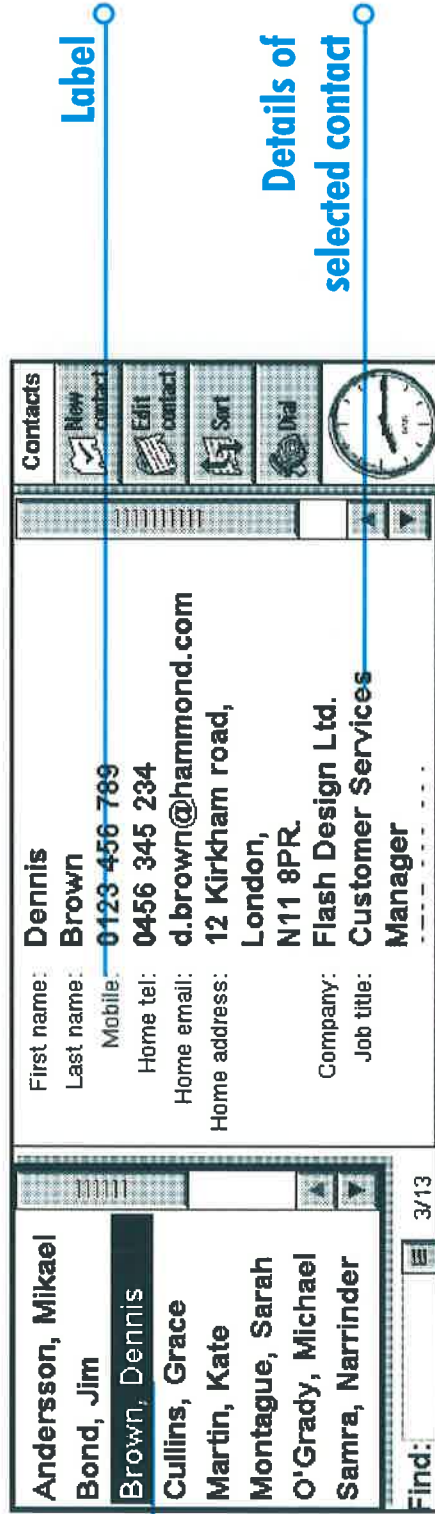



Editing & deleting contacts

To change a contact's details:

1. Select the contact you wish to edit, then tap on the **Edit contact** button on the Toolbar or select the command from the **File** menu.
2. Change the contact details as required, and tap the **Save** button to save your changes.

To delete a contact, select the command from the **File** menu.

Note: If you delete a contact accidentally, select **Undo delete** on the **Edit** menu to get it back again.

Contact labels

If the current contact labels are not suitable for the information you wish to enter, you can add, remove and rename the labels used by all new contacts. It is best to set up the labels you want before you start to type in your entries.

Note: If you wish to store different types of information, you can use the Data program to create a custom database. See the 'Data' chapter for more information on creating your own databases.

Changing labels

Each individual contact can have different labels to other contact entries. To add a label to a single contact:

1. Open a contact by adding a new contact or editing an existing entry.
2. Tap **Add item** and select the label to add to the contact.

Note: The label you select will only be added to this individual contact.

You can add, remove, rename and change the order of labels used for all new contacts. To do this, select **Set up labels** on the **Tools** menu.

- To add a new label, tap **Add item** and select a label type.
- To change the name of a label, select it and tap **Rename**.
- To change the order of a label in the list, select it and use **Move up** and **Move down**.
- To delete a label, select it and tap **Delete**.

Note: You can't delete labels from existing contacts, but you can prevent a label's title appearing by deleting its contents.

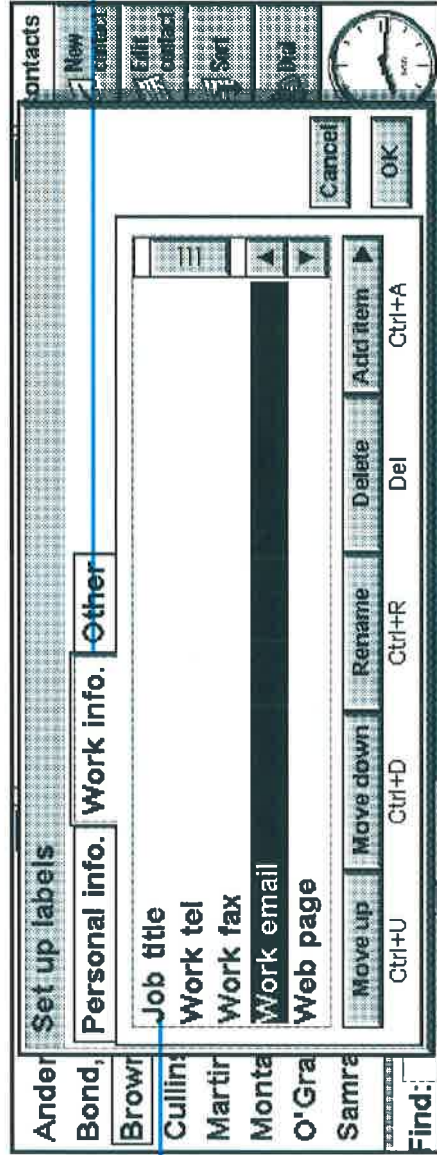

Page label
appears on

Label





Exchanging contacts

You can exchange contact details with other programs and machines which support the 'vCard' standard. You can also exchange contacts using Infrared with other machines which support the 'vCard' and 'IrObex' standards (see 'Infrared' for more details).

To do this, use the **More** command on the **File** menu to:

- **import** information from a vCard file into Contacts.
- **export** contacts as a vCard file for use with another program.

Note: You can choose to export only the selected contact, or all contacts currently in view (e.g. the result of a search).

Printing contacts

You can print all your contacts, or choose a set of contacts to print by using a search.

- Before you print, refer to the instructions in the 'Printing' chapter to select a printer.

To print contacts:

1. Display the contacts you wish to print.

Note: If you do not wish to print all the contacts, select a contact or use the find commands to display a selection of contacts (see 'Finding contacts').

2. Use the **Printing** commands on the **File** menu:
 - Use the **Page setup** command to control the page size, margins, and add headers and footers. See the 'Printing' chapter for more details.
 - Use the **Print setup** command to specify which contacts to print, and the number of copies.
 - Use the **Print preview** command to see how your printed copy will look.
 - Use the **Print** command to print your entries.

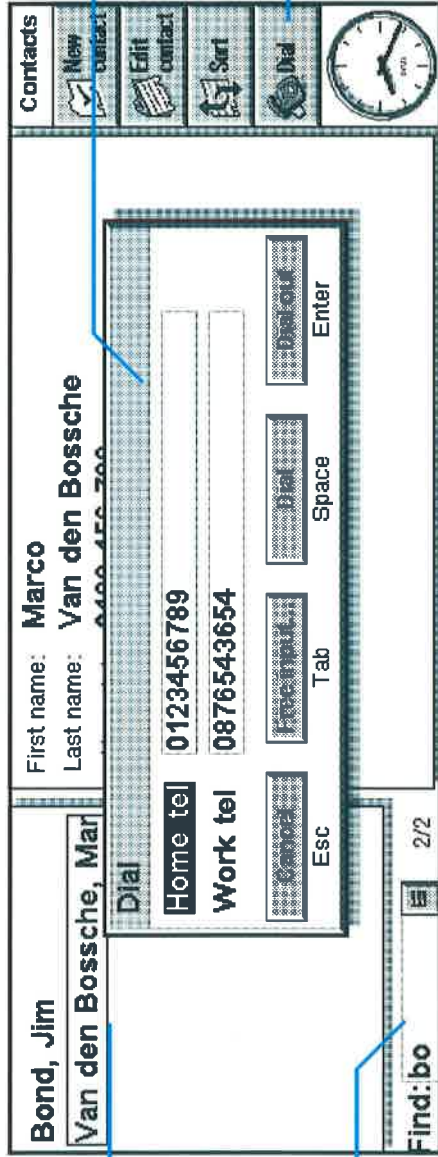

Search results

Search clue

Dial dialog

Dial

Toolbar button





AGENDA

You can use the Agenda program as a time manager, for recording appointments, events, birthdays, anniversaries and lists of things to do.

When you first open Agenda, you'll see a planner for the current week, or the "Week view". You can start adding your appointments and other entries straight away by moving to the appropriate day and typing them in.

What if I already use a PC scheduler?

If you already keep your schedule on your PC, you can use PsiWin to synchronize your PC scheduler with a new Agenda file to quickly bring all your PC entries across. You can then synchronize regularly to keep the information up to date in both places. See the PsiWin on-line help for more details.

The screenshot displays the Agenda software interface. The main window is titled "Jun - Jul 1999" and shows a weekly view of the calendar. The current week is "Week 27". The days shown are Monday (28), Tuesday (29), Wednesday (30), Thursday (1), Friday (2), Saturday (3), and Sunday (4). Handwritten entries are visible: "Squash" on Monday at 7:00, "Report deadline II" on Tuesday at 6:00, and "Send sales report to John" on Wednesday at 7:00. The "Agenda" section on the right lists events with icons: "Wedding anniversary (1988, 9 years)" on Thursday at 7:00, "Jenny - Chinese restaurant" on Thursday at 8:00, "Farrier" on Friday at 7:00, "Holiday" on Saturday at 7:00, "Leave for airport" on Saturday at 8:00, "Flight to Funafuti" on Saturday at 9:00, "Flight to Funafuti" on Sunday, and "Holiday" on Sunday. A toolbar at the top right of the "Agenda" section includes icons for "View", "Sketch", "Today", "Go to", and a clock icon. Labels with lines pointing to specific features are: "Handwritten entry" pointing to the "Squash" entry, "To-do entries" pointing to the "Send sales report to John" entry, "Change view" pointing to the "View" icon, and "Entry crossing midnight" pointing to the "Flight to Funafuti" entry on Sunday.

Handwritten entry

To-do entries

Change view

Entry crossing midnight

Moving around

- Use the arrow keys to move around the days.
- Press the **Today** button on the Toolbar, or the Spacebar to go to today's date. Press the Spacebar again to move back to the day you were on.
- Tap on the "dog ears" in the bottom corners of the pages to move between pages.
- To move between dates, tap on the title of the view or press Ctrl+J to see a calendar (you can also press Tab in some views). Move the highlight to the date you want and press Enter.

Note: The Agenda has a number of other views, e.g. a Day view and a Year view. You can set preferences to change which view you see when you first open the Agenda program, and customise other aspects of the way Agenda works. See 'Customising Agenda' later.

Adding appointments & events

Agenda has 3 types of entries for appointments and events:

- **Timed day entries** for appointments that you wish to give a duration, e.g. a meeting or dental appointment. The duration can be displayed in the Agenda views so that you can see when you are busy. A timed entry can have any duration (up to 31 days).
- **Untimed day entries** for an appointment without a duration.
- **Events** for entries that you wish to last a specified number of days, which do not have start and end times, e.g. holidays.





Timed & untimed entries

To enter a “timed” or “untimed” day entry:

1. Move the cursor to the date of the appointment and start typing. As soon as you start typing the New entry dialog is shown where you can set the start time and duration of the appointment. If the appointment does not need a start time, remove the tick from the Timed entry box.
 - A timed entry appears with a start time, and can also be displayed with a duration. Entries which cross midnight are marked with « on subsequent days.
 - An untimed entry appears with a bullet and is displayed in the time slot where you type it in.
2. You can set the duration or end time of a timed entry in the New entry dialog, or tap the **Alarm/More** button and move to **Details** page to enter a duration longer than 23 hours.

Note: Each view has a standard entry type that is created when you start to type. To add other types of Agenda entry, select **Create new entry** from the **Entry** menu, and then select the type of entry you want. You can change the standard entry type for each view. See ‘Customising Agenda’ later.

Note: You can add a handwritten entry by writing the entry as a sketch; see ‘Attaching a sketch’ later.

Events

- **To enter an event:** select the command for creating a new event from the **Entry** menu. Type in the details of the event, e.g. ‘Holiday in Spain’ and set the start date and duration in days. Event entries are marked with a flag symbol (🚩).

“Pencilling in” a tentative entry

- To pencil in an Agenda entry, e.g. to reserve a time slot for an appointment that has not been confirmed: press the **Alarm/More** button in the New entry dialog, move to the **Other** page and tick the tentative entry box. The entry will be displayed as grey text in the Agenda views.
- **To confirm a tentative entry:** highlight the tentative entry, then select the command from the **Entry** menu to remove the tick from the menu command.

Viewing entries

Agenda has the following views, for looking at Agenda entries in different ways:

- Day view - shows all the entries for one day, hour by hour.
- Week view - shows the entries for the whole week.
- Anniversary view - shows birthdays, anniversaries, etc.
- Busy view - showing your free and busy time over a four week period.

- To-do view - shows lists of things to do.
- Year planner - shows an overview of entries for the year, and displays entry symbols.

Switch between the views by tapping on the **View** button or by selecting the view from the **View** menu.

You can set preferences to change the way the views look. See 'Customising Agenda' later.

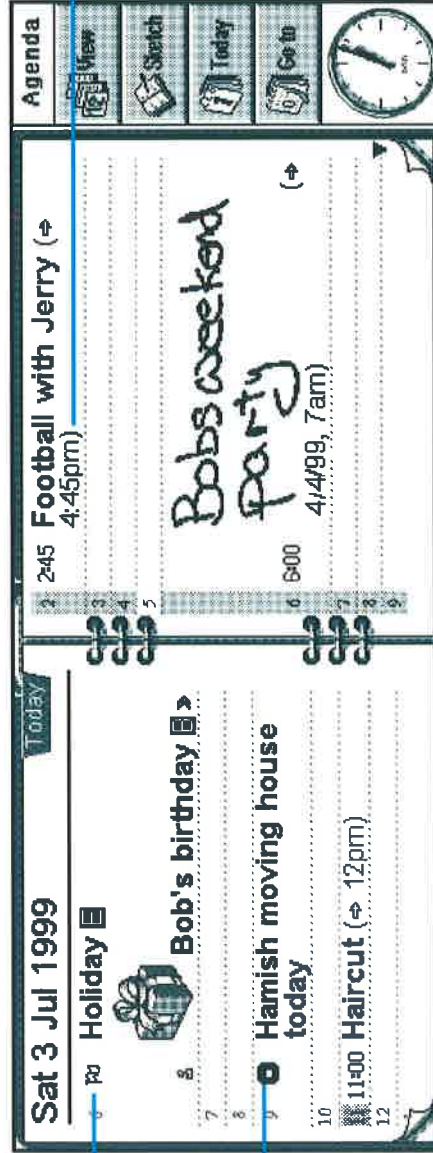

Event entry

Untimed day entry

Timed day entry





Entry symbols

You can group entries together using “entry symbols”. An entry symbol is a letter you can use to identify particular entries, for example, M for meetings. The entry symbol can also be used to show entries in the Year planner.

Birthdays and anniversaries

1. Move to the Anniversary view and just start typing, or select the command for creating a new anniversary entry from the **Entry** menu in any view.
2. Type in the details of the anniversary, e.g. ‘Jane’s birthday’ and set the day and month of the anniversary.
3. Press the **Alarm/More** button if you wish to specify other details about the anniversary, e.g. the start year and whether you want to see the start year (e.g. a person’s year of birth) and/or the number of years since the start year (e.g. their age).

Anniversaries are marked with a candle symbol (🕯).

Reminders for entries - alarms

To set an alarm for an Agenda entry:

1. Move the cursor to the entry.
2. Set the alarm using the command from the **Entry** menu. You can also set an alarm while adding an entry, by pressing the **Alarm/More** button in the New entry dialog and then moving to the Alarm page.
3. Set the amount of warning that you want, or the time at which you want the alarm, and the alarm sound you want.

Initially you will see the list of standard alarm sounds, but you can add your own sounds for alarms using the Record program. See the ‘Customising your Series 5’ chapter for more details.

Entries which have alarms are marked with a bell symbol (🔔).

- To remove an alarm, select the **Set alarm** command from the **Entry** menu and remove the tick from the alarm box.



Will alarms still ring if I close Agenda?

If you close an Agenda file, the Agenda informs the Series 5 clock to ring the next Agenda alarm at the appropriate time. However, the Series 5 will not be able to ring any further Agenda alarms from that file until you open it again.

If you use alarms a lot in your Agenda, it is therefore a good idea to leave the Agenda file open when you are not using it, even when the Series 5 is switched off.

If you do need to close the Agenda file, do not set an alarm and then immediately close the file or switch off. This is because the Agenda program needs a certain amount of time to calculate when the next alarm should ring, and if you switch off before the calculation is complete, the Series 5 clock will not have been informed to sound the alarm.

Alarm warning

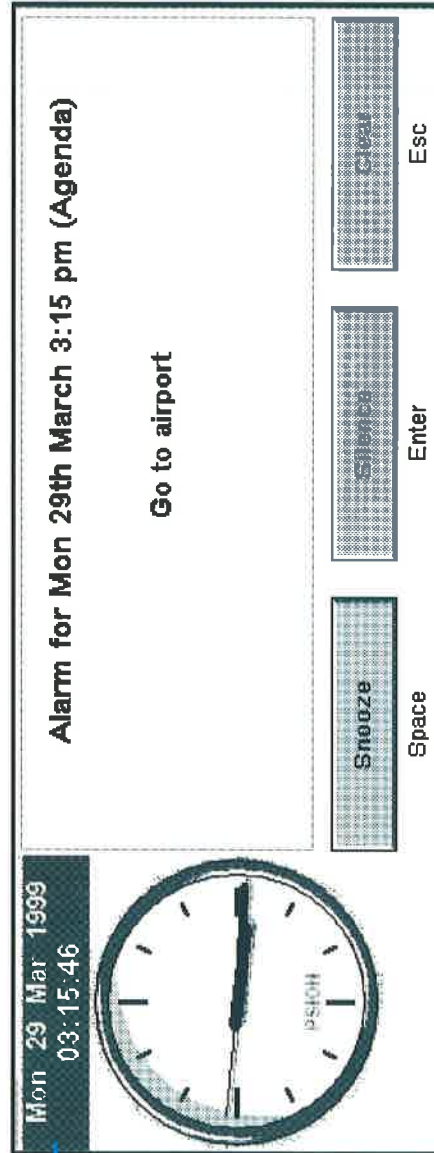



Finding entries and dates

You can search through the Agenda entries for a particular piece of text or for entries with particular settings, or a particular entry symbol.

1. Select the **Find** command from the **Edit** menu.
2. Type the text you want to find (you can leave the line blank if you want to list all of the entries). Select the dates you want to search using the range lines. Select any other settings as appropriate; press the **Options** button to select the entry types you want to find.

A list of matching entries is shown. Move the cursor to an entry in the list and press Enter to display it in full.

Use the commands from the **Edit** menu to go to the previous or next entry or to go to a specific day.

Using the calendar

You can also go to a specific day using the built-in calendar. Tap on the date titles or press Tab to display it in the Day, Week, or Anniversary views; alternatively select the **Calendar** command from the **View** menu in any view. Today's date is circled, and the currently selected date is highlighted. In a calendar you can:

- Press the buttons in the top of the calendar to see a 1, 3 or 12 month calendar.
- Tap on the “dog ears” in the bottom corners of the calendar to move between the calendar “pages”.
- Use the left and right arrow keys to move between days. Use Shift at the same time to move between dates in a month, Ctrl to move to the same day in the previous or next month, or Fn to move to the first or last date on the “page”.

When the highlight is on the day you want, press Enter to move to that day.

Changing and deleting entries

- **To move or copy an entry:** use the **Cut** or **Copy** commands from the **Edit** menu to move or copy an entry. Move the cursor to the new entry position and paste the entry. All entry details are transferred to the new location; alarm settings are adjusted accordingly.
- **To change an entry's "type", e.g. to change a day entry to an event:** highlight the entry you want to change and select the command from the **Entry** menu. Select the new entry type, and complete the settings for the new entry type.
- **To change the entry text:** highlight the entry you want to change and tap on it, or press Enter. Now you can edit the text, making use of the normal text selection and emphasis keys. If you wish to change the font, letter size, etc. press the **Alarm/More** button, then move to the Text page. You can also move an entry by editing the entry in this way and changing the entry time or date.

Deleting entries & crossing out

- To remove an individual entry from the Agenda, select it and press Del or use the command from the **Edit** menu.
- You don't have to delete individual entries in the past, these can be removed automatically by "tidying" the Agenda file. See 'Tidying an Agenda file' later.
 - If you want to mark an entry as completed, without removing it from the Agenda, move the cursor to it and cross it out using the command from the **Entry** menu. The entry will now appear in the Agenda views with a line through it, and any alarm for this entry will be cancelled.





Repeating entries

You can set an entry to repeat automatically, e.g. a monthly meeting.

1. Move the cursor to the entry and set the repeat using the command on the **Entry** menu.
2. Set up the repeat type as appropriate, e.g. Daily, Monthly, Weekly etc. You can also set the repeat to 'Monthly by date', e.g. the 7th of each month, 'Monthly by days', e.g. the first Monday of each month, 'Yearly by date', e.g. once every year on the same date or 'Yearly by day of week', e.g. the third Tuesday in March every year.

3. Press the **Alarm/More** button to set up the days and dates for the repeats (except for 'Daily' repeats). Set the interval for how many days, weeks, months or years you want between repeats.

- If you only want the entry to repeat a few times, remove the tick from the 'Repeat forever' line and set the number of occurrences, or type in the date of the last occurrence on the 'Until' line.
- If you only want to see the next occurrence of a repeated entry, you can choose to show 'Next only'.

Entries which are set to repeat are marked with ».

Note: If you select 'Next only' and the last occurrence has passed, you will not see the entry any more. Use the **Find** command from the **Edit** menu to be able to see them.

Lists and things to do

You can use a “to-do list” to note down tasks or items you want to remember. Initially you have two to-do lists, and you can add more lists later.

You can also give each item on a to-do list a due date, and assign priorities to to-do entries to control the order they appear in the Agenda views.

To-do entries are marked with a circled ‘T’ symbol (Ⓣ).

Adding a to-do

1. Move to the To-do view and just start typing, or create a new to-do entry using the command from the **Entry** menu.
2. Type in the details of the to-do, e.g. ‘Buy paper’. The “Priority” can be used to determine the order in which to-do entries are listed in the to-do list, priority 1 is highest.
3. If the to-do entry has a deadline, press the **Alarm/More** button and tick the ‘Dated’ box. Then set the due date to the deadline date. If you want advanced warning of the

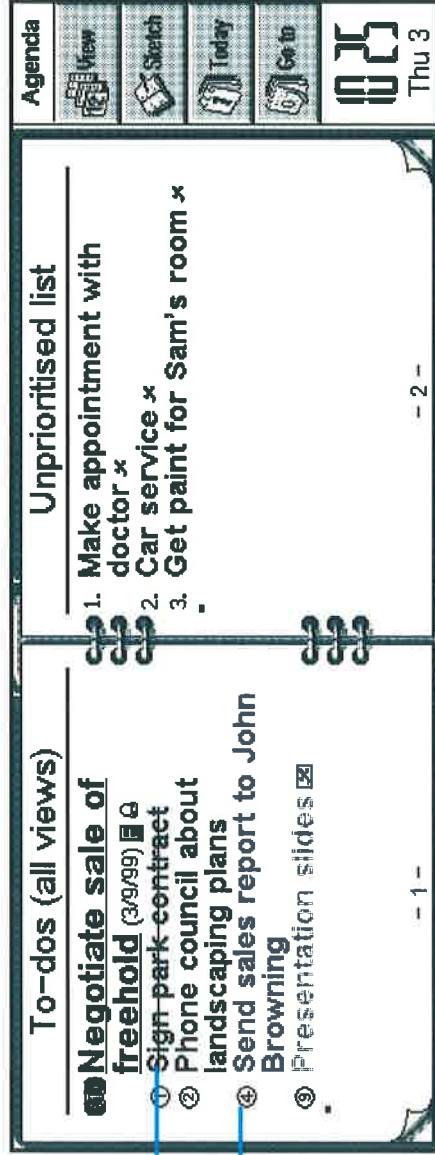

Crossed out entry

To-do priority





deadline, set up warnings as appropriate. You can set how due dates are shown, e.g. Date, Days or Auto (date, days and 'tomorrow') if you want to see when the to-do is due.

Creating a new to-do list

You can create new to-do lists so that you can categorise the things you want to remember, for example you can keep a private to-do list and a work to-do list. Each to-do list is displayed on a "page" in the To-do view. Move between the to-do list pages by tapping on the "dog ears" in the bottom corners, or using the left and right arrow keys. Tap on the to-do list title to see a list of available lists.

1. Create a new to-do list using the command from the **To-do lists** menu.
2. Type in a name for the list, e.g. 'Wedding plans'. You can rename the list later if you need to using the command from the **To-do lists** menu.

3. Specify the page number that you want this to-do list to appear on, and which to-do list you want to base the settings of the new list on.
4. Press the **OK** button to save the new list, and you'll see the new list in the To-do view.

You can delete an unwanted to-do list and all its entries, using the command from the **To-do lists** menu.

Customising a To-do list

You can change the way the to-do list looks and how to-do entries are shown in the Day and Week views.

Select **To-do list preferences** from the **To-do lists** menu.

- Each to-do list is displayed on a "page"; the page number controls the order in which the to-do lists are displayed. If you want to move the to-do list to another page, set the page number as appropriate.

- If you want to be able to arrange to-do entries on the list yourself, set the sort order to Manual. New entries you add to the list will appear at the cursor position, and you can cut, copy and paste to-do entries to put them in the order you want.
- Tick the boxes according to what you want to see in the To-do view and other views.
- If you want to see to-do entries in a specific time slot in the Day view, for example personal to-do entries in the evening, set the time as the standard position.

The screenshot shows a calendar interface with two panes. The left pane is titled "Wedding anniversary (1988, 9 years)" and contains a list of to-do items with checkboxes and page numbers:

- 8 [] Make appointment with doctor x
- 9 [] Car service x
- 10 [] Get paint for Sam's room x
- 11 [] Phone council about landscaping plans
- 12 [] Send sales report to John Browning
- 13 [] Presentation slides x

The right pane is titled "Today" and shows a timeline view for "Sat 3 Jul 1999". It has a vertical axis with time slots and a horizontal axis with page numbers:

- 9:00 [] Haircut x
- 10:00 [] Lunch meeting
- 1:00 [] Environment presentation
- 3:00 [] Jenny - Chinese restaurant x

At the top of the right pane, there are icons for "Agenda", "View", "Sketch", "Today", and "Go to", along with a clock icon.

**To-do entries
(standard
position at 8am)**

**Customised
time slots**





Information from other programs

You can use the **Paste** command to insert text copied in other programs straight in as an Agenda entry. For example, copy some text in Word using the **Copy** command, move to Agenda and to the position you wish the Agenda entry to appear and select **Paste**.

You can also insert information from other programs into an Agenda entry, e.g. add a sketch of a map to the entry for a meeting appointment. This information is called an "object".

Attaching Word documents to entries

You can attach a Word document as a "memo" to any Agenda entry, for example a list of things you want to discuss at a meeting. To do this:

1. Highlight the entry to which you want to attach the Word document.
2. Select the **Word** command from the **Edit object** commands on the **Edit** menu.
3. This takes you to a new Word document where you can

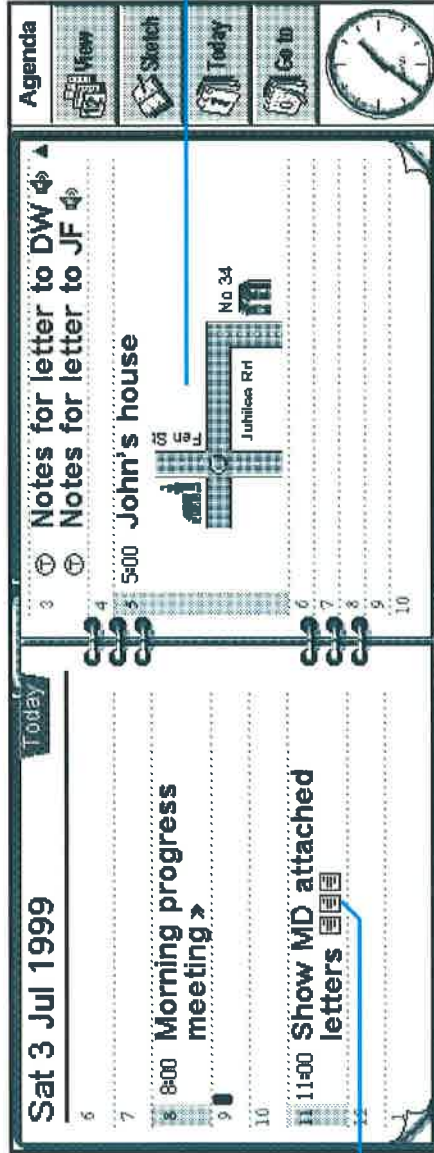

Inserted Word objects

Inserted Sketch object

type in your text. See the 'Word' chapter for more about using Word. When you have finished editing the document, close it to return to Agenda.

- To see or edit the document later, select the entry with the attached memo and then select the **Word** command again.

Attaching a "voice note"

You can attach a spoken memo (a "voice note") or another sound to any Agenda entry. To attach a voice note:

1. Select the entry to which you want to attach the voice note.
2. Select the **Voice note** command from the **Edit object** commands on the **Edit** menu.
3. This takes you to a Record file where you can make the recording in the normal way. See the 'Record' chapter for more about using the Record program. When you have finished making the recording, close Record to return to Agenda.

- To listen to the voice note later, select the entry with the attached voice note and then select the **Voice note** command again. Play the sound in Record and close Record to return to Agenda.

Attaching a sketch

You can add a sketch in one of 2 ways:

- by adding a sketch as an entry using the **Sketch** button in the Toolbar. You can add a picture, or handwritten note in this way. Just create the picture in Sketch and close the Sketch program to return to Agenda.
- by attaching a sketch to a text entry as an icon. Select the entry to which you want to add the sketch, then select the **Sketch** command from the **Edit object** commands on the **Edit** menu.

In either case, to see or edit the picture later, select the entry with the attached picture and then select the **Sketch** command from the **Edit object** commands from the **Edit** menu.





Customising Agenda

You can change the view that you see when you open the Agenda and set preferences for inserted objects by selecting the **General preferences** command from the **Tools** menu.

You can change the way each view looks by selecting **View preferences** from the **Tools** menu, while in the view.

- In the View preferences, you can select which type of entry you will add if you select an empty day or time slot and just start typing, press Enter or tap on an empty slot.
- You can also select which types of entry you want to show in the Day, Week and Year planner views.
- If you want to change the times shown in the day view to suit your working day, change slot definitions in the Day view preferences.
- If you only want to show one entry symbol in the Year planner, set the 'Show which symbols' line in the Year planner preferences to 'One'. Then select the entry symbol you want to show.

You can change the standard settings for entries by selecting **Entry preferences** from the **Tools** menu, and then selecting the entry type.

Agenda files

You may wish to keep separate Agenda files for business, hobbies and so on.

Create a new Agenda file for your information (using the command on the **File** menu).

- You can now add entries to the new Agenda file. You can use cut, copy and paste to move entries between Agenda files.
- If you have two Agenda files and want to combine them, use the **Merge** command from the **File** menu.

"Tidying" an Agenda file

You should tidy the Agenda on a regular basis to stop the file from getting too large. To do this:

1. Select the **Tidy/archive file** command from the **More** commands on the **File** menu.
2. You can select whether you want to copy or move old entries to a new file, or delete them. If you move or copy them to a new file, you must specify the name and location of the new file.

If you copy them to a new file, the entries are not removed from the current Agenda file.

3. Select which entries you wish to tidy, e.g. crossed out entries, and select the entry types you want to tidy by pressing the **Entry types** button.
4. Select the range of entries you want to tidy.

Note: If you have moved or copied entries to a new file, you should see the file on the System screen and be able to open it like any other Agenda file.

Printing Agenda entries

You can print all the Agenda entries, or limit the range you print to certain dates of interest, for example only the coming week.

- Before you print, refer to the 'Printing' chapter; this tells you how to set up the printer and page.

Select the **Printing** command from the **File** menu:

- Use the **Page setup** command to specify how the entries will appear in the printed copy. You can control the page size, margins, and add headers and footers. See the **Printing** section for more about this.

- Use the **Print preview** command to display pages showing how the printed copy will look.

- Use the **Print** command to print the entries.

When you select **Print** or **Print preview**, you'll see a dialog in which you specify the date range of the entries you want to print.

Press the **Entry types** button to set:

- Whether you want to print all repeat entries or only the next one.
- Whether you want to print crossed out entries.
- Whether you want to print only entries with a specific entry symbol.





Synchronising with a PC Scheduler

You can synchronise the Agenda with the PC agenda on your PC using PsiWin, to ensure that both agendas are kept in step with each other.

Note: Refer to the PsiWin on-line help for details of how to synchronise your diaries.

Synchronising entries with a PC scheduler

You can specify for each entry, whether you want to synchronise it with your PC agenda. Entries that aren't synchronised are marked with a , private entries are marked with a .

1. When adding or editing an entry, press the **Alarm/More** button in the entry dialog, then move to the **Other** page.
2. Tick the **Synchronise** box if you want to synchronise the entry with the PC agenda. Tick the **Private on synchronised agenda** box if you want to keep the entry confidential in the PC agenda.

To change the settings of a whole To-do list, select **Agenda synchronisation** from the **To-do lists** menu. If the To-do list is not synchronised, none of the individual To-dos will be. If the To-do list is set to Private, so are all individual To-dos.

Year view

Year planner 1999

	M	T	W	T	F	S	S	M	T	W	T	F	S	S	M	T	W	T	F	S	S	M	T								
Jan	1	2	3	4	5	6	7	8	9	10	11	12	13	14	15	16	17	18	19	20	21	22	23	24	25	26	27	28	29	30	31
Feb	1	2	3	4	5	6	7	8	9	10	11	12	13	14	15	16	17	18	19	20	21	22	23	24	25	26	27	28	29	30	
Mar	1	2	3	4	5	6	7	8	9	10	11	12	13	14	15	16	17	18	19	20	21	22	23	24	25	26	27	28	29	30	31
Apr	1	2	3	4	5	6	7	8	9	10	11	12	13	14	15	16	17	18	19	20	21	22	23	24	25	26	27	28	29	30	
May	1	2	3	4	5	6	7	8	9	10	11	12	13	14	15	16	17	18	19	20	21	22	23	24	25	26	27	28	29	30	31
Jun	1	2	3	4	5	6	7	8	9	10	11	12	13	14	15	16	17	18	19	20	21	22	23	24	25	26	27	28	29	30	31
Jul	1	2	3	4	5	6	7	8	9	10	11	12	13	14	15	16	17	18	19	20	21	22	23	24	25	26	27	28	29	30	31
Aug	1	2	3	4	5	6	7	8	9	10	11	12	13	14	15	16	17	18	19	20	21	22	23	24	25	26	27	28	29	30	31
Sep	1	2	3	4	5	6	7	8	9	10	11	12	13	14	15	16	17	18	19	20	21	22	23	24	25	26	27	28	29	30	
Oct	1	2	3	4	5	6	7	8	9	10	11	12	13	14	15	16	17	18	19	20	21	22	23	24	25	26	27	28	29	30	
Nov	1	2	3	4	5	6	7	8	9	10	11	12	13	14	15	16	17	18	19	20	21	22	23	24	25	26	27	28	29	30	
Dec	1	2	3	4	5	6	7	8	9	10	11	12	13	14	15	16	17	18	19	20	21	22	23	24	25	26	27	28	29	30	31

Personal

View

Sketch

Today

Go to

Wed 30 Jun: 6:00 **KIMBERLEY'S BIRTHDAY :)** (24 years) »

Entry symbol





EMAIL

You can use the Email program to send and receive:

- **Email** (electronic mail) messages.
- **Fax** messages.
- **SMS** (Short Message Service) messages, i.e. text messages on mobile phones.

Note: This chapter only provides information on how to send and receive **email** messages, and assumes you have set up your Series 5 correctly to use Email. See 'To find out more' at the end of this chapter for details.

Read this first

Before you can send and receive messages you will require:

- For **Email** messages: an email account, a modem and a telephone connection.
- For **Fax** messages: a telephone connection.
- For **SMS** messages: a supported mobile phone and an appropriate SMS account with a telephone network.

Note: See 'To find out more' at the end of this chapter for details.

Using Email

You can use the Email program to create, send, receive and manage your email messages. You can prepare, read and reply to messages while on the move, then connect to your email account when you are ready to send them.

Managing emails





When you first open Email, you will see the "Folders" view which displays your mailboxes, folders and messages. The "Local" folders (on the left) are stored on your Series 5, so you can create and view messages in these folders when you aren't connected.

If you have set up an email account, a "Remote" mailbox will be displayed  (with the name you gave your account) below the Local folders. When people send email messages to you, they will be kept in the Remote mailbox until the next time you connect to it. When you connect, you can transfer (or 'download') messages from your Remote mailbox to the Local folders on your Series 5.

Note: If you haven't set up an email account yet, see 'To find out more' at the end of this chapter for details.

Local folders

When you open Email, the following Local folders are displayed:

-  **Inbox:** contains your incoming messages when you receive them.
-  **Outbox:** contains outgoing messages which you can send when you next connect.
-  **Draft:** contains unfinished messages you are still writing.
-  **Sent:** contains copies of messages you have sent.

You can use Local folders in the same way as you use folders in the System screen:

- You can create a new folder by tapping the **New** button on the Toolbar and selecting **Folder**, or by using the command on the **File** menu.
- You can move and copy messages between folders by using the commands on the **Edit** menu.

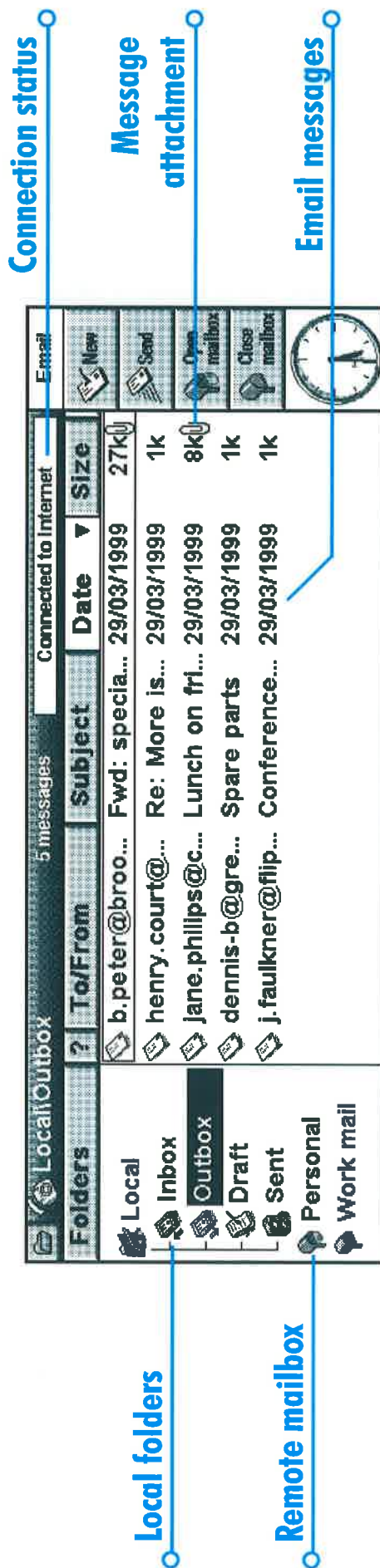



Writing an email

You can write a new email message while working “off-line”, then save it to a Local folder on your Series 5 so you can send it when you next connect. You can save messages in the Draft folder if you want to edit them before sending, or save them in the Outbox folder if you want to send them when you next connect.

Note: You do not need to be connected to your email account (Remote mailbox) to prepare, read and respond to messages; the only time you need to connect is when you wish to send or receive messages.

To write a new email:

1. Tap the **New** button on the Toolbar and select **Email**, or use the command on the **Message** menu. Email displays the “message editor” in which you can write your message.
2. To enter the email address(es) of the recipients of your message, use the following lines:
 - **To**: main recipient(s) of your message.
 - **CC**: recipient(s) you want to send a “carbon copy” of the message to.

- **BCC**: recipients you want to send a “blind carbon copy” of the message to.

Note: You can insert an address from your Contacts address book by tapping **Address** on the Toolbar, or using the command on the **Edit** menu.

3. Type in the title of your message on the **Subject** line.
4. Type in your message at the bottom of the screen (under the subject).
 - You can use the commands on the **Edit** menu to copy, move and find text.
 - You can check the spelling in your message before saving it by using the command on the **Tools** menu.
5. You can send files with your email, e.g. a Word or Sheet document, by adding them as “attachments”. To do this, tap the **Attachments** button on the Toolbar and select **Add**. See ‘Attaching files to messages’ later.



Can I include text formatting or pictures in a message?

No. You can only use plain unformatted text in email messages, but you can attach files to the email containing formatted text and pictures.

Saving unfinished messages as drafts

If you don't have time to finish writing a message, you can save the message as a "draft" in your Local Draft folder. Draft messages are not sent when you connect to your Remote mailbox, and you can edit them as many times as you wish before you send them.

When you've finished writing a draft message, you need to move the message from the Draft folder into the Outbox so that you can send it the next time you connect.

- **To save a message as a draft:** tap the **Save to draft** button on the Toolbar, or select the command from the **File** menu.
- **To edit a draft email:** highlight the message in the Draft folder and tap on it or press Enter.
- **To save a draft message to the Outbox:** highlight the message in the Draft folder, then tap the **Save to outbox** button on the Toolbar, or use the command on the **File** menu.

Message editor

Recipients

05:36:25 am 29/03/1999

Priority: Normal

To: mike.jackson@air-deals.com
katrina.seabrook@air-deals.com

BCC:

Attachments:

Subject: Holiday booking

Hi Mike,

▶ I'd like to confirm my booking for the 3/10/1999.
There's just a few quick questions I need you to answer:

Address Attachments Save as draft Save to outbox

Priority

Message text





Sending email

When you're ready to connect and send your email, make sure all the messages you want to send are in the Outbox folder.

Note: Make sure that your mobile phone or modem is connected to your Series 5.

To send email:

1. Move to the Outbox folder to view the messages you want to send.

2. Tap the **Send** button on the Toolbar, or select **Send from outbox** on the **Transfer** menu, then:
 - Select **All** to send all the messages in the Outbox.
 - Select **Selected** to send only the emails you have highlighted.
 - Select **Email** to send email messages only, i.e. if you don't wish to send fax or SMS messages waiting in the Outbox.

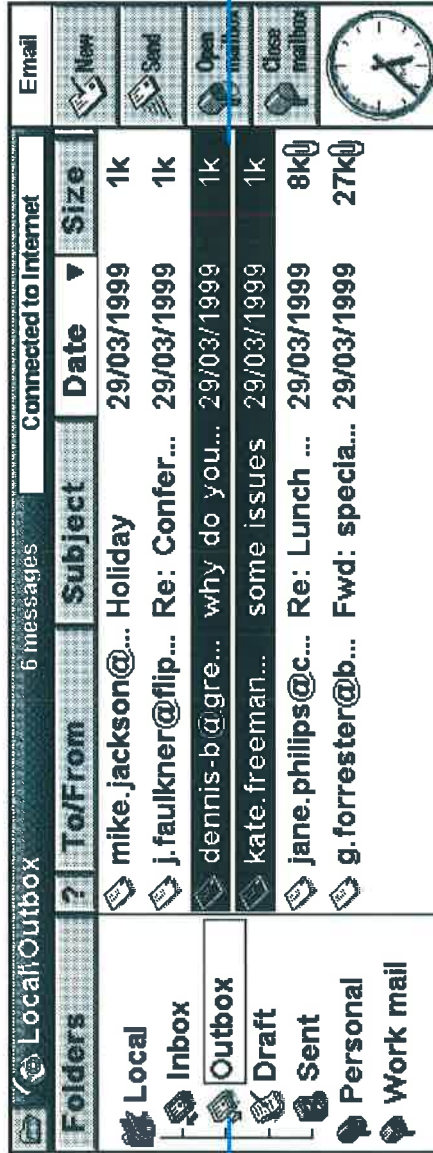

Outbox folder

Messages to be sent

Note: If you are not connected to the Internet, you will be shown details of the connection which your Series 5 will use. Make sure these settings are correct before proceeding. Once connected, your message(s) will be sent.

Email will send the messages from your Local mailbox to your Remote mailbox. Copies of emails that have been sent are placed in the Sent folder; whilst messages which couldn't be sent are left in the Outbox and displayed in *italics*.

Note: Delete messages you no longer require from the Sent folder to save disk space.

How do I send Outbox messages automatically when I connect?

If you want messages in the Outbox to be sent automatically when you make a connection, first select the name of your account from the **Account settings** commands on the **Tools** menu. Then move to the 'Outgoing' page for your account and tick the **Auto send on opening** box.

Receiving email

In order to receive your email, you first need to connect to your Remote mailbox to see your incoming messages. You can then select which messages to download to the Local Inbox folder on your Series 5.

Note: Make sure that your mobile phone or modem is connected to your Series 5.

To connect and receive your email:

1. Tap the **Open mailbox** button on the Toolbar and select the name of your account, or use the **Open** commands on the **Transfer** menu.

Note: If you are not connected to the Internet, you will be shown details of the connection which your Series 5 will use. Make sure these settings are correct before proceeding.

2. When you have connected to your mailbox, you can see all the messages it contains by tapping on the mailbox icon (with your account name shown next to it). The title and details of each message are displayed, with new messages displayed in **bold**.





3. To read the messages in your Remote mailbox, you must transfer (or 'download') them to the Local Inbox on your Series 5. Highlight the messages you want to read then:
 - To copy the message to your Local Inbox, tap the **Copy (Inbox)** button on the Toolbar, or select the command from the **Transfer** menu.
 - To move the message to your Local Inbox, select **Move to inbox** from the **Transfer** menu.

Note: If you move messages from your Remote mailbox, the only copies of these messages will be in the Local Inbox on your Series 5.

- Select **Delete** from the **Edit** menu to delete any messages.
- Note: If you delete messages in the Remote mailbox they will be lost unless you have first copied them to your Local Inbox.

Viewing an email

The messages you transfer from your Remote mailbox to your Local Inbox are displayed in the Folders view. Unread messages are displayed in **bold**. A paperclip symbol  indicates that the message has an attachment (see 'Attaching files to messages').

To view an email:

1. Select the message you want to read and tap on it or press Enter.
2. Once you've read the message you can:
 - Reply to or forward the message by using the **Reply/f'ward** button on the Toolbar or the commands on the **Message** menu.
 - Close the message by using the command on the **File** menu.

Replying to & forwarding emails

You can respond to an email whilst you are reading it, or if you have selected it in the Folders view.

To reply to or forward an email:

- Tap the **Reply/f'ward** button on the Toolbar, or use the commands on the **Message** menu, then select:
 - **Reply to sender**: to reply only to the sender of the original email.
 - **Reply to all addressees**: to reply to everyone who received the original email.
 - **Forward**: to forward a copy of the original email to someone else.

You can now type in your response in the “message editor”. The original message text is included in your message below a ‘Header’. You can change the message address(es), subject, or add an attachment in the same way as you would when writing a new message. See ‘Writing an email’ for more details.

When you have finished writing:

- If you want to send the message the next time you connect, tap the **Save to mailbox** button on the Toolbar.
- If you don’t want to send the message yet, tap the **Save as draft** button on the Toolbar to save the message in the Draft folder.

Can I stop messages being included in my reply?

Yes. You can choose whether to retain the original message text in your response by using **Editor preferences** on the **Tools** menu in the message editor.

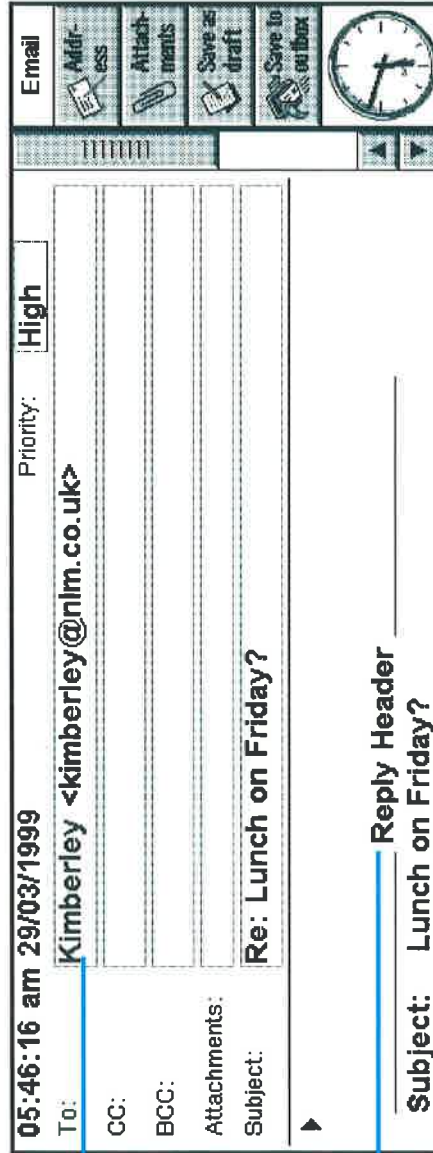

Original author

Header separator





Attaching files to messages

You can send files with emails, e.g. a Word or Sheet document, by adding them as “attachments”.

To add an attachment to a message you are writing:

- Tap the **Attachments** button on the Toolbar and select **Add**. When you attach files to the message they are displayed on the **Attachments** line.

Messages which contain attachments are displayed by a paperclip symbol  in the Folders view. If you have received a message

containing an attachment, you can view the file or save a copy of the file to disk. You can view attached Microsoft Word documents as plain text files.

To view or save an attachment:

1. Open the message containing the file you want to view.
2. Select the attachment on the Attachment line, then tap the **Attachments** button and select:
 - **Open**: to view the attachment.
 - **Save as**: to save a copy of the file on your Series 5's disk.

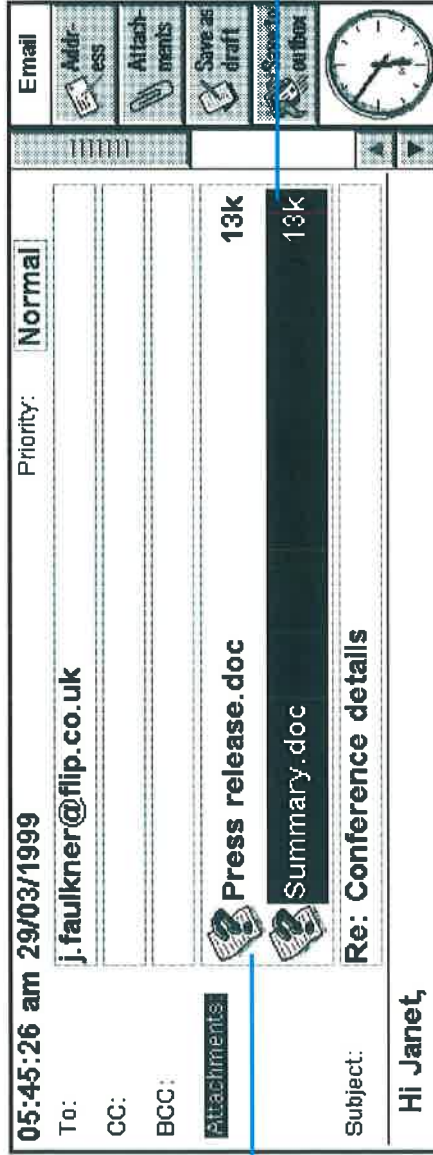

Attached files

File sizes

Disconnecting

When you've finished using email on your Series 5, you can disconnect from your Remote mailbox by closing your email account.

To disconnect from your Remote mailbox:

- Tap the **Close mailbox** button on the Toolbar, or select your account name from the **Close** commands on the **Transfer** menu.

You can disconnect from your email account's Remote mailbox without disconnecting from the Internet, e.g. your "dial-up" connection. You may wish to stay connected to the Internet if you want to open a different mailbox or use the Web program.

To disconnect from the Internet:

- Select **Disconnect from Internet** on the **File** menu.



Important:

You should close any remote mailboxes you have open before disconnecting from the Internet.

Note: For details about setting up and using more than one email account, see 'To find out more'.

To find out more

This User Guide chapter provides an overview of how to send and receive email messages only. For more comprehensive information about what you can do using the Email program, see:

- **Email Getting Started Guide:** a step-by-step guide on what you need to know about using email on your Series 5, and how to set up your machine to send and receive email messages.
- **Email on-line help:** detailed information about all the features of the Email program. To display on-line help about Email, open the Email program and select **Help on Email** from the **Tools** menu.
- **Email manual** (on PsiWin CD ROM): comprehensive information about the Email program, including: setting up your Series 5, sending and receiving email, fax and SMS messages, and using multiple email accounts.





CALC

Calc is the calculator program. It is split into two views: Desk and Scientific. The two calculators are distinct, so you can carry out two calculations at the same time without them affecting each other.

- The Desk view is a desktop calculator which produces a “till roll” output. Use this calculator for general arithmetical calculations, and those involving percentages.

- The Scientific view is a scientific calculator with 26 memories. Use this for more advanced calculations, including those that involve trigonometry or logarithms.

When you first use Calc, it displays the Desk calculator. Use the **Desk** and **Sci** buttons to move between the views, or select the view you want from the **View** menu.

Note: You may find the display suits your style of working better when it is “flipped”, i.e. when the left and right sides of the screen are swapped over. Just tap **Flip layout**, or use the command on the **View** menu.

Desk view

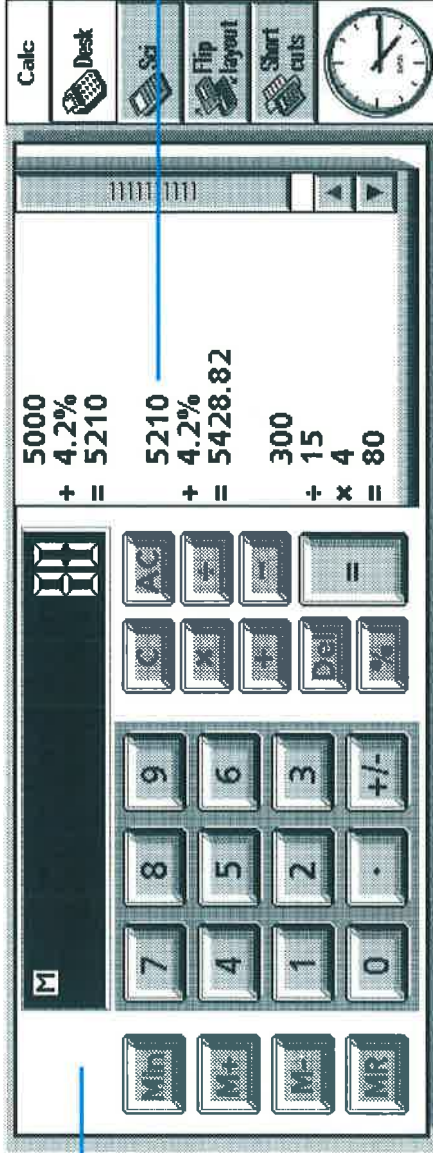

Till roll

General calculations

To perform a calculation in the Desk calculator:

1. Enter your calculation using the number and operator buttons (+, -, × and ÷) on screen or the keyboard. There is no operator precedence in the Desk view: all calculations are performed as you type them in. So, $10 + 5 \times 3 = 45$, not 25.
2. Tap = or press Enter to get the result.
 - Use +/- or the m key to change the sign of a number.
 - Tap the **Shortcuts** button in the Toolbar to display a list of shortcut keypresses.
 - To clear the calculation line without ending the current calculation, press **C**.
 - To clear the calculation line and end the current calculation, tap **AC** or press Esc.

The till roll keeps a record of your calculations so that you can refer back to work you did earlier. The till roll scrollbar will appear when the calculations cover more than one page. To move around the till roll, use the scrollbar or the arrow keys. Use the command on the **Tools** menu to clear the till roll.

Using the memory

You can use the memory to store a value that you want to re-use, or to act as a “running total”. The **Memory** commands are on the **Tools** menu.

- **To store a number in the memory:** tap **Min** or select the **Save in** command while the number you want to store is in the calculation line. An ‘M’ will appear in the calculator display while there is a value stored in the memory.
- **To retrieve a number:** tap **MR** or select the **Recall** command.
- **To add the current number to the number in the memory:** tap **M+** or select the **Add to** command.
- **To subtract the current number from the number in the memory:** tap **M-** or select the **Subtract from** command.
- **To clear the memory:** tap **Min** while 0 is displayed in the calculation line, or select the **Clear** command.





Percentage calculations

Use **%** on the Desk calculator to perform percentage calculations.

- **To calculate 40% of 60:** enter 60×40 , then tap **%**.
- **To increase 60 by 40%:** enter $60 + 40$, then tap **%**.
- **To decrease 60 by 40%:** enter $60 - 40$, then tap **%**.
- **To calculate what % 60 is of 200:** enter $60 \div 200$, then tap **%**.
- **To find the number that 60 is 40% of:** enter $60 \div 40$, then tap **%**.

You can use a combination of the memory and the **%** facility for, say, tax calculations. If you have the rate of taxation stored in the memory, you can quickly add or deduct the tax from any number:

- **To add the tax to a number:** enter the number and tap **+**. Tap **MR** and then **%**.
- **To deduct the tax from a number:** repeat the above, using **-** instead of **+**.

Scientific calculations

To perform a calculation in the Scientific view:

1. Use the number, operator and function buttons to enter your calculation. Enter scientific functions in the order you would write them down. For example, tap **log** BEFORE entering the number you want to find the log of, but tap **x²** AFTER entering the number you want to square.
 2. Tap **=** or press Enter to get the result.
 - Tap the **Shortcuts** button in the Toolbar to display a list of shortcut keypresses.
 - **To clear the calculator display:** tap **AC** or press Esc.
 - **To remove the item immediately to the left of the cursor:** press Del.

You can position the cursor anywhere on the calculation line using the pen or the arrow keys.

Operator precedence

Operator precedence in the Scientific view is as follows (highest first):

- Information in brackets.
- Functions which follow the value to which they refer, e.g. $x!$.
- Powers.
- Implicit multiplication before a memory value, i.e. 30A.
- Prefix functions which precede the value they refer to, e.g. \sin .

- Implicit multiplication before prefix function, such as $5\sin 30$, or before an open bracket, as in $4(4+5)$.
- Multiplication and division equal, calculated left to right.
- Addition and subtraction equal, calculated left to right (lowest).

See the Series 5 help for more about entering expressions and operator precedence in the Scientific calculator.

Scientific or 'Sci' view

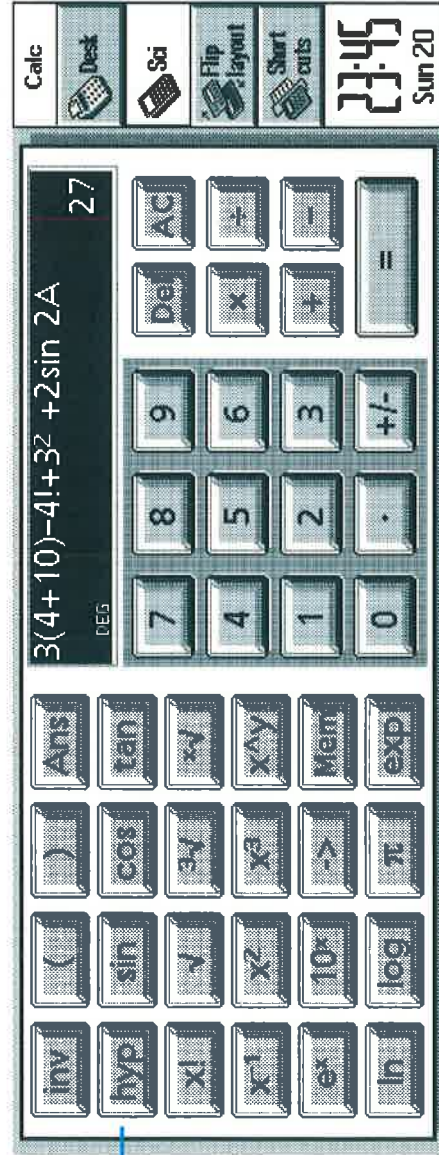



Re-using answers and calculations

In the Scientific view you can re-use the answer from your last calculation.

- **To insert the last answer at any point in a calculation:** tap the **Ans** button at the appropriate point. The calculator will insert 'Ans' in the calculation line, representing the last result.
- **To start a new expression with the last answer:** just enter the rest of the expression as though the answer was already written at the start. The calculator will prefix the expression with 'Ans'.

You can also re-use and edit calculations you have performed earlier. This can save time if you want to perform a new calculation which differs only slightly from a previous one.

- **To re-use a previous expression:** use the up and down keys, or the **Edit previous** and **Edit next** commands on the **Edit** menu, to display the last 10 calculations one by one on the calculation line. When you find the expression you want to re-use, change it if required and proceed as normal.

Note: The value of Ans used in a calculation will always be the value of the last calculation. If you re-use a calculation based on a

value of Ans, the result will be calculated using the current value of Ans rather than the value at the time of the original calculation.

Using the memories

The Scientific calculator has 26 memories, labelled A through to Z. You can assign a value to each of these memories, and then incorporate the names into expressions.

To assign a value to a memory:

1. Enter the number to be stored. If the calculation line is displaying an unsolved expression, the stored value will be the RESULT of the expression.
2. Tap **->**, or select **Assign to** from the **Memories** commands on the **Tools** menu.
3. Type the memory name. As memory names must be entered as a capital letter, you will probably need to hold down the letter key for the memory name.

Note: You can also assign a value to a memory by tapping the **Mem** button, highlighting the memory to use and then tapping the **Assign to** button in the dialog.

- **To display the contents of the memories:** tap the **Mem** button, or select **Show all** from the **Memories** commands on the **Tools** menu.
- **To use a stored number in a calculation:** type the capital letter corresponding to the memory at the appropriate point in the calculation. Alternatively, tap the **Mem** button to display the list of memories, highlight the memory you want and tap **Select**.

Note: You can assign values to the memories in any order you like, so use the names as a reminder of the information they contain. For example, use the T memory for a rate of taxation, Y for the rate of exchange into yen and so on.

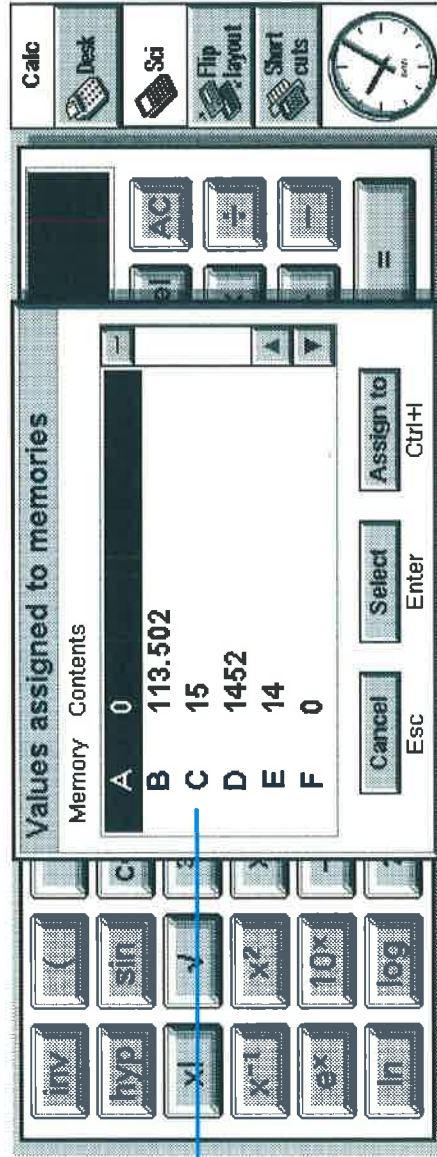

Memory contents





Powers, roots & reciprocals

You can calculate squares, cubes and powers using the buttons in the Scientific view.

- **To calculate the square of a number:** enter the number, tap x^2 , then press =.
- **To calculate the cube of a number:** enter the number, tap x^3 , then press =.
- **To calculate a number to a given power:** enter the number you want to raise to a given power. Tap x^y and enter the power. Press =.
- **To calculate the square root of a number:** tap $\sqrt{\quad}$, enter the number, then press =.
- **To calculate the cube root of a number:** tap $\sqrt[3]{\quad}$, enter the number, then press =.
- **To find the x root of a number:** enter the number of the root you want to find, e.g. 4 for the fourth root. Tap $\sqrt[x]{\quad}$, and enter the number you want to find the x root of. Press =.
- **To calculate the reciprocal (1/x) of a number:** enter the number then tap x^{-1} and tap =.

Trigonometric functions

- **To calculate the sine, cosine or tangent of a number:** tap **sin**, **cos** or **tan**. Enter the number and press =.
- **To calculate the inverse sine, cosine or tangent of a number:** tap **inv** once, then tap **sin**, **cos** or **tan**. Enter the number and press =.
- **To calculate the hyperbolic sine, cosine or tangent of a number:** tap **hyp** once, then tap **sin**, **cos** or **tan**. Enter the number and press =.
- **To calculate the inverse hyperbolic sine, cosine or tangent of a number:** tap **hyp** and **inv** once each to depress them, then tap **sin**, **cos** or **tan**. Enter the number and press =.

Angle formats

The scientific calculator can express angles in degrees, radians and gradients ($360 \text{ degrees} = 2\pi \text{ radians} = 400 \text{ gradients}$). The angle units you use will affect the outcome of trigonometric calculations.

- **To change the angle format:** select the **Formats** command from the **Tools** menu. Select the format you require.

You can also change the angle format by tapping on the abbreviation in the calculation line (e.g. DEG). If the result of a trigonometric calculation is being displayed when you do this, the result will automatically be re-evaluated.

Factorials

The **x!** button in the Scientific view calculates the factorial of a number. A factorial is the result of multiplying all the numbers from a given starting number down to one. So, the factorial of 4 (written as $4!$) is $4 \times 3 \times 2 \times 1 = 24$.

Note: You can use factorials to find the number of ways things can be arranged. For example, if you want to find possible anagrams of a word with four letters, $4!$ shows that there are 24 ways these letters can be arranged.

- **To find the factorial of a number:** enter the number of which you want to find the factorial. Tap **x!** and tap **=**.

Logarithms

You can use the Scientific calculator to calculate logs and natural logs.

- **To calculate the log (base 10) of a number:** tap **log**, then enter the number. Press **=**.
- **To calculate the natural log (base e) of a number:** tap **ln**, then enter the number. Press **=**.
- **To calculate e to a given power:** tap **e^x**, then enter the value you want to find e to the power of. Press **=**.





Displaying numbers

The Scientific calculator can display numbers in the following formats:

- **Normal:** this is adequate for most calculations. Numbers are displayed in standard notation to 12 significant figures, with decimal places and an exponent as required.
- **Fixed:** this format always displays results with a specified number of decimal places, e.g. for currency calculations.
- **Scientific:** you may find this useful for dealing with very large or very small numbers. Numbers are displayed as a single digit to the left of the decimal point, a specified number of significant figures, and then an exponent.

To change the number format: select the command from the **Tools** menu. If you choose Fixed or Scientific, you can set the number of decimal places or significant figures to be displayed.

Exponent notation

You can express very large and very small numbers more succinctly using positive and negative exponents. For example, 57 200 000 can be expressed as 5.72E7.

To express a number as an exponent:

1. Enter the first part of the number, normally as a decimal fraction.
2. Tap **exp**. An 'E' will appear on the calculation line. To express a very small number, tap +/- to insert a minus sign before the second number.
3. Enter the number of decimal places that the first number needs to be moved to the left.





JOTTER

Use the Jotter program to jot down notes and information quickly, for example, when you are on the phone or in a meeting. You can keep each item of information as a separate entry, and search for text to find entries easily.

You may want to use a Jotter file as a quick and easy storage location for pieces of information, and then copy text to a more appropriate file or location later. Alternatively, you could have a number of Jotter files for different subjects or types of notes and keep the information for reference.

Adding a note

- When you first start Jotter, you can start typing a note straight away. You can type as much text as you like or use the **Paste** command on the **Edit** menu to insert text from other programs.
- If your Series 5 is connected to your PC, you can use CopyAnywhere in PsiWin to copy text on your PC and paste it straight into a Jotter entry. You can find out more about CopyAnywhere by looking at the PsiWin on-line help.

Split view

directions to conference

- take exit 22, then 1st left towards the city centre
- keep going until you reach the roundabout next to the cathedral
- turn left, hall is on the right hand side of the street

Last updated 29 March 1999 3/5

Entry date

shopping list

- sales meeting notes
- directions to conference
- spare part numbers
- meeting with jane

Meeting no. View Insert sketch Find New entry

Selected entry

- To insert special characters or symbols in the text use the **Special character** command on the **Insert** menu and select the character from the list.
Use the **View** button on the Toolbar to change between the Jotter views. Edit view displays one entry using the full width of the screen, List view displays a list of text from each entry, and Split view shows the list and the text of the current entry. You can add entries from any view.

Starting Jotter with a blank entry.

When you open a Jotter file, you will see the entry you were using the last time you opened the file. If you want to add an entry, you have to use the **New entry** command. To save time when you want to quickly type a note, you can set up Jotter so that it always starts with a blank entry. To do this, use **Entry preferences** from the **Tools** menu.

Formatting the text

- **To insert a bullet:** Move the cursor to the paragraph and select the **Bullet** command from the **Text** menu. To remove a bullet from a paragraph, move the cursor to the paragraph and select the command again to remove the tick.
- **To format text:** Highlight the text you wish to format and use the commands on the **Text** menu to change the font, size of the text, underline the text or make it bold or italic.





Inserting other information

To insert the date:

- Select **Date** from the **Insert** menu. Note that Jotter can display either the date that you created the entry, or the date it was last changed. See 'Customising Jotter' for more details.

To insert a sketch:

1. Select **Sketch** from the **Insert** menu, or tap the **Insert sketch** button on the Toolbar.
2. Draw the sketch, then tap the **Done** button to return to Jotter and insert the sketch.

To insert other objects, i.e. a graph, table, text or a sound, select **Other object** from the **Insert** menu and then select the program you want to use. Create the information you want to insert then tap **Done** when you've finished.

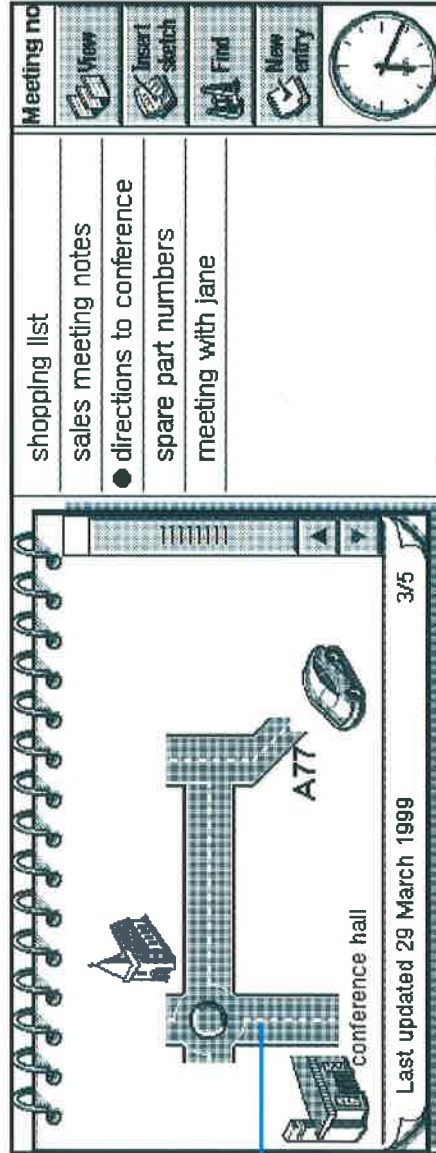

Inserted sketch

- You can include Sheet information as a graph or table, so display the information as you want it to appear before tapping **Done**.
- To change the appearance of a Sheet or Sketch object, select **Format Object** from the **Object** commands on the **Edit** menu. You can change the size, crop the edges or just display the object as an icon. Note that Jotter can only display inserted sounds and Word objects as icons so you cannot change any format settings.
- If you wish to make changes to a sketch, graph or other object in a Jotter entry, highlight the object and press Enter. Change the object as required, then tap **Done** to return to Jotter and update the object.

Finding a note

If you need to find a particular entry, you can:

- **browse for the entry in the List or Split view.** To display text from the entries in a list, tap the **View** button on the Toolbar and select either **List** or **Split**. The List view may be useful if you can identify the entry from the first few words. The Split view shows the text in the current entry as well as the list.
- **search for text in the entry.** To do this, tap on the **Find** button on the Toolbar, or select the command from the **Edit** menu. Type the text you want to find, then press Enter to search all the entries and display the first entry that includes the text. Use **Next** and **Prev** to move between the entries in the search results. Tap **Done** to end the search and display all the entries again.

Deleting entries

If you don't want to keep a Jotter entry, select the entry and use **Delete entry** from the **Edit** menu to delete it. If you accidentally delete an entry, you can restore it by using **Undo delete entry** on the **Edit** menu.





Customising Jotter

You can change some aspects of how Jotter looks and works using the commands on the **Tools** menu.

- To display either the date you created an entry, or the date you last updated it, use **View preferences** in the Split view.
- You can display the list of entries in the Split view on the left or right, or change the proportion of the screen taken up by the entry and title list. To change these settings, move to the Split view and select **View preferences**.
- You can change the amount of information included in the list of entries in the List and Split view using the **Entry preferences** command. You can display as much of the text as will fit (with a comma marking different paragraphs) or just the first line of the entry. You may want to do this if you want to use the first line of the entry as a title.

Sorting entries

Jotter lists entries in the order in which you add them, with the newest entries at the end of the list. To sort them into alphabetical or date order:

1. Select the **Sort** command from the **Tools** menu.
2. Specify how you wish to sort the entries, e.g. alphabetically or by date.
3. Specify whether to sort the entries in ascending or descending order. For date ordering, ascending order means that Jotter lists the most recently added or updated entries last.

Jotter files

If you wish to start a new Jotter file, select **Create new file** on the **File** menu.

To combine the entries of two Jotter files, first open one of the files in Jotter. Select **Merge in** from the **More** commands on the **File** menu, then select the name of the file you want to merge.

Printing Jotter entries

You can print the current entry or all the entries in the current view using the **Printing** commands on the **File** menu.

- **To check the printer model:** select **Print setup**. If the printer model displayed is not the printer that you're using, use the **Printer** button to select the correct printer.
- **To set up the page for printing:** select **Page setup**.
- **To see how the information will look:** select **Print preview**.
- **To print:** select **Print**, then choose whether to print just the current entry or all the entries in the current view and tap **Print**.

Note: Refer to the instructions in the 'Printing' chapter to select a printer.





TIME

You can use the Time program to set, display and manage alarms, and to display a map of the world that gives you information on cities, times and dialling codes.

The Time program has two views: the Map view and Alarms view. To switch views, tap the **Map** or **Alarms** button on the Toolbar, or use the commands on the **View** menu.

Using alarms

You can use the Alarms view to set alarms that will ring even when your Series 5 is switched off, e.g. a 'repeating' wake-up alarm that will ring each day you work, and 'once only' alarms to remind you of appointments.

The Alarms view allows you to set up to 8 alarms, each up to 7 days ahead, and control their sounds.

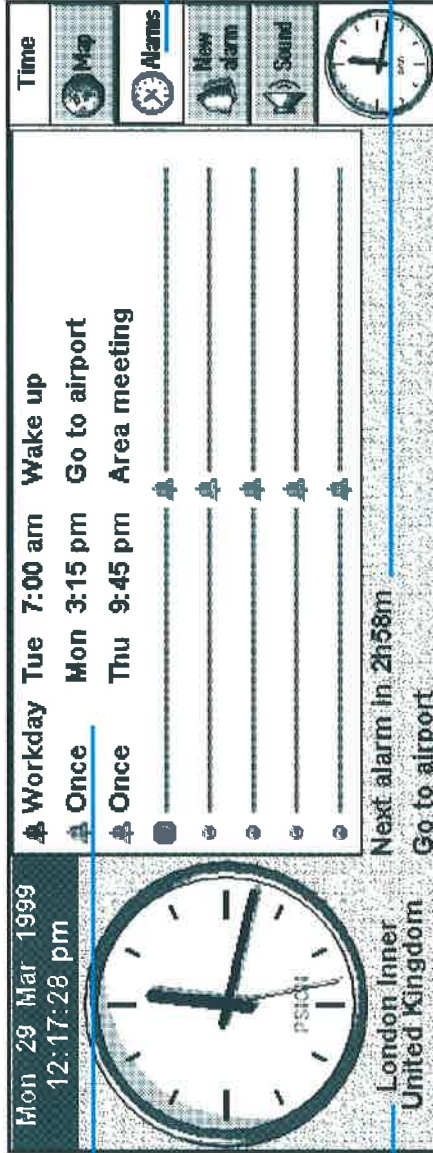

Alarms

Alarms view

Home city

Next alarm

Setting an alarm

To set a new alarm, move to a blank line and then tap on it or press Enter (or just start typing the alarm text or the time you wish the alarm to ring). Alternatively, select the **New alarm** command from the **Edit** menu or Toolbar.

- I. Set the time at which you wish the alarm to ring, and select one of the following alarm types:
 - ‘Next 24 hours’, if the alarm is to ring once at the specified time during the next 24 hours, or ‘Once only’, followed by a day, if you wish the alarm to ring once at the specified time more than 24 hours from now.
 - ‘Daily’, if you wish the alarm to ring every day of the week at the specified time, or ‘Weekly’, on a particular day, if you wish the alarm to ring at the specified time on that day every week.
 - ‘Workdays’, if you wish the alarm to ring at the specified time on each day you work. If your workdays are not Monday to Friday, select the **Workdays** command from the **Tools** menu.

2. Type the text you wish to be displayed when the alarm rings. This text will remain on screen until you respond to the alarm, so do not enter anything you do not wish others to see.
3. Select the required alarm sound, or ‘Silent’ if you wish the alarm to ring “silently” (you’ll still see the alarm text on screen). To hear the selected sound now, press the **Test sound** button.

Note: A selection of alarm sounds is supplied with the Series 5, but you can also select any sound that you have created as an alarm sound yourself. See the ‘Record’ chapter for more details.





Responding to an alarm

When the time and date correspond to an alarm that has been set in Time or Agenda, the alarm rings and the alarm text is displayed on screen. The voice note LED will flash to indicate that an alarm is ringing.

- **To clear the alarm:** press the **Clear** button or press Esc. If it is a once only alarm, it is removed. If it is a repeating alarm, it is automatically set to the next time it is due to ring.

- **To silence the alarm but leave the text displayed:** press the **Silence** button or press Enter. If the Series 5 is closed when an alarm rings, you can silence it by pressing any of the voice note buttons on the outer casing.

- **To 'snooze' the alarm (i.e. to stop it from ringing) for 5 minutes:** press the **Snooze** button or press the Spacebar - each further press adds 5 minutes to the 'snooze' time, up to a maximum of one hour. You can carry on using the Series 5 while the alarm is 'snoozed'.

Alarm warning

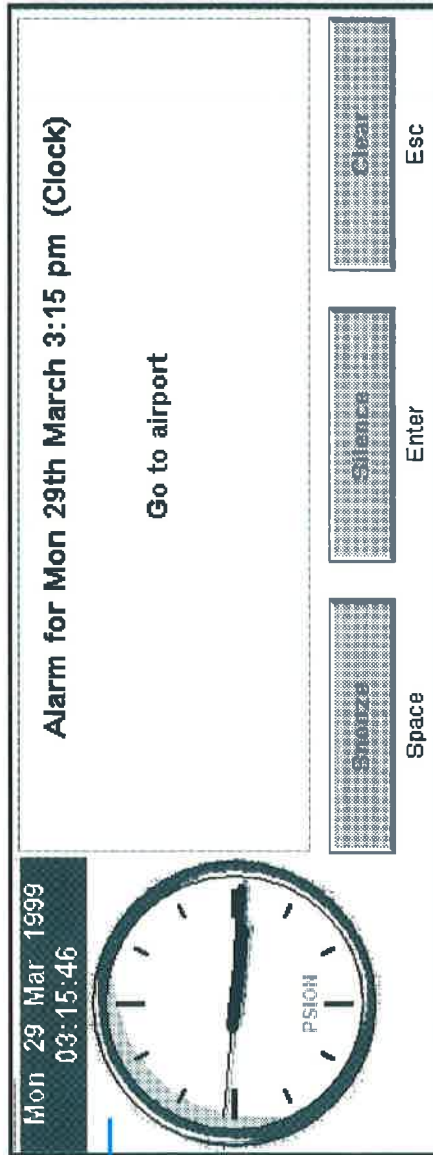

The alarm will snooze automatically for 5 minutes if you press one of the external voice note buttons, or a Program icon to move to another program, while an alarm is ringing. You don't have to press the **Snooze** button. After this time, the alarm will ring again.

Note: If you are recording a voice note or other sound when an alarm is due to ring, the alarm will be delayed until you have finished the recording.

Changing & deleting alarms

If you wish to change any aspect of an alarm you have set, e.g. the time or the alarm text, move to the relevant line and press Enter or select the **Change alarm details** command from the **Edit** menu.

To remove an alarm, move to the relevant line, and press Del or select the command from the **Edit** menu. You can also delete any alarms that were set using the Time program from the **View next alarms** list. To delete one, highlight it and press the **Delete** button or key.

Note: When you delete a 'repeating' alarm, it is deleted for all days on which it is due to repeat.

Silencing alarms

If you wish to silence alarms for a particular period, e.g. the duration of a meeting or journey:

1. Tap the **Sound** setting at the bottom of the screen. Alternatively, select **Sound** from the Toolbar or **Tools** menu.
2. Set the alarm sound to 'Silent for' and specify the duration you wish alarms should be silenced. If you wish to silence alarm sounds indefinitely, set the alarm sound to off.

Note: When a 'silenced' alarm rings, the alarm text still appears on screen, and you need to respond to it as you would for an audible alarm.

- If you wish to stop an alarm from ringing without deleting it completely, e.g. if you wish to suspend your wake-up alarm while you are on holiday, move to the relevant line and select the **Disable alarm** command from the **Edit** menu. The alarm has a line drawn through it to show that it is no longer active.
- To make the alarm active again, move back to the relevant line and deselect **Disable alarm**.





Viewing alarms

The countdown to the next alarm, whether set in Time or Agenda, is given at the bottom of the screen. Use the **View next alarms** command on the **Edit** menu to view the alarms that are to ring in the future, and the **View past alarms** command to list the last 8 alarms to have been cleared (e.g. if you cancel an alarm, but need to be reminded of the alarm text).

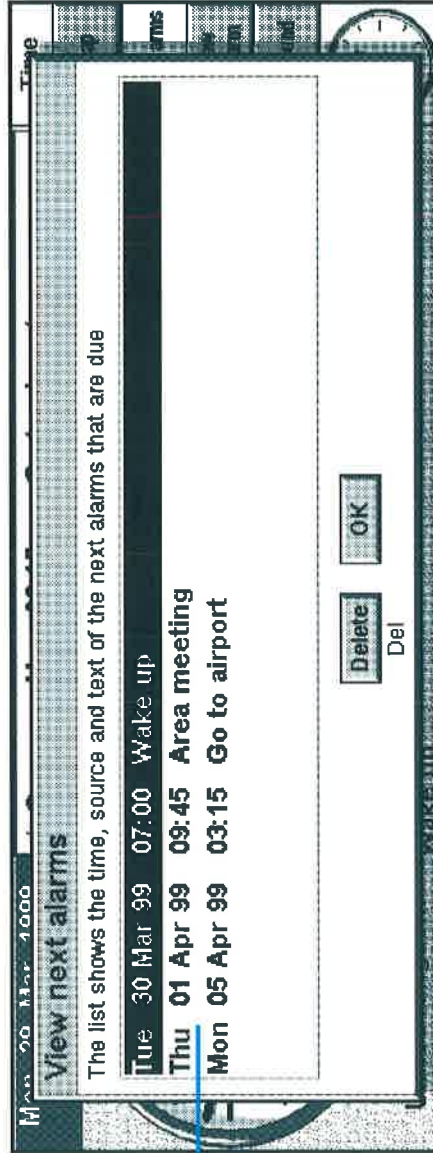

Next alarms

Using the map

You can use the Map view to display information for cities around the world. Set the city in which you are currently located as your 'Home' city, and then select other cities to find their time differences, dialling codes and distances from your Home city.

Important: In order for world information to be accurate, make sure you have defined your Home city, and the current time and date. Refer to the 'Getting started' chapter.

Selecting a country or city

To select a particular country or city, move to the country or city line at the bottom of the screen, and then:

- Start typing the name of the required country or city. Continue typing until the correct city and country combination is displayed, or use the right and left arrow keys to scroll through the available countries and cities in alphabetical order until you come to the one you require.



Home city

Selected city

Map view





- If you scroll through the countries, only the capital cities are listed. If you wish to view only the cities in one particular country, select the country, and then select the **Cities in current country** command from the **View** menu. To go back to displaying cities for all countries, reselect the command.

When you select a city, the cross hairs on the map move to the selected city, and information about the city appears at the bottom of the screen.

- The time difference between the Home city and selected city is displayed. This includes the difference in “GMT (Greenwich Mean Time) offsets” (the time zone difference) and includes a correction for summer time if necessary. For information about summer times, refer to ‘Setting summer time’ later.
- The code next to the telephone symbol at the bottom of the screen shows the digits needed to dial the selected city from the Home city.

Adding a town or city

If a place you require is not included in the Map view, you can add it:

1. Select the **Add city** command from the **Edit** menu.
2. Type the name of the city, its country, the latitude and longitude if known (this allows accurate distances and sunrise and sunset times to be calculated), the telephone area code, the GMT offset, and ‘Summer time zone’ (see ‘Setting summer time’ later in the chapter).
3. Position the intersection of the cross hairs on the town or city location, using the pen or the arrow keys.
You can select the command from the **Edit** menu to subsequently change any of the city details.

You can only delete a non-capital city that you have added to the map yourself. To do this, select it at the bottom of the screen and then select the appropriate command from the **Edit** menu.

Adding a country

If a country you deal with is not included in the Map view, you can add it:

1. Select the **Add country** command from the **Edit** menu.
2. Type the country's name, its national dialling code, its national dialling prefix (i.e. the digit(s) that needs to be dialled immediately prior to each city area code when telephoning from one city to another within the country) and its international dialling prefix.
3. Each country must have a capital city, and a dialog is automatically displayed for you to create one. Complete it as in the previous section.
4. Position the cross hairs on the capital city's location, using the pen or arrow keys.

You can select the commands on the **Edit** menu to change any of the country or capital city details.

Note: You can only delete a country that you have added to the map yourself. To do this, select it at the bottom of the screen and then select the appropriate command from the **Edit** menu.

Customising Time

To change the city clocks from 'analog' to 'digital', or vice-versa, tap the clock that is displayed next to either the Home or selected city. You can also change the Toolbar clock by tapping it.

The distance from the Home city to the selected city is given in the currently selected units (Kilometres, Miles or Nautical miles). These units can be changed using the command on the **View** menu.

Select the **Formats** command from the **Tools** menu if you wish to change:

- The clock format, e.g. from 12 to 24 hours.
- The time separator (usually ':' as in '6:19 pm').
- The date format (e.g. 'Day Month Year' or 'Month Day Year').
- The date separator (e.g. '/' as in '01/03/97').

You can also set preferences for a standard alarm time if you tend to set alarms for the same time of day, or for a particular alarm sound to appear when you set a new alarm.





Setting summer time

If you are not interested in making use of world times, and are happy to use the **Time & date** command to change the time when clocks go forward or back, you can ignore this section.

However, if you travel or wish to be precise about world times, you should set your own time to 'winter time' (in the UK, this is GMT), and modify the 'summer time' setting when the clocks go forward or back.

You can also take into account the 'summer times' used in the different areas of the world. Most of the cities on the world map can be included in one of 3 basic areas, or "Summer time zones" - 'Europe', 'Southern' and 'Northern'. The approximate 'summer times' for these zones are:

Europe	End of March to end of October.
Northern	Early April to end of October.
Southern	Late October to end of February.

Each city on the map is associated with one of these zones, or with 'None'. To check what the Summer time zone is for a city, select the city in the Map view, and then select **Change city details** from the **Edit** menu.

When the clocks are due to go forward or back in the cities in a particular Summer time zone:

1. Select the **Summer times** command from the **Tools** menu.
2. Tick the time zone if it is changing to summer time; remove the tick if it is changing back to winter time. If your Home city is in that zone, then 'Home' is ticked automatically and the Series 5 clock will adjust accordingly.

The clocks, and sunrise and sunset times, for each of the cities associated with the 'Summer time zone' are changed.

Note: If the Home city has a 'Summer time zone' of 'None' because it is not in one of these 3 zones, but its clocks are due to change, you can change the Series 5 clock to 'summer time' by ticking 'Home'.

When you travel

Whenever you travel, reset your Home city to the town or city to which you have travelled. Then, provided that the city details and 'summer time' setting are correct on the Series 5 for the city to which you have travelled, the information in the Map view will automatically be accurate.





DATA

You can use Data to store information like a card index system, with a separate entry for each "card".

When you first use Data, the "labels" (e.g. Subject:, Notes:, and so on) are designed so that you can start a "knowledgebase" of information straight away. You can use the standard labels to keep track of items of information about different subjects in

one file or in different files. For example, you may want to keep a database for notes about software products, another one for interesting Web sites, and another for restaurants you want to visit.

You can also create databases for other types of information by changing the labels to match the information you wish to enter. See 'Customising the database' later.

Labels

The screenshot shows a window titled 'Data' with a menu bar (File, Edit, View, Help) and a toolbar. The main area displays a card for 'Modems' with the following fields:

- Item: Modems
- Supplier: Intertrade Ltd
- Notes: fax order

At the bottom of the window, there is a 'Find:' field and 'Prev' and 'Next' buttons. The status bar at the bottom right shows '10/12'.

Card view

The screenshot shows a window titled 'Data' with a menu bar (File, Edit, View, Help) and a toolbar. The main area displays a list of parts:

- CPU's
- Cables
- Cases
- Graphics cards
- Keyboards
- Monitors
- Mouse mats
- Motherboards
- Modems
- Printers

At the bottom of the window, there is a 'Find:' field and 'Prev' and 'Next' buttons. The status bar at the bottom right shows '13:06 Mon 29'.

Card

Card browser

Adding an entry

You can add entries in any order. You can sort them into alphabetical order later; see 'Sorting entries' later. To add an entry:

1. Tap the **New entry** button or select the command from the **Edit** menu.
2. Type the information in the appropriate boxes. If you don't have any information for one of the labels, you can leave the box blank.
 - Tap on a label or use the Tab key to move between the boxes. Use the scroll bar to move to boxes which are not currently displayed.
3. While you're typing, you can use the arrow keys to move the cursor around the text. Press Enter to start a new line of text.
 - Use the **Object** button to insert information from another program, e.g. a sketch. Select the program to use, then use the other program to create the "object". Close the other program to return to Data.
4. Use the **Save** button when you've finished typing an entry. This saves the information you've typed, and clears the dialog so that you can type another entry.
5. Use the **Close** button when you have finished adding your entries.





Looking at entries

Data has two views you can use to look at entries. The Card view shows the information for each entry as a single page. A list of entries is shown in the Card browser next to the page; the currently displayed entry is marked with a bullet. The List view shows entries in a list, one entry per line, like a telephone directory.

- Tap the **Cards** button or the **List** button to move to a view, or select the commands on the **View** menu to switch between the views.

- In the Card view, tap on an entry from the Card browser to display the entry. You can also use the **Next** and **Prev** buttons or left and right arrow keys to move between entries.

- In the List view, use the up and down arrow keys to move through the list. You can use the scroll bars or the left and right arrow keys to see the other columns not currently shown.

Labels

Item	Supplier	Price (\$)	Notes
Anti-glare	Vision International	199.00	
CPUs	GM Components	299.00	
Cables	GM Components	9.00	
Cases	GM Components	35.00	
Graphics cards	ERS Europe	85.00	
Keyboards	GM Components	23.00	
Monitors	Vision International	14.00	
Mouse mats	JDF distribution	4.00	
Motherboards	GM Components	82.00	
● Modems	Intertrade Ltd		

List view

Sorting entries

Entries are listed in the order you add them. To sort them into alphabetical order, select the **Sort by label** command from the **Tools** menu. You can sort by any label and can also set the number of the labels to sort by, if you wish to sort by more than one label.

For example, in a database where you keep lists of your CDs, you could sort using the 'Artist' label, or the 'Title'. Or, you may wish to sort using both labels, 'Artist', then 'Title'.

Note: See 'Customising the database' for more about setting up a database with different labels.

Customising Data

To change the order of the labels in the Card view, and the columns in the List view, and change the way the labels are displayed:

1. Select the **Label preferences** or **Column preferences** command from the **Tools** menu.
2. Tap the label or column , or press the Spacebar to tick the label(s) or column(s) you wish to change, then use:
 - the **Move up** or **Move down** buttons to move them to a new position with respect to the other labels or columns.
 - the **Hide/Show** button to "hide" the label or column so that its information will not appear in the Card view or List view. You may wish to do this if the information is confidential and you do not wish the information to appear on screen in the Data views. Even if a label or column is hidden, you can still view and edit its information when you add or edit an entry.
 - the **Font** button to change the font size or type, or apply other formatting to the text.

You can also use the **View preferences** command in the Card view or List view to control how each view looks.





Finding an entry

You can find a particular entry, or a number of entries, simply by typing the text or characters that you want to find into the 'Find:' box. You can do this in either view.

- Start typing some text that you know is included in the entry you wish to find. Press Enter to display all the entries which contain the text.

Note: The information next to every label is searched, so you can find an entry by typing text that is beside a "hidden" label.

You may prefer to limit the labels that are searched, to make finding entries quicker:

- Select the **Find by label** command from the **Tools** menu, and tick the label(s) you want to use for searching. Add or remove a tick by pressing the Spacebar or by tapping the label with the pen.

Changing or deleting entries

To change the contents of an entry:

1. Select the entry by displaying it in the Card view, or by highlighting the line for the entry in the List view.
2. Tap the **Edit entry** button or select the command from the **Edit** menu.
3. Change the information as required, and press the **Save** button to save your changes.

To delete an entry:

1. Select the entry as described above.
2. Select the **Delete entry** command from the **Edit** menu.

Note: If you delete an entry by mistake, you can undo the damage by selecting the **Undo delete** command from the **Edit** menu.

Customising the database

You can use Data to store many different types of information. All you need to do is create a new file then change the labels in the file.

You can change the text in any label, or add or remove labels. If you wish, you can set up a new set of labels so that you can use a Data file for information other than names and addresses.

Important: It is best to set up the labels you want before you start to type in your entries.

To change the labels:

1. Select the **Change labels** command from the **Tools** menu.
2. Select a label and use the **Delete** button to remove it, or use the **Edit** button to change the existing text.

Note: When you delete a label, the information associated with it will be lost.

The screenshot shows the Data software interface. On the left, a detailed view of an entry for 'Anti-glare screens' is displayed. The entry includes the following information:

- Description: Anti-glare screens
- Order No.: 54030523/A
- Part No.: 2924942SDF
- Supplier: Eyeshield Inc.
- Price per item in \$US: 15.60
- Lead time (working days): 7
- Amount in stock: 3
- Re-order Y/N?: Yes

At the bottom of this view is a 'Find:' field with a search icon, and 'Prev' and 'Next' buttons. A page indicator '1/65' is visible in the top right corner of this window.

On the right, a list of items is shown in a table-like format:

- Anti-glare screens
- CPU's
- Keyboards QWERTY
- Memory disks 2Mb
- Memory disks 4Mb
- Memory disks 10Mb
- Monitors
- Mouse mats
- Printed circuit boards
- Printers - Series 3
- Printers - Series 4
- User Guides

At the bottom of the list are navigation arrows. To the right of the list is a vertical toolbar with icons for 'Stock', 'Cards', 'List', 'New entry', 'Edit entry', and a clock icon.





Adding labels

Use the **Change labels** command and the **Add** button to add labels to a database. You can add labels for different types of information, e.g. text, numbers, dates, Yes/No only, and specify the number of characters which can be typed for a text label.

You can also use the **Options** button to control how the label information is handled by the Data program, e.g. if the label should be checked when looking for telephone numbers when DTMF dialling is used, and how many characters are used when sorting the entries.

Important: It is not possible to change the data type for a label or the number of characters length of a text field after the label has been set. It is best to plan the database and label types first.

Printing Data entries

You can print all your Data entries, the current card, or choose a set of entries to print by typing a search clue.

- Before you print, refer to the instructions in the 'Printing' chapter to select a printer.

To print Data entries:

1. Display the entries to print by typing a search clue which the entries you want to print will contain. If you want to print all the entries, press Esc to make sure that all the entries are included.
2. Use the **Printing** commands on the **File** menu:
 - Use the **Page setup** command to control the page size, margins, and add headers and footers. See the 'Printing' chapter for more details.
 - Use the **Print setup** command to specify how the entries will appear in the printed copy.
 - Use the **Print preview** command to display pages showing how your printed copy will look.
 - Use the **Print** command to print your entries.





SKETCH

You can use Sketch to produce pictures, including maps, freehand sketches, invitations etc.

You can start straight away, by drawing freehand with the pen on the screen. However, you may want to change the “pen” or “paper” before you begin to draw.

You can select:

- The “tool” to draw with. Each type of line or shape you can draw has a tool which you can select. When you start Sketch the Freehand drawing tool  is selected.
- The colour of the tool. The default drawing colour is black. To change the shade tap on a colour in the Toolbar, or select the **Colour** palette tool from the **Tools** menu.

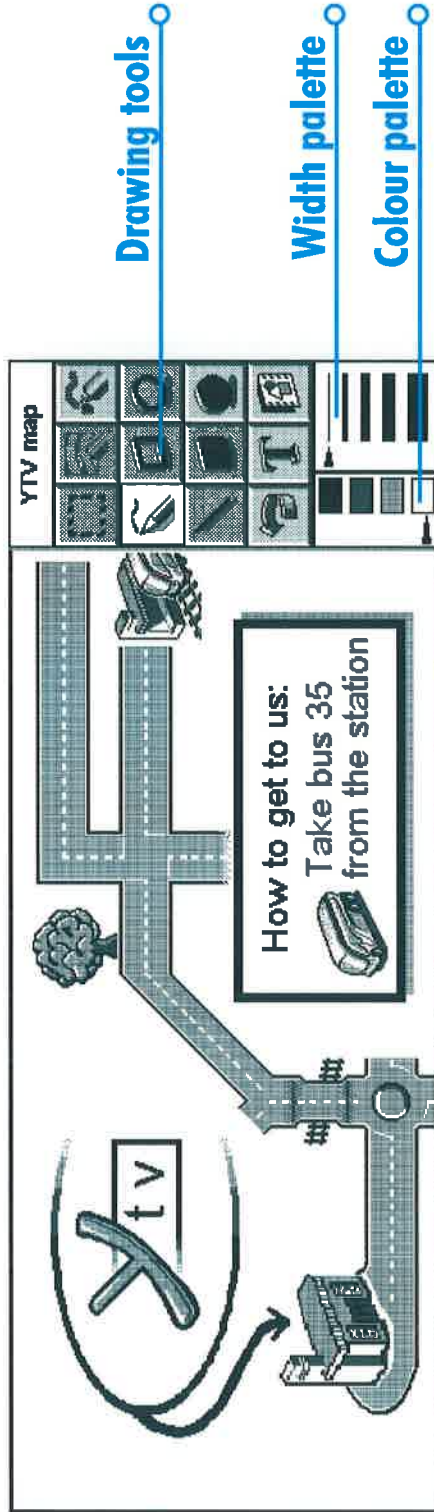







- The width of the line for the drawing tools and the erase tool. To change the width tap on a width in the tool bar, or select the **Width** palette tool from the **Tools** menu.
- The size of the sketch or the area on which you can draw. When you first start this is set to the same size as the screen. If you want to make it larger, select the **Resize sketch** command from the **Tools** menu and type in the new size. If the sketch is larger than the screen, you can use the scroll bars to move around the screen.

What are pixels?

You can specify some settings used in Sketch in “pixels”, e.g. the pen width. Pixels are dots on the page which are combined to make up a picture. For example, when you draw a line on the page Sketch treats it as a number of coloured pixels grouped together to form a line. If you later want to change the line, you have to edit each pixel.

Drawing sketches

- Tap on a button in the Toolbar to select a different drawing tool, or select a drawing tool from the **Tools** menu.
- Change the pen colour and width **before** starting to draw.

- Use the pen to draw, or hold down the Shift key and use the arrow keys.
- **To draw a straight line:** tap , or select the **Line** drawing tool from the **Tools** menu. To draw a vertical line, horizontal line or one at 45 degrees hold down the Ctrl key as you draw.
- **To draw either hollow or filled circles and ellipses:** tap  or , or select the **Oval** or **Filled oval** drawing tools from the **Tools** menu. You can draw a circle by holding down the Ctrl key as you draw.
- **To draw either hollow or coloured squares and rectangles:** tap  or , or select either the **Rectangle** or **Filled rectangle** drawing tools from the **Tools** menu. You can draw a square by holding down the Ctrl key as you draw.
- **To draw in a similar style to using a can of spray paint:** tap , or select the **Spray** drawing tool from the **Tools** menu.





Note: If you use the keyboard to draw, the drawing will start from the current cursor position. You might find it useful to show the cursor position so you can see where the drawing will start. You can use the commands on the **View** menu to view the cursor position as cross hairs, or as a message showing the number of pixels across (the X co-ordinate) and down (the Y co-ordinate).

Changing a sketch

You can change a sketch in two ways:

- by selecting an area and changing the selected area, e.g. moving, rotating, flipping or resizing it.
- by editing the pixels which make up the sketch.

To view the sketch in more detail, select the **Zoom in** command on the **View** menu. When you zoom in on a picture you can see the pixels comprising the picture and edit them individually.

Selecting & moving objects

- **To select part of the picture:** tap , or select the **Select area** command from the drawing tools on the **Tools** menu, then use the pen or arrow keys to drag a box over the area.



- **To select the whole picture:** select the **Select all** command from the **Edit** menu.
- **To resize an area:** select an area, then use the pen to drag one of the “handles” surrounding the area to a new position to enlarge or reduce the area. Use a handle at a corner to resize both the horizontal and vertical dimensions keeping the same proportions; the handle from the midpoint of a horizontal “edge” to resize only the vertical dimension, and the handle from the midpoint of a vertical edge to resize only the horizontal dimension.
- **To resize an area using the keyboard:** select the area then hold down the Shift key and use the arrow keys to move the cross hair of the cursor onto one of the handles surrounding the text. When the cursor is positioned directly over the handle, release the Shift key and use the arrow keys to resize the area. Press Enter to fix the selected area to the sketch.
- **To move an area:** select an area then tap inside the selected area with the pen and drag the area to the new position. You can also or move the area using the arrow keys. Tap elsewhere press Enter to fix the selected area to the sketch.

You can turn selected areas over, and turn them round at angles of 90 degrees.

- **To flip part of a sketch:** select the area and then select either the **Flip horizontally** or **Flip vertically** command from the **Transform** menu.
- **To rotate part of a sketch:** select the area and then select the **Rotate** command from the **Transform** menu.



Transparency

When you move a selected area you can “overlay” it on top of an existing area of the sketch. You can specify whether the existing sketch shows through by making areas “transparent”.

- To make a selected area transparent either press the  button in the Toolbar, or ensure that the **Make transparent** command on the **Transform** menu is ticked.
- To make the selected area opaque (so that any underlying sketch does not show through), either press the  button in the Toolbar or remove the tick from the **Make transparent** command on the **Transform** menu.

Erasing & undoing

You can delete either all or part of your sketch, or undo up to the previous five actions you performed:

- To delete part of your sketch tap , or select the **Erase** drawing tool from the **Tools** menu. Use the pen or the arrow keys to delete part of the picture, starting from the cursor position.
- **To change the width of the Erase tool:** tap on a width in the Toolbar, or select the **Width** palette tool from the **Tools** menu. Change the width as required.
- **To delete the whole sketch:** select the **Delete all** command from the **Edit** menu.
- Tap , or select the **Undo** command from the **Edit** menu to remove the last action performed.





Changing colours

You can change the colour of an area by selecting a different colour and using the Freehand drawing tool to draw over the existing colour. You can select the **Zoom in** command from the **View** menu to view the picture in more detail, and change the colour of the individual pixels.

Use the **Reverse colour** command from the **Transform** menu to invert the colour of a selected area. For example, reversing the colour of an area makes any black areas white and vice versa.





Cutting out, cropping & re-sizing

You can cut out part of a picture by selecting the area to remove and selecting the **Cut** command from the **Edit** menu.

To remove unused space from around the edges of a sketch, select the **Crop** command from the **Tools** menu.





Adding text

To add text to your picture:

1. Tap , or select the **Insert text** command from the **Tools** menu.
2. Type in the text. You can format the text before you insert it using ,  or , and use the **Set Font** button to set the font type, size, colour and printing position of the text.
3. Press the **Insert** button to add the text to your picture.
4. The text is selected when you insert it into the sketch. You can move or resize it as usual.
5. Tap elsewhere on the screen or press Enter to fix the text onto the sketch.

Inserting "clipart"

Sketch includes a gallery of "clipart" pictures which you can insert into a drawing:

1. Tap , or select the **Clipart** command from the **Tools** menu. The clipart palette is displayed.
2. To select a piece of clipart either tap the picture, or use the arrow keys to select a picture and press Enter. You can rotate the clipart, for example, if you draw an arrow  then flip it vertically you get . Rotating  once provides .
3. The clipart is selected when you insert it into the sketch. You can move or resize it as usual.
4. Tap elsewhere on the screen or press Enter to fix the picture onto the sketch.

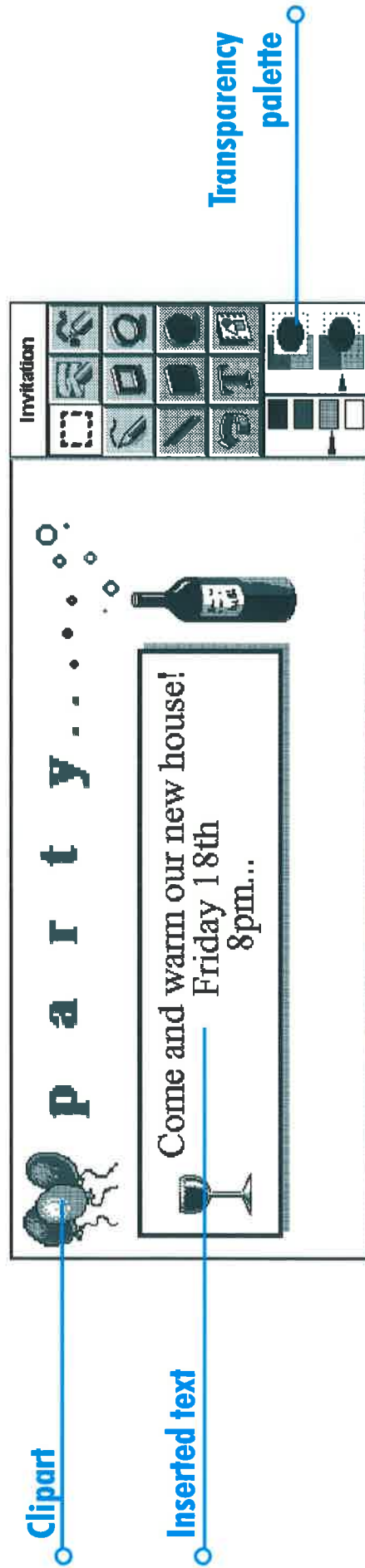



Printing sketches

The Printing commands are on the **File** menu.

- Before printing, it is useful to see what the sketch will look like on the page. To preview your picture use the **Print preview** command.
- To change the page size, orientation and margins, or add headers and footers to a sketch, use the **Page setup** command.
- When you are ready to print the picture, select the **Print** command.

Sketch files

When you use Sketch for the first time, you will see a blank screen. When you run Sketch at other times, the last sketch you created is automatically opened so that you can continue working.

- **To start a new sketch file:** use the command on the **File** menu.
- **To return to a different sketch file:** open the file using the command on the **File** menu.

The current file is saved each time you exit Sketch. You can also use the **More** commands on the **File** menu to:

- save the file at any other time using the **Save** command, or give it a different name using the **Save as** command.
- reject all changes made to a file since it was last saved using the **Revert to saved** command.



Creating “wallpaper”.

You can change the “wallpaper” that appears in the background on the System screen. You can use any picture that you draw or import into Sketch. See the ‘Customising your Series 5’ chapter for more information.

Zoom in
to view pixels

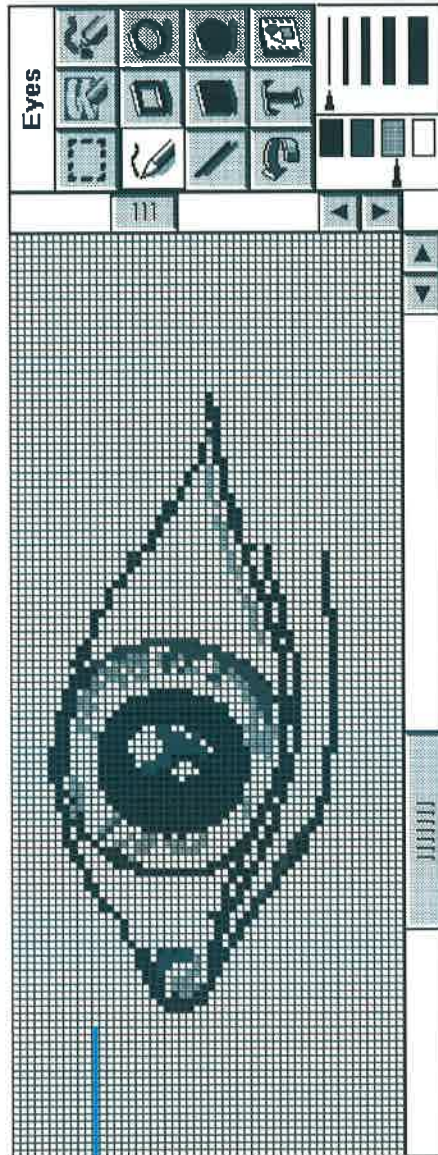

SPELL

You can use the Spell program to check the spelling of words, search for anagrams, find missing letters to help solve crossword clues and search for synonyms using the thesaurus.

You can also use the **Paste** command in Spell to insert words 'copied' in other programs into the box, and 'copy' the corrected word back into the other program. Refer to the 'Word' chapter for more information on checking the spelling of text in the Word program.

Spell-checking and correction

- **To check the spelling of a word:** type a word in the box and tap the **Spell** button, or select the **Spell check** command from the **Tools** menu.

If Spell finds the word you entered in its dictionary, it displays a message to tell you that the word is correct. If the word is not in the Spell dictionary, Spell searches for possible alternatives and lists them as they are found.



You can clear the display to remove the suggested solutions using the command on the **View** menu. You can also use the  button to display the “history list” which contains the words you have used in this Spell session.

Using the thesaurus

You can use the thesaurus to search for synonyms, i.e. words which have the same or a similar meaning to a word you enter.

- **To use the thesaurus:** type the word in the box and tap the **Thes** button, or select the **Thesaurus** command from the **Tools** menu.

If there are suitable words, Spell lists them as they are found.

Spell divides the synonyms into categories, each category relating to a different meaning of the entered word, with the main suggestions in bold. The words are separated into groups, e.g. adjectives, nouns, verbs etc.

You can select any word from the list of suggestions to look up again. To do this, either tap on a word to highlight it, and then tap again to select it, or use the arrow keys to highlight the word and press Enter. You can also select a word from the list, then use one of the Toolbar buttons straight away.

Solving anagrams

You can use Spell to search for anagrams of words or letters. An anagram is a word which has some or all of the letters as another word, arranged in a different order. For example, anagram suggestions for ‘angle’ could include ‘glean’, ‘angel’, ‘lane’ and ‘age’.

- **To search for possible anagrams of a word:** type the word in the box, tap the **Anag** button, or select the command from the **Tools** menu.

Spell lists possible anagrams as they are found. Spell lists the words in order of size, starting with the longest words it can find. If Spell doesn’t find any anagrams, it displays a message to tell you that no solutions were found.



Finding missing letters - Xword

To find missing letters to help solve crossword clues:

1. Type a word in the Word text box, entering '*' or '?' in place of the unknown letter(s). Enter '*' to search for several replacement letters, or '?' to search for one replacement letter.

For example, if you enter 'For*ed' suggestions include 'Forced', 'Foresighted', and 'Foraged', alternatively if you enter 'For?ed' the suggestions include 'Formed', 'Forked' and 'Forced'. You can enter '*' or '?' more than once when looking for missing letters, for example if you entered 'F?:r?ed' the suggestions would include 'Forced' and 'Farmed'.

2. Tap the **Xword** button, or select the **Crossword** command from the **Tools** menu.

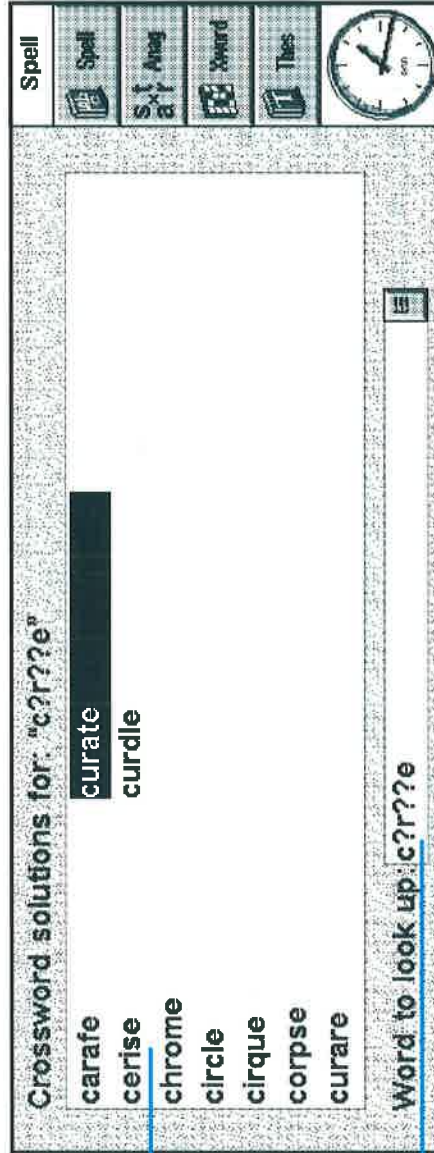

Crossword solutions

Search clue

Adding words to Spell

Spell has two dictionaries it uses when checking the spelling of words:

- The Spell dictionary, which contains the built-in words. The Spell dictionary is always used when checking a word.
- The Personal dictionary, which you can use to add other words that you want to keep in Spell, e.g. if you use a specialised vocabulary for your work.

You can use the Personal dictionary in addition to the Spell dictionary. You can view the contents of the Personal dictionary, and delete words if they are no longer required, or if you added them by mistake.

- **To use the personal dictionary as well as the Spell dictionary:** select the command from the **File** menu. This setting is saved when you close Spell, and also applies when spell checking words in other programs, e.g. when spell checking a Word document.
- **To add a word to the Personal dictionary:** type the word in the box then select the **Add to** command from the **Personal dictionary** commands on the **File** menu.

- **To view the contents of the Personal dictionary:** select the **Show contents** command from the **Personal dictionary** commands on the **File** menu. This makes it easier for you to remove unwanted words, especially if you can't remember all the words you have added to the Personal dictionary.
- **To delete a word from the Personal dictionary:** show the contents of the Personal dictionary (as described above), highlight the word you want to delete and select the command from **Personal dictionary** commands on the **File** menu.





RECORD

You can use the Record program to make sound recordings and create alarm sounds. You can record sounds and play back from any point in the sound.

You can also use the Record program to record "voice notes" - see 'Recording voice notes' later for more details.

Recording a sound

When you open the Record program you can begin to record right away. Simply place the machine so that the microphone is near the sound source and press the **REC** button or press Enter.

Press the **STOP** button, or press Esc to stop recording.

Note: The microphone is located at the front right-hand edge of the machine, just in front of the disk drive door.

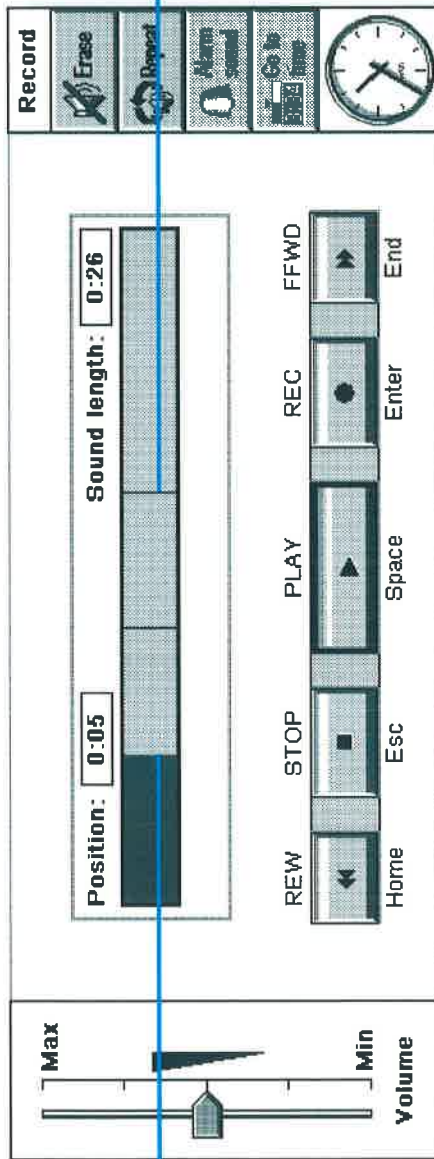

Playback point

Start position of a recorded sound

- To record some more, tap **REC** or press Enter again. New sound is added to the end of the existing recording.
- To start a new file, select the command from the **File** menu. Type in the name before you begin recording.
- To save your file under a different name, select the **Save as** command from the **File** menu.
- To replace the ending of an existing recording, use the pen to drag the bar to the point where you want to begin recording (or select the **Go to time** command from the **Play** menu and specify a start point in minutes and seconds), then select the **Record & replace** command from the **Record** menu.
- To erase the whole of the current recording, select the **Erase all** command from the **Record** menu.

The maximum recording length depends on the amount of disk space available. While recording, a 'Time remaining' indicator shows how much more sound you could record if you wanted to use the available space. Record will not allow you to completely fill the disk, and will always leave 100K free so that you can use other programs.

Note: If an alarm is due to ring while you are recording or playing a sound, you may hear warning "ticks" and the alarm will be postponed until you finish the current action.



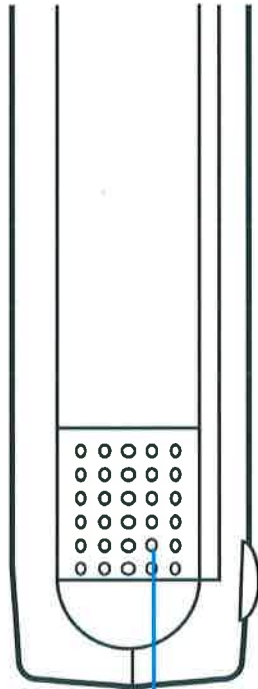

Loudspeaker

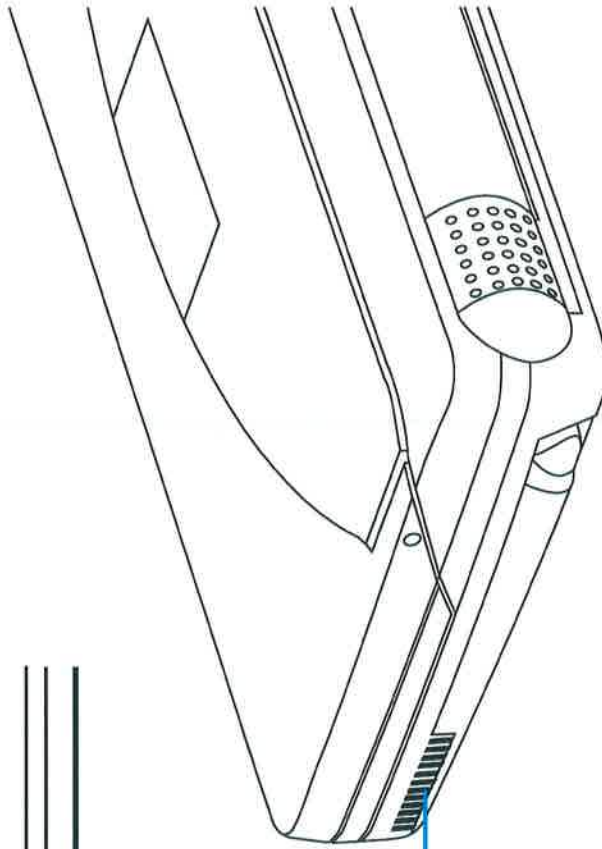

Microphone

Playing sounds

To play back the entire sound file, tap the **PLAY** button, press the Spacebar, or select the command on the **Play** menu.

Note: The loudspeaker is located in the spine of the machine, next to the battery compartment and at the opposite end from the Infrared window.

- To play back only part of a sound, use the pen to drag the cursor to the point where you want to begin playing (or select the **Go to time** command from the **Play** menu and enter the start position in minutes and seconds), then press **PLAY**. Playback begins from the selected point. To pause playback, press **PLAY** again.
- To adjust the volume, use the pen or the up and down arrow keys to move the volume fader to one of the volume settings, or set it to **Min** to turn off the sound completely.
- To play back a sound recording several times in succession, select the **Repeat sound** command from the **Tools** menu and set the number of occurrences as appropriate.

Recording voice notes

You can use the Series 5 as a dictating machine by using the external buttons to record and play back voice notes. A “voice note” is a sound recording you can create and play back without starting the Record program, switching the Series 5 on, or even opening the the Series 5 case.

Voice notes are stored as sound files. You can use the files in the Record program, like other sound files.

Slide back the cover to reveal the voice note buttons. To avoid accidental recordings, replace the cover when you are not using the buttons.



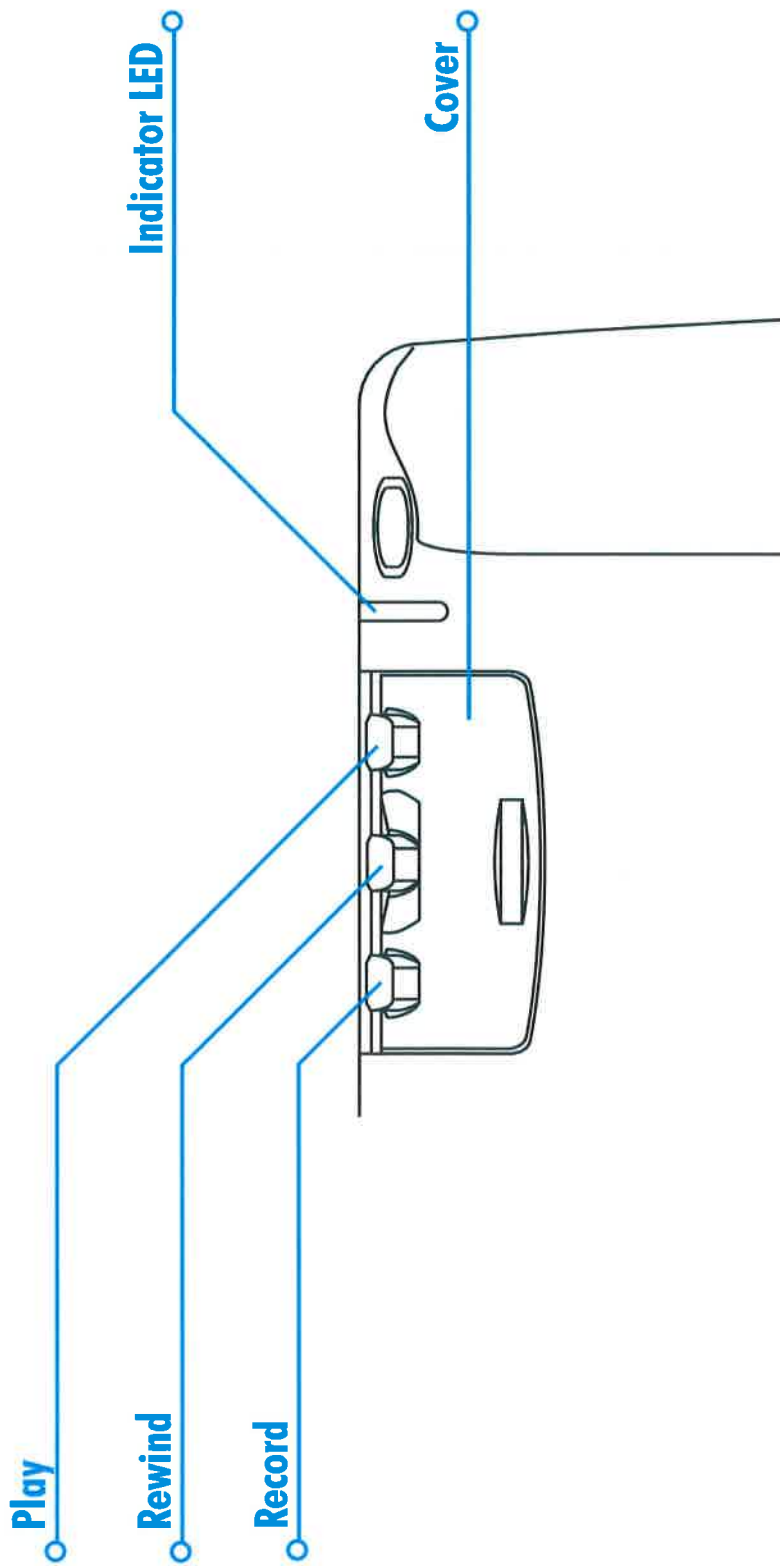

Recording a voice note

- To record a voice note, press and hold down the '●' voice note button on the external casing of the Series 5. The red recording indicator LED should come on, and you can begin to dictate your voice note. If the LED does not come on, release it again and press it again until you hear a beep.
- Release the '●' voice note button to stop recording.
- To add more recording to your voice note, press the '●' voice note button again. New voice note recordings are always added to the end of any existing voice note recording, so it is not possible to accidentally record over your existing voice note.

Note: If you run out of disk space while recording, the recording indicator LED will begin flashing. You will not be able to record more unless you free some space by exiting another open program or deleting some files.

Important: Note that the machine will remain on after recording a voice note, for as long as specified for the auto switch-off command. It is best not to set the auto switch-off time to 'No' if you record voice notes as the Series 5 will remain on until the batteries are exhausted.

Playing back a voice note

- **To play the current voice note:** press the '▶' button when you have finished recording. To replay the current voice note at any time from the start, press the '▶' button again.
- **To begin playback from a different position in the voice note file:** press the '■' button once to start rewinding in 2-second jumps. Press the '■' voice note button again to stop rewinding. Press the '▶' button to start playing from the new position in the voice note file.

Note: To rewind straight to the beginning of the file, press and hold down the '■' button.

The machine will beep when the playback point is at the beginning of the file.





Using voice notes in Record

When you press an external voice note button, the Record program opens to record your voice note.

Voice note are always added to the 'Voice notes' file, which is stored in the folder set as the standard folder in the System screen (this is initially the Documents folder). The 'Voice notes' file can be loaded and used in the Record program just like any other Record file.

See the built-in help for advanced keypresses.

Voice note files

Important: As new voice notes are always added to the end of the 'Voice notes' file, this file may grow very large. Make sure that you delete the contents of the voice note file if the information is no longer required.

- To delete the contents of the voice note file, open the 'Voice notes' file in the Record program and select the **Erase all** command from the **Record** menu.
- If you wish to keep an existing voice note recording and record another, rename the 'Voice notes' file to a different filename using the **Rename** command on the **File** menu in the System screen.

File sizes and compression

Digital sound recordings can be very large. In order to save disk space a compression process is applied to Record files as they are being recorded.

- To save even more disk space use the **Compress sound** command on the **Tools** menu and select ADPCM (4 minutes per Mbyte) before starting to record the sound. This approximately halves the amount of space required. Search and skip functions may take slightly longer if a file is ADPCM compressed.





BOMBS- THE SERIES 5 GAME

Bombs is a game of speed and logical thinking. The object of the game is to discover and mark the position of all the concealed “bombs” in a grid of squares as quickly as possible, without accidentally uncovering any of the bombs.

You can select between easy, medium and hard skill levels, and 5 different grid sizes, using the **Skill level** button on the Toolbar. The harder the skill level, the more bombs are hidden in the grid. You can set the number of bombs by selecting the Custom skill level.

Number of adjacent bombs

Time 00:32 Bombs 16 Flags 8

Flagged square

Bombs

Close

Skill level

Best times

New game

Clock

How to play

You can test a square by “stepping” on it. To do so:

- Highlight a square by tapping on it or by moving to it with the arrow keys. Then, to “step” on the square, tap on it again or press the Spacebar.

If you step on a square containing a bomb, you lose and the game is over. If there isn't a bomb under the square, stepping on it will reveal the number of bombs in the 8 adjacent squares. If you uncover a blank, the surrounding eight squares are revealed automatically because there cannot be any bombs under them.

If you suspect that a square conceals a bomb, mark it with a flag. To do so:

- Hold down the Shift key and tap on the square, or highlight the square then tap on the Flags counter or press Enter.
Remove a flag in the same way.

If you know that all the bombs surrounding a numbered square have been marked with a flag, select the square and tap on it or press the Spacebar to uncover all the surrounding squares.

Scoring

Your score for the game is the time it takes to reveal all the bombs. The top two scores for each level, together with the name of the player, are kept in the **Best times** list.





PROGRAMMING

You can:

- Create and use programs on your Series 5 using the built-in programming language, OPL. Complete details of OPL command syntax is described in the OPL Programming Manual, available on the PsiWin CD ROM.

Creating & running OPL programs

1. Create the program in the Program editor program. Simply type in the OPL commands as required. You can edit text using the menu commands in the Program editor, which work in the same way as the commands in the Word processor, e.g. cut, copy, find.

Note: Text formatting will be applied to all the text in the file.

```

PROC exchange:
LOCAL pounds, rate
AT 1.4
PRINT "How many pounds sterling? ",
INPUT "pounds : REM value from keyboard"
PRINT "Exchange rate (£ to US$)? ",
INPUT rate : REM value from keyboard
PRINT "=", pounds*rate, "US Dollars"
GET
▶ENDP

```

2. Tap the **Tran** button on the Toolbar or use the command on the **Tools** menu to translate the file into a program you can run on the Series 5.

If an error is found during translation, the cursor is positioned at the point in the program where the error is found and an error message is displayed. Refer to the OPL Programming Manual for details of error messages.

3. Once the program has been translated without errors, you can run it.

The translated (executable) file will be given the same filename as the source file, but with the extension **.OPO**. To run the program from the System screen, highlight it and then tap on it, or press Enter.





PRINTING

You can print from most of the programs on the Series 5, including Data, Agenda, Word, Contacts, Sheet, Sketch and Program.

To print, you need one of the following:

- A printer which is IrDA Infrared compatible, if you wish to print files using Infrared.
- PsiWin installed on your PC, if you wish to print files via a PC.
- A Parallel Printer Link to connect to a parallel printer.
- The Docking cable and a Serial Printer Converter to connect to a serial printer.

Before you start printing, you need to specify:

- the method by which you are going to print.
- the “printer driver” for the printer you wish to use.

Setting up the printer

You can select the “standard” printer you normally use to print out files on the Series 5 from the System screen. The printer you select in the System screen is used for all programs unless you select a different printer from within a program, to use for that program only.

- **To select the standard printer:** tap the **Control panel** button on the Toolbar, or select the **Control panel** command from the **Tools** menu. Select the Printer icon, and select the printer model.
- **To select a different printer to use for an individual program:** open the program for which you want to change from the standard printer. Select the **Print setup** command from the **Printing** commands on the **File** menu, and press the **Printer** button to change the printer model and/or port.

Printing using Infrared

You can print directly from the Series 5 to any Infrared capable (IrDA) printer. To set up the Series 5:

1. Select the Printer icon from the Control panel in the System screen, or the **Print setup** command from the **Printing** commands on the **File** menu.
2. If necessary, press the **Printer** button. Select the printer model and select 'Infrared' as the method via which you want to print.
3. If you want, check the layout of the document using **Print preview**, then select the **Print** command from the **Printing** commands on the **File** menu.
4. Enter the range of pages and number of copies.
5. Point the Series 5 at the printer, making sure that the Series 5 and printer are no more than one metre apart, and press **Print**.

Printing to a parallel printer

You can use a Parallel Printer Link to connect the Series 5 directly to a parallel printer:

To do this:

1. Select the Printer icon from the Control panel in the System screen, or the **Print setup** command from the **Printing** commands on the **File** menu.
2. If necessary, press the **Printer** button. Select the printer model and select 'Parallel port' as the method via which you want to print.

Your Series 5 is now ready to print directly to a parallel printer. Refer to the documentation accompanying the Parallel Printer Link for more information on connecting it to your Series 5.

Printing to a serial printer

You can print to a serial printer using the Docking cable supplied and a Serial Printer Converter to connect to the printer. To set up your Series 5 to print via a serial printer:

1. Select the Printer icon from the Control panel in the System screen, or the **Print setup** command from the printing commands on the **File** menu in the program you want to print from.





2. If necessary, press the **Printer** button. Select the printer model and select 'Serial port' as the method via which you want to print.

You can change the settings for the serial port and handshaking by pressing the **Settings** button.

Using PsiWin to print via a PC

You can use PsiWin to connect your Series 5 to a PC using the Docking cable. You can then print files from your Series 5 to almost any of the printers installed in Windows on your PC, whether directly connected, or networked to your PC.

1. Select the Printer icon from the Control panel in the System screen, or the **Print setup** command from the printing commands on the **File** menu in the program from which you want to print.
2. If you are printing from within a program, press the **Printer** button.
3. Select 'Printer via PC' as the method via which you want to print.

You can now print a file using PsiWin to print via a PC. Refer to the PsiWin on-line help for more information.

Printing to a file

You can use the Series 5 to print a document to a file. To set up your Series 5 to print to a file:

1. Select the Printer icon from the Control panel in the System screen, or the **Print setup** command from printing commands on the **File** menu, in the program from which you want to print.
2. If necessary, press the **Printer** button. Select the printer model and select 'File' as the method via which you want to print.
3. Press the **Settings** button to specify the name of the file, and the folder and disk to which you want to print. Press **OK** to redisplay the Printer setup dialog.

When you print the file it will be saved in the file you specified in the Print to file dialog.

Important: Ensure that you use the correct filename, folder and disk drive. If a file of the same name already exists it will be deleted and replaced with the new file which you are printing.

Selecting the printer model

You can choose to print to various printer models. To select a printer:

1. Select the Printer icon from the Control panel in the System screen, or the **Print setup** command from the **Printing** commands on the **File** menu, in one of the programs from which you can print.
2. If necessary, press the **Printer** button. Select the printer to which you want to print.
3. If required, change the method via which you want to print.

Note: When printing via a PC, you can only change the printer model on the PC. Refer to the PsiWin on-line help for more information.

Page setup

You can change the size of the page and specify other layout settings by selecting the **Page setup** command from the **Printing** commands on the **File** menu:

- Select the size of the page on which you want to print (e.g. A4) and the page orientation. If the page size you require is not in the list of sizes, select 'Custom', and then type in the width and height of the page you want.
- Use the **Margins** page to change the distance between the edge of the paper and the text.
- Use the **Header** and **Footer** pages to enter the text that you'd like printed at the top and bottom of each page. You can format the header and footer text, and insert other information in it, including page numbers and the date.
- Use the **Other** page to specify where you want page numbering to begin in the document, and from which page you want to display the headers and footers.





Previewing a document

You can see how the document will look when printed by selecting the **Print preview** command from the **Printing** commands on the **File** menu.

To select the page you want to preview press the **Go to** button and enter the number of the page you want to view.

You can change the setup of the printed page and preview from the Print preview dialog by pressing the **Setup** button to display a list of options:

- To change the layout of the page, select **Setup**.
- To specify the number of pages shown in the preview and whether you want to view the margins, select **Preview**.
- To change the printer model and method, select **Printer**.

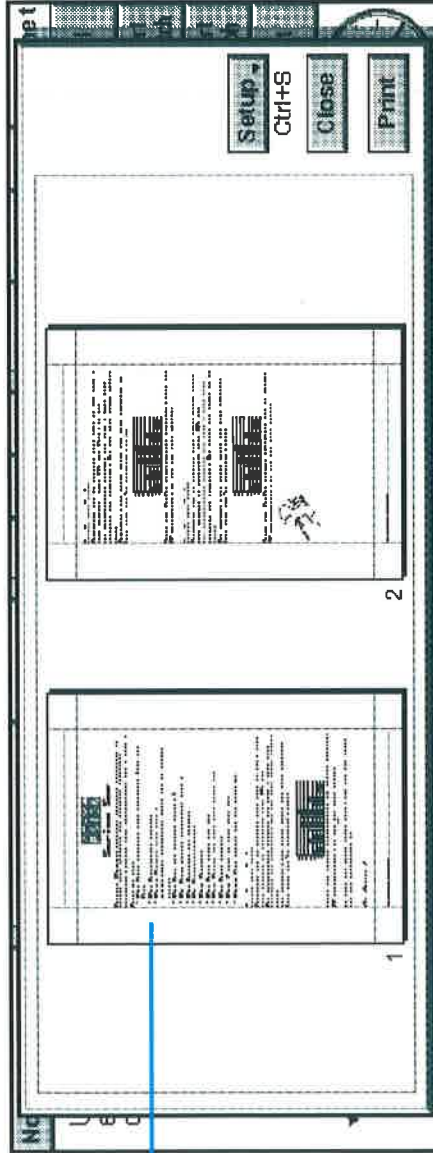

Print preview

Printing a document

You can print out all or part of a document from the Contacts, Data, Agenda, Word, Sheet, Sketch and Program editor programs.

To do this:

1. Select the **Print** command from printing commands on the **File** menu.
2. In the dialog you need to specify how many copies of the selected pages you want to print.:
(In Word you can also change the range of pages to print. If you don't change the range, one copy of the whole document will be printed.)
3. Press **OK** to start printing the document.





INFRARED

The Series 5 has Infrared built in, allowing you to transfer selected information to another Series 5 without the use of a cable.

You can also use Infrared to print directly to printers which support Infrared - see the 'Printing' chapter for more details.



Before you start.

Make sure that both Series 5s are ready to communicate using Infrared. To do this, move to the System screen, then select **Remote link** from the **Tools** menu, and ensure that the **Link** line is set to 'Infrared'.

Ready to send by infrared

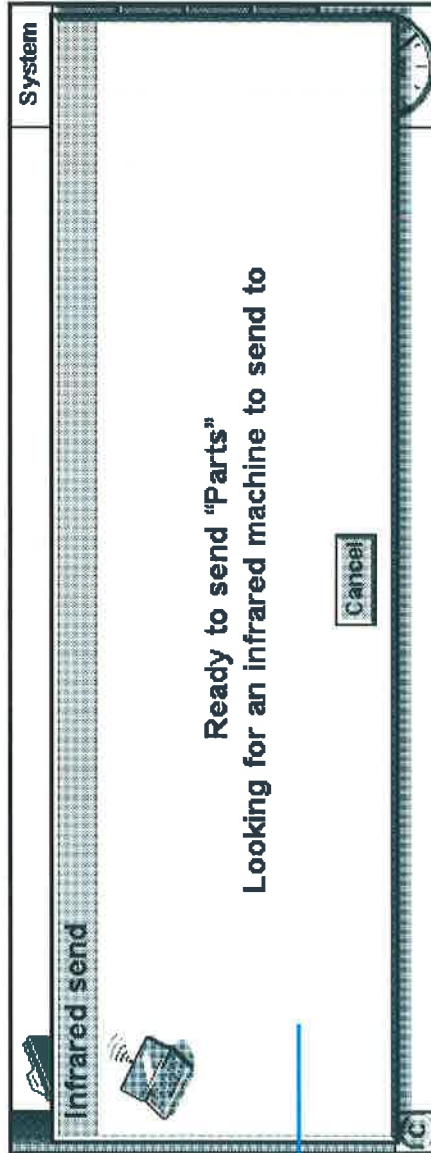

Selecting data to transfer

On the machine **from** which information is to be transferred (the 'sending machine'), select the information you want to transfer:

- If the information is a file, ensure that the file is closed and highlight the filename on the System screen. Hold down the Shift key and tap additional filenames if you want to transfer more than one file.
- If the information is an object already inserted from another program, e.g. a graph displayed in Word, just select the object. If the inserted object is displayed as an icon, you can just select the icon.
- If the information is an Agenda or Data entry, open the appropriate file and move the cursor to the required entry.
- If you wish to transfer a graph, highlight the cell contents in Sheet view. Graphs cannot be transferred direct from one Sheet file to another, only the cell contents. Relative and absolute cell references are preserved.

- Otherwise, open the file from which the selected information is to be transferred, and select the required information (e.g. the piece of text, range of spreadsheet cells, sketch area).



Note: Objects can be transferred like other information. They appear as objects on the receiving machine.

Transferring the information

1. Ask the other user of the other Series 5 to open the program or file where the information is to be transferred to.
- If the information to be transferred is an entire file, ask the other user to tap the System icon and move to the folder to which the file is to be transferred.
 - If the information is an Agenda or Data entry, ask the other user to open the appropriate Agenda or Data file.
 - Otherwise, ask the other user to open the file or program to which the selected information is to be transferred, and move the cursor to the appropriate point in the file.





2. On the receiving Series 5, tap the  command icon or select the **Infrared receive** command (or select it from the **Tools** menu). The “Ready to receive” screen will be displayed.
3. Position the two Series 5s, aligning the Infrared windows on the two machines (ideally, both should be resting on the same flat surface). The Infrared window on each Series 5 is on the outer casing to the left of the main battery door when the Series 5 is open in front of you. **The machines should be no more than one metre apart.**
4. On the sending machine, tap the  command icon and select the **Infrared send** command (or select it from the **Tools** menu). If the Infrared windows are in range, the transfer begins. Infrared screens appear on both machines to indicate that the transfer is taking place, and the progress of the transfer is displayed.

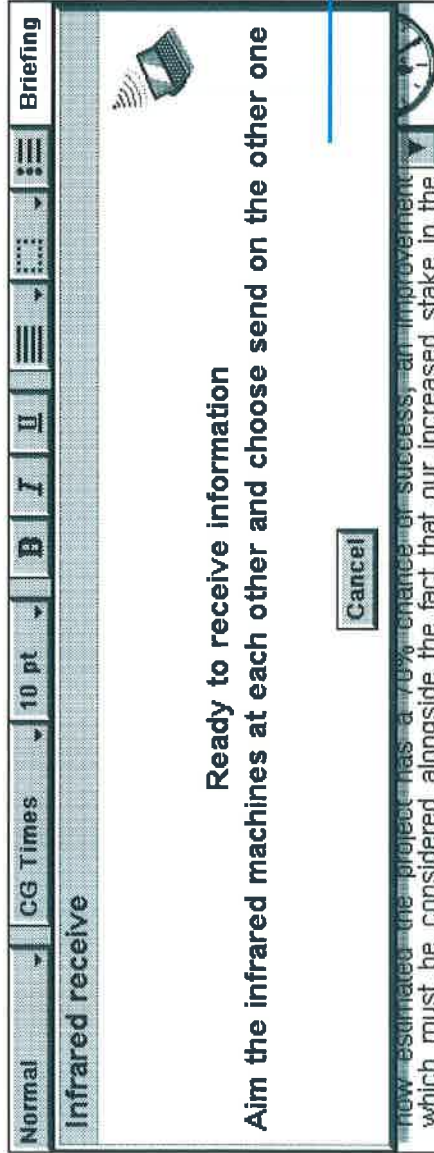

Ready to
receive by
infrared

When the transfer is complete

When the transfer is complete the Infrared screens disappear. There is now a copy of the selected information or file on the receiving machine.

Note: If a file is being transferred, and the folder on the receiving machine already contains a file of that name, then the receiving machine displays a dialog where you can rename the received file, or move it to another folder or disk drive.

The information on the sending machine is not affected by the transfer.

Cancelling the transfer

To stop the transfer while it is in progress, press Esc on either machine.

If the transfer fails

If the transfer fails, a message is displayed to indicate why. Follow the advice given by the message and try again.

Note: It is not possible to send information by Infrared between a Series 5 range machine and a Series 3c/3mx or a Siena.

Infrared window

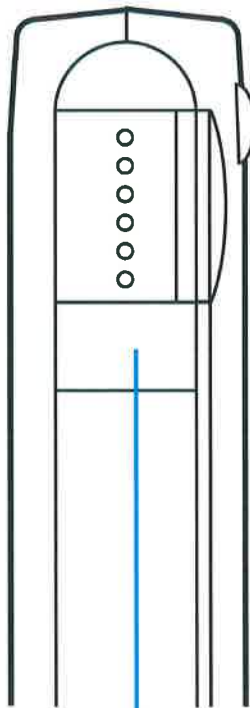



DIALLING

The Series 5 can generate the “DTMF” tones used for dialling telephone numbers. You can only use dialling from within the Contacts program, Agenda and Data.

Note: Phone systems do vary. DTMF dialling cannot be guaranteed to work with all types of phone.

You can dial a number as follows:

- If the number is included in a Contacts entry, select the entry and tap the **Dial** button on the Toolbar.

- If the number is already entered as part of a Contacts, Data or Agenda entry, you can just select the entry and use the Dial keypress (Fn+Menu). The Series 5 will find the numbers in the entry so that you can select which number to dial.

- If the number is not already entered as part of a Contacts, Data or Agenda entry, you can use “free input” dialling where the Series 5 will dial the number as you type it.

Phone numbers in Contacts entry

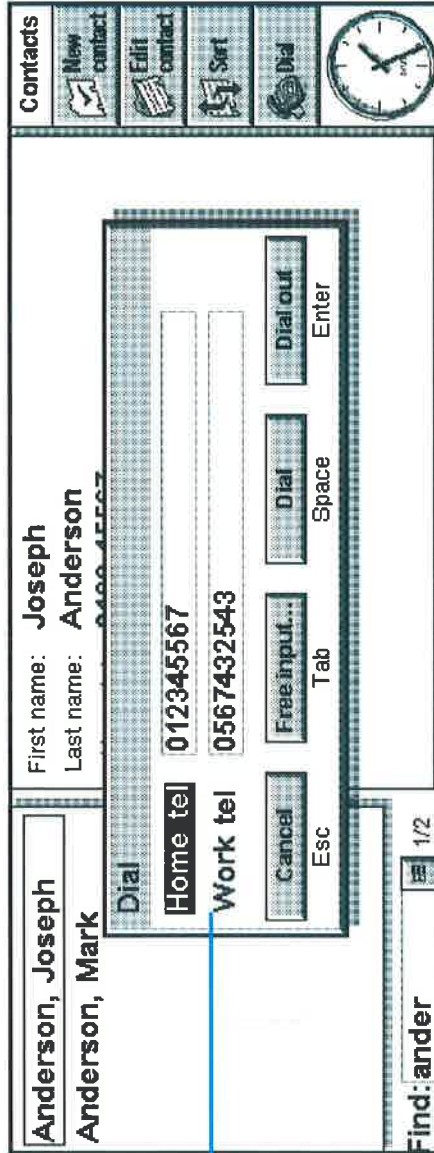

Setting up

You can use free input dialling straight away, though you should remember to add any dial-out code (this is often a '9') required to obtain an outside line if you are calling from a building that has a private exchange.

If you have already entered a telephone number in Contacts, Data or Agenda, you can set up the Series 5 to include the dial-out code only when you need to. To do this:

1. In the System screen, tap on the **Control panel** button on the Toolbar or select the command from the **Tools** menu, and select the Dialling icon.
2. Move to the **Location** page and select the **Current location**, e.g. 'Office', then tap **Edit**.
3. Move to the **Dial out** page and enter the numbers you have to dial to get an outside line in the **Local code** and **Long distance code** lines. If the internal telephone system requires a pause after the dial out code, add a comma after the number.

Note: You can set the time length of the pause after the dial out code on the **Dial settings** page.

You can also set up the Series 5 so that the correct international prefixes and area codes are used when dialling. To do this:

1. In the System screen, tap on the **Control panel** button on the Toolbar or select the command from the **Tools** menu, and select the Dialling icon.
2. Move to the **Country** page and set the 'Country' where you would normally dial non-international numbers, i.e. your country of residence. If you go abroad, change the 'Home city' but leave the 'Country' set as usual. The Series 5 will then be able to use the correct codes to dial numbers.





Entering phone numbers

You can enter a telephone number to dial in a Contacts, Data or Agenda entry.

In Data, you can set whether a label is checked when the Series 5 looks for telephone numbers to dial. **To include a label in the search:** select the **Change labels** command from the **Tools** menu, select the label and press the **Edit** button. Then, press the **Options** button and tick the box to make sure that the label is searched when dialling. You can remove the tick if you do not want to search a particular label, perhaps if it contains other numerical information.

Note: If it appears that the Series 5 does not find a telephone number you have entered in a Data entry, it may be that the label is not being searched. Follow the instructions above to ensure that the label is included in the search.

Note: You can enter a telephone number anywhere in an Agenda entry, but try to avoid mixing telephone numbers and other numbers in the same entry.

For numbers in your own country, you should include the required area code in the telephone number. For international numbers, you should include the international prefix (or use a + instead) and the required national code. If you don't know the national code for a particular country, you can look it up in the Time program. You can use numerous other characters (e.g. brackets or a hyphen) to separate parts of the number. Do not use a comma as this represents a pause when dialling.

Dialling phone numbers

To dial a number already entered in the **Contacts** program, or in a **Data** or **Agenda** file:

1. Highlight the entry you want to dial from.
2. Press the **Fn** and **Menu** keys together, or tap the **Dial** button on the **Toolbar** in **Contacts**. The **Series 5** will find up to five numbers in each entry.
3. Select the number you want to dial, and hold the **Series 5** loudspeaker near to the telephone mouthpiece, approximately 2 inches (5 cm) away.
 - Press the **Dial** button to dial the number.
 - If you wish to use the dial out code, press the **Dial out** button to dial the number preceded by the dial out code.
 - You can change the number if it is not correct.
 - If you need to dial additional digits, press the **Free input** button to make the **Series 5** dial the **DTMF** codes as you type each number.

To dial using free input dialling: press the **Ctrl** key with the **Fn** and **Menu** keys, then dial the number in the 'Free input' dialog. You can use the digits 0...9, *, and #. Press the **Redial** button to redial the number if necessary.

Note: The preset tone and delay times will normally be fine for dialling, unless you are using a poor quality telephone line. If dialling doesn't work in a particular location, try increasing the value of the 'Tone time' and 'Delay time'. Tone, Delay and Pause times are measured in units of 1/32 seconds.



CUSTOMISING THE SERIES 5

This chapter includes some ideas for customising the Series 5.

Note: You can customise the way many programs work using the **Preferences** commands on the program's **Tools** menu.

Creating your own wallpaper

You can change the “wallpaper” that appears in the background on the System screen. You can use any picture that you draw or import into Sketch.

To create wallpaper:

1. Display the picture in Sketch. If you only want to use part of a picture, select the area.
2. Select **Save as System wallpaper** from the **More** commands on the **File** menu.
3. Type a name for the wallpaper file. Sketch keeps the files that contain wallpaper separate from the original Sketch files so you can carry on using your original picture without affecting the wallpaper.

- **To select wallpaper:** move to the System screen and select **Preferences** from the **Tools** menu, then select the name of the wallpaper file that you want to display.
- **To delete a file containing wallpaper:** move to Sketch and select **Delete System wallpaper** from the **More** commands on the **File** menu. Select the wallpaper that you want to remove. You cannot delete the built-in wallpaper included with the Series 5.

Recording your own alarms

You can use the Record program to create alarm sounds which can be used in Time and Agenda.

- **To save a recording for use as an alarm sound:** select the **Save as alarm sound** command from the **File** menu and type a name for the alarm sound. This creates another version of the sound as an alarm, and leaves the original file open in Record.
- **To delete a custom alarm sound:** select the **Delete alarm sound** command from the **File** menu, and select the alarm to delete from the list. You cannot delete or modify the built-in Series 5 alarm sounds.

Customising the System screen

You can use the commands on the **View** menu to change how the System screen looks and works:

- change the position of the **Title** by selecting **Title position**, and the width of the columns by selecting **Column width**.
- use **Zoom in** and **Zoom out** to change the size of text and icons on screen so that more or fewer files and folders are displayed.
- turn the **Toolbar** off and on with **Show toolbar**; without the **Toolbar** you can see more of the System screen.
- control how the files are sorted, and what file information is displayed with **Sort files** and **Show file details**. When you first use the Series 5, files are grouped 'by type' (i.e. according to program); you can change this to sort them by date, name or size.

You can customise many of the ways that the Series 5 works from the System screen using the **Preferences** command and the icons in the **Control panel**. For example, you might want to change the automatic switch off setting, owner information, the standard printer and print preview settings, and set up a password to protect your files from prying eyes.

You can customise the positions of icons on the Extras bar, e.g. so that the icons for your favourite programs appear in particular positions. To display a dialog where you can set this, press the Enter key when the Extras bar is displayed, or tap the word "Extras" on the left of the Extras bar.

The System screen preferences allow you to display "hidden" files and the "System" folder in the System screen, change the standard folder for files, and change the keypress for opening multiple files.



Caution:

The "System" folder contains files that are used by the Series 5 programs themselves. You should not normally need to access these files, which is why this folder is not shown as standard. **Do not delete or modify files in this folder, or create new files in this folder, otherwise you may have problems using the Series 5 programs.**

CARE & SAFETY

When used according to the instructions in this manual, the Series 5 should remain in good working order for many years. However, there are certain precautions you should take to ensure continued trouble-free use:

- **Do** keep the Series 5 at a room temperature of 0°C to +40°C (+32°F to +104°F) and avoid sudden extremes in temperature, exposure to direct sunlight or rain, heat sources (electric heaters, etc.), dust, sand, and other fine particles.
- **Do** keep the Series 5 away from strong magnetic fields (e.g. loudspeakers) and sources of static electricity.
- **Do** cover the voice note buttons and serial port with their protective covers when not in use.
- If you wish to use mains power, use only the Psion-approved mains adaptor.
- If you will not be using the Series 5 for a while, store it in a place that is dry, free from damp, dust and extremes of heat and cold. If you normally use rechargeable batteries, it is

wise to replace them with ordinary alkaline batteries while you are not using it.

- **Do** back up regularly. You can use PsiWin to back up your Series 5 to your PC, or you can make backups on a Memory disk. See the 'Security & backups' chapter for more information.
- **To clean the screen:** switch the Series 5 off and use a soft, clean, dry cloth to gently wipe the keyboard and screen. **Under no circumstances use water or chemical solvents that may have a corrosive effect.** (If the Series 5 is set to turn on automatically when you open the case or tap the screen, you should turn this preference off before cleaning the screen; see 'Turning on & off' for more information.)
- **Do not** tap the screen with any object that has a sharp tip or you may damage the screen. Don't use any type of ink pen, as the ink may be impossible to remove. When not in use, keep the pen supplied with the Series 5 in its storage compartment.

- **Do not** immerse the Series 5 in water, or any other liquid, or spill liquids onto it.
- **Do not** drop, throw, or try to bend the Series 5, or press the keys with extreme force.
- **Do not** keep the Series 5 next to credit cards or transport tickets; the speaker magnet could corrupt the information on the magnetic strip.
- **Do not** attempt to dismantle the Series 5. There are no user-serviceable parts inside and any attempt to do so will render the warranty void.
- **Do not** use a combination of different types of battery, or mix old and new batteries.
- **Do not** remove the main batteries and backup battery at the same time when replacing them; **you will lose all your information if you do this.**

Powering the Series 5

- We recommend that you use high power alkaline or rechargeable batteries to power the Series 5.
-  **Batteries recommended by Psion:**
 Lithium backup batteries: Duracell DL2032, Hitachi Maxell CR2032, Panasonic CR2032, Sony CR2032, Ultralife CR2032, Varta CR2032.
 AA-size batteries: Duracell Ultra.
 - Fit new batteries or change rechargeable ones as soon as you start getting the low batteries message. If you use rechargeable batteries, it's best to keep two sets of batteries - one set on charge while the other set is in the Series 5.

How do I check the battery power?

To check the battery power, move to the System screen and select **Battery** from the **Information** menu.

Rechargeable batteries

You can use AA-sized rechargeable Nickel Cadmium batteries (sometimes called NiCd, NiHM or Nicad batteries) to power the Series 5, but some care is required.

If you use rechargeable batteries:

- You are advised to keep two sets of rechargeable batteries; when the pair in the Series 5 needs recharging, swap them over. If you have just one pair, you will run down the backup battery while you are recharging them.
- You should replace them with fresh non-rechargeable, preferably alkaline batteries, if you are not going to use the Series 5 for a while.

Note: Rechargeable batteries have a significantly shorter life than alkaline batteries. When rechargeable batteries go flat, they do so very quickly, and you may get very little advance warning. The backup battery will preserve your information for a limited time.

Changing the batteries

The Series 5 will warn you when the main and backup batteries need replacing. The backup battery compartment is designed to be “child-proof”; you will need to use the pen to remove the backup battery, as shown.

- If both the main and backup batteries are low, replace the backup battery first. If the main batteries are so low that you cannot turn the Series 5 on connect the series 5 to mains power using the mains adaptor **before** changing the backup battery.

Important:

Never remove the main and the backup batteries at the same time. If you remove all power from your Series 5, **you will lose all of your information.**

**Use the Series 5
pen to remove the
backup battery**

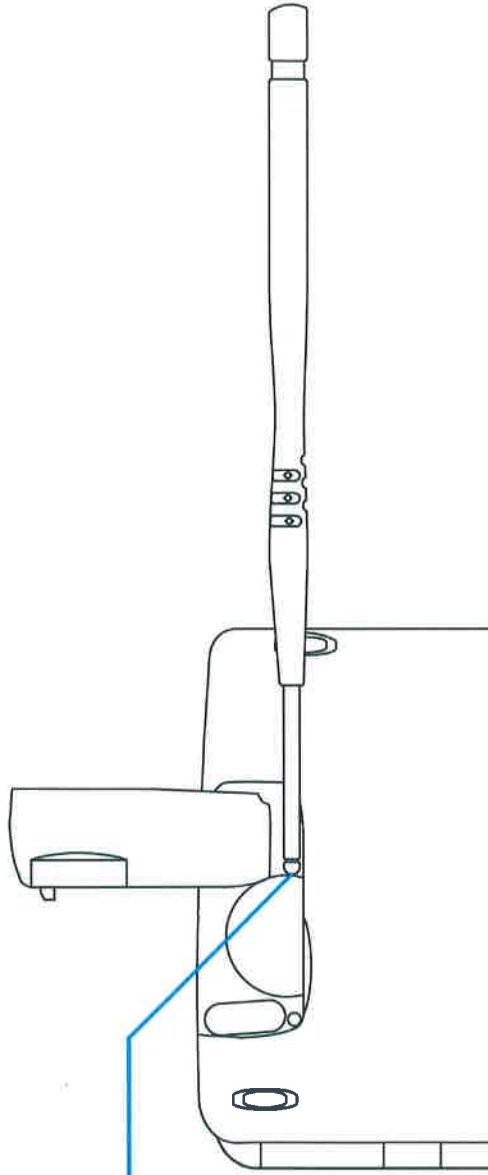

Battery safety

- Always observe correct polarity of batteries (+ and -) when inserting them.
- Don't store batteries at temperatures in excess of +60°C; the optimum storage temperature for maximum battery life is +10°C to +35°C.
- Don't dispose of batteries in a fire - there is a danger of explosion.
- Don't crush, puncture, open, dismantle, or otherwise mechanically interfere with batteries.
- If a battery should leak, do not allow the contents to come into contact with your skin or your eyes. If it does, wash immediately with plenty of cold water and seek medical advice.
- If a battery has been accidentally swallowed, it is ESSENTIAL that medical assistance is sought IMMEDIATELY. If the small backup battery has been swallowed, advise the medical person that a LITHIUM battery is involved.

Caution:

There is a danger of explosion if the backup battery is incorrectly replaced. Replace battery only with the same or equivalent type recommended by Psion. Dispose of used batteries according to the manufacturer's instructions.

Prolonging battery life

You can take steps to help your batteries last longer:

- Turn off the remote link when not in use.
- Set Auto switch-off times for the machine and the backlight.
- Use Data and Agenda files on the Internal disk (C) instead of a Memory disk (D), as the Series 5 requires more power to write to the Memory disk.

When your Series 5 is switched off, it is on "standby" and will continue to use a small amount of battery power, at a rate of about 1% per day. If you are going to leave your Series 5 switched off for a long period of time, you are advised to back up your data beforehand as the batteries will eventually run out.

How long your batteries last will depend upon how you use your Series 5. Your Series 5 will use considerably more battery power when you are recording sounds, have the backlight switched on, are using files stored on a Memory disk, or are using Infrared.

Note: To check the battery power, move to the System screen and select **Battery** from the **Information** menu.

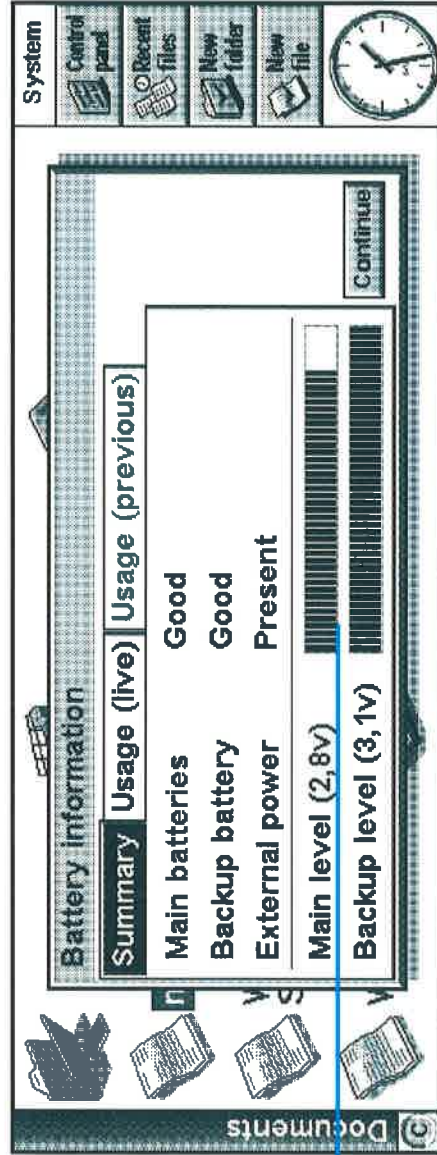

Battery power levels



SECURITY & BACKUPS

There are no known problems with passing the Series 5 through airport security machines and other X-rays.

There are several things that you can do to secure your files against other hazards. You can make your files “read-only” to avoid accidental deletion; back up your files regularly in case they get lost; set passwords to protect information from prying eyes and enter contact information so that your Series 5 can be returned to you if you lose it.

Note: It isn't possible for anyone to copy information from or to your machine using Infrared, unless they are able to access its Infrared 'Send' and 'Receive' commands.



Backing up to a PC

You can use PsiWin to back up individual files or folders, the Series 5's entire Internal disk, or files on Memory disks to the PC.

See the PsiWin on-line help for details.

Backing up to Memory Disks

You can back up individual files, individual folders or groups of files and folders to a Memory Disk. To back up the files and folders, copy them from the internal disk to a Memory Disk using the **Copy** and **Paste** commands in the system screen.

1. Select the files and folders you want to back up, then select the **Copy** command from the **Edit** menu.
2. Set the current disk to be D (i.e. the Memory disk), and select the folder you want to use for the backup on disk D.
3. Select the **Paste** command from the **Edit** menu.

Restoring files from a backup

To restore the files and folders on a Memory Disk to your Series 5, copy them from the Memory Disk to the Internal disk in the same way as backing up. This time, set the current disk to D to select the files on the Memory disk, then change it to C to paste the copied files to the Internal disk.



You should read this chapter if you have any questions or experience problems using your Series 5.

If an alarm doesn't ring

If the alarm sounds like beeps, your batteries are too low to play the alarm sound you have chosen.

It may also be that the 'Sound' is off so that the alarm screen is displayed but the sound is inaudible. The alarm screen will indicate if the sound is off or silenced for a particular period. Use the **Sound** icon from the **Control panel** in the System screen to switch the sound back on again.

If an alarm is due to ring while you are recording another sound, the alarm will be postponed until you have finished your recording.

If world times don't seem to be correct in the Time program

This is likely to be because of "daylight saving" or "summer time" settings (where clocks are put forward for the summer months).

The dates that clocks are set to change vary from country to country, and sometimes even within a country; some countries do not use summer times at all. Therefore, the Series 5 clock will not change automatically on the date that the clocks change. You will need to make sure that each zone is set to use its "summer time" setting when the clocks change in those countries. See the 'Time' chapter for more details.

If a file appears to have “vanished”

When you tap on a program icon, the Series 5 will open the program with the file that you last used. If you only use one Agenda file, for example, this will always be displayed when you tap the Agenda icon.

However, if you move or rename your file, the Series 5 will not be able to find this “last used” file when you tap the program icon. So, it looks for a file with a standard filename (e.g. Word, Agenda, Sheet etc.) and displays this file instead. If there is no file with this name in the standard folder, a new file is created.

You can re-open the original file from its new location using the **Open file** command on the **File** menu.

If you forget your password

If you forget a password set for a Word or Sheet file, you will not be able to open the file again until you remember the correct password.

If you forget the password set for the whole machine, you will not be able to use the Series 5 until you perform a “hard reset”.

All the files on the Internal disk will be lost and cannot be retrieved.

See ‘How do I reset the Series 5’ for more information.

If the Series 5 doesn’t seem to turn on/turn off

If the Series 5 doesn’t seem to turn on:

- Check the screen contrast to make sure it isn’t set too low.
- Replace the main batteries. If you continue to use the Series 5 when the main batteries are low, it will eventually not have enough power and will switch off. You will not be able to switch it on again until you replace the main batteries.

If the Series 5 doesn’t seem to turn off:

- Check the automatic switch off time using the **Switch on/off** icon from the Control panel in the System screen.

Note: If you use OPL, note that a running OPL program can prevent automatic switch off if it neither pauses or waits for a keypress.

How do I reset the Series 5?

If you find that you cannot exit a program normally, move to the System screen and select the **List open files** command from the File menu. Select the program from the list and press the **Close file** button.

If this does not work, or if your Series 5 appears to have “locked up”, you can always perform a “soft reset”. This should restart your Series 5 while preserving most of your information.

It is worth trying a soft reset if the keys on the Series 5 do not appear to respond, or if the Series 5 does appear to switch on and you are sure the batteries are good (especially if the contrast adjustment still appears to work), but the screen is otherwise blank.

- **To perform a soft reset:** gently press something like an unfolded paperclip into the reset hole, above the backup battery location.

After a soft reset, any changes to open Word or Sheet files (or OPL programs) will be lost. Your other files on the Internal disk will almost always be safe.

It is possible (although unlikely) that a program failure causes the reset to lose the information on the Internal disk; it could even prevent the reset from working at all. If this happens, you will have to perform a “hard reset”.

- **To perform a hard reset:** press the unfolded paperclip into the reset hole as for the soft reset. Then, hold down both Shift keys, and press Esc to switch on.

Important: A hard reset resets the Series 5 completely, and **all information on the Internal disk will be lost.**

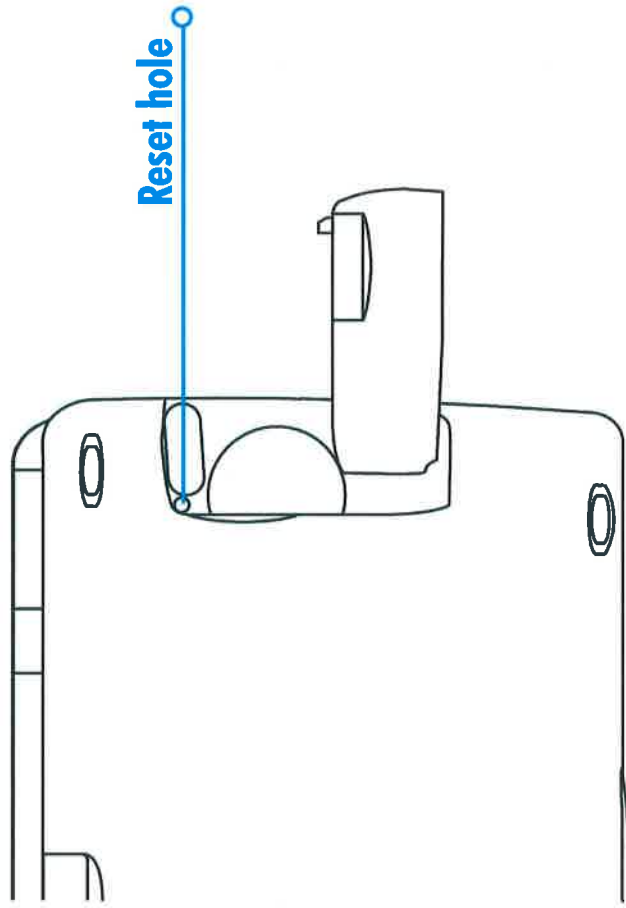

Reset hole

If your pen doesn't 'click' into place

The pen supplied with your Series 5 is held inside the case by a latch mechanism, similar to that of a spring loaded biro. If the pen doesn't 'click' into place when you press the end in gently, the latch mechanism may be "locked". This usually happens if you pull the pen out of the Series 5, without first pushing the pen in so that it 'clicks' and unlocks the latch.

To "unlock" the latch mechanism, first try the following steps:

1. Push the pen in until it meets resistance, then gently apply pressure to the end of the pen.
2. Release pressure from the pen when you hear the latch mechanism 'click'. The pen should now 'click' into place without any more problems.

If these steps didn't fix the problem, you can try using the alternative method below, or contact your local authorised Psion service centre.

1. Open the cover of the RS232 serial port at the rear of your Series 5.
2. Look at the serial port carefully; you will notice that there is a very narrow gap directly underneath the 'RS232' motif (below the serial connector), and above the curved "thumbnail" groove.
3. GENTLY insert a thin, non-metallic item into the gap, e.g. your thumbnail, or the corner of a plastic card (do not use a credit card or bank card in case you damage them). DO NOT apply excessive pressure.
4. You should hear a 'click' when you unlock the pen mechanism. The pen should now 'click' into place without any more problems.

If neither of these methods solve the problem, contact your local authorised Psion service centre.

If you can't connect your cable

If you are having difficulty connecting the cable to your Series 5, you may be attempting to insert the connector upside down. Make sure that the "RS232" motif is facing **down** when you insert the connector. You should not have to apply force when inserting the connector into the port on your Series 5.

Character set

The Series 5 contains several fonts, but all have the same basic character set. This is the **IBM Code Page 1252** character set.

In addition to the characters that you can enter directly from the keyboard, there are many other special characters which you can use. You can display and insert them using the **Insert special character** command in the Word program.

To insert special characters in Word:

1. Open the Word file.
2. Select the **Special character** command from the **Insert** menu.
3. Select the required character and press OK.

Note: You can also use the Shift + Ctrl + C shortcut keypress to display the Special character dialog when typing text in most other programs.

To insert special characters when you can't display the Special character dialog:

1. Move to Word, select the **Special character** command from the **Insert** menu.
2. Move the highlight to the character you want to insert to display its shortcut key at the bottom of the dialog, e.g. the special character [™] has the shortcut Ctrl + I53.
3. Move back to the program in which you want to insert the character and press its shortcut key, e.g. to insert [™] hold down Ctrl and press I, then 5 and then 3.

IBM codepage 1252

!	032	5	053	J	074	095	t	0116	% _o	0137	0158	³	È	0200	Ý	0221	ò	0242
"	033	6	054	K	075	096	u	0117	Š	0138	0159	´	É	0201	Þ	0222	ó	0243
#	034	7	055	L	076	097	v	0118	‹	0139	0160	µ	Ê	0202	ß	0223	ô	0244
\$	035	8	056	M	077	098	w	0119	Œ	0140	0161	¶	Ë	0203	à	0224	õ	0245
%	036	9	057	N	078	099	x	0120	¸	0141	0162	·	Ì	0204	á	0225	ö	0246
&	037	:	058	O	079	100	y	0121	£	0142	0163	,	Í	0205	â	0226	÷	0247
'	038	;	059	P	080	101	z	0122	¤	0143	0164	ı	Î	0206	ã	0227	ø	0248
(039	<	060	Q	081	102	{	0123	¥	0144	0165	°	Ï	0207	ä	0228	ù	0249
)	040	=	061	R	082	103		0124	¦	0145	0166	»	Ð	0208	å	0229	ú	0250
*	041	>	062	S	083	104	}	0125	§	0146	0167	¼	Ñ	0209	æ	0230	û	0251
+	042	?	063	T	084	105	~	0126	¨	0147	0168	½	Ò	0210	ç	0231	ü	0252
,	043	@	064	U	085	106	€	0127	©	0148	0169	¾	Ó	0211	è	0232	ý	0253
-	044	A	065	V	086	107	•	0128	ª	0149	0170	¿	Ô	0212	é	0233	þ	0254
.	045	B	066	W	087	108	-	0129	«	0150	0171	À	Õ	0213	ê	0234	ÿ	0255
/	046	C	067	X	088	109	—	0130	¬	0151	0172	Á	Ö	0214	ë	0235		
0	047	D	068	Y	089	110	~	0131	-	0152	0173	Â	×	0215	ì	0236		
1	048	E	069	Z	090	111	™	0132	®	0153	0174	Ã	Ø	0216	í	0237		
2	049	F	070	[091	112	§	0133	™	0154	0175	Ä	Ù	0217	î	0238		
3	050	G	071	\	092	113	>	0134	°	0155	0176	Å	Ú	0218	ï	0239		
4	051	H	072]	093	114	œ	0135	±	0177	0177	Æ	Û	0219	ð	0240		
	052	I	073	^	094	115	¸	0136	²	0178	0178	Ç	Ü	0220	ñ	0241		



Specification

Dimensions:

Size: 172×89×24 mm.

Weight: 350g (with batteries).

Screen:

9 touch-sensitive icons for program selection.

5 touch-sensitive icons for commands.

Internal memory:

ROM: 10MB (Series 5mx), containing multi-tasking, windowed operating system.

RAM: 16MB (Series 5mx).

Note: Information correct at time of print. Memory configurations may vary according to model (see product packaging for details).

Disk drive:

Accepts Psion Memory Disks/Program disks (Compact Flash Type 1).

Processor:

32bit ARM 710T core, 36.864MHz.

Sound:

Loudspeaker - ½W, 8 ohm.

Microphone - Electret with active gain control.

Power:

2 × AA size Alkaline batteries.

Standard Lithium (CR 2032) battery protects RAM while main batteries are changed.

Optional mains adapter (6V DC ± 10%, 1A).

Keyboard:

53 key, QWERTY layout, computer-style keyboard.

Operating temperature:

0-40 degrees Centigrade.

Communications options:

Fast RS232-compatible serial link provides data transfer speeds of up to 115200 baud.

IrDA SIR optical link supports Infrared communications.



INDEX**Symbols**

- # sign
 - in Sheet 57
- \$ sign
 - in Sheet 59
 - » in Agenda 81
- 12/24 hour clock 19, 124
- 3D graphs 64

A

- Absolute references
 - in Sheet 59
- absolute references in Sheet 59
- accented characters 189
- adding
 - Agenda entries 75
 - anniversaries in Agenda 77
- appointments 75
- birthdays in Agenda 77
- calculations in Calc 102
- city 123
- clipart to a Sketch 140
- country 124
- day entries in Agenda 75
- entries in Contacts 67
- entries in Data 128
- entries in Jotter 111
- event entries in Agenda 75
- files to emails 93, 99
- information in Sheet cells 56
- labels in Contacts 69
- labels in Data 133
- memos in Agenda 85
- numbers in Calc 102
- passwords to files 35
- phone numbers 171
- pictures in Agenda 86
- programs 38
- scientific calculations 103
- text in Sketch 139
- titles to graphs 65
- to-do entries 82
- to-do lists in Agenda 83
- town or city 123
- voice notes in Agenda 86
- words to Spell 146
- addresses
 - in Email 93, 97
- Agenda
 - alarms 78
 - dialling 171
 - Infrared 166
 - moving & renaming files 36
 - PC agendas 5, 89
 - alarms 117
 - changing 120
 - deleting 120, 173
- alarms 78
- alarms 117
- alarms 144
- anagrams 144
- analog clocks 124
- angle formats 108
- anniversaries in Agenda 77
- annual appointments 81
- applications. See programs
- applying styles in Word 44
- appointments in Agenda 75
- archiving Agenda files 87
- in Agenda 77, 78
- recording 173
- responding to 119
- setting 118
- troubleshooting 183
- alignment
 - in Sheet 60
 - in Word 42
- alphabetical order in Contacts 67
- alphabetical order in Data 130
- am/pm clock 19
- anagrams 144
- analog clocks 124
- angle formats 108
- anniversaries in Agenda 77
- annual appointments 81
- applications. See programs
- applying styles in Word 44
- appointments in Agenda 75
- archiving Agenda files 87

- arrows
 - in menu commands 13
 - on dialog lines 13
 - assigning memories in Calc 105
 - attachments
 - adding 93, 99
 - opening/viewing 99
 - saving 99
 - attributes 35
 - automatic
 - send in Email 96
 - automatic switch on/off 7
 - and voice notes 152
 - axis titles 65
- B**
- background
 - screen. See wallpaper
 - background colour in Word 43
 - backing up
 - to a PC 5
 - to Memory disks 36
 - backlight 9, 26
 - backup battery 7
 - removing 177
 - backups
 - files 25, 181
 - on Memory Disks 25, 181
 - on PCs 25
 - restoring 181
 - bar graphs 64
 - batteries
 - and voice notes 152
 - changing 176, 177
 - checking power 176
 - fitting 7
 - NiCd 177
 - prolonging life 179
 - recommended 176
 - beaming. See Infrared
 - bell symbol in Agenda 77
 - birthdays in Agenda 77
 - blind copy in Email 93
 - bold text
 - in Sheet 60
 - in System screen 10, 29
 - in Word 41
 - Bombs game 155
 - bookmark in System screen 27
 - borders
 - in Sheet 60
 - in Word 43
 - browsing folders 33
 - bullets
 - in Jotter 112
 - in Word 42
 - Busy view in Agenda 76
 - buttons
 - external 150
 - in dialogs 15
- C**
- Calc program 101
 - calculations
 - general 102
 - in Sheet 58
 - scientific 103
 - calendar
 - in Agenda 79
 - in dialogs 15
 - calibrating the screen 26
 - cancelling
 - dialogs 15
 - Infrared transfer 168
 - candle symbol in Agenda 77
 - care of the Series 5 175

- categories in Agenda. See entry symbols
- CC in Email 93
- centred text in Word 42
- changing
 - Agenda entries 80
 - alarm details 120
 - angle formats 108
 - batteries 176
 - city details 123, 124
 - colours in Sketch 139
 - Contact entries 69
 - country details 124
 - current disk 27
 - Data entries 131
 - font in Word 41
 - labels in Contacts 69, 70
 - labels in Data 130, 132
 - number formats in Calc 109
 - templates 49
- character set 189
- check box 13
- circles & ellipses 136
- cities 117
 - adding 123
 - changing details 123, 124
 - deleting 123
 - selecting 122
 - sunrise and sunset times 125
- cleaning the screen 175
- clearing
 - alarms 119
 - the Calculator display 103
 - clipart in Sketch 140
 - clocks 124
 - closing
 - email accounts 100
 - files 29
 - files & folders 29
 - programs 29
- colours in Word 41
- column graphs 64
- column widths
 - in Data 130
 - in System screen 174
- combining information 16
- command icons 9
- commands on menus 13
- Comms program 24
- compiling an OPL program 158
- compressing
 - sounds 153
 - confirming tentative Agenda entries 75
- connecting
 - to mailboxes 95, 96
 - connecting to PCs 5
- Contacts
 - dialling 171
 - contacts
- adding 67
- deleting 69
- editing 69
- finding 68
- labels 69
- sorting 67
- contrast of screen 9, 26
- Control panel 19, 25
- converting files to PC programs 5
- copying
 - Agenda entries 80
 - by Infrared 165
 - disks 36
 - files & folders 36
 - text in Word 40
 - words to spell check 143
- copying files
 - to Memory Disks 25, 181
- COS function 107
- countries

- changing details 124
- deleting 124
- creating
 - emails 93
 - fax & SMS messages 91
 - files 12, 31
 - folders 30, 33
 - graphs 63
 - Local folders 92
 - sketches 135
 - styles 45
 - templates 49
 - to-do lists 83
 - wallpaper 173
 - Word files 49
- cropping
 - in Sketch 139
 - objects in Jotter 114
 - objects in Word 48
- crossing out
- Agenda entries 80
 - in Word 41
 - crossword clues 145
 - cube roots in Calc 107
 - cubing numbers in Calc 107
 - currency 25
 - current disk 27
 - customising
 - Agenda 87
 - Extras bar 174
 - Jotter 115
 - System screen 174
 - to-do lists 84
 - cutting
 - files & folders 36
 - Sketch 139
- D**
 - daily appointments 81
 - Data 127
 - dialling 171
 - Infrared 166
 - labels 171
 - moving & renaming files 36
 - date 122
 - format 25, 124
 - setting 19
 - day entries in Agenda 75
 - daylight saving time 125
 - deadlines for To-do entries 82
 - decimal places in Calc 109
 - default printer 159
 - defining ranges in Sheet 60
 - degrees in Calc 108
 - deleting
 - Agenda entries 80
 - alarms 120, 173
 - cities 123
 - Contact entries 69
 - dialling 169
 - and Data labels 171
 - codes 117
 - free input dialling 172
 - in Contacts 67
 - troubleshooting 171
 - dialogs 13
 - buttons 15
 - country 124
 - Data entries 131
 - emails 97
 - files & folders 37
 - in Sketch 138
 - Jotter entries 114
 - styles 45
 - wallpaper 173
 - deselecting files & folders 36
 - Desk view in Calc 102
 - detaching files from email 99
 - dial out codes 170
 - dialling 169
 - and Data labels 171
 - codes 117
 - free input dialling 172
 - in Contacts 67
 - troubleshooting 171
 - dialogs 13
 - buttons 15
 - day entries in Agenda 75
 - daylight saving time 125
 - deadlines for To-do entries 82
 - decimal places in Calc 109
 - default printer 159
 - defining ranges in Sheet 60
 - degrees in Calc 108
 - deleting
 - Agenda entries 80
 - alarms 120, 173
 - cities 123
 - Contact entries 69
 - dialling 169
 - and Data labels 171
 - codes 117
 - free input dialling 172
 - in Contacts 67
 - troubleshooting 171
 - dialogs 13
 - buttons 15

- cancelling 15
- moving between pages 14
- saving settings 15
- dictating machine 150
- dictionaries in Spell 146
- digital clocks 124
- disabling alarms 120
- disconnecting
 - in Email 100
- disks
 - copying 36
 - formatting 38
 - renaming 37
 - root folder 29
- displaying
 - help 17
 - non-printing characters 43
- distance units 124
- distances 122
- dividing in Calc 102
- downloading. *See* receiving
- Draft
 - folder 92, 94
 - draft
 - emails 94
 - drawing
 - circles and ellipses 136
 - in Sketch 135
 - squares and rectangles 136
 - tools in Sketch 135
 - DTMF dialling 169
 - due dates for To-do entries 82
- E**
 - editing
 - colours in Sketch 139
 - Contact entries 69
 - Data entries 131
 - pictures in Agenda 86
 - previous calculations in Calc 105
- embeddng. *See* inserting
- objects
 - Enter key 15
 - entry symbols in Agenda 87
 - erase tool in Sketch 138
 - Esc key 15
 - exponents in Calc 109
 - Extras bar 29
 - and Memory disks 38
 - customising 174
 - Extras icon 29
- F**
 - facsimilie. *See* fax
 - factorials in Calc 108
 - Fax
 - requirements 91
 - fax
 - messages 91
 - file lists in System screen 174
 - repeat entries in Agenda 81
 - electronic mail. *See* Email
 - Email 91
 - addresses 93, 97
 - attachments 93, 99
 - closing messages 97
 - connecting 95, 96
 - creating messages 93
 - disconnecting 100
 - finding out more 100
 - forwarding 97
 - message editor 93, 98
 - on-line help 100
 - receiving 96
 - replying to 97
 - requirements 91
 - saving draft messages 94
 - sending 95
 - setting up 100
 - viewing messages 97

file manager 27
 filenames 31, 36
 files
 adding to emails 93, 99
 Agenda 87
 archiving Agenda files 87
 attributes 35
 backing up to Memory Disks 25, 181
 backing up to PCs 25
 browsing 33
 closing 29
 creating 12, 31
 details 33
 file sizes 37
 finding 33, 184
 highlighting 36
 in System screen 12, 27, 30
 Infrared transfer 166
 managing 33, 36, 37
 merging 87
 naming 31
 opening 29, 31, 33
 passwords 35
 read-only 35
 selecting 36
 sorting 33, 174
 transferring to PCs 30
 files & icons 12
 finding
 Agenda entries 79
 anagrams 144
 dates in Agenda 79
 entries in Contacts 68
 entries in Data 131
 help 17
 in Sheet 56
 Jotter entries 114
 missing letters 145
 synonyms 144
 text in Word 40
 finding files 33, 184
 fitting the batteries 7
 Fixed number format 109
 flipping
 layout in Calc 101
 sketches 138
 Fn key 29
 folders
 browsing 33
 closing 29
 creating 12, 30, 33
 Draft 92, 94
 highlighting 36
 Inbox 92, 96
 Local 92
 managing 33, 36, 37
 names 27, 30
 naming 31
 opening 29
 font
 for Data Labels 130
 in Sheet 60
 in Sketch 139
 in Word 41
 footers
 in Page setup 162
 in Word 53
 forced line break 41
 foreign characters 42, 189
 formats
 numbers in Calc 109
 numbers in Sheet 62
 time & date 25, 124
 formatting
 disks 38
 Outbox 92, 93, 94, 95
 selecting 36
 Sent 92, 96
 types in Email 92

- objects in Jotter 114
 - objects in Word 48
 - paragraphs 41
 - text in Word 41
 - formulae 56
 - forwarding email 97
 - free input dialling 172
 - free memory 37
 - functions
 - in Calc 103
 - in Sheet 59
- G**
- game 155
 - GMT (Greenwich Mean Time) 123
 - going to entries in Agenda 79
 - gradients in Calc 108
 - graphs 63
 - in Jotter 114
 - in Word 47
 - Infrared 166
 - grey
 - dialog lines 14
 - menu commands 13
 - grid lines in Sheet 65
- H**
- handshaking 161
 - hanging indents 42
 - hard hyphen in Word 43
 - hard reset 185
 - headers
 - in Page setup 162
 - in Word 53
 - Help
 - keypress 17
 - on Email 100
 - using 17
 - hidden
 - files 174
 - labels in Data 130
 - text in Word 43
 - highlighting
 - cells in Sheet 56
 - files & folders 36
 - text in Word 40
 - Home city 122
 - setting 19
 - when you travel 125
 - hyperbolic functions in Calc 107
- I**
- icons
 - in Jotter 114
 - in System screen 12, 27
 - images
 - in Sketch 135
 - Inbox
 - folder 92, 96
 - indents in Word 42
 - Infrared 165
 - printing 160
 - security 181
 - inserting
 - batteries 7
 - date in Jotter 113
 - foreign characters 189
 - objects in Jotter 113
 - objects in Word 47
 - page breaks 52
 - installing programs 38
 - international
 - dialling 123, 171
 - settings 25
 - Internet
 - connecting 95, 96
 - disconnecting 100

- IrObex standard 71
- italic text
 - in Sheet 60
 - in Word 41
- J**
 - Jotter 111
 - adding entries 111
 - finding entries 114
 - inserting objects 113
 - printing 116
- K**
 - keyboard
 - settings 26
 - where things are 7
 - keypresses 26
 - keys
 - Enter 15
 - Esc 7, 15
 - Help 17
 - on & off 7
 - shortcuts 15
 - kilometres 124
 - L**
 - labels
 - in Contacts 69
 - in Data 132
 - left aligned text in Word 42
 - line graphs 64
 - line spacing in Word 43
 - lines in Sketch 136
 - listing open files 12, 29
 - Local
 - mailbox 96
 - Local folders 91, 92
 - logarithms 108
 - loudspeaker 150
 - low batteries message 7
 - M**
 - mail. See Email
 - mailbox
 - connecting 95, 96
 - Local 96
 - Remote 91, 94, 96, 100
 - types in Email 91
 - mains adaptors 7, 175, 191
 - managing
 - emails and folders 91
 - files & folders 33
 - map of the world 117
 - margins
 - in Word 42
 - printing 162
 - memories in Calc
 - in Desk 102
 - Scientific 105
 - memory 38
 - memory disks 38
 - backups 25, 181
 - Memory Disks
 - displaying in System screen 27
 - formatting 38
 - memory disks 191
 - memos in Agenda 85
 - menus & menu commands 13
 - merging
 - in Jotter 116
 - merging Agenda files 87
 - messages
 - email, SMS and fax 91
 - microphone 147
 - midnight 19
 - miles 124
 - monthly appointments 81
 - messages
 - in Word 42
 - printing 162
 - memories in Calc
 - in Desk 102
 - Scientific 105
 - memory 38
 - memory disks 38
 - backups 25, 181
 - Memory Disks
 - displaying in System screen 27
 - formatting 38
 - memory disks 191
 - memos in Agenda 85
 - menus & menu commands 13
 - merging
 - in Jotter 116
 - merging Agenda files 87
 - messages
 - email, SMS and fax 91
 - microphone 147
 - midnight 19
 - miles 124
 - monthly appointments 81
 - gauge 37
 - information 37

- moving
 - Agenda entries 80
 - Agenda files 36
 - an area in Sketch 137
 - Data files 36
 - files & folders 36
 - multiple files
 - and Infrared 166
 - multiple graphs 65
 - multiplying in Calc 102
- N**
 - names & addresses 67
 - naming ranges in Sheet 60
 - natural logarithms 108
 - natural numbers in Calc 108
 - nautical miles 124
 - navigating
 - Word files 46
 - NiCd batteries 177
- non-breaking hyphen in Word 43
- non-breaking space in Word 43
- non-printing characters 43
- Normal number format in Calc 109
- notepad program 111
- number formats
 - in Calc 109
 - in Sheet 62
- number of years in Agenda 77
- O**
 - objects 166
 - combining information 16
 - in Word 47
 - on/off (switching on/off)
 - 7, 25, 184
 - tapping an icon 7
 - open files 12, 29
- opening
 - attachments 99
 - draft emails 94
 - emails 97
 - files 33
 - files & folders 10, 29
 - multiple files 29, 31, 174
 - operator precedence in Calc
 - Desk view 102
 - Scientific 104
 - operators in Calc 102
 - OPL 157
 - Outbox
 - folder 92, 93, 94, 95
 - outline navigation
 - in Word 45
 - owner information 21
- P**
 - page breaks in Word 52
 - page layout 162
 - margins 162
 - numbering 162
 - size of the page 162
 - page numbers in Word 53
 - pages in dialogs 14
 - paragraph
 - alignment 42
 - styles 44
 - parallel printers 160
 - password
 - files 35
 - system 22
 - passwords
 - forgotten 184
 - pasting
 - files & folders 36
 - PCs 5
 - backups 25
 - transferring files to 30

pen
 finding & using 9
 not locking 187
 pen colour in Sketch 135
 pen width in Sketch 136
 pencilling in an Agenda entry 75
 percentages in Calc 103
 personal dictionary 146
 phone numbers. *See* dialling
 pictures
 in Agenda 86
 in Sketch 135
 in Word 47
 pie chart 64
 pixels 136
 playing voice notes 152
 port settings 161
 power. *See* batteries
 powers in Calc 107
 precedence in calculations 104

 Preferences
 Extras bar 174
 in Jotter 115
 in System screen 174
 preferences
 in Jotter 115
 printing 159
 Agenda entries 88
 Contacts entries 71
 Data entries 133
 documents 164
 entry symbols in Agenda 88
 Help cards 17
 in Jotter 116
 in Word 53
 previewing a document 163
 selecting the printer model 162
 setting up the printer 159
 Sketch pictures 141

 ranges in Sheet 60
 re-sizing
 objects in Jotter 114
 re-using
 answers in Calc 105
 calculations in Calc 105
 read-only files 35
 recalculating a worksheet 59
 receiving
 emails 96
 rechargeable batteries 177
 reciprocals in Calc 107
 recommended batteries 176
 Record program 147
 and voice notes 153
 recording
 alarms 173
 sounds 147
 voice notes 152

 to a file 161
 to a parallel printer 160
 to a serial printer 160
 using Infrared 160
 via a PC 5, 161
 priority of To-do entries 82
 Program editor 157
 program icons
 9, 12, 29, 38, 174
 program manager 27
 programs
 described 12
 running 12
 PsiWin 5
 CopyAnywhere 111
 synchronising Agenda 89

R
 radians in Calc 108
 radio buttons 13

- Relative references
 - in Sheet 59
 - relative references in Sheet 59
 - reminders for Agenda entries 77
- Remote
 - mailbox 91, 94, 96, 100
 - renaming
 - disks 37
 - files & folders 36, 37
 - labels in Contacts 70
 - to-do lists 83
 - repeat appointments 81
 - repeat entries 81
 - repeating sounds 150
 - replacing text in Word 40
 - replying to email 97
 - resetting the Series 5 185
 - resizing
 - in Sketch 137
 - objects in Word 48
- the background in Sketch
 - 139
 - responding to an alarm 119
 - restoring backups 181
 - reversing the layout in Calc 101
 - reverting to saved
 - in Word 51
 - rewinding voice notes 152
 - right aligned text in Word 42
 - root of disks 29
 - roots in Calc 107
 - rotating sketches 138
 - running an OPL program 158
- S**
 - saving
 - and switching off 7
 - attachments 99
 - dialog settings 15
 - draft emails 94
 - Scientific number format 109
 - Scientific view in Calc 103
 - screen
 - backlight 9
 - calibrating 26
 - cleaning 175
 - contrast 9
 - settings 26
 - size of text 9
 - wallpaper 173
 - searching
 - in Joffer 114
 - security
 - Infrared 181
 - Memory disks 35
 - other machines 35
 - PCs 35
 - selecting
 - all files & folders 36
 - Sent
 - folder 92, 96
 - serial port settings 161
 - serial printers 160
 - Series 3/3a/3c/3mx
 - upgrading files 5
 - setting
 - alarms 118
 - alarms in Agenda 77
 - dialling options 170
 - Home city 19, 122
 - setting
 - alarms 118
 - alarms in Agenda 77
 - dialling options 170
 - Home city 19, 122
 - Serial printers 160
 - Series 3/3a/3c/3mx
 - upgrading files 5
 - Serial port settings 161
 - Serial printers 160
 - Series 3/3a/3c/3mx
 - upgrading files 5
 - Setting
 - alarms 118
 - alarms in Agenda 77
 - dialling options 170
 - Home city 19, 122
 - Sketch
 - an area in Sketch 137
 - cities & countries 122
 - cities in one country 123
 - files & folders 36
 - menu commands 13
 - sending
 - by Infrared 165
 - emails 95
 - fax & SMS messages 91
 - Sent
 - folder 92, 96
 - serial port settings 161
 - serial printers 160
 - Series 3/3a/3c/3mx
 - upgrading files 5
 - setting
 - alarms 118
 - alarms in Agenda 77
 - dialling options 170
 - Home city 19, 122

- passwords on files 35
- screen contrast 9
- summer time 125
- system password 22
- time & date 19, 122
- setting up
 - Email 100
 - setting up the Series 5 19
 - shading cells in Sheet 60
 - Sheet
 - Infrared 166
 - sorting 61
 - Sheet program 55
- Short Message Service. *See* SMS
- shortcut keys 15
 - in Calc 103
- significant figures in Calc 109
- silencing alarms 119, 120
- SIN function 107
- size
 - of files 33
 - text on screen 9
- Sketch program 135
 - adding clipart 140
 - adding text 139
 - background size 136
 - circles & squares 136
 - cropping the picture 139
 - flipping & rotating 138
 - transparency 138
- sketches
 - in Jotter 113
 - sketches in Word 47
- SMS
 - messages 91
 - requirements 91
 - snoozing an alarm 119
 - soft reset 185
 - solving
- spell program 143
- spray painting in Sketch 136
- spreadsheets 55
- square roots in Calc 107
- squares & rectangles in Sketch 136
- squaring numbers in Calc 107
- standby mode 179
- start year in Agenda 77
- status window. *See* toolbar
- storing the Series 5 175
- strikethrough. *See* crossing out
- styles
 - and outline navigation 45
 - styles in Word 44
 - stylesheets. *See* template
 - stylus. *See* pen
 - subscript text 41
 - subtracting in Calc 102
- anagrams 144
- crossword clues 145
- sorting
 - entries in Contacts 67
 - entries in Data 130
 - files 33, 174
 - in Jotter 115
 - in Sheet 61
 - labels in Contacts 70
 - labels in Data 130
 - to-do lists 84
- sounds
 - in Agenda 86
 - in Word 47
 - recording & playing 147
 - settings 26
 - special characters 42, 189
 - specification 191
 - spell checking 143
 - in Word 48

- summer time 125
- sunrise and sunset times 125
- superscript text 41
- switching
 - auto switch off 7
 - backlight on & off 9
 - between files 29
 - on & off 7, 25
 - on/off and Jotter 112
 - on/off and voice notes 152
- tasks 29
- symbol characters 189
- symbols
 - in Jotter 112
- symbols in Agenda 87
- synchronising Agenda 89
- synonyms 144
- System folder 174
- system password 22
- System screen 27
 - introduction to 10
- system settings 19
- T**
 - T symbol in Agenda 82
 - Tab key 15, 33
 - tables
 - in Sheet 55
 - in Word 47
 - sorting in Sheet 61
 - tabs in Word 42
 - TAN function 107
 - task list 29
 - telephone codes 123
 - telephone numbers. *See* dialling
 - templates
 - creating & changing 49
 - in Word 49
- setting default 50
- tentative entries in Agenda 75
- testing alarms 118
- text
 - adding to a sketch 139
 - colour in Word 41
 - entering in dialogs 13
 - size in Word 41
 - size on screen 9
 - thesaurus 144
 - things to do 82
 - tick box 13
 - tidying Agenda files 87
 - till roll in Calc 102
- time
 - 12/24 hour format 19
 - am/pm clock 19
 - format 25
 - setting 19
 - time differences 122
- Time program 117
- timed entry in Agenda 75
- times 117
- title in System screen
 - 10, 27, 29, 37, 174
- to-do entries 82
- to-do lists 82
 - creating 83
 - customising 84
 - renaming 83
 - sorting entries 84
 - viewing 76
- tone dialling 169
- toolbars 174
- transferring
 - files to PCs 30
 - information by Infrared 165
 - translating an OPL program 158
- transparency in Sketch 138

- travelling 125
 - trigonometric functions 107
 - turning on/off 7
- U**
- underlining
 - in Sheet 60
 - in Word 41
 - undoing changes
 - in Jotter 114
 - in Sketch 138
 - in Word 51
 - units of distance 124
 - updating Contact entries 69
 - updating Data entries 131
 - used memory 37
- V**
- vCard standard in Contacts 71
 - viewing
 - alarms 121
 - attachments 99
 - emails 97
 - entries in Data 129
 - views in Agenda 76
 - voice note buttons 119
 - voice notes 150
 - in Agenda 86
 - wallpaper
 - creating 173
 - deleting 173
 - Week view in Agenda 76
 - weekly appointments 81
 - wildcards 68
 - windows. See dialogs
 - Word 39
 - Workdays 118
 - world map 117
 - wrapping text
 - in Word 40
 - non-printing characters 42
 - writing. See creating
 - wysiwyg text 40
- X**
- X-rays 181
 - X/Y scatter graphs 64
 - Xword in Spell 145
- Y**
- Year planner in Agenda 76
 - yearly appointments 81
- Z**
- zooming in & out 9, 174