



US008805001B2

(12) **United States Patent**  
**Pirim**

(10) **Patent No.:** **US 8,805,001 B2**  
(45) **Date of Patent:** **\*Aug. 12, 2014**

(54) **IMAGE PROCESSING METHOD**

(75) Inventor: **Patrick Pirim**, Paris (FR)

(73) Assignee: **Image Processing Technologies LLC**,  
Suffern, NY (US)

(\* ) Notice: Subject to any disclaimer, the term of this patent is extended or adjusted under 35 U.S.C. 154(b) by 528 days.

This patent is subject to a terminal disclaimer.

(21) Appl. No.: **12/620,092**

(22) Filed: **Nov. 17, 2009**

(65) **Prior Publication Data**

US 2010/0215214 A1 Aug. 26, 2010

**Related U.S. Application Data**

(60) Continuation of application No. 11/676,926, filed on Feb. 20, 2007, now Pat. No. 7,650,015, which is a division of application No. 09/792,294, filed on Feb. 23, 2001, now Pat. No. 7,181,047, which is a continuation-in-part of application No. 09/230,502, filed on Sep. 13, 1999, now Pat. No. 6,486,909, which is a continuation-in-part of application No. PCT/EP98/05383, filed on Aug. 25, 1998, and a continuation-in-part of application No. PCT/FR97/01354, filed on Jul. 22, 1997.

(30) **Foreign Application Priority Data**

Jul. 22, 1996 (FR) ..... 96 09420

(51) **Int. Cl.**  
**G06K 9/00** (2006.01)

(52) **U.S. Cl.**  
USPC ..... **382/103**; 382/128; 382/168

(58) **Field of Classification Search**  
USPC ..... 382/100, 103, 107, 128-132, 168-180, 382/199-206, 224, 291  
See application file for complete search history.

(56) **References Cited**

**U.S. PATENT DOCUMENTS**

4,783,828 A 11/1988 Sadjadi  
5,008,946 A 4/1991 Ando

(Continued)

**FOREIGN PATENT DOCUMENTS**

EP 0046110 A1 2/1982  
EP 0 380 659 A1 8/1990

(Continued)

**OTHER PUBLICATIONS**

Swain et al., IEEE Publication, 1990, "Indexing via color histograms" (pp. 390-393).\*

(Continued)

*Primary Examiner* — Manav Seth

(74) *Attorney, Agent, or Firm* — Novak Druce Connolly Bove + Quigg LLP

(57) **ABSTRACT**

A method and apparatus for localizing an area in relative movement and for determining the speed and direction thereof in real time is disclosed. Each pixel of an image is smoothed using its own time constant. A binary value corresponding to the existence of a significant variation in the amplitude of the smoothed pixel from the prior frame, and the amplitude of the variation, are determined, and the time constant for the pixel is updated. For each particular pixel, two matrices are formed that include a subset of the pixels spatially related to the particular pixel. The first matrix contains the binary values of the subset of pixels. The second matrix contains the amplitude of the variation of the subset of pixels. In the first matrix, it is determined whether the pixels along an oriented direction relative to the particular pixel have binary values representative of significant variation, and, for such pixels, it is determined in the second matrix whether the amplitude of these pixels varies in a known manner indicating movement in the oriented direction. In each of several domains, histogram of the values in the first and second matrices falling in such domain is formed. Using the histograms, it is determined whether there is an area having the characteristics of the particular domain. The domains include luminance, hue, saturation, speed (V), oriented direction (D1), time constant (CO), first axis (x(m)), and second axis (y(m)).

**13 Claims, 13 Drawing Sheets**

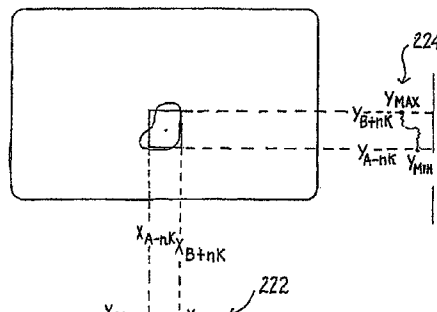

(56)

References Cited

U.S. PATENT DOCUMENTS

5,088,488 A 2/1992 Markowitz et al.  
 5,109,425 A 4/1992 Lawton  
 5,123,055 A \* 6/1992 Kasdan ..... 382/134  
 5,163,095 A 11/1992 Kosaka  
 5,263,098 A \* 11/1993 Horikami ..... 382/128  
 5,278,921 A \* 1/1994 Nakamura et al. .... 382/167  
 5,359,533 A 10/1994 Ricka et al.  
 5,384,865 A 1/1995 Loveridge  
 5,430,809 A \* 7/1995 Tomitaka ..... 382/173  
 5,473,369 A \* 12/1995 Abe ..... 348/169  
 5,488,430 A 1/1996 Hong  
 5,521,843 A \* 5/1996 Hashima et al. .... 700/253  
 5,546,475 A \* 8/1996 Bolle et al. .... 382/190  
 5,565,920 A 10/1996 Lee et al.  
 5,592,226 A 1/1997 Lee et al.  
 5,592,237 A 1/1997 Greenway et al.  
 5,608,820 A \* 3/1997 Vaidyanathan ..... 382/169  
 5,610,653 A \* 3/1997 Abecassis ..... 348/170  
 5,625,717 A 4/1997 Hashimoto et al.  
 5,694,495 A 12/1997 Hara et al.  
 5,712,729 A 1/1998 Hashimoto  
 5,774,581 A 6/1998 Fassnacht et al.  
 5,793,888 A 8/1998 Delaney  
 5,912,980 A \* 6/1999 Hunke ..... 382/103  
 5,982,944 A \* 11/1999 Vaidyanathan et al. .... 382/271  
 6,226,388 B1 \* 5/2001 Qian et al. .... 382/103  
 6,256,608 B1 7/2001 Malvar  
 6,304,187 B1 10/2001 Pirim  
 6,486,909 B1 11/2002 Pirim  
 6,597,738 B1 7/2003 Park et al.  
 6,717,518 B1 4/2004 Pirim  
 7,181,047 B2 2/2007 Pirim  
 7,650,015 B2 \* 1/2010 Pirim ..... 382/103  
 2002/0101432 A1 8/2002 Ohara et al.  
 2002/0120594 A1 8/2002 Pirim  
 2002/0156753 A1 10/2002 Pirim  
 2002/0169732 A1 11/2002 Pirim  
 2003/0067978 A1 4/2003 Pirim  
 2003/0152267 A1 8/2003 Pirim  
 2007/0140526 A1 6/2007 Pirim

FOREIGN PATENT DOCUMENTS

EP 0 394 959 A2 10/1990  
 EP 574831 A1 \* 12/1993 ..... G01N 21/88  
 FR 2611063 A1 8/1988  
 FR 2751772 A1 1/1998  
 JP 06-205780 A 7/1994  
 WO WO 98/05002 2/1998  
 WO WO 99/36893 7/1999  
 WO WO 99/36894 7/1999  
 WO WO 00/11609 A1 3/2000  
 WO WO 00/11610 A1 3/2000  
 WO WO 01/63557 A2 8/2001

OTHER PUBLICATIONS

Grove et al., IEEE Publication, Aug. 1998, "Colour Based Object Tracking" (pp. 4).\*

Stephane C. Mallat, "A Theory for Multiresolution Signal Decomposition: The Wavelet Representation", IEEE Transactions on Pattern Analysis and Machine Intelligence, vol. 11, No. 7, Jul. 1989, pp. 674-693.

John G. Daugman, "Complete Discrete 2-D Gabor Transforms by Neural Networks for Image Analysis and Compression", IEEE Transaction on Acoustics, Speech and Signal Processing, vol. 36, No. 7, Jul. 1988, pp. 1169-1179.

Alberto Tomita, Jr., et al., "Hand Shape Extraction from a Sequence of Digitized Gray-Scale Images", IECON '94, 20th International Conference on Industrial Electronics, Control and Instrumentation, vol. 3 of 3, Special Sessions, Signal Processign and Control, pp. 1925-1930.

Giacomo Indiveri et al., "System Implementations of Analog VLSI Velocity Sensors", 1996 IEEE Proceedings of MicroNeuro '96, pp. 15-22.

Pierre-Francois Rüedi, "Motion Detection Silicon Retina Based on Event Correlations", 1996 IEEE Proceedings of MicroNeuro '96, pp. 23-29.

Revue Trimestrielle Des <<Techniques de Lingenieur>>, "Instantanés Technique" Techniques De ingénieur, Mars 1997-N °5 (40F), ISSN 0994-0758.

Es Professionnels de L'informatique En Entreprise Magazine, "Objectif Securite Des Reseaux", No. 24, Janvier, 1997.

Electronique International Hebdo, Dec. 5, 1996-No. 245, "Premier . . . oeil", Francoise Gru svelet (with translation).

Nabeel Al Adsani, "For Immediate Release The Generic Visual Perception Processor", Oct. 10, 1997, p. 1.

Colin Johnson, "Vision Chip's Circuitry Has Its Eye Out For You", <http://192.215.107.74/wire/news/1997/09/0913vision.html>, pp. 1-3.

The Japan Times, "British firm has eye on the future", Business & Technology, Tuesday, Nov. 18, 1997, 4th Edition.

Inside the Pentagon's, Inside Missile Defense, an exclusive biweekly report on U.S. missile defense programs, procurement and policymaking, "Missile Technology" vol. 3, No. 16—Aug. 13, 1997, p. 5.

Electronique, "Le Mechanisme de la Vision Humaine Dans Le Silicium", Electronique Le Mensuel Des Ingenieurs De Conception, No. 68, Mar. 1997, ISSN 1157-1151 (with translation).

"Electronik Revue" ER, Eine Elsevier-Thomas-Publikation, Jahrgang 8, Mar. 1997, NR. 3, ISSN0939-1134.

"Un Processor de Perception Visuelle", LeHAUT PARLEUR, 25F Des solutions électroniques pour tous, No. 1856, Jan. 15, 1997 (with translation).

"Realiser Un Decodeur Pour TV Numberique", Electronique, Le Mensuel Des Ingenieurs De Conception, No. 66, Jan. 1997.

Kenichi Yamada, et al; "Image Understanding Based on Edge Histogram Method for Rear-End Collision Avoidance System", Vehicle Navigation & Information Systems Conference Proceedings; (1994), pp. 445 450 Published Aug. 31, 1994; XP 000841348.

\* cited by examiner

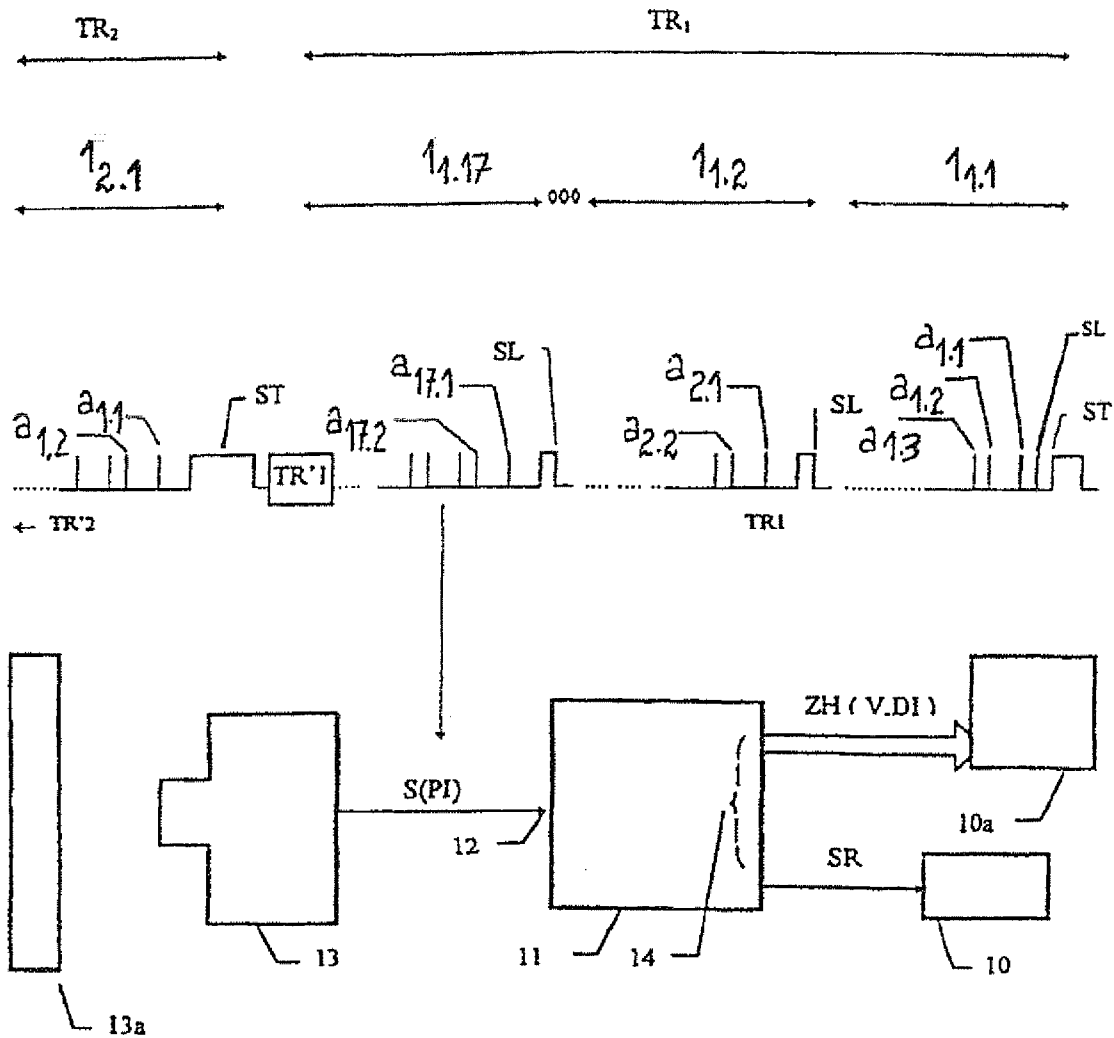

FIG. 1

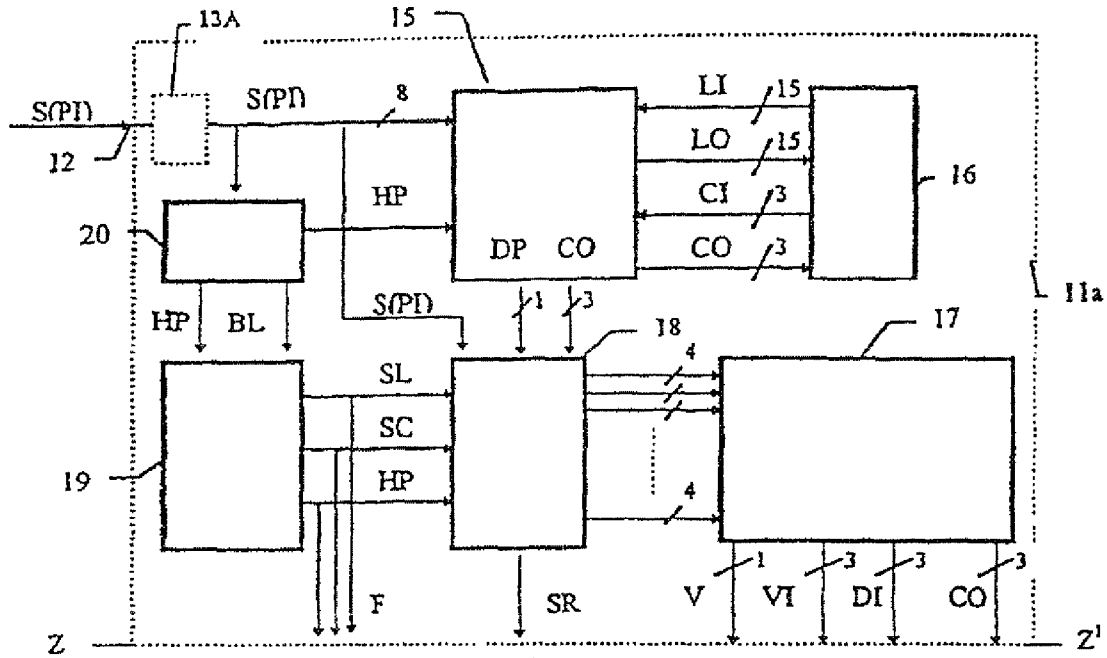

FIG. 2

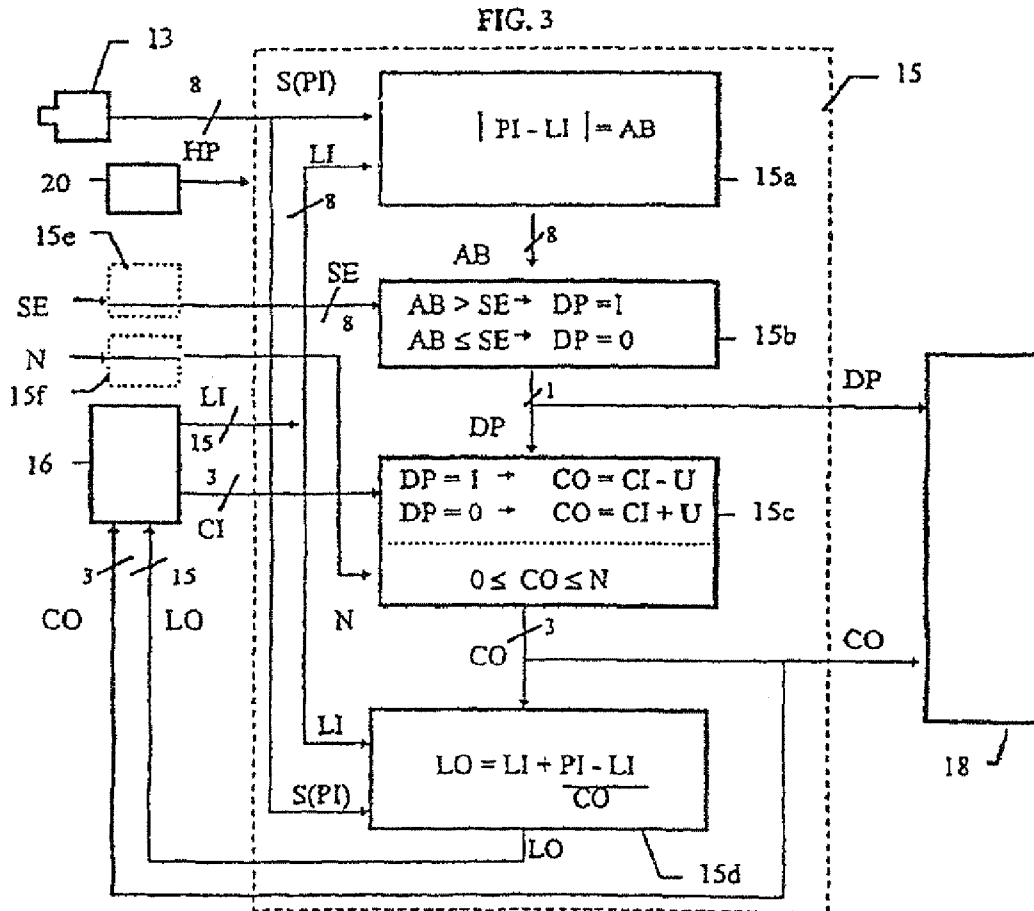

FIG. 3

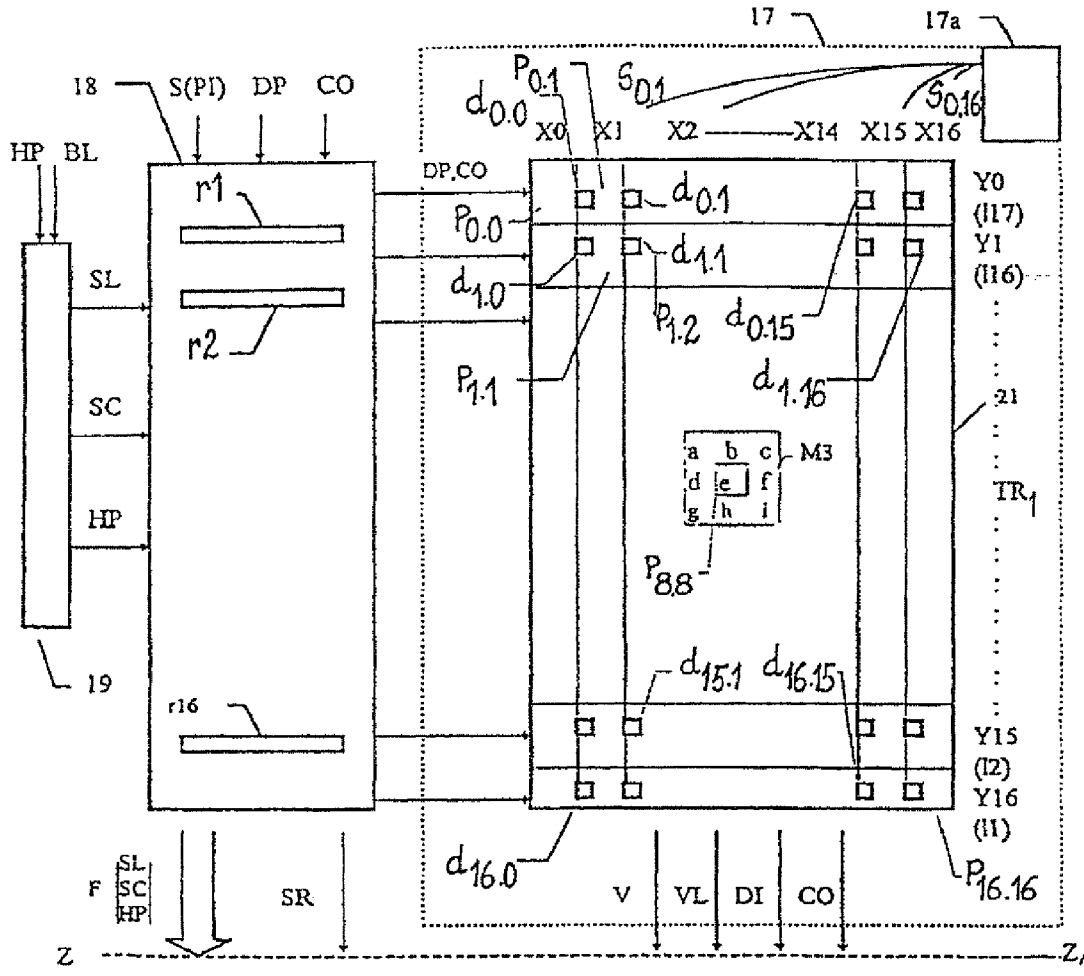

FIG. 4

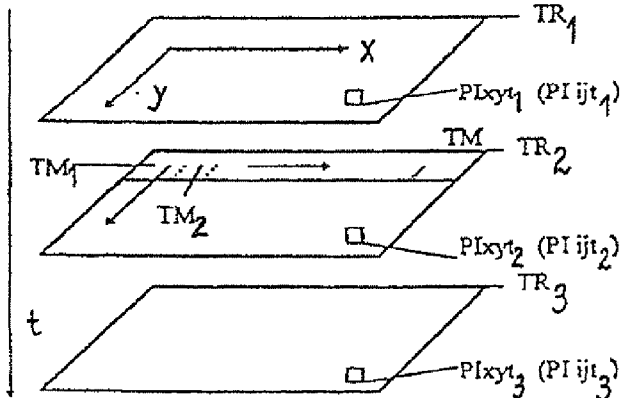

FIG. 5

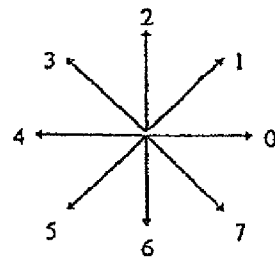

FIG. 6

# Explore Litigation Insights

Docket Alarm provides insights to develop a more informed litigation strategy and the peace of mind of knowing you're on top of things.

## Real-Time Litigation Alerts



Keep your litigation team up-to-date with **real-time alerts** and advanced team management tools built for the enterprise, all while greatly reducing PACER spend.

Our comprehensive service means we can handle Federal, State, and Administrative courts across the country.

## Advanced Docket Research



With over 230 million records, Docket Alarm's cloud-native docket research platform finds what other services can't. Coverage includes Federal, State, plus PTAB, TTAB, ITC and NLRB decisions, all in one place.

Identify arguments that have been successful in the past with full text, pinpoint searching. Link to case law cited within any court document via Fastcase.

## Analytics At Your Fingertips



Learn what happened the last time a particular judge, opposing counsel or company faced cases similar to yours.

Advanced out-of-the-box PTAB and TTAB analytics are always at your fingertips.

## API

Docket Alarm offers a powerful API (application programming interface) to developers that want to integrate case filings into their apps.

## LAW FIRMS

Build custom dashboards for your attorneys and clients with live data direct from the court.

Automate many repetitive legal tasks like conflict checks, document management, and marketing.

## FINANCIAL INSTITUTIONS

Litigation and bankruptcy checks for companies and debtors.

## E-DISCOVERY AND LEGAL VENDORS

Sync your system to PACER to automate legal marketing.