

[54] SENSOR HAVING CUTANEOUS CONFORMANCE

2262952 10/1975 France .

[75] Inventors: David E. Goodman, San Francisco; James E. Corenman, Menlo Park; William New, Jr., Woodside; Mark Yelderman, Menlo Park, all of Calif.

OTHER PUBLICATIONS

Cohen, Arnon, "Photoelectric Determination of the Relative Oxygenation of Blood", Carnegie-Mellon University, Ph.D. Thesis, 1969, (pp. 57-77).

[73] Assignee: Nellcor Incorporated, Hayward, Calif.

Primary Examiner—Edward M. Coven
Attorney, Agent, or Firm—Thomas L. Giannetti; Jeffrey H. Ingerman

[21] Appl. No.: 70,619

[57] ABSTRACT

[22] Filed: Jul. 7, 1987

A sensor for trans-illumination of a blood perfused portion of flesh to measure light extinction during trans-illumination is disclosed. The sensor is preferably mounted on a fingertip but any digit or blood perfused portion of flesh will work. The sensor includes a first end for disposition on one side of the trans-illuminated flesh and a second end for disposition on the opposite and opposed side of the trans-illuminated flesh. A light source is mounted to the first side and a photo-sensor is mounted to the second side. If an elongated flexible strip is used, it is provided with adhesive and is suitably windowed that light is allowed to take an optical path through the finger. If no flexible strip is used, the two ends are aligned and secured to the flesh such that the light emitted takes an optical path through the finger. When the adhesive fastener is used, the effect of the light source and photo-detector substrates being integrated into the adhesive fastener is that they become, in effect, a part of the skin. The resulting device is resistant to accidental removal and avoids constriction of blood vessels. Most importantly, the low mass of the sensor itself and its conformance to, so as to effectively become a part of, the skin, prevents relative motion between the light source and sensor and the perfused flesh. This eliminates the common interference associated with the operation of conventional plethysmographs and oximeters.

Related U.S. Application Data

[63] Continuation of Ser. No. 873,129, Jun. 11, 1986, abandoned, which is a continuation of Ser. No. 539,865, Oct. 7, 1983, abandoned, which is a continuation-in-part of Ser. No. 493,442, May 11, 1983, abandoned.

[51] Int. Cl.⁴ A61B 5/02

[52] U.S. Cl. 128/665; 128/666

[58] Field of Search 128/633, 637, 640, 644, 128/665, 667, 664, 689, 690, 691

[56] References Cited

U.S. PATENT DOCUMENTS

3,167,658	1/1965	Richter	128/666 X
3,599,629	8/1971	Gordy	128/640
3,602,213	8/1971	Howell et al.	128/2.05 F
3,769,974	11/1973	Smart et al.	128/666
3,807,388	4/1974	Orn et al.	128/690
4,013,067	3/1977	Kresse et al.	128/660
4,091,803	5/1978	Pinda	128/666
4,305,401	12/1981	Reissmueller et al.	128/690
4,350,165	9/1982	Striese	128/640
4,370,984	2/1983	Cartmell	128/640
4,380,240	4/1983	Jöbsis et al.	128/633
4,406,289	9/1983	Wesseling et al.	128/690

FOREIGN PATENT DOCUMENTS

671279	10/1963	Canada	128/690
0019478	11/1980	European Pat. Off.	

2 Claims, 4 Drawing Sheets

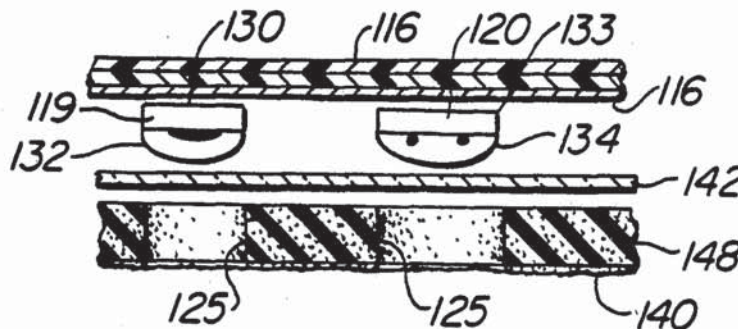

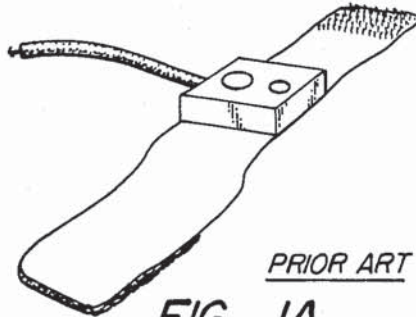

PRIOR ART
FIG. 1A.

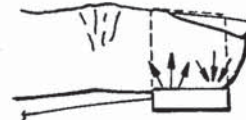

PRIOR ART
FIG. 1B.

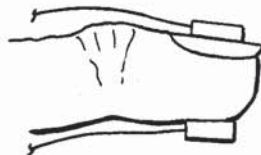

PRIOR ART
FIG. 1C.

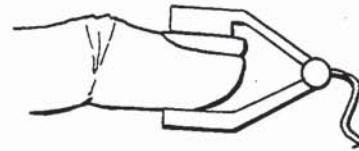

PRIOR ART
FIG. 1D.

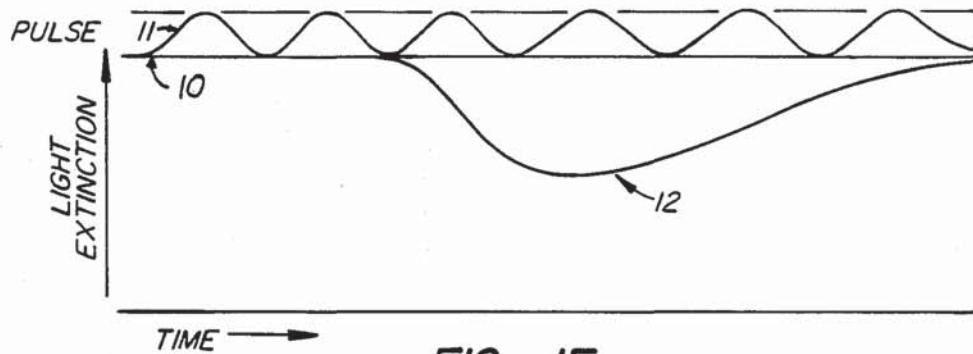

FIG. 1E.

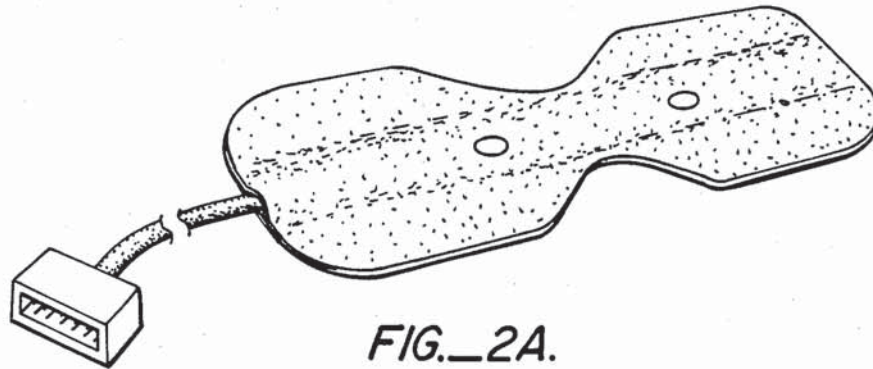

FIG. 2A.

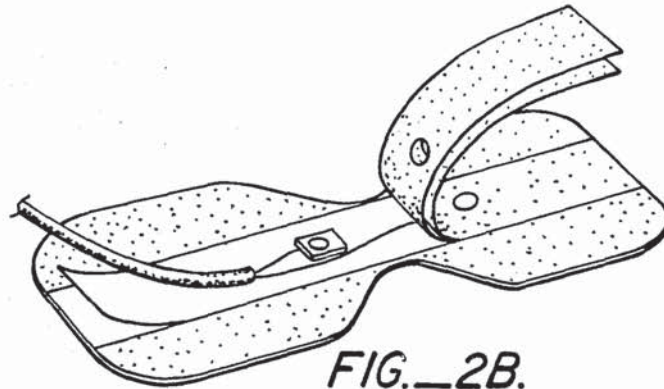

FIG. 2B.

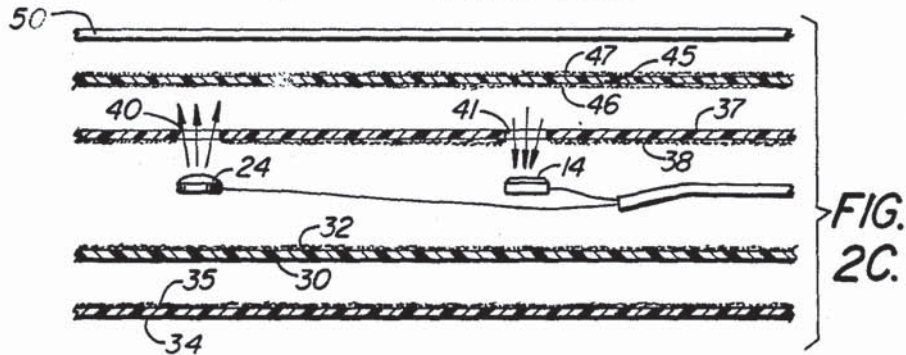

FIG. 2C.



FIG. 3A.

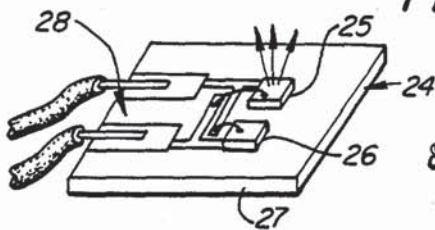

FIG. 3B.

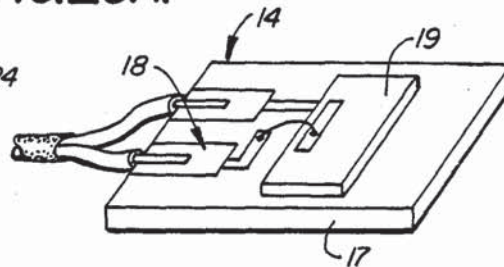
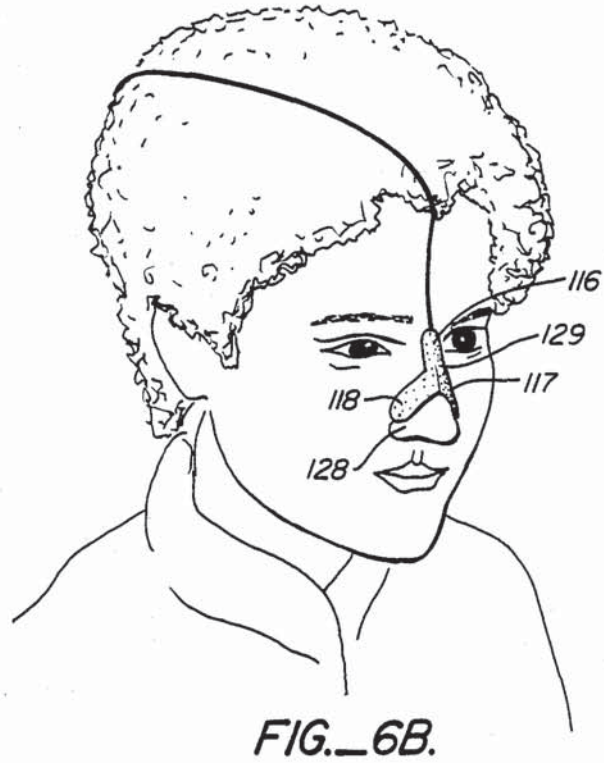
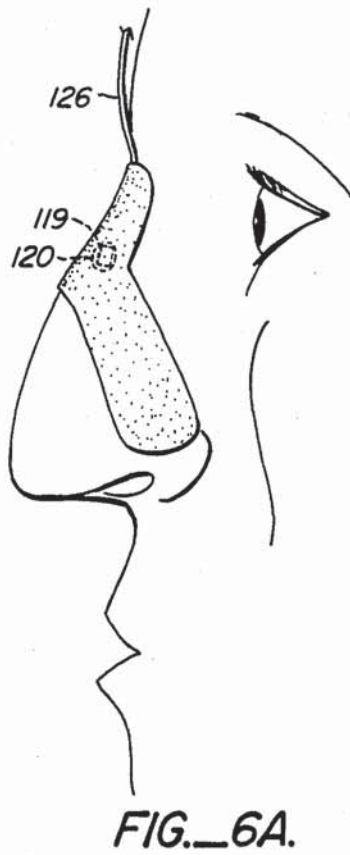
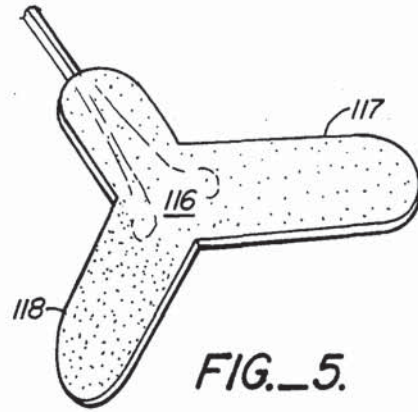
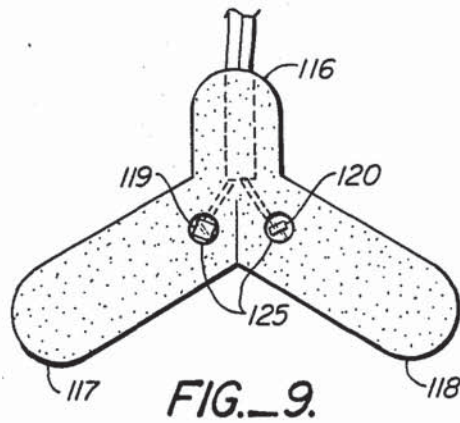
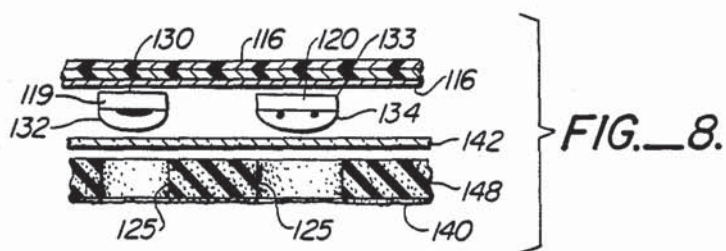
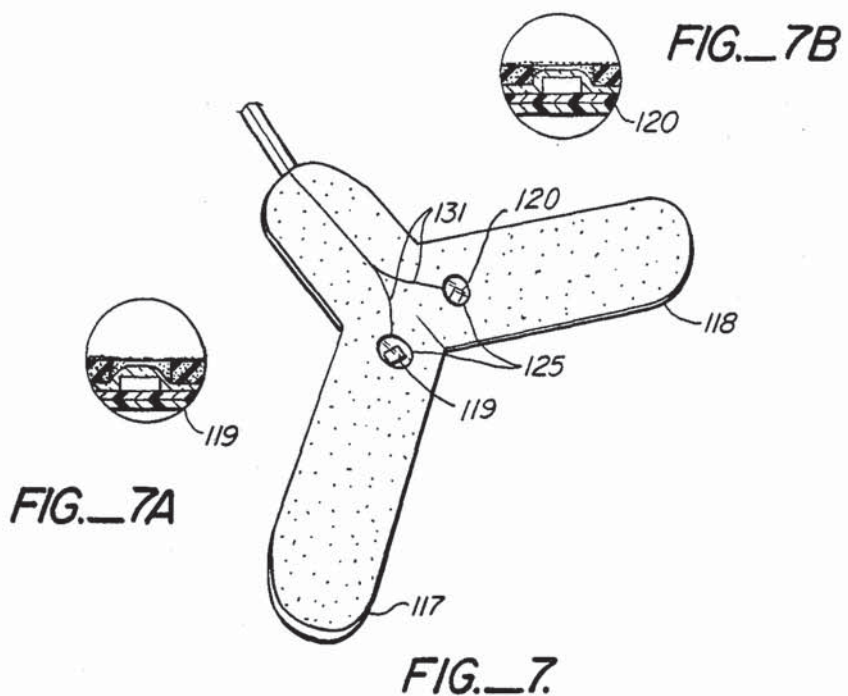

FIG. 3C.



FIG. 4.





Explore Litigation Insights

Docket Alarm provides insights to develop a more informed litigation strategy and the peace of mind of knowing you're on top of things.

Real-Time Litigation Alerts



Keep your litigation team up-to-date with **real-time alerts** and advanced team management tools built for the enterprise, all while greatly reducing PACER spend.

Our comprehensive service means we can handle Federal, State, and Administrative courts across the country.

Advanced Docket Research



With over 230 million records, Docket Alarm's cloud-native docket research platform finds what other services can't. Coverage includes Federal, State, plus PTAB, TTAB, ITC and NLRB decisions, all in one place.

Identify arguments that have been successful in the past with full text, pinpoint searching. Link to case law cited within any court document via Fastcase.

Analytics At Your Fingertips



Learn what happened the last time a particular judge, opposing counsel or company faced cases similar to yours.

Advanced out-of-the-box PTAB and TTAB analytics are always at your fingertips.

API

Docket Alarm offers a powerful API (application programming interface) to developers that want to integrate case filings into their apps.

LAW FIRMS

Build custom dashboards for your attorneys and clients with live data direct from the court.

Automate many repetitive legal tasks like conflict checks, document management, and marketing.

FINANCIAL INSTITUTIONS

Litigation and bankruptcy checks for companies and debtors.

E-DISCOVERY AND LEGAL VENDORS

Sync your system to PACER to automate legal marketing.