

AO 120 (Rev. 08/10)

TO: Mail Stop 8 Director of the U.S. Patent and Trademark Office P.O. Box 1450 Alexandria, VA 22313-1450	REPORT ON THE FILING OR DETERMINATION OF AN ACTION REGARDING A PATENT OR TRADEMARK
---	---

In Compliance with 35 U.S.C. § 290 and/or 15 U.S.C. § 1116 you are hereby advised that a court action has been filed in the U.S. District Court Eastern District of Texas, Marshall Division on the following

Trademarks or Patents. (the patent action involves 35 U.S.C. § 292.);

DOCKET NO. 2:15-cv-1575	DATE FILED 10/2/2015	U.S. DISTRICT COURT Eastern District of Texas, Marshall Division
PLAINTIFF LoganTree LP		DEFENDANT FitBit Inc.
PATENT OR TRADEMARK NO.	DATE OF PATENT OR TRADEMARK	HOLDER OF PATENT OR TRADEMARK
1 6,059,576	5/1/2000	Theodore L. Brann
2		
3		
4		
5		

In the above—entitled case, the following patent(s)/ trademark(s) have been included:

DATE INCLUDED	INCLUDED BY	
	<input type="checkbox"/> Amendment <input type="checkbox"/> Answer <input type="checkbox"/> Cross Bill <input type="checkbox"/> Other Pleading	
PATENT OR TRADEMARK NO.	DATE OF PATENT OR TRADEMARK	HOLDER OF PATENT OR TRADEMARK
1		
2		
3		
4		
5		

In the above—entitled case, the following decision has been rendered or judgement issued:

DECISION/JUDGEMENT

CLERK	(BY) DEPUTY CLERK	DATE
-------	-------------------	------

Copy 1—Upon initiation of action, mail this copy to Director Copy 3—Upon termination of action, mail this copy to Director
 Copy 2—Upon filing document adding patent(s), mail this copy to Director Copy 4—Case file copy

MCCATHERN

MELINDA LLOYD
Legal Assistant
mlloyd@mccatherlaw.com

October 8, 2015

Via CMRRR 7014 0150 0001 5173 8087

Mail Stop 8
Director of the U.S. Patent and Trademark Office
P.O. Box 1450
Alexandria, VA 22313-1450

Re: Cause No. 2:15-cv-1575; *LoganTree LP v. FitBit Inc.*, Eastern District of Texas,
Marshall Division.

To Whom It May Concern:

Enclosed please find a file-stamped copy of Form AO120 regarding U.S. Patent No.
6,059,576, currently pending in the above-referenced Court.

Sincerely,

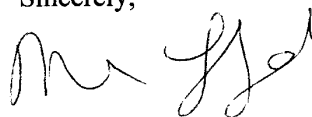

Melinda Lloyd

HAS/ml
Encl.



UNITED STATES PATENT AND TRADEMARK OFFICE

Commissioner for Patents
United States Patent and Trademark Office
P.O. Box 1450
Alexandria, VA 22313-1450
www.uspto.gov

Patent No. 6059576

NOTICE OF *EX PARTE* REEXAMINATION

Notice is hereby given that a request for *ex parte* reexamination of U.S. Patent No. 6059576 on 04/04/14 under 35 U.S.C. § 302 and 37 C.F.R. § 1.510(a).

The reexamination proceeding has been assigned Control No. 90/013201

This Notice incorporates by reference into the patent file, all papers entered into the reexamination file.

Note: This Notice should be entered into the patent file.



P75M

MICHAEL CAYWOOD
LOCKE PURNELL RAIN HARRELL
100 CONGRESS SUITE 300
AUSTIN TX 78701

DATE PRINTED

11/19/07

MAINTENANCE FEE REMINDER

According to the records of the U.S. Patent and Trademark Office (USPTO) the maintenance fee for the patent(s) listed below (for which the above address is on record as the fee address under 37 CFR 1.363) has not been paid within the six-month period set forth in 37 CFR 1.362(d). **THE MAINTENANCE FEE MAY STILL BE PAID WITH THE APPLICABLE SURCHARGE SET FORTH IN 37 CFR 1.20(h), WITHIN THE SIX-MONTH GRACE PERIOD SET FORTH IN 37 CFR 1.362(e).**

Unless payment of the maintenance fee and the applicable surcharge is received in the USPTO within the six-month grace period, **THE PATENT WILL EXPIRE AS OF THE END OF THE GRACE PERIOD.** 35 U.S.C. 41(b).

The total payment due is the amount required on the date the fee is paid (and not necessarily the amount indicated below). All USPTO fees (including maintenance fees) are subject to change. Customers should refer to the USPTO Web site (www.uspto.gov) or call the Maintenance Fee Branch at 571-272-6500 for the most current fee amounts for the correct entity status before submitting payment. The total payment due indicated below is based on the entity status according to current Office records (shown below).

Timely payment of the total payment due is required in order to avoid expiration of the patent. A maintenance fee payment can be timely made using the certificate of mailing or transmission procedure set forth in 37 CFR 1.8.

PATENT NUMBER	FEE MAINT. AMT	U.S. APPL SURCHG	U.S. APPL NUMBER	PATENT ISSUE DATE	APPL. FILING DATE	PAY- MENT YEAR	SMALL ENTITY?	TOTAL PYMT DUE	ATTORNEY DOCKET NUMBER
6059576	180	65	08976228	05/09/00	11/21/97	8	YES	1245	13326/59157

The maintenance fee and the applicable surcharge can be paid quickly and easily over the Internet at www.uspto.gov by electronic funds transfer (EFT), credit card, or USPTO deposit account payment methods. The mailing address for all maintenance fee payments not electronically submitted over the Internet is: U.S. Patent and Trademark Office, P.O. Box 979070, St. Louis, MO 63197-9000.

Direct any questions about this notice to: Mail Stop M Correspondence, Director of the United States Patent and Trademark Office, P.O. Box 1450, Alexandria, VA 22313-1450.

NOTE: This notice was automatically generated based on the amount of time that elapsed since the date a patent was granted. It is possible that the patent term may have ended or been shortened due to a terminal disclaimer that was filed in the application. Also, for any patent that issued from an application filed on or after June 8, 1995 containing a specific reference to an earlier filed application or applications under 35 U.S.C. 120, 121, or 365(c), the patent term ends 20 years from the date on which the earliest such application was filed, unless the term was adjusted or extended under 35 U.S.C. 154 or 156. Patentee should determine the relevant patent term for a patent before paying the maintenance fee.



UNITED STATES PATENT AND TRADEMARK OFFICE

COMMISSIONER FOR PATENTS
UNITED STATES PATENT AND TRADEMARK OFFICE
P.O. BOX 1450
ALEXANDRIA, VA 22313-1450
www.uspto.gov

Paper No. 15

THEODORE L. BRANN
P.O. BOX 2345
BOERNE, TX 78006-6766

COPY MAILED

MAY 24 2006

OFFICE OF PETITIONS

In re Patent No. 6,059,576
Issue Date: May 9, 2000
Application No. 08/976,228
Filed: November 21, 1997
Patentee: Theodore L. Brann

ON PETITION

This is a decision on the petition under 37 CFR 1.378(c) to accept the unintentionally delayed payment of a maintenance fee for the above-identified patent filed May 5, 2006. This is also a decision on the petition under 37 CFR 1.182 requesting expedited consideration of the petition under 37 CFR 1.378(c).

The petitions are GRANTED.

The 3 ½ year maintenance fee in this case is hereby accepted and the above-identified patent is hereby reinstated as of the mail date of this decision.

It is noted that a change of correspondence address was filed on May 22, 2002. However, petitioner should note that the mere filing of a change of correspondence address will not affect the fee address. Therefore, if petitioner desires to receive future correspondence regarding any Maintenance Fee Reminder which may be mailed regarding maintenance fees for the above-identified patent, the "fee address" and/or "customer number" forms should be submitted to the Maintenance Fee Division.

Telephone inquiries concerning this matter may be directed to the undersigned at (571) 272-3204.

The patented file is being returned to the Files Repository.

Sherry D. Binkley
Sherry D. Binkley
Petitions Examiner
Office of Petitions



Under the Paperwork Reduction Act of 1995, no persons are required to respond to a collection of information unless it displays a valid OMB control number.

CHANGE OF CORRESPONDENCE ADDRESS <i>Patent</i> Address to: Mail Stop Post Issue Commissioner for Patents P.O. Box 1450 Alexandria, VA 22313-1450	Patent Number	6059576
	Issue Date	05/09/2000
	Application Number	08976228
	Filing Date	11/21/1997
	First Named Inventor	Theodore L. Brann
	Attorney Docket Number	

Please change the Correspondence Address for the above-identified patent to:

The address associated with Customer Number:

OR

FILE COPY

Firm or Individual Name LoganTree LP

Theodore L. Brann, GP
 P O Box 2345

Address

City Boerne **State** TX **ZIP** 78006

Country USA

Telephone 210-698-6020, Ext. 40 **Email**

This form cannot be used to change the data associated with a Customer Number. To change the data associated with an existing Customer Number use "Request for Customer Number Data Change" (PTO/SB/124).

This form will not affect any "fee address" provided for the above-identified patent. To change a "fee address" use the "Fee Address Indication Form" (PTO/SB/47).

I am the:

- Patentee.
- Assignee of record of the entire interest. See 37 CFR 3.71. Statement under 37 CFR 3.73(b) is enclosed. (Form PTO/SB/96).
- Attorney or agent of record. Registration Number _____

Signature *Theodore L. Brann*

Typed or Printed Name Theodore L. Brann, GP

Date 05/05/2006 **Telephone** 210-698-6020, Ext. 40

NOTE: Signatures of all the inventors or assignees of record of the entire interest or their representative(s) are required. Submit multiple forms if more than one signature is required, see below".

*Total of one forms are submitted.

This collection of information is required by 37 CFR 1.33. The information is required to obtain or retain a benefit by the public which is to file (and by the USPTO to process) an application. Confidentiality is governed by 35 U.S.C. 122 and 37 CFR 1.11 and 1.14. This collection is estimated to take 3 minutes to complete, including gathering, preparing, and submitting the completed application form to the USPTO. Time will vary depending upon the individual case. Any comments on the amount of time you require to complete this form and/or suggestions for reducing this burden, should be sent to the Chief Information Officer, U.S. Patent and Trademark Office, U.S. Department of Commerce, P.O. Box 1450, Alexandria, VA 22313-1450. DO NOT SEND FEES OR COMPLETED FORMS TO THIS ADDRESS. SEND TO: Mail Stop Post Issue, Commissioner for Patents, P.O. Box 1450, Alexandria, VA 22313-1450.

If you need assistance in completing the form, call 1-800-PTO-9199 and select option 2.

05-08-06

DAC

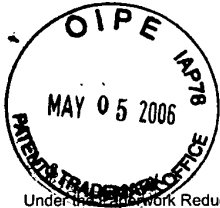

PTO/SB/66 (10-05)
Approved for use through 05/31/2006. OMB 0651-0016
U.S. Patent and Trademark Office; U.S. DEPARTMENT OF COMMERCE
Under the Paperwork Reduction Act of 1995, no persons are required to respond to a collection of information unless it displays a valid OMB control number.

PETITION TO ACCEPT UNINTENTIONALLY DELAYED PAYMENT OF MAINTENANCE FEE IN AN EXPIRED PATENT (37 CFR 1.378(c)) Docket Number (Optional)

Mail to: Mail Stop Petition
Commissioner for Patents
P.O. Box 1450
Alexandria, VA 22313-1450
Fax: (571) 273-8300

NOTE: If information or assistance is needed in completing this form, please contact Petitions Information at (571) 272-3282.

Patent No. 6059576 Application Number 08976228

Issue Date 05/09/2006 Filing Date 11/21/1997

CAUTION: Maintenance fee (and surcharge, if any) payment must correctly identify: (1) the patent number (or reissue patent number, if a reissue) and (2) the application number of the actual U.S. application (or reissue application) leading to issuance of that patent to ensure the fee(s) is/are associated with the correct patent. 37 CFR 1.366(c) and (d).

Also complete the following information, if applicable

The above - identified patent:

- is a reissue of original Patent No. _____, original issue date _____; original application number _____, original filing date _____.
- resulted from the entry into the U.S. under 35 U.S.C. 371 of international application _____ filed on _____.

CERTIFICATE OF MAILING (37 CFR 1.8(a))

I hereby certify that this paper (along with any paper referred to as being attached or enclosed) is being deposited with the United States Postal Service on the date shown below with sufficient postage as first class mail in an envelope addressed to Mail Stop Petition, Commissioner for Patents, P.O. Box 1450, Alexandria, VA 22313-1450, or facsimile transmitted to the U.S. Patent and Trademark Office on the date shown below.

05/05/2006
Date

Theodore L. Brown
Signature

05/30/2006 CKHLOK 00000009 6059576

05/09/2006 TBESHAI 00000029 6059576

Typed or printed name of person signing Certificate

01 FC:1599

2490.00 DP

01 FC:2551
02 FC:1558
03 FC:1462

450.00 OP
1640.00 OP
400.00 OP

[Page 1 of 3]

This collection of information is required by 37 CFR 1.378(c). The information is required to obtain or retain a benefit by the public which is to file (and by the USPTO to process) an application. Confidentiality is governed by 35 U.S.C. 122 and 37 CFR 1.11 and 1.14. This collection is estimated to take 1 hour to complete, including gathering, preparing, and submitting the completed application form to the USPTO. Time will vary depending upon the individual case. Any comments on the amount of time you require to complete this form and/or suggestions for reducing this burden, should be sent to the Chief Information Officer, U.S. Patent and Trademark Office, U.S. Department of Commerce, P.O. Box 1450, Alexandria, VA 22313-1450. DO NOT SEND FEES OR COMPLETED FORMS TO THIS ADDRESS. SEND TO: Mail Stop Petition, Commissioner for Patents, P.O. Box 1450, Alexandria, VA 22313-1450.

If you need assistance in completing the form, call 1-800-PTO-9199 and select option 2.

RECEIVED

MAY 16 2006

OFFICE OF PETITIONS

Ex. 1002 / Page 7 of 169

Adjustment date: 05/30/2006 CKHLOK
05/09/2006 TBESHAI 00000029 6059576
01 FC:1599 2490.00 DP

Under the Paperwork Reduction Act of 1995, no persons are required to respond to a collection of information unless it displays a valid OMB control number.

1. SMALL ENTITY

Patentee claims, or has previously claimed, small entity status. See 37 CFR 1.27.

2. LOSS OF ENTITLEMENT TO SMALL ENTITY STATUS

Patentee is no longer entitled to small entity status. See 37 CFR 1.27(g).

3. MAINTENANCE FEE (37 CFR 1.20(e)-(g))

The appropriate maintenance fee must be submitted with this petition, unless it was paid earlier.

NOT Small Entity			Small Entity		
Amount	Fee	(Code)	Amount	Fee	(Code)
<input type="checkbox"/> \$ _____	3 1/2 yr fee	(1551)	<input checked="" type="checkbox"/> \$ <u>450.00</u>	3 1/2 yr fee	(2551)
<input type="checkbox"/> \$ _____	7 1/2 yr fee	(1552)	<input type="checkbox"/> \$ _____	7 1/2 yr fee	(2552)
<input type="checkbox"/> \$ _____	11 1/2 yr fee	(1553)	<input type="checkbox"/> \$ _____	11 1/2 yr fee	(2553)

MAINTENANCE FEE BEING SUBMITTED \$ 450.00

4. SURCHARGE

The surcharge required by 37 CFR 1.20(i)(2) of \$ 1640.00 (Fee Code 1558) must be paid as a condition of accepting unintentionally delayed payment of the maintenance fee.

SURCHARGE BEING SUBMITTED \$ 1640.00

5. MANNER OF PAYMENT

Enclosed is a check for the sum of \$ 2490.00.

Please charge Deposit Account No. _____ the sum of \$ _____. A duplicate copy of this authorization is attached.

Payment by credit card. Form PTO-2038 is attached.

6. AUTHORIZATION TO CHARGE ANY FEE DEFICIENCY

The Director is hereby authorized to charge any maintenance fee, surcharge or petition deficiency to Deposit Account No. _____. A duplicate copy of this authorization is attached.

RECEIVED
 MAY 16 2006
 OFFICE OF PETITIONS

Under the Paperwork Reduction Act of 1995, no persons are required to respond to a collection of information unless it displays a valid OMB control number

7. OVERPAYMENT

As to any overpayment made please

- Credit to Deposit Account No. _____
- OR
- Send refund check.

WARNING:

Petitioner/applicant is cautioned to avoid submitting personal information in documents filed in a patent application that may contribute to identity theft. Personal information such as social security numbers, bank account numbers, or credit card numbers (other than a check or credit card authorization form PTO-2038 submitted for payment purposes) is never required by the USPTO to support a petition or an application. If this type of personal information is included in documents submitted to the USPTO, petitioners/applicants should consider redacting such personal information from the documents before submitting them to the USPTO. Petitioner/applicant is advised that the record of a patent application is available to the public after publication of the application (unless a non-publication request in compliance with 37 CFR 1.213(a) is made in the application) or issuance of a patent. Furthermore, the record from an abandoned application may also be available to the public if the application is referenced in a published application or an issued patent (see 37 CFR 1.14). Checks and credit card authorization forms PTO-2038 submitted for payment purposes are not retained in the application file and therefore are not publicly available.

8. STATEMENT

The delay in payment of the maintenance fee to this patent was unintentional.

9. PETITIONER(S) REQUEST THAT THE DELAYED PAYMENT OF THE MAINTENANCE FEE BE ACCEPTED AND THE PATENT REINSTATED.

 Signature(s) of Petitioner(s)

 Date

 THEODORE L. BRANN
 Typed or printed name(s)

 Registration Number, if applicable

 210-347-5380
 Telephone Number

 P O BOX 2345
 Address

 BOERNE, TX 78006-6766
 Address

37 CFR 1.378(d) states: "Any petition under this section must be signed by an attorney or agent registered to practice before the Patent and Trademark Office, or by the patentee, the assignee, or other party in interest."

ENCLOSURES:

- Maintenance Fee payment
- Surcharge under 37 CFR 1.20(i)(2) (fee for filing the maintenance fee petition)
- REQUEST FOR EXPEDITED SERVICES: RETURN ADDRESSED POSTCARD

RECEIVED

MAY 16 2006

OFFICE OF PATENT AND TRADEMARK



PETITION FOR EXPEDITED SERVICES

FROM: Theodore L Brann
Logan Tree LP
P O Box 2345
Boerne, TX 78006-6345

TO: Commissioner for Patents
Attn: Sherry Brinkley
P O Box 1450
Alexandria, VA 22313-1450

Dear Sherry,

Included in the amount check number 3761 is written for is an additional \$400 to pay for expedited services associated with the processing of my "Petition To Accept Unintentionally Delayed Payment of Maintenance Fee In An Expired Patent."

Per the advice I received today from Cliff I will contact you in a few days to bring this request to your attention.

Thank you for your assistance.

Sincerely,

Theodore L. Brann

MAY 5, 2006

RECEIVED

MAY 16 2006

OFFICE OF PETITIONS

MAY 22 2002

#13

Please type a plus sign (+) inside this box

PTO/SB/123 (10-00)

Approved for use through 10/31/2002. OMB 0851-0035
U.S. Patent and Trademark Office; U.S. DEPARTMENT OF COMMERCE

Under the Paperwork Reduction Act of 1995, no persons are required to respond to a collection of information unless it displays a valid OMB control number.

CHANGE OF CORRESPONDENCE ADDRESS Patent Address to: Assistant Commissioner for Patents Washington, D.C. 20231	Patent Number	6,059,576
	Issue Date	MAY 9, 2000
	Application Number	08/976228
	Filing Date	NOV. 21, 1997
	First Named Inventor	THEODORE L. BRANN

Please change the Correspondence Address for the above-identified patent to:

Customer Number → Place Customer Number Bar Code Label here

OR

Type Customer Number here

Firm or Individual Name	THEODORE L. BRANN		
Address	P O BOX 2345		
Address			
City	BOERNE	State	TX
		ZIP	78006
Country	USA		
Telephone	210-698-6020	Fax	

This form cannot be used to change the data associated with a Customer Number. To change the data associated with an existing Customer Number use "Request for Customer Number Data Change" (PTO/SB/124).

This form will not affect any "fee address" provided for the above-identified patent. To change a "fee address" use the "Fee Address Indication Form" (PTO/SB/47).

I am the:

- Patentee.
- Assignee of record of the entire interest. See 37 CFR 3.71. Statement under 37 CFR 3.73(b) is enclosed. (Form PTO/SB/96).
- Attorney or agent of record.

Typed or Printed Name	THEODORE L. BRANN
Signature	<i>Theodore L. Brann</i>
Date	MAY 22, 2002

NOTE: Signatures of all the inventors or assignees of record of the entire interest or their representative(s) are required. Submit multiple forms if more than one signature is required, see below.

*Total of _____ forms are submitted.

Burden Hour Statement: This form is estimated to take 3 minutes to complete. Time will vary depending upon the needs of the individual case. Any comments on the amount of time you are required to complete this form should be sent to the Chief Information Officer, U.S. Patent and Trademark Office, Washington, DC 20231. DO NOT SEND FEES OR COMPLETED FORMS TO THIS ADDRESS. SEND TO: Assistant Commissioner for Patents, Washington, DC 20231.

87 08 6916

*** RX REPORT ***

RECEPTION OK

TX/RX NO	6230
CONNECTION TEL	
CONNECTION ID	
START TIME	05/22(WE)12:40
USAGE TIME	00'48"
PGS.	1
RESULT	OK

PART B—ISSUE FEE-TRANSMITTAL

Complete and mail this form, together with applicable fees, to: **Box ISSUE FEE**
Assistant Commissioner for Patents
Washington, D.C. 20231

MAILING INSTRUCTIONS: This form should be used for transmitting the ISSUE FEE. Blocks 1 through 4 should be completed where appropriate. All further correspondence including the Issue Fee Receipt, the Patent, advance orders and notification of maintenance fees will be mailed to the current correspondence address as indicated unless corrected below or directed otherwise in Block 1, by (a) specifying a new correspondence address; and/or (b) indicating a separate "FEE ADDRESS" for maintenance fee notifications.

CURRENT CORRESPONDENCE ADDRESS (Note: Legibly mark-up with any corrections or use Block 1)

MICHAEL CAYWOOD
 LOCKE PURNELL RAIN HARRELL
 100 CONGRESS SUITE 300
 AUSTIN TX 78701

QM12/1206



Note: The certificate of mailing below can only be used for domestic mailings of the Issue Fee Transmittal. This certificate cannot be used for any other accompanying papers. Each additional paper, such as an assignment or formal drawing, must have its own certificate of mailing.

Certificate of Mailing

I hereby certify that this Issue Fee Transmittal is being deposited with the United States Postal Service with sufficient postage for first class mail in an envelope addressed to the Box Issue Fee address above on the date indicated below.

Cecilia Howells (Depositor's name)

Cecilia Howells (Signature)

Feb. 23, 2000 (Date)

APPLICATION NO.	FILING DATE	TOTAL CLAIMS	EXAMINER AND GROUP ART UNIT	DATE MAILED
08/976,228	11/21/97	029	CHENG, J 3713	12/06/99
First Named Applicant	BRANN,		35 USC 154(b) term ext. =	0 Days.

TITLE OF INVENTION: TRAINING AND SAFETY DEVICE, SYSTEM AND METHOD TO AID IN PROPER MOVEMENT DURING PHYSICAL ACTIVITY

ATTY'S DOCKET NO.	CLASS-SUBCLASS	BATCH NO.	APPLN. TYPE	SMALL ENTITY	FEE DUE	DATE DUE
3	13326/59157	434-247.000	F27	UTILITY	YES \$605.00	03/06/00

1. Change of correspondence address or indication of "Fee Address" (37 CFR 1.363). Use of PTO form(s) and Customer Number are recommended, but not required.

- Change of correspondence address (or Change of Correspondence Address form PTO/SB/122) attached.
- "Fee Address" indication (or "Fee Address" Indication form PTO/SB/47) attached.

2. For printing on the patent front page, list (1) the names of up to 3 registered patent attorneys or agents OR, alternatively, (2) the name of a single firm (having as a member a registered attorney or agent) and the names of up to 2 registered patent attorneys or agents. If no name is listed, no name will be printed.

- 1 Locke Liddell & Sapp LLP
- 2 _____
- 3 _____

3. ASSIGNEE NAME AND RESIDENCE DATA TO BE PRINTED ON THE PATENT (print or type)
PLEASE NOTE: Unless an assignee is identified below, no assignee data will appear on the patent. Inclusion of assignee data is only appropriate when an assignment has been previously submitted to the PTO or is being submitted under separate cover. Completion of this form is NOT a substitute for filing an assignment.

(A) NAME OF ASSIGNEE

(B) RESIDENCE: (CITY & STATE OR COUNTRY)

Please check the appropriate assignee category indicated below (will not be printed on the patent)

- individual
- corporation or other private group entity
- government

4a. The following fees are enclosed (make check payable to Commissioner of Patents and Trademarks):

- Issue Fee
- Advance Order - # of Copies 10

4b. The following fees or deficiency in these fees should be charged to:

DEPOSIT ACCOUNT NUMBER _____
 (ENCLOSE AN EXTRA COPY OF THIS FORM)

- Issue Fee
- Advance Order - # of Copies _____

The COMMISSIONER OF PATENTS AND TRADEMARKS IS requested to apply the Issue Fee to the application identified above.

(Authorized Signature) Michael Caywood (Date) Feb. 23, 2000

NOTE: The Issue Fee will not be accepted from anyone other than the applicant; a registered attorney or agent; or the assignee or other party in interest as shown by the records of the Patent and Trademark Office.

Burden Hour Statement: This form is estimated to take 0.2 hours to complete. Time will vary depending on the needs of the individual case. Any comments on the amount of time required to complete this form should be sent to the Chief Information Officer, Patent and Trademark Office, Washington, D.C. 20231. DO NOT SEND FEES OR COMPLETED FORMS TO THIS ADDRESS. SEND FEES AND THIS FORM TO: Box Issue Fee, Assistant Commissioner for Patents, Washington D.C. 20231

Under the Paperwork Reduction Act of 1995, no persons are required to respond to a collection of information unless it displays a valid OMB control number.

03/02/2000 RTSEGAY1 00000049 08976228

01 FC:242 605.00 GP
 02 FC:561 30.00 GP

TRANSMIT THIS FORM WITH FEE

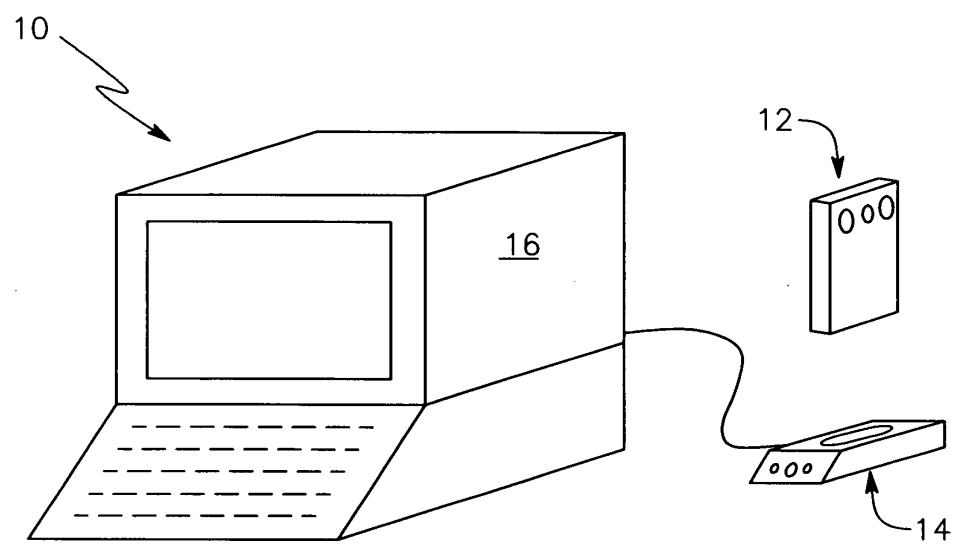

FIG. 1



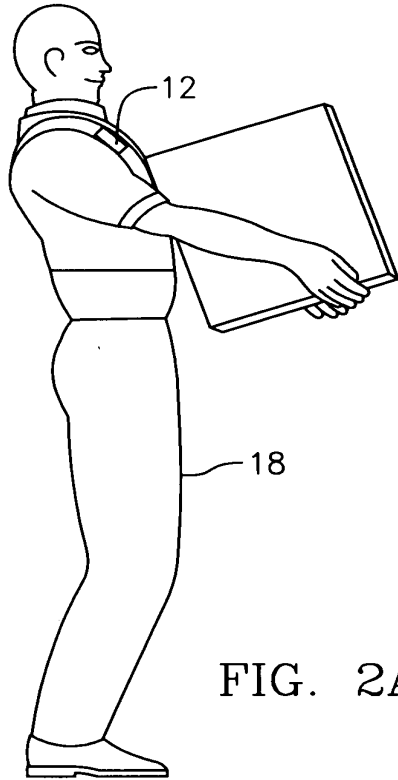

FIG. 2A

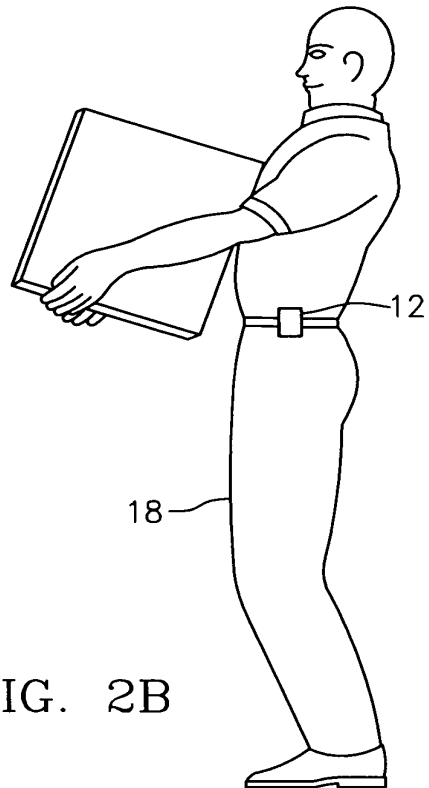

FIG. 2B



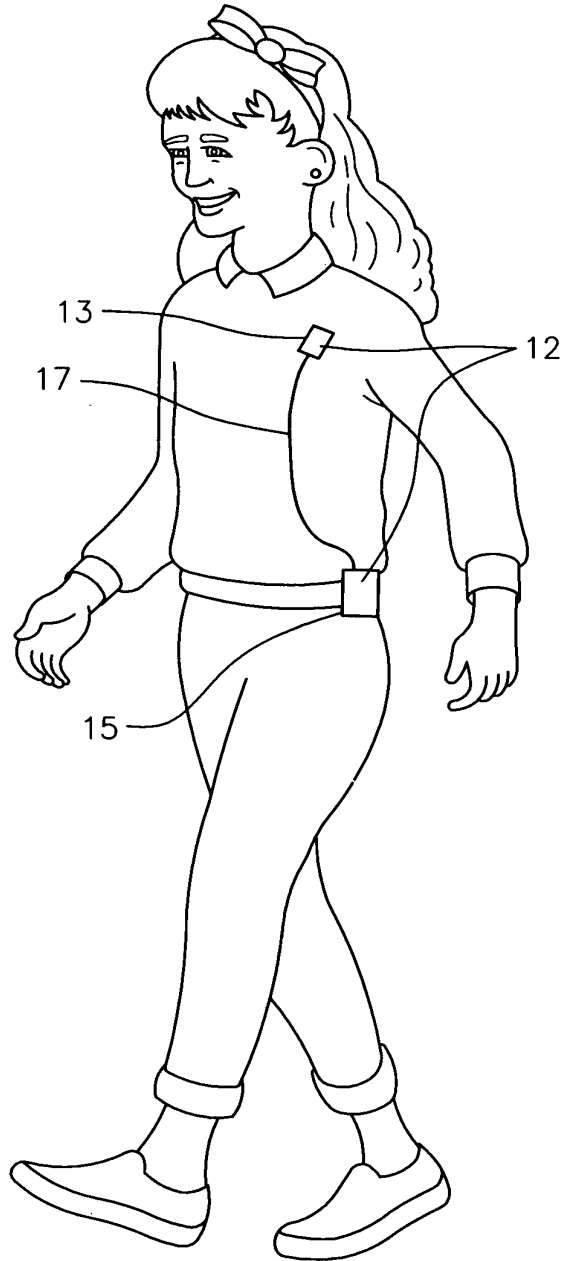

FIG. 2C

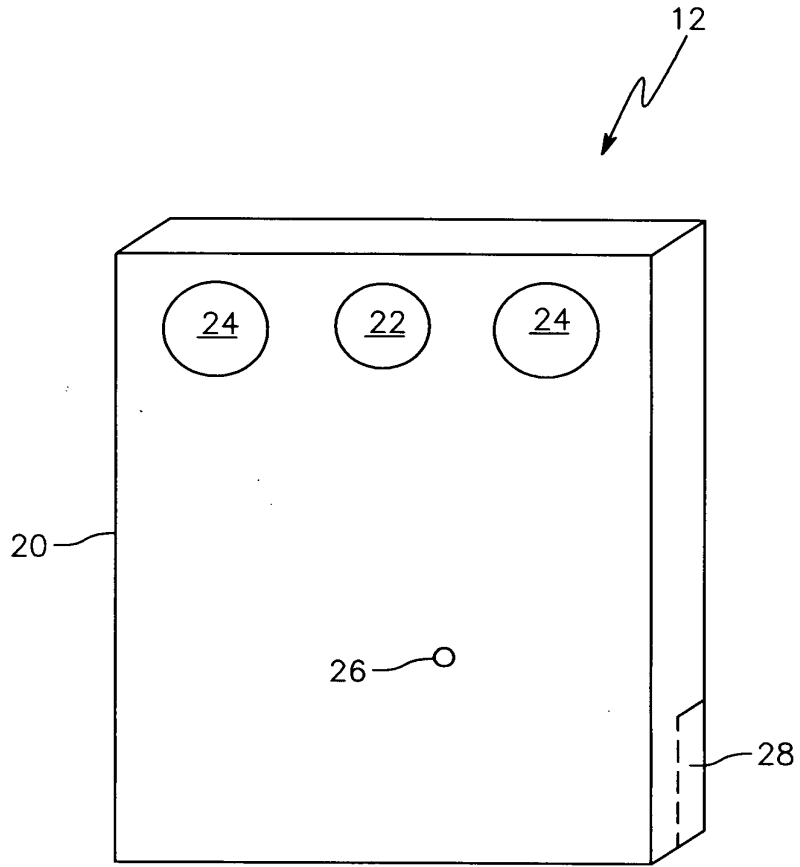

FIG. 3



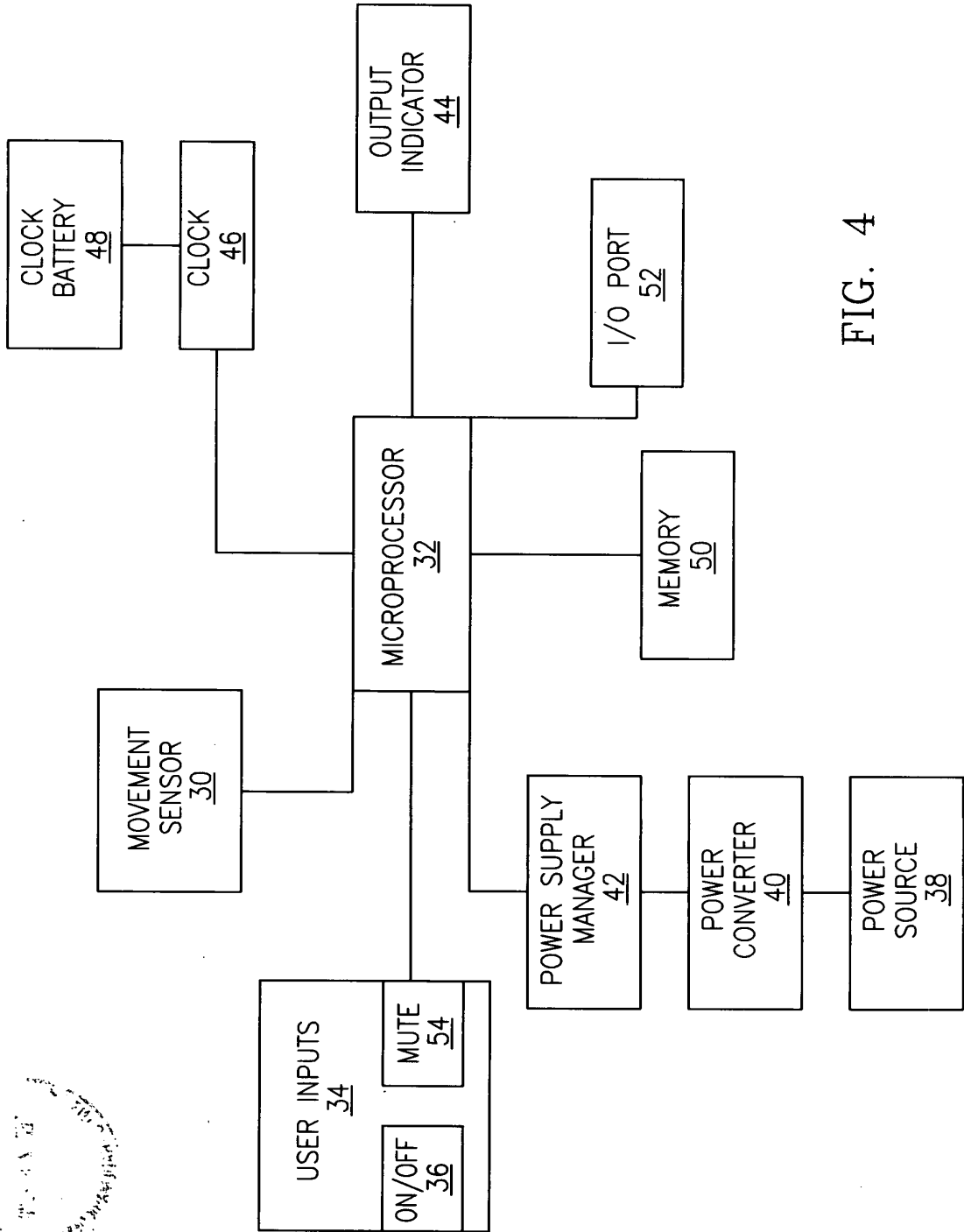

FIG. 4



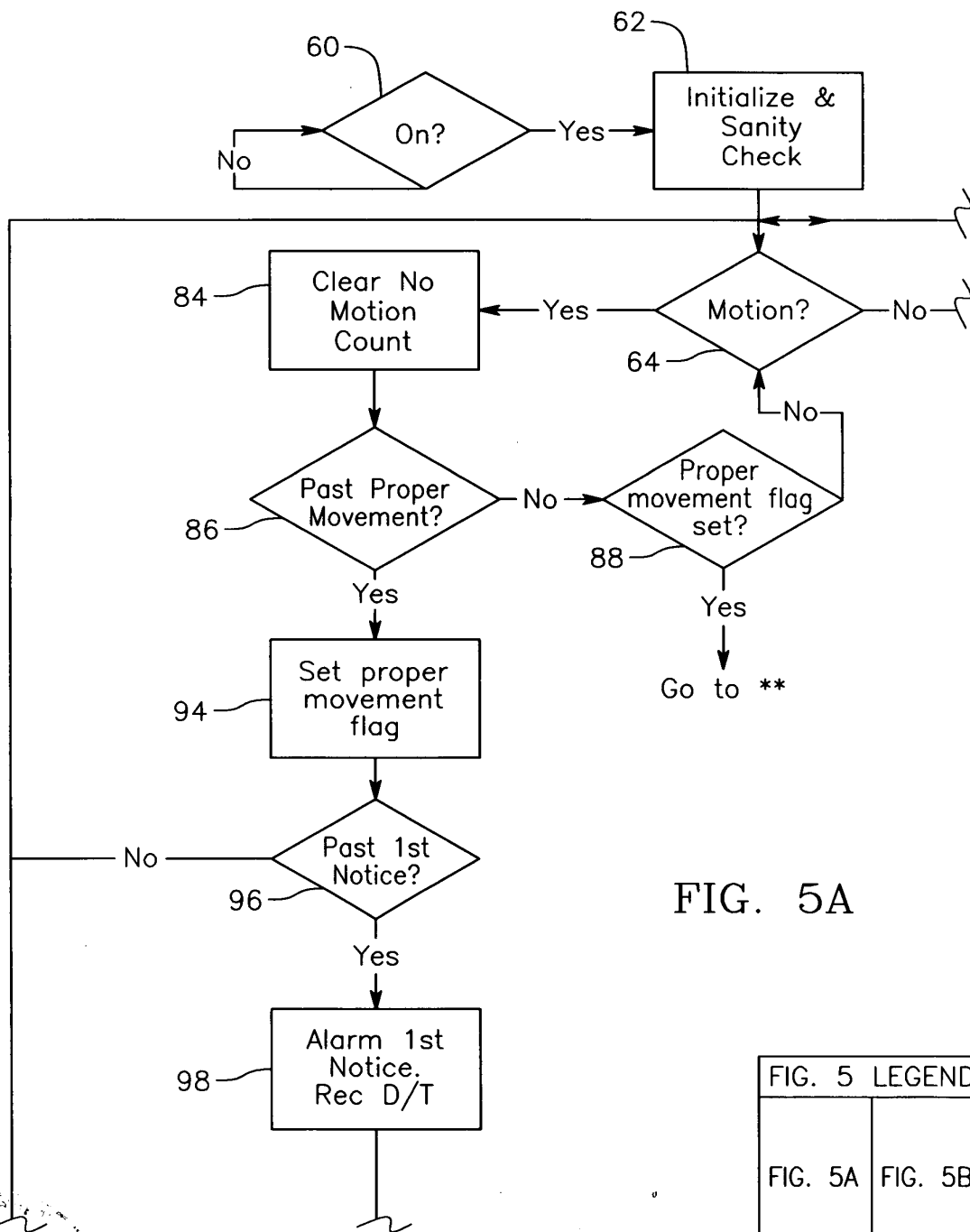

FIG. 5A

FIG. 5 LEGEND	
FIG. 5A	FIG. 5B
FIG. 5C	FIG. 5D

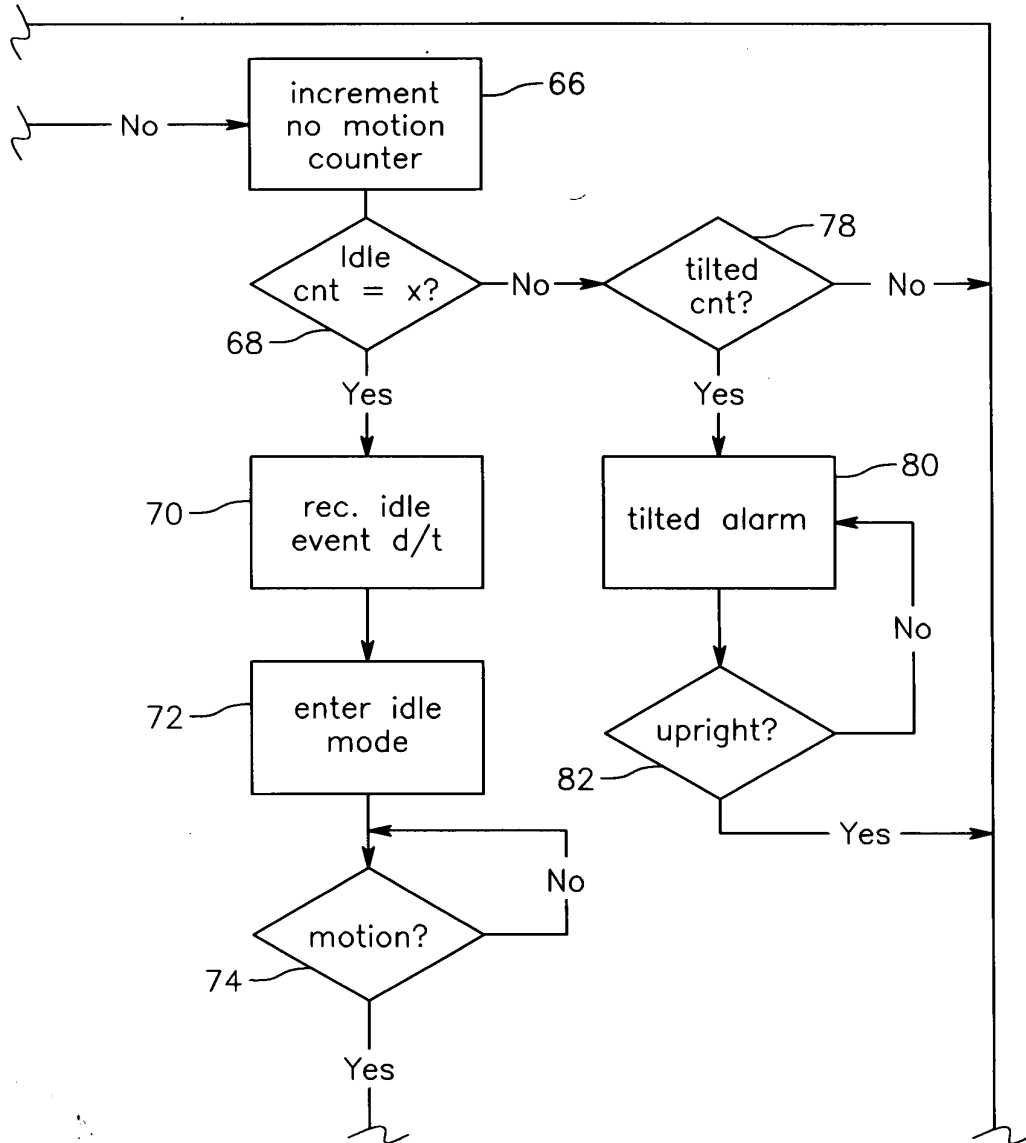

FIG. 5B

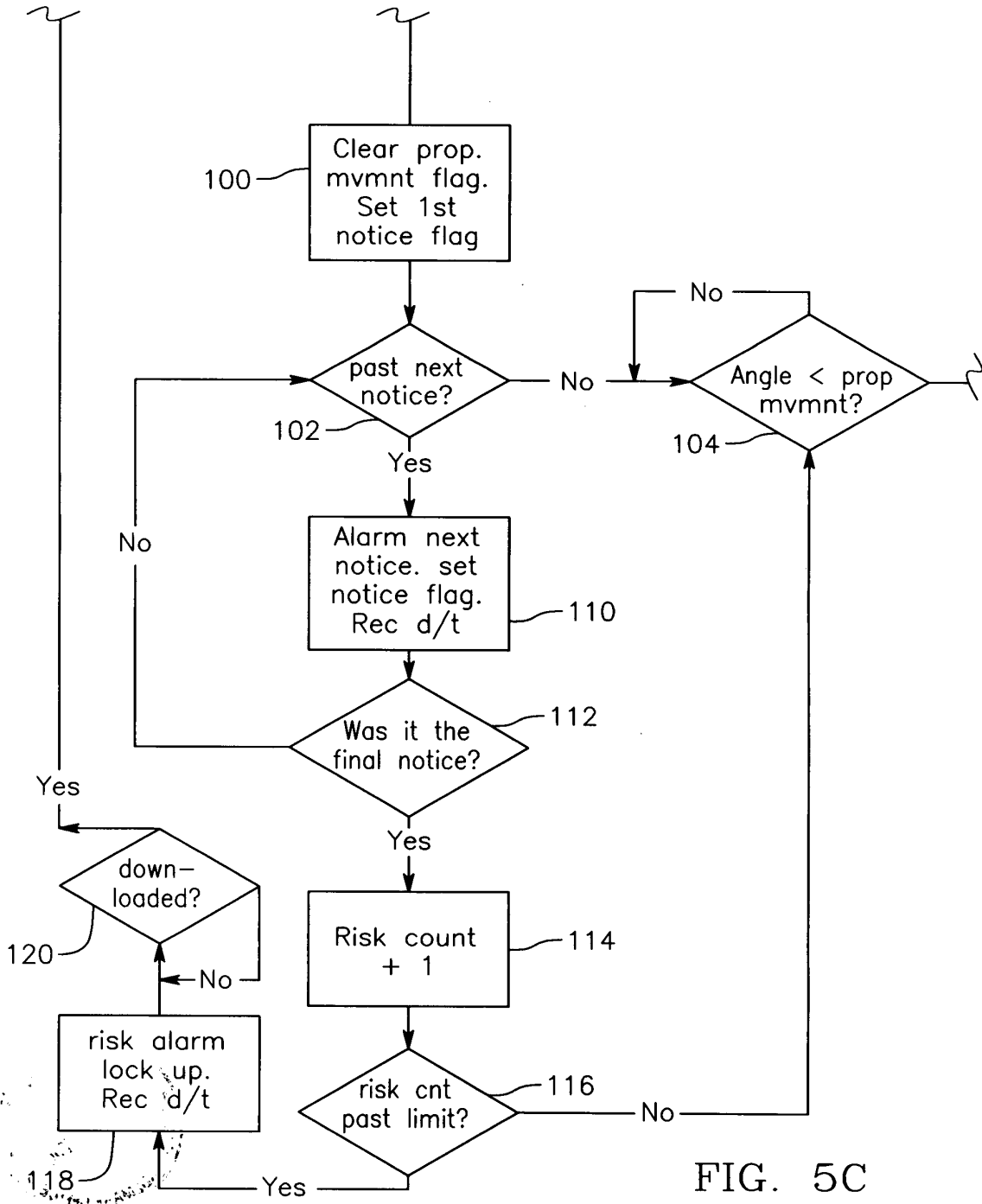

FIG. 5C

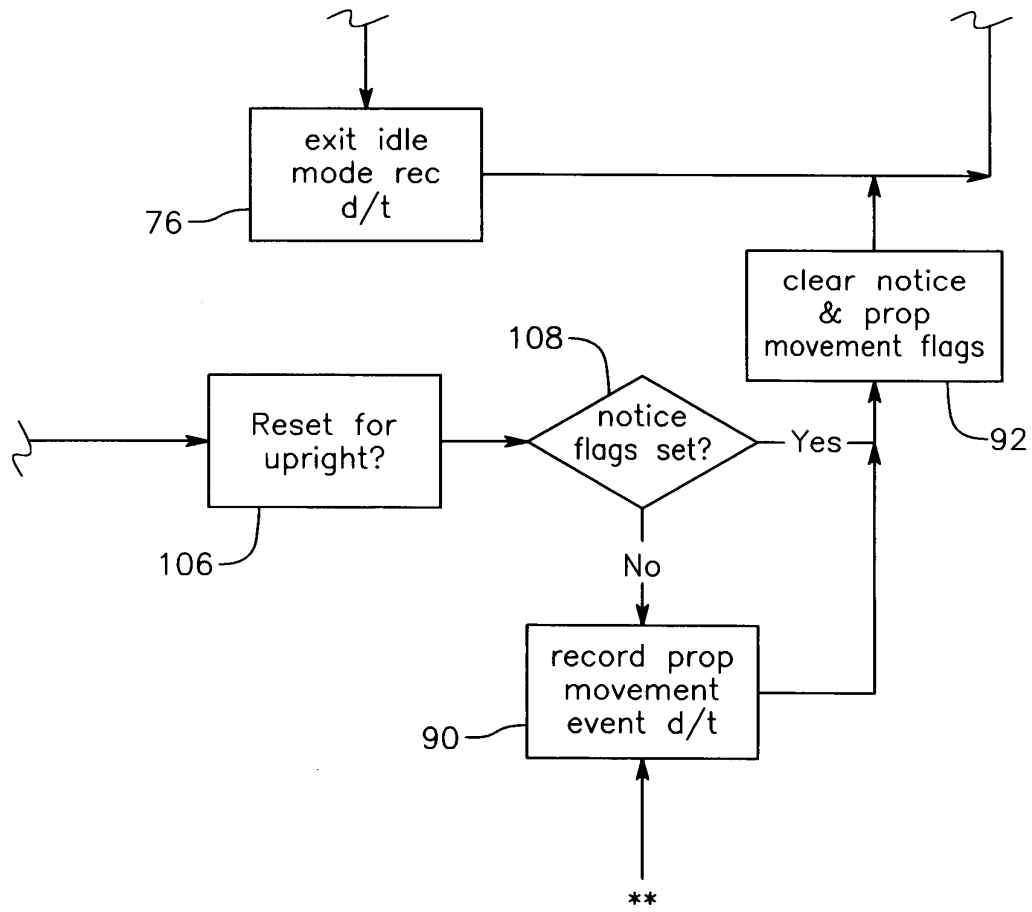

FIG. 5D

B

PATENT

IN THE UNITED STATES PATENT AND TRADEMARK OFFICE

IN RE: Brann, T.
 SERIAL NO.: 08/976,228
 FILED: November 21, 1997
 ALLOWED: December 6, 1999
 FOR: A TRAINING AND SAFETY DEVICE,
 SYSTEM AND METHOD TO AID IN
 PROPER MOVEMENT DURING
 PHYSICAL ACTIVITY



§
§
§
§
§
§
§
§

GROUP NO.: 3713
 EXAMINER: Cheng, J.
 BATCH NO.: F27

#12M

BOX OFFICIAL DRAFTSMAN
 THE COMMISSIONER OF PATENTS AND TRADEMARKS*
 WASHINGTON, D.C. 20231

LETTER OF TRANSMITTAL

Attached please find the following documents:

1. Submittal of Formal Drawings, including Conditional Petition for Extension of Time to File Formal Drawings;
2. Nine (9) drawing sheets; and
3. A self-addressed, stamped return-receipt postcard.

If any additional extension and/or fee is required or if any overpayment has been made, the Commissioner is hereby authorized to charge any deficit or credit any overpayment to Account No. 12-1781.

RESPECTFULLY SUBMITTED,

Date: Feb. 23, 2000
 Registration No. 37,797

Michael Caywood
 Michael Caywood
 ATTORNEY FOR APPLICANT
 Locke Liddell & Sapp LLP
 100 Congress Avenue, Suite 300
 Austin, Texas 78701
 (512) 305-4724

*CERTIFICATE OF MAILING (37 CFR § 1.8)

I hereby certify that this paper (along with any paper referred to as being attached or enclosed) is being deposited with the United States Postal Service with sufficient postage for first class mail in an envelope addressed to the Box Official Draftsman, Assistant Commissioner for Patents, Washington, D.C. 20231 on the date indicated below.

Date: Feb. 23, 2000

Cecilia Howells
Cecilia Howells
 Signature

JL

BJ

ATTORNEY DOCKET NO. 13326/59157

PATENT

IN THE UNITED STATES PATENT AND TRADEMARK OFFICE

IN RE: Brann, T.
 SERIAL NO.: 08/976,228
 FILED: November 21, 1997
 ALLOWED: December 6, 1999
 FOR: A TRAINING AND SAFETY DEVICE,
 SYSTEM AND METHOD TO AID IN
 PROPER MOVEMENT DURING
 PHYSICAL ACTIVITY



§
 § GROUP NO.: 3713
 §
 § EXAMINER: Cheng, J.
 §
 § BATCH NO.: F27
 §
 §
 §

BOX ISSUE FEE
 Assistant Commissioner for Patents
 Washington, D.C. 20231

TRANSMITTAL LETTER

Dear Sir:

Enclosed herewith please find the following documents for filing for the above-identified patent application:

1. Submittal of Base Issue Fee;
2. Part B of ISSUE FEE TRANSMITTAL FORM;
3. Copy of letter of transmittal for Submittal of Formal Drawings;
4. Check in the amount of \$605.00 for the base issue fee;
5. Check in the amount of \$30.00 for ten (10) initial copies; and
6. Self-Addressed and Stamped Return Receipt Postcard.

If any additional extension and/or fee is required or if any overpayment has been made, the Commissioner is hereby authorized to charge any deficit or credit any overpayment to Account No. 12-1781.

RESPECTFULLY SUBMITTED,

Michael Caywood

Michael Caywood
 ATTORNEY FOR APPLICANT
 Locke Liddell & Sapp LLP
 100 Congress Avenue, Suite 300
 Austin, Texas 78701
 Telephone: 512/305-4700
 Facsimile: 512/305-4800

Date: Feb. 23, 2000
 Registration No. 37,797

*CERTIFICATE OF MAILING (37 CFR § 1.8)

I hereby certify that this Issue Fee Transmittal is being deposited with the United States Postal Service with sufficient postage for first class mail in an envelope addressed to the Box Issue Fee, Assistant Commissioner for Patents, Washington, D.C. 20231 on the date indicated below.

Date: Feb. 23, 2000

Cecilia Howells
Cecilia Howells
 Signature

IN THE UNITED STATES PATENT AND TRADEMARK OFFICE

IN RE:	Brann, T.	§	
SERIAL NO.:	08/976,228	§	GROUP NO.: 3713
FILED:	November 21, 1997	§	EXAMINER: Cheng, J.
ALLOWED:	December 6, 1999	§	BATCH NO.: F27
FOR:	A TRAINING AND SAFETY DEVICE, SYSTEM AND METHOD TO AID IN PROPER MOVEMENT DURING PHYSICAL ACTIVITY	§	



BOX ISSUE FEE
THE COMMISSIONER OF PATENTS AND TRADEMARKS¹
WASHINGTON, D.C. 20231

SUBMITTAL OF BASE ISSUE FEE

Dear Madam:

The applicant herewith submits to the Commissioner of Patent and Trademarks the Base Issue Fee in response to the Notice of Allowance dated December 6, 1999.

The Applicant also requests ten (10) copies of the issued patent and submits the payment of the appropriate fee.

STATUS

At the time of this filing the Applicant/Assignee is:

- a small entity - the verified statement is,
- attached, or
- already on file.

- other than a small entity.

CERTIFICATE OF MAILING (37 CFR § 1.8)

I hereby certify that this Issue Fee Transmittal is being deposited with the United States Postal Service with sufficient postage for first class mail in an envelope addressed to the Box Issue Fee, Assistant Commissioner for Patents, Washington, D.C. 20231 on the date indicated below.

Date: Feb. 23, 2000

Cecilia Howells
Cecilia Howells
 Signature

FEE PAYMENT

- [X] Attached are checks in the sum of \$ 635.00 for the Base Issue Fee and for ten (10) copies.
- [X] If any additional extension and/or fee is required or if any overpayment has been made, the Commissioner is hereby authorized to charge any deficit or credit any overpayment to Account No. 12-1781.

RESPECTFULLY SUBMITTED,

Date: Feb. 23, 2000
Registration No. 37,797

Michael Caywood
ATTORNEY FOR APPLICANT
Locke Liddell & Sapp LLP
100 Congress Avenue, Suite 300
Austin, Texas 78701
(512) 305-4700

IN THE UNITED STATES PATENT AND TRADEMARK OFFICE

IN RE: Brann, T.
SERIAL NO.: 08/976,228
FILED: November 21, 1997
ALLOWED: December 6, 1999
FOR: A TRAINING AND SAFETY DEVICE,
SYSTEM AND METHOD TO AID IN
PROPER MOVEMENT DURING
PHYSICAL ACTIVITY

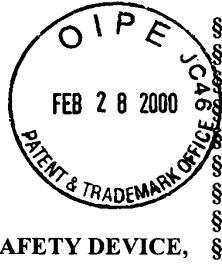

GROUP NO.: 3713
EXAMINER: Cheng, J.
BATCH NO.: F27

BOX OFFICIAL DRAFTSMAN
THE COMMISSIONER OF PATENTS AND TRADEMARKS*
WASHINGTON, D.C. 20231

SUBMITTAL OF FORMAL DRAWINGS

Dear Sir:

To correct the informalities in the drawings noted in the Draftsman's objections on PTO-948, applicant submits herewith nine (9) new sheets of drawings for this application.

The three month period of response set in the Notice of Allowability expires on March 6, 2000. This submission is on or before this expiration date.

CONDITIONAL PETITION FOR EXTENSION OF TIME TO FILE FORMAL DRAWINGS

If an extension of term is deemed to be required, please consider this a request therefor.

If any extension or additional fee is required or if any overpayment has been made, the Commissioner is hereby authorized to charge any deficit or credit any overpayment to Account No. 12-1781.

RESPECTFULLY SUBMITTED,

Date: Feb. 23, 2000
Registration No. 37,797

Michael Caywood
Michael Caywood
ATTORNEY FOR APPLICANT
Locke Liddell & Sapp LLP
100 Congress Avenue, Suite 300
Austin, Texas 78701
(512) 305-4724

*CERTIFICATE OF MAILING (37 CFR § 1.8)

I hereby certify that this paper (along with any paper referred to as being attached or enclosed) is being deposited with the United States Postal Service with sufficient postage for first class mail in an envelope addressed to the Box Official Draftsman, Assistant Commissioner for Patents, Washington, D.C. 20231 on the date indicated below.

Date: Feb. 23, 2000

Cecilia Howells
Cecilia Howells
Signature



UNITED STATES DEPARTMENT OF COMMERCE
Patent and Trademark Office

NOTICE OF ALLOWANCE AND ISSUE FEE DUE

QM12/1206

MICHAEL CAYWOOD
LOCKE PURNELL RAIN HARRELL
100 CONGRESS SUITE 300
AUSTIN TX 78701

APPLICATION NO.	FILING DATE	TOTAL CLAIMS	EXAMINER AND GROUP ART UNIT	DATE MAILED
08/976,228	11/21/97	029	CHENG, J	12/06/99
First Named Applicant	BRANN,		35 USC 154(b) term ext. =	0 Days.

TITLE OF INVENTION TRAINING AND SAFETY DEVICE, SYSTEM AND METHOD TO AID IN PROPER MOVEMENT DURING PHYSICAL ACTIVITY

ATTY'S DOCKET NO.	CLASS-SUBCLASS	BATCH NO.	APPLN. TYPE	SMALL ENTITY	FEE DUE	DATE DUE
3	13326/59157	434-247.000	F27	UTILITY	YES \$605.00	03/06/00

THE APPLICATION IDENTIFIED ABOVE HAS BEEN EXAMINED AND IS ALLOWED FOR ISSUANCE AS A PATENT. PROSECUTION ON THE MERITS IS CLOSED.

THE ISSUE FEE MUST BE PAID WITHIN THREE MONTHS FROM THE MAILING DATE OF THIS NOTICE OR THIS APPLICATION SHALL BE REGARDED AS ABANDONED. THIS STATUTORY PERIOD CANNOT BE EXTENDED.

HOW TO RESPOND TO THIS NOTICE:

I. Review the SMALL ENTITY status shown above.

If the SMALL ENTITY is shown as YES, verify your current SMALL ENTITY status:

- A. If the status is changed, pay twice the amount of the FEE DUE shown above and notify the Patent and Trademark Office of the change in status, or
- B. If the status is the same, pay the FEE DUE shown above.

If the SMALL ENTITY is shown as NO:

- A. Pay FEE DUE shown above, or
- B. File verified statement of Small Entity Status before, or with, payment of 1/2 the FEE DUE shown above.

II. Part B-Issue Fee Transmittal should be completed and returned to the Patent and Trademark Office (PTO) with your ISSUE FEE. Even if the ISSUE FEE has already been paid by charge to deposit account, Part B Issue Fee Transmittal should be completed and returned. If you are charging the ISSUE FEE to your deposit account, section "4b" of Part B-Issue Fee Transmittal should be completed and an extra copy of the form should be submitted.

III. All communications regarding this application must give application number and batch number. Please direct all communications prior to issuance to Box ISSUE FEE unless advised to the contrary.

IMPORTANT REMINDER: Utility patents issuing on applications filed on or after Dec. 12, 1980 may require payment of maintenance fees. It is patentee's responsibility to ensure timely payment of maintenance fees when due.

PATENT AND TRADEMARK OFFICE COPY

Notice of Allowability

Application No. 08/976,228	Applicant(s) Brann
Examiner Joe H. Cheng	Group Art Unit 3713



All claims being allowable, PROSECUTION ON THE MERITS IS (OR REMAINS) CLOSED in this application. If not included herewith (or previously mailed), a Notice of Allowance and Issue Fee Due or other appropriate communication will be mailed in due course.

- This communication is responsive to the Preliminary Amendment filed November 22, 1999.
- The allowed claim(s) is/are 1-7 and 9-30.
- The drawings filed on _____ are acceptable.
- Acknowledgement is made of a claim for foreign priority under 35 U.S.C. § 119(a)-(d).
 - All Some* None of the CERTIFIED copies of the priority documents have been
 - received.
 - received in Application No. (Series Code/Serial Number) _____.
 - received in this national stage application from the International Bureau (PCT Rule 17.2(a)).
- *Certified copies not received: _____
- Acknowledgement is made of a claim for domestic priority under 35 U.S.C. § 119(e).

A SHORTENED STATUTORY PERIOD FOR RESPONSE to comply with the requirements noted below is set to EXPIRE **THREE MONTHS FROM THE "DATE MAILED"** of this Office action. Failure to timely comply will result in ABANDONMENT of this application. Extensions of time may be obtained under the provisions of 37 CFR 1.136(a).

- Note the attached EXAMINER'S AMENDMENT or NOTICE OF INFORMAL APPLICATION, PTO-152, which discloses that the oath or declaration is deficient. A SUBSTITUTE OATH OR DECLARATION IS REQUIRED.
 - Applicant **MUST** submit **NEW FORMAL DRAWINGS**
 - because the originally filed drawings were declared by applicant to be informal.
 - including changes required by the Notice of Draftsperson's Patent Drawing Review, PTO-948, attached hereto or to Paper No. 3.
 - including changes required by the proposed drawing correction filed on _____, which has been approved by the examiner.
 - including changes required by the attached Examiner's Amendment/Comment.
- Identifying indicia such as the application number (see 37 CFR 1.84(c)) should be written on the reverse side of the drawings. The drawings should be filed as a separate paper with a transmittal letter addressed to the Official Draftsperson.

- Note the attached Examiner's comment regarding REQUIREMENT FOR THE DEPOSIT OF BIOLOGICAL MATERIAL.

Any response to this letter should include, in the upper right hand corner, the APPLICATION NUMBER (SERIES CODE/SERIAL NUMBER). If applicant has received a Notice of Allowance and Issue Fee Due, the ISSUE BATCH NUMBER and DATE of the NOTICE OF ALLOWANCE should also be included.

Attachment(s)

- Notice of References Cited, PTO-892
- Information Disclosure Statement(s), PTO-1449, Paper No(s). _____
- Notice of Draftsperson's Patent Drawing Review, PTO-948
- Notice of Informal Patent Application, PTO-152
- Interview Summary, PTO-413
- Examiner's Amendment/Comment
- Examiner's Comment Regarding Requirement for Deposit of Biological Material
- Examiner's Statement of Reasons for Allowance

Art Unit: 3713

REASONS FOR ALLOWANCE

1. The following is an examiner's statement of reasons for allowance:

None of the prior art of record shows the combination of the structure of the claimed portable self-contained device and method for monitoring physical movement of body parts during physical activity comprising the movement sensor capable of measuring data associated with unrestrained movement in any direction and generating signals indicative of the movement, which are the angle and velocity of the movement, the power source, the microprocessor capable of receiving, interpreting, storing and responding to the movement data based on the user-defined operational parameters, at least one user input connected to the microprocessor for controlling the operation of the portable self-contained device, the real-time clock connected to the microprocessor, memory for storing the movement data, and the output indicator connected to the microprocessor for signaling the occurrence of user-defined events, or the combination of the structure of the claimed system to aid in training and safety during physical activity comprising the portable self-contained movement measuring device which comprising the movement sensor capable of measuring data associated with unrestrained movement in any direction and generating signals indicative of the movement, which are the angle and velocity of the movement, the power source, the microprocessor capable of receiving, interpreting, storing and responding to the movement data based on the user-defined operational parameters, at least one user input connected to the microprocessor for controlling the operation of the portable self-contained device, the real-time clock connected to the microprocessor, memory for storing the movement

Art Unit: 3713

data, at least one input/output port connected to the microprocessor for downloading the data and uploading the operational parameters and the output indicator connected to the microprocessor, the computer running a program capable of interpreting and reporting the movement data based on the operational parameters, and the download device electronically connecting to the movement measuring device and the computer for transmitting the movement data and operational parameters between the movement measuring device and the computer for analysis, reporting and operation purposes.

Any comments considered necessary by applicant must be submitted no later than the payment of the issue fee and, to avoid processing delays, should preferably accompany the issue fee. Such submissions should be clearly labeled "Comments on Statement of Reasons for Allowance."

2. Any inquiry concerning this communication or earlier communications from the examiner should be directed to Joe H. Cheng whose telephone number is (703) 308-2667.

Any inquiry of a general nature or relating to the status of this application or proceeding should be directed to the receptionist whose telephone number is (703) 308-1148.

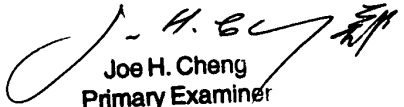
Joe H. Cheng
Primary Examiner

Joe H. Cheng
December 4, 1999

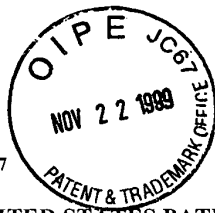

937B
#

ATTORNEY DOCKET NO: 13326/59157

IN THE UNITED STATES PATENT AND TRADEMARK OFFICE

PATENT

#9 Request for CPA
h. Morgan
12/1/99

IN RE: Brann
SERIAL NO.: 08/976,228
FILED: November 21, 1997
FOR: A TRAINING AND SAFETY DEVICE,
SYSTEM AND METHOD TO AID IN
PROPER MOVEMENT DURING
PHYSICAL ACTIVITY

§
§ GROUP NO.: 3713
§
§ EXAMINER: Cheng, J.
§
§
§

RECEIVED
NOV 26 1999
Group 3700

Box CPA
FEE
ASSISTANT COMMISSIONER FOR PATENTS*
Washington, D.C. 20231

CONTINUED PROSECUTION APPLICATION (CPA)
(37 C.F.R. § 1.53(d))

1. This is a request for the filing of a

- continuation
- divisional

continued prosecution application under 37 C.F.R. § 1.53(d) of the above-identified prior nonprovisional application.

It is further requested that this continued prosecution application utilize the file jacket and contents of the prior application, including the specification, drawings, and oath or declaration from the prior application, to constitute this new application, and that the application number of the above-identified prior application be assigned for identification purposes. 37 C.F.R. § 1.53(d)(2)(iv).

It is also requested that the above-identified prior application be expressly abandoned as of the filing date accorded this continued prosecution application. 37 C.F.R. § 1.53(d)(2)(v).

*CERTIFICATE OF EXPRESS MAILING (37 CFR § 1.10)

EL417713015US

I hereby certify that this paper (along with any paper referred to as being attached or enclosed) is being deposited with the United States Postal Service as Express Mail Post Office to Addressee on the date shown below in an envelope with sufficient postage for and with Express Mail label number shown above, and is addressed to: BOX CPA, FEE, ASSISTANT COMMISSIONER FOR PATENTS, WASHINGTON, D.C. 20231.

Date: Nov. 22, 1999

CECILIA HOWELLS

Cecilia Howells
Signature

11/24/1999 DVUONG 00000116 08976228

01 FC:231
02 FC:203

380.00 OP
81.00 OP

Repln. Ref: 11/24/1999 DVUONG 0021105700
DAH:121781 Name/Number:08976228
FC: 704 \$81.00 CR

2. With respect to the above-identified prior nonprovisional application, this continued prosecution application is being filed:

- A. before the earliest of the:
- termination of the proceedings on the prior application (37 C.F.R. § 1.53(d)(1)(ii)(C))
 - payment of the issue fee on the prior application (37 C.F.R. § 1.53(d)(1)(ii)(A)).
 - abandonment of the prior application (37 C.F.R. § 1.53(d)(1)(ii)(B))

OR

B. after the payment of the issue fee – but a petition under § 1.313(b)(5) has been granted in the prior application. 37 C.F.R. § 1.53(d)(1)(ii)(A).

C. The term for response or taking action in the prior application expires on November 20, 1999.

3. It is noted that:

- This application discloses and claims only subject matter disclosed in the prior application. 37 C.F.R. § 1.53(d)(2)(ii).
- Filing of this continued prosecution application is to be construed to include a waiver of confidentiality by the applicant under 35 U.S.C. § 122, to the extent that any member of the public, who is entitled under the provisions of § 1.14 to access to, copies of, or information concerning, either the prior application or any continuing application filed under the provisions of 37 C.F.R. § 1.53(d), may be given similar access to, copies of, or similar information concerning the other application or applications in the file jacket. 37 C.F.R. § 1.53(d)(6).
- Filing of this request is the specific reference required by 35 U.S.C. § 120 to every application assigned the application number identified in this request. No amendment in this application may delete this specific reference to any prior application. 37 C.F.R. §§ 1.53(d)(7) and 1.78(a)(2).

4. This continued prosecution application names as inventors:

the same inventor named in the prior application on the date this continued prosecution application under 37 C.F.R. § 1.53(d)(2)(iii) is being filed.

fewer than all the inventors named in the prior application. 37 C.F.R. § (d)(4).

Please delete the following name(s) as inventor(s), who are not inventor(s) of the invention being claimed in this new application:

Please add the following name(s) as inventors:

A petition under § 1.48 is attached.

5. **Information Disclosure Statement**

Enclosed is an Information Disclosure Statement in accordance with the requirements of 37 C.F.R. § 1.98.

6. **Fee Calculation (37 CFR 1.16)**

Regular application

CLAIMS AS FILED

	Number Filed	Max	Above Max	Above Max Fee		
Basic Fee 37 CFR §1.16(a)						\$760.00
Total Claims 37 CFR §1.16(c)	29	- 20	9	x \$18.00	=	\$162.00
Independent Claims 37 CFR §1.16(b)	3	- 3	0	x \$78.00	=	\$0.00
Multiple Dependant Claims 37 CFR §1.16(d)			0	x \$260.00	=	\$0.00

- An amendment canceling extra claims is enclosed
- An amendment deleting multiple-dependencies is enclosed.
- The fee for extra claims is not being paid at this time.

Filing Fee Total \$922.00

After Small Entity Discount of 50% \$ 461.00

Filing Fee Calculation \$ 461.00

7. **Small Entity Statement(s)**

- Statement(s) that this is filing by a small entity under 37 C.F.R. §§ 1.9 and 1.27 is(are) attached
- Status as a small entity was claimed in prior application 08/976,228, filed on November 21, 1997, from which benefit is being claimed for this application under:

35 U.S.C. § 119(e),
 120,
 121,
 365(c),

and which status as a small entity is still proper and desired.

- A copy of the statement in the prior application is included.

8. **Fee Payment Being Made at This Time**

- Not enclosed
- Enclosed \$ 597.00

9. **Total Fee Calculation**

- Filing Fee \$ 416.00
- No filing fee is to be paid at this time.
- Recording Assignment
(\$40.00—37 C.F.R. § 1.21(h))
(See attached "COVER SHEET
FOR ASSIGNMENT ACCOMPANYING
NEW APPLICATION.") \$ _____
- Petition fee for one month extension of time \$ 55.00
- Total fees calculated** **\$ 516.00**

10. **Method of Payment of Fees**

- [X] Attached is check number 7482 in the amount of \$597.00.
- [] Charge Account No. 12-1781 the \$ sum of . A duplicate of this transmittal is attached.
- [X] If any additional extension and/or fee is required or if any overpayment has been made, the Commissioner is hereby authorized to charge any deficit or credit any overpayment to Account No.12-1781.

Date: Nov. 22, 1999
Registration No. 37,797

RESPECTFULLY SUBMITTED,

Michael Caywood

Michael Caywood
ATTORNEY FOR APPLICANT
Locke Liddell & Sapp LLP
100 Congress Avenue, Suite 300
Austin, Texas 78701
Telephone: 512/305-4700
Facsimile: 512/305-4800

13326:59157:AUSTIN:186897.1

#8/ Extension (Lmon)
L. Morgan
12/1/99 PATENT

IN THE UNITED STATES PATENT AND TRADEMARK OFFICE

IN RE: Brann
SERIAL NO.: 08/976,228
FILED: November 21, 1997
FOR: A TRAINING AND SAFETY DEVICE,
SYSTEM AND METHOD TO AID IN
PROPER MOVEMENT DURING
PHYSICAL ACTIVITY

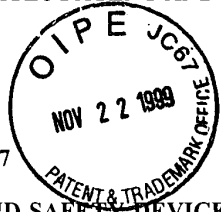

§
§ GROUP NO.: 3713
§
§ EXAMINER: Cheng, J.
§
§
§

BOX CPA
FEE
ASSISTANT COMMISSIONER FOR PATENTS*
WASHINGTON, D.C. 20231

PETITION FOR EXTENSION OF TIME AND
RESPONSE TRANSMITTAL

Transmitted herewith is an amendment for this application.

STATUS

When the application was filed, the Applicant was

- a small entity - verified statement:
 - attached.
 - already filed.
- other than a small entity.

11/24/1999 DVUONG 00000116 08976228

03 FC:215 55.00 OP

*CERTIFICATE OF EXPRESS MAILING (37 CFR § 1.10)

EL417713015US

I hereby certify that this paper (along with any paper referred to as being attached or enclosed) is being deposited with the United States Postal Service as Express Mail Post Office to Addressee on the date shown below in an envelope with sufficient postage for and with Express Mail label number shown above, and is addressed to: BOX CPA, FEE, ASSISTANT COMMISSIONER FOR PATENTS WASHINGTON, D.C. 20231.

Date: Nov. 22, 1999

CECILIA HOWELLS
Cecilia Howells
Signature

EXTENSION REQUESTED

The proceedings herein are for a patent application and the provisions of 37 CFR §1.136 apply.

Applicant petitions for an extension of time under 37 CFR §1.136 and §1.17(a)-(d) for the total number of months checked below:

<u>Extension (months)</u>	<u>Fee</u>	<u>Fee for Small Entity</u>
<input checked="" type="checkbox"/> one month	110.00	\$ 55.00
<input type="checkbox"/> two months	380.00	\$ 190.00
<input type="checkbox"/> three months	870.00	\$ 435.00
<input type="checkbox"/> four months	1,360.00	\$ 680.00



Total fee due for extension of time to respond \$ 55.00.

FEE PAYMENT

Attached is check no. 7482 totaling \$597.00 which includes payment for the extension.

Charge Account No. 12-1781 the sum of \$ _____. A duplicate of this transmittal is attached.

If any additional extension and/or fee is required or if any overpayment has been made, the Commissioner is hereby authorized to charge any deficit or credit any overpayment to Account No. 12-1781.

RESPECTFULLY SUBMITTED,

Date: Nov. 22, 1999
Registration No. 37,797

Michael Caywood
Michael Caywood
ATTORNEY FOR APPLICANT
Locke Liddell & Sapp LLP
100 Congress Ave., Suite 300
Austin, Texas 78701
512/305-4724 phone
512/305-4800 fax

13326:59157:AUSTIN:186898.1

Atty. Docket No.: 13326/59157



#10/Pre B
L. Morgan
12/1/99
PATENT

IN THE UNITED STATES PATENT AND TRADEMARK OFFICE

IN RE:	Brann	§	
SERIAL NO.:	08/976,228	§	GROUP NO.: 3713
FILED:	November 21, 1997	§	EXAMINER: Cheng, J.
FOR:	A TRAINING AND SAFETY DEVICE, SYSTEM AND METHOD TO AID IN PROPER MOVEMENT DURING PHYSICAL ACTIVITY	§ § § § § §	

BOX CPA
FEE
ASSISTANT COMMISSIONER FOR PATENTS*
WASHINGTON, D.C. 20231

PRELIMINARY AMENDMENT

This preliminary amendment is being included with the filing papers for a Continued Prosecution Application along with a one-month extension of time requested and paid for pursuant to the petition and fee for extension under 37 CFR 1.17(a)(1) referenced and provided for in the transmittal of the CPA. The Examiner issued a Final Office Action dated July 20, 1999.

*CERTIFICATE OF EXPRESS MAILING (37 CFR § 1.10)

EL417713015US

I hereby certify that this paper (along with any paper referred to as being attached or enclosed) is being deposited with the United States Postal Service as Express Mail Post Office to Addressee on the date shown below in an envelope with sufficient postage for and with Express Mail label number shown above, and is addressed to: BOX CPA, FEE, ASSISTANT COMMISSIONER FOR PATENTS, WASHINGTON, D.C. 20231.

Date: Nov. 22, 1999

CECILIA HOWELLS
Cecilia Howells
Signature

AMENDMENT

Please amend the claims as follows:

1. (Amended) A portable, self-contained device for monitoring [detecting] movement of body parts during physical activity, said device comprising:

a movement sensor capable of measuring data associated with unrestrained movement in any direction [of said device] and generating signals indicative of said movement;

a power source;

a microprocessor connected to said movement sensor and to said power source, said microprocessor capable of receiving, interpreting, storing and responding to said movement data based on user-defined operational parameters;

at least one user input connected to said microprocessor for controlling the operation of said device;

a real-time clock connected to said microprocessor;

memory for storing said movement data; and

an output indicator connected to said microprocessor for signaling the occurrence of user-defined events;

wherein said movement sensor measures the angle and velocity of said movement.

3. (Amended) The device of claim 1 wherein said device is compact and weighs less than one pound [movement sensor can detect the velocity of said movement].

5. (Amended) The device of claim 1 wherein said movement sensor can simultaneously detect real time movement along at least two orthogonal axes.

B4

7. (Amended) The device of claim 1 wherein said monitored body part movement is torso or limb movement [further comprising a power supply manager connected between said power source and said microprocessor].

B5

§ 9. (Amended) The device of claim 1 wherein said data measured by said movement sensor includes the [angle,] distance [and speed] of said movement.

13 14. (Twice Amended) A system to aid in training and safety during physical activity, said system comprising

a portable, self-contained movement measuring device, said movement measuring device further comprising

a movement sensor capable of measuring data associated with unrestrained movement in any direction [of said device] and generating signals indicative of said movement;

a power source;

a microprocessor connected to said power source, said microprocessor capable of receiving, interpreting, storing and responding to said movement data based on user-defined operational parameters;

at least one user input connected to said microprocessor for controlling the operation of said device;

a real-time clock connected to said microprocessor;

memory for storing said movement data;

at least one input/output port connected to said microprocessor for downloading said data and uploading said operational parameters;

and

an output indicator connected to said microprocessor;

a computer running a program capable of interpreting and reporting said movement data based on said operational parameters; and

27

B6
cancel.

a download device electronically connected to said movement measuring device and said computer for transmitting said movement data and operational parameters between said movement measuring device and said computer for analysis, reporting and operation purposes; wherein said movement sensor measures the angle and velocity of said movement.

B7

14 ~~15~~. (Amended) The system of claim ~~14~~¹³ wherein said computer is a [standalone] personal computer.

B8

20 ~~21~~. (Amended) A method to monitor physical movement of a body part comprising the steps of:

attaching a portable, self-contained movement measuring device to said body part for measuring unrestrained movement in any direction;
measuring data associated with said physical movement;
interpreting said physical movement data based on user-defined operational parameters and a real-time clock; and
storing said data in memory.

B9

26 ~~27~~. (Amended) The method of claim ~~26~~²⁰ further comprising the step of providing real time [instant] feedback regarding said movement.

REMARKS

Pursuant to the Office Action dated July 20, 1999 and the subsequent telephone interview with Examiner Cheng on October 5, 1999, the Applicant has amended the pending claims in order to overcome the rejections stated in the Office Action. Applicant files herewith a CPA along with this Preliminary Amendment. In particular, Applicant has amended the independent claims to more distinctly point out the unique aspects of the invention. These inventive aspects include the portability of Applicant's device and its

L

28

use to measure unrestricted torso or limb movement along multiple axes. Once these limitations are taken into account, the rejections raised by the Examiner based on the patents issued to Stark, Platt and Plotke no longer apply. The amended claims also distinguish Applicant's claimed invention from those disclosed by Prince and Linial.

REQUEST FOR ALLOWANCE

Applicant submits that all of the pending claims of the present application are in condition for allowance. Therefore, allowance and passage to issue of the claims is respectfully requested.

RESPECTFULLY SUBMITTED,

Date: Nov. 22, 1999
Registration No. 37,797

Michael Caywood
Michael Caywood
ATTORNEY FOR APPLICANTS
Locke Liddell & Sapp LLP
100 Congress Ave., Suite 300
Austin, Texas 78701
512/305-4724

13326:59157:AUSTIN:186899.1

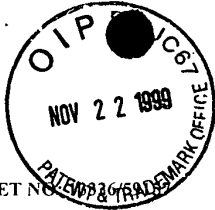

ATTORNEY DOCKET NO.

PATENT

IN THE UNITED STATES PATENT AND TRADEMARK OFFICE

IN RE:	Brann	§	
SERIAL NO.:	08/976,228	§	GROUP NO.: 3713
FILED:	November 21, 1997	§	EXAMINER: Cheng, J.
FOR:	A TRAINING AND SAFETY DEVICE, SYSTEM AND METHOD TO AID IN PROPER MOVEMENT DURING PHYSICAL ACTIVITY	§	

BOX CPA
 Fee
 ASSISTANT COMMISSIONER FOR PATENTS*
 WASHINGTON, D.C. 20231

TRANSMITTAL LETTER

Dear Sir:

Enclosed with this letter please find the following in connection with the above-referenced application for U.S. patent:

1. Continued Prosecution Application (CPA) (37 C.F.R. § 1.53(d));
2. Petition for Extension of Time and Amendment Transmittal;
3. Preliminary Amendment;
4. Check No. 7482 in the amount of \$597.00; and
5. Self-Addressed and Stamped Return Receipt Postcard.

*

CERTIFICATE OF EXPRESS MAILING (37 C.F.R. § 1.10)
 Express Mail Label Number
 EL417713015US

I hereby certify that this paper (along with any paper referred to as being attached or enclosed) is being deposited with the United States Postal Service as Express Mail Post Office to Addressee on the date shown below in an envelope with sufficient postage for and with Express Mail label number shown above, and is addressed to: Box CPA, Fee, Assistant Commissioner for Patents, Washington, D.C. 20231.

Date: Nov. 22, 1999

CECILIA HOWELLS

Cecilia Howell
 Signature

If any additional extension and/or fee is required or if any overpayment has been made, the Commissioner is hereby authorized to charge any deficit or credit any overpayment to Account No. 12-1781.

RESPECTFULLY SUBMITTED,

Date: Nov. 22, 1999
Registration No. 37,797

Michael Caywood
Michael Caywood
ATTORNEY FOR APPLICANT
Locke Liddell & Sapp LLP
100 Congress Avenue, Suite 300
Austin, Texas 78701
(512) 305-4724

13326:59157:AUSTIN:186896.1

Best Available Copy



**UNITED STATES DEPARTMENT OF COMMERCE
Patent and Trademark Office**

Address: COMMISSIONER OF PATENTS AND TRADEMARKS
Washington, D.C. 20231

APPLICATION NO.	FILING DATE	FIRST NAMED INVENTOR	ATTORNEY DOCKET NO.
08/01/99	11/21/97	BRACHIN	13328/09107

QM21/1008

MICHAEL RAYWOOD
2000 PENNSILL RAIN HARRELL
100 BUSINESS SUITE 000
MILFORD TX 75701

EXAMINER
CHENG, J

ART UNIT	PAPER NUMBER
3713	

DATE MAILED: 10/08/99

Please find below and/or attached an Office communication concerning this application or proceeding.

Commissioner of Patents and Trademarks

Interview Summary

Application No. 08/976,228	Applicant(s) Brann
Examiner Joe H. Cheng	Group Art Unit 3713



All participants (applicant, applicant's representative, PTO personnel):

- (1) Joe H. Cheng (examiner) (3) _____
(2) Michael Caywood (applicant's Attorney) (4) _____

Date of Interview Oct 5, 1999

Type: Telephonic Personal (copy is given to applicant applicant's representative).

Exhibit shown or demonstration conducted: Yes No. If yes, brief description:

Agreement was reached. was not reached.

Claim(s) discussed: 1-7 and 9-30

Identification of prior art discussed:

Linial et al (U.S. Pat. No. 4,665,928), Stark et al (U.S. Pat. No. 5,052,375), Pratt, Jr. (U.S. Pat. No. 4,912,638) and Prince et al (U.S. Pat. No. 5,348,519).

Description of the general nature of what was agreed to if an agreement was reached, or any other comments:

The aforementioned claims were discussed. No agreement has been reached. Applicant's attorney will file CPA in response to the Final Office Action in the forthcoming.

(A fuller description, if necessary, and a copy of the amendments, if available, which the examiner agreed would render the claims allowable must be attached. Also, where no copy of the amendments which would render the claims allowable is available, a summary thereof must be attached.)

1. It is not necessary for applicant to provide a separate record of the substance of the interview.

Unless the paragraph above has been checked to indicate to the contrary, A FORMAL WRITTEN RESPONSE TO THE LAST OFFICE ACTION IS NOT WAIVED AND MUST INCLUDE THE SUBSTANCE OF THE INTERVIEW. (See MPEP Section 713.04). If a response to the last Office action has already been filed, APPLICANT IS GIVEN ONE MONTH FROM THIS INTERVIEW DATE TO FILE A STATEMENT OF THE SUBSTANCE OF THE INTERVIEW.

2. Since the Examiner's interview summary above (including any attachments) reflects a complete response to each of the objections, rejections and requirements that may be present in the last Office action, and since the claims are now allowable, this completed form is considered to fulfill the response requirements of the last Office action. Applicant is not relieved from providing a separate record of the interview unless box 1 above is also checked.

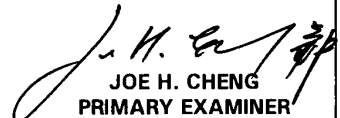
JOE H. CHENG
PRIMARY EXAMINER
ART UNIT 3713

Examiner Note: You must sign and stamp this form unless it is an attachment to a signed Office action.



**UNITED STATES DEPARTMENT OF COMMERCE
Patent and Trademark Office**

Address: COMMISSIONER OF PATENTS AND TRADEMARKS
Washington, D.C. 20231

APPLICATION NO.	FILING DATE	FIRST NAMED INVENTOR	ATTORNEY DOCKET NO.
08/976,228	11/21/97	BRANN	T 13326759157

OM12/0720
MICHAEL CAYWOOD
LOCKE PURNELL RAIN HARRELL
100 CONGRESS SUITE 300
AUSTIN TX 78701

EXAMINER
CHENG, J

ART UNIT PAPER NUMBER
3713 6

DATE MAILED: 07/20/99

Please find below and/or attached an Office communication concerning this application or proceeding.

Commissioner of Patents and Trademarks

Office Action Summary

Application No.
08/976,228

Applicant(s)
Brann

Examiner
Joe H. Cheng

Group Art Unit
3713



Responsive to communication(s) filed on May 4, 1999

This action is **FINAL**.

Since this application is in condition for allowance except for formal matters, **prosecution as to the merits is closed** in accordance with the practice under *Ex parte Quayle*, 1935 C.D. 11; 453 O.G. 213.

A shortened statutory period for response to this action is set to expire three month(s), or thirty days, whichever is longer, from the mailing date of this communication. Failure to respond within the period for response will cause the application to become abandoned. (35 U.S.C. § 133). Extensions of time may be obtained under the provisions of 37 CFR 1.136(a).

Disposition of Claims

Claim(s) 1-7 and 9-30 is/are pending in the application.

Of the above, claim(s) _____ is/are withdrawn from consideration.

Claim(s) _____ is/are allowed.

Claim(s) 1-7 and 9-30 is/are rejected.

Claim(s) _____ is/are objected to.

Claims _____ are subject to restriction or election requirement.

Application Papers

See the attached Notice of Draftsperson's Patent Drawing Review, PTO-948.

The drawing(s) filed on _____ is/are objected to by the Examiner.

The proposed drawing correction, filed on _____ is approved disapproved.

The specification is objected to by the Examiner.

The oath or declaration is objected to by the Examiner.

Priority under 35 U.S.C. § 119

Acknowledgement is made of a claim for foreign priority under 35 U.S.C. § 119(a)-(d).

All Some* None of the CERTIFIED copies of the priority documents have been
 received.

received in Application No. (Series Code/Serial Number) _____.

received in this national stage application from the International Bureau (PCT Rule 17.2(a)).

*Certified copies not received: _____

Acknowledgement is made of a claim for domestic priority under 35 U.S.C. § 119(e).

Attachment(s)

Notice of References Cited, PTO-892

Information Disclosure Statement(s), PTO-1449, Paper No(s). _____

Interview Summary, PTO-413

Notice of Draftsperson's Patent Drawing Review, PTO-948

Notice of Informal Patent Application, PTO-152

--- SEE OFFICE ACTION ON THE FOLLOWING PAGES ---

Art Unit: 3713

DETAILED ACTION

1. In response to the Amendment filed on May 4, 1999, claim 8 has been cancelled and claims 1-7 and 9-30 are pending.

Claim Rejections - 35 USC § 102

2. The following is a quotation of the appropriate paragraphs of 35 U.S.C. 102 that form the basis for the rejections under this section made in this Office action:

A person shall be entitled to a patent unless --

(b) the invention was patented or described in a printed publication in this or a foreign country or in public use or on sale in this country, more than one year prior to the date of application for patent in the United States.

3. Claims 1, 2, 4-7, 9-11, 13-17, 21, 23-27 and 29 are rejected under 35 U.S.C. 102(b) as being anticipated by Stark et al (U.S. Pat. No. 5,052,375) for the reasons set forth in the prior Office action (see Paper No. 3) and incorporated herein.

Response to Arguments

4. Applicant's arguments filed on May 4, 1999 have been fully considered but they are not deemed to be persuasive. It is noted that applicant's own analysis of the Stark et al device indicates how the device anticipates the claimed invention. Namely applicant admits that Stark et al "measures the relative angular position ...". This reads on the claimed language. In addition, applicant's argument directed to the "a *highly portable device* used to measure *torso or limb*

Art Unit: 3713

movement along multiple axes, including distance and speed of the movement, without any restraint to the movement". Applicant is reading the limitations into the claim which is just not there. It is noted that the specification is not the measure of the invention. Therefore, limitations contained therein can not be read into the claims for the purpose of avoiding the prior art. *In re Spork*, 55 CCPA 743, 386 F.2d 924, 155 USPQ 687 (1968). Hence, applicant's argument is not deemed to be persuasive and the rejection under 35 U.S.C. §102 (b) is proper and stand.

Claim Rejections - 35 USC § 103

5. The following is a quotation of 35 U.S.C. 103(a) which forms the basis for all obviousness rejections set forth in this Office action:

(a) A patent may not be obtained though the invention is not identically disclosed or described as set forth in section 102 of this title, if the differences between the subject matter sought to be patented and the prior art are such that the subject matter as a whole would have been obvious at the time the invention was made to a person having ordinary skill in the art to which said subject matter pertains. Patentability shall not be negated by the manner in which the invention was made.

The factual inquiries set forth in *Graham v. John Deere Co.*, 383 U.S. 1, 148 USPQ 459 (1966), that are applied for establishing a background for determining obviousness under 35 U.S.C. 103(a) are summarized as follows:

1. Determining the scope and contents of the prior art.
2. Ascertaining the differences between the prior art and the claims at issue.
3. Resolving the level of ordinary skill in the pertinent art.
4. Considering objective evidence present in the application indicating obviousness or nonobviousness.

Art Unit: 3713

6. Claims 8 and 18-20 are rejected under 35 U.S.C. 103(a) as being unpatentable over Stark et al (U.S. Pat. No. 5,052,375) for the reasons set forth in the prior Office action (see Paper No. 3) and incorporated herein.

7. Claims 3, 22, 28 and 30 are rejected under 35 U.S.C. 103(a) as being unpatentable over Stark et al (U.S. Pat. No. 5,052,375) as applied to claims 1, 2, 4-7, 9-11, 13-17, 21, 23-27 and 29 above, and further in view of Pratt, Jr. (U.S. Pat. No. 4,912,638) for the reasons set forth in the prior Office action (see Paper No. 3) and incorporated herein.

8. Claim 12 is rejected under 35 U.S.C. 103(a) as being unpatentable over Stark et al (U.S. Pat. No. 5,052,375) as applied to claims 1, 2, 4-7, 9-11, 13-17, 21, 23-27 and 29 above, and further in view of Plotke (U.S. Pat. No. 5,715,160) for the reasons set forth in the prior Office action (see Paper No. 3) and incorporated herein.

Response to Arguments

9. Applicant's arguments directed to the capability to modify the reference is not obviousness. It is noted that the disclosure in a reference must be evaluated for what they would fairly teach one of ordinary skill in the art. *In re Snow*, 471 F.2d 1400, 176 USPQ 328 (CCPA 1973); *In re Boe*, 355 F.2d 961, 148 USPQ 507 (CCPA 1966). In considering the teachings of a reference, it is proper to take into account not only the specific teachings of the reference, but

Art Unit: 3713

also the inferences that one skilled in the art would reasonably have been expected to draw from the reference. *In re Preda*, 401 F.2d 825, 159 USPQ 342 (CCPA 1968); *In re Shepard*, 319 F.2d 194, 138 USPQ 148 (CCPA 1963). In addition, it is proper to taken into consideration not only the teachings of the prior art, but also the level of ordinary skill in the art. *In re Luck*, 476 F.2d 650, 177 USPQ 523 (CCPA 1973). Specifically, those of ordinary skill in the art are presumed to have some knowledge of the art apart from what is expressly disclosed in the references. *In re Jacoby*, 309 F.2d 513, 135 USPQ 317 (CCPA 1962). Hence, the type of download device or docking station from which data contained in the control means may be downloaded to a computer or other device for processing is a design consideration within the skill of the art. *In re Reese*, 290 F.2d 839, 129 USPQ 402 (CCPA 1961). Further, "It should be too well settled now to require citation or discussion that the test for combining references is not what the individual references themselves suggest but rather what the combination of disclosures taken as a whole would suggest to one of ordinary skill in the art. Any judgment on obviousness is in a sense necessarily a reconstruction based upon hindsight reasoning, but so long as it takes into account only knowledge which was within the level of ordinary skill at the time the claimed invention was made and does not include knowledge gleaned only from applicant's disclosure, such reconstruction is proper." *In re McLaughlin*, 443 F.2d 1392, 1395, 170 USPQ 209, 212 (CCPA 1971). Furthermore, where the structure and function of a prior art is similar to the structure and function of the invention, the prior art device may be considered analogous to the invention. *In re Mlot-Fijalkowski*, 676 F.2d 666, 213 USPQ 713 (CCPA 1982). Finally, "No reference need be

Art Unit: 3713

cited by Patent Office to show lack of novelty in notoriously old business arrangement.” *In re Wiechers*, 146 USPQ 52. Hence, applicant's argument is not deemed to be persuasive and the rejections under 35 U.S.C. §103(a) are proper and stand.

Conclusion

10. **THIS ACTION IS MADE FINAL.** Applicant is reminded of the extension of time policy as set forth in 37 CFR 1.136(a).

A shortened statutory period for reply to this final action is set to expire **THREE MONTHS** from the mailing date of this action. In the event a first reply is filed within **TWO MONTHS** of the mailing date of this final action and the advisory action is not mailed until after the end of the **THREE-MONTH** shortened statutory period, then the shortened statutory period will expire on the date the advisory action is mailed, and any extension fee pursuant to 37 CFR 1.136(a) will be calculated from the mailing date of the advisory action. In no event, however, will the statutory period for reply expire later than **SIX MONTHS** from the mailing date of this final action.

11. Any inquiry concerning this communication or earlier communications from the examiner should be directed to Joe H. Cheng whose telephone number is (703) 308-2667.

Any inquiry of a general nature or relating to the status of this application or proceeding should be directed to the receptionist whose telephone number is (703) 308-1148.

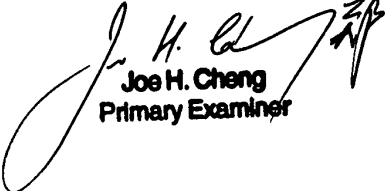
Joe H. Cheng
Primary Examiner

Joe H. Cheng



E. Chan
5-14-99
#10
PATENT

*fee
o.k.*

IN THE UNITED STATES PATENT AND TRADEMARK OFFICE

IN RE: Theodore L. Brann
SERIAL NO.: 08/976,228
FILED: November 21, 1997
FOR: A TRAINING AND SAFETY DEVICE,
SYSTEM AND METHOD TO AID IN
PROPER MOVEMENT DURING
PHYSICAL ACTIVITY

§
§
§
§
§
§
§
§
§
§

GROUP NO.: 3713
EXAMINER: Cheng, Joe H.
ATTY DKT: 13326/59157

RECEIVED
MAY 13 1999
Group 3700

BOX NON-FEE AMENDMENT
ASSISTANT COMMISSIONER FOR PATENTS*
WASHINGTON, D.C. 20231

AMENDMENT & RESPONSE

In response to the Examiner's Office Action mailed February 4, 1999, applicant requests that the application be amended as follows.

In the Specification

Please amend the specification as follows:

1. On page 16, line 19, delete "was".

In the Claims

Please delete claim 8.

Please amend the following claims as indicated (insert / [delete]):

Q1

2. (Amended) The device of claim 1 further comprising at least one input/output port connected to said microprocessor for downloading said data and uploading said operational parameters to and from a computer.

CERTIFICATE OF EXPRESS MAILING (37 C.F.R. § 1.10)

EL382623201US

Express Mail Label Number

I hereby certify that this paper (along with any paper referred to as being attached or enclosed) is being deposited with the United States Postal Service as Express Mail Post Office to Addressee on the date shown below in an envelope with sufficient postage for and with Express Mail label number shown above, and is addressed to: Box Non-Fee Amendment, Assistant Commissioner for Patents, Washington, D.C. 20231.

CATHERINE A. BERGLUND

Catherine A. Berglund
Signature

Date: May 4, 1999

25

Swb, B6 >

14. (Amended) A system to aid in training and safety during physical activity, said system comprising

- a movement measuring device, said movement measuring device further comprising
 - a movement sensor capable of measuring data associated with movement of said device and generating signals indicative of said movement;
 - a power source;
 - a microprocessor connected to said power source, said microprocessor capable of receiving, interpreting, storing and responding to said movement data based on user-defined operational parameters;
 - at least one user input connected to said microprocessor for controlling the operation of said device;
 - a real-time clock connected to said microprocessor;
 - memory for storing said movement data;
 - at least one input/output port connected to said microprocessor for downloading said data and uploading said operational parameters; and
 - an output indicator connected to said microprocessor;
- a computer running a program capable of interpreting and reporting said movement data based on said operational parameters; and
- a download device electronically connected to said movement measuring device and said computer for transmitting said movement data and operational parameters between said movement measuring device and said computer for analysis, reporting and operation purposes.

A2

REMARKS

The Examiner has objected to the declaration for failing to state whether the inventor is a sole or joint inventor. In this application, claims 1-30 are pending. The Examiner has rejected claims 2 and 14-20 under 35 U.S.C. 112, second paragraph, as being indefinite for failing to particularly point out and distinctly claim the subject matter of the invention. The Examiner has also rejected claims 1, 2, 4-7, 9-11, 13-17, 21, 23-27 and 29 under 35 U.S.C. 102(b) as being anticipated by Stark et al. The Examiner has rejected claims 8 and 18-20 under 35 U.S.C. 103(a) as being unpatentable over Stark. Claims 3, 22, 28 and 30 have been rejected as being unpatentable over Stark in view of Pratt. Claim 12 is rejected as being obvious in light of Stark and Plotke. Applicant respectfully disagrees with the Examiner as to the rejection of the claims and addresses the Examiner's rejections, in part, by amendment to the claims requested above and, in part, by the following discussion.

Oath/Declaration

The Examiner's objection concerning the defective declaration has been addressed by filing a new declaration in compliance with 37 CFR 1.67(a) identifying the application by application number and filing date. Although the previously filed declaration was entitled "Declaration, Power of Attorney, and Petition of Sole Inventor," the new declaration more clearly states that the named inventor is the sole inventor.

Claim Rejections – 35 USC 112

The Examiner's rejection of claims 2 and 14-20 has been duly noted. The Examiner expresses concern as to whether the "at least one port" refers to the "download device" described in the specification. This concern has been addressed by amending claims 2 and 14 to more explicitly refer to the input/output port (reference numeral 52 in Fig. 4) which is part of the movement measuring device 12

A

and to distinguish the port from the download device (reference numeral 14 in Fig. 1) that serves as an interface (i.e., docking station) between the device 12 and the computer 16.

Claim Rejections – 35 USC 102

The Examiner has rejected claims 1, 2, 4-7, 9-11, 13-17, 21, 23-27 and 29 under Section 102(b) as being anticipated by U.S. Pat. No. 5,052,375 issued to Stark et al. The Examiner states that Stark “broadly discloses the concept of the system and method for monitoring physical movement of the body part.” The Examiner apparently misunderstands the applicant’s invention. Stark describes an orthopedic limb immobilization device while applicant’s invention is designed to measure an individual’s free movement of limb or torso. In particular, Stark’s invention is an orthopedic restraining device used to immobilize and rehabilitate injured human limbs by providing controlled resistance to movement of the limb. The device monitors the force exerted by the wearer via the injured limb through stress sensing means. And it is this sensed data which is monitored and recorded by the device. The only real movement measured by Stark’s device is the relative angular position of the “distal end sections” of the device (col. 2, line 55-58) about an adjustable hinge. Stark does not describe a highly portable device used to measure torso or limb movement along multiple axes, including distance and speed of the movement, without any restraint to the movement as is taught by applicant’s invention. Thus, Stark’s disclosure does not anticipate any of the claims made by the applicant in the present invention.

Claim Rejections – 35 USC 103

In order to support the rejection of claims under Section 103, the Examiner must identify something that suggests the various elements mentioned in the rejection be used together to achieve a useful purpose. See In re Fritch, 23 USPQ 2d 1780, 1983 (Fed. Cir. 1992), citing ACS Hosp. Systems, Inc. v. Montefiore Hosp., 732 F.2d 1572, 1577 (Fed. Cir. 1984) (“Obviousness cannot be established by combining the teachings of the prior art to produce the claimed invention, absent some teaching or suggestion supporting the combination. Under Section 103, teachings of references can be combined only if there is some suggestion or incentive to do so.”); In re Fine, 837 F.2d 1071 (Fed. Cir. 1988) (The PTO has the burden under section 103 to establish a prima facie case of obviousness . . .). Nothing in the references cited by the Examiner suggests that these elements be combined or integrated in the unique way they have been integrated in the claims of the present invention.

I. The Examiner has rejected claims 8 and 18-20 under Section 103 as unpatentable over Stark. In particular, the rejection of claims 8 and 18-20 are based solely on Stark without combining it with any other reference. Therefore, the combination of elements must be obvious from Stark alone. Applicant has deleted claim 8. However, because Stark does not disclose or imply the use of any type of download device or docking station from which data contained in the “control means” may be downloaded to a computer or other device for processing, Stark does not suggest or teach the use of such a download device in any form. Thus, claims 18-20, which describe various physical means for achieving the transfer of data from applicant’s device for remote data processing, are not obvious in light of Stark.

II. The Examiner has rejected claims 3, 22, 28 and 30 under Section 103 as being unpatentable over Stark in view of Pratt. However, this rejection is ill-founded. Pratt, just as with Stark, discloses a device which is a “resisting apparatus” (col. 3, lines 8-9). This is in direct opposition to applicant’s device which allows the wearer to move in any desired direction and with any desired speed for purposes of monitoring the wearer’s movement. Thus, while both Stark and Pratt disclose devices used to restrain or resist the wearer’s movement, applicant’s device does not and in fact could not in order for it to be used for its intended purpose. The wearer of the applicant’s device is not restrained in any way, and this is critical in order to monitor the wearer’s natural motion for analysis, whether while performing physical labor or

athletic drills. Furthermore, applicant's invention measures and records a wide variation of movement speeds whereas Pratt simply controls the device resistance in order to maintain constant speed throughout the movement (claim 6). Thus, nothing in these two references integrate to form the unique and non-obvious aspects claimed in claims 3, 22, 28 and 30.

III. The Examiner has rejected claim 12 under Section 103 as unpatentable over Stark in view of Plotke. Because Stark describes an immobilization and restraining device that severely limits the wearer's movement and Plotke discloses a motion and force evaluation system for measuring physical movement, there is no suggestion to combine Stark with Plotke. Thus, Stark teaches away from the tactile device disclosed in Plotke.

Request for Allowance

Applicant submits that: all of the rejections and objections cited by the Examiner have been addressed and that, with the above-requested amendments, all of the pending claims of the present application recite patentable improvements. Allowance and passage to issue of the present application is therefore respectfully requested.

RESPECTFULLY SUBMITTED,

Date: May 4, 1999
Registration No. 27,811
Registration No. 37,797

Michael Caywood ✓
Jerry M. Keys
Michael Caywood
ATTORNEYS FOR APPLICANT
Locke Liddell & Sapp LLP
100 Congress Ave., Suite 300
Austin, Texas 78701
512/305-4724

13326:59157:AUSTIN:45752.1

5-14-99
PATENT

5 | Sub
Declaration

IN THE UNITED STATES PATENT AND TRADEMARK OFFICE

IN RE:	Theodore L. Brann	§	GROUP NO.:	3713
SERIAL NO.:	08/976,228	§	EXAMINER:	Joe H. Cheng
FILED:	November 21, 1997	§	ATTY DKT:	13326/59157
FOR:	A TRAINING AND SAFETY DEVICE, SYSTEM AND METHOD TO AID IN PROPER MOVEMENT DURING PHYSICAL ACTIVITY	§		

BOX NON-FEE AMENDMENT
ASSISTANT COMMISSIONER FOR PATENTS*
WASHINGTON, D.C. 20231



DECLARATION, POWER OF ATTORNEY, AND PETITION
OF SOLE INVENTOR

As below-named inventor, I hereby individually declare that:

TYPE OF DECLARATION

This Declaration is of the following application type:

- Original
- Design
- Supplemental
- National Stage of PCT
- Divisional with Preliminary Amendment of Claims and Title
- Continuation
- Continuation-in-Part (CIP)

INVENTORSHIP IDENTIFICATION

My residence, post office address and citizenship are as stated below next to my name, I believe that I am the original, first and sole inventor of the subject matter which is claimed and for which a patent is sought on the invention entitled:

*

CERTIFICATE OF EXPRESS MAILING (37 C.F.R. § 1.10)

EL382623201US

Express Mail Label Number

I hereby certify that this paper (along with any paper referred to as being attached or enclosed) is being deposited with the United States Postal Service as Express Mail Post Office to Addressee on the date shown below in an envelope with sufficient postage for and with Express Mail label number shown above, and is addressed to: Box Patent Application, Commissioner of Patents and Trademarks, Washington, D.C. 20231.

Date: May 4, 1999

CATHERINE A. BERGLUND

Catherine A. Berglund
Signature

G:\CORP\13326\59157\PTO\DEC_INV.WPD

TITLE OF INVENTION

A TRAINING AND SAFETY DEVICE, SYSTEM AND
METHOD TO AID IN PROPER MOVEMENT
DURING PHYSICAL ACTIVITY

SPECIFICATION IDENTIFICATION

the specification of which

- is attached hereto.
 was filed on November 21, 1997 and has been given
Application Serial No.: 08/976,228.
 was described and claimed in PCT International Application No. _____ filed on
_____ (if applicable) and as amended under PCT Article 19 on
_____.

ACKNOWLEDGMENT OF REVIEW OF PAPERS AND DUTY OF CANDOR

I hereby state that I have reviewed and understand the contents of the above-identified specification, including the claims, as amended by any amendment referred to above.

I acknowledge that duty to disclose information which is material to the examination of this application in accordance with Title 37, Code of Federal Regulations, Section 1.56(a).

DECLARATION

I hereby declare that all statements made herein of my own knowledge are true and that all statements made on information and belief are believed to be true; and further that these statements were made with the knowledge that willful false statements and the like so made are punishable by fine or imprisonment, or both, under Section 1001 of Title 18 of the United States Code, and that willful false statements may jeopardize the validity of the application or any patent issued thereon.

POWER OF ATTORNEY

I hereby appoint Jerry M. Keys, Registration No. 27,811 and/or Michael Caywood, Registration No. 37,797, Attorneys at Law, Locke Liddell & Sapp LLP, 100 Congress Ave., Suite 300, Austin, Texas 78701, (512) 305-4724, my attorneys, with full power of substitution and revocation, to prosecute this application and to transact all business in the Patent and Trademark Office connected therewith.

And I hereby request that all correspondence be sent to:

Michael Caywood
Locke Liddell & Sapp LLP
100 Congress, Suite 300
Austin, Texas 78701

PETITION

Wherefore, I pray that Letters Patent be granted to me for the invention or discovery described and claimed in the foregoing specification and claims, and I hereby subscribe my name to the attached specification and claims, declaration, power of attorney and this petition.

Full Name of First Listed Inventor:

Theodore L. Brann

Inventor's Signature:

Theodore L. Brann

Theodore L. Brann

Date: April 28, 1999

Citizenship:

United States of America

Residence:

P.O. Box 1766
Boerne, Texas 78006

G:\CORP\13326\59157\PTO\DEC_INV.WPD

GAU 3713

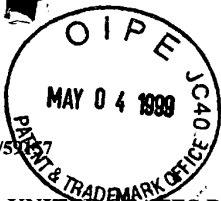

ATTORNEY DOCKET NO. 13326/50

PATENT

IN THE UNITED STATES PATENT AND TRADEMARK OFFICE

IN RE:	Theodore L. Brann	§	GROUP NO.:	3713
SERIAL NO.:	08/976,228	§	EXAMINER:	Cheng, Joe H.
FILED:	November 21, 1997	§		
FOR:	A Training and Safety Device, System and Method to Aid in Proper Movement During Physical Activity	§		

BOX NON-FEE AMENDMENT
Assistant Commissioner for Patents
Washington, D.C. 20231

RECEIVED
MAY 13 1999
Group 3700

TRANSMITTAL LETTER

Dear Sir:

Enclosed herewith please find the following documents for filing for the above-identified patent application:

1. Amendment & Response:
2. Declaration, Power of Attorney and Petition of Sole Inventor: and
3. Self-Addressed and Stamped Return Receipt Postcard.

If any additional extension and/or fee is required or if any overpayment has been made, the Commissioner is hereby authorized to charge any deficit or credit any overpayment to Account No. 12-1781.

RESPECTFULLY SUBMITTED,

Date: May 4, 1999
Registration No. 27,811
Registration No. 37,797

Michael Caywood
Jerry M. Keys
Michael Caywood
ATTORNEYS FOR APPLICANT
Locke Liddell & Sapp, LLP
100 Congress Avenue, Suite 300
Austin, Texas 78701
Telephone: 512/305-4700
Facsimile: 512/305-4800

*CERTIFICATE OF EXPRESS MAILING (37 CFR ' 1.10)

EL382623201US

I hereby certify that this paper (along with any paper referred to as being attached or enclosed) is being deposited with the United States Postal Service as Express Mail Post Office to Addressee on the date shown below in an envelope with sufficient postage for and with Express Mail label number shown above, and is addressed to: BOX NON-FEE AMENDMENT, Assistant Commissioner for Patents, Washington, D.C. 20231.

Date: May 4, 1999

Catherine A. Berglund
Catherine A. Berglund
Signature



**UNITED STATES DEPARTMENT OF COMMERCE
Patent and Trademark Office**

Address: COMMISSIONER OF PATENTS AND TRADEMARKS
Washington, D.C. 20231

APPLICATION NO.	FILING DATE	FIRST NAMED INVENTOR	ATTORNEY DOCKET NO.
-----------------	-------------	----------------------	---------------------

08/976,228 11/21/97 BRANN

T 13326/59157

EXAMINER

QM11/0204

MICHAEL CAYWOOD
LOCKE PURNELL RAIN HARRELL
100 CONGRESS SUITE 300
AUSTIN TX 78701

CHENG, J
ART UNIT

PAPER NUMBER

3

3713
DATE MAILED:

02/04/99

Please find below and/or attached an Office communication concerning this application or proceeding.

Commissioner of Patents and Trademarks

Office Action Summary

Application No. 08/976,228	Applicant(s) Brann
Examiner Joe H. Cheng	Group Art Unit 3713



- Responsive to communication(s) filed on _____.
- This action is **FINAL**.
- Since this application is in condition for allowance except for formal matters, **prosecution as to the merits is closed** in accordance with the practice under *Ex parte Quayle*, 1935 C.D. 11; 453 O.G. 213.

A shortened statutory period for response to this action is set to expire three month(s), or thirty days, whichever is longer, from the mailing date of this communication. Failure to respond within the period for response will cause the application to become abandoned. (35 U.S.C. § 133). Extensions of time may be obtained under the provisions of 37 CFR 1.136(a).

Disposition of Claims

- Claim(s) 1-30 is/are pending in the application.
Of the above, claim(s) _____ is/are withdrawn from consideration.
- Claim(s) _____ is/are allowed.
- Claim(s) 1-30 is/are rejected.
- Claim(s) _____ is/are objected to.
- Claims _____ are subject to restriction or election requirement.

Application Papers

- See the attached Notice of Draftsperson's Patent Drawing Review, PTO-948.
- The drawing(s) filed on _____ is/are objected to by the Examiner.
- The proposed drawing correction, filed on _____ is approved disapproved.
- The specification is objected to by the Examiner.
- The oath or declaration is objected to by the Examiner.

Priority under 35 U.S.C. § 119

- Acknowledgement is made of a claim for foreign priority under 35 U.S.C. § 119(a)-(d).
 - All Some* None of the CERTIFIED copies of the priority documents have been
 - received.
 - received in Application No. (Series Code/Serial Number) _____.
 - received in this national stage application from the International Bureau (PCT Rule 17.2(a)).
- *Certified copies not received: _____
- Acknowledgement is made of a claim for domestic priority under 35 U.S.C. § 119(e).

Attachment(s)

- Notice of References Cited, PTO-892
- Information Disclosure Statement(s), PTO-1449, Paper No(s). 2
- Interview Summary, PTO-413
- Notice of Draftsperson's Patent Drawing Review, PTO-948
- Notice of Informal Patent Application, PTO-152

--- SEE OFFICE ACTION ON THE FOLLOWING PAGES ---

Art Unit: 3713

DETAILED ACTION

Oath/Declaration

1. The oath or declaration is defective. A new oath or declaration in compliance with 37 CFR 1.67(a) identifying this application by application number and filing date is required. See MPEP §§ 602.01 and 602.02.

The oath or declaration is defective because:

It does not state whether the inventor is a sole or joint inventor of the invention claimed.

Drawings

2. This application has been filed with informal drawings which are acceptable for examination purposes only. Formal drawings will be required when the application is allowed.

Claim Rejections - 35 USC § 112

3. The following is a quotation of the second paragraph of 35 U.S.C. 112:

The specification shall conclude with one or more claims particularly pointing out and distinctly claiming the subject matter which the applicant regards as his invention.

4. Claims 2 and 14-20 are rejected under 35 U.S.C. § 112, second paragraph, as being indefinite for failing to particularly point out and distinctly claim the subject matter which applicant regards as the invention.

Art Unit: 3713

Regarding claims 2 and 14-20, it is not understood as to whether the "at least one port" is referred to the "download device" or not. If it is not then what is it referred to? If it is the same, then it is confusing and misdescriptive.

Claim Rejections - 35 USC § 102

5. The following is a quotation of the appropriate paragraphs of 35 U.S.C. 102 that form the basis for the rejections under this section made in this Office action:

A person shall be entitled to a patent unless --

(b) the invention was patented or described in a printed publication in this or a foreign country or in public use or on sale in this country, more than one year prior to the date of application for patent in the United States.

6. Claims 1, 2, 4-7, 9-11, 13-17, 21, 23-27 and 29 are rejected under 35 U.S.C. 102(b) as being anticipated by Stark et al (U.S. Pat. No. 5,052,375).

As per claims 1, 2, 4-7, 9-11, 13-17, 21, 23-27 and 29, Figs. 1-16C of Stack et al broadly discloses the concept of the system and method for monitoring physical movement of the body part during physical activity having the movement measuring device comprising the movement sensor (4") having at least one accelerometer for simultaneously measuring angle along at least two orthogonal axes, distance and speed of the movement and generating signals indicative of the measured movement data, the microprocessor (64) for receiving, interpreting, storing and responding to the measured movement data based on the user-defined operational parameters, the power supply manager (66) connected between the power source (69) and the microprocessor, at

Art Unit: 3713

least one user input switch (74) for controlling the operation of the device, the real-time clock (72) connected to the microprocessor, memory (68, 70) for storing the movement data, at least one port (78) which is the physical docking station (modem) for downloading and uploading the data and the operational parameters to and from a network of other standard personal computer for interpreting and reporting the movement data based on the operational parameter, and the audio output indicator (78) and the visual output indicator (76) , so as to teach the user how to properly perform the physical movement and for providing instant feedback regarding the movement. In addition, the movement sensor is housed separately from the microprocessor. See from column 7, line 9 to column 48, line 38.

Claim Rejections - 35 USC § 103

7. The following is a quotation of 35 U.S.C. 103(a) which forms the basis for all obviousness rejections set forth in this Office action:

(a) A patent may not be obtained though the invention is not identically disclosed or described as set forth in section 102 of this title, if the differences between the subject matter sought to be patented and the prior art are such that the subject matter as a whole would have been obvious at the time the invention was made to a person having ordinary skill in the art to which said subject matter pertains. Patentability shall not be negated by the manner in which the invention was made.

The factual inquiries set forth in *Graham v. John Deere Co.*, 383 U.S. 1, 148 USPQ 459 (1966), that are applied for establishing a background for determining obviousness under 35

U.S.C. 103(a) are summarized as follows:

1. Determining the scope and contents of the prior art.
2. Ascertaining the differences between the prior art and the claims at issue.
3. Resolving the level of ordinary skill in the pertinent art.

Art Unit: 3713

4. Considering objective evidence present in the application indicating obviousness or nonobviousness.

8. Claims 8 and 18-20 are rejected under 35 U.S.C. 103(a) as being unpatentable over Stark et al (U.S. Pat. No. 5,052,375).

As per claims 8 and 18-20, it is noted that the teaching of Stark et al does not specifically disclose the power converter (as per claim 8) and the download device is a wireless device (as per claim 18), or uses radio frequency (as per claim 19), or infrared light (as per claim 20) as required. However, such limitations of the power converter, and the wireless download device, or radio frequency download device, or infrared light download device are old and well known, and are considered an arbitrary obvious design choice, so as to convert the power source to the power supply manager, and to provide different types of download device.

9. Claims 3, 22, 28 and 30 are rejected under 35 U.S.C. 103(a) as being unpatentable over Stark et al (U.S. Pat. No. 5,052,375) as applied to claims 1, 2, 4-7, 9-11, 13-17, 21, 23-27 and 29 above, and further in view of Pratt, Jr. (U.S. Pat. No. 4,912,638).

As per claims 3, 22, 28 and 30, it is noted that the teaching of Stark et al does not specifically disclose the movement sensor for detecting the velocity of the movement (as per claims 3 and 22) and the physical movement is physical labor (as per claim 28) or the exercise to improve technique related to the athelia skill (as per claim 30) as required. However, the teaching

Art Unit: 3713

of Pratt, Jr. broadly discloses that such features of the movement sensor for detecting the velocity of the movement (see column 3, lines 8-49) and the physical movement is physical labor or the exercise to improve technique related to the athelia skill (see Figs. 1-10) are old and well known. Hence, it would have been obvious to one of ordinary skill in the art to modify the system and method of Stark et al with the feature of the velocity of the movement and the physical labor movement or the technique related to the athelia skill as taught by Pratt, Jr. as both Stark et al and Pratt, Jr. are directed to the system and method of monitoring physical movement of the body part, so as to provide the safety aid for training the user during physical activity.

10. Claim 12 is rejected under 35 U.S.C. 103(a) as being unpatentable over Stark et al (U.S. Pat. No. 5,052,375) as applied to claims 1, 2, 4-7, 9-11, 13-17, 21, 23-27 and 29 above, and further in view of Plotke (U.S. Pat. No. 5,715,160).

As per claim 12, it is noted that the teaching of Stark et al does not specifically disclose the output indicator is tactile as required. However, the teaching of Plotke broadly discloses the tactile output indicator (37). Hence, it would have been obvious to one of ordinary skill in the art to modify the system and method of Stark et al with the feature of the tactile output indicator as taught by Plotke as both Stark et al and Plotke are directed to the system and method of monitoring physical movement of the body part, so as to provide the tactile feedback to the user during physical activity.

Art Unit: 3713

Conclusion

11. The prior art made of record and not relied upon is considered pertinent to applicant's disclosure. However, applicant is strongly urged to consider them carefully when amending the claims in response to the current Office Action.

Silverman et al (U.S. Pat. No. 4,571,682) - note Figs. 1-4B;

Matsumoto et la (U.S. Pat. No. 4,911,427) - note Figs. 1-15;

McIntosh (U.S. Pat. No. 4,934,694) - note Figs. 1-11;

Prince et al (U.S. Pat. No. 5,348,519) - note Figs. 1-47.

12. Any inquiry concerning this communication or earlier communications from the examiner should be directed to Joe H. Cheng whose telephone number is (703) 308-2667.

Any inquiry of a general nature or relating to the status of this application or proceeding should be directed to the receptionist whose telephone number is (703) 308-1148.

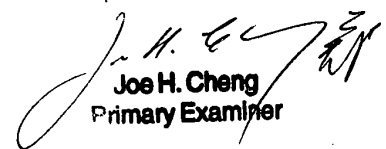
Joe H. Cheng
Primary Examiner

Joe H. Cheng
January 30, 1999

Attachment 08/976, 228

The drawings submitted with this application were declared informal by the applicant. Accordingly they have not been reviewed by a draftsman at this time. When formal drawings are submitted, the draftsman will perform a review.

Direct any inquires concerning drawing review to the Drawing Review Branch (703) 305-8404.

Notice of References Cited

Application No. 08/976,228	Applicant(s) Brann	
Examiner Joe H. Cheng	Group Art Unit 3713	Page 1 of 1

U.S. PATENT DOCUMENTS

	DOCUMENT NO.	DATE	NAME	CLASS	SUBCLASS
A	4,571,682	Feb. 1986	Silverman et al	482	903x
B	4,911,427	Mar. 1990	Matsumoto et al	482	902x
C	4,912,638	Mar. 1990	Pratt, Jr.	482	903x
D	4,934,694	Jun. 1990	McIntosh	482	902x
E	5,052,375	Oct. 1991	Stark et al	482	902x
F	5,348,519	Sep. 1994	Prince et al	482	903x
G	5,715,160	Feb. 1998	Plotke	482	902x
H					
I					
J					
K					
L					
M					

FOREIGN PATENT DOCUMENTS

	DOCUMENT NO.	DATE	COUNTRY	NAME	CLASS	SUBCLASS
N						
O						
P						
Q						
R						
S						
T						

NON-PATENT DOCUMENTS

	DOCUMENT (Including Author, Title, Source, and Pertinent Pages)	DATE
U		
V		
W		
X		

IN RE: Theodore L. Brann
 SERIAL NO.: Unknown
 FILED: Herewith
 FOR: A TRAINING AND SAFETY DEVICE,
 SYSTEM AND METHOD TO AID IN
 PROPER MOVEMENT DURING
 PHYSICAL ACTIVITY

§
§
§
§
§
§
§
§
§
§

GROUP NO.: Unknown
 EXAMINER: Unknown
 ATTY DKT: 13326/59157

Other Art

(including Author, Title, Pertinent Pages, etc.)

Examiner
Initial *

Author

Title

Page

Patent Documents Cited by Examiner

Examiner
Initial*

Document
Number

Issue
Date

Name

Sub
Class

Class

Trans-
lation

Examiner: _____

Date Considered: _____

*EXAMINER: Initial if reference considered, whether or not citation is in conformance with MPEP 609; draw line through citation if not in conformance and not considered. Include copy of this form with next communication to applicant.

IN RE: Theodore L. Brann
 SERIAL NO.: Unknown
 FILED: Herewith
 FOR: A TRAINING AND SAFETY DEVICE,
 SYSTEM AND METHOD TO AID IN
 PROPER MOVEMENT DURING
 PHYSICAL ACTIVITY

§
§
§
§
§
§
§
§
§
§
§

GROUP NO.: Unknown
 EXAMINER: Unknown
 ATTY DKT: 13326/59157

Prior Art Cited by Applicant(s)

While the filing of prior art statements is voluntary, the procedure is governed by the guidelines of Section 609 of the Manual of Patent Examining Procedure and 37 C.F.R. §§ 1.97 and 1.98. To be considered a proper prior art statement, Form PTO-1449 shall be accompanied by an explanation of relevance of each listed item, a copy of each listed patent or publication or other item of information and a translation of the pertinent portions of foreign documents (if an existing translation is readily available to the applicant), and should be submitted in a timely manner as set out in MPEP Sec. 609.

Examiners will consider all prior art citations submitted in conformance with 37 C.F.R. § 1.98 and MPEP Sec. 609 and place their initials adjacent the citations in the spaces provided on this form. Examiners will also initial citations not in conformance with the guidelines which may have been considered. A reference may be considered by the Examiner for any reason whether or not the citation is in full conformance with the guidelines. A line will be drawn through a citation if it is not in conformance with the guidelines AND has not been considered. A copy of the submitted form, as reviewed by the Examiner, will be returned to the applicant with the next communication. The original of the form will be entered into the application file.

Each citation initialed by the Examiner will be printed on the issued patent in the same manner as prior art cited by the Examiner on Form PTO-892.

The reference designations "A1", "A2", etc. (referring to Applicant's reference 1, Applicant's reference 2, etc.) will be used by the Examiner in the same manner as Examiner's reference designations "A", "B", "C", etc. on Office Action Form PTO-1142.

E:\CORP\13326\59157\PTO\1449.01

Examiner: _____

Date Considered: _____

*EXAMINER: Initial if reference considered, whether or not citation is in conformance with MPEP 609; draw line through citation if not in conformance and not considered. Include copy of this form with next communication to applicant.

A

PATENT

IN THE UNITED STATES PATENT AND TRADEMARK OFFICE

11/21/97
JCS46 U.S. PRO

IN RE: Theodore L. Brann
SERIAL NO.: Unknown
FILED: Herewith
FOR: A TRAINING AND SAFETY DEVICE,
SYSTEM AND METHOD TO AID IN
PROPER MOVEMENT DURING
PHYSICAL ACTIVITY

§
§
§
§
§
§
§
§
§
§

GROUP NO.: Unknown
EXAMINER: Unknown
ATTY DKT: 13326/59157

65705 U.S. PRO
08/976228
11/21/97

BOX PATENT APPLICATION
THE COMMISSIONER OF PATENTS AND TRADEMARKS*
WASHINGTON, D.C. 20231

NEW APPLICATION COVER SHEET

Transmitted herewith for filing is a patent application entitled:

Title

A TRAINING AND SAFETY DEVICE, SYSTEM AND
METHOD TO AID IN PROPER MOVEMENT
DURING PHYSICAL ACTIVITY

Inventor is:

Name: Theodore L. Brann
Residence: P.O. Box 1897
Mission, Texas 78572
Citizenship: U.S.A.

08976228 11/21/97

*
CERTIFICATE OF EXPRESS MAILING (37 CFR § 1.10)
EM000794447US

I hereby certify that this paper (along with any paper referred to as being attached or enclosed) is being deposited with the United States Postal Service as Express Mail Post Office to Addressee on the date shown below in an envelope with sufficient postage for and with Express Mail label number shown above, and is addressed to: Box Patent Application, Commissioner of Patents and Trademarks, Washington, D.C. 20231.

Date: Nov. 21, 1997

MICHAEL CAYWOOD
Michael Caywood
Signature

Type of Application:

This new application is a(n):

- Original
- Design
- Plant
- Divisional
- Continuation
- Continuation-in-Part (CIP)

Papers Enclosed That Are Required for Filing Date under 37 C.F.R. 1.53(b) (Regular) or 37 C.F.R. 1.153 (Design) Application

- 19 Pages of specification
- 5 Pages of claims
- 1 Pages of Abstract
- 6 Sheets of drawing
 - formal
 - informal

Additional papers enclosed

- Preliminary Amendment
- Information Disclosure Statement (37 C.F.R. 1.98)
- Form PTO-1449 (PTO/SB/08A and 08B)
- Citations
- Declaration of Biological Deposit
- Submission of "Sequence Listing," computer readable copy and/or amendment pertaining thereto for biotechnology invention containing nucleotide and/or amino acid sequence.
- Authorization of Attorney(s) to Accept and Follow Instructions from Representative
- Special Comments
- Other

Declaration of Inventorship

- Enclosed.
- Legal Representative/Refusal Petition/International Application Exception (see attached documents).

Benefit of Prior Application

- This new application claims the benefit of prior U. S. applications identified in the Related Applications section of the attached application Disclosure.
- A redlined copy of the application is enclosed to show changes to the prior application. In addition, the following new changes have been made to the drawings: new drawing Fig. _____ has been added.

Small Entity Statement(s) [if any]

- Verified Statement(s) that this is a filing by a small entity under 37 CFR 1.9 and 1.27 is(are):
 - filed herewith.
 - will follow.

Fee Calculation (37 CFR 1.16)

- Regular application

CLAIMS AS FILED

	Number Filed		Max	Above Max		Above Max Fee		
Basic Fee 37 CFR §1.16(a)								\$ 790.00
Total Claims 37 CFR §1.16 [©]	30	-	20	10	x	\$ 22.00	=	\$220.00
Independent Claims 37 CFR §1.16(b)	3	-	3	0	x	\$ 82.00	=	\$0.00
Multiple Dependant Claims 37 CFR §1.16(d)				0	x	\$270.00	=	\$0.00

Filing Fee Total \$ 1010.00

After Small Entity Discount of 50% \$ 505.00

Total Fee Calculation

- Enclosed
 - filing fee \$ _____
 - extension fee \$ _____
 - incomplete filing surcharge (37 C.F.R. 1.16(e)) \$ _____
 - petition fee for filing by other than all the inventors or person on behalf of the inventor where inventor refused to sign or cannot be reached. (37 CFR 1.47 and 1.17(h)) \$ _____
 - processing and retention fee (\$130.00; 37 CFR 1.53(d) and 1.21(l)) \$ _____
- Total Fees Enclosed** \$ _____

Correspondence

Please address all correspondence in connection with this application to:

Michael Caywood
Locke Purnell Rain Harrell, P.C.
100 Congress Avenue, Suite 300
Austin, Texas 78701

ACCEPTED FOR MAILING

FEE PAYMENT

- Attached is a check in the sum of \$_____.
- Charge Account No. 12-1781 the sum of \$505.00. A duplicate of this transmittal is attached.
- If any additional extension and/or fee is required or if any overpayment has been made, the Commissioner is hereby authorized to charge any deficit or credit any overpayment to Account No.12-1781.

Copies

- A duplicate of this sheet is enclosed [if authorization to charge account is checked above].

RESPECTFULLY SUBMITTED,

Date: Nov. 21, 1997
Registration No. 27,811
Registration No. 37,797

Michael Caywood
Jerry M. Keys
Michael Caywood
ATTORNEYS FOR APPLICANT
Locke Purnell Rain Harrell, P.C.
100 Congress Avenue, Suite 300
Austin, Texas 78701
(512) 305-4724

STATE BAR OF TEXAS

E:\CORP\13326\59157PTO\NEWAPP.CVR

IN THE UNITED STATES PATENT AND TRADEMARK OFFICE

IN RE:	Theodore L. Brann	§	GROUP NO.:	Unknown
SERIAL NO.:	Unknown	§	EXAMINER:	Unknown
FILED:	Herewith	§	ATTY DKT.:	13326/59157
FOR:	A TRAINING AND SAFETY DEVICE, SYSTEM AND METHOD TO AID IN PROPER MOVEMENT DURING PHYSICAL ACTIVITY	§		

65705 U.S. PTO
08/976228
11/21/97

BOX PATENT APPLICATION
THE COMMISSIONER OF PATENTS AND TRADEMARKS*
WASHINGTON, D.C. 20231

LETTER OF TRANSMITTAL

Dear Sir:

Enclosed with this letter please find the following in connection with the above-referenced application for U.S. patent:

1. New Application Cover Sheet;
2. Declaration, Power of Attorney, and Petition of Sole Inventor;
3. Declaration(s) of Small Entity Status by an Independent Inventor;
4. New Application Disclosure:

Specification	<u>19</u> page(s)
Claims	<u>5</u> page(s)
Informal Drawings	<u>6</u> sheet(s)
Abstract	<u>1</u> page(s)
5. Information Disclosure Statement package; and
6. Self-Addressed and Stamped Return Receipt Postcard.

08976228-11/21/97

*
CERTIFICATE OF EXPRESS MAILING (37 C.F.R. § 1.10)
EM000794447US
Express Mail Label Number
I hereby certify that this paper (along with any paper referred to as being attached or enclosed) is being deposited with the United States Postal Service as Express Mail Post Office to Addressee on the date shown below in an envelope with sufficient postage for and with Express Mail label number shown above, and is addressed to: Box Patent Application, Commissioner of Patents and Trademarks, Washington, D.C. 20231.

Date: Nov. 21, 1997

MICHAEL CAYWOOD
Michael Caywood
Signature

If any additional extension and/or fee is required or if any overpayment has been made, the Commissioner is hereby authorized to charge any deficit or credit any overpayment to Account No. 12-1781.

RESPECTFULLY SUBMITTED,

Date: Nov. 21, 1997
Registration No. 27,811
Registration No. 37,797

Michael Caywood
Jerry M. Keys
Michael Caywood
ATTORNEYS FOR APPLICANT
Locke Purnell Rain Harrell, P.C.
100 Congress Avenue, Suite 300
Austin, Texas 78701
(512) 305-4702

65777 82368

E:\CORP\13326\59157\PTO\APP_TRAN.WPD

IN THE UNITED STATES PATENT AND TRADEMARK OFFICE

IN RE:	Theodore L. Brann	§	GROUP NO.:	Unknown
SERIAL NO.:	Unknown	§	EXAMINER:	Unknown
FILED:	Herewith	§	ATTY DKT:	13326/59157
FOR:	A TRAINING AND SAFETY DEVICE, SYSTEM AND METHOD TO AID IN PROPER MOVEMENT DURING PHYSICAL ACTIVITY	§		

BOX PATENT APPLICATION
THE COMMISSIONER OF PATENTS AND TRADEMARKS*
WASHINGTON, D.C. 20231

DECLARATION, POWER OF ATTORNEY, AND PETITION
OF SOLE INVENTOR

As below-named inventor, I hereby individually declare that:

TYPE OF DECLARATION

This Declaration is of the following application type:

- Original
- Design
- Supplemental
- National Stage of PCT
- Divisional with Preliminary Amendment of Claims and Title
- Continuation
- Continuation-in-Part (CIP)

INVENTORSHIP IDENTIFICATION

My residence, post office address and citizenship are as stated below next to my name, I believe that I am the original, and first inventor of the subject matter which is claimed and for which a patent is sought on the invention entitled:

*

CERTIFICATE OF EXPRESS MAILING (37 C.F.R. § 1.10)

EM000794447US

Express Mail Label Number

I hereby certify that this paper (along with any paper referred to as being attached or enclosed) is being deposited with the United States Postal Service as Express Mail Post Office to Addressee on the date shown below in an envelope with sufficient postage for and with Express Mail label number shown above, and is addressed to: Box Patent Application, Commissioner of Patents and Trademarks, Washington, D.C. 20231.

Date: Nov. 21, 1997

E:\CORP\13326\59157\PTO\DEC_INV.WPD

MICHAEL CAYWOOD

Michael Caywood
Signature

TITLE OF INVENTION

A TRAINING AND SAFETY DEVICE, SYSTEM AND
METHOD TO AID IN PROPER MOVEMENT
DURING PHYSICAL ACTIVITY

SPECIFICATION IDENTIFICATION

the specification of which

- is attached hereto.
 was filed on _____ [date] and has been given
Application Serial No.: _____.
 was described and claimed in PCT International Application No. _____ filed on
_____ (if applicable) and as amended under PCT Article 19 on
_____.

ACKNOWLEDGMENT OF REVIEW OF PAPERS AND DUTY OF CANDOR

I hereby state that I have reviewed and understand the contents of the above-identified specification, including the claims, as amended by any amendment referred to above.

I acknowledge that duty to disclose information which is material to the examination of this application in accordance with Title 37, Code of Federal Regulations, Section 1.56(a).

DECLARATION

I hereby declare that all statements made herein of my own knowledge are true and that all statements made on information and belief are believed to be true; and further that these statements were made with the knowledge that willful false statements and the like so made are punishable by fine or imprisonment, or both, under Section 1001 of Title 18 of the United States Code, and that willful false statements may jeopardize the validity of the application or any patent issued thereon.

POWER OF ATTORNEY

I hereby appoint Jerry M. Keys, Registration No. 27,811 and/or Michael Caywood, Registration No. 37,797, Attorneys at Law, Locke Purnell Rain Harrell, P.C., 100 Congress Ave., Suite 300, Austin, Texas 78701, (512) 305-4724, my attorneys, with full power of substitution and revocation, to prosecute this application and to transact all business in the Patent and Trademark Office connected therewith.

And I hereby request that all correspondence be sent to:

Michael Caywood
Locke Purnell Rain Harrell, P.C.,
100 Congress, Suite 300
Austin, Texas 78701

08978223 4349
4577 08292500

PETITION

Wherefore, I pray that Letters Patent be granted to me for the invention or discovery described and claimed in the foregoing specification and claims, and I hereby subscribe my name to the attached specification and claims, declaration, power of attorney and this petition.

Full Name of First Listed Inventor:

Theodore L. Brann

Inventor's Signature:

Theodore L. Brann
Theodore L. Brann

Date: NOVEMBER 20, 1997

Citizenship:

United States of America

Residence:

P.O. Box 1897
Mission, Texas 78752

E:\CORP\13326\59157\PTO\DEC_INV.WPD

00976200 4 23 97

IN THE UNITED STATES PATENT AND TRADEMARK OFFICE

IN RE:	Theodore L. Brann	§	GROUP NO.:	Unknown
SERIAL NO.:	Unknown	§	EXAMINER:	Unknown
FILED:	Herewith	§	ATTY DKT:	13326/59157
FOR:	A TRAINING AND SAFETY DEVICE, SYSTEM AND METHOD TO AID IN PROPER MOVEMENT DURING PHYSICAL ACTIVITY	§		

BOX PATENT APPLICATION
THE COMMISSIONER OF PATENTS AND TRADEMARKS*
WASHINGTON, D.C. 20231

**DECLARATION OF SMALL ENTITY STATUS
BY AN INDEPENDENT INVENTOR**

I hereby declare that as a below named inventor, I qualify as an independent inventor as defined in 37 CFR § 1.9(c) for purposes of paying reduced fees under 35 USC §41(a) and (b) with regard to the invention by entitled:

*A TRAINING AND SAFETY DEVICE, SYSTEM AND
METHOD TO AID IN PROPER MOVEMENT
DURING PHYSICAL ACTIVITY*

described in:

- the specification filed herewith.
- Application Serial No. _____, filed on _____.
- Patent No. _____, issued on _____.

To the best of my knowledge, I have not assigned, granted, conveyed or licensed and am under not obligation under contract or law to assign, grant, convey or license, any rights in the invention to any person who could not be classified as: (1) an independent inventory under 37 CFR §1.9(c) if that person had made the invention, or (2) to any concern which would not qualify as a small business concern under 37 CFR 1.9(d) or (3) to a nonprofit organization under 37 CFR 1.9(e).

*

CERTIFICATE OF EXPRESS MAILING (37 C.F.R. § 1.10)

EM000794447US

Express Mail Label Number

I hereby certify that this paper (along with any paper referred to as being attached or enclosed) is being deposited with the United States Postal Service as Express Mail Post Office to Addressee on the date shown below in an envelope with sufficient postage for and with Express Mail label number shown above, and is addressed to: Box Patent Application, Commissioner of Patents and Trademarks, Washington, D.C. 20231.

Date: Nov. 21, 1997

MICHAEL CAYWOOD
Michael Caywood
Signature

E:\CORP\13326\59157\PTO\DEC_SES.WPD

A TRAINING AND SAFETY DEVICE, SYSTEM AND METHOD TO AID IN PROPER
MOVEMENT DURING PHYSICAL ACTIVITY

FIELD OF THE INVENTION

5 This invention relates to the field of electronic training and safety devices used to monitor human physical activity. More specifically, the invention detects, measures, records, and/or analyzes the time, date, and other data associated with movement of the device and produces meaningful feedback regarding the measured movement.

BACKGROUND

It has long been known that improper physical movement, especially when repeated, can result in injury to a person. This injury may manifest itself in a wide range of symptoms anywhere from sore or bruised muscles to chronic, debilitating loss of movement. In order to study and better understand safe human movement which does not result in injury, a variety of sensing, monitoring, and notification devices have been created. In general, these devices fall under the general category of range of motion (ROM) detectors.

Several such inventions have been patented to measure the range of motion of various joints of the human body for both medical studies and industry applications. Typically, these inventions require that two people simultaneously use the device: the patient/wearer and the operator of the device. The purpose of these devices is to quantitatively determine a range of motion of a human joint in angular degrees as exemplified by U.S. Patent Nos. 4,665,928; 5,042,505; and 5,373,858.

20 Although the devices disclosed in these patents serve the purposes for which they are intended, they do not warn the device wearer when the wearer is nearing, or has reached, a potentially dangerous angle of movement.

5
10
15
20

Another class of ROM devices has attempted to provide a warning to the wearer through an audible alarm or flashing light. Typically, these devices activate the alarm when a predetermined angle of flexion or extension has been exceeded in order to try and reduce the number of injuries that can occur as a result of the improper movement. Because of the general weakness of the human spine and back muscles, most of these devices are geared toward detecting improper torso movement while lifting an object. One such invention described in U.S. Patent No. 5,128,655 uses a mercury switch set at a predetermined angle to trigger a counting mechanism in order to count the number of times the predetermined angle is exceeded during forward bending. Another such device described in U.S. Patent No. 5,398,697 uses a "T" shaped collimated light beam to detect both forward and lateral bending of the spine. However, these devices are not convenient to operate and serve to merely report rather than analyze the information detected.

Training an individual to make proper movements requires more than just counting the number of times a predetermined angle is surpassed and warning the wearer of the incorrect movement. In order to prevent incorrect movement in hopes of reducing injuries, lost man hours, and workmen's compensation claims, a device must not only be able to record the frequency of improper movements, but also monitor the angular velocity and general tendencies of the wearer with regard to the unsafe movement habits. The angular velocity of any physical action affects the stretching and tautness of the muscle involved in the motion. Thus, information on angular velocity is important to monitoring and analyzing improper movement. Finally, the wearer must also be informed about the tendencies he has regarding his performance of a specific task. In particular, it is helpful to know whether improper movements occur more often in the morning or afternoon.

SUMMARY OF THE INVENTION

According to the present invention, the foregoing and other objects and advantages are attained by a system which may be used to monitor and train a wearer during physical movement. The system employs an electronic device which tracks and monitors an individual's motion through the use of a movement sensor capable of measuring data associated with the wearer's movement. The device also employs a user-programmable microprocessor which receives, interprets, stores and responds to the movement data based on customizable operation parameters, a clock connected to the microprocessor, memory for storing the movement and analysis data, a power source, a port for downloading the data from the device to other computation or storage devices contained within the system, and various input and output components. The downloadable, self-contained device can be worn at various positions along the torso or appendages being monitored depending on the specific physical task being performed. The device also monitors the speed of the movements made while the device is being worn. When a pre-programmed recordable event is recognized, the device records the time and date of the occurrence while providing feedback to the wearer via visual, audible and/or tactile warnings. Periodically, data from the device may be downloaded into an associated computer program which analyzes the data. The program can then format various reports to aid in recognizing and correcting trends in incorrect physical movement.

It is, therefore, an object of this invention to provide a user programmable training and safety device designed to observe and record the direction and frequency of physical movement of the wearer.

It is another object of this invention to provide a system which monitors, records and analyzes the time, date, angle of movement, and angular velocity of physical movement for subsequent interpretation.

It is still another object of this invention to monitor bi-directional movement of the torso about the spine during a lifting movement.

It is yet another object of this invention to detect and monitor a series of angles of movement and to visually and audibly warn the wearer as each angle limit is exceeded during physical movement.

It is yet another object of this invention to provide a device to assist in training an individual in proper posture while executing an identified physical activity.

To achieve these and other objects which will become readily apparent upon a reading of the attached disclosure and appended claims, an improved training and safety device is provided. Additional objects, advantages, and novel features of the invention will be set forth in part in the description which follows, and in part will become apparent to those skilled in the art upon examination of the following, or may be learned by practice of the invention. The objects and advantages of the invention may be realized and attained by means of the instrumentalities and combinations particularly pointed out in the appended claims.

BRIEF DESCRIPTION OF THE DRAWINGS

Fig. 1 is a plan view of the system of the present invention, including the movement measuring device, the download device, and the computer.

Fig. 2A is a plan view of a wearer showing a possible location for the movement measuring device in operation.

Fig. 2B is a plan view of a wearer showing another location for the device during operation.

Fig. 2C is a plan view of a wearer showing the location of an alternative embodiment of the device of the present invention.

Fig. 3 is a perspective view of another alternative embodiment of the self-contained movement measuring device of the present invention.

Fig. 4 is a block diagram of the movement measuring device of the present invention.

Fig. 5 is a flowchart of the steps performed by the microprocessor in operating the movement measuring device.

DETAILED DESCRIPTION OF THE PREFERRED EMBODIMENT

Reference is now made to Fig. 1 for a description of a preferred embodiment of the system 10 of the current invention. Fig. 1 shows the movement measuring device 12 positioned above a download device 14 connected to a computer 16. The movement measuring device 12 is designed to be physically attached to a user whose movements are to be monitored by the system 10. The self-contained movement measuring device 12 may be worn by the individual being monitored in a variety of positions based on the specific movement being observed, the particular application in which the device is used, and the convenience of the wearer.

For example, Fig. 2A shows placement of the movement measuring device 12 on the upper torso of an individual 18. Placement of the device 12 at this location will allow monitoring of the flexion and extension of the spinal column during a lifting activity. Similarly, Fig. 2B shows placement of the movement measuring device 12 on the waist or hip of an individual 18. The movement measuring device 12 may be attached via a clip, Velcro, its own belt, or any other means known in the art. Placement of the device 12 on the belt as shown will also permit monitoring of the individual's movement during physical activity. In particular, the device 12 can monitor the forward and backward bending of the spine as well as lateral bending of the spine to aid in correct bending and lifting tasks. The device 12 is also capable of measuring the distance the wearer walks and how fast he walked. Fig. 2C shows another alternative embodiment of the movement measuring

device 12. In this version, the movement sensor 13 is separate from the remaining components 15 of the device 12 and is electronically connected to the remaining components 15 via a cable 17 or other commonly used connector. Separating the measurement sensor 13 from the remaining components 15 in this way gives additional flexibility in the use of the device 12. The device 12 operates in the same manner as previously described; however, the movement sensor 13 can be placed anywhere on the individual's body. Again, the specific application will dictate where the movement sensor 13 should be placed. For example, if a monitored activity requires repeated arm movement, the sensor 13 may be placed anywhere along the individual's arm thereby monitoring and recording movement data for the arm.

Fig. 3 shows a more detailed view of the movement measurement device 12 which forms a crucial part of the previously described system along with its respective external components. The internal components of the movement measurement device 12 are housed in a casing 20. This casing 20 serves to protect the internal components and is most commonly made of hard molded plastic, although any suitable material may be substituted. Externally visible on the device 12 is at least one visual indicator 22 which is activated by the device 12 when appropriate. In one preferred embodiment, the visual indicator 22 is a bi-colored light emitting diode (LED) which is activated to notify the wearer when a predetermined angle of motion has been exceeded. Through different colors and blinking patterns, the visual indicator 22 signals many different conditions sensed by the device 12 including when the device 12 is turned on or off, when each of various angle limits is exceeded, and when downloading movement data recorded by the device 12. Alternatively, the visual indicator 22 may be a liquid crystal display or any other display device on which a variety of movement information may be shown. The movement measuring device 12 also contains user inputs 24. In the preferred embodiment, one user input 24 is an ON/OFF switch for controlling the operation of the device 12. Another user input 24 on the device 12 is a MUTE button which permits

the wearer of the device to turn off any audible indicators. Typically, once an angle limit has been exceeded, the wearer will be notified through the illumination of a visual indicator, the sounding of an audible alarm, vibration of the device 12, or a combination thereof. In the case of an audible alarm, the MUTE button 24 may be used to turn off the alarm. Any sounds emitted by the device 12 are created by a speaker (not shown) behind the speaker cover 26 located in the external casing 20. Finally, the casing 20 contains a removable battery cover 28 over an externally accessible battery compartment (not shown) which allows the operator of the device 12 to replace the internal power source. In the preferred embodiment this power source is a 1.5 volt battery.

Reference is now made to a block diagram in Fig. 4 which shows the major internal components of the movement measuring device 12 and their interconnections. The device 12 includes a movement sensor 30 which detects movement and measures associated data such as angle, speed, and distance. The movement sensor 30 generates signals corresponding to the measurement data collected. In a preferred embodiment, the movement sensor 30 is an accelerometer which is capable of detecting angles of movement in multiple planes as well as the velocity at which the movement occurs. Alternatively, multiple accelerometers, each capable of measuring angles of movement in only one plane, may be oriented within the device 12 so that movement in multiple planes may be detected. Although many accelerometers are available on the market, the preferred embodiment uses Part No. AD22217 manufactured by Analog Devices of Norwood, Massachusetts. This component is a low G, multi-axis accelerometer. The movement sensor 30 is electronically connected to a microprocessor 32 which receives the signals generated by the movement sensor 30 for analysis and subsequent processing. The microprocessor 32 not only analyzes and responds to the movement data signals from the sensor 30, but also controls the actions of all of the electronic components of the device 12. In a preferred embodiment, the microprocessor 32 is a Motorola MC68HC705C8AFN. It should be noted, however, that other low power, programmable

microprocessors may be suitable. The microprocessor 32 constantly monitors the user inputs 34 and acts accordingly. For example, if the device is turned off, the microprocessor 32 monitors the ON/OFF user input 36 to detect when the device 12 is turned back on. Once an "ON" condition is detected, the microprocessor 32 powers up and runs its internal program. The internal program may be stored within read-only memory located in the microprocessor itself or in memory (not shown) located outside the microprocessor 32.

The components of the device 12 receive power from a power source 38. In a preferred embodiment the power source 38 is a 1.5 volt DC battery; however, other power sources, including alternating current, may be used. The power source 38 is connected to a power converter 40 if DC-DC or AC-DC conversion is required. In one embodiment the power converter 40 converts the 1.5 volt DC power supply from the battery to 3.3 volts DC for use with the other electronic components of the device 12.

Also connected between the power source 38 and the microprocessor 32 is a conventional power supply manager 42 such as part number ADM706TAR from Analog Devices. The power supply manager 42 performs several functions. If a low battery condition exists, the power supply manager 42 reports the problem to the microprocessor 32 so that the microprocessor 32 may indicate the condition to the user through one or more output indicators 44. The output indicators 44 consist of any combination of audible, visual, or tactile indicators for communicating with the wearer of the device. Audible indicators range from a single pitched tone to voice-synthesized messages in English or any foreign language. Visual indicators which could be used include single, monochromatic LEDs, multiple colored lights, and/or liquid crystal displays. The tactile indicator used in a preferred embodiment is a conventional vibrator mechanism which can be detected by the wearer. The power supply manager 42 also regulates the activity of the power converter 40 to insure that the proper voltage is constantly supplied to the device components.

The microprocessor 32 is connected to a clock 46 which is used as an internal clock for coordinating the functioning of the microprocessor 32. The clock 46 also serves as a real time clock to provide date and time information to the microprocessor 32. The clock 46 may have its own clock battery 48 or may receive power directly from power source 38.

5 The microprocessor 32 constantly monitors the movement data received from the movement sensor 30. The microprocessor 32 analyzes the movement data received from the sensor 30 and, based on its internal programming, responds to the data. If a recordable event occurs, the microprocessor 32 retrieves the date/time stamp from the clock 46 and records the event information along with the date/time stamp in memory 50. In a preferred embodiment, the memory is electrically erasable programmable read-only memory (EEPROM) so that, in the event the device should lose power, the information recorded in memory 50 will not be lost. The device also contains an input/output (I/O) port 52 which is connected to the microprocessor 32. The I/O port 52 is used to receive and transmit data collected by the device 12 between the microprocessor 32 and an external computer (not shown). In a preferred embodiment, the I/O port 52 is a serial port which includes an RS232 voltage level converter download board. Movement data stored in memory 50 can be sent through the I/O port 52 to a download device. In addition, user-programmable configuration information can be entered by a user via the external computer and uploaded through the I/O port 52 for use by microprocessor 32. The configuration information can encompass an array of information including, but not limited to, a series of notice levels corresponding to increasing angles of movement, an event threshold, a reset range for tilt determination, and a time period for entering idle mode. Once the device 12 is operating, the microprocessor 32 constantly checks to see if the angle movement information received from the movement sensor 30 indicates that the wearer has exceeded any of the pre-set notice levels. Depending on which notice level has been exceeded, the microprocessor 32 will cause the device 12 to react; i.e., by sounding an alarm. In addition, the

microprocessor 32 will obtain the date/time stamp from the clock 46 and store that information along with the notice level that was exceeded into memory 50 for later analysis and reporting. Whenever an alarm is activated by the microprocessor 32, the MUTE control switch 54 may be used to deactivate the alarm; however, the corresponding movement data associated with the activation of the alarm is still recorded in memory 50. Furthermore, the date and time the MUTE control switch 54 was activated is also recorded by the device 12.

A significant feature of the device 12 of the present invention is that it gives instant information to the wearer at the moment of incorrect movement and also records the information for future reference and analysis. The device 12 monitors a wide variety of "events" and records each event with a date/time stamp. Many different types of "events" may be defined to be monitored by the device 12. As previously stated, any movement which surpasses any identified angle limit of movement (based on the specific physical task being accomplished and the range of motion needed to execute the task properly) is a standard recordable event. In addition, the device will record when no discernable movement has occurred for a predetermined amount of time (idle function), when the wearer has pressed the MUTE switch in response to an alarm (MUTE function), when the wearer's speed of movement exceeds a predefined speed (quickness function), when the device is turned on or off, when a low battery warning has been issued, when the battery is changed, when the device has been tampered with (such as removing the battery before a low battery condition has been detected), when the device is tilted outside of a specified range for a designated period of time, and when the device has measured a predetermined maximum number of particular angle limits reached. These functions are further described hereinbelow.

Whenever an incorrect user movement is sensed by the device 12, the angular limit notice as programmed by the user is given only once. Before the device 12 can reset itself to be able to give that same angle notice on the next incorrect movement, the device 12 must return to a predetermined

5

position (usually the upright position). If the device 12 is maintained outside of its predefined reset range for a designated period of time after an angle limit has been exceeded, a “tilt” event will be recorded and an alarm may be activated. When this situation occurs, the device 12 must be returned to its defined reset position, or the MUTE button must be pressed. The device 12 is also programmed to automatically enter a power saving mode when no motion has been detected for a given amount of time. This “idle” function event is recorded by the microprocessor 32 to indicate that the device is either not being worn or is not being used properly. The device 12 maintains the minimum amount of operating power required to detect the next movement so that, once movement is detected, the device 12 exits the idle mode and records the date and time when the exit occurred.

10

The device 12 will record any attempted tampering. In a preferred embodiment, this event occurs when the battery is removed before a low battery condition is detected by the device. The device 12 will also inform the wearer when the battery is low. In the preferred embodiment, the device 12 has two batteries, a battery which operates the device 12 and an internal time clock battery. The internal clock battery powers the time clock 46 and aids in other operations of the device 12 when the voltage drops on the device battery. The microprocessor 32 and memory 50 do not lose information when battery power is lost from either battery.

15

20

As previously mentioned, the device 12 is completely user programmable via an external computer. These user programmed operation parameters are uploaded to the microprocessor 32 through the download device (not shown). The user may program the microprocessor 32 with an array of functions for the device 12 to perform. Primary among these is the ability to change the angular levels at which notices will be generated in order to fulfill particular application needs. In this way, the user may choose the angular positions at which he wants to be warned when they are exceeded. In the preferred device, up to three angle limits may be monitored by the device; however, any number of angles may be tracked depending upon the application. Each angle limit can be

degree specific or extend over a range of degrees. When a range is used, the user specifies the starting and incremental values in degrees. Thus, an angle limit may be set to occur every five degrees beginning with an initial angle limit value. The movement sensor 30 used in the preferred embodiment can measure angles to within plus or minus 0.5° and as often as 1000 times a second.

5 The most common use for the angle range limits is when the device 12 is worn on the hip since angle measurements cannot be made as accurately there. In contrast, when the device 12 is worn on the upper torso, results can be measured more accurately and the device 12 can be set to measure each degree of movement.

As mentioned above, once a wearer of the device 12 exceeds the first defined angle limit, a notice for that limit is given to the wearer. The notice may be a combination of a visual warning, a tactile warning, and/or an audible warning. The microprocessor 32 also stores the specific angle limit which was exceeded along with the date/time stamp. Upon exceeding the second defined angle, the wearer is issued a second notice which may be the same as or different from the first notice. These different notice characteristics may include a change in pitch for audible alarms, a difference in duration for tactile alarms, and/or a blinking, different colored, or other visual warning.

The “quickness” function of the device 12 measures the speed of an associated physical movement made by the wearer and was developed to address the following problem. In essence, the warning notice due to exceeding a first angle may be overridden by the warning notice for a second angle, thus appearing to give only the second notice. The device 12 may be programmed to recognize when this occurs and to indicate that the associated physical activity was performed by the wearer with excessive speed. If so programmed, the device 12 will record both notices, and the microprocessor 32 will record a quickness violation for further analysis and reporting by the computer. The device 12 may also include an event threshold function in its programming. This feature allows the user of the device 12 who has access to the download capabilities and the analysis

software hereinafter described to determine a maximum number of incorrect movements (“events”) allowed in a predetermined time period by event type. In addition, the user may program a certain response, such as shutting down the device 12 entirely, emitting a special alarm, and/or recording the date and time each event threshold was met. In a preferred embodiment, if the device 12 is programmed for shut down upon reaching the event threshold, the device 12 will require downloading to the computer 16 and being reset before it can be operated again. This feature serves to alert the responsible party of a potential problem that must be dealt with immediately via retraining or any other means the responsible party deems necessary.

The device 12 also has additional functions and capabilities. Each unit can be assigned to a specific individual, patient or employee and later reassigned to a different person through the use of specific identification numbers. In a preferred embodiment, the device 12 requires a download of all movement data stored in memory under a previous identification number before it can be reassigned. Further, the download information along with the specific user identification number can be downloaded to the computer 16 only once in order to avoid duplicate records.

As generally described above, the system and device 12 of the present invention have practical application in a number of situations. They may be used in medical applications requiring the monitoring of physical movement. Among such applications is physical therapy which may be conducted either by the patient in the patient’s home or by medical professionals in a medical environment. More significantly, the device and system have application in an industrial setting, particularly manufacturing, where workers are required to perform repetitive manual tasks. Supervising employers can use the device and system to insure that employees are performing their tasks properly while minimizing the risk of employee injury.

By virtue of the sophisticated nature of the microprocessor 32, the device 12 can fulfill these additional business, industry and medical needs. Furthermore, wireless capabilities may be added

to the device 12 to allow downloading of information from the device 12 to a computer 16 without the need for cables or docking stations. In yet another embodiment, the radio frequency capability may allow the user to wear minimal hardware (consisting primarily of the movement sensor) on the body while transmitting the details of each physical movement to a remote microprocessor 32 for analysis and storage.

Once the data from the device 12 has been downloaded to the computer 16, software running on the computer 16 is used to interpret the data and produce a number of reports and histories. This history information may include, but is not limited to, the dates and times when the device 12 was turned on and off; the number, with dates and times, of each notice given along with the type of notice; the number, date and time the device 12 reached an event threshold; when, how long, and how many times the device 12 powered down; the date and time the device 12 was muted; the date and time when the battery was changed; the date and time when the battery was tampered with; and the last time the device 12 was downloaded. Any of the above-mentioned predefined reports may be generated; in addition, the user may program additional reports and histories specific to the application to be monitored.

Fig. 5 is a flowchart of the steps executed by the microprocessor 32 in the movement measurement device 12 to recognize and record movement data. Referring to Fig. 5, when the device 12 is off, the microprocessor 32 constantly checks for a change in the ON/OFF state 60 by polling the ON/OFF switch to see if it has been switched to the ON position. Once the microprocessor 32 detects that the device 12 has been turned on, the microprocessor 32 conducts some basic initialization and housekeeping functions 62. This may include checking memory to ensure angle limits have been entered, verifying that angle limits are increasing in value (i.e., the second angle limit is not smaller than the first), and initializing internal program parameters. Then the microprocessor 32 checks to see whether any motion has been detected 64 by the movement

009768-15

5 sensor 30. If no motion has been detected, the microprocessor 32 will increment a “no-motion” counter 66. The microprocessor 32 then checks whether the no-motion counter has reached a predefined number of cycles indicating that the device should power down. If the requisite number of cycles indicating idle mode have elapsed, the microprocessor records the idle event (along with the date and time stamp) in memory, and the device enters the idle mode 72. Once in idle mode, the microprocessor repeatedly checks for motion 72. As long as no motion occurs, the device remains in idle mode. Once motion is detected, the microprocessor records an event that the device has exited idle mode (with the corresponding date and time) 76. The microprocessor then returns to step 64 where it again attempts to detect motion. If the no-motion counter has not reached the preset limit corresponding to idle mode, the microprocessor will check to see whether the device has remained outside of its predefined reset range for a designated amount of time 78. If not, the microprocessor reexecutes the cycle for detecting motion 64. If, however, the microprocessor recognizes a tilt event, an alarm corresponding to a tilt event is activated 80. Once the microprocessor has recognized a tilt event, it repeatedly checks whether the device has been moved back within its reset range 82. If it has not, the microprocessor continues to activate the tilt alarm. Once the device has been returned to within its reset range, the microprocessor checks again for motion 64.

20 Once the microprocessor detects motion in step 64, the first thing it does is clear the no-motion counter 84. The microprocessor then checks to see whether it has recorded a “proper movement” in the past 86. If no proper movement has occurred, the microprocessor checks whether the proper movement flag has been set 88. If the proper movement flag has not been set, the microprocessor returns to its initial motion checking step 64. If, however, the proper movement flag has been set, the microprocessor will record the occurrence of a proper movement event along with the date/time stamp 90. The microprocessor then clears all notice and the proper movement flags in step 92 and returns to the motion detection step 64. If, on the other hand, the microprocessor has

detected a prior proper movement 86, it so indicates by setting the proper movement 94. The microprocessor then checks whether the first angle limit has been exceeded 96. If this first limit has not yet been exceeded, the microprocessor returns to the motion detection step 64. If the first angle limit has been exceeded, the microprocessor activates the appropriate alarm and records the event along with the date and time 98. The microprocessor then clears the proper movement flag and sets the first angle notice flag 100. The microprocessor then checks whether the device has moved beyond the next angle limit 102. If not, the microprocessor checks whether the angle is less than that required to constitute a proper movement 104. If not, then the microprocessor continues to check whether the angle of movement is less than a proper movement angle. If the angle is less than that constituting a proper movement, the microprocessor triggers a reset flag indicating that the device has been reset 106. After reset, the microprocessor checks whether any of the angle limits have been exceeded thereby setting any of the notice flags 108. If any notice flags have been set, the microprocessor will perform step 92 to clear all of the notice flags and reset the proper movement flag. If none of the notice flags have been set before the device was reset, the microprocessor will perform step 90 to record a proper movement event along with the date and time. It then continues processing at step 92.

Once the angle of movement detected exceeds the next angle limit, the microprocessor will record the corresponding notice event along with the date and time and activate the appropriate notice alarm in step 110. The microprocessor then checks if the last movement was exceeded the final angle limit at step 112. If not, then the process returns to step 102 to check for movement beyond the next angle limit. If the final notice event was detected, then the microprocessor will increment the event threshold counter by one at step 114 if this option has been selected by the user. Next, the microprocessor will check to see whether the event threshold limit has been reached 116. If not, the microprocessor will perform step 104 until the device is reset due to the movement angle

being less than that required for a proper movement. If the event threshold has been reached, then the microprocessor will record the event threshold, activate the associated alarm, and shut down the device 118. The microprocessor will prevent the device from operating any further until its information has been downloaded 120. Once the stored data has been downloaded, the microprocessor returns to its initial motion detection step 64 for further operation.

As previously alluded to herein, the device and system of the present invention can be used in a wide number of different applications requiring monitoring and feedback of physical movement. In particular, the device and system have various medical applications including rehabilitation and physical therapy associated with an injured patient. The movement sensor is simply attached to the appropriate body part requiring monitoring, and data collection is then commenced. Besides providing the operator with instant feedback regarding the physical movement being monitored, a variety of data may be collected from the number of movement repetitions meeting or exceeding a required range to the determination and tracking of maximum range-of-motion mobility of an injured patient for later analysis. While the device and system may be operated by a medical professional in a supervisory capacity, both are simple enough to be used by an individual patient alone with download and analysis by the medical professional at a later time.

The device also has excellent application to the monitoring and analysis of physical labor performed by employees. The devices may be passed out to employees having repetitive physical tasks so that proper safety in performing the tasks, such as lifting, may be practiced. Each device can be assigned to a particular individual for a specified amount of time and programmed to monitor that individual's physical tasks. After the device is turned in, its collected information can be downloaded to the system for reporting and analysis purposes based on specific movement limits and other operational parameters programmed into the device for the particular movement being monitored. Improper movements made by the individual during the time period in question are

identified, and the employee can be notified in order to make necessary corrections to the way the task is performed in order to avoid injury resulting from improper movement. The device can be used again later to ensure that the employee continues to exercise the movement guidelines as previously instructed.

5 The device also has application in the area of sports. For example, it may be worn by a golfer in order to monitor torso, waist, shoulder and arm movement during various drives and putts. The data collected by the device may then be used as a tool to aid in the analysis and improvement of the individual's stroke technique. Use of the device is not limited to golf but may be used for any number of sports, including football, baseball, basketball, or tennis. And, due to the unique
10 programmability of the device, it has more than one application within any single sport. For example, in baseball, the device and system may be used to improve technique associated with hitting or with throwing.

 Still other objects and advantages of the present invention will become readily apparent to those skilled in this art from the detailed description, wherein multiple preferred embodiments of the invention are shown and described, simply by way of illustration of the best mode contemplated by the inventor for carrying out the invention. As will be realized, the invention is capable of other and different embodiments, and its several details are capable of modifications in various obvious respects, all without departing from the invention. Accordingly, the drawings and description are to be regarded as illustrative in nature, and not as restrictive. Variations in the description likely to
15 be conceived of by those skilled in the art still fall within the breadth and scope of the disclosure of the present invention. The primary import of the present invention lies in its compact size, ease of use, and detailed information gathering and reporting features. Its benefits derive from the versatility of its monitoring capabilities as well as the specific applications for which it may be used. Again,
20

it is understood that other applications of the present invention will be apparent to those skilled in the art upon reading the preferred embodiments and consideration of the appended claims.

SECRET

We claim:

1. A device for detecting movement of body parts during physical activity, said device comprising:

a movement sensor capable of measuring data associated with movement of said device and

5 generating signals indicative of said movement;

a power source;

a microprocessor connected to said movement sensor and to said power source, said
microprocessor capable of receiving, interpreting, storing and responding to said
movement data based on user-defined operational parameters;

10 at least one user input connected to said microprocessor for controlling the operation of said
device;

a real-time clock connected to said microprocessor;

memory for storing said movement data; and

an output indicator connected to said microprocessor for signaling the occurrence of user-
defined events.

15 2. The device of claim 1 further comprising at least one port connected to said microprocessor
for downloading said data and uploading said operational parameters to and from a computer.

3. The device of claim 1 wherein said movement sensor can detect the velocity of said
movement.

20 4. The device of claim 1 wherein said movement sensor comprises at least one accelerometer.

SECRET 10

5. The device of claim 1 wherein said movement sensor can simultaneously detect movement along at least two orthogonal axes.

6. The device of claim 1 wherein said movement sensor is housed separately from said microprocessor.

5 7. The device of claim 1 further comprising a power supply manager connected between said power source and said microprocessor.

8. The device of claim 7 further comprising a power converter connected to said power source and said power supply manager.

9. The device of claim 1 wherein said data measured by said movement sensor include angle, distance and speed of said movement.

10. The device of claim 1 wherein said output indicator is visual.

11. The device of claim 1 wherein said output indicator is audible.

12. The device of claim 1 wherein said output indicator is tactile.

13. The device of claim 1 wherein said user input is a switch.

10
SUBJECT MATTER

14. A system to aid in training and safety during physical activity, said system comprising a movement measuring device, said movement measuring device further comprising
- a movement sensor capable of measuring data associated with movement of said device and generating signals indicative of said movement;
 - 5 a power source;
 - a microprocessor connected to said power source, said microprocessor capable of receiving, interpreting, storing and responding to said movement data based on user-defined operational parameters;
 - at least one user input connected to said microprocessor for controlling the operation of said device;
 - 10 a real-time clock connected to said microprocessor;
 - memory for storing said movement data;
 - at least one port connected to said microprocessor for downloading said data and uploading said operational parameters; and
 - 15 an output indicator connected to said microprocessor;
 - a computer running a program capable of interpreting and reporting said movement data based on said operational parameters; and
 - 20 a download device electronically connected to said movement measuring device and said computer for transmitting said movement data and operational parameters between said movement measuring device and said computer for analysis, reporting and operation purposes.

15. The system of claim 14 wherein said computer is a standalone personal computer.

16. The system of claim 14 wherein said computer is connected to a network of other computers.

17. The system of claim 14 wherein said download device is a physical docking station.

18. The system of claim 14 wherein said download device is a wireless device.

19. The system of claim 18 wherein said wireless device uses radio frequency.

5 20. The system of claim 18 wherein said wireless device uses infrared light.

21. A method to monitor physical movement of a body part comprising the steps of:
attaching a movement measuring device to said body part;
measuring data associated with said physical movement;
interpreting said physical movement data based on user-defined operational parameters and
a real-time clock; and
storing said data in memory.

22. The method of claim 21 wherein said physical movement data includes velocity data of said movement, angle measurement data taken along at least two orthogonal axes, and related date and time data.

15 23. The method of claim 22 further comprising the step of defining said parameters for a specific physical movement prior to said interpreting step.

24. The method of claim 22 further comprising the step of downloading said data from said movement measuring device to a computer for reporting and analysis purposes.

25. The method of claim 22 wherein said interpreting step comprises teaching an individual how to properly perform said physical movement.

5 26. The method of claim 21 wherein said movement measuring device is an accelerometer.

27. The method of claim 21 further comprising the step of providing instant feedback regarding said movement.

28. The method of claim 27 wherein said physical movement is physical labor.

29. The method of claim 27 wherein said physical movement is an exercise related to medical treatment.

30. The method of claim 27 wherein said physical movement is an exercise to improve technique related to an athletic skill.

E:\CORP\13326\59157\PTO\PATENT.APP

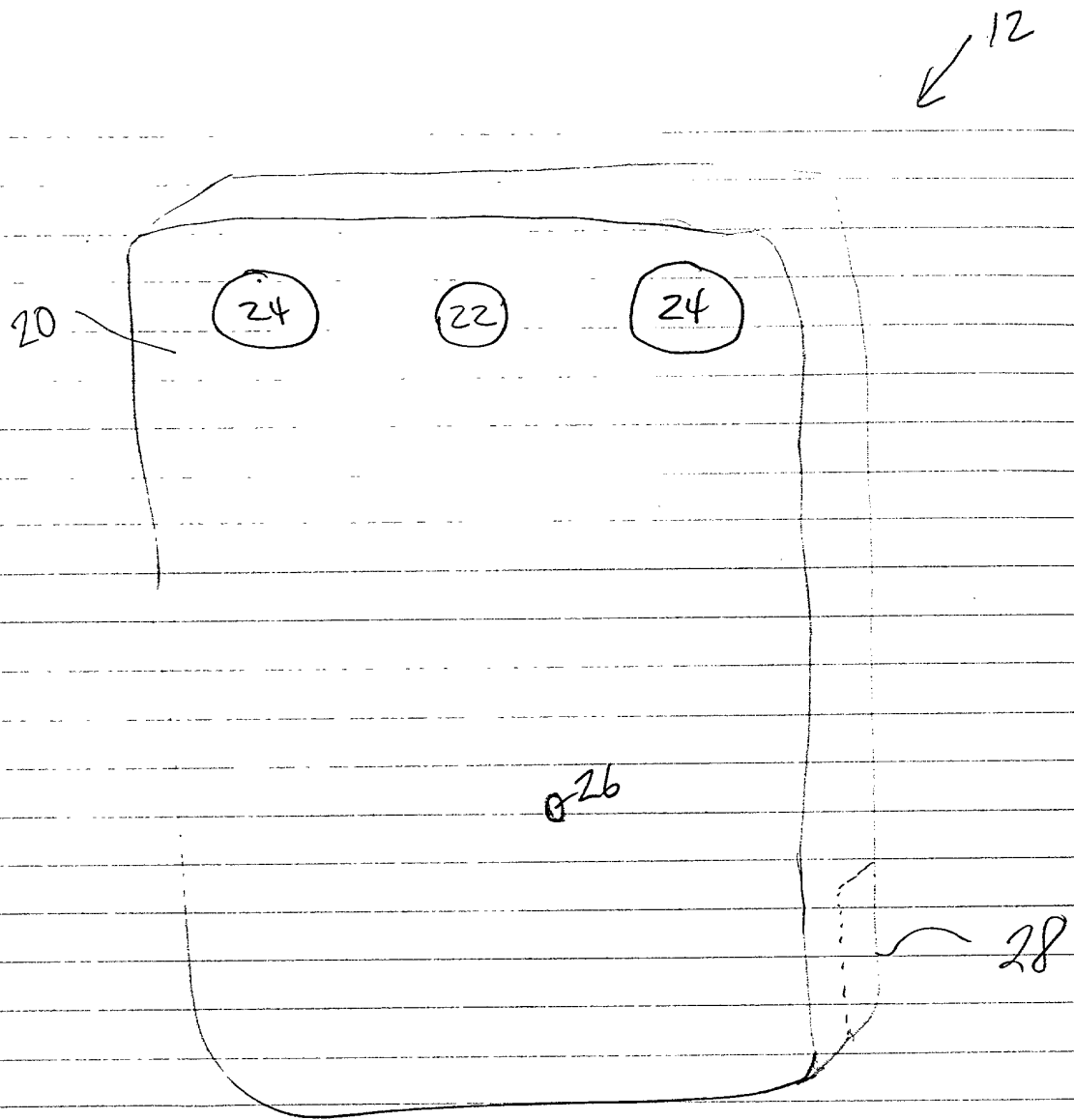

FIG. 3

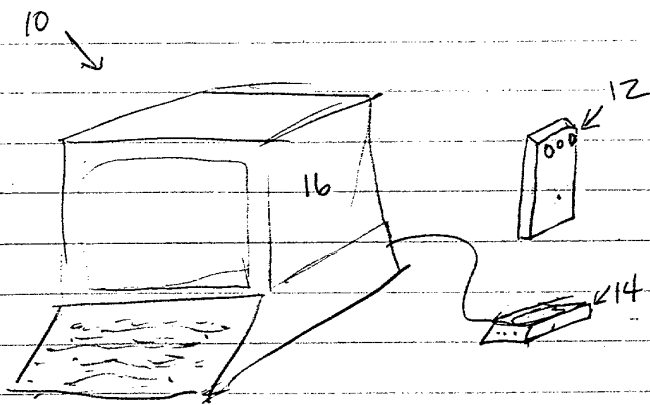

FIG. 1

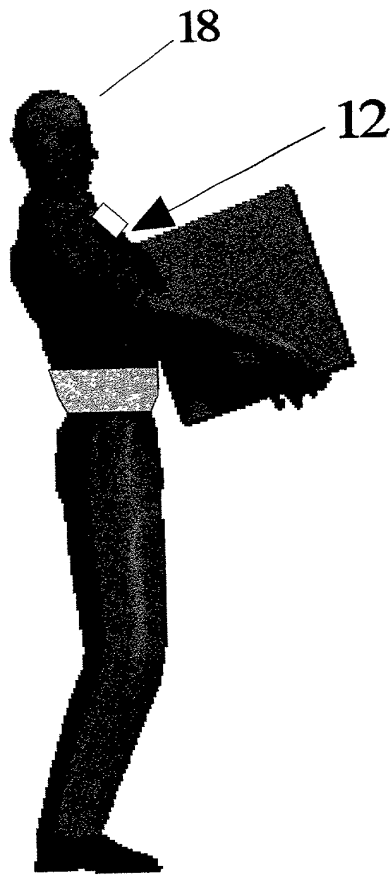

FIG. 2A

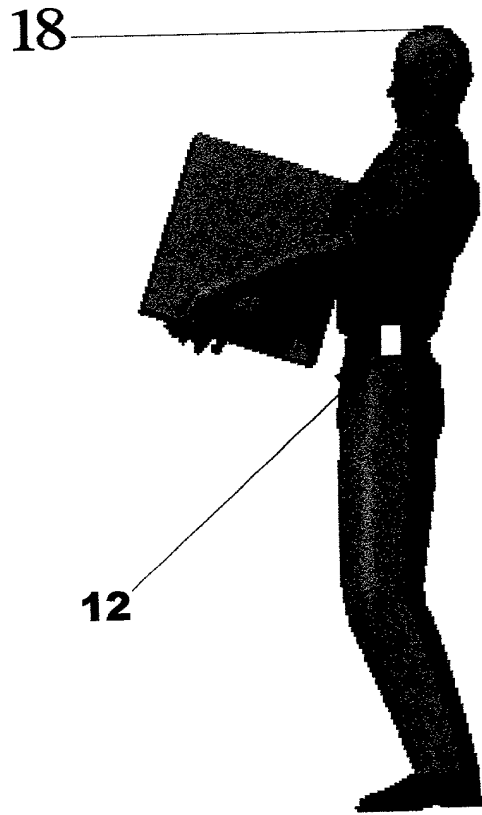

FIG. 2B

4677-3294680

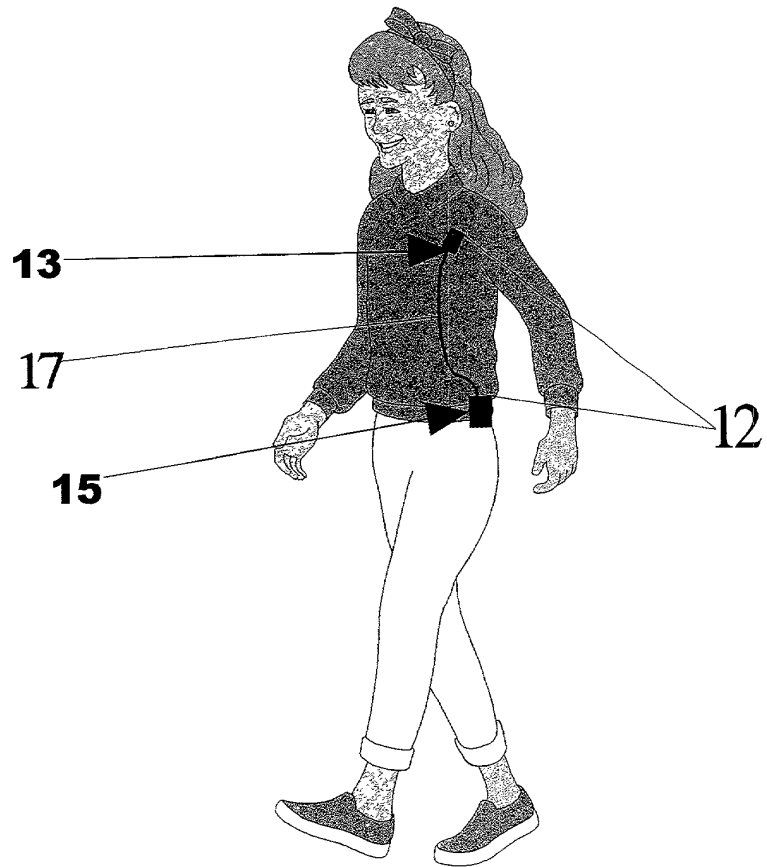

FIG. 2C

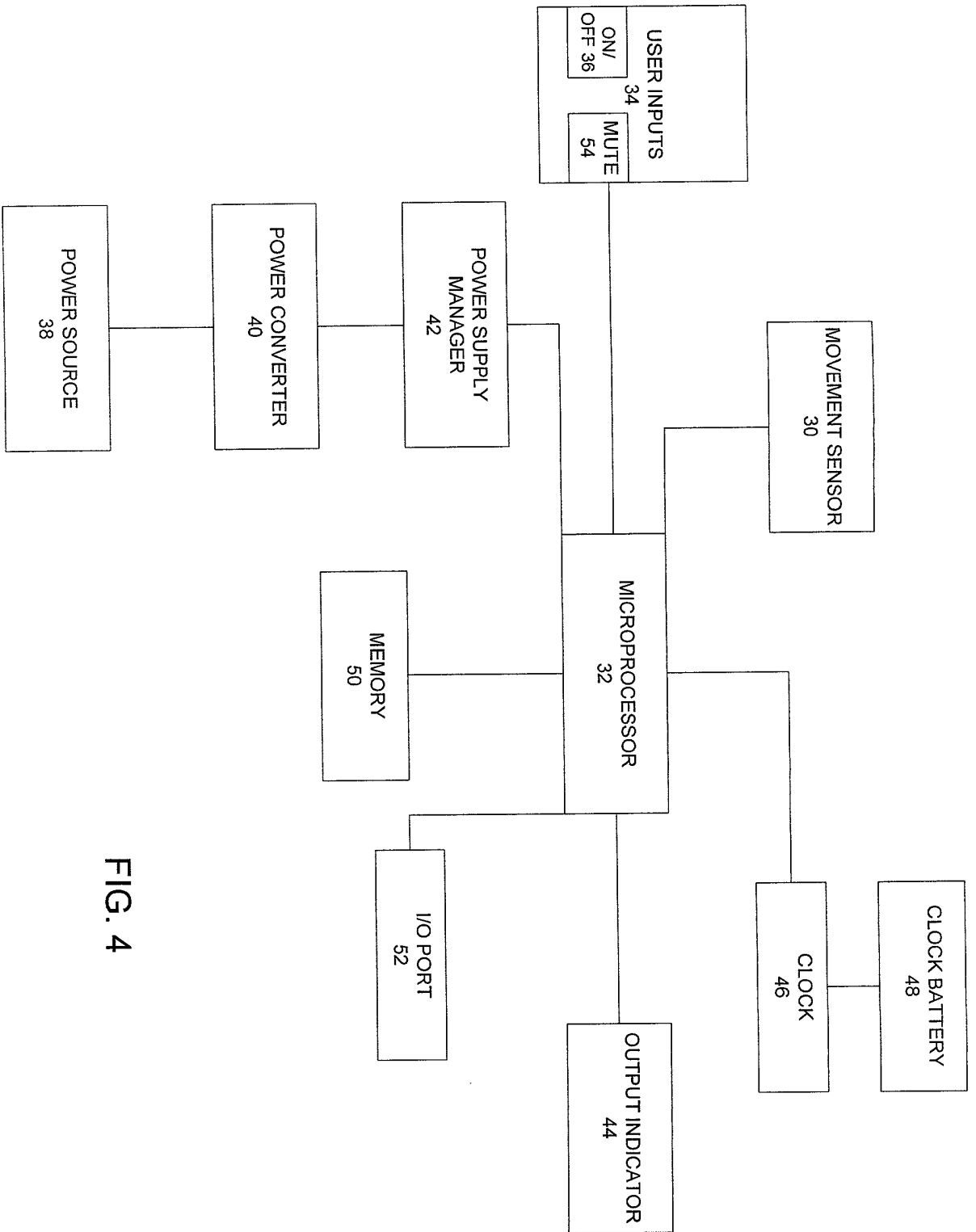

FIG. 4

08976223 . 4.4.97

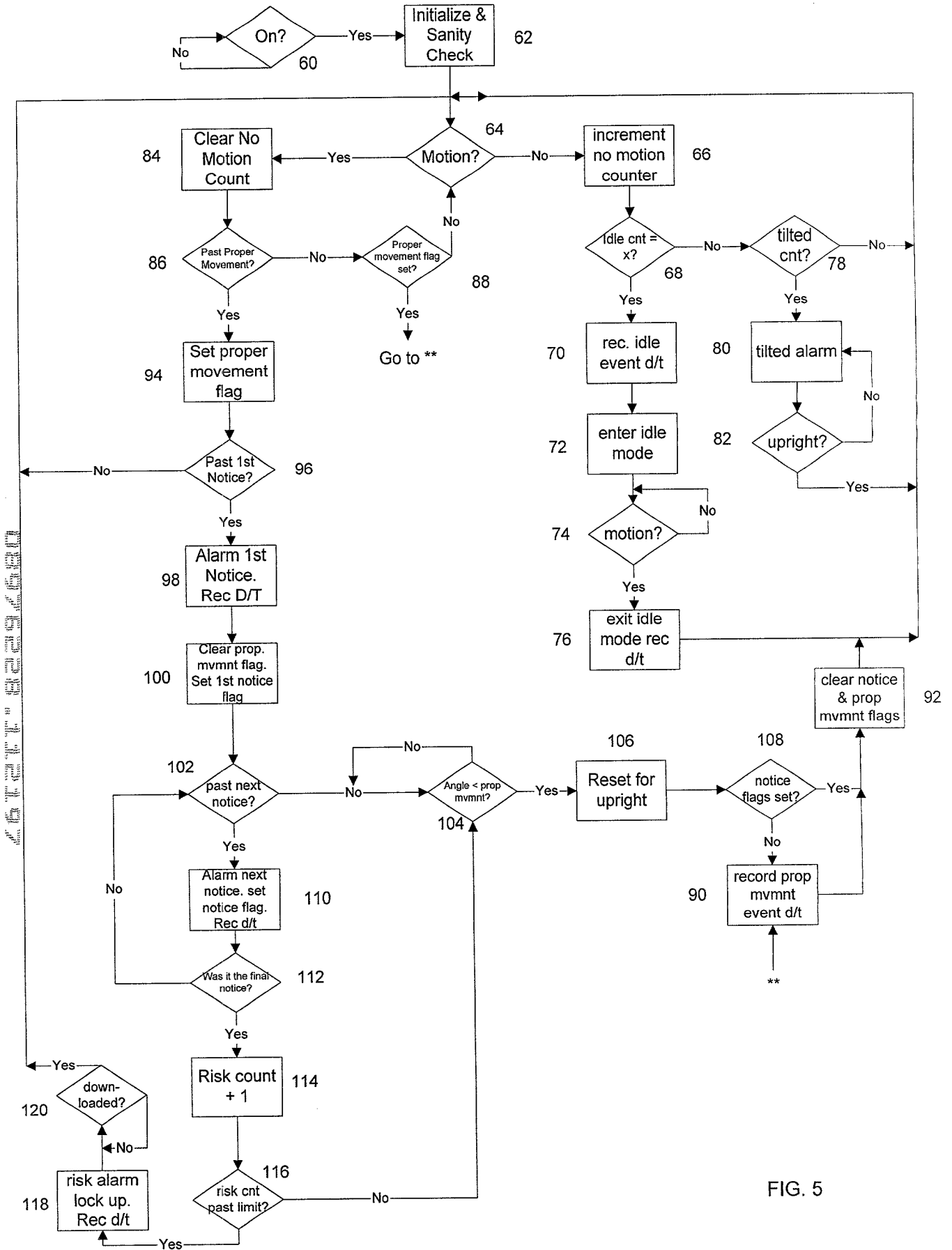

FIG. 5

A

PATENT

IN THE UNITED STATES PATENT AND TRADEMARK OFFICE

JCS46 U.S. PTO
11/21/97

IN RE:	Theodore L. Brann	§	GROUP NO.:	Unknown
SERIAL NO.:	Unknown	§	EXAMINER:	Unknown
FILED:	Herewith	§	ATTY DKT:	13326/59157
FOR:	A TRAINING AND SAFETY DEVICE, SYSTEM AND METHOD TO AID IN PROPER MOVEMENT DURING PHYSICAL ACTIVITY	§		

65705 U.S. PTO
08/976228
11/21/97

BOX PATENT APPLICATION
THE COMMISSIONER OF PATENTS AND TRADEMARKS*
WASHINGTON, D.C. 20231

NEW APPLICATION COVER SHEET

Transmitted herewith for filing is a patent application entitled:

Title

A TRAINING AND SAFETY DEVICE, SYSTEM AND
METHOD TO AID IN PROPER MOVEMENT
DURING PHYSICAL ACTIVITY

Inventor is:

Name: Theodore L. Brann
 Residence: P.O. Box 1897
 Mission, Texas 78572
 Citizenship: U.S.A.

08976228 11/21/97

*

CERTIFICATE OF EXPRESS MAILING (37 CFR § 1.10)

EM000794447US

I hereby certify that this paper (along with any paper referred to as being attached or enclosed) is being deposited with the United States Postal Service as Express Mail Post Office to Addressee on the date shown below in an envelope with sufficient postage for and with Express Mail label number shown above, and is addressed to: Box Patent Application, Commissioner of Patents and Trademarks, Washington, D.C. 20231.

Date: Nov. 21, 1997

MICHAEL CAYWOOD

Michael Caywood
Signature

Type of Application:

This new application is a(n):

- Original
- Design
- Plant
- Divisional
- Continuation
- Continuation-in-Part (CIP)

Papers Enclosed That Are Required for Filing Date under 37 C.F.R. 1.53(b) (Regular) or 37 C.F.R. 1.153 (Design) Application

- 19 Pages of specification
- 5 Pages of claims
- 1 Pages of Abstract
- 6 Sheets of drawing
 - formal
 - informal

Additional papers enclosed

- Preliminary Amendment
- Information Disclosure Statement (37 C.F.R. 1.98)
- Form PTO-1449 (PTO/SB/08A and 08B)
- Citations
- Declaration of Biological Deposit
- Submission of "Sequence Listing," computer readable copy and/or amendment pertaining thereto for biotechnology invention containing nucleotide and/or amino acid sequence.
- Authorization of Attorney(s) to Accept and Follow Instructions from Representative
- Special Comments
- Other

Declaration of Inventorship

- Enclosed.
- Legal Representative/Refusal Petition/International Application Exception (see attached documents).

Benefit of Prior Application

- This new application claims the benefit of prior U. S. applications identified in the Related Applications section of the attached application Disclosure.
- A redlined copy of the application is enclosed to show changes to the prior application. In addition, the following new changes have been made to the drawings: new drawing Fig. _____ has been added.

Small Entity Statement(s) [if any]

- Verified Statement(s) that this is a filing by a small entity under 37 CFR 1.9 and 1.27 is(are):
 - filed herewith.
 - will follow.

Fee Calculation (37 CFR 1.16)

- Regular application

20250923 11:21:29

CLAIMS AS FILED

	Number Filed		Max	Above Max		Above Max Fee		
Basic Fee 37 CFR §1.16(a)								\$ 790.00
Total Claims 37 CFR §1.16 ^o	30	-	20	10	x	\$ 22.00	=	\$220.00
Independent Claims 37 CFR §1.16(b)	3	-	3	0	x	\$ 82.00	=	\$0.00
Multiple Dependant Claims 37 CFR §1.16(d)				0	x	\$270.00	=	\$0.00

Filing Fee Total \$ 1010.00

After Small Entity Discount of 50% \$ 505.00

Total Fee Calculation

- Enclosed
 - filing fee \$ _____
 - extension fee \$ _____
 - incomplete filing surcharge (37 C.F.R. 1.16(e)) \$ _____
 - petition fee for filing by other than all the inventors or person on behalf of the inventor where inventor refused to sign or cannot be reached. (37 CFR 1.47 and 1.17(h)) \$ _____
 - processing and retention fee (\$130.00; 37 CFR 1.53(d) and 1.21(l)) \$ _____
- Total Fees Enclosed** \$ _____

Correspondence

Please address all correspondence in connection with this application to:

Michael Caywood
Locke Purnell Rain Harrell, P.C.
100 Congress Avenue, Suite 300
Austin, Texas 78701

46767-32950

FEE PAYMENT

- Attached is a check in the sum of \$_____.
- Charge Account No. 12-1781 the sum of \$505.00. A duplicate of this transmittal is attached.
- If any additional extension and/or fee is required or if any overpayment has been made, the Commissioner is hereby authorized to charge any deficit or credit any overpayment to Account No.12-1781.

Copies

- A duplicate of this sheet is enclosed **[if authorization to charge account is checked above]**.

RESPECTFULLY SUBMITTED,

Date: Nov. 21, 1997
Registration No. 27,811
Registration No. 37,797

Michael Caywood
Jerry M. Keys
Michael Caywood
ATTORNEYS FOR APPLICANT
Locke Purnell Rain Harrell, P.C.
100 Congress Avenue, Suite 300
Austin, Texas 78701
(512) 305-4724

REGISTERED

E:\CORP\13326\59157\PTO\NEWAPP.CVR

IN THE UNITED STATES PATENT AND TRADEMARK OFFICE

IN RE:	Theodore L. Brann	§	GROUP NO.:	Unknown
SERIAL NO.:	Unknown	§	EXAMINER:	Unknown
FILED:	Herewith	§	ATTY DKT.:	13326/59157
FOR:	A TRAINING AND SAFETY DEVICE, SYSTEM AND METHOD TO AID IN PROPER MOVEMENT DURING PHYSICAL ACTIVITY	§		

65705 U.S. PTO
08/976228
11/21/97

BOX PATENT APPLICATION
THE COMMISSIONER OF PATENTS AND TRADEMARKS*
WASHINGTON, D.C. 20231

LETTER OF TRANSMITTAL

Dear Sir:

Enclosed with this letter please find the following in connection with the above-referenced application for U.S. patent:

1. New Application Cover Sheet;
2. Declaration, Power of Attorney, and Petition of Sole Inventor;
3. Declaration(s) of Small Entity Status by an Independent Inventor;
4. New Application Disclosure:

Specification	<u>19</u> page(s)
Claims	<u>5</u> page(s)
Informal Drawings	<u>6</u> sheet(s)
Abstract	<u>1</u> page(s)
5. Information Disclosure Statement package; and
6. Self-Addressed and Stamped Return Receipt Postcard.

08976228-112197

*

CERTIFICATE OF EXPRESS MAILING (37 C.F.R. § 1.10)

EM000794447US
Express Mail Label Number

I hereby certify that this paper (along with any paper referred to as being attached or enclosed) is being deposited with the United States Postal Service as Express Mail Post Office to Addressee on the date shown below in an envelope with sufficient postage for and with Express Mail label number shown above, and is addressed to: Box Patent Application, Commissioner of Patents and Trademarks, Washington, D.C. 20231.

Date: Nov. 21, 1997

MICHAEL CAYWOOD
Michael Caywood
Signature

E:\CORP\13326\59157\PTO\APP_TRAN.WPD

39/2
12
1-b

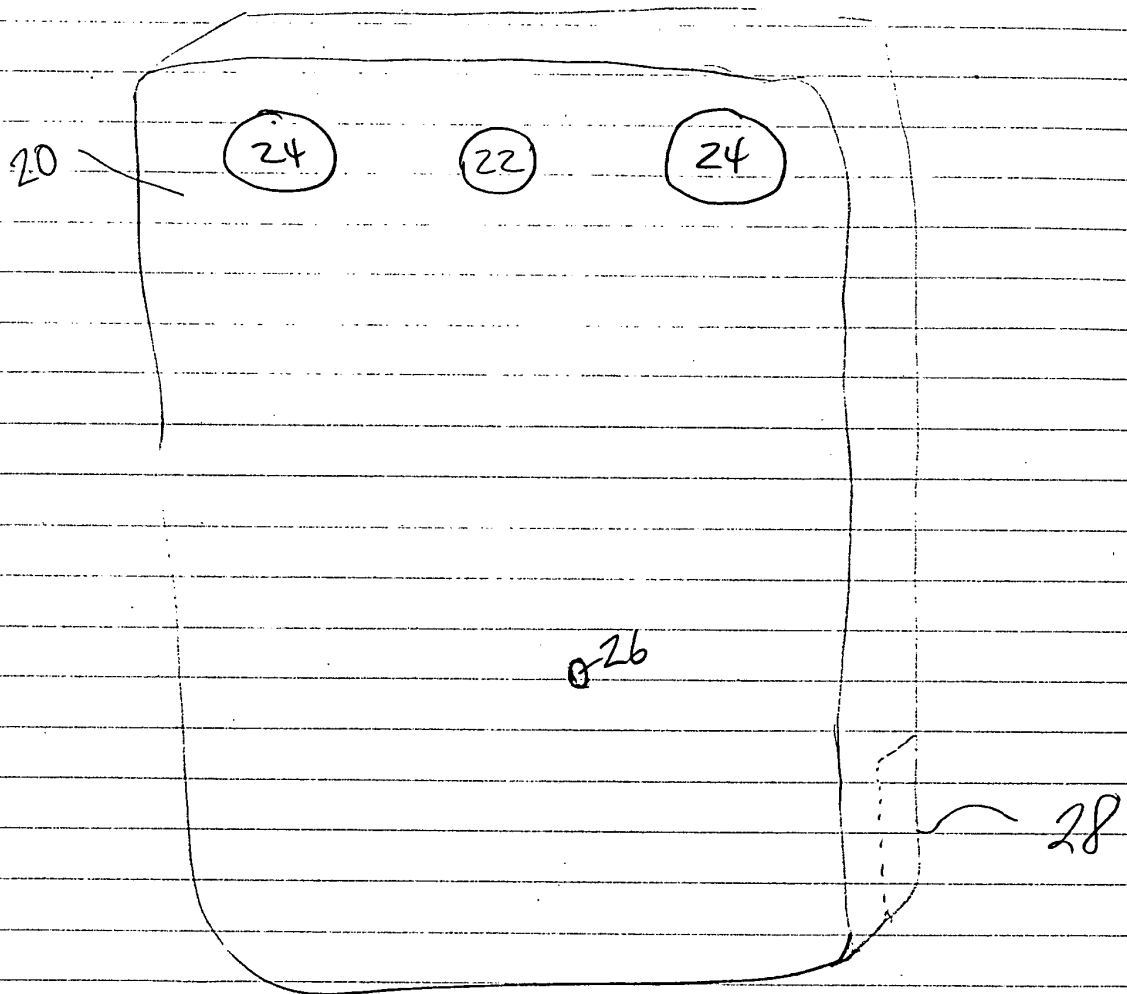

FIG. 3

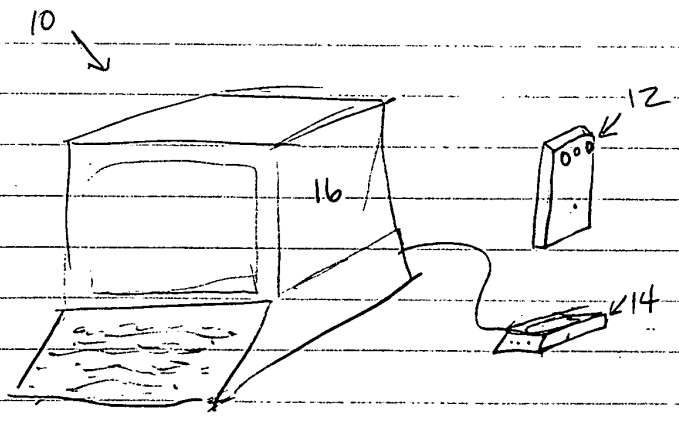

FIG. 1

08976228-112197

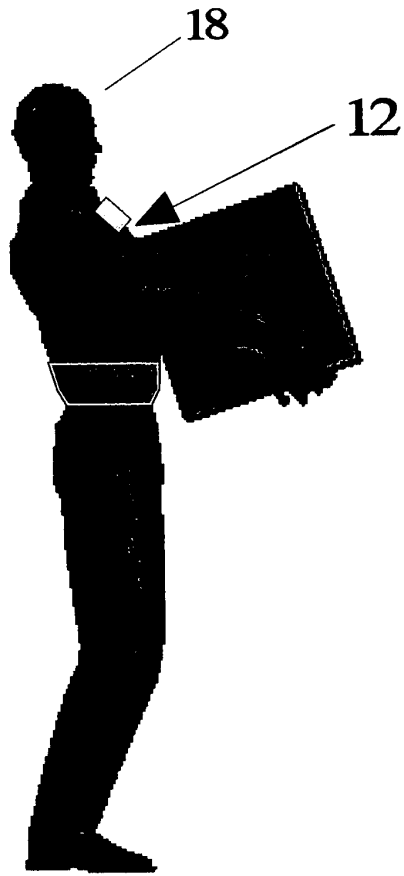

FIG. 2A

08976228-1219

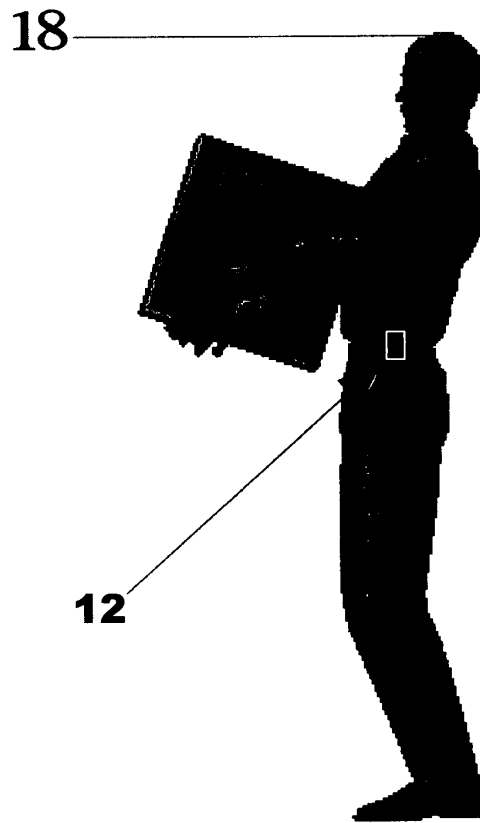

FIG. 2B

08976228.F121.97

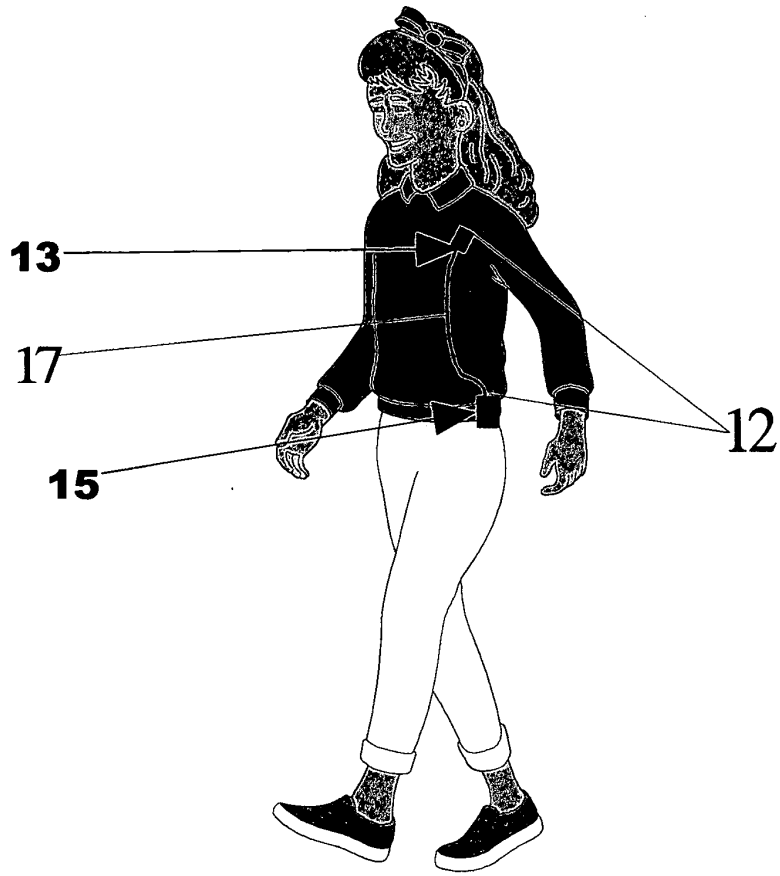

FIG. 2C

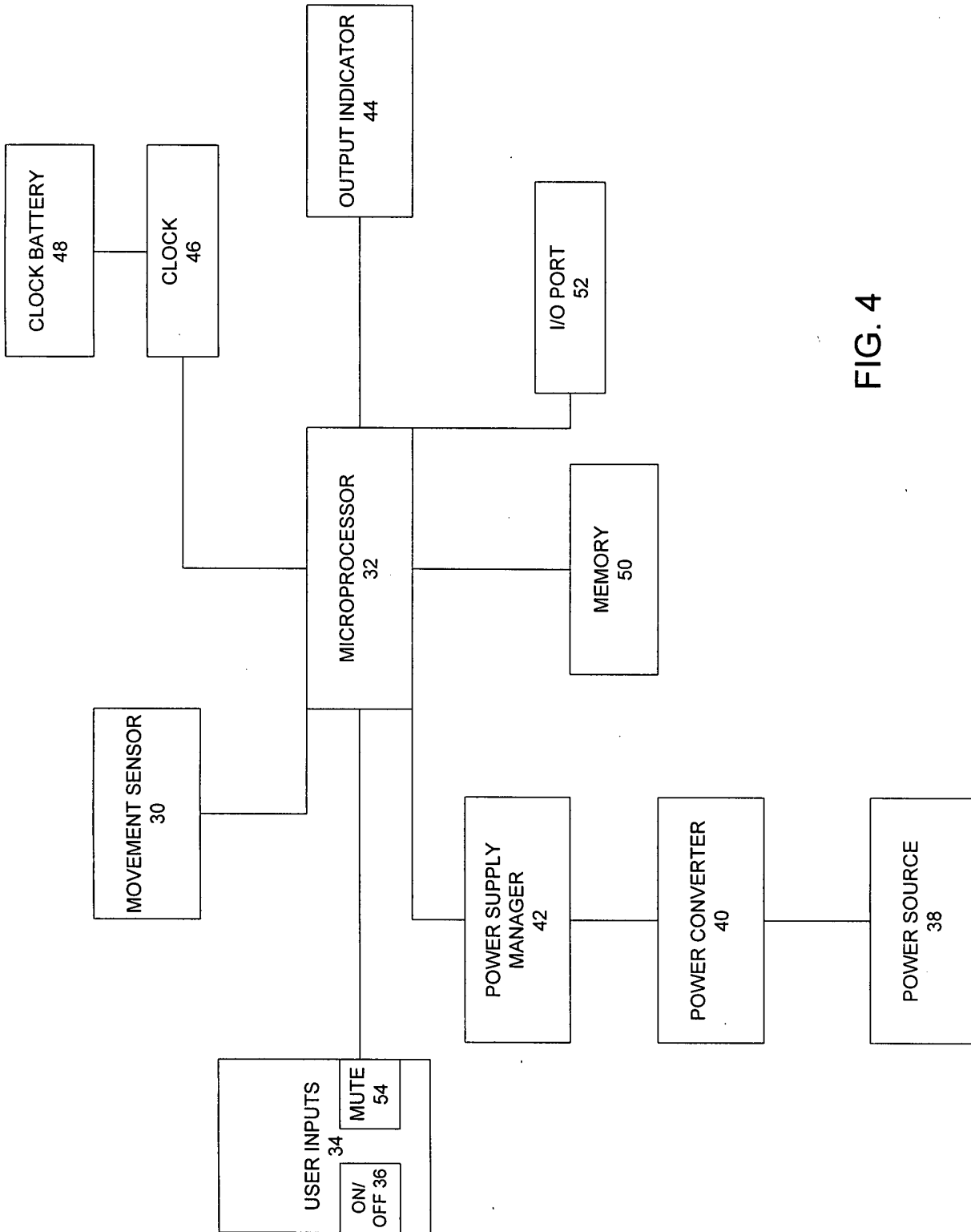

FIG. 4

08976228 - 1.12.197

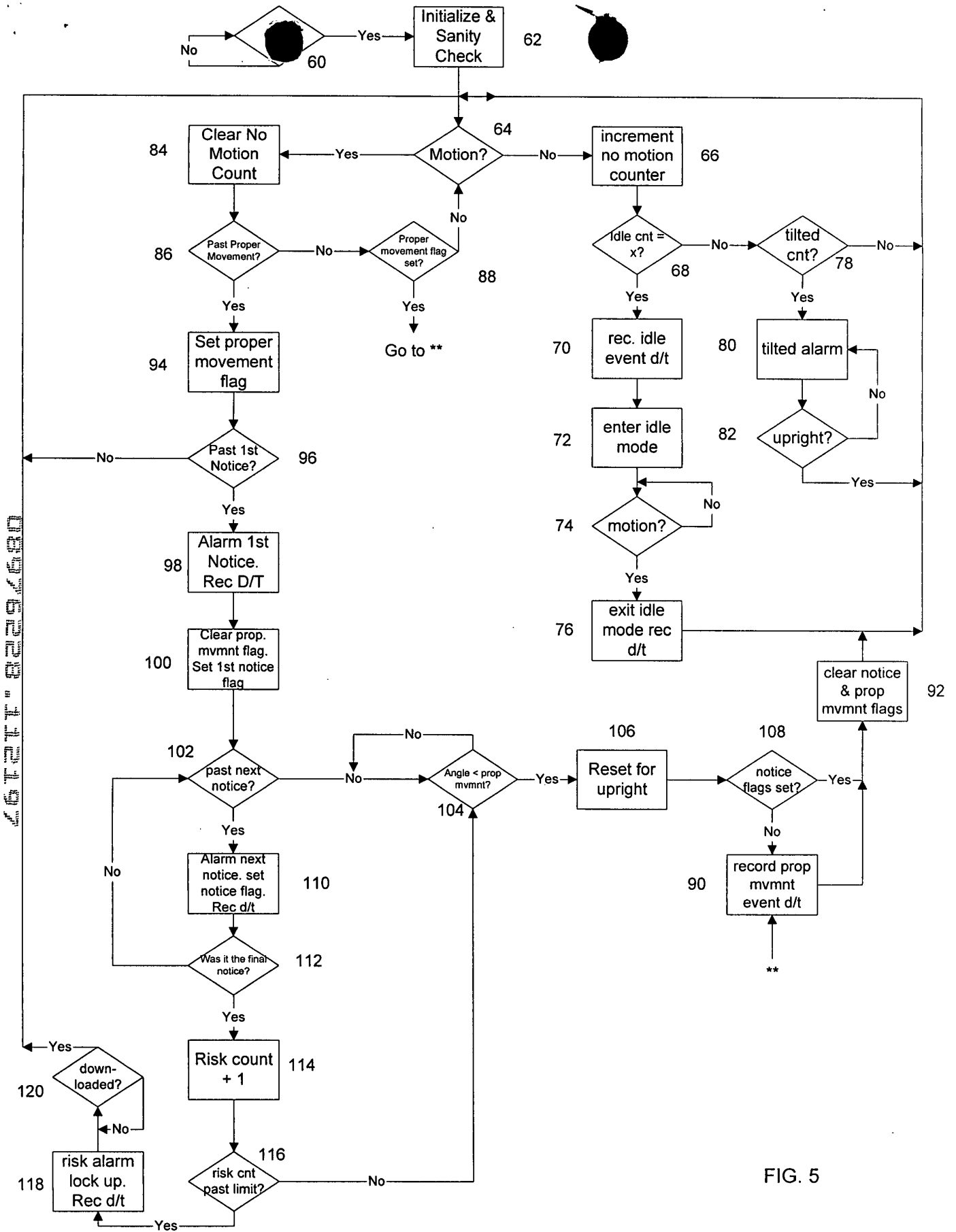

FIG. 5

SCORE Placeholder Sheet for IFW Content

Application Number: **08976228**

Document Date: **11/21/1997**

The presence of this form in the IFW record indicates that the following document type was received in paper and is scanned and stored in the SCORE database.

- Drawings

Images of the original documents are scanned in gray scale or color and stored in SCORE. Bi-tonal images are also stored in IFW. Defects visible in both IFW and SCORE are indicative of defects in the original paper documents.

To access the documents in the SCORE database, refer to instructions developed by SIRA.

At the time of document entry (noted above):

- Examiners may access SCORE content via the eDAN interface.
- Other USPTO employees can bookmark the current SCORE URL (<http://Score.uspto.gov/ScoreAccessWeb/>).
- External customers may access SCORE content via the Public and Private PAIR interfaces.

A TRAINING AND SAFETY DEVICE, SYSTEM AND METHOD TO AID IN PROPER
MOVEMENT DURING PHYSICAL ACTIVITY

FIELD OF THE INVENTION

This invention relates to the field of electronic training and safety devices used to monitor human physical activity. More specifically, the invention detects, measures, records, and/or analyzes the time, date, and other data associated with movement of the device and produces meaningful feedback regarding the measured movement.

BACKGROUND

It has long been known that improper physical movement, especially when repeated, can result in injury to a person. This injury may manifest itself in a wide range of symptoms anywhere from sore or bruised muscles to chronic, debilitating loss of movement. In order to study and better understand safe human movement which does not result in injury, a variety of sensing, monitoring, and notification devices have been created. In general, these devices fall under the general category of range of motion (ROM) detectors.

Several such inventions have been patented to measure the range of motion of various joints of the human body for both medical studies and industry applications. Typically, these inventions require that two people simultaneously use the device: the patient/wearer and the operator of the device. The purpose of these devices is to quantitatively determine a range of motion of a human joint in angular degrees as exemplified by U.S. Patent Nos. 4,665,928; 5,042,505; and 5,373,858.

Although the devices disclosed in these patents serve the purposes for which they are intended, they do not warn the device wearer when the wearer is nearing, or has reached, a potentially dangerous angle of movement.

SUMMARY OF THE INVENTION

According to the present invention, the foregoing and other objects and advantages are attained by a system which may be used to monitor and train a wearer during physical movement. The system employs an electronic device which tracks and monitors an individual's motion through the use of a movement sensor capable of measuring data associated with the wearer's movement. The device also employs a user-programmable microprocessor which receives, interprets, stores and responds to the movement data based on customizable operation parameters, a clock connected to the microprocessor, memory for storing the movement and analysis data, a power source, a port for downloading the data from the device to other computation or storage devices contained within the system, and various input and output components. The downloadable, self-contained device can be worn at various positions along the torso or appendages being monitored depending on the specific physical task being performed. The device also monitors the speed of the movements made while the device is being worn. When a pre-programmed recordable event is recognized, the device records the time and date of the occurrence while providing feedback to the wearer via visual, audible and/or tactile warnings. Periodically, data from the device may be downloaded into an associated computer program which analyzes the data. The program can then format various reports to aid in recognizing and correcting trends in incorrect physical movement.

It is, therefore, an object of this invention to provide a user programmable training and safety device designed to observe and record the direction and frequency of physical movement of the wearer.

It is another object of this invention to provide a system which monitors, records and analyzes the time, date, angle of movement, and angular velocity of physical movement for subsequent interpretation.

08976228-FILED

4

It is still another object of this invention to monitor bi-directional movement of the torso about the spine during a lifting movement.

It is yet another object of this invention to detect and monitor a series of angles of movement and to visually and audibly warn the wearer as each angle limit is exceeded during physical movement.

It is yet another object of this invention to provide a device to assist in training an individual in proper posture while executing an identified physical activity.

To achieve these and other objects which will become readily apparent upon a reading of the attached disclosure and appended claims, an improved training and safety device is provided.

Additional objects, advantages, and novel features of the invention will be set forth in part in the description which follows, and in part will become apparent to those skilled in the art upon examination of the following, or may be learned by practice of the invention. The objects and advantages of the invention may be realized and attained by means of the instrumentalities and combinations particularly pointed out in the appended claims.

BRIEF DESCRIPTION OF THE DRAWINGS

Fig. 1 is a plan view of the system of the present invention, including the movement measuring device, the download device, and the computer.

Fig. 2A is a plan view of a wearer showing a possible location for the movement measuring device in operation.

Fig. 2B is a plan view of a wearer showing another location for the device during operation.

Fig. 2C is a plan view of a wearer showing the location of an alternative embodiment of the device of the present invention.

Fig. 3 is a perspective view of another alternative embodiment of the self-contained movement measuring device of the present invention.

Fig. 4 is a block diagram of the movement measuring device of the present invention.

Fig. 5 is a flowchart of the steps performed by the microprocessor in operating the movement measuring device.

DETAILED DESCRIPTION OF THE PREFERRED EMBODIMENT

Reference is now made to Fig. 1 for a description of a preferred embodiment of the system 10 of the current invention. Fig. 1 shows the movement measuring device 12 positioned above a download device 14 connected to a computer 16. The movement measuring device 12 is designed to be physically attached to a user whose movements are to be monitored by the system 10. The self-contained movement measuring device 12 may be worn by the individual being monitored in a variety of positions based on the specific movement being observed, the particular application in which the device is used, and the convenience of the wearer.

For example, Fig. 2A shows placement of the movement measuring device 12 on the upper torso of an individual 18. Placement of the device 12 at this location will allow monitoring of the flexion and extension of the spinal column during a lifting activity. Similarly, Fig. 2B shows placement of the movement measuring device 12 on the waist or hip of an individual 18. The movement measuring device 12 may be attached via a clip, Velcro, its own belt, or any other means known in the art. Placement of the device 12 on the belt as shown will also permit monitoring of the individual's movement during physical activity. In particular, the device 12 can monitor the forward and backward bending of the spine as well as lateral bending of the spine to aid in correct bending and lifting tasks. The device 12 is also capable of measuring the distance the wearer walks and how fast he walked. Fig. 2C shows another alternative embodiment of the movement measuring

device 12. In this version, the movement sensor 13 is separate from the remaining components 15 of the device 12 and is electronically connected to the remaining components 15 via a cable 17 or other commonly used connector. Separating the measurement sensor 13 from the remaining components 15 in this way gives additional flexibility in the use of the device 12. The device 12 operates in the same manner as previously described; however, the movement sensor 13 can be placed anywhere on the individual's body. Again, the specific application will dictate where the movement sensor 13 should be placed. For example, if a monitored activity requires repeated arm movement, the sensor 13 may be placed anywhere along the individual's arm thereby monitoring and recording movement data for the arm.

Fig. 3 shows a more detailed view of the movement measurement device 12 which forms a crucial part of the previously described system along with its respective external components. The internal components of the movement measurement device 12 are housed in a casing 20. This casing 20 serves to protect the internal components and is most commonly made of hard molded plastic, although any suitable material may be substituted. Externally visible on the device 12 is at least one visual indicator 22 which is activated by the device 12 when appropriate. In one preferred embodiment, the visual indicator 22 is a bi-colored light emitting diode (LED) which is activated to notify the wearer when a predetermined angle of motion has been exceeded. Through different colors and blinking patterns, the visual indicator 22 signals many different conditions sensed by the device 12 including when the device 12 is turned on or off, when each of various angle limits is exceeded, and when downloading movement data recorded by the device 12. Alternatively, the visual indicator 22 may be a liquid crystal display or any other display device on which a variety of movement information may be shown. The movement measuring device 12 also contains user inputs 24. In the preferred embodiment, one user input 24 is an ON/OFF switch for controlling the operation of the device 12. Another user input 24 on the device 12 is a MUTE button which permits

the wearer of the device to turn off any audible indicators. Typically, once an angle limit has been exceeded, the wearer will be notified through the illumination of a visual indicator, the sounding of an audible alarm, vibration of the device 12, or a combination thereof. In the case of an audible alarm, the MUTE button 24 may be used to turn off the alarm. Any sounds emitted by the device 12 are created by a speaker (not shown) behind the speaker cover 26 located in the external casing 20. Finally, the casing 20 contains a removable battery cover 28 over an externally accessible battery compartment (not shown) which allows the operator of the device 12 to replace the internal power source. In the preferred embodiment this power source is a 1.5 volt battery.

Reference is now made to a block diagram in Fig. 4 which shows the major internal components of the movement measuring device 12 and their interconnections. The device 12 includes a movement sensor 30 which detects movement and measures associated data such as angle, speed, and distance. The movement sensor 30 generates signals corresponding to the measurement data collected. In a preferred embodiment, the movement sensor 30 is an accelerometer which is capable of detecting angles of movement in multiple planes as well as the velocity at which the movement occurs. Alternatively, multiple accelerometers, each capable of measuring angles of movement in only one plane, may be oriented within the device 12 so that movement in multiple planes may be detected. Although many accelerometers are available on the market, the preferred embodiment uses Part No. AD22217 manufactured by Analog Devices of Norwood, Massachusetts. This component is a low G, multi-axis accelerometer. The movement sensor 30 is electronically connected to a microprocessor 32 which receives the signals generated by the movement sensor 30 for analysis and subsequent processing. The microprocessor 32 not only analyzes and responds to the movement data signals from the sensor 30, but also controls the actions of all of the electronic components of the device 12. In a preferred embodiment, the microprocessor 32 is a Motorola MC68HC705C8AFN. It should be noted, however, that other low power, programmable

microprocessors may be suitable. The microprocessor 32 constantly monitors the user inputs 34 and acts accordingly. For example, if the device is turned off, the microprocessor 32 monitors the ON/OFF user input 36 to detect when the device 12 is turned back on. Once an "ON" condition is detected, the microprocessor 32 powers up and runs its internal program. The internal program may be stored within read-only memory located in the microprocessor itself or in memory (not shown) located outside the microprocessor 32.

The components of the device 12 receive power from a power source 38. In a preferred embodiment the power source 38 is a 1.5 volt DC battery; however, other power sources, including alternating current, may be used. The power source 38 is connected to a power converter 40 if DC-DC or AC-DC conversion is required. In one embodiment the power converter 40 converts the 1.5 volt DC power supply from the battery to 3.3 volts DC for use with the other electronic components of the device 12.

Also connected between the power source 38 and the microprocessor 32 is a conventional power supply manager 42 such as part number ADM706TAR from Analog Devices. The power supply manager 42 performs several functions. If a low battery condition exists, the power supply manager 42 reports the problem to the microprocessor 32 so that the microprocessor 32 may indicate the condition to the user through one or more output indicators 44. The output indicators 44 consist of any combination of audible, visual, or tactile indicators for communicating with the wearer of the device. Audible indicators range from a single pitched tone to voice-synthesized messages in English or any foreign language. Visual indicators which could be used include single, monochromatic LEDs, multiple colored lights, and/or liquid crystal displays. The tactile indicator used in a preferred embodiment is a conventional vibrator mechanism which can be detected by the wearer. The power supply manager 42 also regulates the activity of the power converter 40 to insure that the proper voltage is constantly supplied to the device components.

9

467277-8284680

microprocessor 32 will obtain the date/time stamp from the clock 46 and store that information along with the notice level that was exceeded into memory 50 for later analysis and reporting. Whenever an alarm is activated by the microprocessor 32, the MUTE control switch 54 may be used to deactivate the alarm; however, the corresponding movement data associated with the activation of the alarm is still recorded in memory 50. Furthermore, the date and time the MUTE control switch 54 was activated is also recorded by the device 12.

A significant feature of the device 12 of the present invention is that it gives instant information to the wearer at the moment of incorrect movement and also records the information for future reference and analysis. The device 12 monitors a wide variety of "events" and records each event with a date/time stamp. Many different types of "events" may be defined to be monitored by the device 12. As previously stated, any movement which surpasses any identified angle limit of movement (based on the specific physical task being accomplished and the range of motion needed to execute the task properly) is a standard recordable event. In addition, the device will record when no discernable movement has occurred for a predetermined amount of time (idle function), when the wearer has pressed the MUTE switch in response to an alarm (MUTE function), when the wearer's speed of movement exceeds a predefined speed (quickness function), when the device is turned on or off, when a low battery warning has been issued, when the battery is changed, when the device has been tampered with (such as removing the battery before a low battery condition has been detected), when the device is tilted outside of a specified range for a designated period of time, and when the device has measured a predetermined maximum number of particular angle limits reached. These functions are further described hereinbelow.

Whenever an incorrect user movement is sensed by the device 12, the angular limit notice as programmed by the user is given only once. Before the device 12 can reset itself to be able to give that same angle notice on the next incorrect movement, the device 12 must return to a predetermined

degree specific or extend over a range of degrees. When a range is used, the user specifies the starting and incremental values in degrees. Thus, an angle limit may be set to occur every five degrees beginning with an initial angle limit value. The movement sensor 30 used in the preferred embodiment can measure angles to within plus or minus 0.5° and as often as 1000 times a second.

5 The most common use for the angle range limits is when the device 12 is worn on the hip since angle measurements cannot be made as accurately there. In contrast, when the device 12 is worn on the upper torso, results can be measured more accurately and the device 12 can be set to measure each degree of movement.

As mentioned above, once a wearer of the device 12 exceeds the first defined angle limit, a
10 notice for that limit is given to the wearer. The notice may be a combination of a visual warning, a tactile warning, and/or an audible warning. The microprocessor 32 also stores the specific angle limit which was exceeded along with the date/time stamp. Upon exceeding the second defined angle, the wearer is issued a second notice which may be the same as or different from the first notice. These different notice characteristics may include a change in pitch for audible alarms, a
15 difference in duration for tactile alarms, and/or a blinking, different colored, or other visual warning.

The “quickness” function of the device 12 measures the speed of an associated physical movement made by the wearer and was developed to address the following problem. In essence, the warning notice due to exceeding a first angle may be overridden by the warning notice for a second angle, thus appearing to give only the second notice. The device 12 may be programmed to
20 recognize when this occurs and to indicate that the associated physical activity was performed by the wearer with excessive speed. If so programmed, the device 12 will record both notices, and the microprocessor 32 will record a quickness violation for further analysis and reporting by the computer. The device 12 may also include an event threshold function in its programming. This feature allows the user of the device 12 who has access to the download capabilities and the analysis

08979228-11219
467277-82297680

13

software hereinafter described to determine a maximum number of incorrect movements (“events”) allowed in a predetermined time period by event type. In addition, the user may program a certain response, such as shutting down the device 12 entirely, emitting a special alarm, and/or recording the date and time each event threshold was met. In a preferred embodiment, if the device 12 is programmed for shut down upon reaching the event threshold, the device 12 will require downloading to the computer 16 and being reset before it can be operated again. This feature serves to alert the responsible party of a potential problem that must be dealt with immediately via retraining or any other means the responsible party deems necessary.

The device 12 also has additional functions and capabilities. Each unit can be assigned to a specific individual, patient or employee and later reassigned to a different person through the use of specific identification numbers. In a preferred embodiment, the device 12 requires a download of all movement data stored in memory under a previous identification number before it can be reassigned. Further, the download information along with the specific user identification number can be downloaded to the computer 16 only once in order to avoid duplicate records.

As generally described above, the system and device 12 of the present invention have practical application in a number of situations. They may be used in medical applications requiring the monitoring of physical movement. Among such applications is physical therapy which may be conducted either by the patient in the patient’s home or by medical professionals in a medical environment. More significantly, the device and system have application in an industrial setting, particularly manufacturing, where workers are required to perform repetitive manual tasks. Supervising employers can use the device and system to insure that employees are performing their tasks properly while minimizing the risk of employee injury.

By virtue of the sophisticated nature of the microprocessor 32, the device 12 can fulfill these additional business, industry and medical needs. Furthermore, wireless capabilities may be added

0896238-1439

141

to the device 12 to allow downloading of information from the device 12 to a computer 16 without the need for cables or docking stations. In yet another embodiment, the radio frequency capability may allow the user to wear minimal hardware (consisting primarily of the movement sensor) on the body while transmitting the details of each physical movement to a remote microprocessor 32 for analysis and storage.

Once the data from the device 12 has been downloaded to the computer 16, software running on the computer 16 is used to interpret the data and produce a number of reports and histories. This history information may include, but is not limited to, the dates and times when the device 12 was turned on and off; the number, with dates and times, of each notice given along with the type of notice; the number, date and time the device 12 reached an event threshold; when, how long, and how many times the device 12 powered down; the date and time the device 12 was muted; the date and time when the battery was changed; the date and time when the battery was tampered with; and the last time the device 12 was downloaded. Any of the above-mentioned predefined reports may be generated; in addition, the user may program additional reports and histories specific to the application to be monitored.

Fig. 5 is a flowchart of the steps executed by the microprocessor 32 in the movement measurement device 12 to recognize and record movement data. Referring to Fig. 5, when the device 12 is off, the microprocessor 32 constantly checks for a change in the ON/OFF state 60 by polling the ON/OFF switch to see if it has been switched to the ON position. Once the microprocessor 32 detects that the device 12 has been turned on, the microprocessor 32 conducts some basic initialization and housekeeping functions 62. This may include checking memory to ensure angle limits have been entered, verifying that angle limits are increasing in value (i.e., the second angle limit is not smaller than the first), and initializing internal program parameters. Then the microprocessor 32 checks to see whether any motion has been detected 64 by the movement

08976228-11197
4512111-82294680

5

10

5

20

15

sensor 30. If no motion has been detected, the microprocessor 32 will increment a “no-motion” counter 66. The microprocessor 32 then checks whether the no-motion counter has reached a predefined number of cycles indicating that the device should power down. If the requisite number of cycles indicating idle mode have elapsed, the microprocessor records the idle event (along with the date and time stamp) in memory, and the device enters the idle mode 72. Once in idle mode, the microprocessor repeatedly checks for motion 72. As long as no motion occurs, the device remains in idle mode. Once motion is detected, the microprocessor records an event that the device has exited idle mode (with the corresponding date and time) 76. The microprocessor then returns to step 64 where it again attempts to detect motion. If the no-motion counter has not reached the preset limit corresponding to idle mode, the microprocessor will check to see whether the device has remained outside of its predefined reset range for a designated amount of time 78. If not, the microprocessor reexecutes the cycle for detecting motion 64. If, however, the microprocessor recognizes a tilt event, an alarm corresponding to a tilt event is activated 80. Once the microprocessor has recognized a tilt event, it repeatedly checks whether the device has been moved back within its reset range 82. If it has not, the microprocessor continues to activate the tilt alarm. Once the device has been returned to within its reset range, the microprocessor checks again for motion 64.

Once the microprocessor detects motion in step 64, the first thing it does is clear the no-motion counter 84. The microprocessor then checks to see whether it has recorded a “proper movement” in the past 86. If no proper movement has occurred, the microprocessor checks whether the proper movement flag has been set 88. If the proper movement flag has not been set, the microprocessor returns to its initial motion checking step 64. If, however, the proper movement flag has been set, the microprocessor will record the occurrence of a proper movement event along with the date/time stamp 90. The microprocessor then clears all notice and the proper movement flags in step 92 and returns to the motion detection step 64. If, on the other hand, the microprocessor has

08976228-1249

16

detected a prior proper movement 86, it so indicates by setting the proper movement 94. The microprocessor then checks whether the first angle limit has been exceeded 96. If this first limit has not yet been exceeded, the microprocessor returns to the motion detection step 64. If the first angle limit has been exceeded, the microprocessor activates the appropriate alarm and records the event along with the date and time 98. The microprocessor then clears the proper movement flag and sets the first angle notice flag 100. The microprocessor then checks whether the device has moved beyond the next angle limit 102. If not, the microprocessor checks whether the angle is less than that required to constitute a proper movement 104. If not, then the microprocessor continues to check whether the angle of movement is less than a proper movement angle. If the angle is less than that constituting a proper movement, the microprocessor triggers a reset flag indicating that the device has been reset 106. After reset, the microprocessor checks whether any of the angle limits have been exceeded thereby setting any of the notice flags 108. If any notice flags have been set, the microprocessor will perform step 92 to clear all of the notice flags and reset the proper movement flag. If none of the notice flags have been set before the device was reset, the microprocessor will perform step 90 to record a proper movement event along with the date and time. It then continues processing at step 92.

Once the angle of movement detected exceeds the next angle limit, the microprocessor will record the corresponding notice event along with the date and time and activate the appropriate notice alarm in step 110. The microprocessor then checks if the last movement ~~was~~ exceeded the final angle limit at step 112. If not, then the process returns to step 102 to check for movement beyond the next angle limit. If the final notice event was detected, then the microprocessor will increment the event threshold counter by one at step 114 if this option has been selected by the user. Next, the microprocessor will check to see whether the event threshold limit has been reached 116. If not, the microprocessor will perform step 104 until the device is reset due to the movement angle

0897E22B-11319
46F3E115

Q

20

17

being less than that required for a proper movement. If the event threshold has been reached, then the microprocessor will record the event threshold, activate the associated alarm, and shut down the device 118. The microprocessor will prevent the device from operating any further until its information has been downloaded 120. Once the stored data has been downloaded, the microprocessor returns to its initial motion detection step 64 for further operation.

As previously alluded to herein, the device and system of the present invention can be used in a wide number of different applications requiring monitoring and feedback of physical movement. In particular, the device and system have various medical applications including rehabilitation and physical therapy associated with an injured patient. The movement sensor is simply attached to the appropriate body part requiring monitoring, and data collection is then commenced. Besides providing the operator with instant feedback regarding the physical movement being monitored, a variety of data may be collected from the number of movement repetitions meeting or exceeding a required range to the determination and tracking of maximum range-of-motion mobility of an injured patient for later analysis. While the device and system may be operated by a medical professional in a supervisory capacity, both are simple enough to be used by an individual patient alone with download and analysis by the medical professional at a later time.

The device also has excellent application to the monitoring and analysis of physical labor performed by employees. The devices may be passed out to employees having repetitive physical tasks so that proper safety in performing the tasks, such as lifting, may be practiced. Each device can be assigned to a particular individual for a specified amount of time and programmed to monitor that individual's physical tasks. After the device is turned in, its collected information can be downloaded to the system for reporting and analysis purposes based on specific movement limits and other operational parameters programmed into the device for the particular movement being monitored. Improper movements made by the individual during the time period in question are

10
08975228-112197

18

identified, and the employee can be notified in order to make necessary corrections to the way the task is performed in order to avoid injury resulting from improper movement. The device can be used again later to ensure that the employee continues to exercise the movement guidelines as previously instructed.

5 The device also has application in the area of sports. For example, it may be worn by a golfer in order to monitor torso, waist, shoulder and arm movement during various drives and putts. The data collected by the device may then be used as a tool to aid in the analysis and improvement of the individual's stroke technique. Use of the device is not limited to golf but may be used for any number of sports, including football, baseball, basketball, or tennis. And, due to the unique programmability of the device, it has more than one application within any single sport. For
10 example, in baseball, the device and system may be used to improve technique associated with hitting or with throwing.

 Still other objects and advantages of the present invention will become readily apparent to those skilled in this art from the detailed description, wherein multiple preferred embodiments of the invention are shown and described, simply by way of illustration of the best mode contemplated by
15 the inventor for carrying out the invention. As will be realized, the invention is capable of other and different embodiments, and its several details are capable of modifications in various obvious respects, all without departing from the invention. Accordingly, the drawings and description are to be regarded as illustrative in nature, and not as restrictive. Variations in the description likely to
20 be conceived of by those skilled in the art still fall within the breadth and scope of the disclosure of the present invention. The primary import of the present invention lies in its compact size, ease of use, and detailed information gathering and reporting features. Its benefits derive from the versatility of its monitoring capabilities as well as the specific applications for which it may be used. Again,

03978228-472197

19

it is understood that other applications of the present invention will be apparent to those skilled in the art upon reading the preferred embodiments and consideration of the appended claims.

089528-1319
46777-828480

20

We claim:

Sub. B1 >

1. A device for detecting movement of body parts during physical activity, said device comprising:

5

a movement sensor capable of measuring data associated with movement of said device and generating signals indicative of said movement;

a power source;

a microprocessor connected to said movement sensor and to said power source, said microprocessor capable of receiving, interpreting, storing and responding to said movement data based on user-defined operational parameters;

10

at least one user input connected to said microprocessor for controlling the operation of said device;

a real-time clock connected to said microprocessor;

memory for storing said movement data; and

an output indicator connected to said microprocessor for signaling the occurrence of user-defined events.

0897688
15

Sub. A11

2. The device of claim 1 further comprising at least one port connected to said microprocessor for downloading said data and uploading said operational parameters to and from a computer.

Sub. B2 >

3. The device of claim 1 wherein said movement sensor can detect the velocity of said movement.

20

4. The device of claim 1 wherein said movement sensor comprises at least one accelerometer.

21

Sub. B3 >

5. The device of claim 1 wherein said movement sensor can simultaneously detect movement along at least two orthogonal axes.

6. The device of claim 1 wherein said movement sensor is housed separately from said microprocessor.

Sub. B4 >

7. The device of claim 1 further comprising a power supply manager connected between said power source and said microprocessor.

8. The device of claim 7 further comprising a power converter connected to said power source and said power supply manager.

Sub. B5 >

9. The device of claim 1 wherein said data measured by said movement sensor include angle, distance and speed of said movement.

9. The device of claim 1 wherein said output indicator is visual.

10. The device of claim 1 wherein said output indicator is audible.

11. The device of claim 1 wherein said output indicator is tactile.

12. The device of claim 1 wherein said user input is a switch.

039751811219

22

Sub A 2

14. A system to aid in training and safety during physical activity, said system comprising a movement measuring device, said movement measuring device further comprising

a movement sensor capable of measuring data associated with movement of said device and generating signals indicative of said movement;

a power source;

a microprocessor connected to said power source, said microprocessor capable of receiving, interpreting, storing and responding to said movement data based on user-defined operational parameters;

at least one user input connected to said microprocessor for controlling the operation of said device;

a real-time clock connected to said microprocessor;

memory for storing said movement data;

at least one port connected to said microprocessor for downloading said data and uploading said operational parameters; and

an output indicator connected to said microprocessor;

a computer running a program capable of interpreting and reporting said movement data based on said operational parameters; and

a download device electronically connected to said movement measuring device and said computer for transmitting said movement data and operational parameters between said movement measuring device and said computer for analysis, reporting and operation purposes.

5

10

08976228-FTF

5

20

Sub. B 7

15. The system of claim 14 wherein said computer is a standalone personal computer.

15
~~16~~. The system of claim ~~14~~¹³ wherein said computer is connected to a network of other computers.

16
~~17~~. The system of claim ~~14~~¹³ wherein said download device is a physical docking station.

17
~~18~~. The system of claim ~~14~~¹³ wherein said download device is a wireless device.

18
~~19~~. The system of claim ~~18~~¹⁷ wherein said wireless device uses radio frequency.

5
~~20~~. The system of claim ~~18~~¹⁷ wherein said wireless device uses infrared light.

20
21
22
23
24
25
26
27
28
29
30
31
32
33
34
35
36
37
38
39
40
41
42
43
44
45
46
47
48
49
50
51
52
53
54
55
56
57
58
59
60
61
62
63
64
65
66
67
68
69
70
71
72
73
74
75
76
77
78
79
80
81
82
83
84
85
86
87
88
89
90
91
92
93
94
95
96
97
98
99
100

~~21~~. A method to monitor physical movement of a body part comprising the steps of:
attaching a movement measuring device to said body part;
measuring data associated with said physical movement;
interpreting said physical movement data based on user-defined operational parameters and
a real-time clock; and
storing said data in memory.

21
~~22~~. The method of claim ~~21~~²⁰ wherein said physical movement data includes velocity data of said movement, angle measurement data taken along at least two orthogonal axes, and related date and time data.

15
~~23~~. The method of claim ~~22~~²¹ further comprising the step of defining said parameters for a specific physical movement prior to said interpreting step.

23

²³
24. The method of claim ²¹22 further comprising the step of downloading said data from said movement measuring device to a computer for reporting and analysis purposes.

²⁴
25. The method of claim ²¹22 wherein said interpreting step comprises teaching an individual how to properly perform said physical movement.

5 ²⁵
26. The method of claim ²⁰21 wherein said movement measuring device is an accelerometer.

Sub. B97 27. The method of claim 21 further comprising the step of providing instant feedback regarding said movement.

08976228-112197
08976228-112197

²⁷
28. The method of claim ²⁶27 wherein said physical movement is physical labor.

²⁹
29. The method of claim ²⁶27 wherein said physical movement is an exercise related to medical treatment.

²⁹
30. The method of claim ²⁶27 wherein said physical movement is an exercise to improve technique related to an athletic skill.

ABSTRACT

An electronic device, system and method to monitor and train an individual on proper motion during physical movement. The system employs an electronic device which tracks and monitors an individual's motion through the use of an accelerometer capable of measuring parameters associated with the individual's movement. The device also employs a user-programmable microprocessor which receives, interprets, stores and responds to data relating to the movement parameters based on customizable operation parameters, a real-time clock connected to the microprocessor, memory for storing the movement data, a power source, a port for downloading the data from the device to other computation or storage devices contained within the system, and various input and output components. The downloadable, self-contained device can be worn at various positions along the torso or appendages being monitored depending on the specific physical task being performed. The device also detects the speed of movements made while the device is being worn. When a pre-programmed recordable event is recognized, the device records the time and date of the occurrence while providing feedback to the wearer via visual, audible and/or tactile warnings.

5

06976228 : 1.1.1.97

1

IN THE UNITED STATES PATENT AND TRADEMARK OFFICE

IN RE:	Theodore L. Brann	§	GROUP NO.:	Unknown
SERIAL NO.:	Unknown	§	EXAMINER:	Unknown
FILED:	Herewith	§	ATTY DKT:	13326/59157
FOR:	A TRAINING AND SAFETY DEVICE, SYSTEM AND METHOD TO AID IN PROPER MOVEMENT DURING PHYSICAL ACTIVITY	§ § § § § §		

BOX PATENT APPLICATION
THE COMMISSIONER OF PATENTS AND TRADEMARKS*
WASHINGTON, D.C. 20231

DECLARATION, POWER OF ATTORNEY, AND PETITION
OF SOLE INVENTOR

As below-named inventor, I hereby individually declare that:

TYPE OF DECLARATION

This Declaration is of the following application type:

- Original
- Design
- Supplemental
- National Stage of PCT
- Divisional with Preliminary Amendment of Claims and Title
- Continuation
- Continuation-in-Part (CIP)

INVENTORSHIP IDENTIFICATION

My residence, post office address and citizenship are as stated below next to my name, I believe that I am the original, and first inventor of the subject matter which is claimed and for which a patent is sought on the invention entitled:

*

CERTIFICATE OF EXPRESS MAILING (37 C.F.R. § 1.10)

EM000794447US

Express Mail Label Number

I hereby certify that this paper (along with any paper referred to as being attached or enclosed) is being deposited with the United States Postal Service as Express Mail Post Office to Addressee on the date shown below in an envelope with sufficient postage for and with Express Mail label number shown above, and is addressed to: Box Patent Application, Commissioner of Patents and Trademarks, Washington, D.C. 20231.

Date: Nov. 21, 1997

MICHAEL CAYWOOD

Michael Caywood
Signature

E:\CORP\13326\59157\PTO\DEC_INV.WPD

1332659157

TITLE OF INVENTION

A TRAINING AND SAFETY DEVICE, SYSTEM AND
METHOD TO AID IN PROPER MOVEMENT
DURING PHYSICAL ACTIVITY

SPECIFICATION IDENTIFICATION

the specification of which

- is attached hereto.
 was filed on ___[date]___ and has been given
Application Serial No.: _____.
 was described and claimed in PCT International Application No. _____ filed on
_____ (if applicable) and as amended under PCT Article 19 on
_____.

ACKNOWLEDGMENT OF REVIEW OF PAPERS AND DUTY OF CANDOR

I hereby state that I have reviewed and understand the contents of the above-identified specification, including the claims, as amended by any amendment referred to above.

I acknowledge that duty to disclose information which is material to the examination of this application in accordance with Title 37, Code of Federal Regulations, Section 1.56(a).

DECLARATION

I hereby declare that all statements made herein of my own knowledge are true and that all statements made on information and belief are believed to be true; and further that these statements were made with the knowledge that willful false statements and the like so made are punishable by fine or imprisonment, or both, under Section 1001 of Title 18 of the United States Code, and that willful false statements may jeopardize the validity of the application or any patent issued thereon.

POWER OF ATTORNEY

I hereby appoint Jerry M. Keys, Registration No. 27,811 and/or Michael Caywood, Registration No. 37,797, Attorneys at Law, Locke Purnell Rain Harrell, P.C., 100 Congress Ave., Suite 300, Austin, Texas 78701, (512) 305-4724, my attorneys, with full power of substitution and revocation, to prosecute this application and to transact all business in the Patent and Trademark Office connected therewith.

And I hereby request that all correspondence be sent to:

Michael Caywood
Locke Purnell Rain Harrell, P.C.,
100 Congress, Suite 300
Austin, Texas 78701

LOCKE PURNELL RAIN HARRELL

PETITION

Wherefore, I pray that Letters Patent be granted to me for the invention or discovery described and claimed in the foregoing specification and claims, and I hereby subscribe my name to the attached specification and claims, declaration, power of attorney and this petition.

Full Name of First Listed Inventor:

Theodore L. Brann

Inventor's Signature:

Theodore L. Brann

Theodore L. Brann

Date: NOVEMBER 20, 1997

Citizenship:

United States of America

Residence:

P.O. Box 1897
Mission, Texas 78752

E:\CORP\13326\59157\PTO\DEC_INV.WPD

08976223-1249

IN THE UNITED STATES PATENT AND TRADEMARK OFFICE

IN RE:	Theodore L. Brann	§	GROUP NO.:	Unknown
SERIAL NO.:	Unknown	§	EXAMINER:	Unknown
FILED:	Herewith	§	ATTY DKT:	13326/59157
FOR:	A TRAINING AND SAFETY DEVICE, SYSTEM AND METHOD TO AID IN PROPER MOVEMENT DURING PHYSICAL ACTIVITY	§		

BOX PATENT APPLICATION
 THE COMMISSIONER OF PATENTS AND TRADEMARKS*
 WASHINGTON, D.C. 20231

**DECLARATION OF SMALL ENTITY STATUS
 BY AN INDEPENDENT INVENTOR**

I hereby declare that as a below named inventor, I qualify as an independent inventor as defined in 37 CFR § 1.9(c) for purposes of paying reduced fees under 35 USC §41(a) and (b) with regard to the invention by entitled:

*A TRAINING AND SAFETY DEVICE, SYSTEM AND
 METHOD TO AID IN PROPER MOVEMENT
 DURING PHYSICAL ACTIVITY*

described in:

- the specification filed herewith.
- Application Serial No. _____, filed on _____.
- Patent No. _____, issued on _____.

To the best of my knowledge, I have not assigned, granted, conveyed or licensed and am under not obligation under contract or law to assign, grant, convey or license, any rights in the invention to any person who could not be classified as: (1) an independent inventory under 37 CFR §1.9(c) if that person had made the invention, or (2) to any concern which would not qualify as a small business concern under 37 CFR 1.9(d) or (3) to a nonprofit organization under 37 CFR 1.9(e).

*

CERTIFICATE OF EXPRESS MAILING (37 C.F.R. § 1.10)

EM000794447US

Express Mail Label Number

I hereby certify that this paper (along with any paper referred to as being attached or enclosed) is being deposited with the United States Postal Service as Express Mail Post Office to Addressee on the date shown below in an envelope with sufficient postage for and with Express Mail label number shown above, and is addressed to: Box Patent Application, Commissioner of Patents and Trademarks, Washington, D.C. 20231.

Date: Nov. 21, 1997

MICHAEL CAYWOOD
Michael Caywood
 Signature

E:\CORP\13326\59157\PTO\DEC_SES.WPD

08976228-11219

I acknowledge the duty to file in this application or patent, notification of any change in status resulting in loss of entitlement to small entity status prior to paying, or at the time of paying, the earliest of the issue fee or any maintenance fee due after the date on which status as a small entity is no longer appropriate. (37 CFR 1.28(b))

I hereby declare that all statements made herein of my own knowledge are true and that all statements made on information and belief are believed to be true; and further that these statements were made with the knowledge that willful false statements and the like so made are punishable by fine or imprisonment, or both, under 18 USC §1001, and that such willful false statements may jeopardize the validity of the application, any patent issuing thereon, or any patent to which the verified statement is directed.

Date: November 20, 1997

Theodore L. Brann

Theodore L. Brann
P.O. Box 1897
Mission, Texas 78572

E:\CORP\13326\59157\PTO\DEC_SES.WPD

08975228 11.23.97

65705 U.S. PTO
08/976228
11/21/97

PATENT APPLICATION SERIAL NO. _____

U.S. DEPARTMENT OF COMMERCE
PATENT AND TRADEMARK OFFICE
FEE RECORD SHEET

01/20/1998 JWASHING 00000166 DA#121781 08976228
01 FC:201 395.00 CH
02 FC:203 110.00 CH

PTO-1556
(5/87)

PATENT APPLICATION FEE DETERMINATION RECORD

Effective October 1, 1997

Application or Docket Number

976228

CLAIMS AS FILED - PART I

(Column 1) (Column 2)

FOR	NUMBER FILED	NUMBER EXTRA
BASIC FEE		
TOTAL CLAIMS	30 minus 20 = *	10
INDEPENDENT CLAIMS	3 minus 3 = *	
MULTIPLE DEPENDENT CLAIM PRESENT		

* If the difference in column 1 is less than zero, enter "0" in column 2

SMALL ENTITY TYPE

OR

OTHER THAN SMALL ENTITY

RATE	FEE	OR	RATE	FEE
	395.00	OR		790.00
x\$11=	110 ⁰⁰	OR	x\$22=	
x41=		OR	x82=	
+135=		OR	+270=	
TOTAL		OR	TOTAL	

CLAIMS AS AMENDED - PART II

(Column 1) (Column 2) (Column 3)

AMENDMENT A	CLAIMS REMAINING AFTER AMENDMENT		HIGHEST NUMBER PREVIOUSLY PAID FOR	PRESENT EXTRA
	Total	* 29	Minus	** 30
Independent	* 3	Minus	*** 3	=
FIRST PRESENTATION OF MULTIPLE DEPENDENT CLAIM				

SMALL ENTITY

OR

OTHER THAN SMALL ENTITY

RATE	ADDITIONAL FEE	OR	RATE	ADDITIONAL FEE
x\$11=		OR	x\$22=	
x41=		OR	x82=	
+135=		OR	+270=	
TOTAL ADDIT. FEE		OR	TOTAL ADDIT. FEE	

(Column 1) (Column 2) (Column 3)

AMENDMENT B	CLAIMS REMAINING AFTER AMENDMENT		HIGHEST NUMBER PREVIOUSLY PAID FOR	PRESENT EXTRA
	Total	*	Minus	**
Independent	*	Minus	***	=
FIRST PRESENTATION OF MULTIPLE DEPENDENT CLAIM				

RATE	ADDITIONAL FEE	OR	RATE	ADDITIONAL FEE
x\$11=		OR	x\$22=	
x41=		OR	x82=	
+135=		OR	+270=	
TOTAL ADDIT. FEE		OR	TOTAL ADDIT. FEE	

(Column 1) (Column 2) (Column 3)

AMENDMENT C	CLAIMS REMAINING AFTER AMENDMENT		HIGHEST NUMBER PREVIOUSLY PAID FOR	PRESENT EXTRA
	Total	*	Minus	**
Independent	*	Minus	***	=
FIRST PRESENTATION OF MULTIPLE DEPENDENT CLAIM				

RATE	ADDITIONAL FEE	OR	RATE	ADDITIONAL FEE
x\$11=		OR	x\$22=	
x41=		OR	x82=	
+135=		OR	+270=	
TOTAL ADDIT. FEE		OR	TOTAL ADDIT. FEE	

* If the entry in column 1 is less than the entry in column 2, write "0" in column 3.
 ** If the "Highest Number Previously Paid For" IN THIS SPACE is less than 20, enter "20."
 *** If the "Highest Number Previously Paid For" IN THIS SPACE is less than 3, enter "3."
 The "Highest Number Previously Paid For" (Total or Independent) is the highest number found in the appropriate box in column 1.

IN THE UNITED STATES PATENT AND TRADEMARK OFFICE

IN RE:	Theodore L. Brann	§	GROUP NO.:	Unknown
SERIAL NO.:	Unknown	§	EXAMINER:	Unknown
FILED:	Herewith	§	ATTY DKT:	13326/59157
FOR:	A TRAINING AND SAFETY DEVICE, SYSTEM AND METHOD TO AID IN PROPER MOVEMENT DURING PHYSICAL ACTIVITY	§		



2
K. Cobb
4/13/98

THE COMMISSIONER OF PATENTS AND TRADEMARKS*
WASHINGTON, D.C. 20231

INFORMATION DISCLOSURE STATEMENT

Applicant submits this Statement in accordance with his duty of disclosure under 37 C.F.R. § 1.56, § 1.97 and § 1.98. This Statement is filed in accordance with 37 C.F.R. § 1.97(b)(1), within three months of the filing date of the application. Applicant respectfully requests that the art listed below be considered in the examination of the above-referenced application and made of record therein.

While no representation is made that a specific search of office files or patent office records has been conducted or that no better art exists, the undersigned attorney of record believes that the enclosed art is the closest to the claimed invention (taken in its entirety) of which the undersigned is presently aware, and no art which is closer to the claimed invention (taken in its entirety) has been knowingly withheld.

However, no representation is made that any of these references may be "prior art" within the meaning of that term under 35 U.S.C. § 102 or § 103. The enclosed list of references is disclosed so as to fully comply with the duty of disclosure set forth in 37 C.F.R. § 1.56.

CERTIFICATE OF EXPRESS MAILING (37 C.F.R. § 1.10)

EM000794447US

Express Mail Label Number

I hereby certify that this paper (along with any paper referred to as being attached or enclosed) is being deposited on the date shown below with the United States Postal Service in an envelope with sufficient postage as first class mail and is addressed to: Commissioner of Patents and Trademarks, Washington, D.C. 20231.

Date: Nov. 21, 1997

MICHAEL CAYWOOD

Michael Caywood
Signature

E:\CORP\13326\59157\PTO\IDS.01

PATENT DOCUMENTS

<u>U.S. Patent No.</u>	<u>Patentee</u>	<u>Date</u>
4,665,928	Linial et al	May 19, 1987
5,042,505	Mayer et al	August 27, 1991
5,128,655	Shore	July 7, 1992
5,373,858	Rose et al	December 20, 1994
5,375,610	LaCourse et al	December 27, 1994
5,394,888	Stone et al	March 7, 1995
5,398,697	Spielman	March 21, 1995
5,435,321	McMillen et al	July 25, 1995
5,462,065	Cusimano	October 31, 1995
5,469,862	Kovacevic	November 28, 1995
5,474,088	Zaharkin et al	December 12, 1995
5,513,651	Cusimano et al	May 7, 1996
5,588,444	Petragallo	December 31, 1996
5,621,667	Waters	April 15, 1997

OTHER INFORMATION

<u>Author</u>	<u>Title</u>	<u>Page</u>
---------------	--------------	-------------

COPIES PROVIDED

A copy of each reference, together with a listing on Form PTO-1449, is submitted herewith. Applicant respectfully solicits the Examiner's consideration of the cited references and entry thereof into the record of this application.

ENGLISH TRANSLATIONS

- [X] As all references listed on attached Form PTO-1449 are in English, under 37 C.F.R. § 1.98(a)(3), no commentary is required.

SUBMISSION FEE UNDER 37 C.F.R. § 1.97©

- [X] Although Applicant submits that no fee is required under 37 C.F.R. § 1.97 to have the listed references considered, Applicant conditionally requests that any required fee be charged to Deposit Account No. 12-1781 of the undersigned, if such fee is necessary to have the listed references considered.

RESPECTFULLY SUBMITTED,

Date: Nov. 21, 1997
Registration No. 27,811
Registration No. 37,797

Michael Caywood
Jerry M. Keys
Michael Caywood
ATTORNEYS FOR APPLICANT
Locke Purnell Rain Harrell, P.C.
100 Congress Ave., Suite 300
Austin, Texas 78701
512/305-4724

E:\CORP\13326\59157\PTO\IDS.01

6059576
 6059576
 6059576

SERIAL NUMBER 087976228 FILING DATE 12/16/99 CLASS 4126 SUBCLASS 247 GROUP ART UNIT 3713 EXAMINER Cheng

APPLICANTS THEODORE L. BRANN, MISSION, TX.

CONTINUING DATA
 VERIFIED
Name of

FOREIGN APPLICATIONS
 VERIFIED
Name of



FOREIGN FILING LICENSE GRANTED 03/06/98 ***** SMALL ENTITY *****

Foreign priority claimed: 35 USC 119 conditions met	<input type="checkbox"/> yes <input checked="" type="checkbox"/> no	AS FILED	STATE OR COUNTRY	SHEETS DRWGS.	TOTAL CLAIMS	INDEP. CLAIMS	FILING FEE RECEIVED	ATTORNEY'S DOCKET NO.
Verified and Acknowledged	Examiner's Initials	→	TX	6	30	3	\$605.00	13326/59157

ADDRESS
 MICHAEL LAYWOOD
 LOCKE FURNELL RAIN HARRELL
 100 CONGRESS SUITE 300
 AUSTIN TX 78701

TITLE
 TRAINING AND SAFETY DEVICE, SYSTEM AND METHOD TO AID IN PROPER MOVEMENT DURING PHYSICAL ACTIVITY

U.S. DEPT. OF COMM./PAT. & TM—PTO-436L (Rev.12-84)

PARTS OF APPLICATION FILED SEPARATELY		NOTICE OF ALLOWANCE MAILED 12/16/99		CLAIMS ALLOWED Total Claims: 30, Print Claim: 3	
ISSUE FEE Amount Due: 605, Date Paid: 12/16/99		Assistant Examiner		DRAWING Sheets: 6, Figs: 10, Print: 3	
Label Area		Primary Examiner: Joe H. Cheng		ISSUE BATCH NUMBER: F 3713	
PREPARED FOR ISSUE WARNING: The information disclosed herein may be restricted. Unauthorized disclosure may be prohibited by the United States Code, Title 35, Sections 122, 181 and 368. Possession outside the U.S. Patent & Trademark Office is restricted to authorized employees and contractors only.					

Form PTO-436A (Rev. 8/92)
 T. DYSON QUERY Issue Fee 703-306-3076
 K. PRINKNEY QUERY
 Formal Drawings (4 sheets) set
 (FACE)

PATENT NUMBER		ORIGINAL CLASSIFICATION	
		CLASS	SUBCLASS
		434	247
APPLICATION SERIAL NUMBER		CROSS REFERENCE(S)	
08/976,228			
APPLICANT'S NAME (PLEASE PRINT)		CLASS	SUBCLASS (ONE SUBCLASS PER BLOCK)
BRANN		128	782
		600	595
		601	34
IF REISSUE, ORIGINAL PATENT NUMBER		482	8 901
		340	686.1
		702	101
INTERNATIONAL CLASSIFICATION		GROUP ART UNIT	
A 63 B	69/00		
G 09 B	9/00		
	/		
	/	ASSISTANT EXAMINER (PLEASE STAMP OR PRINT FULL NAME)	
		3713	
		PRIMARY EXAMINER (PLEASE STAMP OR PRINT FULL NAME)	
		JOS H. CHENG	

PTO 270
(REV. 5-91)

ISSUE CLASSIFICATION SLIP

U.S. DEPARTMENT OF COMMERCE
PATENT AND TRADEMARK OFFICE

Staple Issue Slip Here

POSITION	ID NO.	DATE
CLASSIFIER		
EXAMINER	60854	3-6-78
TYPIST		
VERIFIER		
CORPS CORR.		
SPEC. HAND		
FILE MAINT.		
DRAFTING		

INDEX OF CLAIMS

Claim	Final	Original	Date
1	1	1	
2	2	2	
3	3	3	
4	4	4	
5	5	5	
6	6	6	
7	7	7	
8	8	8	
9	9	9	
10	10	10	
11	11	11	
12	12	12	
13	13	13	
14	14	14	
15	15	15	
16	16	16	
17	17	17	
18	18	18	
19	19	19	
20	20	20	
21	21	21	
22	22	22	
23	23	23	
24	24	24	
25	25	25	
26	26	26	
27	27	27	
28	28	28	
29	29	29	
30	30	30	
31			
32			
33			
34			
35			
36			
37			
38			
39			
40			
41			
42			
43			
44			
45			
46			
47			
48			
49			
50			

Claim	Final	Original	Date
51			
52			
53			
54			
55			
56			
57			
58			
59			
60			
61			
62			
63			
64			
65			
66			
67			
68			
69			
70			
71			
72			
73			
74			
75			
76			
77			
78			
79			
80			
81			
82			
83			
84			
85			
86			
87			
88			
89			
90			
91			
92			
93			
94			
95			
96			
97			
98			
99			
100			

- SYMBOLS
- ✓ Rejected
 - = Allowed
 - (Through numeral) Canceled
 - + Restricted
 - W Non-elected
 - I Interference
 - A Appeal
 - O Objected

(1 FEET INSIDE)

