

AO 120 (Rev. 08/10)

<b>TO:</b> <b>Mail Stop 8</b> <b>Director of the U.S. Patent and Trademark Office</b> <b>P.O. Box 1450</b> <b>Alexandria, VA 22313-1450</b>	<b>REPORT ON THE</b> <b>FILING OR DETERMINATION OF AN</b> <b>ACTION REGARDING A PATENT OR</b> <b>TRADEMARK</b>
---	---

In Compliance with 35 U.S.C. § 290 and/or 15 U.S.C. § 1116 you are hereby advised that a court action has been filed in the U.S. District Court Eastern District of Texas, Marshall Division on the following  
 Trademarks or  Patents. (  the patent action involves 35 U.S.C. § 292.);

DOCKET NO. 2:16-cv-777	DATE FILED 7/15/2016	U.S. DISTRICT COURT Eastern District of Texas, Marshall Division
PLAINTIFF UNILOC USA, INC., and UNILOC LUXEMBOURG, S.A.		DEFENDANT AVAYA INC.,
PATENT OR TRADEMARK NO.	DATE OF PATENT OR TRADEMARK	HOLDER OF PATENT OR TRADEMARK
1 7,535,890	5/19/2009	UNILOC LUXEMBOURG, S.A.
2 8,995,433	3/31/2015	UNILOC LUXEMBOURG, S.A.
3 8,724,622	5/13/2014	UNILOC LUXEMBOURG, S.A.
4 8,243,723	8/14/2012	UNILOC LUXEMBOURG, S.A.
5 8,199,747	6/12/2012	UNILOC LUXEMBOURG, S.A.

In the above—entitled case, the following patent(s)/ trademark(s) have been included:

DATE INCLUDED	INCLUDED BY <input type="checkbox"/> Amendment <input type="checkbox"/> Answer <input type="checkbox"/> Cross Bill <input type="checkbox"/> Other Pleading		
PATENT OR TRADEMARK NO.	DATE OF PATENT OR TRADEMARK	HOLDER OF PATENT OR TRADEMARK	
1			
2			
3			
4			
5			

In the above—entitled case, the following decision has been rendered or judgement issued:

DECISION/JUDGEMENT
--------------------

CLERK	(BY) DEPUTY CLERK	DATE
-------	-------------------	------

Copy 1—Upon initiation of action, mail this copy to Director    Copy 3—Upon termination of action, mail this copy to Director  
 Copy 2—Upon filing document adding patent(s), mail this copy to Director    Copy 4—Case file copy

Apple 1024  
U.S. Pat. 8,243,723

AO 120 (Rev. 08/10)

<b>TO:</b> <b>Mail Stop 8</b> <b>Director of the U.S. Patent and Trademark Office</b> <b>P.O. Box 1450</b> <b>Alexandria, VA 22313-1450</b>	<b>REPORT ON THE</b> <b>FILING OR DETERMINATION OF AN</b> <b>ACTION REGARDING A PATENT OR</b> <b>TRADEMARK</b>
---	---

In Compliance with 35 U.S.C. § 290 and/or 15 U.S.C. § 1116 you are hereby advised that a court action has been filed in the U.S. District Court Eastern District of Texas, Marshall Division on the following  
 Trademarks or  Patents. (  the patent action involves 35 U.S.C. § 292.);

DOCKET NO. 2:16-cv-779	DATE FILED 7/15/2016	U.S. DISTRICT COURT Eastern District of Texas, Marshall Division
PLAINTIFF UNILOC USA, INC., and UNILOC LUXEMBOURG, S.A.		DEFENDANT SHORETEL, INC.
PATENT OR TRADEMARK NO.	DATE OF PATENT OR TRADEMARK	HOLDER OF PATENT OR TRADEMARK
1 7,535,890	5/19/2009	UNILOC LUXEMBOURG, S.A.
2 8,995,433	3/31/2015	UNILOC LUXEMBOURG, S.A.
3 8,724,622	5/13/2014	UNILOC LUXEMBOURG, S.A.
4 8,243,723	8/14/2012	UNILOC LUXEMBOURG, S.A.
5		

In the above—entitled case, the following patent(s)/ trademark(s) have been included:

DATE INCLUDED	INCLUDED BY <input type="checkbox"/> Amendment <input type="checkbox"/> Answer <input type="checkbox"/> Cross Bill <input type="checkbox"/> Other Pleading	
PATENT OR TRADEMARK NO.	DATE OF PATENT OR TRADEMARK	HOLDER OF PATENT OR TRADEMARK
1		
2		
3		
4		
5		

In the above—entitled case, the following decision has been rendered or judgement issued:

DECISION/JUDGEMENT
--------------------

CLERK	(BY) DEPUTY CLERK	DATE
-------	-------------------	------

Copy 1—Upon initiation of action, mail this copy to Director    Copy 3—Upon termination of action, mail this copy to Director  
 Copy 2—Upon filing document adding patent(s), mail this copy to Director    Copy 4—Case file copy



UNITED STATES PATENT AND TRADEMARK OFFICE

UNITED STATES DEPARTMENT OF COMMERCE  
United States Patent and Trademark Office  
Address: COMMISSIONER FOR PATENTS  
P.O. Box 1450  
Alexandria, Virginia 22313-1450  
www.uspto.gov

APPLICATION NUMBER	FILING OR 371(C) DATE	FIRST NAMED APPLICANT	ATTY. DOCKET NO./TITLE
10/740,030	12/18/2003	Michael J. Rojas	EMP0021-US

**CONFIRMATION NO. 1731**

**POA ACCEPTANCE LETTER**

67050  
KASHA LAW LLC  
14532 Dufief Mill Road  
North Potomac, MD 20878



Date Mailed: 09/10/2013

**NOTICE OF ACCEPTANCE OF POWER OF ATTORNEY**

This is in response to the Power of Attorney filed 08/27/2013.

The Power of Attorney in this application is accepted. Correspondence in this application will be mailed to the above address as provided by 37 CFR 1.33.

/sharris/

Office of Data Management, Application Assistance Unit (571) 272-4000, or (571) 272-4200, or 1-888-786-0101



UNITED STATES PATENT AND TRADEMARK OFFICE

UNITED STATES DEPARTMENT OF COMMERCE  
United States Patent and Trademark Office  
Address: COMMISSIONER FOR PATENTS  
P.O. Box 1450  
Alexandria, Virginia 22313-1450  
www.uspto.gov

APPLICATION NUMBER	FILING OR 371(C) DATE	FIRST NAMED APPLICANT	ATTY. DOCKET NO./TITLE
10/740,030	12/18/2003	Michael J. Rojas	17188

**CONFIRMATION NO. 1731**

**POWER OF ATTORNEY NOTICE**

23389  
SCULLY SCOTT MURPHY & PRESSER, PC  
400 GARDEN CITY PLAZA  
SUITE 300  
GARDEN CITY, NY 11530



Date Mailed: 09/10/2013

**NOTICE REGARDING CHANGE OF POWER OF ATTORNEY**

This is in response to the Power of Attorney filed 08/27/2013.

- The Power of Attorney to you in this application has been revoked by the assignee who has intervened as provided by 37 CFR 3.71. Future correspondence will be mailed to the new address of record(37 CFR 1.33).

/sharris/

Office of Data Management, Application Assistance Unit (571) 272-4000, or (571) 272-4200, or 1-888-786-0101

Under the Paperwork Reduction Act of 1995, no persons are required to respond to a collection of information unless it displays a valid OMB control number.

**POWER OF ATTORNEY  
OR  
REVOCAION OF POWER OF ATTORNEY  
WITH A NEW POWER OF ATTORNEY  
AND  
CHANGE OF CORRESPONDENCE ADDRESS**

Application Number	10740090
Filing Date	2003-12-18
First Named Inventor	Michael J. Rojas
Title	System and Method for Instant VoIP Message
Art Unit	2814
Examiner Name	Craigton H. Smith
Attorney Docket Number	EMP0021-US

I hereby revoke all previous powers of attorney given in the above-identified application.

 A Power of Attorney is submitted herewith.

OR

 I hereby appoint Practitioner(s) associated with the following Customer Number as my/our attorney(s) or agent(s) to prosecute the application identified above, and to transact all business in the United States Patent and Trademark Office connected therewith:

67050

OR

 I hereby appoint Practitioner(s) named below as my/our attorney(s) or agent(s) to prosecute the application identified above, and to transact all business in the United States Patent and Trademark Office connected therewith:

Practitioner(s) Name	Registration Number

Please recognize or change the correspondence address for the above-identified application to:

 The address associated with the above-mentioned Customer Number.

OR

 The address associated with Customer Number:

OR

 Firm or Individual Name

Address

City

State

Zip

Country

Telephone

Email

I am the:

 Applicant/Inventor.

OR

 Assignee of record of the entire interest. See 37 CFR 3.71.

Statement under 37 CFR 3.73(b) (Form PTO/SB/96) submitted herewith or filed on \_\_\_\_\_.

SIGNATURE of Applicant or Assignee of Record

Signature		Date	8-27-2013
Name	Daniel Mitry	Telephone	
Title and Company	Principal, Empirs IP LLC		

NOTE: Signatures of all the inventors or assignees of record of the entire interest or their representative(s) are required. Submit multiple forms if more than one signature is required, see below.

 \*Total of 1 forms are submitted.

This collection of information is required by 37 CFR 1.31, 1.32 and 1.33. The information is required to obtain or retain a benefit by the public which is to file (and by the USPTO to process) an application. Confidentiality is governed by 35 U.S.C. 422 and 27 CFR 1.11 and 1.14. This collection is estimated to take 3 minutes to complete, including gathering, preparing, and submitting the completed application form to the USPTO. Time will vary depending upon the individual case. Any comments on the amount of time you require to complete this form and/or suggestions for reducing this burden, should be sent to the Chief Information Officer, U.S. Patent and Trademark Office, U.S. Department of Commerce, P.O. Box 1450, Alexandria, VA 22313-1450. DO NOT SEND FEES OR COMPLETED FORMS TO THIS ADDRESS. SEND TO: Commissioner for Patents, P.O. Box 1450, Alexandria, VA 22313-1450.

If you need assistance in completing the form, call 1-800-PTO-9199 and select option 2.

**STATEMENT UNDER 37 CFR 3.73(b)**Applicant/Patent Owner: Empire IP LLCApplication No./Patent No.: 7,535,890Filed/Issue Date: 2009-05-19Titled: System and Method for Instant VoIP Messaging

Empire IP LLC, a Corporation

(Name of Assignee)

(Type of Assignee, e.g., corporation, partnership, university, government agency, etc.)

states that it is:

1.  the assignee of the entire right, title, and interest in;
2.  an assignee of less than the entire right, title, and interest in (The extent (by percentage) of its ownership interest is \_\_\_\_\_ %); or
3.  the assignee of an undivided interest in the entirety of (a complete assignment from one of the joint inventors was made)

the patent application/patent identified above, by virtue of either:

- A.  An assignment from the inventor(s) of the patent application/patent identified above. The assignment was recorded in the United States Patent and Trademark Office at Reel \_\_\_\_\_, Frame \_\_\_\_\_, or for which a copy therefore is attached.

OR

- B.  A chain of title from the inventor(s), of the patent application/patent identified above, to the current assignee as follows:

1. From: Rojas, Michael J. To: Ayalogic, Inc.The document was recorded in the United States Patent and Trademark Office at Reel 014827, Frame 0059, or for which a copy thereof is attached.2. From: Ayalogic, Inc. To: Empire IP LLCThe document was recorded in the United States Patent and Trademark Office at Reel 030922, Frame 0336, or for which a copy thereof is attached.

3. From: \_\_\_\_\_ To: \_\_\_\_\_

The document was recorded in the United States Patent and Trademark Office at Reel \_\_\_\_\_, Frame \_\_\_\_\_, or for which a copy thereof is attached.

- Additional documents in the chain of title are listed on a supplemental sheet(s).

- As required by 37 CFR 3.73(b)(1)(i), the documentary evidence of the chain of title from the original owner to the assignee was, or concurrently is being, submitted for recordation pursuant to 37 CFR 3.11.

(NOTE: A separate copy (i.e., a true copy of the original assignment document(s)) must be submitted to Assignment Division in accordance with 37 CFR Part 3, to record the assignment in the records of the USPTO. See MPEP 302.06)

The undersigned (whose title is supplied below) is authorized to act on behalf of the assignee.

Signature

Date

Daniel Mitry

Principal

Printed or Typed Name

Title

This collection of information is required by 37 CFR 3.73(b). The information is required to obtain or retain a benefit by the public which is to be (and by the USPTO to process) an application. Confidentiality is governed by 35 U.S.C. 122 and 37 CFR 1.11 and 1.14. This collection is estimated to take 12 minutes to complete, including gathering, preparing, and submitting the completed application form to the USPTO. Time will vary depending upon the individual case. Any comments on the amount of time you require to complete this form and/or suggestions for reducing this burden, should be sent to the Chief Information Officer, U.S. Patent and Trademark Office, U.S. Department of Commerce, P.O. Box 1450, Alexandria, VA 22313-1450. DO NOT SEND FEES OR COMPLETED FORMS TO THIS ADDRESS. SEND TO: Commissioner for Patents, P.O. Box 1450, Alexandria, VA 22313-1450.

## Electronic Acknowledgement Receipt

<b>EFS ID:</b>	16696004
<b>Application Number:</b>	10740030
<b>International Application Number:</b>	
<b>Confirmation Number:</b>	1731
<b>Title of Invention:</b>	SYSTEM AND METHOD FOR INSTANT VOIP MESSAGING
<b>First Named Inventor/Applicant Name:</b>	Michael J. Rojas
<b>Customer Number:</b>	23389
<b>Filer:</b>	John Kasha
<b>Filer Authorized By:</b>	
<b>Attorney Docket Number:</b>	17188
<b>Receipt Date:</b>	27-AUG-2013
<b>Filing Date:</b>	18-DEC-2003
<b>Time Stamp:</b>	13:36:56
<b>Application Type:</b>	Utility under 35 USC 111(a)

### Payment information:

Submitted with Payment	no
------------------------	----

### File Listing:

Document Number	Document Description	File Name	File Size(Bytes)/ Message Digest	Multi Part /.zip	Pages (if appl.)
1	Power of Attorney	EMP0021-US_poa_signed1.pdf	384208 <small>cf7dc5435967b29f44f0fde86261e8559f5c6868</small>	no	2

### Warnings:

### Information:

This Acknowledgement Receipt evidences receipt on the noted date by the USPTO of the indicated documents, characterized by the applicant, and including page counts, where applicable. It serves as evidence of receipt similar to a Post Card, as described in MPEP 503.

**New Applications Under 35 U.S.C. 111**

If a new application is being filed and the application includes the necessary components for a filing date (see 37 CFR 1.53(b)-(d) and MPEP 506), a Filing Receipt (37 CFR 1.54) will be issued in due course and the date shown on this Acknowledgement Receipt will establish the filing date of the application.

**National Stage of an International Application under 35 U.S.C. 371**

If a timely submission to enter the national stage of an international application is compliant with the conditions of 35 U.S.C. 371 and other applicable requirements a Form PCT/DO/EO/903 indicating acceptance of the application as a national stage submission under 35 U.S.C. 371 will be issued in addition to the Filing Receipt, in due course.

**New International Application Filed with the USPTO as a Receiving Office**

If a new international application is being filed and the international application includes the necessary components for an international filing date (see PCT Article 11 and MPEP 1810), a Notification of the International Application Number and of the International Filing Date (Form PCT/RO/105) will be issued in due course, subject to prescriptions concerning national security, and the date shown on this Acknowledgement Receipt will establish the international filing date of the application.





UNITED STATES PATENT AND TRADEMARK OFFICE

UNITED STATES DEPARTMENT OF COMMERCE  
United States Patent and Trademark Office  
Address: COMMISSIONER FOR PATENTS  
P.O. Box 1450  
Alexandria, Virginia 22313-1450  
www.uspto.gov

APPLICATION NO.	ISSUE DATE	PATENT NO.	ATTORNEY DOCKET NO.	CONFIRMATION NO.
10/740,030	05/19/2009	7535890	17188	1731

23389            7590            04/29/2009  
SCULLY SCOTT MURPHY & PRESSER, PC  
400 GARDEN CITY PLAZA  
SUITE 300  
GARDEN CITY, NY 11530

**ISSUE NOTIFICATION**

The projected patent number and issue date are specified above.

**Determination of Patent Term Adjustment under 35 U.S.C. 154 (b)**  
(application filed on or after May 29, 2000)

The Patent Term Adjustment is 799 day(s). Any patent to issue from the above-identified application will include an indication of the adjustment on the front page.

If a Continued Prosecution Application (CPA) was filed in the above-identified application, the filing date that determines Patent Term Adjustment is the filing date of the most recent CPA.

Applicant will be able to obtain more detailed information by accessing the Patent Application Information Retrieval (PAIR) WEB site (<http://pair.uspto.gov>).

Any questions regarding the Patent Term Extension or Adjustment determination should be directed to the Office of Patent Legal Administration at (571)-272-7702. Questions relating to issue and publication fee payments should be directed to the Customer Service Center of the Office of Patent Publication at (571)-272-4200.

APPLICANT(s) (Please see PAIR WEB site <http://pair.uspto.gov> for additional applicants):

Michael J. Rojas, North Canton, OH;



UNITED STATES PATENT AND TRADEMARK OFFICE

UNITED STATES DEPARTMENT OF COMMERCE
United States Patent and Trademark Office
Address: COMMISSIONER FOR PATENTS
P.O. Box 1450
Alexandria, Virginia 22313-1450
www.uspto.gov

Table with 5 columns: APPLICATION NO., FILING DATE, FIRST NAMED INVENTOR, ATTORNEY DOCKET NO., CONFIRMATION NO.
10/740,030 12/18/2003 Michael J. Rojas 17188 1731

23389 7590 04/22/2009
SCULLY SCOTT MURPHY & PRESSER, PC
400 GARDEN CITY PLAZA
SUITE 300
GARDEN CITY, NY 11530

Table with 1 column: EXAMINER

SMITH, CREIGHTON H

Table with 2 columns: ART UNIT, PAPER NUMBER

2614

Table with 2 columns: MAIL DATE, DELIVERY MODE

04/22/2009

PAPER

Please find below and/or attached an Office communication concerning this application or proceeding.

The time period for reply, if any, is set in the attached communication.

<b>Notice of Allowability</b>	<b>Application No.</b>	<b>Applicant(s)</b>	
	10/740,030	ROJAS, MICHAEL J.	
	<b>Examiner</b>	<b>Art Unit</b>	
	CREIGHTON SMITH	2614	

**-- The MAILING DATE of this communication appears on the cover sheet with the correspondence address--**

All claims being allowable, PROSECUTION ON THE MERITS IS (OR REMAINS) CLOSED in this application. If not included herewith (or previously mailed), a Notice of Allowance (PTOL-85) or other appropriate communication will be mailed in due course. **THIS NOTICE OF ALLOWABILITY IS NOT A GRANT OF PATENT RIGHTS.** This application is subject to withdrawal from issue at the initiative of the Office or upon petition by the applicant. See 37 CFR 1.313 and MPEP 1308.

1.  This communication is responsive to ids filed on 02.27.09.
2.  The allowed claim(s) is/are 1-5,7-20,22-35,37-45,47-57,59-69 and 71-76.
3.  Acknowledgment is made of a claim for foreign priority under 35 U.S.C. § 119(a)-(d) or (f).
  - a)  All    b)  Some\*    c)  None    of the:
    1.  Certified copies of the priority documents have been received.
    2.  Certified copies of the priority documents have been received in Application No. \_\_\_\_\_.
    3.  Copies of the certified copies of the priority documents have been received in this national stage application from the International Bureau (PCT Rule 17.2(a)).

\* Certified copies not received: \_\_\_\_\_.

Applicant has THREE MONTHS FROM THE "MAILING DATE" of this communication to file a reply complying with the requirements noted below. Failure to timely comply will result in ABANDONMENT of this application.

**THIS THREE-MONTH PERIOD IS NOT EXTENDABLE.**

4.  A SUBSTITUTE OATH OR DECLARATION must be submitted. Note the attached EXAMINER'S AMENDMENT or NOTICE OF INFORMAL PATENT APPLICATION (PTO-152) which gives reason(s) why the oath or declaration is deficient.
  5.  CORRECTED DRAWINGS ( as "replacement sheets") must be submitted.
    - (a)  including changes required by the Notice of Draftsperson's Patent Drawing Review ( PTO-948) attached
      - 1)  hereto or 2)  to Paper No./Mail Date \_\_\_\_\_.
    - (b)  including changes required by the attached Examiner's Amendment / Comment or in the Office action of Paper No./Mail Date \_\_\_\_\_.
- Identifying indicia such as the application number (see 37 CFR 1.84(c)) should be written on the drawings in the front (not the back) of each sheet. Replacement sheet(s) should be labeled as such in the header according to 37 CFR 1.121(d).**
6.  DEPOSIT OF and/or INFORMATION about the deposit of BIOLOGICAL MATERIAL must be submitted. Note the attached Examiner's comment regarding REQUIREMENT FOR THE DEPOSIT OF BIOLOGICAL MATERIAL.

**Attachment(s)**

- |  |   |
|--|---|
| <ol style="list-style-type: none"> <li>1. <input type="checkbox"/> Notice of References Cited (PTO-892)</li> <li>2. <input type="checkbox"/> Notice of Draftsperson's Patent Drawing Review (PTO-948)</li> <li>3. <input checked="" type="checkbox"/> Information Disclosure Statements (PTO/SB/08),<br/>Paper No./Mail Date <u>02.27.09</u></li> <li>4. <input type="checkbox"/> Examiner's Comment Regarding Requirement for Deposit of Biological Material</li> </ol> | <ol style="list-style-type: none"> <li>5. <input type="checkbox"/> Notice of Informal Patent Application</li> <li>6. <input type="checkbox"/> Interview Summary (PTO-413),<br/>Paper No./Mail Date _____.</li> <li>7. <input type="checkbox"/> Examiner's Amendment/Comment</li> <li>8. <input type="checkbox"/> Examiner's Statement of Reasons for Allowance</li> <li>9. <input type="checkbox"/> Other _____.</li> </ol> |
|--|---|

/CREIGHTON SMITH/  
Primary Examiner, Art Unit 2614

15 APR '09

Form PTO-1449 U.S. DEPARTMENT OF COMMERCE (REV. 7-80) PATENT AND TRADEMARK OFFICE		<b>Atty. Docket No. (Optional)</b> 17188		<b>Application Number</b> 10/740,030				
<b>INFORMATION DISCLOSURE CITATION</b> (Use several sheets if necessary)				<b>Applicant(s)</b> Michael Rojas				
				<b>Filing Date</b> December 18, 2003				
				<b>Group Art Unit</b> 2614				
<b>U.S. PATENT DOCUMENTS</b>								
EXAMINER INITIAL*		DOCUMENT NUMBER	DATE	NAME	CLASS	SUBCLASS	FILING DATE (if appropriate)	
	AA							
	AB							
	AC							
<b>FOREIGN PATENT DOCUMENTS</b>								
	REF	DOCUMENT NUMBER	DATE	COUNTRY	CLASS	SUBCLASS	TRANSLATION	
							YES	NO
<b>OTHER DOCUMENTS</b> (Including Author, Title, Date, Pertinent Pages, Etc.)								
		<a href="http://www.cisco.com/warp/public/cc/pd/nemnsw/callmn/prodlit/cm33_ds.htm">http://www.cisco.com/warp/public/cc/pd/nemnsw/callmn/prodlit/cm33_ds.htm</a> ; "Data Sheet Cisco CallManager Version 3.3", November 22, 2002.						
		<a href="http://www.cisco.com/en/US/products/hw/switches/ps1925/products_data_sheet_09186a00800a3c3d.html">http://www.cisco.com/en/US/products/hw/switches/ps1925/products_data_sheet_09186a00800a3c3d.html</a> ; "Data Sheet Cisco MGX 8000 Series" (date unknown).						
		<a href="http://www.hsteliann.com/english/?zone=3100-V21P">http://www.hsteliann.com/english/?zone=3100-V21P</a> ; "Telephone 3100-V21P", 2003.						
		<a href="http://www.linuxdevices.com/articles/AT5199947519.html">http://www.linuxdevices.com/articles/AT5199947519.html</a> ; "Device Profile: snom 100 VoIP phone", May 15, 2002.						
		<a href="http://www.pingtel.com/pr_xpressa.jsp">http://www.pingtel.com/pr_xpressa.jsp</a> ; "No limits with the advanced industry standard SIP phone; December 8, 2003.						
		AudioCoded Enabling Technology Products, TPM-1100 VoP Media Gateway Modules, copyright 2003.						
<b>EXAMINER</b> /Creighton Smith/			<b>DATE CONSIDERED</b> 04/15/2009					
* EXAMINER: Initial if reference considered, whether or not citation is in conformance with MPEP 609; draw line through citation if not in conformance and not considered. Include copy of this form with next communication to applicant.								



UNITED STATES PATENT AND TRADEMARK OFFICE

UNITED STATES DEPARTMENT OF COMMERCE  
United States Patent and Trademark Office  
Address: COMMISSIONER FOR PATENTS  
P.O. Box 1450  
Alexandria, Virginia 22313-1450  
www.uspto.gov

APPLICATION NO.	FILING DATE	FIRST NAMED INVENTOR	ATTORNEY DOCKET NO.	CONFIRMATION NO.
10/740,030	12/18/2003	Michael J. Rojas	17188	1731

23389 7590 04/16/2009  
SCULLY SCOTT MURPHY & PRESSER, PC  
400 GARDEN CITY PLAZA  
SUITE 300  
GARDEN CITY, NY 11530

EXAMINER

SMITH, CREIGHTON H

ART UNIT	PAPER NUMBER
2614	

MAIL DATE	DELIVERY MODE
04/16/2009	PAPER

**Please find below and/or attached an Office communication concerning this application or proceeding.**

The time period for reply, if any, is set in the attached communication.

<b>supplemental Notice of Allowability</b>	<b>Application No.</b>	<b>Applicant(s)</b>	
	10/740,030	ROJAS, MICHAEL J.	
	<b>Examiner</b>	<b>Art Unit</b>	
	CREIGHTON SMITH	2614	

**-- The MAILING DATE of this communication appears on the cover sheet with the correspondence address--**

All claims being allowable, PROSECUTION ON THE MERITS IS (OR REMAINS) CLOSED in this application. If not included herewith (or previously mailed), a Notice of Allowance (PTOL-85) or other appropriate communication will be mailed in due course. **THIS NOTICE OF ALLOWABILITY IS NOT A GRANT OF PATENT RIGHTS.** This application is subject to withdrawal from issue at the initiative of the Office or upon petition by the applicant. See 37 CFR 1.313 and MPEP 1308.

1.  This communication is responsive to ids filed on 27 FEB '09.
2.  The allowed claim(s) is/are 1-5,7-20,22-35,37-45,47-57,59-69 and 71-76.
3.  Acknowledgment is made of a claim for foreign priority under 35 U.S.C. § 119(a)-(d) or (f).
  - a)  All    b)  Some\*    c)  None    of the:
    1.  Certified copies of the priority documents have been received.
    2.  Certified copies of the priority documents have been received in Application No. \_\_\_\_\_.
    3.  Copies of the certified copies of the priority documents have been received in this national stage application from the International Bureau (PCT Rule 17.2(a)).

\* Certified copies not received: \_\_\_\_\_.

Applicant has THREE MONTHS FROM THE "MAILING DATE" of this communication to file a reply complying with the requirements noted below. Failure to timely comply will result in ABANDONMENT of this application.  
**THIS THREE-MONTH PERIOD IS NOT EXTENDABLE.**

4.  A SUBSTITUTE OATH OR DECLARATION must be submitted. Note the attached EXAMINER'S AMENDMENT or NOTICE OF INFORMAL PATENT APPLICATION (PTO-152) which gives reason(s) why the oath or declaration is deficient.
5.  CORRECTED DRAWINGS ( as "replacement sheets") must be submitted.
  - (a)  including changes required by the Notice of Draftsperson's Patent Drawing Review ( PTO-948) attached
    - 1)  hereto or 2)  to Paper No./Mail Date \_\_\_\_\_.
  - (b)  including changes required by the attached Examiner's Amendment / Comment or in the Office action of Paper No./Mail Date \_\_\_\_\_.

**Identifying indicia such as the application number (see 37 CFR 1.84(c)) should be written on the drawings in the front (not the back) of each sheet. Replacement sheet(s) should be labeled as such in the header according to 37 CFR 1.121(d).**
6.  DEPOSIT OF and/or INFORMATION about the deposit of BIOLOGICAL MATERIAL must be submitted. Note the attached Examiner's comment regarding REQUIREMENT FOR THE DEPOSIT OF BIOLOGICAL MATERIAL.

**Attachment(s)**

- |  |  |
|--|--|
| 1. <input type="checkbox"/> Notice of References Cited (PTO-892)   | 5. <input type="checkbox"/> Notice of Informal Patent Application                      |
| 2. <input type="checkbox"/> Notice of Draftsperson's Patent Drawing Review (PTO-948)   | 6. <input type="checkbox"/> Interview Summary (PTO-413),<br>Paper No./Mail Date _____. |
| 3. <input checked="" type="checkbox"/> Information Disclosure Statements (PTO/SB/08),<br>Paper No./Mail Date <u>02.27.09</u> | 7. <input type="checkbox"/> Examiner's Amendment/Comment                               |
| 4. <input type="checkbox"/> Examiner's Comment Regarding Requirement for Deposit<br>of Biological Material                   | 8. <input type="checkbox"/> Examiner's Statement of Reasons for Allowance              |
|  | 9. <input type="checkbox"/> Other _____.   |

/CREIGHTON SMITH/  
Primary Examiner, Art Unit 2614

15 APR '09

Form PTO-1449 U.S. DEPARTMENT OF COMMERCE (REV. 7-80) PATENT AND TRADEMARK OFFICE		<b>Atty. Docket No. (Optional)</b> 17188		<b>Application Number</b> 10/740,030				
<b>INFORMATION DISCLOSURE CITATION</b> (Use several sheets if necessary)				<b>Applicant(s)</b> Michael Rojas				
				<b>Filing Date</b> December 18, 2003				
				<b>Group Art Unit</b> 2614				
<b>U.S. PATENT DOCUMENTS</b>								
EXAMINER INITIAL*		DOCUMENT NUMBER	DATE	NAME	CLASS	SUBCLASS	FILING DATE (if appropriate)	
	AA							
	AB							
	AC							
<b>FOREIGN PATENT DOCUMENTS</b>								
	REF	DOCUMENT NUMBER	DATE	COUNTRY	CLASS	SUBCLASS	TRANSLATION	
							YES	NO
<b>OTHER DOCUMENTS</b> (Including Author, Title, Date, Pertinent Pages, Etc.)								
		<a href="http://www.cisco.com/warp/public/cc/pd/nemnsw/callmn/prodlit/cm33_ds.htm">http://www.cisco.com/warp/public/cc/pd/nemnsw/callmn/prodlit/cm33_ds.htm</a> ; "Data Sheet Cisco CallManager Version 3.3", November 22, 2002.						
		<a href="http://www.cisco.com/en/US/products/hw/switches/ps1925/products_data_sheet_09186a00800a3c3d.html">http://www.cisco.com/en/US/products/hw/switches/ps1925/products_data_sheet_09186a00800a3c3d.html</a> ; "Data Sheet Cisco MGX 8000 Series" (date unknown).						
		<a href="http://www.hsteliann.com/english/?zone=3100-V21P">http://www.hsteliann.com/english/?zone=3100-V21P</a> ; "Telephone 3100-V21P", 2003.						
		<a href="http://www.linuxdevices.com/articles/AT5199947519.html">http://www.linuxdevices.com/articles/AT5199947519.html</a> ; "Device Profile: snom 100 VoIP phone", May 15, 2002.						
		<a href="http://www.pingtel.com/pr_xpressa.jsp">http://www.pingtel.com/pr_xpressa.jsp</a> ; "No limits with the advanced industry standard SIP phone; December 8, 2003.						
		AudioCoded Enabling Technology Products, TPM-1100 VoP Media Gateway Modules, copyright 2003.						
<b>EXAMINER</b> /Creighton Smith/			<b>DATE CONSIDERED</b> 03/04/2009					
* EXAMINER: Initial if reference considered, whether or not citation is in conformance with MPEP 609; draw line through citation if not in conformance and not considered. Include copy of this form with next communication to applicant.								

Please enter this IDS.

CHS

04 MAR '09

J:\Work\1732\17188\Misc\supplemental1449.doc

ALL REFERENCES CONSIDERED EXCEPT WHERE LINED THROUGH. /C.S./

**PART B - FEE(S) TRANSMITTAL**

Complete and send this form, together with applicable fee(s), to: **Mail** Mail Stop ISSUE FEE  
**Commissioner for Patents**  
**P.O. Box 1450**  
**Alexandria, Virginia 22313-1450**  
**or Fax (571)-273-2885**

**INSTRUCTIONS:** This form should be used for transmitting the ISSUE FEE and PUBLICATION FEE (if required). Blocks 1 through 5 should be completed where appropriate. All further correspondence including the Patent, advance orders and notification of maintenance fees will be mailed to the current correspondence address as indicated unless corrected below or directed otherwise in Block 1, by (a) specifying a new correspondence address; and/or (b) indicating a separate "FEE ADDRESS" for maintenance fee notifications.

CURRENT CORRESPONDENCE ADDRESS (Note: Use Block 1 for any change of address)

Note: A certificate of mailing can only be used for domestic mailings of the Fee(s) Transmittal. This certificate cannot be used for any other accompanying papers. Each additional paper, such as an assignment or formal drawing, must have its own certificate of mailing or transmission.

23389 7590 12/05/2008

**SCULLY SCOTT MURPHY & PRESSER, PC**  
**400 GARDEN CITY PLAZA**  
**SUITE 300**  
**GARDEN CITY, NY 11530**

**Certificate of Mailing or Transmission**

I hereby certify that this Fee(s) Transmittal is being deposited with the United States Postal Service with sufficient postage for first class mail in an envelope addressed to the Mail Stop ISSUE FEE address above, or being facsimile transmitted to the USPTO (571) 273-2885, on the date indicated below.

(Depositor's name)
(Signature)
(Date)

APPLICATION NO.	FILING DATE	FIRST NAMED INVENTOR	ATTORNEY DOCKET NO.	CONFIRMATION NO.
-----------------	-------------	----------------------	---------------------	------------------

10/740,030 12/18/2003 Michael J. Rojas 17188 1731

TITLE OF INVENTION: SYSTEM AND METHOD FOR INSTANT VOIP MESSAGING

APPLN. TYPE	SMALL ENTITY	ISSUE FEE DUE	PUBLICATION FEE DUE	PREV. PAID ISSUE FEE	TOTAL FEE(S) DUE	DATE DUE
-------------	--------------	---------------	---------------------	----------------------	------------------	----------

nonprovisional YES \$755 \$300 \$0 \$1055 03/05/2009

EXAMINER	ART UNIT	CLASS-SUBCLASS
----------	----------	----------------

SMITH, CREIGHTON H 2614 370-352000

1. Change of correspondence address or indication of "Fee Address" (37 CFR 1.363).

- Change of correspondence address (or Change of Correspondence Address form PTO/SB/122) attached.
- "Fee Address" indication (or "Fee Address" Indication form PTO/SB/47; Rev 03-02 or more recent) attached. Use of a Customer Number is required.

2. For printing on the patent front page, list

- (1) the names of up to 3 registered patent attorneys or agents OR, alternatively,
- (2) the name of a single firm (having as a member a registered attorney or agent) and the names of up to 2 registered patent attorneys or agents. If no name is listed, no name will be printed.

1 Scully, Scott, Murphy  
 2 & Presser, P.C.  
 3 \_\_\_\_\_

3. ASSIGNEE NAME AND RESIDENCE DATA TO BE PRINTED ON THE PATENT (print or type)

PLEASE NOTE: Unless an assignee is identified below, no assignee data will appear on the patent. If an assignee is identified below, the document has been filed for recordation as set forth in 37 CFR 3.11. Completion of this form is NOT a substitute for filing an assignment.

(A) NAME OF ASSIGNEE **Ayalogic, Inc.** (B) RESIDENCE: (CITY AND STATE OR COUNTRY) **Akron, Ohio**

Please check the appropriate assignee category or categories (will not be printed on the patent):  Individual  Corporation or other private group entity  Government

4a. The following fee(s) are submitted:

- Issue Fee
- Publication Fee (No small entity discount permitted)
- Advance Order - # of Copies \_\_\_\_\_

4b. Payment of Fee(s): (Please first reapply any previously paid issue fee shown above)

- A check is enclosed.
- Payment by credit card. Form PTO-2038 is attached.
- The Director is hereby authorized to charge the required fee(s), any deficiency, or credit any overpayment, to Deposit Account Number \_\_\_\_\_ (enclose an extra copy of this form).

5. Change in Entity Status (from status indicated above)

- a. Applicant claims SMALL ENTITY status. See 37 CFR 1.27.
- b. Applicant is no longer claiming SMALL ENTITY status. See 37 CFR 1.27(g)(2).

NOTE: The Issue Fee and Publication Fee (if required) will not be accepted from anyone other than the applicant; a registered attorney or agent; or the assignee or other party in interest as shown by the records of the United States Patent and Trademark Office.

Authorized Signature   
 Typed or printed name **Paul J. Esatto, Jr.**

Date **March 5, 2009**  
 Registration No. **30,749**

This collection of information is required by 37 CFR 1.311. The information is required to obtain or retain a benefit by the public which is to file (and by the USPTO to process) an application. Confidentiality is governed by 35 U.S.C. 122 and 37 CFR 1.14. This collection is estimated to take 12 minutes to complete, including gathering, preparing, and submitting the completed application form to the USPTO. Time will vary depending upon the individual case. Any comments on the amount of time you require to complete this form and/or suggestions for reducing this burden, should be sent to the Chief Information Officer, U.S. Patent and Trademark Office, U.S. Department of Commerce, P.O. Box 1450, Alexandria, Virginia 22313-1450. DO NOT SEND FEES OR COMPLETED FORMS TO THIS ADDRESS. SEND TO: Commissioner for Patents, P.O. Box 1450, Alexandria, Virginia 22313-1450.

Under the Paperwork Reduction Act of 1995, no persons are required to respond to a collection of information unless it displays a valid OMB control number.



## Electronic Patent Application Fee Transmittal

<b>Application Number:</b>	10740030			
<b>Filing Date:</b>	18-Dec-2003			
<b>Title of Invention:</b>	SYSTEM AND METHOD FOR INSTANT VOIP MESSAGING			
<b>First Named Inventor/Applicant Name:</b>	Michael J. Rojas			
<b>Filer:</b>	Paul J. Esatto/Roseann Gallo			
<b>Attorney Docket Number:</b>	17188			
Filed as Small Entity				
<b>Utility under 35 USC 111(a) Filing Fees</b>				
<b>Description</b>	<b>Fee Code</b>	<b>Quantity</b>	<b>Amount</b>	<b>Sub-Total in USD(\$)</b>
<b>Basic Filing:</b>				
<b>Pages:</b>				
<b>Claims:</b>				
<b>Miscellaneous-Filing:</b>				
<b>Petition:</b>				
<b>Patent-Appeals-and-Interference:</b>				
<b>Post-Allowance-and-Post-Issuance:</b>				
Utility Appl issue fee	2501	1	755	755
Publ. Fee- early, voluntary, or normal	1504	1	300	300

Description	Fee Code	Quantity	Amount	Sub-Total in USD(\$)
<b>Extension-of-Time:</b>				
<b>Miscellaneous:</b>				
<b>Total in USD (\$)</b>				<b>1055</b>

## Electronic Acknowledgement Receipt

<b>EFS ID:</b>	4910739
<b>Application Number:</b>	10740030
<b>International Application Number:</b>	
<b>Confirmation Number:</b>	1731
<b>Title of Invention:</b>	SYSTEM AND METHOD FOR INSTANT VOIP MESSAGING
<b>First Named Inventor/Applicant Name:</b>	Michael J. Rojas
<b>Customer Number:</b>	23389
<b>Filer:</b>	Paul J. Esatto/Roseann Gallo
<b>Filer Authorized By:</b>	Paul J. Esatto
<b>Attorney Docket Number:</b>	17188
<b>Receipt Date:</b>	05-MAR-2009
<b>Filing Date:</b>	18-DEC-2003
<b>Time Stamp:</b>	14:46:57
<b>Application Type:</b>	Utility under 35 USC 111(a)

### Payment information:

Submitted with Payment	yes
Payment Type	Deposit Account
Payment was successfully received in RAM	\$1055
RAM confirmation Number	210
Deposit Account	191013
Authorized User	

The Director of the USPTO is hereby authorized to charge indicated fees and credit any overpayment as follows:

Charge any Additional Fees required under 37 C.F.R. Section 1.16 (National application filing, search, and examination fees)

Charge any Additional Fees required under 37 C.F.R. Section 1.17 (Patent application and reexamination processing fees)

<b>File Listing:</b>					
<b>Document Number</b>	<b>Document Description</b>	<b>File Name</b>	<b>File Size(Bytes)/ Message Digest</b>	<b>Multi Part /.zip</b>	<b>Pages (if appl.)</b>
1	Issue Fee Payment (PTO-85B)	17188ISSUEFEE.pdf	110917 e29ffedc3b5caca2f2525898457f5135a55a1b48	no	1
<b>Warnings:</b>					
<b>Information:</b>					
2	Fee Worksheet (PTO-06)	fee-info.pdf	31539 54cde0d55e656e647b7e751ab3273ed08b297f6b	no	2
<b>Warnings:</b>					
<b>Information:</b>					
<b>Total Files Size (in bytes):</b>			142456		
<p><b>This Acknowledgement Receipt evidences receipt on the noted date by the USPTO of the indicated documents, characterized by the applicant, and including page counts, where applicable. It serves as evidence of receipt similar to a Post Card, as described in MPEP 503.</b></p> <p><b><u>New Applications Under 35 U.S.C. 111</u></b>  <b>If a new application is being filed and the application includes the necessary components for a filing date (see 37 CFR 1.53(b)-(d) and MPEP 506), a Filing Receipt (37 CFR 1.54) will be issued in due course and the date shown on this Acknowledgement Receipt will establish the filing date of the application.</b></p> <p><b><u>National Stage of an International Application under 35 U.S.C. 371</u></b>  <b>If a timely submission to enter the national stage of an international application is compliant with the conditions of 35 U.S.C. 371 and other applicable requirements a Form PCT/DO/EO/903 indicating acceptance of the application as a national stage submission under 35 U.S.C. 371 will be issued in addition to the Filing Receipt, in due course.</b></p> <p><b><u>New International Application Filed with the USPTO as a Receiving Office</u></b>  <b>If a new international application is being filed and the international application includes the necessary components for an international filing date (see PCT Article 11 and MPEP 1810), a Notification of the International Application Number and of the International Filing Date (Form PCT/RO/105) will be issued in due course, subject to prescriptions concerning national security, and the date shown on this Acknowledgement Receipt will establish the international filing date of the application.</b></p>					

**TRANSMITTAL OF FORMAL DRAWINGS**

Docket No.

17188

In Re Application Of: **Michael J. Rojas**

Application No.	Filing Date	Examiner	Customer No.	Group Art Unit	Confirmation No.
10/740,030	December 18, 2003	Creighton H. Smith	23389	2614	1731

Invention: **SYSTEM AND METHOD FOR INSTANT VOIP MESSAGING**

Address to:  
**Commissioner for Patents  
P.O. Box 1450  
Alexandria, VA 22313-1450**

Transmitted herewith are:

9 sheets of formal drawing(s) for this application.

Each sheet of drawing indicates the identifying indicia suggested in 37 CFR Section 1.84(c).



*Seth Weinfeld*  
Signature

**Seth Weinfeld**  
Registration No.: 50,929  
Scully, Scott, Murphy & Presser, P.C.  
400 Garden City Plaza - Suite 300  
Garden City, New York 11530  
(516) 742-4343

Dated: **March 4, 2009**

I hereby certify that this correspondence is being deposited with the United States Postal Service with sufficient postage as first class mail in an envelope addressed to "Commissioner for Patents, P.O. Box 1450, Alexandria, VA 22313-1450" [37 CFR 1.8(a)] on

(Date)

Signature of Person Mailing Correspondence

Typed or Printed Name of Person Mailing Correspondence

## Electronic Acknowledgement Receipt

<b>EFS ID:</b>	4905745
<b>Application Number:</b>	10740030
<b>International Application Number:</b>	
<b>Confirmation Number:</b>	1731
<b>Title of Invention:</b>	SYSTEM AND METHOD FOR INSTANT VOIP MESSAGING
<b>First Named Inventor/Applicant Name:</b>	Michael J. Rojas
<b>Customer Number:</b>	23389
<b>Filer:</b>	Seth Weinfeld/Roseann Gallo
<b>Filer Authorized By:</b>	Seth Weinfeld
<b>Attorney Docket Number:</b>	17188
<b>Receipt Date:</b>	04-MAR-2009
<b>Filing Date:</b>	18-DEC-2003
<b>Time Stamp:</b>	18:20:16
<b>Application Type:</b>	Utility under 35 USC 111(a)

### Payment information:

Submitted with Payment	no
------------------------	----

### File Listing:

Document Number	Document Description	File Name	File Size(Bytes)/ Message Digest	Multi Part /.zip	Pages (if appl.)
1	Drawings-only black and white line drawings	17188formaldrawings.pdf	529689 <small>3e39aeaac05cc87f5d8c9b440a417396ccc63d8d</small>	no	9

### Warnings:

### Information:

2	Miscellaneous Incoming Letter	17188Transmittal.pdf	38729 <small>15ed4f36260aee585dd293d42104f24aceb b790</small>	no	1
<b>Warnings:</b>					
<b>Information:</b>					
<b>Total Files Size (in bytes):</b>			568418		
<p><b>This Acknowledgement Receipt evidences receipt on the noted date by the USPTO of the indicated documents, characterized by the applicant, and including page counts, where applicable. It serves as evidence of receipt similar to a Post Card, as described in MPEP 503.</b></p> <p><b><u>New Applications Under 35 U.S.C. 111</u></b>  <b>If a new application is being filed and the application includes the necessary components for a filing date (see 37 CFR 1.53(b)-(d) and MPEP 506), a Filing Receipt (37 CFR 1.54) will be issued in due course and the date shown on this Acknowledgement Receipt will establish the filing date of the application.</b></p> <p><b><u>National Stage of an International Application under 35 U.S.C. 371</u></b>  <b>If a timely submission to enter the national stage of an international application is compliant with the conditions of 35 U.S.C. 371 and other applicable requirements a Form PCT/DO/EO/903 indicating acceptance of the application as a national stage submission under 35 U.S.C. 371 will be issued in addition to the Filing Receipt, in due course.</b></p> <p><b><u>New International Application Filed with the USPTO as a Receiving Office</u></b>  <b>If a new international application is being filed and the international application includes the necessary components for an international filing date (see PCT Article 11 and MPEP 1810), a Notification of the International Application Number and of the International Filing Date (Form PCT/RO/105) will be issued in due course, subject to prescriptions concerning national security, and the date shown on this Acknowledgement Receipt will establish the international filing date of the application.</b></p>					

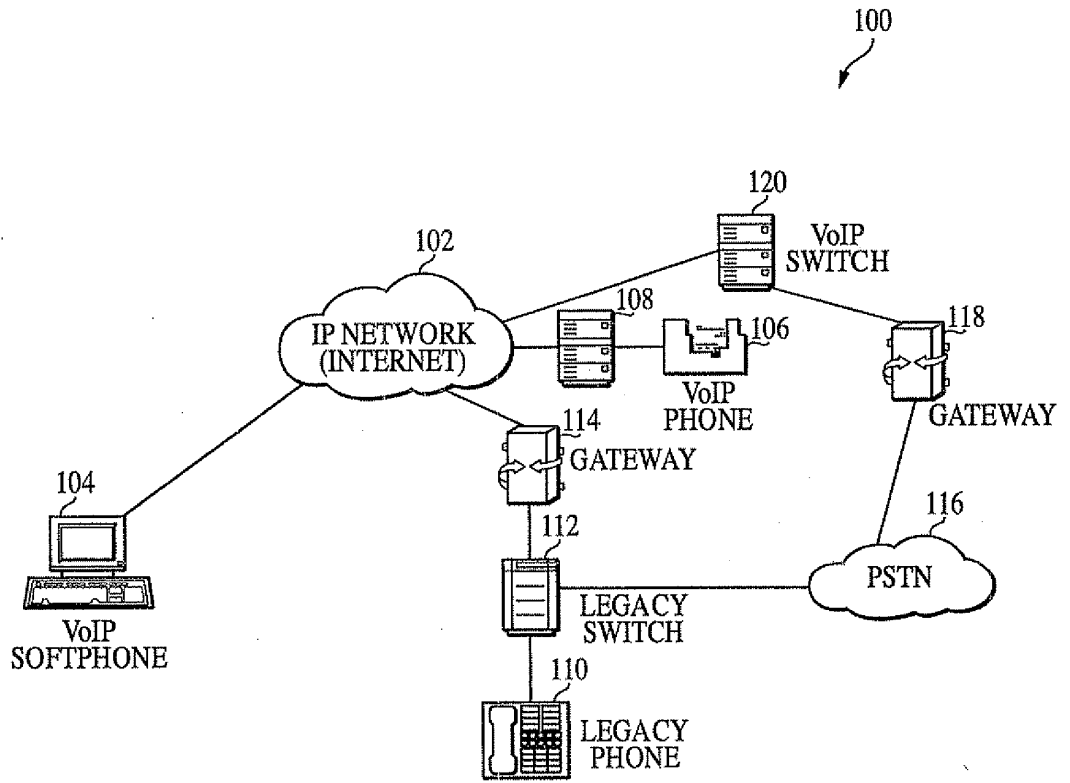

FIG. 1  
(PRIOR ART)



SYSTEM AND METHOD FOR INSTANT VOIP MESSAGING

Michael J. Rojas  
U.S. Serial No.: 10/740,030  
Replacement Sheet

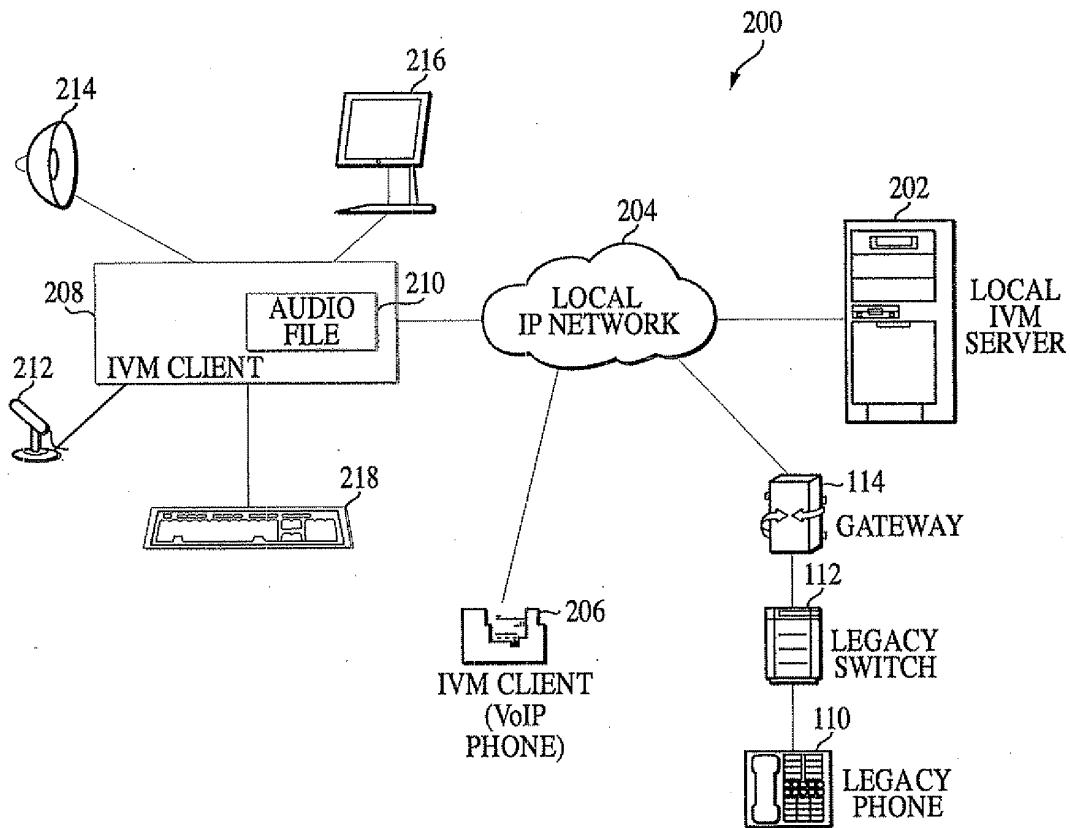

FIG. 2

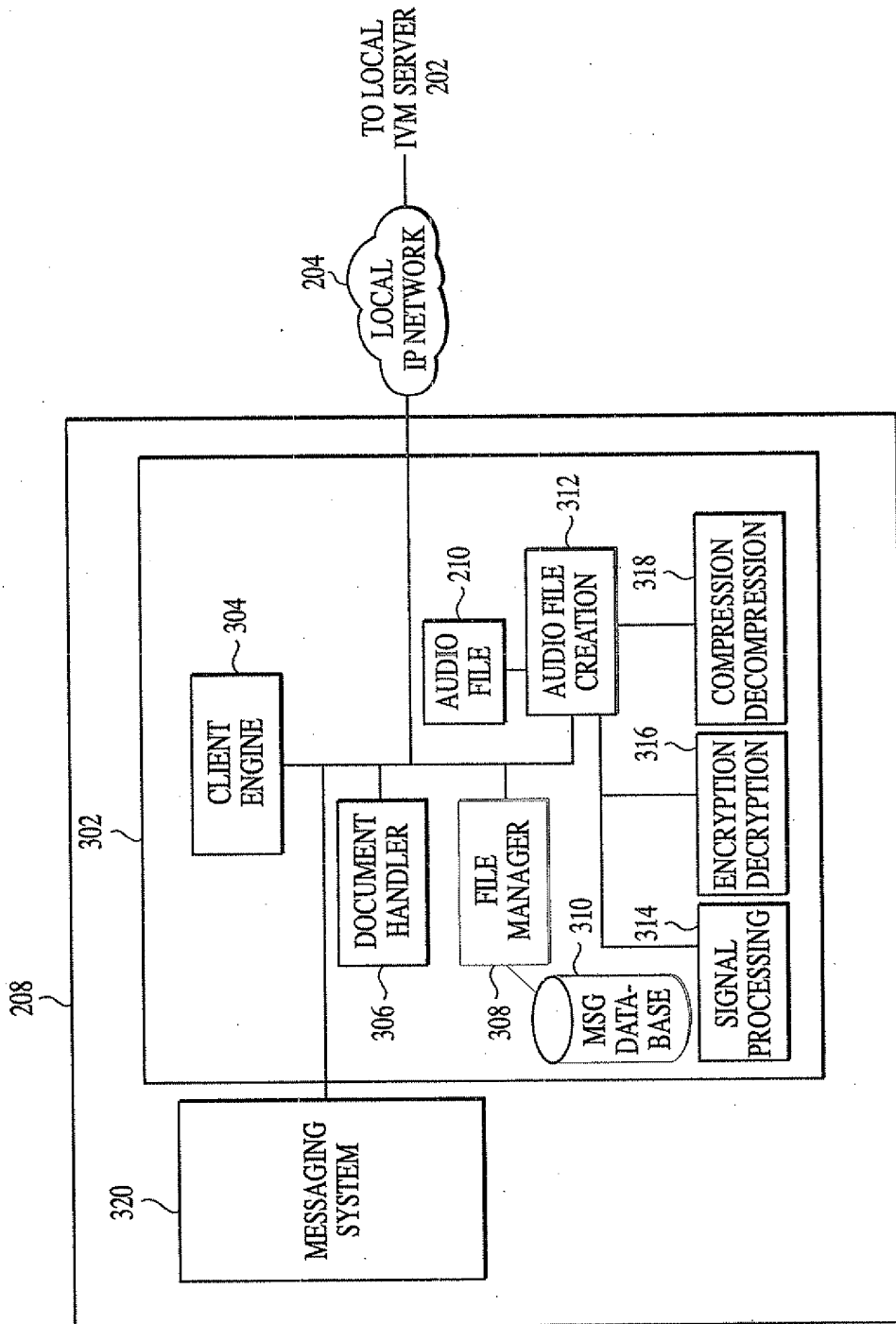

FIG. 3

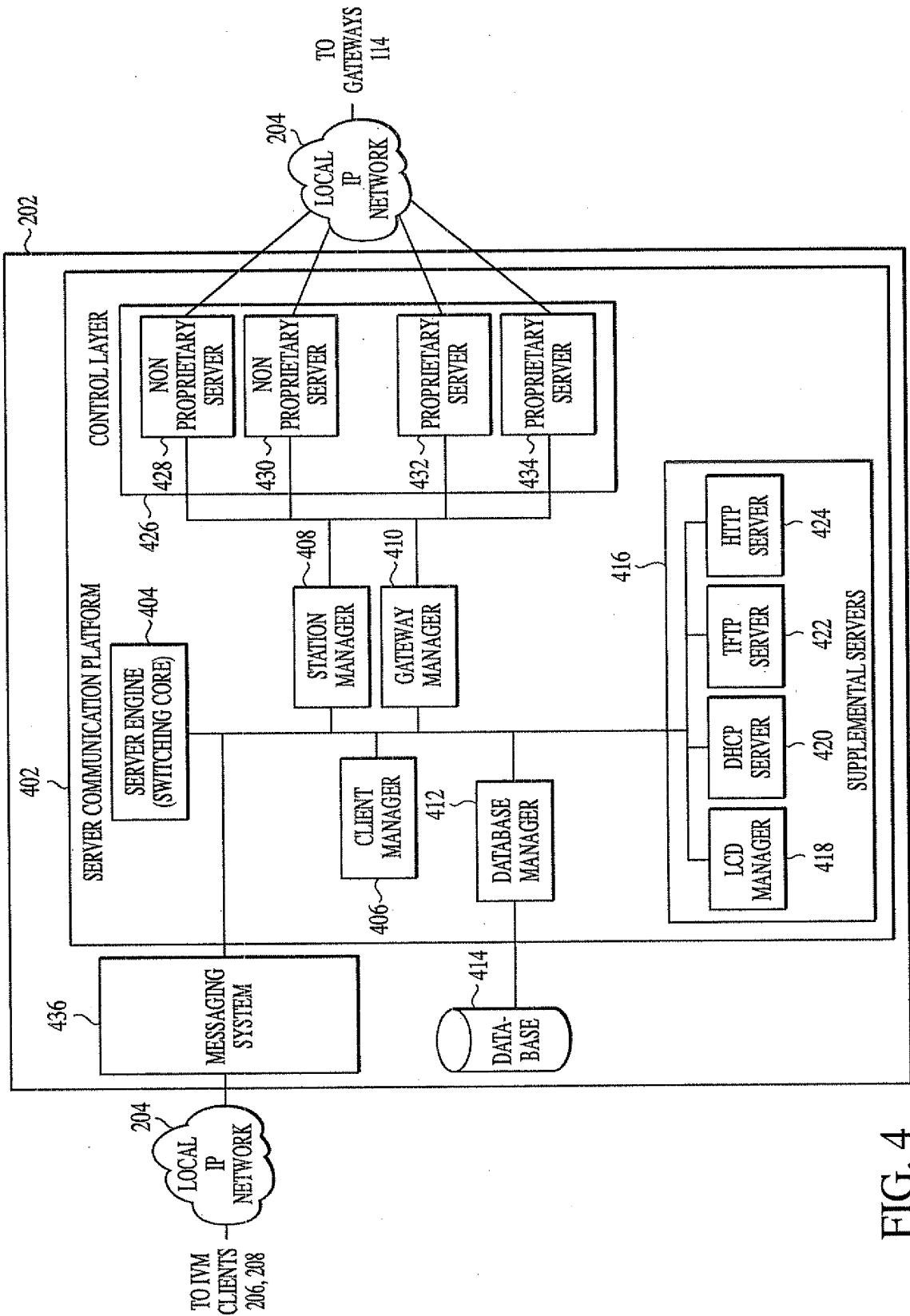

FIG. 4

SYSTEM AND METHOD FOR INSTANT VOIP MESSAGING

Michael J. Rojas  
 U.S. Serial No.: 10/740,030  
 Replacement Sheet

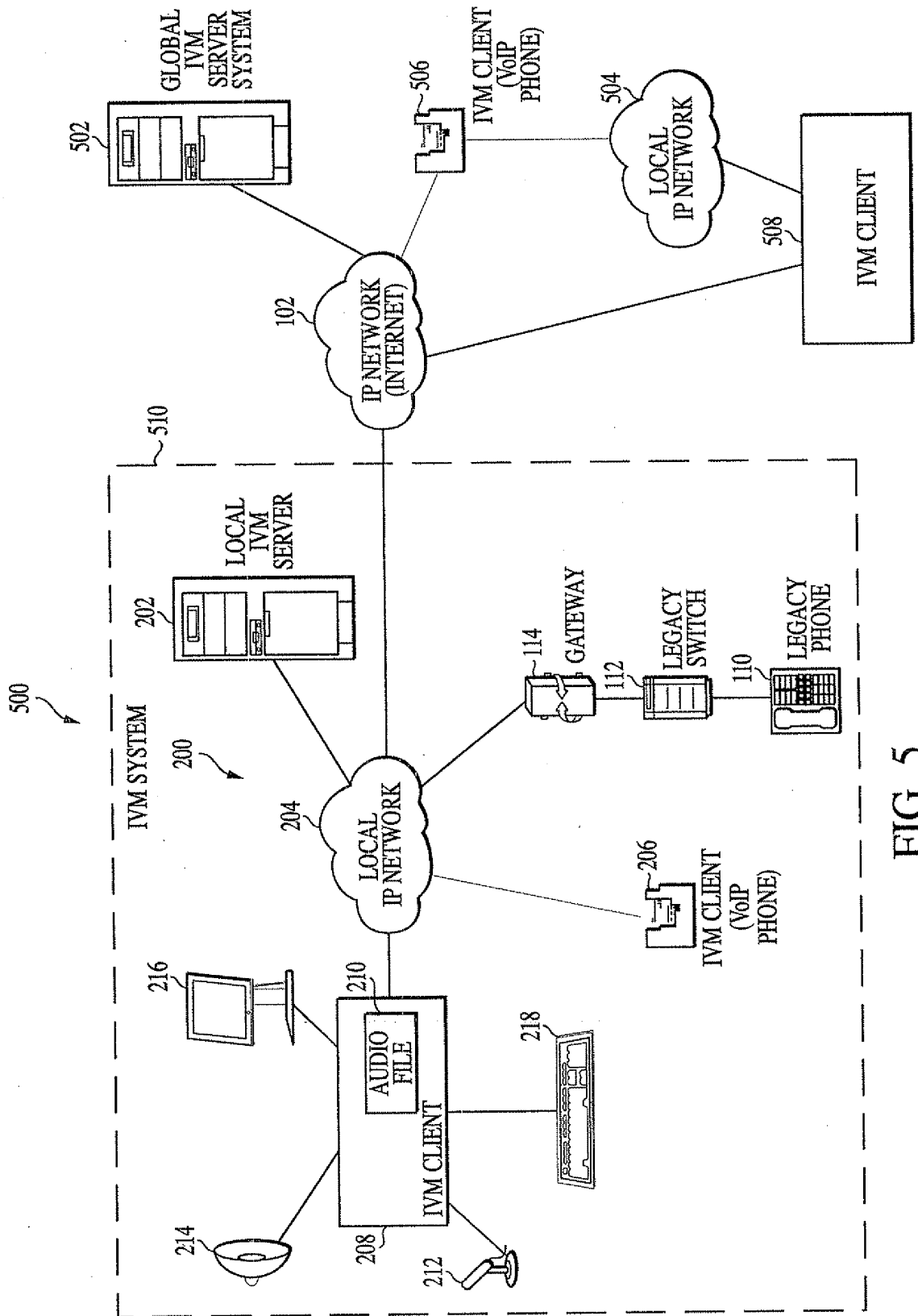

FIG. 5

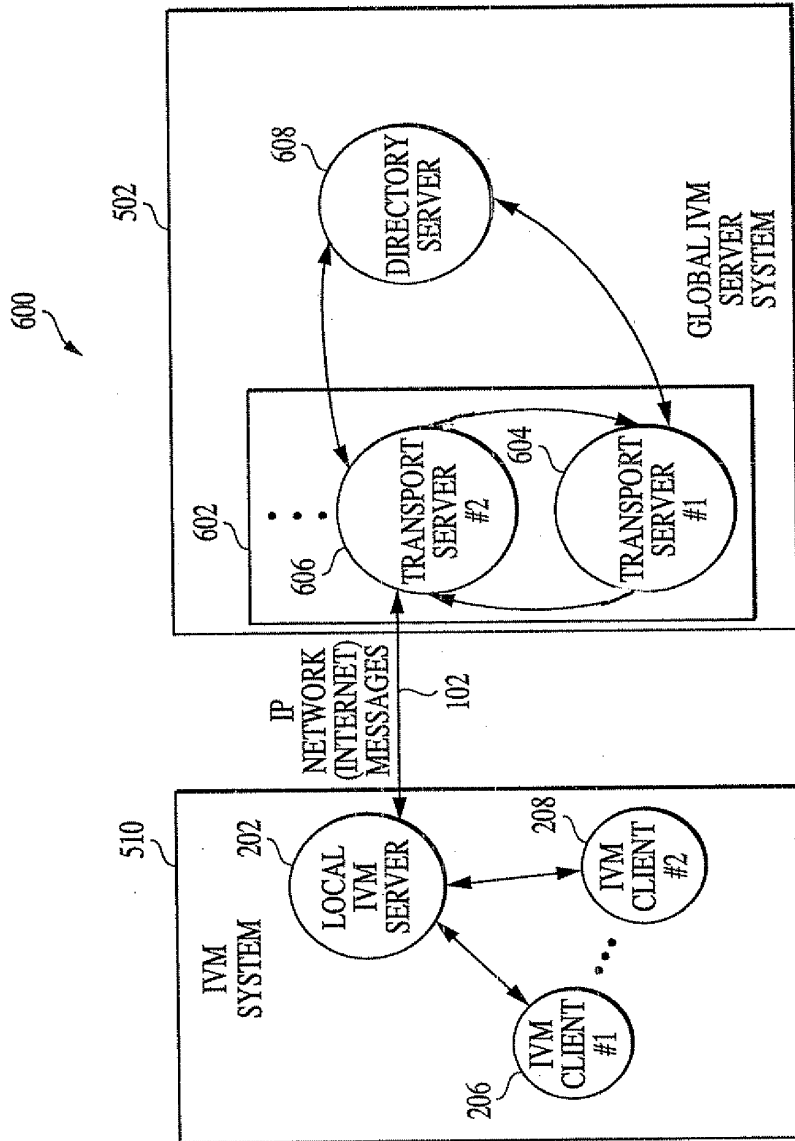

FIG. 6

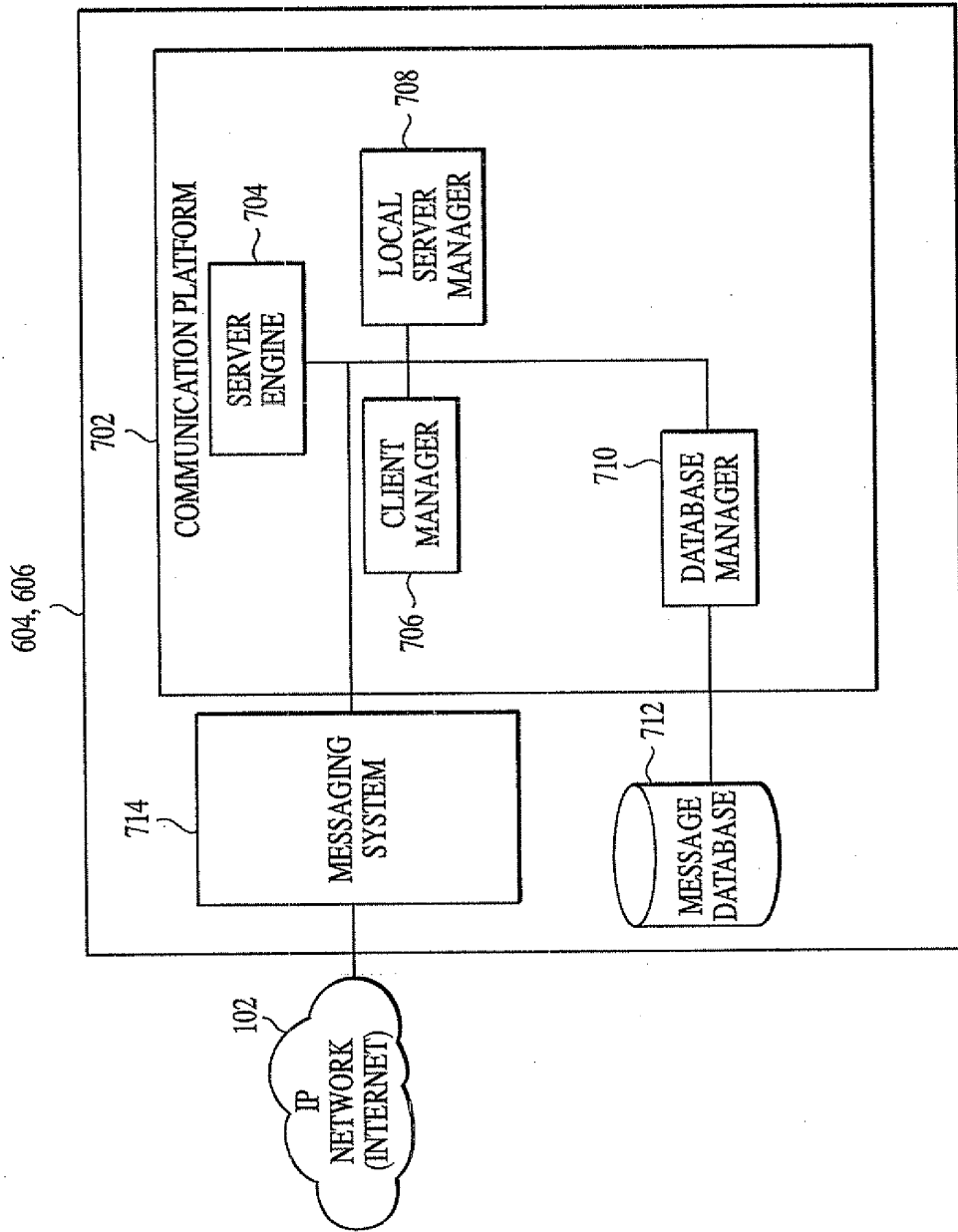

FIG. 7

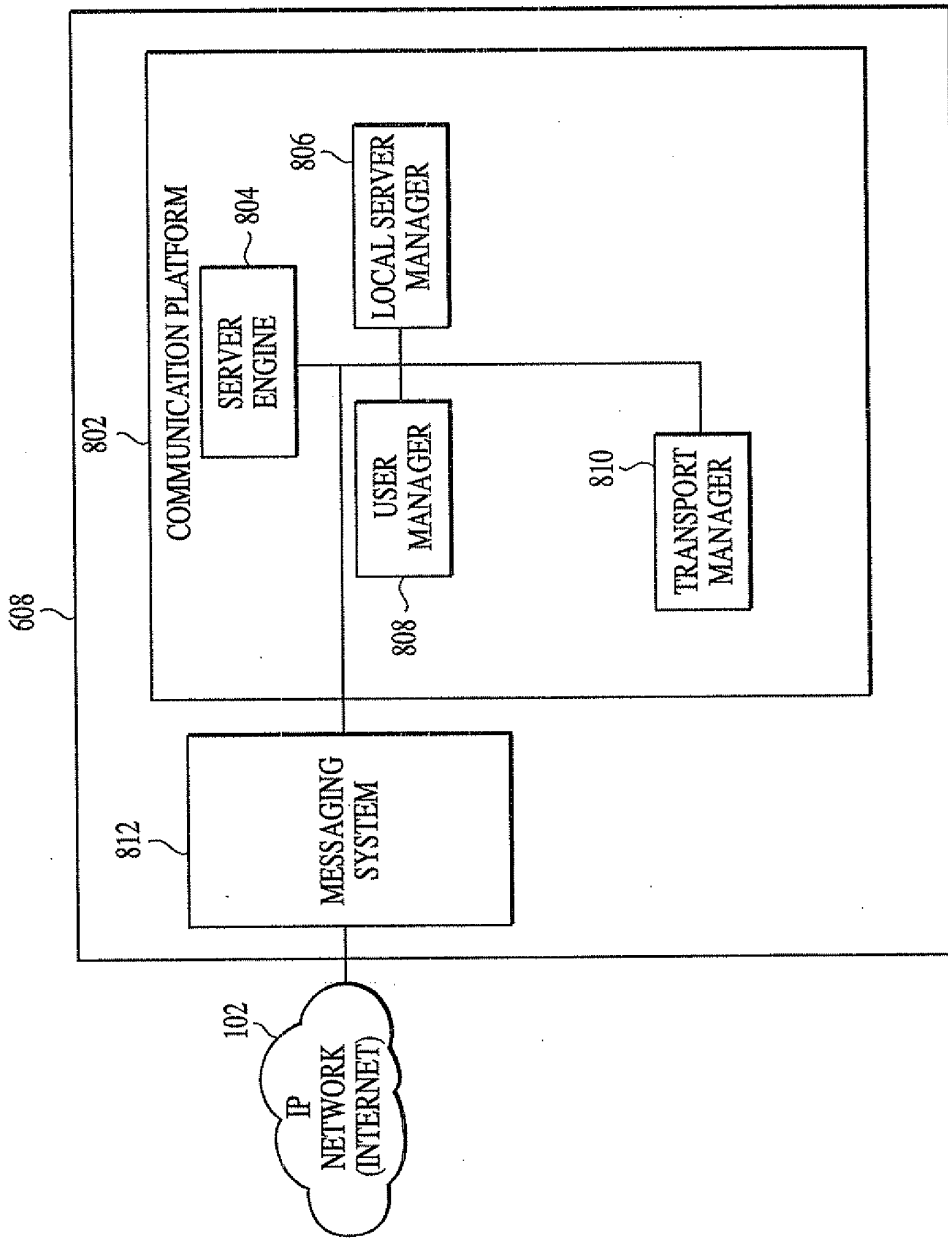

FIG. 8

SYSTEM AND METHOD FOR INSTANT VOIP MESSAGING

Michael J. Rojas  
 U.S. Serial No.: 10/740,030  
 Replacement Sheet

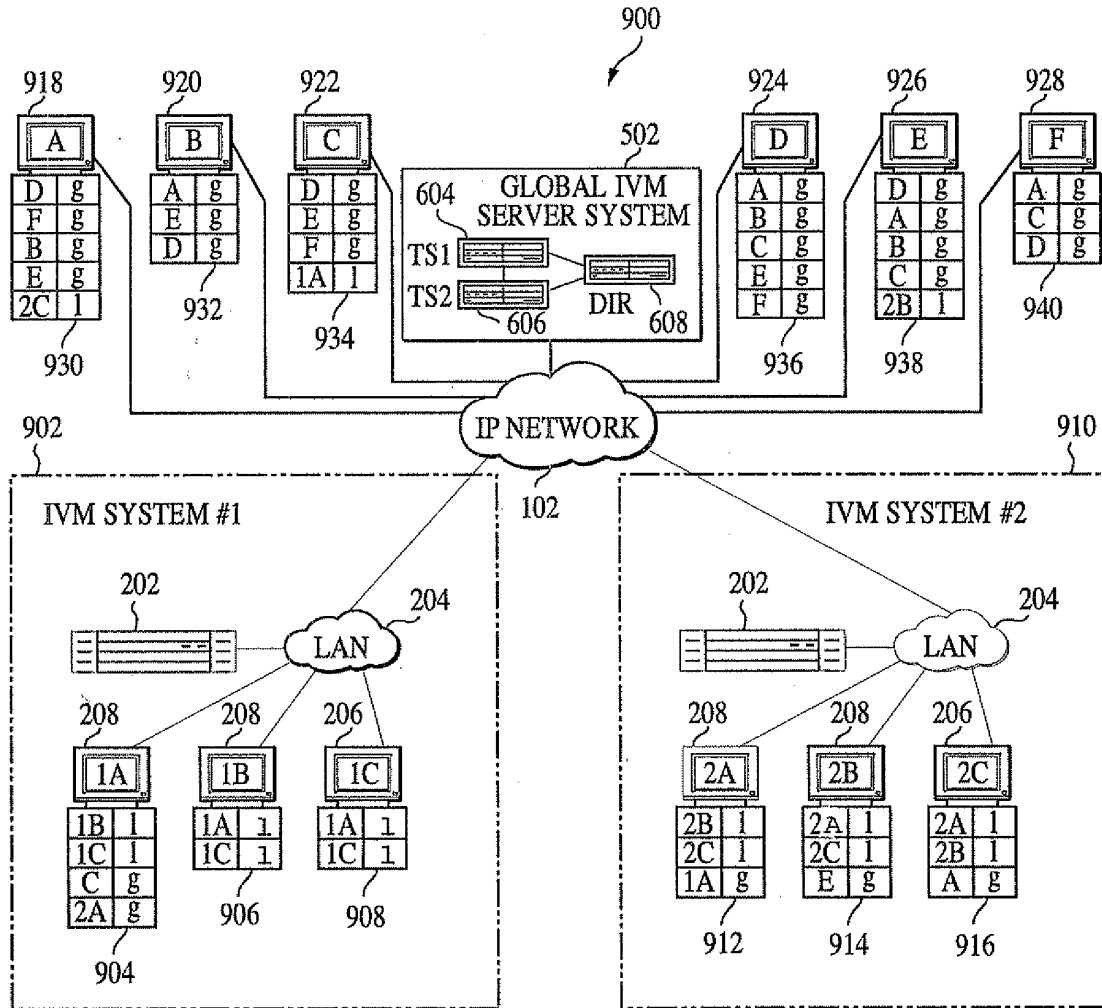

FIG. 9





Form 1449 to the First Office Action on the Merits indicating that all of the references were considered. The First Office Action did not include any of the references submitted in the Information Disclosure Statement in any of the rejections of the claims.

Subsequently, Examiner Smith attached the same PTO Form 1449 to the Notice of Allowability, however, the PTO Form 1449 had all of the references crossed off, indicating that the references were not considered. Applicant's representative conducted a series of Examiner interviews with both Examiner Smith and Examiner Fsang (Examiner Smith's Supervisor). The Examiners notified Applicant's representative that the PTO Form 1449 did not include a date for each of the references identified.

Applicant maintains that the Information Disclosure Statement should be considered, since the Examiner did in fact consider the Information Disclosure Statement during the prosecution of the application, and, therefore, the references should be listed on the face of the patent.

However, to expedite the issuance of the patent, Applicant is submitting the supplemental Information Disclosure Statement which includes the best available dates for the references, if known, with a replacement PTO Form 1449.

An archive website indicates that Reference 1 was posted on November 22, 2002. Attached herewith is a copy of a document printed from an archive web site evidencing the post date.

An archive website indicates that Reference 3 was copyrighted in 2003. Attached herewith is a copy of a document printed from an archive website indicating a copyright date.

Reference 4 bears a date of May 15, 2002 on the reference.

Reference 5 was archived by a website on December 8, 2003. Attached herewith is a copy of a document printed from an archive website indicating the archive date for Reference 5.

Reference 6 bears a copyright date of 2003.

Applicant respectfully requests consideration of the Supplemental Information Disclosure Statement pursuant to the Examiner interview with Examiner Fsang.

The Director is hereby authorized to charge Deposit Account No. 19-1013/SSMP any additional fees if required.

Respectfully submitted,

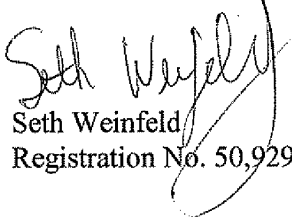

Seth Weinfeld  
Registration No. 50,929

Scully, Scott, Murphy & Presser  
400 Garden City Plaza  
Garden City, New York 11530  
(516) 742-4343

SW:reg  
Enclosures



3. <http://www.hsteliann.com/english/?zone=3100-V21P>; "Telephone 3100-V21P", 2003;
4. <http://www.linuxdevices.com/articles/AT5199947519.html>; "Device Profile: snom 100 VoIP phone", (May 15, 2002);
5. [http://www.pingtel.com/pr\\_xpressa.jsp](http://www.pingtel.com/pr_xpressa.jsp); "No limits with the advanced industry standard SIP phone, December 8, 2003; and
6. AudioCoded Enabling Technology Products, TPM-1100 VoP Media Gateway Modules; 2003.

The above-identified references were previously submitted in an Information Disclosure Statement dated August 19, 2004. Therefore, Applicant is not submitting copies of the references. This Supplemental Information Disclosure Statement includes the best available dates for the references, if known.

Respectfully submitted,



Seth Weinfeld  
Registration No. 50,929

Scully, Scott, Murphy & Presser  
400 Garden City Plaza  
Garden City, New York 11530  
(516) 742-4343

SW:reg

Form PTO-1449 (REV. 7-80)		U.S. DEPARTMENT OF COMMERCE PATENT AND TRADEMARK OFFICE		<b>Atty. Docket No. (Optional)</b> 17188		<b>Application Number</b> 10/740,030	
<b>INFORMATION DISCLOSURE CITATION</b>  <i>(Use several sheets if necessary)</i>				<b>Applicant(s)</b> Michael Rojas			
				<b>Filing Date</b> December 18, 2003		<b>Group Art Unit</b> 2614	
				<b>U.S. PATENT DOCUMENTS</b>			
<b>EXAMINER INITIAL*</b>		<b>DOCUMENT NUMBER</b>	<b>DATE</b>	<b>NAME</b>	<b>CLASS</b>	<b>SUBCLASS</b>	<b>FILING DATE (if appropriate)</b>
	AA						
	AB						
	AC						
<b>FOREIGN PATENT DOCUMENTS</b>							
	<b>REF</b>	<b>DOCUMENT NUMBER</b>	<b>DATE</b>	<b>COUNTRY</b>	<b>CLASS</b>	<b>SUBCLASS</b>	<b>TRANSLATION</b>
							<b>YES</b> <b>NO</b>
<b>OTHER DOCUMENTS</b> <i>(Including Author, Title, Date, Pertinent Pages, Etc.)</i>							
		<a href="http://www.cisco.com/warp/public/cc/pd/nemnsw/callmn/prodlit/cm33_ds.htm">http://www.cisco.com/warp/public/cc/pd/nemnsw/callmn/prodlit/cm33_ds.htm</a> ; "Data Sheet Cisco CallManager Version 3.3", November 22, 2002.					
		<a href="http://www.cisco.com/en/US/products/hw/switches/ps1925/products_data_sheet_09186_a00800a3c3d.html">http://www.cisco.com/en/US/products/hw/switches/ps1925/products_data_sheet_09186_a00800a3c3d.html</a> ; "Data Sheet Cisco MGX 8000 Series" (date unknown).					
		<a href="http://www.hsteliann.com/english/?zone=3100-V21P">http://www.hsteliann.com/english/?zone=3100-V21P</a> ; "Telephone 3100-V21P", 2003.					
		<a href="http://www.linuxdevices.com/articles/AT5199947519.html">http://www.linuxdevices.com/articles/AT5199947519.html</a> ; "Device Profile: snom 100 VoIP phone", May 15, 2002.					
		<a href="http://www.pingtel.com/pr_xpressa.jsp">http://www.pingtel.com/pr_xpressa.jsp</a> ; "No limits with the advanced industry standard SIP phone; December 8, 2003.					
		AudioCoded Enabling Technology Products, TPM-1100 VoP Media Gateway Modules, copyright 2003.					
<b>EXAMINER</b>				<b>DATE CONSIDERED</b>			
<small>* EXAMINER: Initial if reference considered, whether or not citation is in conformance with MPEP 609; draw line through citation if not in conformance and not considered. Include copy of this form with next communication to applicant.</small>							

## Electronic Acknowledgement Receipt

<b>EFS ID:</b>	4876766
<b>Application Number:</b>	10740030
<b>International Application Number:</b>	
<b>Confirmation Number:</b>	1731
<b>Title of Invention:</b>	SYSTEM AND METHOD FOR INSTANT VOIP MESSAGING
<b>First Named Inventor/Applicant Name:</b>	Michael J. Rojas
<b>Customer Number:</b>	23389
<b>Filer:</b>	Seth Weinfeld/Roseann Gallo
<b>Filer Authorized By:</b>	Seth Weinfeld
<b>Attorney Docket Number:</b>	17188
<b>Receipt Date:</b>	27-FEB-2009
<b>Filing Date:</b>	18-DEC-2003
<b>Time Stamp:</b>	16:28:44
<b>Application Type:</b>	Utility under 35 USC 111(a)

### Payment information:

Submitted with Payment	no
------------------------	----

### File Listing:

Document Number	Document Description	File Name	File Size(Bytes)/ Message Digest	Multi Part /.zip	Pages (if appl.)
1	Miscellaneous Incoming Letter	17188submission.pdf	1067171 aa63f7b4e93171cf0812aaa48dd799474ab28431	no	20

### Warnings:

### Information:

This Acknowledgement Receipt evidences receipt on the noted date by the USPTO of the indicated documents, characterized by the applicant, and including page counts, where applicable. It serves as evidence of receipt similar to a Post Card, as described in MPEP 503.

**New Applications Under 35 U.S.C. 111**

If a new application is being filed and the application includes the necessary components for a filing date (see 37 CFR 1.53(b)-(d) and MPEP 506), a Filing Receipt (37 CFR 1.54) will be issued in due course and the date shown on this Acknowledgement Receipt will establish the filing date of the application.

**National Stage of an International Application under 35 U.S.C. 371**

If a timely submission to enter the national stage of an international application is compliant with the conditions of 35 U.S.C. 371 and other applicable requirements a Form PCT/DO/EO/903 indicating acceptance of the application as a national stage submission under 35 U.S.C. 371 will be issued in addition to the Filing Receipt, in due course.

**New International Application Filed with the USPTO as a Receiving Office**

If a new international application is being filed and the international application includes the necessary components for an international filing date (see PCT Article 11 and MPEP 1810), a Notification of the International Application Number and of the International Filing Date (Form PCT/RO/105) will be issued in due course, subject to prescriptions concerning national security, and the date shown on this Acknowledgement Receipt will establish the international filing date of the application.





UNITED STATES PATENT AND TRADEMARK OFFICE

UNITED STATES DEPARTMENT OF COMMERCE
United States Patent and Trademark Office
Address: COMMISSIONER FOR PATENTS
P.O. Box 1450
Alexandria, Virginia 22313-1450
www.uspto.gov

NOTICE OF ALLOWANCE AND FEE(S) DUE

23389 7590 12/05/2008
SCULLY SCOTT MURPHY & PRESSER, PC
400 GARDEN CITY PLAZA
SUITE 300
GARDEN CITY, NY 11530

EXAMINER

SMITH, CREIGHTON H

ART UNIT PAPER NUMBER

2614

DATE MAILED: 12/05/2008

Table with 5 columns: APPLICATION NO., FILING DATE, FIRST NAMED INVENTOR, ATTORNEY DOCKET NO., CONFIRMATION NO.

10/740,030 12/18/2003 Michael J. Rojas 17188 1731
TITLE OF INVENTION: SYSTEM AND METHOD FOR INSTANT VOIP MESSAGING

Table with 7 columns: APPLN. TYPE, SMALL ENTITY, ISSUE FEE DUE, PUBLICATION FEE DUE, PREV. PAID ISSUE FEE, TOTAL FEE(S) DUE, DATE DUE

nonprovisional YES \$755 \$300 \$0 \$1055 03/05/2009

THE APPLICATION IDENTIFIED ABOVE HAS BEEN EXAMINED AND IS ALLOWED FOR ISSUANCE AS A PATENT. PROSECUTION ON THE MERITS IS CLOSED. THIS NOTICE OF ALLOWANCE IS NOT A GRANT OF PATENT RIGHTS. THIS APPLICATION IS SUBJECT TO WITHDRAWAL FROM ISSUE AT THE INITIATIVE OF THE OFFICE OR UPON PETITION BY THE APPLICANT. SEE 37 CFR 1.313 AND MPEP 1308.

THE ISSUE FEE AND PUBLICATION FEE (IF REQUIRED) MUST BE PAID WITHIN THREE MONTHS FROM THE MAILING DATE OF THIS NOTICE OR THIS APPLICATION SHALL BE REGARDED AS ABANDONED. THIS STATUTORY PERIOD CANNOT BE EXTENDED. SEE 35 U.S.C. 151. THE ISSUE FEE DUE INDICATED ABOVE DOES NOT REFLECT A CREDIT FOR ANY PREVIOUSLY PAID ISSUE FEE IN THIS APPLICATION. IF AN ISSUE FEE HAS PREVIOUSLY BEEN PAID IN THIS APPLICATION (AS SHOWN ABOVE), THE RETURN OF PART B OF THIS FORM WILL BE CONSIDERED A REQUEST TO REAPPLY THE PREVIOUSLY PAID ISSUE FEE TOWARD THE ISSUE FEE NOW DUE.

HOW TO REPLY TO THIS NOTICE:

I. Review the SMALL ENTITY status shown above.

If the SMALL ENTITY is shown as YES, verify your current SMALL ENTITY status:

- A. If the status is the same, pay the TOTAL FEE(S) DUE shown above.
B. If the status above is to be removed, check box 5b on Part B - Fee(s) Transmittal and pay the PUBLICATION FEE (if required) and twice the amount of the ISSUE FEE shown above, or

If the SMALL ENTITY is shown as NO:

- A. Pay TOTAL FEE(S) DUE shown above, or
B. If applicant claimed SMALL ENTITY status before, or is now claiming SMALL ENTITY status, check box 5a on Part B - Fee(s) Transmittal and pay the PUBLICATION FEE (if required) and 1/2 the ISSUE FEE shown above.

II. PART B - FEE(S) TRANSMITTAL, or its equivalent, must be completed and returned to the United States Patent and Trademark Office (USPTO) with your ISSUE FEE and PUBLICATION FEE (if required). If you are charging the fee(s) to your deposit account, section "4b" of Part B - Fee(s) Transmittal should be completed and an extra copy of the form should be submitted. If an equivalent of Part B is filed, a request to reapply a previously paid issue fee must be clearly made, and delays in processing may occur due to the difficulty in recognizing the paper as an equivalent of Part B.

III. All communications regarding this application must give the application number. Please direct all communications prior to issuance to Mail Stop ISSUE FEE unless advised to the contrary.

IMPORTANT REMINDER: Utility patents issuing on applications filed on or after Dec. 12, 1980 may require payment of maintenance fees. It is patentee's responsibility to ensure timely payment of maintenance fees when due.

**PART B - FEE(S) TRANSMITTAL**

**Complete and send this form, together with applicable fee(s), to: Mail** **Mail Stop ISSUE FEE**  
**Commissioner for Patents**  
**P.O. Box 1450**  
**Alexandria, Virginia 22313-1450**  
**or Fax (571)-273-2885**

**INSTRUCTIONS:** This form should be used for transmitting the ISSUE FEE and PUBLICATION FEE (if required). Blocks 1 through 5 should be completed where appropriate. All further correspondence including the Patent, advance orders and notification of maintenance fees will be mailed to the current correspondence address as indicated unless corrected below or directed otherwise in Block 1, by (a) specifying a new correspondence address; and/or (b) indicating a separate "FEE ADDRESS" for maintenance fee notifications.

CURRENT CORRESPONDENCE ADDRESS (Note: Use Block 1 for any change of address)

23389                      7590                      12/05/2008

**SCULLY SCOTT MURPHY & PRESSER, PC**  
**400 GARDEN CITY PLAZA**  
**SUITE 300**  
**GARDEN CITY, NY 11530**

Note: A certificate of mailing can only be used for domestic mailings of the Fee(s) Transmittal. This certificate cannot be used for any other accompanying papers. Each additional paper, such as an assignment or formal drawing, must have its own certificate of mailing or transmission.

**Certificate of Mailing or Transmission**

I hereby certify that this Fee(s) Transmittal is being deposited with the United States Postal Service with sufficient postage for first class mail in an envelope addressed to the Mail Stop ISSUE FEE address above, or being facsimile transmitted to the USPTO (571) 273-2885, on the date indicated below.

(Depositor's name)
(Signature)
(Date)

APPLICATION NO.	FILING DATE	FIRST NAMED INVENTOR	ATTORNEY DOCKET NO.	CONFIRMATION NO.
10/740,030	12/18/2003	Michael J. Rojas	17188	1731

TITLE OF INVENTION: SYSTEM AND METHOD FOR INSTANT VOIP MESSAGING

APPLN. TYPE	SMALL ENTITY	ISSUE FEE DUE	PUBLICATION FEE DUE	PREV. PAID ISSUE FEE	TOTAL FEE(S) DUE	DATE DUE
nonprovisional	YES	\$755	\$300	\$0	\$1055	03/05/2009

EXAMINER	ART UNIT	CLASS-SUBCLASS
SMITH, CREIGHTON H	2614	370-352000

<p>1. Change of correspondence address or indication of "Fee Address" (37 CFR 1.363).</p> <p><input type="checkbox"/> Change of correspondence address (or Change of Correspondence Address form PTO/SB/122) attached.</p> <p><input type="checkbox"/> "Fee Address" indication (or "Fee Address" Indication form PTO/SB/47; Rev 03-02 or more recent) attached. <b>Use of a Customer Number is required.</b></p>	<p>2. For printing on the patent front page, list</p> <p>(1) the names of up to 3 registered patent attorneys or agents OR, alternatively, _____ 1</p> <p>(2) the name of a single firm (having as a member a registered attorney or agent) and the names of up to 2 registered patent attorneys or agents. If no name is listed, no name will be printed. _____ 2</p> <p>_____ 3</p>
---	---

3. ASSIGNEE NAME AND RESIDENCE DATA TO BE PRINTED ON THE PATENT (print or type)

PLEASE NOTE: Unless an assignee is identified below, no assignee data will appear on the patent. If an assignee is identified below, the document has been filed for recordation as set forth in 37 CFR 3.11. Completion of this form is NOT a substitute for filing an assignment.

(A) NAME OF ASSIGNEE \_\_\_\_\_ (B) RESIDENCE: (CITY and STATE OR COUNTRY) \_\_\_\_\_

Please check the appropriate assignee category or categories (will not be printed on the patent):  Individual  Corporation or other private group entity  Government

<p>4a. The following fee(s) are submitted:</p> <p><input type="checkbox"/> Issue Fee</p> <p><input type="checkbox"/> Publication Fee (No small entity discount permitted)</p> <p><input type="checkbox"/> Advance Order - # of Copies _____</p>	<p>4b. Payment of Fee(s): (Please first reapply any previously paid issue fee shown above)</p> <p><input type="checkbox"/> A check is enclosed.</p> <p><input type="checkbox"/> Payment by credit card. Form PTO-2038 is attached.</p> <p><input type="checkbox"/> The Director is hereby authorized to charge the required fee(s), any deficiency, or credit any overpayment, to Deposit Account Number _____ (enclose an extra copy of this form).</p>
---	--

5. Change in Entity Status (from status indicated above)

a. Applicant claims SMALL ENTITY status. See 37 CFR 1.27.  b. Applicant is no longer claiming SMALL ENTITY status. See 37 CFR 1.27(g)(2).

NOTE: The Issue Fee and Publication Fee (if required) will not be accepted from anyone other than the applicant; a registered attorney or agent; or the assignee or other party in interest as shown by the records of the United States Patent and Trademark Office.

Authorized Signature \_\_\_\_\_ Date \_\_\_\_\_

Typed or printed name \_\_\_\_\_ Registration No. \_\_\_\_\_

This collection of information is required by 37 CFR 1.311. The information is required to obtain or retain a benefit by the public which is to file (and by the USPTO to process) an application. Confidentiality is governed by 35 U.S.C. 122 and 37 CFR 1.14. This collection is estimated to take 12 minutes to complete, including gathering, preparing, and submitting the completed application form to the USPTO. Time will vary depending upon the individual case. Any comments on the amount of time you require to complete this form and/or suggestions for reducing this burden, should be sent to the Chief Information Officer, U.S. Patent and Trademark Office, U.S. Department of Commerce, P.O. Box 1450, Alexandria, Virginia 22313-1450. DO NOT SEND FEES OR COMPLETED FORMS TO THIS ADDRESS. SEND TO: Commissioner for Patents, P.O. Box 1450, Alexandria, Virginia 22313-1450.

Under the Paperwork Reduction Act of 1995, no persons are required to respond to a collection of information unless it displays a valid OMB control number.



UNITED STATES PATENT AND TRADEMARK OFFICE

UNITED STATES DEPARTMENT OF COMMERCE
United States Patent and Trademark Office
Address: COMMISSIONER FOR PATENTS
P.O. Box 1450
Alexandria, Virginia 22313-1450
www.uspto.gov

Table with columns: APPLICATION NO., FILING DATE, FIRST NAMED INVENTOR, ATTORNEY DOCKET NO., CONFIRMATION NO.
10/740,030 12/18/2003 Michael J. Rojas 17188 1731
23389 7590 12/05/2008
SCULLY SCOTT MURPHY & PRESSER, PC
400 GARDEN CITY PLAZA
SUITE 300
GARDEN CITY, NY 11530
EXAMINER SMITH, CREIGHTON H
ART UNIT 2614 PAPER NUMBER
DATE MAILED: 12/05/2008

Determination of Patent Term Adjustment under 35 U.S.C. 154 (b)
(application filed on or after May 29, 2000)

The Patent Term Adjustment to date is 848 day(s). If the issue fee is paid on the date that is three months after the mailing date of this notice and the patent issues on the Tuesday before the date that is 28 weeks (six and a half months) after the mailing date of this notice, the Patent Term Adjustment will be 848 day(s).

If a Continued Prosecution Application (CPA) was filed in the above-identified application, the filing date that determines Patent Term Adjustment is the filing date of the most recent CPA.

Applicant will be able to obtain more detailed information by accessing the Patent Application Information Retrieval (PAIR) WEB site (http://pair.uspto.gov).

Any questions regarding the Patent Term Extension or Adjustment determination should be directed to the Office of Patent Legal Administration at (571)-272-7702. Questions relating to issue and publication fee payments should be directed to the Customer Service Center of the Office of Patent Publication at 1-(888)-786-0101 or (571)-272-4200.

<b>Notice of Allowability</b>	<b>Application No.</b>	<b>Applicant(s)</b>	
	10/740,030	ROJAS, MICHAEL J.	
	<b>Examiner</b>	<b>Art Unit</b>	
	CREIGHTON SMITH	2614	

**-- The MAILING DATE of this communication appears on the cover sheet with the correspondence address--**

All claims being allowable, PROSECUTION ON THE MERITS IS (OR REMAINS) CLOSED in this application. If not included herewith (or previously mailed), a Notice of Allowance (PTOL-85) or other appropriate communication will be mailed in due course. **THIS NOTICE OF ALLOWABILITY IS NOT A GRANT OF PATENT RIGHTS.** This application is subject to withdrawal from issue at the initiative of the Office or upon petition by the applicant. See 37 CFR 1.313 and MPEP 1308.

1.  This communication is responsive to remarks filed on 06 NOV '08.
2.  The allowed claim(s) is/are 1-5,7-20,22-35,37-45,47-57,59-69 and 71-76.
3.  Acknowledgment is made of a claim for foreign priority under 35 U.S.C. § 119(a)-(d) or (f).
  - a)  All    b)  Some\*    c)  None    of the:
    1.  Certified copies of the priority documents have been received.
    2.  Certified copies of the priority documents have been received in Application No. \_\_\_\_\_.
    3.  Copies of the certified copies of the priority documents have been received in this national stage application from the International Bureau (PCT Rule 17.2(a)).

\* Certified copies not received: \_\_\_\_\_.

Applicant has THREE MONTHS FROM THE "MAILING DATE" of this communication to file a reply complying with the requirements noted below. Failure to timely comply will result in ABANDONMENT of this application.  
**THIS THREE-MONTH PERIOD IS NOT EXTENDABLE.**

4.  A SUBSTITUTE OATH OR DECLARATION must be submitted. Note the attached EXAMINER'S AMENDMENT or NOTICE OF INFORMAL PATENT APPLICATION (PTO-152) which gives reason(s) why the oath or declaration is deficient.
5.  CORRECTED DRAWINGS ( as "replacement sheets") must be submitted.
  - (a)  including changes required by the Notice of Draftsperson's Patent Drawing Review ( PTO-948) attached
    - 1)  hereto or 2)  to Paper No./Mail Date \_\_\_\_\_.
  - (b)  including changes required by the attached Examiner's Amendment / Comment or in the Office action of Paper No./Mail Date \_\_\_\_\_.

**Identifying indicia such as the application number (see 37 CFR 1.84(c)) should be written on the drawings in the front (not the back) of each sheet. Replacement sheet(s) should be labeled as such in the header according to 37 CFR 1.121(d).**
6.  DEPOSIT OF and/or INFORMATION about the deposit of BIOLOGICAL MATERIAL must be submitted. Note the attached Examiner's comment regarding REQUIREMENT FOR THE DEPOSIT OF BIOLOGICAL MATERIAL.

**Attachment(s)**

- |  |  |
|--|--|
| <ol style="list-style-type: none"> <li>1. <input checked="" type="checkbox"/> Notice of References Cited (PTO-892)</li> <li>2. <input type="checkbox"/> Notice of Draftsperson's Patent Drawing Review (PTO-948)</li> <li>3. <input checked="" type="checkbox"/> Information Disclosure Statements (PTO/SB/08),<br/>Paper No./Mail Date <u>8.23.04</u></li> <li>4. <input type="checkbox"/> Examiner's Comment Regarding Requirement for Deposit of Biological Material</li> </ol> | <ol style="list-style-type: none"> <li>5. <input type="checkbox"/> Notice of Informal Patent Application</li> <li>6. <input type="checkbox"/> Interview Summary (PTO-413),<br/>Paper No./Mail Date _____.</li> <li>7. <input type="checkbox"/> Examiner's Amendment/Comment</li> <li>8. <input checked="" type="checkbox"/> Examiner's Statement of Reasons for Allowance</li> <li>9. <input type="checkbox"/> Other _____.</li> </ol> |
|--|--|

### **REASONS FOR ALLOWANCE**

The following is an examiner's statement of reasons for allowance: The prior art fails to teach/disclose applicant's instant voice messaging system having a server that temporarily stores an instant voice message if a recipient is unavailable and delivers the stored instant voice message when the recipient becomes available. No obvious combination of references found would have taught one of ordinary skill in the art to use applicant's system and method as claimed.

Any comments considered necessary by applicant must be submitted no later than the payment of the issue fee and, to avoid processing delays, should preferably accompany the issue fee. Such submissions should be clearly labeled "Comments on Statement of Reasons for Allowance."

Any inquiry concerning this communication or earlier communications from the examiner should be directed to CREIGHTON SMITH whose telephone number is (571)272-7546. The examiner can normally be reached on 5-4-9.

If attempts to reach the examiner by telephone are unsuccessful, the examiner's supervisor, fan tsang can be reached on 27548. The fax phone number for the organization where this application or proceeding is assigned is 571-273-8300.

Application/Control Number: 10/740,030  
Art Unit: 2614

Page 3

Information regarding the status of an application may be obtained from the Patent Application Information Retrieval (PAIR) system. Status information for published applications may be obtained from either Private PAIR or Public PAIR. Status information for unpublished applications is available through Private PAIR only. For more information about the PAIR system, see <http://pair-direct.uspto.gov>. Should you have questions on access to the Private PAIR system, contact the Electronic Business Center (EBC) at 866-217-9197 (toll-free). If you would like assistance from a USPTO Customer Service Representative or access to the automated information system, call 800-786-9199 (IN USA OR CANADA) or 571-272-1000.

02 DEC '08

/ creighton smith/  
for Primary, Examiner of Art Unit  
2614

\*\*\*

<b>Notice of References Cited</b>	Application/Control No. 10/740,030	Applicant(s)/Patent Under Reexamination ROJAS, MICHAEL J.	
	Examiner CREIGHTON SMITH	Art Unit 2614	Page 1 of 1

**U.S. PATENT DOCUMENTS**

*	Document Number Country Code-Number-Kind Code	Date MM-YYYY	Name	Classification	
*	A	US-6,763,226	07-2004	McZeal, Jr., Alfred	455/90.2
*	B	US-2004/0252679	12-2004	Williams et al.	370/356
*	C	US-2004/0122906	06-2004	Goodman et al.	709/206
*	D	US-2005/0053230	03-2005	Gierachf, Karl	379/406.06
*	E	US-2005/0105697	05-2005	Hollowell et al.	379/088.13
*	F	US-2003/0087632	05-2003	Sagi et al.	455/414
*	G	US-2006/0268750	11-2006	Weiner, Moshe	370/260
*	H	US-2004/0030046	02-2004	Schultes et al.	525/71
*	I	US-2007/0112925	05-2007	Malik, Dale W.	709/206
	J	US-			
	K	US-			
	L	US-			
	M	US-			

**FOREIGN PATENT DOCUMENTS**

*	Document Number Country Code-Number-Kind Code	Date MM-YYYY	Country	Name	Classification
	N				
	O				
	P				
	Q				
	R				
	S				
	T				

**NON-PATENT DOCUMENTS**

*	Document Number Country Code-Number-Kind Code	Date MM-YYYY	Country	Name	Classification
	Include as applicable: Author, Title Date, Publisher, Edition or Volume, Pertinent Pages)				
	U				
	V				
	W				
	X				

\*A copy of this reference is not being furnished with this Office action. (See MPEP § 707.05(a).)  
Dates in MM-YYYY format are publication dates. Classifications may be US or foreign.

<b>Index of Claims</b>  	<b>Application/Control No.</b>  10740030	<b>Applicant(s)/Patent Under Reexamination</b>  ROJAS, MICHAEL J.
	<b>Examiner</b>  CREIGHTON SMITH	<b>Art Unit</b>  2614

✓	<b>Rejected</b>
=	<b>Allowed</b>

-	<b>Cancelled</b>
÷	<b>Restricted</b>

N	<b>Non-Elected</b>
I	<b>Interference</b>

A	<b>Appeal</b>
O	<b>Objected</b>

Claims renumbered in the same order as presented by applicant
  CPA
  T.D.
  R.1.47

CLAIM		DATE							
Final	Original	08/05/2008	11/17/2008						
1	1	✓	=						
2	2	✓	=						
3	3	✓	=						
4	4	✓	=						
5	5	✓	=						
	6	✓	-						
6	7	✓	=						
7	8	✓	=						
8	9	✓	=						
9	10	✓	=						
10	11	✓	=						
11	12	✓	=						
12	13	✓	=						
13	14	✓	=						
14	15	✓	=						
15	16	✓	=						
16	17	✓	=						
17	18	✓	=						
18	19	✓	=						
19	20	✓	=						
	21	✓	-						
20	22	✓	=						
21	23	✓	=						
22	24	✓	=						
23	25	✓	=						
24	26	✓	=						
25	27	✓	=						
26	28	✓	=						
27	29	✓	=						
28	30	✓	=						
29	31	✓	=						
30	32	✓	=						
31	33	✓	=						
32	34	✓	=						
33	35	✓	=						
	36	✓	-						



<b>Index of Claims</b>  	<b>Application/Control No.</b>  10740030	<b>Applicant(s)/Patent Under Reexamination</b>  ROJAS, MICHAEL J.
	<b>Examiner</b>  CREIGHTON SMITH	<b>Art Unit</b>  2614

✓	<b>Rejected</b>
=	<b>Allowed</b>

-	<b>Cancelled</b>
÷	<b>Restricted</b>

N	<b>Non-Elected</b>
I	<b>Interference</b>

A	<b>Appeal</b>
O	<b>Objected</b>

Claims renumbered in the same order as presented by applicant
  CPA
  T.D.
  R.1.47

CLAIM		DATE							
Final	Original	08/05/2008	11/17/2008						
34	37	✓	=						
35	38	✓	=						
36	39	✓	=						
37	40	✓	=						
38	41	✓	=						
39	42	✓	=						
40	43	✓	=						
41	44	✓	=						
42	45	✓	=						
	46	✓	-						
43	47	✓	=						
44	48	✓	=						
45	49	✓	=						
46	50	✓	=						
47	51	✓	=						
48	52	✓	=						
49	53	✓	=						
50	54	✓	=						
51	55	✓	=						
52	56	✓	=						
53	57	✓	=						
	58	✓	-						
54	59	✓	=						
55	60	✓	=						
56	61	✓	=						
57	62	✓	=						
58	63	✓	=						
59	64	✓	=						
60	65	✓	=						
61	66	✓	=						
62	67	✓	=						
63	68	✓	=						
64	69	✓	=						
	70	✓	-						
65	71	✓	=						
66	72	✓	=						

<b>Index of Claims</b>  	<b>Application/Control No.</b>  10740030	<b>Applicant(s)/Patent Under Reexamination</b>  ROJAS, MICHAEL J.
	<b>Examiner</b>  CREIGHTON SMITH	<b>Art Unit</b>  2614

✓	<b>Rejected</b>
=	<b>Allowed</b>

-	<b>Cancelled</b>
÷	<b>Restricted</b>

N	<b>Non-Elected</b>
I	<b>Interference</b>

A	<b>Appeal</b>
O	<b>Objected</b>

<input type="checkbox"/> Claims renumbered in the same order as presented by applicant		<input type="checkbox"/> CPA		<input type="checkbox"/> T.D.		<input type="checkbox"/> R.1.47			
CLAIM		DATE							
Final	Original	08/05/2008	11/17/2008						
67	73	✓	=						
68	74	✓	=						
69	75	✓	=						
70	76	✓	=						

<b>Issue Classification</b> 	<b>Application/Control No.</b> 10740030	<b>Applicant(s)/Patent Under Reexamination</b> ROJAS, MICHAEL J.
	<b>Examiner</b> CREIGHTON SMITH	<b>Art Unit</b> 2614

ORIGINAL						INTERNATIONAL CLASSIFICATION														
CLASS			SUBCLASS			CLAIMED					NON-CLAIMED									
370			352			H	O	4	L	12 / 66 (2006.01.01)										
<b>CROSS REFERENCE(S)</b>																				
CLASS	SUBCLASS (ONE SUBCLASS PER BLOCK)																			
709	206																			

Claims renumbered in the same order as presented by applicant
  CPA
  T.D.
  R.1.47

Final	Original	Final	Original	Final	Original	Final	Original	Final	Original	Final	Original	Final	Original	Final	Original
1	1	16	17	31	33	45	49	60	65						
2	2	17	18	32	34	46	50	61	66						
3	3	18	19	33	35	47	51	62	67						
4	4	19	20		36	48	52	63	68						
5	5		21	34	37	49	53	64	69						
	6	20	22	35	38	50	54		70						
6	7	21	23	36	39	51	55	65	71						
7	8	22	24	37	40	52	56	66	72						
8	9	23	25	38	41	53	57	67	73						
9	10	24	26	39	42		58	68	74						
10	11	25	27	40	43	54	59	69	75						
11	12	26	28	41	44	55	60	70	76						
12	13	27	29	42	45	56	61								
13	14	28	30		46	57	62								
14	15	29	31	43	47	58	63								
15	16	30	32	44	48	59	64								

NONE	<b>Total Claims Allowed:</b>	
(Assistant Examiner)	(Date)	70
/CREIGHTON SMITH/ Primary Examiner.Art Unit 2614	11.17.08	O.G. Print Claim(s)
(Primary Examiner)	(Date)	1
		O.G. Print Figure
		1

<b>Search Notes</b>  	<b>Application/Control No.</b>  10740030	<b>Applicant(s)/Patent Under Reexamination</b>  ROJAS, MICHAEL J.
	<b>Examiner</b>  Creighton H Smith	<b>Art Unit</b>  2614

<b>SEARCHED</b>			
<b>Class</b>	<b>Subclass</b>	<b>Date</b>	<b>Examiner</b>
370	352	17 NOV '08	

<b>SEARCH NOTES</b>			
<b>Search Notes</b>		<b>Date</b>	<b>Examiner</b>
EAST Search		05 AUG '08	chs
EAST		17 NOV '08	chs

<b>INTERFERENCE SEARCH</b>			
<b>Class</b>	<b>Subclass</b>	<b>Date</b>	<b>Examiner</b>
EAST interfernces earch		17 NOV '08	chs

--	--



4. <http://www.linuxdevices.com/articles/AT5199947519.html>; "Device Profile: snom 100 VoIP phone".

5. [http://www.pingtel.com/pr\\_xpressa.jsp](http://www.pingtel.com/pr_xpressa.jsp); "No limits with the advanced industry standard SIP phone.

6. AudioCoded Enabling Technology Products, TPM-1100 VoP Media Gateway Modules.

Applicant is submitting a copy of the above-cited references.

Inasmuch as this Information Disclosure Statement is being submitted in accordance with the schedule set out in 37 C.F.R. § 1.97(b), no statement or fee is required.

Respectfully submitted,



Paul J. Esatto, Jr.  
Registration No. 30,749

Scully, Scott, Murphy & Presser  
400 Garden City Plaza  
Garden City, New York 11530  
(516) 742-4343

PJE:ae

Form PTO-1449 U.S. DEPARTMENT OF COMMERCE (REV. 7-80) PATENT AND TRADEMARK OFFICE  <b>INFORMATION DISCLOSURE CITATION</b>  (Use several sheets if necessary)	<b>Atty. Docket No. (Optional)</b> 17188	<b>Application Number</b> 10/740,030
	<b>Applicant(s)</b> Michael Rojas	
	<b>Filing Date</b> December 18, 2003	<b>Group Art Unit</b> 2661
		

**U.S. PATENT DOCUMENTS**

EXAMINER INITIAL*	DOCUMENT NUMBER	DATE	NAME	CLASS	SUBCLASS	FILING DATE (if appropriate)
AA						
AB						
AC						

**FOREIGN PATENT DOCUMENTS**

REF	DOCUMENT NUMBER	DATE	COUNTRY	CLASS	SUBCLASS	TRANSLATION	
						YES	NO

**OTHER DOCUMENTS** (Including Author, Title, Date, Pertinent Pages, Etc.)

	<a href="http://www.cisco.com/warp/public/cc/pd/nemnsw/callmn/prodlit/cm33_ds.htm">http://www.cisco.com/warp/public/cc/pd/nemnsw/callmn/prodlit/cm33_ds.htm</a> ; "Data Sheet Cisco CallManager Version 3.3"
	<a href="http://www.cisco.com/en/US/products/hw/switches/ps1925/products_data_sheet_09186_a00800a3c3d.html">http://www.cisco.com/en/US/products/hw/switches/ps1925/products_data_sheet_09186_a00800a3c3d.html</a> ; "Data Sheet Cisco MGX 8000 Series"
	<a href="http://www.hoteliann.com/english/?zone=3100_V21P">http://www.hoteliann.com/english/?zone=3100_V21P</a> ; "Telephone 3100 V21P"
	<a href="http://www.linuxdevices.com/articles/AT5199947519.html">http://www.linuxdevices.com/articles/AT5199947519.html</a> ; "Device Profile: snom 100 VoIP phone"
	<a href="http://www.pingtel.com/pr_xpressa.jsp">http://www.pingtel.com/pr_xpressa.jsp</a> ; "No limits with the advanced industry standard SIP phone AudioCoded Enabling Technology Products, TPM.1100 VoP Media Gateway Modules"

<b>EXAMINER</b> /Creighton Smith/	<b>DATE CONSIDERED</b> 12/03/2008
--------------------------------------	--------------------------------------

\* EXAMINER: Initial if reference considered, whether or not citation is in conformance with MPEP 609; draw line through citation if not in conformance and not considered. Include copy of this form with next communication to applicant.

JFW

**TRANSMITTAL OF INFORMATION DISCLOSURE STATEMENT  
(Under 37 CFR 1.97(b) or 1.97(c))**

Docket No.  
17188

In Re Application Of: **Michael J. Rojas**

Application No.	Filing Date	Examiner	Customer No.	Group Art Unit	Confirmation No.
10/740,030	December 18, 2003	Unassigned	23389	2661	1731

Title:

**SYSTEM AND METHOD FOR INSTANT VoIP MESSAGING**



Address to:  
**Commissioner for Patents**  
**P.O. Box 1450**  
**Alexandria, VA 22313-1450**

**37 CFR 1.97(b)**

1.  The Information Disclosure Statement submitted herewith is being filed within three months of the filing of a national application other than a continued prosecution application under 37 CFR 1.53(d); within three months of the date of entry of the national stage as set forth in 37 CFR 1.491 in an international application; before the mailing of a first Office Action on the merits, or before the mailing of a first Office Action after the filing of a request for continued examination under 37 CFR 1.114.

**37 CFR 1.97(c)**

2.  The Information Disclosure Statement submitted herewith is being filed after the period specified in 37 CFR 1.97(b), provided that the Information Disclosure Statement is filed before the mailing date of a Final Action under 37 CFR 1.113, a Notice of Allowance under 37 CFR 1.311, or an Action that otherwise closes prosecution in the application, and is accompanied by one of:

- the statement specified in 37 CFR 1.97(e);

**OR**

- the fee set forth in 37 CFR 1.17(p).



**TRANSMITTAL OF INFORMATION DISCLOSURE STATEMENT**  
(Under 37 CFR 1.97(b) or 1.97(c))

Docket No.  
17188

In Re Application: Michael J. Rojas

Application No.	Filing Date	Examiner	Customer No.	Group Art Unit	Confirmation No.
10/740,030	December 18, 2003	Unassigned	23389	2661	1731

**SYSTEM AND METHOD FOR INSTANT VoIP MESSAGING**

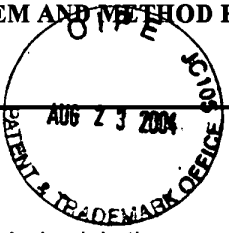

**Payment of Fee**

(Only complete if Applicant elects to pay the fee set forth in 37 CFR 1.17(p))

- A check in the amount of \_\_\_\_\_ is attached.
- The Director is hereby authorized to charge and credit Deposit Account **19-1013/SSMP** as described below.
- Charge the amount of \_\_\_\_\_
  - Credit any overpayment.
  - Charge any additional fee required.

**Certificate of Transmission by Facsimile\***

I certify that this document and authorization to charge deposit account is being facsimile transmitted to the United States Patent and Trademark Office (Fax No. \_\_\_\_\_)

\_\_\_\_\_  
(Date)

\_\_\_\_\_  
Signature

\_\_\_\_\_  
Typed or Printed Name of Person Signing Certificate

**Certificate of Mailing by First Class Mail**

I certify that this document and fee is being deposited on **8/19/04** th the U.S. Postal Service as first class mail under 37 C.F.R. 1.8 and is addressed to the Commissioner for Patents, P.O. Box 1450, Alexandria, VA 22313-1450.

\_\_\_\_\_  
Signature of Person Mailing Correspondence

Paul J. Esatto, Jr.  
\_\_\_\_\_  
Typed or Printed Name of Person Mailing Certificate

\*This certificate may only be used if paying by deposit account.

\_\_\_\_\_  
Signature

Dated: August 19, 2004

Paul J. Esatto, Jr.  
Registration No. 30,749  
Scully, Scott, Murphy & Presser  
400 Garden City Plaza  
Garden City, New York 11530  
516-742-4343

CC:



## REMARKS

Applicant has filed the present Response in reply to the outstanding Official Action of August 11, 2008. Applicant believes the Response is fully responsive to the Official Action for at least the reasons set forth herein.

At the onset, Applicant would like to thank the Examiner for taking the time to have a telephone interview with Applicant's representative on October 31, 2008.

During the interview, Bernstein, Williams and Gierachf references were discussed.

With respect to the Bernstein reference, Applicant noted that the reference fails to teach (i) any consideration of **availability/unavailability**; (ii) **temporarily** storing the instant voice message; and (iii) **delivering** the stored instant voice message to the selected recipient once the selected recipient becomes **available**. The Examiner agreed to take another look at Bernstein and update the search using additional search terms.

With respect to Williams, Applicant noted that the reference fails to teach that the client requests a list of recipients associated with the client from the server and the server transmits the list of recipients to the client for selection of the one or more recipients. Williams only teaches transmitting the list of recipients if a voice command is not recognized.

With respect to Gierachf, Applicant noted that the reference is not prior art and referred the Examiner to the inventor declaration under 37 C.F.R. § 1.131.

Claims 1-3, 5, 11-18, 26-29, 43, 45, 51-54, 65 and 66 stand rejected under 35 U.S.C. § 103(a) as being unpatentable in view of McZeal (previously cited) and

Bernstein, U.S. Patent Publication No. 2004/00128356. Claims 4, 19, 20, and 44 stand rejected under 35 U.S.C. § 103(a) in view of McZeal, Bernstein and Williams. Claims 7, 22 and 47 stand rejected under 35 U.S.C. § 103(a) as being unpatentable in view of McZeal, Bernstein, and Sagi. Claims 8, 23 and 48 stand rejected under 35 U.S.C. § 103(a) as being unpatentable in view of McZeal, Bernstein and Goodman. Claims 9, 24 and 49 stand rejected under 35 U.S.C. § 103(a) as being unpatentable in view of McZeal, Bernstein and Gierachf, U.S. Patent Publication No. 2005/0053230. Claims 10, 25 and 50 stand rejected under 35 U.S.C. § 103(a) as being unpatentable in view of McZeal, Bernstein and Creamer et al., U.S. Pat. Pub 2003/0126207.

Claims 30-33, 35, 41, 55, 57, 63, 64, 67, 69 and 75 stand rejected under 35 U.S.C. § 103(a) as being unpatentable in view of McZeal, Bernstein and Monroe, U.S. Patent No. 6,970,183. Claims 42 and 76 stand rejected under 35 U.S.C. § 103(a) as being unpatentable in view of McZeal, Bernstein, Monroe and Boukobza. Claims 34, 56 and 68 stand rejected under 35 U.S.C. § 103(a) as being unpatentable in view of McZeal, Bernstein, Williams and Monroe. Claims 37, 59 and 71 were rejected under 35 U.S.C. § 103(a) as being unpatentable in view of McZeal, Bernstein, Sagi and Monroe.

Claims 38, 60 and 72 stand rejected under 35 U.S.C. § 103(a) as being unpatentable in view of McZeal, Bernstein, Goodman and Monroe. Claims 39, 61 and 73 stand rejected under 35 U.S.C. § 103(a) as being unpatentable in view of McZeal, Bernstein, Gierachf and Monroe. Claims 40, 62 and 74 stand rejected under 35 U.S.C. § 103(a) as being unpatentable in view of McZeal, Bernstein, Creamer and Monroe.

Applicant respectfully disagrees with the rejection and traverses with at least the following remarks.

Applicant submits that all of the cited references, whether taken alone or in any combination thereof, fail to teach, suggest or render obvious the limitation of the server temporarily stores the instant voice message if a selected recipient is unavailable and delivers the stored instant voice message to the selected recipient once the selected recipient becomes available, as recited in each of the independent claims.

The Official Action asserts that Bernstein teaches this feature. Applicant respectfully disagrees. As noted above, the reference fails to teach (i) any consideration of **availability/unavailability**; (ii) **temporarily** storing the instant voice message; and (iii) **delivering** the stored instant voice message to the selected recipient once the selected recipient becomes **available**.

**(I) Storing only when unavailable**

At best, Bernstein teaches storing all of the IM messages in a remote server, i.e., communication history or database. Bernstein teaches that the IM messages are stored for an IM session. The IM session implies that two parties are already available and IMing, i.e., a session is a flow of instant messages between at least two users.

Bernstein states that the server program system performs a step of maintained a database referencing a history of the instant messaging session with the universally unique identifier for the audience collection. See paragraphs 0086 and 0088. The audience collection is a list of users that **accepted** an invitation to the session. When and if a recipient responds to the instant messaging invitation email message, it becomes a

member of the audience collection 138. The first user sends an email invitation for the IM session and at least one other user replies to the invitation. *See* Paragraphs 0078-81.

At paragraph 0090, the reference states a step of sending the processed communication from the first member as content in the areas associated with the first member to the history of the instant message session with the universally unique identifier. The database receives the transferred communication from the first member to create a history-received communication from the first member.

In embodiments when there is a database 150, it includes a history 154 of the instant messaging session 130. History 154 includes the universally unique identifier 132 of instant messaging session 130. History 154 also includes an audience list 162 based upon audience collection 138 and a communication history 166, which further references communications records 168, each of which may be based upon at least one of the received communication 142, processed communication 144, and transferred communication 146. Additionally, in an embodiment, the server 100 may retain the complete transcript 166 of the Instant Messaging session.

In other words, **when the store feature is active, every message is stored, without a determination of whether the recipient is available. In fact, since a session is active, the recipient must be available and online (emphasis added).**

In stark contrast, in the claimed invention the IVM is only stored in the server if the recipient (IVM client) is not currently connected to the local IVM server. In fact, the reference only suggests that the IM is not stored if confidentiality cannot be maintained. *See* paragraph 0094.

**(II) Temporarily storing the instant voice message if a selected recipient is unavailable**

Bernstein fails to teach that the IVM is temporarily stored.

Bernstein states that the *user whenever looking at that email at any time in the future*, will trigger the server 100 to attempt fetching all the Instant Messaging messages 168 has stored for that email. *See* paragraph 0100. At any time in the future implies that the messages are stored permanently.

**(III) Pushing IMV to recipient when available.**

Additionally, the reference does not teach that the stored IVM is delivered to the client when the client connects to the IVM (after not being initiately connected).

Bernstein states that the *user whenever looking at that email at any time in the future*, will trigger the server 100 to attempt fetching all the Instant Messaging messages 168 has stored for that email. *See* paragraph 0100. In Bernstein, the user initiates the fetching process by sending a request, i.e., pulling the message data. In stark contrast, in the claimed invention, the server pushes or delivers the message when the recipient is determined to be available.

The other cited references fail to cure these deficiencies.

Therefore, the cited references fail to teach, suggest or render obvious each and every limitation of the claims; the claims are patentable over the cited combination.

Applicant further submits that claims 9, 24, 39, 49, 61, and 73 are patentable over the cited references based at least upon the following additional analysis. The Official Action cites Gierachf in the rejection of these claims. Applicant submits the Gierachf is

not prior art. Notably, in Applicant's declaration pursuant to 1.131, Applicant at paragraph 3 stated that the Applicant conceived the claimed invention prior to August 15 2003. *See* Declaration Pursuant to §1.131 ¶ 3. Gierachf has a filing date of September 6, 2003. Therefore, Applicant completed the invention claimed in the instant application prior to the filing date of the reference.

Applicant further submits that claims 4, 19, 34, 44, 56 and 68 are patentable over the cited references based at least upon the following additional analysis. Each of these claims recites, *inter alia*, a limitation directed to requesting a list of recipients associated with the server from the server. Applicant submits that the cited references fail to teach this limitation. At best, Williams (cited as a teaching of this limitation) teaches that the server sends a list of potential recipients **after a voice command is not recognized**. Notably, Williams describes an embodiment, where if a first word of the voice message does not satisfy a predetermined condition, the message is saved and a list of recipients is transmitted to the local client. *See* paragraph 0055. Clearly, the client is not requesting the list; rather the server determines that a command is not understood and that all available options should be transmitted to the user. The client makes no request.

Additionally, Applicant notes that this function is not in the context of an instant voice message.

None of the other cited references cure the above-identified deficiency.

Therefore, claims 4, 19, 34, 44, 56 and 68 are patentable over the cited references, whether taken alone or in any combination thereof.



Applicant further submits that claims 7, 22, 37, 47, 59 and 71 are patentable over the cited references based at least upon the following additional analysis.

Applicant submits that the references, whether taken alone or in any combination thereof teach or suggest recording an instant voice message in an audio file, at the client, where the audio file is a instant voice message, as recited in each of these claims. At best, Sagi teaches that an audio file can be transmitted to a server. Sagi teaches that an instant text message is converted into an instant voice message and then transmitted (Steps 420 and 425). The server relays the voice message to a cellular telephone. Sagi then describes that at step 435, user b sends an instant message in a voice message format to user via the gateway. The voice message is converted into a text message. Notably, Sagi does not teach that the voice message from user B to user A is recorded on the user device. None of the other cited references cure the above-identified deficiency.

Therefore, claims 7, 22, 37, 47, 59 and 71 are patentable over the cited references, whether taken alone or in any combination thereof.

Based upon the foregoing, Applicant respectfully requests that the Examiner withdraw all of the pending rejections pursuant to 35 U.S.C. § 103(a).

In conclusion, the Applicant believes that the above-identified application is in condition for allowance and henceforth respectfully solicits the Examiner to allow the application. If the Examiner believes a telephone conference might expedite the

allowance of this application, the Applicant respectfully requests that the Examiner call the undersigned, Applicant's attorney, at the following telephone number: (516) 742-4343.

Respectfully submitted,

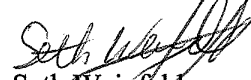

Seth Weinfeld

Registration No: 50,929

Scully, Scott, Murphy & Presser, P.C.  
400 Garden City Plaza, Suite 300  
Garden City, New York 11530  
516-742-4343

SW:reg

**TRANSMITTAL LETTER  
(General - Patent Pending)**

Docket No.  
**17188**

In Re Application Of: **Michael J. Rojas**

Application No.	Filing Date	Examiner	Customer No.	Group Art Unit	Confirmation No.
<b>10/740,030</b>	<b>December 18, 2003</b>	<b>Creighton H. Smith</b>	<b>23389</b>	<b>2614</b>	<b>1731</b>

Title: **SYSTEM AND METHOD FOR INSTANT VoIP MESSAGING**

COMMISSIONER FOR PATENTS:

Transmitted herewith is:

**RESPONSE UNDER 37 C.F.R. § 1.111**

in the above identified application.

- No additional fee is required.
- A check in the amount of \_\_\_\_\_ is attached.
- The Director is hereby authorized to charge and credit Deposit Account No. **19-1013/SSMP** as described below.
  - Charge the amount of \_\_\_\_\_
  - Credit any overpayment.
  - Charge any additional fee required.
- Payment by credit card. Form PTO-2038 is attached.

**WARNING: Information on this form may become public. Credit card information should not be included on this form. Provide credit card information and authorization on PTO-2038.**

  
\_\_\_\_\_  
*Signature*

Dated: **November 6, 2008**

Seth Weinfeld  
Registration No: 50,929  
Scully, Scott, Murphy & Presser, P.C.  
400 Garden City Plaza, Suite 300  
Garden City, New York 11530  
516-742-4343  
SW:reg

I hereby certify that this correspondence is being deposited with the United States Postal Service with sufficient postage as first class mail in an envelope addressed to the "Commissioner for Patents, P.O. Box 1450, Alexandria, VA 22313-1450" [37 CFR 1.8(a)] on

\_\_\_\_\_  
(Date)

\_\_\_\_\_  
*Signature of Person Mailing Correspondence*

\_\_\_\_\_  
*Typed or Printed Name of Person Mailing Correspondence*

cc:

## Electronic Acknowledgement Receipt

<b>EFS ID:</b>	4244655
<b>Application Number:</b>	10740030
<b>International Application Number:</b>	
<b>Confirmation Number:</b>	1731
<b>Title of Invention:</b>	System and method for instant VoIP messaging
<b>First Named Inventor/Applicant Name:</b>	Michael J. Rojas
<b>Customer Number:</b>	23389
<b>Filer:</b>	Paul J. Esatto/Roseann Gallo
<b>Filer Authorized By:</b>	Paul J. Esatto
<b>Attorney Docket Number:</b>	17188
<b>Receipt Date:</b>	06-NOV-2008
<b>Filing Date:</b>	18-DEC-2003
<b>Time Stamp:</b>	15:20:12
<b>Application Type:</b>	Utility under 35 USC 111(a)

### Payment information:

Submitted with Payment	no
------------------------	----

### File Listing:

Document Number	Document Description	File Name	File Size(Bytes)/ Message Digest	Multi Part /.zip	Pages (if appl.)
1		17188AM3.pdf	422767 c5cce47930f25917cf0d3096e12360a11e803ab8	yes	10

<b>Multipart Description/PDF files in .zip description</b>		
<b>Document Description</b>	<b>Start</b>	<b>End</b>
Amendment/Req. Reconsideration-After Non-Final Reject	1	1
Applicant Arguments/Remarks Made in an Amendment	2	9
Miscellaneous Incoming Letter	10	10
<b>Warnings:</b>		
<b>Information:</b>		
<b>Total Files Size (in bytes):</b>	422767	
<p><b>This Acknowledgement Receipt evidences receipt on the noted date by the USPTO of the indicated documents, characterized by the applicant, and including page counts, where applicable. It serves as evidence of receipt similar to a Post Card, as described in MPEP 503.</b></p> <p><b><u>New Applications Under 35 U.S.C. 111</u></b>  If a new application is being filed and the application includes the necessary components for a filing date (see 37 CFR 1.53(b)-(d) and MPEP 506), a Filing Receipt (37 CFR 1.54) will be issued in due course and the date shown on this Acknowledgement Receipt will establish the filing date of the application.</p> <p><b><u>National Stage of an International Application under 35 U.S.C. 371</u></b>  If a timely submission to enter the national stage of an international application is compliant with the conditions of 35 U.S.C. 371 and other applicable requirements a Form PCT/DO/EO/903 indicating acceptance of the application as a national stage submission under 35 U.S.C. 371 will be issued in addition to the Filing Receipt, in due course.</p> <p><b><u>New International Application Filed with the USPTO as a Receiving Office</u></b>  If a new international application is being filed and the international application includes the necessary components for an international filing date (see PCT Article 11 and MPEP 1810), a Notification of the International Application Number and of the International Filing Date (Form PCT/RO/105) will be issued in due course, subject to prescriptions concerning national security, and the date shown on this Acknowledgement Receipt will establish the international filing date of the application.</p>		



UNITED STATES PATENT AND TRADEMARK OFFICE

UNITED STATES DEPARTMENT OF COMMERCE  
United States Patent and Trademark Office  
Address: COMMISSIONER FOR PATENTS  
P.O. Box 1450  
Alexandria, Virginia 22313-1450  
www.uspto.gov

APPLICATION NO.	FILING DATE	FIRST NAMED INVENTOR	ATTORNEY DOCKET NO.	CONFIRMATION NO.
10/740,030	12/18/2003	Michael J. Rojas	17188	1731

23389 7590 08/11/2008  
SCULLY SCOTT MURPHY & PRESSER, PC  
400 GARDEN CITY PLAZA  
SUITE 300  
GARDEN CITY, NY 11530

EXAMINER
----------

SMITH, CREIGHTON H

ART UNIT	PAPER NUMBER
2614	

2614

MAIL DATE	DELIVERY MODE
08/11/2008	PAPER

08/11/2008

PAPER

**Please find below and/or attached an Office communication concerning this application or proceeding.**

The time period for reply, if any, is set in the attached communication.

<b>Office Action Summary</b>	<b>Application No.</b> 10/740,030	<b>Applicant(s)</b> ROJAS, MICHAEL J.	
	<b>Examiner</b> Creighton H. Smith	<b>Art Unit</b> 2614	

-- The MAILING DATE of this communication appears on the cover sheet with the correspondence address --

**Period for Reply**

A SHORTENED STATUTORY PERIOD FOR REPLY IS SET TO EXPIRE 3 MONTH(S) OR THIRTY (30) DAYS, WHICHEVER IS LONGER, FROM THE MAILING DATE OF THIS COMMUNICATION.

- Extensions of time may be available under the provisions of 37 CFR 1.136(a). In no event, however, may a reply be timely filed after SIX (6) MONTHS from the mailing date of this communication.
- If NO period for reply is specified above, the maximum statutory period will apply and will expire SIX (6) MONTHS from the mailing date of this communication.
- Failure to reply within the set or extended period for reply will, by statute, cause the application to become ABANDONED (35 U.S.C. § 133). Any reply received by the Office later than three months after the mailing date of this communication, even if timely filed, may reduce any earned patent term adjustment. See 37 CFR 1.704(b).

**Status**

- 1)  Responsive to communication(s) filed on 07 JUL '08.
- 2a)  This action is **FINAL**.                      2b)  This action is non-final.
- 3)  Since this application is in condition for allowance except for formal matters, prosecution as to the merits is closed in accordance with the practice under *Ex parte Quayle*, 1935 C.D. 11, 453 O.G. 213.

**Disposition of Claims**

- 4)  Claim(s) 1-76 is/are pending in the application.  
4a) Of the above claim(s) \_\_\_\_\_ is/are withdrawn from consideration.
- 5)  Claim(s) \_\_\_\_\_ is/are allowed.
- 6)  Claim(s) 1-76 is/are rejected.
- 7)  Claim(s) \_\_\_\_\_ is/are objected to.
- 8)  Claim(s) \_\_\_\_\_ are subject to restriction and/or election requirement.

**Application Papers**

- 9)  The specification is objected to by the Examiner.
- 10)  The drawing(s) filed on \_\_\_\_\_ is/are: a)  accepted or b)  objected to by the Examiner.  
Applicant may not request that any objection to the drawing(s) be held in abeyance. See 37 CFR 1.85(a).  
Replacement drawing sheet(s) including the correction is required if the drawing(s) is objected to. See 37 CFR 1.121(d).
- 11)  The oath or declaration is objected to by the Examiner. Note the attached Office Action or form PTO-152.

**Priority under 35 U.S.C. § 119**

- 12)  Acknowledgment is made of a claim for foreign priority under 35 U.S.C. § 119(a)-(d) or (f).  
a)  All    b)  Some \*    c)  None of:
1.  Certified copies of the priority documents have been received.
2.  Certified copies of the priority documents have been received in Application No. \_\_\_\_\_.
3.  Copies of the certified copies of the priority documents have been received in this National Stage application from the International Bureau (PCT Rule 17.2(a)).
- \* See the attached detailed Office action for a list of the certified copies not received.

**Attachment(s)**

- |  |   |
|--|---|
| 1) <input checked="" type="checkbox"/> Notice of References Cited (PTO-892)                                | 4) <input type="checkbox"/> Interview Summary (PTO-413)<br>Paper No(s)/Mail Date. _____ |
| 2) <input type="checkbox"/> Notice of Draftsperson's Patent Drawing Review (PTO-948)                       | 5) <input type="checkbox"/> Notice of Informal Patent Application                       |
| 3) <input type="checkbox"/> Information Disclosure Statement(s) (PTO/SB/08)<br>Paper No(s)/Mail Date _____ | 6) <input type="checkbox"/> Other: _____  |

The following is a quotation of 35 U.S.C. 103(a) which forms the basis for all obviousness rejections set forth in this Office action:

(a) A patent may not be obtained though the invention is not identically disclosed or described as set forth in section 102 of this title, if the differences between the subject matter sought to be patented and the prior art are such that the subject matter as a whole would have been obvious at the time the invention was made to a person having ordinary skill in the art to which said subject matter pertains. Patentability shall not be negated by the manner in which the invention was made.

Claims 1-3, 5, 11-18, 26-29, 43, 45, 51-54, 65, 66 are rejected under 35 U.S.C. 103(a) as being unpatentable over McZeal, Jr. '226 in view of Bernstein et al, U.S. Pat. App. Pub. #2004/00128356.

McZeal discloses in col. 4, lines 18 et seq. that until his invention there was no device which could take full advantage of the Internet and IM for voice quality purposes, and which uses computer data networks for voice. In col. 28, lines 5 et seq. McZeal discloses that his invention provides customers with instant IM which uses VoIP. In col. 16, lines 39 et seq. McZeal discloses that his invention can use both the Internet and the PSTN. Bernstein et al disclose in P.0050 that each IM session has a universally unique identifier, which the server computer uses to identify and store individual Instant Messages. To have provided Bernstein et al teaching of storing IM in a server in McZeal's communication system would have been obvious to a person having ordinary skill in the art, because the skilled practitioner in this communication art will realize the need to store messages if the called party lacked the present ability to receive the IM.

For claims 2 & 3, McZeal discloses in cols. 1 & 16, lines 42-43 & 25-30 that his invention can be used in local or wide area networks - LAN/WAN.

Regarding claim 11, see McZeal @ col. 16, lines 42 & 59-60. Pertaining to claim 20, with McZeal's disclosure that his device that his device can be used in either a WAN



(Internet) or LAN (local area network). If the voice message is to be routed out beyond a LAN, then an external serving system will have to be employed until the message reaches the recipient inside of the LAN, whereupon the LAN and its associated server will route the message to the intended recipient.

Claims 4, 19, 20, 44 are rejected under 35 U.S.C. 103(a) as being unpatentable over McZeal in view of Bernstein et al as applied to claim 1 above, and further in view of Williams et al.

Williams et al disclose in P.0055 that a messaging server (105) will save a voice message and send a list of recipients to the user from an address book. To have provided Williams teaching of a server providing a user a calling list of recipients in McZeal's Instant Voice Messaging server system would have been obvious to a person having ordinary skill in the art because the skilled practitioner in the communications and server arts will readily realize that there are an unlimited amount of commands and information that a server can hold which can be communicated to anyone throughout the world that has proper equipment.

Claims 7, 22, 47 are rejected under 35 U.S.C. 103(a) as being unpatentable over McZeal in view of Bernstein et al as applied to claim 1 above, and further in view of Sagi et al.

Sagi et al disclose in claim 24 where a server will receive an audio file from a subscriber, and then in claim 29 Sagi et al disclose that the transmission is sent to a 2<sup>nd</sup> subscriber. To have similarly used Sagi et al disclosure of transmitting an audio file to a server in McZeal's device would have been obvious to a person having ordinary skill in

the art, because the skilled practitioner in communications art will realize that the sending party can either directly record a voice message or send an audio file. Either way, a called party will receive the voice message.

Claims 8, 23, 48 are rejected under 35 U.S.C. 103(a) as being unpatentable over McZeal in view of Bernstein et al as applied to claim 1 above, and further in view of Goodman et al.

Goodman et al disclose in P.0033 that an audio message can be transformed from any of encrypted, decrypted, compressed, or decompressed format. To have similarly provided Goodman's teaching of encrypting, decrypting, compressing, and decompressing audio into McZeal's device would have been obvious to a person having ordinary skill in the art, because by compressing the audio will take up less memory in the server.

Claims 9, 24, 49 are rejected under 35 U.S.C. 103(a) as being unpatentable over McZeal in view of Bernstein et al as applied to claim 1 above, and further in view of Gierachf.

Gierachf discloses in P.0044 in Step- 266 that the audio data or voice message is sent to audio buffer 19B'. To have similarly used Gierachf's method of buffering the audio data in McZeal's apparatus would have been obvious to a person having ordinary skill in the art.

Claims 10, 25, 50 are rejected under 35 U.S.C. 103(a) as being unpatentable over McZeal in view of Bernstein et al as applied to claim 1 above, and further in view of Creamer et al, U.S. Pat. App. Pub. #2003/0126207.

Creamer et al disclose in P.0006 that IM chat systems can also support the exchange of attachments. Attachments are electronic files such as images, documents, or binary objects which can be attached to an IM and transmitted therewith. To have used creamer et al teaching of attaching an electronic file to an IM in McZeal's instant voice messaging system would have been obvious to a person having ordinary skill in this art because the skilled practitioner will realize the efficiency of alerting a multitude of persons located throughout the world that an email/document from the sender is being sent to the recipients, such as the minutes of an important meeting.

Claims 30-33, 35, 41, 55, 57, 63, 64, 67, 69, 75 are rejected under 35 U.S.C. 103(a) as being unpatentable over McZeal in view of Bernstein et al as applied to claim 1 above, and further in view of Monroe.

Monroe discloses in col. 20, lines 28 et seq. and in Fig. 9 a local server (460) connected to a LAN, which provides a gateway to a WAN like the Internet. In col. 32, lines 11 et seq. Monroe discloses that pre-recorded voice messages can be delivered to a modem and then delivered throughout the network. To have used Monroe's teaching of connecting a local server to an Internet server in McZeal's device would have been obvious to a person having ordinary skill in the art because a local server will only reach a few, select individuals in close proximity to each other, whereas the Internet will have global reach, thus insuring connectivity to clients worldwide.

Claims 42 & 76 are rejected under 35 U.S.C. 103(a) as being unpatentable over McZeal in view of Bernstein et al and Monroe as applied to claim 30 above, and further in view of Boukobza, U.S. Pat. App. Pub. #2006/0167883.

Boukobza's method as disclosed in P.0020 is for load balancing databases within a network having a plurality of servers. To have provided Boukobza's method of load balancing servers in Monroe as applied to McZeal would have been obvious to a person having ordinary skill in the art, because the skilled practitioner would realize that as one server becomes filled with IM, or as one server is being inundated with high volume traffic, it would become necessary to route some of those IM to another server for storing.

Claims 34, 56, 68 are rejected under 35 U.S.C. 103(a) as being unpatentable over Mczeal in view of Bernstein et al and Monroe as applied to claim 30 above, and further in view of Williams et al.

Claims 37, 59, 71 are rejected under 35 U.S.C. 103(a) as being unpatentable over McZeal in view of Bernstein et al and Monroe as applied to claim 30 above, and further in view of Sagi et al.

Claims 38, 60, 72 are rejected under 35 U.S.C. 103(a) as being unpatentable over McZeal in view of Bernstein et al and Monroe as applied to claim 30 above, and further in view of Goodman et al.

Claims 39, 61, 73 are rejected under 35 U.S.C. 103(a) as being unpatentable over McZeal in view of Bernstein et al and Monroe as applied to claim 30 above, and further in view of Gierachf.

Claims 40, 62, 74 are rejected under 35 U.S.C. 103(a) as being unpatentable over McZeal in view of Bernstein et al and Monroe as applied to claim 30 above, and further in view of Creamer et al.

Application/Control Number: 10/740,030  
Art Unit: 2614

Page 7

Any inquiry concerning this communication should be directed to Creighton H. Smith at telephone number 571/272-7546.

04 AUG '08

/Creighton H Smith/  
Primary Examiner, Art Unit 2614

<b>Notice of References Cited</b>	Application/Control No. 10/740,030	Applicant(s)/Patent Under Reexamination ROJAS, MICHAEL J.	
	Examiner Creighton H. Smith	Art Unit 2614	Page 1 of 1

**U.S. PATENT DOCUMENTS**

*	Document Number Country Code-Number-Kind Code	Date MM-YYYY	Name	Classification
*	A US-2004/0128356	07-2004	Bernstein et al.	709/206
*	B US-2003/0126207	07-2003	Creamer et al.	709/204
C	US-			
D	US-			
E	US-			
F	US-			
G	US-			
H	US-			
I	US-			
J	US-			
K	US-			
L	US-			
M	US-			

**FOREIGN PATENT DOCUMENTS**

*	Document Number Country Code-Number-Kind Code	Date MM-YYYY	Country	Name	Classification
N					
O					
P					
Q					
R					
S					
T					

**NON-PATENT DOCUMENTS**

*	Document Number Country Code-Number-Kind Code	Date MM-YYYY	Country	Name	Classification
	Include as applicable: Author, Title Date, Publisher, Edition or Volume, Pertinent Pages)				
U					
V					
W					
X					

\*A copy of this reference is not being furnished with this Office action. (See MPEP § 707.05(a).)  
Dates in MM-YYYY format are publication dates. Classifications may be US or foreign.

<b>Index of Claims</b>  	<b>Application/Control No.</b>  10740030	<b>Applicant(s)/Patent Under Reexamination</b>  ROJAS, MICHAEL J.
	<b>Examiner</b>  Creighton H Smith	<b>Art Unit</b>  2614

✓	<b>Rejected</b>
=	<b>Allowed</b>

-	<b>Cancelled</b>
÷	<b>Restricted</b>

N	<b>Non-Elected</b>
I	<b>Interference</b>

A	<b>Appeal</b>
O	<b>Objected</b>

Claims renumbered in the same order as presented by applicant
  CPA
  T.D.
  R.1.47

CLAIM		DATE									
Final	Original	08/05/2008									
	1	✓									
	2	✓									
	3	✓									
	4	✓									
	5	✓									
	6	✓									
	7	✓									
	8	✓									
	9	✓									
	10	✓									
	11	✓									
	12	✓									
	13	✓									
	14	✓									
	15	✓									
	16	✓									
	17	✓									
	18	✓									
	19	✓									
	20	✓									
	21	✓									
	22	✓									
	23	✓									
	24	✓									
	25	✓									
	26	✓									
	27	✓									
	28	✓									
	29	✓									
	30	✓									
	31	✓									
	32	✓									
	33	✓									
	34	✓									
	35	✓									
	36	✓									

<b>Index of Claims</b>  	<b>Application/Control No.</b>  10740030	<b>Applicant(s)/Patent Under Reexamination</b>  ROJAS, MICHAEL J.
	<b>Examiner</b>  Creighton H Smith	<b>Art Unit</b>  2614

✓	<b>Rejected</b>
=	<b>Allowed</b>

-	<b>Cancelled</b>
÷	<b>Restricted</b>

N	<b>Non-Elected</b>
I	<b>Interference</b>

A	<b>Appeal</b>
O	<b>Objected</b>

Claims renumbered in the same order as presented by applicant
  CPA
  T.D.
  R.1.47

CLAIM		DATE									
Final	Original	08/05/2008									
	37	✓									
	38	✓									
	39	✓									
	40	✓									
	41	✓									
	42	✓									
	43	✓									
	44	✓									
	45	✓									
	46	✓									
	47	✓									
	48	✓									
	49	✓									
	50	✓									
	51	✓									
	52	✓									
	53	✓									
	54	✓									
	55	✓									
	56	✓									
	57	✓									
	58	✓									
	59	✓									
	60	✓									
	61	✓									
	62	✓									
	63	✓									
	64	✓									
	65	✓									
	66	✓									
	67	✓									
	68	✓									
	69	✓									
	70	✓									
	71	✓									
	72	✓									



<b><i>Index of Claims</i></b>  	<b>Application/Control No.</b>  10740030	<b>Applicant(s)/Patent Under Reexamination</b>  ROJAS, MICHAEL J.
	<b>Examiner</b>  Creighton H Smith	<b>Art Unit</b>  2614

✓	<b>Rejected</b>
=	<b>Allowed</b>

-	<b>Cancelled</b>
÷	<b>Restricted</b>

N	<b>Non-Elected</b>
I	<b>Interference</b>

A	<b>Appeal</b>
O	<b>Objected</b>

<input type="checkbox"/> Claims renumbered in the same order as presented by applicant		<input type="checkbox"/> CPA	<input type="checkbox"/> T.D.	<input type="checkbox"/> R.1.47					
CLAIM		DATE							
Final	Original	08/05/2008							
	73	✓							
	74	✓							
	75	✓							
	76	✓							

<b>Search Notes</b>  	<b>Application/Control No.</b>  10740030	<b>Applicant(s)/Patent Under Reexamination</b>  ROJAS, MICHAEL J.
	<b>Examiner</b>  Creighton H Smith	<b>Art Unit</b>  2614

<b>SEARCHED</b>			
<b>Class</b>	<b>Subclass</b>	<b>Date</b>	<b>Examiner</b>

<b>SEARCH NOTES</b>		
<b>Search Notes</b>	<b>Date</b>	<b>Examiner</b>
EAST Search	05 AUG '08	chs

<b>INTERFERENCE SEARCH</b>			
<b>Class</b>	<b>Subclass</b>	<b>Date</b>	<b>Examiner</b>

## EAST Search History

Ref #	Hits	Search Query	DBs	Default Operator	Plurals	Time Stamp
L1	207	((@ad<="20021218") and (stor\$3 with (im or instant adj mesag\$3) with server\$1))	US-PGPUB; USPAT; USOCR; EPO; JPO; DERWENT; IBM_TDB	OR	OFF	2008/08/04 13:09
L2	411	((@ad<="20021218") and ((attach\$3 or fasten\$3 or affix \$3 or connect\$3 or join\$3 or add\$3) with email with (audio or voice)))	US-PGPUB; USPAT; USOCR; EPO; JPO; DERWENT; IBM_TDB	OR	OFF	2008/08/04 14:43
L3	3411	((@ad<="20021218") and ((attach\$3 or fasten\$3 or affix \$3 or connect\$3 or join\$3 or add\$3) with (file\$1 or email) with (audio or voice)))	US-PGPUB; USPAT; USOCR; EPO; JPO; DERWENT; IBM_TDB	OR	OFF	2008/08/04 14:44
L4	17	((@ad<="20021218") and ((attach\$3 or fasten\$3 or affix \$3 or connect\$3 or join\$3 or add\$3) with email with (im or instant adj mesag\$3)))	US-PGPUB; USPAT; USOCR; EPO; JPO; DERWENT; IBM_TDB	OR	OFF	2008/08/04 14:48
L5	44	((@ad<="20021218") and ((attach\$3 or fasten\$3 or affix \$3 or connect\$3 or join\$3 or add\$3) with (email or file\$1) with (im or instant adj mesag \$3)))	US-PGPUB; USPAT; USOCR; EPO; JPO; DERWENT; IBM_TDB	OR	OFF	2008/08/04 15:08

8/ 4/ 2008 3:48:57 PM

C:\Documents and Settings\csmith1\My Documents\EAST\Workspaces\10566778.wsp

**UNITED STATES PATENT AND TRADEMARK OFFICE**

Applicant(s): Michael J. Rojas                      Examiner:    Creighton H. Smith  
Serial No:    10/740,030                              Art Unit:    2614  
Filed:        December 18, 2003                              Docket:     17188  
For:         SYSTEM AND METHOD FOR                      Dated:       July 7, 2008  
              INSTANT VoIP MESSAGING

Confirmation No. 1731

Commissioner for Patents  
P. O. Box 1450  
Alexandria, VA 22313-1450

**RESPONSE UNDER 37 C.F.R. § 1.111**

Sir:

Applicant submits this Response in reply to the Official Action dated March 6, 2008. Applicant respectfully requests reconsideration of the application in view of the following remarks.

---

**CERTIFICATE OF ELECTRONIC FILING**

I hereby certify that this correspondence is being deposited with the United States Patent & Trademark Office via Electronic Filing through the United States Patent and Trademark Office e-business website, on July 7, 2008.

Dated: July 7, 2008

  
Seth Weinfeld

## REMARKS

Applicant has filed the present Response in reply to the outstanding Official Action of March 6, 2008, and the Applicant believes the Response to be fully responsive to the Official Action for at least the reasons set forth herein.

Claims 1-3, 5, 11-18, 26-29, 43, 45, 51-54, 65 and 66 stand rejected under 35 U.S.C. § 103(a) as being unpatentable in view of McZeal (previously cited) and Barry, U.S. Patent Publication No. 2007/0174403. Claims 4, 19, 20, and 44 stand rejected under 35 U.S.C. § 103(a) in view of McZeal, Barry and Williams. Claims 7, 22 and 47 stand rejected under 35 U.S.C. § 103(a) as being unpatentable in view of McZeal, Barry, and Sagi. Claims 8, 23 and 48 stand rejected under 35 U.S.C. § 103(a) as being unpatentable in view of McZeal, Barry and Goodman. Claims 9, 24 and 49 stand rejected under 35 U.S.C. § 103(a) as being unpatentable in view of McZeal, Barry and Gierachf, U.S. Patent Publication No. 2005/0053230. Claims 10, 25 and 50 stand rejected under 35 U.S.C. § 103(a) as being unpatentable in view of McZeal, Barry and Hollowell et al., U.S. Pat. Pub 2005/0105697.

Claims 30-33, 35, 41, 55, 57, 63, 64, 67, 69 and 75 stand rejected under 35 U.S.C. § 103(a) as being unpatentable in view of McZeal, Barry and Monroe, U.S. Patent No. 6,970,183. Claims 42 and 46 stand rejected under 35 U.S.C. § 103(a) as being unpatentable in view of McZeal, Barry, Monroe and Boukobza. Claims 34, 56 and 68 stand rejected under 35 U.S.C. § 103(a) as being unpatentable in view of McZeal, Barry, Williams and Monroe. Claims 37, 59 and 71 were rejected under 35 U.S.C. § 103(a) as being unpatentable in view of McZeal, Barry, Sagi and Monroe.

Claims 38, 60 and 72 stand rejected under 35 U.S.C. § 103(a) as being unpatentable in view of McZeal, Barry, Goodman and Monroe. Claims 39, 61 and 73 stand rejected under 35

U.S.C. § 103(a) as being unpatentable in view of McZeal, Barry, Gierachf and Monroe. Claims 40, 62 and 74 stand rejected under 35 U.S.C. § 103(a) as being unpatentable in view of McZeal, Barry, Hollowell and Monroe.

Applicant respectfully disagrees with the rejection and traverses with at least the following remarks and comments. Applicant submits that Barry and Hollowell are not prior art. Annexed hereto is a declaration pursuant to 37 C.F.R. § 1.131 attesting to Applicant's prior conception of the claimed invention. As asserted in paragraphs 2 and 3, Applicant completed the invention claimed in the instant application prior to the filing dates of both references. Applicant worked diligently with two different patent attorneys to file a patent application.

Based upon the foregoing, Applicant respectfully requests that the Examiner withdraw all of the pending rejections pursuant to 35 U.S.C. § 103(a).

In conclusion, the Applicant believes that the above-identified application is in condition for allowance and henceforth respectfully solicits the Examiner to allow the application. If the Examiner believes a telephone conference might expedite the allowance of this application, the Applicant respectfully requests that the Examiner call the undersigned, Applicant's attorney, at the following telephone number: (516) 742-4343.

Respectfully submitted,

  
Seth Weinfeld  
Registration No: 50,929

Scully, Scott, Murphy & Presser, P.C.  
400 Garden City Plaza, Suite 300  
Garden City, New York 11530  
516-742-4343

SW:reg



**COMBINED AMENDMENT & PETITION FOR EXTENSION OF  
TIME UNDER 37 CFR 1.136(a) (Small Entity)**

Docket No.  
**17188**

The fee for the amendment and extension of time is to be paid as follows:

- A check in the amount of \_\_\_\_\_ for the amendment and extension of time is enclosed.
- Please charge Deposit Account No. **19-1013/SSMP** in the amount of **\$60.00**
- The Director is hereby authorized to charge payment of the following fees associated with this communication or credit any overpayment to Deposit Account No.
  - Any additional filing fees required under 37 C.F.R. 1.16.
  - Any patent application processing fees under 37 CFR 1.17.
- If an additional extension of time is required, please consider this a petition therefor and charge any additional fees which may be required to Deposit Account No. **19-1013/SSMP**
- Payment by credit card. Form PTO-2038 is attached.

**WARNING: Information on this form may become public. Credit card information should not be included on this form. Provide credit card information and authorization on PTO-2038.**

  
\_\_\_\_\_  
*Signature*

Dated: July 7, 2008

Seth Weinfeld  
Registration No. 50,929  
Scully, Scott, Murphy & Presser, P. C.  
400 Garden City Plaza - Suite 300  
Garden City, New York 11530  
(516) 742-4343

I hereby certify that this correspondence is being deposited with the United States Postal Service with sufficient postage as first class mail in an envelope addressed to the "Commissioner for Patents, P.O. Box 1450, Alexandria, VA 22313-1450" [37 CFR 1.8(a)] on _____ (Date)
_____ <i>Signature of Person Mailing Correspondence</i>
_____ <i>Typed or Printed Name of Person Mailing Correspondence</i>

cc:



**UNITED STATES PATENT AND TRADEMARK OFFICE**

<b>Applicant:</b>	<b>Michael J. Rojas</b>	<b>Examiner:</b>	<b>Creighton H. Smith</b>
<b>Serial No:</b>	<b>10/740,030</b>	<b>Art Unit:</b>	<b>2614</b>
<b>Filed:</b>	<b>December 18, 2003</b>	<b>Docket:</b>	<b>17188</b>
<b>For:</b>	<b>SYSTEM AND METHOD FOR INSTANT VoIP MESSAGING</b>		

**Confirmation No. 1731**

Commissioner for Patents  
P. O. Box 1450  
Alexandria, VA 22313-1450

**DECLARATION PURSUANT TO 37 C.F.R. § 1.131**

Sir:

I, MICHAEL ROJAS, hereby declare that:

1. I am the Applicant of United States Patent Application No. 10/740,030, filed on December 18, 2003.
2. I completed the invention disclosed and claimed in United States Patent Application No. 10/740,030, prior to November 14, 2003, which is the filing date of United States Publication No. 2005/0105697 A1, cited as a reference under 35 U.S.C. § 103, against the present application by the Examiner.
3. I completed the invention disclosed and claimed in United States Patent Application No. 10/740,030, prior to August 15, 2003, which is the filing date of United States Publication No. 2007/0174403 A1, cited as a reference under 35 U.S.C. § 103, against the present application by the Examiner.
4. The completion of the present invention consisted of the timely preparation of an invention disclosure outlining the subject matter of the invention. As evidence thereof

- annexed hereto and made a part of this Declaration is Exhibit A, which is a redacted copy of the invention entitled "Instant Voice Communication" and comprising nineteen (19) pages of description.
5. All of the salient features of Applicant's United States Patent Application No. 10/740,030 are fully described in the annexed Exhibit A.
  6. The material, as set forth in Exhibit A, fully and comprehensively describes the subject matter of the claims of the United States Patent Application No. 10/740,030, setting forth the features of the claimed invention.
  7. The invention disclosure was timely submitted to outside counsel, Bradley C. Corsello (hereinafter "Corsello"), to prepare and file a provisional patent application.
  8. A first draft of the provisional patent application was received from Corsello, prior to August 15, 2003.
  9. On August 11, 2003, Corsello and Applicant had a teleconference regarding drafting the application and visit by Corsello to Applicant's office scheduled for August 19, 2003. Annexed herein as Exhibit B is a redacted email evidencing the teleconference.
  10. On August 28, 2003, Corsello responded to a series of questions from Applicant regarding information needed to draft the application. Annexed herein as Exhibit C is a redacted email from Corsello.
  11. On September 8, 2003, a representative of the assignee, Ayalogic, Neil Adams (hereinafter "Adams") inquired about the status of the application. Corsello informed Applicant that he was working on the revised draft. Annexed herein as Exhibit D is a redacted email regarding the inquiry and response.

12. On September 17, 2003, Adams emailed Applicant inquiring about information and material needed for the draft of the provisional application. Annexed herein as Exhibit E is a redacted email regarding the inquiry.
13. On September 22, 2003, Adams emailed Corsello information and material for the provisional application. The material is appended to the email as an attachment. Annexed herein as Exhibit F is a redacted email regarding the submission of material.
14. On October 3, 2003, assignee, Ayalogic (hereinafter "Ayalogic") decided to look for another law firm to file a patent application regarding the subject matter described in the invention disclosure.
15. Between October 3, 2003-October 27, 2003, Ayalogic searched for a law firm to preparing the patent application.
16. On October 28, 2003, Ayalogic engaging the firm Scully, Scott, Murphy and Presser, P.C., (hereinafter "Scully Scott") to preparing a patent application.
17. On October 30, 2003, Adams forwarded the latest draft of the provisional application to Scully Scott. Annexed herein as Exhibit G is a redacted email forwarding the document.
18. On November 4, 2003, Adams and Scully Scott conducted a teleconference regarding drafting of the application. Annexed herein as Exhibit H is a redacted email reflecting the teleconference.
19. On November 6, 2003, Adams emailed Applicant a revised draft and forwarded draft to Scully Scott. Annexed herein as Exhibit I is a redacted email evidencing the submission of the draft to Scully Scott.

- 20. Between November 6, 2003 and December 1, 2003, Adams inquired about the status of the application no less than three times.
- 21. Scully Scott prepared a draft of the application in timely manner. A first draft of the application was sent from Scully Scott to Applicant on December 2, 2003. Annexed herein as Exhibit J is a redacted email enclosing the draft. A series of revisions to the application were emailed to Applicant between December 3 and 4, after a teleconference with Applicant.
- 22. Applicant diligently reviewed the drafts of the application and provided comments thereto on December 9, 2003. Annexed herein as Exhibit K is a redacted email reflecting the comments.
- 23. A final draft of the application was sent to Applicant on December 16, 2003.
- 24. The United States Patent Application No. 10/740,030 was filed on December 18, 2003, after a timely and expedient review by the Applicant.
- 25. I further declare that all statements made herein of my own knowledge are true and that all statements made on information and belief are believed to be true; and further that these statements are made with knowledge that willful false statements and the like so made are punishable by fine or imprisonment or both, under Section 1001 of Title 18 of the United States Code and that such willful false statements may jeopardize the validity of the application or any patent issued thereon.

  
MICHAEL ROJAS

7-3-2008  
Dated:

A



## Instant Voice Communications

REDACTED

Michael Rojas  
Executive Vice President

REDACTED

**Ayalogic, Inc.**  
530 South Main Street, Suite 1732  
Akron, Ohio 44311-1010  
voice 330.253.2700  
fax 330.253.3055

[www.ayalogic.com](http://www.ayalogic.com)

# Instant Voice Communications

## Abstract

This paper outlines the next step for communications systems – *instant voice communication* over internet protocol. With Ayalogic's™ new offering, QuickTalk™ business professionals will have the option to speak instantly with one another, revolutionizing the concept of telephone, voice mail and instant messaging. The IP technology behind QuickTalk will allow companies with this system to save dramatically on time, equipment and maintenance costs.

## Instant Voice Messaging

QuickTalk™ offers instant connectedness – like an intercom that reaches everyone in the company, or a walkie talkie that spans the world. Touch a button and you can talk immediately with anyone anywhere the internet touches. The closest comparable technology is instant messaging – wildly popular, even with the significant handicap of using text instead of the clear, quality voice over IP that QuickTalk™ offers.

Instant messaging technology has been around in its most familiar form since 1996 and in recent years has become a common feature on PCs and cellular phones. It works like this: you create a “buddy list” of various people you may want to contact. When you want to communicate with a list member you simply type a message and it is instantly delivered to that person’s desktop (usually in a pop-up window). How popular is instant messaging? CNET.COM, a prominent downloads site, reported the number of ICQ instant messaging software downloads just in a single week at over 500,000.

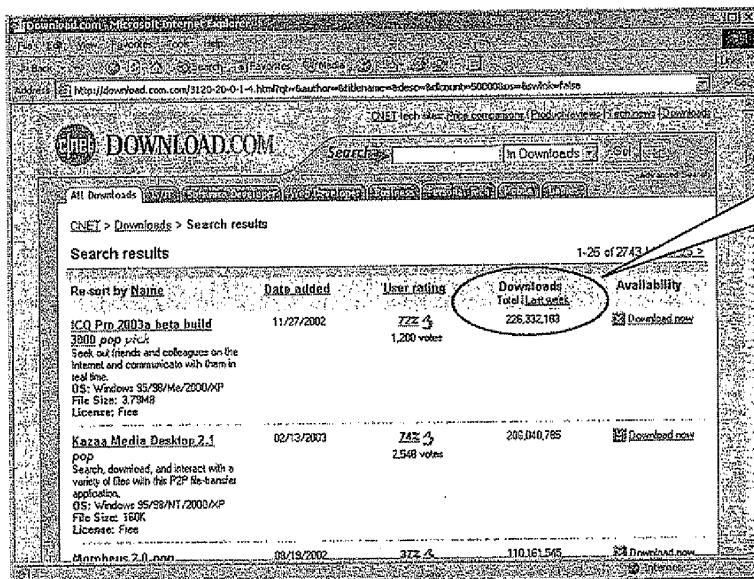

Re-sort by	Name	Date added	User rating	Downloads Total/Last week	Availability
	ICQ Pro 2003a beta build	11/27/2002	72% 1,200 votes	266,332,183	Download now
	Kazaa Media Desktop 2.1 pop	02/13/2003	74% 2,548 votes	205,040,785	Download now
	Members 2.0.exe	03/19/2002	97% 24	110,161,545	Download now

266,332,183 Downloads!

CNET.COM Website captured on March 27, 2003

The substitution of voice for text makes QuickTalk™ infinitely more attractive. Nothing to type, just push a button and speak. Leave a voice mail message without dialing and check your own messages without lengthy punch pad scroll through. Ease of use and the comfort of voice communications set QuickTalk™ apart.

### **Innovation**

No instant messaging vendor is concentrating on voice. We believe that by combining the best features of instant messaging with Voice over IP technology, we can provide a new form of communication – *instant voice*.

Messages are recorded, digitized, encrypted, and transmitted instantly to anywhere in the world. Since the digitization occurs at the time of recording, the voice quality will not suffer degradation as the message moves through the Internet. The voice quality will be superb every time – regardless of congestion on the global network.

### **New Levels of Privacy and Connectedness**

QuickTalk™ promises to replace voice mail as we now know it with unprecedented levels of both connectedness and privacy. To leave a message with another user, simply push a button and speak. As for receiving messages, you may now choose *in advance* who can reach you instantly and which messages are sent automatically to voice mail – without screening. Change your preferences whenever you like, based on your schedule or specific project needs. Screen all your messages if you like, or send all messages to be stored for later pick up.

When you wish to reach others, a QuickTalk™ display on your PC screen – or a display on certain types of phones – will tell you whether they are “in” or “out,” again according to their preferences. This offers all of the connection of instant messaging with none of the productivity shattering intrusiveness.

### **Wherever You Go, There you Are**

QuickTalk™ can reach you wherever you go, at whatever device you designate. Cellular phones, laptops, palm pilots – all can be used by the QuickTalk™ system whenever you designate that you wish to be reached somewhere other than at your desk. Using Ayalogic's™ proprietary gateway and software, you can now be reached (at whatever level of privacy you choose) instantly everywhere.

### **Voice over Internet Protocol (VoIP)**

Telephone technology has changed very little since its inception. It is still primarily an analog modulated electrical voltage running on copper wires to each home – exactly how Alexander Graham Bell designed it. Now the Internet has is forcing a change in this 100-year-old technology. That change is called Voice over IP.



Voice over IP (or IP telephony) is a method of voice transmission in which analog speech is converted to digital information and transported across a computer network. This technology enables the transmission of speech to anywhere in the world that the Internet touches. When the digital voice information arrives, it is converted back into its analog form using technology built directly into the phone or receiving device.

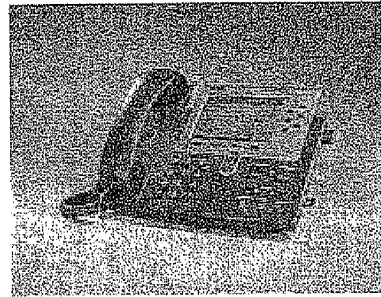

Cisco 7960 VoIP Phone

The introduction of this technology, primarily by Cisco Systems, alarmed many traditional phone manufacturers. At first, they resisted the technology, citing that it was unreliable and of poor voice quality. However, as the technology's adoption rate grew, they began to incorporate it into their core products. Today, every vendor has some form of IP telephony offering.

Some manufacturers started from scratch creating new communication systems completely based on software, called softswitches. The philosophy was that once the voice was converted into digital packets, it could most easily be manipulated using computers and software. The goal was to speed the introduction of new phone services without having to upgrade expensive hardware. Cisco's CallManager product is an example of a softswitch.



Since Cisco had already cornered the Voice over IP *enterprise market*, the other softswitch vendors charged into the *service provider market*. Their customers were traditional phone companies, such as Verizon, and competitive local exchange carriers known as CLECs. However, when the telecommunication sector slumped, the service providers cut drastically back in capital expenditures, all but evaporating the Voice over IP market for service providers.

In reaction to this, every softswitch vendor did an about-face, and introduced an enterprise-version of their carrier-class products. This means that the enterprise market has over 50 softswitch vendors vying for position in a market dominated by Cisco. To compete, prices on this technology are dropping precipitously.

## New Phones

Accelerating this price pressure is the weekly announcement of new devices that can leverage this technology. Companies such as Alcatel, Teliann, Lucent, Nortel, NEC, Cisco, Snom, Polycom, and Pingtel all offer VoIP phones. Up to now, the major growth inhibitor has been the cost the end device. In a normal communication system, the phones account for over 70% of the cost of the system.

Here is a sampling of the available phones as of March 27, 2003:

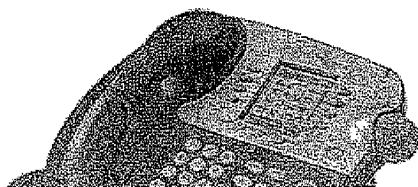

Vendor: PingTel  
Model: expressa  
Price: \$599

Description:  
The PingTel phone is intelligent, has a built-in java processor and uses industry standard Session Initiation Protocol (SIP).

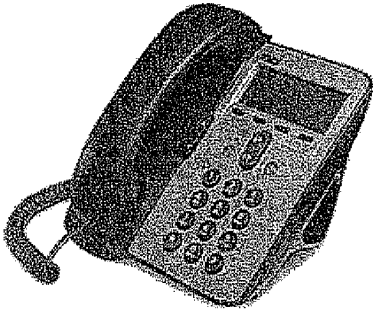

Vendor: Cisco Systems  
Model: 7905  
Price: \$230

Description:  
This is Cisco's entry level IP phone based on the SIP standard.

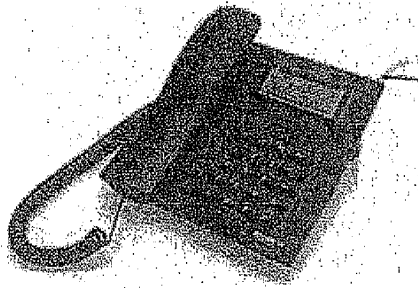

Vendor: Snom  
Model: 100b  
Price: \$240

Description:  
Entry level VoIP Phone, supporting multiple standards such as SIP and H.323/H.450.

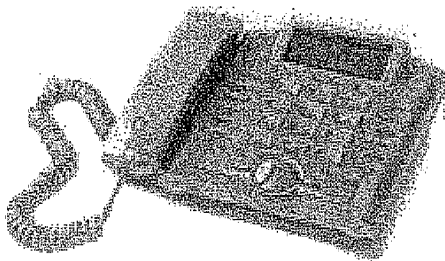

Vendor: Teliann  
Model: HS Teliann IP Phone  
Price: \$120

Description:  
Korean-built, lowest cost VoIP phone on the market today – supports industry standard H.323 – SIP is planned.

The Teliann IP Phone was introduced at the Voice over Network conference (VON2002) in winter of 2002. Retailing at \$120, the phone has the potential of finally removing the price barrier to the market.

## Phone-Speak

Every one of these devices requires a signaling protocol to make them function properly. This protocol is a series of commands and response messages that control every aspect of the phone. Call Hold, Call Forward, Answer, Hang-Up, and other basic features are handled by this protocol. Until recently, another large inhibitor of the market was the lack of agreement as to a standard for this signaling.

Here is a brief list of the competing signal standards:

- **H.323** - This is actually an umbrella standard that covers a number of other standards. This collection originated in the International Telecommunication Union (ITU) and like most telecommunication standards, is large and complex.
- **MGCP** (Media Gateway Control Protocol) - This standard was introduced by the Internet Engineering Task Force to control endpoint conversion devices, called gateways.
- **MEGACO** (MEdia GAteway COontrol Protocol) - Similar to MGCP, this protocol attempts to provide additional functionality in controlling endpoint gateways.
- **SIP** (Session Initiation Protocol) -- A simple text-based protocol which has its roots in HTTP (Hypertext Transport Protocol), the protocol that drives every web page of the Internet today.
- **SCCP** (Skinny Client Control Protocol) -- This is a proprietary protocol that every Cisco phone uses to provide advanced services beyond the standard protocols. Only the Cisco CallManager product supports this protocol.

For the past few years, the industry wrestled with each standard, slowing the adoption of the technology. Many products were introduced that could not communicate with each other because of these different standards.

As of this writing, the standards war is ending, with SIP becoming the winner. Microsoft, Cisco, Alcatel, Lucent, Nortel, and other vendors have all introduced SIP-based products. SIP is favored because of the simple and extensible nature of the protocol. With the adoption of SIP as a standard across all products, the Voice over IP market has removed one more inhibitor.

However, the most important standard that Voice over IP introduces is not the signaling standard, but the *network technology* for the phone itself -- Ethernet and TCP/IP.

## The Real Voice over IP Standard - Ethernet

Every one of these devices shares a common characteristic. They all use TCP/IP protocol over Ethernet as the network standard to connect to the computer network.

This provides some very important benefits:

- **Flexibility** – Because Ethernet and TCP/IP are so prevalent, the devices can be deployed in many networking environments. They can be part of Wireless Local Area Networks (WLAN) such as 802.11b and connect over broadband connections such as cable modem, and DSL.
- **Cost** – Since Ethernet is widely available, the equipment to support such a network can enjoy the benefits of economies of scale. Networking gear is inexpensive, easy to obtain and install, allowing a wide audience to be reached.
- **Mobility** - All Ethernet devices have a unique number called the Media Access Control address (MAC). This number represents a unique piece of hardware and is never duplicated. This means that no matter where the phone connects to the network, that particular phone can be located and has the *same* identity.
- **Interoperability** – All the devices that deploy Ethernet inherently have the ability to communicate with one another. The devices may disagree on the *format* of the messages, but with additional software acting as a translator, these devices can communicate.

### Flexibility

Ethernet provides for a wide variety of deployment possibilities. The networking standard can operate over twisted pair cabling, coax, and even wireless. Hundreds of network equipment manufacturers provide equipment for routing, switching, transporting, and configuring Ethernet-based systems.

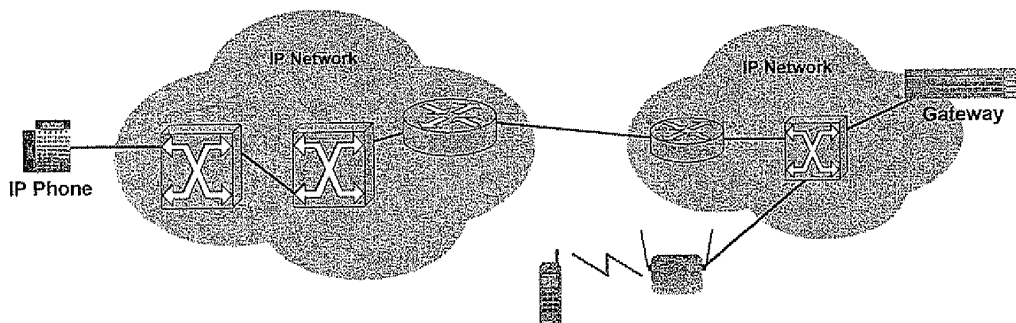

This allows the customer to choose best solutions for their particular business goals – while maintaining compatibility and interoperability.

## Cost

With so many vendors offering compatible equipment, Voice over IP using Ethernet provides for significant cost savings. For example, a proprietary, 16-port station line card for a typical phone system costs \$1200. This allows the system to be expanded by 16 endpoints. In contrast, to add an additional 16 endpoints to a Voice over IP system, an Ethernet switch could be installed which retails for \$97.

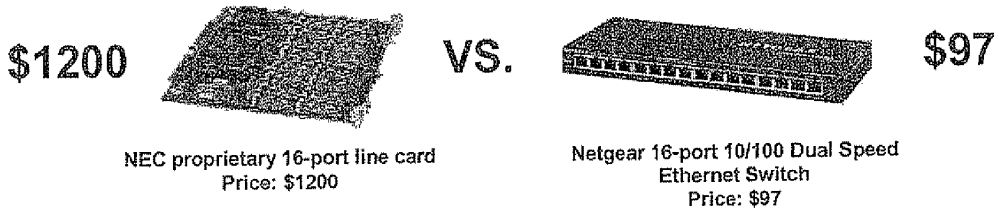

## Mobility

In a traditional phone network, the typical business phone is a proprietary device using proprietary electrical signaling to connect to a central switching system. Even though the device may be located far from this system, its proprietary signaling limits where the device can be hooked up. It must be *directly connected*. This means that in order to move the device to a new location, the physical wiring must be changed.

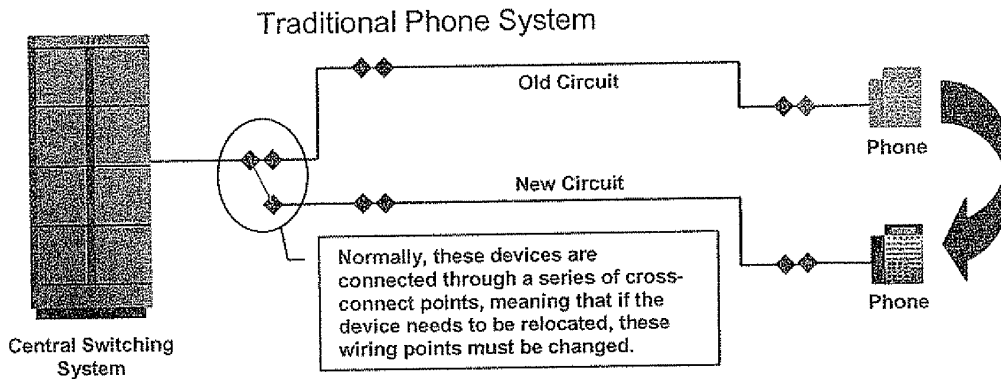

However, when the device employs Ethernet, the customer has complete flexibility in the location of the endpoint. All jacks can be provisioned identically regardless of which physical device will ultimately be connected.

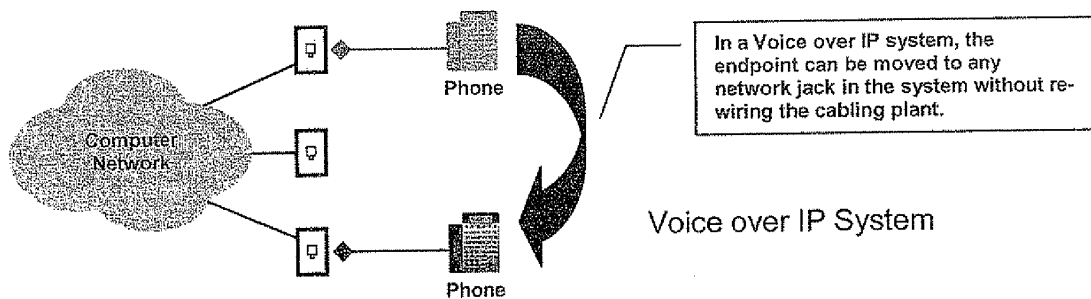

This is possible because each endpoint maintains its identity using the MAC address burned into the device. The *intelligence* in the system has been moved from a large

central device (PBX) into the endpoints itself. This give a Voice over IP system seamless *mobility* in relocating telephony equipment with a significant savings in administration costs.

## Interoperability

Since the proprietary electrical signaling has been eliminated, it is possible to mix multiple vendor devices into the same network. This protects the customer's infrastructure investment and provides flexibility in determining the correct endpoint for a particular solution. Multiple systems can be combined into a single larger system regardless of whether the equipment is from the same vendor.

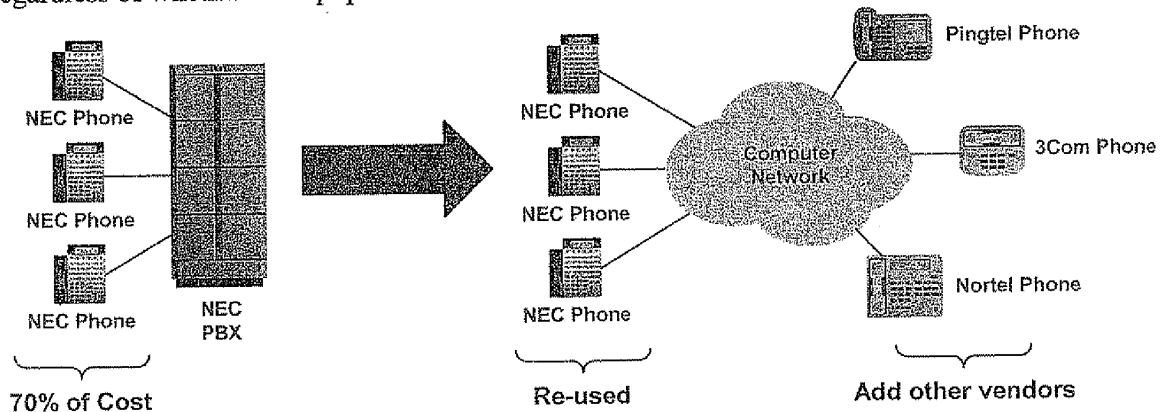

In the same way mainframes and *dumb* terminals gave way to personal computers and local area networks, the telecommunications industry can now move from cumbersome and costly switches and homogenous equipment to greater independence for end users and economical, as-needed equipment purchasing. All of this makes it possible to build a highly distributed and largely dispersed communication system that provides connectivity opportunities in ways that were not previously envisioned. We believe that this technology has paved the way to provide a new form of always-on, always-accessible, instant voice communications.

All that is required to connect one VoIP endpoint to another – instantly - is the software to control it.

## Why the PC is not a Phone

Most proponents of Voice over IP technology always arrive at the conclusion that the PC should be used as a *replacement* for the phone. After all, a personal computer has a processor, network card, and a sound card, so all you need is software and - voila! - you have an IP phone. In the VoIP industry, this type of software is known as a *softphone*.

Softphones have been slow to catch on because of several reasons:

- **Reliability** – PCs are not always ready to receive calls, because of system reboots, lock-ups, and crashes. If the softphone software is not running at the time the call comes in, the call is lost.
- **Latency** – Not all users are running the latest Windows OS with the latest processor speeds, making it hard to predict whether the system will be able to support real-time two-way audio. In addition, most PCs are used for other daily activities. In some cases, even running Microsoft Word could deprive the softphone of the necessary resources to provide quality audio streaming.
- **Performance** – most audio needs real-time compression in order to be transmitted across the Internet. This compression can consume as much as 25% of most Pentium III processor cycles.
- **Ergonomics** – A personal computer is somewhat uncomfortable to use as a phone. You will need to use a microphone and speakers at a minimum, making it impossible to have a private conversation. If you use a headset, you have a feeling of being tethered to the workstation.
- **Interface** – Most softphones require dialing to be performed using the mouse or keyboard. This is an awkward situation at best. Even if you use the numeric keypad on the keyboard, the numbers are arranged upside-down of those on a telephone.
- **Financial** – Some implementations require the addition of cards into the PC. Many IT departments balk at the task of opening every PC just to deploy a phone system, making this logistically and financially difficult.

According to a recent IDC report, 94% of all users prefer to talk using an actual phone rather than their PC. Any new communication technology must be able to interoperate with new and existing telephony devices.

However, let's look at another growing communication technology – instant messaging.

## **Instant Messaging (IM) for the Business Market**

While the consumer market is quite comfortable with instant messaging, the business market has viewed the technology with distrust, as problematic to manage and secure. Many corporations see the technology as *decreasing* productivity rather than enhancing it. However, whether individual IT groups sanction the use of the technology or not, instant messaging has invaded the workplace. The use of the technology can be broken down into several areas:

- **Personal** – While most companies have put into place strict phone abuse controls, instant messaging has effectively circumvented everything their IT groups have adopted. While most companies allow a reasonable amount of time for “calls to

home”, IM can quickly lead to abuse. If a corporation thinks IM decreases productivity, this is the most common reason provided.

- **Co-Worker** – Usually a very legitimate use, leading to greater productivity if deployed properly. A classic example is the use of the technology in customer service centers. The caller can be kept on the line talking with the service agent, while the agent chats with the problem specialist (co-worker) using instant messaging. This enables the customer to be served without a transfer or being put on-hold.
- **Customer** – Highly productive, convenient, low-cost way to serve your customer. Usually the biggest hurdle is getting the customer to use it.
- **Vendor** – Also productive. Easier to convince vendors to use the technology, since they have a sales motivation.

Since the invasion of IM technology into the enterprise, many large and small companies have rushed into the market. Almost all are focusing on security, manageability, and control in order to satisfy the business environment.

### Current Instant Messaging Vendors

Vendors	Products
All Instant, Inc.	LiveGate, LiveStudio/Live Manager, Live Tracker, Live Archive 2.0
America Online, Inc.	AOL Instant Messenger (AIM) 4.7 ICQ
Bantu, Inc.	Bantu Instant Messaging & Presence Platform 1.5
Flypaper, Inc.	Open Web Services Platform 3.0
IBM	Lotus Sametime Server 2.5
Ikimbo	Omniprise 1.3
Jabber, Inc.	Jabber Communications Platform 1.1
Microsoft Corp.	Microsoft MSN Messenger
Netscape Communications	Netscape Navigator Chat
Openwave Systems, Inc.	Openwave IM
PeopleLink	OnLine Community Solutions-Msg. Boards, Chat, Instant Messaging
Rockliffe, Inc.	MailSite DataCenter 4.5



Sonork S.R.L.	Sonork Instant Messaging Client 1.6 Sonork Instant Messaging Server 1.6
Wiredred Software	ie/pop - Real-time Communication Software for Corporations 3.0
Yahoo!, Inc.	Yahoo! Instant Messenger

The big players are, of course, AOL and Microsoft. IBM has the most aggressive growth because they integrated their instant messaging platform into Lotus Notes.

However, even though these companies say they support VoIP conferencing (usually via Microsoft NetMeeting), they are primarily a text-based messaging system. If they do support voice, the only option is full, real-time communications – the same communication method as a phone, but with a noticeable reduction in voice quality. In fact, they require the user to use the PC as a replacement for the phone. This approach has had very limited success, and *recently Microsoft has announced they are dropping support for voice in their instant messaging product (MSN Messenger).*

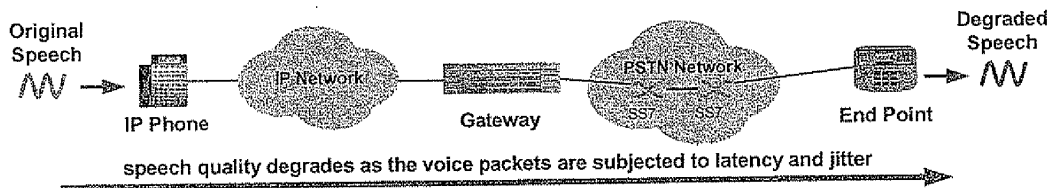

No instant messaging vendor is concentrating on voice. We believe that by combining the best features of instant messaging with Voice over IP technology, we can provide a new form of communication – *instant voice*. This technology allows the user to send and receive voice messages with a *push-to-talk* feel.

Messages are recorded, digitized, encrypted, and transmitted instantly to anywhere in the world. Since the digitization occurs at the time of recording, the voice quality will not suffer degradation as the message moves through the Internet. The voice quality will be superb every time – regardless of the currently congestion on the global network.

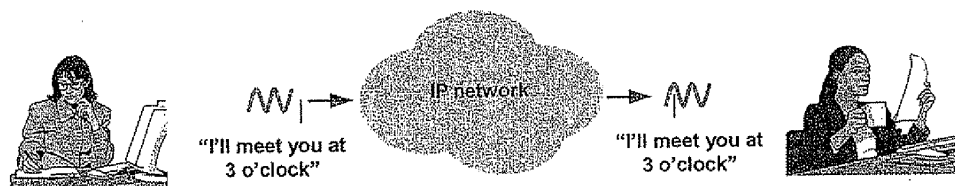

The user still has the option of controlling the *realtime-ness* of the communication – allowing instant messages, instant voice mails, paging, or full, two-way connections to be used.

## Our Technology

Our product philosophy involves three key elements:

- **Simplicity in use** – Above everything else, the product will be easy for ordinary people to use everyday. The product can be received with very little training. It must be obvious to the casual user how the product can be put to use.
- **Powerful in function** – Through the creation of business enhancing features, the product will provide immediate, real-world productivity on a daily basis.
- **Business class software** – The software is designed from the ground up by business people for business.

*Our flagship product, the QuickTalk Communication Platform<sup>™</sup>, is an enterprise class instant voice communication system designed to meet these goals. This system provides businesses with secure, manageable, and scalable instant voice communications. The product works with practically any existing phone system as an adjunct server providing advanced business-to-business collaborative communications.*

Leveraging the latest software technologies, the server software is .NET managed code running on a Windows .NET Server platform with a Microsoft SQL Server database.

### Client Server Architecture

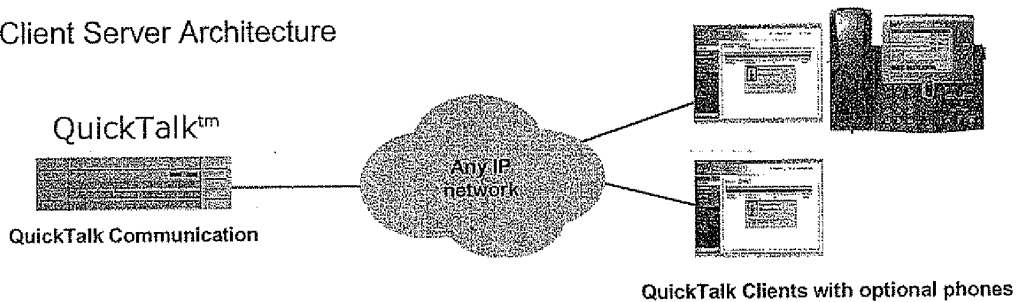

The entire software platform is installed on a rack-mountable industrial-grade server. This server features a front panel LCD which can control everything from assigning the network address, to rebooting the system.

Multiple servers may be deployed for system redundancy and load balancing.

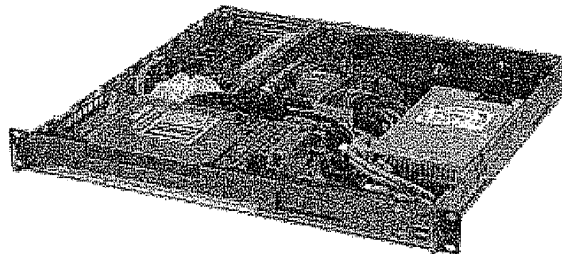

## Instant Voice Communications

When using this form of communication, the end user simply designates a recipient, speaks the desired message and the audio is digitized, compressed, encrypted and immediately delivered using voice over IP technology. It is fast, easy and convenient. You can think of this as voice mail in reverse. No more waiting for the beep – just leave your message and go.

To see the benefit of using instant voice communication, look how an old-style voice mail message is delivered today:

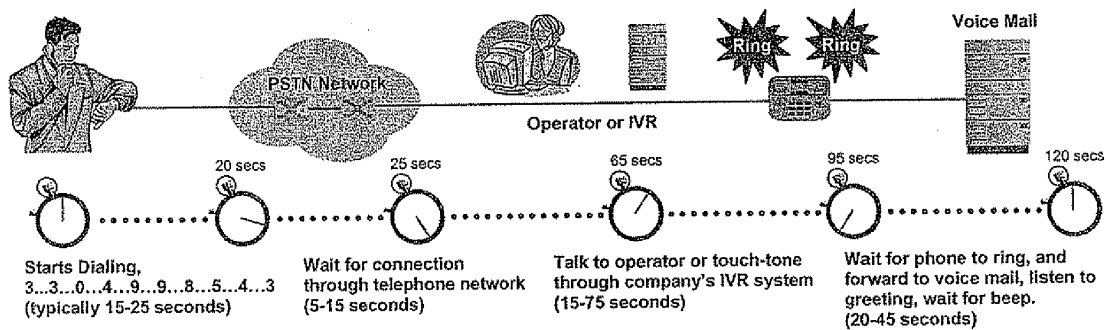

After dialing, connecting, transferring, ringing, and listening to the voice mail greeting, the caller has wasted over 1-2 minutes. This is the businessperson's typical waiting time *before* a voice message can begin. In addition to this waiting time, the caller must also spend time providing identification information in the voice mail message itself, further increasing the time of the entire effort.

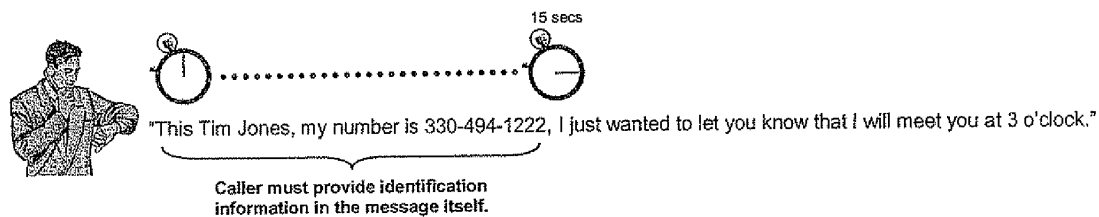

With instant voice communication, the caller simply presses a **push-to-talk** button on her PC keyboard or her phone and speaks her message. The message is delivered *instantly* via her telephone (which can be set directly on speaker or with a special ring signal).

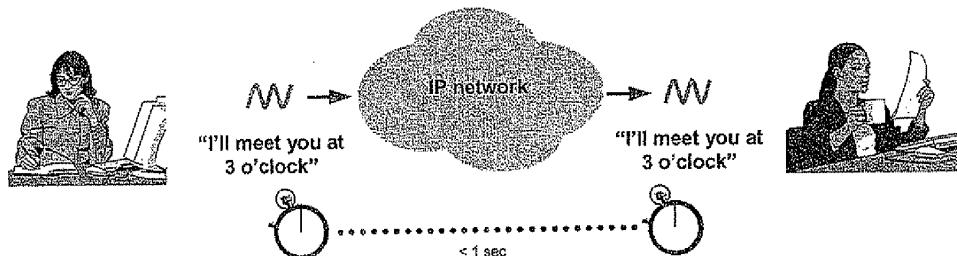

If the receiving party of the message wishes to reply, they can do so *instantly* by replying hands-free to the incoming message. The reply is delivered immediately to the sender.

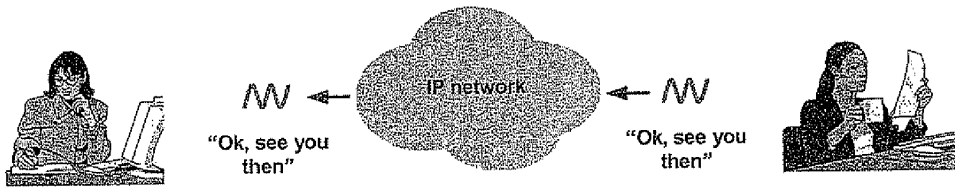

All of this occurred without dialing, transferring, connecting, or most importantly – waiting. The productivity gains are enormous. Let’s look at a hypothetical ball bearing company.

Number of Employees	2000 employees
Average calls placed or received per day per employee (station-station and outside calls)	8 calls
Average salary of an employee	22.50 / hour
Percent of calls that reach voice mail or caller must wait for answer/callback	60% = 4.8 calls are "callbacks" or reach voice mail
Time wasted per call waiting to leave message	2 minutes
Total Time wasted in company per day	19,200 minutes per day
Total dollars saved using instant voice communications	\$7,200 / day = \$1,872,000 / year

Many companies spend hundreds of thousands of dollars on voice mail technologies so that they don’t miss important messages. QuickTalk provides all the benefits of traditional voice messaging without the wait. The key to this technology is the patent-

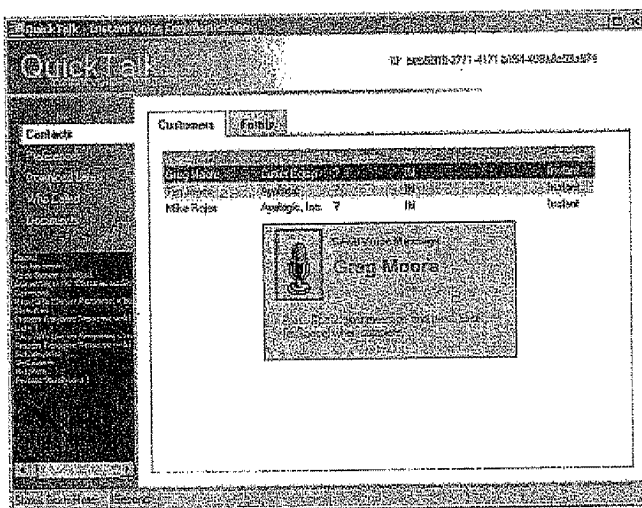

pending technology in the QuickTalk client software. This runs on Windows 95/98, 2000, NT, and XP and provides an easy-to-use interface to the product.

To use the technology, the user simply highlights the intended recipient, presses the space bar, and speaks the desired message. When the key is released, the message is instantly delivered to the intended contact.

If the user wishes to give or receive a more private conversation, the user may speak her message into a telephone instead of a PC microphone -- handoff is seamless between the client software and the physical telephony device.

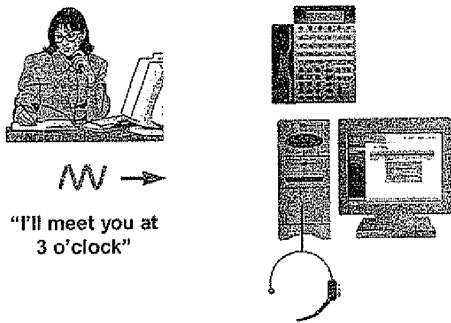

User has a choice of using the phone, PC microphone or headset for sending and receiving messages.

The client software provides a high-level view of all contacts using instant voice communications.

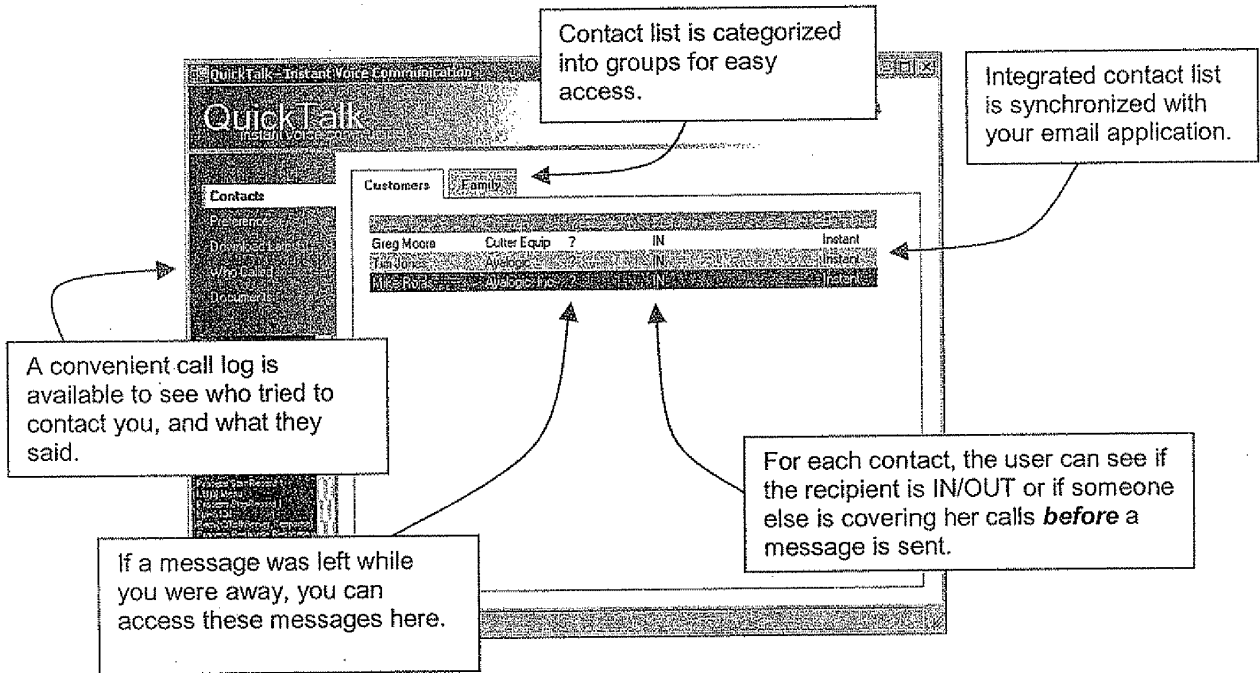

The client software can also be deployed on any system that utilizes the Microsoft .NET framework. This provides the flexibility to deploy the client onto a number of different computing devices: Pocket PCs, Laptops, Tablet PCs, and desktop computers.



When a wireless LAN card is added to the device, the client software can be configured for *cordless* instant voice communications providing mobility to the user.

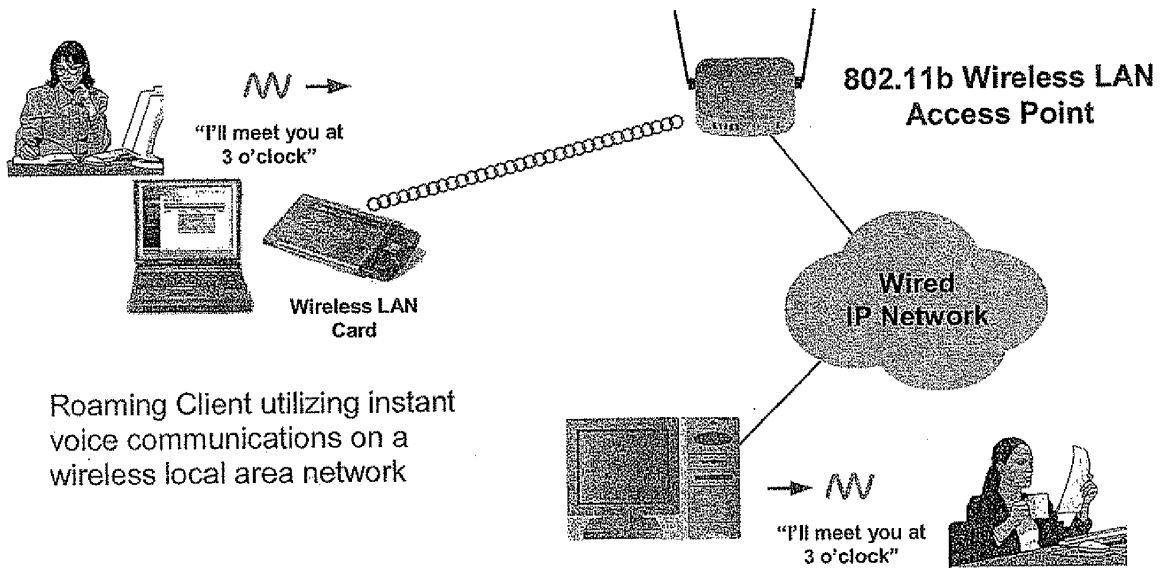

Roaming Client utilizing instant voice communications on a wireless local area network

Another important aspect of the client software is interoperability with the actual telephone infrastructure. When the client software is configured to utilize an actual phone, complete control of the software can be handled through the device itself.

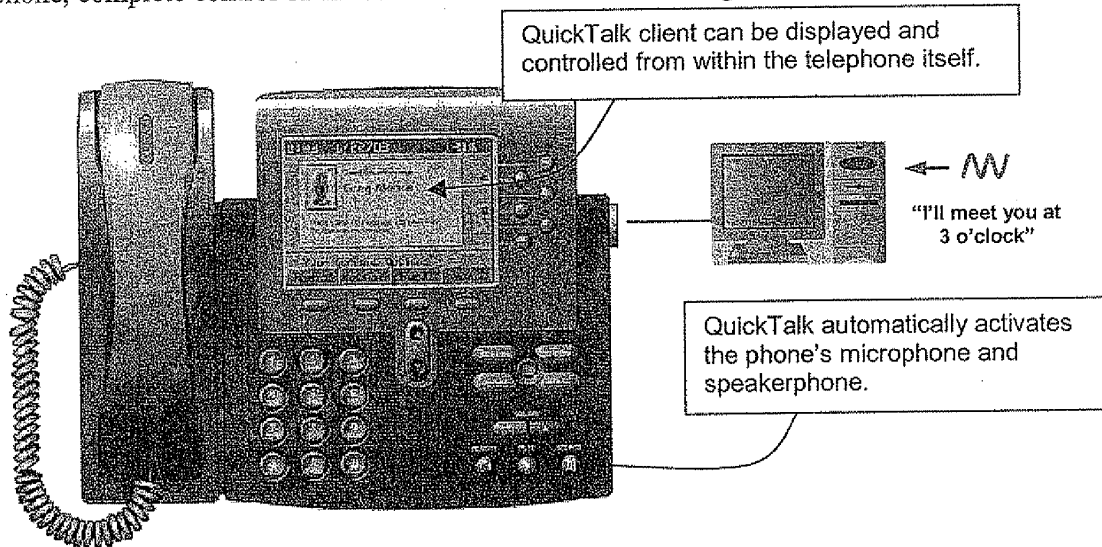

QuickTalk can support Voice over IP telephony hardware such as Cisco, Snom, Polycom, Teliann, and Pingtel, as well as legacy, circuit-based telephone infrastructure. This allows the product to provide instant voice communications on the customer's existing telephone system.

QuickTalk supports the following vendors:

- Avaya™ DEFINITY® ECS and MERLIN MAGIX®
- Nortel Meridian® and Norstar®
- NEC NEAX, Electra Elite and i-Series
- Toshiba Strata DK
- Ericsson MD110
- Alcatel 4200 and 4400
- Iwatsu ADIX APS
- Panasonic DBS 576 and 576HD

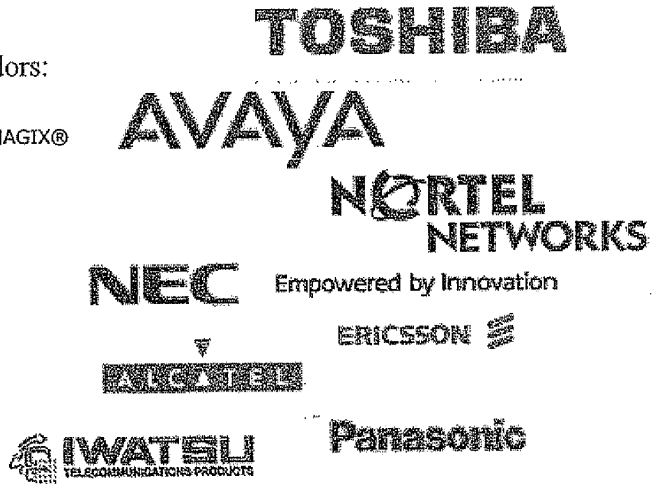

Here the allowable configuration modes of the client:

### Stand-Alone (PC Only)

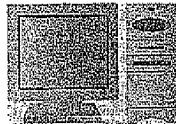

In this mode, communication is provided through the PC's speakers and microphone. The user can utilize an optional headset for a private conversation.



### Stand-Alone with locally controlled VoIP phone

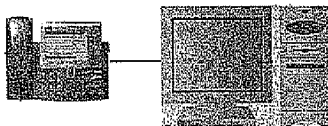

The user is free to use the phone and/or PC for instant voice communications. To transfer communication to the phone the user simply picks up the handset of the phone.

### Remotely controlled VoIP phone



In this mode, the phone is remotely controlled from a virtual client on the *QuickTalk Communication Platform*. This allows the phone to be used independently from a PC.

### Non-VoIP phone controlled by QuickTalk Server

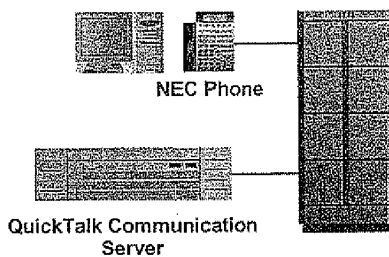

In this mode, the phone is remotely controlled by the *QuickTalk Communication Platform*. Control is accomplished by using integration technology to connect to the existing telephone system. This configuration allows existing infrastructure to be used for instant voice communications.

## Wireless LAN IP devices

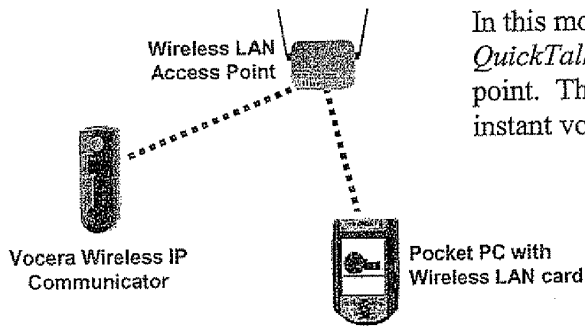

In this mode, the devices are remotely controlled by the *QuickTalk Communication Platform* via a wireless access point. This allows roaming clients to send and receive instant voice communications over a wireless network.

## A Different Voice

QuickTalk™ offers a product unlike any other. No other company offers voice over IP technology in such a clear and convenient form. None works so completely with different machines (phones, PCs, Pocket PCs) and brands with such flexibility and mobility. Instant messaging is intrusive and voice mail as we know it can be cumbersome. QuickTalk™ with its patent pending *instant voice* technology promises to be the most convenient and cost-effective messaging solution for business people on the move.



B

REDACTED

REDACTED

-----Original Message-----

From: Brad Corsello

REDACTED

Sent: Monday, August 11, 2003 11:45 AM

To: Michael J. Rojas

Subject: Meeting on Tuesday, August 19

Mike, following up on our phone conversation today, I've booked a flight for Tuesday, August 19 arriving at 11:35 at Akron-Canton. I'll just drive up from the airport and arrive at about 12:00-12:15 (or at a later time if that is more convenient for you).

REDACTED

REDACTED

This email is a confidential and privileged attorney-client communication.

REDACTED

This email is a confidential and privileged attorney-client communication.

C

REDACTED

REDACTED

REDACTED

----- Original Message -----  
From: "Brad Corsello" <  
To: "Neil Adams" <nadams@ayalogic.com>  
Sent: Thursday, August 28, 2003 12:08 PM  
Subject: Re: CD with IMvox software

> Neil, '

REDACTED

>

REDACTED

>

REDACTED

But I think we will wrap things

> up next week.

>

> On Wed, 2003-08-27 at 16:26, neil adams wrote:

>> Brad,

>>

>>

>>

>> ,

>

REDACTED

>>

REDACTED

REDACTED

REDACTED

>>

>> Do you have examples of prior patent submittals that answer these type  
>> of questions?

>>

>> Neil

>

>

>

REDACTED

>

> This email is a confidential and privileged attorney-client communication.

>

D

REDACTED

REDACTED

-----Original Message-----

From: neil adams [mailto:nadams@ayalogic.com]  
Sent: Monday, September 08, 2003 3:37 PM  
To: mrojas@ayalogic.com  
Subject: Patents - status, Brad

FYI

Neil

----- Original Message -----

From: "Brad Corsello" <bcorsello@corsellolaw.com>  
To: "Neil Adams" <nadams@ayalogic.com>  
Sent: Monday, September 08, 2003 3:21 PM  
Subject: Re: CD with IMvox software

> Neil, I am working on it now and will have it to you tonight or tomorrow  
> morning.

>

> On Mon, 2003-09-08 at 10:04, neil adams wrote:

>> Brad,

>>

>> What's the status on changes to the patent app'n?

>>

>> Neil

>> ----- Original Message -----

>> From: "Brad Corsello" <bcorsello@corsellolaw.com>

>> To: "Neil Adams" <nadams@ayalogic.com>

>> Sent: Thursday, August 28, 2003 12:08 PM

>> Subject: Re: CD with IMvox software

>>

>>

:

:

|

REDACTED

>>>

REDACTED

>>

REDACTED

REDACTED

REDACTED

>>>  
>>>  
|  
>

REDACTED

REDACTED

>>>  
>>>

>>> On Wed, 2003-08-27 at 16:26, neil adams wrote:  
>>>> Brad,  
>>>>

REDACTED

>>>>  
>>  
>>>  
>>  
>>>  
>>>>  
>>>>  
>>

REDACTED

REDACTED

>>>>  
>>>>  
>>>> Neil  
>>>> --  
>>>  
>>>

REDACTED

>>>>  
>>>> --

>>> This email is a confidential and privileged attorney-client communication.

>>>  
> --

>  
>

REDACTED

>  
>  
> --

> This email is a confidential and privileged attorney-client communication.  
>



E

REDACTED

REDACTED

From: neil adams [mailto:nadams@ayalogic.com]  
Sent: Wednesday, September 17, 2003 11:08 AM  
To: mrojas@ayalogic.com; misha@ayalogic.com  
Subject: CD for patents - questions

Mike,

Here's some additional information I need to add to the CD for Brad.

REDACTED

Questions

REDACTED

REDACTED

REDACTED

REDACTED

REDACTED

REDACTED

REDACTED -

Neil



REDACTED

REDACTED

From: neil adams [mailto:nadams@ayalogic.com]  
Sent: Monday, September 22, 2003 12:29 PM  
To: bcorsello@corsellolaw.com  
Cc: mrojas@ayalogic.com  
Subject: CD folders/files

Brad,

Attached is a compressed copy of the IMvox software and a Readme document that gives a brief overview of the software and hardware requirements.

REDACTED

REDACTED

Neil

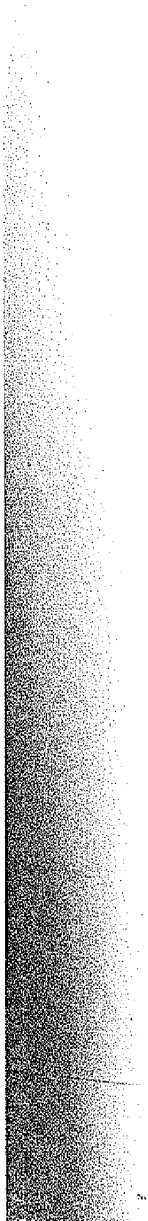

G

REDACTED

REDACTED

From: neil adams [mailto:nadams@ayalogic.com]  
Sent: Thursday, October 30, 2003 1:03 PM  
To: mrojas@ayalogic.com; Herbert Breger (E-mail); jbreger@ayalogic.com;  
bdiehl@ayalogic.com; misha@ayalogic.com  
Subject: Prov patent forwarded to Paul Esatto at Scully et al.

The Provisional patent document was sent at 12:00 noon today.

REDACTED

Neil



H



REDACTED

REDACTED

From: neil adams [mailto:nadams@ayalogic.com]  
Sent: Tuesday, November 04, 2003 1:50 PM  
To: mrojas@ayalogic.com; Herbert Breger (E-mail)  
Subject: Scully contact/discussions

I talked with the person at Scully who will be responsible for supporting our patent application. He is Alex Vodovozov.

REDACTED

Basically we went through a variety of questions about the patent draft

REDACTED

REDACTED

REDACTED

Neil



REDACTED

REDACTED

REDACTED

From: neil adams [mailto:nadams@ayalogic.com]  
Sent: Thursday, November 06, 2003 2:28 PM  
To: mrojas@ayalogic.com  
Subject: Status - Patent Draft

Mike,

REDACTED

REDACTED

REDACTED

I am sending this version to Alex at Scully.

If you came up with a newer version please send it to me at nadams@sssnet.com.

I'll be back on Sunday and can review the changes prior to our 10:30 teleconference with Alex and Paul on Monday.

Neil



REDACTED

REDACTED

-----Original Message-----

From: Alex Vodovozov [mailto:avodovozov@ssmp.com]  
Sent: Tuesday, December 02, 2003 5:09 PM  
To: mrojas@ayalogic.com  
Cc: Nadams@sssnet.com  
Subject: IVM appl.

Dear Mike and Neil:

Please see a draft of the application.

REDACTED

Thank you for your assistance.

Regards,

Alexander G. Vodovozov, Esq.  
Scully, Scott, Murphy & Presser  
400 Garden City Plaza  
Garden City, New York 11530  
(516) 742-4343 (telephone)  
(516) 742-4366 (facsimile)  
avodovozov@ssmp.com (email)

THIS ELECTRONIC MESSAGE AND ATTACHMENTS, IF ANY, ARE INTENDED ONLY FOR THE INDIVIDUAL OR ENTITY NAMED ABOVE (OR THOSE PROPERLY ENTITLED TO ACCESS THE INFORMATION) AND MAY CONTAIN INFORMATION THAT IS PRIVILEGED, CONFIDENTIAL, ATTORNEY-WORK PRODUCT OR OTHERWISE EXEMPT FROM DISCLOSURE UNDER APPLICABLE LAW. IF THE READER OF THIS TRANSMISSION IS NOT THE INTENDED OR AN AUTHORIZED RECIPIENT, YOU ARE HEREBY NOTIFIED THAT ANY UNAUTHORIZED DISTRIBUTION, DISSEMINATION, OR COPYING OF THIS TRANSMISSION, IS PROHIBITED.

IF YOU HAVE RECEIVED THIS TRANSMISSION IN ERROR, PLEASE CONTACT THE SENDER IMMEDIATELY AND DELETE AND DESTROY ALL COPIES OF THIS TRANSMISSION



REDACTED

REDACTED

From: neil adams [mailto:nadams@ayalogic.com]  
Sent: Tuesday, December 09, 2003 4:30 PM  
To: 'Herbert Breger'; mrojas@ayalogic.com  
Subject: Latest draft mods sent to Alex for review.

REDACTED

REDACTED

Neil

## Electronic Patent Application Fee Transmittal

<b>Application Number:</b>	10740030			
<b>Filing Date:</b>	18-Dec-2003			
<b>Title of Invention:</b>	System and method for instant VoIP messaging			
First Named Inventor/Applicant Name:	Michael J. Rojas			
<b>Filer:</b>	Paul J. Esatto/Roseann Gallo			
<b>Attorney Docket Number:</b>	17188			
Filed as Small Entity				
<b>Utility Filing Fees</b>				
<b>Description</b>	<b>Fee Code</b>	<b>Quantity</b>	<b>Amount</b>	<b>Sub-Total in USD(\$)</b>
<b>Basic Filing:</b>				
<b>Pages:</b>				
<b>Claims:</b>				
<b>Miscellaneous-Filing:</b>				
<b>Petition:</b>				
<b>Patent-Appeals-and-Interference:</b>				
Post-Allowance-and-Post-Issuance:				
<b>Extension-of-Time:</b>				
Extension - 1 month with \$0 paid	2251	1	60	60



Description	Fee Code	Quantity	Amount	Sub-Total in USD(\$)
<b>Miscellaneous:</b>				
<b>Total in USD (\$)</b>				<b>60</b>

## Electronic Acknowledgement Receipt

<b>EFS ID:</b>	3574061
<b>Application Number:</b>	10740030
<b>International Application Number:</b>	
<b>Confirmation Number:</b>	1731
<b>Title of Invention:</b>	System and method for instant VoIP messaging
<b>First Named Inventor/Applicant Name:</b>	Michael J. Rojas
<b>Customer Number:</b>	23389
<b>Filer:</b>	Paul J. Esatto/Roseann Gallo
<b>Filer Authorized By:</b>	Paul J. Esatto
<b>Attorney Docket Number:</b>	17188
<b>Receipt Date:</b>	07-JUL-2008
<b>Filing Date:</b>	18-DEC-2003
<b>Time Stamp:</b>	15:59:25
<b>Application Type:</b>	Utility under 35 USC 111(a)

### Payment information:

Submitted with Payment	yes
Payment Type	Deposit Account
Payment was successfully received in RAM	\$ 60
RAM confirmation Number	1347
Deposit Account	191013
Authorized User	

The Director of the USPTO is hereby authorized to charge indicated fees and credit any overpayment as follows:

Charge any Additional Fees required under 37 C.F.R. Section 1.16 (National application filing, search, and examination fees)

Charge any Additional Fees required under 37 C.F.R. Section 1.17 (Patent application and reexamination processing fees)

<b>File Listing:</b>					
<b>Document Number</b>	<b>Document Description</b>	<b>File Name</b>	<b>File Size(Bytes) /Message Digest</b>	<b>Multi Part /.zip</b>	<b>Pages (if appl.)</b>
1		AMEND2EOT.pdf	272137 559af11695555820ed554ec18a03c5e9b91852a6	yes	5
<b>Multipart Description/PDF files in .zip description</b>					
		<b>Document Description</b>	<b>Start</b>	<b>End</b>	
		Amendment - After Non-Final Rejection	1	1	
		Applicant Arguments/Remarks Made in an Amendment	2	3	
		Extension of Time	4	5	
<b>Warnings:</b>					
<b>Information:</b>					
2	Rule 130, 131 or 132 Affidavits	1131EXHIBIT.pdf	2419512 343cb6c54645324e787bcf9ad0412dc2dcd7dec	no	47
<b>Warnings:</b>					
<b>Information:</b>					
3	Fee Worksheet (PTO-06)	fee-info.pdf	8143 1290891803c33abbdad5ae675d70fcd01936076	no	2
<b>Warnings:</b>					
<b>Information:</b>					
<b>Total Files Size (in bytes):</b>			2699792		
<p><b>This Acknowledgement Receipt evidences receipt on the noted date by the USPTO of the indicated documents, characterized by the applicant, and including page counts, where applicable. It serves as evidence of receipt similar to a Post Card, as described in MPEP 503.</b></p> <p><b><u>New Applications Under 35 U.S.C. 111</u></b>  If a new application is being filed and the application includes the necessary components for a filing date (see 37 CFR 1.53(b)-(d) and MPEP 506), a Filing Receipt (37 CFR 1.54) will be issued in due course and the date shown on this Acknowledgement Receipt will establish the filing date of the application.</p> <p><b><u>National Stage of an International Application under 35 U.S.C. 371</u></b>  If a timely submission to enter the national stage of an international application is compliant with the conditions of 35 U.S.C. 371 and other applicable requirements a Form PCT/DO/EO/903 indicating acceptance of the application as a national stage submission under 35 U.S.C. 371 will be issued in addition to the Filing Receipt, in due course.</p> <p><b><u>New International Application Filed with the USPTO as a Receiving Office</u></b>  If a new international application is being filed and the international application includes the necessary components for an international filing date (see PCT Article 11 and MPEP 1810), a Notification of the International Application Number and of the International Filing Date (Form PCT/RO/105) will be issued in due course, subject to prescriptions concerning national security, and the date shown on this Acknowledgement Receipt will establish the international filing date of the application.</p>					

Under the Paperwork Reduction Act of 1995, no persons are required to respond to a collection of information unless it displays a valid OMB control number.

<b>PATENT APPLICATION FEE DETERMINATION RECORD</b> Substitute for Form PTO-875	Application or Docket Number <b>10/740,030</b>	Filing Date <b>12/18/2003</b>	<input checked="" type="checkbox"/> To be Mailed
---	---	----------------------------------	--

APPLICATION AS FILED – PART I			OTHER THAN SMALL ENTITY				
(Column 1)	(Column 2)		SMALL ENTITY <input checked="" type="checkbox"/>	OR		SMALL ENTITY	
FOR	NUMBER FILED	NUMBER EXTRA	RATE (\$)	FEE (\$)	OR	RATE (\$)	FEE (\$)
<input type="checkbox"/> BASIC FEE <small>(37 CFR 1.16(a), (b), or (c))</small>	N/A	N/A	N/A			N/A	
<input type="checkbox"/> SEARCH FEE <small>(37 CFR 1.16(k), (l), or (m))</small>	N/A	N/A	N/A			N/A	
<input type="checkbox"/> EXAMINATION FEE <small>(37 CFR 1.16(o), (p), or (q))</small>	N/A	N/A	N/A			N/A	
TOTAL CLAIMS <small>(37 CFR 1.16(i))</small>	minus 20 = *		X \$ =		OR	X \$ =	
INDEPENDENT CLAIMS <small>(37 CFR 1.16(h))</small>	minus 3 = *		X \$ =			X \$ =	
<input type="checkbox"/> APPLICATION SIZE FEE <small>(37 CFR 1.16(s))</small>	If the specification and drawings exceed 100 sheets of paper, the application size fee due is \$250 (\$125 for small entity) for each additional 50 sheets or fraction thereof. See 35 U.S.C. 41(a)(1)(G) and 37 CFR 1.16(s).						
<input type="checkbox"/> MULTIPLE DEPENDENT CLAIM PRESENT <small>(37 CFR 1.16(j))</small>							
* If the difference in column 1 is less than zero, enter "0" in column 2.			TOTAL			TOTAL	

APPLICATION AS AMENDED – PART II					OTHER THAN SMALL ENTITY				
(Column 1)	(Column 2)	(Column 3)			SMALL ENTITY	OR		SMALL ENTITY	
AMENDMENT	07/07/2008	CLAIMS REMAINING AFTER AMENDMENT	HIGHEST NUMBER PREVIOUSLY PAID FOR	PRESENT EXTRA	RATE (\$)	ADDITIONAL FEE (\$)	OR	RATE (\$)	ADDITIONAL FEE (\$)
	Total <small>(37 CFR 1.16(i))</small>	* 70	Minus	** 76	=	0	OR	X \$ =	
	Independent <small>(37 CFR 1.16(h))</small>	* 14	Minus	*** 14	=	0	OR	X \$ =	
	<input type="checkbox"/> Application Size Fee <small>(37 CFR 1.16(s))</small>								
	<input type="checkbox"/> FIRST PRESENTATION OF MULTIPLE DEPENDENT CLAIM <small>(37 CFR 1.16(j))</small>								
					TOTAL ADD'L FEE	0	OR	TOTAL ADD'L FEE	

(Column 1)	(Column 2)	(Column 3)			RATE (\$)	ADDITIONAL FEE (\$)	OR	RATE (\$)	ADDITIONAL FEE (\$)
AMENDMENT	CLAIMS REMAINING AFTER AMENDMENT	HIGHEST NUMBER PREVIOUSLY PAID FOR	PRESENT EXTRA		X \$ =		OR	X \$ =	
	Total <small>(37 CFR 1.16(i))</small>	*	Minus	**	=		OR	X \$ =	
	Independent <small>(37 CFR 1.16(h))</small>	*	Minus	***	=		OR	X \$ =	
	<input type="checkbox"/> Application Size Fee <small>(37 CFR 1.16(s))</small>								
	<input type="checkbox"/> FIRST PRESENTATION OF MULTIPLE DEPENDENT CLAIM <small>(37 CFR 1.16(j))</small>								
					TOTAL ADD'L FEE		OR	TOTAL ADD'L FEE	

\* If the entry in column 1 is less than the entry in column 2, write "0" in column 3.  
 \*\* If the "Highest Number Previously Paid For" IN THIS SPACE is less than 20, enter "20".  
 \*\*\* If the "Highest Number Previously Paid For" IN THIS SPACE is less than 3, enter "3".

The "Highest Number Previously Paid For" (Total or Independent) is the highest number found in the appropriate box in column 1.

Legal Instrument Examiner:  
 /NICHELE PETERSON/

This collection of information is required by 37 CFR 1.16. The information is required to obtain or retain a benefit by the public which is to file (and by the USPTO to process) an application. Confidentiality is governed by 35 U.S.C. 122 and 37 CFR 1.14. This collection is estimated to take 12 minutes to complete, including gathering, preparing, and submitting the completed application form to the USPTO. Time will vary depending upon the individual case. Any comments on the amount of time you require to complete this form and/or suggestions for reducing this burden, should be sent to the Chief Information Officer, U.S. Patent and Trademark Office, U.S. Department of Commerce, P.O. Box 1450, Alexandria, VA 22313-1450. DO NOT SEND FEES OR COMPLETED FORMS TO THIS ADDRESS. **SEND TO: Commissioner for Patents, P.O. Box 1450, Alexandria, VA 22313-1450.**  
 If you need assistance in completing the form, call 1-800-PTO-9199 and select option 2.



UNITED STATES PATENT AND TRADEMARK OFFICE

UNITED STATES DEPARTMENT OF COMMERCE  
United States Patent and Trademark Office  
Address: COMMISSIONER FOR PATENTS  
P.O. Box 1450  
Alexandria, Virginia 22313-1450  
www.uspto.gov

APPLICATION NO.	FILING DATE	FIRST NAMED INVENTOR	ATTORNEY DOCKET NO.	CONFIRMATION NO.
10/740,030	12/18/2003	Michael J. Rojas	17188	1731

23389 7590 03/06/2008  
SCULLY SCOTT MURPHY & PRESSER, PC  
400 GARDEN CITY PLAZA  
SUITE 300  
GARDEN CITY, NY 11530

EXAMINER

SMITH, CREIGHTON H

ART UNIT	PAPER NUMBER
2614	

MAIL DATE	DELIVERY MODE
03/06/2008	PAPER

Please find below and/or attached an Office communication concerning this application or proceeding.

The time period for reply, if any, is set in the attached communication.

<b>Office Action Summary</b>	<b>Application No.</b> 10/740,030	<b>Applicant(s)</b> ROJAS, MICHAEL J.	
	<b>Examiner</b> Creighton H. Smith	<b>Art Unit</b> 2614	

-- The MAILING DATE of this communication appears on the cover sheet with the correspondence address --

**Period for Reply**

A SHORTENED STATUTORY PERIOD FOR REPLY IS SET TO EXPIRE 3 MONTH(S) OR THIRTY (30) DAYS, WHICHEVER IS LONGER, FROM THE MAILING DATE OF THIS COMMUNICATION.

- Extensions of time may be available under the provisions of 37 CFR 1.136(a). In no event, however, may a reply be timely filed after SIX (6) MONTHS from the mailing date of this communication.
- If NO period for reply is specified above, the maximum statutory period will apply and will expire SIX (6) MONTHS from the mailing date of this communication.
- Failure to reply within the set or extended period for reply will, by statute, cause the application to become ABANDONED (35 U.S.C. § 133). Any reply received by the Office later than three months after the mailing date of this communication, even if timely filed, may reduce any earned patent term adjustment. See 37 CFR 1.704(b).

**Status**

- 1)  Responsive to communication(s) filed on \_\_\_\_\_.
- 2a)  This action is FINAL.                      2b)  This action is non-final.
- 3)  Since this application is in condition for allowance except for formal matters, prosecution as to the merits is closed in accordance with the practice under *Ex parte Quayle*, 1935 C.D. 11, 453 O.G. 213.

**Disposition of Claims**

- 4)  Claim(s) 1-5, 7-20, 22-35, 37-45, 47-57, 59-69 and 71-76 is/are pending in the application.  
4a) Of the above claim(s) 6, 21, 36, 46, 58, 70 is/are withdrawn from consideration.
- 5)  Claim(s) \_\_\_\_\_ is/are allowed.
- 6)  Claim(s) 1-5, 7-20, 22-35, 37-45, 47-57, 59-69, 71-76 is/are rejected.
- 7)  Claim(s) \_\_\_\_\_ is/are objected to.
- 8)  Claim(s) \_\_\_\_\_ are subject to restriction and/or election requirement.

**Application Papers**

- 9)  The specification is objected to by the Examiner.
- 10)  The drawing(s) filed on \_\_\_\_\_ is/are: a)  accepted or b)  objected to by the Examiner.  
Applicant may not request that any objection to the drawing(s) be held in abeyance. See 37 CFR 1.85(a).  
Replacement drawing sheet(s) including the correction is required if the drawing(s) is objected to. See 37 CFR 1.121(d).
- 11)  The oath or declaration is objected to by the Examiner. Note the attached Office Action or form PTO-152.

**Priority under 35 U.S.C. § 119**

- 12)  Acknowledgment is made of a claim for foreign priority under 35 U.S.C. § 119(a)-(d) or (f).  
a)  All    b)  Some \*    c)  None of:  
1.  Certified copies of the priority documents have been received.  
2.  Certified copies of the priority documents have been received in Application No. \_\_\_\_\_.  
3.  Copies of the certified copies of the priority documents have been received in this National Stage application from the International Bureau (PCT Rule 17.2(a)).  
\* See the attached detailed Office action for a list of the certified copies not received.

**Attachment(s)**

- 1)  Notice of References Cited (PTO-892)
- 2)  Notice of Draftsperson's Patent Drawing Review (PTO-948)
- 3)  Information Disclosure Statement(s) (PTO/SB/08)  
Paper No(s)/Mail Date \_\_\_\_\_
- 4)  Interview Summary (PTO-413)  
Paper No(s)/Mail Date. \_\_\_\_\_
- 5)  Notice of Informal Patent Application
- 6)  Other: \_\_\_\_\_

The following is a quotation of 35 U.S.C. 103(a) which forms the basis for all obviousness rejections set forth in this Office action:

(a) A patent may not be obtained though the invention is not identically disclosed or described as set forth in section 102 of this title, if the differences between the subject matter sought to be patented and the prior art are such that the subject matter as a whole would have been obvious at the time the invention was made to a person having ordinary skill in the art to which said subject matter pertains. Patentability shall not be negated by the manner in which the invention was made.

Claims 1-3, 5, 11-18, 26-29, 43, 45, 51-54, 65, 66 rejected under 35 U.S.C. 103(a) as being unpatentable over McZeal in view of Barry, U.S. Pat. App. Pub. #2007/0174403.

McZeal discloses in col. 4, lines 18 et seq. that until his invention there was no device which would take full advantage of the Internet and instant messaging for voice quality purposes, and which uses computer data networks for voice.

In col. 28, lines 5 et seq., McZeal discloses that his invention provides customers with instant voice messaging which uses Voice over Internet Protocol (VoIP). In col. 16, lines 39 et seq., McZeal discloses that his invention can use both the Internet and the PSTN. Barry discloses in [0031] that instant messages/IM are stored in server 150. To have provided Barry's teaching of an IM server, that will store the IM until a user is ready to retrieve them, in McZeal's communication system would have been obvious to a person having ordinary skill in the art, because the skilled practitioner in this communications art would realize the need to store messages if the called party lacked the present ability to receive the IM.

For claims 2 & 3, McZeal discloses in cols. 1 & 16, lines 42-43 & 25-30 that his invention can be used in local or wide area networks, i.e., LAN/WAN.

Regarding claim 11, see McZeal @ col. 16, lines 42 & 59-60.

Pertaining to claim 30, with McZeal's disclosure that his device can be used in either a WAN (internet) or LAN (local area network). If the voice message is to be routed out beyond a LAN, then an external serving system will be employed until the message reaches the recipient inside of the LAN, whereupon the LAN and its associated server will route the message to the intended recipient.

Claims 4, 19, 20, 44 are rejected under 35 U.S.C. 103(a) as being unpatentable over McZeal in view of Barry, U.S. Pat. App. Pub. #2007/0174403 and Williams et al.

Williams et al disclose in ¶-0055 that a messaging server (105) will save a voice message and send a list of recipients to the user from an address book. To have provided Williams teaching of a server providing a user a calling list of recipients in McZeal's Instant Voice Messaging server system would have been obvious to a person having ordinary skill in the art, because the skilled practitioner in the communications and server arts will readily realize that there are an unlimited amount of commands and information that a server can hold which can be communicated to anyone throughout the world that has the proper equipment.

Claims 7, 22, 47, are rejected under 35 U.S.C. 103(a) as being unpatentable over McZeal in view of Barry, U.S. Pat. App. Pub. #2007/0174403 and to Sagi et al.

Sagi et al disclose in claim 24 where a server will receive an audio file from a subscriber, and then in claim 29 Sagi et al disclose that the transmission is sent to a second subscriber. To have similarly used Sagi et al disclosure of transmitting an audio file to a server in McZeal's device would have been obvious to a person having ordinary skill in the art, because the skilled practitioner in the communications art will realize that



the sending party can either directly record a voice message or send an audio file.

Either way, a called party will receive the voice message.

Claims 8, 23, 48 are rejected under 35 U.S.C. 103(a) as being unpatentable over McZeal in view of Barry, U.S. Pat. App. Pub. #2007/0174403 and Goodman et al.

Goodman et al disclose in ¶-0033 that an audio message can be transformed from any of encrypted, decrypted, compressed, or decompressed format. To have similarly provided Goodman's teaching of encrypting, decrypting, compressing, and decompressing audio into McZeal's device would have been obvious to a person having ordinary skill in the art, because by compressing the audio will take up less memory in the server.

Claims 9, 24, 49, are rejected under 35 U.S.C. 103(a) as being unpatentable over McZeal in view of Barry, U.S. Pat. App. Pub. #2007/01774403 and Gierachf.

Gierachf discloses in ¶-0044 in Step 266 that the audio data, or voice message, is sent to an audio buffer 19B'. To have similarly used Gierachf method of buffering the audio data in McZeal's device would have been obvious to a person having ordinary skill in the art.

Claims 10, 25, 50 are rejected under 35 U.S.C. 103(a) as being unpatentable over McZeal in view of Barry, U.S. Pat. App. Pub. #2007/0174403 and Hollowell et al.

Hollowell et al teach in ¶-0031 attaching an email message to an audio message. To have provided this teaching in McZeal would have been obvious to a person having ordinary skill in the art because the skilled practitioner in this communications art will realize the efficiency of alerting a multitude of persons located throughout the world that

an email from the sender is being sent to the recipients, such as the minutes of an important meeting.

Claims 30-33, 35, 41, 55, 57, 63, 64, 67, 69, 75 are rejected under 35 U.S.C. 103(a) as being unpatentable over McZeal in view of Barry, U.S. Pat. App. Pub. 32007/0174403 and Monroe.

Monroe discloses in col. 20, lines 28 et seq. and in Fig. 9 a local server (460) connected to a LAN, which provides a gateway to a wide area network like the Internet. In col. 32, lines 11 et seq. Monroe discloses that pre-recorded voice messages can be delivered to a modem and then delivered throughout the Network. To have used Monroe's teaching of connecting a local server to an Internet server into McZeal's device would have been obvious to a person having ordinary skill in the art because a local server will only reach a few, select individuals in close proximity to each other, whereas the Internet will have global reach, thus insuring connectivity to clients worldwide.

Claims 42 and 76 are rejected under 35 U.S.C. 103(a) as being unpatentable over McZeal in view of Barry and Monroe as applied to claim 30 above, and further in view of Boukobza, U.S. Pat. App. Pub. #2006/0167883.

Boukobza's method as disclosed in [0020] and claim 14 is for load balancing databases within a network having a plurality of servers. To have provided Boukobza's method of load balancing servers in Monroe as applied to McZeal would have been obvious to a person having ordinary skill in the art, because the skilled practitioner would realize that as one server becomes filled with IM, or as one server is being

inundated with high traffic volume, it would be necessary to route some of those IM to another server for storing.

Claims 34, 56, 68 are rejected under 35 U.S.C. 103(a) as being unpatentable over McZeal in view of Barry and Monroe as applied to claim 30 above, and further in view of Williams et al.

Claims 37, 59, 71 are rejected under 35 U.S.C. 103(a) as being unpatentable over McZeal in view of Barry and Monroe as applied to claim 30 above, and further in view of Sagi et al.

Claims 38, 60, 72 are rejected under 35 U.S.C. 103(a) as being unpatentable over McZeal in view of Barry and Monroe as applied to claim 30 above, and further in view of Goodman et al.

Claims 39, 61, 73 are rejected under 35 U.S.C. 103(a) as being unpatentable over McZeal, Jr. in view of Barry and Monroe as applied to claim 30 above, and further in view of Gierachf.

Claims 40, 62, 74 are rejected under 35 U.S.C. 103(a) as being unpatentable over McZeal, jr. in view of Barry and Monroe as applied to claim 30 above, and further in view of Hollowell et al.

Any inquiry concerning this communication should be directed to Creighton H. Smith at telephone number 571/272-7546.

02 MAR '08

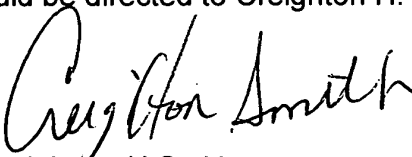
  
Creighton H Smith  
Primary Examiner  
Art Unit 2614

<b>Notice of References Cited</b>	Application/Control No. 10/740,030	Applicant(s)/Patent Under Reexamination ROJAS, MICHAEL J.	
	Examiner Creighton H. Smith	Art Unit 2614	Page 1 of 1

**U.S. PATENT DOCUMENTS**

*	Document Number Country Code-Number-Kind Code	Date MM-YYYY	Name	Classification
*	A US-2007/0174403	07-2007	Barry, Mona Elisabeth	709/207
*	B US-2006/0167883	07-2006	Boukobza, Eric	707/010
C	US-			
D	US-			
E	US-			
F	US-			
G	US-			
H	US-			
I	US-			
J	US-			
K	US-			
L	US-			
M	US-			

**FOREIGN PATENT DOCUMENTS**

*	Document Number Country Code-Number-Kind Code	Date MM-YYYY	Country	Name	Classification
N					
O					
P					
Q					
R					
S					
T					

**NON-PATENT DOCUMENTS**

*	Include as applicable: Author, Title Date, Publisher, Edition or Volume, Pertinent Pages)
U	
V	
W	
X	

\*A copy of this reference is not being furnished with this Office action. (See MPEP § 707.05(a).)  
Dates in MM-YYYY format are publication dates. Classifications may be US or foreign.

**Index of Claims**



Application/Control No.

10/740,030

Examiner

Creighton H. Smith

Applicant(s)/Patent under Reexamination

ROJAS, MICHAEL J.

Art Unit

2614

✓	Rejected
=	Allowed

-	(Through numeral) Cancelled
+	Restricted

N	Non-Elected
I	Interference

A	Appeal
O	Objected

Claim		Date	
Final	Original		
	3		
	8		
1	✓		
2	✓		
3	✓		
4	✓		
5	✓		
6	✓		
7	✓		
8	✓		
9	✓		
10	✓		
11	✓		
12	✓		
13	✓		
14	✓		
15	✓		
16	✓		
17	✓		
18	✓		
19	✓		
20	✓		
21	✓		
22	✓		
23	✓		
24	✓		
25	✓		
26	✓		
27	✓		
28	✓		
29	✓		
30	✓		
31	✓		
32	✓		
33	✓		
34	✓		
35	✓		
36	✓		
37	✓		
38	✓		
39	✓		
40	✓		
41	✓		
42	✓		
43	✓		
44	✓		
45	✓		
46	✓		
47	✓		
48	✓		
49	✓		
50	✓		

Claim		Date	
Final	Original		
	3		
	8		
51	✓		
52	✓		
53	✓		
54	✓		
55	✓		
56	✓		
57	✓		
58	✓		
59	✓		
60	✓		
61	✓		
62	✓		
63	✓		
64	✓		
65	✓		
66	✓		
67	✓		
68	✓		
69	✓		
70	✓		
71	✓		
72	✓		
73	✓		
74	✓		
75	✓		
76	✓		
77	✓		
78	✓		
79	✓		
80	✓		
81	✓		
82	✓		
83	✓		
84	✓		
85	✓		
86	✓		
87	✓		
88	✓		
89	✓		
90	✓		
91	✓		
92	✓		
93	✓		
94	✓		
95	✓		
96	✓		
97	✓		
98	✓		
99	✓		
100	✓		

Claim		Date	
Final	Original		
101			
102			
103			
104			
105			
106			
107			
108			
109			
110			
111			
112			
113			
114			
115			
116			
117			
118			
119			
120			
121			
122			
123			
124			
125			
126			
127			
128			
129			
130			
131			
132			
133			
134			
135			
136			
137			
138			
139			
140			
141			
142			
143			
144			
145			
146			
147			
148			
149			
150			

**Search Notes**

Application/Control No.

10/740,030

Examiner

Creighton H. Smith

Applicant(s)/Patent under Reexamination

ROJAS, MICHAEL J.

Art Unit

2614

**SEARCHED**

Class	Subclass	Date	Examiner

**SEARCH NOTES  
(INCLUDING SEARCH STRATEGY)**

	DATE	EXMR
EAST search -see printout	3/3/2008	CHS

**INTERFERENCE SEARCHED**

Class	Subclass	Date	Examiner

## EAST Search History

Ref #	Hits	Search Query	DBs	Default Operator	Plurals	Time Stamp
L1	1127	((plural\$3 or multipl\$5) with servers with load near3 balanc\$3) and (@ad<="20031218")	US-PGPUB; USPAT; USOCR; EPO; JPO; DERWENT; IBM_TDB	OR	OFF	2008/03/03 09:46
L2	1032	((plural\$3 or multipl\$5) with servers with (load adj balanc\$3)) and (@ad<="20031218")	US-PGPUB; USPAT; USOCR; EPO; JPO; DERWENT; IBM_TDB	OR	OFF	2008/03/03 09:46
L3	0	((plural\$3 or multipl\$5) with servers with (load adj balanc\$3)) same (global with IM) and (@ad<="20031218")	US-PGPUB; USPAT; USOCR; EPO; JPO; DERWENT; IBM_TDB	OR	OFF	2008/03/03 09:51
L4	935	((plural\$3 or multipl\$5) near5 servers with (load adj balanc\$3)) and (@ad<="20031218")	US-PGPUB; USPAT; USOCR; EPO; JPO; DERWENT; IBM_TDB	OR	OFF	2008/03/03 09:57

**UNITED STATES PATENT AND TRADEMARK OFFICE**

**Applicant(s):** Michael J. Rojas                      **Examiner:** Creighton Smith  
**Serial No:** 10/740,030                                  **Art Unit:** 2614  
**Filed:** December 18, 2003                          **Docket:** 17188  
**For:** SYSTEM AND METHOD FOR                  **Dated:** February 19, 2008  
          INSTANT VoIP MESSAGING

**Confirmation No.** 1731

Commissioner for Patents  
P. O. Box 1450  
Alexandria, VA 22313-1450

**AMENDMENT AND RESPONSE UNDER 37 C.F.R. § 1.111**

Sir:

Applicant submits this Amendment and Response in reply to the Official Action dated September 18, 2007. Applicant respectfully requests reconsideration of the application in view of the following amendments and remarks.

---

**CERTIFICATE OF ELECTRONIC FILING**

I hereby certify that this correspondence is being deposited with the United States Patent & Trademark Office via Electronic Filing through the United States Patent and Trademark Office e-business website, on February 19, 2008.

Dated: February 19, 2008

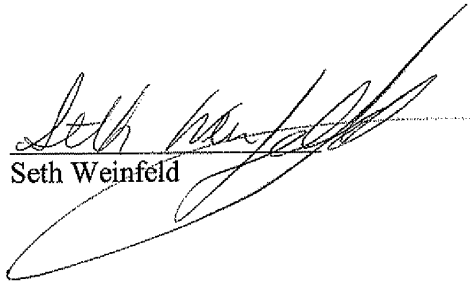
  
Seth Weinfeld



## IN THE CLAIMS

This version of the claims replaces and supercedes all prior versions of the claims.

1. (Currently Amended) An instant voice messaging system for delivering instant messages over a packet-switched network, the system comprising:

a client connected to the network, the client selecting one or more recipients, generating an instant voice message therefor, and transmitting the selected recipients and the instant voice message therefor over the network; and

a server connected to the network, the server receiving the selected recipients and the instant voice message therefor, and delivering the instant voice message to the selected recipients over the network, the selected recipients enabled to audibly play the instant voice message, and the server temporarily storing the instant voice message if a selected recipient is unavailable and delivering the stored instant voice message to the selected recipient once the selected recipient becomes available.

2. (Original) The instant voice messaging system according to Claim 1, wherein the packet-switched network is a local network.

3. (Original) The instant voice messaging system according to Claim 1, wherein the packet-switched network is the Internet.

4. (Original) The instant voice messaging system according to Claim 1, wherein the client requests a list of recipients associated with the client from the server

and the server transmits the list of recipients to the client for selection of the one or more recipients.

5. (Original) The instant voice messaging system according to Claim 1, wherein the server delivers the instant voice message to the selected recipients that are available.

6. Cancelled

7. (Original) The instant voice messaging system according to Claim 1, wherein the client records the instant voice message in an audio file, transmits the audio file to the server, and the server delivers the audio file to the selected recipients, the selected recipients being enabled to audibly play the audio file.

8. (Original) The instant voice messaging system according to Claim 7, wherein the client signal processes, compresses and encrypts the audio file, and the selected recipients being enabled to decrypt and decompress the audio file before audibly playing the audio file.

9. (Original) The instant voice messaging system according to Claim 1, wherein the client buffers each of a plurality of successive portions of the instant voice message as the instant message is recorded, and the client transmits each successive

buffered portion to the server for delivery to the to the selected recipients, the selected recipients being enabled to audibly playing each successive portion as it is delivered.

10. (Original) The instant voice messaging system according to Claim 1, wherein the client is enabled to attach one or more files to the instant voice message and the selected recipients are enabled to store or display the one or more attached files.

11. (Original) The instant voice messaging system according to Claim 1, the system further comprising a public switched telephone network (PSTN) telephone connected to the network to provide input audio of the instant voice message to the client.

12. (Original) The instant voice messaging system according to Claim 1, the system further comprising a voice-over-internet-protocol (VoIP) telephone connected to the network to provide input audio of the instant voice message to the client.

13. (Currently Amended) An instant voice messaging system for delivering instant messages over a packet-switched network enabling public switched telephone network (PSTN) support, the system comprising:

a PSTN telephone connected to the network for providing input audio;

a client connected to the network, the client selecting one or more recipients, generating an instant voice message therefor using the input audio provided by the PSTN telephone, and transmitting the selected recipients and the instant voice message therefor over the network;

a server connected to the network, the server receiving the selected recipients and the instant voice message therefor, and delivering the instant voice message to the selected recipients over the network, the selected recipients being enabled to audibly play the instant voice message, and the server temporarily storing the instant voice message if a selected recipient is unavailable and delivering the stored instant voice message to the selected recipient once the selected recipient becomes available.

14. (Currently Amended) An instant voice messaging system for delivering instant messages over a packet-switched network, the system comprising:

a voice-over-internet-protocol (VoIP) telephone connected to the network for providing input audio;

a client connected to the network, the client selecting one or more recipients, generating an instant voice message therefor using the input audio provided by the VoIP telephone, and transmitting the selected recipients and the instant voice message therefor over the network;

a server connected to the network, the server receiving the selected recipients and the instant voice message therefor, and delivering the instant voice message to the selected recipients over the network, the selected recipients being enabled to audibly play the instant voice message, and the server temporarily storing the instant voice message if a selected recipient is unavailable and delivering the stored instant voice message to the selected recipient once the selected recipient becomes available.

15. (Currently Amended) An instant voice messaging system for delivering instant messages over a plurality of packet-switched networks, the system comprising:

a client connected to a local network, the client selecting one or more external recipients connected to an external network outside the local network, generating an instant voice message therefor, and transmitting the selected recipients and the instant voice message therefor over the local network and the external network; and

a server connected to the external network, the server receiving the selected recipients and the instant voice message therefor, and delivering the instant voice message to the selected recipients over the external network, the selected recipients being enabled to audibly play the instant voice message, and the server temporarily storing the instant voice message if a selected recipient is unavailable and delivering the stored instant voice message to the selected recipient once the selected recipient becomes available.

16. (Original) The instant voice messaging system according to Claim 15, the client further selects one or more local recipients connected to the local network and transmits the selected local recipients and the instant voice message therefor over the local network, wherein the system further comprises:

a local server connected to the local network, the local server receiving the selected local recipients and the instant message therefor from the client, and delivering the instant voice message to the selected local recipients over the local network, the selected local recipients being enabled to audibly play the instant voice message.

17. (Original) The instant voice messaging system according to Claim 15, wherein the local network is a network within an enterprise.

18. (Original) The instant voice messaging system according to Claim 15, wherein the external network is the Internet.

19. (Original) The instant voice messaging system according to Claim 15, wherein the client requests a list of recipients associated with the client from the server and the server transmits the list of recipients to the client for selection of the one or more recipients.

20. (Original) The instant voice messaging system according to Claim 15, wherein the server delivers the instant voice message to the selected recipients that are available.

21. Cancelled

22. (Original) The instant voice messaging system according to Claim 15, wherein the client records the instant voice message in an audio file, transmits the audio file to the server, and the server delivers the audio file to the selected recipients, the selected recipients being enabled to audibly play the audio file.

23. (Original) The instant voice messaging system according to Claim 22, wherein the client signal processes, compresses and encrypts the audio file, and the selected recipients are enabled to decrypt and decompress the audio file before audibly playing the audio file.

24. (Original) The instant voice messaging system according to Claim 15, wherein the client buffers each of a plurality of successive portions of the instant voice message as the instant message is recorded, and the client transmits each successive portion to the server for delivery to the selected recipients, the selected recipients being enabled to audibly playing each successive portion as it is delivered.

25. (Original) The instant voice messaging system according to Claim 15, wherein the client is enabled to attach one or more files to the instant voice message and the selected recipients are enabled to store or display the one or more attached files.

26. (Original) The instant voice messaging system according to Claim 15, the system further comprising a public switched telephone network (PSTN) telephone connected to the local network to provide input audio of the instant voice message to the client.

27. (Original) The instant voice messaging system according to Claim 15, the system further comprising a voice-over-internet-protocol (VoIP) telephone connected to the local network to provide input audio of the instant voice message to the client.

28. (Currently Amended) An instant voice messaging system for delivering instant messages over a plurality of packet-switched networks enabling public switched telephone network (PSTN) support, the system comprising:

a PSTN telephone connected to a local network for providing input audio;

a client connected to the local network, the client selecting one or more external recipients connected to an external network outside the local network, generating an instant voice message therefor using the input audio provided by the PSTN telephone, and transmitting the selected recipients and the instant voice message therefor over the local network and the external network;

a server connected to the external network, the server receiving the selected recipients and the instant voice message therefor, and delivering the instant voice message to the selected recipients over the external network, the selected recipients being enabled to audibly play the instant voice message, and the server temporarily storing the instant voice message if a selected recipient is unavailable and delivering the stored instant voice message to the selected recipient once the selected recipient becomes available.

29. (Currently Amended) An instant voice messaging system for delivering instant messages over a plurality of packet-switched networks, the system comprising:

a voice-over-internet-protocol (VoIP) telephone connected to a local network for providing input audio;



a client connected to the local network, the client selecting one or more external recipients connected to an external network outside the local network, generating an instant voice message therefor using the input audio provided by the VoIP telephone, and transmitting the selected recipients and the instant voice message therefor over the local network and the external network;

an server connected to the external network, the external server receiving the selected recipients and the instant voice message therefor, and delivering the instant voice message to the selected recipients over the external network, the selected recipients being enabled to audibly play the instant voice message, and the server temporarily storing the instant voice message if a selected recipient is unavailable and delivering the stored instant voice message to the selected recipient once the selected recipient becomes available.

30. (Currently Amended) An instant voice messaging system for delivering instant messages over a plurality of packet-switched networks, the system comprising:

a client connected to an external network, the client selecting one or more recipients connected to a local network, generating an instant voice message therefor, and transmitting the selected recipients and the instant voice message therefor over the external network; and

a external server system connected to the external network, the external server system receiving the selected recipients and the instant voice message, and routing

the selected recipients and the instant voice message over the external network and the local network;

a local server connected to the local network, the local server receiving the selected recipients and the instant voice message therefor, and delivering the instant voice message to the selected recipients over the local network, the selected recipients being enabled to audibly play the instant voice message, and the local server temporarily storing the instant voice message if a selected recipient is unavailable and delivering the stored instant voice message to the selected recipient once the selected recipient becomes available.

31. (Original) The instant voice messaging system according to Claim 30, the client further selects one or more external recipients connected to the external and transmits the selected external recipients over the external network to the external server, and the external server receives the selected external recipients and delivers the instant voice message to the selected external recipients over the external network, the selected external recipients being enabled to audibly play the instant voice message.

32. (Original) The instant voice messaging system according to Claim 30, wherein the local network is a network within an enterprise.

33. (Original) The instant voice messaging system according to Claim 30, wherein the external network is the Internet.

34. (Original) The instant voice messaging system according to Claim 30, wherein the client requests a list of recipients associated with the client from the external server system and the external server system transmits the list of recipients to the client for selection of the one or more recipients.

35. (Original) The instant voice messaging system according to Claim 30, wherein the local server delivers the instant voice message to the selected recipients that are available.

36. Cancelled

37. (Original) The instant voice messaging system according to Claim 30, wherein the client records the instant voice message in an audio file, transmits the audio file to the external server, the external server system routes the audio file to the local server, and the local server delivers the audio file to the selected recipients, the selected recipients being enabled to audibly play the audio file.

38. (Original) The instant voice messaging system according to Claim 37, wherein the client signal processes, compresses and encrypts the audio file, and the selected recipients are enabled to decrypt and decompress the audio file before audibly playing the audio file.

39. (Original) The instant voice messaging system according to Claim 30, wherein the client buffers each of a plurality of successive portions of the instant voice message as the instant message is recorded, and the client transmits each successive buffered portion to the external server system, the external server system routes each successive portion to the local server, and the local server delivers each successive portion to the to the selected recipients, the selected recipients being enabled to audibly play each successive portion as it is delivered.

40. (Original) The instant voice messaging system according to Claim 30, wherein the client is enabled to attach one or more files to the instant voice message and the selected recipients are enabled to store or display the one or more attached files.

41. (Original) The instant voice messaging system according to Claim 30, the system further comprising a voice-over-internet-protocol (VoIP) telephone connected to the client via a local network, the client providing input audio of the instant voice message to the client via the local network.

42. (Original) The instant voice messaging system according to Claim 30, wherein the external server system comprises:

a transport server mesh including a plurality of transport servers for routing instant voice messages;

a directory server for maintaining the transport server mesh and facilitating load-balancing of the instant voice messages within the transport server mesh.

43. (Currently Amended) A method for instant voice messaging over a packet-switched network, the method comprising:

- selecting one or more recipients for instant voice messaging at a client;
- generating an instant voice message for the selected recipients at the client;
- transmitting the selected recipients and the instant voice message therefor over the network from the client to a server;
- receiving the selected recipients and the instant voice message therefor at the server;
- delivering the instant voice message from the server to the selected recipients over the network;
- temporarily storing at the server the instant voice message if a selected recipient is unavailable;
- delivering from the server the stored instant voice message to the selected recipient once the selected recipient becomes available; and
- audibly playing the instant voice message at the selected recipients.

44. (Original) The method for instant voice messaging according to Claim 43, wherein the method further comprises:

- requesting from the client a list of recipients associated with the client from the server; and
- transmitting from the server the list of recipients to the client for selection of the one or more recipients.

45. (Original) The method for instant voice messaging according to Claim 43, wherein the method further comprises:

delivering the instant voice message from the server to the selected recipients that are available.

46. Cancelled.

47. (Original) The method for instant voice messaging according to Claim 43, wherein the method further comprises:

recording the instant voice message at the client in an audio file;

transmitting the audio file to the server;

delivering the audio file from the server to the selected recipients; and

audibly playing the audio file at the least one of the selected recipients.

48. (Original) The method for instant voice messaging according to Claim 47, wherein the method further comprises:

signal processing, compressing and encrypting the audio file at the client;

decrypting and decompressing the audio file at the at least one selected recipient; and

audibly playing the decrypted and decompressed audio file at the least one of the selected recipients.

49. (Original) The method for instant voice messaging according to Claim 43, further comprising:

buffering each of a plurality of successive portions of the instant voice message at the client as the instant message is recorded;

transmitting from the client each successive buffered portion to the server;

delivering each successive portion from the server to the selected recipients, the selected recipients audibly playing each successive portion as it is delivered.

50. (Original) The method for instant voice messaging according to Claim 43, wherein the method further comprises:

attaching one or more files to the instant voice message at the client;

storing or displaying the one or more attached files at the selected recipients.

51. (Original) The method for instant voice messaging according to Claim 43, wherein the method further comprises:

providing input audio of the instant voice message to the client from a public switched telephone network (PSTN) telephone connected to the network.

52. (Original) The method for instant voice messaging according to Claim 43, wherein the method further comprises:

providing input audio of the instant voice message to the client from a voice-over-internet-protocol (VoIP) telephone connected to the network.

53. (Currently Amended) A method for instant voice messaging over a packet-switched network enabling public switched telephone network (PSTN) support, the method comprising:

providing input audio via a PSTN telephone connected over the network;  
selecting one or more recipients for instant voice messaging at a client;  
generating an instant voice message using the input audio from the PSTN telephone for the selected recipients at the client;

transmitting the selected recipients and the instant voice message therefor over the network from the client to a server;

receiving the selected recipients and the instant voice message therefor at the server;

delivering the instant voice message from the server to the selected recipients over the network;

temporarily storing at the server the instant voice message if a selected recipient is unavailable;

delivering from the server the stored instant voice message to the selected recipient once the selected recipient becomes available; and

audibly playing the instant voice message at selected recipients.



54. (Currently Amended) A method for instant voice messaging over a packet-switched network, the method comprising:

- providing input audio via a voice-over-internet-protocol (VoIP) telephone connected over the network;
- selecting one or more recipients for instant voice messaging at a client;
- generating an instant voice message using the input audio from the VoIP telephone for the selected recipients at the client;
- transmitting the selected recipients and the instant voice message therefor over the network from the client to a server;
- receiving the selected recipients and the instant voice message therefor at the server;
- delivering the instant voice message from the server to the selected recipients over the network;
- temporarily storing at the server the instant voice message if a selected recipient is unavailable;
- delivering from the server the stored instant voice message to the selected recipient once the selected recipient becomes available; and
- audibly playing the instant voice message at the selected recipients.

55. (Currently Amended) A method for instant voice messaging over a plurality of packet-switched networks, the method comprising:

selecting one or more external recipients for instant voice messaging at a client connected to a local network, the one or more external recipients connected to an external network outside the local network;

generating an instant voice message for the selected external recipients at the client;

transmitting the selected external recipients and the instant voice message therefor over the local network and the external network;

receiving the selected external recipients and the instant voice message therefor at an external server connected to the external network;

delivering the instant voice message to the selected external recipients over the external network;

temporarily storing the instant voice message at the external server if a selected recipient is unavailable;

delivering the stored instant voice message to the selected recipient once the selected recipient becomes available; and

audibly playing the instant voice message at the selected external recipients.

56. (Original) The method for instant voice messaging according to Claim 55, wherein the method further comprises:

requesting from the external server a list of external recipients associated with the client; and

transmitting the list of external recipients from the external server to the client for selection of the one or more external recipients.

57. (Original) The method for instant voice messaging according to Claim 55, wherein the method further comprises:

delivering the instant voice message from the external server to the selected recipients that are available.

58. Cancelled.

59. (Original) The method for instant voice messaging according to Claim 55, wherein the method further comprises:

recording the instant voice message in an audio file at the client;  
transmitting the audio file to the external server;  
delivering the audio file to the selected recipients from the external server;

and

audibly playing the audio file at the selected recipients.

60. (Original) The method for instant voice messaging according to Claim 59, wherein the method further comprises:

signal processing, compressing and encrypting the audio file at the client;

and

decrypting and decompressing the audio file at the selected recipients; and

audibly playing the decrypted and decompressed audio file at the selected recipients.

61. (Original) The method for instant voice messaging according to Claim 55, wherein the method further comprises:

buffering each of a plurality of successive portions of the instant voice message at the client as the instant message is recorded;

transmitting from the client each successive portion to the external server;

delivering each successive portion from the external server to the selected external recipients,

audibly playing each successive portion at the selected external recipients as it is delivered.

62. (Original) The method for instant voice messaging according to Claim 55, wherein the method further comprises:

attaching one or more files to the instant voice message;

storing or displaying the one or more attached files at the selected external recipients.

63. (Original) The method for instant voice messaging according to Claim 55, wherein the method further comprises providing input audio of the instant voice message to the client from a public switched telephone network (PSTN) telephone over the local network.

64. (Original) The method for instant voice messaging according to Claim 55, wherein the method further comprises providing input audio of the instant voice message to the client from a voice-over-internet-protocol (VoIP) telephone over the local network.

65. (Currently Amended) A method for instant voice messaging system over a plurality of packet-switched networks enabling public switched telephone network (PSTN) support, the method comprising:

providing input audio via a PSTN telephone connected to a local network;  
selecting one or more external recipients for instant voice messaging at a client, the one or more external recipients connected to an external network outside the local network;

generating an instant voice message for the one or more external recipients using the input audio provided by the PSTN telephone;

transmitting the selected recipients and the instant voice message therefor over the local network and the external network;

receiving the selected recipients and the instant voice message therefor at a server connected to the external network;

delivering the instant voice message to the selected recipients from the server over the external network;

temporarily storing at the server the instant voice message if a selected recipient is unavailable;

delivering from the server the stored instant voice message to the selected recipient once the selected recipient becomes available; and

audibly playing the instant voice message at the selected recipients.

66. (Currently Amended) A method for instant voice messaging system over a plurality of packet-switched networks, the method comprising:

providing input audio via a voice-over-internet-protocol (VoIP) telephone connected to a local network;

selecting one or more external recipients for instant voice messaging at a client, the one or more external recipients connected to an external network outside the local network;

generating an instant voice message for the one or more external recipients using the input audio provided by the VoIP telephone;

transmitting the selected recipients and the instant voice message therefor over the local network and the external network;

receiving the selected recipients and the instant voice message therefor at a server connected to the external network;

delivering the instant voice message to the selected recipients from the server over the external network;

temporarily storing at the server the instant voice message if a selected recipient is unavailable;

delivering from the server the stored instant voice message to the selected recipient once the selected recipient becomes available; and

audibly playing the instant voice message at the selected recipients.

67. (Currently Amended) A method for instant voice messaging over a plurality of a plurality of packet-switched networks, the method comprising:

selecting one or more recipients connected to a local network at a client connected to an external network;

generating an instant voice message for the selected recipients at the client;

transmitting the selected recipients and the instant voice message therefor over the external network from the client to an external server system;

receiving the selected recipients and the instant voice message at the external server system;

routing the selected recipients and the instant voice message over the external network and the local network;

receiving the selected recipients and the instant voice message therefor at a local server connected to the local network;

delivering the instant voice message to the selected recipients over the local network;

temporarily storing the instant voice message at the local server if a selected recipient is unavailable;

delivering the stored instant voice message to the selected recipient once the selected recipient becomes available; and

audibly playing the instant voice message at the selected recipients.

68. (Original) The method for instant voice messaging according to Claim 67, wherein the method further comprises:

requesting a list of recipients associated with the client from the external server system; and

transmitting the list of recipients from the external server system to the client for selection of the one or more recipients.

69. (Original) The method for instant voice messaging according to Claim 67, wherein the method further comprises:

delivering the instant voice message from the local server to the selected recipients that are available.

70. Cancelled

71. (Original) The method for instant voice messaging according to Claim 67, wherein the method further comprises:

recording the instant voice message in an audio file at the client;

transmitting the audio file from the client to the external server system;

routing the audio file from the external server system to the local server;

and



delivering the audio file from the local server to the selected recipients;  
and  
audibly playing the audio file at the selected recipients.

72. (Original) The method for instant voice messaging according to Claim 71, wherein the method further comprises:

signal processing, compressing and encrypting the audio file at the client;  
decrypting and decompressing the audio file at the selected recipients;  
audibly playing the decrypted and decompressed audio file at the selected recipients.

73. (Original) The method for instant voice messaging according to Claim 67, wherein the method further comprises:

buffering each of a plurality of successive portions of the instant voice message at the client as the instant message is recorded;  
transmitting from the client each successive portion to the external server system;  
routing each successive portion from the external server system to the local server;  
delivering each successive portion from local server to the selected external recipients; and  
audibly playing each successive portion at the selected recipients as it is delivered.

74. (Original) The method for instant voice messaging according to Claim 67, wherein the method further comprises:

attaching one or more files to the instant voice message at the client;  
storing or displaying the one or more attached files at the selected recipients.

75. (Original) The method for instant voice messaging according to Claim 67, wherein the method further comprises:

providing input audio of the instant voice message from a voice-over-internet-protocol (VoIP) telephone to the client via a local network connecting the VoIP telephone to the client.

76. (Original) The method for instant voice messaging according to Claim 67, wherein the method further comprises:

maintaining a transport server mesh including a plurality of transport servers for routing instant voice messages; and  
load-balancing the instant voice messages within the transport server mesh.

## REMARKS

Applicant has filed the present Amendment and Response in reply to the outstanding Official Action of September 18, 2007, and the Applicant believes the Amendment and Response to be fully responsive to the Official Action for at least the reasons set forth herein.

Applicant would like to thank the Examiner for indicating that claims 6, 21, 36, 42, 58, 70 and 76 have allowable subject matter and would be allowed if rewritten in independent form including all of the limitations of the base claim and all intervening claims. Accordingly, independent claims 1, 15, 30, 43, 55 and 67 have been rewritten incorporating the subject matter of allowable claims 6, 21, 36, 46, 58 and 70, respectively. Applicant submits that the independent claims should be allowed in view of the aforementioned amendments.

Additionally, Applicant notes that independent claims 13, 14, 28, 29, 53, 54, 65 and 66 have been amended. Each of the above-identified independent claims have been amended to recite similar limitations as the allowable claims, e.g., the server temporarily storing the instant voice message if a selected recipient is unavailable and delivering the stored instant voice message to the selected recipient once the selected recipient becomes available or temporarily storing at the server the instant voice message if a selected recipient is unavailable and delivering from the server the stored instant voice message to the selected recipient once the selected recipient becomes available. Claims 6, 21, 36, 46, 58 and 70 have been cancelled. No new matter has been added to the application by way of the aforementioned amendments. Applicant submits that all of the pending claims should be allowable in view of the aforementioned amendments.

Claims 1-3, 5, 11-18, 26-29, 43, 45, 51-54, 65, and 66 were rejected under 35 U.S.C. § 102(e) as being anticipated by McZeal Jr., U.S. Patent No. 6,763,226. Claims 4, 19, 20, and 44 were rejected under § 103(a) as being unpatentable over McZeal, U.S. Patent No. 6,763,226 in view of Williams et al., U.S. Pat. Pub 2004/0252679 (Williams). Claims 7, 22 and 47 were rejected under 35 U.S.C § 103(a) as being unpatentable over McZeal in view of Sagi et al., U.S. Pat. Pub. 2003/0087632. Claims 8, 23, and 48 were rejected under 35 U.S.C § 103(a) as being unpatentable over McZeal in view of Goodman et al., U.S. Pat. Pub 2004/0122906. Claims 9, 24 and 49 were rejected under 35 U.S.C § 103(a) as being unpatentable over McZeal in view of Gierachf, U.S. Pat. Pub 2005/0053230. Claims 10, 25 and 50 were rejected under 35 U.S.C. § 103(a) as being unpatentable over McZeal in view of Hollowell et al., U.S. Pat. Pub 2005/0105697.

Claims 30-33, 35, 41, 55, 57, 63, 64, 67, 69 and 75 were rejected under 35 U.S.C. § 103(a) as being unpatentable over McZeal in view of Monroe, U.S. Patent No. 6,970,183. Claims 34, 56 and 68 were rejected under 35 U.S.C. § 103(a) as being unpatentable over McZeal, Williams and Monroe. Claims 37, 59 and 71 were rejected under 35 U.S.C. § 103(a) as being unpatentable over McZeal, Sagi in view of Monroe.

Claims 38, 60 and 72 were rejected under 35 U.S.C. § 103(a) as being unpatentable over McZeal, Goodman and Monroe. Claims 39, 61 and 73 were rejected under 35 U.S.C. § 103(a) as being unpatentable over McZeal, Gierachf and Monroe. Claims 40, 62 and 74 were rejected under 35 U.S.C. § 103(a) as being unpatentable over McZeal, Hollowell in view of Monroe.

Applicant submits that the rejections set forth in the outstanding Official Action and listed above are rendered moot by the aforementioned amendments.

Based upon the foregoing, Applicant respectfully requests that the Examiner withdraw all of the pending rejections pursuant to either 35 U.S.C. § 102(e) or § 103(a).

In conclusion, the Applicant believes that the above-identified application is in condition for allowance and henceforth respectfully solicits the Examiner to allow the application. If the Examiner believes a telephone conference might expedite the allowance of this application, the Applicant respectfully requests that the Examiner call the undersigned, Applicant's attorney, at the following telephone number: (516) 742-4343.

Respectfully submitted,

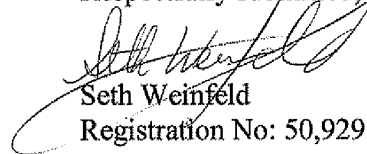

Seth Weinfeld  
Registration No: 50,929

Scully, Scott, Murphy & Presser, P.C.  
400 Garden City Plaza, Suite 300  
Garden City, New York 11530  
516-742-4343

SW:reg

**COMBINED AMENDMENT & PETITION FOR EXTENSION OF  
TIME UNDER 37 CFR 1.136(a) (Small Entity)**

Docket No.  
17188

In Re Application Of: **Michael J. Rojas**

Application No. <b>10/740,030</b>	Filing Date <b>December 18, 2003</b>	Examiner <b>Creighton Smith</b>	Customer No. <b>23389</b>	Group Art Unit <b>2614</b>	Confirmation No. <b>1731</b>
--------------------------------------	---	------------------------------------	------------------------------	-------------------------------	---------------------------------

Invention: **SYSTEM AND METHOD FOR INSTANT VoIP MESSAGING**

COMMISSIONER FOR PATENTS:

This is a combined amendment and petition under the provisions of 37 CFR 1.136(a) to extend the period for filing a response to the Office Action of September 18, 2007 in the above-identified application.  
*Date*

The requested extension is as follows (check time period desired):

One month      Two months      Three months      Four months      Five months

from: December 18, 2007     until: February 18, 2007  
*Date*     *Date*

Applicant claims small entity status. See 37 CFR 1.27.

The fee for the amendment and extension of time has been calculated as shown below:

CLAIMS AS AMENDED

	CLAIMS REMAINING AFTER AMENDMENT	HIGHEST # PREV. PAID FOR	NUMBER EXTRA CLAIMS PRESENT	RATE	ADDITIONAL FEE
TOTAL CLAIMS	70 -	76 =	0	x \$25.00	\$0.00
INDEP. CLAIMS	14 -	14 =	0	x \$105.00	\$0.00
FEE FOR AMENDMENT					\$0.00
FEE FOR EXTENSION OF TIME					\$230.00
<b>TOTAL FEE FOR AMENDMENT AND EXTENSION OF TIME</b>					<b>\$230.00</b>

**COMBINED AMENDMENT & PETITION FOR EXTENSION OF  
TIME UNDER 37 CFR 1.136(a) (Small Entity)**

Docket No.  
**17188**

The fee for the amendment and extension of time is to be paid as follows:

- A check in the amount of \_\_\_\_\_ for the amendment and extension of time is enclosed.
- Please charge Deposit Account No. **19-1013/SSMP** in the amount of **\$230.00**
- The Director is hereby authorized to charge payment of the following fees associated with this communication or credit any overpayment to Deposit Account No. **19-1013/SSMP**
  - Any additional filing fees required under 37 C.F.R. 1.16.
  - Any patent application processing fees under 37 CFR 1.17.
- If an additional extension of time is required, please consider this a petition therefor and charge any additional fees which may be required to Deposit Account No.
- Payment by credit card. Form PTO-2038 is attached.

**WARNING: Information on this form may become public. Credit card information should not be included on this form. Provide credit card information and authorization on PTO-2038.**

  
\_\_\_\_\_  
*Signature*

Seth Weinfeld  
Registration No.: 50,929  
Scully, Scott, Murphy & Presser, P.C.  
400 Garden City Plaza - Suite 300  
Garden City, New York 11530  
(516) 742-4343

Dated: **February 19, 2008**

I hereby certify that this correspondence is being deposited with the United States Postal Service with sufficient postage as first class mail in an envelope addressed to the "Commissioner for Patents, P.O. Box 1450, Alexandria, VA 22313-1450" [37 CFR 1.8(a)] on

\_\_\_\_\_  
(Date)

\_\_\_\_\_  
*Signature of Person Mailing Correspondence*

\_\_\_\_\_  
*Typed or Printed Name of Person Mailing Correspondence*

CC:

## Electronic Patent Application Fee Transmittal

<b>Application Number:</b>	10740030			
<b>Filing Date:</b>	18-Dec-2003			
<b>Title of Invention:</b>	System and method for instant VoIP messaging			
First Named Inventor/Applicant Name:	Michael J. Rojas			
<b>Filer:</b>	Paul J. Esatto/Roseann Gallo			
<b>Attorney Docket Number:</b>	17188			
Filed as Small Entity				
<b>Utility Filing Fees</b>				
<b>Description</b>	<b>Fee Code</b>	<b>Quantity</b>	<b>Amount</b>	<b>Sub-Total in USD(\$)</b>
<b>Basic Filing:</b>				
<b>Pages:</b>				
<b>Claims:</b>				
<b>Miscellaneous-Filing:</b>				
<b>Petition:</b>				
<b>Patent-Appeals-and-Interference:</b>				
Post-Allowance-and-Post-Issuance:				
<b>Extension-of-Time:</b>				
Extension - 2 months with \$0 paid	2252	1	230	230



Description	Fee Code	Quantity	Amount	Sub-Total in USD(\$)
<b>Miscellaneous:</b>				
<b>Total in USD (\$)</b>				<b>230</b>

## Electronic Acknowledgement Receipt

<b>EFS ID:</b>	2881556
<b>Application Number:</b>	10740030
<b>International Application Number:</b>	
<b>Confirmation Number:</b>	1731
<b>Title of Invention:</b>	System and method for instant VoIP messaging
<b>First Named Inventor/Applicant Name:</b>	Michael J. Rojas
<b>Customer Number:</b>	23389
<b>Filer:</b>	Paul J. Esatto/Roseann Gallo
<b>Filer Authorized By:</b>	Paul J. Esatto
<b>Attorney Docket Number:</b>	17188
<b>Receipt Date:</b>	19-FEB-2008
<b>Filing Date:</b>	18-DEC-2003
<b>Time Stamp:</b>	18:43:01
<b>Application Type:</b>	Utility under 35 USC 111(a)

### Payment information:

Submitted with Payment	yes
Payment Type	Deposit Account
Payment was successfully received in RAM	\$ 230
RAM confirmation Number	4208
Deposit Account	191013
Authorized User	

The Director of the USPTO is hereby authorized to charge indicated fees and credit any overpayment as follows:

Charge any Additional Fees required under 37 C.F.R. Section 1.16 (National application filing, search, and examination fees)

Charge any Additional Fees required under 37 C.F.R. Section 1.17 (Patent application and reexamination processing fees)

<b>File Listing:</b>					
<b>Document Number</b>	<b>Document Description</b>	<b>File Name</b>	<b>File Size(Bytes) /Message Digest</b>	<b>Multi Part /.zip</b>	<b>Pages (if appl.)</b>
1		AMEND1EOT.pdf	1389410 23f5737b15542285efd889fd6d95dcd4578688a6	yes	32
<b>Multipart Description/PDF files in .zip description</b>					
		<b>Document Description</b>	<b>Start</b>	<b>End</b>	
		Amendment - After Non-Final Rejection	1	1	
		Claims	2	27	
		Applicant Arguments/Remarks Made in an Amendment	28	30	
		Extension of Time	31	32	
<b>Warnings:</b>					
<b>Information:</b>					
2	Fee Worksheet (PTO-06)	fee-info.pdf	8139 395425fd31cf9a5b8804651233797ab1b1789be7	no	2
<b>Warnings:</b>					
<b>Information:</b>					
<b>Total Files Size (in bytes):</b>			1397549		
<p><b>This Acknowledgement Receipt evidences receipt on the noted date by the USPTO of the indicated documents, characterized by the applicant, and including page counts, where applicable. It serves as evidence of receipt similar to a Post Card, as described in MPEP 503.</b></p> <p><b><u>New Applications Under 35 U.S.C. 111</u></b>  If a new application is being filed and the application includes the necessary components for a filing date (see 37 CFR 1.53(b)-(d) and MPEP 506), a Filing Receipt (37 CFR 1.54) will be issued in due course and the date shown on this Acknowledgement Receipt will establish the filing date of the application.</p> <p><b><u>National Stage of an International Application under 35 U.S.C. 371</u></b>  If a timely submission to enter the national stage of an international application is compliant with the conditions of 35 U.S.C. 371 and other applicable requirements a Form PCT/DO/EO/903 indicating acceptance of the application as a national stage submission under 35 U.S.C. 371 will be issued in addition to the Filing Receipt, in due course.</p> <p><b><u>New International Application Filed with the USPTO as a Receiving Office</u></b>  If a new international application is being filed and the international application includes the necessary components for an international filing date (see PCT Article 11 and MPEP 1810), a Notification of the International Application Number and of the International Filing Date (Form PCT/RO/105) will be issued in due course, subject to prescriptions concerning national security, and the date shown on this Acknowledgement Receipt will establish the international filing date of the application.</p>					

Under the Paperwork Reduction Act of 1995, no persons are required to respond to a collection of information unless it displays a valid OMB control number.

<b>PATENT APPLICATION FEE DETERMINATION RECORD</b> Substitute for Form PTO-875	Application or Docket Number <b>10/740,030</b>	Filing Date <b>12/18/2003</b>	<input type="checkbox"/> To be Mailed
---	---	----------------------------------	---------------------------------------

APPLICATION AS FILED – PART I			OTHER THAN SMALL ENTITY			
FOR	NUMBER FILED (Column 1)	NUMBER EXTRA (Column 2)	SMALL ENTITY <input checked="" type="checkbox"/>	OR	SMALL ENTITY	OTHER THAN SMALL ENTITY
			RATE (\$)		FEE (\$)	
<input type="checkbox"/> BASIC FEE <small>(37 CFR 1.16(a), (b), or (c))</small>	N/A	N/A	N/A			N/A
<input type="checkbox"/> SEARCH FEE <small>(37 CFR 1.16(k), (l), or (m))</small>	N/A	N/A	N/A			N/A
<input type="checkbox"/> EXAMINATION FEE <small>(37 CFR 1.16(o), (p), or (q))</small>	N/A	N/A	N/A			N/A
TOTAL CLAIMS <small>(37 CFR 1.16(i))</small>	minus 20 =	*	X \$ =	OR		X \$ =
INDEPENDENT CLAIMS <small>(37 CFR 1.16(h))</small>	minus 3 =	*	X \$ =			X \$ =
<input type="checkbox"/> APPLICATION SIZE FEE <small>(37 CFR 1.16(s))</small>	If the specification and drawings exceed 100 sheets of paper, the application size fee due is \$250 (\$125 for small entity) for each additional 50 sheets or fraction thereof. See 35 U.S.C. 41(a)(1)(G) and 37 CFR 1.16(s).					
<input type="checkbox"/> MULTIPLE DEPENDENT CLAIM PRESENT <small>(37 CFR 1.16(j))</small>						
* If the difference in column 1 is less than zero, enter "0" in column 2.			TOTAL		TOTAL	

APPLICATION AS AMENDED – PART II					OTHER THAN SMALL ENTITY			
	(Column 1)	(Column 2)	(Column 3)	SMALL ENTITY	OR	SMALL ENTITY	OTHER THAN SMALL ENTITY	
				RATE (\$)		ADDITIONAL FEE (\$)		
<b>AMENDMENT</b>	<b>02/19/2008</b>	CLAIMS REMAINING AFTER AMENDMENT	HIGHEST NUMBER PREVIOUSLY PAID FOR	PRESENT EXTRA				
	Total <small>(37 CFR 1.16(i))</small>	* 70	Minus	** 76	=	0		
	Independent <small>(37 CFR 1.16(h))</small>	* 14	Minus	*** 14	=	0		
	<input type="checkbox"/> Application Size Fee <small>(37 CFR 1.16(s))</small>							
<input type="checkbox"/> FIRST PRESENTATION OF MULTIPLE DEPENDENT CLAIM <small>(37 CFR 1.16(j))</small>								
				TOTAL ADD'L FEE		0	TOTAL ADD'L FEE	

	(Column 1)	(Column 2)	(Column 3)	SMALL ENTITY	OR	SMALL ENTITY	OTHER THAN SMALL ENTITY
				RATE (\$)		ADDITIONAL FEE (\$)	
<b>AMENDMENT</b>		CLAIMS REMAINING AFTER AMENDMENT	HIGHEST NUMBER PREVIOUSLY PAID FOR	PRESENT EXTRA			
	Total <small>(37 CFR 1.16(i))</small>	*	Minus	**	=		
	Independent <small>(37 CFR 1.16(h))</small>	*	Minus	***	=		
	<input type="checkbox"/> Application Size Fee <small>(37 CFR 1.16(s))</small>						
<input type="checkbox"/> FIRST PRESENTATION OF MULTIPLE DEPENDENT CLAIM <small>(37 CFR 1.16(j))</small>							
				TOTAL ADD'L FEE		TOTAL ADD'L FEE	

\* If the entry in column 1 is less than the entry in column 2, write "0" in column 3.  
 \*\* If the "Highest Number Previously Paid For" IN THIS SPACE is less than 20, enter "20".  
 \*\*\* If the "Highest Number Previously Paid For" IN THIS SPACE is less than 3, enter "3".  
 The "Highest Number Previously Paid For" (Total or Independent) is the highest number found in the appropriate box in column 1.

Legal Instrument Examiner:  
 /TRINA L. RIDDICK/

This collection of information is required by 37 CFR 1.16. The information is required to obtain or retain a benefit by the public which is to file (and by the USPTO to process) an application. Confidentiality is governed by 35 U.S.C. 122 and 37 CFR 1.14. This collection is estimated to take 12 minutes to complete, including gathering, preparing, and submitting the completed application form to the USPTO. Time will vary depending upon the individual case. Any comments on the amount of time you require to complete this form and/or suggestions for reducing this burden, should be sent to the Chief Information Officer, U.S. Patent and Trademark Office, U.S. Department of Commerce, P.O. Box 1450, Alexandria, VA 22313-1450. DO NOT SEND FEES OR COMPLETED FORMS TO THIS ADDRESS. **SEND TO: Commissioner for Patents, P.O. Box 1450, Alexandria, VA 22313-1450.**  
 If you need assistance in completing the form, call 1-800-PTO-9199 and select option 2.

ak



UNITED STATES PATENT AND TRADEMARK OFFICE

UNITED STATES DEPARTMENT OF COMMERCE  
United States Patent and Trademark Office  
Address: COMMISSIONER FOR PATENTS  
P.O. Box 1450  
Alexandria, Virginia 22313-1450  
www.uspto.gov

APPLICATION NO.	FILING DATE	FIRST NAMED INVENTOR	ATTORNEY DOCKET NO.	CONFIRMATION NO.
10/740,030	12/18/2003	Michael J. Rojas	17188	1731

23389 7590 09/18/2007  
SCULLY SCOTT MURPHY & PRESSER, PC  
400 GARDEN CITY PLAZA  
SUITE 300  
GARDEN CITY, NY 11530

EXAMINER

SMITH, CREIGHTON H

ART UNIT	PAPER NUMBER
2614	

MAIL DATE	DELIVERY MODE
09/18/2007	PAPER

Please find below and/or attached an Office communication concerning this application or proceeding.

The time period for reply, if any, is set in the attached communication.

<b>Office Action Summary</b>	<b>Application No.</b> 10/740,030	<b>Applicant(s)</b> ROJAS, MICHAEL J.	
	<b>Examiner</b> Creighton H. Smith	<b>Art Unit</b> 2614	

-- The MAILING DATE of this communication appears on the cover sheet with the correspondence address --

**Period for Reply**

A SHORTENED STATUTORY PERIOD FOR REPLY IS SET TO EXPIRE 3 MONTH(S) OR THIRTY (30) DAYS, WHICHEVER IS LONGER, FROM THE MAILING DATE OF THIS COMMUNICATION.

- Extensions of time may be available under the provisions of 37 CFR 1.136(a). In no event, however, may a reply be timely filed after SIX (6) MONTHS from the mailing date of this communication.
- If NO period for reply is specified above, the maximum statutory period will apply and will expire SIX (6) MONTHS from the mailing date of this communication.
- Failure to reply within the set or extended period for reply will, by statute, cause the application to become ABANDONED (35 U.S.C. § 133). Any reply received by the Office later than three months after the mailing date of this communication, even if timely filed, may reduce any earned patent term adjustment. See 37 CFR 1.704(b).

**Status**

- 1)  Responsive to communication(s) filed on \_\_\_\_\_.
- 2a)  This action is **FINAL**.                      2b)  This action is non-final.
- 3)  Since this application is in condition for allowance except for formal matters, prosecution as to the merits is closed in accordance with the practice under *Ex parte Quayle*, 1935 C.D. 11, 453 O.G. 213.

**Disposition of Claims**

- 4)  Claim(s) \_\_\_\_\_ is/are pending in the application.  
4a) Of the above claim(s) \_\_\_\_\_ is/are withdrawn from consideration.
- 5)  Claim(s) \_\_\_\_\_ is/are allowed.
- 6)  Claim(s) 1-5, 7-20, 22-35, 37-41, 43-45, 47-57, 59-69 and 71-75 is/are rejected.
- 7)  Claim(s) 6, 21, 36, 42, 46, 58, 70 and 76 is/are objected to.
- 8)  Claim(s) \_\_\_\_\_ are subject to restriction and/or election requirement.

**Application Papers**

- 9)  The specification is objected to by the Examiner.
- 10)  The drawing(s) filed on \_\_\_\_\_ is/are: a)  accepted or b)  objected to by the Examiner.  
Applicant may not request that any objection to the drawing(s) be held in abeyance. See 37 CFR 1.85(a).  
Replacement drawing sheet(s) including the correction is required if the drawing(s) is objected to. See 37 CFR 1.121(d).
- 11)  The oath or declaration is objected to by the Examiner. Note the attached Office Action or form PTO-152.

**Priority under 35 U.S.C. § 119**

- 12)  Acknowledgment is made of a claim for foreign priority under 35 U.S.C. § 119(a)-(d) or (f).  
a)  All    b)  Some \*    c)  None of:  
1.  Certified copies of the priority documents have been received.  
2.  Certified copies of the priority documents have been received in Application No. \_\_\_\_\_.  
3.  Copies of the certified copies of the priority documents have been received in this National Stage application from the International Bureau (PCT Rule 17.2(a)).

\* See the attached detailed Office action for a list of the certified copies not received.

**Attachment(s)**

- 1)  Notice of References Cited (PTO-892)
- 2)  Notice of Draftsperson's Patent Drawing Review (PTO-948)
- 3)  Information Disclosure Statement(s) (PTO/SB/08)  
Paper No(s)/Mail Date 23.08.04.
- 4)  Interview Summary (PTO-413)  
Paper No(s)/Mail Date: \_\_\_\_\_
- 5)  Notice of Informal Patent Application
- 6)  Other: \_\_\_\_\_

The following is a quotation of the appropriate paragraphs of 35 U.S.C. 102 that form the basis for the rejections under this section made in this Office action:

A person shall be entitled to a patent unless –

(e) the invention was described in (1) an application for patent, published under section 122(b), by another filed in the United States before the invention by the applicant for patent or (2) a patent granted on an application for patent by another filed in the United States before the invention by the applicant for patent, except that an international application filed under the treaty defined in section 351(a) shall have the effects for purposes of this subsection of an application filed in the United States only if the international application designated the United States and was published under Article 21(2) of such treaty in the English language.

Claims 1-3, 5, 11-18, 26-29, 43, 45, 51-54, 65, 66 are rejected under 35 U.S.C. 102(E) as being anticipated by McZeal, Jr., U.S. Patent #6,763,226.

McZeal discloses in col. 4, lines 18 et seq. that until his invention there was no device which would take full advantage of the Internet and instant messaging for voice quality purposes, and which uses computer data networks for voice.

In col. 28, lines 5 et seq., McZeal discloses that his invention provides customers with instant voice messaging which uses Voice over Internet Protocol (VoIP). In col. 16, lines 39 et seq., McZeal discloses that his invention can use both the Internet and the PSTN.

For claims 2 & 3, McZeal discloses in cols. 1 & 16, lines 42-43 & 25-30 that his invention can be used in local or wide area networks, i.e., LAN/WAN.

Regarding claim 11, see McZeal @ col. 16, lines 42 & 59-60.

Pertaining to claim 30, with McZeal's disclosure that his device can be used in either a WAN (internet) or LAN (local area network). If the voice message is to be routed out beyond a LAN, then an external serving system will be employed until the

message reaches the recipient inside of the LAN, whereupon the LAN and its associated server will route the message to the intended recipient.

The following is a quotation of 35 U.S.C. 103(a) which forms the basis for all obviousness rejections set forth in this Office action:

(a) A patent may not be obtained though the invention is not identically disclosed or described as set forth in section 102 of this title, if the differences between the subject matter sought to be patented and the prior art are such that the subject matter as a whole would have been obvious at the time the invention was made to a person having ordinary skill in the art to which said subject matter pertains. Patentability shall not be negated by the manner in which the invention was made.

Claims 4, 19, 20, 44 are rejected under 35 U.S.C. 103(a) as being unpatentable over McZeal in view of Williams et al, U.S. Patent Publication #2004/0252679.

Williams et al disclose in ¶-0055 that a messaging server (105) will save a voice message and send a list of recipients to the user from an address book. To have provided Williams teaching of a server providing a user a calling list of recipients in McZeal's Instant Voice Messaging server system would have been obvious to a person having ordinary skill in the art, because the skilled practitioner in the communications and server arts will readily realize that there are an unlimited amount of commands and information that a server can hold which can be communicated to anyone throughout the world that has the proper equipment.

Claims 7, 22, 47, are rejected under 35 U.S.C. 103(a) as being unpatentable over McZeal in view of Sagi et al, U.S. Patent Publication #2003/0087632.

Sagi et al disclose in claim 24 where a server will receive an audio file from a a subscriber, and then in claim 29 Sagi et al disclose that the transmission is sent to a second subscriber. To have similarly used Sagi et al disclosure of transmitting an audio file to a server in McZeal's device would have been obvious to a person having ordinary



skill in the art, because the skilled practitioner in the communications art will realize that the sending party can either directly record a voice message or send an audio file.

Either way, a called party will receive the voice message.

Claims 8, 23,48 are rejected under 35 U.S.C. 103(a) as being unpatentable over McZeal in view of Goodman et al, U.S. Patent Publication #2004/0122906.

Goodman et al disclose in ¶-0033 that an audio message can be transformed from any of encrypted, decrypted, compressed, or decompressed format. To have similarly provided Goodman's teaching of encrypting, decrypting, compressing, and decompressing audio into McZeal's device would have been obvious to a person having ordinary skill in the art, because by compressing the audio will take up less memory in the server.

Claims 9, 24, 49, are rejected under 35 U.S.C. 103(a) as being unpatentable over McZeal in view of Gierachf, U.S. Patent Publication #2005/0053230.

Gierachf discloses in ¶-0044 in Step 266 that the audio data, or voice message, is sent to an audio buffer 19B'. To have similarly used Gierachf method of buffering the audio data in McZeal's device would have been obvious to a person having ordinary skill in the art.

Claims 10, 25, 50, are rejected under 35 U.S.C. 103(a) as being unpatentable over McZeal in view of Hollowell et al, U.S. Patent Publication #2005/0105697.

Hollowell et al teach in ¶-0031 attaching an email message to an audio message. To have provided this teaching in McZeal would have been obvious to a person having ordinary skill in the art because the skilled practitioner in this communications art will

realize the efficiency of alerting a multitude of persons located throughout the world that an email from the sender is being sent to the recipients, such as the minutes of an important meeting.

Claims 30-33, 35, 41, 55, 57, 63, 64, 67, 69, 75 are rejected under 35 U.S.C. 103(a) as being unpatentable over McZeal in view of Monroe, U.S. Patent #6970183.

Monroe discloses in col. 20, lines 28 et seq. and in Fig. 9 a local server (460) connected to a LAN, which provides a gateway to a wide area network like the Internet. In col. 32, lines 11 et seq. Monroe discloses that pre-recorded voice messages can be delivered to a modem and then delivered throughout the Network. To have used Monroe's teaching of connecting a local server to an Internet server into McZeal's device would have been obvious to a person having ordinary skill in the art because a local server will only reach a few, select individuals in close proximity to each other, whereas the Internet will have global reach, thus insuring connectivity to clients worldwide.

Claims 34, 56, 68 are rejected under 35 U.S.C. 103(a) as being unpatentable over McZeal in view of Monroe as applied to claim 30 above, and further in view of Williams et al.

Claims 37, 59, 71 are rejected under 35 U.S.C. 103(a) as being unpatentable over McZeal in view of Monroe as applied to claim 30 above, and further in view of Sagi et al.

Claims 38, 60, 72 are rejected under 35 U.S.C. 103(a) as being unpatentable over McZeal in view of Monroe as applied to claim 30 above, and further in view of Goodman et al.

Claims 39, 61, 73 are rejected under 35 U.S.C. 103(a) as being unpatentable over McZeal, Jr. in view of Monroe as applied to claim 30 above, and further in view of Gierachf.

Claims 40, 62, 74 are rejected under 35 U.S.C. 103(a) as being unpatentable over McZeal, jr. in view of Monroe as applied to claim 30 above, and further in view of Hollowell et al.

Claims 6, 21, 36, 42, 46, 58, 70, 76 are objected to as being dependent upon a rejected base claim, but would be allowable if rewritten in independent form including all of the limitations of the base claim and any intervening claims.

The prior art made of record and not relied upon is considered pertinent to applicant's disclosure. Malik, Grabelsky et al, Weiner

Any inquiry concerning this communication should be directed to Creighton H. Smith at telephone number 571/272-7546.

11 SEP '07

  
Creighton H Smith  
Primary Examiner  
Art Unit 2614

Form PTO-1449 U.S. DEPARTMENT OF COMMERCE (REV. 7-80) PATENT AND TRADEMARK OFFICE  <b>INFORMATION DISCLOSURE CITATION</b>  (Use several sheets if necessary)  	Atty. Docket No. (Optional) 17188	Application Number 10/740,030
Applicant(s) Michael Rojas		Filing Date December 18, 2003
		Group Art Unit 2661

**U.S. PATENT DOCUMENTS**

EXAMINER INITIAL*	DOCUMENT NUMBER	DATE	NAME	CLASS	SUBCLASS	FILING DATE (if appropriate)
AA						
AB						
AC						

**FOREIGN PATENT DOCUMENTS**

REF	DOCUMENT NUMBER	DATE	COUNTRY	CLASS	SUBCLASS	TRANSLATION	
						YES	NO

**OTHER DOCUMENTS** (Including Author, Title, Date, Pertinent Pages, Etc.)

CHS	<a href="http://www.cisco.com/warp/public/cc/pd/nemnsw/callmn/prodlit/cm33_ds.htm">http://www.cisco.com/warp/public/cc/pd/nemnsw/callmn/prodlit/cm33_ds.htm</a> ; "Data Sheet Cisco CallManager Version 3.3"
CHS	<a href="http://www.cisco.com/en/US/products/hw/switches/ps1925/products_data_sheet_09186a00800a3c3d.html">http://www.cisco.com/en/US/products/hw/switches/ps1925/products_data_sheet_09186a00800a3c3d.html</a> ; "Data Sheet Cisco MGX 8000 Series"
CHS	<a href="http://www.hsteliann.com/english/?zone=3100-V21P">http://www.hsteliann.com/english/?zone=3100-V21P</a> ; "Telephone 3100-V21P"
CHS	<a href="http://www.linuxdevices.com/articles/AT5199947519.html">http://www.linuxdevices.com/articles/AT5199947519.html</a> ; "Device Profile: snom 100 VoIP phone"
CHS	<a href="http://www.pingtel.com/pr_xpressa.jsp">http://www.pingtel.com/pr_xpressa.jsp</a> ; "No limits with the advanced industry standard SIP phone"
CHS	AudioCoded Enabling Technology Products, TPM-1100 VoP Media Gateway Modules

EXAMINER <i>Smith</i>	DATE CONSIDERED <i>9/07</i>
--------------------------	--------------------------------

\* EXAMINER: Initial if reference considered, whether or not citation is in conformance with MPEP 609; draw line through citation if not in conformance and not considered. Include copy of this form with next communication to applicant.

<b>Notice of References Cited</b>	Application/Control No. 10/740,030	Applicant(s)/Patent Under Reexamination ROJAS, MICHAEL J.	
	Examiner Creighton H. Smith	Art Unit 2614	Page 1 of 1

**U.S. PATENT DOCUMENTS**

*		Document Number Country Code-Number-Kind Code	Date MM-YYYY	Name	Classification
*	A	US-6,763,226	07-2004	McZeal, Jr., Alfred	455/90.2
*	B	US-2004/0252679	12-2004	Williams et al.	370/356
*	C	US-2004/0122906	06-2004	Goodman et al.	709/206
*	D	US-2005/0053230	03-2005	Gierachf, Karl	379/406.06
*	E	US-2005/0105697	05-2005	Hollowell et al.	379/088.13
*	F	US-2003/0087632	05-2003	Sagi et al.	455/414
*	G	US-2006/0268750	11-2006	Weiner, Moshe	370/260
*	H	US-2004/0030046	02-2004	Schultes et al.	525/71
*	I	US-2007/0112925	05-2007	Malik, Dale W.	709/206
	J	US-			
	K	US-			
	L	US-			
	M	US-			

**FOREIGN PATENT DOCUMENTS**

*		Document Number Country Code-Number-Kind Code	Date MM-YYYY	Country	Name	Classification
	N					
	O					
	P					
	Q					
	R					
	S					
	T					

**NON-PATENT DOCUMENTS**

*		Include as applicable: Author, Title Date, Publisher, Edition or Volume, Pertinent Pages)
	U	
	V	
	W	
	X	

\*A copy of this reference is not being furnished with this Office action. (See MPEP § 707.05(a).)  
Dates in MM-YYYY format are publication dates. Classifications may be US or foreign.



UNITED STATES PATENT AND TRADEMARK OFFICE

UNITED STATES DEPARTMENT OF COMMERCE  
 United States Patent and Trademark Office  
 Address: COMMISSIONER FOR PATENTS  
 P.O. Box 1450  
 Alexandria, Virginia 22313-1450  
 www.uspto.gov



Bib Data Sheet

CONFIRMATION NO. 1731

<b>SERIAL NUMBER</b> 10/740,030	<b>FILING OR 371(c) DATE</b> 12/18/2003 <b>RULE</b>	<b>CLASS</b> 370	<b>GROUP ART UNIT</b> 2614	<b>ATTORNEY DOCKET NO.</b> 17188
------------------------------------	---	---------------------	-------------------------------	-------------------------------------

**APPLICANTS**  
 Michael J. Rojas, North Canton, OH;  
*No CHS*  
**\*\* CONTINUING DATA \*\*\*\*\***  
*No CHS*  
**\*\* FOREIGN APPLICATIONS \*\*\*\*\***  
**IF REQUIRED, FOREIGN FILING LICENSE GRANTED\*\* SMALL ENTITY \*\***  
**\*\* 03/30/2004**

Foreign Priority claimed 35 USC 119 (a-d) conditions met Verified and Acknowledged	<input type="checkbox"/> yes <input checked="" type="checkbox"/> no <input type="checkbox"/> yes <input checked="" type="checkbox"/> no <input type="checkbox"/> Met after Allowance Examiner's Signature <i>CHS</i> Initials	<b>STATE OR COUNTRY</b> OH	<b>SHEETS DRAWING</b> 9	<b>TOTAL CLAIMS</b> 76	<b>INDEPENDENT CLAIMS</b> 14
--	---	-------------------------------	----------------------------	---------------------------	---------------------------------

**ADDRESS**  
23389

**TITLE**  
System and method for instant VoIP messaging

<b>FILING FEE RECEIVED</b> 1362	FEES: Authority has been given in Paper No. _____ to charge/credit DEPOSIT ACCOUNT No. _____ for following:	<input type="checkbox"/> All Fees <input type="checkbox"/> 1.16 Fees ( Filing ) <input type="checkbox"/> 1.17 Fees ( Processing Ext. of time ) <input type="checkbox"/> 1.18 Fees ( Issue ) <input type="checkbox"/> Other _____ <input type="checkbox"/> Credit
------------------------------------	---	---

**Index of Claims**



Application/Control No.

10/740,030

Examiner

Creighton H. Smith

Applicant(s)/Patent under Reexamination

ROJAS, MICHAEL J.

Art Unit

2614

✓	Rejected
=	Allowed

-	(Through numeral) Cancelled
+	Restricted

N	Non-Elected
I	Interference

A	Appeal
O	Objected

Claim		Date	
Final	Original		
	1	✓	
	2		
	3		
	4		
	5	✓	
	6	0	
	7	✓	
	8		
	9		
	10		
	11		
	12		
	13		
	14		
	15		
	16		
	17		
	18		
	19		
	20	✓	
	21	0	
	22	✓	
	23		
	24		
	25		
	26		
	27		
	28		
	29		
	30		
	31		
	32		
	33		
	34		
	35	✓	
	36	0	
	37	✓	
	38		
	39		
	40		
	41	7	
	42	0	
	43	✓	
	44		
	45	✓	
	46	0	
	47	✓	
	48		
	49		
	50	✓	

Claim		Date	
Final	Original		
	51	✓	
	52		
	53		
	54		
	55		
	56		
	57		
	58		
	59		
	60		
	61		
	62		
	63		
	64		
	65		
	66		
	67		
	68		
	69	✓	
	70		
	71	0	
	72		
	73		
	74		
	75		
	76	0	
	77		
	78		
	79		
	80		
	81		
	82		
	83		
	84		
	85		
	86		
	87		
	88		
	89		
	90		
	91		
	92		
	93		
	94		
	95		
	96		
	97		
	98		
	99		
	100		

Claim		Date	
Final	Original		
	101		
	102		
	103		
	104		
	105		
	106		
	107		
	108		
	109		
	110		
	111		
	112		
	113		
	114		
	115		
	116		
	117		
	118		
	119		
	120		
	121		
	122		
	123		
	124		
	125		
	126		
	127		
	128		
	129		
	130		
	131		
	132		
	133		
	134		
	135		
	136		
	137		
	138		
	139		
	140		
	141		
	142		
	143		
	144		
	145		
	146		
	147		
	148		
	149		
	150		

**Search Notes**



Application/Control No.

10/740,030

Examiner

Creighton H. Smith

Applicant(s)/Patent under Reexamination

ROJAS, MICHAEL J.

Art Unit

2614

**SEARCHED**

Class	Subclass	Date	Examiner
370	354	9/11/2007	CHS

**SEARCH NOTES  
(INCLUDING SEARCH STRATEGY)**

	DATE	EXMR
EAST Search - see printout	9/11/2007	CHS

**INTERFERENCE SEARCHED**

Class	Subclass	Date	Examiner



	Type	Hits	Search Text	DBs
1	BRS	7	instant adj voice adj messag\$3 with (internet or packet-switch\$3 or packet adj switch\$3) and (@ad<="20031218")	US-PGPUB; USPAT; USOCR; EPO; JPO; DERWENT; IBM_TDB
2	BRS	1	server with stor\$3 with temporar\$3 with unavailabl\$3 and (voice adj messag\$3) and (@ad<="20031218")	US-PGPUB; USPAT; USOCR; EPO; JPO; DERWENT; IBM_TDB
3	BRS	128	((audio or voice) with compress\$3 with encrypt\$3 with decrypt\$3 with decompress\$3) and (@ad<="20031218")	US-PGPUB; USPAT; USOCR; EPO; JPO; DERWENT; IBM_TDB
4	BRS	7	server and S1	US-PGPUB; USPAT; USOCR; EPO; JPO; DERWENT; IBM_TDB
5	BRS	38	(voice near4 messag\$3) with ((list near7 recipients) or (calling near4 list)) and (@ad<="20031218")	US-PGPUB; USPAT; USOCR; EPO; JPO; DERWENT; IBM_TDB
6	BRS	38	((voice near4 messag\$3) with ((list near7 recipients) or (calling near4 list))) and (@ad<="20031218")	US-PGPUB; USPAT; USOCR; EPO; JPO; DERWENT; IBM_TDB
7	BRS	4	(lan or local adj network or local adj area adj network) and S2	US-PGPUB; USPAT; USOCR; EPO; JPO; DERWENT; IBM_TDB
8	BRS	0	recipient adj list and S2	US-PGPUB; USPAT; USOCR; EPO; JPO; DERWENT; IBM_TDB
9	BRS	1	recipient\$1 near4 list and S2	US-PGPUB; USPAT; USOCR; EPO; JPO; DERWENT; IBM_TDB
10	BRS	2	server with stor\$3 with temporar\$3 with message with unavailabl\$3 and (@ad<="20031218")	US-PGPUB; USPAT; USOCR; EPO; JPO; DERWENT; IBM_TDB
11	BRS	124	(attach\$4 or add\$3 or suppl\$3) with file\$1 with (voice adj messag\$3) and (@ad<="20031218")	US-PGPUB; USPAT; USOCR; EPO; JPO; DERWENT; IBM_TDB
12	BRS	15	(server with stor\$3 with temporar\$3 with unavailabl\$3) and (@ad<="20031218")	US-PGPUB; USPAT; USOCR; EPO; JPO; DERWENT; IBM_TDB
13	BRS	165	(buffer\$3 with (voice adj messag\$3)) and (@ad<="20031218")	US-PGPUB; USPAT; USOCR; EPO; JPO; DERWENT; IBM_TDB

	Type	Hits	Search Text	DBs
14	BRS	1	(buffer\$3 with (instant adj voice adj messag\$3)) and (@ad<="20031218")	US-PGPUB; USPAT; USOCR; EPO; JPO; DERWENT; IBM_TDB
15	BRS	98	((voice adj messag\$3) with (audio adj file)) and (@ad<="20031218")	US-PGPUB; USPAT; USOCR; EPO; JPO; DERWENT; IBM_TDB
16	BRS	24	((voice adj messag\$3) with (audio adj file) with server) and (@ad<="20031218")	US-PGPUB; USPAT; USOCR; EPO; JPO; DERWENT; IBM_TDB



**THE UNITED STATES PATENT AND TRADEMARK OFFICE**

Applicant(s):	Michael J. Rojas	Examiner:	Unassigned
Serial No:	10/740,030	Art Unit:	2661
Filed:	December 18, 2003	Docket:	17188
For:	<b>SYSTEM AND METHOD FOR INSTANT VoIP MESSAGING</b>	Dated:	<b>August 19, 2004</b>

**Confirmation No. 1731**

Mail Stop Amendment  
Commissioner for Patents  
P. O. Box 1450  
Alexandria, VA 22313-1450

**INFORMATION DISCLOSURE STATEMENT**

Sir:

In accordance with 37 C.F.R. §§ 1.97 and 1.98, it is requested that the following references, which are also listed on the attached Form PTO-1449, be made of record in the above-identified case.

1. [http://www.cisco.com/warp/public/cc/pd/nemnsw/callmn/prodlit/cm33\\_ds.htm](http://www.cisco.com/warp/public/cc/pd/nemnsw/callmn/prodlit/cm33_ds.htm); "Data Sheet Cisco CallManager Version 3.3".
2. [http://www.cisco.com/en/US/products/hw/switches/ps1925/products\\_data\\_sheet\\_09186\\_a00800a3c3d.html](http://www.cisco.com/en/US/products/hw/switches/ps1925/products_data_sheet_09186_a00800a3c3d.html); "Data Sheet Cisco MGX 8000 Series".
3. <http://www.hsteliann.com/english/?zone=3100-V21P>; "Telephone 3100-V21P".

---

**CERTIFICATE OF MAILING UNDER 37 C.F.R. §1.8(a)**

I hereby certify that this correspondence is being deposited with the United States Postal Service as first class mail in an envelope addressed to: Mail Stop Amendment, Commissioner of Patents, P. O. Box 1450, Alexandria, VA, 22313-1450 on August 19, 2004.

Dated: August 19, 2004

\_\_\_\_\_  
Paul J. Esatto, Jr.

4. <http://www.linuxdevices.com/articles/AT5199947519.html>; "Device Profile: snom 100 VoIP phone".

5. [http://www.pingtel.com/pr\\_xpressa.jsp](http://www.pingtel.com/pr_xpressa.jsp); "No limits with the advanced industry standard SIP phone.

6. AudioCoded Enabling Technology Products, TPM-1100 VoP Media Gateway Modules.

Applicant is submitting a copy of the above-cited references.

Inasmuch as this Information Disclosure Statement is being submitted in accordance with the schedule set out in 37 C.F.R. § 1.97(b), no statement or fee is required.

Respectfully submitted,



Paul J. Esatto, Jr.  
Registration No. 30,749

Scully, Scott, Murphy & Presser  
400 Garden City Plaza  
Garden City, New York 11530  
(516) 742-4343

PJE:ae

Form PTO-1449 U.S. DEPARTMENT OF COMMERCE (REV. 7-80) PATENT AND TRADEMARK OFFICE  <b>INFORMATION DISCLOSURE CITATION</b>  (Use several sheets if necessary)	<b>Atty. Docket No. (Optional)</b> 17188	<b>Application Number</b> 10/740,030
	<b>Applicant(s)</b> Michael Rojas	
	<b>Filing Date</b> December 18, 2003	<b>Group Art Unit</b> 2661



**U.S. PATENT DOCUMENTS**

EXAMINER INITIAL*	DOCUMENT NUMBER	DATE	NAME	CLASS	SUBCLASS	FILING DATE (if appropriate)
AA						
AB						
AC						

**FOREIGN PATENT DOCUMENTS**

	REF	DOCUMENT NUMBER	DATE	COUNTRY	CLASS	SUBCLASS	TRANSLATION	
							YES	NO

**OTHER DOCUMENTS** (Including Author, Title, Date, Pertinent Pages, Etc.)

	<a href="http://www.cisco.com/warp/public/cc/pd/nemnsw/callmn/prodlit/cm33_ds.htm">http://www.cisco.com/warp/public/cc/pd/nemnsw/callmn/prodlit/cm33_ds.htm</a> ; "Data Sheet Cisco CallManager Version 3.3"
	<a href="http://www.cisco.com/en/US/products/hw/switches/ps1925/products_data_sheet_09186_a00800a3c3d.html">http://www.cisco.com/en/US/products/hw/switches/ps1925/products_data_sheet_09186_a00800a3c3d.html</a> ; "Data Sheet Cisco MGX 8000 Series"
	<a href="http://www.hsteliann.com/english/?zone=3100-V21P">http://www.hsteliann.com/english/?zone=3100-V21P</a> ; "Telephone 3100-V21P"
	<a href="http://www.linuxdevices.com/articles/AT5199947519.html">http://www.linuxdevices.com/articles/AT5199947519.html</a> ; "Device Profile: snom 100 VoIP phone"
	<a href="http://www.pingtel.com/pr_xpressa.jsp">http://www.pingtel.com/pr_xpressa.jsp</a> ; "No limits with the advanced industry standard SIP phone"
	AudioCoded Enabling Technology Products, TPM-1100 VoP Media Gateway Modules

EXAMINER	DATE CONSIDERED
----------	-----------------

\* EXAMINER: Initial if reference considered, whether or not citation is in conformance with MPEP 609; draw line through citation if not in conformance and not considered. Include copy of this form with next communication to applicant.

JFW

**TRANSMITTAL OF INFORMATION DISCLOSURE STATEMENT  
(Under 37 CFR 1.97(b) or 1.97(c))**

Docket No.  
17188

In Re Application Of: **Michael J. Rojas**

Application No.	Filing Date	Examiner	Customer No.	Group Art Unit	Confirmation No.
10/740,030	December 18, 2003	Unassigned	23389	2661	1731

Title:

**SYSTEM AND METHOD FOR INSTANT VoIP MESSAGING**



Address to:  
 Commissioner for Patents  
 P.O. Box 1450  
 Alexandria, VA 22313-1450

**37 CFR 1.97(b)**

1.  The Information Disclosure Statement submitted herewith is being filed within three months of the filing of a national application other than a continued prosecution application under 37 CFR 1.53(d); within three months of the date of entry of the national stage as set forth in 37 CFR 1.491 in an international application; before the mailing of a first Office Action on the merits, or before the mailing of a first Office Action after the filing of a request for continued examination under 37 CFR 1.114.

**37 CFR 1.97(c)**

2.  The Information Disclosure Statement submitted herewith is being filed after the period specified in 37 CFR 1.97(b), provided that the Information Disclosure Statement is filed before the mailing date of a Final Action under 37 CFR 1.113, a Notice of Allowance under 37 CFR 1.311, or an Action that otherwise closes prosecution in the application, and is accompanied by one of:

- the statement specified in 37 CFR 1.97(e);

**OR**

- the fee set forth in 37 CFR 1.17(p).

**TRANSMITTAL OF INFORMATION DISCLOSURE STATEMENT**  
(Under 37 CFR 1.97(b) or 1.97(c))

Docket No.  
17188

In Re Application: Michael J. Rojas

Application No.	Filing Date	Examiner	Customer No.	Group Art Unit	Confirmation No.
10/740,030	December 18, 2003	Unassigned	23389	2661	1731

**SYSTEM AND METHOD FOR INSTANT VoIP MESSAGING**

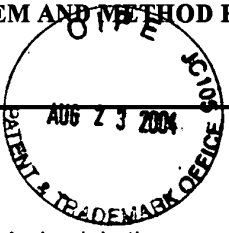

**Payment of Fee**

(Only complete if Applicant elects to pay the fee set forth in 37 CFR 1.17(p))

- A check in the amount of \_\_\_\_\_ is attached.
- The Director is hereby authorized to charge and credit Deposit Account **19-1013/SSMP** as described below.
- Charge the amount of \_\_\_\_\_
  - Credit any overpayment.
  - Charge any additional fee required.

**Certificate of Transmission by Facsimile\***

I certify that this document and authorization to charge deposit account is being facsimile transmitted to the United States Patent and Trademark Office (Fax. No. \_\_\_\_\_)

\_\_\_\_\_  
(Date)

\_\_\_\_\_  
Signature

\_\_\_\_\_  
Typed or Printed Name of Person Signing Certificate

**Certificate of Mailing by First Class Mail**

I certify that this document and fee is being deposited on **8/19/04** th the U.S. Postal Service as first class mail under 37 C.F.R. 1.8 and is addressed to the Commissioner for Patents, P.O. Box 1450, Alexandria, VA 22313-1450.

Signature of Person Mailing Correspondence

Paul J. Esatto, Jr.  
Typed or Printed Name of Person Mailing Certificate

\*This certificate may only be used if paying by deposit account.

Signature

Dated: August 19, 2004

Paul J. Esatto, Jr.  
Registration No. 30,749  
Scully, Scott, Murphy & Presser  
400 Garden City Plaza  
Garden City, New York 11530  
516-742-4343

CC:

16569 U.S. PTO  
121803

# UTILITY PATENT APPLICATION TRANSMITTAL (Small Entity)

(Only for new nonprovisional applications under 37 CFR 1.53(b))

Docket No.  
17188

Total Pages in this Submission  
4

## TO THE COMMISSIONER FOR PATENTS

Mail Stop Patent Application  
P.O. Box 1450  
Alexandria, VA 22313-1450

Transmitted herewith for filing under 35 U.S.C. 111(a) and 37 C.F.R. 1.53(b) is a new utility patent application for an invention entitled:

SYSTEM AND METHOD FOR INSTANT VoIP MESSAGING

22387 U.S. PTO  
10740030

and invented by:

MICHAEL J. ROJAS

If a CONTINUATION APPLICATION, check appropriate box and supply the requisite information:

Continuation  Divisional  Continuation-in-part (CIP) of prior application No.: \_\_\_\_\_

Which is a:

Continuation  Divisional  Continuation-in-part (CIP) of prior application No.: \_\_\_\_\_

Which is a:

Continuation  Divisional  Continuation-in-part (CIP) of prior application No.: \_\_\_\_\_

Enclosed are:

### Application Elements

1.  Filing fee as calculated and transmitted as described below
2.  Specification having 75 pages and including the following:
  - a.  Descriptive Title of the Invention
  - b.  Cross References to Related Applications (if applicable)
  - c.  Statement Regarding Federally-sponsored Research/Development (if applicable)
  - d.  Reference to Sequence Listing, a Table, or a Computer Program Listing Appendix
  - e.  Background of the Invention
  - f.  Brief Summary of the Invention
  - g.  Brief Description of the Drawings (if filed)
  - h.  Detailed Description
  - i.  Claim(s) as Classified Below
  - j.  Abstract of the Disclosure



**UTILITY PATENT APPLICATION TRANSMITTAL  
(Small Entity)**

*(Only for new nonprovisional applications under 37 CFR 1.53(b))*

Docket No.  
17188

Total Pages in this Submission  
4

**Application Elements (Continued)**

3.  Drawing(s) *(when necessary as prescribed by 35 USC 113)*
- a.  Formal      Number of Sheets      9
- b.  Informal      Number of Sheets      \_\_\_\_\_
4.  Oath or Declaration
- a.  Newly executed *(original or copy)*       Unexecuted
- b.  Copy from a prior application (37 CFR 1.63(d)) *(for continuation/divisional application only)*
- c.  With Power of Attorney       Without Power of Attorney
- d.  DELETION OF INVENTOR(S)  
Signed statement attached deleting inventor(s) named in the prior application,  
see 37 C.F.R. 1.63(d)(2) and 1.33(b).
5.  Incorporation By Reference *(usable if Box 4b is checked)*  
The entire disclosure of the prior application, from which a copy of the oath or declaration is supplied under  
Box 4b, is considered as being part of the disclosure of the accompanying application and is hereby  
incorporated by reference therein.
6.  CD ROM or CD-R in duplicate, large table or Computer Program (Appendix)
7.  Application Data Sheet (See 37 CFR 1.76)
8.  Nucleotide and/or Amino Acid Sequence Submission *(if applicable, all must be included)*
- a.  Computer Readable Form (CFR)
- b.  Specification Sequence Listing on:
- i.  CD-ROM or CD-R (2 copies); or
- ii.  Paper
- c.  Statement(s) Verifying Identical Paper and Computer Readable Copy

**Accompanying Application Parts**

9.  Assignment Papers (cover sheet & document(s))
10.  37 CFR 3.73(B) Statement (when there is an assignee)
11.  English Translation Document (if applicable)
12.  Information Disclosure Statement/PTO-1449       Copies of IDS Citations
13.  Preliminary Amendment
14.  Return Receipt Postcard (MPEP 503) (Should be specifically itemized)
15.  Certified Copy of Priority Document(s) (if foreign priority is claimed)
16.  Certificate of Mailing
- First Class       Express Mail *(Specify Label No.):* EV-244-125-044-US

**UTILITY PATENT APPLICATION TRANSMITTAL  
(Small Entity)**

*(Only for new nonprovisional applications under 37 CFR 1.53(b))*

Docket No.  
17188

Total Pages in this Submission  
4

**Accompanying Application Parts (Continued)**

17.  Applicant claims small entity status. See 37 CFR 1.27.  
 (Optional) Small Entity Statement(s) - Specify Number of Statements Submitted: \_\_\_\_\_
18.  Additional Enclosures (*please identify below*):

Assignee: Ayalogic, Inc.  
Akron, Ohio 44311

**Request That Application Not Be Published Pursuant To 35 U.S.C. 122(b)(2)**

19.  Pursuant to 35 U.S.C. 122(b)(2), Applicant hereby requests that this patent application not be published pursuant to 35 U.S.C. 122(b)(1). Applicant hereby certifies that the invention disclosed in this application has not and will not be the subject of an application filed in another country, or under a multilateral international agreement, that requires publication of applications 18 months after filing of the application.

**Warning**

***An applicant who makes a request not to publish, but who subsequently files in a foreign country or under a multilateral international agreement specified in 35 U.S.C. 122(b)(2)(B)(i), must notify the Director of such filing not later than 45 days after the date of the filing of such foreign or international application. A failure of the applicant to provide such notice within the prescribed period shall result in the application being regarded as abandoned, unless it is shown to the satisfaction of the Director that the delay in submitting the notice was unintentional.***

**UTILITY PATENT APPLICATION TRANSMITTAL  
(Small Entity)**

*(Only for new nonprovisional applications under 37 CFR 1.53(b))*

Docket No.  
17188

Total Pages in this Submission  
4

**Correspondence Address:**

**Customer No. 23389**

**Fee Calculation and Transmittal**

**CLAIMS AS FILED**

For	#Filed	#Allowed	#Extra	Rate	Fee
Total Claims	76	- 20 =	56	x \$9.00	\$504.00
Ind p. Claims	14	- 3 =	11	x \$43.00	\$473.00
Multiple Dependent Claims (check if applicable) <input type="checkbox"/>					\$0.00
<b>BASIC FEE</b>					\$385.00
<b>OTHER FEE (specify purpose)</b> _____					\$0.00
<b>TOTAL FILING FEE</b>					<b>\$1,362.00</b>

- A check in the amount of \_\_\_\_\_ to cover the filing fee is enclosed.
- The Director is hereby authorized to charge and credit Deposit Account No. **19-1013 SSMP** as described below.
- Charge the amount of **\$1,362.00** as filing fee.
  - Credit any overpayment.
  - Charge any additional filing fees required under 37 C.F.R. 1.16 and 1.17.
  - Charge the issue fee set in 37 C.F.R. 1.18 at the mailing of the Notice of Allowance, pursuant to 37 C.F.R. 1.311(b).

Dated: **December 18, 2003**

*Signature*

**Paul J. Esatto, Jr.  
Registration No. 30,749**

cc:

<b>CERTIFICATE OF MAILING BY "EXPRESS MAIL" (37 CFR 1.10)</b>		Docket No.
Applicant(s): <b>MICHAEL J. ROJAS</b>		<b>17188</b>

Serial No. <b>unassigned</b>	Filing Date <b>herewith</b>	Examiner <b>unassigned</b>	Group Art Unit <b>unassigned</b>
---------------------------------	--------------------------------	-------------------------------	-------------------------------------

Invention:  
**SYSTEM AND METHOD FOR INSTANT VoIP MESSAGING**

I hereby certify that this **NEW PATENT APPLICATION**  
*(Identify type of correspondence)*  
 is being deposited with the United States Postal Service "Express Mail Post Office to Addressee" service under  
 37 CFR 1.10 in an envelope addressed to: Director of the United States Patent and Trademark Office, P.O. Box  
 1450, Alexandria, VA 22313-1450 on **December 18, 2003**  
*(Date)*

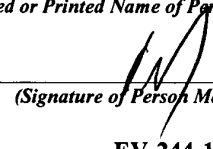
**Paul J. Esatto, Jr.**  
*(Typed or Printed Name of Person Mailing Correspondence)*  
  
*(Signature of Person Mailing Correspondence)*  
**EV-244-125-044-US**  
*("Express Mail" Mailing Label Number)*

**Note: Each paper must have its own certificate of mailing.**

16569 U.S. PTO  
121803

# UTILITY PATENT APPLICATION TRANSMITTAL (Small Entity)

(Only for new nonprovisional applications under 37 CFR 1.53(b))

Docket No.  
17188

Total Pages in this Submission  
4

## TO THE COMMISSIONER FOR PATENTS

Mail Stop Patent Application  
P.O. Box 1450  
Alexandria, VA 22313-1450

Transmitted herewith for filing under 35 U.S.C. 111(a) and 37 C.F.R. 1.53(b) is a new utility patent application for an invention entitled:

SYSTEM AND METHOD FOR INSTANT VoIP MESSAGING

22387 U.S. PTO  
10740030

and invented by:

MICHAEL J. ROJAS

If a CONTINUATION APPLICATION, check appropriate box and supply the requisite information:

Continuation  Divisional  Continuation-in-part (CIP) of prior application No.: \_\_\_\_\_

Which is a:

Continuation  Divisional  Continuation-in-part (CIP) of prior application No.: \_\_\_\_\_

Which is a:

Continuation  Divisional  Continuation-in-part (CIP) of prior application No.: \_\_\_\_\_

Enclosed are:

### Application Elements

1.  Filing fee as calculated and transmitted as described below
2.  Specification having 75 pages and including the following:
  - a.  Descriptive Title of the Invention
  - b.  Cross References to Related Applications (if applicable)
  - c.  Statement Regarding Federally-sponsored Research/Development (if applicable)
  - d.  Reference to Sequence Listing, a Table, or a Computer Program Listing Appendix
  - e.  Background of the Invention
  - f.  Brief Summary of the Invention
  - g.  Brief Description of the Drawings (if filed)
  - h.  Detailed Description
  - i.  Claim(s) as Classified Below
  - j.  Abstract of the Disclosure

**UTILITY PATENT APPLICATION TRANSMITTAL  
(Small Entity)**

*(Only for new nonprovisional applications under 37 CFR 1.53(b))*

Docket No.  
17188

Total Pages in this Submission  
4

**Application Elements (Continued)**

3.  Drawing(s) *(when necessary as prescribed by 35 USC 113)*
- a.  Formal      Number of Sheets      9
- b.  Informal      Number of Sheets      \_\_\_\_\_
4.  Oath or Declaration
- a.  Newly executed *(original or copy)*       Unexecuted
- b.  Copy from a prior application (37 CFR 1.63(d)) *(for continuation/divisional application only)*
- c.  With Power of Attorney       Without Power of Attorney
- d.  DELETION OF INVENTOR(S)  
Signed statement attached deleting inventor(s) named in the prior application,  
see 37 C.F.R. 1.63(d)(2) and 1.33(b).
5.  Incorporation By Reference *(usable if Box 4b is checked)*  
The entire disclosure of the prior application, from which a copy of the oath or declaration is supplied under  
Box 4b, is considered as being part of the disclosure of the accompanying application and is hereby  
incorporated by reference therein.
6.  CD ROM or CD-R in duplicate, large table or Computer Program (Appendix)
7.  Application Data Sheet (See 37 CFR 1.76)
8.  Nucleotide and/or Amino Acid Sequence Submission *(if applicable, all must be included)*
- a.  Computer Readable Form (CFR)
- b.  Specification Sequence Listing on:
- i.  CD-ROM or CD-R (2 copies); or
- ii.  Paper
- c.  Statement(s) Verifying Identical Paper and Computer Readable Copy

**Accompanying Application Parts**

9.  Assignment Papers (cover sheet & document(s))
10.  37 CFR 3.73(B) Statement (when there is an assignee)
11.  English Translation Document (if applicable)
12.  Information Disclosure Statement/PTO-1449       Copies of IDS Citations
13.  Preliminary Amendment
14.  Return Receipt Postcard (MPEP 503) (Should be specifically itemized)
15.  Certified Copy of Priority Document(s) (if foreign priority is claimed)
16.  Certificate of Mailing
- First Class       Express Mail *(Specify Label No.):* EV-244-125-044-US

**UTILITY PATENT APPLICATION TRANSMITTAL  
(Small Entity)**

*(Only for new nonprovisional applications under 37 CFR 1.53(b))*

Docket No.  
17188

Total Pages in this Submission  
4

**Accompanying Application Parts (Continued)**

17.  Applicant claims small entity status. See 37 CFR 1.27.  
 (Optional) Small Entity Statement(s) - Specify Number of Statements Submitted: \_\_\_\_\_
18.  Additional Enclosures (*please identify below*):

Assignee: Ayalogic, Inc.  
Akron, Ohio 44311

**Request That Application Not Be Published Pursuant To 35 U.S.C. 122(b)(2)**

19.  Pursuant to 35 U.S.C. 122(b)(2), Applicant hereby requests that this patent application not be published pursuant to 35 U.S.C. 122(b)(1). Applicant hereby certifies that the invention disclosed in this application has not and will not be the subject of an application filed in another country, or under a multilateral international agreement, that requires publication of applications 18 months after filing of the application.

**Warning**

***An applicant who makes a request not to publish, but who subsequently files in a foreign country or under a multilateral international agreement specified in 35 U.S.C. 122(b)(2)(B)(i), must notify the Director of such filing not later than 45 days after the date of the filing of such foreign or international application. A failure of the applicant to provide such notice within the prescribed period shall result in the application being regarded as abandoned, unless it is shown to the satisfaction of the Director that the delay in submitting the notice was unintentional.***

**UTILITY PATENT APPLICATION TRANSMITTAL  
(Small Entity)**

*(Only for new nonprovisional applications under 37 CFR 1.53(b))*

Docket No.  
17188

Total Pages in this Submission  
4

**Correspondence Address:**

**Customer No. 23389**

**Fee Calculation and Transmittal**

**CLAIMS AS FILED**

For	#Filed	#Allowed	#Extra	Rate	Fee
Total Claims	76	- 20 =	56	x \$9.00	\$504.00
Ind p. Claims	14	- 3 =	11	x \$43.00	\$473.00
Multiple Dependent Claims (check if applicable) <input type="checkbox"/>					\$0.00
<b>BASIC FEE</b>					\$385.00
<b>OTHER FEE (specify purpose)</b> _____					\$0.00
<b>TOTAL FILING FEE</b>					<b>\$1,362.00</b>

- A check in the amount of \_\_\_\_\_ to cover the filing fee is enclosed.
- The Director is hereby authorized to charge and credit Deposit Account No. **19-1013 SSMP** as described below.
- Charge the amount of **\$1,362.00** as filing fee.
  - Credit any overpayment.
  - Charge any additional filing fees required under 37 C.F.R. 1.16 and 1.17.
  - Charge the issue fee set in 37 C.F.R. 1.18 at the mailing of the Notice of Allowance, pursuant to 37 C.F.R. 1.311(b).

Dated: **December 18, 2003**

*Signature*

**Paul J. Esatto, Jr.  
Registration No. 30,749**

cc:



<b>CERTIFICATE OF MAILING BY "EXPRESS MAIL" (37 CFR 1.10)</b>		Docket No.
Applicant(s): <b>MICHAEL J. ROJAS</b>		<b>17188</b>

Serial No. <b>unassigned</b>	Filing Date <b>herewith</b>	Examiner <b>unassigned</b>	Group Art Unit <b>unassigned</b>
---------------------------------	--------------------------------	-------------------------------	-------------------------------------

Invention:  
**SYSTEM AND METHOD FOR INSTANT VoIP MESSAGING**

I hereby certify that this **NEW PATENT APPLICATION**  
*(Identify type of correspondence)*  
 is being deposited with the United States Postal Service "Express Mail Post Office to Addressee" service under  
 37 CFR 1.10 in an envelope addressed to: Director of the United States Patent and Trademark Office, P.O. Box  
 1450, Alexandria, VA 22313-1450 on **December 18, 2003**  
*(Date)*

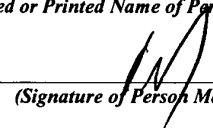
**Paul J. Esatto, Jr.**  
*(Typed or Printed Name of Person Mailing Correspondence)*  
  
*(Signature of Person Mailing Correspondence)*  
**EV-244-125-044-US**  
*("Express Mail" Mailing Label Number)*

**Note: Each paper must have its own certificate of mailing.**

**SYSTEM AND METHOD**  
**FOR INSTANT VoIP MESSAGING**

**BACKGROUND OF THE INVENTION**

5

Technical Field of the Invention

The present invention generally relates to Internet telephony (IP telephony). More particularly, the present invention is directed to a system and method for enabling local and global instant VoIP messaging over an IP network, such as the Internet, with PSTN support.

Description of the Prior Art

15 Traditional telephony is based on a public switched telephone network (i.e., "PSTN"). In the PSTN, a telephone terminal is electrically connected to a conventional or legacy switch. The telephone terminal and the legacy switch communicate via a proprietary protocol, which may be different depending on the vendor of the legacy switch. Circuit switching provides a communication path (i.e., dedicated circuit) for a telephone call from the telephone terminal to another device over the PSTN, including another telephone terminal. During the telephone call, voice communication takes place over that communication path.

25 An alternative to the PSTN is Voice over Internet Protocol (i.e., "VoIP"), also known as IP telephony or Internet telephony. In the IP telephony, a VoIP terminal device is connected to a packet-switched network (e.g., Internet) and voice

communication from the VoIP terminal device is digitized, packetized and transmitted over the packet-switched network to a destination VoIP terminal device, which reconstructs the packets and audibly plays, stores or otherwise processes the transmission. The VoIP terminal device may be a VoIP telephone or a general-purpose personal computer (PC) enabled for IP telephony. More specifically, the PC is  
5 programmed with the software and equipped with audio input/output devices (e.g., a combination of microphone and speaker or a headset) to serve as a VoIP terminal device. The PC so enabled and equipped will herein be referred to as a VoIP terminal device or a VoIP softphone.

10

Figure 1 is an illustrative example of a prior art IP telephony system 100. The IP telephony system 100 comprises a packet-switched IP network 102, such as the Internet, which transmits VoIP traffic from and to a plurality of terminal devices 104, 106 and 110. Terminal device 104 is a VoIP softphone that is enabled for IP telephony over  
15 the network 102. Terminal device 106 is a VoIP telephone, which is connected to the network 102 via a softswitch 108. The VoIP softswitch 108 is disposed on the packet-switched network (e.g., Internet) 102 between an origination terminal device (such as VoIP softphone 104) and a destination terminal device (such as VoIP telephone 106), and routes packets over the packet-switched IP network 102. The softswitch 108 may also  
20 manage and perform administrative functions for the terminal device or devices (e.g., VoIP telephone 106) to which it is connected. Whether the terminal device is a VoIP softphone 104 or a VoIP telephone 106, the terminal device is connected to the IP network 102 via a networking standard such as Ethernet, Bluetooth, IEEE 1394 (also

known as “Firewire”), IEEE 802.11 (also known as “WiFi”), or networking over serial communication channels such as the Universal Serial Bus (i.e., “USB”). Data communication over the network then takes place using a connection protocol, e.g., transfer control protocol/Internet protocol (i.e., “TCP/IP”).

5

Further regarding Fig. 1, terminal device 110 is a legacy telephone that is connected to a legacy switch 112 for (circuit-switched) voice communications over the PSTN 116 with other terminal devices. A media gateway 114 may be provided between the legacy switch 112 and the packet-switched network 102 to enable IP telephony  
10 between the legacy telephone 110 and a VoIP terminal device, such as a VoIP softphone 104 or VoIP telephone 106. More specifically, the media gateway 114 converts the audio signal carried over PSTN to packets carried over the packet-switched IP network 102. In addition, a media gateway 118 may be disposed over the PSTN 116 and connected to a softswitch 120 to convert the audio signal from the legacy telephone 110 to packets  
15 routed over the IP network 102 via the softswitch 120.

Voice messaging in both the VoIP and PSTN is known. More specifically, the foregoing systems may be provided with a facility to allow users to leave voice messages for recipients, which is a feature that is familiar to anyone who uses a  
20 telephone. Conventionally, leaving a voice message involves dialing the recipient's telephone number (often without knowing whether the recipient will answer), waiting for the connection to be established, speaking to an operator or navigating through a menu of options, listening to a greeting message, and recording the message for later pickup by

the recipient. In that message, the user must typically identify himself or herself in order for the recipient to return the call.

Instant text messaging is likewise known. More specifically, a user is  
5 provided with a client terminal, which is typically a general-purpose PC programmed with instant text messaging software and in data communication over an IP network with an instant text-messaging server. The instant text-messaging server presents the user, via the client terminal, with a list of persons who are currently “online” and ready to receive text messages on their own client terminals. The user then uses the client terminal to  
10 select one or more persons to whom the message will be sent and types in a text message. The text message is sent immediately via the text-messaging server to the selected one or more persons and is displayed on their respective client terminals.

However, notwithstanding the foregoing advances in the VoIP/PSTN  
15 voice communication and voice/text messaging, there is still a need in the art for providing a system and method for providing instant VoIP messaging over an IP network. More particularly, there is a need in the art for providing local and global instant voice messaging over VoIP with PSTN support.

20 **SUMMARY OF THE INVENTION**

The present invention is directed to a system and method for enabling local and global instant VoIP messaging over an IP network, such as the Internet.

According to an embodiment of the present invention, there is provided an instant voice messaging system for delivering instant messages over a packet-switched network, the system comprising: a client connected to the network, the client selecting one or more recipients, generating an instant voice message therefor, and transmitting the selected recipients and the instant voice message therefor over the network; and a server connected to the network, the server receiving the selected recipients and the instant voice message therefor, and delivering the instant voice message to the selected recipients over the network, the selected recipients being enabled to audibly play the instant voice message.

According to another embodiment of the present invention, there is provided an instant voice messaging system for delivering instant messages over a packet-switched network enabling public switched telephone network (PSTN) support, the system comprising: a PSTN telephone connected to the network for providing input audio; a client connected to the network, the client selecting one or more recipients, generating an instant voice message therefor using the input audio provided by the PSTN telephone, and transmitting the selected recipients and the instant voice message therefor over the network; a server connected to the network, the server receiving the selected recipients and the instant voice message therefor, and delivering the instant voice message to the selected recipients over the network, the selected recipients being enabled to audibly play the instant voice message.

According to a further embodiment of the present invention, there is provided an instant voice messaging system for delivering instant messages over a packet-switched network, the system comprising: a voice-over-internet-protocol (VoIP) telephone connected to the network for providing input audio; a client connected to the network, the client selecting one or more recipients, generating an instant voice message therefor using the input audio provided by the VoIP telephone, and transmitting the selected recipients and the instant voice message therefor over the network; a server connected to the network, the server receiving the selected recipients and the instant voice message therefor, and delivering the instant voice message to the selected recipients over the network, the selected recipients being enabled to audibly play the instant voice message.

According to still another embodiment of the present invention, there is provided an instant voice messaging system for delivering instant messages over a plurality of packet-switched networks, the system comprising: a client connected to a local network, the client selecting one or more external recipients connected to an external network outside the local network, generating an instant voice message therefor, and transmitting the selected recipients and the instant voice message therefor over the local network and the external network; and a server connected to the external network, the server receiving the selected recipients and the instant voice message therefor, and delivering the instant voice message to the selected recipients over the external network, the selected recipients being enabled to audibly play the instant voice message.

According to yet another embodiment of the present invention, there is provided an instant voice messaging system for delivering instant messages over a plurality of packet-switched networks enabling public switched telephone network (PSTN) support, the system comprising: a PSTN telephone connected to a local network for providing input audio; a client connected to the local network, the client selecting one or more external recipients connected to an external network outside the local network, generating an instant voice message therefor using the input audio provided by the PSTN telephone, and transmitting the selected recipients and the instant voice message therefor over the local network and the external network; a server connected to the external network, the server receiving the selected recipients and the instant voice message therefor, and delivering the instant voice message to the selected recipients over the external network, the selected recipients being enabled to audibly play the instant voice message.

According to yet a further embodiment of the present invention, there is provided an instant voice messaging system for delivering instant messages over a plurality of packet-switched networks, the system comprising: a voice-over-internet-protocol (VoIP) telephone connected to a local network for providing input audio; a client connected to the local network, the client selecting one or more external recipients connected to an external network outside the local network, generating an instant voice message therefor using the input audio provided by the VoIP telephone, and transmitting the selected recipients and the instant voice message therefor over the local network and the external network; an server connected to the external network, the external server



receiving the selected recipients and the instant voice message therefor, and delivering the instant voice message to the selected recipients over the external network, the selected recipients being enabled to audibly play the instant voice message.

5           According to still a further embodiment of the present invention, there is provided an instant voice messaging system for delivering instant messages over a plurality of packet-switched networks, the system comprising: a client connected to an external network, the client selecting one or more recipients connected to a local network, generating an instant voice message therefor, and transmitting the selected recipients and  
10 the instant voice message therefor over the external network; an external server system connected to the external network, the external server system receiving the selected recipients and the instant voice message, and routing the selected recipients and the instant voice message over the external network and the local network; a local server connected to the local network, the local server receiving the selected recipients and the  
15 instant voice message therefor, and delivering the instant voice message to the selected recipients over the local network, the selected recipients being enabled to audibly play the instant voice message.

          According to an embodiment of the present invention, there is provided a  
20 method for instant voice messaging over a packet-switched network, the method comprising: selecting one or more recipients for instant voice messaging at a client; generating an instant voice message for the selected recipients at the client; transmitting the selected recipients and the instant voice message therefor over the network from the

client to a server; receiving the selected recipients and the instant voice message therefor at the server; delivering the instant voice message from the server to the selected recipients over the network; and audibly playing the instant voice message at the selected recipients.

5

According to another embodiment of the present invention, there is provided a method for instant voice messaging over a packet-switched network enabling public switched telephone network (PSTN) support, the method comprising: providing input audio via a PSTN telephone connected over the network; selecting one or more recipients for instant voice messaging at a client; generating an instant voice message using the input audio from the PSTN telephone for the selected recipients at the client; transmitting the selected recipients and the instant voice message therefor over the network from the client to a server; receiving the selected recipients and the instant voice message therefor at the server; delivering the instant voice message from the server to the selected recipients over the network; and audibly playing the instant voice message at the selected recipients.

According to a further embodiment of the present invention, there is provided a method for instant voice messaging over a packet-switched network, the method comprising: providing input audio via a voice-over-internet-protocol (VoIP) telephone connected over the network; selecting one or more recipients for instant voice messaging at a client; generating an instant voice message using the input audio from the VoIP telephone for the selected recipients at the client; transmitting the selected

recipients and the instant voice message therefor over the network from the client to a server; receiving the selected recipients and the instant voice message therefor at the server; delivering the instant voice message from the server to the selected recipients over the network; and audibly playing the instant voice message at the selected recipients.

5

According to still another embodiment of the present invention, there is provided a method for instant voice messaging over a plurality of packet-switched networks, the method comprising: selecting one or more external recipients for instant voice messaging at a client connected to a local network, the one or more external recipients connected to an external network outside the local network; generating an  
10 instant voice message for the selected external recipients at the client; transmitting the selected external recipients and the instant voice message therefor over the local network and the external network; receiving the selected external recipients and the instant voice message therefor at an external server connected to the external network; delivering the  
15 instant voice message to the selected external recipients over the external network; and audibly playing the instant voice message at the selected external recipients.

According to yet another embodiment of the present invention, there is provided a method for instant voice messaging system over a plurality of packet-switched  
20 networks enabling public switched telephone network (PSTN) support, the method comprising: providing input audio via a PSTN telephone connected to a local network; selecting one or more external recipients for instant voice messaging at a client, the one or more external recipients connected to an external network outside the local network;

generating an instant voice message for the one or more external recipients using the input audio provided by the PSTN telephone; transmitting the selected recipients and the instant voice message therefor over the local network and the external network; receiving the selected recipients and the instant voice message therefor at a server connected to the external network; delivering the instant voice message to the selected recipients from the server over the external network; and audibly playing the instant voice message at the selected recipients.

According to still a further embodiment of the present invention, there is provided a method for instant voice messaging system over a plurality of packet-switched networks, the method comprising: providing input audio via a voice-over-internet-protocol (VoIP) telephone connected to a local network; selecting one or more external recipients for instant voice messaging at a client, the one or more external recipients connected to an external network outside the local network; generating an instant voice message for the one or more external recipients using the input audio provided by the VoIP telephone; transmitting the selected recipients and the instant voice message therefor over the local network and the external network; receiving the selected recipients and the instant voice message therefor at a server connected to the external network; delivering the instant voice message to the selected recipients from the server over the external network; and audibly playing the instant voice message at the selected recipients.

According to yet a further embodiment of the present invention, there is provided a method for instant voice messaging over a plurality of a plurality of packet-

switched networks, the method comprising: selecting one or more recipients connected to a local network at a client connected to an external network; generating an instant voice message for the selected recipients at the client; transmitting the selected recipients and the instant voice message therefor over the external network from the client to an external  
5 server system; receiving the selected recipients and the instant voice message at the external server system; routing the selected recipients and the instant voice message over the external network and the local network; receiving the selected recipients and the instant voice message therefor at a local server connected to the local network; delivering the instant voice message to the selected recipients over the local network; audibly  
10 playing the instant voice message at the selected recipients.

### **BRIEF DESCRIPTION OF THE DRAWINGS**

The objects, features and advantages of the present invention will become  
15 apparent to one skilled in the art, in view of the following detailed description taken in combination with the attached drawings, in which:

Figure 1 illustrates an example of a prior art IP telephony system;

Figure 2 illustrates an exemplary local IVM system for enabling instant  
voice messaging according to the present invention;

20 Figure 3 illustrates an exemplary IVM client of Figure 2 for enabling instant voice messaging according to the present invention;

Figure 4 illustrates an exemplary IVM server of Figure 2 for enabling instant voice messaging according to the present invention;

Figure 5 illustrates an exemplary global IVM system comprising a local IVM system and global IVM clients, according to the present invention;

Fig. 6 illustrates an exemplary global IVM server system depicted in Fig. 5, according to the present invention;

5 Fig. 7 illustrates an exemplary transport server depicted in Fig. 6, according to the present invention;

Fig. 8 illustrates an exemplary directory server depicted in Fig. 6, according to the present invention; and

10 Fig. 9 illustrates an exemplary global IVM system comprising a plurality of local IVM systems and global IVM clients, according to the present invention.

### **DETAILED DESCRIPTION OF THE PREFERRED EMBODIMENT OF THE INVENTION**

15 The present invention is directed to a system and method for enabling local and global instant VoIP messaging over an IP network with PSTN support.

Figure 2 is an exemplary illustration of a local instant voice messaging (IVM) system 200 according to the present invention. The instant voice messaging system 200 comprises a local IVM server 202 that provides the core functionality for enabling instant voice messaging with PSTN support according to the present invention. The architecture of the local IVM server 202 will be described in detail hereinbelow with reference to Fig. 4. According to the exemplary IVM system 200, the local IVM server 202 is enabled to provide instant voice messaging to one or more IVM clients 206 and 25 208, as well support instant voice messaging for PSTN legacy telephones 110. It is noted

that although Fig. 2 depicts one of each IVM client 206, 208 and legacy telephone 110 for clarity and brevity, the local IVM server 202 is enabled to support a plurality of each of the foregoing IVM clients 206, 208 and legacy telephone 110. The local packet-switched IP network 204 interconnects the IVM clients 206, 208 and the legacy telephone 5 110 to the local IVM server 202 as well as interconnecting the local IVM server 202 to the local IP network 204. The network 204 may be a local area network (LAN), a wide area network (WAN), or the like, which supports both wired and wireless devices. The exemplary IVM client 208 is a VoIP softphone, the architecture of which will be described in detail hereinbelow with reference to Fig. 3. A microphone 212 is connected 10 to the IVM client 208 and enables the recording of an instant voice message according to the present invention into an audio file 210 for transmission to the local IVM server 202 over the network 204. An input device 218 (e.g., a keyboard) is connected to the IVM client 208 to select one or more recipients that are to receive the recorded instant voice message. Although not depicted in Fig. 2, the input device 218 may include a trackball, 15 digitizing pad or mouse, or the like. A display device 216 is connected to the IVM client 208 to display instant voice messages recorded and/or received by a user of the IVM client 208. An audio device 214, such as external speaker, is connected to the IVM client 208 to play received instant voice messages. It is noted that the microphone 212, audio device 214, display device 216 and input device 218 may form integral parts of the IVM 20 client 208.

Further with reference to Fig. 2, IVM client 206 is interconnected via the network 204 to the local IVM server 202. An exemplary IVM client 206 is a VoIP

telephone, which comprises a screen display (not shown) capable of displaying instant voice messages recorded and/or received by a user of the IVM client 206 according to the present invention. The VoIP telephone 206 further comprises a handset and/or speakerphone for recording instant voice messages and listening to instant voice messages received at the VoIP telephone 206 according to the present invention. The VoIP telephones which may be implemented to provide instant voice messaging functionality according to the present invention are commercially available from many vendors, including Alcatel™, Lucent™, NEC™ and Cisco™, to name just a few. In addition to the foregoing IVM clients 206, 208, the IVM system 200 supports a legacy telephone 110 for instant voice messaging according to the present invention. The legacy telephone 110 is connected to a legacy switch 112. The legacy switch 112 is further connected to a media gateway 114. Both the legacy switch 112 and the media gateway 114 interconnect the legacy telephone 110 via the network 204 to the local IVM server 202, thereby facilitating instant voice messaging according to the present invention. The media gateway 114 may be a gateway that supports trunk pack network control (i.e., “TPNCP”) protocol, media gateway control protocol (i.e., “MGCP”), or a media gateway control H.428 protocol (i.e., “MEGACO”). As previously mentioned, the media gateway 114 converts the audio signal carried over PSTN to packets to be transmitted over a packet-switched IP network, such as the local network 204.

20

The implementation of the instant voice messaging for IVM client 208 will be described first and will be followed by the implementations for IVM client 206 and legacy telephone 110, with reference to the local IVM system 200 depicted in Fig. 2.



These implementations implement a “record mode” of the instant voice messaging according to the present invention. There will further be described an “intercom mode” of the instant voice messaging according to the present invention. Therefore, in operation of the IVM client 208 according to Fig. 2, the IVM client (IVM softphone) 208 is

5 connected over the network 204 to the IVM server 202, which as aforementioned enables instant voice messaging functionality over the network 204. The IVM client 208 displays a list of one or more IVM recipients on its display 216, provided and stored by the local IVM server 202, as will be particularly described hereinbelow with reference to Fig. 4.

The user operates the IVM client 208 by using the input device 218 to indicate a selection

10 of one or more IVM recipients from the list. The user selection is transmitted to the IVM server 202. The user selection also generates a start signal to the IVM client 208 that the user is ready to begin instant voice messaging according to the present invention. In response to the start signal, the IVM client (softphone) 208 listens to the input audio device 212 and records the user’s speech into a digitized audio file 210 (i.e., instant voice

15 message) stored on the IVM client 208. The audio file 210 at the IVM client 208 is finalized via a stop signal, which is generated by the user via the input device 218 or a preset time period without speech input via the input audio device 212 on the IVM client 208. Once the recording of the user’s speech is finalized, IVM client 208 generates a send signal indicating that the digitized audio file 210 (instant voice message) is ready to

20 be sent to the selected recipients. The user generates the send signal when the user operates the IVM client 208 via the input device 218, e.g., pressing a key on a keyboard or clicking a button on a mouse. The IVM client 208 transmits the digitized audio file 210 and the send signal to the local IVM server 202. In response to the send signal

indicating that the instant voice message is ready to be sent, the IVM client 208 sends the recorded audio file 210 destined for the selected one or more recipients via local IVM server 202. After receiving the audio file 210, the IVM server 202 thereafter delivers the transmitted instant voice message to the selected one or more recipients via the local IP network 204. The one or more recipients are enabled to display an indication that the instant voice message has been received and audibly play the instant voice message to an associated user. It should be understood that only the available IVM recipients, currently connected to the IVM server 202, will receive the instant voice message. It is noted that if a recipient IVM client is not currently connected to the local IVM server 202 (i.e., is unavailable), the IVM server temporarily saves the instant voice message and delivers it to the IVM client when the IVM client connects to the local IVM server 202 (i.e., is available).

There are several embodiments for the operation of the IVM client (VoIP telephone) 206 within the IVM system 200, according to the present invention. In the first embodiment, the VoIP telephone 206 is a standalone IVM client 206 enabled for instant voice messaging according to the present invention. In the second embodiment, the VoIP telephone 206 operates synchronously either with the IVM client 208 or IVM server 202 to enable instant voice messaging according to the present invention. Thus, in operation according to the first embodiment in Fig. 2, the IVM client (VoIP telephone) 206 is connected over the network 204 to the IVM server 202, which as aforementioned enables instant voice messaging functionality over the local network 204. The IVM client 206 displays a list of one or more IVM recipients on its associated display provided and stored by the local IVM server 202, as will be particularly described hereinbelow

with reference to Fig. 4. The user operates the IVM client 206 by using a keypad on the VoIP telephone 206 to indicate a selection of one or more IVM recipients from the list. The VoIP telephone 206 transmits the selection to the IVM server 202. The user selection also generates a start signal to the IVM client 206 indicating the user is ready to

5 begin instant voice messaging according to the present invention. The user speaks into the handset of the IVM client 206 or a speakerphone on the IVM client 206. Although not shown in Fig. 2, the VoIP telephone 206 may provide a dedicated storage device, which in response to the start signal records an audio file, similar to the audio file 210 in the IVM client 208. The audio file is finalized via a stop signal. The stop signal is

10 generated when the user presses a button on the keypad, a preset time period without speech input to the VoIP telephone 206, or when the user returns the handset to the cradle of the VoIP telephone 206. Once the recording of the user's speech is complete, a send signal is generated indicating that the instant voice message is ready to be sent to the selected recipients. The user generates the send signal when the user presses a button on

15 the keypad or returns the handset of the VoIP telephone 206 to its cradle (on-hook). In response to the send signal, the IVM client 206 sends the recorded audio to the local IVM server 202 via the network 204. The IVM server 202 thereafter delivers the instant voice message to the selected one or more recipients via the IP network 204. As before, the one or more recipients are enabled to display an indication that the instant voice message

20 has been received and audibly play the instant voice message. As aforementioned, if a recipient IVM client is not currently connected to the local IVM server 202, the IVM server 202 temporarily saves the instant voice message and delivers it to the IVM client when the IVM client connects to the local IVM server 202.

In the second embodiment of the IVM client 206 according to Fig. 2, the VoIP telephone 206 operates synchronously either with the IVM client 208 or the IVM server 202 to enable instant voice messaging according to the present invention. Thus, in operation according to the second embodiment, the IVM client (VoIP telephone) 206 is still connected over the network 204 to the IVM server 202, which as aforementioned enables instant voice messaging functionality over the local network 204. However, VoIP telephone 206 cooperates with the IVM client 208 or IVM server 202 to record and send an instant voice message. More specifically, the VoIP telephone 206 is only used as a recording/listening device for recording or listing to instant voice messages, while the IVM client 208 is used for displaying and selecting instant voice message recipients as described hereinabove. In operation, the IVM client 208 displays a list of IVM recipients on the display device 216 provided and stored by the local IVM server 202. The user operates the IVM client 208 by using the input device 218 on the IVM client 208 to indicate a selection of one or more IVM recipients from the list. The user selection is transmitted to the IVM server 202. The user selection generates a start signal to the IVM server 202 indicating that the user is ready to begin instant voice messaging according to the present invention. In response to receiving the start signal, the IVM server 202 transmits a ring signal to the VoIP telephone 206, thereby indicating to the user the IVM system 200 is ready to record an instant voice message. The IVM server 202 also signals the IVM client 208 to generate audio file 210 to record the instant voice message. As the user picks up the handset of the VoIP telephone 206 (off-hook), a connection is established via the network 204 between the local IVM server 202 and the VoIP

telephone 206. Thereafter, the IVM server 202 forwards the user's speech transmitted from VoIP telephone 206 to the IVM client 208 for storage into digitized audio file 210 on the IVM client 208. The audio file 210 is finalized by returning the handset its cradle (on-hook) or by pressing a designated button on the keypad VoIP telephone 206, which  
5 transmits the stop signal to the IVM server 202 and further from the IVM server 202 to the IVM client 208. Returning the handset to its cradle preferably generates a send signal to the IVM server 202, which transmits the signal to the IVM client 208. The IVM client thereafter transmits the recorded audio file 210 (instant voice message) to IVM server 202 for delivery to the selected one or more IVM recipients. Alternatively, the user may  
10 press a key on the keyboard 218 to initiate the send signal. In response to the send signal, the IVM client 206 sends the recorded audio to the local IVM server 202 via the network 204. The IVM server 202 thereafter delivers the instant voice message to the selected one or more recipients via the IP network 204. The one or more recipients are enabled to display an indication that the instant voice message has been received and audibly play  
15 the instant voice message. If a recipient IVM client is not currently connected to the local IVM server 202, the IVM server 202 temporarily saves the instant voice message and delivers it to the IVM client when the IVM client connects to the local IVM server 202.

20 In operation of the legacy telephone 110 according to Fig. 2, the legacy telephone 110 is connected to the local IVM server 202 via media gateway 114 and legacy switch 112. The legacy telephone 110 cooperates with the IVM client 208 to record and send an instant voice message. More specifically, the legacy telephone 110 is

used as a recording/listening device for recording or listing to instant voice messages, while the IVM client 208 is used for displaying and selecting instant voice message recipients as described hereinabove. Thus, in operation the IVM client 208 displays a list of IVM recipients on the display device 216 provided and stored by the local IVM server 202. The user operates the IVM client 208 by using the input device 218 on the IVM client 208 to indicate a selection of one or more IVM recipients from the list. The user selection is transmitted to the IVM server 202. The user selection generates a start signal to the IVM server 202 indicating that the user is ready to begin instant voice messaging according to the present invention. In response to receiving the start signal, the IVM server 202 transmits an emulation code to the legacy telephone 110 to ring, thereby indicating to the user the IVM system 200 is ready to record an instant voice message. As the user picks up the handset of the legacy telephone 110 (off-hook), a connection is established via the network 204 between the legacy telephone 110 and the IVM server 202. Thereafter, the IVM server forwards the user's speech transmitted from the legacy telephone 110 to the IVM client 208 for storage into the digitized audio file 210 (i.e., instant voice message). The audio file on the IVM client 208 is finalized by returning the handset of the legacy telephone 110 to its cradle (on-hook) or by pressing a designated button on the keypad of the legacy telephone 110, which transmits a stop signal to the IVM server 202 and further to the IVM client 208. Returning the handset to its cradle also generates a send signal to the IVM server to transmit the recorded audio file (instant voice message) to the selected one or more IVM recipients. The IVM server 202 thereafter delivers the instant voice message to the selected one or more recipients via the IP network 204. The one or more recipients are enabled to display an indication that the

received instant voice message has been received and audibly play the instant voice message. If a recipient IVM client is not currently connected to the local IVM server 202, the IVM server 202 temporarily saves the instant voice message and delivers it to the IVM client when the IVM client connects to the local IVM server 202.

5

Regarding the operational embodiments described with reference to Fig. 2 for recoding and transmitting an instant voice message according to the present invention, the digitized audio file is preferably compressed by applying a compression algorithm before sending the audio file to the one or more selected recipients. The audio file is preferably compressed within the IVM clients 206, 208 before forwarding the audio file to the IVM server 202 for subsequent delivery to the one or more selected recipients. Alternatively, the compression may be implemented within the IVM server 202 before the audio file is transmitted to the one or more selected recipients. A Lempel-Ziv compression algorithm is preferably used to compress the audio file according to the present invention. It is noted that many suitable compression algorithms are known to persons of skill in the art, including Huffman encoding, audio compression standards promulgated by the Moving Pictures Experts Group (“MPEG”), G.722 wideband speech encoding standard, fractal compression, and wavelet compression. Any of the foregoing compression algorithms may be implemented within the scope of the present invention.

20

Further regarding the operational embodiments described with reference to Fig. 2 for recoding and transmitting an instant voice message according to the present invention, the digitized audio file (which may or may not be compressed as described

above) is further preferably encrypted via an encryption algorithm before transmitting the audio file to the one or more selected recipients. The encryption is preferably implemented within the IVM clients 206, 208 before forwarding the audio file to the IVM server 202 for subsequent delivery to the one or more selected recipients.

- 5 Alternatively, the encryption may be implemented within the IVM server 202 before the audio file is transmitted to the one or more selected recipients. An AES (Rijndael) encryption algorithm is preferably used to encrypt the audio file according to the present invention. It is noted that many suitable encryption algorithms are known to persons skilled in the art, including DES, Triple DES, Blowfish, Twofish, Serpent, and the like.
- 10 Any of the foregoing encryption algorithms may be implemented within the scope of the present invention.

Lastly with reference to Fig. 2, in addition to the “record mode” of instant voice messaging, the instant voice messaging system 200 also supports an “intercom mode” of voice messaging. The “intercom mode” represents real-time instant voice messaging. In the “intercom mode,” instead of creating an audio file 210, one or more buffers (not shown) of a predetermined size are generated in the IVM client 206, 208 or local IVM server 202. The one or more buffers are used to automatically write successive portions of the instant voice message. Once a first buffer is full, i.e., input audio of the predetermined size is written to the buffer, the content of the first buffer is automatically transmitted to the IVM server 202 for transmission to the one or more IVM recipients. A second buffer is meanwhile written with the next successive portion of input audio. Once, the second buffer is full, i.e., input audio of the predetermined size is



written to the buffer, the content of the second buffer is transmitted to the IVM server 202 for transmission to the one or more IVM recipients. If the entire instant voice message or a successive portion thereof (such as a last successive portion in the instant voice message) written to either buffer is smaller the predetermined size, then the buffered content of less than the predetermined size is automatically transmitted to the IVM server 202. The foregoing buffering using the first and second buffers is repeated until the entire instant voice message has been transmitted to the IVM server 202 for transmission to the one or more IVM recipients. It is noted that the invention is not limited to a particular number of buffers. The foregoing buffering and transmission allows a “real-time” instant voice message to be transmitted to the one or more IVM recipients. The “intercom mode” may be designated as a default mode when an IVM recipient is on-line, while the “record mode” may be designated as a default if the IVM recipient is unavailable, i.e., not on-line. The user may easily change the “intercom mode” to the “record mode” on the respective IVM client 206, 208. Finally, the audio contents of the buffers may be signal processed (for clarity), encrypted and compressed before transmission, as will be described in more detail hereinbelow with reference to Fig. 3.

Fig 3. an exemplary illustration of the architecture in the IVM client 208 for enabling instant voice messaging according to the present invention. More specifically, the IVM client 208 comprises a client platform 302 for generating an instant voice message and a messaging system 320 for messaging between the IVM client 208 and the IVM server 202 for enabling instant voice messaging according to the present

invention. The IVM client 208 is a general-purpose programmable computer equipped with a network interface (not shown), such as an Ethernet card, to provide connectivity to the network 204. It is noted that any suitable networking protocol, not only Ethernet, could be used to connect the IVM client to a network 204 and thus is considered within  
5 the scope of the present invention. The client platform 302 comprises a client engine 304, which controls other components, namely the document handler 306, file manager 308, audio file creation 312, signal processing 314, encryption/decryption 316, and compression/decompression 318. The messaging system 320 and the client engine 304 communicate via standard inter-process communication. The messaging system 320 and  
10 client engine 304 also communicate with the IVM server 202 over the network interface via the network 204. The document handler 306 oversees the retrieving, sending, receiving and storing of one or more documents (or files) attached to instant voice messages from/to the one or more selected IVM recipients that may be communicating with the IVM client 208. More specifically, when an instant voice message is to be  
15 transmitted to the one or more IVM recipients, one or more documents may be attached to the instant voice message to be, stored or displayed by the one or more selected IVM recipients. The file manager accesses a message database 310, in which both the received and recorded instant voice messages are represented as database records, each record comprising a message identifier and the instant voice message. The file manager 308  
20 services requests from the user to record, delete or retrieve messages to/from the message database 310. Audio file creation 312 creates an instant voice message as audio file 210, and is responsible for receiving input speech for the instant voice message from audio input device 212 or via network 204 and storing the input speech into audio file 210.

Signal processing 314 performs noise removal and signal optimization in the audio file 210. Encryption/decryption 316 provides for respectively encrypting/decrypting of outgoing/incoming audio files (i.e., instant voice messages), and compression/decompression 318 respectively compresses/decompresses the  
5 outgoing/incoming audio files.

Further with reference to Fig. 3, the reception of an instant voice message is described as follows. It is assumed that the local IVM server 202 has determined that the IVM client 208 is available to receive an instant voice message by checking the IVM  
10 client's 208 current status, i.e., whether the IVM client 208 is "on-line." The local IVM server 202 maintains the current status of the IVM clients connected to the local IVM server 202, i.e., IVM clients 206, 208. It is further assumed that an IVM client has transmitted an instant voice message to the IVM client 208. The local IVM server 202 receives the instant voice message over the local IP network 204 and forwards the instant  
15 voice message to the IVM client 208. Upon receipt at the IVM client 208, the instant voice message is decrypted at 316, decompressed at 318, and stored in the message database 310 using the file manager 308. Any files attached to the instant voice message are also stored in the message database 310 using the file manager 308. A visual and/or sound effect is initiated to notify a user of the IVM client 208 that a new instant voice  
20 message has been received at the IVM client 208. At this point in time, the instant voice message and any file attachments are available to the user. The user can select the instant voice message from a listing of available instant voice messages displayed on the IVM client 208 and play the newly received instant voice message. The user may also open

any file attachments and move or save the files to a separate location on the client using a drag-and-drop process.

Still further with reference to Fig. 3, the generation and transmission of an  
5 instant voice message is described as follows. The user selects the available one or more  
IVM recipients and initiates the creation of an instant voice message as described above  
with reference to Fig. 2. The client engine 304 detects the start signal and invokes audio  
file creation 312 of the audio file 210. The audio file 210 is initialized and captures the  
audio voice message input by the user. Once the client engine 304 detects a stop signal,  
10 the instant voice message is finalized in the audio file 210 via audio file creation 312.  
The audio file 210 is adjusted for gain, and noise is removed via signal processing 314.  
The audio file 210 is further compressed at 318 and encrypted at 316. The completion of  
these processes causes the client engine 304 to inform the user via display 216 that the  
instant voice message is available to be sent. After the client engine 304 detects the send  
15 signal from the user, the instant voice message (audio file 210) is transferred to the local  
IVM server 202. Before the transmission of the instant voice message (i.e., before the  
send signal), the user has the option to review the instant voice message, re-record the  
instant voice message, delete the instant voice, as well as attach one or more files (i.e.,  
documents). The attachment of one or more files is enabled conventionally via a  
20 methodology such as “drag-and-drop” and the like, which invokes the document handler  
306 to make the appropriate linkages to the one or more files and flags the messaging  
system 320 that the instant voice message also has the attached one or more files.

Fig 4. an exemplary illustration of the local IVM server 202 for enabling instant voice messaging according to the present invention. The IVM server 202 is a general-purpose programmable computer equipped with a network interface, such as an Ethernet card, to provide connectivity to a network 204. It is noted that any suitable networking protocol may be implemented to connect the IVM server 202 to a network 204. The IVM server 202 comprises a server communication platform 402, a messaging system 436 and a database 414, thereby enabling instant voice messaging according to the present invention. The server communication platform 402 comprises a server engine 404, client manager 406, station manager 408, gateway manager 410, database manager 412 that accesses database 414, supplemental servers 416 (including particular server subsystems 418-424), as well as a control layer 426 (including non-proprietary server subsystems 428, 430 and proprietary server subsystems 432, 434). The messaging system 436 and the server engine 304 communicate via standard inter-process communication. The messaging system 436 and the server engine are also able to communicate with the IVM clients 206, 208 over the network interface via the network 204. The database 414 stores users (e.g., IVM clients as well as legacy telephone clients) that are known to the IVM server 202 via the database manager 412. The users are represented in the database as records, each record comprising a user name, a password, and a contact list (a list of other users with whom the user wishes to exchange instant voice messages), and other data relating to the user. The database manager 412 services requests to add, update, delete, or retrieve database records to/from the database 414. The password may be stored in the database 414 as plaintext, in encrypted form, or as a

hash (e.g., MD5 hash). The messaging system 436 communicates to the server engine 404 via message objects.

A message object comprises an action field, an ID field, a source field, a destination field, and an object field. The content of the action field is selected from a list of permitted actions, which among other actions includes: connect, disconnect, 5 subscribe, unsubscribe, and post message. In addition, the actions include: determining if an IVM client is awake (i.e., pinging), disconnecting from the IVM client, processing an IVM client message, and notifying IVM clients if the IVM server 202 goes down. The client messages include sending an instant voice message portions, checkin message, 10 send message, set status message, send a phone command message, and send control parameters message. The content of the ID field represents a unique identifier for the message object. The content of the source field is a globally unique identifier (“GUID”) that uniquely identifies the sender of the message. This unique identifier can be generated by any known way, including the Globally Unique ID function call available in 15 the Microsoft Windows and Microsoft .NET environments. In some circumstances, the source field is set to a special value to indicate that the sender of the message object is entitled to special privileges. The senders with special privileges are in fact IVM servers. This allows the IVM servers to broadcast messages to one another, subscribe to special events, and directly send messages to specific IVM servers. These privileges can depend 20 upon whether the IVM servers are local servers or global servers. As an example, there can exist more than one local IVM server, each of these local IVM servers automatically has privileges to communicate to other local IVM server. On a global server system, a directory server can communicate with one or more transport servers. The content of the

destination field is a GUID of an intended IVM recipient of the instant voice message. The content of the object field is a block of data being carried by the message object, which may be, for example, a digitized instant voice message. Depending on the circumstances in which the message object is sent, some of the message object fields may be left blank or ignored. For example, the message object may merely require an action to be performed based upon the GUID supplied. In this case, the action does not necessarily require any data to be sent or received and some of the message object's fields may be left blank or ignored.

Connection objects maintain the logical connections between the IVM server 202 and IVM clients 206, 208 connected to the IVM server 202. More specifically, a connection object comprises data representing the state of the connection and code (one or more methods) for establishing and maintaining the logical connections between the IVM server 202 and the IVM clients 206, 208 within the IVM system 200 of Fig. 2. The connection object can contain both data and/or commands, including information that describes the socket, the size of the data to be transferred, and the priority of the transfer (e.g., high, normal, low, unknown). On start up the local IVM server 202 generates and maintains a list for each IVM client 206, 208. The local IVM server 202 then waits to receive connection objects from the IVM clients 206, 208 that are stored in the respective lists, decodes the received connection objects to obtain specific requests, and then services the specific requests from the IVM clients 206, 208.

Further with reference to Fig. 4, the server engine 404 controls all other subsystems in the server communication platform 402, and it is responsible for startup

and shutdown of the IVM server 202 and the IVM system 200. The client manager 406 controls the IVM clients 206, 208, providing contact presence (connection) information and message scheduling and delivery. The station manager 408 controls the individual legacy telephone 110 and coordinates its activity to work synchronously with the IVM

5 client 208 and server 202. The gateway manager 410 enables the IVM server 202 to communicate with the legacy telephones, such as legacy telephone 110. The control layer 426 comprises a plurality of server subsystems 428-434, each of which provides translation services to different proprietary and non-proprietary gateways 114, such as TPNCIP, MGCP, and MEGACO gateways. The proprietary server subsystems 428, 430

10 and non-proprietary server subsystems 432, 434 are connected to respective gateways 114 via the local IP network 204. The supplemental server subsystems 416 provide a number of required services such as display manager subsystem 418, dynamic host configuration protocol (i.e., "DHCP") subsystem 420, trivial file transfer protocol (i.e., "TFTP") server subsystem 422, and hypertext transfer protocol (i.e., "HTTP"). Each of

15 the supplemental servers 418-424 in the subsystem 416 is used during the initial set-up of the IVM system 200. The boot-up process and allocation of IP addresses to IVM clients 206, 208 are performed through an LCD panel (not shown) associated with the local IVM server 202. The LCD manager 418 supports this boot-up process. The DHCP server 420 is used to allocate IP addresses as required and allows the advanced configuration of

20 network settings in the instant voice messaging system. The TFTP server 422 provides a TCP/IP file transfer capability. Lastly, the HTTP server 424 provides services for a web server.



Figure 5 is an exemplary illustration of a global instant voice messaging (IVM) system 500, according to the present invention. In the global IVM system 500, the local IVM system 200 is depicted as a local IVM system 510, which is connected to a packet-switched network 102 (i.e., Internet). The global IVM system 500 comprises the local IVM system 510, global IVM server system 502, and global IVM clients 506 and 508 that are optionally connected via local IP network 504. The global IVM server system 502 is connected to the IP network (i.e., Internet) 102 for enabling the local IVM clients 206, 208 and legacy telephone 110 in the local IVM system 510 to generate and send instant voice messages to the global IVM clients 506, 508, as well as the local IVM clients 206, 208 to receive instant voice messages from the global IVM clients 506, 508. The implementation of the global instant voice messaging for the IVM client 208 will be described first and will be followed by the implementations for IVM client 206 and legacy telephone 110, with reference to the global IVM system 500 depicted in Fig. 5. Thereafter, instant voice messaging for global clients 506 and 508 will be described according to the present invention. These implementations implement a “record mode” of the instant voice messaging according to the present invention. Thereafter, there will lastly be described an “intercom mode” of the instant voice messaging according to the present invention.

Therefore, in operation of the IVM client 208 according to Fig. 5, the IVM client 208 is connected via the networks 204, 102 to the global IVM server system 502, which enables the global instant voice messaging functionality outside the local IVM system 510 over the network (i.e., Internet) 102. More specifically, the IVM client 208

requests from the global IVM server system 502 a global contact list (not shown) of global one or more IVM recipients with which the IVM client 208 may exchange instant voice messages. For the purposes of illustration, it is assumed that global IVM clients 506, 508 are in the contact list. The global IVM server system 502 stores and maintains this contact list. Thus, the global IVM server system 502 responds by transmitting the contact list to the IVM client 208. The IVM client 208 displays the contact list on its display 216. Alternatively, the global contact list may be replicated to the local IVM server 202 within the local IVM system 510, in which case the local IVM client 208 obtains the global contact list from the local IVM server 202. The user operates the IVM client 208 by using the input device 218 to indicate a selection of one or more IVM recipients from the global contact list. Here, for the purposes of illustration it is again assumed that IVM client 208 selected global IVM clients 506, 508. The user selection is transmitted to the IVM server 202. The user selection also generates a start signal to the IVM client 208 that the user is ready to begin instant voice messaging. In response to the start signal, the IVM client 208 listens to the input audio device 212 and records the user's speech into a digitized audio file 210 (i.e., instant voice message) stored on the IVM client 208. The audio file 210 is finalized via a stop signal, which is generated by the user via the input device 218 or a preset time period without speech input via the input audio device 212. Once the recording is finalized, the IVM client 208 generates a send signal indicating that the digitized audio file 210 (instant voice message) is ready to be sent to the selected one or more IVM recipients. The user generates the send signal when the user operates the IVM client 208 via the input device 218. The IVM client 208 transmits the digitized audio file 210 and the send signal to the global IVM server system

502 via the local IP network 204 and the global IP network 102. After receiving the audio file 210, the global IVM server system 502 delivers the transmitted instant voice message to the selected one or more recipients (e.g., IVM clients 506 and 508) via the IP network 102. The one or more recipients are enabled to display an indication that the instant voice message has been received and audibly play the instant voice message to an associated user. It is noted that if a recipient IVM client 506, 508 is not currently connected to the global IVM server system 502, the global IVM server system 502 temporarily saves the instant voice message and delivers it to the global IVM client 506, 508 when the IVM client connects to the global IVM server system 502.

10

There are several embodiments for the operation of the IVM client (VoIP telephone) 206 within the global IVM system 500 of Fig. 5, according to the present invention. In the first embodiment, the VoIP telephone 206 is a standalone IVM client 206 enabled for instant voice messaging according to the present invention. In the second embodiment, the VoIP telephone 206 operates synchronously with the IVM client 208 to enable instant voice messaging according to the present invention. Thus, in operation according to the first embodiment in Fig. 5, the IVM client 206 is connected via the networks 204, 102 to the global IVM server system 502, which enables instant voice messaging functionality over the IP network (Internet) 102. As mentioned previously, the IVM client 206 is also connected to the local IVM server 202. The IVM client 208 requests from the global IVM server system 502 a global contact list (not shown) of the global one or more IVM recipients with which the IVM client 206 may exchange instant voice messages. For the purposes of illustration, it is assumed that the

global IVM clients 506, 508 are in the contact list. The global IVM server system 502 stores and maintains this contact list. Thus, the global IVM server system 502 responds by transmitting the global contact list to the IVM client 206. Alternatively, the global contact list may be replicated to the local IVM server 202 within the local IVM system

5 510, in which case the local IVM client 206 obtains the global contact list from the local IVM server 202. The IVM client 206 displays a list of the one or more IVM recipients on its associated display. The user operates the IVM client 206 by using a keypad on the VoIP telephone 206 to indicate a selection of one or more IVM recipients from the list. The VoIP telephone 206 transmits the selection to the global IVM server system 502.

10 The user selection also generates a start signal to the IVM client 206 indicating the user is ready to begin instant voice messaging according to the present invention. The user speaks into the handset of the IVM client 206 or a speakerphone on the IVM client 206. Although not shown in Fig. 5, the VoIP telephone 206 may provide a dedicated storage device, which in response to the start signal records an audio file, similar to the audio file

15 210 in the IVM client 208. The audio file is finalized via a stop signal. The stop signal is generated when the user presses a button on the keypad, a preset time period without speech input to the VoIP telephone 206, or when the user returns the handset to the cradle of the VoIP telephone 206. Once the recording of the user's speech is complete, a send signal is generated indicating that the instant voice message is ready to be sent to the

20 selected recipients. The user generates the send signal when the user presses a button on the keypad or returns the handset of the VoIP telephone 206 to its cradle. In response to the send signal, the IVM client 206 sends the recorded audio file (instant voice message) to the global IVM server system 502 via the networks 204, 102 for delivery to the

selected one or more IVM recipients. The global IVM server 502 thereafter delivers the instant voice message to the selected one or more recipients (e.g., IVM clients 506 and 508) via the IP network 102. As before, the one or more recipients are enabled to display an indication that the instant voice message has been received and audibly play the instant voice message. If a recipient IVM client is not currently connected to the global IVM server system 502, the global IVM server system 502 temporarily saves the instant voice message and delivers it to the IVM client when the IVM client connects to the global IVM server system 502.

10                    In the second embodiment of the IVM client 206 according to Fig. 5, the VoIP telephone 206 operates synchronously with the IVM client 208 to enable global instant voice messaging according to the present invention. Thus, in operation according to the second embodiment in Fig. 5, the VoIP telephone 206 is connected over the network 204 to the IVM client 208 and the IVM client 208 is connected via the networks 15 204, 102 to the global IVM server system 502, which enables instant voice messaging functionality over the IP network (Internet) 102. The VoIP telephone 206 cooperates with the IVM client 208 to record and send a global instant voice message outside the local IVM system 510. The IVM client 208 displays a global contact list of IVM recipients (not shown) on the display device 216 provided by the global IVM server 20 system 502, as described hereinabove. Alternatively, the global contact list may be replicated to the local IVM server 202 within the local IVM system 510, in which case the IVM client 208 obtains the global contact list from the local IVM server 202. The user operates the IVM client 208 by using the input device 218 to indicate a selection of

one or more IVM recipients from the contact list. The user selection generates a start signal in the IVM client 208 indicating that the user is ready to begin instant voice messaging according to the present invention. In response to the start signal, the IVM client 208 generates audio file 210 to record an instant voice message and transmits a ring  
5 signal to the VoIP telephone 206. As the user picks up the handset of the VoIP telephone 206 (off-hook), a connection is established via the network 204 between the local IVM client 208 and the VoIP telephone 206. Thereafter, the VoIP telephone 206 forwards the user's speech to the IVM client 208 for storage into the audio file 210. The audio file 210 is finalized by returning the handset its cradle (on-hook) or by pressing a designated  
10 button on the keypad VoIP telephone 206, which transmits the stop signal to the IVM client 208. Returning the handset to its cradle preferably generates a send signal to the IVM client 208. The IVM client thereafter transmits the recorded audio file 210 (instant voice message) to the global IVM server system 502 via networks 204, 102 for delivery to the selected one or more IVM recipients. Alternatively, the user may press a key on  
15 the keyboard 218 to initiate the send signal. In response to the send signal, the IVM client 208 sends the recorded audio file to the global IVM server system 502 for delivery to the selected one or more IVM recipients. The global IVM server system 502 thereafter delivers the instant voice message to the selected one or more recipients (e.g., IVM clients 506 and 508) via the IP network 102. As before, the one or more IVM recipients  
20 are enabled to display an indication that the instant voice message has been received and audibly play the instant voice message. If a recipient IVM client is not currently connected to the global IVM server system 502, the global IVM server system 502

---

temporarily saves the instant voice message and delivers it to the IVM client when the IVM client connects to the global IVM server system 502.

In operation of the legacy telephone 110 according to Fig. 5, the legacy  
5 telephone 110 is connected to the local IVM client 208 via media gateway 114, legacy  
switch 112 and network 204. The legacy telephone 110 cooperates with the IVM client  
208 to record and send an instant voice message outside the local IVM system 510. More  
specifically, the legacy telephone 110 is used as a recording/listening device for  
recording or listing to instant voice messages, while the IVM client 208 is used for  
10 displaying and selecting instant voice message recipients as described hereinabove.  
Thus, in operation the IVM client 208 requests from the global IVM server system 502 a  
global contact list of global one or more IVM recipients with which the IVM client 208  
may exchange instant voice messages. Alternatively, the global contact list may be  
replicated to the local IVM server 202 within the local IVM system 510, in which case  
15 the IVM client 208 obtains the global contact list from the local IVM server 202. The  
IVM client 208 displays the global list of IVM recipients, as described hereinabove. The  
user operates the IVM client 208 to indicate a selection of one or more IVM recipients  
from the global contact list. The IVM client 208 transmits the user selection to the global  
IVM server system 502. The user selection generates a start signal in the IVM client 208  
20 indicating that the user is ready to begin instant voice messaging according to the present  
invention. In response to the start signal, the IVM client 208 transmits an emulation code  
to the legacy telephone 110 to ring, thereby indicating to the user the global IVM system  
500 is ready to record an instant voice message. As the user picks up the handset of the

legacy telephone 110 (off-hook), a connection is established via the network 204 between the legacy telephone 110 and the IVM client 208. Thereafter, the user's speech is transmitted from the legacy telephone 110 to the IVM client 208 for storage into the digitized audio file 210 (i.e., instant voice message). The audio file 210 is finalized by  
5 returning the handset of the legacy telephone 110 to its cradle (on-hook) or by pressing a designated button on the keypad of the legacy telephone 110, which transmits a stop signal to the IVM client 208. Returning the handset to its cradle may also generate a send signal to the IVM client 208 to transmit the recorded audio file (instant voice message) to the global IVM server system 502 for delivery to the selected one or more IVM  
10 recipients. Alternatively, the send signal is preferably generated from the IVM client 208 as described hereinabove. The global IVM server system 502 thereafter delivers the instant voice message to the selected one or more IVM recipients via the IP network (Internet) 102. The one or more recipients are enabled to display an indication that the instant voice message has been received and audibly play the instant voice message. If a  
15 recipient IVM client is not currently connected to the global IVM server system 502, the global IVM server system 502 temporarily saves the instant voice message and delivers it to the IVM client when the IVM client connects to the global IVM server 502.

Further with reference to Fig. 5, the instant voice messaging for global  
20 clients 506 and 508 will be described according to the present invention. In a first embodiment, each of the global IVM clients 506, 508 is enabled to independently send an instant voice message. The IVM clients 506, 508 have like peripheral devices and functionality described respectively with reference to local IVM clients 206, 208 in Fig.



2. In second embodiment described below, the VoIP telephone 506 operates in conjunction with the IVM client 508 to send an instant voice message. Therefore, in operation of the global IVM clients 506 and 508 according the first embodiment in Fig. 5, the IVM clients 506, 508 are connected via the networks 204, 102 to the global IVM server system 502, which enables the global instant voice messaging functionality outside the local IVM system 510 over the network (i.e., Internet) 102. Each of the global IVM clients 506, 508 is enabled to request from the global IVM server system 502 a contact list (not shown) of global one or more IVM recipients with which each of the global IVM client 506, 508 may exchange instant voice messages. For the purposes of this illustration, it is assumed that the IVM clients 206 and 208 within the local IVM system 510 are in the contact list for each global IVM client 506, 508. The global IVM server system 502 stores and maintains the foregoing contact list for each global IVM client 506, 508. Upon request, the global IVM server system 502 responds by transmitting the contact list to each of the IVM clients 506, 508. Each of the IVM clients 506, 508 displays the contact list on its display. The user operates the IVM client 506, 508 to indicate a selection of one or more IVM recipients from the contact list. Each of the global IVM clients 506, 508 transmits the user selection to the global IVM server system 502. The user selection also generates a start signal to the IVM clients 506, 508 that the user is ready to begin instant voice messaging. In response to the start signal, the IVM clients 506, 508 record the user's speech into a digitized audio file (i.e., instant voice message) stored on the global IVM clients 506, 508. The audio file is finalized via a stop signal, which is generated by the user by operating the global IVM client 506, 508. Once the recording is finalized, the IVM client 506, 508 generates a send signal indicating that

the digitized audio file (instant voice message) is ready to be sent to the selected one or more recipients. The user generates the send signal when the user operates the global IVM client 506, 508. The IVM client 208 transmits the digitized audio file and the send signal to the global IVM server system 502. After receiving the audio file, the global IVM server system 502 delivers the transmitted instant voice message to the local IVM server 202 in the local IVM system 510 for delivery to the selected one or more recipients (e.g., local IVM clients 206 and 208) via the local IP network 204. The one or more recipients IVM 206, 208 are enabled to display an indication that the instant voice message has been received and audibly play the instant voice message to an associated user. It is noted that if a recipient IVM client 206, 208 is not currently connected to the local IVM server 202, the IVM server 202 temporarily saves the instant voice message and delivers it to the local IVM client 206, 208 when the IVM client connects to the local IVM server 202.

In the second embodiment of the IVM client 506 according to Fig. 5, the VoIP telephone 506 operates synchronously with the IVM client 508 to enable global instant voice messaging according to the present invention. In this embodiment, the VoIP telephone 506 and the IVM client 508 may be located in a user's residence and be connected to a local IP network 504. This local IP network 504 can be a WiFi network or a local area network (i.e., LAN), which is also within the user's residence. The local IP network 504 may be connected to the IP network (Internet) 102 via a digital subscriber line (i.e., DSL) connection, cable connection, dialup connection, or the like. As noted above, the IVM clients 506, 508 have like peripheral devices and functionality described

respectively with reference to local IVM clients 206, 208 in Fig. 2. Thus, in operation according to this embodiment in Fig. 5, the global IVM client 508 requests from the global IVM server system 502 a contact list of global one or more IVM recipients with which each of the global IVM client 508 may exchange instant voice messages. For the purposes of this illustration, it is assumed that the IVM clients 206 and 208 within the local IVM system 510 are in the contact list for the global IVM client 508. The global IVM server system 502 stores and maintains the foregoing contact list for the global IVM client 508. The IVM client 508 displays a contact list of IVM recipients on the associated display device provided by the global IVM server system 502, as described hereinabove. The user operates the IVM client 508 by using the associated input device to indicate a selection of one or more IVM recipients from the contact list. The user selection generates a start signal in the IVM client 508 indicating that the user is ready to begin instant voice messaging according to the present invention. In response to the start signal, the IVM client 508 generates audio file to record an instant voice message and transmits a ring signal to the VoIP telephone 506 via local IP network 504. As the user picks up the handset of the VoIP telephone 206 (off-hook), a connection is established via the local network 504 between the local IVM client 508 and the VoIP telephone 506. Thereafter, the VoIP telephone 506 forwards the user's speech to the IVM client 508 for storage into the audio file at the IVM client 508. The audio file is finalized by returning the handset its cradle (on-hook) or by pressing a designated button on the keypad associated with the VoIP telephone 506, which transmits the stop signal to the IVM client 508. Returning the handset to its cradle preferably generates a send signal to the IVM client 508. The IVM client thereafter transmits the recorded audio file (instant voice

message) to the global IVM server system 502 for delivery to the selected one or more IVM recipients. Alternatively, the user may press a key on the input device associated with the IVM client 508 to initiate the send signal. In response to the send signal, the IVM client 508 sends the recorded audio file to the global IVM server system 502 for  
5 delivery to the selected one or more IVM recipients. The global IVM server system 502 thereafter transmits the instant voice message to the local IVM server 202 for delivery selected one or more recipients (e.g., local IVM clients 206 and 208) via the local IP network 204. As before, the one or more recipients are enabled to display an indication that the instant voice message has been received and audibly play the instant voice  
10 message. If a recipient IVM client is not currently connected to the local IVM server 202, the local IVM server 202 temporarily saves the instant voice message and delivers it to the IVM client when the IVM client connects to the local IVM server 202.

Lastly with reference to Fig. 5, in addition to the “record mode” of instant  
15 voice messaging as described above, the instant voice messaging system 500 also supports an “intercom mode” of the instant voice messaging. The “intercom mode” represents real-time instant voice messaging. In the “intercom mode,” instead of creating an audio file as described hereinabove, one or more buffers (not shown) of a predetermined size are generated. The buffers may be generated in any one of the IVM  
20 clients 206, 208, 506 and 508, depending on how the global IVM system 500 is defined. The one or more buffers are used to automatically write successive portions of the instant voice message. Once a first buffer is full, i.e., input audio of the predetermined size is written to the buffer, the content of the first buffer is automatically transmitted. If the

transmission is generated at a local IVM client 206, 208 and destined for one or more local IVM recipients, the content of the first buffer is transmitted to the local IVM server 202 for delivery to the local one or more recipients. If the transmission is generated at a local IVM client 206, 208 and destined for one or more global IVM recipients 506, 508, 5 the content of the first buffer is transmitted to the global IVM server system 502 for delivery to the one or more global recipients. In addition, if the transmission is generated at a global IVM client 506, 508 and destined for the other global IVM clients, the content of the first buffer is transmitted to the global IVM server system 502, such as for example clients 506, 508. Lastly, if the transmission is generated at a global IVM client 506, 508 10 and destined for the local IVM clients 206, 208, the content of the first buffer is transmitted to the global IVM server system 502 and further transmitted by the global IVM server 502 to the local IVM server 202 for delivery to clients 206, 208 within the local IVM system 510. A second buffer is meanwhile written with the next successive portion of input audio. Once, the second buffer is full, i.e., input audio of the 15 predetermined size is written to the buffer, the content of the second buffer is transmitted in similar fashion to the first buffer. If the entire instant voice message or a successive portion thereof (such as a last successive portion in the instant voice message) written to either buffer is smaller the predetermined size, then the buffered content of less than the predetermined size is automatically transmitted to the IVM server 202. The foregoing 20 buffering using the first and second buffers is repeated until the entire instant voice message has been transmitted as described above. It is noted that the invention is not limited to a particular number of buffers. The foregoing buffering and transmission allows a “real-time” instant voice message to be transmitted to the one or more local, as

well as global, IVM recipients. The “intercom mode” may be designated as a default mode when an IVM recipient is on-line, while the “record mode” may be designated as a default if the IVM recipient is unavailable, i.e., not on-line. The user may easily change the “intercom mode” to the “record mode” on the respective IVM client 206, 208, 506, 508. Finally, the audio contents of the buffers may be signal processed (for clarity), encrypted and compressed before transmission, as was described previously.

Fig. 6 is an exemplary detailed illustration 600 of the global IVM server system 502 depicted in Fig. 5, according to the present invention. More specifically, the local IVM system 510 described in Fig. 5 is connected via the IP network (Internet) 102 to the global IVM server system 502. The global IVM server system 502 comprises an IVM transport server mesh 602 and an IVM directory server 608. The IVM transport server mesh 602 comprises a plurality of interconnected IVM transport servers 604, 606. Although the mesh 602 is depicted as having two IVM transport servers 604, 606, it is to be understood that as many IVM transport servers as are desired or required for redundancy and load balancing may be interconnected in a mesh. The IVM transport servers 604, 606 may be centrally located and configured to communicate (i.e., forward and receive messages) with local IVM clients 206, 208, local IVM server 202 and global IVM client 506, 508 (not depicted in Fig. 6). The plurality of IVM transport servers 604, 606 in the IVM transport server mesh 602 permits load balancing and redundancy in the global IVM system 500. The directory server 608 maintains a transport server list of all the IVM transport servers 604, 606 currently connecting to the mesh 602. Each of the IVM transport servers 604, 606 first connects to the directory server 608. The directory

server 608 informs each of the connecting IVM transport servers 604, 606 of all the other IVM transport servers currently in the mesh 602 based on an active list (not shown) of transport servers 604, 606 in the mesh 602. The connecting IVM transport server then connects to each of the IVM transport servers in the transport server list, resulting in an interconnected mesh 602 of IVM transport servers 604, 606. The IVM transport servers 604, 606 and the IVM directory server 608 communicate via messages.

Further with reference to Fig. 6, the IVM transport servers 604, 606 connected in the mesh 602 share a database (not shown) of IVM clients, so that each IVM transport server 604, 606 refers to the same client database. It is preferable that each IVM transport server 604, 606 maintains its own copy of the client database, which is mirrored and replicated conventionally amongst the IVM transport servers 604, 606 in the mesh 602. The client database may further be replicated to the local IVM server 202. Alternatively, the client database is stored on a separate file server (not shown) in data communication with the IVM transport servers 604, 606 over a network (not shown).

Fig. 7 is an exemplary detailed illustration of a transport server 604, 606 depicted in Fig. 6, according to the present invention. The IVM transport server 604, 606 is a general-purpose programmable computer comprising a network interface (not shown) connected to IP network (Internet) 102, a communication platform 702, a message database 712, and a messaging system 714. The communication platform 702 comprises a server engine 704, which controls a user manager 706, a local server manager 708, and a storage manager 710. The messaging system 714 and the server engine 704

communicate via standard inter-process communication. The storage manager 710 handles retrieving, sending, and storing of messages, including instant voice messages and attachments thereto, to/from the message database 712. The user manager 706 is responsible for creating/maintaining IVM clients 206, 208, 506, 508, identifying them  
5 and relaying their status to the server engine 704. When an IVM client communicates an instant voice message within the global IVM system 500, the user manager 706 notifies the server engine 704 whether the one or more recipients are unavailable, and thereby the instant voice message is saved in the message database 712. When the one or more IVM recipients become available, the user manager 706 notifies the server engine 704, which  
10 instructs the storage manager 710 to retrieve any undelivered instant voice messages for the one or more recipients and delivers the instant voice messages to the designated one or more IVM recipients. The local server manager 708 is responsible for creating/maintaining and providing the status of available local IVM servers, such as IVM server 202 in Fig. 2. The availability status of the local IVM servers is checked  
15 periodically and updated.

Fig. 8 is an exemplary detailed illustration of a directory server 608 depicted in Fig. 6, according to the present invention. The directory server 608 is a general-purpose programmable computer equipped with a network interface (not shown)  
20 connected to IP network (Internet) 102, a messaging system 812, and a communication platform 802. The communication platform 802 comprises a server engine 804, which controls a local server manager 806, a user manager 808, and a transport manager 810. The messaging system 812 and the server engine 804 communicate via standard inter-



process communication. The transport manager 810 maintains the status of the IVM transport servers 604, 606 in the IVM transport server mesh 602 within the global IVM system 500 and using a load-balancing mechanism distributes instant voice messages to available transport server 604, 606 for routing to the one or more IVM recipients. The user manager 808 is responsible for creating/maintaining IVM clients 206, 208, 506, 508, identifying and relaying their status via the server engine 804 to the IVM transport server 604, 606 to be used. The local server manager 806 is responsible for creating/maintaining and providing the status of available local IVM servers, such as IVM server 202 in Fig. 2. The availability status of the local IVM servers is checked periodically and updated.

Fig. 9 illustrates an exemplary a global instant voice messaging (IVM) system 900, which comprises a plurality of local IVM systems and a plurality of global IVM clients, according to the present invention. In the global IVM system 900, there are depicted a plurality of local IVM systems 902, 910 connected to the global IP network 102. The internal representation and functionality of each local IVM system 902, 904 is identical to the local IVM system 510 described with reference to Fig. 5. In global IVM system 900 of Fig. 9, there are also depicted a plurality of global IVM clients 918-928 and a global IVM server system 502 connected to the global IP network (i.e., Internet) 102. The internal representations of the global IVM client 918-928 and the global IVM server system 502 are identical to the respective IVM client 508 (and/or IVM client or 506) and the global IVM server system 502 described with reference to Fig. 5. In the local IVM system 902, each local IVM client 206, 208 is enabled to request local IVM

recipients from the local IVM server 202 and global IVM recipients from either the global IVM server system 502 or the local IVM server 202. For example, the local IVM client 1A 208 displays a list 904 to a user, comprising both local and global IVM recipients. More specifically, the list 904 enables IVM client 1A to send instant voice messages according to the present invention to local IVM clients 1B 208 and 1C 206, global IVM client C 922 and global IVM client 2A 208 in the local IVM system 910. Similar lists 906-916 are displayed to the users of the respective IVM clients 1B-1C in local IVM system 902, and 2A-2C in local IVM system 910. In addition, the global clients A-F 918-928 are enabled to request IVM recipients from the global IVM server system 502 and display the respective lists of IVM recipients 930-940 on the respective IVM clients 918-928.

While the invention has been particularly shown and described with regard to preferred embodiments thereof, it will be understood by those skilled in the art that the foregoing and other changes in form and details may be made therein without departing from the spirit and scope of the invention.

**CLAIMS:**

Having thus described our invention, what we claim as new, and desire to secure by Letters Patent is:

1. An instant voice messaging system for delivering instant messages over a packet-switched network, the system comprising:

a client connected to the network, the client selecting one or more recipients, generating an instant voice message therefor, and transmitting the selected recipients and the instant voice message therefor over the network; and

a server connected to the network, the server receiving the selected recipients and the instant voice message therefor, and delivering the instant voice message to the selected recipients over the network, the selected recipients enabled to audibly play the instant voice message.

2. The instant voice messaging system according to Claim 1, wherein the packet-switched network is a local network.

3. The instant voice messaging system according to Claim 1, wherein the packet-switched network is the Internet.

4. The instant voice messaging system according to Claim 1, wherein the client requests a list of recipients associated with the client from the server and the server transmits the list of recipients to the client for selection of the one or more recipients.

5. The instant voice messaging system according to Claim 1, wherein the server delivers the instant voice message to the selected recipients that are available.

6. The instant voice messaging system according to Claim 1, wherein the server temporarily stores the instant voice message if a selected recipient is unavailable and delivers the stored instant voice message to the selected recipient once the selected recipient becomes available.

7. The instant voice messaging system according to Claim 1, wherein the client records the instant voice message in an audio file, transmits the audio file to the server, and the server delivers the audio file to the selected recipients, the selected recipients being enabled to audibly play the audio file.

8. The instant voice messaging system according to Claim 7, wherein the client signal processes, compresses and encrypts the audio file, and the selected recipients being enabled to decrypt and decompress the audio file before audibly playing the audio file.

9. The instant voice messaging system according to Claim 1, wherein the client buffers each of a plurality of successive portions of the instant voice message as the instant message is recorded, and the client transmits each successive buffered portion to the server for delivery to the to the selected recipients, the selected recipients being enabled to audibly playing each successive portion as it is delivered.

10. The instant voice messaging system according to Claim 1, wherein the client is enabled to attach one or more files to the instant voice message and the selected recipients are enabled to store or display the one or more attached files.

11. The instant voice messaging system according to Claim 1, the system further comprising a public switched telephone network (PSTN) telephone connected to the network to provide input audio of the instant voice message to the client.

12. The instant voice messaging system according to Claim 1, the system further comprising a voice-over-internet-protocol (VoIP) telephone connected to the network to provide input audio of the instant voice message to the client.

13. An instant voice messaging system for delivering instant messages over a packet-switched network enabling public switched telephone network (PSTN) support, the system comprising:

a PSTN telephone connected to the network for providing input audio;

a client connected to the network, the client selecting one or more recipients, generating an instant voice message therefor using the input audio provided by the PSTN telephone, and transmitting the selected recipients and the instant voice message therefor over the network;

a server connected to the network, the server receiving the selected recipients and the instant voice message therefor, and delivering the instant voice

message to the selected recipients over the network, the selected recipients being enabled to audibly play the instant voice message.

14. An instant voice messaging system for delivering instant messages over a packet-switched network, the system comprising:

a voice-over-internet-protocol (VoIP) telephone connected to the network for providing input audio;

a client connected to the network, the client selecting one or more recipients, generating an instant voice message therefor using the input audio provided by the VoIP telephone, and transmitting the selected recipients and the instant voice message therefor over the network;

a server connected to the network, the server receiving the selected recipients and the instant voice message therefor, and delivering the instant voice message to the selected recipients over the network, the selected recipients being enabled to audibly play the instant voice message.

15. An instant voice messaging system for delivering instant messages over a plurality of packet-switched networks, the system comprising:

a client connected to a local network, the client selecting one or more external recipients connected to an external network outside the local network, generating an instant voice message therefor, and transmitting the selected recipients and the instant voice message therefor over the local network and the external network; and

a server connected to the external network, the server receiving the selected recipients and the instant voice message therefor, and delivering the instant voice message to the selected recipients over the external network, the selected recipients being enabled to audibly play the instant voice message.

16. The instant voice messaging system according to Claim 15, the client further selects one or more local recipients connected to the local network and transmits the selected local recipients and the instant voice message therefor over the local network, wherein the system further comprises:

a local server connected to the local network, the local server receiving the selected local recipients and the instant message therefor from the client, and delivering the instant voice message to the selected local recipients over the local network, the selected local recipients being enabled to audibly play the instant voice message.

17. The instant voice messaging system according to Claim 15, wherein the local network is a network within an enterprise.

18. The instant voice messaging system according to Claim 15, wherein the external network is the Internet.

19. The instant voice messaging system according to Claim 15, wherein the client requests a list of recipients associated with the client from the server and the

server transmits the list of recipients to the client for selection of the one or more recipients.

20. The instant voice messaging system according to Claim 15, wherein the server delivers the instant voice message to the selected recipients that are available.

21. The instant voice messaging system according to Claim 15, wherein the server temporarily stores the instant voice message if a selected recipient is unavailable and delivers the stored instant voice message to the selected recipient once the selected recipient becomes available.

22. The instant voice messaging system according to Claim 15, wherein the client records the instant voice message in an audio file, transmits the audio file to the server, and the server delivers the audio file to the selected recipients, the selected recipients being enabled to audibly play the audio file.

23. The instant voice messaging system according to Claim 22, wherein the client signal processes, compresses and encrypts the audio file, and the selected recipients are enabled to decrypt and decompress the audio file before audibly playing the audio file.

24. The instant voice messaging system according to Claim 15, wherein the client buffers each of a plurality of successive portions of the instant voice message as



the instant message is recorded, and the client transmits each successive portion to the server for delivery to the selected recipients, the selected recipients being enabled to audibly playing each successive portion as it is delivered.

25. The instant voice messaging system according to Claim 15, wherein the client is enabled to attach one or more files to the instant voice message and the selected recipients are enabled to store or display the one or more attached files.

26. The instant voice messaging system according to Claim 15, the system further comprising a public switched telephone network (PSTN) telephone connected to the local network to provide input audio of the instant voice message to the client.

27. The instant voice messaging system according to Claim 15, the system further comprising a voice-over-internet-protocol (VoIP) telephone connected to the local network to provide input audio of the instant voice message to the client.

28. An instant voice messaging system for delivering instant messages over a plurality of packet-switched networks enabling public switched telephone network (PSTN) support, the system comprising:

a PSTN telephone connected to a local network for providing input audio;

a client connected to the local network, the client selecting one or more external recipients connected to an external network outside the local network, generating an instant voice message therefor using the input audio provided by the PSTN telephone,

and transmitting the selected recipients and the instant voice message therefor over the local network and the external network;

a server connected to the external network, the server receiving the selected recipients and the instant voice message therefor, and delivering the instant voice message to the selected recipients over the external network, the selected recipients being enabled to audibly play the instant voice message.

29. An instant voice messaging system for delivering instant messages over a plurality of packet-switched networks, the system comprising:

a voice-over-internet-protocol (VoIP) telephone connected to a local network for providing input audio;

a client connected to the local network, the client selecting one or more external recipients connected to an external network outside the local network, generating an instant voice message therefor using the input audio provided by the VoIP telephone, and transmitting the selected recipients and the instant voice message therefor over the local network and the external network;

an server connected to the external network, the external server receiving the selected recipients and the instant voice message therefor, and delivering the instant voice message to the selected recipients over the external network, the selected recipients being enabled to audibly play the instant voice message.

30. An instant voice messaging system for delivering instant messages over a plurality of packet-switched networks, the system comprising:

a client connected to an external network, the client selecting one or more recipients connected to a local network, generating an instant voice message therefor, and transmitting the selected recipients and the instant voice message therefor over the external network; and

a external server system connected to the external network, the external server system receiving the selected recipients and the instant voice message, and routing the selected recipients and the instant voice message over the external network and the local network;

a local server connected to the local network, the local server receiving the selected recipients and the instant voice message therefor, and delivering the instant voice message to the selected recipients over the local network, the selected recipients being enabled to audibly play the instant voice message.

31. The instant voice messaging system according to Claim 30, the client further selects one or more external recipients connected to the external and transmits the selected external recipients over the external network to the external server, and the external server receives the selected external recipients and delivers the instant voice message to the selected external recipients over the external network, the selected external recipients being enabled to audibly play the instant voice message.

32. The instant voice messaging system according to Claim 30, wherein the local network is a network within an enterprise.

33. The instant voice messaging system according to Claim 30, wherein the external network is the Internet.

34. The instant voice messaging system according to Claim 30, wherein the client requests a list of recipients associated with the client from the external server system and the external server system transmits the list of recipients to the client for selection of the one or more recipients.

35. The instant voice messaging system according to Claim 30, wherein the local server delivers the instant voice message to the selected recipients that are available.

36. The instant voice messaging system according to Claim 30, wherein the local server temporarily stores the instant voice message if a selected recipient is unavailable and delivers the stored instant voice message to the selected recipient once the selected recipient becomes available.

37. The instant voice messaging system according to Claim 30, wherein the client records the instant voice message in an audio file, transmits the audio file to the external server, the external server system routes the audio file to the local server, and the local server delivers the audio file to the selected recipients, the selected recipients being enabled to audibly play the audio file.

38. The instant voice messaging system according to Claim 37, wherein the client signal processes, compresses and encrypts the audio file, and the selected recipients are enabled to decrypt and decompress the audio file before audibly playing the audio file.

39. The instant voice messaging system according to Claim 30, wherein the client buffers each of a plurality of successive portions of the instant voice message as the instant message is recorded, and the client transmits each successive buffered portion to the external server system, the external server system routes each successive portion to the local server, and the local server delivers each successive portion to the to the selected recipients, the selected recipients being enabled to audibly play each successive portion as it is delivered.

40. The instant voice messaging system according to Claim 30, wherein the client is enabled to attach one or more files to the instant voice message and the selected recipients are enabled to store or display the one or more attached files.

41. The instant voice messaging system according to Claim 30, the system further comprising a voice-over-internet-protocol (VoIP) telephone connected to the client via a local network, the client providing input audio of the instant voice message to the client via the local network.

42. The instant voice messaging system according to Claim 30, wherein the external server system comprises:

a transport server mesh including a plurality of transport servers for routing instant voice messages;

a directory server for maintaining the transport server mesh and facilitating load-balancing of the instant voice messages within the transport server mesh.

43. A method for instant voice messaging over a packet-switched network, the method comprising:

selecting one or more recipients for instant voice messaging at a client;

generating an instant voice message for the selected recipients at the client;

transmitting the selected recipients and the instant voice message therefor over the network from the client to a server;

receiving the selected recipients and the instant voice message therefor at the server;

delivering the instant voice message from the server to the selected recipients over the network; and

audibly playing the instant voice message at the selected recipients.

44. The method for instant voice messaging according to Claim 43, wherein the method further comprises:

requesting from the client a list of recipients associated with the client from the server; and

transmitting from the server the list of recipients to the client for selection of the one or more recipients.

45. The method for instant voice messaging according to Claim 43, wherein the method further comprises:

delivering the instant voice message from the server to the selected recipients that are available.

46. The method for instant voice messaging according to Claim 43, wherein the method further comprises:

temporarily storing at the server the instant voice message if a selected recipient is unavailable; and

delivering from the server the stored instant voice message to the selected recipient once the selected recipient becomes available.

47. The method for instant voice messaging according to Claim 43, wherein the method further comprises:

recording the instant voice message at the client in an audio file;

transmitting the audio file to the server;

delivering the audio file from the server to the selected recipients; and

audibly playing the audio file at the least one of the selected recipients.

48. The method for instant voice messaging according to Claim 47, wherein the method further comprises:

- signal processing, compressing and encrypting the audio file at the client;
- decrypting and decompressing the audio file at the at least one selected recipient; and
- audibly playing the decrypted and decompressed audio file at the least one of the selected recipients.

49. The method for instant voice messaging according to Claim 43, further comprising:

- buffering each of a plurality of successive portions of the instant voice message at the client as the instant message is recorded;
- transmitting from the client each successive buffered portion to the server;
- delivering each successive portion from the server to the selected recipients, the selected recipients audibly playing each successive portion as it is delivered.

50. The method for instant voice messaging according to Claim 43, wherein the method further comprises:

- attaching one or more files to the instant voice message at the client;
- storing or displaying the one or more attached files at the selected recipients.



51. The method for instant voice messaging according to Claim 43, wherein the method further comprises:

providing input audio of the instant voice message to the client from a public switched telephone network (PSTN) telephone connected to the network.

52. The method for instant voice messaging according to Claim 43, wherein the method further comprises:

providing input audio of the instant voice message to the client from a voice-over-internet-protocol (VoIP) telephone connected to the network.

53. A method for instant voice messaging over a packet-switched network enabling public switched telephone network (PSTN) support, the method comprising:

providing input audio via a PSTN telephone connected over the network;

selecting one or more recipients for instant voice messaging at a client;

generating an instant voice message using the input audio from the PSTN telephone for the selected recipients at the client;

transmitting the selected recipients and the instant voice message therefor over the network from the client to a server;

receiving the selected recipients and the instant voice message therefor at the server;

delivering the instant voice message from the server to the selected recipients over the network; and

audibly playing the instant voice message at selected recipients.

54. A method for instant voice messaging over a packet-switched network, the method comprising:

providing input audio via a voice-over-internet-protocol (VoIP) telephone connected over the network;

selecting one or more recipients for instant voice messaging at a client;

generating an instant voice message using the input audio from the VoIP telephone for the selected recipients at the client;

transmitting the selected recipients and the instant voice message therefor over the network from the client to a server;

receiving the selected recipients and the instant voice message therefor at the server;

delivering the instant voice message from the server to the selected recipients over the network; and

audibly playing the instant voice message at the selected recipients.

55. A method for instant voice messaging over a plurality of packet-switched networks, the method comprising:

selecting one or more external recipients for instant voice messaging at a client connected to a local network, the one or more external recipients connected to an external network outside the local network;

generating an instant voice message for the selected external recipients at the client;

transmitting the selected external recipients and the instant voice message therefor over the local network and the external network;

receiving the selected external recipients and the instant voice message therefor at an external server connected to the external network;

delivering the instant voice message to the selected external recipients over the external network; and

audibly playing the instant voice message at the selected external recipients.

56. The method for instant voice messaging according to Claim 55, wherein the method further comprises:

requesting from the external server a list of external recipients associated with the client; and

transmitting the list of external recipients from the external server to the client for selection of the one or more external recipients.

57. The method for instant voice messaging according to Claim 55, wherein the method further comprises:

delivering the instant voice message from the external server to the selected recipients that are available.

58. The method for instant voice messaging according to Claim 55,  
wherein the method further comprises:  
temporarily storing the instant voice message at the external server if a  
selected recipient is unavailable;  
delivering the stored instant voice message to the selected recipient once  
the selected recipient becomes available.

59. The method for instant voice messaging according to Claim 55,  
wherein the method further comprises:  
recording the instant voice message in an audio file at the client;  
transmitting the audio file to the external server;  
delivering the audio file to the selected recipients from the external server;  
and  
audibly playing the audio file at the selected recipients.

60. The method for instant voice messaging according to Claim 59,  
wherein the method further comprises:  
signal processing, compressing and encrypting the audio file at the client;  
and  
decrypting and decompressing the audio file at the selected recipients; and  
audibly playing the decrypted and decompressed audio file at the selected  
recipients.

61. The method for instant voice messaging according to Claim 55,  
wherein the method further comprises:  
buffering each of a plurality of successive portions of the instant voice  
message at the client as the instant message is recorded;  
transmitting from the client each successive portion to the external server;  
delivering each successive portion from the external server to the selected  
external recipients,  
audibly playing each successive portion at the selected external recipients  
as it is delivered.

62. The method for instant voice messaging according to Claim 55,  
wherein the method further comprises:  
attaching one or more files to the instant voice message;  
storing or displaying the one or more attached files at the selected external  
recipients.

63. The method for instant voice messaging according to Claim 55,  
wherein the method further comprises providing input audio of the instant voice message  
to the client from a public switched telephone network (PSTN) telephone over the local  
network.

64. The method for instant voice messaging according to Claim 55, wherein the method further comprises providing input audio of the instant voice message to the client from a voice-over-internet-protocol (VoIP) telephone over the local network.

65. A method for instant voice messaging system over a plurality of packet-switched networks enabling public switched telephone network (PSTN) support, the method comprising:

providing input audio via a PSTN telephone connected to a local network;

selecting one or more external recipients for instant voice messaging at a client, the one or more external recipients connected to an external network outside the local network;

generating an instant voice message for the one or more external recipients using the input audio provided by the PSTN telephone;

transmitting the selected recipients and the instant voice message therefor over the local network and the external network;

receiving the selected recipients and the instant voice message therefor at a server connected to the external network;

delivering the instant voice message to the selected recipients from the server over the external network; and

audibly playing the instant voice message at the selected recipients.

66. A method for instant voice messaging system over a plurality of packet-switched networks, the method comprising:

providing input audio via a voice-over-internet-protocol (VoIP) telephone connected to a local network;

selecting one or more external recipients for instant voice messaging at a client, the one or more external recipients connected to an external network outside the local network;

generating an instant voice message for the one or more external recipients using the input audio provided by the VoIP telephone;

transmitting the selected recipients and the instant voice message therefor over the local network and the external network;

receiving the selected recipients and the instant voice message therefor at a server connected to the external network;

delivering the instant voice message to the selected recipients from the server over the external network; and

audibly playing the instant voice message at the selected recipients.

67. A method for instant voice messaging over a plurality of a plurality of packet-switched networks, the method comprising:

selecting one or more recipients connected to a local network at a client connected to an external network;

generating an instant voice message for the selected recipients at the client;

transmitting the selected recipients and the instant voice message therefor over the external network from the client to an external server system;

receiving the selected recipients and the instant voice message at the external server system;

routing the selected recipients and the instant voice message over the external network and the local network;

receiving the selected recipients and the instant voice message therefor at a local server connected to the local network;

delivering the instant voice message to the selected recipients over the local network;

audibly playing the instant voice message at the selected recipients.

68. The method for instant voice messaging according to Claim 67, wherein the method further comprises:

requesting a list of recipients associated with the client from the external server system; and

transmitting the list of recipients from the external server system to the client for selection of the one or more recipients.

69. The method for instant voice messaging according to Claim 67, wherein the method further comprises:

delivering the instant voice message from the local server to the selected recipients that are available.



70. The method for instant voice messaging according to Claim 67,  
wherein the method further comprises:  
temporarily storing the instant voice message at the local server if a  
selected recipient is unavailable; and  
delivering the stored instant voice message to the selected recipient once  
the selected recipient becomes available.

71. The method for instant voice messaging according to Claim 67,  
wherein the method further comprises:  
recording the instant voice message in an audio file at the client;  
transmitting the audio file from the client to the external server system;  
routing the audio file from the external server system to the local server;  
and  
delivering the audio file from the local server to the selected recipients;  
and  
audibly playing the audio file at the selected recipients.

72. The method for instant voice messaging according to Claim 71,  
wherein the method further comprises:  
signal processing, compressing and encrypting the audio file at the client;  
decrypting and decompressing the audio file at the selected recipients;  
audibly playing the decrypted and decompressed audio file at the selected  
recipients.

73. The method for instant voice messaging according to Claim 67, wherein the method further comprises:

- buffering each of a plurality of successive portions of the instant voice message at the client as the instant message is recorded;
- transmitting from the client each successive portion to the external server system;
- routing each successive portion from the external server system to the local server;
- delivering each successive portion from local server to the selected external recipients; and
- audibly playing each successive portion at the selected recipients as it is delivered.

74. The method for instant voice messaging according to Claim 67, wherein the method further comprises:

- attaching one or more files to the instant voice message at the client;
- storing or displaying the one or more attached files at the selected recipients.

75. The method for instant voice messaging according to Claim 67, wherein the method further comprises:

providing input audio of the instant voice message from a voice-over-internet-protocol (VoIP) telephone to the client via a local network connecting the VoIP telephone to the client.

76. The method for instant voice messaging according to Claim 67, wherein the method further comprises:

maintaining a transport server mesh including a plurality of transport servers for routing instant voice messages; and

load-balancing the instant voice messages within the transport server mesh.

**SYSTEM AND METHOD  
FOR INSTANT VoIP MESSAGING**

**ABSTRACT OF THE DISCLOSURE**

5

There is provided an instant voice messaging system (and method) for delivering instant messages over a packet-switched network, the system comprising: a client connected to the network, the client selecting one or more recipients, generating an instant voice message therefor, and transmitting the selected recipients and the instant voice message therefor over the network; and a server connected to the network, the server receiving the selected recipients and the instant voice message therefor, and delivering the instant voice message to the selected recipients over the network, the selected recipients being enabled to audibly play the instant voice message.

10

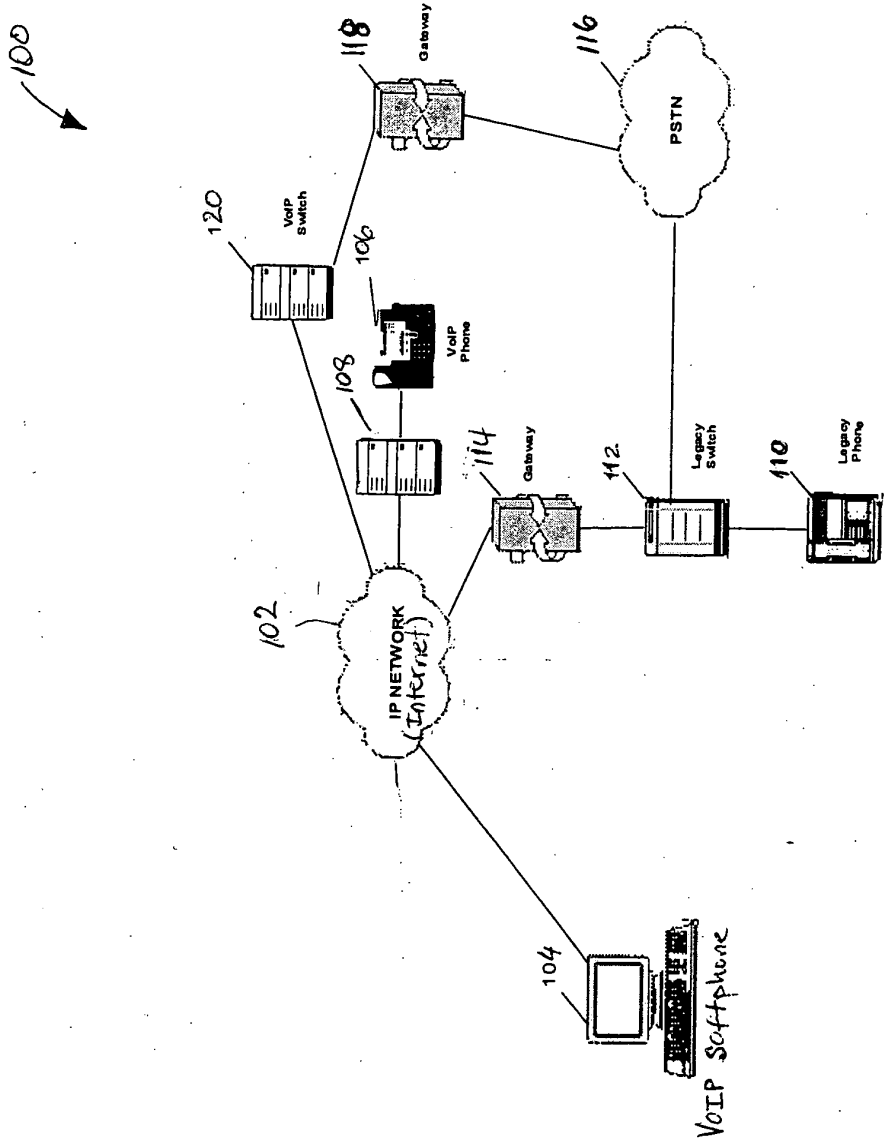

Fig. 1  
(Prior art)

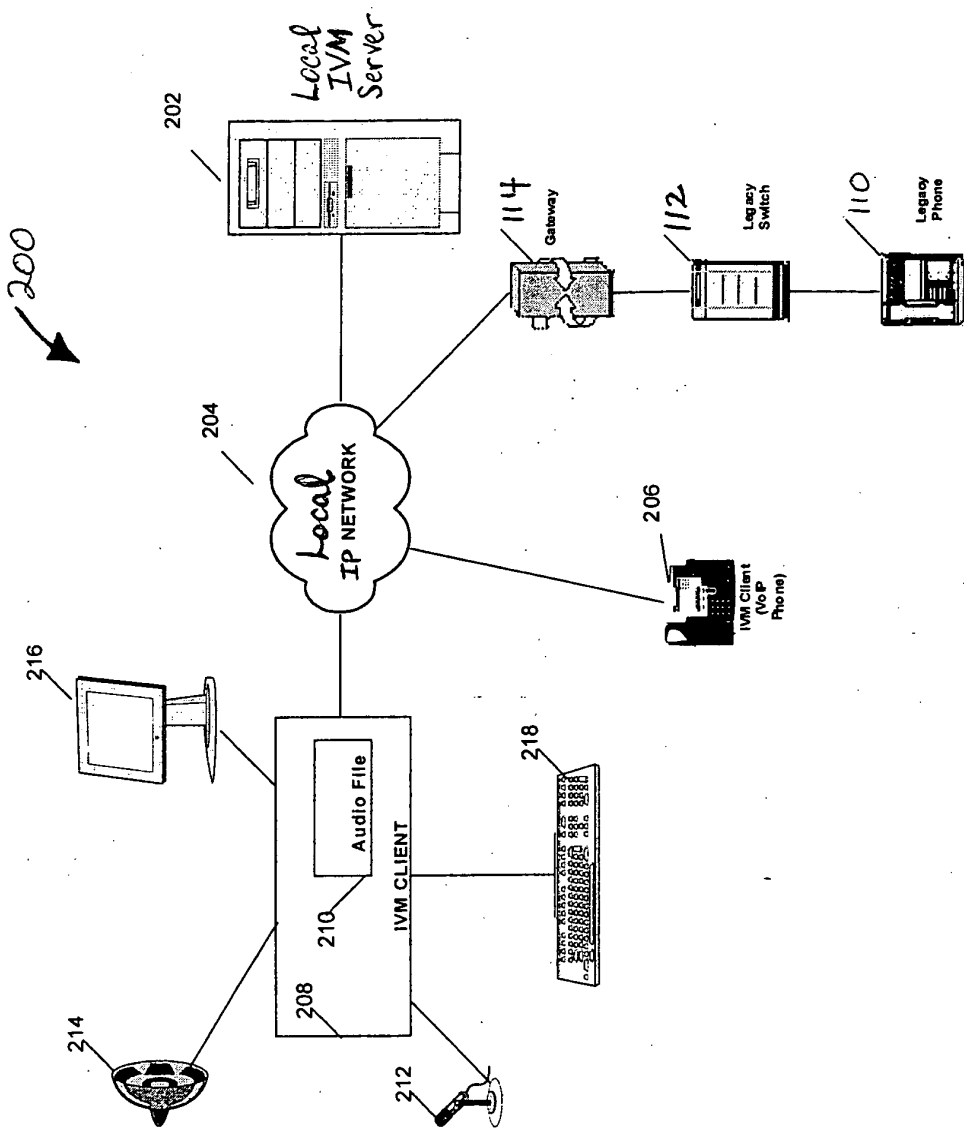

Fig. 2.

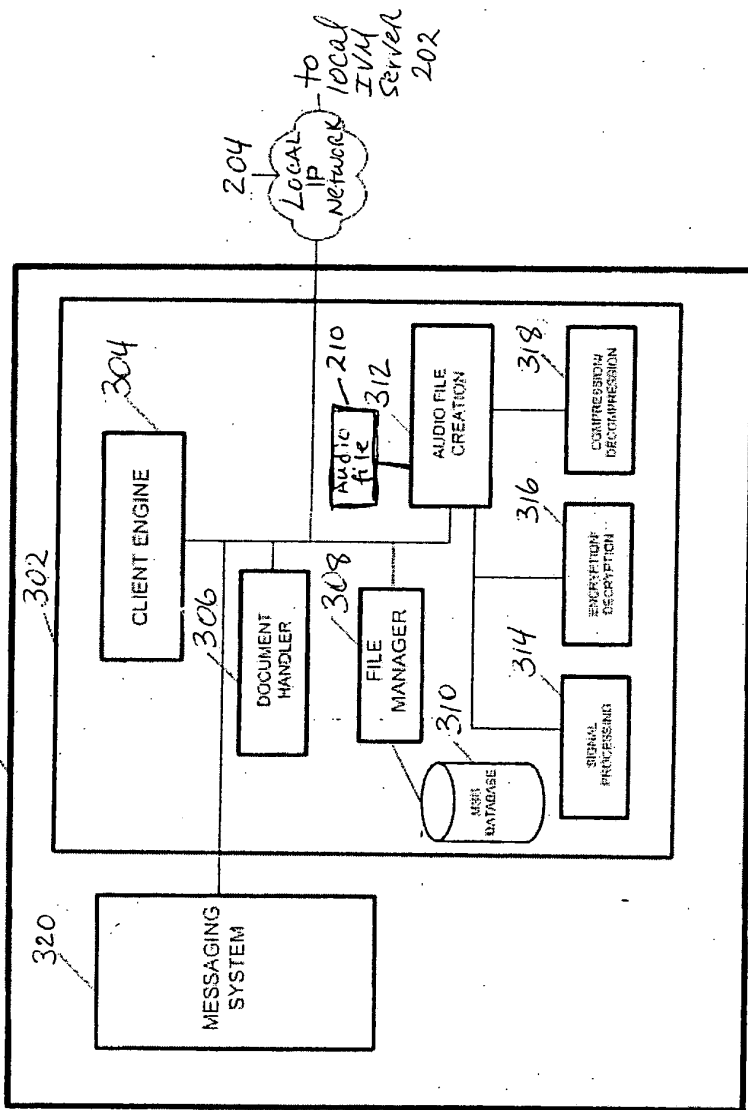

FIG. 3 Client Software Architecture

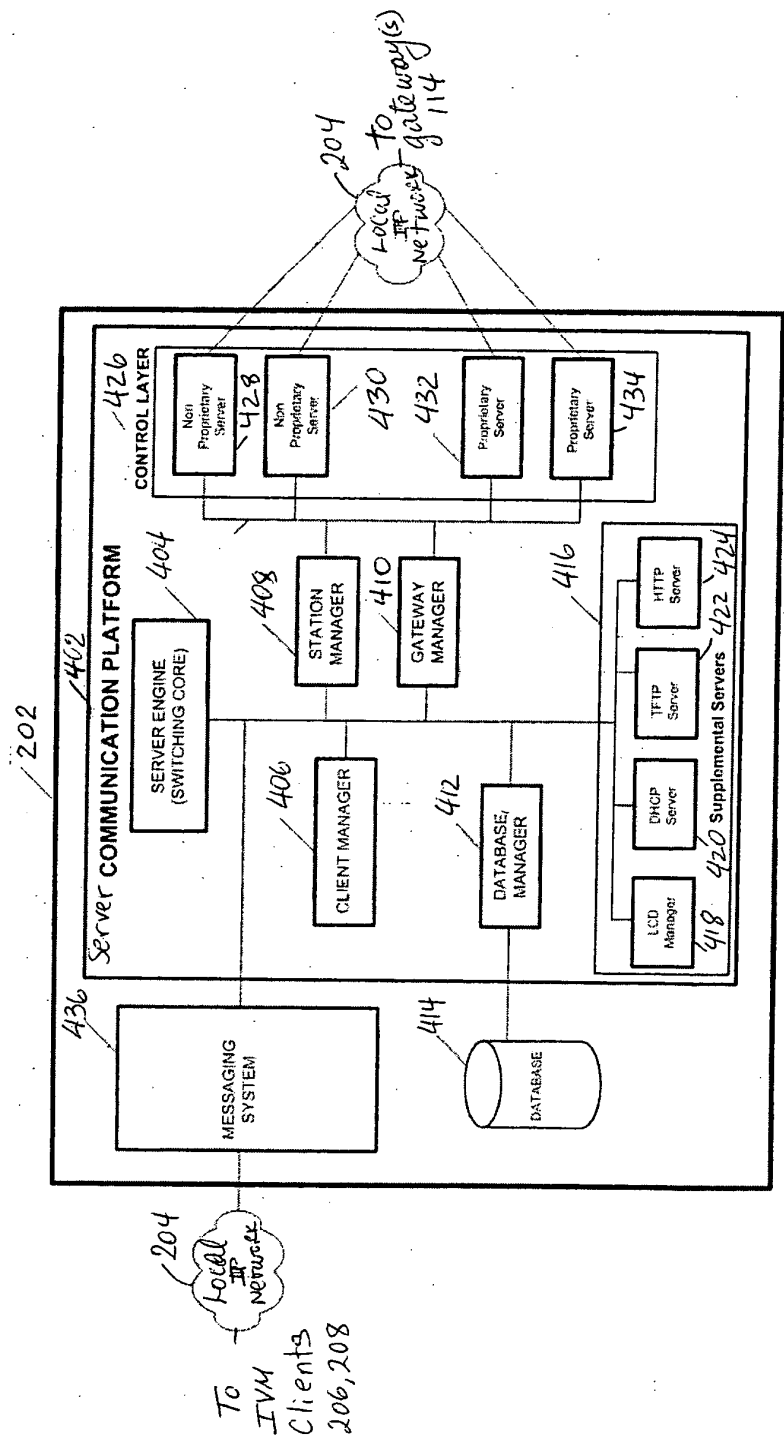

FIG. 4 Local Server (IVM) Architecture



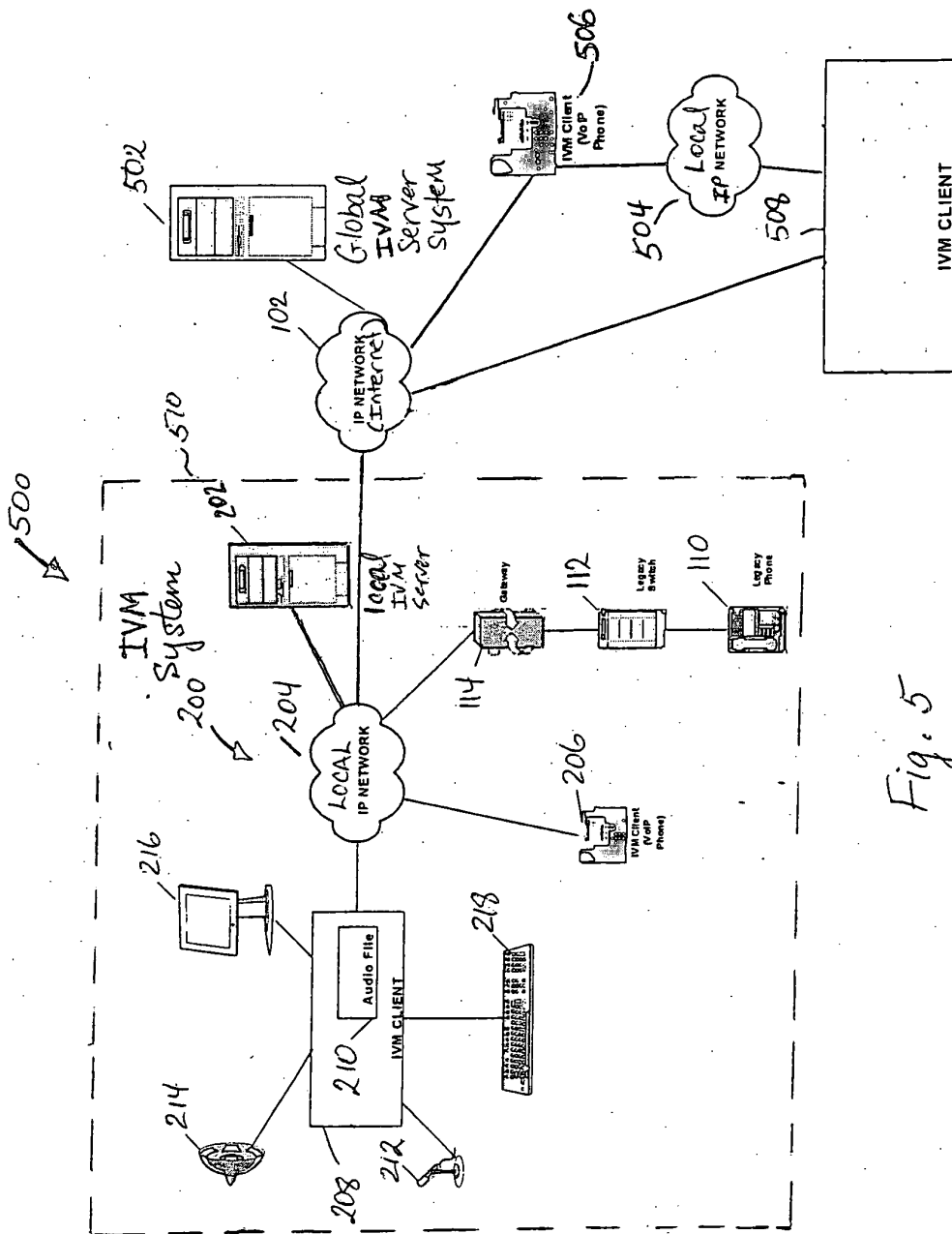

Fig. 5

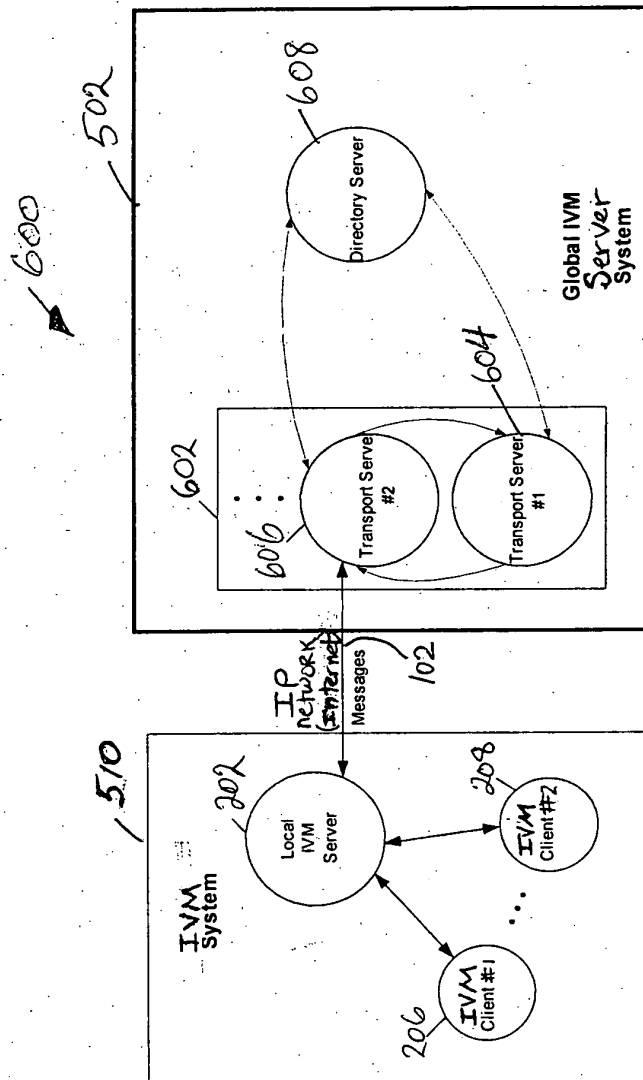

Fig. 6

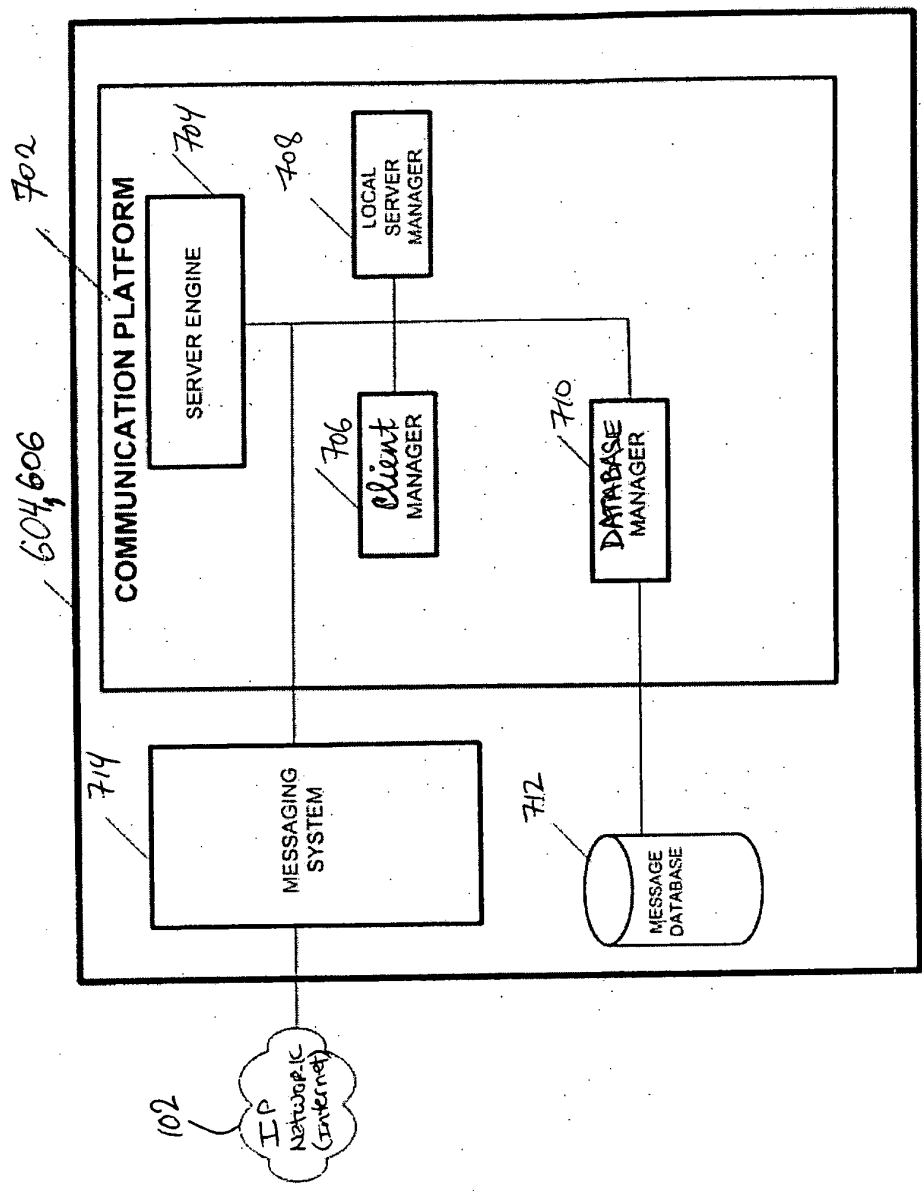

FIG. 7 TRANSPORT SERVER ARCHITECTURE

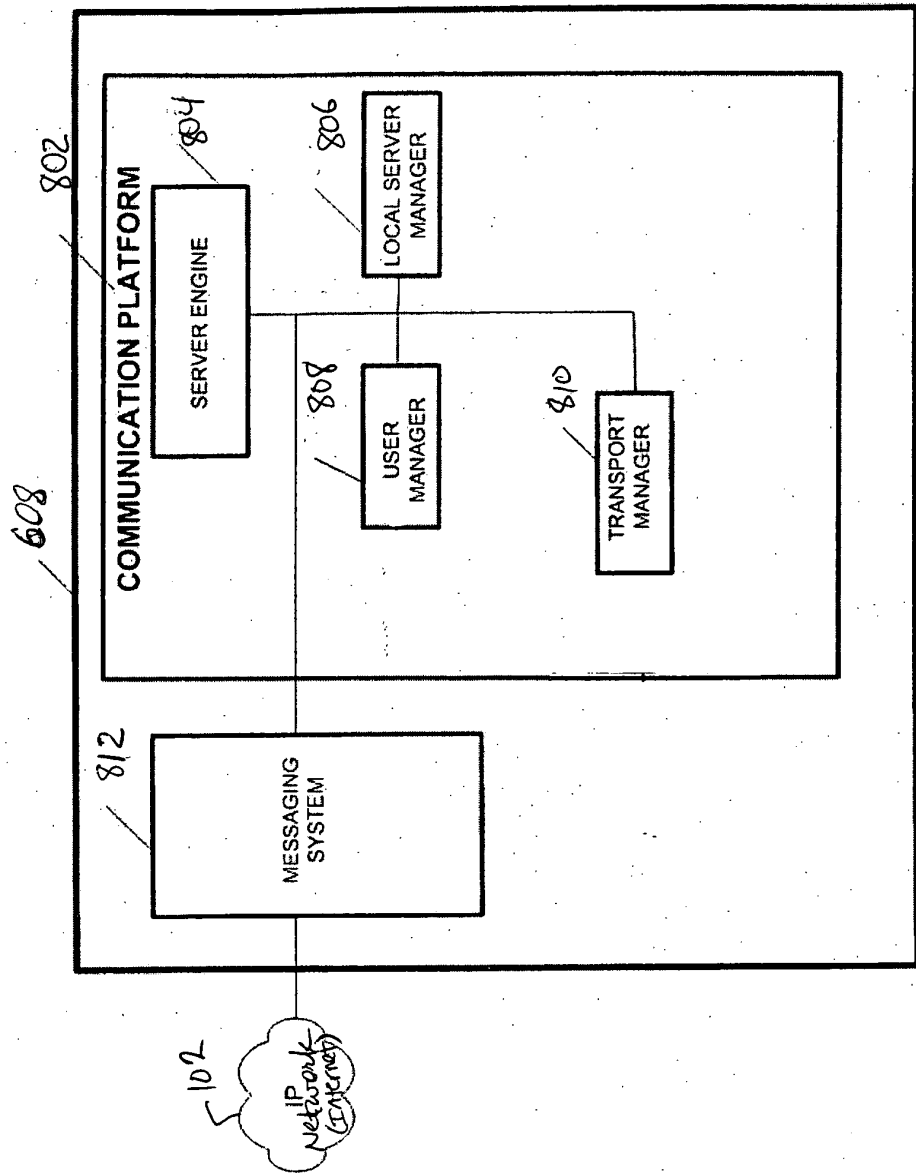

FIG. 8 Directory Server Architecture

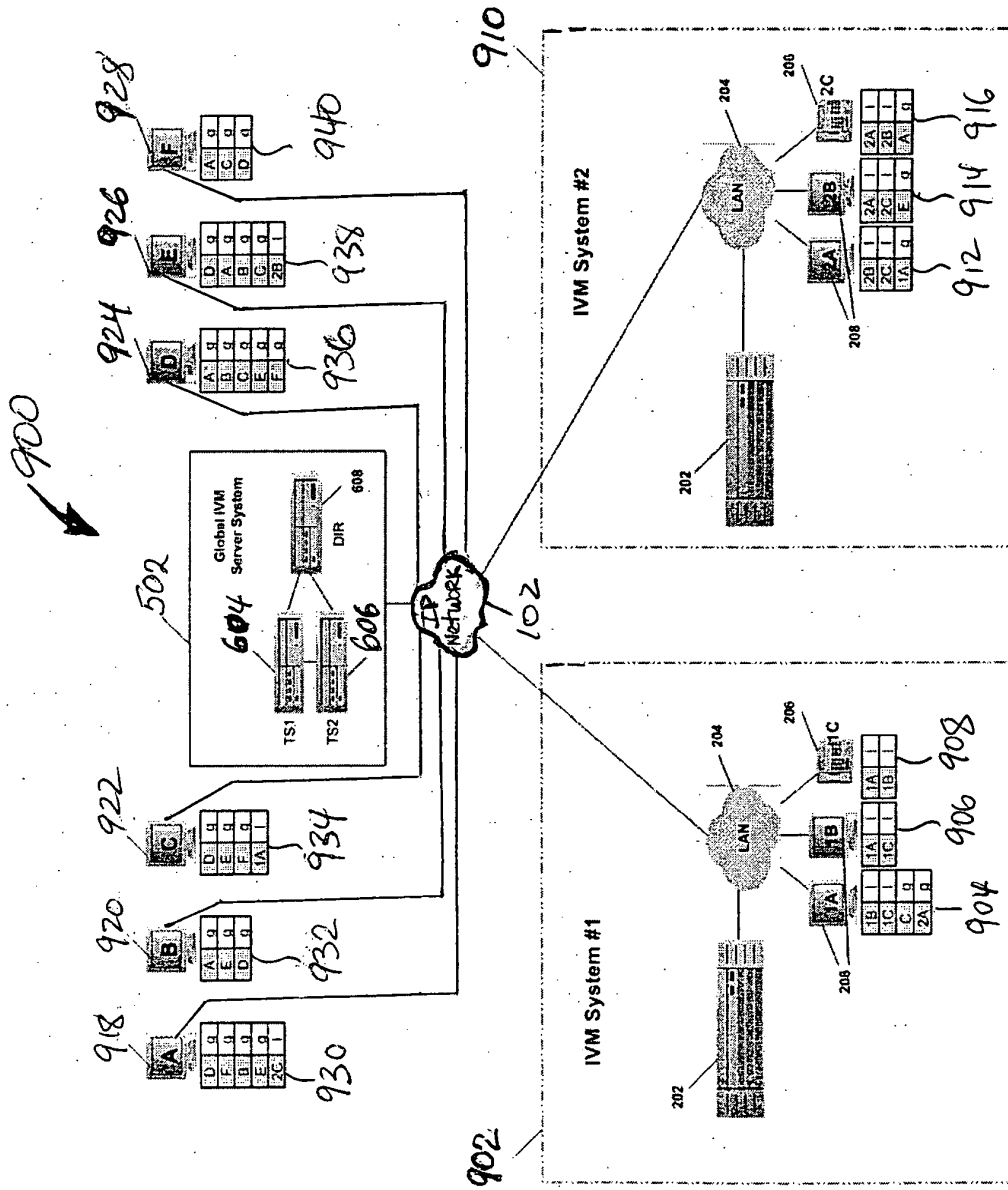

Fig. 9

Express Mail Label No.

Page 1 of 3

Docket No.  
17188

# Declaration and Power of Attorney For Patent Application

## English Language Declaration

As a below named inventor, I hereby declare that:

My residence, post office address and citizenship are as stated below next to my name,

I believe I am the original, first and sole inventor (if only one name is listed below) or an original, first and joint inventor (if plural names are listed below) of the subject matter which is claimed and for which a patent is sought on the invention entitled

### SYSTEM AND METHOD FOR INSTANT VoIP MESSAGING

the specification of which

(check one)

is attached hereto.

was filed on \_\_\_\_\_ as United States Application No. or PCT International Application Number \_\_\_\_\_ and was amended on \_\_\_\_\_

(If applicable)

I hereby state that I have reviewed and understand the contents of the above identified specification, including the claims, as amended by any amendment referred to above.

I acknowledge the duty to disclose information which is material to patentability as defined in 37 CFR 1.56, including for continuation-in-part applications, material information which became available between the filing date of the prior application and the national or PCT international filing date of the continuation-in-part application.

I hereby claim foreign priority benefits under 35 U.S.C. 119(a)-(d) or (f), or 365(b) of any foreign application(s) for patent, or plant breeder's rights certificate(s), or 365(a) of any PCT International application which designated at least one country other than the United States of America, listed below and have also identified below, by checking the box, any foreign application for patent, inventor's or plant breeder's rights certificate(s), or any PCT international application having a filing date before that of the application on which priority is claimed.

Prior Foreign Application(s)			Priority Not Claimed
_____	_____	_____	<input type="checkbox"/>
(Number)	(Country)	(Day/Month/Year Filed)	
_____	_____	_____	<input type="checkbox"/>
(Number)	(Country)	(Day/Month/Year Filed)	
_____	_____	_____	<input type="checkbox"/>
(Number)	(Country)	(Day/Month/Year Filed)	

I hereby claim the benefit under 35 U.S.C. Section 119(e) of any United States provisional application(s) listed below:

(Application Serial No.)	(Filing Date)
(Application Serial No.)	(Filing Date)
(Application Serial No.)	(Filing Date)

I hereby claim the benefit under 35 U. S. C. Section 120 of any United States application(s), or Section 365(c) of any PCT International application designating the United States, listed below and, insofar as the subject matter of each of the claims of this application is not disclosed in the prior United States or PCT International application in the manner provided by the first paragraph of 35 U.S.C. Section 112, I acknowledge the duty to disclose to the United States Patent and Trademark Office all information known to me to be material to patentability as defined in Title 37, C. F. R., Section 1.56 which became available between the filing date of the prior application and the national or PCT International filing date of this application:

(Application Serial No.)	(Filing Date)	(Status) (patented, pending, abandoned)
(Application Serial No.)	(Filing Date)	(Status) (patented, pending, abandoned)
(Application Serial No.)	(Filing Date)	(Status) (patented, pending, abandoned)

I hereby declare that all statements made herein of my own knowledge are true and that all statements made on information and belief are believed to be true; and further that these statements were made with the knowledge that willful false statements and the like so made are punishable by fine or imprisonment, or both, under Section 1001 of Title 18 of the United States Code and that such willful false statements may jeopardize the validity of the application or any patent issued thereon.

**POWER OF ATTORNEY:** As a named inventor, I hereby appoint the following attorney(s) and/or agent(s) to prosecute this application and transact all business in the Patent and Trademark Office connected therewith. *(list name and registration number)*

- Frank S. DiGiglio; Reg. No. 31,346
- Leopold Presser; Reg. No. 19,827
- William C. Roch; Reg. No. 24,972
- Edward W. Grolz; Reg. No. 33,705
- Paul J. Esatto, Jr.; Reg. No. 30,749
- John S. Sensny; Reg. No. 28,757
- Mark J. Cohen; Reg. No. 32,211
- Steven Fischman; Reg. No. 34,594
- Peter I. Bernstein; Reg. No. 43,497
- Thomas Spinelli, Reg. No. 39,533

Send Correspondence to: **Paul J. Esatto, Jr.**  
**SCULLY, SCOTT, MURPHY & PRESSER**  
 400 Garden City Plaza  
 Garden City, New York 11530

Direct Telephone Calls to: *(name and telephone number)*  
**Paul J. Esatto, Jr. (516) 742-4343**

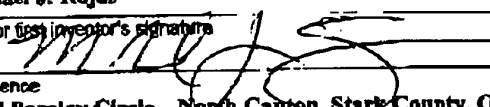
Full name of sole or first inventor	
Michael J. Rojas	
Sole or first inventor's signature	Date
	12-18-2003
Residence	
2828 Barclay Circle, North Canton, Stark County, Ohio 44720	
Citizenship	
U.S.A.	
Post Office Address	
Same as above	

Full name of second inventor, if any	
Second inventor's signature	Date
Residence	
Citizenship	
Post Office Address	



PATENT APPLICATION SERIAL NO. \_\_\_\_\_

U.S. DEPARTMENT OF COMMERCE  
PATENT AND TRADEMARK OFFICE  
FEE RECORD SHEET

12/24/2003 MMEKONEN 00000010 191013 10740030

01 FC:2001	385.00 DA
02 FC:2201	473.00 DA
03 FC:2202	504.00 DA

PTO-1556  
(5/87)

**PATENT APPLICATION FEE DETERMINATION RECORD**  
Effective October 1, 2003

Application or Docket Number

17188

**CLAIMS AS FILED - PART I**

	(Column 1)	(Column 2)
TOTAL CLAIMS	76	
FOR	NUMBER FILED	NUMBER EXTRA
TOTAL CHARGEABLE CLAIMS	76 minus 20 =	* 56
INDEPENDENT CLAIMS	14 minus 3 =	* 11
MULTIPLE DEPENDENT CLAIM PRESENT		<input type="checkbox"/>

\* If the difference in column 1 is less than zero, enter "0" in column 2

**SMALL ENTITY TYPE**  OR

RATE	FEE
BASIC FEE	385.00
XS 9=	
X43=	
+145=	
TOTAL	

**OTHER THAN SMALL ENTITY**

RATE	FEE
BASIC FEE	770.00
XS18=	504
X86=	473
+290=	
TOTAL	1362

**CLAIMS AS AMENDED - PART II**

	(Column 1)	(Column 2)	(Column 3)
<b>AMENDMENT A</b>	CLAIMS REMAINING AFTER AMENDMENT		HIGHEST NUMBER PREVIOUSLY PAID FOR
	Total	*	Minus **
	Independent	*	Minus ***
	FIRST PRESENTATION OF MULTIPLE DEPENDENT CLAIM		

**SMALL ENTITY** OR

RATE	ADDITIONAL FEE
XS 9=	
X43=	
+145=	
TOTAL ADDIT. FEE	

**OTHER THAN SMALL ENTITY**

RATE	ADDITIONAL FEE
XS18=	
X86=	
+290=	
TOTAL ADDIT. FEE	

	(Column 1)	(Column 2)	(Column 3)
<b>AMENDMENT B</b>	CLAIMS REMAINING AFTER AMENDMENT		HIGHEST NUMBER PREVIOUSLY PAID FOR
	Total	*	Minus **
	Independent	*	Minus ***
	FIRST PRESENTATION OF MULTIPLE DEPENDENT CLAIM		

RATE	ADDITIONAL FEE
XS 9=	
X43=	
+145=	
TOTAL ADDIT. FEE	

RATE	ADDITIONAL FEE
XS18=	
X86=	
+290=	
TOTAL ADDIT. FEE	

	(Column 1)	(Column 2)	(Column 3)
<b>AMENDMENT C</b>	CLAIMS REMAINING AFTER AMENDMENT		HIGHEST NUMBER PREVIOUSLY PAID FOR
	Total	*	Minus **
	Independent	*	Minus ***
	FIRST PRESENTATION OF MULTIPLE DEPENDENT CLAIM		

RATE	ADDITIONAL FEE
XS 9=	
X43=	
+145=	
TOTAL ADDIT. FEE	

RATE	ADDITIONAL FEE
XS18=	
X86=	
+290=	
TOTAL ADDIT. FEE	

\* If the entry in column 1 is less than the entry in column 2, write "0" in column 3.  
 \*\* If the "Highest Number Previously Paid For" IN THIS SPACE is less than 20, enter "20."  
 \*\*\* If the "Highest Number Previously Paid For" IN THIS SPACE is less than 3, enter "3."  
 The "Highest Number Previously Paid For" (Total or Independent) is the highest number found in the appropriate box in column 1.