



US005956729A

# United States Patent [19]

[11] Patent Number: **5,956,729**

Goetz et al.

[45] Date of Patent: **Sep. 21, 1999**

[54] **MULTIMEDIA FILE, SUPPORTING MULTIPLE INSTANCES OF MEDIA TYPES, AND METHOD FOR FORMING SAME**

5,737,595 4/1998 Cohen et al. .... 707/100  
5,768,527 6/1998 Zhu et al. .... 395/200.61  
5,774,583 6/1998 Sasaki et al. .... 382/190

[75] Inventors: **Tom Goetz**, Attleboro; **Manickam R. Sridhar**, Holliston; **Mukesh Prasad**, Chestnut Hill, all of Mass.

### OTHER PUBLICATIONS

RealMedia Overview, "The First Open Multimedia Streaming Platform," <http://www.realuadio.com/> or e-mail [radinfo@prognnet.com](mailto:radinfo@prognnet.com); copyright © Progressive Networks, 1996.

[73] Assignee: **Motorola, Inc.**, Schaumburg, Ill.

RealMedia, "Technical White Paper," <http://www.realuadio.com/> or e-mail [radinfo@prognnet.com](mailto:radinfo@prognnet.com); copyright © Progressive Networks, 1996.

[21] Appl. No.: **08/711,696**

Primary Examiner—**Maria N. Von Buhr**  
Attorney, Agent, or Firm—**Peter M. Dichiaro**; **Jeffrey T. Klayman**

[22] Filed: **Sep. 6, 1996**

[51] Int. Cl.<sup>6</sup> ..... **G06F 17/30**

[52] U.S. Cl. .... **707/104**; 707/102; 707/103

[58] Field of Search ..... 707/102–104,  
707/200, 1

### [57] ABSTRACT

### [56] References Cited

#### U.S. PATENT DOCUMENTS

5,333,299	7/1994	Koval et al. ....	395/650
5,339,413	8/1994	Koval et al. ....	395/550
5,487,167	1/1996	Dinallo et al. ....	395/650
5,504,892	4/1996	Atsatt et al. ....	707/103
5,574,898	11/1996	LeBlang et al. ....	707/1
5,574,905	12/1996	de Carmo ....	707/1
5,586,255	12/1996	Tanaka et al. ....	395/200.53
5,608,859	3/1997	Taguchi ....	345/302
5,644,766	7/1997	Coy et al. ....	707/204
5,664,182	9/1997	Nierenberg et al. ....	707/102
5,694,334	12/1997	Donahue et al. ....	395/200.77
5,696,500	12/1997	Diem ....	340/825.44
5,701,465	12/1997	Baughner et al. ....	707/10
5,732,256	3/1998	Smith ....	707/1

A multimedia file and method for forming the same organize instances of multimedia information according to media information type (e.g., audio, video, MIDI, etc.), encoding format, media subtype, and encoding rate. Several instances of the same media information type are included, each of such instances having a different encoding format, media subtype, and/or encoding rate. A presentation application utilizes the subject multimedia file to identify, select, and present specific instances of the multimedia information, permitting the presentation application to customize a multimedia presentation based on, among other things, the rate of the connection from the presentation application to the presentation consumer and the decoding capabilities of the presentation consumer.

**31 Claims, 8 Drawing Sheets**

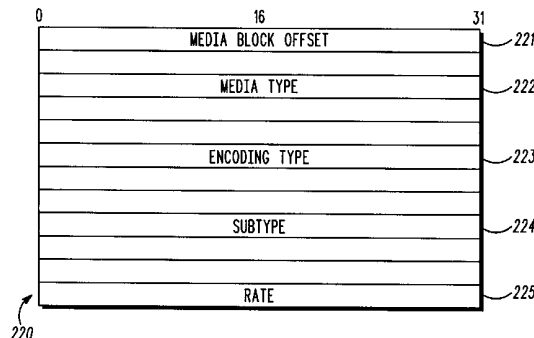
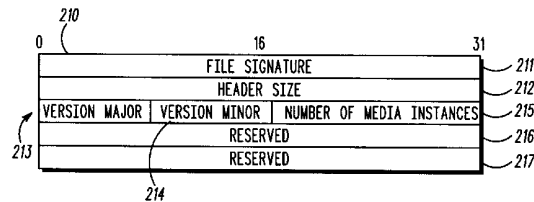
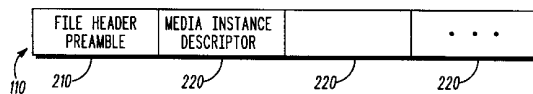

RPX Exhibit 1041  
RPX DAE

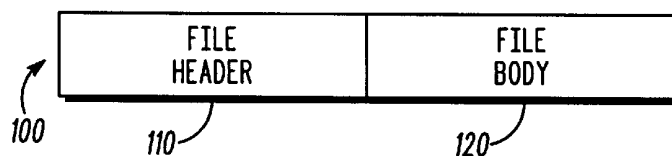

FIG. 1

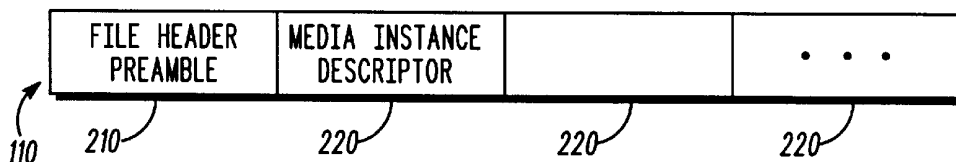

FIG. 2A

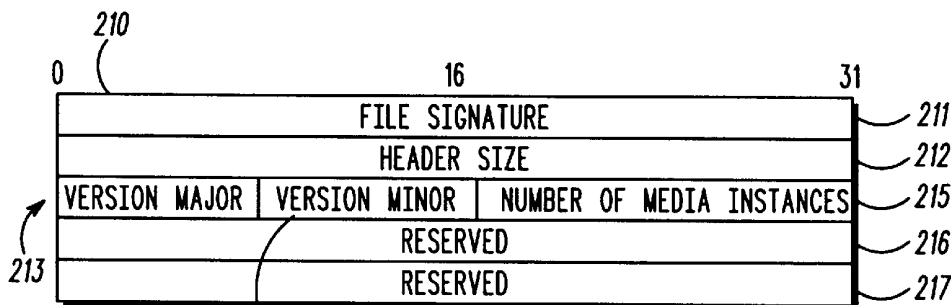

FIG. 2B

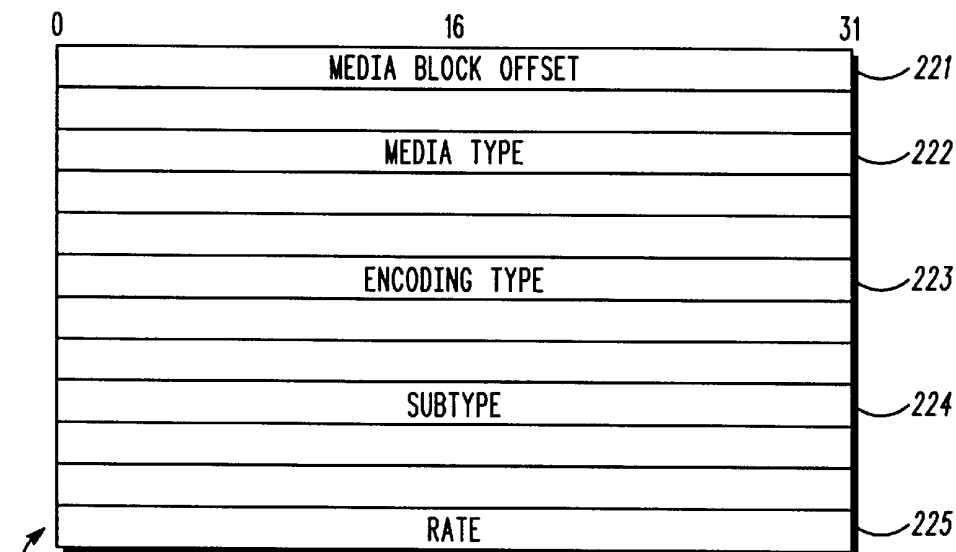
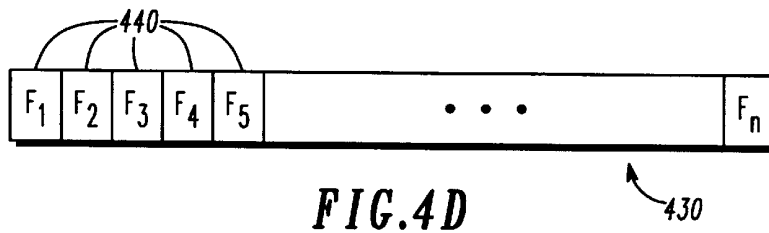
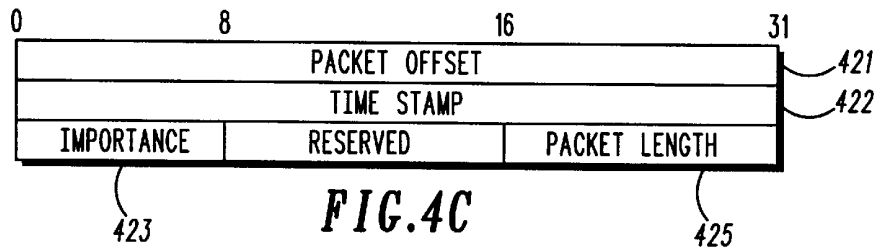
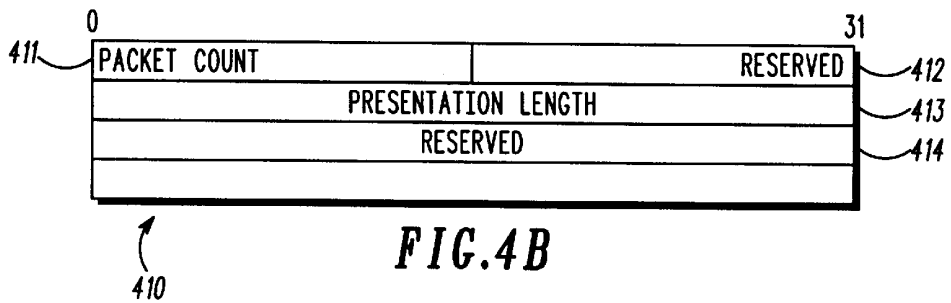
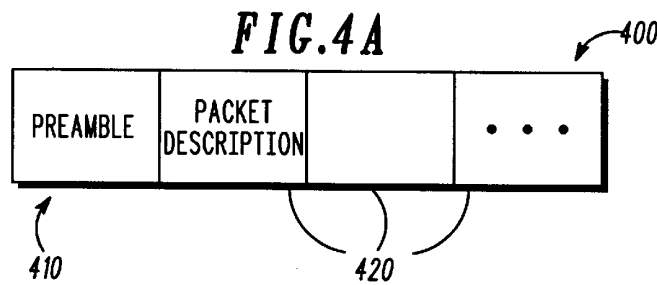
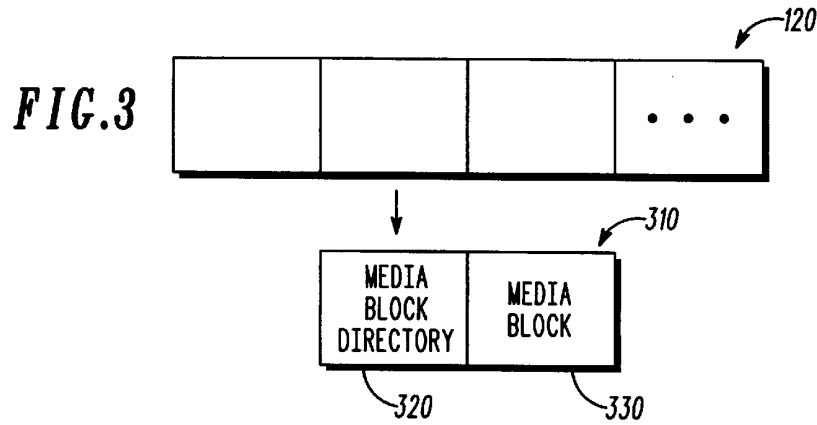
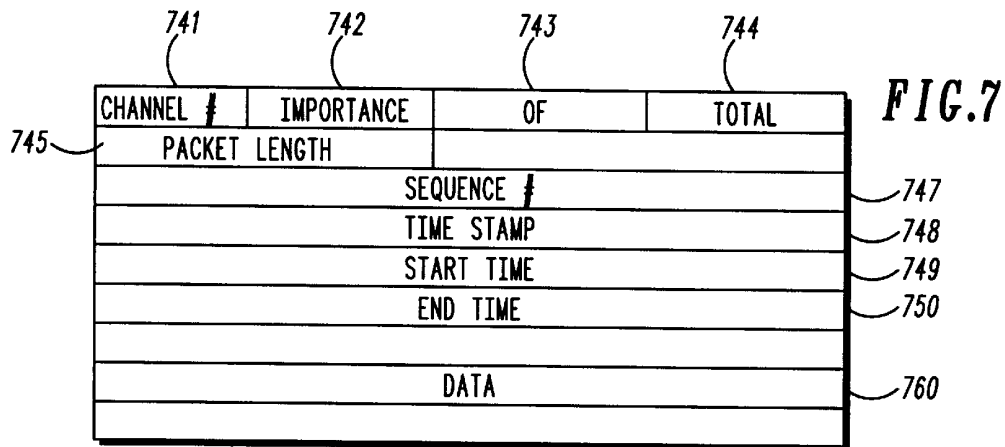
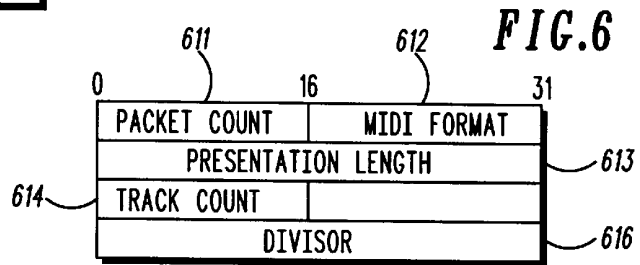
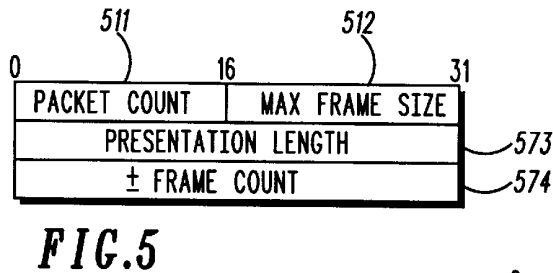
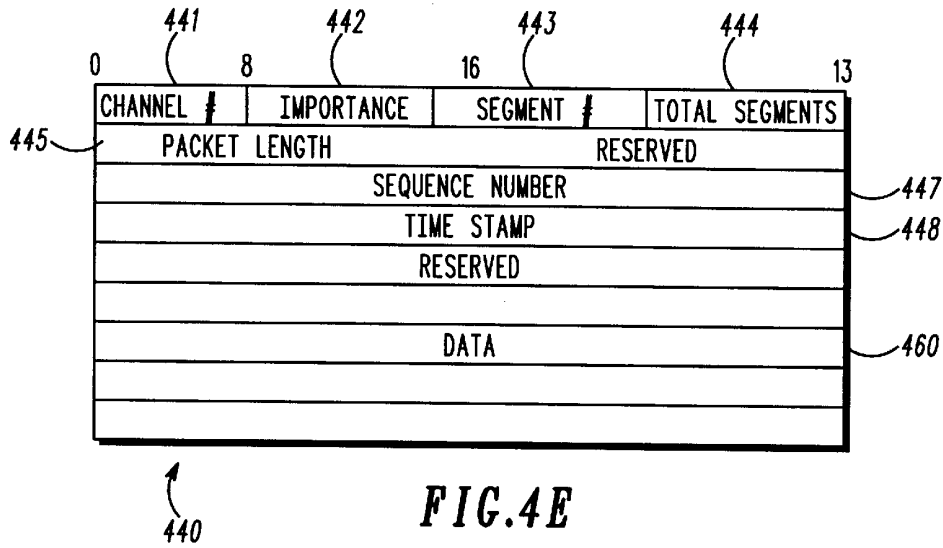

FIG. 2C





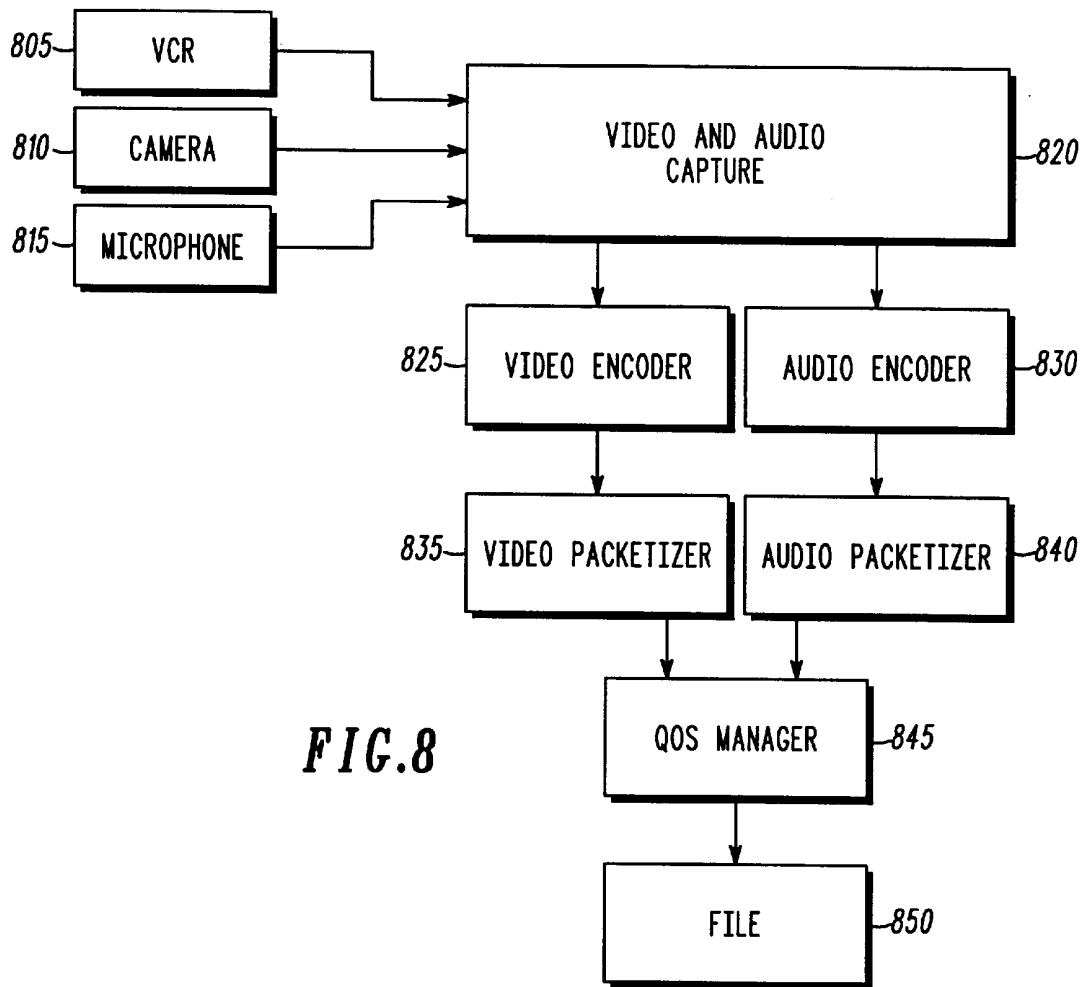

FIG. 8

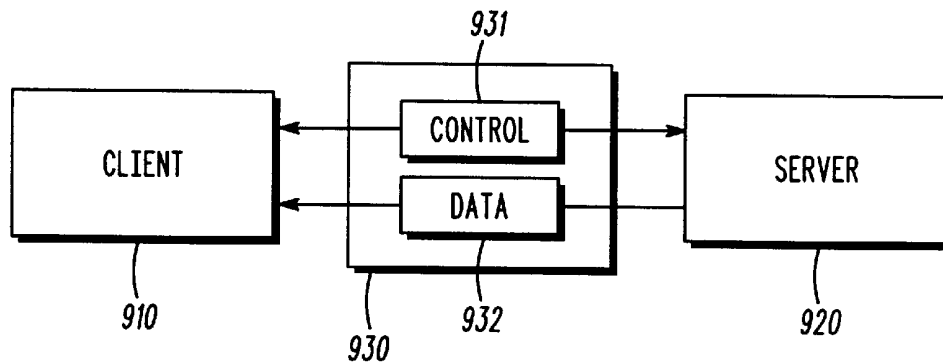

FIG. 9

# Explore Litigation Insights

Docket Alarm provides insights to develop a more informed litigation strategy and the peace of mind of knowing you're on top of things.

## Real-Time Litigation Alerts



Keep your litigation team up-to-date with **real-time alerts** and advanced team management tools built for the enterprise, all while greatly reducing PACER spend.

Our comprehensive service means we can handle Federal, State, and Administrative courts across the country.

## Advanced Docket Research



With over 230 million records, Docket Alarm's cloud-native docket research platform finds what other services can't. Coverage includes Federal, State, plus PTAB, TTAB, ITC and NLRB decisions, all in one place.

Identify arguments that have been successful in the past with full text, pinpoint searching. Link to case law cited within any court document via Fastcase.

## Analytics At Your Fingertips



Learn what happened the last time a particular judge, opposing counsel or company faced cases similar to yours.

Advanced out-of-the-box PTAB and TTAB analytics are always at your fingertips.

## API

Docket Alarm offers a powerful API (application programming interface) to developers that want to integrate case filings into their apps.

## LAW FIRMS

Build custom dashboards for your attorneys and clients with live data direct from the court.

Automate many repetitive legal tasks like conflict checks, document management, and marketing.

## FINANCIAL INSTITUTIONS

Litigation and bankruptcy checks for companies and debtors.

## E-DISCOVERY AND LEGAL VENDORS

Sync your system to PACER to automate legal marketing.