

# United States Patent [19]

**Kudo**

[11] **Patent Number:** 4,606,044

[45] **Date of Patent:** Aug. 12, 1986

[54] **ADJUSTING DATA TRANSMISSION RATE  
BASED ON RECEIVED SIGNAL QUALITY**

[75] **Inventor:** Shozo Kudo, Yokohama, Japan

[73] **Assignee:** Ricoh Company, Ltd., Tokyo, Japan

[21] **Appl. No.:** 586,509

[22] **Filed:** Mar. 5, 1984

[30] **Foreign Application Priority Data**

Mar. 9, 1983 [JP] Japan ..... 58-37274

[51] **Int. Cl.<sup>4</sup>** ..... H04J 3/22

[52] **U.S. Cl.** ..... 375/13; 375/58;  
370/84

[58] **Field of Search** ..... 375/13, 58, 109, 121;  
371/5; 370/79, 84; 178/69 A, 69 M

[56] **References Cited**

### U.S. PATENT DOCUMENTS

3,536,840 10/1970 Sullivan ..... 375/58

3,988,539 10/1976 Motley et al. .... 375/39

4,153,916 5/1979 Miwa et al. .... 358/288

### FOREIGN PATENT DOCUMENTS

0039191 11/1981 European Pat. Off. .... 371/5

*Primary Examiner*—Benedict V. Safourek  
*Assistant Examiner*—Raymond C. Glenn  
*Attorney, Agent, or Firm*—David G. Alexander

### [57] ABSTRACT

A data transmission control system for allowing remote transceiver stations to transmit data via a telephone line or like analog transmission line through modems. When transmit and receive stations have been interconnected by a call, a training sequence for the modem is executed and, also, a test signal transmission sequence is effected to set up a data transmission rate before delivery of information. When the receive station has received test training data inclusive of a plurality of transmission rates from the transmit station, the function of the modem at the receive station is checked with respect to each of the transmission rates on a signal space diagram, thereby determining whether the receive station is capable of normally receiving data at the transmission rate. Training on the transmission rates which a modem can use is executed satisfying a predetermined protocol and without increasing the protocol time.

**9 Claims, 11 Drawing Figures**

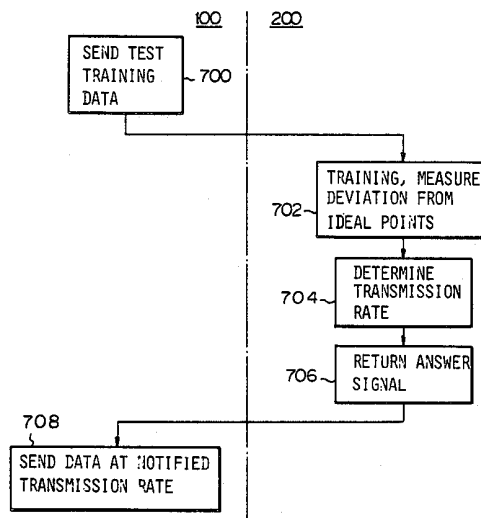
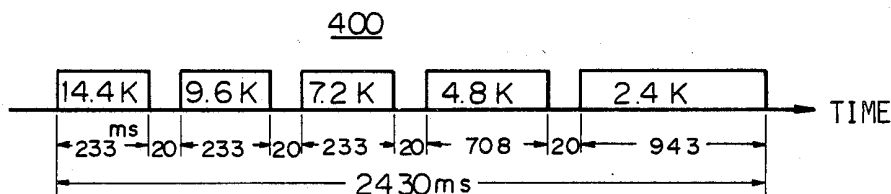

RPX Exhibit 1040  
RPX v. DAE

Fig. 1

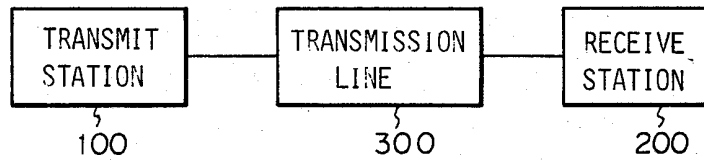

Fig. 2

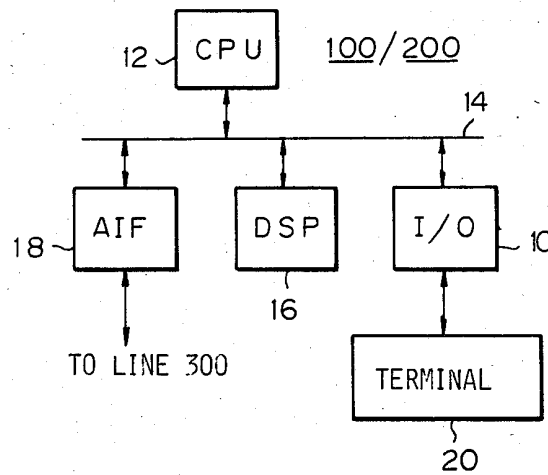

Fig. 3

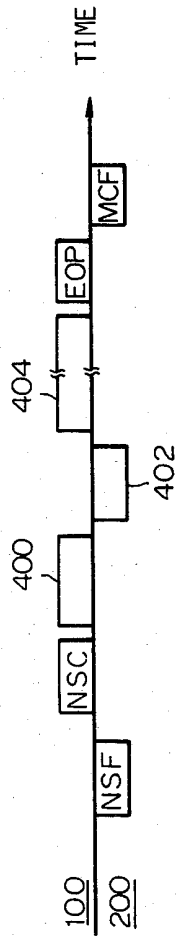

Fig. 4

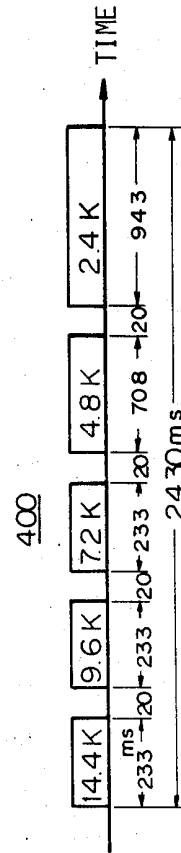

Fig. 5A

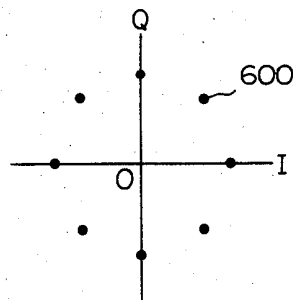
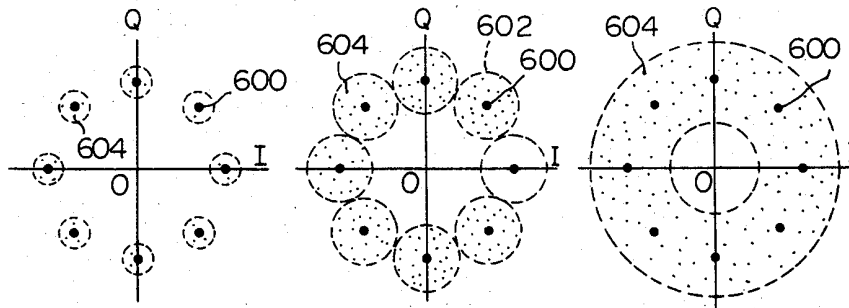
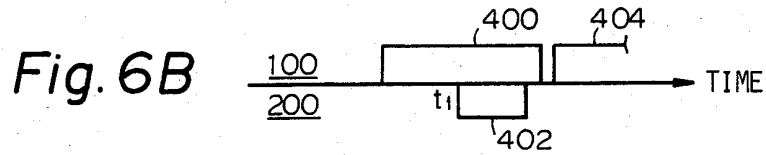
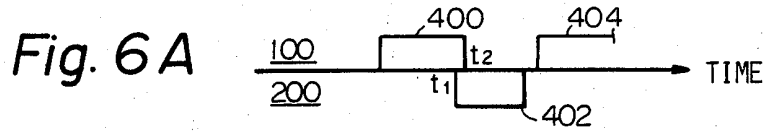

Fig. 5B

Fig. 5C

Fig. 5D





*Fig. 7*

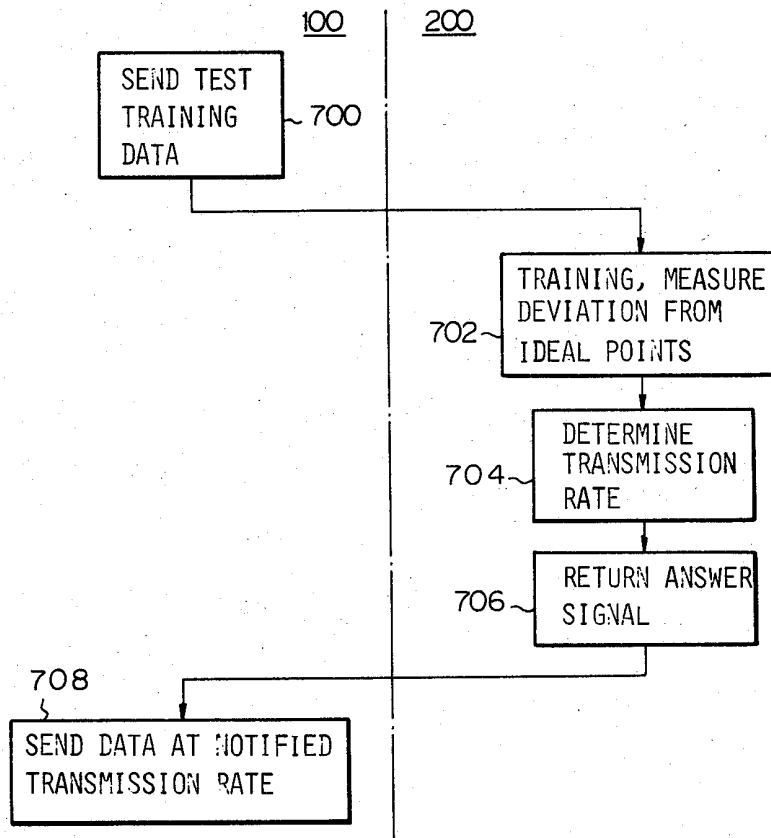

# Explore Litigation Insights

Docket Alarm provides insights to develop a more informed litigation strategy and the peace of mind of knowing you're on top of things.

## Real-Time Litigation Alerts



Keep your litigation team up-to-date with **real-time alerts** and advanced team management tools built for the enterprise, all while greatly reducing PACER spend.

Our comprehensive service means we can handle Federal, State, and Administrative courts across the country.

## Advanced Docket Research



With over 230 million records, Docket Alarm's cloud-native docket research platform finds what other services can't. Coverage includes Federal, State, plus PTAB, TTAB, ITC and NLRB decisions, all in one place.

Identify arguments that have been successful in the past with full text, pinpoint searching. Link to case law cited within any court document via Fastcase.

## Analytics At Your Fingertips



Learn what happened the last time a particular judge, opposing counsel or company faced cases similar to yours.

Advanced out-of-the-box PTAB and TTAB analytics are always at your fingertips.

## API

Docket Alarm offers a powerful API (application programming interface) to developers that want to integrate case filings into their apps.

## LAW FIRMS

Build custom dashboards for your attorneys and clients with live data direct from the court.

Automate many repetitive legal tasks like conflict checks, document management, and marketing.

## FINANCIAL INSTITUTIONS

Litigation and bankruptcy checks for companies and debtors.

## E-DISCOVERY AND LEGAL VENDORS

Sync your system to PACER to automate legal marketing.