

(19) **United States**

(12) **Patent Application Publication** (10) **Pub. No.: US 2003/0236567 A1**

Elliot

(43) **Pub. Date: Dec. 25, 2003**

(54) **IMPLANTABLE PROSTHESIS WITH DISPLACEABLE SKIRT**

(57) **ABSTRACT**

(75) Inventor: **Chris Elliot, Hopkinton, MA (US)**

Correspondence Address:
HOFFMANN & BARON, LLP
6900 JERICHO TURNPIKE
SYOSSET, NY 11791 (US)

(73) Assignee: **Scimed Life Systems, Inc.**

(21) Appl. No.: **10/179,535**

(22) Filed: **Jun. 25, 2002**

Publication Classification

(51) **Int. Cl.⁷ A61F 2/06**

(52) **U.S. Cl. 623/1.13; 623/1.3**

An implantable prosthesis is provided having a radially-expandable tubular body and at least one skirt extending therefrom. The skirt terminates in a peripheral edge, wherein at least portions of the peripheral edge are free and displaceable to a greater diameter of the tubular body. Thus, with the implantable prosthesis being a stent-graft used to treat an aortic aneurysm (e.g., abdominal aortic aneurysm ("AAA")), the skirt may be used to inhibit Type I endoleaks upon its selective displacement in response to irregular aortic shaping and/or aneurysm neck expansion. The skirt may actively inhibit Type I endoleaks by forming a physical barrier against flow between the tubular body and the aortic wall. In addition, the skirt may passively inhibit endoleak formation by sufficiently restricting blood flow to allow coagulation and clot formation, which would act as a barrier against endoleakage.

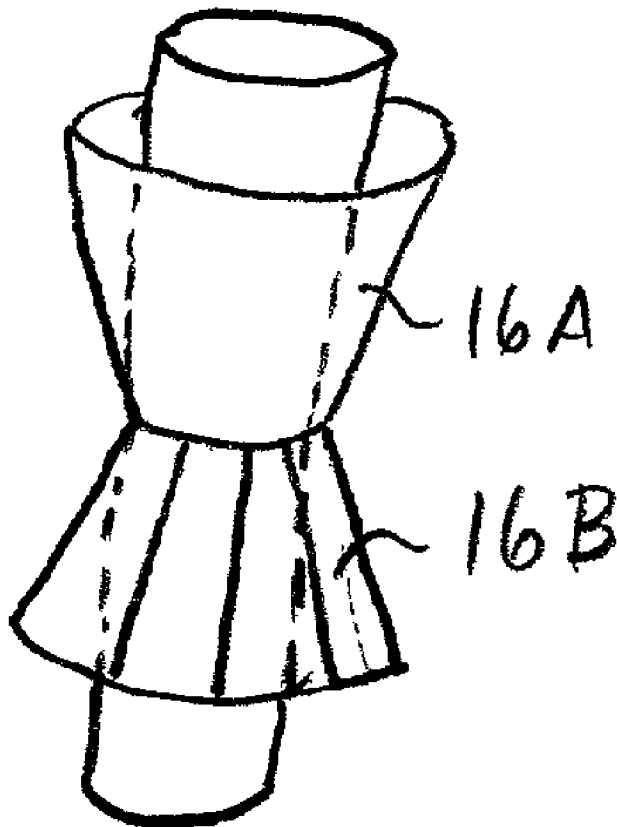

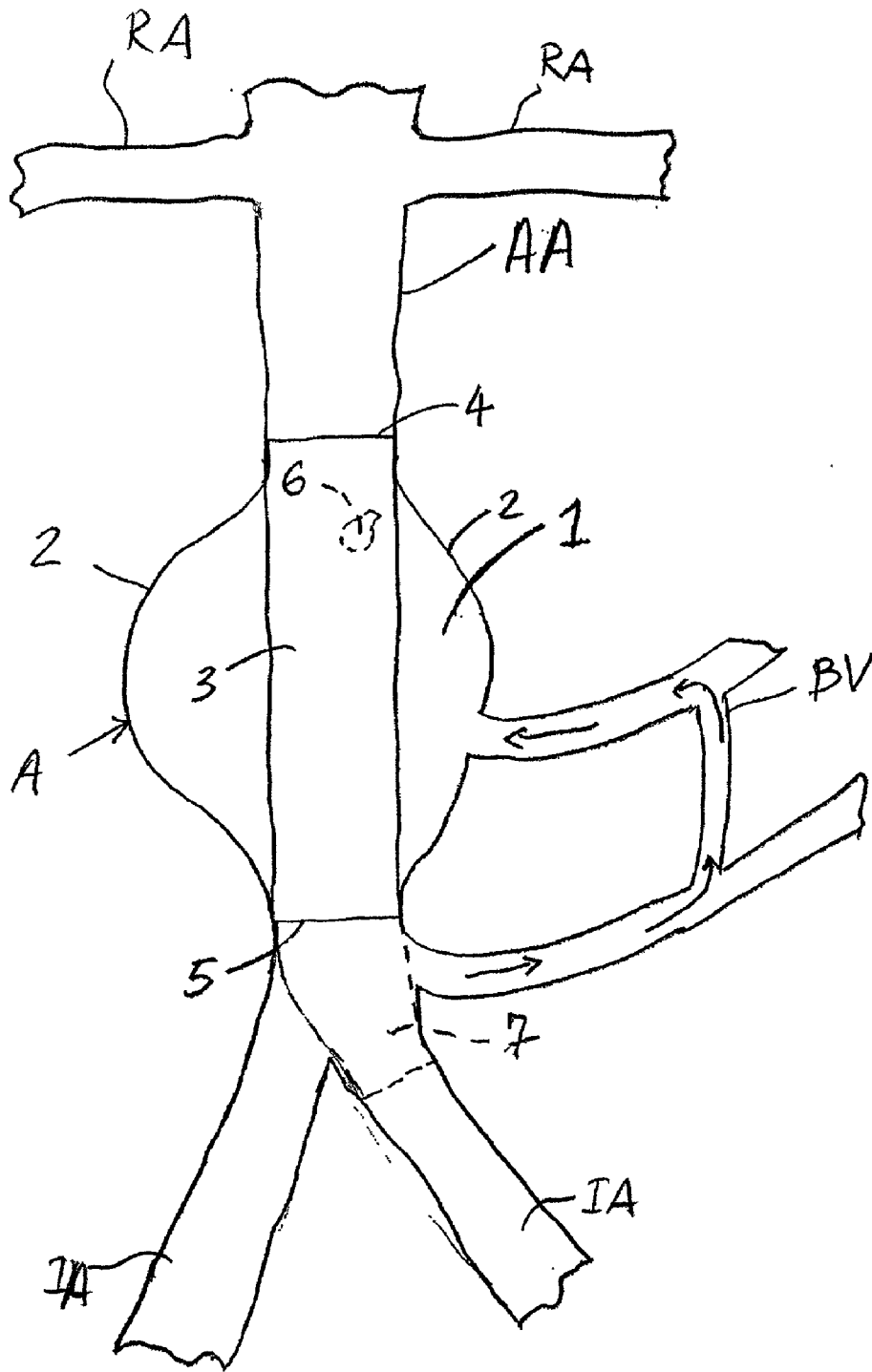

FIG. 1
PRIOR ART

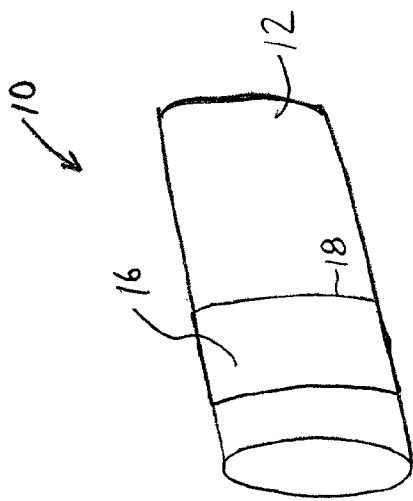

FIG. 2a

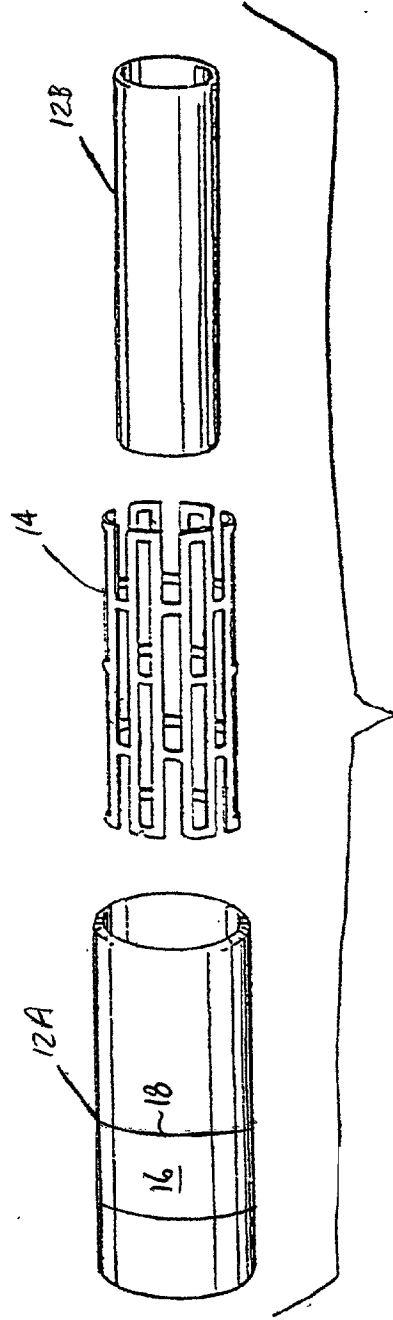

FIG. 2b

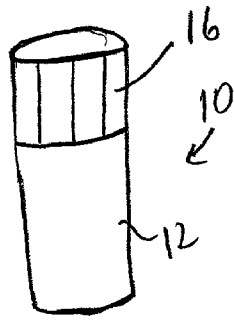

FIG. 3a



FIG. 3b

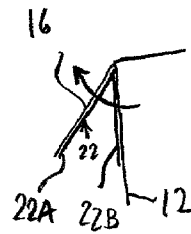

FIG. 3e

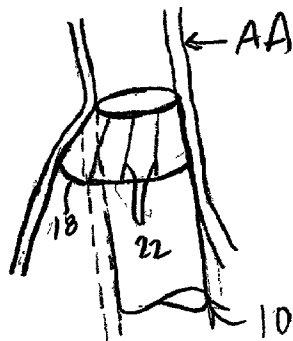

FIG. 3c

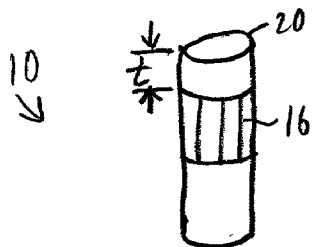

FIG. 3d

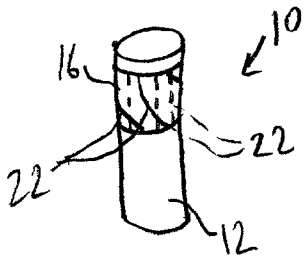

FIG. 4a

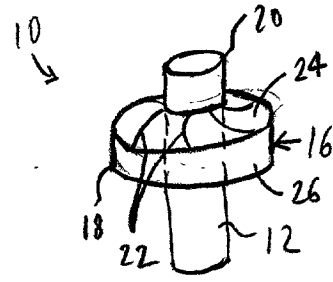

FIG. 4b

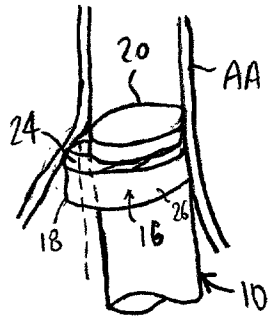

FIG. 4c

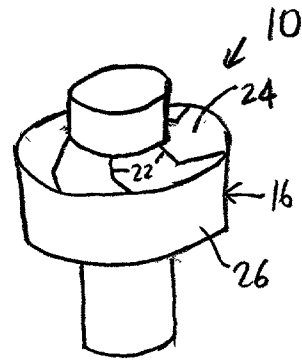

FIG. 4d

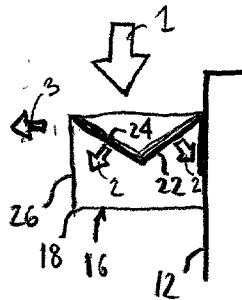

FIG. 4e

Explore Litigation Insights

Docket Alarm provides insights to develop a more informed litigation strategy and the peace of mind of knowing you're on top of things.

Real-Time Litigation Alerts



Keep your litigation team up-to-date with **real-time alerts** and advanced team management tools built for the enterprise, all while greatly reducing PACER spend.

Our comprehensive service means we can handle Federal, State, and Administrative courts across the country.

Advanced Docket Research



With over 230 million records, Docket Alarm's cloud-native docket research platform finds what other services can't. Coverage includes Federal, State, plus PTAB, TTAB, ITC and NLRB decisions, all in one place.

Identify arguments that have been successful in the past with full text, pinpoint searching. Link to case law cited within any court document via Fastcase.

Analytics At Your Fingertips



Learn what happened the last time a particular judge, opposing counsel or company faced cases similar to yours.

Advanced out-of-the-box PTAB and TTAB analytics are always at your fingertips.

API

Docket Alarm offers a powerful API (application programming interface) to developers that want to integrate case filings into their apps.

LAW FIRMS

Build custom dashboards for your attorneys and clients with live data direct from the court.

Automate many repetitive legal tasks like conflict checks, document management, and marketing.

FINANCIAL INSTITUTIONS

Litigation and bankruptcy checks for companies and debtors.

E-DISCOVERY AND LEGAL VENDORS

Sync your system to PACER to automate legal marketing.