

Data Acquisition Systems Introduction

Data acquisition and conversion systems interface between the real world of physical parameters, which are analog, and the artificial world of digital computation and control. With current emphasis on digital systems, the interfacing function has become an important one; digital systems are used widely because complex circuits are low cost, accurate, and relatively simple to implement. In addition, there is rapid growth in use of minicomputers and microcomputers to perform difficult digital control and measurement functions.

Computerized feedback control systems are used in many different industries today in order to achieve greater productivity in our modern industrial society. Industries which presently employ such automatic systems include steel making, food processing, paper production, oil refining, chemical manufacturing, textile production, and cement manufacturing.

The devices which perform the interfacing function between analog and digital worlds are analog-to-digital (A/D) and digital-to-analog (D/A) converters, which together are known as data converters. Some of the specific applications in which data converters are used include data telemetry systems, pulse code modulated communications, automatic test systems, computer display systems, video signal processing systems, data logging systems, and sampled data control systems. In addition, every laboratory digital multimeter or digital panel meter contains an A/D converter.

Besides A/D and D/A converters, data acquisition and distribution systems may employ one or more of the following circuit functions:

Basic Data Distribution Systems

- Transducers
- Amplifiers
- Filters
- Nonlinear Analog Functions
- Analog Multiplexers
- Sample-Holds

The interconnection of these components is shown in the diagram of the data acquisition portion of a computerized feedback control system in Figure 1.

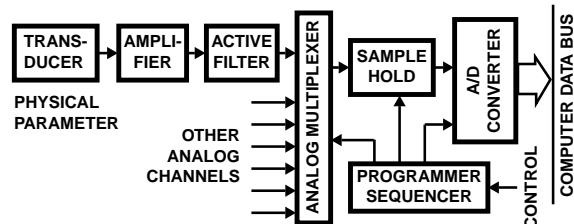

FIGURE 1. DATA ACQUISITION SYSTEM

The input to the system is a physical parameter such as temperature, pressure, flow, acceleration, and position, which are analog quantities. The parameter is first converted into an electrical signal by means of a transducer, once in electrical form, all further processing is done by electronic circuits.

Next, an amplifier boosts the amplitude of the transducer output signal to a useful level for further processing. Transducer outputs may be microvolt or millivolt level signals which are then amplified to 1 to 10V levels. Furthermore, the transducer output may be a high impedance signal, a differential signal with common-mode noise, a current output, a signal superimposed on a high voltage, or a combination of these. The amplifier, in order to convert such signals into a high level voltage, may be one of several specialized types.

The amplifier is frequently followed by a low pass active filter which reduces high frequency signal components, unwanted electrical interference noise, or electronic noise from the signal. The amplifier is sometimes also followed by a special nonlinear analog function circuit which performs a nonlinear operation on the high level signal. Such operations include squaring, multiplication, division, RMS conversion, log conversion, or linearization.

The processed analog signal next goes to an analog multiplexer which sequentially switches between a number of different analog input channels. Each input is in turn connected to the output of the multiplexer for a specified period of time by the multiplexer switch. During this connection time a sample-hold circuit acquires the signal voltage and then holds its value while an analog-to-digital converter converts the value into digital form. The resultant digital word goes to a computer data bus or to the input of a digital circuit.

Thus the analog multiplexer, together with the sample-hold, time shares the A/D converter with a number of analog input channels. The timing and control of the complete data acquisition system is done by a digital circuit called a programmer-sequencer, which in turn is under control of the

computer. In some cases the computer itself may control the entire data acquisition system.

While this is perhaps the most commonly used data acquisition system configuration, there are alternative ones. Instead of multiplexing high-level signals, low-level multiplexing is sometimes used with the amplifier following the multiplexer. In such cases just one amplifier is required, but its gain may have to be changed from one channel to the next during multiplexing. Another method is to amplify and convert the signal into digital form at the transducer location and send the digital information in serial form to the computer. Here the digital data must be converted to parallel form and then multiplexed onto the computer data bus.

Basic Data Acquisition System

The data distribution portion of a feedback control system, illustrated in Figure 2, is the reverse of the data acquisition system. The computer, based on the inputs of the data acquisition system, must close the loop on a process and control it by means of output control functions. These control outputs are in digital form and must therefore be converted into analog form in order to drive the process. The conversion is accomplished by a series of digital-to-analog converters as shown. Each D/A converter is coupled to the computer data bus by means of a register which stores the digital word until the next update. The registers are activated sequentially by a decoder and control circuit which is under computer control.

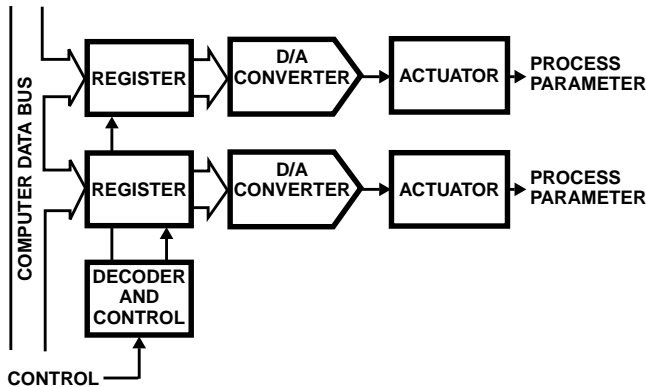

FIGURE 2. DATA DISTRIBUTION SYSTEM

The D/A converter outputs then drive actuators which directly control the various process parameters such as temperature, pressure, and flow. Thus the loop is closed on the process and the result is a complete automatic process control system under computer control.

Quantizing Theory

Introduction

Analog-to-digital conversion in its basic conceptual form is a two-step process: quantizing and coding. Quantizing is the process of transforming a continuous analog signal into a set

of discrete output states. Coding is the process of assigning a digital code word to each of the output states. Some of the early A/D converters were appropriately called quantizing encoders.

Quantizer Transfer Function

The nonlinear transfer function shown in Figure 3 is that of an ideal quantizer with 8 output states; with output code words assigned, it is also that of a 3-bit A/D converter. The 8 output states are assigned the sequence of binary numbers from 000 through 111. The analog input range for this quantizer is 0 to +10V.

There are several important points concerning the transfer function of Figure 3. First, the resolution of the quantizer is defined as the number of output states expressed in bits; in this case it is a 3-bit quantizer. The number of output states for a binary coded quantizer is 2^n , where n is the number of bits. Thus, an 8-bit quantizer has 256 output states and a 12-bit quantizer has 4096 output states.

As shown in the diagram, there are $2^n - 1$ analog decision points (or threshold levels) in the transfer function. These points are at voltages of +0.625, +1.875, +3.125, +4.375, +5.625, +6.875, and +8.125. The decision points must be precisely set in a quantizer in order to divide the analog voltage range into the correct quantized values.

The voltages +1.25, +2.50, +3.75, +5.00, +6.25, +7.50, and +8.75 are the center points of each output code word. The analog decision point voltages are precisely halfway between the code word center points. The quantizer staircase function is the best approximation which can be made to a straight line drawn through the origin and full scale point; notice that the line passes through all of the code word center points.

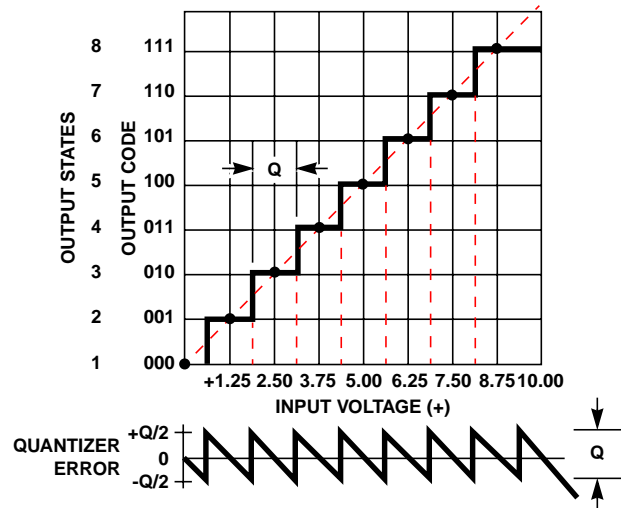

FIGURE 3. TRANSFER FUNCTION OF IDEAL 3-BIT QUANTIZER

Quantizer Resolution and Error

At any part of the input range of the quantizer, there is a small range of analog values within which the same output code word is produced. This small range is the voltage difference between any two adjacent decision points and is known as the analog quantization size, or quantum, Q. In Figure 3, the quantum is 1.25V and is found in general by dividing the full scale analog range by the number of output states. Thus

$$Q = \frac{FSR}{2^n} \tag{EQ. 1}$$

where FSR is the full scale range, or 10V in this case. Q is the smallest analog difference which can be resolved, or distinguished, by the quantizer. In the case of a 12-bit quantizer, the quantum is much smaller and is found to be

$$Q = \frac{FSR}{2^n} = \frac{10V}{4096} = 2.44mV \tag{EQ. 2}$$

If the quantizer input is moved through its entire range of analog values and the difference between output and input is taken, a sawtooth error function results, as shown in Figure 3. This function is called the quantizing error and is the irreducible error which results from the quantizing process. It can be reduced only by increasing the number of output states (or the resolution) of the quantizer, thereby making the quantization finer.

For a given analog input value to the quantizer, the output error will vary anywhere from 0 to $\pm Q/2$; the error is zero only at analog values corresponding to the code center points. This error is also frequently called quantization uncertainty or quantization noise.

The quantizer output can be thought of as the analog input with quantization noise added to it. The noise has a peak-to-peak value of Q but, as with other types of noise, the average value is zero. Its RMS value, however, is useful in analysis and can be computed from the triangular waveshape to be $Q/2\sqrt{3}$.

Sampling Theory

Introduction

An analog-to-digital converter requires a small, but significant, amount of time to perform the quantizing and coding operations. The time required to make the conversion depends on several factors; the converter resolution, the conversion technique, and the speed of the components employed in the converter. The conversion speed required for a particular application depends on the time variation of the signal to be converted and on the accuracy desired.

Aperture Time

Conversion time is frequently referred to as aperture time. In general, aperture time refers to the time uncertainty (or time

window) in making a measurement and results in an amplitude uncertainty (or error) in the measurement if the signal is changing during this time.

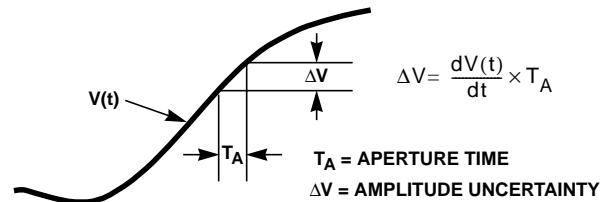

FIGURE 4. APETURE TIME AND AMPLITUDE UNCERTAINTY

As shown in Figure 4, the input signal to the A/D converter changes by ΔV during the aperture time T_A in which the conversion is performed. The error can be considered an amplitude error or a time error, the two are related as follows:

$$\Delta V = T_A \frac{dV(t)}{dt} \tag{EQ. 3}$$

where $dV(t)/dt$ is the rate of change with time of the input signal.

It should be noted that ΔV represents the maximum error due to signal change, since the actual error depends on how the conversion is done. At some point in time within T_A , the signal amplitude corresponds exactly with the output code word produced.

For the specific case of a sinusoidal input signal, the maximum rate of change occurs at the zero crossing of the waveform, and the amplitude error is

$$\Delta V = T_A \frac{d}{dt}(A \sin \omega t)_{t=0} = T_A A \omega \tag{EQ. 4}$$

The resultant error as a fraction of the peak to peak full scale value is

$$\epsilon = \frac{\Delta V}{2A} = \pi f T_A \tag{EQ. 5}$$

From this result the aperture time required to digitize a 1kHz signal to 10 bits resolution can be found. The resolution required is one part in 2^{10} or 0.001.

$$T_A = \frac{\epsilon}{\pi f} = \frac{0.001}{3.14 \times 10^3} = 320 \times 10^{-9} \tag{EQ. 6}$$

The result is a required aperture time of just 320ns!

One should appreciate the fact that 1kHz is not a particularly fast signal, yet it is difficult to find a 10-bit A/D converter to perform this conversion at any price! Fortunately, there is a relatively simple and inexpensive way around this dilemma by using a sample-and-hold circuit.

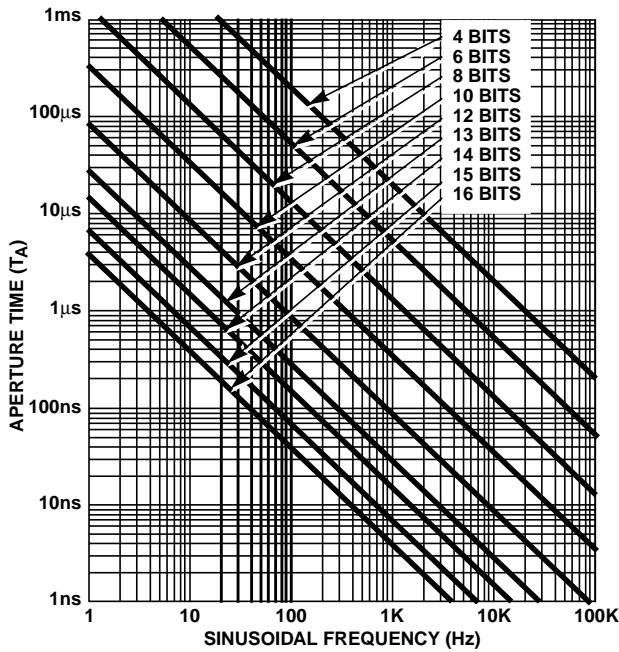

FIGURE 5. GRAPH FOR APERTURE ERROR FOR SINUSOIDAL SIGNALS

Sample-Holds and Aperture Error

A sample-and-hold circuit samples the signal voltage and then stores it on a capacitor for the time required to perform the A/D conversion. The aperture time of the A/D converter is therefore greatly reduced by the much shorter aperture time of the sample-and-hold circuit. In turn, the aperture time of the sample-and-hold is a function of its bandwidth and switching time.

Figure 5 is a useful graph of Equation 5. It gives the aperture time required for converting sinusoidal signals to a maximum error less than one part in 2^n where n is the resolution of the converter in bits. The peak to peak value of the sinusoid is assumed to be the full scale range of the A/D converter. The graph is most useful in selecting a sample-and-hold by aperture time or an A/D converter by conversion time.

Sampled-Data Systems and the Sampling Theorem

In data acquisition and distribution systems, and other sampled-data systems, analog signals are sampled on a periodic basis as illustrated in Figure 6. The train of sampling pulses in Figure 6B represents a fast-acting switch which connects to the analog signal for a very short time and then disconnects for the remainder of the sampling period.

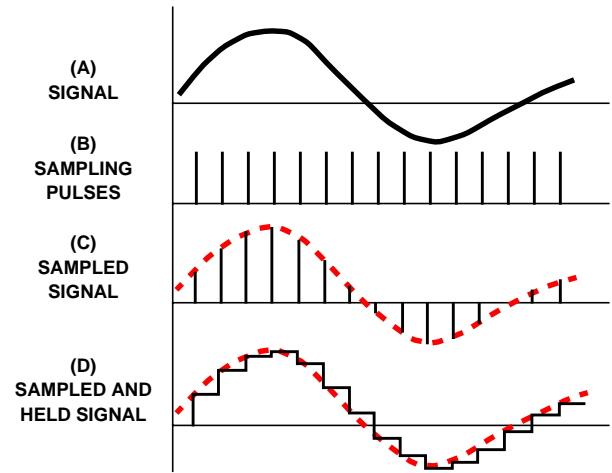

FIGURE 6. SIGNAL SAMPLING

The result of the fast-acting sampler is identical with multiplying the analog signal by a train of sampling pulses of unity amplitude, giving the modulated pulse train of Figure 6C. The amplitude of the original signal is preserved in the modulation envelope of the pulses. If the switch type sampler is replaced by a switch and capacitor (a sample-and-hold circuit), then the amplitude of each sample is stored between samples and a reasonable reconstruction of the original analog signal results, as shown in Figure 6D.

The purpose of sampling is the efficient use of data processing equipment and data transmission facilities. A single data transmission link, for example, can be used to transmit many different analog channels on a sampled basis, where-as it would be uneconomical to devote a complete transmission link to the continuous transmission of a single signal.

Likewise, a data acquisition and distribution system is used to measure and control the many parameters of a process control system by sampling the parameters and updating the control inputs periodically. In data conversion systems it is common to use a single, expensive A/D converter of high speed and precision and then multiplex a number of analog inputs into it.

An important fundamental question to answer about sampled-data systems is this: "How often must I sample an analog signal in order not to lose information from it?" It is obvious that all useful information can be extracted if a slowly varying signal is sampled at a rate such that little or no change takes place between samples. Equally obvious is the fact that information is being lost if there is a significant change in signal amplitude between samples.

The answer to the question is contained in the well known Sampling Theorem which may be stated as follows: If a continuous bandwidth-limited signal contains no frequency components higher than f_c , then the original signal can be recovered without distortion if it is sampled at a rate of at least $2 f_c$ samples per second.

Frequency Folding and Aliasing

The Sampling Theorem can be demonstrated by the frequency spectra illustrated in Figure 7. Figure 7A shows the frequency spectrum of a continuous bandwidth-limited analog signal with frequency components out to f_C . When this signal is sampled at a rate f_S , the modulation process shifts the original spectrum out of f_S , $2f_S$, $3f_S$, etc. in addition to the one at the origin. A portion of this resultant spectrum is shown in Figure 7B.

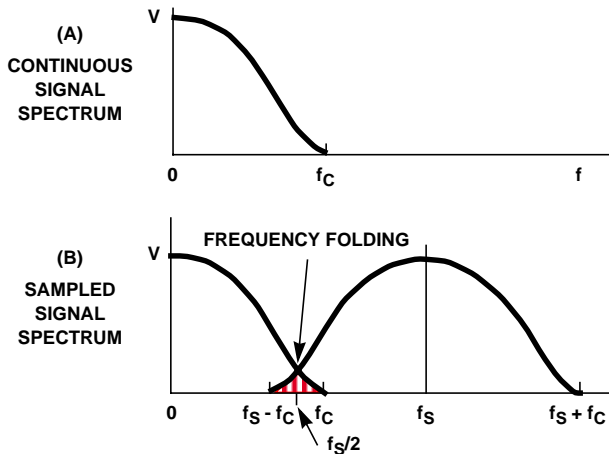

FIGURE 7. FREQUENCY SPECTRA DEMONSTRATING THE SAMPLING THEOREM

If the sampling frequency f_S is not high enough, part of the spectrum centered about f_S will fold over into the original signal spectrum. This undesirable effect is called frequency folding. In the process of recovering the original signal, the folded part of the spectrum causes distortion in the recovered signal which cannot be eliminated by filtering the recovered signal.

From the figure, if the sampling rate is increased such that $f_S - f_C > f_C$, then the two spectra are separated and the original signal can be recovered without distortion. This demonstrates the result of the Sampling Theorem that $f_S > 2f_C$. Frequency folding can be eliminated in two ways: first by using a high enough sampling rate, and second by filtering the signal before sampling to limit its bandwidth to $f_S/2$.

One must appreciate the fact that in practice there is always some frequency folding present due to high frequency signal components, noise and non-ideal pre-sample filtering. The effect must be reduced to negligible amounts for the particular application by using a sufficiently high sampling rate. The required rate, in fact, may be much higher than the minimum indicated by the Sampling Theorem.

The effect of an inadequate sampling rate on a sinusoid is illustrated in Figure 8; an alias frequency in the recovered signal results. In this case, sampling at a rate slightly less than twice per cycle gives the low frequency sinusoid shown by the dotted line in the recovered signal. This alias

frequency can be significantly different from the original frequency. From the figure it is easy to see that if the sinusoid is sampled at least twice per cycle, as required by the Sampling Theorem, the original frequency is preserved.

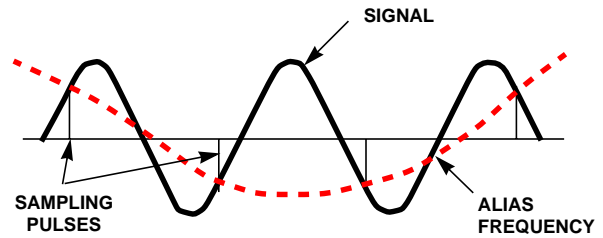

FIGURE 8. ALIAS FREQUENCY CAUSED BY INADEQUATE SAMPLING RATE

Coding for Data Converters

Natural Binary Code

A/D and D/A converters interface with digital systems by means of an appropriate digital code. While there are many possible codes to select, a few standard ones are almost exclusively used with data converters. The most popular code is natural binary, or straight binary, which is used in its fractional form to represent a number

$$N = a_1 2^{-1} + a_2 2^{-2} + a_3 2^{-3} + \dots + a_n 2^{-n} \tag{EQ. 7}$$

where each coefficient "a" assumes a value of zero or one. N has a value between zero and one.

A binary fraction is normally written as 0.110101, but with data converter codes the decimal point is omitted and the code word is written 110101. This code word represents a fraction of the full scale value of the converter and has no other numerical significance.

The binary code word 110101 therefore represents the decimal fraction $(1 \times 0.5) + (1 \times 0.25) + (1 \times 0.125) + (1 \times 0.0625) + (0 \times 0.03125) + (1 \times 0.015625) = 0.828125$ or 82.8125% of full scale for the converter. If full scale is +10V, then the code word represents +8.28125V. The natural binary code belongs to a class of codes known as positive weighted codes since each coefficient has a specific weight, none of which is negative.

The leftmost bit has the most weight, 0.5 of full scale, and is called the most significant bit, or MSB; the rightmost bit has the least weight, 2^{-n} of full scale, and is therefore called the least significant bit, or LSB. The bits in a code word are numbered from left to right from 1 to n.

The LSB has the same analog equivalent value as Q discussed previously, namely

$$\text{LSB (Analog Value)} = \frac{\text{FSR}}{2^n} \tag{EQ. 8}$$

Explore Litigation Insights

Docket Alarm provides insights to develop a more informed litigation strategy and the peace of mind of knowing you're on top of things.

Real-Time Litigation Alerts



Keep your litigation team up-to-date with **real-time alerts** and advanced team management tools built for the enterprise, all while greatly reducing PACER spend.

Our comprehensive service means we can handle Federal, State, and Administrative courts across the country.

Advanced Docket Research



With over 230 million records, Docket Alarm's cloud-native docket research platform finds what other services can't. Coverage includes Federal, State, plus PTAB, TTAB, ITC and NLRB decisions, all in one place.

Identify arguments that have been successful in the past with full text, pinpoint searching. Link to case law cited within any court document via Fastcase.

Analytics At Your Fingertips



Learn what happened the last time a particular judge, opposing counsel or company faced cases similar to yours.

Advanced out-of-the-box PTAB and TTAB analytics are always at your fingertips.

API

Docket Alarm offers a powerful API (application programming interface) to developers that want to integrate case filings into their apps.

LAW FIRMS

Build custom dashboards for your attorneys and clients with live data direct from the court.

Automate many repetitive legal tasks like conflict checks, document management, and marketing.

FINANCIAL INSTITUTIONS

Litigation and bankruptcy checks for companies and debtors.

E-DISCOVERY AND LEGAL VENDORS

Sync your system to PACER to automate legal marketing.