



US005508821A

United States Patent [19]

Murata

[11] Patent Number: **5,508,821**

[45] Date of Patent: **Apr. 16, 1996**

[54] **IMAGE SCANNER AND IMAGE FORMING APPARATUS WITH AN INTERFACE FOR CONNECTION WITH AN EXTERNAL COMPUTER**

[75] Inventor: **Kazuyuki Murata**, Tsuzuki, Japan

[73] Assignee: **Matsushita Electric Industrial Co., Ltd.**, Kadoma, Japan

[21] Appl. No.: **36,028**

[22] Filed: **Mar. 23, 1993**

[30] **Foreign Application Priority Data**

Apr. 9, 1992 [JP] Japan 4-88541
Aug. 7, 1992 [JP] Japan 4-211102

[51] **Int. Cl.⁶** **H04N 1/00**; H04N 1/21; G06F 3/00; G06F 9/455; G06F 13/00

[52] **U.S. Cl.** **358/442**; 358/444; 358/471; 395/500; 395/828; 395/830; 395/882; 395/883; 395/892

[58] **Field of Search** 358/471, 452, 358/474; 395/500, 275, 444, 468, 828, 830, 882, 883, 892

[56] **References Cited**

U.S. PATENT DOCUMENTS

4,855,905 8/1989 Estrada et al. 364/500

4,896,262	1/1990	Wayama et al.	395/500
4,958,315	9/1990	Balch	395/500
4,975,829	12/1990	Clarey et al.	364/500
5,088,033	2/1992	Binkley et al.	395/500
5,131,089	7/1992	Cole	395/500
5,157,384	10/1992	Greanias et al.	345/156

OTHER PUBLICATIONS

Operating Systems: Design and Implementation, Andrew S. Tanenbaum, 1987, pp. 299-308.

Primary Examiner—Scott A. Rogers
Attorney, Agent, or Firm—Ratner & Prestia

[57] **ABSTRACT**

An image scanner is occasionally used with an external host computer and includes an optical system and a CCD image sensor for reading an image of a document placed on a document platform. The image scanner further includes a small computer system interface (SCSI) for connecting the image scanner to the external host apparatus, and a CPU, a nonvolatile memory, an SCSI controller etc. for emulating a file system contained in the external host computer.

10 Claims, 7 Drawing Sheets

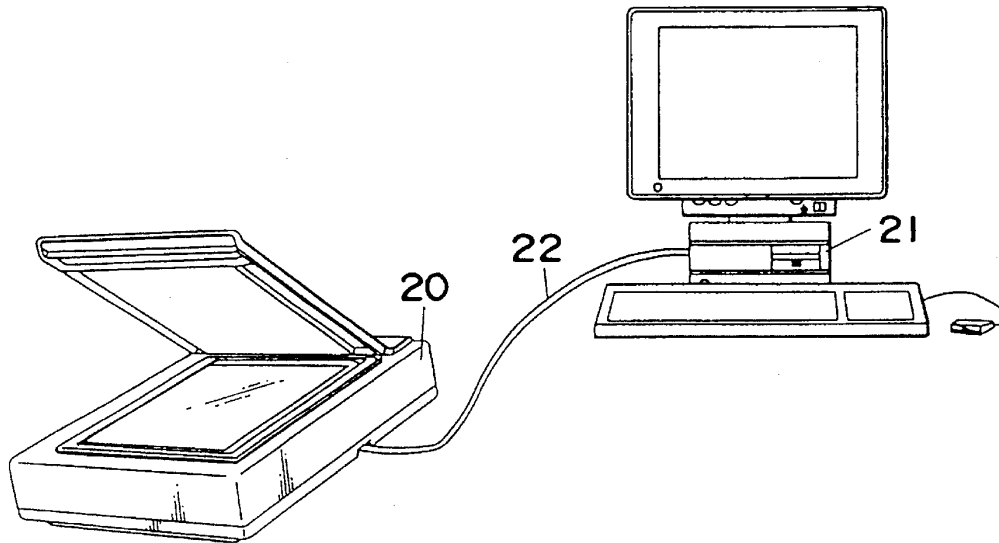

Papst Licensing GmbH & Co., KG.
Petitioner - Apple, Inc.
Patent Owner - Papst Licensing GmbH & Co., KG.
IPR2016-01841

Fig. 1

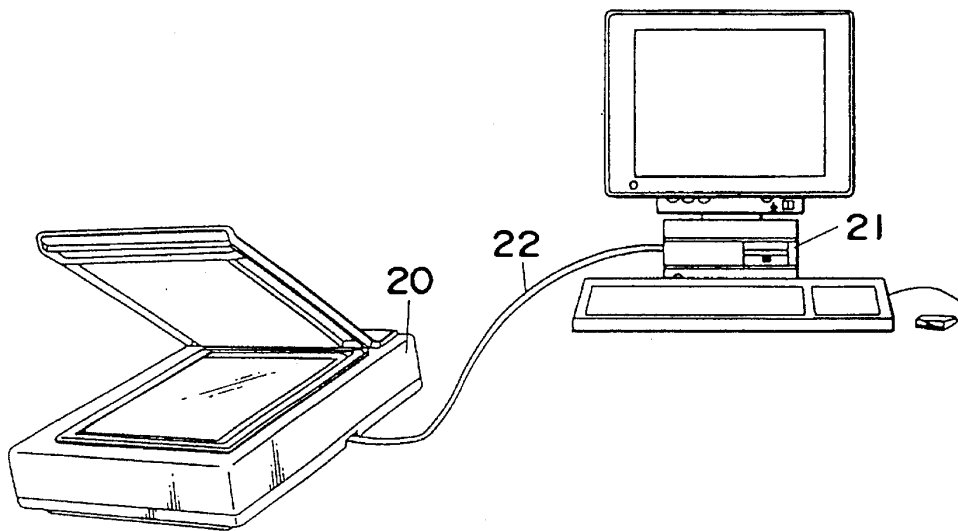
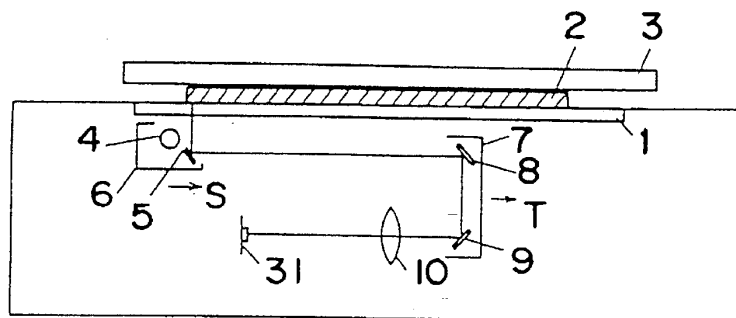

Fig. 2



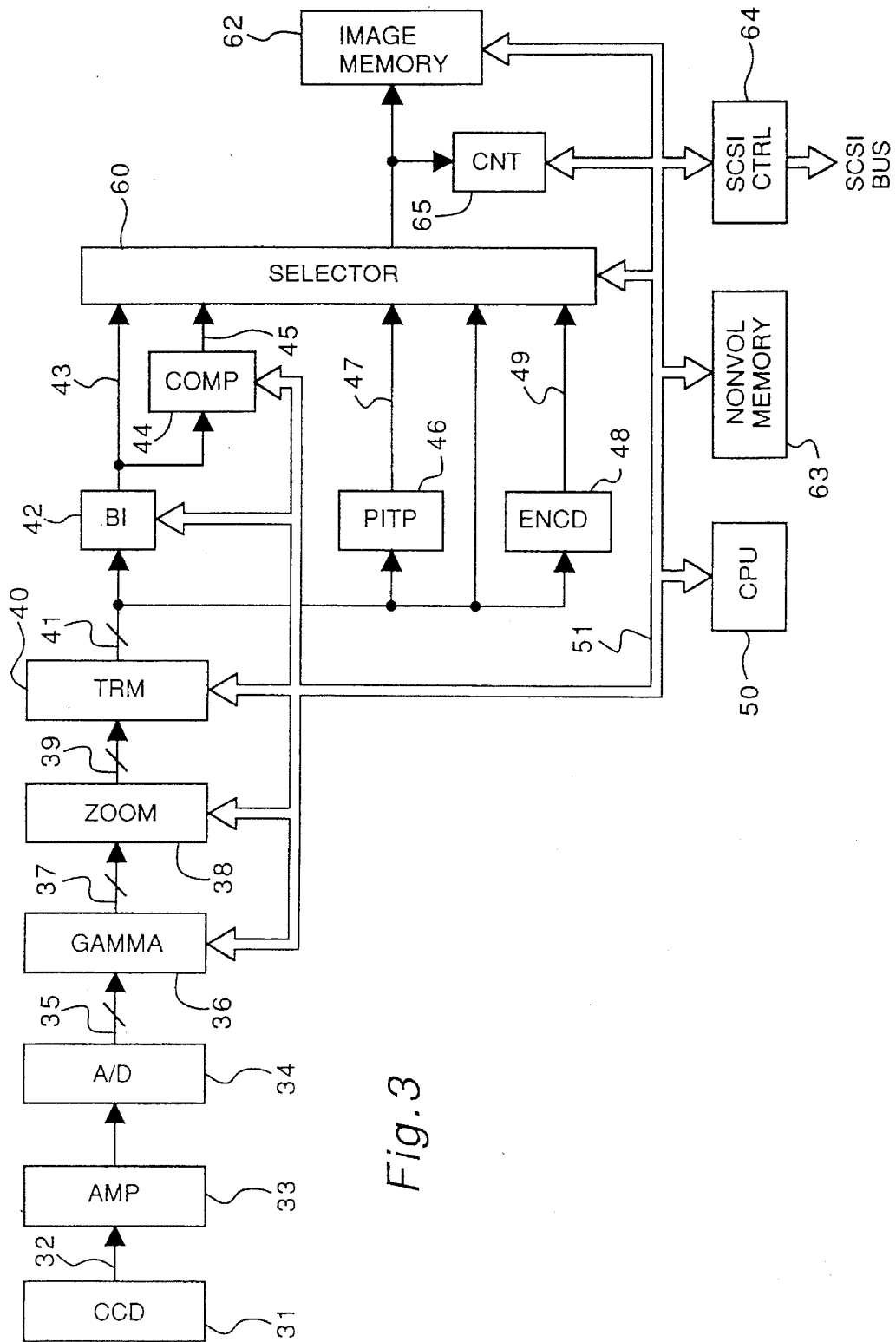

Fig. 3

Fig.4

```

#SCANNER PARAMETER FILE EXAMPLE
# AREA PARAMETER(inch)
# X,Y,XL,YL
1.2
2.4
5.5
6.3

#ZOOMING PARAMETER(%) XZ,YZ
100
150

#IMAGE PROCESSING PARAMETER
#     SIMPLE BI-LEVEL IMAGE           ->0
#     BI-LEVEL COMPRESSION IMAGE(MH)  ->1
#     BI-LEVEL COMPRESSION IMAGE(MR)  ->2
#     BI-LEVEL COMPRESSION IMAGE(MMR) ->3
#     ERROR DIFFUSION BI-LEVEL IMAGE  ->4
#     88ITS GRAY SCALE IMAGE          ->5
#     88ITS GRAY SCALE COMPRESSION IMAGE ->6
1

#GAMMA TRANSFER PARAMETER
#     LINEAR           ->0
#     DENSITY         ->1
#     DATE SETTABLE   ->2
2

#GAMMA TRANSFER DATA TABLE
#DATA MUST BE 0 (<=.255) =
00 10 17 1C 20 24 27 2A 20 30 32 35 37 3A 3C 3E
40 42 44 46 47 49 4B 4D 4E 50 51 53 54 56 57 59
5A 5C 5D 5E 60 61 62 64 65 66 67 69 6A 6B 6C 6D
6F 70 71 72 73 74 75 76 77 79 7A 7B 7C 7D 7E 7F
80 81 82 83 84 85 86 87 87 88 89 8A 8B 8C 8D 8E
8F 90 91 91 92 93 94 95 96 97 97 98 99 9A 9B 9C
9C 9D 9E 9F A0 A0 A1 A2 A3 A4 A4 A5 A6 A7 A7 A8
A9 AA AA AB AC AD AD AE AF B0 B0 B1 B2 B3 B3 B4
B5 B5 B6 B7 B7 B8 B9 BA BA BB BC BC BD BE BE BF
C0 C0 C1 C2 C2 C3 C4 C4 C5 C6 C6 C7 C7 C8 C9 C9
CA CB CB CC CC CD CE CE CF D0 D0 D1 D1 D2 D3 D3
D4 D4 D5 D6 D6 D7 D7 D8 D9 D9 DA DA DB DC DC DD
DD DE DE DF E0 E0 E1 E1 E2 E2 E3 E4 E4 E5 E5 E6
E6 E7 E7 E8 E9 E9 EA EA EB EB EC EC ED ED EE EE
EF F0 F0 F1 F1 F2 F2 F3 F3 F4 F4 F5 F5 F6 F6 F7
F7 F8 F8 F9 F9 FA FA FB FB FC FC FD FD FE FE FF

```

Fig.5

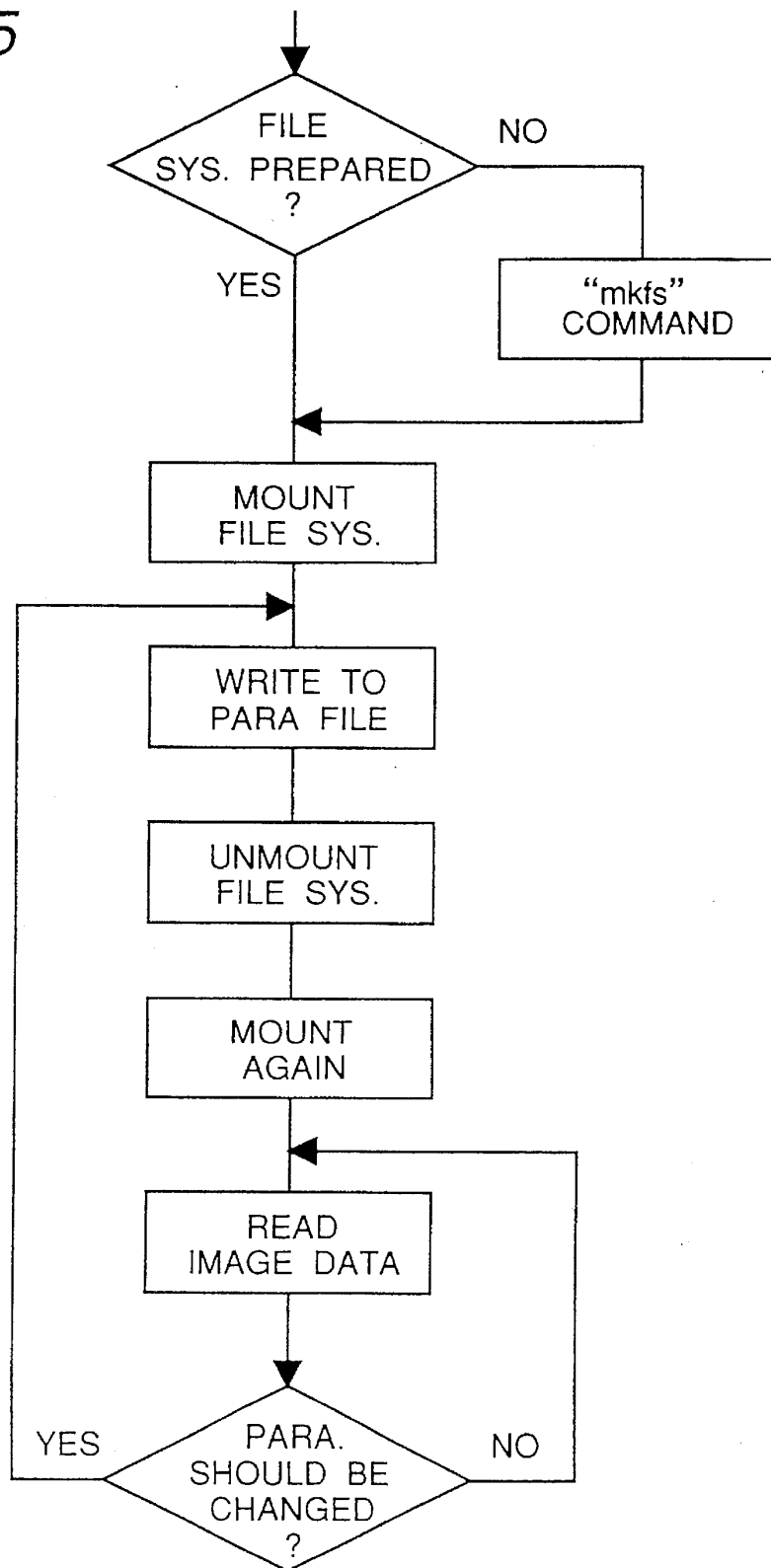

Explore Litigation Insights

Docket Alarm provides insights to develop a more informed litigation strategy and the peace of mind of knowing you're on top of things.

Real-Time Litigation Alerts



Keep your litigation team up-to-date with **real-time alerts** and advanced team management tools built for the enterprise, all while greatly reducing PACER spend.

Our comprehensive service means we can handle Federal, State, and Administrative courts across the country.

Advanced Docket Research



With over 230 million records, Docket Alarm's cloud-native docket research platform finds what other services can't. Coverage includes Federal, State, plus PTAB, TTAB, ITC and NLRB decisions, all in one place.

Identify arguments that have been successful in the past with full text, pinpoint searching. Link to case law cited within any court document via Fastcase.

Analytics At Your Fingertips



Learn what happened the last time a particular judge, opposing counsel or company faced cases similar to yours.

Advanced out-of-the-box PTAB and TTAB analytics are always at your fingertips.

API

Docket Alarm offers a powerful API (application programming interface) to developers that want to integrate case filings into their apps.

LAW FIRMS

Build custom dashboards for your attorneys and clients with live data direct from the court.

Automate many repetitive legal tasks like conflict checks, document management, and marketing.

FINANCIAL INSTITUTIONS

Litigation and bankruptcy checks for companies and debtors.

E-DISCOVERY AND LEGAL VENDORS

Sync your system to PACER to automate legal marketing.