

CONTAINS A SCSI
MONITOR TOOL TOGETHER WITH
COMPLETE EXAMPLE SOURCE CODE
ON DISK

The SCSI Bus and IDE Interface

Protocols, Applications
and Programming

Friedhelm Schmidt



ADDISON-WESLEY



DISK INCLUDED

Apple 1007
U.S. Pat. 9,189,437

—◆—

The
SCSI Bus
and
IDE Interface

—◆—

◆

The SCSI Bus and IDE Interface

Protocols, Applications and Programming

◆

Friedhelm Schmidt

Translated by
J. Michael Schultz
TransTech Translations



ADDISON-WESLEY
PUBLISHING
COMPANY

Wokingham, England • Reading, Massachusetts • Menlo Park, California • New York
Don Mills, Ontario • Amsterdam • Bonn • Sydney • Singapore
Tokyo • Madrid • San Juan • Milan • Paris • Mexico City • Seoul • Taipei

© 1995 Addison-Wesley Publishers Ltd.
© 1995 Addison-Wesley Publishing Company Inc.

Translated from the German edition *SCSI-Bus und IDE-Schnittstelle*
published by Addison-Wesley (Deutschland) GmbH.

All rights reserved. No part of this publication may be reproduced, stored in a retrieval system, or transmitted in any form or by any means, electronic, mechanical, photocopying, recording or otherwise, without prior written permission of the publisher.

The programs in this book have been included for their instructional value. They have been tested with care but are not guaranteed for any particular purpose. The publisher does not offer any warranties or representations nor does it accept any liabilities with respect to the programs.

Many of the designations used by manufacturers and sellers to distinguish their products are claimed as trademarks. Addison-Wesley has made every attempt to supply trademark information about manufacturers and their products mentioned in this book.

Cover designed by Designers & Partners, Oxford
and printed by The Riverside Printing Co. (Reading) Ltd.
Typeset by VAP Group, Kidlington, Oxon.
Printed and bound in Great Britain at T.J. Press (Padstow) Ltd, Padstow, Cornwall

First printed 1995

ISBN 0-201-42284-0

British Library Cataloguing in Publication Data
A catalogue record for this book is available from the British Library.

Library of Congress Cataloging-in-Publication Data
Schmidt, Friedhelm
(SCSI-Bus und IDE-Schnittstelle. English)
The SCSI bus and IDE interface/Friedhelm Schmidt; translated by
Michael Schultz.

p. cm.

Includes index.

ISBN 0-201-42284-0

1. SCSI (Computer bus) 2. IDE (Standard) I. Title

TK7895.B87S36 1995

004. 6'2--dc20

94-23813
CIP

Preface

The SCSI bus and IDE interface are without question the two most important interfaces for computer peripherals in use today. The IDE hard disk interface is found almost exclusively in the world of IBM PC compatibles. The SCSI bus, on the other hand, is designed not only for hard drives but also for tape drives, CD-ROM, scanners, and printers. Almost all modern computers, from PCs to workstations to mainframes, are equipped with a SCSI interface.

Both SCSI and IDE are ANSI standards. However, aside from the actual ANSI documentation, there exists almost no additional reference material to either specification. The purpose of this book is to fill that void with a clear, concise description of both interfaces. The essential terminology is introduced, while the commands and protocols are broken down in full. In the interest of economy the less important details and options have been omitted in certain cases. Often a specific section in the ANSI documentation will be cited for easy cross-referencing. After reading this book you should be in the position to easily understand relevant technical documentation, including the ANSI specifications themselves.

First and foremost, a thorough introduction to the terminology is in order. Especially with respect to SCSI, there is a deluge of terms and definitions that are used nowhere else or are used differently than in other computer domains. These keywords, which include signal names and interface commands, are typeset in small capital letters, for example `FORMAT UNIT`.

This book is intended for readers with a broad range of technical backgrounds and interests. Those working on the design of mass storage devices, for example, will find the protocol descriptions extremely useful. Readers writing software or device drivers may have other interests. They will find the hardware descriptions, such as that of the physical organization of a disk drive, very helpful.

This book is not meant to replace the ANSI documentation. On the other hand, those specifications are not meant to explain the technology, rather to define it. It is very difficult to find your way around in the original documentation without an understanding of the subject matter. The book's thorough, in-depth descriptions, along with index and glossary, make it the perfect tutor for IDE and SCSI, as well as a helpful guide to the ANSI literature.

*Friedhelm Schmidt
February 1993*

Contents

Preface	v
Part I Introduction	1
1 Computers and peripherals	3
1.1 Mass storage	4
1.2 Peripheral interfaces	5
2 Traditional peripheral interfaces	7
2.1 The RS-232 serial interface	7
2.2 The Centronics printer interface	10
2.3 Hard disks and their interfaces	13
2.4 ST506	19
2.5 ESDI	23
3 Computer buses	29
3.1 Characteristics of buses	30
3.2 Specialized buses	32
Part II The IDE interface	35
4 Background	37
4.1 The origin of IDE	37
4.2 Overview	38
4.3 Outlook	40
4.4 Documentation	41
5 The physical IDE interface	44
5.1 The electrical interface	44
5.2 Timing specifications	47
6 IDE protocol	50
6.1 The register model of the IDE controller	50
6.2 Command execution	55
6.3 Power-up or hardware reset	58

7	The model of an IDE disk drive	60
7.1	Organization of the medium	60
7.2	Defect management	62
7.3	The sector buffer	63
7.4	Power conditions	64
8	IDE commands	66
8.1	Mandatory commands	66
8.2	Optional commands	70
Part III	The SCSI bus	75
9	Background	77
9.1	The evolution of SCSI	77
9.2	Overview	79
9.3	Outlook	84
9.4	Documentation	85
10	SCSI hardware	89
10.1	SCSI configurations	89
10.2	SCSI signals	92
10.3	Cables and connectors	96
10.4	Single-ended SCSI	96
10.5	Differential SCSI	100
10.6	SCSI bus phases	102
10.7	Synchronous transfers and Fast SCSI	113
10.8	Wide SCSI	116
11	SCSI bus protocol	117
11.1	The message system	117
11.2	I/O processes	119
11.3	SCSI pointers	122
11.4	Disconnect-reconnect: freeing the bus	123
11.5	Transfer options	124
11.6	Tagged queues	126
11.7	Termination of I/O processes	127
11.8	Error handling in the message system	129
11.9	Asynchronous event notification	129
12	SCSI commands	131
12.1	The SCSI target model	131
12.2	Command descriptor blocks	133
12.3	Commands for all SCSI devices	138
12.4	Mode parameter pages for all device classes	155

13	Direct access devices	158
13.1	The model of a SCSI disk drive	158
13.2	Hard disk commands	165
13.3	Mode parameter pages for disk drives	173
14	Tape drives	180
14.1	The model of a SCSI tape drive	180
14.2	Commands for tape devices	184
14.3	Mode parameters for tape devices	190
15	Printers	193
15.1	The model of a SCSI printer	193
15.2	Printer commands	194
15.3	Mode parameters for printers	197
16	Scanners	200
16.1	The model of a SCSI scanner	200
16.2	Scanner commands	202
16.3	Mode parameters for scanners	204
17	Processor devices	206
17.1	The model of a SCSI processor device	206
17.2	Commands for processor devices	207
18	Communications devices	210
18.1	The model of a SCSI communications device	210
18.2	Commands for SCSI communications devices	211
18.3	Mode parameter pages for communications devices	213
19	Optical storage and WORM drives	214
19.1	The SCSI model of optical storage	214
19.2	Commands for optical storage and WORM drives	215
19.3	Mode parameters for optical storage	220
20	CD-ROM	222
20.1	The model of a SCSI CD-ROM drive	222
20.2	Commands for CD-ROM	224
20.3	Audio commands for CD-ROM	227
20.4	Mode parameters for CD-ROMs	229
21	Medium-changer devices	233
21.1	The model of a SCSI medium-changer device	233
21.2	Commands for medium-changers	235
21.3	Mode parameter pages for medium-changers	237
22	The SCSI monitor program	240

23	Software interfaces	247
23.1	The concept of ASPI	248
23.2	SCSI request blocks	248
23.3	ASPI initialization and function calls	253
24	Test equipment	257
24.1	SCSI analyzers	257
24.2	SCSI emulators	258
24.3	Examples from industry	259
25	SCSI protocol chips	262
25.1	The NCR 5385	263
25.2	Target applications: EMULEX ESP200	264
25.3	PC host adapters: FUTURE DOMAIN TMC-950	266
Appendix A	SCSI commands (by opcode)	269
Appendix B	SCSI commands (alphabetically)	273
Appendix C	SCSI sense codes	276
Appendix D	The SCSI bulletin board	281
Appendix E	Source code for SCANSCSI.PAS	283
	Glossary	290
	Index	295

Part I

Introduction

- 1 Computers and peripherals
 - 2 Traditional peripheral interfaces
 - 3 Computer buses
-

1 Computers and peripherals

A computer can be broken down into a number of interdependent functional blocks. The most important of these are the central processing unit (CPU), main memory, input/output (I/O) and mass storage. The CPU executes the instructions of a program, which, along with the necessary data, must reside in main memory at execution time. Therefore, before a program can be run it must be loaded into main memory from mass storage. The data to be processed by the program comes either from mass storage or from an input device such as the keyboard. The CPU accesses memory at least once for each program step in order to read the corresponding machine instructions. In fact, several accesses are usually necessary to read and write data. For this reason the CPU and memory are very tightly coupled: access is uncomplicated and, above all, fast.

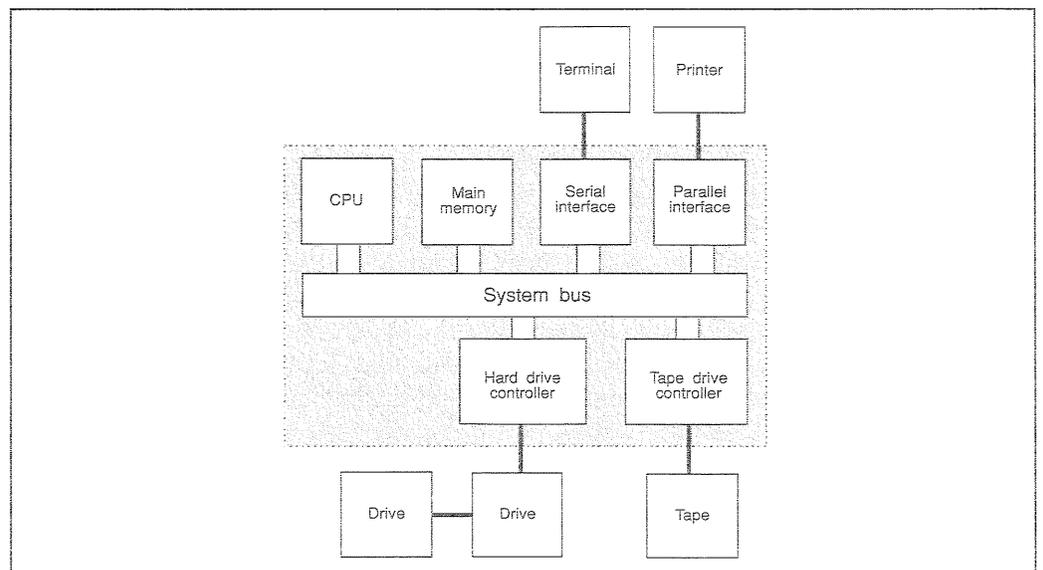

Figure 1.1 Computer system with peripheral devices.

In contrast to memory, I/O devices and mass storage are located further from the CPU, hence the name 'peripherals' (Figure 1.1). Access to such devices

is slower and more complicated. Communication with the peripherals is accomplished using an interface such as SCSI or IDE. On the other end of the interface is a controller, which in turn communicates with the CPU and memory.

1.1 Mass storage

A mass storage device is capable of storing data many times the size of main memory. In addition, information stored here is nonvolatile: when the device is turned off the data remains intact.

Hard disks Disk drives or hard disks store information by writing it onto rotating disks. The information is divided up into blocks of fixed length, each of which can be accessed relatively quickly, typically around 30 milliseconds (ms). For this reason hard disks are also referred to as random access mass storage devices. Among the different types of mass storage devices are hard disks, exchangeable medium drives, diskettes, optical disks and CD-ROM.

Tape devices In contrast to hard disks, tape devices (or tape drives) write data sequentially onto magnetic tape. The length of time needed to access a specific block of information depends on which position is presently underneath the read/write head. If it is necessary to rewind or fast forward the tape a very long distance, a tape access can take as long as several minutes. Tape drives are also known as sequential mass storage devices. Among these are the traditional reel-to-reel drives, cassette drives, drives that use video cassettes for recording and 4 mm digital audio tape (DAT) drives.

I/O devices Under the heading I/O devices are the monitor and keyboard used for communication between the user and the computer. Further examples of output devices are printers, plotters and even speakers used for outputting speech. Among the many input devices are mice, analog to digital converters, scanners and microphones used in speech recognition.

Network connections also fall into this category. This is especially so today where mass storage is often replaced by a file server across a network. Computers with no mass storage of their own are called diskless workstations.

Miscellaneous devices There are many more devices that exchange data with computers, although one hardly refers to a computer controlled lathe or a music synthesizer as a computer peripheral. Nevertheless, they function as peripherals and communicate with the computer using I/O.

1.2 Peripheral interfaces

Peripheral devices are connected to computer systems via interfaces. The abstract model of a peripheral interface is made up of many layers, the boundaries of which are not always clear, especially for older interfaces. It is also true that some layers are omitted in certain interface definitions. In this book I adhere to a model with four layers for the SCSI interface, as was agreed upon by the American National Standards Institute (ANSI) committee for the first time for SCSI-3. The strata of layers are designed bottom up. All low level layers are mandatory for the implementation of an interface. An uppermost layer, however, can be omitted in some cases. A high level interface refers to the case where all possible levels have been implemented.

Among those things defined in the lowest level are cable and connector types. Also defined are the signal voltages and the current requirements of the drivers. Finally, the timing and coordination of all of the signals of the bus are described here. This lowest level is referred to as the physical interface.

Directly above the physical layer resides the protocol layer. The protocol of an interface contains, for example, information about the difference between data bytes and command bytes and about the exchange of messages between devices. If corrupted data is to be corrected through the use of error correction, this is described in the interface protocol.

On top of the protocol layer lies the peripheral device model. Here the behavior of devices to be connected to the interface is described. These descriptions can be very detailed and precise. The SCSI bus is an example of such a detailed model, where in addition to the characteristics of general purpose SCSI devices, those of hard disks, tape drives, printers and so on are defined.

Finally, some interfaces go so far as to define which commands must be understood by the interface devices. The command set builds upon the device model and represents the fourth layer of the interface.

The term 'interface' always refers to all implemented layers in their entirety. There are distinct peripheral interfaces defined using the same physical level but a unique protocol level. It is also possible for a single interface to allow for different options in the physical level.

The interface used for printers is a good example of a four-layer interface. Figure 1.2 makes the relationships among the layers clear. The two lower levels are covered by the Centronics interface. This parallel interface contains the definition of the physical and protocol layers. The particular printer model in Figure 1.2 is a page printer. This means that the printer constructs an entire page in internal memory before printing it. In contrast to line printers, the lines of a page can be sent in any order as long as a page boundary is not crossed. However, once a page is printed it is impossible to retrieve it in order to make changes.

The page description language PostScript is an excellent example of a large and complex command set. It is built upon the page printer model and makes it possible to output text as well as various graphic elements. These elements can be positioned freely on the current page. Naturally, there are other

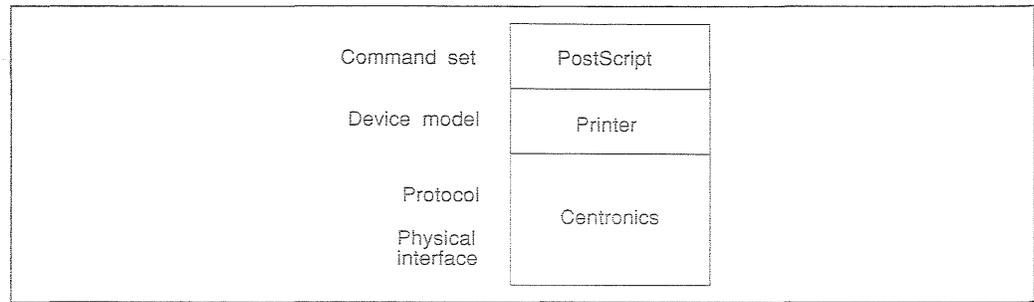

Figure 1.2 Layers of a printer interface.

such page formatting languages written for the page printer model. This makes the division between device and language very intuitive.

As you can see, this interface is complete in that it contains all four interface layers. If you purchase a printer with such an interface, it makes no difference which brand name you choose. As long as it is true to the interface specification it will work with any computer also equipped with the printer interface. However, if you were to omit even only the uppermost layer of the specification, then the interface description would be incomplete. It would still be possible to connect up the printer, but whether it would function properly would be a matter of luck.

The IDE interface and the SCSI bus are likewise complete interface definitions. Before getting to these, however, I would like to introduce in Chapter 2 a few classic examples of peripheral interfaces. For the most part their definitions contain only the lower layers of the interface model. This chapter will help to underscore the difference between traditional interfaces on the one hand and the complete IDE and SCSI interfaces on the other.

2 Traditional peripheral interfaces

This chapter will help to familiarize you with several classic peripheral interfaces of the computer industry. As with the printer interface outlined in Chapter 1, these will be described within the framework of the layered interface model. These descriptions are by no means comprehensive; complete specifications would turn this book into several volumes.

I have two goals in mind in presenting these interfaces. First of all, the interfaces are very simple; they will allow you to become acquainted with interface characteristics that are valid for all interfaces, including computer buses. Secondly, to a certain degree these specifications are the forerunners of competition to the IDE and SCSI bus interfaces. A background in the more traditional interfaces will make it much easier to evaluate and understand their modern descendants, the main topic of this book.

2.1 The RS-232 serial interface

RS-232C is the most widely used serial interface. 'Serial' means that the data is transferred one bit at a time across a single connection. RS-232C is used mainly for the connection of computer terminals and printers. Nonetheless, it is also appropriate for the exchange of data between computers. Machine tools and measurement instruments are frequently connected to computers using RS-232C. Understandably, it is not a device specific interface. RS-232C is the responsibility of the Electronic Industries Association (EIA).

The specification for RS-232C contains the physical layer and hardware protocol. In addition, there are software protocols, of which only a few build on top of the RS-232 hardware protocol. This leads to an uncommon situation with RS-232C and other serial interfaces – not all applications use all of the signals. Frequently cables are used that conduct only a few of the defined signals, a situation that would be unthinkable for IDE or SCSI. I concentrate here on a variation of the interface using only three signals, which I call mini-RS-232.

The physical interface

Mini-RS-232 establishes a bidirectional point-to-point connection between equipment. Each direction has its own data signal and a single ground signal is shared. The data signals are called TD (transmit data) and RD (receive data). When two devices are coupled to each other, these signals are crossed such that the TD of one device connects to the RD of the other (Figure 2.1).

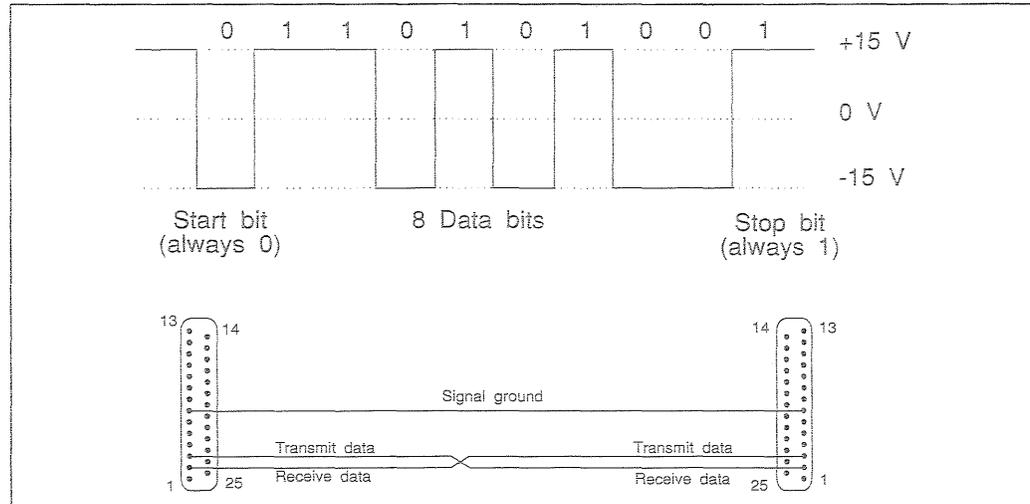

Figure 2.1 Physical interface: mini-RS-232.

The connector chosen by the EIA standard is the 25-pin DB25. Other connectors, however, are frequently employed, such as the DB9 for the IBM AT or the RJ11 telephone connector used in various minicomputers.

On the signal lines, a logical 1 is represented by a voltage between +5 V and +15 V, and the receiver recognizes anything above +3 V as such. Likewise, logical 0 is represented by a signal voltage between -5 V and -15 V. Again, the receiver recognizes any signal below -3 V as such.

Data transfer takes place serially, character by character. The characters are further broken down into bits, which are sent across the line one by one. On the other end, the receiver then assembles the bits back into characters. The number of bits per character lies between five and eight; eight is precisely what is needed to transfer one byte. The data bits are preceded by a start bit and followed by a stop bit. In addition, a parity bit may be sent for error detection. The transfer rate can range between 75 and 115 000 bits per second (baud), and a cable alone cannot compensate for different transfer rates; the devices must be set at the same speed otherwise no exchange of data can take place.

Now comes a rather confusing point: this method of transfer over the serial interface is called asynchronous even though the data is sent and received relative to a clock. Among other serial interfaces the term 'synchronous' is used whenever a clock is involved. For RS-232C, however, the transfer is referred to as asynchronous because the clocks are not tied to each other. The RS-232C specification includes signals that allow the sender and the receiver to use the same clock for data transfer. When these signals are employed the data transfer is

referred to as synchronous. True asynchronous transfer uses control signals to exchange data. This point, among others, will be made clear in Section 2.2.

As a rule of thumb, when thinking about data throughput you can consider a byte or character to be 10 bits (one stop, one start and eight data bits). When the fastest transfer rate possible is employed, namely 115 000 bits per second, the maximum throughput is approximately 11.5 Kbytes per second.

The protocol Mini-RS-232 has no protocol of its own. However, there is a protocol that is often used with the interface, called the XON/XOFF protocol (Figure 2.2). It works in the following way. When the receiving device is no longer able to take on data from the sender, it sends a special character, an XOFF byte, to indicate this. Later, when it is ready to continue receiving data, it sends an XON byte to tell the sender to proceed. This protocol is in no way error proof – characters are sometimes lost. In addition, the protocol cannot be used for bidirectional transfer of binary data. The reason for this restriction is simple: for text data only a subset of the possible bytes is sent over the interface, those corresponding to letters, numbers, and symbols. This leaves room for a number of special characters, of which XON and XOFF are examples. When, on the other hand, binary data is transferred, the data is not restricted to certain characters; any binary pattern may occur. In this situation there is no room for the special characters and the XON/XOFF protocol is unusable. For connecting monitors and printers, however, the protocol is actually very practical.

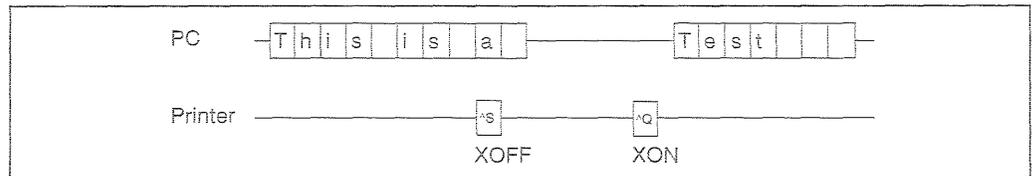

Figure 2.2 XON/XOFF protocol.

An example of a higher level protocol for the transfer of binary data (file transfer) is Kermit. This public domain program can be used at no cost for non-commercial purposes. A number of computer manufacturers have also developed their own internal protocols built on top of RS-232.

Commands There are no commands special to the RS-232 interface. As RS-232 was developed, commands were designed for specific devices apart from the interface. SCSI is among the first interfaces to define universal command sets for whole device classes.

Nevertheless, some command sets have been designed for use with RS-232. Examples are page formatting languages for printers, such as PostScript.

Summary As you can see, an interface that builds on top of RS-232 has many possible variations. The complete description of my printer-PC interface would be: RS-232 at 9600 baud, 1 stop bit, no parity, XON/XOFF protocol, PostScript. If I were to change a parameter for only the printer or only the PC, for example by not sending PostScript or starting to use a parity bit, nothing would print. Although mini-RS-232 appears to be simple (only three wires), there are almost an uncountable number of ways in which the connection can fail. What is missing is a protocol that allows the devices to agree upon the available options. Although RS-232 has given a good portion of frustration to just about everyone who has worked with it, it nonetheless has the decided advantage that it exists on every computer and is also device independent.

2.2 The Centronics printer interface

The Centronics interface is a parallel interface developed for printers. It is an industry standard that, to my knowledge, has never been officially approved. As a result there are many variations. This is especially so with respect to the status signals that reflect the printer's current state. Centronics defines the physical interface and the protocol. As a command set, either PostScript or another printer language is used.

Originally developed as a unidirectional interface, the parallel printer link for PCs can also be used bidirectionally. This extension is not our concern here. We are interested in Centronics mostly as another example of the various computer interfaces. However, it is also a good idea to know this interface in order to understand the difference from SCSI printers (see Figure 2.3).

The physical interface

Centronics uses a shielded twisted-pair cable with 36 signals, of maximum length 5 meters (about 16 feet). A 36-pin amphenol connector is used on the printer end, which most people have come to refer to as a Centronics connector. The computer end of the cable has either a corresponding female Centronics or a female DB25.

Electrical specifications

The signal voltages correspond to those for transistor-transistor logic (TTL). A 0 is recognized from 0 V to +0.8 V, a 1 from +2.4 V to +5.0 V. Table 2.1 lists the signals of the Centronics interface. Note that I have described the data signals starting with 0; that is, using the logical names. The actual signal names, however, are DATA1 to DATA8.

Data transfer takes place in parallel across signals DATA1 to DATA8. The signals STROBE, BUSY and ACKNLG control the sequencing, which is shown in Figure 2.3. The term 'protocol' does not apply completely here. Relative to our layer model, this timing belongs to the definition of the physical interface.

Table 2.1 The signals of the Centronics interface.

<i>Pin (Cen)</i>	<i>Pin (DB25)</i>	<i>Signal</i>	<i>Source</i>	<i>Description</i>
1	1	STROBE	Host	Indicates valid data on DATA1-8
2	2	DATA1	Host	Data bit 0
3	3	DATA2	Host	Data bit 1
4	4	DATA3	Host	Data bit 2
5	5	DATA4	Host	Data bit 3
6	6	DATA5	Host	Data bit 4
7	7	DATA6	Host	Data bit 5
7	8	DATA7	Host	Data bit 6
9	9	DATA8	Host	Data bit 7
10	10	ACKNLG	Printer	Indicates printer has accepted DATA1-8
11	11	BUSY	Printer	Indicates printer is not ready for new data
12	12	PE	Printer	Paper error
13	13	SELECT	Printer	Printer is online
14	14	AUTOFEED SIGNAL	Host	The printer should add a carriage return to each line feed
16		GROUND		
17		CHASSIS GROUND		
18		+5V	Printer	+5 V power (50 mA maximum)
19-30	18-25	SIGNAL GROUND		
31	16	INIT	Host	Initialize printer
32	15	ERROR	Printer	General error
36	17	SLCT IN	Host	Select printer

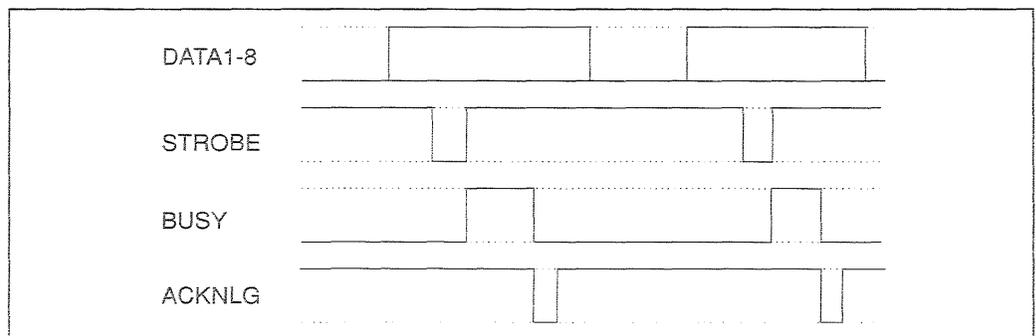
**Figure 2.3** Centronics interface timing.**Request/
acknowledge
handshake**

The transfer of a byte begins when the computer sets the 8 bits on signals DATA1 to DATA8. After waiting for at least a microsecond, it then activates a pulse across STROBE, which indicates that there is valid data on the data lines. In response, the printer sets BUSY and reads the data byte. As soon as the byte has been successfully read and the printer is ready to receive the next byte, it clears the BUSY signal and sends a pulse across the ACKNLG line. Now the computer may change the

data signals and send the next STROBE for the next byte. This method of data transfer, where a signal is used to indicate a request (here STROBE) and another to acknowledge that request (here ACKNLG), is called asynchronous. The mechanism itself is termed request/acknowledge handshake.

Throughput Throughput, or the amount of data transferred per second, is dependent upon how long the printer leaves its BUSY signal active for each byte. The other signals involved in the handshake need at least 4 microseconds (μs) in total. If a printer were exceptionally fast, it could accept a byte in around 10 μs . This would correspond to a data rate of 100 Kbytes per second. The handbook for my laser printer reports a value of approximately 100 μs for the length of BUSY, which allows for a rate no faster than 10 Kbytes per second.

The protocol The Centronics interface protocol is very simple. The flow of data is solely the responsibility of the physical layer. When the printer is not able to receive data it simply holds BUSY active. There are, however, a couple of status signals that reflect the printer's status. These fall under the category of message exchange, which places them in the protocol layer. These signals are PE, SELECT, and ERROR. In addition to these are the control signals AUTOFEED, INIT, and SLCT IN. All of these signals are described in Table 2.1.

Summary The Centronics printer interface is our first example of a device specific interface. The method of data transfer is very similar to many parallel interfaces. Nevertheless, the status signals for end of paper and carriage return pertain strictly to printers. Although this is the case, devices have been developed that use Centronics as a general purpose parallel interface simply by ignoring the printer specific signals. Examples of these include network adapters and disk drives.

The data transfer is parallel and asynchronous, controlled by the handshaking signals STROBE/ACKNLG. The transfer rate is dependent on the speed of the printer: the faster the printer is able to activate its ACKNLG signal, the higher the transfer rate. This characteristic of asynchronous transfer will appear again when we look at the SCSI bus.

As in the case of RS-232, the Centronics interface itself contains neither a device model nor a command set. As shown in Figure 1.2, all components are necessary in order to define a complete printer interface. On the other hand, the interface as it stands is flexible. There are even tape back-up devices that take advantage of this very adaptable interface.

Centronics, like RS-232, establishes a point-to-point connection between devices. This means that only a single printer can be used for each interface because the ability to address different devices is lacking. This new feature belongs to the next interface we will discuss.

2.3 Hard disks and their interfaces

This section and the following two sections on ST506 and ESDI delve more deeply into details than previous sections, because it is here that the foundation for understanding IDE and SCSI is laid. If you are not well acquainted with the internals and workings of hard disks, you will find this section especially interesting. Here, you will learn the terminology of the disk drive domain.

A little history

Disk drive interfaces were standardized early on. Beginning in 1975, drives with a diameter of 14 inches and then 8 inches were shipped with the SMD interface. The name comes from the Storage Module Drives of the company, CDC. CDC has since sold its drive production to Seagate. During the late 1980s, as a result of steady improvements, SMD became the favorite interface for 8 inch high performance drives. SMD-E, the final version, had a transfer rate of 24 MHz or about 3 Mbytes per second. The interface, however, could not survive the transition to 5¼ inch drives, primarily because of the very wide cable. As a result SMD died along with 8 inch drives in about 1990.

Five years after the arrival of SMD, Seagate introduced a 5¼ inch drive with a storage capacity of 5 Mbytes. This economical disk drive, at the lower end of the performance scale, used a new interface called ST506. You will often hear ST506/ST412 being used to refer to the same interface. ST506 was not developed from scratch, but evolved from the floppy interface. The transfer rate was increased to 5 MHz (about 625 Kbytes per second) but the method of moving the heads by sending step pulses remained the same. In the past few years, advances have allowed the transfer rate to be doubled once again. However, the demands of modern PCs have finally exceeded the interface's capabilities: ST506 has been steadily losing ground to IDE and SCSI since around 1991.

It was apparent early on that 5¼ inch drives would be capable of performance that ST506 could not support. SMD could have fitted the bill but it was too big and too expensive. In 1983 the disk drive manufacturer Maxtor came out with the Enhanced Small Device Interface (ESDI) to remedy this situation. The ESDI used the same cables as ST506 but allowed transfer rates of up to 20 MHz (2.4 Mbytes per second). In addition, ESDI had commands, for example, seek to track. Today, ESDI can occasionally be found in the microcomputer and workstation domain. However, it too is quickly being crowded out by SCSI. New drives with the ESDI interface are no longer being developed.

The disk drive model

On our way to understanding IDE we will make two stops to examine its predecessors, the ST506 and ESDI interfaces. Before we do this, however, we need to become acquainted with the basic model of a disk drive. A hard disk drive stores information on a set of rotating disks. The information can be written and read any number of times and the data remains intact even after the drive is turned off.

The term 'hard disk' most often refers to a drive with nonremovable media although some removable media drives do use hard disks. A hard disk contrasts with the flexible media used in floppy drives.

This model of a disk drive will say nothing about the exact method of writing to the medium. This means that it will be valid for magnetic disk drives as well as magneto-optical, diskettes, and removable media drives. CD-ROM and WORM drives, however, do not fall into this category; these formats lack the ability to rewrite information.

Organization of the medium

The disk assembly of a drive usually consists of a number of writable surfaces, each of which stores data on concentric rings called tracks. The tracks are further divided into sectors, which are the smallest readable/writable unit. A sector is accessed by first positioning the read/write head above the proper track. The drive then waits until the desired sector rotates underneath the head and reads the data. Writing and reading the sector is done serially bit by bit.

A drive usually contains somewhere between two and eight disks, and both sides of a disk can be utilized for storage. Each surface has its own read/write head although only one track can be written to or read at a given time. The heads are positioned collectively over the tracks. A set of tracks that can be accessed by the heads from a single position is called a cylinder. A consequence of this organization is that every sector of the drive can be uniquely addressed by its cylinder, head and sector numbers. This is referred to as the drive geometry (Figure 2.4).

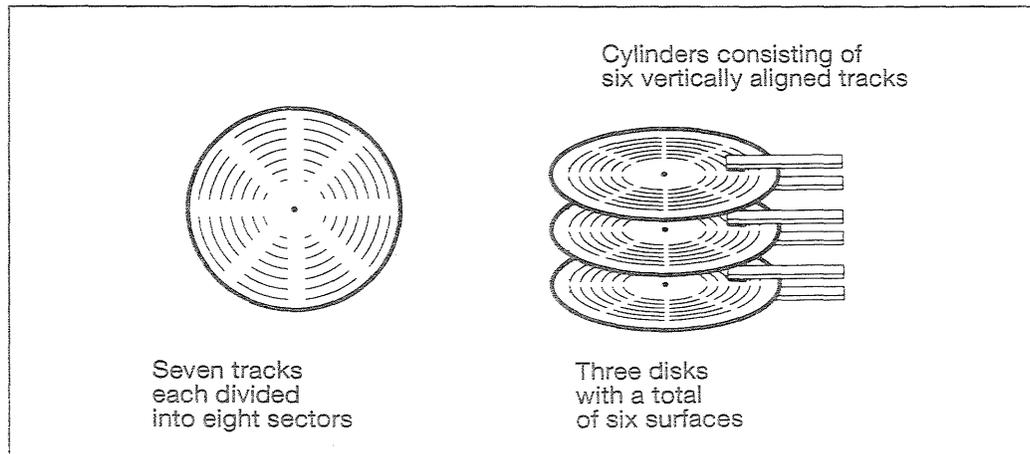

Figure 2.4 Structure of disk medium.

Sector format

In order to identify the beginning of a track there is an interface signal called INDEX, which issues a pulse at the precise moment when the heads reach this position. This is where the first sector of the track begins. At the start of the other sectors another interface signal, SECTOR, issues a pulse. If the sector pulse is generated by special circuitry that senses the relative angular position of the disks, the drive is said to be hard sectored. The drive is soft sectored if the beginning of the sector is actually read off the medium by the heads.

A computer uses data in parallel; that is, bytes not bits. The disk formatter is a chip, which in addition to identifying sectors by their sector number also takes the serial data from the heads and groups it properly into bytes. The data separator sits between the heads and the formatter chip. When data is read from the drive it generates an accompanying clock. Finally, the read/write amplifier circuitry amplifies the analog signals to and from the heads. The electronics that pertain to actual reading and writing of information are collectively referred to as the data channel.

A sector is made up of a number of different fields which are together referred to as the sector format. Sector formats differ from interface to interface but a typical format can be described as follows: first comes a field for synchronizing the data separator followed by the address field. The address field contains the cylinder, head, and sector numbers. With this information the controller verifies that it is reading or writing the correct sector. After the address field comes the cyclic redundancy code (CRC) checksum, which is used to check whether the address was read properly. All fields up to this point are collectively referred to as the header. Now comes the data. Here too a synchronization field is used, followed by the actual data of the sector. In the place where the address field has a CRC checksum, the data has a number of error correction code (ECC) bytes. The ECC allows the controller to test whether the data has been correctly written or read. In addition a certain number of incorrectly read bits can actually be corrected using this code. The sector ends with a gap used to even out small differences in motor speed. The number of data bytes in a sector corresponds to its formatted capacity. Typical formatted sector sizes are 512, 1024 and 4096 bytes. The header, ECC and gaps use up space for between 40 and 100 bytes, depending on the sector format (Figure 2.5).

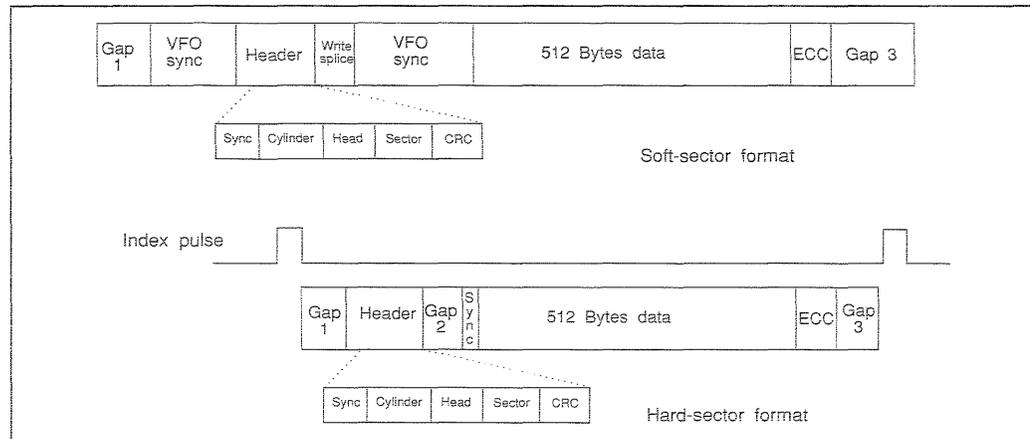

Figure 2.5 Typical sector format.

**Formatting,
reading, and
writing**

Only after the drive's medium has been formatted is it usable for data storage. This procedure involves writing not only the headers but also the data field. An arbitrary data pattern is usually written along with the correct ECC. Normally the entire drive is formatted at one time although soft sectoring allows a single track and hard sectoring a single sector to be formatted.

The reading of a sector is relatively simple. As soon as the head is positioned at the correct cylinder, the desired head is chosen and the formatter chip reads headers until the proper address comes by. The data directly following this header is the data required.

Writing a sector is a bit more complicated. A write looks just like a read until the proper header is found, then the amplifier circuitry switches from reading to writing, and the new data, along with ECC, is written. A write-splice is located between the header and the data field to allow time to turn on the write current.

Format characteristics

It is not necessarily the case that two sectors with adjacent addresses are adjacent to one another on the medium. The limited throughput of early drive controllers made it necessary to employ certain techniques in the format design. The techniques discussed here are pertinent to IDE as well SCSI.

Interleave

Early drive controllers had a very small local buffer which held at most a sector's worth of data. This situation forces the controller to pass the data on to the computer before reading the next sector. If this cannot be accomplished in the time it takes the head to pass over the short gap between sectors, the controller must wait for a complete revolution of the disk for the sector to come around again. For drives of this era, this meant waiting 17 ms for the next sector. In order to avoid this delay, the format of the track can employ an interleave to insure that there is enough time to get ready for the next sector. With a interleave of two, for example, the sector with the next adjacent address is two physical sectors away. This makes it possible to read all sectors of a track with only two rotations of the disk while insuring that there is ample time to pass the data to the computer. Older devices employed even larger interleaves. An interleave of three means that two physical sectors lie between adjacent sector addresses. Modern controllers no longer use interleaving; they have data buffers, which accommodate at least an entire track.

Track and cylinder skew

To obtain the highest throughput for transferring large blocks of data the controller or operating system will place the data on a single track. If the data occupies more than a single track then the track of the next head in this same cylinder is used, and so on, until the cylinder is full. The reason for this organization is that the time needed to change heads is much shorter than the time needed to change tracks. Only after the entire cylinder has been used must the heads be repositioned to the next cylinder, where the procedure can begin again.

Even switching the heads, which is done electronically, can cause enough of a delay to miss a sector. When the last sector of a track is read and the heads are switched to begin a new track, the resulting lag may prevent the first sector of the track being read. Waiting for an additional revolution (called 'missing a rev') can be avoided by offsetting the first sector address by one or several physical sectors. This feature is called track skew (spiral offset). Modern controllers, however, are usually capable of a track skew of zero with the help of very fast data channel electronics.

The delay resulting from a seek from one cylinder to the next adjacent cylinder is of the order of 2 ms. In this case as well, an offset can be employed to avoid missing a rev. However, transfers of this size, across cylinder boundaries, rarely occur. Therefore, the implementation of a cylinder skew is often forgone (see Figure 2.6).

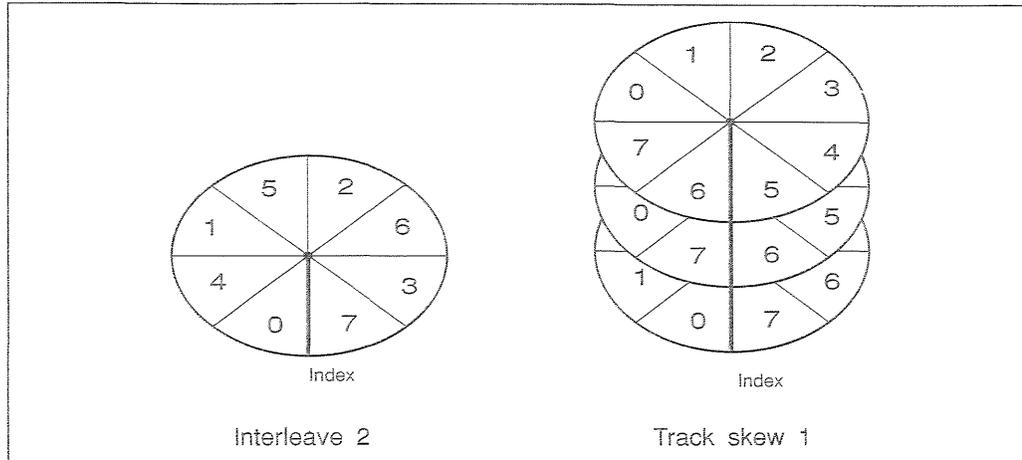

Figure 2.6 Interleave and track skew.

Technical specifications

The physical drive model described above is the basis for the technical specifications cited for disk drives. The most important of these are the capacity, transfer rate, and average seek time.

Capacity

Two capacities are usually given for a drive. The unformatted net capacity is the product of the number of bits per track, the number of cylinders, and the number of heads. Its value is usually given in bytes and is independent of the sector format. The formatted capacity, on the other hand, is directly dependent on the sector format employed. Its value is the product of the sector size, the number of sectors per track, and the number of heads.

Transfer rate and throughput

Transfer rate refers to the speed at which bits are serially read and written to the drive by the heads. It is simply the product of the number of bits on a track and the number of rotations of the disk per second. The units are actually megabits per second, but MHz is often used, which corresponds to one bit per Hz.

Throughput, the amount of data the drive can deliver or accept at the interface on a sustained basis, can be estimated fairly accurately in the following way. Divide the transfer rate by eight (giving the number of bytes per second). Take this result and divide it by the interleave (in this context think of interleave as the number of revolutions needed to read a track). Take off 10% of this value (for headers and so on), and you are left with the approximate throughput of the drive in bytes per second. Throughput, then, is a function of how quickly the

medium can be written to and read, plus formatting factors. A drive's peak transfer rate, which is an instantaneous rate, will be higher.

Average access time

The average access time has two components. The average seek time is the mean time it takes to position the heads to a specific cylinder. In addition to this is the time it takes for the desired sector to rotate under the heads. On average this is the time for half a revolution. This second component, called the rotational latency, is by no means insignificant. For a disk that rotates at 5400 rotations per minute it takes 11 ms for a complete revolution. This translates to an average rotational latency of 5.5 ms. The same drive may have an average seek time of 11 ms which means that rotational latency accounts for about 30% of the average access time.

Where to put the interface

A hard disk is actually a subsystem of many components. First of all is the drive mechanism, consisting of the medium, the heads, the analog data electronics, and the head positioning electronics. This group is called the head disk assembly (HDA). Next comes the data separator to digitize the analog signal data, followed by the formatter for parallelization of the data. The controller is in charge of orchestrating reading and writing, along with positioning the heads. Finally, a host adapter is the link between the controller and the host system (Figure 2.7).

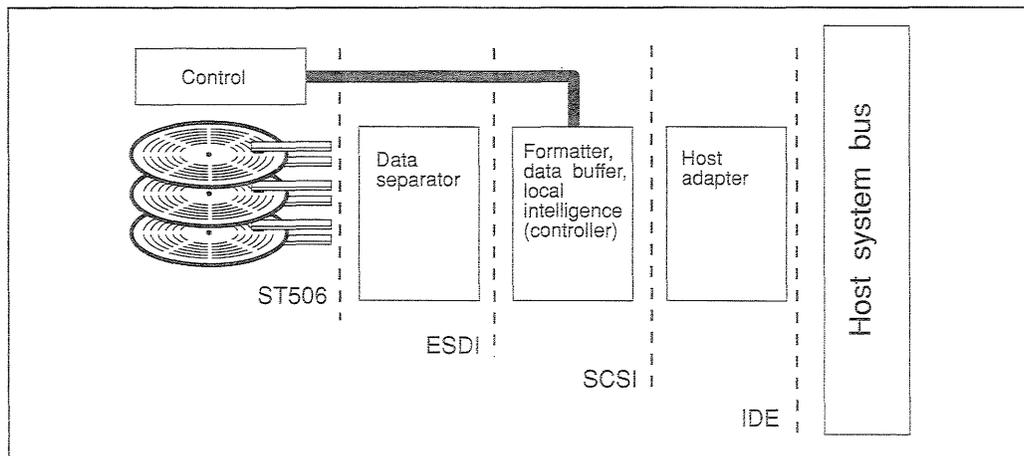

Figure 2.7 Various drive interfaces.

Physically, the interface is the cable that connects the unit built by the drive manufacturer to the computer. There are a number of different possible locations along the data channel where this cable can be placed in the design of a drive. The trend, as SCSI's success indicates, is to incorporate more and more functionality in the drive itself. This moves the cable further from the heads, so to speak.

The ST506 interface lies between the analog data electronics and the data separator. One result of this is that the controller determines the analog method

of writing data to the drive. In practice, two techniques are employed – modified frequency modulation (MFM) and run length limited (RLL) – across the ST506 interface. The ESDI interface moves one step from ST506 and incorporates the data separator into the drive. Next in line, SCSI packs the formatter and controller into the drive as well. Finally, IDE integrates almost the entire host adapter onto its circuit board. This final step has its disadvantages: by integrating the host adapter, the drive is compatible with only one type of host system, in this case IBM PC compatibles. This approach makes sense in the PC market due to sheer volume.

Summary When we finally reach the SCSI standard later in the book, you will be introduced to a model of a class of peripherals known as logical devices. In principle, any interface, for instance any of those discussed so far, could be used with such a device. For example, a RAM disk could be equipped with an ST506 interface. Of course, in order for the RAM disk to simulate an ST506 device it would have to simulate sectors with track, head, and sector number. In addition, a strategy would be needed to prevent the data being lost when the device is turned off.

2.4 ST506

The ST506 interface lies between the read/write amplifier and the data separator. The data separator is the component that generates a clock and a data signal from the pulses stored on the medium.

Physical interface ST506 can address up to four drives (Figure 2.8). Two cables, named A and B, are used to make the connections. The A cable, which is a single cable, contains control signals, and runs from drive to drive in what is called a daisy chain. The last drive in the chain must contain terminating resistance. The B cable carries the analog read/write data. Each drive has its own B cable. You can recognize a controller that supports four drives by the connectors for a single A cable and four B cables. The maximum cable length for ST506 is 3 meters.

Cables, connectors, and electrical specifications The A cable is a ribbon cable with 34 connections. On the controller end of the cable is a ribbon connector. The two drives are attached using edge connectors. The signals are single ended; 7438/7414 open collector drivers and receivers are used (Figure 2.9).

For the first time, we meet the need for terminating resistors in an interface. The signals of the A cable must be connected to +5 V across a 150 ohm resistor. The resistors for all signals are usually incorporated in a single dual in-line package. Since only the last drive may have termination, terminators are mounted in a socket for easy removal.

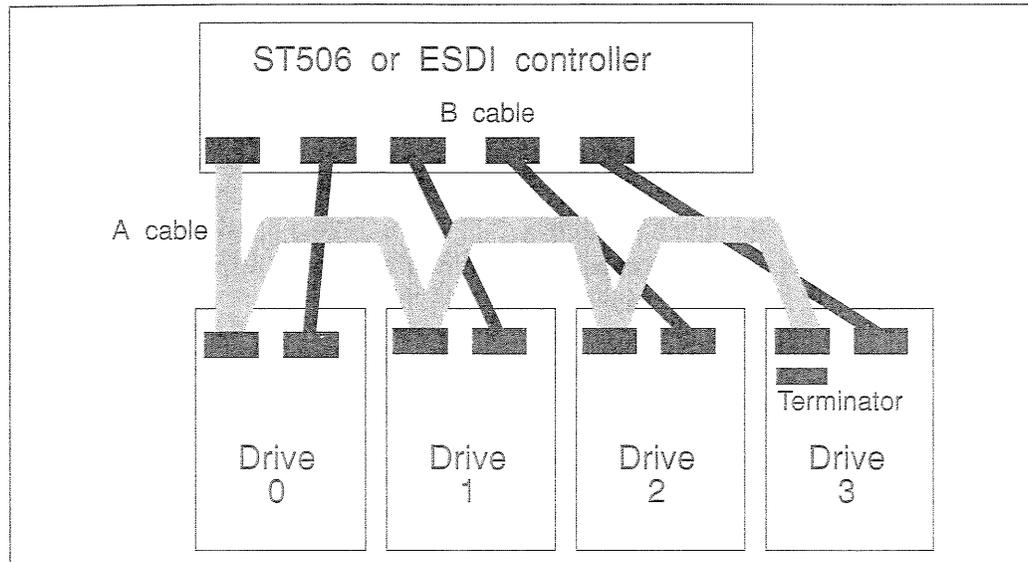

Figure 2.8 ST506 configuration.

The B cable is a ribbon cable with 25 connections. Like the A cable, there is a ribbon cable connector on the controller end and an edge connector on the drive end. The signals here are differential. A 26LS31 and 26LS32 pair is recommended as driver and receiver. Since each drive has its own B cable there is no need to make termination for these signals removable.

Signals Tables 2.2 and 2.3 show the signal assignments for the ST506 cables. Every other signal is ground, which acts as shielding.

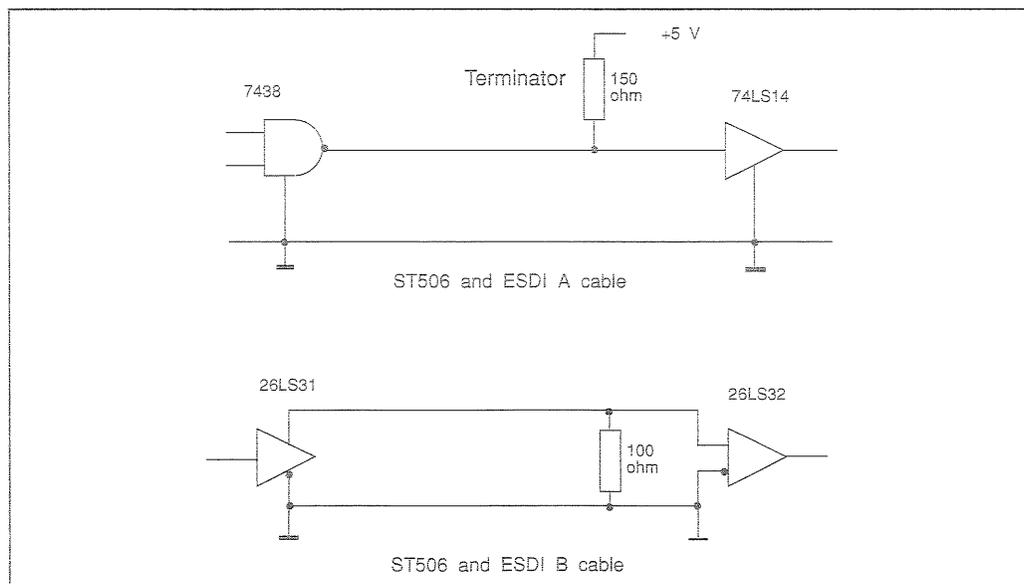

Figure 2.9 ST506 drivers and receivers.

Table 2.2 ST506 A cable signals.

<i>Pin</i>	<i>Name</i>	<i>Signal source</i>	<i>Description</i>
1, 3, 5, 7, 9, 11, 13, 15, 17, 19, 21, 23, 25, 27, 29, 31, 33	GROUND		
2	REDUCED WRITE CURRENT/HEAD SELECT 3	Controller	Once used to reduce write current, now bit 3 of head number
4	HEAD SELECT 2	Controller	Bit 2 of head number
6	WRITE GATE	Controller	Activates write current
8	SEEK COMPLETE	Drive	Indicates cylinder has been reached
10	TRACK 00	Drive	Indicates heads are on cylinder zero
12	WRITE FAULT	Controller	Write error
14	HEAD SELECT 0	Controller	Bit 0 of the head number
16	ERROR RECOVERY	Controller	
18	HEAD SELECT 1	Controller	Bit 1 of the head number
20	INDEX	Drive	Indicates beginning of track
22	READY	Drive	The drive is up to speed and ready for read/write
24	STEP	Controller	The heads are to be moved by one cylinder
26	DRIVE SELECT 1	Controller	Drive 1 selected
26	DRIVE SELECT 2	Controller	Drive 2 selected
26	DRIVE SELECT 3	Controller	Drive 3 selected
26	DRIVE SELECT 4	Controller	Drive 4 selected
34	DIRECTION IN	Controller	Selects direction for head movement

Addressing

In order to choose a specific sector for reading or writing, the head, cylinder, and sector number of the proper drive must be selected. There are four signals for addressing drives on the ST506 interface labeled DRIVE SELECT 1-4. This means that each drive has a dedicated select line.

In contrast to this, the four signals HEAD SELECT 0-3 select the track under one of 16 possible heads. HEAD SELECT 3 did not exist in the original specification; originally, this connection was used to control the amount of write current. The inner tracks of a disk need less write current than the outer tracks. This signal became unnecessary as disk drives themselves controlled the amount of write current.

The method for choosing a cylinder using the ST506 interface is identical to that for floppy drives. A pulse on the STEP signal causes the heads to move one cylinder in the direction indicated by the signal DIRECTION IN. The status signal SEEK COMPLETE indicates that this positioning of the heads has been completed. Another status signal, TRACK 00, reflects whether or not the heads are on track 0, the outermost cylinder. Using this signal the controller can find track 0 by sending STEP pulses until TRACK 00 is true.

The ST506 interface supports only soft sectoring. For this reason there is no sector pulse among the signals; the desired sector is found by the address

Table 2.3 ST506 B cable signals.

<i>Pin</i>	<i>Name</i>	<i>Signal source</i>	<i>Description</i>
1	DRIVE SELECTED	Drive	Drive is selected
2	GROUND		Ground
3	RESERVED		Reserved
4	GROUND		Ground
5	RESERVED		Reserved
6	GROUND		Ground
7	RESERVED		Reserved
8	GROUND		Ground
9	NOT USED		Not used
10	NOT USED		Not used
11	GROUND		Ground
12	GROUND		Ground
13	+ MFMRLL WRITE DATA	Controller	Differential write data
14	- MFMRLL WRITE DATA	Controller	Differential write data
15	GROUND		Ground
16	GROUND		Ground
17	+ MFMRLL READ DATA	Drive	Differential read data
18	- MFMRLL READ DATA	Drive	Differential read data
19	GROUND		Ground
20	GROUND		Ground

information in the header. The INDEX signal is generated by the drive and indicates the beginning of the first sector. It is used during formatting to align the sectors of the different heads.

Clearly, an ST506 controller has a lot of responsibility in controlling the drive. The method of positioning the heads is primitive and slow. The only advantage of the step pulse approach is that the number of cylinders is unlimited.

Data encoding In principle, many methods of data encoding can be used with the ST506 interface. The encoding of the data results in pulses that can be written to the actual drive medium. Originally, MFMR encoding was used and more recently RLL encoding. Not all ST506 drives can accommodate RLL, however, because typically a drive's data channel electronics are optimized for MFMR.

The data rate for MFMR encoding is 5 MHz, which corresponds to 625 Mbytes per second. MFMR drives have 17 sectors per track, each of 512 bytes. RLL allows a data rate of 7.5 MHz. Here a track can hold 22 512 byte sectors. Therefore, the use of RLL encoding increases the capacity of the drive by 50%.

Summary A well-defined protocol layer or command set is not defined for the ST506 interface. The bus timing definitions belong solely to the physical layer. ST506 is undeniably device specific; it makes no sense to use it for anything other than a disk drive.

ST506 has its weak points. The low data transfer rate makes it nearly unusable for higher performance drives. Other low performance characteristics include its lack of commands and step impulse positioning.

Despite its shortcomings the ST506 has been incorporated into systems far beyond the PC domain. Even the IDE and SCSI interfaces show signs of their ST506 origins – you still see, for instance, a parameter to reduce the write current.

2.5 ESDI

ESDI was designed to overcome the deficiencies of ST506. The electrical and mechanical specifications were adopted unchanged from its predecessor. The data separator was moved from the controller to the drive, allowing the maximum data rate to be increased to 20 MHz. Soft as well as hard sectoring of the drive is supported. The interface includes a protocol layer with commands such as seek for head positioning. The drive model for ESDI has been extended to include a format for defect lists. This makes it possible to store in a standard way the list of defects identified by the manufacturer.

The fact that ESDI is also defined for tape drives is not well known and, as far as I know, such a drive has never been built. In this light, ESDI represents a step, however small, toward device independent interfaces. In contrast, SCSI, which appeared at about the same time, was successful in this regard.

Physical interface

ESDI uses the same cable and connectors as ST506. Even the drivers and receivers are the same. The signal assignments, however, are quite different. In addition to the ST506 signals, the A cable includes signals for sending command and status information. Cable A also includes a sector pulse signal used for hard as well as soft sectoring. Drive addressing takes place over three address lines. Although a total of eight addresses are possible, only 1 through 7 are used. Address 0 means that no drive is selected (Table 2.4).

Changes were incorporated into the B cable as well (Table 2.5). Most importantly, the data transferred across the cable is digital. The necessary clock signals were added here, and read and write data is transferred synchronously to these clock signals. Modern ESDI drives have transfer rates of up to 24 MHz or approximately 3 Mbytes per second.

You may have noticed that the index pulse appears on the B cable in addition to the A cable. There is a reason for this. The A cable signal originates only from the selected drive; the B cables, on the other hand, carry the index signals for all drives, selected or not. The controller can use these B cable signals to determine the relative position of each disk. When multiple I/O requests are queued for different drives, the controller can service the request that will result in the shortest rotational latency and seek time. This method of optimization is called rotational position sensing (RPS).

Commands and status/configuration data can be sent across the interface at the same time that data is transferred because dedicated signals for this

Table 2.4 ESDI A cable signals.

<i>Pin</i>	<i>Name</i>	<i>Signal source</i>	<i>Description</i>
1, 3, 5, 7, 9, 11, 13, 15, 17, 19, 21, 23, 25, 27, 29, 31, 33	GROUND		Ground
2	HEAD SELECT 3	Controller	Head select bit 3
4	HEAD SELECT 2	Controller	Head select bit 2
6	WRITE GATE	Controller	Turns on write head
8	CONFIG/STATUS DATA	Drive	Status information
10	TRANSFER ACK	Drive	Handshake for serial communication: the drive accepted command bit, or the status bit is valid
12	ATTENTION	Drive	
14	HEAD SELECT 0	Controller	Head select bit 0
16	SECTOR/ADDRESS MARK FOUND	Drive	Sector pulse
18	HEAD SELECT 1	Controller	Head select bit 1
20	INDEX	Drive	Impulse at beginning of track
22	READY	Drive	The drive is ready to receive a command
24	TRANSFER ACK	Controller	Handshake for serial communication: the command bit is valid, or controller expects a status bit
26	DRIVE SELECT 1	Controller	Drive select bit 0
26	DRIVE SELECT 2	Controller	Drive select bit 1
26	DRIVE SELECT 3	Controller	Drive select bit 2
26	COMMAND DATA	Controller	Command transfer
34	DIRECTION IN	Controller	Direction for head movement

**Figure 2.10** ESDI command transfer.

Table 2.5 ESDI B cable signals.

<i>Pin</i>	<i>Name</i>	<i>Signal source</i>	<i>Description</i>
1	DRIVE SELECTED	Drive	Drive is selected
2	N.C.		No correction
3	COMMAND COMPLETE	Drive	Command is finished
4	ADDRESS MARK ENABLE	Controller	
5	RESERVED		Reserved
6	GROUND		Ground
7	+ WRITE CLOCK	Controller	Write clock
8	- WRITE CLOCK	Controller	Write clock
9	RESERVED		Reserved
10	+ READ/REFERENCE CLOCK	Drive	Read clock
11	- READ/REFERENCE CLOCK	Drive	Read clock
12	GROUND		Ground
13	+ NRZ WRITE DATA	Controller	Write data
14	- NRZ WRITE DATA	Controller	Write data
15	GROUND		Ground
16	GROUND		Ground
17	+ NRZ READ DATA	Drive	Read data
18	- NRZ READ DATA	Drive	Read data
19	GROUND		Ground
20	INDEX	Drive	Impulse at beginning of track

purpose reside on the A cable. As before, bus timing details belong to the physical layer of the model.

At this point we turn our attention to a new method of data transfer. Commands and status/configuration data are sent across the interface using asynchronous serial transfers. Four signals are used to support a request/acknowledge handshake – two for data, and two for control. Figure 2.10 shows the timing of these transfers.

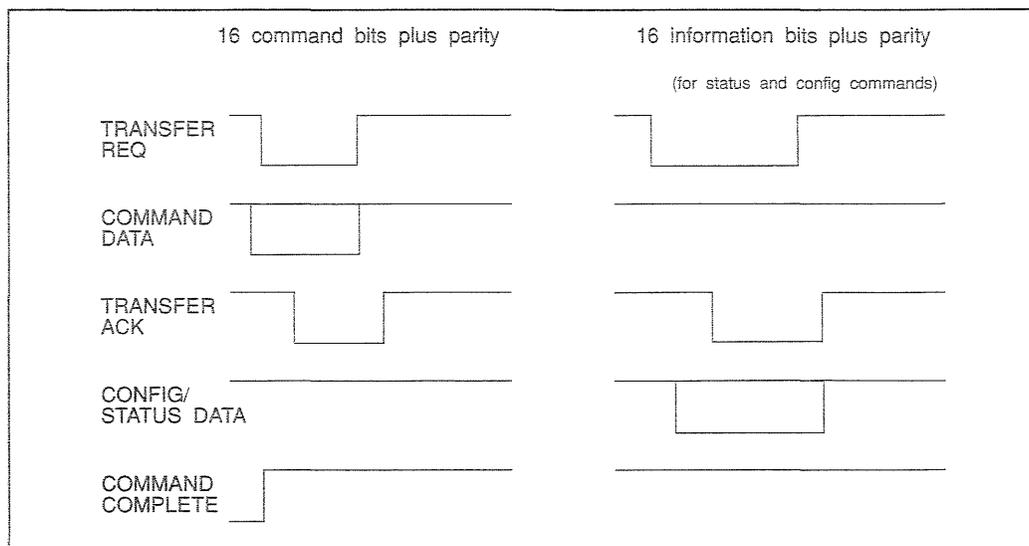
Protocol ESDI commands are 16 bits in length plus an additional parity bit. The controller is allowed to send a command when the drive has activated COMMAND COMPLETE. As soon as the first bit is transferred the drive resets COMMAND COMPLETE. Not until after the command has been executed by the drive will it again activate this signal. Some commands request status or configuration data from the drive. This information transfer is part of the command execution. Figure 2.11 shows the sequencing of such a command.

So far the controller has been in charge of initiating activity across the interface, regardless of the direction of the data. If some type of drive error should occur, the drive uses the ATTENTION signal to notify the controller that it has something to say. In response, the controller issues a REQUEST STATUS command to discover the reason for the ATTENTION condition (Figure 2.12).

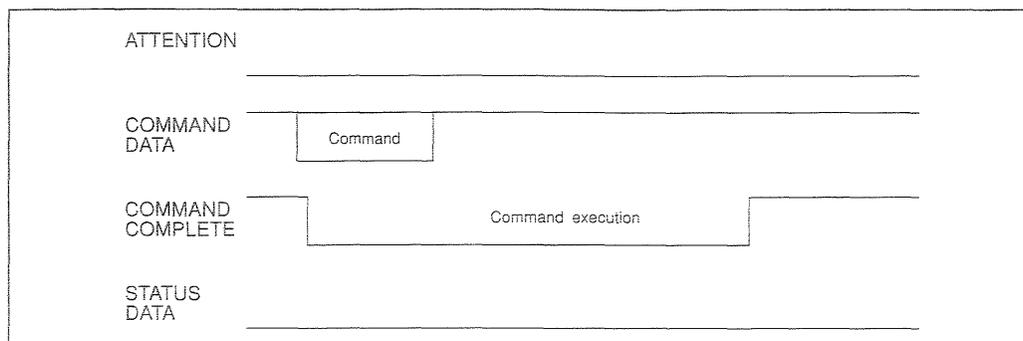

Figure 2.11 Normal command sequence.

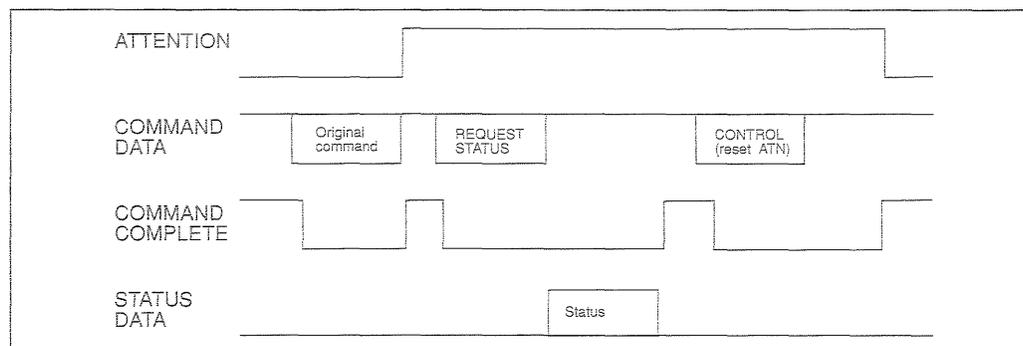

Figure 2.12 ESDI error handling.

The ESDI drive model

For the most part, the ESDI drive model corresponds to that of the ST506 drive. The interface presents to the controller a drive divided into cylinders, tracks, and sectors. An ESDI drive can have 16 groups, each with 16 heads. The implementation of groups is optional. Typically, a maximum of 4095 cylinders are supported. This number can be increased to 65 535 using extended addressing. Up to 256 sectors per track are supported.

Another part of the ESDI model is the defect list format. A cylinder is set aside for the purpose of storing the defect list. This logical cylinder has the number 4095 (65 535), even when there are much fewer cylinders than this. Where this cylinder is located physically on the drive is up to the drive manufacturer.

Commands

The basic format of an ESDI command is shown in Table 2.6. It consists of a 4 bit opcode along with either command extensions or parameter data. There are also commands that can optionally use 16 bit long parameter information. An example of this is the SEEK command. The extended field enables the drive to address more than 4095 cylinders. In order to use this option, the command SET HIGH ORDER VALUE is first sent along with the 4 most significant bits of the parameter, then the actual command follows with the other 12 bits of parameter information (Table 2.7).

Table 2.6 ESDI command format.

15	14	13	12	11	10	9	8	7	6	5	4	3	2	1	0	P
Opcode				Modifier				0	0	0	0	0	0	0	0	0
Opcode				Modifier				Extra								
Opcode				Parameter												

Table 2.7 ESDI commands.

Opcode	Command	Optional	Modifier	Extra	Parameter	Status
0000	SEEK				Yes	
0001	RECALIBRATE					
0010	REQUEST STATUS		Yes	Yes		Yes
0011	REQUEST CONFIGURATION		Yes	Yes		Yes
0100	SELECT HEAD GROUP	Yes			Yes	
0101	CONTROL		Yes			
0110	DATA STROBE OFFSET	Yes	Yes			
0111	TRACK OFFSET	Yes	Yes			
1000	INITIATE DIAGNOSTICS	Yes			Yes	
1001	SET UNFORMATTED BYTES/SECTOR	Yes			Yes	
1010	SET HIGH ORDER VALUE	Yes			Bits 0-3	
1011	RESERVED					
1100	RESERVED					
1101	RESERVED					
1110	SET CONFIGURATION	Yes	Yes	Yes		
1111	RESERVED					

Defect list format

A medium defect is a small region on the medium where information cannot be stored reliably. On disk drives, these are spots where the thin layer of magnetic material has been damaged. Since it is not economical to manufacture completely defect-free media, a certain number of defects are tolerated. It then becomes the responsibility of the computer system to deal with them. These locations are identified so that when the drive is formatted sectors can avoid these positions. It is also possible for the computer to find these defects for itself by writing and reading data patterns to the drive. However, the methods used by the manufacturer are much more accurate. They employ analog test equipment to examine the surface of the disk. In fact, this method is able to identify locations that can be read and written to successfully at the moment, but over time will probably lead to data loss.

Defect lists have existed since the inception of disk drives. Originally, they were delivered with the drive in the form of a printed list. There are various methods for describing the precise position of a defect. A popular approach is the 'bytes after index' format. As the name implies, the position of the defect is described by its distance from the index pulse in bytes.

For an ESDI drive, three copies of the list reside on the drive itself. The first list is found on the last cylinder, the second eight cylinders before this, and

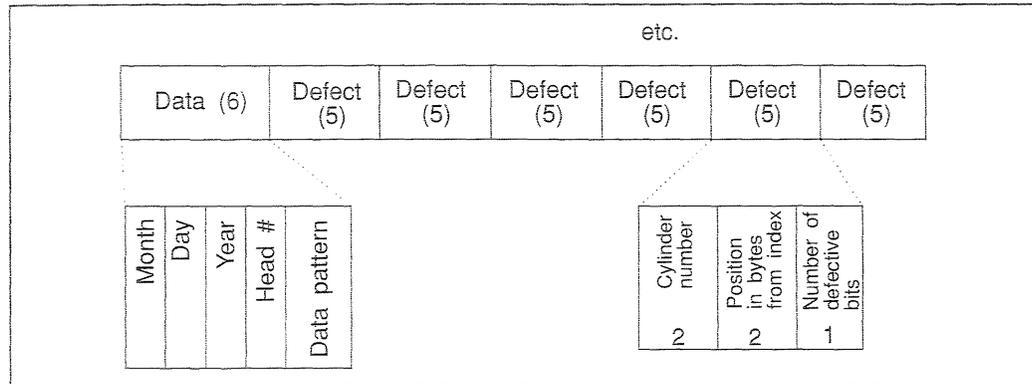

Figure 2.13 ESDI defect list.

the last resides on logical cylinder 4095. This last cylinder is outside the data region and therefore cannot be overwritten. Figure 2.13 shows the format of a sector from the defect list.

Summary The ESDI interface is the most modern of the drive specific interfaces. It may represent the end of development of such a device specific approach. The throughput of up to 3 Mbytes per second is a tremendous improvement over ST506. While SMD can provide a throughput equal to ESDI, it does so at much higher cost. The addition of a protocol layer and command set is a large step in the direction of modern interfaces like IDE and SCSI.

3 Computer buses

In contrast to the peripheral interfaces discussed so far, a computer bus is designed to connect the various components within the computer. All computers utilize a number of internal buses. These buses transport information between the system components like the nervous system of an organism. The more complex a computer system, the more exotic its buses can become (Figure 3.1).

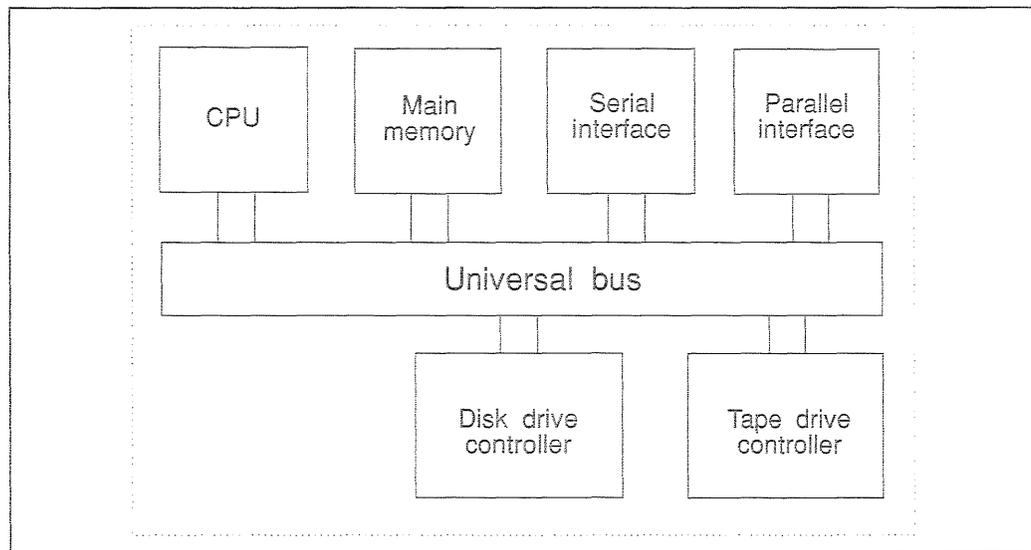

Figure 3.1 Universal bus.

The boundary between a bus and an interface is blurred at best. I consider it an important characteristic of a bus to connect various devices of equal authority. By this measure the IDE interface is excluded, as are all computer memory buses, for that matter. The SCSI bus, on the other hand, clearly matches this definition of a bus. Of course, the discussion of such border cases is purely academic.

The layer model for interfaces can also be applied to computer buses. It is defined by the physical interface, bus protocol and optional device model along with a command set.

A computer bus is built from three basic functional blocks: addressing, data transfer and control. In the literature you will frequently see block diagrams depicting the address, data, and control bus as separate paths. However, since all three of these components depend on the others we will always refer to a computer bus in its entirety.

3.1 Characteristics of buses

There are a number of characteristics that make a bus well suited for a particular application. The most important of these are the throughput, the address space, the real-time performance, the electrical and mechanical characteristics, and the production costs. The following sections examine these in closer detail.

Data throughput Data throughput, also known as bandwidth, is the amount of information the bus can transport per unit of time. It is measured in Mbytes per second. Two parameters come into play in order to calculate the net throughput: the clock speed and the data width. The clock speed tells how many data words are transferred per second. The data width is the number of bits in one data word and usually corresponds to the width of the bus. The net throughput is the product of the clock speed and the data width. It is reduced by an appreciable amount by the bus protocol, otherwise known as the protocol overhead.

For example, SCSI-1 supports a synchronous clock speed of 5 MHz; the bus width is 1 byte. The resulting throughput is 5 Mbytes per second. Under SCSI-2, fast-SCSI allows 10 MHz clock speed; the Wide-SCSI option allows a 4 byte bus width. Together they contribute to a 40 Mbyte per second throughput.

Address space In order to transfer data in a meaningful manner, a method is needed to uniquely identify the source and destination of the transfer. The identification is made using an address, and the scheme is called addressing. The address space of a bus is dependent upon the width of the address; that is, the number of bits in the address. A bus with an address width of 16 bits uniquely identifies 2^{16} or exactly 65 536 locations.

For example, the Q-22 bus of a PDP-11 has an address width of 22 bits. It can therefore address 4 Mbytes of memory. The ISA bus of IBM PC compatibles has 24 address bits and is able to address 16 Mbytes. Modern systems with 32 bit data buses also have 32 bit address buses, corresponding to an address space of 4 Gbytes.

Real-time capabilities Real-time systems are distinguished from other systems by their ability to react to an external event within a given amount of time. This external event may occur at any time. In addition the system may not be able to anticipate the exact moment. A real-time system does not necessarily have to be very fast; however,

its reaction time must be predictable and, of course, adequate for the application. This predictability usually means that a mechanism has been implemented to interrupt running processes. A real-time capable I/O bus must allow, for example, interruption of a lengthy data transfer from disk to tape for an event with higher priority. A bus without this capability could also be used for real-time applications, but only when used for a single device.

Electrical characteristics

Two important attributes result directly from the electrical characteristics of a bus: the maximum length of the bus and the integrity of the data. While the bus inside a PC is only a few inches long, I/O buses more than 30 feet in length are often used to connect computers and peripherals. When many such cables are in close proximity to each other, as is often the case, data integrity is a major issue. A bus in a cable duct needs to be less sensitive to electromagnetic interference than a bus that resides inside a metal enclosure.

Mechanical characteristics

There are two basic ways to implement a bus physically. Internally, the individual signals are usually part of a printed circuit board. Insertable boards use edge connectors to link to the main bus of a system. The mother board of a computer sometimes has a number of slots that are nothing other than bus connections for such boards. Another type of board, referred to as a backplane, has no other circuitry than that to connect together bus slots. Backplanes are common for the VME and ECB buses. Recently entire PC systems have come on the market that reside on an insertable board. These are inserted along with other boards into a backplane to form a system.

The other type of physical bus is the cable. A bus cable is defined with regard to its maximum length, resistance, whether shielded or unshielded and to other less important details. The bus cable connector is also very precisely standardized.

Production costs

An important factor in the mass production of PCs, workstations, and mass storage devices is the associated production costs of the bus. As a rule of thumb, the more signals a bus has, the more costly it becomes; the more sophisticated the control logic, the more costly; the fewer items produced, the more costly. The success of SCSI and IDE can be attributed above all to the availability of economical bus interface components and the fact that a simple ribbon cable can be used to interconnect devices. Moreover, peripheral manufacturers need to equip devices with at most two connector types. Cost is also the reason why SCSI and IDE can coexist in the marketplace: IDE costs slightly less to manufacture than SCSI. In fact, this is often reflected in the price of the IDE and SCSI versions of a particular drive model.

3.2 Specialized buses

The ideal bus, then, would have a large address space, a maximal throughput, and excellent real-time capabilities. There would be no constraints on its length and it would be simple and inexpensive to produce. Unfortunately, such a bus is not even theoretically possible, as the following example shows. A real-time system is characterized by its reaction time to a particular event. This time is independent of, among other things, the length of system buses. Since electrical signals travel with finite speed, as the length of a bus increases so does the reaction time to any signal on the bus. Therefore, it is impossible to design a bus of unconstrained length, which at the same time guarantees an arbitrary reaction time.

For this reason a wide range of buses with differing characteristics have come into existence, each for a particular application.

Memory bus A memory bus connects the CPU or memory controller to memory. The main requirement of this bus is high bandwidth since every CPU instruction and all data must travel over this path. To meet this constraint, most memory buses are very short. The address space of a memory bus is the physical address space of the computer system.

The CPU of a MicroVAX, for example, has an address width of 32 bits. While this corresponds to an address space of 4 Gbytes, the system physically accommodates only 16 Mbytes. Consequently, the memory bus could be implemented using only 24 address lines.

A memory bus need not implement any real-time or interrupt capabilities. The division of labor is well defined among system components: the CPU makes a request, the memory reads or writes the information. By my definition of a bus at the beginning of this chapter, the memory bus is not a bus at all since in this case the devices do not have equal authority over one another.

I/O bus An I/O bus connects the CPU with the I/O devices. Here the requirements are somewhat different. The I/O bus must be able to support a variety of devices. It must be able to handle slow as well as fast devices. In addition, there must be a method for determining which device may use the bus when more than one requests use of it. This mechanism is called arbitration. Depending on the application, an I/O bus must also be capable of near real-time performance. This can be extremely important in the area of computer controlled systems. One need only look at the example of a nuclear reactor: it is imperative that the CPU be informed the moment some particular event occurs. All other I/O processes must be suspendable. An I/O bus that allows this must employ interrupt and event priority mechanisms.

Universal bus Many less sophisticated computer systems use a universal bus to link together the CPU, memory and I/O devices. The goal here is to find the best compromise

between bandwidth, real-time capability, and production cost. Examples of universal buses include the ECB bus, VME bus and the ISA bus of IBM AT compatibles. The older PDP 11/73 with its Q-22 bus is another example. In this light, Figure 1.1 can be viewed as a simplified block diagram of an IBM AT. Figure 3.2 shows the structure of a more complex system, the VAX 8800, with several specialized buses.

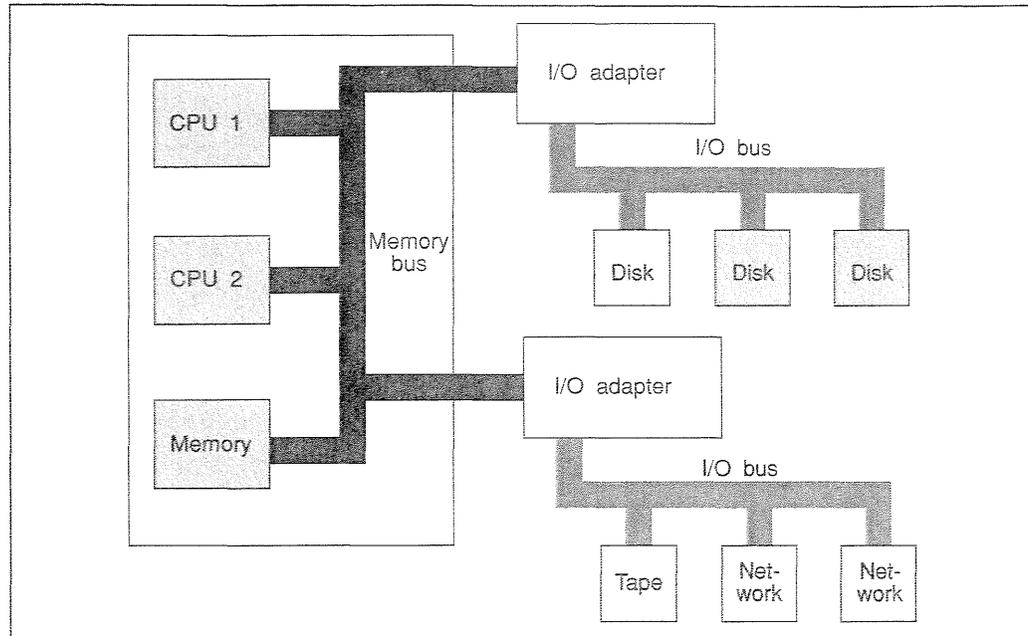

Figure 3.2 Computer system with multiple buses.

Part II

The IDE interface

- 4 Background
- 5 The physical IDE interface
- 6 IDE protocol
- 7 The model of an IDE disk drive
- 8 IDE commands

4 Background

Several common expressions for the IDE interface are currently in use. IDE stands for Integrated Disk Electronics. Another popular name is the AT bus interface, which refers to the fact that the integrated electronics within the drive emulate the hard disk controller of an IBM AT computer. However, when used out of context, this name can be confusing, since the term 'AT bus' is also used for the system bus of the IBM AT. The official name for the IDE interface is AT-Attachment (ATA).

In this book, the name IDE will be used when discussing interfaces in general. When the proposed ANSI standard is meant, the term ATA will be used. The system bus of IBM AT compatible computers will always be referred to as the ISA bus.

ATA is administered by the X3T9.2 ANSI working group, the same group that is responsible for the SCSI standard.

4.1 The origin of IDE

The development of the IDE interface began in 1984, stimulated by the Texan computer manufacturer, Compaq. The idea was to embed the hard disk controller of an IBM AT compatible on the disk drive. Compaq contacted the controller manufacturer, Western Digital, in California. They were to produce an ST506 controller that could be mounted directly on the disk drive and connected to the system bus via a 40 pin cable. In 1985, the disk manufacturer, Imprimis, integrated this controller into its hard disk drives. Thus, the first IDE disk drive was built and installed in a Compaq computer system.

Other hard disk and computer manufacturers recognized the advantage of IDE. Not only was the increase in the cost of the disk drive negligible, but there was a great saving on the hard disk controller. Gradually, more and more IDE implementations were developed, and with them, the various deviations of the industry standard.

As a consequence, a committee of the X3T9.2 working group of ANSI began to deal with the problem in October 1988. As its first project, the common access method (CAM) committee put forward a suggestion for the normalization

of the IDE interface. The new name for the IDE interface was ATA. At the time of writing (February 1993), version 3.1 of the proposed standard was the current version, and the process to make it an ANSI standard was underway.

4.2 Overview

The essential functions of the IDE interface have already been described in Part I. Nevertheless, much new ground will be covered in this part. Figure 2.7 shows the fundamental shift in the function of IDE, from serving the host to serving the peripherals. Also shown is how the IDE controller has been embedded physically into the peripheral unit. The only components left from the IDE bus adaptor in the IBM AT are a few driver and decoder components. It is this aspect where the IDE resembles a system bus more than a peripheral interface. The similarity between the IDE and a system bus will be described in more detail when the physical interface is discussed (Figure 4.1).

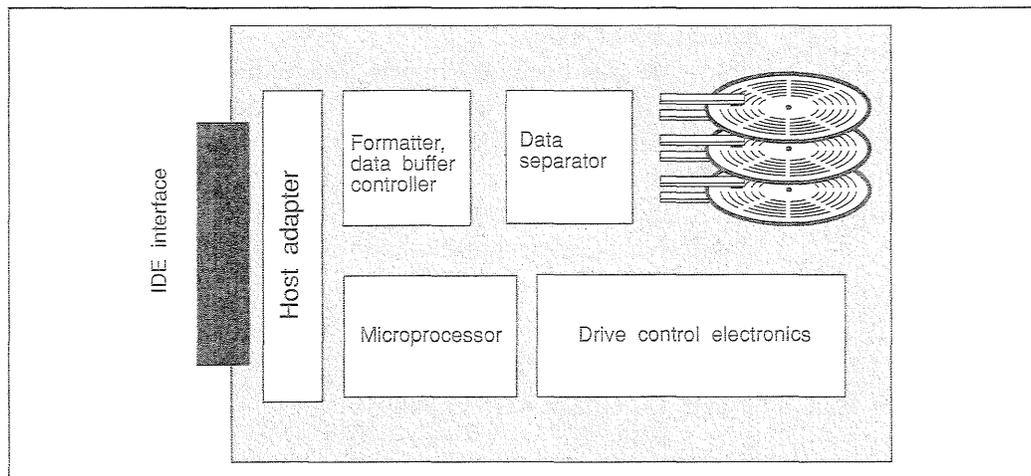

Figure 4.1 IDE drive block diagram.

Despite its similarity to a system bus, IDE is not referred to as an I/O bus, because the universal addressing required to access various different units is lacking. IDE can only serve one or two hard disks, and allows only one host access to the disks.

IDE configuration

In this section three possible configurations for the IDE bus are introduced. The first is the standard configuration of IDE, consisting of an interface board, also called an IDE adapter, installed in a host with an ISA bus. Two IDE disk drives connect directly to the IDE adapter. The drive with address 0 is the master drive; the drive with address 1 is the slave drive. In normal operation the two drives operate independently of each other. The master/slave relation only comes into play, for example, at system start-up, or after a reset (Figure 4.2).

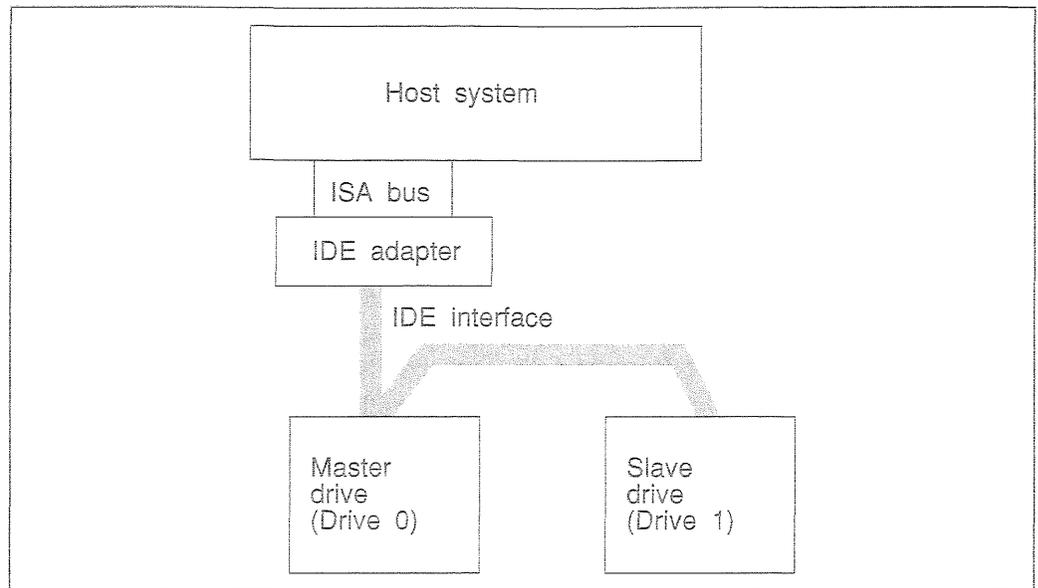

Figure 4.2 IDE configuration for AT compatibles.

The second configuration is more unusual (Figure 4.3). A host adapter is installed in a host with basically any system bus that serves the hard disk through the IDE interface. An IDE host adapter with cache for the EISA bus would be an example of this configuration. However, in this configuration, the major advantage of not needing an expensive host adapter is lost. For the same cost, an equally effective SCSI host adapter can be used, supporting not only hard disks but also many other types of devices. The hard disk IDE version

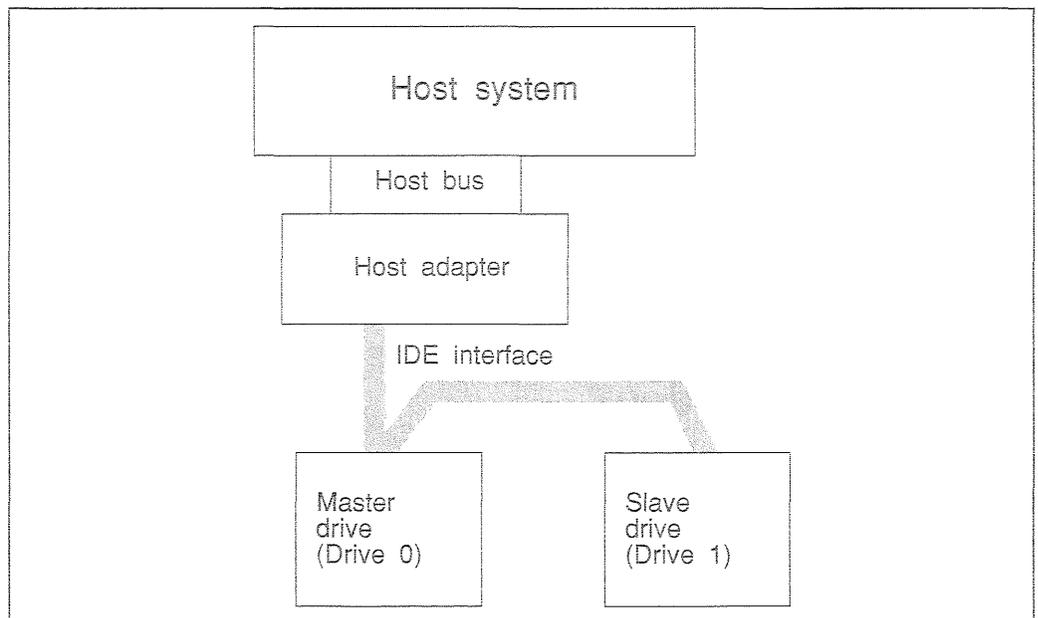

Figure 4.3 IDE configuration for AT compatibles.

remains an option only because of the price, which at present is slightly less than the SCSI version. Still, the use of IDE in this configuration is rare.

The above configurations are special in the following way: since both disk drives share a single controller, disk commands go to both controllers simultaneously. The disk drive addressing in the drive register determines which controller, and therefore which disk drive, is being accessed at a given time.

Lastly, a third configuration is described by the ATA standard. In this configuration, a controller with an IDE interface connects two disks with the classic ESDI or ST506 hard disk interface. Such a controller is called a bridge controller (Figure 4.4). This configuration is inefficient and not very sensible. It involves a controller plus almost a complete conventional disk controller, so why make a detour through the IDE interface? I am unaware of any product that utilizes this approach.

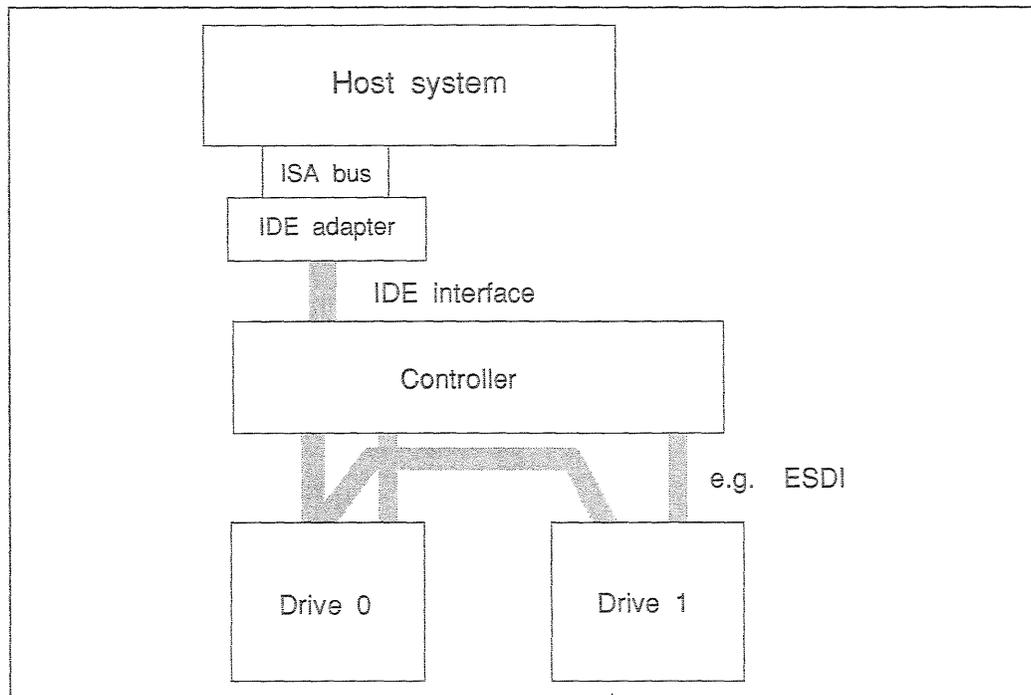

Figure 4.4 IDE configuration with bridge controller.

4.3 Outlook

The ATA committee of ANSI is working on various extensions of the current draft of the IDE standard. One of the extensions includes the possibility of faster direct memory access (DMA) and the addressing of logical blocks.

Whether or not the extensions will be included will depend, among other things, on how well competing interfaces satisfy these needs. The justification for the IDE bus in the first place is that the host adapter is no longer need-

ed in systems that use the ISA bus. SCSI is very strong in both of these areas and is very often the choice over IDE in high-end PCs and outside the PC world.

At the lower end of the performance spectrum, serious competition is developing with the new PCMCIA standard. This interface, originally developed for the credit card size semiconductor memory, has been expanded to support network adapters, modems, and hard disks. There is no end in sight for the miniaturization of all PC components, and the PCMCIA is no exception. Looking at the history of SCSI, it may be correct to assume that the PCMCIA competitors may also be forced to produce this bus. The SCSI bus was also originally intended for limited use in lower priced and lower performance computers, but it has swept the market with features that had been developed originally for high performance and mainframe computers.

4.4 Documentation

The draft for the ANSI standard ATA is called X3T9.2/90-143. Version 3.1 came out in January 1993. It is available, like the SCSI standard, either in printed form or electronically through the SCSI mailbox. The addresses and telephone numbers, including a short description of the standard, can be found in Appendix D. A short summary of the contents and an example from the proposed ANSI standard are given in Figures 4.5 and 4.6.

1.	Scope
1.1	Description of Clauses
2.	References
3.	General Description
3.1	Structure
4.	Definitions and Conventions
4.1	Definitions
4.2	Conventions
5.	Interface Cabling Requirements
5.1	Configuration
5.2	Addressing Considerations
5.3	DC Cable and Connector
5.4	I/O Connector
5.5	I/O Cable
6.	Physical Interface
6.1	Signal Conventions
6.2	Signal Summary
6.3	Signal Descriptions
7.	Logical Interface
7.1	General
7.2	I/O Register Descriptions
8.	Programming Requirements
8.1	Reset Response
8.2	Translate Mode
8.3	Power Conditions
8.4	Error Posting
9.	Command Descriptions
9.1	Acknowledge Media Change (Removable)
...	usw ...
9.32	Write Verify
10.	Protocol Overview
10.1	PIO Data In Commands
10.2	PIO Data Out Commands
10.3	Non-Data Commands
10.4	Miscellaneous Commands
10.5	DMA Data Transfer Commands (Optional)
11.	Timing
11.1	Deskewing
11.2	Symbols
11.3	Terms
11.4	Data Transfers
11.5	Power On and Hard Reset

Figure 4.5 Contents of the ANSI proposal for ATA.

Figure 4.6 (opposite) Sample page from the ANSI proposal for ATA.

10.1 PIO Data In Commands

This class includes:

- Identify Drive
- Read Buffer
- Read Long
- Read Sector(s)

Execution includes the transfer of one or more 512 byte (512 bytes on Read Long) sectors of data from the drive to the host.

- a) The host writes any required parameters to the Features, Sector Count, Sector Number, Cylinder and Drive/Head registers.
- b) The host writes the command code to the Command Register.
- c) The drive sets BSY and prepares for data transfer.
- d) When a sector of data is available, the drive sets DRQ and clears BSY prior to asserting INTRQ.
- e) After detecting INTRQ, the host reads the Status Register, then reads one sector of data via the Data Register. In response to the Status Register being read, the drive negates INTRQ.
- f) The drive clears DRQ. If transfer of another sector is required, the drive also sets BSY and the above sequence is repeated from d).

10.1.1 PIO Read Command

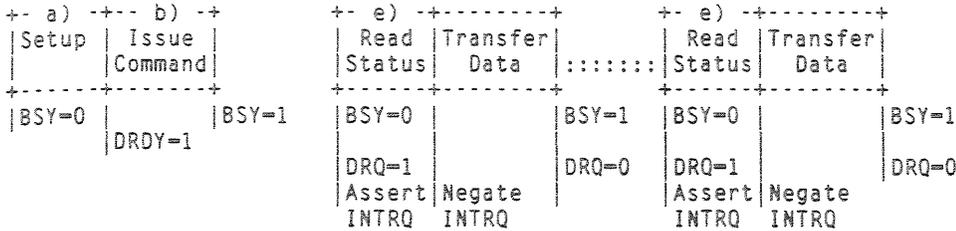

If Error Status is presented, the drive is prepared to transfer data, and it is at the host's discretion that the data is transferred.

10.1.2 PIO Read Aborted Command

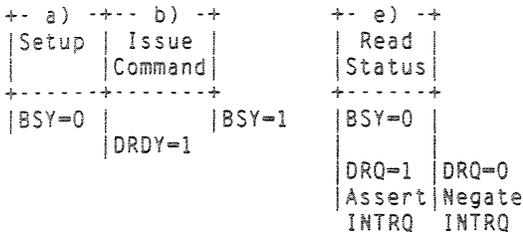

Although DRQ=1, there is no data to be transferred under this condition.

10.2 PIO Data Out Commands

This class includes:

- Format
- Write Buffer
- Write Long
- Write Sector(s)

Execution includes the transfer of one or more 512 byte (512 bytes on Write Long) sectors of data from the drive to the host.

- a) The host writes any required parameters to the Features, Sector Count, Sector Number, Cylinder and Drive/Head registers.
- b) The host writes the command code to the Command Register.
- c) The drive sets DRQ when it is ready to accept the first sector of data.
- d) The host writes one sector of data via the Data Register.
- e) The drive clears DRQ and sets BSY.
- f) When the drive has completed processing of the sector, it clears BSY and asserts INTRQ. If transfer of another sector is required, the drive also sets DRQ.
- g) After detecting INTRQ, the host reads the Status Register.
- h) The drive clears the interrupt.
- i) If transfer of another sector is required, the above sequence is repeated from d).

5 The physical IDE interface

5.1 The electrical interface

The ATA standard for the IDE interface encompasses both the signal cable and the power supply cord. The standard takes recent technological developments into account by including not only specifications for the common 5 V logic, but also for new systems using a 3.3 V power source.

Signal cable and connectors

The IDE interface uses a 40-pin ribbon cable. The length of the cable may not normally exceed 46 cm (18 inches). Cable connectors, which are crimped on, are used both at the host end and at the disk drive end of the cable. Table 5.1 gives the specifications for 5 V and 3.3 V systems. Almost all signal lines use TTL drivers and receivers, except for the signals DASP, PDIAG, IOCS16 and SPSYNC:PSEL.

Table 5.1 Cable parameters for 0.5 m cable length.

<i>Parameter</i>	<i>Minimum</i>	<i>Maximum</i>
Drive sink current at +5 V	12 mA	
Driver sink current at +3.3 V	8 mA	
Driver leakage current for logical 1		-400 μ A
Capacitive load		200 pF

Supply voltages

The power supply to the disk drives is also covered by the ATA standard. Provision is made for either the 4-pin AMP connector familiar to users of 5¼ inch disk drives, or a 3-pin Molex connector. With the 3-pin Molex connector there is also a specification for disk drives that run on a 3.3 V power supply. These drives, however, must also be capable of error-free operation on a 5 V power supply. Disk drives which run on 3.3 V are becoming more and more common, particularly for use in notebook computers. Table 5.2 shows the specifications for the power supply.

Table 5.2 Supply volages for IDE drives.

Connector	Pin	Signal	
AMP	1	+12 V	
	2	Ground	
	3	Ground	
	4	+5 V	
Molex		3.3 V source	5 V source
	1	+ 3.3 V	+5 V
	2	+5 V	+12 V
	3	Ground	Ground

Signals

The ATA standard specifies signals by their names as well as by their abbreviations. Both the signal name and its abbreviation are written in capital letters. As elsewhere in this book, I use small capital letters when referring to names and signals specified by the standard. The signals are listed in Table 5.3. Signals that are low active are indicated by a bar over the name of the signal. The direction of data flow is given with respect to the disk drive: IN means to the drive, and OUT means from the drive. Bidirectional data lines are designated I/O.

- $\overline{\text{CS1FX}}$: This signal selects the command register block. It is generated from the ISA bus addresses by the IDE bus adapter and is active when an I/O port address between 1F0h and 1FFh is being accessed.
- $\overline{\text{CS3FX}}$: This signal selects the control register block. It is generated from the ISA bus addresses by the IDE bus adapter and is active when an I/O port address between 3F0h und 3FFh is being accessed.

These two signals are the reason why an IDE disk drive still requires an adapter to interface with the ISA bus. Of course, it would also have been possible to reproduce the address lines of the ISA bus on the IDE cable, but this would have caused it to exceed the capacity of a 40-pin cable. The solution to this problem is thus a compromise between the desire to achieve full integration of the disk drive with the controller and the desire to use the smallest and least expensive cable possible.

- DA0 through DA2: These signals are taken directly from the ISA bus addresses. They select one of the registers from the command or control register block.
- $\overline{\text{DASP}}$: This signal fulfills two distinct functions. Immediately after the system is powered up, or after a reset, disk drive 1 should assert this signal to indicate that it is present. This process is described in more detail in Chapter 6. In normal operation, this signal indicates that the selected disk drive is active, and is used for the disk drive activity display.
- DD0 through DD15: These signals are taken directly from the ISA bus data lines. They are used in the transfer of data to the register block and to the disk drive.

Table 5.3 IDE interface pin assignments.

Name	Source	Signal	Pin	Pin	Signal	Source	Name
RESET	I	$\overline{\text{RESET}}$	1	2	Ground		Ground
DATA BUS BIT 7	I/O	DD7	3	4	DD8	I/O	DATA BUS BIT 8
DATA BUS BIT 6	I/O	DD6	5	6	DD9	I/O	DATA BUS BIT 9
DATA BUS BIT 5	I/O	DD5	7	8	DD10	I/O	DATA BUS BIT 10
DATA BUS BIT 4	I/O	DD4	9	10	DD11	I/O	DATA BUS BIT 11
DATA BUS BIT 3	I/O	DD3	11	12	DD12	I/O	DATA BUS BIT 12
DATA BUS BIT 2	I/O	DD2	13	14	DD13	I/O	DATA BUS BIT 13
DATA BUS BIT 1	I/O	DD1	15	16	DD14	I/O	DATA BUS BIT 14
DATA BUS BIT 0	I/O	DD0	17	18	DD15	I/O	DATA BUS BIT 15
Ground		Ground	19	20	N.C.		No Connection
DMA REQUEST	O	$\overline{\text{DMARQ}}$	21	22	Ground		Ground
I/O WRITE	I	$\overline{\text{DIOW}}$	23	24	Ground		Ground
I/O READ	I	$\overline{\text{DIOR}}$	25	26	Ground		Ground
I/O CHANNEL READY	O	$\overline{\text{IORDY}}$	27	28	SPSYNC: CSEL		SPINDLE SYNC or CABLE SELECT
DMA ACKNOWLEDGE	I	$\overline{\text{DMACK}}$	29	30	Ground		Ground
INTERRUPT REQUEST	O	$\overline{\text{INTRQ}}$	31	32	$\overline{\text{IOCS16}}$	O	16 BIT I/O
ADDRESS BIT 1	I	$\overline{\text{DA1}}$	33	34	$\overline{\text{PDIAG}}$		PASSED DIAGNOSTIC
ADDRESS BIT 0	I	$\overline{\text{DA0}}$	35	36	$\overline{\text{DA2}}$	I	ADDRESS BIT 2
CHIP SELECT 0	I	$\overline{\text{CS1FX}}$	37	38	$\overline{\text{CS3FX}}$	I	CHIP SELECT 1
DRIVE ACTIVE/ DRIVE 1 PRESENT	O	$\overline{\text{DASP}}$	39	40	Ground		Ground

- $\overline{\text{DIOR}}$ and $\overline{\text{DIOW}}$: Handshake request for read or write access to the disk drive register.
- $\overline{\text{DMARQ}}$ and $\overline{\text{DMACK}}$: Handshake signals for the transfer of data between host and disk drive. Since DMA is an optional feature, so are these signals.
- $\overline{\text{INTRQ}}$: This signal triggers an interrupt in the host.
- $\overline{\text{IOCS16}}$: This signal tells the host that a 16-bit data transfer is occurring; otherwise the transfer is 8-bit using the data lines DD0 to DD7. However, it only applies to register accesses, not to DMA. If 8-bit DMA is implemented, this is specified in the feature register.
- $\overline{\text{IORDY}}$: This signal is optional. When it is not implemented, it should be set to high impedance. If it is implemented, a low level indicates that the controller is momentarily denying access to the registers, and that the host must delay its access cycle.
- $\overline{\text{PDIAG}}$: This signal is part of the power-up protocol. It indicates to the master drive that the slave drive has completed its self-test.
- $\overline{\text{RESET}}$: This signal from the host resets both disk drives. It forces an initialization to occur identical to that after power-up.

The signal SPSYNC shares a line with the signal CSEL. The implementation of both signals is optional, but only one of the two can be used. Both drives must be

using the signal for the same purpose, otherwise drive behavior is unpredictable. This is a potential source of errors.

- **SPSYNC:** This signal is vendor specific since drive synchronization only makes sense if the two disk drives that are communicating are identical. The only specification for this signal is that the master drive is the signal source and the slave is the receiver.
- **CSEL:** This optional signal allows a disk drive to change its number. If it is attached to the disk drive interface, the disk drive is the master drive and has the number 0; otherwise it is the slave drive and has the number 1. In this way it is possible for both drives to modify their numbers without anything needing to be changed on the drives themselves.

5.2 Timing specifications

Data can be transferred over the IDE interface in one of two ways: via programmed I/O (PIO) or via direct memory access (DMA). In this chapter on the physical interface only the timing of these transfer methods is discussed. The higher level description of the interface, for instance how the host sets up the transfer, is considered as part of the protocol level and is discussed in Chapter 6.

A preliminary remark about the timings listed: the ATA standard defines three operating modes for PIO and DMA. Mode 0 is the normal mode, and is also the slowest. The parameter list of the command IDENTIFY DRIVE tells which operating mode the controller has implemented. The exact timings of all operating modes have not been listed in this book. These are necessary only if you wish to build an IDE controller, in which case the newest version of the ATA standard should be obtained.

PIO data transfer

All accesses to the controller register are executed via PIO. This includes the reading of status and error information, the setting of parameters and the writing of commands. However, even read and write operations can be carried out via the data register using PIO or DMA. It is called PIO because, in contrast to DMA, every access must be individually programmed. A simplified timing diagram for a PIO access is given in Figure 5.1.

For a PIO data transfer, the host first puts the addresses on the address lines. These are the signals $\overline{CS1FX}$, $\overline{CS3FX}$ and DA0-DA2. After 70 nanoseconds (ns), it asserts the signal \overline{DIOR} for read access or the signal \overline{DIOW} for write access. Simultaneously, it indicates with the signal $\overline{IOCS16}$ whether it wants an 8-bit or a 16-bit transfer. For a write access, the host places the data on the data lines; for a read access, the controller supplies the data. This data must be valid by the time \overline{DIOR} (in the case of a read) or \overline{DIOW} (in the case of a write) is negated. The data is then read in by the host or the controller, depending on the direction of the transfer. Shortly thereafter, the address, data and $\overline{IOCS16}$ lines must be released, and the cycle is complete. This entire cycle normally lasts 600 ns, but the specification also includes faster modes with cycle times as fast as 240 ns.

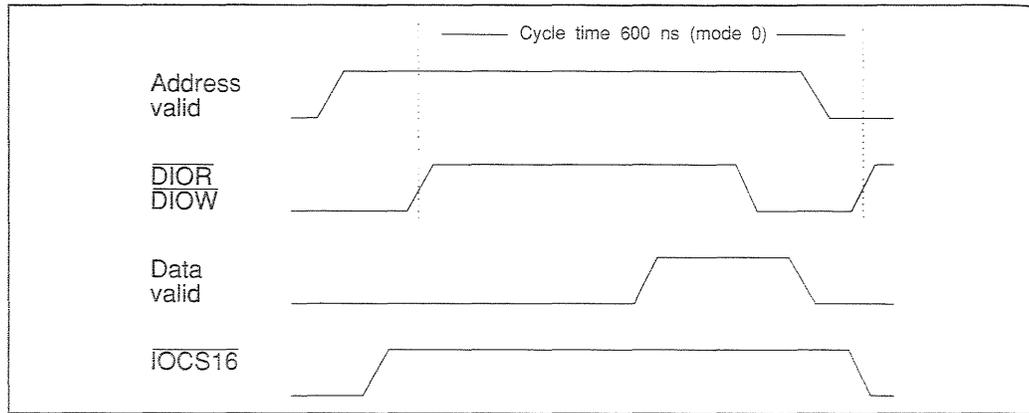

Figure 5.1 Timing diagram for PIO data transfer.

Single-word DMA

Apart from the initial request, DMA transfers take place without intervention by the CPU. This is advantageous above all in multi-tasking systems; while one process waits for its I/O access to be completed, the CPU is free to do computations for other processes. Figure 5.2 shows the simplified timing diagram for a single-word DMA.

In what follows, the sequence of events involved in a read access is described; a write access works in an analogous way. The host asserts the $\overline{\text{DMARQ}}$ signal to initiate a DMA transfer. The IDE controller replies by asserting $\overline{\text{DMACK}}$. Within 200 ns, the host releases the $\overline{\text{DMARQ}}$ signal and asserts $\overline{\text{DIOR}}$ for 480 ns. The controller must then immediately set the data signals because data is gated on the falling edge of $\overline{\text{DIOR}}$. At the same time, the controller may remove its $\overline{\text{DMACK}}$ signal. After 50 ns, the data bus is released and the host can begin the next cycle. A cycle takes between 240 and 960 ns, depending on the operating mode used.

Multiple DMA transfers

DMA really begins to pay off only with multiple DMA. This is the case because the CPU need issue only one transfer request to initiate a sequence of many data accesses. Figure 5.3 shows the simplified timing diagram for multiple DMA.

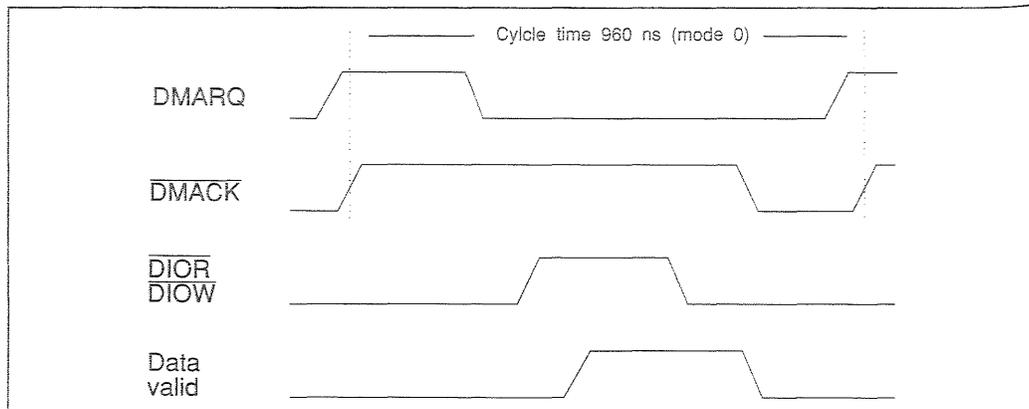

Figure 5.2 Timing diagram for single-word DMA.

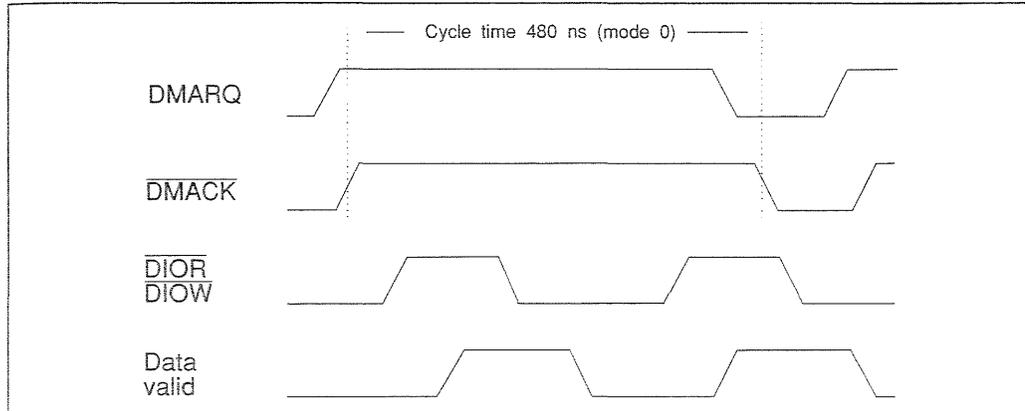

Figure 5.3 Timing diagram for multiple DMA transfers.

Once again, a read access is used as an example. The cycle begins in exactly the same way as with a single-word DMA, up to the point where the transfer of the first word is complete and the data lines are once again free. Unlike in the single-word case, however, the host does not stop asserting the DMARQ signal, and in response the DMACK signal also remains high. About 200 ns after the host negates $\overline{\text{DIOR}}$, it asserts it again, and the next transfer begins. During the transfer of the last data word, while $\overline{\text{DIOR}}$ is asserted, the host removes the DMARQ signal. The transfer request is over when this last transfer is completed.

6 IDE protocol

6.1 The register model of the IDE controller

The register model of the IDE controller describes how the controller appears to the host system. The IDE interface mediates between the host and the controller. The controller belongs to the description of the interface and the ATA standard. I have included the register model in this chapter on protocol because the status bits play a very important role in the protocol.

To the host system, the IDE controller essentially looks like the ST506 controller of the original IBM AT. There are, however, a few additional features. The host sees an IDE controller as two blocks of I/O registers. They lie in the I/O space of the ISA bus rather than in the memory address space. Here they could occupy addresses between 0 and FFFFh but PC compatible computers restrict the I/O space to 0 to 3FFh. The command register block is used to send commands to the disk drive and to exchange data. The control register block is used for disk control. The command register block is often called the AT task file, although I avoid this terminology.

The two register blocks are differentiated by the lines $\overline{CS1FX}$ and $\overline{CS3FX}$. $\overline{CS1FX}$ is derived from the ISA bus and, as its name suggests, is active when an address in the range 1F0–1FF is accessed. Analogously, $\overline{CS3FX}$ is active when an address in the range 3F0–3FF is accessed. Whether the signals are actually decoded in this way, however, is up to the IDE adapter card. It is often possible to choose an alternative address range for the two register blocks using a jumper. In this way, it is possible to have more than one IDE interface in a single computer.

In some cases the same address is used to access multiple registers in order to save I/O address space; during a read the address refers to one register, during a write to a different register. Table 6.1 gives an overview of both register blocks.

The data register
(1F0h,
read/write)

The data register is used to exchange 8- or 16-bit data words between the host and the disk drive buffer. The signal IOCS16 indicates a 16-bit access. Transfer of data using this register is called PIO because the computer must retrieve each word of data individually. Data transfers may also be accomplished using DMA.

Table 6.1 IDE command and control register.

Addresses					Name and Function	
CS1FX	CS3FX	DA2	DA1	DA0	Read access	Write access
<i>Command register block</i>						
1	0	0	0	0	Data register	Data register
1	0	0	0	1	Error register	Feature register
1	0	0	1	0	Sector count register	Sector count register
1	0	0	1	1	Sector number register	Sector number register
					Sector number or block address 0-7	Sector number or block address 0-7
1	0	1	0	0	Cylinder register 0	Cylinder register 0
					Cylinder 0-7 or Block address 8-15	Cylinder 0-7 or Block address 8-15
1	0	1	0	1	Cylinder register 1	Cylinder register 1
					Cylinder 8-15 or Block address 16-23	Cylinder 8-15 or Block address 16-23
1	0	1	1	0	Drive/head register	Drive/head register
					Drive/head number or block address 24-27	Drive/head number or block address 14-31
1	0	1	1	1	Status register	Command register
<i>Control register block</i>						
0	1	0	0	0	Not used	Not used
0	1	0	0	1	Not used	Not used
0	1	0	1	0	Not used	Not used
0	1	0	1	1	Not used	Not used
0	1	1	0	0	Not used	Not used
0	1	1	0	1	Not used	Not used
0	1	1	1	0	Alternate status register	Control register
0	1	1	1	1	Address register	Not used

The error register (1F1h, read)

After power-up, reset or the execution of the command EXECUTE DRIVE DIAGNOSTICS, this register contains a diagnostic code. The diagnostic codes are listed in Chapter 7 together with the command EXECUTE DRIVE DIAGNOSTICS.

If the ERR bit in the status register is set, then this register contains the error code of the last executed command. In this case, the contents of the register are as follows (Table 6.2):

Table 6.2 IDE error register.

7	6	5	4	3	2	1	0
BBK	UNC	MC	IDNF	MCR	ABRT	TK0NF	AMNF

- **BBK** (bad block detected): Set if an error mark is detected in the header of the requested sector. Error marks are explained in Chapter 7.

- **UNC (uncorrectable data error):** Set if an error was detected in the data field of the requested sector and this error could not be corrected by the ECC. The data is unusable.
- **MC (media change):** A replaceable medium was changed since the last access. This is not an error but a signal to the host to take appropriate measures (for example, to reset the software cache) so that the new medium can be used.
- **IDNF (ID not found):** The controller could not find the address field of the requested sector. Either it is damaged or a sector was requested that does not exist.
- **MCR (media change requested):** Signals to the host that the user has pressed the button that initiates a change of medium. It is now up to the host to take the necessary steps (such as completing any pending I/O requests) and then to issue a MEDIA EJECT or DOOR UNLOCK command.
- **ABRT (aborted command):** The command was interrupted because it was illegal or because of a disk drive error.
- **TK0NF (track 0 not found):** Track 0 could not be found during the execution of a RECALIBRATE command. This is usually a fatal error.
- **AMNF (address mark not found):** The data region of the requested sector could not be found.

The feature register (1F1h, write)

This register is not used with all disk drives. In accordance with the ATA standard, it is used to set certain features of the interface using the command SET FEATURES.

In the case of a normal ST506 controller for the IBM AT, this register contains the cylinder number divided by four, indicating where the write precompensation begins. A few older IDE controllers, which do not conform to the ATA standard, expect to find this number here as well.

The sector count register (1F2h, read/write)

This register contains the number of sectors to be read or written. The value 0 is interpreted as 256. If an error occurs, this register contains the number of sectors yet to be transferred.

A few commands use this register for other purposes. Refer to the description of commands INITIALIZE DRIVE PARAMETERS, FORMAT TRACK and WRITE SAME in Chapter 8.

The address registers

The sector number register, cylinder number register and drive register contain the address of the sector to be processed. I refer to this group of registers collectively as the address registers. Their importance varies depending on whether the system uses physical or logical addressing (see Chapter 7).

The sector number register (1F3h, read/write) This register contains the number of the first sector to be transferred. In logical block address (LBA) mode it contains byte 0 of the logical block number.

The cylinder number register (cylinder low register, 1F4h, cylinder high register, 1F5h, read/write) This pair of registers contains the cylinder number. The ATA standard allows 65 536 cylinders to be addressed. Earlier IDE controllers use only bits 0 and 1 from the high byte of the cylinder address (1F5h), which limits the number of addressable cylinders to 1024. In LBA mode, the register holds bytes 1 and 2 of the logical block number.

The drive/head register (1F6h, read/write) This register contains the drive number, head number and addressing mode. It is broken down as follows (Table 6.3):

Table 6.3 IDE drive/head register.

7	6	5	4	3	2	1	0
1	L	1	DRV	HS3	HS2	HS1	HS0

- HS0–HS3 (head select 0–3): Head number. In LBA mode these bits represent the low four bits of byte 3 of the logical block address. The high four bits are always 0.
- DRV (drive): Disk drive number. Drive 0 is always the master drive.
- L (LBA mode): When this bit is set LBA addressing is being used; otherwise the usual cylinder/head/sector (CHS) method is being used (see Chapter 7).

The status register (1F7h, read) The status register contains the status of the disk drive as of the last command. A read access to this register clears pending interrupt requests (see protocol). To avoid this, one can read the alternate status register (3F6h, read). Both status registers consist of the following fields (Table 6.4):

Table 6.4 IDE status register.

7	6	5	4	3	2	1	0
BSY	DRDY	DWF	DSC	DRQ	CORR	IDX	ERR

- BSY (busy): If BSY is set, no other bits in the status register are valid. BSY is always set when the controller itself is accessing the command register block. During this time the host may not access any of the other registers in the command register block.
- DRDY (drive ready): Indicates that the drive is ready to accept a command. When the drive is first switched on, DRDY remains clear until the drive is ready for operation.

- DWF (drive write fault): Indicates a write error on the disk drive.
- DSC (drive seek complete): Indicates that the heads are positioned over the desired cylinder.

After a command resulting in an error, BSY, DWF and DSC remain unchanged until the status register is read. Afterwards they will reflect the drive's current status.

- DRQ (data request): This bit is set when the drive wants to exchange a byte with the host via the data register.
- CORR (corrected data): This bit is set if a correctable read error has occurred. The data transfer continues uninterrupted.
- IDX (index): This bit is set once per rotation of the medium, when the index mark passes under the read/write head.
- ERR (error): Indicates an error has occurred in the process of executing the previous command. The error register contains further information.

The command register (1F7h, write)

This register receives the commands that are sent to the controller. The commands and their parameters are part of the command level of the interface model and are described in Chapter 8.

The alternate status register (3F6h, read)

This register contains the same information as the status register. However, a read from this register has no effect on pending interrupt requests.

The device control register (3F6h, write)

Two bits are defined in this register (Table 6.5):

Table 6.5 IDE control register.

7	6	5	4	3	2	1	0
-	-	-	-	1	SRST	$\overline{\text{IEN}}$	0

- SRST (software reset): As long as this bit is set, the attached disk drives are in the RESET state. When this bit changes to 0, the drives are executing a start-up procedure.
- $\overline{\text{IEN}}$ (interrupt enable): This bit is negative true. A 0 signifies that interrupts are allowed; a 1 blocks them.

The drive address register (3F7h, read)

This register contains constantly updated information about the execution of the current command. The head-number information is not always correct for drives using caching and mapping. All bits in this register are negative true (Table 6.6):

Table 6.6 IDE address register.

7	6	5	4	3	2	1	0
-	$\overline{\text{WTG}}$	$\overline{\text{HS3}}$	$\overline{\text{HS2}}$	$\overline{\text{HS1}}$	$\overline{\text{HS0}}$	$\overline{\text{DS1}}$	$\overline{\text{DS0}}$

- $\overline{\text{WTG}}$ (write gate): If this bit is clear then a write access is currently taking place on the selected drive.
- $\overline{\text{HS3}}\text{--}\overline{\text{HS0}}$ (head select 3–0): Inverted current head number of the selected disk drive.
- DS1 (drive 1 selected): When this bit is 0 the slave drive is selected.
- DS0 (drive 0 selected) When this bit is 0 the master drive is selected.

6.2 Command execution

There are five classes of IDE commands. A different protocol governs the execution of commands for each class.

Class 1: PIO read commands

Read commands are commands that involve the reading of the sector buffer one or more times. A class 1 command is executed in the following way. The host first writes any required parameters to the address and feature registers. It then writes the opcode to the command register to begin execution (Figure 6.1).

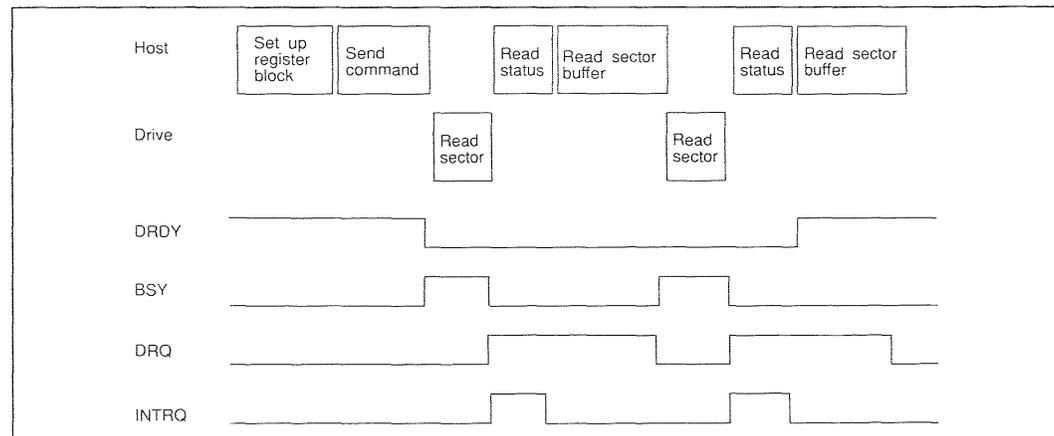

Figure 6.1 Timing of a class 1 command.

The drive sets the BSY bit in the status register and puts data for the transfer into the sector buffer (see Chapter 7). When the sector buffer is ready, the drive sets the DRQ bit and clears the BSY bit. It simultaneously asserts the signal INTRQ.

The host then reads the status register, whereupon the drive negates INTRQ. The DRQ bit tells the host that it may now read 512 bytes (or more in the case of the READ LONG command) from the sector buffer. This read is then performed according to the timing specifications described in Chapter 5.

As soon as all the data in the buffer has been read, the drive resets the DRQ bit. After all of the requested sectors have been read the command is complete. Otherwise, the drive again sets the BSY bit and prepares the next sector for transfer.

In the event of an error, the drive still attempts to prepare the sector buffer for a read but also sets the corresponding error bit in the status register. It is then up to the host to decide whether or not to read the sector buffer despite the error.

Things are different when a command is aborted. In this case, the drive resets the DRQ bit immediately after the host has read the status register, and no data is transferred.

Class 2: PIO write commands

Class 2 commands are write commands. Thus the first thing that must happen is that the sector buffer must be filled with 512 bytes of data (or more in the case of WRITE LONG). Figure 6.2 shows the sequence of steps involved in executing this command. In this example, two sectors are being written.

First, the host places the necessary parameters in the appropriate registers of the command register block. It then waits until the DRDY bit is set and writes the opcode to the command register.

At this point, the drive sets the DRQ bit in the status register and thereby signals that it is waiting to receive data. The host writes the data via the data register to the sector buffer. When the sector buffer is full the disk drive sets the BSY bit and clears DRQ.

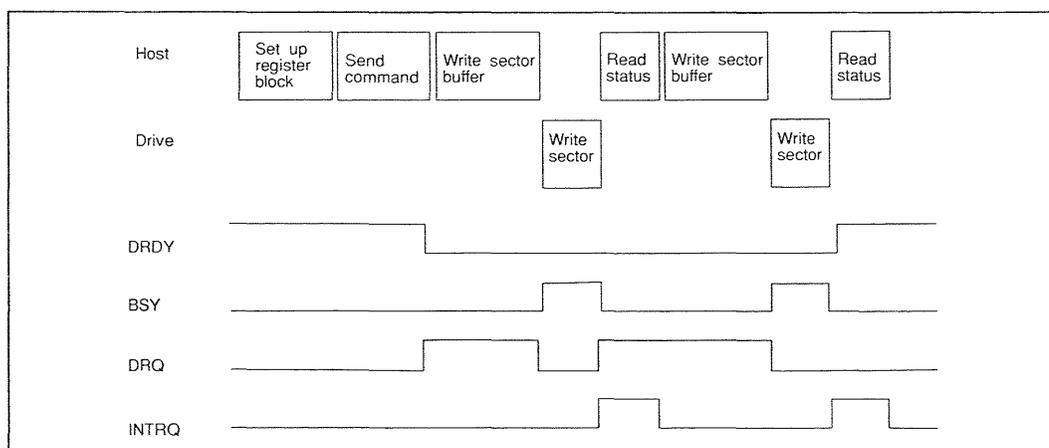

Figure 6.2 Timing of a class 2 command.

As soon as the data in the buffer has been processed (for example, been written to the medium), the drive clears the BSY bit and sets INTRQ. This signals to the host that it should read the status register. Once this has happened, the drive resets INTRQ.

If only one sector is to be written the command is now complete. Otherwise, if the write involves multiple sectors, the drive again sets DRQ and the next sector is processed.

In the event of an illegal command the drive does not set DRQ after the command has been written, but instead indicates that status is to be read by setting INTRQ. The host can then examine the error bits of the status register.

**Class 3:
Commands
without data
transfer**

Commands not involving data transfer do not use the sector buffer. Nevertheless, such commands may involve an exchange of information between drive and host. This exchange of information is accomplished by reading and writing registers.

Here the sequence of steps is more simple. The host writes the necessary parameters to the controller registers and writes the opcode to the command register. The drive sets BSY and executes the command. When it finishes it writes status to the status register, resets BSY and sets INTRQ. The host then reads the status, the drive clears INTRQ and the command is complete.

**Class 4: DMA
commands**

This class is comprised of only two optional commands, one for reading and the other for writing. Although DMA transfers involve more work for the processor before and after each transfer, the processor is completely free during the transfer. Also, during the transfer of multiple sectors, an interrupt occurs only at the end of the entire transfer, not after each sector. This is especially advantageous in multi-tasking systems where the processor can utilize the time it gains through DMA. The execution of DMA commands can be broken down into three phases (Figure 6.3).

In the command phase the host first initializes a DMA channel. It then writes the parameters and opcode to the controller registers, just as in the PIO case. The drive sets BSY and executes the command.

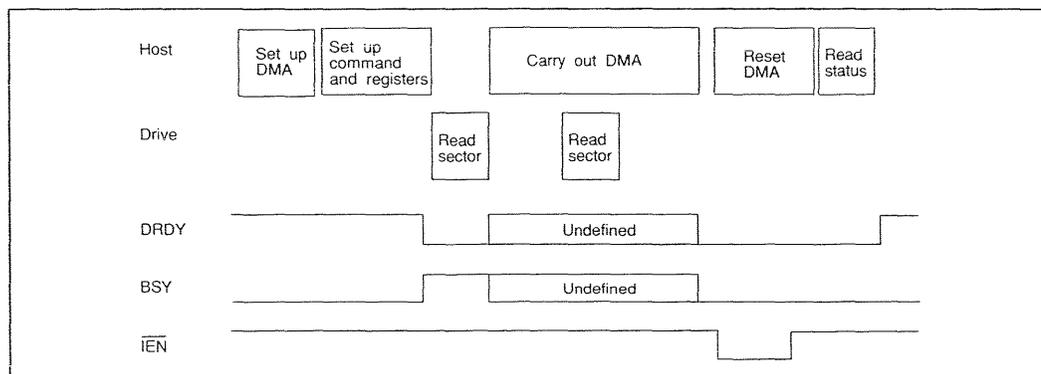

Figure 6.3 Timing of a class 4 command.

In the data phase the DMA channel transfers the data using the DMARQ handshake sequence. The contents of the controller's registers are not valid during the data phase.

The drive then begins the status phase by triggering an interrupt. In response the host resets the DMA channel and reads the status and (if necessary) the error register.

In case of error the status phase may occur before the data phase or interrupt it, since the drive requests an interrupt the moment the error occurs.

Class 5: Other commands

There are a few commands that do not fit neatly into the above classifications because their execution protocols differ slightly from those described above. These differences are explained together with the commands in Chapter 8.

6.3 Power-up or hardware reset

The same sequence of steps is executed after both power-up and a hardware reset. The procedure varies slightly depending on whether one or two disk drives are present.

The timing diagrams require a few words of explanation. All signals are represented as active high even when they are marked as inverted by a bar above their names. This makes the diagrams simpler to understand. In reality, that is, on an oscilloscope or a logic analyzer, these signals would appear inverted.

The timing diagrams are not drawn to scale. Thus, it is possible that an event lasting 400 ns might appear to be as long as one lasting 450 ms. Important times are also included in the diagram. For complete specifications consult the most recent ATA standard.

Reset in a single-drive system

The host activates the signal $\overline{\text{RESET}}$ for at least 25 μs . It should be noted that the host is responsible for a $\overline{\text{RESET}}$ after the system first powers on and all system voltages have stabilized. At most 400 ns after $\overline{\text{RESET}}$ goes low again the master drive sets the BSY bit in the status register. At most 1 ms after that, the drive negates $\overline{\text{DASP}}$ and carries out its self-test. Simultaneously, it observes $\overline{\text{DASP}}$ for 450 ms to see if a slave drive is present. Since a slave will not be found the master is able to use $\overline{\text{DASP}}$ to indicate drive activity. As soon as the master drive has completed its self-test and is ready to accept commands it resets the BSY bit. All of this must occur within 31 seconds.

Reset in a two-drive system

Before the ATA standard there was no standard way of determining whether a slave drive was present or not. Often the master drive was equipped with a special jumper for this purpose. Such drives may be incompatible with drives using the ATA protocol described here.

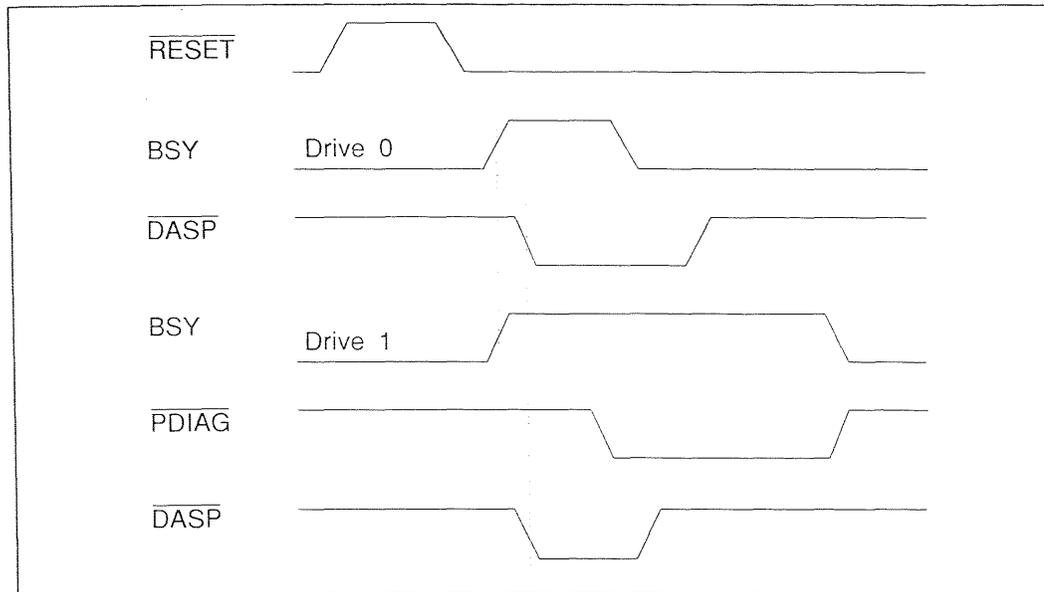

Figure 6.4 Timing at power-up or RESET.

Both ATA compliant drives negate $\overline{\text{DASP}}$ at most 1 ms after $\overline{\text{RESET}}$ is negated. The master drive detects the existence of a slave within 400 ms after $\overline{\text{RESET}}$ by examining $\overline{\text{DASP}}$. Prior to this the slave negates $\overline{\text{PDIAG}}$ thereby indicating that it has begun its self-test.

When the self-test is finished and the slave drive is ready to accept commands it asserts $\overline{\text{PDIAG}}$. This must occur no more than 30 seconds after the reset. If the master drive does not recognize the slave within 31 seconds it concludes that an error has occurred and sets bit 7 in the error register.

The slave drive should negate $\overline{\text{DASP}}$ within 30 seconds of receiving the first valid command (Figure 6.4).

The Conner protocol

Many drive manufacturers use special protocols for detecting a slave drive, which differ from the ATA protocol sketched above. One such protocol, that used by Conner Peripherals, is discussed here.

When the slave powers up it activates the signal $\overline{\text{PDIAG}}$ within 1 ms. (If the master does not see $\overline{\text{PDIAG}}$ within 4 ms, it assumes that no slave drive is present.) $\overline{\text{PDIAG}}$ remains active until the slave clears its $\overline{\text{BSY}}$ bit or until 14 seconds have elapsed. If the slave is still not ready it stops asserting $\overline{\text{PDIAG}}$ but continues asserting $\overline{\text{BSY}}$. Before clearing its $\overline{\text{BSY}}$ bit, the master waits until the slave clears $\overline{\text{PDIAG}}$, but does not wait longer than 14.5 seconds.

The same procedure is followed for a software reset; however, here the slave must clear the $\overline{\text{PDIAG}}$ signal within 400 ms.

7 The model of an IDE disk drive

When examined briefly, the model of an IDE disk drive corresponds to that of an ST506 drive. This is not at all surprising given that IDE is a direct descendant of ST506. However, the IDE model of the ATA standard contains a number of significant improvements over its predecessor.

7.1 Organization of the medium

The medium of an IDE drive is organized by head (surface), cylinder and sector. An IDE drive can have 16 heads, 1024 cylinders and 256 sectors. The ATA standard even permits up to 65 636 cylinders. A sector normally contains 512 bytes of usable data. These sectors are addressed in one of two ways.

Physical addressing (CHS mode)

In CHS mode the cylinder, head and sector number uniquely identify a given sector. IDE comes from ST506, which always has 17 sectors of 512 bytes each per track. For this reason many IDE drives with more than 17 sectors utilize either a natural or translated mode of addressing. In the natural mode the drive geometry is presented as it physically exists to the host. In the translated mode the physical geometry is mapped to a logical one. The logical geometry has 17 sectors but with a greater number of logical heads so that the total capacity is the same.

IDE drives use a linear mapping for physical addressing. This means that consecutive sectors begin at cylinder 0, head 0, sector 0. This track is used first, then head 1 of the same cylinder and so on until the entire cylinder is used. This is then repeated for the next cylinder number with head 0. This mapping must be known to the host since the IDE interface has commands that transfer as many as 256 sectors at one time.

Another aspect of IDE that perhaps belongs to the drive model is that average access time within a given track is shorter than when a head switch must occur. A head switch, on the other hand, takes less time than a change of cylinders. This is not necessarily true in translation mode. Here a head switch may take place within a logical track access.

Logical addressing (LBA mode)

In this mode the drive presents itself as a continuous sequence of blocks which are addressed by their logical block number. In this case the drive's physical geometry need not be known to the host.

The ATA standard specifies that the mapping from physical geometry to logical block numbers should be accomplished in the following manner:

$$\text{LBA} := (\text{CylinderNumber} * \text{HeadCount} + \text{HeadNumber}) * \text{SectorCount} + \text{SectorNumber} - 1$$

This mapping assures that the time needed to access from LBA n to LBA $n + 1$ is shorter than from LBA n to LBA $n + 2$. In other words, the logical blocks are also in sequential order in terms of access time. This is important for the host because it means that large blocks of data will be written and read in the shortest possible time if the logical blocks are continuous.

Zone-bit recording

Using such a mapping, be it translated physical or logical addressing, it is now possible to employ drives that do not have the same number of sectors per cylinder for the entire surface of the medium.

This leads to a recording technique that makes possible an increase of up to 50% in capacity without special heads or medium. In order to describe this technique, known as zone-bit recording, we need to talk a bit about disk recording in general. The composition of the magnetic surface of the disk and the type of the heads used determine the maximum recording density in flux changes per millimeter. For the purpose of our discussion here, we can think of a flux change as corresponding to a bit written to the disk. Using traditional recording methods, it is the innermost track that determines the maximum number of flux changes per track, but since the circumferences of the tracks increase as one moves away from the center, the number of flux changes that can be accommodated also increases. Zone-bit recording makes it possible to take advantage of this by increasing the number of flux changes in outer tracks. This is done by dividing the medium into several regions, in each of which the number of sectors per track is constant. The innermost region has the least number of sectors per track while the outermost region has the greatest. The regions in between bridge the two extremes. In this way the ideal of maximal flux density is approached and the capacity is significantly increased. A side effect of this is that the data rate of the medium increases from the inner tracks to the outer tracks. This, however, is an aspect that only the drive electronics has to deal with, not the IDE interface. The ST506 cannot accommodate zone-bit recording since the data comes directly from the heads and would therefore come at varying rates.

7.2 Defect management

The definition of the IDE interface and also the ATA standard specify no precise rules for dealing with errors. There are, however, two basic approaches that may be employed.

Defective sectors may be marked as such during formatting. Exactly how this is to be done is left up to the manufacturer. When the sectors are read they are recognized as defective and dealt with appropriately.

The second approach reallocates defective sectors. This is possible with translated physical addressing or logical addressing only. Here a specific area of the drive is reserved for replacement sectors. When a sector is identified as defective multiple copies of the replacement sector's address are written in that defective sector. This procedure is known as reallocation. In this way it is possible to present the host with an apparently defect free medium at all times.

Care must be taken in order to keep the access time of a reallocated sector to a minimum. Bear in mind the relevant time relationships: a revolution takes 11 ms, a track-to-track seek about 2 ms, the average seek time is 11 ms, and a head switch takes approximately 1 ms. Since a seek is most costly, it makes sense for each cylinder to contain several replacement sectors for that cylinder. This approach avoids seeks altogether.

Better still is the approach where each track has a sector for defect management. However, if the defective sector is simply reallocated to the reserve sector this is still not optimal. Figure 7.1 describes the situation. In order to read sectors 0 through 2, one must first read sector 0 and then wait almost an entire revolution until the replaced sector 1 is reached. Afterwards one must wait until sector 2 finally revolves underneath the heads to be read. The entire procedure takes $1\frac{1}{4}$ revolutions although only $\frac{1}{4}$ of a revolution is needed for reading; in other words, an entire revolution is lost.

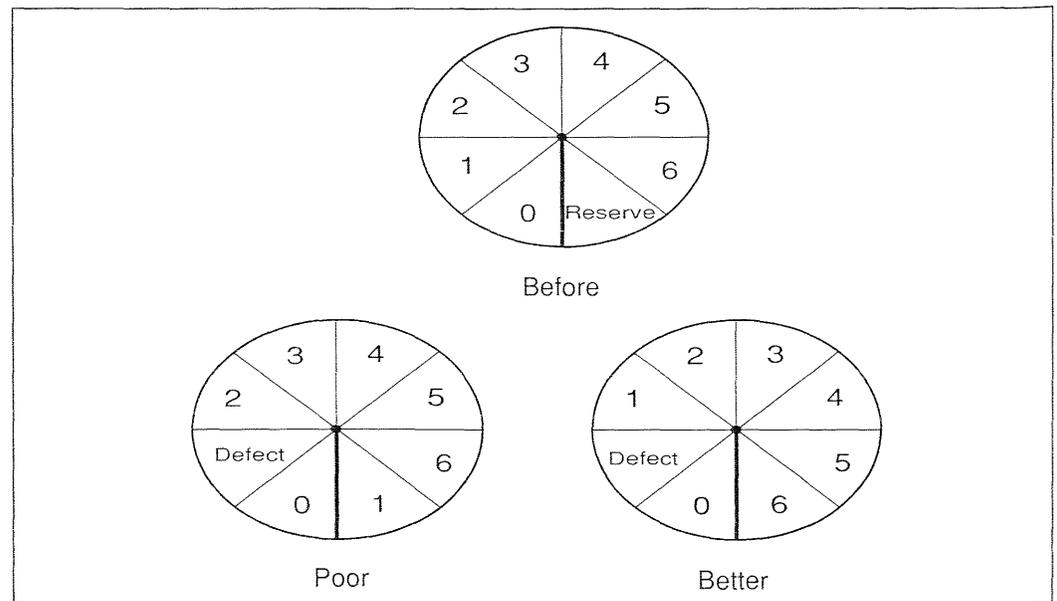

Figure 7.1 Strategies for sector reallocation.

The following is an approach that minimizes the access time to reallocated sectors. A replacement sector is reserved for defect management for each track. When a defective sector is found it is marked as such, and all subsequent sectors of the track are shifted by one. In this way even after the reallocation access to a continuous sequence of sectors can take place without losing a revolution. In addition, a number of replacement cylinders are also reserved for reallocation purposes. In the event that a track is found to have more than a single defective sector then the entire track can be reallocated.

7.3 The sector buffer

The sector buffer is used as a temporary storage for all read and write operations. This decouples the rate at which data is exchanged with the host and the rate at which data is written and read from the medium. This is necessary since a sector must always be written or read as a whole.

In the simplest case the sector buffer is an area of RAM on the IDE controller. If the buffer can only be used to exchange data with the medium or the host, one speaks of a single ported buffer. A buffer that is able to receive data from the host and write data to the disk simultaneously is referred to as a double ported buffer (Figure 7.2).

A double ported buffer must be able to hold more than a single sector. Only after an entire sector has been received will the controller begin to write the data to the medium. If during that time the buffer is able to receive additional data from the host the throughput of the system is significantly improved.

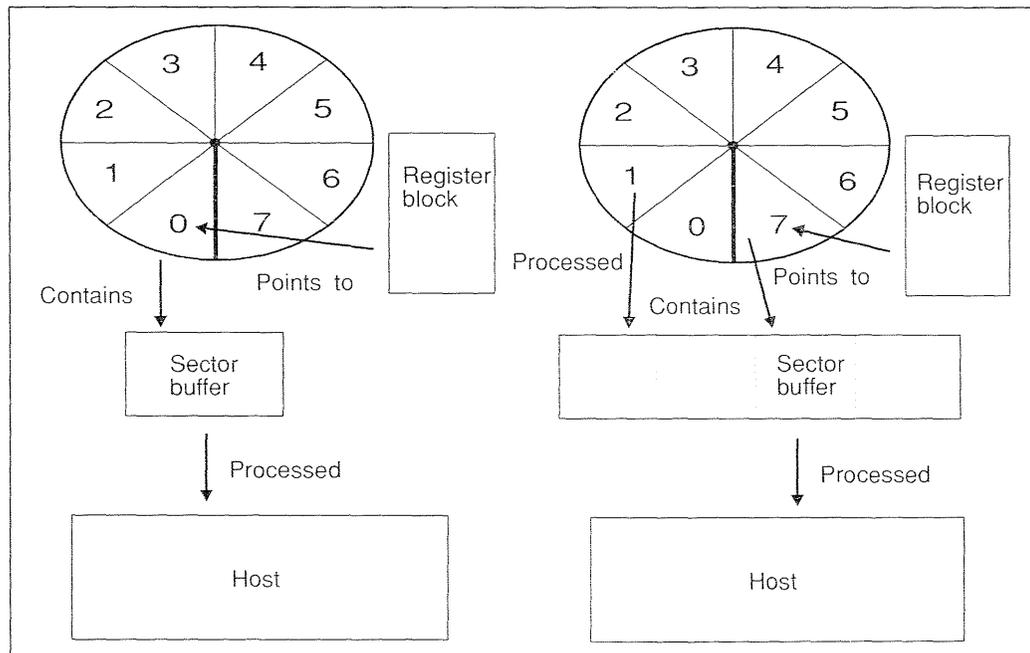

Figure 7.2 Single and double ported sectors.

As a further example, assume that we are reading a number of sequential sectors. A drive with a single ported buffer is forced to use an interleave, otherwise a subsequent sector will be lost by the time the host reads the first sector. This approximately halves the throughput of a double ported buffer, where the host can read the first sector during the time the second sector is read from the medium.

A double ported buffer looks like a sector buffer to the host in that it contains the data of the current sector. In a sense the sector buffer is a window through which the host and medium exchange data. The window is constantly shifted so that the data always corresponds to the current contents of the address register. Figure 7.2 makes these relationships clear.

The communication between the sector buffer and the host takes place either byte- or word-wise via the data register of the controller (PIO). Optionally, direct memory transfers are possible using DMA.

7.4 Power conditions

The ATA model of an IDE disk drive includes various power conditions. An IDE drive can be put into energy saving states of differing levels. This is an important capability in view of the increasing number of laptop and portable computers. Table 7.1 shows the possible states and the corresponding status bits. The status bits themselves are explained below. In the *REST* state the drive is either turned off or is preparing itself to be turned off. The host is informed of the condition of the drive and the controller so that when the drive is powered up again the original states can be restored.

This mode is useful for hosts that after being turned off and on are capable of maintaining all running programs precisely where they were before powering down. This applies to laptops particularly, because they have the battery necessary to maintain main memory and the drive status in the powered down state.

A small observation is perhaps in order at this point. This feature seems to be designed especially for laptops running MS-DOS, otherwise things would work the other way around: that is, a power-fail routine would be included in the operating system to save the contents of main memory to disk in the event of power loss. There the data would be safe indefinitely without power to the system. At power up the original state of the system could then be restored.

Table 7.1 Power conditions for IDE drives.

<i>Power condition</i>	<i>SRST</i>	<i>BSY</i>	<i>DRDY</i>	<i>Interface</i>	<i>Medium</i>
REST	0	0	0	0	0
SLEEP	*			*	0
STANDBY	x	0	1	1	0
IDLE	x	0	1	1	1
ACTIVE	x	x	x	1	1

However, the power supply must be capable of delivering power for long enough to carry out the procedure even after source power is gone. For a large amount of memory this requires several seconds.

A drive only leaves the REST state as the result of a power-up sequence or a reset.

In the SLEEP state the drive is turned on, but uses as little power as possible. Only through a RESET can the drive be brought into the active state again. Since in this state the motor may be turned off, a medium access may take as long as 30 seconds.

In the STANDBY state the IDE interface is capable of accepting commands. Here too the motor may be turned off, so a medium access may take up to 30 seconds. At its own discretion the drive can decide to switch from the IDLE state to the STANDBY state. Using CHECK POWER MODE the host can determine in which of the two states the drive currently resides.

In the IDLE state the motor is on and the drive is able to react to commands immediately. However, certain portions of the drive electronics may be turned off for power savings if this will cause only minimal delay for a medium access.

Finally, the ACTIVE mode is the normal state of the drive. Commands are executed in the shortest possible time in this state.

8 IDE commands

In this chapter, all the key IDE commands defined in the ATA standard are introduced briefly. The commands are listed in Table 8.1. Among these twelve are mandatory. The others may be optionally implemented, but then only in accordance with the ATA standard.

The table gives the command name, followed by the opcode. The mandatory commands are labeled with M in the M/O column, and the column labeled Class designates the command class. The last five columns show which control register is used for parameters. Included are FR (feature register), SC (sector count register), SN (sector number register), CN (cylinder number register), and DH (drive/head register). D in the DH column means that only the disk drive number is used; D* means that disk drive 0 is addressed, but both disk drives execute the command.

Some commands have a second opcode in parentheses. These opcodes were established by the industry prior to the ATA standard and are still in use. Conner drives use these earlier opcodes.

In addition, some manufacturers implement optional commands that are often very useful. A good example of this would be a command to read the defect list. In any case, it is always a good idea to consult the drive handbook when planning a large project.

8.1 Mandatory Commands

EXECUTE DRIVE
DIAGNOSTICS
(90h)

This command is always issued to disk drive 0, but initiates the internal diagnostics of both disk drives. After the diagnostics have run, the `BSY` bit is cleared and an interrupt given. The results for drive 0 can be retrieved from the error register. However, the contents must be interpreted with the aid of the error codes listed in Table 8.2.

If both drives are used and the slave drive has an error, it informs the master drive by not activating `PDIAG`. The master drive then sets the seventh bit in the error register. The host can read the error code of the slave drive by setting the `DRV` bit in the drive/head register and subsequently reading the error register.

Table 8.1 IDE commands of the ATA standard.

Command name	Command			Registers				
	Opcode	O/M	Class	FR	SC	SN	CN	DH
ACKNOWLEDGE MEDIA CHANGE	DBh	O	3					D
BOOT POST-BOOT	DCh	O	3					D
BOOT PRE-BOOT	DDh	O	3					D
CHECK POWER MODE	98h (E5h)	O	3		*			D
DOOR LOCK	DEh	O	3					D
DOOR UNLOCK	DFh	O	3					D
EXECUTE DRIVE DIAGNOSTIC	90h	M	3					D*
FORMAT TRACK	50h	M	2	*	*		*	*
IDENTIFY DRIVE	ECh	O	1					D
IDLE	97h (E3h)	O	3		*			D
IDLE IMMEDIATE	95h (E1h)	O	3					D
INITIALIZE DRIVE PARAMETERS	91h	M	3		*			*
RECALIBRATE	1xh	M	3					D
READ BUFFER	E4h	O	1					D
READ DMA (with and without retries)	C8h, 09h	O	4		*	*	*	*
READ DRIVE STATE	E9h	O	3	*				
READ MULTIPLE	C4h	O	5		*	*	*	*
READ SECTORS (with and without retries)	20h, 21h	M	1		*	*	*	*
READ LONG (with and without retries)	22h, 23h	M	1		*	*	*	*
READ VERIFY SECTORS (with and without retries)	40h, 41h	M	3		*	*	*	*
REST	E7h	O	5	*				
RESTORE DRIVE STATE	EAh	O	5	*				
SEEK	7xh	M	3			*	*	*
SET FEATURES	EFh	O	3	*				D
SET MULTIPLE MODE	C6h	O	3		*			D
SET SLEEP MODE	99h (E6h)	O	5					D
STANDBY	96h (E2h)	O	3		*			D
STANDBY IMMEDIATE	94h (E0h)	O	3					D
WRITE BUFFER	E8h	O	2					D
WRITE DMA (with and without retries)	CAh, CBh	O	4		*	*	*	*
WRITE MULTIPLE	C5h	O	5	*	*	*	*	*
WRITE SAME	E9h	O	5	*	*	*	*	*
WRITE SECTORS (with and without retries)	30h, 31h	M	2	*	*	*	*	*
WRITE LONG (with and without retries)	32h, 33h	M	2	*	*	*	*	*
WRITE VERIFY	3Ch	O	2	*	*	*	*	*

Table 8.2 Error codes for EXECUTE DRIVE DIAGNOSTICS.

Code	Defective component
01h	No error
02h	Formatter
03h	Data buffer
04h	ECC circuitry
05h	Microprocessor
8xh	Slave drive

FORMAT TRACK (50h) A few preliminary remarks are necessary concerning **FORMAT TRACK**. Although the command is mandatory it is left to the manufacturer exactly what will be performed. Some drives format the track from scratch, others initialize only the data area of the sectors, others do nothing at all. The ATA standard recommends that drives should at least write the sector with a data pattern. In this way formatting will always erase all data, which is desirable for security reasons.

The command formats an entire track. The sector count register, the cylinder number register, and the drive/head register must be loaded with the address of the track, then 256 16-bit words must be transferred to the sector buffer. Afterwards, the drive sets **BSY** and executes the command.

The codes written to the sector buffer have the meaning shown in Table 8.3. Whether or not the drive uses these or instead uses its default parameters is up to the manufacturer.

A data word should be written to the sector buffer for each sector, with the remainder filled with 0s. Each data word contains the sector number in the upper byte. If an interleave is called for, it is suppressed. The lower byte holds the code that indicates how the sector should be formatted.

INITIALIZE DRIVE PARAMETERS (91h) Using this command, the disk drive geometry can be configured. This is accomplished by loading the number of sectors in the sector count register and the disk drive number and number of heads in the drive/head register.

This command also allows a drive to be switched from natural to translated physical addressing. According to the ATA standard, the parameters do not have to be checked. If they are incorrect, the next disk access will result in an error. However, many drives use the default values when incorrect parameters are given for this command.

RECALIBRATE (1xh) All opcodes between 10h and 1Fh are interpreted as a **RECALIBRATE** command, whereupon the disk drive seeks track 0. If it is not found, **TK0NF** will be set in the error register.

RECALIBRATE is often used when trying to recover from an error situation. For example, when a sector cannot be found, a **RECALIBRATE** should be tried. If this works, a sector access can be tried again. Otherwise, it is fatal disk error.

READ SECTORS (20h with and 21h without retries) This command reads the number of sectors given in the sector count register. A value of 0 means 256 sectors. The address of the first sector is given in the address register. An interrupt follows each sector that is read. If the heads are not over the desired track, they are positioned automatically. After the command is executed, the address register holds the address of the last sector read.

In case of error the action taken depends on whether the command was issued with or without retries. Without retries the command will be aborted and the **IDNF** bit set in the error register if the correct sector is not found in two revolutions. Otherwise repeated attempts will be made to read the proper sector. The number of repeated attempts is manufacturer-specific.

Table 8.3 Codes for FORMAT TRACK.

<i>Code</i>	<i>Format</i>
00h	Format good sector
20h	Suspend reallocation
40h	Reallocate sector
80h	Mark sector defective

When the sector is found, the start of the data field is expected within a given number of bits. If it is not found, the command is aborted with an AMNF bit in the error register.

If a correctable ECC error occurs, the corresponding bit is set in the error register, but the command is not aborted. Only uncorrectable ECC errors lead to a command being aborted.

After a command is aborted, the address register contains the address of the sector in which the error occurred. The sector buffer could contain damaged data.

**READ LONG
(22h with and
23h without
retries)**

Unlike the READ SECTORS command, READ LONG always reads only one sector. Not only is the data transferred, but also the ECC bytes of the sector. The ECC is not checked. In all other respects, including errors, the command executes identically to the READ SECTORS command.

**READ VERIFY
SECTORS (40h
with and 41h
without retries)**

This command reads the requested sectors, but no data is transferred. It only verifies (hence the name) whether or not the sectors are readable. The response to an error is identical to that of the READ SECTORS command.

SEEK (7xh)

This command instructs the drive to position the heads over the cylinder given in the address register, and to switch to that head. Since the READ and WRITE commands explicitly position the head, the SEEK command is rarely needed.

**WRITE SECTORS
(30h with and
31h without
retries)**

This command behaves exactly like READ SECTORS, except that the data are written instead of read.

**WRITE LONG
(32h with and
33h without
retries)**

This command behaves exactly like the READ LONG command, except that the data are written instead of read. Here, the ECC must also be written to the sector buffer. This is not trivial, since the ATA standard does not specify the sector format or how the ECC polynomial is to be computed. This command may be used when running system tests in order to produce an ECC error. A sector can be read using READ LONG, the data and ECC modified so as to reflect an ECC error, and the falsified sector rewritten using WRITE LONG. In this way, the error handling can be tested.

8.2 Optional commands

- ACKNOWLEDGE MEDIA CHANGE (DBh)** This command clears the MC bit in the error register. The operating system uses this to acknowledge that the media change has been recognized.
- CHECK POWER MODE (98h, E5h)** With this command, the host can determine whether the drive is in an IDLE or STANDBY state. This is necessary since the drive can go to STANDBY on its own, which, under certain circumstances, can cause a delay of up to 30 seconds for the first command.
If the drive is in STANDBY or transitioning to this state, it replies with the value 00h in the sector count register. In the IDLE state, the drive replies with FFh in the sector count register.
- DOOR LOCK (DEh) and DOOR UNLOCK (DFh)** These commands, which are for removable media drives, close and lock, and unlock and open the door.
- IDENTIFY DRIVE (ECh)** The command IDENTIFY DRIVE is of special interest. After receiving this command, the drive writes a parameter block with information about the drive in the sector buffer. This parameter block is then read in the normal way from the sector buffer by the host. Table 8.4 shows the structure of the parameter block.
The parameter block consists of 255 16-bit words. Some of the fields require further explanation. First, word 0 is a bitwise-coded word with configuration parameters. Table 8.5 illustrates the meaning of the individual bits.
The geometry values given in Table 8.4 for words 1 to 6 refer to the default mapping, which is usually physical addressing without translation. The current geometry of the disk drive is found in words 54 to 58.
The following values are defined for the buffer type: 0001h stands for a one-way buffer implemented for a single sector, 0002h stands for a two-way buffer of several sectors, and 0003h indicates a read cache.
- IDLE (97h, E3h) and IDLE IMMEDIATE (95h, E1h)** These commands put the drive into the IDLE state. A timeout value can be provided in the sector count register measured in 5-second increments. If a new command is received within this time the drive will not change to the IDLE state.
- READ BUFFER (E4h)** This command functions differently to the READ command. It reads 512 bytes from the sector buffer without a disk access. The address register is therefore not used. Whatever is in the sector buffer will be read.
- READ DMA (C8h with and C9h without retries)** This command functions like the other READ commands, except that the contents of the sector buffer will be read using DMA. It is therefore necessary for the host to set up the proper DMA channel.

Table 8.4 Parameter list of the IDENTIFY command.

<i>Word</i>	<i>Contents</i>
0	Configuration
1	Number of cylinders
2	Reserved
3	Number of heads
4	Bytes per track unformatted
5	Bytes per sector unformatted
6	Sectors per track
7–9	Vendor specific
10–19	Serial number (ASCII)
20	Buffer type
21	Buffer size in 512-byte segments
22	Number of ECC bytes for READ and WRITE LONG
23–26	Firmware revision (ASCII)
27–46	Model name (ASCII)
47	Bits 7–0: sectors per interrupt for READ and WRITE MULTIPLE
48	Bit 0: double word I/O possible
49	Bit 9: LBA; bit 8: DMA supported
50	Reserved
51	Bit 15–8: timing mode for PIO data transfers
52	Bit 15–8: timing mode for DMA data transfers
53	Reserved
54	Apparent number of cylinders
55	Apparent number of heads
56	Apparent number of sectors per track
57–58	Apparent capacity in sectors
59	Bit 7–0: number of sectors per interrupt
60–61	Total number of addressable sectors (LBA mode)
62	Bit 15–8: active mode for single DMA Bit 7–0: supported modes for single DMA
63	Bit 15–8: active mode for multiple DMA Bit 7–0: supported modes for multiple DMA
64–127	Reserved
128–159	Vendor specific
160–255	Reserved

READ DRIVE STATE (E9h) Using this command the host can read the current status of the drive after a REST command. This status can then be sent back to the drive using the RESTORE DRIVE STATE command when the REST state is over.

READ MULTIPLE (C4h) This command functions similarly to the READ SECTORS command. The difference is that instead of a single sector, blocks of several sectors are transferred without an interrupt occurring in between. The number of the sector must be given in the sector count register. Just how many sectors are to be included in a block is determined by the SET MULTIPLE MODE command. If the required sectors do not fit into the block size, an additional block (not fully used) will be transferred containing the remaining sectors.

Table 8.5 Configuration bits for IDENTIFY data.

<i>Bit</i>	<i>Meaning</i>
0	Reserved
1	Hard-sectored drive
2	Soft-sectored drive
3	Encoding other than MFM
4	Head switching time 15 μ s
5	Spindle motor control implemented
6	Hard drive
7	Changeable medium
8	Data rate to 5 MHz
9	Data rate between 5 and 10 MHz
10	Data rate above 10 MHz
11	Motor speed tolerance above 0.5%
12	Data clock offset available
13	Track offset available
14	Speed tolerance gap necessary
15	Reserved

REST (E7h) This command puts the disk drive into the REST state. It then waits for a READ DRIVE STATE command to be informed of its state before the execution of the last command. After this command is executed only the READ DRIVE STATE command will be accepted; all others will be rejected. If two drives are installed, first the slave drive then the master drive will be put into the REST state.

RESTORE DRIVE STATE (EAh) If a drive's status is collected and the drive is put into the rest state before being turned off this prior state can be restored at power-up using this command, assuming that it is the first command received after turning on. Bear in mind that the head position and the status of the controller are restored but that the contents of the sector buffer and cache are lost.

SET FEATURES (EFh) This command enables the setting of various characteristics of the drive by writing a specific opcode in the feature register. Opcodes higher than 80h represent the default values after booting or a reset. Table 8.6 lists the opcodes.

SET MULTIPLE MODE (C6h) The block size for the commands READ MULTIPLE and WRITE MULTIPLE are given to the disk drive via the sector count register using this command. If the block size is not supported, or if it is 0, the multiple commands will be turned off.

Disk drives that have at least 8 KByte buffer must support at least block sizes 2, 4, 8, and 16.

SLEEP (99h, E6h) This command puts the drive in the SLEEP state. The motor will also be switched off. Only a hardware or software reset will end the SLEEP state.

Table 8.6 Opcodes for SET FEATURES.

<i>Opcode</i>	<i>Meaning</i>
01h	Enable 8-bit data transfers
02h	Enable write cache
22h	WRITE SAME write the specified area
33h	Disable retries
44	Vendor specific ECC length for READ LONG and WRITE LONG
54	Place number of cache segments in sector number register
55h	Disable read ahead
66h	Maintain parameters after software reset
77h	Disable ECC
81h	Disable 8-bit data transfers
82h	Disable write cache
88h	Enable ECC
99h	Enable retries
AAh	Enable read ahead
ABh	Use the value in the sector count register as the number of sectors to be read ahead
ACh	Allow REST mode
BBh	4 bytes of ECC for READ LONG and WRITE LONG
CCh	Software reset loads default features
DDh	WRITE SAME to write entire medium

- STANDBY (96h, E2h) and STANDBY IMMEDIATE (94h, E0h)** This command puts the drive into STANDBY state. The STANDBY IMMEDIATE command is executed immediately. If the sector count register has a value other than 0 when the STANDBY command is issued, the shutdown procedure will begin automatically, and the timer will begin as soon as the drive is in the IDLE state (see IDLE command, above).
- WRITE BUFFER (E8h)** This command writes the sector buffer of the drive with a data pattern. No writing to the medium will occur.
- WRITE DMA (CAh with and CBh without retries)** This command functions like the other WRITE commands except that the contents of the sector buffer are written using DMA. The host must initialize the proper DMA channel beforehand.
- WRITE MULTIPLE (C5h)** This command functions analogously to the READ MULTIPLE command.
- WRITE SAME (E9h)** Depending upon the mode set in the feature register, this command will write all or part of the medium with the same data. The feature register must previously be loaded with either 22h (for part of the medium) or DDh (for the entire medium) using the SET FEATURES command. Otherwise, the command will be rejected.

WRITE VERIFY (3Ch) This command functions like the **WRITE SECTORS** command, with the exception that the sectors are subsequently verified. During verification only the ECC is checked without a transfer of data. Any read errors are reported.

Part III

The SCSI bus

- 9 Background
- 10 SCSI hardware
- 11 SCSI bus protocol
- 12 SCSI commands
- 13 Direct access devices
- 14 Tape drives
- 15 Printers
- 16 Scanners
- 17 Processor devices
- 18 Communications devices
- 19 Optical storage and WORM drives
- 20 CD-ROM
- 21 Medium-changer devices
- 22 The SCSI monitor program
- 23 Software interfaces
- 24 Test equipment
- 25 SCSI protocol chips

9 Background

9.1 The evolution of SCSI

SCSI, which the entire industry affectionately refers to as 'scuzzy', stands for Small Computer Systems Interface. SCSI can trace its beginnings back to 1979, when the disk drive manufacturer Shugart began work on a new interface. The goal was to develop a drive interface that supported logical addressing of data instead of physical addressing. Moreover, the interface would present data byte-wise instead of serially. Such an interface could end the compatibility problems associated with bringing new drive technologies to market. In the past it took a long time for computer companies to support the new drives. The interface to solve this problem was originally called SASI (Shugart Associates Systems Interface), and the specification totaled 20 pages. SASI is the forerunner of the modern SCSI. The interface specification, which included some 6-byte commands and defined single-ended drivers and receivers, was made public to encourage companies to build SASI controllers. Companies such as OMTI and DTC became involved in these early days. In 1980, Shugart's first attempt to make SASI an ANSI standard failed. At that time ANSI preferred the more sophisticated IPI interface.

Progress began in 1981, but not before a failed agreement between NCR and Shugart to work together on further development of SASI. NCR wanted 10-byte commands and a differential interface, features Shugart considered unnecessary. Most likely Shugart believed that these options would make the interface too complicated. At this point the company Optimem came on the scene. A subsidiary of Shugart, Optimem manufactured optical disks. They needed to be able to address more than 2^{21} logical blocks for their optical drives. Moreover, the 6 meters cables then in use were too short. These were precisely the reasons why Shugart had declined to work with NCR in the first place. In December 1981, Shugart, together with NCR, requested that an ANSI committee be formed for SASI.

In April 1982 ANSI committee X3T9.2 met for the first time and began the work that has evolved into SCSI. In the following years a draft proposal was prepared, which was presented to ANSI for approval in 1984. However, even before final approval had been given, manufacturers began producing SCSI host adapters and device controllers. The first protocol chip, the NCR 5385, came on

the market in 1983. The interface had become an industry standard long before it received approval from ANSI. In June 1986, SCSI-1 became official as ANSI X3.131-1986.

The growing number of SCSI products exposed weak points in the definition. In defining commands, too much room for variation was given for vendor unique options. For example, format parameters for disk drives were not standardized. In addition, although a SCSI drive should present a virtual defect free medium to the host – by having medium defects managed transparently by the device – defect management was left undefined. Consequently, each manufacturer implemented these things as they saw fit, which basically meant that a new device driver had to be written for each new SCSI device. The goal of a device independent interface was definitely lacking on the software side. At that time it was fair to say that SCSI was not necessarily SCSI compatible.

Looking for a solution to this problem, the drive specialists in the committee began defining a Common Command Set (CCS) for disk drives in 1985. The main purpose of the command set was to nail down some of the many options for disk drives. Among the features introduced in the CCS was the defect list format, which you will learn more about in Chapter 13. The CCS was a big step forward and once again the manufacturers began implementing it before it became official. However, CCS was only a solution for disk drives; tape drive manufacturers had to make do with SCSI-1 the way it was.

In 1986, even before SCSI-1 had become an official standard, work on SCSI-2 began. In addition to further development of the CCS and the other device classes, the committee worked on numerous modifications in protocol and hardware. Many features were developed, only to be discarded in the end. The option to support more than eight devices is an example of this. On the other hand, 10 MHz synchronous transfers were incorporated along with a 32-bit wide data bus. Of course, the real challenge in the implementation of these options lay in maintaining compatibility among the different devices. As a protocol option, a device could inform a host ‘unsolicited’ of change in device status. This is important, for example, when a cassette is removed from a tape drive.

The formal approval procedure for SCSI-2 began in February 1989. As usual, there were dozens of devices already equipped with SCSI-2 before it became a standard. These early releases, incidentally, were never a problem. During the final phases of development the standard had become so stable that only minor changes were being discussed. Above all, tape drive manufacturers were anxious to implement SCSI-2 for their devices. However, late amendments caused the early 1992 delivery date to be postponed. Finally, two years later, at the beginning of 1994, SCSI-2 became an official ANSI standard. The event was, needless to say, very anticlimactic.

Dal Allan, a SCSI industry specialist, wrote in an article for the magazine, *Computer Technology Review*:

No technical rationale can be offered as to why SCSI-1 ended and SCSI-2 began, or as to why SCSI-2 ended and SCSI-3 began. The justification is much more simple – you have to stop sometime and get a standard printed. Popular interfaces never stop evolving, adapting, and expanding to meet more uses than originally envisaged.

9.2 Overview

I begin with a broad overview of the SCSI bus. Everything discussed here will be gone over in greater detail later in the book. If you are only interested in particular aspects of SCSI, read this section first, then use the index to find specific topics.

The SCSI interface is a device independent I/O bus, allowing a variety of devices to be linked to a computer system using a single bus. The electrical characteristics and protocol of the bus were designed with the requirements of peripheral devices in mind. SCSI makes available a number of commands for querying a device about necessary parameters. This makes it possible to write device drivers for a device without knowing device specific details.

SCSI offers greater functionality, especially in the case of disk drives, than device level interfaces. Firstly, data is addressed logically instead of physically. The host need not concern itself with the exact organization of data on the drive. Moreover, the drive can manage defects autonomously, making it possible to present a defect-free medium to the host.

SCSI devices Up to eight devices can be addressed using the SCSI bus. The SCSI address is referred to as the SCSI ID. These devices play the role of either an initiator or a target. An initiator is a device that begins a transaction by giving another device a certain task to perform; the SCSI host adapter of a computer is a typical initiator. The target is the device that carries out the task; a disk drive is a typical target. A bus configuration may have any combination of targets and initiators totaling eight: a minimal system would consist of a single initiator and single target. It is worth noting that some devices can play the role of both a target and an initiator. However, for an individual transaction it is clearly defined which is the initiator and which is the target.

Figure 9.1 introduces two more terms that have a particular meaning in the SCSI world. A computer system is connected to the SCSI bus through a host adapter. For a peripheral device the corresponding role is played by a controller. This SCSI specific terminology can be confusing because in other computer domains – for example, the IDE interface – a controller often connects a peripheral directly to a computer. Both controllers and host adapters can be implemented either as a separate board or integrated into the device or system. Host adapters often reside directly on the mother board of workstations and modern personal computers, in which case they are referred to as embedded host adapters. PC compatibles use the insertable card variation. SCSI controllers are usually embedded in the drive electronics of disk drives. When the controller is implemented on a separate board it is referred to as a bridge controller. Bridge controllers were often used with ESDI disk drives, which were not available with SCSI. Today intelligent bridge controllers are used in applications such as RAID arrays, which make several drives act as one powerful SCSI drive. Figure 9.2 shows a bridge controller connecting a Centronics printer to the SCSI bus. Yet another application of bridge controllers takes advantage of the eight logical units (LUNs) that SCSI allows for each device. In this case each LUN can repre-

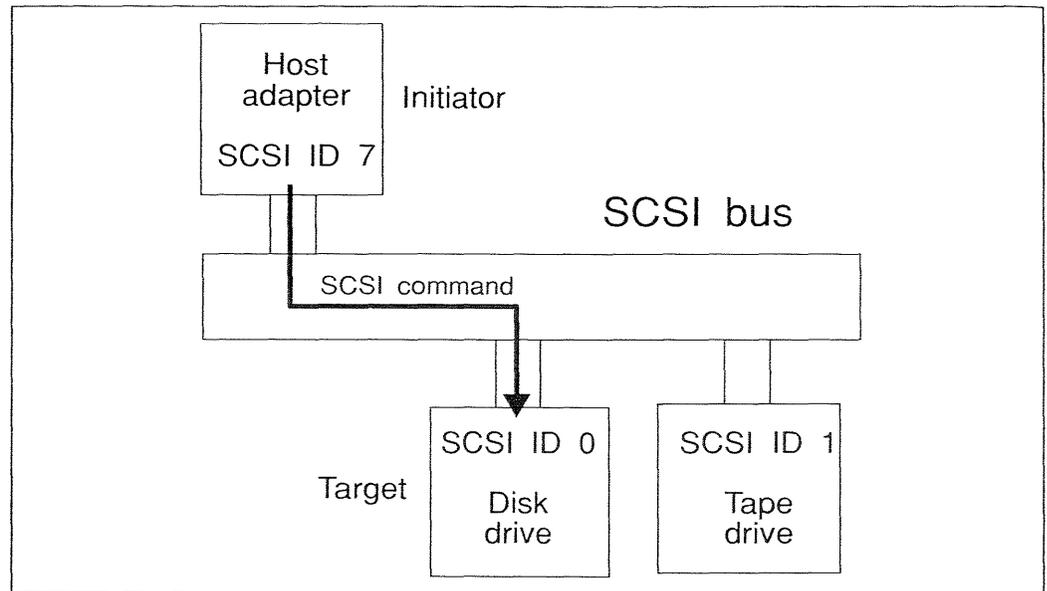

Figure 9.1 A simple SCSI configuration.

sent a separate peripheral device. Such a controller must possess a number of device specific interfaces, one for each LUN.

Hardware

Up to now we have focused on SCSI devices, not on the bus itself. The SCSI bus is from 8 to 32 bits wide, depending on configuration. A simple 50-pin ribbon cable can be used for the 8-bit bus, including all other necessary control signals. The 16- and 32-bit variations are called Wide SCSI and call for an additional cable. Naturally, any device that supports Wide SCSI must also have a second connector. Wide SCSI is a SCSI-2 feature, which is optional and has been imple-

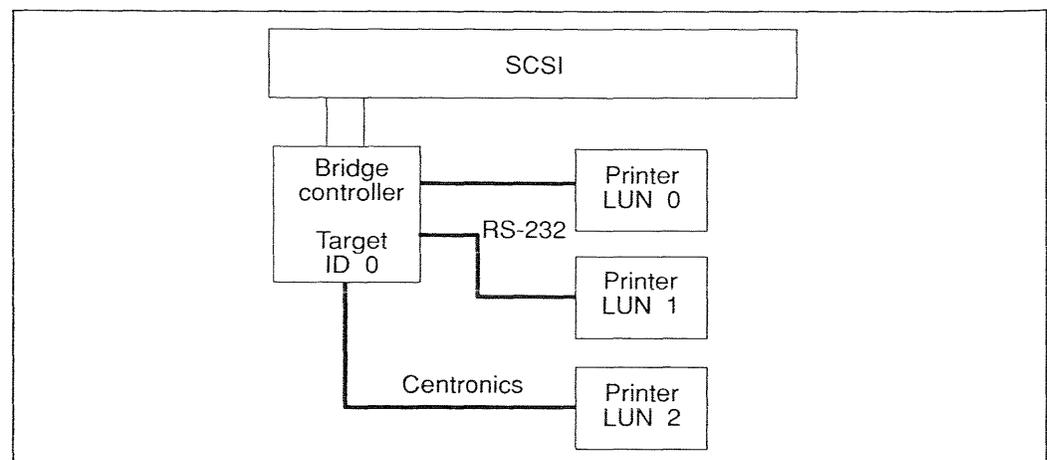

Figure 9.2 Bridge controller with logical units.

mented for very few devices. Just what advantages does Wide SCSI offer in view of these cable complications? Using the same clock frequency, the bandwidth of 32-bit SCSI is four times that of 8-bit SCSI.

Commands, messages and status are sent across the bus exclusively using asynchronous transfers. This means that the sender and receiver exchange data using a request/acknowledge handshake. This allows devices that do not implement Wide SCSI (or Fast, as we shall see) to use the same bus. Asynchronous transfers can reach a maximum of approximately 3 MHz. Additionally, there exists the option to transfer data synchronously, which under SCSI-2 allows devices to exchange data at speeds of up to 10 MHz. Whether or not synchronous transfers will be used is negotiated by the two devices beforehand. This alleviates any problems that might occur between SCSI-1 and SCSI-2 devices on the same bus.

The SCSI cable is usually a 50-pin ribbon cable. It runs from device to device and can reach a maximum of 6 meters. A small 'stub cable' of up to 0.10 meter can be used to connect a device to the main cable. Since most SCSI devices have only a single SCSI connector, a cable is used that has the appropriate number of connectors crimped along its length. The devices on the extreme ends of the bus – and no other devices – must have terminating resistors. These terminators are usually socketted to allow placement in any position on the bus (see Figure 9.3).

There are two fundamentally different variations on the type of electrical signals used for the bus: single-ended and differential. These variations are not compatible with each other. Devices with single-ended and differential interfaces cannot be used on the same bus, although they can use the same type of cable. Before configuring a system, the decision must be made as to what type of interface will be used. This choice is made somewhat easier by the fact that most devices are only available with single-ended SCSI.

Single-ended SCSI uses open-collector drivers to power the bus. One advantage of this is that the drivers can usually withstand an improperly inserted connector. There is no reason to panic if you accidentally insert a connector the wrong way: I've done this a number of times and haven't damaged a device

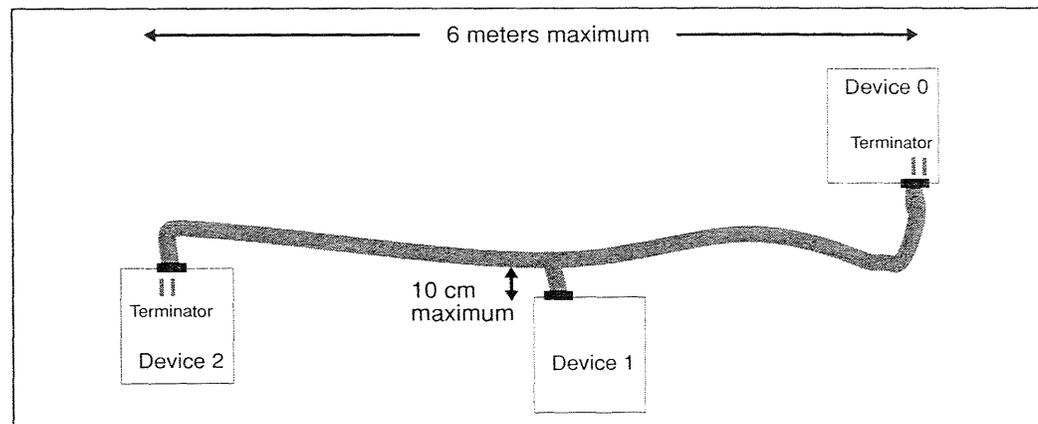

Figure 9.3 SCSI cable.

yet! The pin assignments are such that a ground is opposite every signal. In addition to flat cable, twisted-pair cables can also be used.

Differential drivers allow cable lengths beyond the 6 meters of the single-ended drivers, up to 25 meters. Since so few devices come with a differential interface, single-ended to differential adapters have appeared on the market.

Summary of hardware options

Many terms have been introduced in the preceding section. Here they are brought together in one place. These are the terms that you will find in SCSI product manuals (Figure 9.4):

- **Asynchronous SCSI:** This method of data transfer is basic to all SCSI devices. The transfer rate is normally around 1.5 MHz although modern chips are capable of 3–4 MHz.
- **Synchronous SCSI:** This optional method of data transfer makes possible rates of 5 MHz with SCSI-1 and 10 MHz with SCSI-2. Since commands and other protocol related information are sent asynchronously, devices are able to negotiate which method will be used. Devices that use this option and those that do not can function side by side on the same bus. The synchronous option is found on most high performance devices.
- **Fast SCSI:** An improvement to synchronous transfers for SCSI-2 devices allowing a data rate up to 10 MHz. Fast SCSI is quickly becoming standard for high-performance disk drives.
- **Wide SCSI:** 16- or 32-bit transfers are made possible with an additional cable (B cable). The resulting data rate is double or quadruple the previous rate. This SCSI-2 option also allows a mix of device types on a single bus. The B cable is simply omitted for 8-bit devices. Wide SCSI is not often used because of the complications of an additional cable.
- **Single-ended/differential:** These two variations on the implementation of the electrical signals were already part of the original SCSI definition. The vast majority of devices employ a single-ended interface. Here the maximum cable length is 6 meters. The differential option allows cable lengths up to 25 meters. Single-ended and differential devices cannot be used together on the same bus.

Device classes and commands

A well-defined command set is an important element of a device independent interface. With respect to the SCSI bus, device independence takes on two dimensions. On the one hand, there are the ten SCSI device classes, of which hard disks and tape drives are two examples. Each class defines a specific model and command set for the devices of that class. On the other hand, a number of different physical devices can be supported by a single device class. For example, consider the different types of tape drives available. One component of a device model is a set of parameters that adequately defines these differences.

Transactions take place on the SCSI bus in more or less the following manner: an initiator sends a command to a target, and the target carries out the command and afterwards informs the initiator of the outcome. The nature of

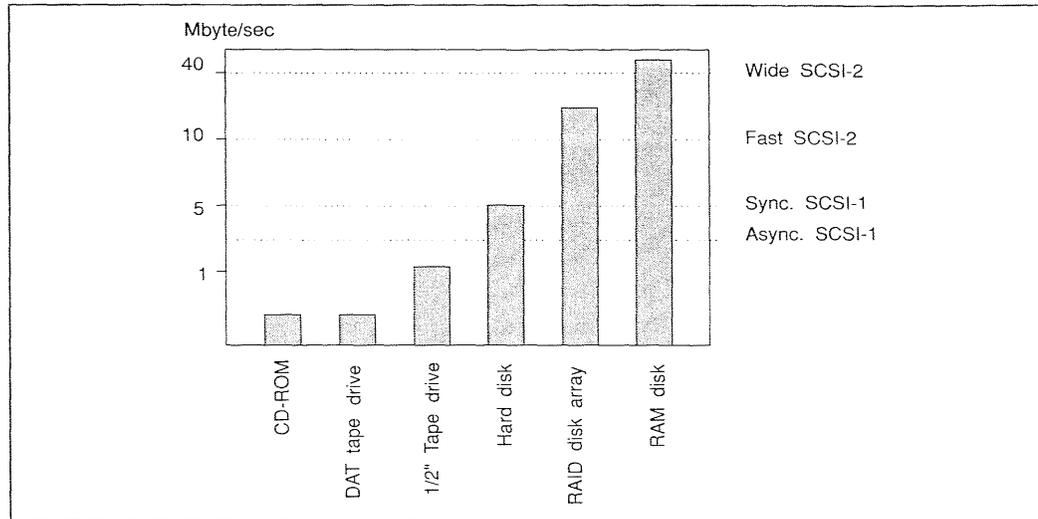

Figure 9.4 SCSI transfer rates.

SCSI commands gives a great deal of autonomy to the device carrying out the command. In this way an initiator can send a SCSI floppy drive a `FORMAT UNIT` command and relinquish complete control to the drive. When the formatting is finished, the initiator is merely informed of success or failure.

Another example of device autonomy is the `READ` command for disk drives. The initiator instructs the target to fetch a certain number of blocks starting at a particular block number. The target calculates a physical address of cylinder, head, and sector number from the logical block number and sends the data to the initiator. An important difference with the SCSI interface is that this data is strictly usable information – no headers, no ECC, no gaps. All of these ancillary fields are managed by the target alone. This is important because different devices use completely different formats to store information on the medium. This also explains how it is possible to produce a very inexpensive host adapter capable of controlling up to seven different devices. The intelligence is located in the devices, not in the host adapter.

SCSI makes available a number of commands for general interrogation of devices on the SCSI bus. A possible scenario could begin with a host looking to see which SCSI IDs are occupied. Afterwards, the host can determine what types of devices are located at those IDs. Finally, device specific commands can be used to gather detailed information about each device. A device driver can be written in just this way without knowing the specific details of the device.

Evolution of the command sets

The SCSI-1 standard originally contained many commands that have remained unchanged in SCSI-2. SCSI-1 also left many parameters vendor unique or unspecified, which sidestepped the original intent of the standard. The result was that practically every device needed its own slightly different device driver. This complicated the goal of device independent software. It was at this point

that many people felt that SCSI simply was not SCSI compatible. These were some of the problems that SCSI-2 solved, in addition to its improvements.

The CCS supplement to SCSI-1, which became an official part of SCSI-2, had the aim of further standardizing the hard disk command set. The CCS introduced the concept of mode parameter page for the `MODE SELECT` command and defined a set of defect list formats. Tape drives and other device classes, however, were not included in the CCS. These had to make do with SCSI-1 as it was originally formulated.

Finally, a very significant step forward was made in the definition of SCSI-2. In SCSI-2, a model is defined for every device class. Moreover, the same level of detail used in the CCS for disk drives was used in defining the other device classes. It is worth noting that the first SCSI implementations were for streamer tape devices. It is fair to say that the goal of a device independent software interface was reached with SCSI-2.

Note that new devices are no longer shipped with a SCSI-1 implementation. Today, both tape devices and disk drives are equipped with SCSI-2. However, the CCS of SCSI-1 is still very accurate with respect to disk drives.

9.3 Outlook

The popularity of SCSI continues to grow. An increasing number of devices and host adapters are supporting more and more SCSI-2 features. Judging by its functionality and throughput capabilities, SCSI-2 should be able to meet the needs of peripheral devices for many years to come.

The ANSI SCSI committee has already been working for quite some time on SCSI-3. In the tradition of the previous specifications, SCSI-3 will be compatible with SCSI-2. Among more tangible improvements, the documentation for SCSI-3 is better organized and more modular. Figure 9.5 depicts this new organization. The shaded modules are those that already exist in SCSI-2.

In the physical and protocol area, SCSI-3 defines new interface formats such as fiber optics. The idea of communicating with SCSI devices across a regular serial interface is also very attractive. An additional bus phase will be added to the parallel interface SCSI that has been discussed so far. Support for multiple hosts will be improved and 16-bit Wide SCSI over a single cable has been included and already adopted by the Industry.

One noteworthy addition to the new specification is a set of commands specifically for use in graphics applications. In fact, a number of new device classes can be expected. In general, we can expect device classes and models to be more strictly defined, along with command set implementation for those devices.

Although it is true that SCSI-3 will offer a number of improvements over SCSI-2 in general, in the area of mass storage there is little new. SCSI-3 will offer alternatives in areas where at present the physical interface is available but the command sets are lacking.

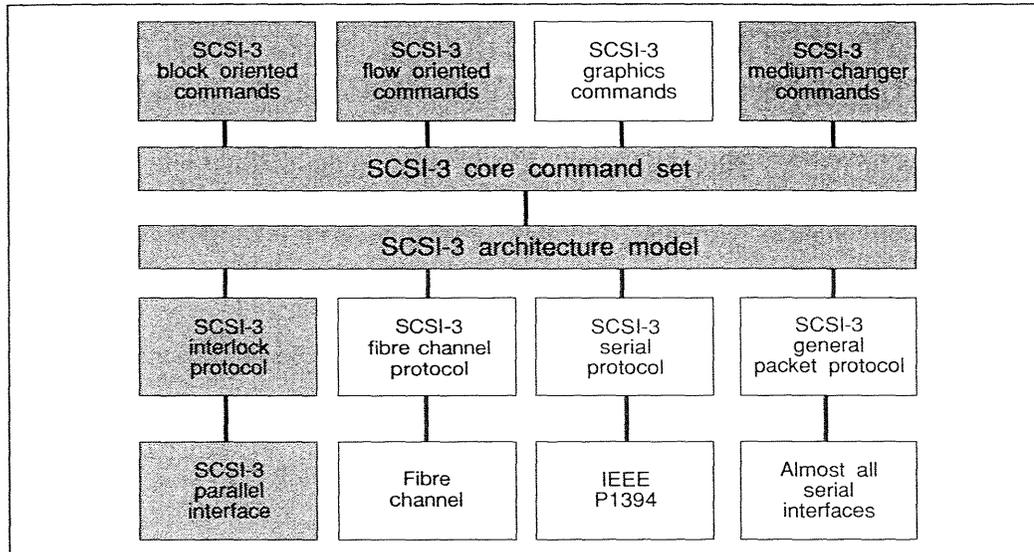

Figure 9.5 The SCSI-3 architecture.

9.4 Documentation

One goal of this book, in addition to providing a thorough overview of SCSI, is to give enough detailed information to make possible the undertaking of simple SCSI projects without the need of additional documentation. Naturally, if you wish to take advantage of the vendor specific features of a certain device, you will need that device's SCSI manual. For example, the optional commands and parameter pages can be found there.

If you are interested in working with SCSI at a professional level, you cannot avoid getting a copy of the original ANSI documentation in addition to this book. A project involving writing firmware for a SCSI target or host adapter would be of this magnitude, as would writing a software driver that used more than simply READ and WRITE commands. Copies of the standard may be ordered from:

Global Engineering Documents,
2805 McGaw,
Irvine, CA 92714, USA
Telephone: 1-800-854-7179

The SCSI-2 document is called X3.131-1994. If you only need a copy of the SCSI-1 standard (which is considerably thinner than SCSI-2), the name is X3.131-1986.

You can also download the SCSI documentation from the SCSI Bulletin Board. The telephone number and the procedure are described in detail in Appendix D.

The organization of the SCSI standard

The SCSI-2 standard is a document of about 600 pages, which is organized in the following way:

- 1 Scope
- 2 Reference standards and organizations
- 3 Glossary and conventions
- 4 Physical characteristics
 - 4.1 Physical description
 - 4.2 Cable requirements
 - 4.3 Connector requirements
 - 4.4 Electrical description
 - 4.5 SCSI bus
 - 4.6 SCSI bus signals
 - 4.7 SCSI bus timing
 - 4.8 Fast synchronous transfer option
- 5 Logical characteristics
 - 5.1 SCSI bus phases
 - 5.2 SCSI bus conditions
 - 5.3 SCSI phase sequences
 - 5.4 SCSI pointers
 - 5.5 Message system description
 - 5.6 SCSI messages
- 6 SCSI commands and status
 - 6.1 Command implementation requirements
 - 6.2 Command descriptor block
 - 6.3 Status
 - 6.4 Command examples
 - 6.5 Command processing considerations and exception conditions
 - 6.6 Contingent allegiance condition
 - 6.7 Extended contingent allegiance condition
 - 6.8 Queued I/O processes
 - 6.9 Unit attention condition

Sections 7 to 17 of the standard deal with the individual device classes. They are all organized in the same way: first comes a description of the device model of the class, followed by a summary of commands, and finally the MODE parameters for the class.

- 7 All device types
- 8 Direct-access devices
- 9 Sequential-access devices
- 10 Printers
- 11 Processor devices
- 12 WORM
- 13 CD-ROM
- 14 Scanners
- 15 Optical memory devices
- 16 Medium-changer devices

17 Communication devices
A-J Appendices

Figure 9.6 shows a page from the actual SCSI documentation. Many drive manufacturers organize their own manuals in a similar manner, including, naturally, only those chapters which are relevant for a given device. The result is that once you are familiar with the ANSI specification, it is very easy to find your way around in SCSI manuals in general. If you know one — you know them all. This makes it easy to concentrate on important things, namely, implementation details.

All Device Types

3/9/90

7.2.5 INQUIRY Command

Table 7-14: INQUIRY Command

Bit	7	6	5	4	3	2	1	0
Byte								
0	Operation Code (12h)							
1	Logical Unit Number			Reserved				EVPD
2	Page Code							
3	Reserved							
4	Allocation Length							
5	Control							

The INQUIRY command (Table 7-14) requests that information regarding parameters of the target and its attached peripheral device(s) be sent to the initiator. An option allows the initiator to request additional information about the target or logical unit (see 7.2.5.2).

An enable vital product data (EVPD) bit of one specifies that the target shall return the optional vital product data specified by the page code field. If the target does not support vital product data and this bit is set to one, the target shall return CHECK CONDITION status with the sense key set to ILLEGAL REQUEST and an additional sense code of INVALID FIELD IN CDB.

An EVPD bit of zero specifies that the target shall return the standard INQUIRY data. If the page code field is not zero, the target shall return CHECK CONDITION status with the sense key set to ILLEGAL REQUEST and an additional sense code of INVALID FIELD IN CDB.

The page code field specifies which page of vital product data information the target shall return (see 7.3.4).

The INQUIRY command shall return CHECK CONDITION status only when the target cannot return the requested INQUIRY data.

IMPLEMENTORS NOTE: It is recommended that the INQUIRY data be returned even though the peripheral device may not be ready for other commands.

If an INQUIRY command is received from an initiator with a pending unit attention condition (i.e., before the target reports CHECK CONDITION status), the target shall perform the INQUIRY command and shall not clear the unit attention condition (see 6.9).

SCSI-2 draft proposed American National Standard

Revision 10c

Figure 9.6 Sample page from the SCSI-2 standard.

10 SCSI hardware

10.1 SCSI configurations

SCSI devices SCSI makes it possible to connect up to eight devices using a single bus. At any given time only two of the devices may communicate with one another. The device that issues a command is called the initiator, while the device that executes it is called the target. SCSI devices are uniquely identified by a SCSI ID, which also serves as its address. The ID simultaneously defines the device's priority for arbitration: ID 0 has the lowest priority, ID 7 the highest.

These and other bare essentials are described in the ANSI standard in section 4.5; however, some clarification is in order. Whenever two devices communicate with each other, no other devices take part in the exchange. The only way to affect all devices simultaneously is through a SCSI reset, for which there is a special bus signal. Outside of this there is no way for a third-party device to interrupt communication across the bus. All devices, regardless of priority, must wait until the bus is freed by those devices using it.

In fact, most devices cooperate as much as possible in keeping the bus free. As soon as a command has been received by a target it will release the bus for other devices before executing it. After the work is done it reconnects to the initiator and delivers any information. The mechanism for this – disconnect/reconnect – is covered in Chapter 11, where the bus protocol is described in greater detail.

The SCSI ID for each device on the bus is set independently and must be unique. The priority associated with the ID plays only a secondary role; it is only important when two or more devices attempt to use the bus at the same time. When a connection has been established between two devices or when there is a substantial delay (2.4 μ s) between requests for the bus, priority no longer plays a role.

Host adapters and SCSI controllers A computer has access to the SCSI bus via a host adapter. This host adapter may be implemented as a separate board, as is the case with most PC systems, or it may be integrated onto the system motherboard, as is popular with workstations. It is also possible for a system to have a number of host adapters with access to as many SCSI buses (Figure 10.1). In such a case each SCSI bus is

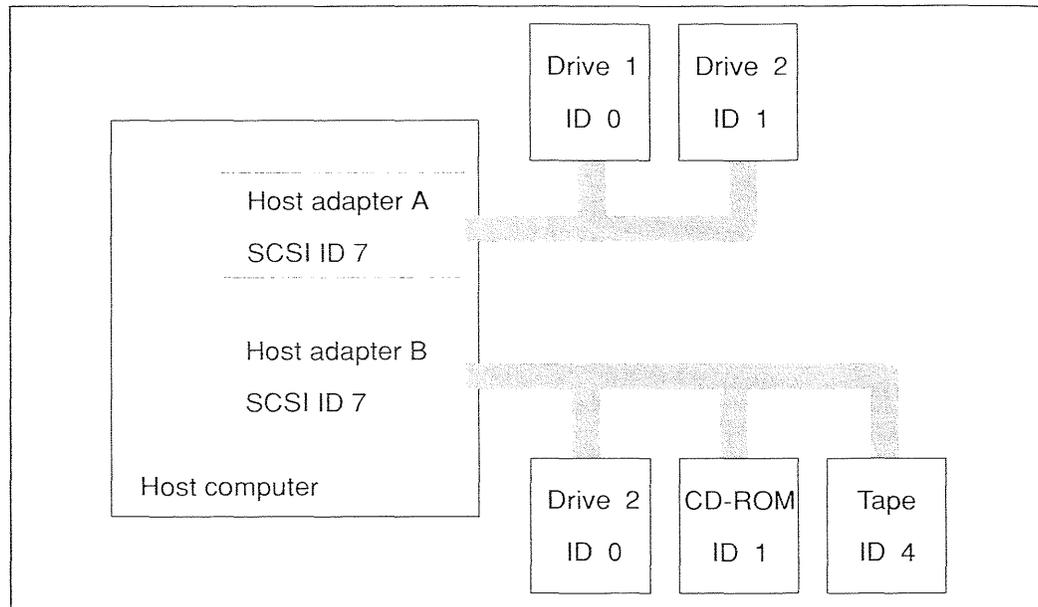

Figure 10.1 Computer with multiple SCSI buses.

completely separate from the others. For instance, the individual buses are allowed to use the same SCSI IDs since there is no chance of confusion.

For peripherals access to the bus is provided through a SCSI controller. The controller itself has the SCSI ID and the peripheral device is seen as a LUN. Most commonly the controller is embedded into the peripheral. In this case only a single LUN is supported, namely the peripheral itself. However, controllers are also implemented separately, in which case they are known as bridge controllers. Figures 9.2 and 10.2 show SCSI controllers with LUNs.

Almost by convention, the first host adapter of a SCSI bus system usually receives ID 7. The remaining host adapters are assigned IDs from 6 downward. This convention, however, is not laid down anywhere in the SCSI specification. It is the responsibility of the software to handle all possible ID assignments.

Initiator and target

Devices on the SCSI bus play either the role of an initiator or that of a target. These roles are completely independent of whether a device is a host adapter or other component. Originally, most devices assumed one role or the other, then it was the case that host adapters were strictly initiators and controllers strictly targets. However, more and more devices are able to assume either role. Almost all tape drives, for example, are capable of becoming an initiator during the course of the COPY command, when data is copied between the drive and a third device.

An initiator begins a transaction on the SCSI bus by selecting a target. However, as soon as the selection is complete, the target takes control of the bus protocol. The target decides whether or not to free the bus and afterwards when to reconnect to the initiator. Michael Schultz, a former colleague of mine, coined the phrase, 'The initiator is the master in function and the slave in protocol; the target is the slave in function and the master in protocol.'

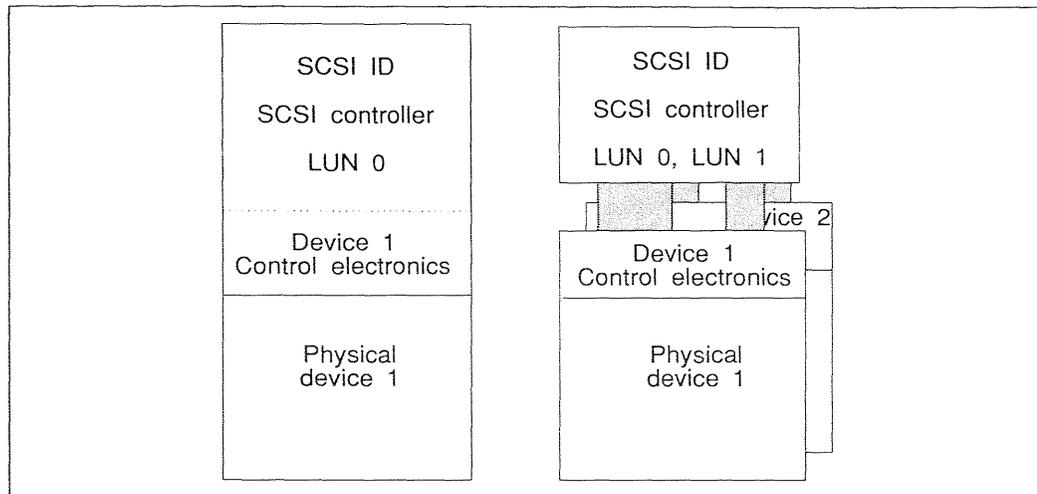

Figure 10.2 Embedded SCSI and bridge controllers.

SCSI configurations

SCSI supports any mixture of initiators and targets as long as there is at least one of each. The following three base configurations represent the range of complexity to be found in a typical SCSI system (Figure 10.3).

Single initiator, single target

This is the most simple and probably the most common configuration. A single initiator, a host adapter, communicates with a single target, the peripheral device. This configuration is also the most SASI-like. You will often read that disconnect/reconnect for this setup is superfluous. This is not exactly true, as we will see in Section 11.4.

Single initiator, multiple targets

This configuration makes good on one of SCSI's promises: connectivity for multiple device types using a single I/O bus. In this case it is important that all devices strive to keep the bus as free as possible by using the disconnect/reconnect feature. Although this feature is optional for all versions of SCSI, in practice most devices support it. If you install an older device that does not support this feature try to limit the number of peripherals on this bus.

Multiple initiators, multiple targets

In this configuration it is good practice for an initiator to reserve a target when accessing it. This rule of thumb is naturally dependent on the device class. Operating systems do not like it when more than one host has write access to a single file on a disk drive. For read-only CD-ROMs, on the other hand, this is not a problem. I recommend that targets be reserved even in systems with only a single initiator. The software overhead is minimal compared with the savings when one day an additional host is added to the system.

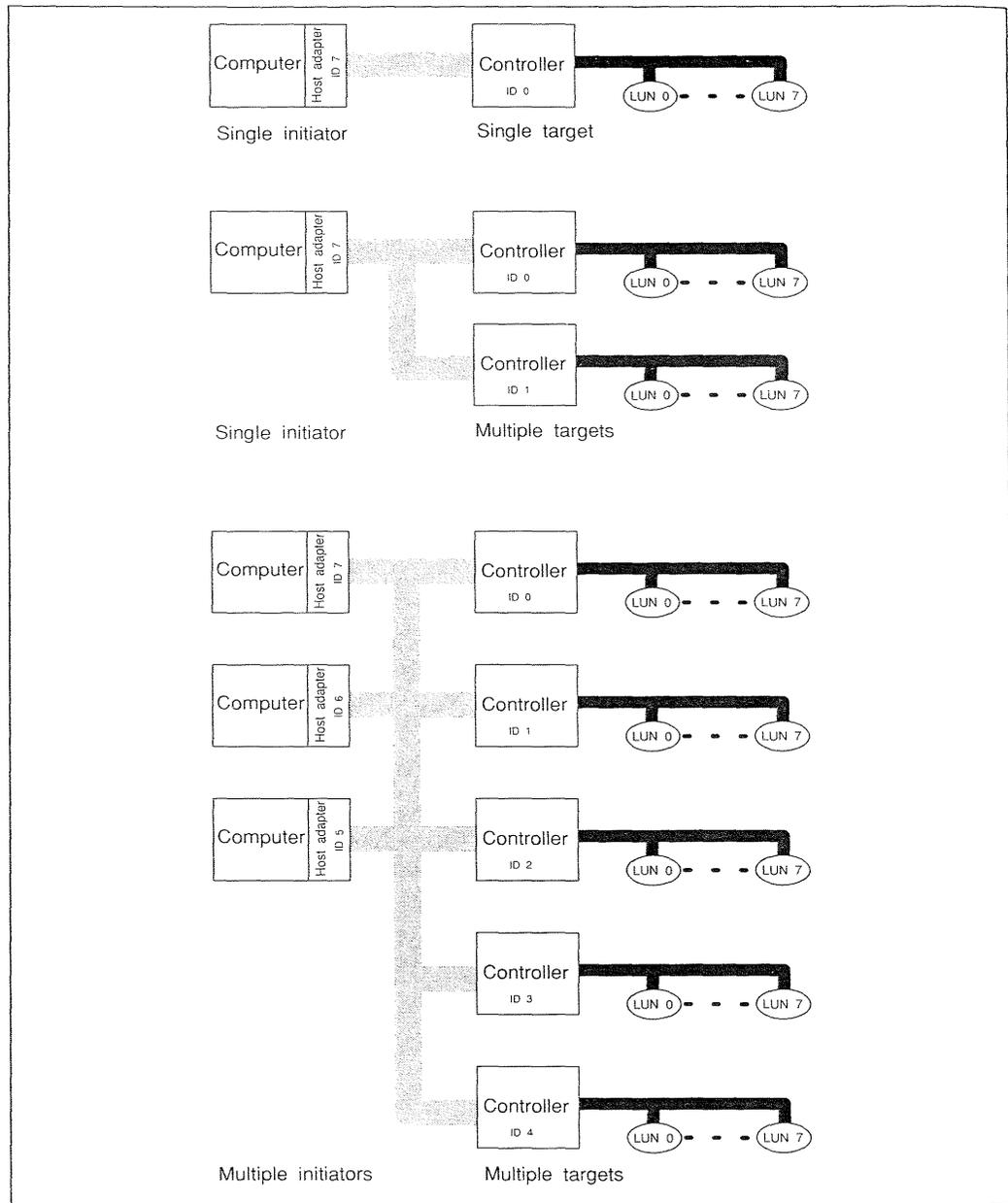

Figure 10.3 Basic SCSI configurations.

10.2 SCSI signals

The standard 8-bit wide SCSI bus has 18 signals. These are all contained in a single 50-pin flat-band cable, the so-called A cable. In this book all timing diagrams show signals as active-high; in other words, a logic 1 is represented by a high signal. In reality, however, signals are either active-low or differential for SCSI. Termination resistors hold the signals nonactive until bus drivers drive the signal active. This makes it possible to leave devices on the bus whose power has been turned off.

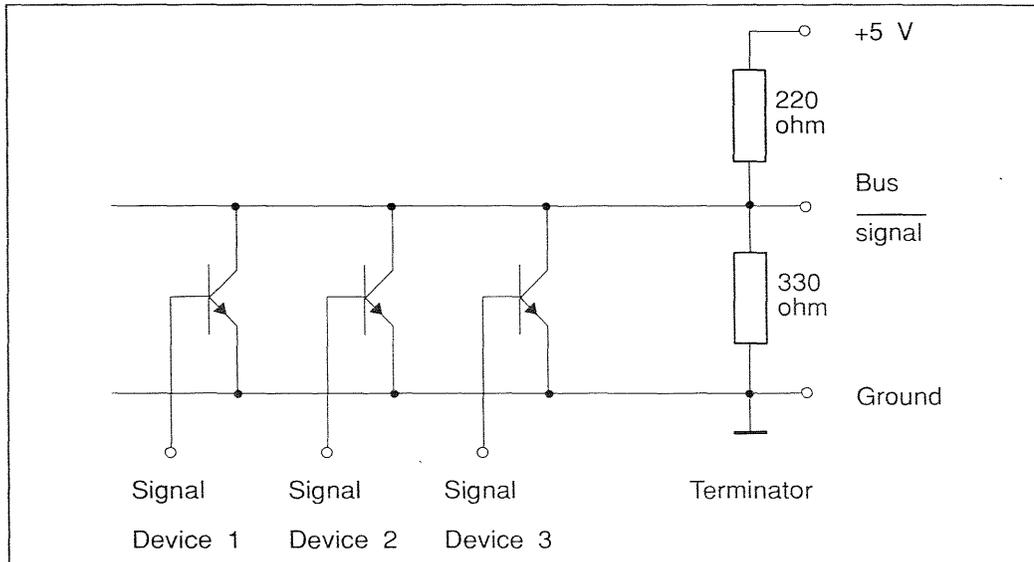

Figure 10.4 Wired-or bus signals.

Three of the SCSI signals *BSY*, *SEL*, and *RST*, must be implemented as wired-or. This allows more than one driver to activate the signal at a given time. Of course, only one driver is necessary to make it active. All other signals need not be wired-or and are usually implemented with tri-state drivers.

Figure 10.4 shows a wired-or signal implemented with open collector transistors. As long as the transistor is inactive, the terminator assures the high, inactive state. When the transistor turns on it pulls the voltage down to the active state. Even if more than one transistor becomes active simultaneously the result is the same.

Wide SCSI Wide SCSI is a SCSI-2 option, which makes possible 16- or 32-bit wide data transfers. In order to handle the extra width an additional 29 signals are necessary.

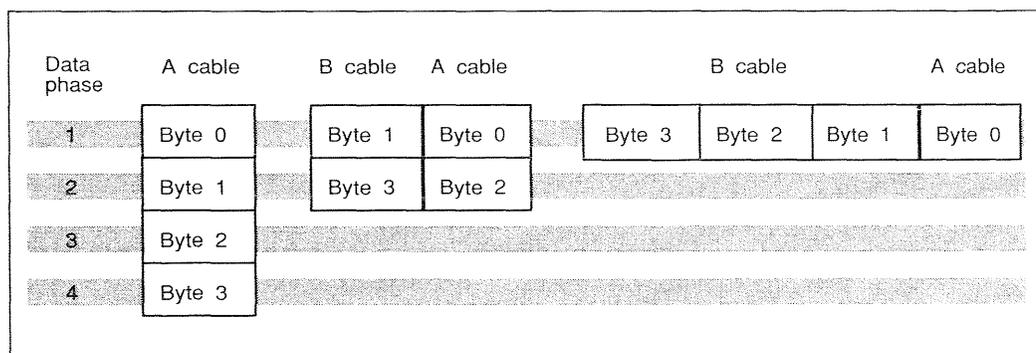

Figure 10.5 Byte ordering for Wide SCSI.

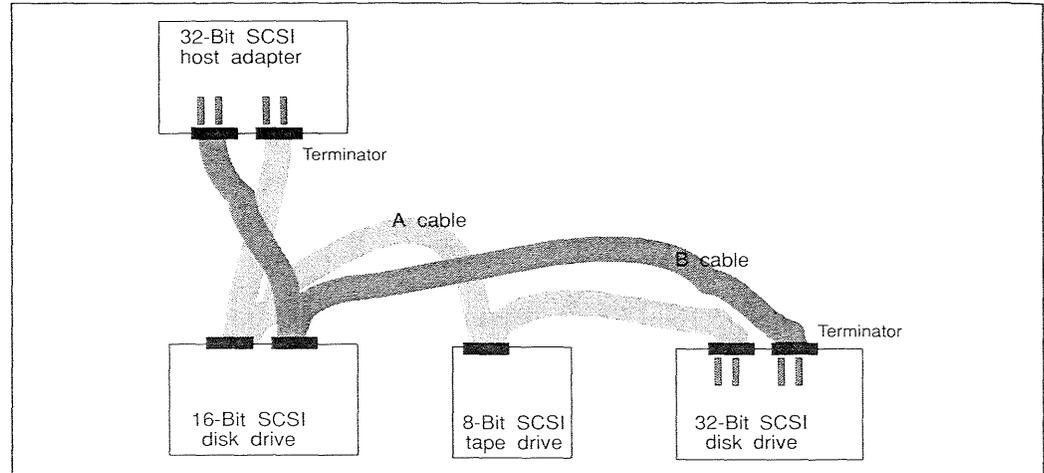

Figure 10.6 Mixed configuration with Wide SCSI.

These signals reside on the 68-pin B cable. Figure 10.5 shows the ordering of bytes for 8-, 16- and 32-bit wide transfers. The B cable is always 68-pin, even if only 16-bit transfers take place.

As with synchronous transfers, the devices involved negotiate whether or not to use Wide SCSI. This is possible because commands and messages always take place across the 8-bit bus. It is even possible to mix devices using different data widths on the same bus. Figure 10.6 shows such a configuration.

Table 10.1 lists all SCSI signals along with their function. A look at the SCSI bus phase descriptions in Section 10.6 will make it easier to understand the role of each signal.

Termination

Each end of the physical SCSI bus must be terminated with the appropriate resistors. Most SCSI devices have sockets for the terminating resistors that facilitate easy removal. The resistors in the two devices located at the ends of the bus should be left installed; the other devices should have their resistors removed. If a cable does not happen to end at a device then this loose end must be terminated with external resistors.

A SCSI terminator must be supplied with +5 V. A signal on the A cable is reserved for this purpose. This makes it possible for a device to provide other devices with terminator power. In general, however, this option is not used because most devices supply their own terminator power.

The data parity bit

The only way to detect a corrupted data byte sent over the SCSI bus is through the parity bit. Parity works as follows: the sender of a data byte counts the number of 1s contained in the byte. If the total number is odd the parity bit is set to 0; if it is even, the parity bit is set to 1. In this way the total number of 1s should always be odd, hence SCSI uses what is called odd parity. The receiver then checks to see if the total number of 1s is odd. When this is the case the receiver

Table 10.1 The SCSI signals.

<i>Abbreviation</i>	<i>Name</i>	<i>Function</i>
BSY	BUSY	Wired-or signal indicating that the bus is in use
SEL	SELECT	Wired-or signal used during selection and reselection
C/D	COMMAND/DATA	Used by the target to indicate the type of data transfer
I/O	INPUT/OUTPUT	Used by the target to indicate the direction of the data transfer (with respect to the initiator). When active the initiator receives data. Also differentiates selection from reselection
MSG	MESSAGE	Used by the target during the MESSAGE phase
REQ	REQUEST	Used by the target during the handshake sequence.
REQB		This signal exists on both the A cable (REQ) and B cable (REQB)
ACK	ACKNOWLEDGE	Used by the initiator during handshake sequence. Also exists on both cables
ACKB		
ATN	ATTENTION	Used by the initiator to indicate the ATTENTION condition
RST	RESET	Wired-or signal that causes the RESET condition
DB(7) ...	DATA BUS	8 data bits and parity bit that comprise the data bus.
DB(0)		The data bits are also used during the arbitration phase. Parity is odd
DB(p)		
DB(31) ...	DATA BUS	24 data bits and 3 parity bits that expand the data bus
DB(8)		
DB(p3) ...		
DB(p1)		

assumes that the data is intact. The implementation of a parity bit went from optional in SCSI-1 to mandatory in SCSI-2. There is one parity bit for every eight data bits (that is, four for 32-bit Wide SCSI). If a SCSI device detects a parity error it will ask that the data be sent again. A detailed example of this can be found on page 122.

One deficiency in the parity bit approach is that only an odd number of 'bad' bits can be detected. This means that it is possible for corrupted data to go unnoticed (Figure 10.7). If an initiator sends a byte where two bits change their value on the bus, the parity bit will still be good. The target receives the byte and

Bit	7	6	5	4	3	2	1	0	P	
Original	1	1	0	1	0	0	0	0	1	Parity OK
1 Error	1	1	0	0	0	0	0	0	1	Parity error
2 Error	1	1	1	0	0	0	0	0	1	Parity OK!

Figure 10.7 Shortcomings of SCSI parity.

has no way of detecting the corrupted byte. When the target writes this data to the drive the error remains. Although this is an obvious shortcoming, in practice it is extremely rare for an even number of bits to change their value.

Using a single parity bit as the sole method of error detection is not uncommon. Almost all memory buses, from PC to mainframe, share this design. Although I/O buses are generally exposed to noisier environments than internal buses, this simple method of insuring data integrity proves to be effective here as well.

10.3 Cables and connectors

SCSI cables The single-ended and the differential pin assignments for SCSI are designed to make it possible to use the same cables. The A cable is a 50-pin cable while the B cable is 68-pin. Either implementation may use either ribbon cable or twisted-pair, although the latter is recommended for differential buses. Cables should have an impedance between 90 and 140 ohms.

When Fast SCSI is being used – that is, transfer rates above 5 MHz – the cable requirements are somewhat stricter. The cable should be shielded with an impedance between 90 and 132 ohms and a signal attenuation of less than 0.095 dB at 5 MHz.

Connectors Ribbon cables with crimped-on connectors are the most common choice for device internal SCSI connections. The device electronics typically use a 50-pin male header which fits the female ribbon cable connector. Table 10.2 shows the pin assignments for different cable types, including ribbon cable.

For external connections between devices shielded twisted-pair cables are recommended. Here either high-density connectors (shielded or unshielded) or Centronics connectors (unshielded) may be used. For both of these the pin assignments are identical, as can be seen in Table 10.2.

Finally, there is a pin assignment that is not described in the SCSI specification. There are a number of inexpensive host adapters, as well as the Macintosh, that use this DB25 connector for the bus. This assignment scheme is also shown in Table 10.2.

10.4 Single-ended SCSI

The vast majority of devices sold today are equipped with single-ended SCSI. The main reason for this is the extra cost in implementing differential and the cost of twisted-pair cabling. Most SCSI chips have single-ended drivers already built in. Single-ended SCSI allows a bus of up to 6 meters. This is adequate for most applications within a single enclosure. Also allowed are short extensions from the bus, so-called stubs, of 10 cm or less. These must be kept at least 30 cm

Table 10.2 A cable for single-ended SCSI.

Signal	Centronics high density	Ribbon cable		Centronics high density	DB25	Signal
Ground	1	1	2	26	14	$\overline{\text{DB}(0)}$
Ground	2	3	4	27	2	$\overline{\text{DB}(1)}$
Ground	3	5	6	28	15	$\overline{\text{DB}(2)}$
Ground	4	7	8	29	3	$\overline{\text{DB}(3)}$
Ground	5	9	10	30	16	$\overline{\text{DB}(4)}$
Ground	6	11	12	31	4	$\overline{\text{DB}(5)}$
Ground	7	13	14	32	17	$\overline{\text{DB}(6)}$
Ground	8	15	16	33	5	$\overline{\text{DB}(7)}$
Ground	9	17	18	34	18	$\overline{\text{DB}(p)}$
Ground	10	19	20	35	19	Ground
Ground	11	26	22	36	13	Ground
Reserved	12	23	24	37	9	Reserved
Not connected	13	25	26	38		+5 V Terminator
Reserved	14	27	28	39		Reserved
Ground	15	29	30	40	8	Ground
Ground	31	16	32	41	20	$\overline{\text{ATN}}$
Ground	17	33	34	42	6	Ground
Ground	18	35	36	43	23	$\overline{\text{BSY}}$
Ground	19	37	38	44	22	$\overline{\text{ACK}}$
Ground	20	39	40	45	10	$\overline{\text{RST}}$
Ground	21	41	42	46	21	$\overline{\text{MSG}}$
Ground	22	43	44	47	7	$\overline{\text{SEL}}$
Ground	23	45	46	48	11	$\overline{\text{C/D}}$
Ground	24	47	48	49	24	$\overline{\text{REQ}}$
Ground	25	49	50	50	12	$\overline{\text{T/O}}$

apart. Bear in mind that the distance from the protocol chip to the connector must be attributed to the stub length.

Signal levels and termination

Figure 10.8 shows the implementation of a typical single-ended SCSI signal. The output driver is a NAND gate. One input is for the signal and the other for enabling the output. The driver must meet the following specifications: 2.5–5.25 V (inactive); 0.0–0.5 V (active). It must be capable of sinking 48 mA at 0.5 V, of which 44 mA come from the termination. The input must recognize 0.0–0.8 V as active and 2.5–5.25 V as inactive. The input current for an active signal of 0.5 V must lie between 0.0 and –0.4 mA. For an inactive signal the current must lie between 0.0 and 0.1 mA at 5.25 V. The input hysteresis must be at least 0.2 V and the input capacitance at most 25 pF. These values must also hold for devices without power.

Also shown in the figure is the signal termination. This consists of a pair of resistors for each signal of the SCSI bus. The 220 ohm resistor connects to +5 V while the 330 ohm connects to ground. Together the resistors bring the signal level to 3 V when no drivers are active. The resistors are allowed a tolerance

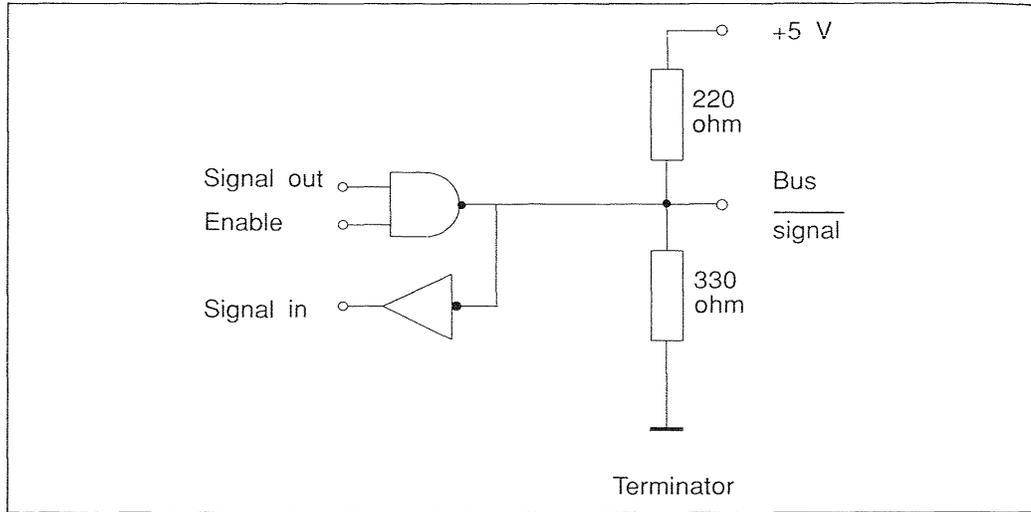

Figure 10.8 Typical single-ended SCSI.

of $\pm 5\%$ although $\pm 1\%$ is recommended. This passive termination scheme was introduced in SCSI-1.

SCSI-2 allows an alternative for terminating a single-ended bus. The most important condition here is that the signal impedance lie between 100 and 132 ohms. This circuit, which is shown in Figure 10.9, is less sensitive to noise than the passive termination.

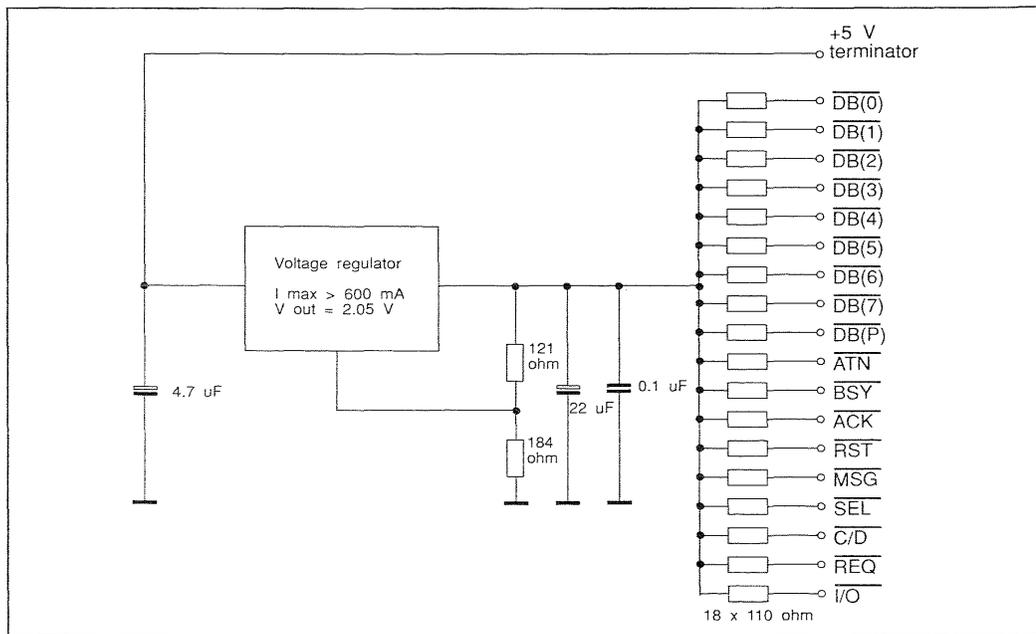

Figure 10.9 Alternative SCSI-2 termination.

Table 10.3 B cable for single-ended Wide SCSI.

<i>Signal</i>	<i>Connector</i>	<i>Cable</i>		<i>Connector</i>	<i>Signal</i>
Ground	1	1	2	35	Ground
Ground	2	3	4	36	DB(8)
Ground	3	5	6	37	DB(9)
Ground	4	7	8	38	DB(10)
Ground	5	9	10	39	DB(11)
Ground	6	11	12	40	DB(12)
Ground	7	13	14	41	DB(13)
Ground	8	15	16	42	DB(14)
Ground	9	17	18	43	DB(15)
Ground	10	19	20	44	DB(P1)
Ground	11	21	22	45	ACKB
Ground	12	23	24	46	Ground
Ground	13	25	26	47	REQB
Ground	14	27	28	48	DB(16)
Ground	15	29	30	49	DB(17)
Ground	16	31	32	50	DB(18)
+5 V terminator	17	33	34	51	+5 V terminator
+5 V terminator	18	35	36	52	+5 V terminator
Ground	19	37	38	53	DB(19)
Ground	20	39	40	54	DB(20)
Ground	21	41	42	55	DB(21)
Ground	22	43	44	56	DB(22)
Ground	23	45	46	57	DB(23)
Ground	24	47	48	58	DB(P2)
Ground	25	49	50	59	DB(24)
Ground	26	51	52	60	DB(25)
Ground	27	53	54	61	DB(26)
Ground	28	55	56	62	DB(27)
Ground	29	57	58	63	DB(28)
Ground	30	59	60	64	DB(29)
Ground	31	61	62	65	DB(30)
Ground	32	63	64	66	DB(31)
Ground	33	65	66	67	DB(P3)
Ground	34	67	68	68	Ground

Improper termination

What happens when a single-ended bus is incorrectly terminated? I can give the following account from my own experience. If the bus has no termination at either end, nothing will work. This rarely happens, however, because usually the host adapter has its termination installed. In general a SCSI bus with termination at only one end will work without problems. However, if the bus is very long or is in a noisy environment then it will be susceptible to intermittent hanging. This is also true for other forms of improper termination. When the termination is not located at the physical end of the bus the problem will usually go unnoticed for quite some time. A bus with three terminators also tends to function without difficulties, in my experience.

This tolerant behavior is attractive but can lead to insidious problems. It is true that an incorrectly terminated bus will often work quite well. However, if

the system is then moved or an additional device is added to the bus it may suddenly hang or show intermittent problems. When this occurs it always makes sense to begin looking for the problem by asking whether the bus is properly terminated.

Pin assignments The various connectors defined in the SCSI standard were described in Section 10.3. There are at least three different pin layouts for the different connectors. The same connectors always use the same assignment. Table 10.2 lists these pin assignments. The pin assignments for the B cable for single-ended Wide SCSI are given in Table 10.3.

10.5 Differential SCSI

Differential SCSI is used mostly in applications that require cable lengths greater than 6 meters. The maximum length allowed here is 25 meters (about 80 feet). Stub lengths must be less than 20 cm. ANSI recommends that only twisted-pair cables be used for a differential bus.

Signal levels and termination

Each differential signal on the SCSI bus uses two wires, named +signal and -signal. The signal is recognized as active when the voltage of +signal is greater than that of -signal and inactive when the converse is true.

The sensor signal makes it possible to implement a circuit for protecting the differential drivers. The corresponding pin on the single-ended cable is connected to ground. In this way if a cable with a single-ended device attached is

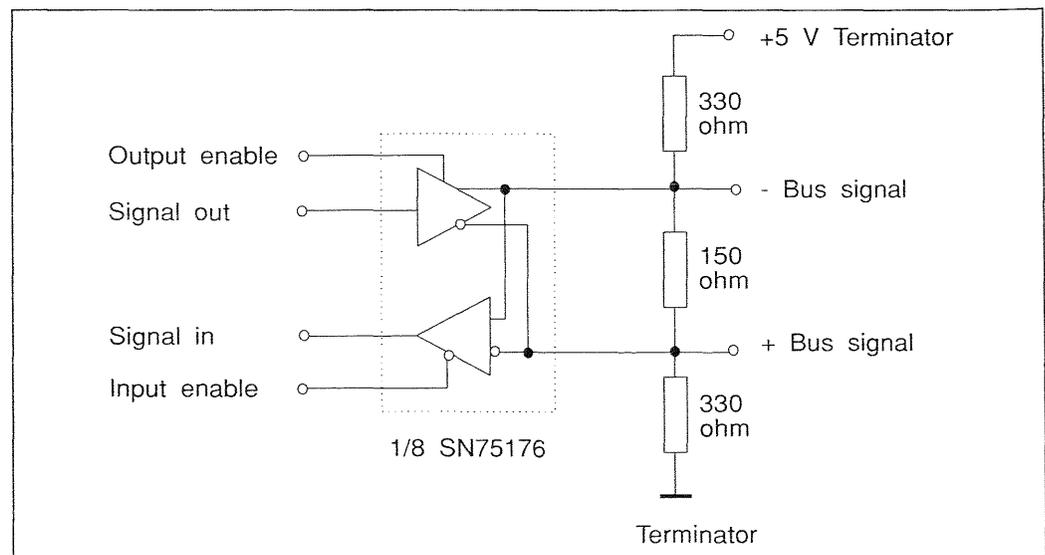

Figure 10.10 Differential SCSI drivers.

Table 10.4 A cable for differential SCSI.

<i>Signal</i>	<i>Connector assignment 2</i>	<i>Cable and connector assignment 1</i>		<i>Connector assignment 2</i>	<i>Signal</i>
Ground	1	1	2	26	Ground
+DB(0)	2	3	4	27	-DB(0)
+DB(1)	3	5	6	28	-DB(1)
+DB(2)	4	7	8	29	-DB(2)
+DB(3)	5	9	10	30	-DB(3)
+DB(4)	6	11	12	31	-DB(4)
+DB(5)	7	13	14	32	-DB(5)
+DB(6)	8	15	16	33	-DB(6)
+DB(7)	9	17	18	34	-DB(7)
+DB(P)	10	19	20	35	-DB(P)
N.C.	11	26	22	36	Ground
Reserved	12	23	24	37	Reserved
+5 V terminator	13	25	26	38	+5 V terminator
Reserved	14	27	28	39	Reserved
+ATN	15	29	30	40	-ATN
Ground	31	16	32	41	Ground
+BSY	17	33	34	42	-BSY
+ACK	18	35	36	43	-ACK
+RST	19	37	38	44	-RAT
+MSG	20	39	40	45	-MSG
+SEL	21	41	42	46	-SEL
+C/D	22	43	44	47	-C/D
+REQ	23	45	46	48	-REQ
+I/O	24	47	48	49	-I/O
Ground	25	49	50	50	Ground

connected to a differential device the sensor signal becomes grounded, disabling the differential drivers. Figure 10.10 shows a differential signal along with its termination. Tables 10.4 and 10.5 show the A and B cables for differential SCSI, respectively.

Table 10.5 B cable for differential SCSI.

Signal	Connector	Cable		Connector	Signal
Ground	1	1	2	35	Ground
+DB(8)	2	3	4	36	-DB(8)
+DB(9)	3	5	6	37	-DB(9)
+DB(10)	4	7	8	38	-DB(10)
+DB(11)	5	9	10	39	-DB(11)
+DB(12)	6	11	12	40	-DB(12)
+DB(13)	7	13	14	41	-DB(13)
+DB(14)	8	15	16	42	-DB(14)
+DB(15)	9	17	18	43	-DB(15)
+DB(P1)	10	19	20	44	-DB(P1)
+ACKB	11	21	22	45	-ACKB
Ground	12	23	24	46	N.C.
+REQB	13	25	26	47	-REQB
+DB(16)	14	27	28	48	-DB(16)
+DB(17)	15	29	30	49	-DB(17)
+DB(18)	16	31	32	50	-DB(18)
+5 V terminator	17	33	34	51	+5 V terminator
+5 V terminator	18	35	36	52	+5 V terminator
+DB(19)	19	37	38	53	-DB(19)
+DB(20)	20	39	40	54	-DB(20)
+DB(21)	21	41	42	55	-DB(21)
+DB(22)	22	43	44	56	-DB(22)
+DB(23)	23	45	46	57	-DB(23)
+DB(P2)	24	47	48	58	-DB(P2)
+DB(24)	25	49	50	59	-DB(24)
+DB(25)	26	51	52	60	-DB(25)
+DB(26)	27	53	54	61	-DB(26)
+DB(27)	28	55	56	62	-DB(27)
+DB(28)	29	57	58	63	-DB(28)
+DB(22)	30	59	60	64	-DB(28)
+DB(30)	31	61	62	65	-DB(28)
+DB(31)	32	63	64	66	-DB(31)
+DB(P3)	33	65	66	67	-DB(P3)
Ground	34	67	68	68	Ground

10.6 SCSI bus phases

All transactions on the SCSI bus are composed from eight distinct bus phases. Everything begins and ends with the `BUS FREE` phase. `BUS FREE` describes the situation where no device is in control of the SCSI bus.

Three phases deal exclusively with bus protocol. During the `ARBITRATION` phase one or more initiators will indicate their wish to use the bus. If more than a single initiator arbitrates, the one with the highest SCSI ID wins. The successful initiator then uses the `SELECTION` phase to choose a target with which to communicate. The `RESELECTION` phase fulfills a similar function: after successfully arbitrating, a target that released the bus to execute a command re-establishes the connection to its initiator.

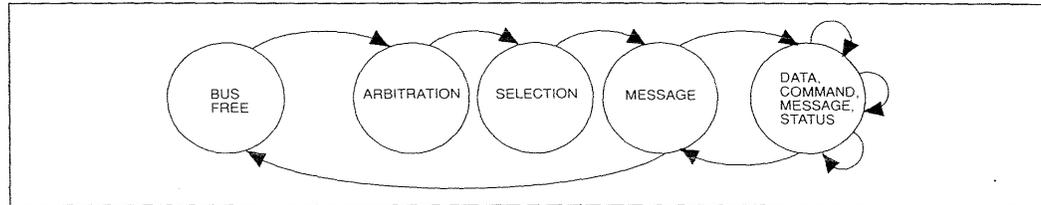

Figure 10.11 Simplified SCSI phase diagram.

Finally, there are four phases for exchanging data. The **COMMAND** phase is used for transferring command opcodes, the **DATA** phase for data bytes. During a **MESSAGE** phase a target sends or receives information concerning the protocol itself. Finally, using the **STATUS** phase the target concludes a SCSI command and informs the initiator of its success or failure.

At any given time the SCSI bus can be in only one specific bus phase. The succession of phases is restricted; it is not possible for any phase to follow any other phase. Figure 10.11 shows a simplified phase diagram of the normal progression of a command. After **BUS FREE** follows **ARBITRATION**, **SELECTION** and a **MESSAGE OUT** phase. After these come the **COMMAND** and **DATA** phases, followed by a **STATUS** phase. The rules governing phase changes have evolved between SCSI-1 and SCSI-2. While **ARBITRATION** and the **MESSAGE OUT** phase were optional after a selection in SCSI-1, these have become mandatory in SCSI-2.

Figure 10.12 shows the complete SCSI phase diagram for SCSI-2. The arrows between the phases indicate that a transition from one phase to another

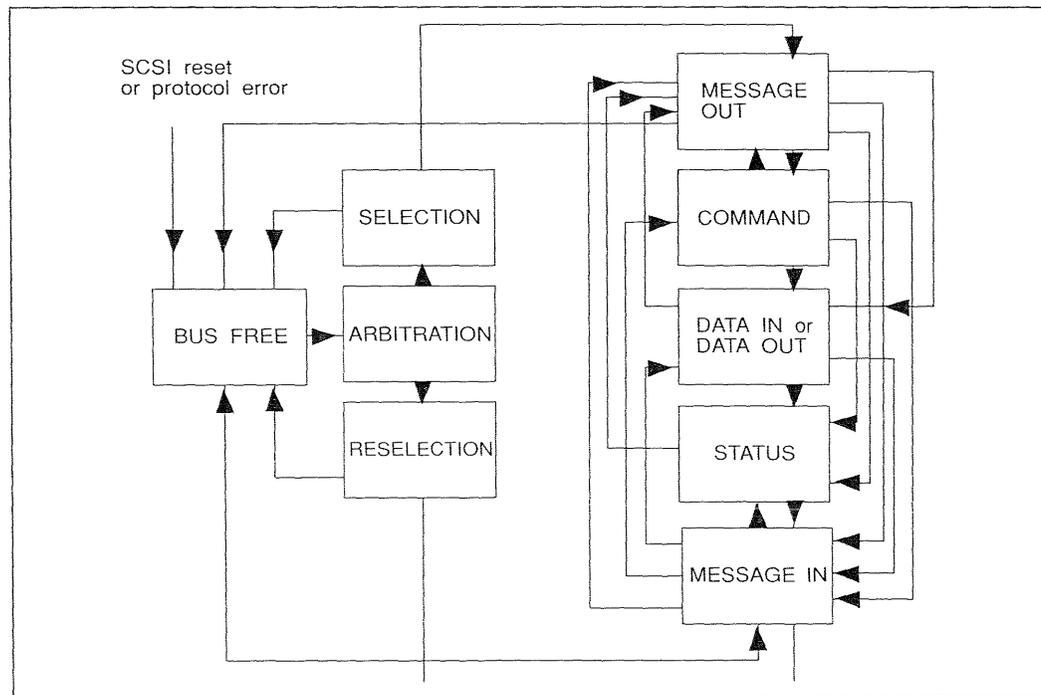

Figure 10.12 Complete SCSI phase diagram.

Seq. Nr.	Phase Symbol	Hex	Comment
0	BUS FREE		
1	ARBITRATION	C0	ID 7 and ID 5, ID 7 wins
2	SELECT	81	Target - ID 0
3	MESSAGE OUT	80	IDENTIFY
4	COMMAND	00	TEST UNIT READY
5	COMMAND	00	
6	COMMAND	00	
7	COMMAND	00	
8	COMMAND	00	
9	COMMAND	00	
10	STATUS	00	GOOD
11	MESSAGE IN	00	COMMAND COMPLETE
12	BUS FREE 00		

Figure 10.13 Phase sequence for TEST UNIT READY.

is allowed. Thus, for example, in SCSI-2, COMMAND and DATA phases can only occur after a MESSAGE phase has taken place. Likewise, a MESSAGE phase must also conclude these phases.

At first glance this phase diagram can be very confusing; much more so than the average SCSI command. Figure 10.13 depicts an actual TEST UNIT READY command as captured by a SCSI analyzer. It begins with BUS FREE. After the typical sequence ARBITRATION, SELECTION, MESSAGE (IDENTIFY) comes a COMMAND phase of six bytes. Since no data is transferred with this command, the succession concludes immediately with the STATUS phase and the MESSAGE (COMMAND COMPLETE).

SCSI bus timing

When electrical signals change their value, they never do so as cleanly and abruptly as is shown in a timing diagram. In reality edges are much rounder, and – as is the case with the SCSI bus, where relatively long cables are used – reflections lead to ‘ringing’ and other distortions. In order to prevent these phenomena from causing ill effects, a number of delays have been built into the protocol. These delays allow the signal enough time to settle on the new value.

Table 10.6 Timing values for Fast SCSI.

Name	Time	Description
Fast assertion period	30 ns	Minimum time that REQ (REQB) and ACK (ACKB) must be active for fast synchronous transfers
Fast cable skew delay	5 ns	Maximum time skew between any two signals for fast transfers
Fast deskew delay	20 ns	Minimum time required for deskew of certain signals for fast synchronous transfers
Fast hold time	10 ns	For fast synchronous transfers
Fast negation period	30 ns	Minimum time for fast transfers between the two REQ (REQB) pulses of a target. The same holds for the ACK (ACKB) pulses of an initiator.

Table 10.7 SCSI timing values.

<i>Name</i>	<i>Time</i>	<i>Description</i>
Arbitration delay	2.4 μ s	During arbitration
Assertion period	90 ns	REQ (REQB) and ACK (ACKB) must be active at least this amount of time
Bus clear delay	800 ns	A device must release all signals within this amount of time after it has detected a BUS FREE phase
Bus free delay	800 ns	After detecting a BUS FREE phase a device must wait at least this long before arbitrating for the bus
Bus set delay	1.8 μ s	Maximum time a device may activate BSY and its ID during arbitration
Bus settle delay	400 ns	Minimum time a device must wait in order that all bus signals settle to their new values
Cable skew delay	10 ns	Maximum difference in propagation time for any two signals of the SCSI cable
Data release delay	400 ns	Maximum time for an initiator to release DB(x) active after I/O goes false
Deskew delay	45 ns	Minimum time necessary to deskew certain signals
Disconnection delay	200 μ s	When a target has freed the bus due to a DISCONNECT message it should wait at least this long before taking part in arbitration
Hold time	45 ns	For synchronous transfers the data must be set at least this long after the activation of REQ (REQB) or ACK (ACKB)
Negation period	90 ns	Minimum time that target must negate REQ (REQB) for synchronous transfers. The same holds for ACK (ACKB) for the initiator
Power on to selection	10 s	Recommended maximum time that a target should need after power-up to reply to commands like TEST UNIT READY
Reset to selection	250 ms	Recommended maximum time that a target should need after a SCSI reset to reply to commands like TEST UNIT READY
Reset hold time	25 μ s	Minimum time that RST must be active
Selection abort time	200 ms	Maximum time for a device to activate BSY after being selected
Selection timeout delay	250 ms	Recommended minimum time that device should wait for a busy response during a SELECTION
Transfer period	progr.	Minimum time between two REQ or ACK pulses for synchronous transfers

Tables 10.6 and 10.7 list and briefly explain all of the timing values defined in the SCSI protocol. More detailed explanations follow in the sections on the individual bus phases.

The BUS FREE phase

When the SCSI bus is not being used by a device it remains in the BUS FREE phase. The bus is defined to be in this phase when the signals BSY and SEL have been inactive for longer than a bus settle delay of 400 ns. After power has been turned on or a SCSI reset has occurred the bus enters the BUS FREE phase.

In normal operation there are two standard cases in which the `BUS FREE` phase is entered. The first occurs after a command has been executed and the message `COMMAND COMPLETE` has been sent. The other normal case occurs when a target releases the bus after first sending a `DISCONNECT` message.

In addition to those just mentioned, there are exceptional cases, which the initiator can bring about by sending a message to the target. In response to these messages the target releases the bus. These messages are `ABORT`, `BUS DEVICE RESET`, `RELEASE RECOVERY`, `ABORT TAG` and `CLEAR QUEUE`. If an initiator detects a `BUS FREE` during the execution of a command that did not follow from one of these messages, it treats this as an error.

This error is called unexpected disconnect. The initiator then attempts to determine the reason for the error by sending a `REQUEST SENSE` command to the target. Another error situation that results in a `BUS FREE` occurs when a device does not respond after selection or reselection.

The ARBITRATION phase

The `ARBITRATION` phase is used to determine which device obtains control of the bus after a `BUS FREE`. If a device wishes to arbitrate for the bus it simultaneously activates the `BSY` signal along with the data bit that corresponds to its SCSI ID. All other signals must be left alone. Figure 10.13 shows the data bus with `C0h` during an `ARBITRATION` phase. Since `DB(7)` and `DB(5)` are set this means that the devices with SCSI IDs 7 and 5 are competing for the bus.

At this point each device arbitrating for the bus must wait for at least an arbitration delay of 2.4 μ s. The device then looks at the data bus to see if a SCSI ID greater than its own has been asserted. The device with the higher ID, in this example ID 7, wins the arbitration and in response asserts the `SEL` signal. This indicates to all other devices that they should release `BSY` and remove their ID bit from the data bus within a bus clear delay of 800 ns. The delay concludes the `ARBITRATION` phase. The successful device now commences with either a `SELECTION` or `RESELECTION` phase.

As opposed to SCSI-1, arbitration is mandatory in SCSI-2 even when the configuration includes only one initiator. In fact, targets also must arbitrate for the bus. This occurs after disconnecting from an initiator to execute a command. When the target is ready it arbitrates for the bus and reselects the initiator. This means that even in a configuration with a single initiator and a single target true competition for the bus can take place; for example when a target wants to reconnect to the initiator at the same time as the initiator wants to send the target another command.

The SELECTION phase

A selection phase takes place after an initiator wins the arbitration phase. If a target wins arbitration then the reselection phase follows. Selection and reselection differ in the state of the `I/O` signal. For reselection `I/O` is asserted; for selection it is not. A device can therefore identify itself as an initiator by not asserting `I/O` during the selection phase.

During the selection phase a connection is established with the desired target. `BSY`, `SEL`, and the initiator ID are all still active from arbitration. Now the initiator asserts the data signal corresponding to the ID of the desired target

along with the ATN signal. The attention signal indicates that a MESSAGE OUT phase will follow selection. In the example in Figure 10.13, the value 81h is on the data bus during selection. This means that the initiator with ID 7 wishes to establish a connection with the target with ID 0. After at least two deskew delays the initiator releases BSY.

At this point all devices look to see whether their SCSI ID bit is asserted on the data bus. The selected device identifies the initiator by the other set data bit on the bus. Before a select abort time of 200 ms has elapsed the selected device must assert BSY and take over control of the SCSI bus. This is an important moment. From this point on the target has complete control over the sequencing of SCSI bus phases. It decides when to receive messages, command bytes or data from the initiator and when to send status. The target also decides whether or not to disconnect during a command and when to reconnect. Although the initiator controls what commands the target executes, the target alone is in charge of the bus protocol.

No more than two deskew delays after the target's assertion of BSY, the initiator must release the SEL signal. With this the selection phase is completed. SCSI-2 now calls for a MESSAGE OUT phase.

A selection phase is unsuccessful if the target device never responds to the initiator. In this case the initiator waits at least a selection abort time, after which it has two options. The initiator can either assert the RST signal, causing a transition to the BUS FREE phase, or it can release first the data signals then SEL and ATN in order to get back to BUS FREE.

An additional word on the effect of SCSI timing on throughput: the selection abort time of 200 ms is very long. In 200 ms a disk drive can perform around 10 I/O operations. For this reason it is very important for a target to react as quickly as possible to selection. A slow target that requires, for example, 5 ms to react to a selection not only reduces its own throughput, but also blocks the bus for all other devices during this time and degrades the overall throughput of the SCSI bus.

Figure 10.14 shows a schematic timing diagram of an ARBITRATION and SELECTION phase. Delay times have been omitted in the interest of simplicity. Actual timing diagrams that reflect precisely what has taken place on a bus can look much different. Figure 10.15 shows such a sequence recorded by a logic analyzer.

Some explanations of the figures showing logic analyzer output is called for. In the line directly above the timing diagram, you see 'Time/Div 5.0 μ s.' This is the length of time per division shown on the upper and lower edge of the diagram. 'Sample period = 10 ns' tells you that measurements are made every 10 ns. On the left-hand side you see the names of all of the signals.

In this example it is easy to see that during the SELECTION phase the BSY signal is inactive for about 1 μ s; this moment represents the transfer of control from the initiator to the target. A glitch can be seen on the data lines during the SELECTION phase. This is caused by the toggling of the target's SCSI ID on the data bus. Such glitches are the reason why delays are built into the protocol.

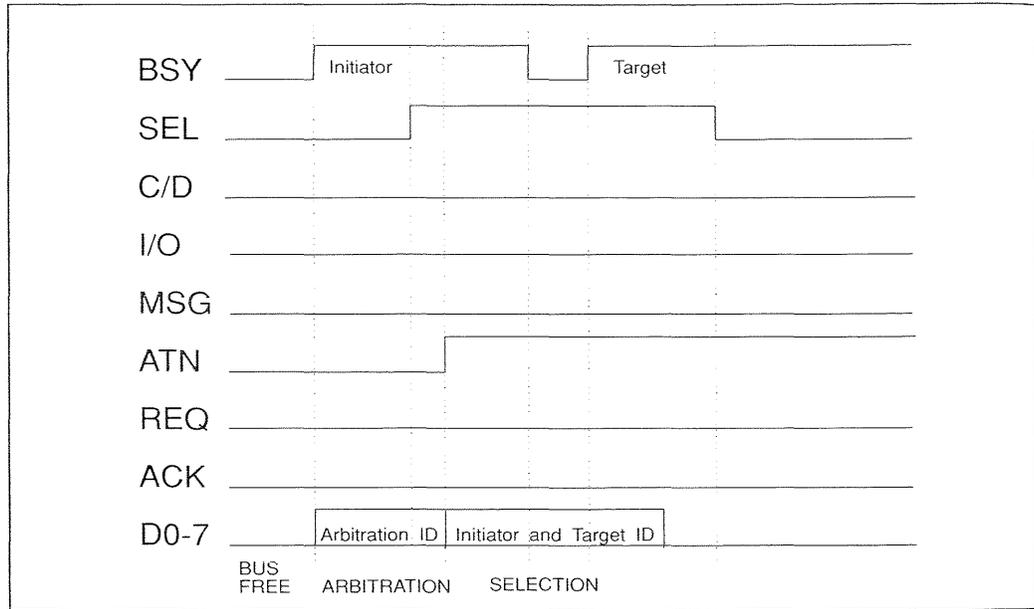

Figure 10.14 ARBITRATION and SELECTION.

The RESELECTION phase

The RESELECTION phase allows a target to reconnect to the initiator after having disconnected to complete a command. Following a successful arbitration the target reselects the initiator that sent it a SCSI command. This phase is differentiated from selection by the active I/O signal. Otherwise, these phases are identical.

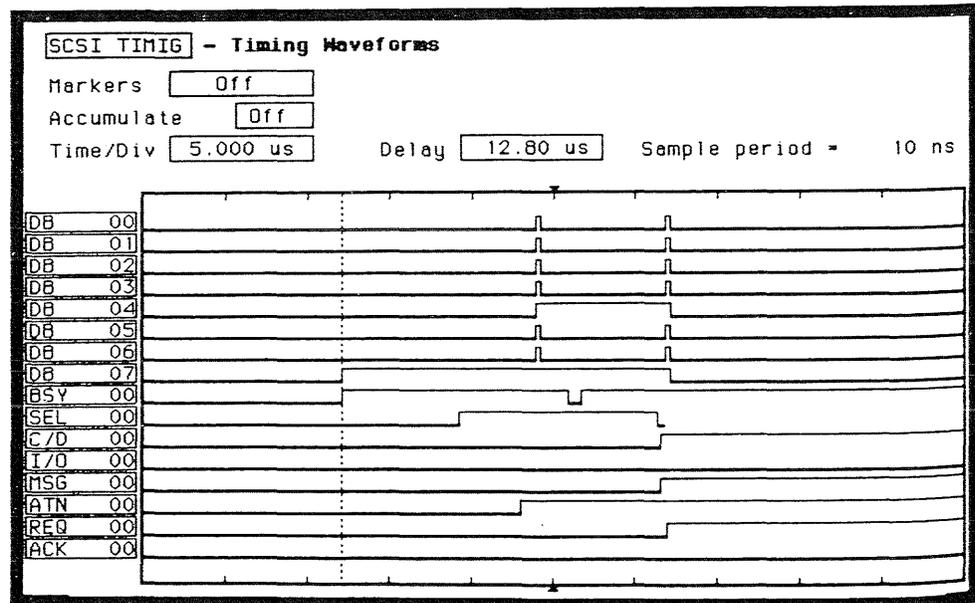

Figure 10.15 ARBITRATION and SELECTION as seen on a logic analyzer.

The MESSAGE phase

The phase following a successful selection is always a MESSAGE OUT phase. A message phase is used by the target to either send or receive a message byte. Message bytes contain information concerning the SCSI bus protocol, where IN and OUT are interpreted with respect to the initiator. A list of messages and their meanings is given in Chapter 11. A message can consist of one, two or a variable number of bytes. The first byte tells which of these three types of messages is being sent. A variable length message is referred to as an extended message, in which case the length of the message is contained in the second byte. What follows is a description of the timing and protocol of the message phase.

A look at the phase diagram in Figure 10.16 shows that a MESSAGE IN phase can take place after each information transfer phase as well as after a RESELECTION. Following the flow of the message phase in Figure 10.16 we see that the BSY signal is still set from the SELECTION phase. The target then activates MSG, I/O and C/D in order to proceed to the MESSAGE IN phase.

Now the message byte is put on the data bus. After deskew and cable deskew delays the target sets the REQ signal. In response the initiator reads in the message byte and sets ACK. The target can now remove the byte from the bus and release REQ. Finally, the initiator responds by releasing ACK. Such an exchange is known as an asynchronous request/acknowledge handshake or REQ/ACK sequence. This method of transfer is used for the command, data, and status phases as well.

At this point the bus is still in the MESSAGE IN phase. If additional bytes are to be sent, that number of REQ/ACK sequences take place to transfer them. To end the message phase the target releases the MSG signal.

The target receives a message from the initiator during a MESSAGE OUT phase. An extra step is needed here since the initiator must inform the target of its message. To do this the initiator activates the ATN signal, which is permitted

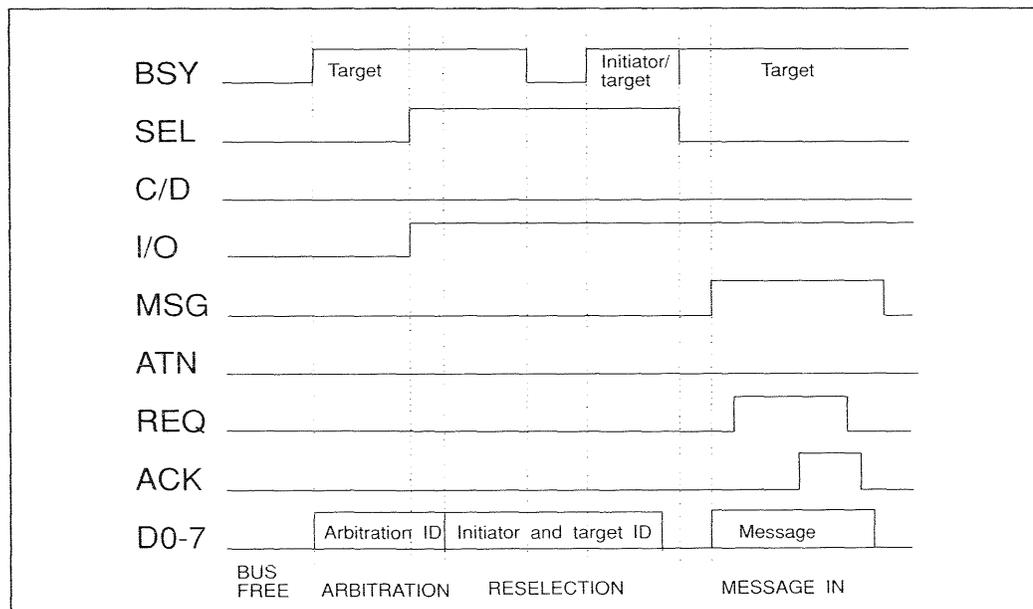

Figure 10.16 RESELECTION and MESSAGE IN.

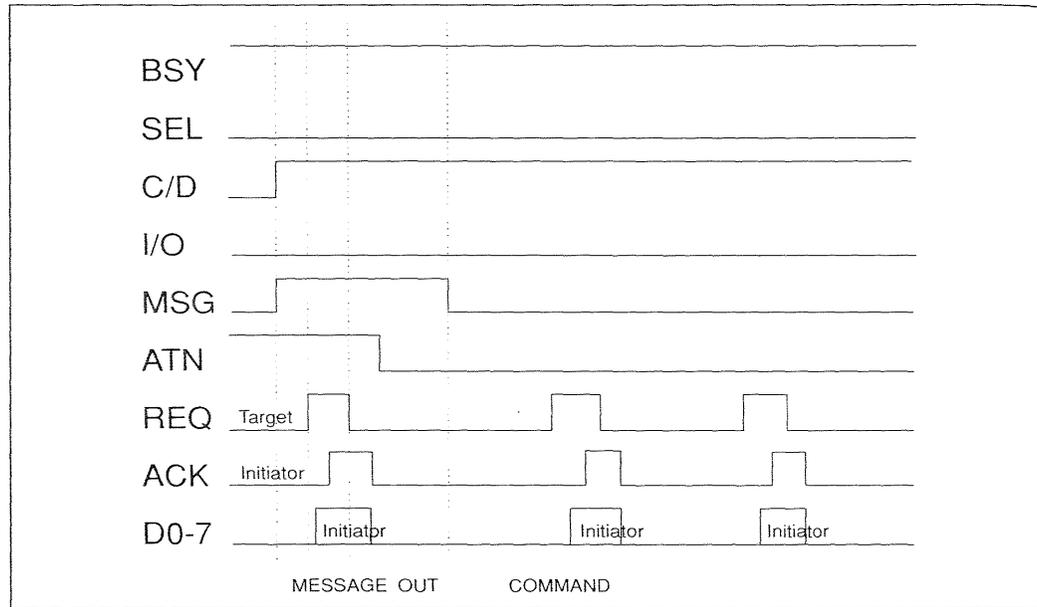

Figure 10.17 MESSAGE OUT and COMMAND.

during any phase except BUS FREE or ARBITRATION. During data and command phases it is up to the target whether to receive the message byte immediately or wait until the end of the phase. ATN during a selection, message or status phase calls for immediate transfer of the message byte after the current REQ/ACK sequence.

This transfer unfolds almost identically to the REQ/ACK sequence described above. The target activates REQ. In response to this the initiator places the message byte onto the data bus and after the proper delays activates ACK. The target then reads the byte and releases REQ. Finally, the initiator releases ACK and the transfer is complete. The target knows whether additional bytes will follow by examining the first message byte. The initiator releases ATN when it has sent all of its message bytes. The target ends the MESSAGE phase by releasing the MSG signal.

Afterwards, if a command phase takes place the signals I/O and C/D are already in the proper state, as Figure 10.17 shows.

The COMMAND phase

The COMMAND phase is used by the target to receive the actual SCSI commands from the initiator. It is important to remember that the target has taken control of the bus since the end of the SELECTION phase. First it finishes the MESSAGE OUT phase, which the initiator brought about using ATN. Immediately thereafter is the beginning of the COMMAND phase.

A command phase is characterized by the C/D line being active while I/O and MSG are inactive. The command phase proceeds with REQ/ACK sequences in the same manner as a MESSAGE OUT phase until all command bytes have been transferred.

On the leftmost side of the timing diagram (Figure 10.18) you can see the target already waiting with active REQ signal. After the first ACK little time is

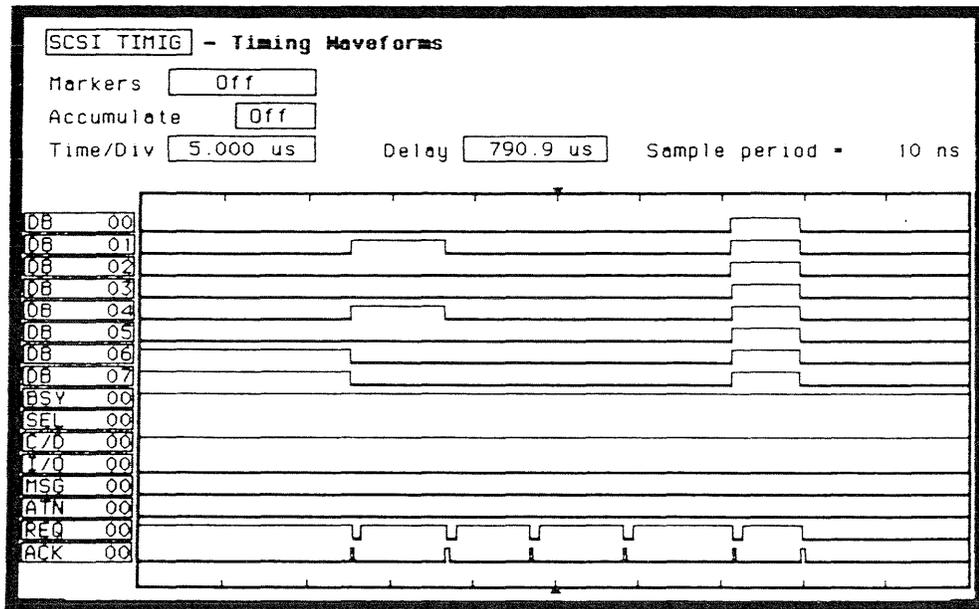

Figure 10.18 COMMAND phase as seen on a logic analyzer.

needed for the target to read the first byte and release REQ. Almost immediately after the initiator releases ACK the target is requesting the second byte. The initiator needs a relatively long time to prepare the bytes, as indicated by the distance between REQ/ACK sequences. This command happens to be an INQUIRY command (12 00 00 00 FF 00), which will be covered in greater detail in Chapter 12.

By examining the first command byte the target can tell how many additional bytes will follow. It collects all bytes from the initiator and releases C/D, thus ending the COMMAND phase.

The DATA IN and DATA OUT phases

Almost all command sequences contain a data phase. This is how control information and user data are exchanged between target and initiator. The target begins a data phase by de-asserting C/D and MSG. At this point either asynchronous or synchronous transfers may take place, depending on a previous agreement between the two devices. The asynchronous method will be described here, while synchronous transfer is covered in Section 10.7.

If the target wishes to send data to the initiator it asserts the I/O signal, indicating a DATA IN phase. On the other hand, when the target wishes to receive data it de-asserts I/O for a DATA OUT phase. Figure 10.19 depicts a single DATA IN and DATA OUT transfer, and Figure 10.20 shows the DATA phase as seen on a logic analyzer. The REQ/ACK sequences proceed as described in the message phases.

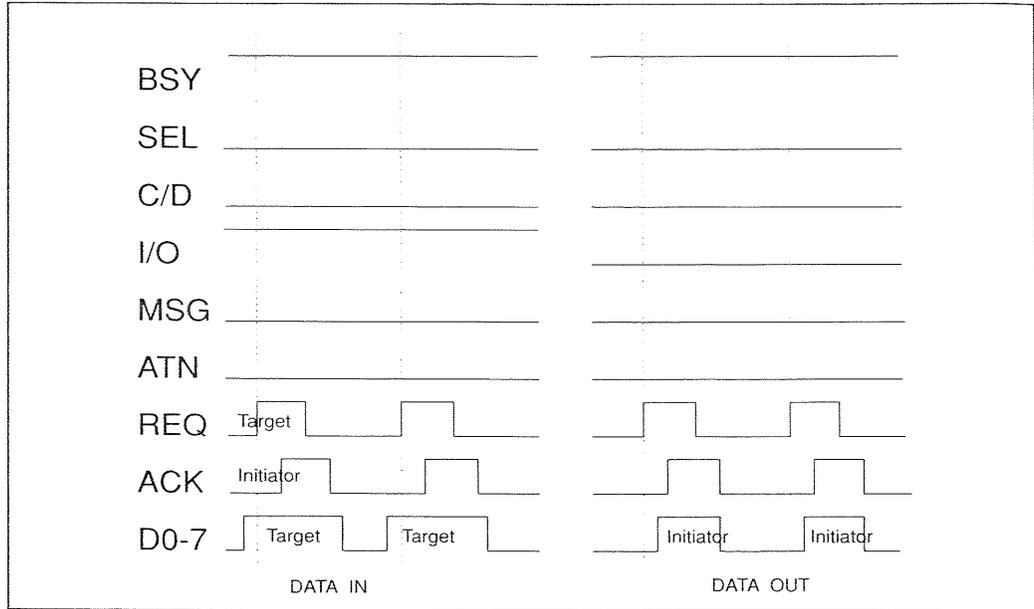

Figure 10.19 DATA IN and DATA OUT.

The STATUS phase

A target uses the status phase to send status information to an initiator. In contrast to a message, which can be sent at any time during a command sequence, a status phase only takes place when a command has completed, been interrupted or been refused by the target. In this phase C/D and I/O are asserted while MSG remains de-asserted. Status information, always one byte in length, is transferred in a single REQ/ACK sequence. A list of status bytes and their meanings can be found in Section 12.2.

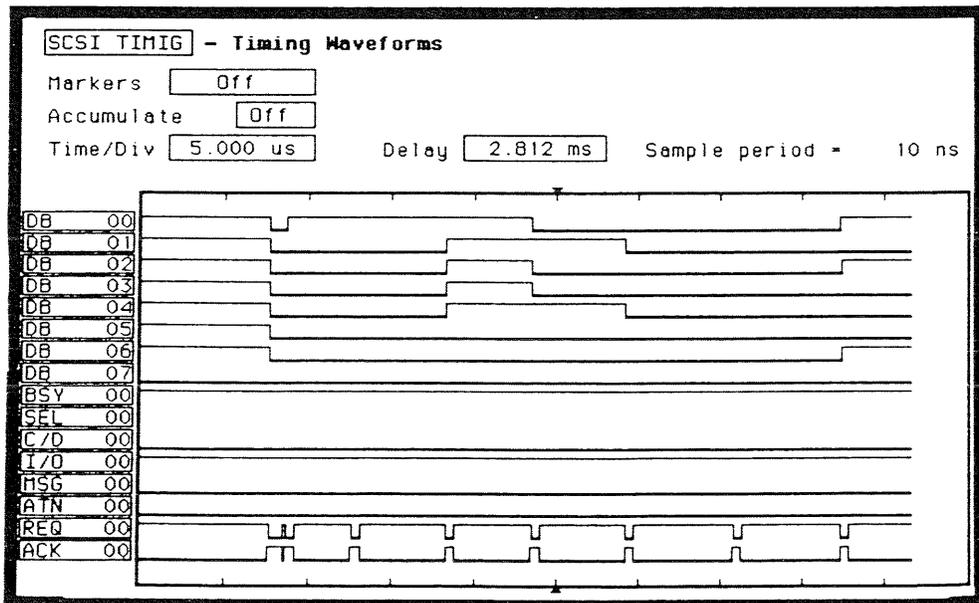

Figure 10.20 DATA phase as seen on a logic analyzer.

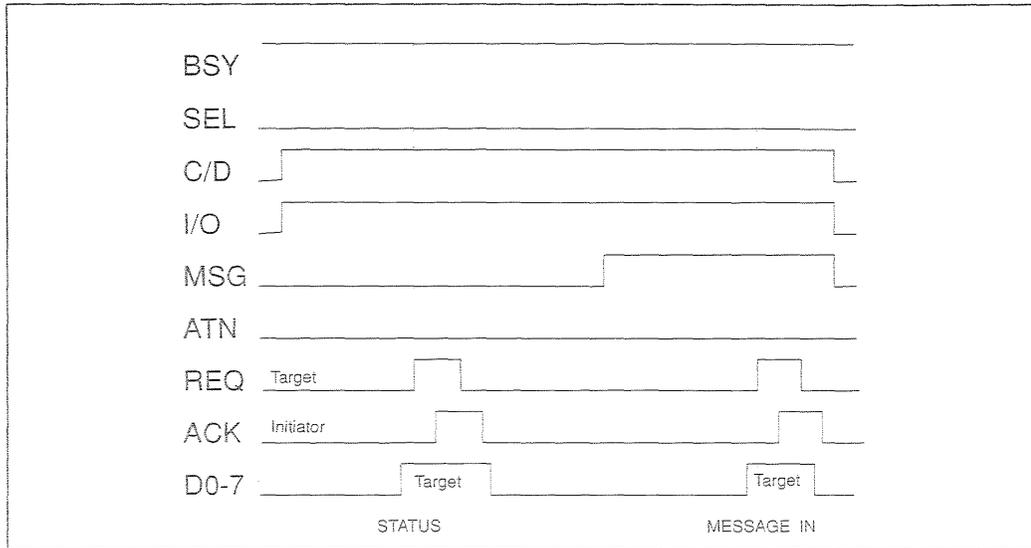

Fig. 10.21 STATUS and MESSAGE IN.

Figure 10.21 shows the status phase and subsequent MESSAGE IN phase of an average SCSI command. The COMMAND COMPLETE message tells the initiator that this command is finished. Afterwards the target releases the bus completely and BUS FREE results.

10.7 Synchronous transfers and Fast SCSI

Synchronous transfers, which were optional in SCSI-1, originally allowed data rates of up to 5 MBytes per second. SCSI-2 increases this to 10 MHz by offering what is known as Fast SCSI. Measuring the speed in MHz makes sense here because SCSI-2 also provides for bus widths of up to 4 bytes. The data rate is simply the bus width in bytes times the rate in MHz. Table 10.8 lists various SCSI throughputs.

Both the original and the Fast synchronous transfers use the same bus protocol. For Fast SCSI, however, the built-in delays are shorter and the overall times are faster. The method with which a target and initiator negotiate transfer parameters has also remained the same for Fast SCSI. Because of their similarity, the general term 'synchronous transfers' will be used for both methods.

Table 10.8 Various SCSI throughputs.

Transfer rate/width	Bandwidth		
	8-bit	16-bit	32-bit
Asynchronous (approximately 3 MHz)	3 Mbyte s ⁻¹	6 Mbyte s ⁻¹	12 Mbyte s ⁻¹
Synchronous	5 Mbyte s ⁻¹	10 Mbyte s ⁻¹	20 Mbyte s ⁻¹
Synchronous	10 Mbyte s ⁻¹	20 Mbyte s ⁻¹	40 Mbyte s ⁻¹

The use of synchronous transfers is negotiated between the initiator and the target using messages. Chapter 11 covers this aspect in greater detail.

**Synchronous
DATA-IN and
DATA-OUT phases**

When a target uses the synchronous method of data transfer it is allowed to send a certain maximum number of REQ pulses without waiting for ACK pulses. The pulses occur at a fixed period, called the synchronous transfer period. The maximum number of REQ pulses without receiving an ACK is called the REQ/ACK offset. Another way to look at the offset is this: given that at the end of a transfer an equal number of REQ and ACK pulses must occur, the offset is the maximum number of outstanding ACK pulses. If the offset is reached then the target must wait until the initiator sends an ACK before it sends further REQs. The result of this approach is that cable delays – the time it takes signals to traverse the length of the SCSI cable – are effectively eliminated from the transfer speed. For asynchronous transfers the transfer rate is directly dependent on the cable length. For each byte sent there is a delay equal to the following: the time it takes the leading edge of the REQ to travel from target to initiator, plus the time it takes the leading edge of the ACK to travel back to the host, plus the time it takes for the trailing edge of the REQ to reach the initiator, plus the time it takes for the trailing edge of the ACK to make it back to the host. The synchronous method eliminates the interlocking handshaking and with it the cable delays.

Figure 10.22 shows synchronous DATA IN and DATA OUT phases. Here a REQ/ACK offset of five is being used. Let us look first at the DATA OUT phase. The target sends five REQ pulses at a fixed frequency determined by the synchronous transfer period. It must then wait since the offset of five outstanding ACK pulses has been reached. Finally, the ACK pulses come along with the data from the

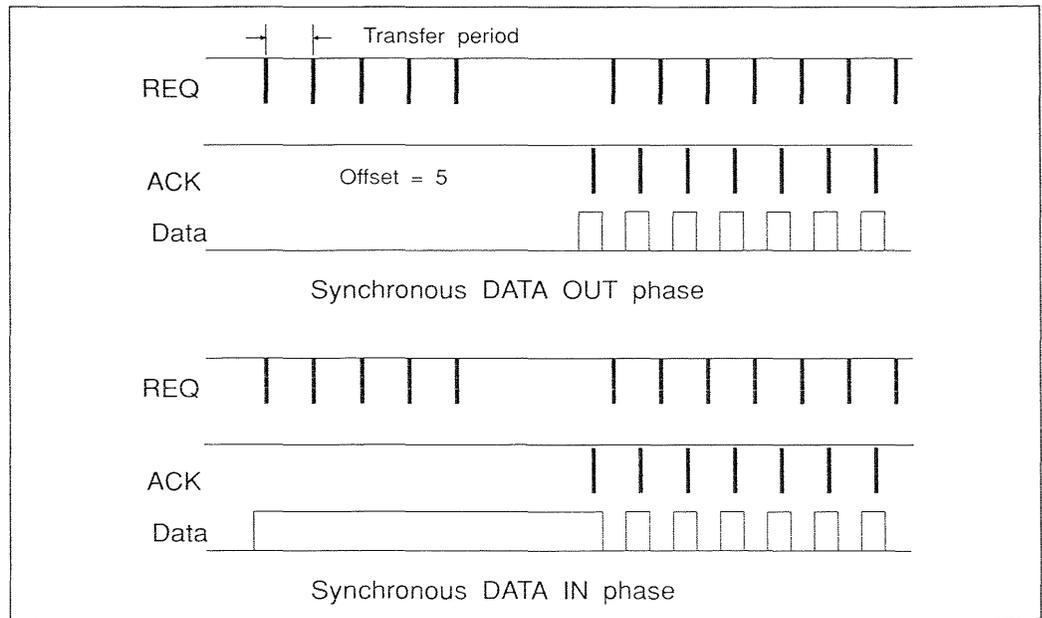

Figure 10.22 Synchronous data phases.

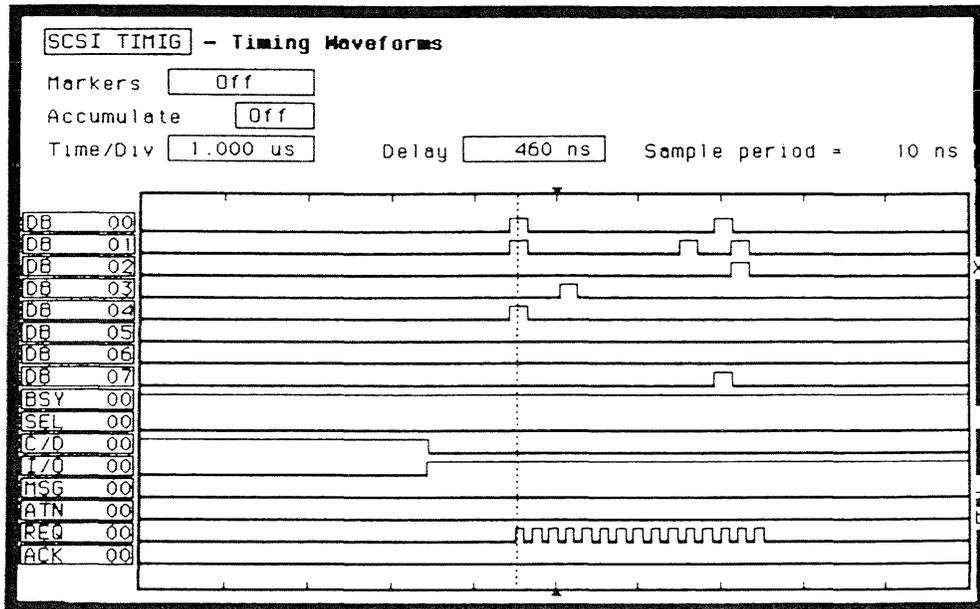

Figure 10.23 Synchronous data phases as seen on a logic analyzer.

initiator at the same frequency. With the arrival of the first ACK pulse the number of outstanding pulses has dropped below the offset and the target responds by sending data continually at the defined frequency. In this way the transfer proceeds with maximum efficiency.

The synchronous DATA IN phase looks very much the same. Here, however, the target places a byte on the data bus before the first REQ pulse. The byte

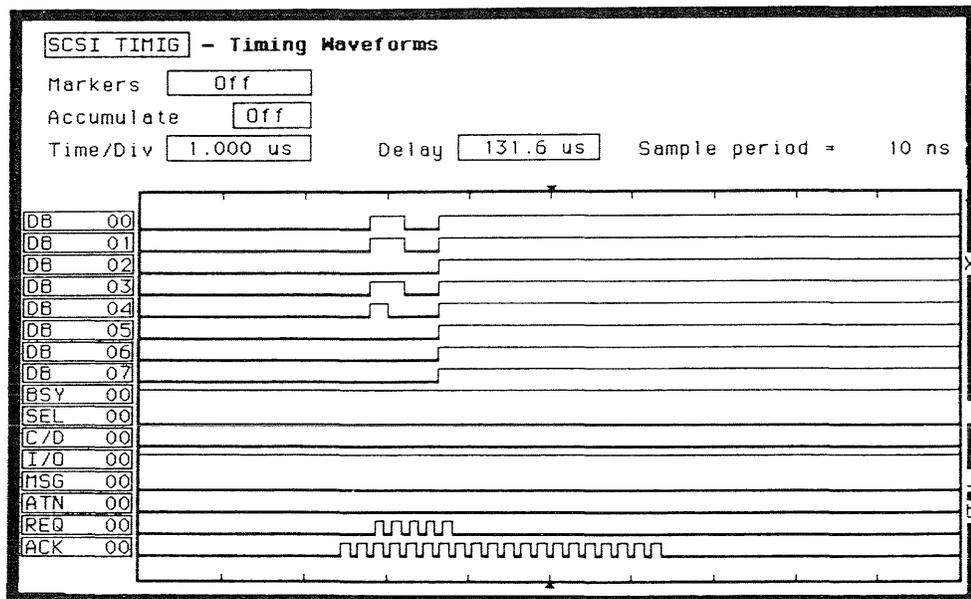

Figure 10.24 Synchronous data phases as seen on a logic analyzer.

is held there until the first ACK signal has been read. Afterwards the transfer takes place at the rate determined by the transfer period.

Figures 10.23 and 10.24 show this phase again, this time as seen by a logic analyzer. These are DATA IN phases as they occur in the real world. The target sends 15 REQ pulses and the accompanying data bytes, then all is still because no ACKS are returned. It is safe to assume that the transfer offset is 15. In the second diagram, which occurs approximately 130 μ s later, the ACK pulses are returned by the initiator. After the second REQ the target proceeds to send the remaining five data bytes. The ACK pulses continue until a total of 20 have been sent.

10.8 Wide SCSI

Wide SCSI uses the same hardware protocol as the 8-bit transfers but with an additional cable to carry extra data signals (see Section 10.2). In order to prevent signal skewing problems resulting from different cable lengths, an additional REQ and ACK are included on the second cable. This allows an independent REQ/ACK sequence for each cable. During all but the DATA IN and DATA OUT phases the second cable is unused.

Just as is the case with Fast SCSI, the use of Wide SCSI is negotiated between devices using the message system.

11 SCSI bus protocol

In this chapter I go into the essentials of the various SCSI messages. At times I will mention things which are not introduced fully until Chapter 12. You may wish to jump ahead at such times or simply ignore the details until the next chapter.

11.1 The message system

In the previous chapter we went over the workings of the MESSAGE phase in detail. We saw that during the course of a normal SCSI command at least two MESSAGE phases occur: after SELECTION or RESELECTION and before the final BUS FREE phase. SCSI messages represent the lowest level of bidirectional communication on the SCSI bus.

We now take a closer look at the SCSI message system. SCSI messages are used for a number of different purposes. Messages are the only means by which an initiator can inform a target of a problem. As an example, consider a parity error on the data bus (Figure 11.1). In general, a message can interrupt the normal flow of phases at any time. The initiator simply sets the ATN signal, completely asynchronously, and the target then collects the message.

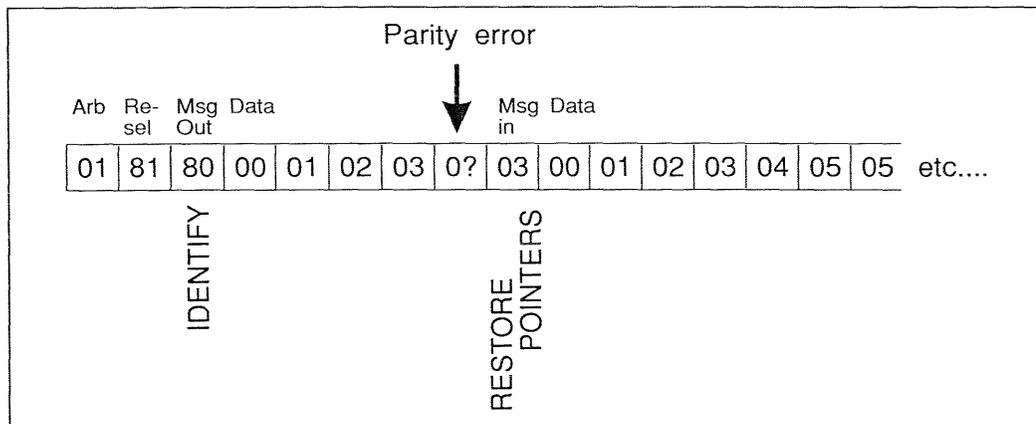

Figure 11.1 Parity error.

The target also uses messages to inform the initiator of events that the initiator cannot foresee. An example of this is when the target wishes to free the bus during a running command. In this case it tells the initiator to secure certain information vital to the I/O process and also informs it of the imminent release of the bus.

Finally, messages are used to negotiate the parameters of the various options such as synchronous or Wide transfers. Here either the target or initiator sends a number of messages indicating the desired option and parameters. The other device then returns messages either echoing these parameters or values corresponding to its capabilities.

SCSI messages consist of one, two or an arbitrary number of bytes. The first byte, known as the message code, determines the format of a message. Table 11.1 shows the message format. In the case of an extended message the second byte gives the length and the third byte contains the extended message code. Table 11.2 depicts the general structure of an extended message.

The following discussions of the individual messages are grouped by function. Table 11.3 is an overview of all SCSI messages ordered by message code.

Table 11.1 SCSI message format.

<i>Value</i>	<i>Message format</i>
00h	One byte message (COMMAND COMPLETE)
01h	Extended messages
02h–1Fh	One byte messages
20h–2Fh	Two byte messages
30h–7Fh	Reserved
80h–FFh	One byte message (IDENTIFY)

Table 11.2 Extended message format.

<i>Byte</i>	<i>Value</i>	<i>Description</i>
0	01h	Extended message
1	n	Number of following message bytes
2	Ext. Code	Extended message code
3 – n+1		Message arguments

Table 11.3 SCSI message codes.

Code	Ini	Tar	Name	Page	Direction	ATN neg.
00h	P	P	COMMAND COMPLETE	152	In	
01, xx, 00h	O	O	MODIFY DATA POINTERS	154	In	
01, xx, 01h	O	O	SYNCHRONOUS DATA TRANSFER REQUEST	156	In/Out	Yes
01, xx, 03h	O	O	WIDE DATA TRANSFER REQUEST	158	In/Out	Yes
02h	O	O	SAVE DATA POINTERS	153	In	
03h	O	O	RESTORE POINTERS	153	In	
04h	O	O	DISCONNECT	155	In/Out	Yes
05h	P	P	INITIATOR DETECTED ERROR	153	Out	Yes
06h	O	P	ABORT	162	Out	Yes
07h	P	P	MESSAGE REJECT	163	In/Out	Yes
08h	P	P	NO OPERATION	152	Out	Yes
09h	P	P	MESSAGE PARITY ERROR	163	Out	Yes
0Ah	O	O	LINKED COMMAND COMPLETE	152	In	
0Bh	O	O	LINKED COMMAND COMPLETE (WITH FLAG)	152	In	
0Ch	O	P	BUS DEVICE RESET	161	Out	Yes
0Dh	O	O	ABORT TAG	162	Out	Yes
0Eh	O	O	CLEAR QUEUE	161	Out	Yes
0Fh	O	O	INITIATE RECOVERY		Out	Yes
10h	O	O	RELEASE RECOVERY		Out	Yes
11h	O	O	TERMINATE I/O PROCESS	162	Out	Yes
20h	O	O	SIMPLE QUEUE TAG	160	In/Out	No
21h	O	O	HEAD OF QUEUE TAG	160	Out	No
22h	O	O	ORDERED QUEUE TAG	160	Out	No
23h	O	O	IGNORE WIDE RESIDUE	159	In	
80h+	P	P	IDENTIFY	151	In/Out	No

11.2 I/O processes

I/O process and nexus

The terms 'nexus' and 'I/O process', as described in the SCSI standard, are loosely defined. An I/O process begins with the initial selection of a target by an initiator and extends through all bus free phases and reselections until a final bus free is reached. The I/O process may consist of a single SCSI command or a series of linked commands. The process normally ends with the BUS FREE phase which follows the final COMMAND COMPLETE message. A process can be terminated in response to a number of different messages, a SCSI reset or a protocol error.

The initiator maintains an area in memory of the host for each I/O process to store COMMAND, DATA, and STATUS information. For each area, or so-called buffer, there exist two pointers: the current and saved pointers. At the start of the process all three current pointers point to the beginning of their respective buffers. As the process progresses these pointers advance through memory. When a disconnect takes place another process may start up and use the bus, so prior to this the active pointers need to be saved. This is actually accomplished by the target, which sends a SAVE POINTERS message to the initiator. Later when the process becomes active again the saved pointers are copied back to the active pointers and the process continues to completion.

Nexus is the term used to describe the relationship between an initiator and a target during an I/O process. As soon as the selection of a target takes place an initiator-target nexus (I_T nexus) is established. However, an I_T nexus alone is not enough to carry out an I/O process.

SCSI commands sent by an initiator are not executed by a target itself, but rather by one of its LUNs or target routines. As we saw earlier, LUNs are the physical devices connected to the target. Target routines are a set of very particular programs that run on the target. These routines, which are optional and only seldom implemented, are used for diagnostic purposes, among other things. We will take a closer look at target routines in Section 12.1.

With the sending of an IDENTIFY message to the target, either a LUN or a target routine is addressed. This replaces the existing I_T nexus with an initiator-target-LUN nexus (I_T_L nexus) or an initiator-target-routine nexus (I_T_R nexus), respectively. The SCSI standard speaks of an I_T_x nexus when referring to either of these. An I_T_x nexus is sufficient to carry out an I/O process.

Tagged queues, which are optionally supported by targets, are an ordered stack for SCSI commands. They allow a target to store up to 256 commands from various initiators. Tagged queues do not exist for target routines. When supported, a QUEUE TAG message follows immediately after the IDENTIFY message. The existing I_T_L nexus is thereby replaced by an initiator-target-LUN-queue nexus (I_T_L_Q nexus). The SCSI standard speaks of an I_T_x_y nexus when referring to either an I_T_x or an I_T_L_Q nexus (Figure 11.2). We will see more on queues later in this chapter.

Without a tagged queue a target can accept only one command per LUN for each initiator on the SCSI bus. In this case only I_T_L nexuses are ever established.

IDENTIFY (80h-FFh)

The IDENTIFY message is used to establish a connection, or nexus, between a device and a LUN or target routine. For the initial SELECTION of an I/O process it is an initiator that establishes this so-called I_T_x nexus. For any subsequent

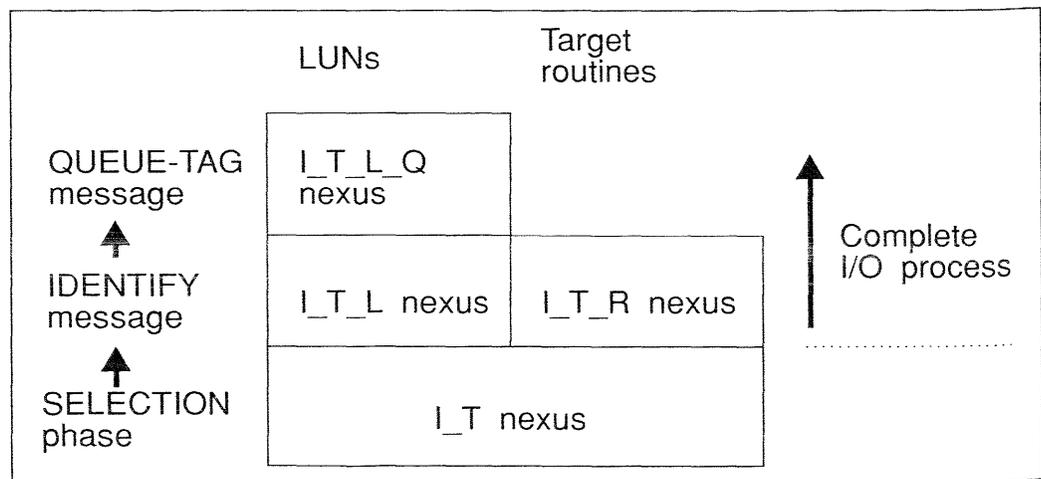

Figure 11.2 Structure of a nexus.

Table 11.4 IDENTIFY message.

7	6	5	4	3	2	1	0
1	DiscPriv	LUNTAR	Res	Res	LUNTRN		

RESELECTION the target then uses an IDENTIFY message to identify a particular I_T_x nexus and thus which I/O process to activate.

The IDENTIFY message itself, which is one byte long, is shown in Table 11.4. As you can see IDENTIFY messages have a variable field within this single byte of information. Bit 7 is always set. In effect this reserves all messages from 80h to FFh as IDENTIFY messages. The remaining seven bits carry the variable information:

- **DiscPriv** (disconnect privilege): This bit may only be set by an initiator. It allows a target to use its own discretion to disconnect from the initiator and thus free the bus for others to use.
- **LUNTAR** (LUN/target routine): When this bit is set a target routine is addressed, otherwise a LUN is addressed. (Note that the name implies otherwise!)
- **LUNTRN** (LUN/target number): The LUN or target routine number.

Since most SCSI devices have embedded controllers – that is, they recognize only LUN 0 – the most common IDENTIFY message is C0h. This means IDENTIFY, LUN 0 with disconnect privilege. If the target is not allowed to release the bus during command execution the message becomes 80h.

An initiator is allowed to send multiple IDENTIFY messages during a single I/O process. However, only the disconnect privilege may be modified. Should an initiator attempt to change the LUN or target routine number this will cause the target to bring about BUS FREE. Such an unexpected disconnect terminates the I/O process.

There are many ways in which an IDENTIFY message will be considered invalid. The simplest case is when either of the two reserved bits is set. Also, a message addressing a target routine is invalid when no such routines are implemented. Here the target may respond with either a MESSAGE REJECT message or a CHECK CONDITION status.

A reselection to an I/O process that does not exist is called an unexpected reselection. In this situation the proper response is an ABORT message.

COMMAND COMPLETE (00h)

The target uses this message to inform the initiator that the I/O process has completed. Afterwards a BUS FREE is brought about by the target.

LINKED COMMAND COMPLETE (0Ah) and LINKED COMMAND COMPLETE WITH FLAG (0Bh)

These messages are sent instead of COMMAND COMPLETE for linked commands of a command chain. LINKED COMMAND COMPLETE (WITH FLAG) is used when the control byte of the command had its flag bit set. The last command of a chain uses the regular COMMAND COMPLETE message.

NO OPERATION (08h) This dummy message, as the name implies, does nothing. As an example of when it might be useful, consider an initiator that has asked to send a message by setting *ATN*. In the time it takes the target to switch to the message phase the initiator may eliminate the need for the message. In this case it sends a **NO OPERATION** in order to use up the message phase and allow the command to continue.

INITIATOR DETECTED ERROR (05h) An initiator uses this message when it encounters an internal problem but believes it can continue with the process. Since it is possible that the active pointers have become defective the target must either send a **RESTORE POINTERS** message or cause **BUS FREE** (without **SAVE DATA POINTERS**) and then reselect the initiator.

11.3 SCSI pointers

As mentioned earlier, each initiator manages a set of three pointers for each I/O process. These pointers keep track of the current position in the *COMMAND*, *DATA* and *STATUS* buffers. The target can influence these pointers using the message system.

SAVE DATA POINTERS (02h) This message causes the initiator to save the active data pointer to the saved data pointer. It is sent before every **BUS FREE** phase change.

RESTORE POINTERS (03h) **RESTORE POINTERS** causes the initiator to copy the saved pointers to the current pointers. This mechanism is put to use, for example, when a target detects a parity error in a *COMMAND*, *DATA* or *STATUS* byte. As soon as such an error is discovered the target sends a **RESTORE POINTERS** message to the initiator. Afterwards the next *DATA OUT* phase starts the transfer at the beginning of the data buffer.

MODIFY DATA POINTER (01h, 05h, 00h, byte 3 ... byte 0) This message allows the target to directly modify the value of the data pointer (Table 11.5). The 4-byte argument is interpreted as a signed integer, which is added to the current value of the data pointer.

Table 11.5 MODIFY DATA POINTERS.

<i>Byte</i>	<i>Value</i>	<i>Description</i>
0	01h	Extended message
1	05h	Length of extended message
2	00h	MODIFY DATA POINTER
3	n	(MSB)
4	n	Argument
5	n	
6	n	(LSB)

11.4 Disconnect–reconnect: Freeing the bus

One of the most important characteristics of the SCSI bus is the ability to interrupt a running I/O process in order to free the bus for other devices. This opportunity arises frequently for targets that must access data from a physical medium. Hard drives typically require in the order of 20 ms to access their data, while tape drives sometimes need several minutes.

When and under what conditions a device should free the bus can be programmed into the target using the `MODE SELECT` command. An entire parameter page, the disconnect–reconnect page, is dedicated to this purpose. In addition, the `DiscPriv` (disconnect privilege) bit in the `IDENTIFY` message tells the target whether it may disconnect for the current I/O process. Besides the `DISCONNECT` message, which will now be introduced, the `SAVE DATA POINTERS` message of the previous section plays an important role in freeing the bus.

DISCONNECT (04h) Using the disconnect–reconnect parameters supplied by the initiator the target decides when to free the SCSI bus. It then sends the messages `SAVE DATA POINTERS` and `DISCONNECT`, and brings about the `BUS FREE` phase. It is important to remember that the `DISCONNECT` message does not cause the data pointer to be saved. `DISCONNECT` indicates only that the target intends to switch to the `BUS FREE` phase.

The initiator may also send the `DISCONNECT` message, which is understood by the target as an ultimatum. In this case the target switches to the `MESSAGE IN` phase and sends the `SAVE DATA POINTERS` and `DISCONNECT` messages. The target must wait for at least a disconnect delay of 200 μ s after `BUS FREE` before arbitrating again for the bus.

Let us turn now to Figure 11.3. Time runs from left to right in the figure. I/O process 1 frees the bus after only a short time. During this disconnect time two other processes take the opportunity to use the bus. The numbers in the boxes represent the data (in hex) on the SCSI bus during the various bus phases, while the details are explained above.

At the left-hand side the initiator with SCSI ID 7 arbitrates for the bus. We see bit 7 set in the data byte or 80h. It wins the arbitration and starts the first I/O process. During the `SELECTION` phase it chooses the target with ID 0. The 81h on the data bus reflects the addition of bit 0 to the initiator's own bit 7. Following selection comes a `MESSAGE OUT` phase, which the initiator uses to send an `IDENTIFY` message with `DiscPriv` set for LUN 0 (C0h). Now comes a `READ(6)` command with the opcode (08h), logical block number (00000h), number of blocks (01h), and control byte (00h). After accepting the command the target decides to release the bus. It sends the message `SAVE DATA POINTER` (02h) and `DISCONNECT` (04h) and frees the bus for other devices.

A little later, after two other processes have been active, I/O process 1 again takes control of the bus. It first arbitrates with ID 0 (01h) and reselects the initiator by adding ID 7 to its own (81h). At this point it could very well be the case that the target and initiator have several active I/O processes. Using an `IDENTIFY` message, the target indicates the specific LUN and therefore I/O

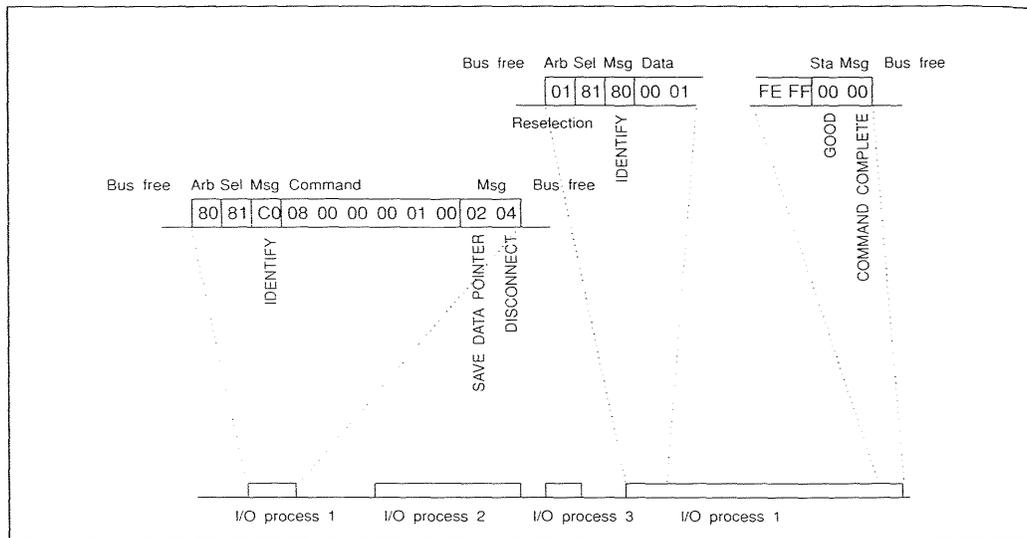

Figure 11.3 Freeing the bus and reselection.

process. With this established the target sends the actual data of the requested logical blocks. Finally, a GOOD status (00h) and COMMAND COMPLETE message (00h) conclude the I/O process.

11.5 Transfer options

SYNCHRONOUS DATA TRANSFER REQUEST (01h, 03h, 01h, mm, nn)

The target and initiator negotiate whether to use synchronous transfers using the message system. Bear in mind that such transfers apply only to the data phases. Commands, messages, and status are always sent asynchronously.

A SCSI device that wishes to use synchronous transfers sends the message SYNCHRONOUS DATA TRANSFER REQUEST to the other device. Contained in this extended message are the desired transfer period and offset. The value in byte 3 times 4 ns equals the transfer period, while byte 4 equals the offset (Table 11.6).

The other device, either initiator or target, replies immediately with its own SYNCHRONOUS DATA TRANSFER REQUEST. This message either echoes the first request or contains less demanding parameters, such as longer period, less offset. If the device does not support synchronous data transfer at all it can send

Table 11.6 SYNCHRONOUS DATA TRANSFER REQUEST.

Byte	Value	Description
0	01h	Extended message
1	03h	Number of message bytes after byte 2
2	01h	SYNCHRONOUS DATA TRANSFER REQUEST
3	n	Transfer period
4	n	REQ/ACK offset

Seq. Nr.	Phase Symbol	Hex	Comment
0	BUS FREE		
1	ARBITRATION	C0	ID 7 and ID 5, ID 7 wins
2	SELECT	81	Target - ID 0
3	MESSAGE OUT	80	IDENTIFY
4	MSG OUT	01	Extended Message
5	MSG OUT	03	Extended Message Length
6	MSG OUT	01	SYNCHRONOUS TRANSFER REQUEST
7	MSG OUT	34	Wants transfer period 136nS
8	MSG OUT	0F	Wants REQ/ACK - Offset 15
9	MSG IN	01	Extended Message
10	MSG IN	03	Extended Message Length
11	MSG IN	01	SYNCHRONOUS TRANSFER REQUEST
12	MSG IN	32	Can transfer period 128nS
13	MSG IN	0F	Can REQ/ACK - Offset 15
14	COMMAND	00	
15	COMMAND	00	
16	COMMAND	00	

Figure 11.4 Synchronous transfer request.

either a MESSAGE REJECT or a SYNCHRONOUS DATA TRANSFER REQUEST with the offset set to zero. In both cases the result is asynchronous transfers for the data phases. Figure 11.4 shows a relevant sequence taken from a SCSI analyzer.

In principle, either target or initiator can request synchronous transfers. In practice, however, the initiator or in general the host adapter is the one that initiates this negotiation. Some older host adapters were known to have difficulty with a SYNCHRONOUS DATA TRANSFER REQUEST from a target. For this reason most target devices allow the synchronous transfer option to be disabled by jumper.

This negotiation does not take place for every I/O process. Rather the agreement holds between devices until the next SCSI reset or a BUS DEVICE RESET message. Of course, either device may decide to negotiate new parameters should a reason arise.

WIDE DATA TRANSFER REQUEST (01h, 02h, 03h, nn)

A device that wishes to use Wide SCSI sends its partner device a WIDE DATA TRANSFER REQUEST. This message contains the desired bus width encoded in byte 3. Here 00h means 8-bit, 01h 16-bit and 02h 32-bit wide transfers (Table 11.7). Just as with the synchronous negotiation, the partner device replies immediately with its own WIDE DATA TRANSFER REQUEST message here either echoing the width or sending a smaller value. If Wide SCSI is not supported then it replies with either a width of zero or sends the MESSAGE REJECT message.

This agreement also holds until a SCSI reset or BUS DEVICE RESET message. Likewise, the negotiation does not take place before each I/O process. Such an implementation would increase the overhead of the SCSI protocol unnecessarily.

Of course, it can also occur that the total number of bytes to be sent is not divisible by the transfer width. Here the valid bytes of the final transfer are padded with one or more dummy bytes. In this case a message is sent immediately following the transfer indicating how many bytes to ignore.

Table 11.7 WIDE DATA TRANSFER REQUEST.

Byte	Value	Description
0	01h	Extended message
1	03h	Number of message bytes after byte 2
2	01h	WIDE DATA TRANSFER REQUEST
3	n	Transfer width 2^{3+n}

IGNORE WIDE
RESIDUE (23h, nn)

IGNORE WIDE RESIDUE indicates which bytes of a final wide transfer to ignore. Table 11.8 shows the structure of the message and the meaning of byte 2.

Table 11.8 IGNORE WIDE RESIDUE.

Byte	Description
0	IGNORE WIDE RESIDUE (23h)
1	Byte mask

Byte mask	Invalid bits	
	32-bit transfers	16-bit transfers
00h	Reserved	Reserved
01h	DB(31-24)	DB(15-8)
02h	DB(31-16)	Reserved
03h	DB(31-8)	Reserved
04h-FFh	Reserved	Reserved

11.6 Tagged queues

We took a first look at tagged queues during the definition of a nexus. Tagged queues are a SCSI-2 option which allows each LUN to queue up to 256 I/O processes per initiator. The main advantage to this approach is that it makes optimization possible.

For targets that support tagged queues, implementing the QUEUE TAG message is obligatory. An initiator enters a command into the queue by sending QUEUE TAG immediately following IDENTIFY. This action sets up an I_T_L_Q nexus replacing the I_T_L nexus previously established.

There are three types of QUEUE TAG messages. All contain a reference number for the I/O process or queue tag in byte 2 (Table 11.9). This same tag is sent in a QUEUE TAG message at reselection time to identify which process is resuming.

Using the QUEUE TAG messages, an initiator also has the ability to influence the position of commands within the queue.

Table 11.9 The QUEUE TAG messages.

Byte	Description
0	Message (20h, 21h, 22h)
1	Number

SIMPLE QUEUE TAG (20h)

This message causes the I/O process to be added to the command queue. It is up to the target to decide exactly when to process it (provided no ORDERED QUEUE TAGS have been received, which are discussed next). Commands with a SIMPLE QUEUE TAG allow, for example, disk drives to optimize time intensive seeks to the medium. Targets always use this message when reselecting an initiator for a tagged process.

HEAD OF QUEUE TAG (21h)

This message leads to placing the I/O process in question at the beginning of the queue. The currently active process is run until completion. Subsequent HEAD OF QUEUE TAG processes are placed ahead of older ones at the beginning of the queue. In this way multiple HEAD OF QUEUE TAG processes are executed in last-in, first-out order.

ORDERED QUEUE TAG (22h)

This message causes I/O processes to be executed in the order in which they were received. In other words, all processes that were already in the queue will be executed before this process and likewise all processes that arrive afterwards will be executed after this one. An exception to this is made for processes with the HEAD OF QUEUE TAG.

Tagged queues and error handling

A target that does not support tagged queues will reply to a QUEUE TAG message with MESSAGE REJECT. If an initiator receives a command tagged with a number already in the queue the result is a so-called incorrect initiator connection. In response, the target terminates all I/O processes of this initiator and sends the CHECK CONDITION status. A subsequent request sense command would then return the sense key ABORTED COMMAND and the extended sense OVERLAPPED COMMANDS ATTEMPTED.

If a target attempts to reselect with an incorrect number in the QUEUE TAG message, the initiator will respond with ABORT TAG.

11.7 Termination of I/O processes

There are a number of ways to terminate or kill I/O processes, for instance simple termination of all processes of a target or LUN. In tagged queues either all or only active processes can be halted. Additionally, an I/O process can be made to terminate 'as soon as possible.'

- BUS DEVICE RESET (0Ch)** This message tells the target to kill all active and outstanding I/O processes. In reality, the target performs a soft reset. This action not only kills all I/O processes but also nullifies device reservations and causes device parameters to be reset to start-up values. The target enters unit attention condition, which means that it will reply to the next command with a CHECK CONDITION status. The sense key for the following REQUEST SENSE command will be UNIT ATTENTION (06h).
- CLEAR QUEUE (0Eh)** This message is only implemented by devices supporting tagged queues. The CLEAR QUEUE message kills the active I/O processes and those waiting in the queue from any and all initiators for this LUN or target routine.
- ABORT TAG (0Dh)** The ABORT TAG message allows I/O processes within ordered tagged queues to be terminated. This message kills only the currently active process. Neither status nor a final message will be sent for the terminated process. The I/O processes in the queue are unaffected. The state of the LUN remains unchanged in all other respects.
- ABORT (06h)** The abort message terminates all running I/O processes and all those in the queue for this I_T_L nexus. As with the ABORT TAG message, the target skips the status and message phases and immediately brings about BUS FREE. All other I_T_L nexuses remain unaffected.
- TERMINATE I/O PROCESS (11h)** This message tells the target to terminate the current I/O process as soon as possible. There are a few differences here with respect to the methods just described.
- Firstly, it is up to the target's own discretion as to when to end the process. In this way it can see to it that, for example, the data structure of a tape is not damaged by continuing a write until the end of the record. If the write were immediately cut short a damaged record would result.
- After the target has terminated the process the progression to the BUS FREE phase takes place normally. First, the status I/O PROCESS TERMINATED is sent followed by a COMMAND COMPLETE message. If by chance an error occurs when terminating the process the status byte will reflect this.
- The message TERMINATE I/O PROCESS is intended for longer I/O processes that may delay the execution of more important tasks. A subsequent request sense command will return the sense key NO SENSE (00h) and the extended sense key I/O PROCESS TERMINATED (00h, 06h). The information field of the sense data will contain the difference between the amount of data requested and the amount transferred.

11.8 Error handling in the message system

Two problems may occur when sending messages for which there is a means to recover. Since the message system represents the lowest level of communication on the SCSI bus, special messages exist to handle precisely these cases.

MESSAGE REJECT (07h)

This message is appropriate when a device does not support an optional message. After receiving the unsupported message the device responds immediately with MESSAGE REJECT.

If an initiator wishes to reject a message it must first assert ATN before deasserting the ACK of the last REQ/ACK sequence.

In the case of a target, which can control bus phases directly, it simply brings about the MESSAGE IN phase and sends the message. If ATN is still active after the MESSAGE REJECT message the target switches back to MESSAGE OUT and collects the messages.

MESSAGE PARITY ERROR (09h)

The target responds to parity errors during COMMAND, DATA, and MESSAGE OUT phases with a RESTORE POINTERS message. This action makes it possible to retry the transfer with the same data.

However, parity errors during a MESSAGE IN phase require a special procedure. In this case the initiator sends the MESSAGE PARITY ERROR message. As always, it asserts ATN to inform the target of its desire to send a message. The target reacts to MESSAGE PARITY ERROR by resending the original message.

11.9 Asynchronous event notification

In addition to messages SCSI provides targets with an alternative method of informing an initiator of unforeseen difficulties. This optional mechanism is called asynchronous event notification (AEN).

To carry out AEN the initiator and target must be able to trade roles temporarily. The target (acting as an initiator) sends the initiator (acting as a target) the SEND command. The data within the command contains information describing the target's difficulties.

The SEND command and the AEN format for the data are described in Chapter 17.

There are a number of applications for AEN. For example, devices of the communications or processor class often have data for an initiator that is not the direct result of a command. AEN allows the target to inform the initiator of the situation, which in turn can request the data from the device.

Another application is the implementation of a write cache for a disk or tape drive. A write cache allows a device to send GOOD status and COMMAND COMPLETE immediately upon receiving the write data into its cache, effectively eliminating the access time from the command execution time. Of course, at this

point the data has not been written to the medium and therefore a write error could still occur. AEN is used to inform the initiator of the problem by sending it the sense data describing the nature of the error (Figure 11.5).

There is a possible alternative to the above approach for devices that have write cache but do not implement AEN. Here the target simply responds with a CHECK CONDITION status for the next command. The disadvantage of this method is obvious: an initiator does not learn of the error until it sends that same device another command. Up until that point it goes on believing that the command was successful.

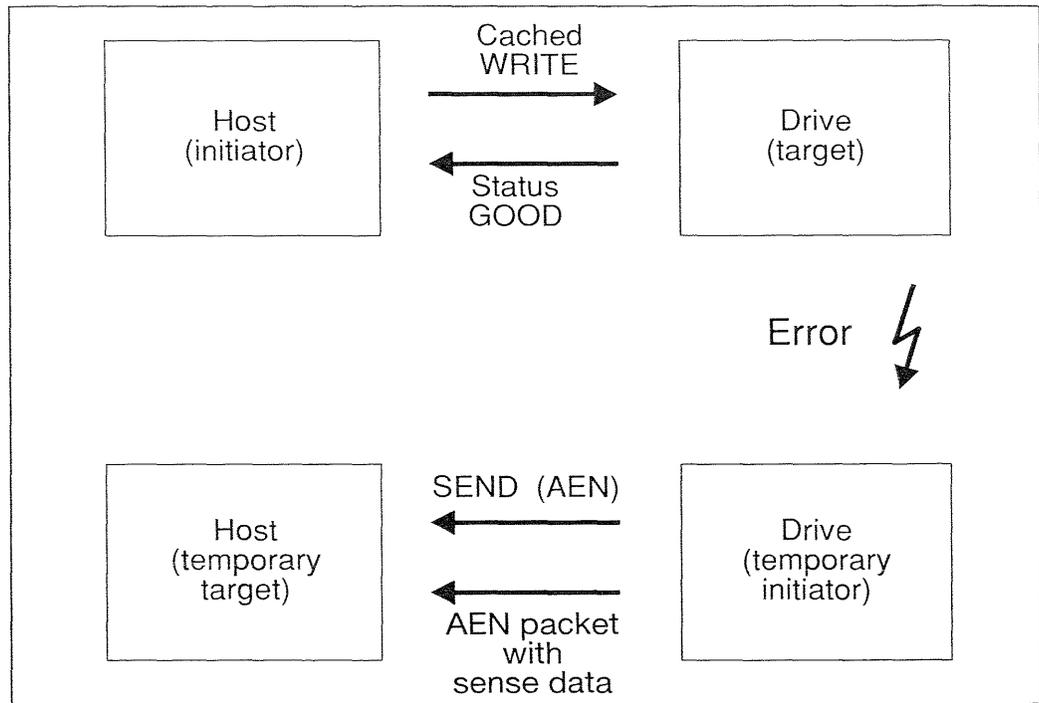

Figure 11.5 Asynchronous event notification.

12 SCSI commands

Chapter 11 described the flow of phases underlying the sending of SCSI commands. The command itself is always embedded within the context of an I/O process. After the IDENTIFY message, the target collects the command bytes from the initiator. The target then executes the command, during which it may decide to free the bus for other devices. Finally, the command concludes with a status byte and COMMAND COMPLETE message.

12.1 The SCSI target model

A simple model for a SCSI target was introduced in Section 10.1. At this point, we take a look at this model in greater detail (Figure 12.1). A SCSI target is addressed using its SCSI ID. Within a single target up to eight LUNs and eight target routines are accessible. A target must implement at least one LUN. Target routines are optional. Each SCSI command is executed by the particular LUN or target routine identified within the command.

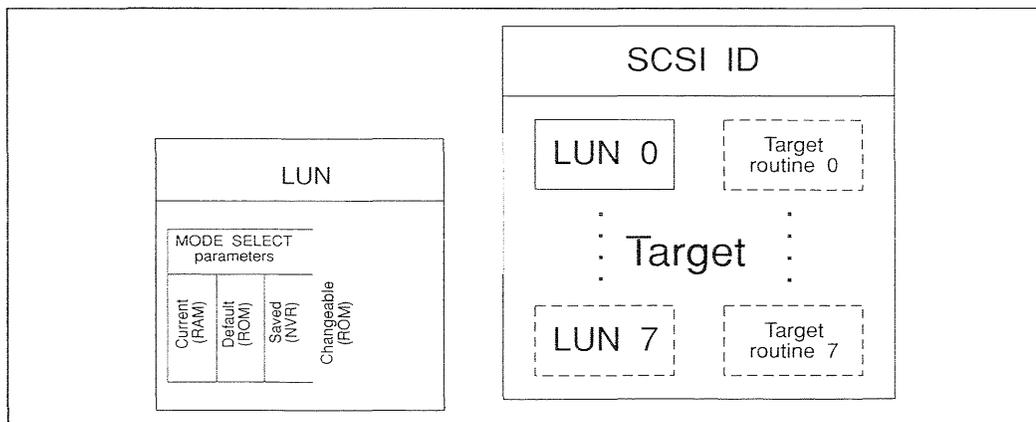

Figure 12.1 Model of a target.

LUNs and target routines

Most commonly a target will consist of a single LUN. This is the case for SCSI disk and tape drives where the controller is embedded within the device. The SCSI standard, however, allows for up to eight physical devices to be controlled by a single target, each addressed by its own unique LUN number. A bridge controller which oversees, for example, four ESDI drives plays this role. Although the specification allows for each LUN to belong to a different device class, the target would need to implement SCSI commands of each class, which is very impractical.

Target routines are I/O processes that run on the target itself. These were added with SCSI-2 and are useful, among other things, for diagnostic and test purposes. Target routines are always vendor unique; there is no model or command set defined in SCSI-2. They are rarely implemented and are at most of secondary importance.

Device classes

SCSI supports a variety of device types, from disk drives to printers to scanners. While disk drives are a source as well as a destination of information, printers only receive and scanners only send data. Data is exchanged with disk drives in a block format. Printers accept data of varying lengths. For these reasons SCSI defines a number of device classes. Table 12.1 shows an example of the data returned from an INQUIRY command.

For each device class SCSI defines a model, a command set and parameter pages for configuring the device. We will cover the device classes in the same way, touching on all three aspects for each class. In addition to the device class specific details, there are commands and parameter pages that are common to all devices. These will be covered in this chapter. Chapters 13–21 cover each device class in detail.

Mode parameters

Every LUN contains a set of parameters that configure its operation. These parameters can be written with MODE SELECT and read with MODE SENSE. Collectively, they are typically referred to as mode parameters. The parameters are sent across the bus in blocks called pages. Here, as with commands, some pages pertain to all devices, while some are only for specific classes.

One thing that all device classes have in common is the way in which the parameters are organized and maintained by the LUN. A LUN has three copies or sets of its parameters: the current, the default, and the saved parameters. The current parameters are those with which the device is currently functioning. These reside in RAM on the target and are lost when the device powers down. The saved values are kept in some type of non-volatile memory. On a disk drive this might be the medium itself, otherwise NOVRAM is frequently employed. At power-on time all devices copy the saved values to the current parameters. The default values are set by the manufacturer into PROM. The saved values reflect default settings when the device is purchased. A SCSI command allows the default to be copied to the saved values.

There is actually a fourth set of parameters, though somewhat different from the others, that the target can access. These changeable parameters are also hard-coded into the firmware. This set tells an initiator which individual parameters may be manipulated and to what extent. In this way a diagnostic program

Table 12.1 List of device classes.

<i>Code</i>	<i>Device classes</i>
00h	Disk drives
01h	Tape drives
02h	Printers
03h	Processor devices
04h	WORM drives
05h	CD-ROM drives
06h	Scanners
07h	Optical disk
08h	Media changer
09h	Communication devices
0Ah–1Eh	Reserved
1Fh	Unknown device

or device driver can determine, for example, which sector sizes a disk drive will allow before blindly attempting to set the value.

UNIT ATTENTION condition

A UNIT ATTENTION condition occurs when a LUN undergoes a change that an initiator should know about. An example of this is the changing of medium for a removable medium drive or tape device. In such a case there are two methods of informing the initiator. The more elegant way is to use an AEN. This approach, however, is supported by very few SCSI devices.

The second, and more standard, approach is for a target in a UNIT ATTENTION condition to interrupt the next command with a CHECK CONDITION status. The initiator can then use a REQUEST SENSE command to determine just exactly what has occurred.

All targets enter UNIT ATTENTION condition immediately following power-up or reset. The first command is always met with a CHECK CONDITION status. When using the SCSI monitor program it is important to be aware that some initiators automatically poll the targets with REQUEST SENSE commands and thus reset the UNIT ATTENTION condition.

12.2 Command descriptor blocks

SCSI commands are sent across the bus as a sequence of bytes called a command descriptor block. Many also include additional parameter lists. While descriptor blocks are sent during the command phase, parameter lists are transmitted during a data phase. Not all commands pertain to user data organized in logical blocks. Some commands use parameter lists to obtain information about the device or to configure them. There are also commands that deliver no information at all except in the status byte that concludes all commands. A descriptor block can be 6, 10, or 12 bytes long.

6-Byte commands

Table 12.2 shows the structure of a typical 6-byte command. Depending on whether the command uses logical blocks, parameter lists or status information, each field will have a different purpose or perhaps no function at all.

Table 12.2 Template for 6-byte commands.

	7	6	5	4	3	2	1	0
0	Opcode							
1	LUN			(MSB)				
2	Logical block (LSB)							
3								
4	Transfer length							
5	Control byte							

Opcodes

The first byte of every command, byte 0, is the opcode. The three most significant bits encode the command group, the remaining five encode the actual command. Each command group corresponds to a descriptor block of a given length. In this way a target knows which command to execute and how many more bytes remain in the descriptor block by examining this first byte alone. Table 12.3 shows the breakdown of SCSI opcodes.

Table 12.3 Format of SCSI opcode.

Bit	7	6	5	4	3	2	1	0
Group				Command				

Command group

The three bits of the command group define eight different groups (Table 12.4). Vendors are not allowed to use the reserved groups. These opcodes are intended for future versions of the standard. Vendor unique commands must be defined as group 6 or 7 commands, though this flexibility is seldom taken advantage of.

Table 12.4 Command groups.

<i>Group</i>	<i>Opcodes</i>	<i>Description</i>
0	00h-1Fh	6-Byte commands
1	20h-3Fh	10-Byte commands
2	40h-5Fh	10-Byte commands
3	60h-7Fh	Reserved
4	80h-9Fh	Reserved
5	A0h-BFh	12-Byte commands
6	C0h-DFh	Vendor unique
7	E0h-FFh	Vendor unique

LUN SCSI commands are always directed to a LUN or to a target routine, not to the target itself. Byte 1 contains the LUN number in the three uppermost bits. This may seem redundant in light of the fact that the IDENTIFY message has already defined the LUN. In fact, this field exists only to be compatible with SCSI-1. All SCSI-2 devices I am familiar with use the IDENTIFY message as well as the LUN field. Target routines are new in SCSI-2 and are addressable only using the IDENTIFY message.

Logical blocks Six-byte commands that operate on logical blocks spread the logical block number (LBN) over three bytes, as shown in Table 12.2. In total, 21 bits are available to address the LBN, which corresponds to approximately 2 million logical blocks. Since a logical block is usually 512 bytes long this represents about a gigabyte of addressable storage. Therefore, 6-byte commands alone cannot access all of the data of devices with more than a gigabyte of storage.

Transfer length This byte reflects the amount that should be transferred. Depending on the command itself, this field is interpreted differently. Some commands transfer no data at all and here the byte is meaningless. If the command uses a parameter list (which I will refer to as a parameter oriented command) then data length reflects the parameter list length in bytes. If there are fewer parameter bytes available than requested, a target will simply send what is there without complaining. For commands that operate on logical blocks (what I call block oriented commands) transfer length represents the number of logical blocks starting at the LBN to be transferred.

The 6-byte commands but also some 10- and 12-byte commands use a single byte for the transfer length. For such commands that are block oriented a transfer length of 0 means that 256 blocks should be sent. For parameter oriented commands 0 means that no data should be transferred.

Control byte The control byte contains just two bits defined in the standard. Both of these are optional and are seldom used. In the interest of completeness, short descriptions of these bits follow (Table 12.5).

The link bit allows commands to be chained together as a single I/O process. No commands will be executed between two commands of a chain, which for optimization reasons might happen otherwise. This is useful, for instance, to read a block, change it, and write it back. In addition linked commands allow the use of relative addresses for logical blocks.

The flag bit may only be used in conjunction with linked commands. If this bit is set it causes the target to end the command with LINKED COMMAND COMPLETE (WITH FLAG) (0Bh) instead of LINKED COMMAND COMPLETE (0Ah). This is typically used to cause an interrupt in the initiator.

Table 12.5 Command control byte.

Bit	7	6	5	4	3	2	1	0
	Vendor spec.	Reserved					Flag	Link

10- and 12-Byte commands

The 10- and 12-byte commands are very much the same as the 6-byte commands (Tables 12.6 and 12.7). The only difference is the number of bytes available for the LBN and the transfer length. A 10-byte command contains a 32-bit block address or an address space of approximately 2 terabytes. The transfer length field is 16 bits long. In SCSI-2 the 12-byte command extends this field to 32 bits.

Table 12.6 Template for 10-byte commands.

	7	6	5	4	3	2	1	0
0	Opcode							
1	LUN			Reserved				
2	(MSB) Logical block (LSB)							
3								
4								
5								
6	Reserved							
7	(MSB) Transfer length (LSB)							
8								
9	Control byte							

Table 12.7 Template for 12-byte commands.

	7	6	5	4	3	2	1	0
0	Opcode							
1	LUN			Reserved				
2	(MSB) Logical block (LSB)							
3								
4								
5								
6	(MSB) Transfer length (LSB)							
7								
8								
9								
10	Reserved							
11	Control byte							

Command types

There are four different types of commands (Table 12.8). These determine how and whether a command must be implemented.

Table 12.8 Command types.

<i>Symbol</i>	<i>Meaning</i>
M	Mandatory: these commands must be implemented
O	Optional: these commands may or may not be implemented. When implemented they must adhere to the standard
V	Vendor specific: these opcodes are reserved for manufacturers to implement their own commands
R	Reserved: these opcodes may not be used. The SCSI committee may assign commands at a later date.

Status All SCSI commands end with a status phase. The only exceptions to this are commands that are interrupted by some unforeseeable event. These were discussed in Chapter 10. During the status phase a single status byte is transferred. Table 12.9 lists all possible status bytes.

The three most common status bytes are GOOD (00h), BUSY (08h) and CHECK CONDITION (02h). The first two have obvious meanings. A good way to become acquainted with the CHECK CONDITION status is with the help of the SCSI monitor program. This status is used, among other things, in response to all illegal commands. The problem here may reside in the command itself or in the parameter list. When a target replies with this status it also prepares a report of sorts, which describes in more detail the nature of the problem. This information is read from the target using the REQUEST SENSE command.

Table 12.9 List of status bytes.

<i>Status byte</i>	<i>Status</i>	<i>Description</i>
00	GOOD	The command completed successfully
02	CHECK CONDITION	The command did not complete successfully. Use the REQUEST SENSE command for more detailed information
04	CONDITION MET	Used, for example, by the SEARCH DATA command to indicate successful search
08	BUSY	The target is momentarily busy. Try again later
10	INTERMEDIATE	Used in place of GOOD for linked commands
14	INTERMEDIATE – CONDITION MET	Used in place of CONDITION MET for linked commands
18	RESERVATION CONFLICT	The LUN is momentarily reserved for another SCSI device. Try again later
22	COMMAND TERMINATED	The target broke off the command due to a TERMINATE I/O PROCESS message
28	QUEUE FULL	This command cannot be added to the command queue at the present time

12.3 Commands for all SCSI devices

There are a number of commands that are common to all device types (Table 12.10). The most important of these will be introduced here. We begin with those commands whose implementation is mandatory.

Table 12.10 Commands for all devices.

<i>Opcode</i>	<i>Name</i>	<i>Type</i>	<i>Page</i>	<i>ANSI</i>	<i>Description</i>
00h	TEST UNIT READY	M	141	7.2.16	Reflects whether or not the LUN is ready to accept a command
03h	REQUEST SENSE	M	142	7.2.14	Returns detailed error information
12h	INQUIRY	M		7.2.5	Returns LUN specific information
15h	MODE SELECT(6)	M	149	7.2.8	Set device parameters
16h	RESERVE UNIT	M	146	8.2.12	Make LUN accessible only to certain initiators
17h	RELEASE UNIT	M	146	8.2.11	Make LUN accessible to other initiators
18h	COPY	O		7.2.3	Autonomous copy from/to another device
1Ah	MODE SENSE(6)	M	149	7.2.10	Read device parameters
1Ch	RECEIVE DIAGNOSTIC RESULTS	O		7.2.13	Read self-test results
1Dh	SEND DIAGNOSTIC	M	147	7.2.1	Initiate self-test
39h	COMPARE	O		7.2.2	Compare data
3Ah	COPY AND VERIFY	O		7.2.4	Autonomous copy from/to another device, verify success
3Bh	WRITE BUFFER	O		7.2.17	Write the data buffer
3Ch	READ BUFFER	O		7.2.12	Read the data buffer
40h	CHANGE DEFINITION	O	149	7.2.1	Set SCSI version
4Ch	LOG SELECT	O		7.2.6	Read statistics
4Dh	LOG SENSE	O		7.2.7	Read statistics
55h	MODE SELECT(10)	O		7.2.9	Set device parameters
5Ah	MODE SENSE(10)	O		7.2.11	Read device parameters

INQUIRY (12h) The inquiry command tells us about a LUN, giving us a list of specific details in a concise format. This command can be used to learn, among other things, which SCSI options have been implemented, the SCSI version number, the device type and the name of the device. This command will function even if the LUN is not able to accept other types of commands. In fact, INQUIRY will only return CHECK CONDITION if the target is unable to return the requested inquiry data. INQUIRY is the only command that does not reply with CHECK CONDITION when a non-existent LUN is addressed. Instead, this fact is reflected in the data returned.

It is most common to see this command with a transfer length of FFh, with all other bytes set to zero (Table 12.11). This represents a request for standard INQUIRY data, where 255 bytes or less are expected:

Table 12.11 The INQUIRY command.

	7	6	5	4	3	2	1	0
0	INQUIRY (12h)							
1	LUN			Reserved			EVDP	
2	Page code							
3	Reserved							
4	Allocation length							
5	Control byte							

- EVDP (enable vital production data): When this bit is clear standard INQUIRY data is returned. When this bit is set the page code determines the type of information returned by the target. Implementation of this bit is optional.
- Page code: This byte is valid only when the EVDP bit is set. It specifies that more detailed information concerning the target be returned as INQUIRY data. Section 7.3.4 of the ANSI standard describes this byte more fully.
- Allocation length: The number of bytes the initiator has reserved for the INQUIRY data. Normally this byte will be set to FFh. In response to this the target will send as much data as it has, up to FFh in total.

The standard INQUIRY data

The standard INQUIRY data is structured in the following manner (Table 12.12):

Table 12.12 INQUIRY data format.

	7	6	5	4	3	2	1	0
0	Peripheral qualifier			Device class				
1	RMB	Reserved (SCSI-1)						
2	ISO		ECMA			ANSI		
3	AEN	TIO	Reserved		Data format			
4	Additional length							
5-6	Reserved (2 bytes)							
7	Rel	W32	W16	Sync	Link	Res.	Que	SftR
8-15	Manufacturer (8 bytes)							
16-31	Product (16 bytes)							
32-35	Revision (4 bytes)							
36-55	Vendor unique (20 bytes)							
56-95	Reserved (40 bytes)							
96-n	Vendor unique							

Table 12.13 Peripheral qualifier.

<i>Status</i>	<i>Description</i>
000b	The device described is connected to the LUN
001b	The target supports such a device
011b	The target does not support a device for this LUN

- Peripheral qualifier (Table 12.13): These three bits reflect whether a physical device can be supported under this LUN and whether or not it is connected, but say nothing about whether the device is ready.
- Peripheral device type: These five bits indicate the peripheral device type, or class, to which the logical unit belongs. A list of these classes can be found on page 133.
- RMB: Removable bit. A 1 indicates that the medium is removable. For example, this bit is always set for diskette drives and tape units.
- ISO version, ECMA version: Indicates that the device supports the ISO IS-9316 or the ECMA-111 versions of the SCSI standard.
- ANSI version: A 0 means that this is a SCSI-1 device, a 1 stands for SCSI-1 with CCS, a 2 stands for SCSI-2. No other values are valid.
- AEN (asynchronous event notification capability): This bit is defined only for processor devices. If set this bit indicates that the device supports asynchronous event notification. Such a device will accept a SEND command from another target.
- TIO: If set this bit indicates that the device supports the message TERMINATE I/O PROCESS.
- Data format: Indicates the response of the following standard INQUIRY data. Interpreted in the same way as the ANSI version field.
- Additional length: Indicates how many additional bytes of information follow.
- Rel: When set this bit indicates that the device supports relative addressing. Relative addressing is only supported with linked commands.
- W32: When set this bit indicates support of 32-bit wide SCSI.
- W16: When set this bit indicates support of 16-bit wide SCSI.
- Sync: When set this bit indicates support of synchronous transfers.
- Link: When set this bit indicates support of linked commands.
- Que: When set this bit indicates support of tagged commands.
- SftR: When set this bit indicates soft reset capability. Otherwise the device performs a hard reset to a RESET condition.

```

SCSI Monitor V1.0 rev 024e 18.7.94(fs)
SCSI Command 00: 12 00 00 00 FF 00 00 00 00 00 00 00 00
ID Lu St lN nX
03 00 00 00 FF
SCSI Data Buffer Nr. 00:
0000: 01 80 02 02 26 00 00 18 48 50 20 20 20 20 20 20 Q&HP
0010: 48 50 33 35 34 38 30 41 20 20 20 20 20 20 20 20 HP35480A
0020: 41 20 20 20 30 30 30 2F 00 00 02 00 00 00 00 00 A 000/
0030: 00 00 00 00 00 00 00 00 00 00 00 00 00 00 00 00
0040: 00 00 00 00 00 00 00 00 00 00 00 00 00 00 00 00
0050: 00 00 00 00 00 00 00 00 00 00 00 00 00 00 00 00
0060: 00 00 00 00 00 00 00 00 00 00 00 00 00 00 00 00
0070: 00 00 00 00 00 00 00 00 00 00 00 00 00 00 00 00
0080: 00 00 00 00 00 00 00 00 00 00 00 00 00 00 00 00
0090: 00 00 00 00 00 00 00 00 00 00 00 00 00 00 00 00
00A0: 00 00 00 00 00 00 00 00 00 00 00 00 00 00 00 00
00B0: 00 00 00 00 00 00 00 00 00 00 00 00 00 00 00 00
00C0: 00 00 00 00 00 00 00 00 00 00 00 00 00 00 00 00
00D0: 00 00 00 00 00 00 00 00 00 00 00 00 00 00 00 00
00E0: 00 00 00 00 00 00 00 00 00 00 00 00 00 00 00 00
00F0: 00 00 00 00 00 00 00 00 00 00 00 00 00 00 00 00
Command: G
    
```

Figure 12.2 Example of INQUIRY command.

- Manufacturer: Manufacturer's name in ASCII.
- Product: Product's name in ASCII.
- Revision: Product's version number in ASCII.

As you can see, the INQUIRY command is capable of delivering a wide variety of useful information. An example of INQUIRY data as the SCSI monitor program presents it on the screen is shown in Figure 12.2. This particular command is inquiring about LUN 0 of SCSI ID 3. A total of 255 bytes (0FFh) have been requested.

In order to simplify interpretation of the INQUIRY data, I have placed it in a frame corresponding to Table 12.12 in Table 12.14. The peripheral qualifier is 000b, meaning that a physical device is addressable under this LUN. The peripheral device type is 00001b, which according to the list on page 133 specifies a tape device. The RMB bit is set in byte 1 indicating removable medium. The ANSI field in byte 2 shows that the device is SCSI-2 compliant. This is also reflected in the response data format of byte 3. Byte 4 tells us that 38 (26h) additional bytes of data follow. The link and sync options are set in byte 5, meaning that the device supports synchronous transfers and linked commands but not, however, tagged queues.

**TEST UNIT READY
(00h)**

The command TEST UNIT READY determines whether the LUN in question will allow access to the medium (Table 12.15). This means, for example, for a removable medium drive that the medium is present and READY for access. Depending on the device, it can take tens of seconds before the READY condition is reached. If you are only interested in finding out whether a certain LUN exists then the INQUIRY command should be used instead.

Table 12.14 Evaluation of INQUIRY data.

	7	6	5	4	3	2	1	0
0	0	0	0	0	0	0	0	1
1	1	0						
2	0	0	0	0	0	0	1	0
3	0	0	0	0	0	0	1	0
4	26h							
5-6	00h, 00h							
7	0	0	0	1	1	0	0	0
8-15	HP							
16-31	HP35480A							
32-35	A							
36-55								
56-95								
96-n								

TEST UNIT READY is an unusual command because no data phase takes place. No parameters are sent and no data is returned. When the physical device is ready this command simply returns a GOOD status, otherwise CHECK CONDITION is returned. Then the precise reason for the lack of readiness can be determined from the sense data using REQUEST SENSE.

REQUEST SENSE (03h)

The command REQUEST SENSE is always used in response to a CHECK CONDITION in order to read the sense data (Table 12.16). This data gives information concerning the reason why the preceding command ended abnormally. The sense data is also updated when a command ends with COMMAND TERMINATED status.

It is important to remember that sense data always reflects the state of the previous command. It is the initiator's responsibility to follow up on a CHECK CONDITION status immediately with REQUEST SENSE. An intervening command will cause sense data to be overwritten.

Table 12.15 The TEST UNIT READY command.

	7	6	5	4	3	2	1	0
0	TEST UNIT READY (00h)							
1	LUN			Reserved				
2	Reserved							
3								
4								
5	Control byte							

Table 12.16 The REQUEST SENSE command.

	7	6	5	4	3	2	1	0
0	REQUEST SENSE (03h)							
1	LUN			Reserved				
2								
3								
4	Data length							
5	Control byte							

The command itself looks similar to the INQUIRY command. Here too the allocation length is in general set to FFh in order to receive all of the data that the target has available.

Sense data Since interpreting sense data can be complicated, to say the least, we divide the task into four steps:

- (1) Determine validity of sense data.
- (2) Evaluation of the sense key
- (3) Evaluation of sense key specific information
- (4) Evaluation of the sense codes

It is often the case that the sense key alone is enough information, making subsequent steps unnecessary.

I explain here only the most important fields, which are shown in bold in Table 12.17; the meaning of the less important fields can be found in the standard:

Table 12.17 Sense data.

	7	6	5	4	3	2	1	0
0	Valid	Error code (70h or 71h)						
1	Segment number							
2	FilMrk	EOM	ILI	Res	Sense key			
3-6	Information							
7	Additional transfer length							
8-11	Command specific information							
12	Sense code							
13	Extended sense code							
14	FRU							
15-17	SKSV	Sense key specific						
18-n	Additional sense bytes							

Table 12.18 The most important sense keys.

<i>Sense key</i>	<i>Description</i>	
0h	NO SENSE	There is no sense information
1h	RECOVERED ERROR	The last command completed successfully but used error correction in the process
2h	NOT READY	The addressed LUN is not ready to be accessed
3h	MEDIUM ERROR	The target detected a data error on the medium
4h	HARDWARE ERROR	The target detected a hardware error during a command or a self-test
5h	ILLEGAL REQUEST	Either the command or the parameter list contains an error
6h	UNIT ATTENTION	The LUN has been reset, for example through SCSI reset or a medium change
7h	DATA PROTECT	Access to the data is blocked
8h	BLANK CHECK	Reached unexpected written or unwritten region of the medium
9h		Vendor specific
Ah	COPY ABORTED	COPY, COMPARE or COPY AND VERIFY was aborted
Bh	ABORTED COMMAND	The target aborted the command
Ch	EQUAL	Comparison for SEARCH DATA successful
Dh	VOLUME OVERFLOW	The medium is full
Eh	MISCOMPARE	Source data and data on the medium do not agree

- **Error code:** An error code of 70h is the normal case. This means that the sense data refers to the current command. An error code of 71h, on the other hand, means that the sense data refer to an earlier command. Such a deferred error can occur, for example, with disk drives using write cache. Here the disk drive will send a GOOD status immediately after receiving the data of a WRITE command. To the host the write appears to be complete, but in reality the data merely resides in the drive's write cache waiting to be written to the medium. We find ourselves in a critical situation if during the actual write to the medium an unrecoverable data error occurs. We will discuss caching and its ramifications in more detail in Chapter 13. Fortunately, such errors occur extremely infrequently.
- **Sense key:** The sense key is the principal information concerning the reason for a CHECK CONDITION. Table 12.18 lists the keys with their corresponding meanings.
- **Sense code:** After deciphering the sense key, we may or may not need to look for more information concerning the error (Table 12.19). For the sense key NOT READY, for example, we look to the sense code for further explanation. This byte tells of possible hardware and medium errors, among others.

ILLEGAL REQUEST is a sense key that occurs often while testing a device with the SCSI monitor. The sense key specific field contains more detailed information. Table 12.20 lists the possibilities for this field for the sense key ILLEGAL REQUEST. Look to the standard for the description of other sense keys. If the SKSV bit is set, this shows that the sense key specific data is valid. Afterwards, the C/D bit should be examined. When set the error lies in the command, otherwise the

bytes for sense data. In the status field for this command is 00h, meaning that the REQUEST SENSE was successful. If you do not have much experience in interpreting hexadecimal numbers it helps to write out each byte in binary on a piece of paper, then, using Table 12.21, draw in the boundaries of the individual fields. Byte 0 of the sense data is error code 70h; that is, this data refers to the previous command. In byte 2 is the sense key 05h: ILLEGAL REQUEST. The sense code is 24h, meaning that a field in the previous command was invalid. Looking at the sense key specific information, byte 15 is C0h; the valid bit is set, indicating that there is useful information here. The C/D bit is also set, meaning that the error is in the command itself. Bytes 16 and 17 contain 00h and 03h; in other words, the error is in the third byte of the INQUIRY command. A look at the definition shows that byte 3 of an INQUIRY command must be zero. The FFh belonged not in byte 3 but in byte 4 as the allocation length. The command should have been 12 00 00 00 FF 00.

Table 12.21 Interpretation of the sense data.

Bit/ Byte	7	6	5	4	3	2	1	0
0	0	1	1	1	0	0	0	0
1	0	0	0	0	0	0	0	0
2	0	0	0	0	0	1	0	1
3-6								
7	0	0	0	0	1	0	1	1
8-11								
12	0	0	1	0	1	0	0	0
13	0	0	0	0	0	0	0	0
14	0	0	0	0	0	0	0	0
15	1	1	0	0	0	1	1	1
16	0	0	0	0	0	0	0	0
17	0	0	0	0	0	0	1	1

**RESERVE (16h)
and RELEASE
(17h)**

This pair of commands makes it possible to reserve a LUN for a particular initiator and then to free it for use by others. These commands are common to all device classes. There are special versions of the commands for disk drives.

What happens when a LUN reserved for a certain initiator receives a command from another initiator? This LUN will end each such command with a RESERVATION CONFLICT status and ignore the command. This reservation mechanism provides a degree of protection, albeit somewhat unsophisticated, in multi-initiator environments. Many operating systems do not allow, for example, two hosts to access a single disk drive. In such situations, however, it is possible to use RESERVE and RELEASE to share drives between two hosts. As soon as one system brings a drive online it reserves that LUN. Should the system go down for any reason, a simple SCSI reset is all that is needed to make the drive accessible for the other host.

Table 12.22 The RESERVE command.

	7	6	5	4	3	2	1	0
0	RESERVE (16h)							
1	LUN		3rdPty	3rd Pty ID			Res	
2	Reserved							
3								
4								
5	Control byte							

The reserve command itself looks standard (Table 12.22). Only two fields call for any explanation; these make it possible for an initiator to reserve a device for a third party:

- **3rdPty:** Third party reservation. When clear, this bit calls for the reservation to be made for the initiator sending the command. When set, the reservation should hold for the initiator whose ID is contained in the third-party device ID field.
- **3rdPty ID:** When third party is set this field holds the ID of the device for which the reservation holds.

It is possible for an initiator to modify its own reservation. It can, for example, first reserve a device for itself, followed later by a reservation for a third device. In this way a device always remains protected. One application for third-party reservation is the COPY command.

A reservation can be dissolved in a number of different ways: by SCSI reset, a DEVICE RESET from any initiator, or by a RELEASE command from the initiator which made the reservation. The RELEASE command looks almost identical to the RESERVE command (Table 12.23).

Table 12.23 The RELEASE command.

	7	6	5	4	3	2	1	0
0	RELEASE (17h)							
1	LUN		3rdPty	3rd Pty ID			Res	
2	Reserved							
3								
4								
5	Control byte							

SEND DIAGNOSTIC (1Dh)

The SEND DIAGNOSTIC command causes the target to run certain diagnostic programs (Table 12.24). In the most simple case, when the ST bit is set, the device will run a self-test. If the self-test discovers no problems then the status returned

Table 12.24 The SEND DIAGNOSTIC command.

	7	6	5	4	3	2	1	0	
0	SEND DIAGNOSTIC (1Dh)								
1	LUN			PF	Res	ST	DevO	UniO	
2	Reserved								
3	(MSB)			Transfer length					
4								(LSB)	
5	Control byte								

is 00h (GOOD). If, on the other hand, a problem is detected a CHECK CONDITION status, 02h, is returned. A follow-up REQUEST SENSE will reveal a sense key of 04h (HARDWARE ERROR). Only this implementation of the command is mandatory. The optional bits of byte 1 are:

- PF (page format): When this bit is set the page format conforms to SCSI-2. In SCSI-1 the page format was vendor specific.
- DevO (device offline): When set, this bit allows the target to run diagnostics that may affect all LUNs and possibly change their state. If clear no such operations will take place.
- UniO (unit offline): This bit plays the same role as DevO but for protecting individual LUNs.

Optionally, various diagnostics can be run using diagnostic pages sent as parameter lists. Diagnostic pages have been defined for each device type. Some pages may be vendor specific. For example, a frequently implemented page is the TRANSLATE ADDRESS page. This page makes it possible to find out the physical address of a logical block. The results are collected from the target using the RECEIVE DIAGNOSTIC RESULTS command. Table 12.25 shows the basic structure of a diagnostic page. Several such pages can be sent together in a single parameter list. The page code and basic structure of the pages are the same for SEND and RECEIVE DIAGNOSTIC. The actual parameters, however, usually differ somewhat.

Table 12.25 Diagnostic page.

	7	6	5	4	3	2	1	0	
0	Page code								
1	Reserved								
2	(MSB)			Page length (n-3)					
3								(LSB)	
4	Diagnostic								
n	parameter								

CHANGE DEFINITION (40h)

This command allows an initiator to configure a SCSI-2 target to behave like an earlier SCSI version (Table 12.26). The following values are allowed in the version field:

- 00h: No change
- 01h: SCSI-1
- 02h: SCSI-1 with CCS
- 03h: SCSI-2

The Save bit causes the target to save the change permanently. At the next power-up cycle the change will be in force. The Transfer length indicates the size of the parameter list that the initiator intends to send to the target. Such lists, however, are vendor unique and in general are seldom used.

Table 12.26 The CHANGE DEFINITION command.

	7	6	5	4	3	2	1	0
0	CHANGE DEFINITION (40h)							
1	LUN			Reserved				
2	Reserved						Save	
3	Res	SCSI version						
4	Reserved							
5								
6								
7								
8	Transfer length							
9	Control byte							

MODE SELECT(6) (15h) and MODE SENSE(6) (1Ah)

MODE SELECT and MODE SENSE are a pair of optional commands that use the same parameter lists. These allow an initiator to configure a device and also to determine its configuration. They are the same for all devices; however, the parameter lists used can be very device dependent. Relative to a typical SCSI command, MODE SENSE and MODE SELECT are complex, with many parameters and fields. Both commands are essential, implemented for virtually all devices. They are covered here in great detail.

There are 6-byte and 10-byte versions of both MODE SELECT and MODE SENSE. Only the 6-byte version is discussed here. The 10-byte version is identical except for the parameter list length, which is two bytes instead of one.

MODE SELECT(6) allows an initiator to set the internal configuration of a LUN (Table 12.27). The command itself is typical. Byte 4 contains the parameter list length, which can be up to 255 bytes long. If this byte is zero no list is sent. In byte 1 there are two bits of interest:

Table 12.27 The MODE SELECT command.

	7	6	5	4	3	2	1	0
0	MODE SELECT(6) (15h)							
1	LUN			PF			SP	
2	Reserved							
3								
4	Transfer length							
5	Control byte							

	7	6	5	4	3	2	1	0
0	MODE SELECT(10) (55h)							
1	LUN			PF			SP	
2	Reserved							
3								
4								
5								
6								
7	(MSB) Transfer length						(LSB)	
8								
9	Control byte							

- PF (page format): When this bit is set the parameter pages conform to SCSI-2; that is, as they are described in this book. Otherwise the parameter pages are SCSI-1 compliant.
- SP (save pages): When this bit is clear changes affect only the current parameters. If the bit is set then changes will also be written to the saved parameters and will be valid at the next power-up cycle.

The MODE SENSE command is used to read the mode parameter lists from a device (Table 12.28). Like the MODE SELECT command, there is a 10-byte version for working with lists longer than 255 bytes:

- DBD (disable block descriptors): When this bit is set no block descriptors are sent before the pages.
- PCF (page control field):
 - 00b: Current values
 - 01b: Changeable values
 - 10b: Default values
 - 11b: Saved values

Table 12.28 The MODE SENSE command.

	7	6	5	4	3	2	1	0
0	MODE SENSE(6) (1Ah)							
1	LUN		Res	DBD	Res			
2	PCF		Page					
3	Reserved							
4	Transfer length							
5	Control byte							

	7	6	5	4	3	2	1	0
0	MODE SENSE(10) (5Ah)							
1	LUN		Res	DBD	Res			
2	PCF		Page					
3	Reserved							
4								
5								
6								
7	(MSB) Transfer length							(LSB)
8								
9	Control byte							

- Page code: The number of the desired parameter page.

The parameter lists for MODE SELECT and MODE SENSE are basically the same. This is useful in that one can read the parameters from the device with MODE SENSE, edit them in memory, and write them back with MODE SENSE. A parameter list consists of three elements: the mode parameter header (Table 12.29), the block descriptors, and the parameter pages. Each element has a pointer to the beginning of the subsequent one. Figure 12.4 shows a typical mode parameter list. This one has a header, two block descriptors, and two parameter pages. The arrows on the right-hand side represent the pointers within the elements. You will need to refer to this figure as we discuss the individual elements.

Table 12.29 Mode parameter header.

	7	6	5	4	3	2	1	0
0	Transfer length							
1	Medium type							
2	Device specific							
3	Block descriptor length							

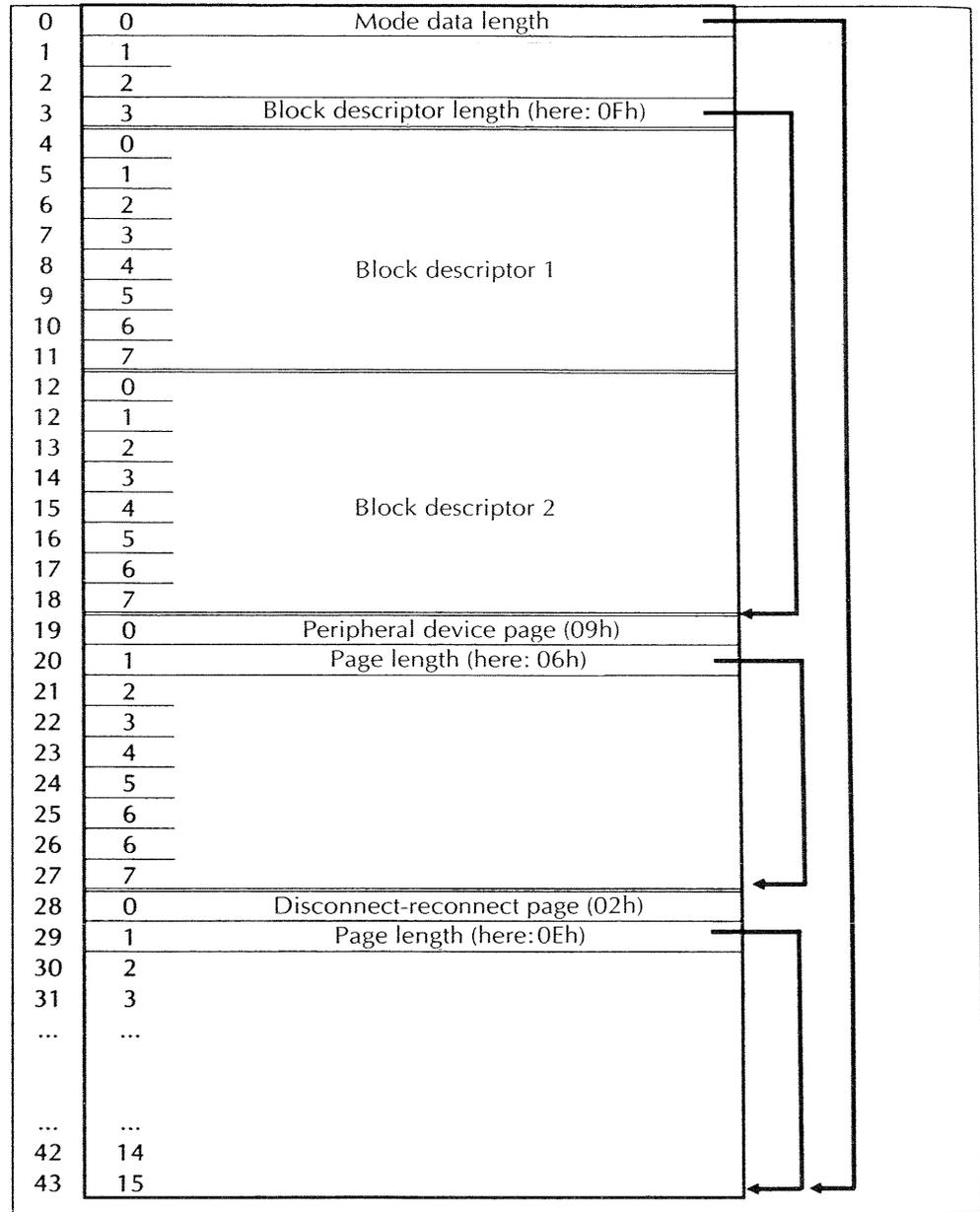

Figure 12.4 Example of a mode parameter page.

Mode parameter header

The header of the 6-byte MODE commands is four bytes long:

- Mode data length: The length of the entire parameter list in bytes.
- Block descriptor length: The total length of the block descriptors. Since a block descriptor is always eight bytes long this field is either zero or a multiple of eight.

Table 12.30 Block descriptor.

0	Write density	
1	(MSB)	Number of blocks
2		
3	(LSB)	
4	Reserved	
5	(MSB)	Block length
6		
7	(LSB)	

Block descriptor

Zero or more block descriptors (Table 12.30) may follow a mode parameter header. The block descriptor defines the logical block length of all or part of the medium. Theoretically, one could use this feature to divide a drive into several partitions of differing logical block sizes. However, in the vast majority of cases a single block descriptor is employed with a block size defined for the entire medium.

- Write density: This field is dependent on device class. For floppy drives there are codes for the popular densities. For disk drives this field has no meaning.
- Number of blocks: The number of blocks that this descriptor defines.
- Block length: The number of bytes per logical block for the blocks defined by this descriptor. For tape drives a block length of zero means that it is variable and is determined by the WRITE command. The block descriptor does not contain a pointer to the next element since the descriptor is of a fixed length (8 bytes).

Mode parameter pages

The third, final, and most important element is the parameter page itself (Table 12.31). A parameter page begins with the page code in the lowest 6 bits of byte 0. It follows that the largest page code is 3Fh. The next byte contains the page length. Parameter pages vary in length but are at most 255 bytes long.

The PS (parameter savable) bit of byte 0 is only defined for MODE SENSE. When set it indicates that the target is able to save these parameters. There are

Table 12.31 Mode parameter page.

	7	6	5	4	3	2	1	0
0	PS	Res	Page					
1	Page length							
2 ...	Mode							
... n	Parameter							

Table 12.32 List of parameter pages.

<i>Code</i>	<i>Name</i>	<i>Device</i>
00h	Vendor specific	DTPCSOM
01h	Read/write error page	DTCO
02h	Disconnect-reconnect page	DTPCSOM
03h	Format page	D
03h	Parallel interface page	P
03h	Measurement units page	S
04h	Rigid disk geometry page	D
04h	Serial interface page	P
05h	Flexible disk page	D
05h	Printer options page	P
06h	Optical memory page	O
07h	Verification error page	DCO
08h	Caching page	DCO
09h	Peripheral device page	DTPCSOM
0Ah	Control mode page	DTPCSOM
0Bh	Medium type page	DTC
0Ch	Notch partitions page	D
0Dh	CD-ROM page	C
0Eh	CD-ROM audio page	C
10h	Device configuration page	T
11h	Medium partitions page 1	T
12h	Medium partitions page 2	T
13h	Medium partitions page 3	T
14h	Medium partitions page 4	T
1Dh	Element address assignment page	M
1Eh	Transport geometry page	M
1Fh	Device capabilities page	M
3Fh	All available pages	DTPCSOM

three parameter pages, which are defined for all device types. These are the control mode page (0Ah), the disconnect-reconnect page (02h), and the peripheral device page (09h).

Most parameter pages are device specific. These pages are defined in the SCSI literature included with the device. Table 12.32 gives an overview of parameter pages defined in the SCSI standard. Of special interest is page code 3Fh, which allows MODE SENSE to read all of the pages maintained by a device. The device column indicates the device classes for which a parameter page is defined. The abbreviations are defined as follows: D, disk drives; T, tape drives; P, printers; C, CD-ROMs; S, scanners; O, optical storage; M, medium changers; and C, communications devices.

12.4 Mode parameter pages for all device classes

The following parameter pages are defined for all device classes.

The disconnect–reconnect page (02h)

The parameters of this page (Table 12.33) determine the behaviour of the target with respect to freeing the bus. Whether or not the target is allowed to free the bus at all is a function of the DiscPriv bit in the IDENTIFY message of every I/O process.

The parameter DTDC (data transfer disconnect) in byte 12 also determines the general behavior of the target. It has the following effect:

- 00b: Disconnection from the bus is allowed.
- 01b: No disconnection should take place once the data transfer has begun until all data has been sent. The time parameters of this page are ignored in this case.
- 10b: Reserved.
- 11b: No disconnection should take place once the data transfer has begun until the command is complete. Time parameters are also ignored in this case.

Table 12.33 The disconnect–reconnect page.

	7	6	5	4	3	2	1	0
0	PS	Res	Disconnect–reconnect page (02h)					
1	Page length (0Eh)							
2	Buffer full condition							
3	Buffer empty condition							
4	(MSB)		Maximum bus					
5			inactivity time				(LSB)	
6	(MSB)		Minimum					
7			bus free time				(LSB)	
8	(MSB)		Maximum					
9			connection time				(LSB)	
10	(MSB)		Maximum					
11			burst length				(LSB)	
12							(DTDC)	
13	Reserved							
14								
15								

The maximal burst length cannot be specified when the DTDC is non-zero. The following parameters affect the target's disconnect-reconnect behavior when DTDC is zero.

- The buffer full ratio determines, for read operations, how full the data buffer should be before the target attempts a reconnect to the initiator. The value is in units of 1/256 times the number of buffers. The buffer empty ratio works the same way for write operations. It determines how empty the buffer should be before attempting to reconnect to the initiator.
- The bus inactivity limit specifies the maximum amount of time in 100 μ s increments that a target may occupy the bus without sending or receiving data. If the limit is exceeded the target must free the bus.
- The disconnect time limit specifies the minimum amount of time in 100 μ s increments that a target must wait after freeing the bus before it attempts a reselection.
- The connect time limit specifies in 100 μ s increments the maximum amount of time that a target may occupy the bus.
- The maximum burst size specifies the maximum number of data bytes (in 512 byte increments) that the target may transfer before relinquishing the bus.

**Peripheral
device page
(09h)**

This parameter page does not allow many settings and is more or less vendor specific (Table 12.34). The interface identifier describes a physical interface. This is meaningful for bridge controllers; otherwise a zero stands for SCSI. A few values are defined in the standard:

- 0000h: SCSI
- 0001h: SMD

Table 12.34 The peripheral device page.

	7	6	5	4	3	2	1	0
0	PS	Res	Peripheral device page (09h)					
1	Page length (n-1)							
2	(MSB)		Interface					(LSB)
3								
4	Reserved							
5	Reserved							
6	Reserved							
7	Reserved							
8 ...	Vendor specific							
... n								

- 0002h: ESDI
- 0003h: IPI-2
- 0004h: IPI-3

Control mode page (0Ah)

The control mode page contains parameters for controlling various SCSI-2 characteristics (Table 12.35). I mention here only a few of the more important ones and refer the reader to the standard for more details.

The queue algorithm modifier pertains to `SIMPLE QUEUE TAG` commands. It takes on two values: a value of 0 specifies that the target must order commands in such a way that data integrity is guaranteed across the entire medium for all initiators. A value of 1 allows the target to re-order commands without restrictions. A drive can often achieve a substantial increase in throughput by optimizing the order in which logical blocks are accessed.

The `DQue` bit allows tagged queuing to be disabled. When set all queue messages are replied to with `MESSAGE REJECT`. The three bits `RAENP`, `UAAENP` and `EAENP` allow AEN in certain situations. If none of these bits is set AEN is disabled.

`RAENP` (ready AEN permission) specifies that the target should use AEN to notify initiators of an initialization instead of responding with `UNIT ATTENTION` for the first command. `UAAENP` (unit attention AEN) allows AEN instead of `UNIT ATTENTION` during normal operation. `EAENP` (error AEN permission) allows a target to use AEN for deferred errors again instead of relying on a `UNIT ATTENTION` response to the next command.

Table 12.35 The control mode page.

	7	6	5	4	3	2	1	0
0	PS	Res	Control mode page (0Ah)					
1	Page length (06h)							
2	Reserved							RLEC
3	Queue algorithms				Reserved		QErr	DQue
4	EECA	Reserved			RAENP	UAAENP	EAENP	
5	Reserved							
6	(MSB)	Ready AEN						
7	Holdoff period							(LSB)

13 Direct access devices

This class includes all devices that allow direct access to any logical block. Disk drives, magneto-optical drives, diskettes and RAM disks are among the most popular examples of this class.

WORM drives use an optical medium that can only be written to once and have their own device class. The same is true of CD-ROM.

13.1 The model of a SCSI disk drive

The basic physical design of disk drives and the organization of data on the medium were described in Part I. Refer to Chapter 2 before continuing if any of the following terms are unclear: read/write head, sector, cylinder, logical block, ECC, CRC, mapping, interleave, track skew, and zone-bit recording

A SCSI disk drive presents the user with a sequence of logical blocks for storing information (Figure 13.1). These blocks can be written to and read any number of times. They are uniquely identified by their logical block number (LBN). The first logical block has the number 0.

In contrast to tape drives, the logical blocks of a disk drive allow direct access to any block. The actual fetching of the data is completely transparent to the host. In general the host has no idea where on the medium a logical block is located.

Normally, a logical block contains exclusively user information. There do exist, however, optional commands that allow limited access to format information like ECC or CRC.

Mapping The mapping of logical blocks to physical sectors is not specified in the SCSI standard (Table 13.1). However, it should be implemented in such a way that the time needed to access adjacent blocks is minimized. Most drives use a linear mapping, where adjacent logical blocks come from adjacent physical sectors.

The following example will help to make this clear. Assume a drive with 400 cylinders (tracks), 2 heads, and 25 sectors. A state-of-the-art disk drive can switch heads within the time it takes to rotate from one sector to another. A

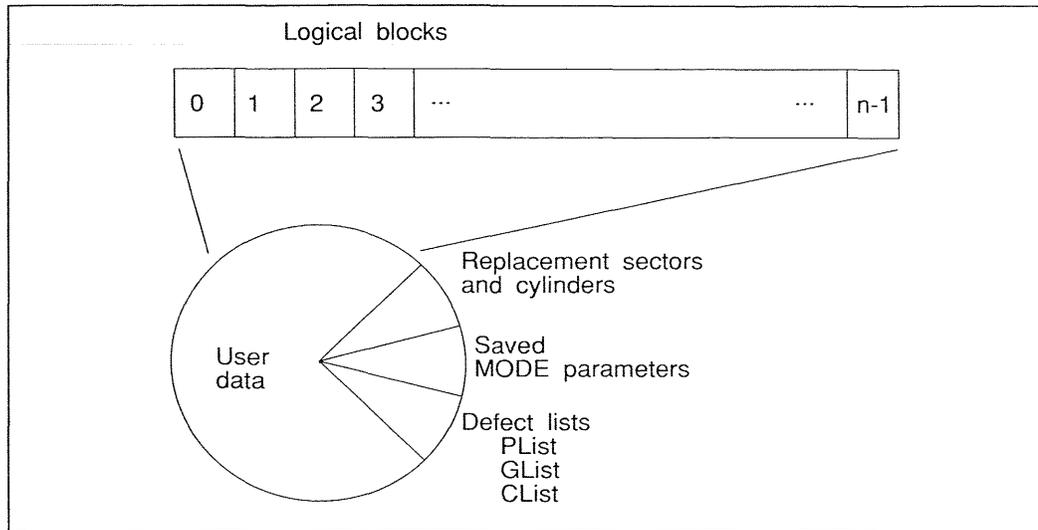

Figure 13.1 Organization of the SCSI medium.

change of tracks typically takes around 2 ms. A linear mapping minimizes delays by switching heads before calling for a change of tracks.

Logical blocks

The size of a logical block can vary between 1 and 64Kbytes. The most widely used size is 512 bytes, as is the case for the DOS operating system. In the UNIX world there are also blocks of 4 Kbytes. A SCSI drive can accommodate more than one block size on a single medium. Theoretically, each block may be a different size.

Table 13.1 Mapping of logical blocks.

LBN	Cylinder	Head	Sector
0	0	0	0
1	0	0	1
⋮			
24	0	0	24
Head switch			
25	0	1	0
⋮			
49	0	1	24
Adjacent track seek and head switch			
50	1	0	0
⋮			
19999	399	1	24

Extends and notches

A continuous sequence of blocks of the same size is called an extend. Extends are defined using the parameter list of a `MODE SELECT` command (see page 150). However, this optional feature is seldom employed. For most applications all blocks of a SCSI drive will have the same block size; that is, they will belong to a single extend. Be careful not to confuse zone-bit recording with extends. Zone-bit recording has to do with how the information is stored on the medium. Here the outer tracks contain more sectors than the inner tracks. The resulting regions of the drive that employ the same number of sectors per track are called notches. Extends, on the other hand, are groupings of logical blocks. Adding to this confusion is the fact that logical block size and sector size may not be the same (see Figure 13.2).

Removable medium drives

The medium of a SCSI drive may or may not be removable. Diskette drives, magneto-optical drives and removable cartridge drives are examples of removable medium drives. The medium is said to be 'mounted' when it is loaded into the unit and is ready to read or write. A SCSI drive in this state is said to be in condition ready. Any attempt to access a drive that is not ready leads to a `CHECK CONDITION` with the sense key `NOT READY`.

RAM disks

The model of a SCSI disk drive does not specify that information must be stored in a nonvolatile manner. This allows for the implementation of a 'disk drive' out of RAM (hence RAM disk). The result is lightning fast storage that loses information when the power is removed.

Medium defects

A medium defect prevents information from being written and read correctly. Such a defect renders an entire sector unusable. Defects are an unavoidable outcome of the plating process of rigid disks but can also result from a fingerprint on a diskette. Section 7.2 goes into more detail concerning medium defects as they actually occur.

SCSI makes it possible for a target to present a virtually defect-free medium to the outside world. This is done by replacing defective logical blocks with

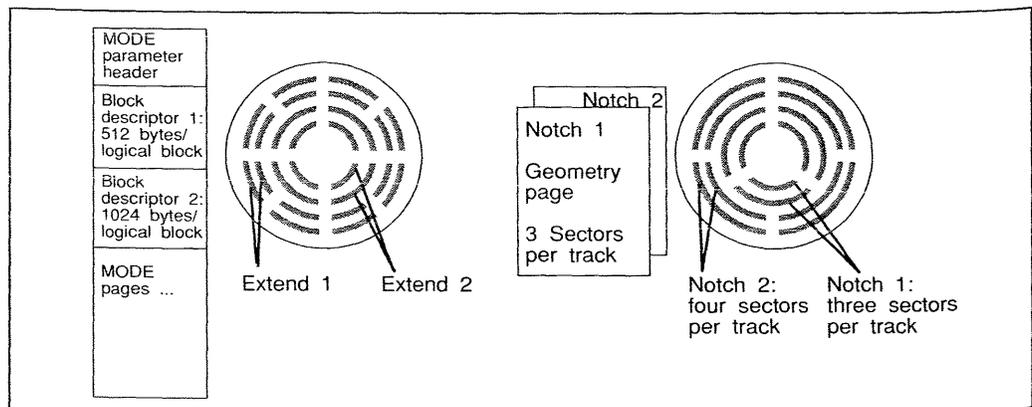

Figure 13.2 SCSI extends and notches.

replacement blocks set aside solely for this purpose. It does not concern an initiator whether or not a logical block has been replaced. The defect management is carried out by the drive alone. Replaceable medium drives like diskettes, however, cannot accommodate such an approach because here the physical format of the medium plays an important role. If SCSI defect management were employed then a diskette written on a SCSI drive could not be read by a standard PC floppy drive.

There are a number of methods of defect management. A target using automatic reallocation replaces a block automatically as soon as a defect is detected. This sounds very attractive but brings with it certain disadvantages as well. If the data in logical block can no longer be read successfully the block will be replaced with a good one. However, the data in this block is obviously not what was written to the original defective block but rather the format pattern. For this reason the target should inform the host of such an action; it can do this using the message system. Automatic reallocation during writing, on the other hand, is not a problem. Here either the data is still in the write buffer and the target can write it to the new block or the target can respond to the host with a write error. Because of the inherent differences SCSI allows these features to be enabled and disabled separately.

In addition to the above method where the drive autonomously manages defects is the more standard approach where the host is in charge. Here defective blocks are replaced using the command `REASSIGN BLOCK`. This method is preferred because the operating system has full control.

Defect lists There are four different types of defect lists used with SCSI drives. The primary defect list (PList) contains the defects discovered by the manufacturer using analog testing equipment. Such equipment can find positions that might not cause errors until the medium ages. The PList is permanent and never changes after the drive leaves the factory. The grown defect list (GList) contains additional defects that were discovered during the operation of the drive. These are defective blocks discovered during formatting or reallocated either automatically or using `REASSIGN BLOCK`. The certification list (CList) contains defects that were discovered during the certification procedure of formatting. The defects of the CList belong to the GList as well. Finally, there are the defects that an initiator sends to the target. Called the DList, this list is sent to the target before formatting takes place, at which time it becomes part of the GList. The PList and GList together contain all medium defects.

Data buffers and cache Every SCSI disk controller has a built-in memory buffer with at least enough room to store a sector's worth of data. A physical sector is written or read in entirety at one time, therefore the data must be processed in real time. Since SCSI cannot guarantee real-time performance a sector's worth of data is first collected in the buffer before writing it to the medium.

Pre-fetch When the data buffer is large enough to accommodate an entire track it is possible to implement speed enhancing options like read pre-fetch. Here a controller will assume that whenever a logical block X is to be read, block $X+1$ will be requested next. The validity of this assumption depends on the operating system of the host. Nevertheless, when the controller reads a sector it reads the rest of the track into the buffer as well. This extra work costs practically no time since it is merely a DMA transfer to the buffer. In the event that the subsequent blocks are called for the transfer can take place immediately. Otherwise, the data can simply be ignored with no penalty.

Another method of optimization is possible when a large enough buffer is available. Assume that a large number of continuous blocks is requested from the drive. After the seek to the proper track is complete it is probably the case that the head is located somewhere in the middle of the set of requested blocks. Normally, the controller would wait until the first block rotates underneath the heads before starting to read. However, when the buffer is large enough the controller can begin to read the sectors into memory immediately. Afterwards the controller simply rearranges the order in which the data is sent to the host. This method can save many milliseconds of time.

Writing optimization

Other methods of optimization are available when writing data to the drive. Consider the point in time just after the data has been collected into the controller's write buffer. Normally, the seek takes place and the data is written to the medium before `COMMAND COMPLETE` is sent to the initiator. However, if the controller responds immediately with `GOOD` status and `COMMAND COMPLETE` the access time is effectively eliminated. This approach brings with it an element of risk. If the actual write to the medium should fail the host must be notified of the error. In SCSI-2 this is possible using `AEN`. Here the target informs the host that the `WRITE` command that originally terminated with `GOOD` status was, in fact, unsuccessful. More difficult is the situation where power is lost. Drives are normally built so that once writing a sector has begun it can be completed, thus maintaining the integrity of the medium even when power is interrupted. However, implementing a feature whereby the entire data buffer could be saved would be much too costly.

An operating system assumes that everything written to a drive is secure. If this is not, in fact, the case the results can be catastrophic. More than just data is at stake here: if configuration information or other operating system specific data is lost it may necessitate reinstallation of the entire system. However, as with any mechanical device, failures do occur no matter what precautions are taken. In this case the increase in performance must be weighed against such risks.

For these reasons this write feature is configurable using the cache page of `MODE SELECT`. When enabled, writes are extremely fast but data integrity is at risk; when disabled data integrity is maintained but with a degradation in performance.

Caching Caching goes one step further with the data buffer than the techniques described above. Since SCSI-2 provides a mode parameter page especially for configuring the cache we will look at caching here in greater detail. Certain aspects of drive performance as well as the definition of average access time can be found in Section 2.3.

In general a cache is fast storage which contains copies of certain portions of another slower storage medium. The cache can be accessed usually at least an order of magnitude faster than the slower storage but is much smaller in capacity. A cache directory is used to determine whether a specific piece of data is resident in the cache. When the desired data is in the cache we speak of a cache hit; otherwise it is called a cache miss.

Caches were first employed in the main memory of mainframe computers. Here very expensive, very fast RAM is used to cache the slower, less expensive, but very large main memory of the system. Even though such a cache is typically only a fraction of the size of main memory it is not uncommon to reach a hit quota of over 90%. Such success is due largely to the fact that much of computer programs are loops.

The situation for mass storage is completely different. The effectiveness of a mass storage cache is very dependent on the operating system and application. At least in multi-user systems, disk accesses are distributed over the entire medium. There are, however, areas that are more frequently accessed, for example, directories and tables that the operating system manages. This makes designing an effective disk cache very challenging.

The hit quota of a disk cache usually lies under 50%. Nevertheless, the increase in performance can be quite high. A cache hit can turn a 17 ms disk access into a 500 ns cache read.

The effectiveness of a disk cache is strongly influenced by the way in which it is configured. The cache fills as read data is copied there. This can happen in parallel to the data transfer so that no loss in performance occurs. When write data is written first into the cache and then onto the disk it is referred to as write-through cache. Here the same potential problems can occur as earlier with the simple memory buffer. If the device waits until the data is written to the medium before responding with GOOD status there is no speed advantage. If GOOD status is returned upon receiving data into the cache, data may be lost. These two features – whether write-through cache is used and when status should be returned – can be controlled using the cache page parameters. A third option is read pre-fetch. Several parameters are used to set how many more blocks than requested should be read into the cache.

The next issue relevant to cache management is determining which blocks should be overwritten when the cache is full. The most simple and most commonly used approach displaces the data that has not been accessed for the longest time. This method can be enhanced by allowing certain areas in the cache to be exempt from being displaced. Additionally, it can be specified that pre-fetch data should be sacrificed first.

Table 13.2 Hard disk commands.

<i>Opcode</i>	<i>Name</i>	<i>Type</i>	<i>Page</i>	<i>ANSI</i>	<i>Description</i>
00h	TEST UNIT READY	M	141	7.2.16	Reflects whether or not the LUN is ready to accept a command
03h	REQUEST SENSE	M	142	7.2.14	Returns detailed error information
04h	FORMAT UNIT	M	168	8.2.1	Format the medium
07h	REASSIGN BLOCKS	O		8.2.10	Defective blocks reassigned
08h	READ(6)	M	165	8.2.5	Read. Limited addressing
0Ah	WRITE(6)	M	165	8.2.5	Write. Limited addressing
0Bh	SEEK(6)	O		8.2.15	Seek to a logical block
12h	INQUIRY	M		7.2.5	Returns LUN specific information
15h	MODE SELECT(6)	M	149	7.2.8	Set device parameters
16h	RESERVE UNIT	M	146	8.2.12	Make LUN accessible only to certain initiators
17h	RELEASE UNIT	M	146	8.2.11	Make LUN accessible to other initiators
18h	COPY	O		7.2.3	Autonomous copy from/to another device
1Ah	MODE SENSE(6)	M	149	7.2.10	Read device specific parameters
1Bh	START STOP UNIT	O		8.2.17	Load/unload medium
1Ch	RECEIVE DIAGNOSTIC RESULTS	O		7.2.13	Read self-test results
1Dh	SEND DIAGNOSTIC	M	147	7.2.1	Initiate self-test
1Eh	PREVENT ALLOW MEDIUM REMOVAL	O		8.2.4	Lock/unlock medium
25h	READ CAPACITY	M		8.2.7	Read number of logical blocks
28h	READ(10)	M	165	8.2.6	Read logical block
2Ah	WRITE(10)	M	165	8.2.6	Write logical block
2Bh	SEEK(10)	O		8.2.15	Seek to a logical block
2Eh	WRITE AND VERIFY	O		8.2.22	Write logical block, verify success
30h	SEARCH DATA HIGH	O		8.2.14	Search logical blocks for data pattern
31h	SEARCH DATA EQUAL	O		8.2.14	Search logical blocks for data pattern
32h	SEARCH DATA LOW	O		8.2.14	Search logical blocks for data pattern
33h	SET LIMITS	O		8.2.16	Define logical block boundaries
34h	PRE-FETCH	O		8.2.3	Read data into buffer
35h	SYNCHRONIZE CACHE	O		8.2.8	Write cache to medium
36h	LOCK UNLOCK CACHE	O		8.2.2	Hold data in cache
37h	READ DEFECT DATA	O		8.2.8	Read list of defective blocks
39h	COMPARE	O		7.2.2	Compare data
3Ah	COPY AND VERIFY	O		7.2.4	Autonomous copy from/to another device, verify success
3Bh	WRITE BUFFER	O		7.2.17	Write the data buffer
3Ch	READ BUFFER	O		7.2.12	Read the data buffer
3Eh	READ LONG	O	166	8.2.9	Read data and ECC
3Fh	WRITE LONG	O	166	8.2.23	Write data and ECC
40h	CHANGE DEFINITION	O	149	7.2.1	Set SCSI version
41h	WRITE SAME	O		8.2.24	Write data pattern
4Ch	LOG SELECT	O		7.2.6	Read statistics
4Dh	LOG SENSE	O		7.2.7	Read statistics
55h	MODE SELECT(10)	O	149	7.2.9	Set device parameters
5Ah	MODE SENSE(10)	O	149	7.2.10	Read device parameters

13.2 Hard disk commands

Table 13.2 shows a list of commands for disk drives. The most important of these are discussed here.

**READ(6) (08h) and
WRITE(6) (0Ah);
READ(10) (28h)
and WRITE(10)
(2Ah)**

The READ command requests a certain number of logical blocks from a target. The WRITE command provides a target with a number of logical blocks to be written to the medium. The structure of these commands is identical (Table 13.3). Each contains the start address and the transfer length expressed in logical blocks.

There is a 6-byte as well as a 10-byte version of both the READ and WRITE commands. The 6-byte version stems from SCSI's predecessor SASI. It has the disadvantage that only 21 bits are provided for the logical block address. Assuming a block length of 512 bytes, this allows a little more than a gigabyte to be addressed. For many modern drives this is simply not adequate.

It hard to believe but at one time host adapters used 6-byte READ and WRITE commands exclusively. At the same time these adapters were capable of recognizing the full capacity of drives of more than a gigabyte. When a block above the magical 21-bit boundary was be addressed, the host adapter would

Table 13.3 READ and WRITE commands.

	7	6	5	4	3	2	1	0
0	READ(6) (08h) or WRITE(6) (0Ah)							
1	LUN			(MSB) Logical block				
2	Logical block (LSB)							
3								
4	Transfer length							
5	Control byte							

	7	6	5	4	3	2	1	0
0	READ(10) (28h) or WRITE(10) (2Ah)							
1	LUN		DPO	FUA	Res.	Rel		
2	(MSB) Logical block							
3								
4								
5								
6	Reserved							
7	(MSB) Transfer length							(LSB)
8								
9	Control byte							

simply ignore the uppermost bits. Of course, this would address and write the wrong logical block on the drive. You can imagine what happened. An operating system would gradually fill a drive starting with the lowermost logical blocks. The system would operate normally until the 21-bit address was reached, at which time logical block 0 would be overwritten. This mistake would wipe out the boot block, the internal medium tables, and the directories (in this order). The drive would mysteriously become unusable without even a hardware error having been detected. For this reason it is highly recommended to avoid the 6-byte READ and WRITE commands, and if you ever find yourself the victim of unexplainable data corruption be sure to investigate whether or not the 6-byte demon is to blame.

Other than the start address and transfer length, the 6-byte versions have no parameters. As with all block oriented 6-byte commands, a transfer length of zero actually means that 256 are requested. In contrast, zero transfer length means just that for the 10-byte commands and no data is sent. In the 10-byte version there are a number of additional control bits:

- DPO (disable page output): This bit helps the target to manage the cache. If it is set, it tells the target that the host does not intend to read the data again in the near future. The target may decide not to keep this data in the cache.
- FUA (force unit access): When this bit is set the target is forced to read the data from the medium even if it resides in the cache. If the cache contains a newer version of the data then it must first be written to the medium and then re-read. In the case of a WRITE command the target must wait until the data is on the medium before responding with GOOD status. This affects drives with cache as well as with buffer memory.
- Rel (relative addressing): This bit, which is valid only in conjunction with linked commands, causes the start address to be interpreted as an offset to the start address of the last command.

READ LONG (3Eh) and WRITE LONG (3Fh)

The most important variants to the READ and WRITE commands are READ LONG and WRITE LONG. Both are 10-byte commands, which operate not only on the user data but also on the ECC. Moreover, these commands operate on strictly one block at a time (Figure 13.3). The transfer length is interpreted as the number of bytes to transfer. Byte 1, bit 1 of a READ LONG command is the COOR control bit. Only if COOR is set will data correction be performed in the event of a read error. Otherwise the data will be transferred just as it comes from the medium.

The type of encoding used to write data onto the medium as well as the ECC polynomial is vendor specific. However, the ECC polynomial must be known if we wish to write a valid ECC along with the data. Unfortunately, this makes it necessary to know device specific information when using READ LONG or WRITE LONG, which is at odds with the vendor independent philosophy of SCSI.

A very practical application of these commands is in the testing of a system's response to a data error. To accomplish this the drive is first connected to a PC running the SCSI monitor and a logical block is read using READ LONG. After modifying a few bytes the data is written back to the drive using WRITE LONG.

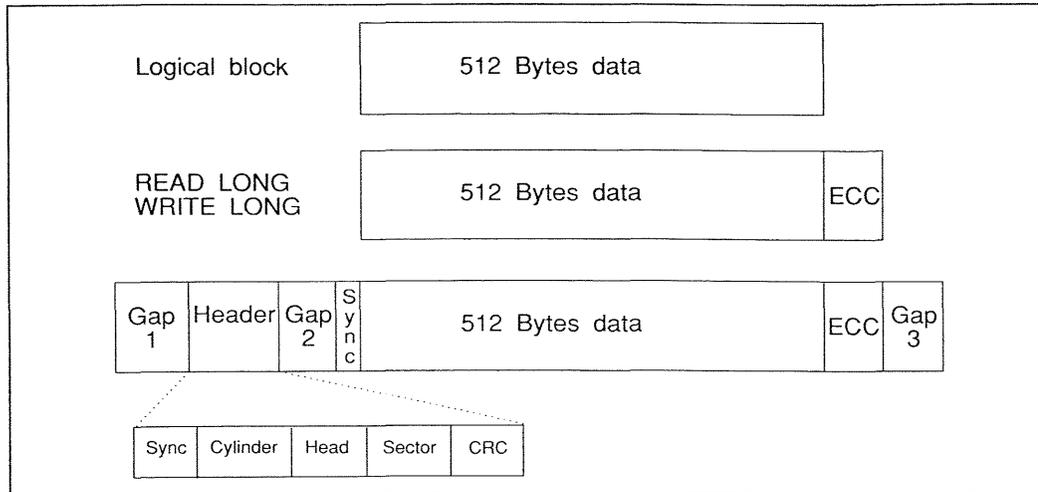

Figure 13.3 Physical layout of a logical block.

Now in the system, the first access to this block will result in an ECC error. With a little practice it is possible to produce correctable as well as uncorrectable data errors.

Other variants of READ and WRITE

Two additional commands remain to be mentioned: WRITE AND VERIFY writes data to the medium and then reads it back while comparing it to the original data. The data is only transferred once across the SCSI bus. Another way to insure absolute data integrity from host memory to the medium is to link together a standard READ and WRITE command and then compare the data in host memory. Finally, the command WRITE SAME allows one to write the same block several times to the medium.

READ CAPACITY

Also mandatory for disk drives is the command READ CAPACITY (Table 13.4). It has the standard structure of 10-byte commands and returns eight bytes of information: four bytes reflect the last LBN of the drive while the remaining four reflect the block length.

The PMI (partial medium indicator) control bit, byte 8, bit 0, plays an important role. When clear, the command returns the LBN of the last logical block of the medium as described above. In this case the block number in the command block must be zero.

When PMI is set the command returns something completely different. Now the LBN in the command is interpreted and the target returns the next LBN, after which a noticeable delay in access will occur. Delays in access occur, for example, at cylinder boundaries. Using this command the operating system can determine whether a certain area of frequently accessed storage is ideally located.

Table 13.4 The READ CAPACITY command.

	7	6	5	4	3	2	1	0
0	READ CAPACITY (25h)							
1	LUN			Reserved			Rel	
2	(MSB)							
3	Logical block							
4								
5								
6	Reserved							
7								
8								PMI
9	Control byte							

**FORMAT UNIT
(04h)**

The FORMAT UNIT command instructs the target to format the medium of a specific LUN (Table 13.5). In its simplest form no parameters are sent and the target formats using default settings. The actual formatting procedure has two phases. First the physical medium is formatted, meaning that each sector is written with header, data, and ECC information. Afterwards, the mapping from physical blocks to logical blocks takes place. Finally, during a second pass over the medium defective blocks are reallocated; that is, replaced with reserve blocks. The target will also accept a list of additional medium defects to be reallocated in a parameter block. Since format parameters are set using the MODE SELECT command it is imperative to first use MODE SELECT then the FORMAT command. Only in this way will the drive configuration reflect the desired mode parameters (see Figure 13.4)

The following parameters are contained in the command itself:

- **Fmt (format data):** This bit must be set when a parameter list follows the FORMAT UNIT command.
- **Cmpl (complete):** This bit may only be set when Fmt is set. It indicates that the defect list in the parameter list is exhaustive. All defect lists except the PList are deleted and newly constructed.

Table 13.5 The FORMAT UNIT command.

	7	6	5	4	3	2	1	0
0	FORMAT UNIT (04h)							
1	LUN			Fmt	Cmpl	Defect list format		
2	Vendor specific							
3	(MSB)							
4	Interleave							
5								
5	Control byte							

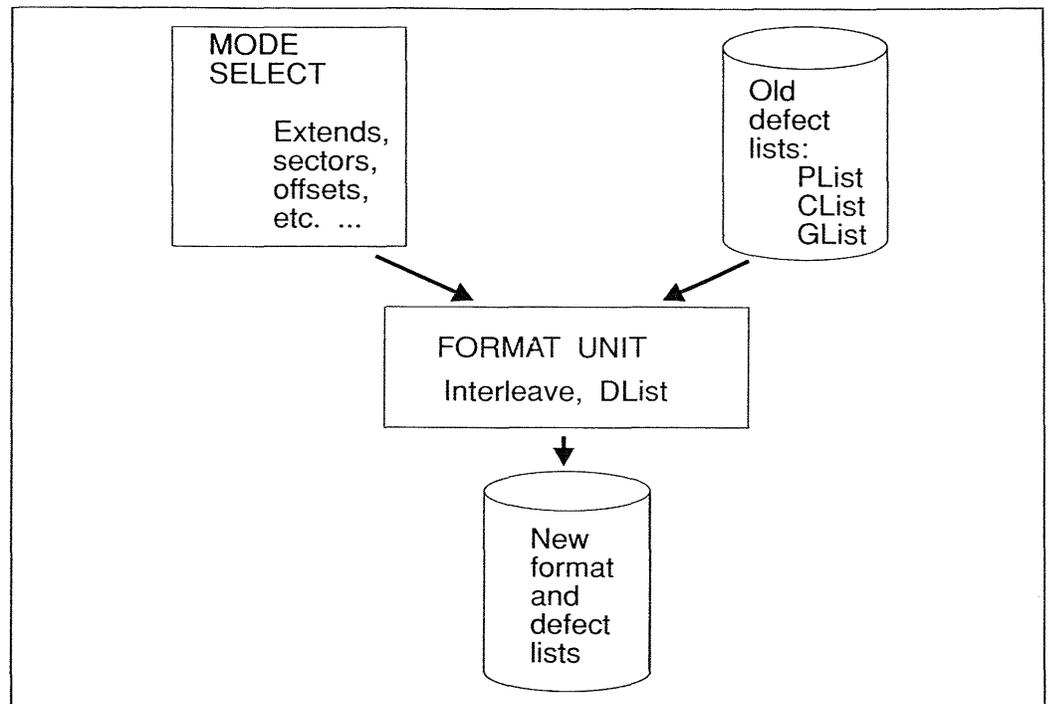

Figure 13.4 Influences on formatting.

- Defect list format: This field indicates one of three defect list formats: block format (000b), index format (100b), or sector format (101b). Only one format type is allowed in a single parameter list. The formats are described in detail later in this section under the heading 'Defect Descriptors'.
- Interleave: The term 'interleave' is explained in Chapter 2. This field indicates the interleave that should be employed. A value of 00h means that the target should use its default values. To assure a one-to-one interleave a value of 01h must be used.

Parameter lists

Figure 13.5 describes by way of example the structure of the `FORMAT UNIT` parameter list. Bytes 0 to 3 contain the header. Next comes the optional initialization pattern descriptor. This has a variable length, which in this example spans from byte 4 to byte 8. This is followed by optional defect descriptors. Thus, a parameter list is necessary when sending either an initialization pattern or defect lists with the `FORMAT` command. Any other pertinent format information is found in the `MODE` parameter pages, especially the format page.

In addition to the control bits in byte 1, the header of the parameter list contains the length of the defect lists in bytes 2 and 3. This length may be zero. The number of defects can be inferred from the list length together with the list format in byte 1 of the command itself. A description of the control bits follows:

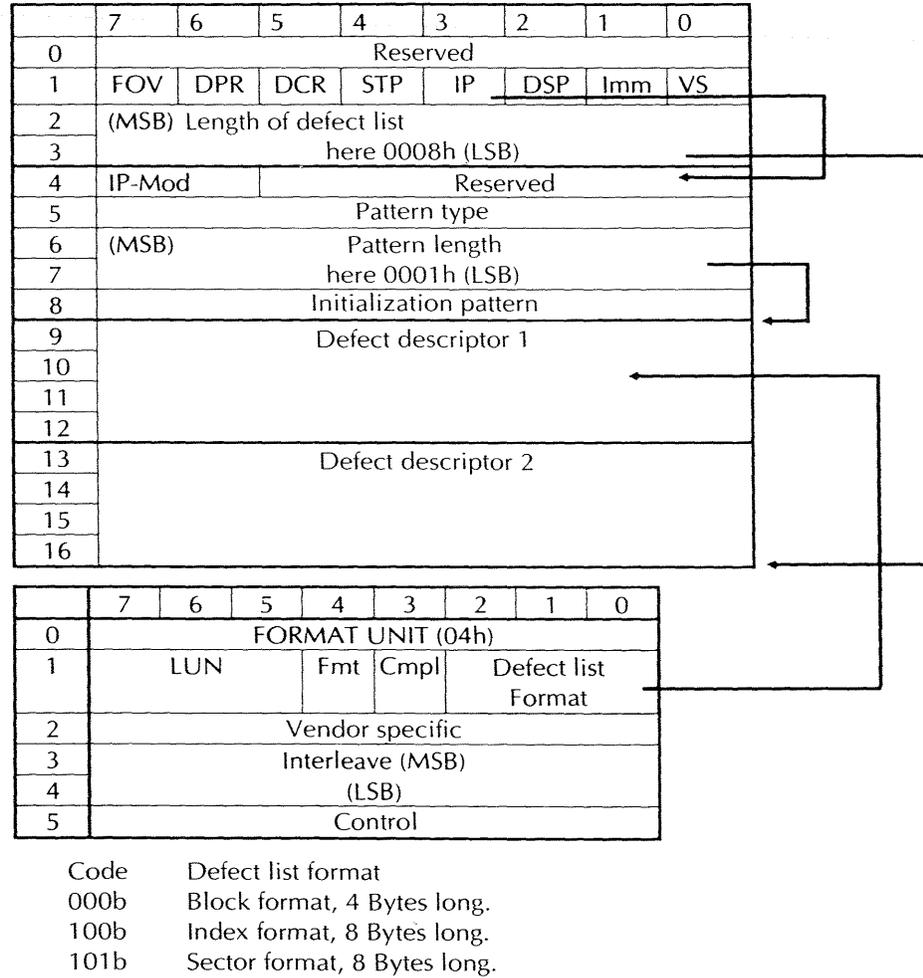

Figure 13.5 Format Unit with parameter list.

- FOV (format option valid): Only when this bit is set are the bits DPR, DCR, STP, IP and DSP valid. Otherwise, these bits must be set to zero and the target will use its default values.
- DPR (disable primary): When this bit is set a PList will not be transferred to the target. The PList constructed by the manufacturer, however, remains intact.
- STP (stop format): This bit controls what should happen when the target does, in fact, accept a PList or GList to use in formatting, but the list cannot be found or read. In both cases the command terminates with CHECK CONDITION status. When STP is set, the target will abort formatting and prepare the sense key MEDIUM ERROR. Otherwise, the formatting will take place and the sense key RECOVERED ERROR will be available.
- IP (initialization pattern): When set this bit indicates that the parameter list contains a descriptor for the initialization pattern.

- DSP(disable saving parameters): Normally all mode parameters are saved during the formatting process. This action is inhibited when DSP is set.
- Imm (immediate): The setting of this bit causes status to be returned as soon as the parameter list has been received. Otherwise the status is sent after completion of the task as usual.
- VS: (vendor specific)

If IP is set then an initialization pattern descriptor follows the parameter list header. The initialization pattern is a sequence of bytes that are written as data to each block of the drive.

- IP-Mod: These control bits allow the target to modify a portion of the initialization pattern for each block. 01b means that the first four bytes of every logical block should contain the logical block number. 10b means that each physical block should contain the logical block number. 00b leaves the initialization pattern unchanged. 11b is reserved.
- Pattern type: Here 00h means that the target should use its default pattern. In this case the pattern length must also be zero or a CHECK CONDITION will result. A value of 01h causes the supplied pattern to be used. The remaining values are reserved or vendor specific.
- Pattern length: Indicates the length of the initialization pattern.
- Initialization pattern: This pattern is written to each logical block during the formatting process. The pattern is repeated until the block is filled.

The rest of the parameter block is comprised of the defect descriptors. The defect descriptors that are used with `FORMAT UNIT` as well as other commands receive special attention in their own section.

In conclusion, consider again the example in Figure 13.5. An arrow points from the IP bit to the beginning of the initialization pattern descriptor because only when this bit is set will the descriptor follow. The pattern length contains the pointer, which points to the end of the descriptor. The defect list length together with the pattern length points to the end of the entire parameter list. In the defect list format field of the `FORMAT UNIT` command is the value 000b, indicating 4-byte long defect descriptors.

Defect descriptors

Defect descriptors are used by the commands `FORMAT UNIT`, `READ DEFECT DATA`, `SEND DIAGNOSTIC` and `RECEIVE DIAGNOSTIC RESULTS`. The various formats are selected using a 3-bit code.

Block format (000b)

The four bytes of the descriptor contain the LBN of the block in which the defect is located (Table 13.6). When using the block format the list must be constructed in ascending order. An LBN may correspond to more than one sector.

Table 13.6 Defect descriptor in block format.

0	(MSB)	Block number of defective block	(LSB)
1			
2			
3			

**Index format
(100b)**

The index pulse indicates the beginning of every track on the disk. The first four bytes of the index format contain the cylinder and head number of the defect (Table 13.7). The remaining four bytes contain the defect position measured in bytes from the index. If FFFFFFFFh is given here the entire track should be regarded as defective. For drives that support variable sector lengths, only the index format may be used for the manufacturer's defect list (PList).

Note that numbers such as FFFFFFFFh are often referred to as -1, which corresponds to their signed integer interpretation. Although this is easier to pronounce, the width of the number is no longer apparent.

Table 13.7 Defect descriptor in index format.

0	(MSB)	Cylinder number of defective block	(LSB)
1			
2			
3		Head number	
4	(MSB)	Position of defect as bytes after index	(LSB)
5			
6			
7			

**Sector format
(101b)**

The sector format is in structure exactly like the index format except that bytes 4 through 7 contain the sector number of the defect. Here too a sector number of FFFFFFFFh indicates that the entire track is defective (Table 13.8).

**Commands for
cache
management**

In addition to the commands that implicitly modify the cache, there are a number of SCSI-2 commands that configure the cache directly.

The command LOCK UNLOCK CACHE allows certain regions in the cache to be locked. Locked blocks will not be overwritten by other data. The command is structured like a READ(10) command. Byte 1, bit 1 is the lock bit. When set, a region is locked; otherwise it is freed. Only those regions that are in the cache at the time of the command are affected. The command PRE-FETCH is also structured like READ(10). It instructs the target to read the specified blocks from the medium into the cache. No transfer across the SCSI bus takes place.

Table 13.8 Defect descriptor in sector format.

0	(MSB)	Cylinder number	
1		of defective block	
2			(LSB)
3		Head number	
4	(MSB)	Defective sector	
5			
6			
7			(LSB)

Finally, SYNCHRONIZE CACHE causes the target to write the specified region of the cache to the medium. This makes sense when a target has been allowed to respond to WRITE commands immediately with GOOD status before actually writing the medium.

13.3 Mode parameter pages for disk drives

The following mode parameter pages are defined for disk drives (Table 13.9):

Table 13.9 Mode parameter pages for disk drives.

<i>Page code</i>	<i>Name</i>	<i>Page</i>	<i>ANSI</i>
01h	Read/write error page		8.3.3.6
02h	Disconnect/reconnect page	155	7.3.3.2
03h	Format page	173	8.3.3.3
04h	Disk drive geometry page	176	8.3.3.7
05h	Floppy disk page		8.3.3.2
07h	Verify error page		8.3.3.8
08h	Cache page	177	8.3.3.1
09h	Peripheral device page	156	7.3.3.3
0Ah	Control mode page	157	7.3.3.1
0Bh	Medium type page		8.3.3.4
0Ch	Notch page	178	8.3.3.5

Format page (03h)

The format page contains the information necessary to format the medium (Table 13.10). In particular it contains information concerning replacement sectors and tracks. The terms interleave, track skew and cylinder skew were already covered in Chapter 2.

A new term is introduced here, however, which has special meaning in the SCSI world. With respect to SCSI, a zone refers to a group of tracks to which a certain number of replacement sectors or tracks are allocated.

Table 13.10 Format page.

	7	6	5	4	3	2	1	0
0	PS	Res	Format page (03h)					
1	Page length (16h)							
2	(MSB)		Tracks per zone					(LSB)
3								
4	(MSB)		Replacement sectors					(LSB)
5	per zone							
6	(MSB)		Replacement tracks					(LSB)
7	per zone							
8	(MSB)		Replacement tracks					(LSB)
9	per LUN							
10	(MSB)		Sectors					(LSB)
11	per track							
12	(MSB)		Data bytes					(LSB)
13	per sector							
14	(MSB)		Interleave					(LSB)
15								
16	(MSB)		Track skew					(LSB)
17								
18	(MSB)		Cylinder skew					(LSB)
19								
20	SSEC	HSEC	RMB	SURF	Reserved			
21	Reserved							
22								
23								

Outside the world of SCSI the term zone is often used in the context of zone-bit recording. Zone-bit recording refers to a recording technique whereby the outer cylinders are written with a higher bit density, and therefore more sectors, than the inner cylinders. In SCSI the regions with a constant number of sectors are called notches. It is unfortunate that the terminology is inconsistent here.

A look at the format page reveals that many values vary with each notch. It is possible for a target to define some or all mode parameter pages separately for each notch. A special notch page contains the number of active notches influenced by the MODE commands:

- Tracks per zone: The entire medium is divided into zones consisting of this number of tracks per zone. The last zone may have fewer tracks. A value of zero treats the entire medium as a single zone.
- Replacement sectors per zone: A zero instructs the target to use its default value. However, a notch page, if implemented, can be used to achieve zero sectors per zone.
- Replacement tracks per zone: Alternate tracks make it possible to replace an entire track that contains many defects. A value of zero is interpreted as such in this field.
- Replacement tracks per LUN: Corresponds to the above fields with respect to a LUN.
- Sectors per track: This is the number of physical sectors including alternates per track.
- Bytes per sector: This is the number of data bytes per physical sector. This is not necessarily equal to the number of bytes per logical block.
- Interleave: This field is only valid for *MODE SENSE*. It reflects the value defined by *FORMAT UNIT*.
- Track skew: Specifies the number of physical sectors between the last logical block of one track and the next logical block of the next track (see also Chapter 2).
- Cylinder skew: Specifies the number of physical sectors between the last logical block of one cylinder and the next logical block of the next cylinder (see also Chapter 2).
- SSEC (soft sector): Specifies that the drive should use soft sectoring.
- HESC (hard sector): Specifies that the drive should use hard sectoring.

The target must support either hard or soft sectoring or both.

- *RMB* (removable): The target uses removable medium. This must reflect the information returned by the *INQUIRY* command.
- *SURF* (surface): When this bit is zero logical blocks are allocated progressively to the sectors of a cylinder before those of the next cylinder. When *SURF* is set logical blocks are allocated progressively to the sectors of a surface before those of the next surface. Most hard disks have this bit clear; most diskette drives have it set.

It is obvious that alternate sectors reduce the space available for user data. If too many alternate sectors are allocated then storage is sacrificed unnecessarily. On the other hand, the medium is unusable as soon as all alternate sectors have been exhausted. The answer is to find a compromise somewhere in between these two extremes.

In practice this is achieved in the following way: for simplicity, assume a medium with constant geometry; that is, without notches. A zone is defined as

being a single track. For each zone one alternate sector is allocated. When necessary this alternate can be read with almost no delay. If additional sectors of the track are defective the entire track is reallocated. An alternate cylinder should be set aside for every 200 cylinders. This rule of thumb allocates between 3 and 5% of the drive capacity to replacement sectors.

Disk drive geometry page (04h)

Hard disks and diskettes use different geometry pages. In this book, however, only the hard disk geometry page is discussed. This page pertains to hard drives with removable medium as well. With the exception of spindle synchronization, the parameters deal strictly with fixed geometry information (Table 13.11). Changeable parameters such as the number of sectors and sector length

Table 13.11 Mode commands: geometry page.

	7	6	5	4	3	2	1	0
0	PS	Res	Geometry page (04h)					
1	Page length (16h)							
2	(MSB)							
3	Number of cylinders							
4	(LSB)							
5	Number of heads							
6	(MSB)							
7	Start cylinder							
8	for write precompensation (LSB)							
9	(MSB)							
10	Start cylinder							
11	for reduced write current (LSB)							
12	(MSB)							
13	Step rate (LSB)							
14	(MSB)							
15	Cylinder number							
16	of landing zone (LSB)							
17	Reserved							
18	Rotational offset							
19	Reserved							
20	(MSB)							
21	Medium rotation rate (LSB)							
22	Reserved							
23	Reserved							

belong to the format page. For most fields, the relevant background terminology is explained in Chapter 2.

The rotational position locking field is used to synchronize the spindles of two or more individual disk drives. Synchronization makes it possible to read and write blocks from different drives at precisely the same time without latency delays by ensuring that these blocks rotate underneath the heads of their respective drives in unison. The drives must not only have the same rotational speed but must also synchronize the relative positions of the heads with respect to the medium. This is accomplished by declaring one drive the master and the remaining drives slaves, which govern their speed relative to the master. Here additional signals are needed that are not provided by the SCSI bus. Spindle synchronization is employed in RAID arrays, which achieve very high throughput by accessing drives in parallel while eliminating latency delays.

- RPL (rotational position locking): 00b disables synchronization; 01b instructs the drive to act as a slave, and 10b as a master.
- Rotational offset: This byte reflects the amount of rotational offset a slave will have to its master measured in 1/256th of a rotation. This allows a staggering of the individual disks.

The cache page (08h)

Table 13.12 shows the cache parameter page for the MODE commands:

- WCE (write cache enable): When set the target replies with a GOOD status as soon as all of the data has been received into the cache. Otherwise this status may not be returned until the data has been successfully written to the medium. Be aware that when WCE is set the target decides when to write the data to the medium. There may be a substantial delay here if a large number of

Table 13.12 Mode parameter cache page

	7	6	5	4	3	2	1	0
0	PS	Res	Cache page (08h)					
1	Page length (0Ah)							
2	Reserved				WCE	MF	RCD	
3	Read retention priority				Write retention priority			
4	(MSB)	Disable pre-fetch						
5	transfer length						(LSB)	
6	(MSB)	Pre-fetch minimum						
7							(LSB)	
8	(MSB)	Pre-fetch maximum						
9							(LSB)	
10	(MSB)	Absolute pre-fetch maximum						
11							(LSB)	

I/O processes must be processed. The command SYNCHRONIZE CACHE forces all cache data yet to be secured to be written to the medium.

- MF (multiplication factor): Normally the values for pre-fetch maximum and minimum reflect a certain number of blocks. However, when MF is set these values represent scalars which are to be multiplied with the transfer length to obtain their meaning.
- RCD (read cache disable): Causes the medium to be read even if the data resides in the cache.
- Read retention priority and write retention priority: Specify with what priority the data either read or written into the cache is to be maintained. The priority given is with respect to data resulting from pre-fetch operations. 0h means that all data should be treated equally; 1h gives the data a lower priority than pre-fetch data; Fh gives the data higher priority than pre-fetch data.
- Disable pre-fetch transfer length: This field specifies the maximal transfer length for which a pre-fetch should occur. Zero disables pre-fetch.
- Pre-fetch minimum: This field specifies the minimum number of blocks that should be pre-fetched regardless of whether other commands are impeded.
- Pre-fetch maximum: This field specifies the maximum number of blocks that should be pre-fetched.

The interpretation of the above two fields is independent of the MF bit. If both values are equal pre-fetch will occur regardless of other pending commands. If there is a difference between minimum and maximum, a pre-fetch will be broken off inside this interval if otherwise another command would be delayed.

- Absolute pre-fetch maximum: This field only has meaning when MF is set. It limits the pre-fetch length resulting from the multiplication factor.

Notch page (0Ch)

The notch page describes the regions of the disk with a constant number of sectors per track (so-called notches). This optional page does not even have to be implemented for drives that do, in fact, contain regions of varying number of sectors (Table 13.13). If notch pages are implemented then each notch will have its own page (Figure 13.6).

- ND (notched drive): Only when this bit is set is the notch page valid. Otherwise the drive has no notches and the rest of the page is empty.
- LPN (logical or physical notch): When set this bit indicates that the boundaries of the active notches are expressed as logical blocks. Otherwise they are expressed as physical addresses. Here the three most significant bytes hold the cylinder number and the lowest byte the head number.
- Active notch: This field contains the number of the notch to which this page and other MODE SELECT pages refer. This number is valid until it is changed by MODE SELECT. A zero means that subsequent mode commands pertain to those parameters that apply across all notches.

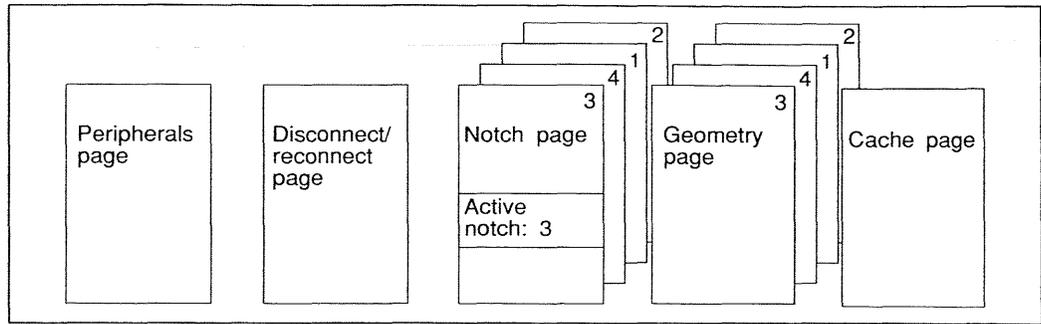

Figure 13.6 Mode parameter pages with notches.

Table 13.13 Mode commands: notch page.

	7	6	5	4	3	2	1	0		
0	PS	Res	Notch page (0Ch)							
1	Page length (16h)									
2	ND	LPN	Reserved							
3	Reserved									
4	(MSB)		Maximum number							
5			of notches				(LSB)			
6	(MSB)		Active notch							
7							(LSB)			
8	(MSB)		Beginning of active notch							
9										
10										
11									(LSB)	
12	(MSB)		End of active notch							
13										
14										
15									(LSB)	
16	3Fh	3Eh	3Dh	...						
...	Mode page									
...	with notches									
23	...		04h	03h	02h	01h	00h			

- Mode pages with notches: This field is 8 bytes long or a total of 64 bits. Each bit represents one of the MODE pages from 00h to 3Fh. The most significant bit corresponds to page 3Fh, the least significant to page 00h. A set bit means that the corresponding MODE page contains parameters that may be different for different notches. A zero means that the page applies to all notches.

14 Tape drives

14.1 The model of a SCSI tape drive

SCSI tape drives belong to the sequential access device class of the ANSI standard. I am not aware of any devices other than tape drives belonging to this class.

The data in a sequential access device is organized on the medium as a linear sequence of blocks. In order to access the data of a certain block the medium must be moved from the current position through all intervening positions to the desired block. It is easy to see that this is precisely the situation described by a tape drive.

The drive The SCSI model of a tape drive differentiates between the drive itself and the exchangeable medium. The drive is either in ready condition or not ready. The drive is in ready condition when it is able to execute all possible commands. For example, the drive is not ready when no medium is present or when an online switch is de-activated.

The drive can also find itself in the write protected state. Although the write protection mechanism is usually implemented on the removable medium, many drives have a write protection switch as well.

The recording medium The recording medium for sequential devices consists of a tape of various widths and lengths coated with magnetic material. This tape may be wound onto single reels or packaged in a cartridge or cassette format. When the medium is loaded in the device and data access is possible the medium is said to be mounted. During loading and unloading the medium is demounted. This terminology corresponds to that of replaceable medium drives.

The usable length of a tape has a beginning and end, which are marked BOM (beginning of medium) and EOM (end of medium), respectively. These do not necessarily correspond to the physical ends of the tape. The length beyond these marks is used to secure the tape to the reels.

Many recording formats include an additional EW (early warning) marking. This mark is placed at a position prior to the EOM mark. It allows the target enough time to warn the initiator of the end of the tape and write any data

that may already be in its buffer. The SCSI tape drive commands are listed in Table 14.1.

Recording formats

The range of recording formats for magnetic tape is almost endless (Figure 14.1). Fortunately, it is of little consequence for the discussion of SCSI tape drives

Table 14.1 SCSI tape drive commands.

<i>Opcode</i>	<i>Name</i>	<i>Type</i>	<i>Page</i>	<i>ANSI</i>	<i>Description</i>
00h	TEST UNIT READY	M	141	7.2.16	Reflects whether or not the LUN is ready to accept a command
01h	REWIND	M	184	9.2.11	Rewinds tape
03h	REQUEST SENSE	M	142	7.2.14	Returns detailed error information
05h	READ BLOCK LIMITS	M	188	9.2.5	Returns possible block lengths
08h	READ	M	185	9.2.4	Read
0Ah	WRITE	M	185	9.2.14	Write
0Fh	READ REVERSE	O		9.2.7	Read backwards
10h	WRITE FILEMARKS	M	187	9.2.15	Write filemarks
11h	SPACE	M	186	9.2.12	Advance tape
12h	INQUIRY	M		7.2.5	Returns LUN specific information
13h	VERIFY	O		9.2.13	Verify data
14h	RECOVER BUFFERED DATA	O		9.2.8	Recover data from buffer
15h	MODE SELECT(6)	M	149	7.2.8	Set device parameters
16h	RESERVE UNIT	M	146	9.2.10	Make LUN accessible only to certain initiators
17h	RELEASE UNIT	M	146	9.2.9	Make LUN accessible to other initiators
18h	COPY	O		7.2.3	Autonomous copy from/to another device
19h	ERASE	M	187	9.2.1	Erase tape
1Ah	MODE SENSE(6)	M	149	7.2.10	Read device parameters
1Bh	LOAD UNLOAD	O	189	9.2.2	Load/unload medium
1Ch	RECEIVE DIAGNOSTIC RESULTS	O		7.2.13	Read self-test results
1Dh	SEND DIAGNOSTIC	M	147	7.2.1	Initiate self-test
1Eh	PREVENT ALLOW MEDIUM REMOVAL	O		8.2.4	Lock/unlock door
2Bh	LOCATE	O	188	9.2.3	Seek LBN
34h	READ POSITION	O		9.2.6	Read current tape position
39h	COMPARE	O		7.2.2	Compare data
3Ah	COPY AND VERIFY	O		7.2.4	Autonomous copy from/to another device, verify success
3Bh	WRITE BUFFER	O		7.2.17	Write the data buffer
3Ch	READ BUFFER	O		7.2.12	Read the data buffer
40h	CHANGE DEFINITION	O	149	7.2.1	Set SCSI version
4Ch	LOG SELECT	O		7.2.6	Read statistics
4Dh	LOG SENSE	O		7.2.7	Read statistics
55h	MODE SELECT(10)	O		7.2.9	Set device parameters
5Ah	MODE SENSE(10)	O		7.2.10	Read device parameters

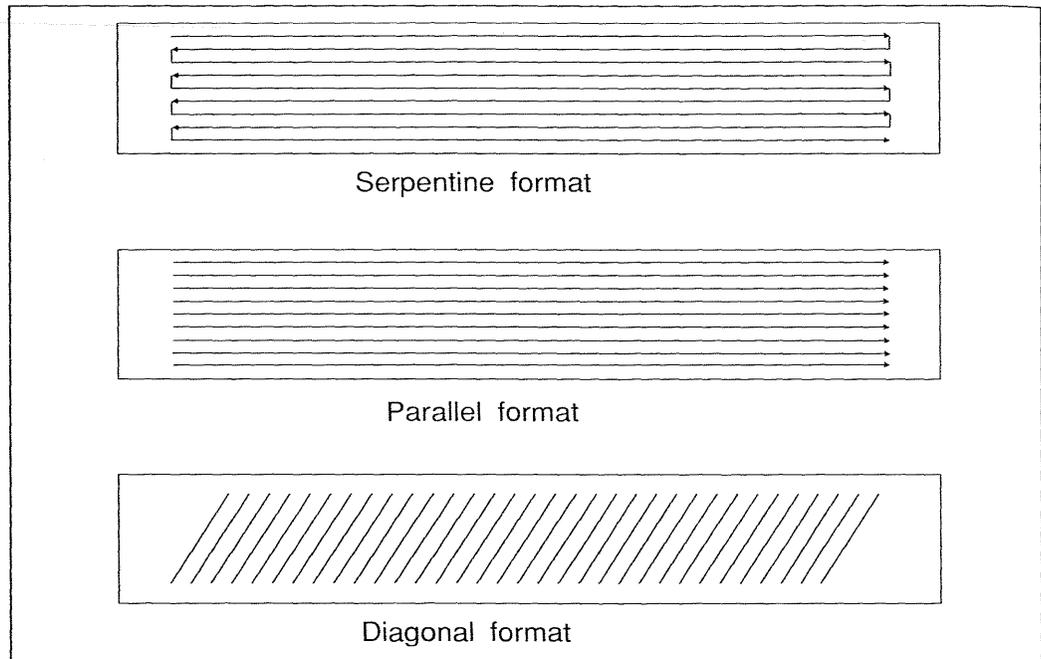

Figure 14.1 Various tape recording formats.

which format is used on the medium itself. The format is strictly a matter of concern for the drive, not the SCSI controller. When a drive is compatible with a number of different formats, the `MODE SELECT` command is used to choose among them.

Nevertheless, as background information three basic recording formats are mentioned here. The first of these is parallel storage format. Here multiple tracks are recorded simultaneously in the same direction. This is the method traditional reel-to-reel devices employ, using nine tracks, eight data and parity, on $\frac{1}{2}$ inch wide tape. The parallel recording technique leads to a relatively high throughput at moderate tape speeds. Common specifications are 6250 bits per inch (BPI) at 125 inches per second (IPS). These values multiplied together yield a data throughput of 780 Kbytes per second. The disadvantage of this method is the necessity of a relatively complex and therefore expensive read/write head.

The second technique uses a simple read/write head and only a single track. The data are written and read serially. When one end of the tape is reached the head is moved slightly so that the track can be continued in the opposite direction. This is repeated until the result is a serpentine track running back and forth across the tape. This method is used mainly in cassette devices following the QIC standard.

The helical scan technique originally came from video cassette recording. Here a rotating head is used to write short diagonal tracks across the width of a relatively slow moving tape. This method is used by the EXABYTE drive and is also similar to the technique used in some 4 mm DAT drives.

Many recording formats use preformatted media. These methods make possible the use of physical blocks in organizing data. The physical block

structure, which is largely hidden from the SCSI interface, can be accessed directly using the LOCATE command.

- Partitions** A tape can be divided into one or more partitions. Partition 0, which always exists, is called the default partition. Every partition has its own identification for beginning, end, and EW, and they are called BOP_x, EOP_x and EW_x, where *x* stands for the number of the partition. Commands for tape devices always pertain to the active partition. The active partition can be changed using either the device configuration page of MODE SELECT or the LOCATE command.
- Objects within a partition** Within a partition data blocks and tape marks are used to segment the medium. These are organized hierarchically, with data blocks at the lowest level followed by filemarks and at the highest level setmarks.
- The EOD (end of data) mark is special in that its implementation is dependent on the type of recording format. In general, this mark is generated when a certain length of unwritten tape has gone past the read head.
- Data blocks** To an initiator a tape, like a disk drive, looks like a sequence of logical blocks, and as with a disk drive logical blocks may or may not correspond one-to-one with physical blocks on the tape. The blocks themselves are either fixed or of variable size up to 16 Mbytes. This is more than adequate. Extremely long blocks should be avoided since a block must be read and written as a single unit without interruption.
- Tape marks** A tape drive may also employ the use of tape marks among the logical blocks holding user data. Tape marks make it possible to locate specific places on the tape without having to read the intervening data. Moreover, tape marks can be identified on higher tape speeds than are used to read actual data. This further decreases the access time. There are two types of tape mark: the filemark and the setmark. Setmarks represent the higher level division of a partition, filemarks the lower level.
- Buffered and unbuffered modes** The role of data buffers with respect to disk I/O was covered earlier in this book. Such a buffer is realized as onboard RAM and its contents are volatile. The buffer is used to store data temporarily before it is written to the medium or passed on to the initiator, as the case may be.
- SCSI tape devices support both buffered and unbuffered modes of operation. The modes relate to the way in which write operations are performed; that is, all commands that write either data blocks or tape marks. In addition, some commands include an Immed (immediate) control bit which overrides the mode for a given command.
- Tape devices without a data buffer always operate in the unbuffered mode. In this mode any write operation will conclude with a status phase only

after a write to the medium has occurred. However, when *Immed* is set, commands that do not write to the medium (like, for instance, *REWIND*) are allowed to return *GOOD* status immediately after the command is received.

Tape devices with a data buffer can be configured to operate in either mode. This configuration is accomplished using the appropriate parameter page of the *MODE SELECT* command.

The data buffer of a SCSI tape device may hold tape marks as well as data. In the buffered mode a tape device is allowed to return *GOOD* status as soon as write data has been received into the buffer. Commands with the *Immed* bit set are allowed to respond in the same manner. When *Immed* is clear this forces a command to be executed in the unbuffered mode.

14.2 Commands for tape devices

Tape device commands differ greatly from those of disk drives in many respects but this is especially so with regard to *READ* and *WRITE* commands and their derivatives. These commands do not make use of logical block numbers but only a transfer length. A command begins its reading or writing at the current position of the tape.

REWIND (01h) The *REWIND* command causes the target to position the medium to the beginning of the active partition (Table 14.2). However, before doing so the target must write to the medium all data, filemarks, and setmarks that may reside in the buffer.

The only parameter is the *Immed* bit in byte 1. When set the target will return status after any buffered data has been written to the medium but before command execution has begun. When clear status will be returned only after the medium has been fully rewound.

SCSI-1 compatible devices do not necessarily write buffered data to the medium before the execution of this command. In order to make SCSI-2 and SCSI-1 devices compatible one can make use of the *WRITE FILEMARKS* command with the *Immed* bit set before issuing a *REWIND* command.

Table 14.2 The *REWIND* command.

	7	6	5	4	3	2	1	0
0	REWIND (01h)							
1	LUN			Reserved				Immed
2	Reserved							
3								
4								
5	Control byte							

Table 14.3 The READ command for tape drives.

	7	6	5	4	3	2	1	0
0	READ (08h)							
1	LUN			Reserved			SILI	Fixed
2	(MSB) Transfer length (LSB)							
3								
4								
5	Control byte							

READ (08h) The READ command is structured differently to the disk drive version (Table 14.3). There is no field for the logical block number since the tape READ command always begins with the next logical block. The next block is the first block reached as the tape moves toward the EOP mark. Lacking the LBN field, the 6-byte version has ample room for the transfer length, making a 10- or 12-byte version of this command unnecessary.

In addition to the LUN number byte 1 contains two further parameters. The Fixed bit indicates whether fixed or variable length blocks are expected. This also defines how the transfer length is to be interpreted.

The SILI (suppress incorrect length indicator) bit specifies how the target should react when a logical block is read with an unexpected length. When the SILI bit is clear the target will abort any command leading to length error with a CHECK CONDITION status. Otherwise, such length errors will be more or less tolerated.

Bytes 2 to 4 contain the transfer length. When the Fixed bit is set then the transfer length reflects the number of blocks of fixed length to be read. The fixed block length can be read using MODE SELECT. If Fixed is clear then a block of variable length will be read and the transfer length indicates how much space the initiator has reserved for the data. The 24-bit transfer length is sufficient for block lengths up to 16 Mbytes, which should be adequate for years to come. When the transfer length is zero the tape will not be moved, nor will data be transferred.

If a tape mark is found during the reading of a block a CHECK CONDITION status will be returned. The precise behavior in such a case can be modified using the mode parameters.

WRITE (0Ah) The WRITE command is analogous to the READ command and functions analogously as well (Table 14.4). Byte 1 contains the LUN number and Fixed bit with the same interpretation they have with the READ command.

The WRITE command is executed in either the buffered or unbuffered mode depending on how the MODE SELECT parameters have been set. In the buffered mode the status phase takes place as soon as the target receives all data into its data buffer. The advantage here is that the I/O process completes more quickly. On the other hand a nonrecoverable write error may occur after GOOD status has been returned. SCSI accommodates such a deferred error using the

Table 14.4 The WRITE command for tape drives.

	7	6	5	4	3	2	1	0
0	WRITE (0Ah)							
1	LUN			Reserved			Fixed	
2	(MSB)							
3	Transfer length							
4								
5	Control byte							

mechanism already described on page 144. The data not yet written to the medium can be recovered using the optional command RECOVER BUFFER DATA. In the unbuffered mode the data must be written to the medium before the status phase takes place. The latter approach is preferred by many system administrators because it avoids such problems.

If an EW mark is found during a WRITE command the device will attempt to finish writing the data and will, in any case, return a CHECK CONDITION status to the initiator. It can be determined whether the data was accommodated in the partition by examining the sense key.

SPACE (11h)

The space command is used to advance or rewind the tape a certain number of data blocks or tape marks (Table 14.5). The rewind capability is optional.

The parameter Count in bytes 2 through 4 indicates the number of objects to be advanced. Negative numbers (in two's complement) indicate rewinding.

In addition to the LUN number byte 1 contains the Code field which specifies what is to be counted. The possible codes are given in Table 14.6. Two of these, filemarks and setmarks, are worth explaining. When sequential filemarks are to be counted then the tape is advanced until Count consecutive filemarks are found. This means that for Count n , the tape will be positioned after the n th filemark when the command completes. Sequential setmarks are handled in the same way.

The hierarchy of objects plays an important role in error and event handling for the SPACE command. The details can be found in the ANSI specification

Table 14.5 The SPACE command.

	7	6	5	4	3	2	1	0
0	SPACE (11h)							
1	LUN			Reserved		Code		
2	(MSB)							
3	Count							
4								
5	Control byte							

Table 14.6 Meaning of the Code field.

<i>Code</i>	<i>Description</i>	<i>M/O</i>
000b	Blocks	M
001b	Filemarks	M
010b	Sequential filemarks	O
011b	End-of-data	O
100b	Setmarks	O
101b	Sequential setmarks	O

in Section 9.2.12. However, a generalization can be made: if a higher level object is encountered during spacing than is being counted, then the command will be broken off at that point with a CHECK CONDITION status. For example, if filemarks are being counted a setmark will lead to command termination.

In addition, reaching either the beginning or the end of a partition during a space command will cause the command to be terminated with CHECK CONDITION status.

**WRITE FILEMARKS
(10h)**

This command writes to the current position the number of tape marks given in the transfer length field (Table 14.7). When the WSmk bit is 1 then setmarks are written; when 0 filemarks are written. The Immed bit specifies that the target should reply with GOOD status as soon as the command is recognized. Otherwise all buffered data and tape marks must be written before the execution of the command begins. WRITE FILEMARKS with transfer length zero can be used to cause the data buffer to be written to tape.

If an EW mark is encountered during or before the write filemarks command the target will attempt to finish writing the requested number of tape marks. In either case it concludes the command with CHECK CONDITION status. The sense data reveal whether or not the tape marks were successfully written.

ERASE (19h)

This command erases the medium starting at the current position (Table 14.8). Just how this is carried out is device dependent. However, afterwards a data pat-

Table 14.7 The WRITE FILEMARKS command.

	7	6	5	4	3	2	1	0
0	WRITE FILEMARKS (10h)							
1	LUN			Reserved			WSmk	Fixed
2	(MSB)							
3	Transfer length							
4								
5	Control byte							

Table 14.8 The ERASE command.

	7	6	5	4	3	2	1	0
0	ERASE (19h)							
1	LUN			Reserved		WMsk	Long	
2	Reserved							
3								
4								
5	Control byte							

tern should be in place where previously data blocks and tape marks were found.

When the Long bit is set, the remainder of the tape starting at the current position will be erased. Otherwise a gap will be erased on the tape whose length is specified in the device configuration parameter page as gap length. The Immed bit has its standard interpretation.

READ BLOCK LIMITS (05h)

This command returns the maximum and minimum block size of the device. There are no parameters.

The block size information is returned in a parameter block where bytes 1 through 3 contain the maximum block length, and bytes 4 through 5 the minimal block length (Table 14.9).

A maximal block length of zero indicates that there is no block length limit. When the maximal and minimal lengths are equal the device supports only a fixed block length. In this case the READ and WRITE commands must always have the Fixed bit set and the block length must reflect the value returned by this command.

LOCATE (2Bh)

The LOCATE command is optional but is, nonetheless, a very useful command (Table 14.10). On the one hand, it makes it possible to search the tape for a specific logical or physical block. Additionally, the command can be used to change the active partition.

Table 14.9 Block limits parameter block.

	7	6	5	4	3	2	1	0
0	Reserved							
1	Maximum block length							
2								
3								
4	Minimum block length							
5								

Table 14.10 The LOCATE command.

	7	6	5	4	3	2	1	0
0	LOCATE (2Bh)							
1	LUN		Reserved		BT	CP	Immed	
2	Reserved							
3	(MSB) Block number (LSB)							
4								
5								
6								
7	Reserved							
8	Partition							
9	Control byte							

Since in general tape can hold an enormous number of blocks LOCATE is a 10-byte command. The block number is contained in bytes 3 through 6, allowing 4 giga-blocks to be addressed. When the BT bit is set the block address is interpreted as a device specific physical address, otherwise as SCSI LBN.

Byte 8 contains the number of the Partition to become active before positioning to the block number. This byte is ignored when the CP bit in byte 2 is not set.

LOAD UNLOAD (1Bh)

This command loads or unloads the medium (Table 14.11). In addition, the tape can be re-tensioned by spooling the entire tape from one reel to the other.

The command has no parameters but a few control bits in byte 4. When the Load bit is set the tape is to be loaded and positioned to the BOT mark.

If the Load bit is clear the tape will be unloaded. All buffered data and tape marks are written to the medium prior to unloading. If the EOT bit is set the tape will be positioned to the EOT mark, otherwise the BOT mark will be sought. In either case the medium is dismounted and any subsequent command calling for medium access will cause a CHECK CONDITION status with the sense key NOT READY.

Finally, the ReTen control bit causes the tape to be re-tensioned before the action described by the Load bit is performed.

Table 14.11 The LOAD UNLOAD command.

	7	6	5	4	3	2	1	0
0	LOAD UNLOAD (1Bh)							
1	LUN		Reserved				Immed	
2	Reserved							
3								
4								
5	Control byte							

14.3 Mode parameters for tape devices

Mode parameter header The device specific byte of the mode parameter header (Table 14.12) returned by the MODE SENSE command contains the following information:

- The WP bit indicates that the medium is write protected.
- Buffer mode is defined for three values. These pertain to commands that write either data or tape marks to the medium, which together are referred to as write operations.

Table 14.12 Device specific parameter byte in header.

Bit	7	6	5	4	3	2	1	0
	WP	Buffer mode			Speed			

- 000b is the unbuffered mode. For all write operations the target must wait until the medium has actually been written before returning status.
- 001b: The target may return GOOD status as soon as all data has been received into the data buffer.
- 010b: The target may return GOOD status as soon as all data has been received into the data buffer *and* all buffered data from other initiators has been written to the medium.
- In the Speed field a 0 represents the device's default tape speed. The values 1h through Fh reflect speeds from slowest to fastest.

Block descriptor Byte 0 of the block descriptor contains a device specific code for the write density. The most important of these are given in Table 14.13.

Table 14.13 Write density for tape drives.

Code	Width	Tracks	BPI	Format	Type
01h	½ inch	9	800	NRZI	Reel-to-reel
02h	½ inch	9	1600	PE	Reel-to-reel
03h	½ inch	9	6250	GCR	Reel-to-reel
0Fh	¼ inch	15	10 000	GCR	QIC-120 cassette
10h	¼ inch	18	10 000	GCR	QIC-150 cassette
11h	¼ inch	26	16 000	GCR	QIC-320 cassette
13h	4 mm	1	61 000	DDS	4 mm DAT
14h	8 mm	1	54 000		EXABYTE
00h	Default density				

Table 14.14 Mode pages for tape devices.

Page code	Name	Page	ANSI
01h	Read–write error page		9.3.3.4
02h	Disconnect–reconnect page	155	7.3.3.2
09h	Peripheral device page	156	7.3.3.3
0Ah	Control mode page	157	7.3.3.1
10h	Device configuration page	191	9.3.3.1
11h	Partitions page 1	192	9.3.3.3
12h	Partitions page 2	192	9.3.3.3
13h	Partitions page 3	192	9.3.3.3
14h	Partitions page 4	192	9.3.3.3

Mode parameter pages

The mode parameter pages in Table 14.14 are defined for tape devices.

The device configuration page (10h)

The device configuration page contains various configuration information for the tape drive (Table 14.15). Only the more important details will be covered here. Refer to Section 9.3.3 of the ANSI specification for further information.

Byte 3 contains the active partition. This can be modified using `MODE SELECT` when the `CAP` (change active partition) bit of byte 2 is set.

Table 14.15 Device configuration page for tape devices.

	7	6	5	4	3	2	1	0
0	PS	Res.	Page code (10h)					
1	Page length							
2	Res.	CAP	CAR	Active format				
3	Active partition							
4	Write buffer full ratio							
5	Read buffer empty ratio							
6	(MSB) Write							
7	Delay (LSB)							
8	DBR	BIS	RSmk	AVC	SOCF	RBO	REW	
9	Gap size							
10	EOD			EEG	SEW	Reserved		
11	(MSB) Buffer size at EW							
12	Buffer size at EW							
13	(LSB)							
14	Data compression							
15	Reserved							

Table 14.16 Partition page 1 for tape devices.

	7	6	5	4	3	2	1	0	
0	PS	Res.	Page code (11h)						
1	Page length								
2	Maximum additional partitions								
3	Additional partitions (n+1)								
4	FDP	SDP	IDP	PSUM		Reserved			
5	Format recognition								
6	Reserved								
7	Reserved								
8-8+2n	Partition size descriptors								
8+2n	(MSB)	Partition							
8+2n+1	Size						(LSB)		

**Partition pages
1 through 4 (11h,
12h, 13h, 14h)**

Partition page 1 has an 8-byte header followed by up to 64 partition size descriptors of 2 bytes each. If more partitions are needed pages 2 through 4 can be used, each of which accommodates 64 partitions. This allows SCSI-2 devices to support up to 256 partitions. Partition page 1 is shown in Table 14.16. Each descriptor contains the length of its partition. The unit of measure for length is defined by the PSUM field. Here the value 00h means bytes, 01h Kbytes, and 02h Mbytes. Unlike page 1, partition pages 2 through 4 consist of only descriptors (Table 14.17).

Table 14.17 Partition pages 2-4 for tape devices.

	7	6	5	4	3	2	1	0	
0	PS	Res.	Page code (12-14h)						
1	Page length								
2-2+2n	Partition descriptors								
2+2n	(MSB)	Partition							
2+2n+1	Size						(LSB)		

15 Printers

The degree to which the various device classes are defined in SCSI-2 varies greatly. Up until this point we have seen very detailed specifications for disk and tape drive devices. This is not the case for printers, as will become apparent in the description of the device model.

15.1 The model of a SCSI printer

The model of a SCSI printer represents to some extent an exception among SCSI device models (Figure 15.1). Here the design is of a bridge controller connected to a printer mechanism. Of course, there is nothing preventing the integration of the controller into the printer itself. We will see that one advantage of this approach is that the `MODE SELECT` command can be used to manipulate the physical printer interface.

The command set basically treats the printer as a black box that accepts data. No page description language is defined here, rather the data format is left up to the initiator. Nevertheless, this 'black box' does allow internal configuration

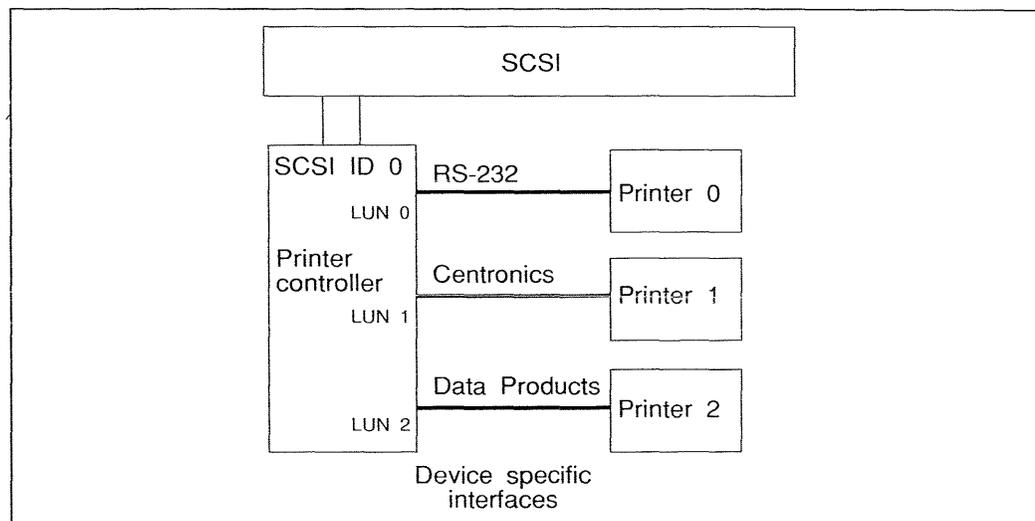

Figure 15.1 Model of a SCSI printer.

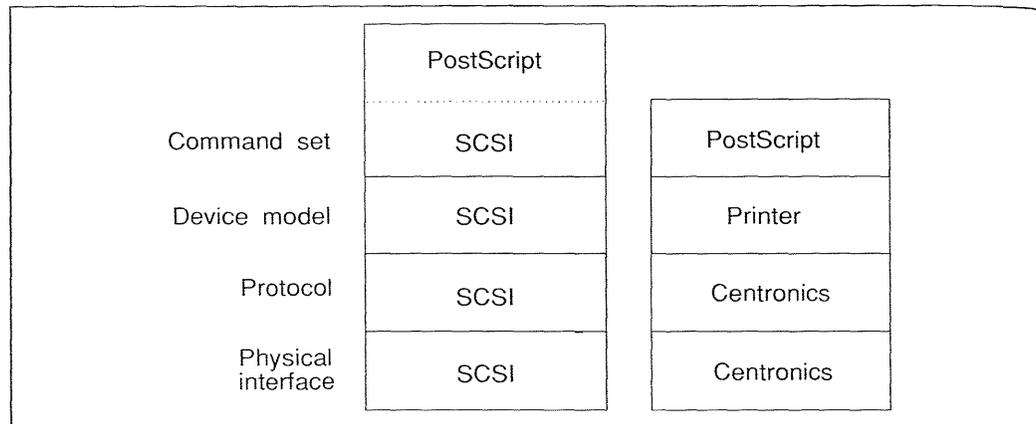

Figure 15.2 SCSI printer interface.

to some degree using SCSI commands. For instance, there is the optional control of printer fonts and forms. The printer itself may be equipped with a data buffer, making a buffered mode possible.

The standard does not specify what the printer must do when it receives a particular character. While a typical dot-matrix printer will simply print any printable character, a PostScript compatible printer will use the page description language PostScript to interpret the character. To make things even more complicated there are also a number of printer manufacturers that have developed unique printer control languages. Some of these have become de facto standards, which are often emulated by other printers. For example, many printers provide HP Laserjet emulation as well as Epson or Diablo emulations. Unfortunately, none of these emulations is defined in the SCSI-2 standard. If this were the case one could simply buy a SCSI printer and plug it in (Figure 15.2). As a result the software must be informed of the printer's emulation in order to function properly.

In summary, one can say that the SCSI-2 command set for printers is limited to data transfer and the control of certain parameters. With reference to the interface model this leaves the top level not completely defined.

15.2 Printer commands

Table 15.1 lists all of the commands defined for SCSI printers. Printers have a relatively large number of commands that are completely vendor unique. These opcodes are 01h, 02h, 05h, 06h, 07h, 08h, 09h, 0Ch, 0Dh, 0Eh, 0Fh, 11h, 13h, 19h and C0h to FFh. All other opcodes are reserved.

PRINT (0Ah) The PRINT command sends the number of bytes contained in Transfer length to the printer (Table 15.2). Depending on buffer mode the status phase will occur either immediately after the data transfer or it will occur after the printing has actually taken place.

Table 15.1 SCSI commands for printers.

<i>Opcode</i>	<i>Name</i>	<i>Type</i>	<i>Page</i>	<i>ANSI</i>	<i>Description</i>
00h	TEST UNIT READY	M	141	7.2.16	Reflects whether or not the LUN is ready to accept a command
03h	REQUEST SENSE	M	142	7.2.14	Returns detailed error information
04h	FORMAT	M	196	10.2.1	Formats medium
0Ah	PRINT	M	194	10.2.2	Print data
0Bh	SLEW AND PRINT	M	196	10.2.4	
10h	SYNCHRONIZE BUFFER	M	196	10.2.6	
12h	INQUIRY	M		7.2.5	Returns LUN specific information
14h	RECOVER BUFFERED DATA	O		10.2.3	Retrieve data from the data buffer
15h	MODE SELECT(6)	M	149	7.2.8	Set device parameters
16h	RESERVE UNIT	M	146	9.2.10	Make LUN accessible only to certain initiators
17h	RELEASE UNIT	M	146	9.2.9	Make LUN accessible to other initiators
18h	COPY	O		7.2.3	Autonomous copy from/to another device
1Ah	MODE SENSE(6)	M	149	7.2.10	Read device parameters
1Bh	STOP PRINT	O	196	10.2.5	
1Ch	RECEIVE DIAGNOSTIC RESULTS	O		7.2.13	Read self-test results
1Dh	SEND DIAGNOSTIC	M	147	7.2.1	Initiate self-test
39h	COMPARE	O		7.2.2	Compare data
3Ah	COPY AND VERIFY	O		7.2.4	Autonomous copy from/to another device, verify success
3Bh	WRITE BUFFER	O		7.2.17	Write the data buffer
3Ch	READ BUFFER	O		7.2.12	Read the data buffer
40h	CHANGE DEFINITION	O	149	7.2.1	Set SCSI version
4Ch	LOG SELECT	O		7.2.6	Read statistics
4Dh	LOG SENSE	O		7.2.7	Read statistics
55h	MODE SELECT(10)	O		7.2.9	Set device parameters
5Ah	MODE SENSE(10)	O		7.2.10	Read device parameters

Table 15.2 The PRINT command.

	7	6	5	4	3	2	1	0
0	PRINT (0Ah)							
1	LUN			Reserved				
2	(MSB)							
3	Transfer length							
4								
5	Control byte							

Table 15.3 The SLEW AND PRINT command.

	7	6	5	4	3	2	1	0
0	SLEW AND PRINT (0Bh)							
1	LUN			Reserved				Channel
2	Slew value							
3	(MSB)		Transfer length					
4							(LSB)	
5	Control byte							

SLEW AND PRINT (0Bh)

This command works just like the PRINT command except that it allows a certain number of lines to be skipped before printing, as well as a choice of forms channel (Table 15.3). When the Channel bit is set the number of the forms channel is given in Slew value. Otherwise, this byte is interpreted as the number of lines to be skipped before printing.

STOP PRINT (1Bh)

This command halts printing (Table 15.4). If the Retain bit is clear then the data remaining in the buffer is discarded. Otherwise, it is held and a subsequent PRINT command or a SYNCHRONIZE BUFFER will allow printing to continue.

Table 15.4 The STOP PRINT command.

	7	6	5	4	3	2	1	0
0	STOP PRINT (1Bh)							
1	LUN			Reserved				Retain
2	Vendor unique							
3	Reserved							
4								
5	Control byte							

FORMAT (04h)

This command makes it possible to send form or font data to the printer (Table 15.5). The value 00b in the Typ field chooses form control, the value 01b font control.

SYNCHRONIZE BUFFER (10h)

This command causes the printer to print the contents of the data buffer (Table 15.6). This is used to make sure that all data has been printed. Page printers sometimes need a form feed in this case. This command waits until after printing to return status. If for any reason printing cannot take place a CHECK CONDITION is returned.

Table 15.5 The FORMAT command for printers.

	7	6	5	4	3	2	1	0
0	FORMAT (04h)							
1	LUN			Reserved			Typ	
2	(MSB) Transfer length (LSB)							
3								
4								
5	Control byte							

Table 15.6 The SYNCHRONIZE BUFFER command.

	7	6	5	4	3	2	1	0
0	SYNCHRONIZE BUFFER (10h)							
1	LUN			Reserved				
2								
3								
4								
5	Control byte							

15.3 Mode parameters for printers

Mode parameter header

The device specific byte in the mode parameter header has the following form (Table 15.7):

- Buffer mode is defined for two values and is relevant for PRINT and SLEW AND PRINT commands. All other values are reserved.
- 000b is for unbuffered mode. The printer controller will not return status until the data has actually been printed.
- 001b is the buffered mode. Here the controller is allowed to return GOOD status as soon as all data has been received into the buffer.

Table 15.7 Device specific byte in mode header.

Bit	7	6	5	4	3	2	1	0
	Res	Buffer mode			Reserved			

Table 15.8 Mode parameter pages for printers.

<i>Page code</i>	<i>Name</i>	<i>Page</i>	<i>ANSI</i>
02h	Disconnect-reconnect page	155	7.3.3.2
03h	Parallel interface page	198	10.3.3.1
04h	Serial interface page	198	10.3.3.3
05h	Printer options page		10.3.3.2
09h	Peripheral device page	156	7.3.3.3
0Ah	Control mode page	157	7.3.3.1

Mode parameter pages

Table 15.8 shows the mode parameter pages defined for printers.

Parallel interface page (03h)

This parameter page controls the characteristics of a parallel printer interface (Table 15.9). The parameter Parity assumes the values 00b for no parity, 01b for even parity and 10b for odd parity. The meaning of byte 2 is explained in detail in section 10.3.3.1 of the ANSI standard.

Table 15.9 Parallel interface page.

	7	6	5	4	3	2	1	0
0	PS	Res	Page code (03h)					
1	Page length (03h)							
2	Parity		PIPC	Res	VCBP	VCBS	VES	Autofeed
3	Reserved							

Serial interface page (04h)

This parameter page controls the characteristics of a serial RS-232C interface. The fields are more or less self explanatory (Table 15.10). Section 2.1 is a good source of background information on the serial interface (Table 15.11). The RTS

Table 15.10 Serial interface page.

	7	6	5	4	3	2	1	0
0	PS	Res	Page code (04h)					
1	Page length (06h)							
2	Reserved		Stop-bit length					
3	Parity			Res	Bits per character			
4	RTS	CTS	Res		Protocol			
5	(MSB)							
6	Baud rate							
7	(LSB)							

Table 15.11 Parameters of the serial interface.

<i>Code</i>	<i>Parity</i>
000b	No parity
001b	Mark
010b	Space
011b	Odd
100b	Even

<i>Code</i>	<i>Protocol</i>
0000b	No protocol
0001b	XON/XOFF
0010b	ETX/ACK
0011b	DTR

bit specifies that the printer controller should activate the RTS signal of the interface. If the CTS bit is clear the controller will ignore the RTS signal altogether. Otherwise output is stopped as long as RTS is inactive.

16 Scanners

16.1 The model of a SCSI scanner

A scanner is a device capable of converting pictures and text to an electronic representation made up of rows of pixels. Pixels can be black and white, color, or gray scale. The number of bits needed to represent a pixel is dependent on which of these three possibilities is chosen. As a result there are different data formats for storing scanned images. These formats are not specified in the SCSI standard; many are vendor unique. Similar to the printer definition, the SCSI standard is limited to the exchange of data and the control of the scanner.

A SCSI scanner uses the coordinate system shown in Figure 16.1. The units of the coordinate system can be specified using the measuring units page of the `MODE SELECT` command. The available units are inches, millimeters or points (1/72 inch) or fractions thereof. The unit of measure chosen does not affect the resolution of the scanner.

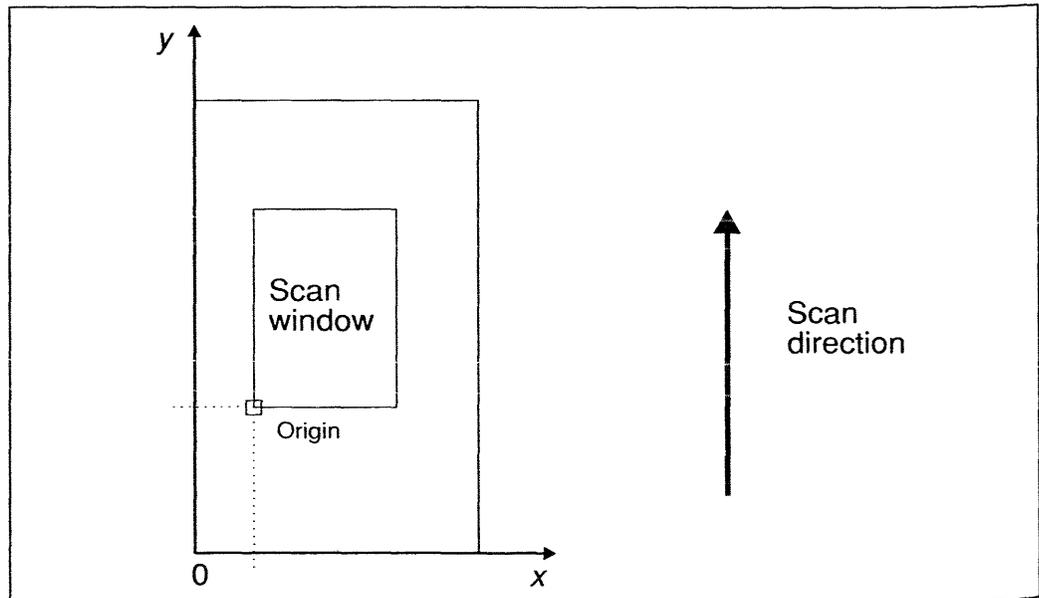

Figure 16.1 Coordinate system and scan window.

Table 16.1 Window descriptor.

	7	6	5	4	3	2	1	0
0	Window identifier							
1	Reserved							Auto
2-3	X-axis resolution							
4-5	Y-axis resolution							
6-9	X-axis upper left							
10-13	Y-axis upper left							
14-17	Window width							
18-21	Window length							
22	Brightness							
23	Threshold							
24	Contrast							
25	Image composition							
26	Bits per pixel							
27-28	Halftone pattern							
29	RIF	Reserved					Padding type	
30-31	Bit ordering							
32	Compression type							
33	Compression argument							
34-39	Reserved							
40-n	Vendor specific							

A SCSI scanner can be configured such that the scanning surface is broken up into one or many windows. These windows may differ in size and location as well as scanning method. Each window is described by a separate window descriptor, an example of which is shown in Table 16.1.

The window descriptor

In order to save space, parameters that occupy more than 1 byte are represented in a single line in the table. As is usually the case for SCSI the length of the parameter block is contained within the parameter block itself.

Most fields here are self-explanatory. The Auto bit specifies that the scanner may create subwindows automatically. When reading the window parameter data this bit reflects whether the window was automatically created. The RIF bit indicates that the image is a negative. The image composition, halftone pattern and compression fields are essentially vendor specific.

16.2 Scanner commands

Table 16.2 lists all of the commands defined for SCSI scanners.

Table 16.2 Commands for scanners.

<i>Opcode</i>	<i>Name</i>	<i>Type</i>	<i>Page</i>	<i>ANSI</i>	<i>Description</i>
00h	TEST UNIT READY	M	141	7.2.16	Reflects whether or not the LUN is ready to accept a command
03h	REQUEST SENSE	M	142	7.2.14	Returns detailed error information
12h	INQUIRY	M		7.2.5	Returns LUN specific information
15h	MODE SELECT(6)	M	149	7.2.8	Set device parameters
16h	RESERVE UNIT	M	146	9.2.10	Make LUN accessible only to certain initiators
17h	RELEASE UNIT	M	146	9.2.9	Make LUN accessible to other initiators
18h	COPY	O		7.2.3	Autonomous copy from/to another device
1Ah	MODE SENSE(6)	M	149	7.2.10	Read device specific parameters
1Bh	SCAN	O	203	14.2.5	Scan
1Ch	RECEIVE DIAGNOSTIC RESULTS	O		7.2.13	Read self-test results
1Dh	SEND DIAGNOSTIC	M	147	7.2.1	Initiate self-test
24h	SET WINDOW	M	202	14.2.6	
25h	GET WINDOW	O		14.2.2	
28h	READ	M	203	14.2.4	Read
2Ah	SEND	O		14.2.7	
31h	OBJECT POSITION	O		14.2.3	
34h	GET DATA BUFFER STATUS	O		14.2.1	
39h	COMPARE	O		7.2.2	Compare data
3Ah	COPY AND VERIFY	O		7.2.4	Autonomous copy from/to another device, verify success
3Bh	WRITE BUFFER	O		7.2.17	Write the data buffer
3Ch	READ BUFFER	O		7.2.12	Read the data buffer
40h	CHANGE DEFINITION	O		7.2.1	Set SCSI version
4Ch	LOG SELECT	O		7.2.6	Read statistics
4Dh	LOG SENSE	O		7.2.7	Read statistics
55h	MODE SELECT(10)	O		7.2.9	Set device parameters
5Ah	MODE SENSE(10)	O		7.2.10	Read device parameters

SET WINDOW (24h)

The SET WINDOW command creates one or more scanning windows (Table 16.3). Here the data phase contains a window list made up of a list header and one or more window descriptors, as in Table 16.1. The header contains only the total length of the window descriptors (Table 16.4). Individual descriptors must all be the same length.

Table 16.3 The SET WINDOW command.

	7	6	5	4	3	2	1	0
0	SET WINDOW (24h)							
1	LUN							
2	Reserved							
3								
4								
5								
6	(MSB) Transfer length							
7								
8	(LSB)							
9	Control byte							

Table 16.4 Window header data.

	7	6	5	4	3	2	1	0
0	Reserved							
1								
2								
3								
4								
5								
6	(MSB) Window descriptor							
7	length (LSB)							

READ (28h) The READ command reads data from the scanner (Table 16.5). Here different types of data are possible. Data type code 00h stands for image data. The data type qualifier is a vendor specific parameter, which is required for some data types. The data length is measured in blocks whose size has been specified using the mode parameter block descriptor.

SCAN (1Bh) The scan command initiates the scanning process (Table 16.6). This command is optional because this is done manually for many scanners. The data length specifies the length of the window list supplied in the data phase of the command. The window list is composed of one or many window numbers previously defined.

Table 16.5 The READ command for scanners.

	7	6	5	4	3	2	1	0		
0	READ (28h)									
1	LUN			Reserved						
2	Data type code									
3	Reserved									
4	(MSB)			Data type						
5				qualifier				(LSB)		
6	(MSB)			Transfer length						
7										
8									(LSB)	
9	Control byte									

Table 16.6 The SCAN command.

	7	6	5	4	3	2	1	0
0	SCAN (1Bh)							
1	LUN							
2	Reserved							
3								
4	Transfer length							
5	Control byte							

16.3 Mode parameters for scanners

MODE parameter pages

Table 16.7 shows the mode parameter pages defined for SCSI scanners.

Table 16.7 Mode parameter pages for scanners.

<i>Page code</i>	<i>Name</i>	<i>Page</i>	<i>ANSI</i>
02h	Disconnect-reconnect page	155	7.3.3.2
03h	Measurements units page	205	14.3.3.1
09h	Peripheral device page	156	7.3.3.3
0Ah	Control mode page	157	7.3.3.1

**Measurement
units page (03h)**

This page is very straightforward (Table 16.8). Byte 2 specifies the basic unit of measure, where 00h stands for inches, 01h for millimeters, and 02h for points (1/72 inch). Bytes 4 and 5 contain the number of units that should make up a basic measurement unit. This means that when byte 2 contains 01h and byte 5 contains 64h that the measurement unit is 1/100 of a millimeter.

Table 16.8 Measurements units page.

	7	6	5	4	3	2	1	0	
0	Page code (03h)								
1	Page length (06h)								
2	Measurement unit								
3	Reserved								
4	(MSB)			Divisor					
5								(LSB)	
6	Reserved								
7									

17 Processor devices

Processor devices are a very general device class. Although such devices only send and receive data across the bus, they are capable of a wide variety of very useful general tasks. Processors that offload a main processor or a data acquisition system are two examples of such devices.

17.1 The model of a SCSI processor device

From the SCSI perspective, a processor device simply exchanges data over the bus with the initiator (Figure 17.1). The kind of data sent is left completely unspecified. Here SCSI simply acts as a physical interface between devices. The protocol above that is left up to the designers.

A processor device, like all SCSI targets, can support up to eight logical devices. If a LUN is momentarily incapable of receiving or sending data it can

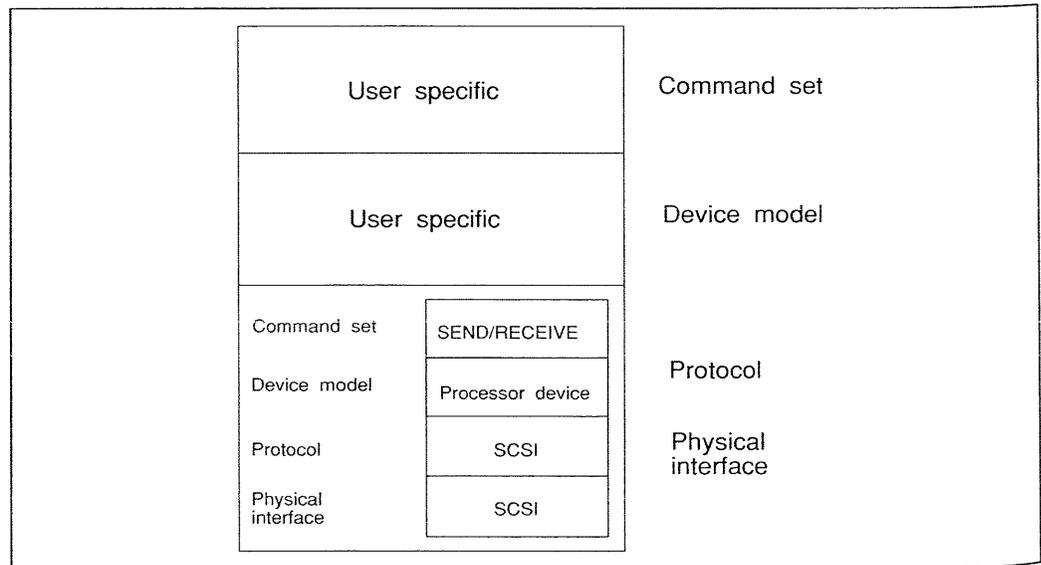

Figure 17.1 User defined protocol.

either return a CHECK CONDITION status or it can disconnect and reconnect at a later time.

What follows are descriptions of two applications for SCSI processor devices. The first consists of two coupled processors, which together act as a redundant file server. Both servers are identical and contain the same data. The servers use the SCSI bus for communicating with each other and for insuring that they each contain the same data. If one system should fail the other system remains fully functional.

The second application is a PC equipped with an A/D converter, which together function as a data acquisition system. The PC collects all of the necessary data and is even capable of preprocessing. It plays the role of a SCSI target and delivers the preprocessed data to a workstation.

There are countless other possible applications for processor devices (Figure 17.2). SCSI is powerful in this area because it allows customized hardware to be controlled using an industry standard interface.

SCSI host adapters for PCs that also function as targets are widely available for this purpose.

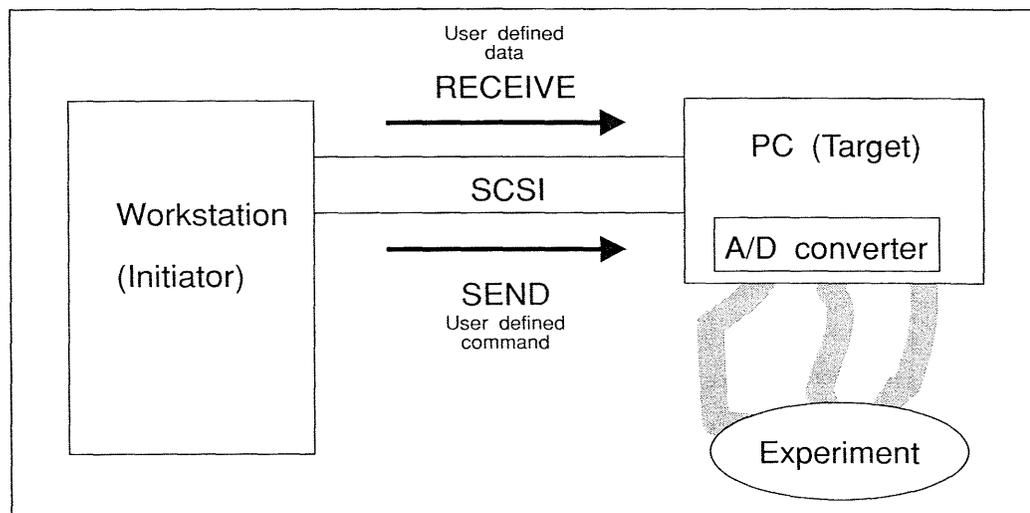

Figure 17.2 Example of a SCSI processor drive.

17.2 Commands for processor devices

Table 17.1 lists all of the commands defined for processor devices.

RECEIVE (08h) The RECEIVE command (relative to the initiator) instructs the target to send data to the initiator (Table 17.2). The direction of the transfer can be confusing. Remember that the direction is the same as that for READ, with which RECEIVE shares an opcode.

Table 17.1 Commands for processor devices.

<i>Opcode</i>	<i>Name</i>	<i>Type</i>	<i>Page</i>	<i>ANSI</i>	<i>Description</i>
00h	TEST UNIT READY	M	141	7.2.16	Reflects whether or not the LUN is ready to accept a command
03h	REQUEST SENSE	M	142	7.2.14	Returns detailed error information
08h	RECEIVE	M	207	11.2.1	Like read
0Ah	SEND	M	208	11.2.2	Like write
12h	INQUIRY	M		7.2.5	Returns LUN specific information
18h	COPY	O		7.2.3	Autonomous copy from/to another device
1Ch	RECEIVE DIAGNOSTIC RESULTS	O		7.2.13	Read self-test results
1Dh	SEND DIAGNOSTIC	M	147	7.2.1	Initiate self-test
39h	COMPARE	O		7.2.2	Compare data
3Ah	COPY AND VERIFY	O		7.2.4	Autonomous copy from/to another device, verify success
3Bh	WRITE BUFFER	O		7.2.17	Write the data buffer
3Ch	READ BUFFER	O		7.2.12	Read the data buffer
40h	CHANGE DEFINITION	O	149	7.2.1	Set SCSI version
4Ch	LOG SELECT	O		7.2.6	Read statistics
4Dh	LOG SENSE	O		7.2.7	Read statistics

Table 17.2 The RECEIVE command.

	7	6	5	4	3	2	1	0
0	RECEIVE (08h)							
1	LUN			Reserved				
2	(MSB)							
3	Transfer length							
4								
5	Control byte							

SEND (0Ah) The SEND command instructs the target to receive data from the initiator (Table 17.3). The transfer length indicates the amount of data to be sent. The AEN bit indicates that the data packet is in AEN format. This is used to send sense data to a processor device.

AEN data format The workings of AEN has already been explained in Chapter 11. Byte 0 of an AEN data packet contains in the lowest three bits the value LUNTRN. When the LUNTAR bit is set then LUNTRN reflects the target routine to which the data pertain. Otherwise the data pertain to the LUN specified in this field (Table 17.4).

Table 17.3 The SEND command.

	7	6	5	4	3	2	1	0
0	SEND (0Ah)							
1	LUN			Reserved			AEN	
2	(MSB) Transfer length (LSB)							
3								
4								
5	Control byte							

Table 17.4 AEN data.

	7	6	5	4	3	2	1	0
0	Reserved		LUN _{IAR}	Reserved		LUN _{TRN}		
1	Reserved							
2								
3								
4 to	Sense data, byte 0							
n+4	Sense data, byte n							

18 Communications devices

18.1 The model of a SCSI communications device

SCSI communications devices closely resemble processor devices. Here too data is received and sent across the bus. While processor devices may locally process the data, communications devices send it further. An important distinction is that communications make possible an additional level of addressing. The channel number allows the addressing of different logical channels. These might be connected to various physical communications ports within the device. On the other hand, these might be used to address different LAN protocols. The channel number is 16 bits long, making 64 000 logical channels available. As always, a communications device may have up to eight LUNs, which explodes this number to half a million.

As with processor devices, the SCSI bus is used strictly as a physical interface since the SCSI-2 standard does not specify the contents of data packets.

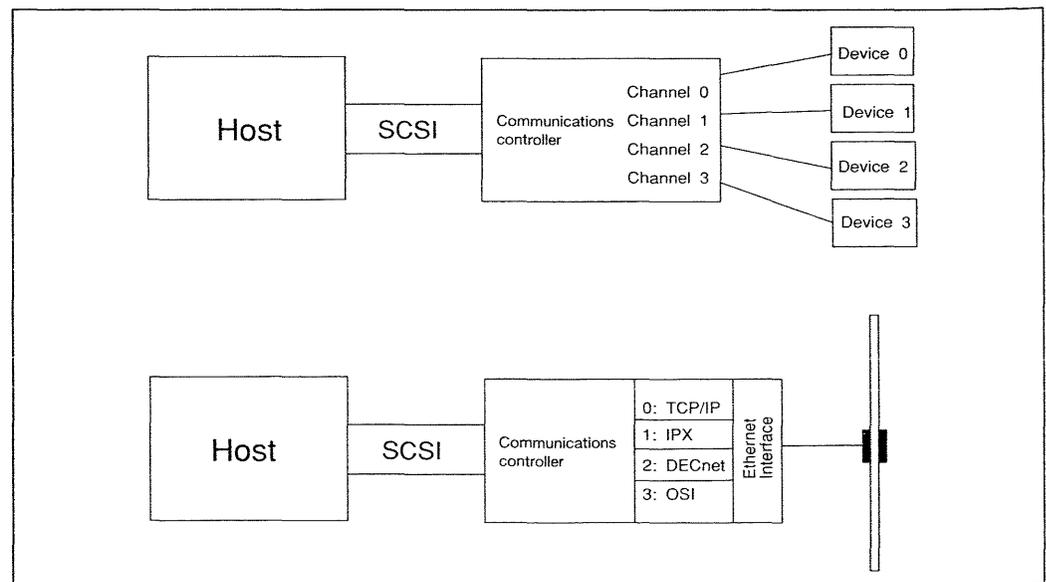

Figure 18.1 Examples of SCSI communications devices.

For this reason communications devices lack device specific parameter pages. Examples of SCSI communications devices are shown in Figure 18.1.

18.2 Commands for SCSI communications devices

Table 18.1 lists the commands defined for SCSI communications devices. For SCSI communications devices there are two additional commands defined, each with a 6-, 10-, and 12-byte version. Since the GET MESSAGE and SEND MESSAGE commands are identical except for the opcode they are discussed here in pairs.

GET MESSAGE(6)
(08h) and SEND
MESSAGE(6) (0Ah)

These versions of the commands are the only ones that are not mandatory. There is no support for logical channels (Table 18.2).

GET MESSAGE(10)
(28h) and SEND
MESSAGE(10)
(2Ah)

The 10-byte version has no support for logical channels but does have a 16-bit wide transfer length field. The maximal length of a data packet is limited to 64 Kbytes (Table 18.3).

Table 18.1 Commands for SCSI communications devices.

<i>Opcode</i>	<i>Name</i>	<i>Type</i>	<i>Page</i>	<i>ANSI</i>	<i>Description</i>
00h	TEST UNIT READY	M	141	7.2.16	Reflects whether or not the LUN is ready to accept a command
03h	REQUEST SENSE	M	142	7.2.14	Returns detailed error information
08h	GET MESSAGE(6)	M	211	17.2.1	Read
0Ah	SEND MESSAGE(6)	M	211	17.2.4	Write
12h	INQUIRY	M		7.2.5	Returns LUN specific information
15h	MODE SELECT(6)	O	149	7.2.8	Set device parameters
1Ah	MODE SENSE(6)	O	149	7.2.10	Read device parameters
1Ch	RECEIVE DIAGNOSTIC RESULTS	O		7.2.13	Read self-test results
1Dh	SEND DIAGNOSTIC	M	147	7.2.1	Initiate self-test
28h	GET MESSAGE(10)	O	211	17.2.2	Receive
2Ah	SEND MESSAGE(10)	O	211	17.2.5	Send
3Bh	WRITE BUFFER	O		7.2.17	Write the data buffer
3Ch	READ BUFFER	O		7.2.12	Read the data buffer
40h	CHANGE DEFINITION	O	149	7.2.1	Set SCSI version
4Ch	LOG SELECT	O		7.2.6	Read statistics
4Dh	LOG SENSE	O		7.2.7	Read statistics
55h	MODE SELECT(10)	O		7.2.9	Set device parameters
5Ah	MODE SENSE(10)	O		7.2.10	Read device parameters
A8h	GET MESSAGE(12)	O	212	17.2.3	Receive
AAh	SEND MESSAGE(12)	O	212	17.2.5	Send

Table 18.2 The GET MESSAGE(6) and SEND MESSAGE(6) commands.

	7	6	5	4	3	2	1	0
0	GET MESSAGE(6) (08h) or SEND MESSAGE(6) (0Ah)							
1	LUN			Reserved				
2	(MSB)							
3	Transfer length							
4								
5	Control byte							

Table 18.3 The GET MESSAGE(10) and SEND MESSAGE(10) commands.

	7	6	5	4	3	2	1	0
0	GET MESSAGE(10) (28h) or SEND MESSAGE(10) (2Ah)							
1	LUN			Reserved				
2	Reserved							
3								
4	(MSB)			Channel				(LSB)
5				number				
6	Reserved							
7	(MSB)			Transfer				(LSB)
8				length				
9	Control byte							

**GET MESSAGE(12)
(A8h) and SEND
MESSAGE(12)
(AAh)**

Finally, the 12-byte version supports logical channels and a transfer length field of 32 bits wide (Table 18.4).

Table 18.4 The GET MESSAGE(12) and SEND MESSAGE(12) commands.

	7	6	5	4	3	2	1	0
0	GET MESSAGE(12) (A8h) or SEND MESSAGE(12) (AAh)							
1	LUN							
2	Reserved							
3								
4	(MSB)			Channel				
5				number (LSB)				
6	(MSB)							
7	Transfer							
8	length							
9	(LSB)							
10	Reserved							
11	Control byte							

18.3 Mode parameter pages for communications devices

There are no device specific mode parameter pages for communications devices. Table 18.5 shows the parameter pages relevant to this class.

Table 18.5 Mode parameter pages for communications devices.

<i>Page code</i>	<i>Name</i>	<i>Page</i>	<i>ANSI</i>
02h	Disconnect-reconnect page	155	7.3.3.2
09h	Peripheral device page	156	7.3.3.3
0Ah	Control mode page	157	7.3.3.1

ld

19 Optical storage and WORM drives

19.1 The SCSI model of optical storage

The SCSI model of optical storage is very similar to that of regular disk drives. We will use magnetic disk drives as a basis for comparison and discuss the differences as they become relevant.

One difference between the two is that optical storage has the potential for much greater storage capacity. For this reason 12-byte commands have been defined for medium access commands. These have a 32-bit logical number field, like the 10-byte version, but also a 32-bit wide transfer length.

The device class for optical storage is very diverse. It includes read-only media (like CD-ROM), media that can be written only once (WORM drives) and media that can be rewritten indefinitely. CD-ROM and WORM drives, however, each have their own device class. Except for the audio dimension of CDs, these classes represent subclasses of the optical storage class presented here.

Nevertheless, a single drive capable of working with all three types of medium is also conceivable. For this reason an initiator must use a `MODE SENSE` to determine what type of medium is involved when working with a device of this class. Naturally, this must occur whenever the medium is replaced.

Optical storage has physical characteristics that are foreign to magnetic disk drives. These differences are accounted for in the command set. For example, for WORM drives, there is a command that allows the seeking to locations that have not been written. Many rewritable optical medium drives require that data be erased before being written again. There is also a command for this purpose.

WORM drives have their own device class, which is a proper subclass of optical storage. Both of these are covered here. We postpone the discussion of CD-ROM at this point since its audio capabilities make it worthy of a separate chapter.

Generations of a logical block

Many devices with write-once media are capable of emulating the rewriting of a block. The `UPDATE` command writes the modified logical block to another location on the medium and makes it available via a pointer to the new location. The original logical block remains unchanged and represents an earlier generation of

the data. Older generations are identified with a lower generation number, starting with zero. The older generations of a logical block are accessible using the READ UPDATED BLOCK command.

The model of a SCSI WORM drive

WORM drives are also a subclass of optical storage. Since the medium can only be written once some commands are dispensable. For example, the ERASE command has no meaning here. Also missing is the FORMAT command because a WORM medium is already formatted.

19.2 Commands for optical storage and WORM drives

Table 19.1 lists the commands defined for optical storage and WORM drives. You will notice that all mandatory commands are either disk drive commands or commands for all SCSI classes. This allows us to concentrate on only those commands that are unique to optical storage devices.

At this point I would also like to skip the 12-byte versions of the READ and WRITE commands. Here the parameters and control bits are identical to the 6- and 10-byte versions.

Table 19.1 Commands for optical storage devices.

<i>Opcode</i>	<i>Name</i>	<i>Opt</i>	<i>WORM</i>	<i>Page</i>	<i>ANSI</i>	<i>Description</i>
00h	TEST UNIT READY	M	M	141	7.2.16	Reflects whether or not the LUN is ready to accept a command
01h	REZERO UNIT	O	O		8.2.13	Seek track 0
03h	REQUEST SENSE	M	M	142	7.2.14	Returns detailed error information
04h	FORMAT UNIT	O	O	168	8.2.1	Formats medium
07h	REASSIGN BLOCKS	O	O		8.2.10	Defective blocks reassigned
08h	READ(6)	O	O	165	8.2.5	Read. Limited addressing
0Ah	WRITE(6)	O	O	165	8.2.5	Write. Limited addressing
0Bh	SEEK(6)	O	O		8.2.15	Seek to a logical block
12h	INQUIRY	M	M		7.2.5	Returns LUN specific information
15h	MODE SELECT(6)	O	O	149	7.2.8	Set device parameters
16h	RESERVE UNIT	M	M	146	8.2.12	Make LUN accessible only to certain initiators
17h	RELEASE UNIT	M	M	146	8.2.11	Make LUN accessible to other initiators
18h	COPY	O	O		7.2.3	Autonomous copy from/to another device
1Ah	MODE SENSE(6)	O	O	149	7.2.10	Read device parameters
1Bh	START STOP UNIT	O	O		8.2.17	Load/unload medium
1Ch	RECEIVE DIAGNOSTIC RESULTS	O	O		7.2.13	Read self-test results
1Dh	SEND DIAGNOSTIC	M	M	147	7.2.1	Initiate self-test
1Eh	PREVENT ALLOW MEDIUM REMOVAL	O	O		8.2.4	Lock/unlock medium

Table 19.1 continued

Opcode	Name	Opt	WORM	Page	ANSI	Description
25h	READ CAPACITY	M	M		8.2.7	Read number of logical blocks
28h	READ(10)	M	M	165	8.2.6	Read logical block
29h	READ GENERATION	O	O	217	15.2.6	Read maximum generation address of LBN
2Ah	WRITE(10)	M	M	165	8.2.6	Write logical block
2Bh	SEEK(10)	O	O		8.2.15	Seek to a logical block
2Ch	ERASE	O	O	219	15.2.1	
2Dh	READ UPDATED BLOCK	O	O	218	15.2.7	Read specific version of changed block
2Eh	WRITE AND VERIFY	O	O		15.2.15	Write logical block, verify success
2Fh	VERIFY	O	O		15.2.11	Verify data on medium
30h	SEARCH DATA HIGH(10)	O	O		8.2.14	Search logical blocks for data pattern
31h	SEARCH DATA EQUAL(10)	O	O		8.2.14	Search logical blocks for data pattern
32h	SEARCH DATA LOW(10)	O	O		8.2.14	Search logical blocks for data pattern
33h	SET LIMITS(10)	O	O		8.2.16	Define logical block boundaries
34h	PRE-FETCH	O	O		8.2.3	Read data into buffer.
35h	SYNCHRONIZE CACHE	O	O		8.2.8	Write cache to medium
36h	LOCK-UNLOCK CACHE	O	O		8.2.2	Hold data in cache
37h	READ DEFECT DATA(10)	O	O		8.2.8	Read list of defective blocks
38h	MEDIUM SCAN	O	O	218	15.2.3	Search for free area
39h	COMPARE	O	O		7.2.2	Compare data
3Ah	COPY AND VERIFY	O	O		7.2.4	Autonomous copy from/to another device, verify success
3Bh	WRITE BUFFER	O	O		7.2.17	Write the data buffer
3Ch	READ BUFFER	O	O		7.2.12	Read the data buffer
3Dh	UPDATE BLOCK	O		217	15.2.10	
3Eh	READ LONG	O	O	166	8.2.9	Read data and ECC
3Fh	WRITE LONG	O	O	166	8.2.23	Write data and ECC
40h	CHANGE DEFINITION	O	O	149	7.2.1	Set SCSI version
4Ch	LOG SELECT	O	O		7.2.6	Read statistics
4Dh	LOG SENSE	O	O		7.2.7	Read statistics
55h	MODE SELECT(10)	O	O		7.2.9	Set device parameters
5Ah	MODE SENSE(10)	O	O		7.2.10	Read device parameters
A8h	READ(12)	O	O		15.2.4	
AAh	WRITE(12)	O	O		15.2.4	
ACh	ERASE(12)	O			15.2.2	
A Eh	WRITE AND VERIFY	O	O		15.2.16	Write logical block, verify success
AFh	VERIFY(12)	O	O		15.2.12	Verify data on medium
B0h	SEARCH DATA HIGH(12)	O	O		15.2.8	Search logical blocks for data pattern
B1h	SEARCH DATA EQUAL(12)	O	O		15.2.8	Search logical blocks for data pattern
B2h	SEARCH DATA LOW(12)	O	O		15.2.8	Search logical blocks for data pattern
B3h	SET LIMITS(12)	O	O		15.2.9	Set logical block boundaries
B7h	READ DEFECT DATA(12)	O	O		15.2.5	

Table 19.2 The UPDATE BLOCK command.

	7	6	5	4	3	2	1	0
0	UPDATE BLOCK (3Dh)							
1	LUN			Reserved			Rel	
2	(MSB) Logical block number (LSB)							
3								
4								
5								
6	Reserved							
7								
8								
9	Control byte							

UPDATE BLOCK (3Dh) This command is used to update the data in a logical block (Table 19.2). The new data is written to a new location on the medium, leaving the old data intact. In fact, the older version can still be accessed using READ UPDATED BLOCK. READ will, of course, always read the current version of the logical block. This command always operates on one logical block at a time, thus there is no transfer length.

READ GENERATION (29h) The READ GENERATION command returns the current generation number of a logical block (Table 19.3). The reply is contained in the first 2 bytes of a 4-byte long parameter block (Table 19.4).

Table 19.3 The READ GENERATION command.

	7	6	5	4	3	2	1	0
0	READ GENERATION (29h)							
1	LUN			Reserved			Rel	
2	(MSB) Logical block number (LSB)							
3								
4								
5								
6	Reserved							
7								
8								
9	Control byte							

Table 19.4 READ GENERATION results.

	7	6	5	4	3	2	1	0
0	(MSB) Maximum							
1	generation address (LSB)							
2	Reserved							
3								

READ UPDATED BLOCK(10) (2Dh)

This command is very much like a normal READ command. Even the control bits in byte 1 have the same meaning. However, there is no transfer length because the command reads exactly one block (Table 19.5).

Bytes 6 and 7 hold the generation of the block to be read. When the Latest bit is set then the most recent generation is numbered zero and the numbers incremented for older generations. Otherwise it is the oldest version that is numbered zero and the numbers incremented for newer generations. If the requested generation does not exist the command will return a CHECK CONDITION status.

MEDIUM SCAN (38h)

This command searches for a continuous region of written or unwritten medium after the start address. The command uses a parameter block containing the length of the region and the length of area to be searched (Table 19.6).

A number of parameter bits are used (Table 19.7). When the WBS (written block search) bit is set then the target will search for a written region; when clear, an unwritten region. The PRA (partial results acceptable) bit indicates that the largest of those regions found should be returned in lieu of a qualifying region. The ASA bit specifies that the written or unwritten region should be

ERA:

Table 19.5 The READ UPDATED BLOCK command.

	7	6	5	4	3	2	1	0
0	READ UPDATED BLOCK(10) (2Dh)							
1	LUN		DPO	FUA	Reserved		Rel	
2	(MSB)							
3	Block address (LBN)							
4								
5								
6	Latest	(MSB)				Generation		
7	(LSB)							
8	Reserved							
9	Control byte							

Table 19.6 The MEDIUM SCAN command.

	7	6	5	4	3	2	1	0
0	MEDIUM SCAN (38h)							
1	LUN		WBS	ASA	RSD	PRA	Rel	
2	(MSB) Start address (LSB)							
3								
4								
5								
6	Reserved							
7	Reserved							
8	Parameter list length (08h)							
9	Control byte							

continuous. The RSD bit instructs the target to search from the end of the medium backwards. The result of the search process is a status. CONDITION MET indicates that a region meeting the specifications was found. Then REQUEST SENSE will return the sense key EQUAL or NO SENSE with the LBN of the region in the information bytes. If no qualifying region is found then GOOD status is returned with the sense key set to NO SENSE.

ERASE(10) (2Ch)

The ERASE command instructs the target to erase a number of logical blocks beginning with a start address (Table 19.8). This command is important for re-writable optical drives which require erasure before writing. Although erasure is already implemented within write commands, for performance reasons it is more effective to erase large regions with a single ERASE command.

When the ERA bit is set the Number field must contain a zero, and all of the medium after the start address will be erased. Otherwise Number holds the number of blocks to be erased.

Table 19.7 MEDIUM SCAN parameter list.

	7	6	5	4	3	2	1	0
0	(MSB) Number of blocks requested (LSB)							
1								
2								
3								
4	(MSB) Number of blocks to scan (LSB)							
5								
6								
7								

Table 19.8 The ERASE command for optical storage.

	7	6	5	4	3	2	1	0
0	ERASE(10) (2Ch)							
1	LUN		Reserved		ERA	RES	Rel	
2	(MSB) Start address (LBN) (LSB)							
3								
4								
5								
6								
7	(MSB) Number (LSB)							
8								
9	Control byte							

19.3 Mode parameters for optical storage

Mode parameter header

The medium type (byte 1) and the device specific parameter (byte 2) have the interpretations shown in Table 19.9.

For a MODE SENSE command WP indicates that the medium is write protected. A set Cache bit indicates that the target has a cache and that cache control is possible using the DPO and FUA bits of the WRITE command.

The EBC (enable blank check) bit causes sectors to be verified as unwritten before a write is executed. When the checking is enabled an attempt to write an already written sector will result in a CHECK CONDITION.

Mode parameter pages

The mode parameter pages are defined in Table 19.10.

Table 19.9 Mode parameter header byte 1 and byte 2.

Code	Medium type							
00h	Default							
01h	Read-only medium (R/O)							
02h	WORM medium (W-O)							
03h	Rewritable medium (R/W)							
04h	R/O or W-O							
05h	R/O or R/W							
06h	W-O or R/W							

Bit	7	6	5	4	3	2	1	0
	WP	Reserved		Cache	Reserved		EBC	

Table 19.10 Mode parameter pages for optical storage.

<i>Page code</i>	<i>Name</i>	<i>Page</i>	<i>ANSI</i>
01h	Read/write error page		8.3.3.6
02h	Disconnect-reconnect page	155	7.3.3.2
06h	Optical device page	221	15.3.3.1
07h	Verification error page		8.3.3.8
08h	Caching page	177	8.3.3.1
09h	Peripheral device page	156	7.3.3.3
0Ah	Control mode page	157	7.3.3.1
0Bh	Medium type page		8.3.3.4

The optical device page (06h)

The optical device page (Table 19.11) contains precisely one parameter: the RUBR (report updated block read) bit. When set this bit causes the target to reply with CHECK CONDITION to a read of a block updated with an UPDATE command. In this way the host will know that the block being accessed does not represent the most recent version of the data.

Table 19.11 The optical device page.

	7	6	5	4	3	2	1	0
0	PS	Res	Page code (06h)					
1	Page length (02h)							
2	Reserved							RUBR
3								

20 CD-ROM

CD-ROM is a wide and varied topic, worthy of an entire book. A number of books have, in fact, been written on the subject. For the purposes of this discussion, however, we will concentrate on those aspects of CD-ROM that are relevant to the SCSI bus. Because of this I will only be able to touch on topics like the recording format and the organization of the medium.

20.1 The model of a SCSI CD-ROM drive

SCSI CD-ROM drives can read data that conforms to the standards laid down in the yellow book and the red book (IEC 908). These CDs may hold audio information in addition to other forms of digital data. One major aspect of CD-ROM is that data can only be written with a device dedicated to the function; typical CD-ROM drives do not write (Figure 20.1).

The recording format demands that the data be written at a constant linear velocity (CLV). This means that the transfer rate is the same over the entire

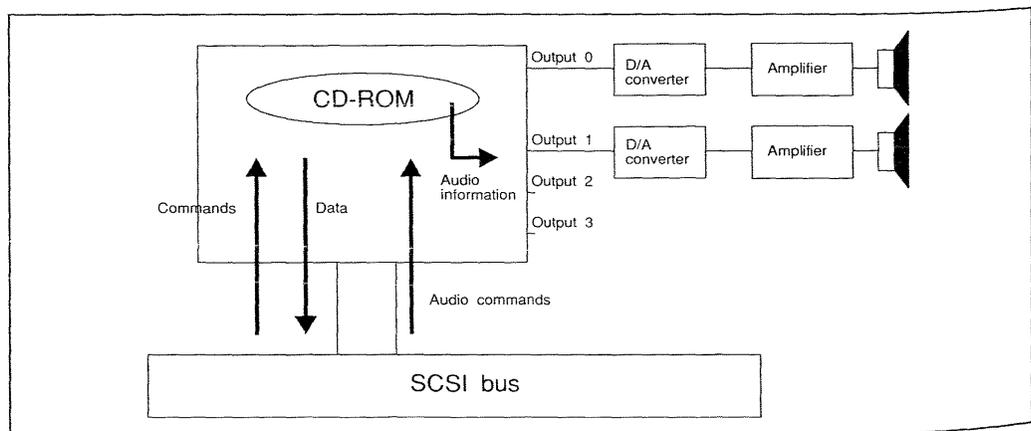

Figure 20.1 Model of a CD-ROM drive.

medium; in other words, there is no zone-bit recording. Nevertheless, the bit density is kept constant by rotating the disk more quickly for outer tracks and more slowly for inner tracks.

Normally the read head of a CD-ROM drive is parked as long as no data access is taking place. However, a CD-ROM drive can assume a HOLD state, in which the head remains in the area of the last read. A timeout is defined among the mode parameters, which specifies how long after an access the head should be kept in the HOLD state.

With respect to data access a CD-ROM drive does not differ significantly from other types of drives. Of course, as mentioned, no write commands have been implemented. On the other hand, in addition to logical blocks CD-ROM drives also employ other forms of data addressing.

Many SCSI CD-ROM drives can also read the audio format. This is accomplished using a separate channel that is not defined within the SCSI standard. However, audio commands and mode parameters are included. Therefore a SCSI CD-ROM drive with audio capabilities can be used as a CD player and be controlled across the SCSI bus.

The CD-ROM medium

In terms of the organization of the medium CD-ROM is fundamentally different to the other types of disks discussed thus far. While the smallest addressable unit is still a physical sector, this sector is 1/75 of a second long. It can contain audio information or computer data. In the latter case sector lengths of 2048, 2336, or 2340 bytes are possible. For computer applications a length of 2048 bytes is usually employed. This provides enough room for adequate error correction information and is divisible by 512.

The address of a sector is specified in terms of minutes, seconds, and sectors (or large frames) in the form MM:SS:FF. This is referred to as the MSF format. When an MSF address is used in a SCSI command it is given as shown in Table 20.1. The individual fields are encoded as a binary encoded decimal.

As a whole the medium is divided in up into 99 tracks. A CD-ROM track is a continuous sequence of sectors of the same type. A transition area must lie between tracks of differing types but these too must be formatted. CD-ROM tracks can contain up to 99 indexes.

The mapping from physical sectors to logical blocks is done linearly. This also takes into account the transition areas in between tracks. This results in the situation where not all logical blocks are accessible by all commands. For instance, the logical blocks containing audio information can only be read with the audio commands, not with the regular read commands. The logical blocks that map to transition areas cannot be read at all.

Table 20.1 CD-ROM address in MSF format.

0	Reserved
1	M-field
2	S-field
3	F-field

20.2 Commands for CD-ROM

For the most part the mandatory CD-ROM commands have already been introduced in previous chapters. An exception is READ CD-ROM CAPACITY which is a variation of the disk drive version. The commands unique to CD-ROM are all optional (Table 20.2). Examples would include the command to read the disk table of contents and the audio commands. Of the latter, if any are implemented they must all be implemented.

Table 20.2 CD-ROM commands.

<i>Opcode</i>	<i>Name</i>	<i>Opt</i>	<i>Page</i>	<i>ANSI</i>	<i>Description</i>
00h	TEST UNIT READY	M	141	7.2.16	Reflects whether or not the LUN is ready to accept a command
01h	REZERO UNIT	O		8.2.13	Seek track 0
03h	REQUEST SENSE	M	142	7.2.14	Returns detailed error information
08h	READ(6)	O	165	8.2.5	Read. Limited addressing
0Ah	WRITE(6)	O	165	8.2.5	Write. Limited addressing
0Bh	SEEK(6)	O		8.2.15	Seek to LBN
12h	INQUIRY	M		7.2.5	Returns LUN specific information
15h	MODE SELECT(6)	O	149	7.2.8	Set device parameters
16h	RESERVE UNIT	M	146	8.2.12	Make LUN accessible only to certain initiators
17h	RELEASE UNIT	M	146	8.2.11	Make LUN accessible to other initiators
18h	COPY	O		7.2.3	Autonomous copy from/to another device
1Ah	MODE SENSE(6)	O	149	7.2.10	Read device parameters
1Bh	START STOP UNIT	O		8.2.17	Load/unload medium
1Ch	RECEIVE DIAGNOSTIC RESULTS	O		7.2.13	Read self-test results
1Dh	SEND DIAGNOSTIC	M	147	7.2.1	Initiate self-test
1Eh	PREVENT ALLOW MEDIUM REMOVAL	O		8.2.4	Lock/unlock door
25h	READ CD-ROM CAPACITY	M	225	13.2.8	Read number of logical blocks
28h	READ(10)	M	165	8.2.6	Read
2Bh	SEEK(10)	O		8.2.15	Seek LBN
2Fh	VERIFY(10)	O		15.2.11	Verify
30h	SEARCH DATA HIGH(10)	O		8.2.14	
31h	SEARCH DATA EQUAL(10)	O		8.2.14	
32h	SEARCH DATA LOW(10)	O		8.2.14	
33h	SET LIMITS(10)	O		8.2.16	Define logical block boundaries
34h	PRE-FETCH	O		8.2.3	Read data into buffer
35h	SYNCHRONIZE CACHE	O		8.2.8	Re-read data into cache
36h	LOCK-UNLOCK CACHE	O		8.2.2	Lock/unlock data in cache
39h	COMPARE	O		7.2.2	Compare data
3Ah	COPY AND VERIFY	O		7.2.4	Autonomous copy from/to another device, verify success

Table 20.2 continued

Opcode	Name	Opt	Page	ANSI	Description
3Bh	WRITE BUFFER	O		7.2.17	Write data buffer
3Ch	READ BUFFER	O		7.2.12	Read data buffer
3Eh	READ LONG	O	166	8.2.9	Read data and ECC
40h	CHANGE DEFINITION	O	149	7.2.1	Set SCSI version
45h	PLAY AUDIO(10)	O*	227	13.2.2	
47h	PLAY AUDIO MSF	O*	227	13.2.4	
48h	PLAY AUDIO	O*	227	13.2.5	
	TRACK/INDEX				
49h	PLAY TRACK				
	RELATIVE(10)	O*		13.2.6	
4Ch	LOG SELECT	O		7.2.6	Read statistics
4Dh	LOG SENSE	O		7.2.7	Read statistics
55h	MODE SELECT(10)	O		7.2.9	Set device parameters
5Ah	MODE SENSE(10)	O		7.2.10	Read device parameters
A5h	PLAY AUDIO(12)	O*	227	13.2.3	
A8h	READ(12)	O		15.2.4	Read
A9h	PLAY TRACK	O*		13.2.7	
	RELATIVE(12)				
AFh	VERIFY(12)	O		15.2.12	Verify data
B0h	SEARCH DATA	O		15.2.8	
	HIGH(12)				
B1h	SEARCH DATA	O		15.2.8	
	EQUAL(12)				
B2h	SEARCH DATA LOW(12)	O		15.2.8	
B3h	SET LIMITS(12)	O		15.2.9	
B7h	READ DEFECT	O		15.2.5	
	DATA(12)				

READ CD-ROM CAPACITY (25h)

This command works just like the corresponding command for disk drives (Table 20.3). When the PMI bit is clear the logical block number must be zero. In this case the logical block address and the length of the last valid block will be returned. If, on the other hand, the PMI bit is set then the command will return the address and the length of the logical block, after which a substantial delay in access time occurs relative to the block provided in the command. In simpler words (though perhaps not exactly correct), the command returns the address of the last logical block of the track containing the logical block provided in the command.

The command returns an 8-byte long parameter block. The first 4 bytes contain the logical block number, the last 4 bytes the block length.

READ TOC (43h)

This command reads the table of contents of the medium (Table 20.4). Track zero is where the table of contents begins. The MSF bit indicates that the CD-ROM address should be returned in MSF format, otherwise a logical block number is returned. The command returns a data block containing the table of contents with the structure shown in Table 20.5.

Table 20.3 The READ CD-ROM CAPACITY command.

	7	6	5	4	3	2	1	0
0	READ CD-ROM CAPACITY (25h)							
1	LUN			Reserved				Rel
2	(MSB) Logical block number (LSB)							
3								
4								
5								
6	Reserved							
7								
8								
9	Control byte							

Table 20.4 The READ TOC command.

	7	6	5	4	3	2	1	0
0	READ TOC (43h)							
1	LUN			Reserved			MSF	Rel
2	Reserved							
3								
4								
5								
6								
7	(MSB) Transfer length (LSB)							
8								
9	Control byte							

Table 20.5 Data format for READ TOC.

	7	6	5	4	3	2	1	0
0	(MSB) Transfer length							
1	(LSB)							
2	First track number							
3	Last track number							
0	Reserved							
1	ADR				Attribute			
2	Track number							
3	Reserved							
4	(MSB) Transfer length							
7	(LSB)							

20.3 Audio commands for CD-ROM

The audio commands make it possible to control a CD-ROM drive remotely across the SCSI bus.

PAUSE/RESUME (4Bh)

This 10-byte command simulates the pause button of a CD player. No parameters are involved except the Resume bit (byte 8, bit 0). When this bit is clear, playing should stop; otherwise it should continue.

PLAY AUDIO(10) (45h) and PLAY AUDIO(12) (A5h)

The PLAY AUDIO commands cause the playing of audio data. The data to be played is specified by the Start address and Transfer length fields. In addition, the SOTC bit of the CD-ROM audio page has influence on these commands.

The 10-byte version of the command is shown in Table 20.6. The 12-byte version uses no additional parameters and follows the usual format.

If the start address is not found or the data specified is not audio information, or if the data type changes during playing, the command will abort with a CHECK CONDITION status.

PLAY AUDIO MSF (47h)

This command also initiates playback of audio data but uses the MSF addressing format (Table 20.7). The data to be played is specified using the starting and ending address.

PLAY AUDIO TRACK/INDEX (48h)

This variant of PLAY AUDIO uses tracks and indexes to specify the data to be played (Table 20.8). Both of these parameters assume values between 0 and 99.

Table 20.6 The PLAY AUDIO command.

	7	6	5	4	3	2	1	0
0	PLAY AUDIO(10) (45h)							
1	LUN			Reserved				Rel
2	(MSB) Start address (logical block) (LSB)							
3								
4								
5								
6	Reserved							
7	(MSB) Transfer length (LSB)							
8								
9	Control byte							

Table 20.7 The PLAY AUDIO MSF command.

	7	6	5	4	3	2	1	0
0	PLAY AUDIO MSF (47h)							
1	LUN			Reserved				
2	Reserved							
3	Start address, M-field							
4	Start address, S-field							
5	Start address, F-field							
6	End address, M-field							
7	End address, S-field							
8	End address, F-field							
9	Control byte							

Table 20.8 The PLAY AUDIO TRACK/INDEX command.

	7	6	5	4	3	2	1	0
0	PLAY AUDIO TRACK/INDEX (48h)							
1	LUN			Reserved				
2	Reserved							
3								
4	Start address, track							
5	Start address, index							
6	Reserved							
7	End address, track							
8	End address, index							
9	Control byte							

20.4 Mode parameters for CD-ROMs

Mode parameter header The mode parameter head contains two parameters for CD-ROM. The field with the Medium type assumes the values shown in Table 20.9.

The device specific byte contains only a single parameter. Bit 4 is the Cache bit and is only defined for MODE SENSE. When set it indicates that the target is equipped with a cache and that the DPO and FUA bits of the WRITE command are supported.

Mode parameter block descriptor The write density parameter in the mode parameter block descriptor takes on the values shown in Table 20.10.

Mode parameter pages The mode parameter pages in Table 20.11 have been defined for CD-ROM.

Table 20.9 CD-ROM medium types.

<i>Code</i>	<i>Medium type</i>
00h	Default
01h	120 mm CD-ROM, data only
02h	120 mm CD-ROM, audio only
03h	120 mm CD-ROM, audio and data
04h	Reserved
05h	80 mm CD-ROM, data only
06h	80 mm CD-ROM, audio only
07h	80 mm CD-ROM, audio and data

Table 20.10 CD-ROM write density.

<i>Code</i>	<i>Medium type</i>
00h	Default
01h	2048 bytes/sector
02h	2336 bytes/sector
03h	2340 bytes/sector
04h	Audio information

Table 20.11 Mode parameter pages for CD-ROM devices.

<i>Page code</i>	<i>Name</i>	<i>Page</i>	<i>ANSI</i>
01h	Read/write error page		13.3.3.3
02h	Disconnect/reconnect page	155	7.3.3.2
09h	Peripheral device page	156	7.3.3.3
0Ah	Control mode page	157	7.3.3.1
0Bh	Medium type page		8.3.3.4
0Dh	CD-ROM page	230	13.3.3.2
0Eh	CD-ROM page	230	13.3.3.1

The CD-ROM page (0Dh)

The CD-ROM page is valid for all medium types (Table 20.12). The inactivity timeout specifies how long the head should remain in the HOLD state before being parked. A key to timeout values is shown in Table 20.13.

The parameter MSF seconds per MSF minute is self-explanatory. The default value here is 60; the default value for MSF frames per MSF minute is 75.

Table 20.12 The CD-ROM page.

	7	6	5	4	3	2	1	0
0	PS	Res	CD-ROM page (0Dh)					
1	Page length (06h)							
2	Reserved							
3	Reserved				Inactive			
4	(MSB) Number of							
5	MSF seconds per MSF minute (LSB)							
6	(MSB) Number of							
7	MSF frames per MSF second (LSB)							

The CD-ROM audio page (0Eh)

The Immed bit has the usual meaning. When set GOOD status is return immediately. When the SOTC (stop on track boundaries) bit is set the target will stop the playback at a track boundary. Otherwise playback will continue until the transfer length has been exhausted (Table 20.14).

Table 20.13 Timeout values.

<i>Code</i>	<i>Timeout</i>
00h	Vendor specific
01h	125 ms
02h	250 ms
03h	500 ms
04h	1 second
05h	2 seconds
06h	4 seconds
07h	8 seconds
08h	16 seconds
09h	32 seconds
0Ah	1 minute
0Bh	2 minutes
0Ch	4 minutes
0Dh	8 minutes
0Eh	16 minutes
0Fh	32 minutes

A set APRV (audio playback rate valid) bit indicates that the LBA factor and the number of LBAs per second is valid.

The Number of LBAs per second field specifies the rate at which data is to be played back. The LBA factor is a multiplier that allows greater resolution for the setting of the LBAs per second. A 0h in this field causes Number of LBAs per second to be multiplied by 1 and a value of 8h multiplies by 1/256.

The end of the parameter page consists of settings for the four output channels. The Output port n select enables channels to port n. For instance, 0000b will mute the port, 0001b will connect channel 1, 0010b will connect channel 2, and so on. The value for Port n volume can range from 00h for very quiet to FFh for very loud.

Table 20.14 CD-ROM audio page.

	7	6	5	4	3	2	1	0
0	PS	Res	CD-ROM audio page (0Eh)					
1	Page length (0Eh)							
2	Reserved					Immed	STOC	Res
3								
4								
5								
5	APRV	Reserved			LBA Factor			
6	(MSB) Number of							
7	LBAs per second (LSB)							
8	Reserved				Output port 0 select			
9	Port 0 volume							
10	Reserved				Output port 1 select			
11	Port 1 volume							
12	Reserved				Output port 2 select			
13	Port 2 volume							
14	Reserved				Output port 3 select			
15	Port 3 volume							

21 Medium-changer devices

21.1 The model of a SCSI medium-changer device

A SCSI medium-changer device is like a juke-box, allowing many individual media to be loaded, unloaded, and accessed just like single media drives (Figure 21.1). There are four basic components or elements of this juke-box: the medium transport element (MTE), the storage element (SE), the import/export element (IOE), and the data transfer element (DTE). A device may, however, contain more than one of any of these elements. Each element is capable of being empty or holding a single medium. All elements are identified using a 16-bit address. The addresses of the various elements are consecutive and do not overlap. Since only element addressing is employed, all media must be of the same type. This means that the SCSI model does not allow a device that supports both cassette tape and optical disks.

Elements of the medium-changer device

The medium transport element

The MTE is the mechanism that moves media from one location to another. When a double-sided medium is being used the element contains the machinery

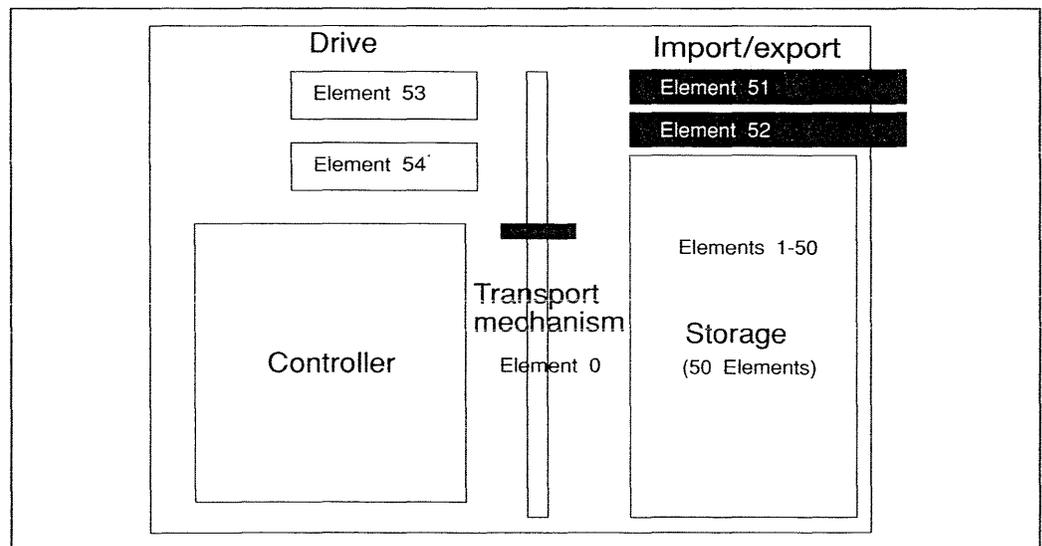

Figure 21.1 Model of a SCSI medium-changer device.

necessary to turn the unit over. Large devices contain more than one MTE.

The storage element

Media is held in the SE until it is needed for access. From here individual media are moved by the MT element to other elements of the device.

The import/export element

The IOE allows an operator to load media into and remove media from the device. Therefore, when a medium unit is to be removed from the device the MTE moves it from its current position into the IOE. The IOE does not necessarily have to be implemented since many devices allow direct hand access to storage. Large medium-changers, on the other hand, may have several IOEs.

The data transfer element

Obviously, media can be accommodated within the DTE, the place where data is ultimately accessed. For this reason it also is addressed in the element address space. Large medium-changers may employ a number of these DTEs.

From the SCSI perspective the DTE and the medium-changer are completely separate entities. No data transfer commands are contained in the medium-changer command set. In fact, the DTE may not even be SCSI compatible. One possibility is that the DTE is connected to the host using an interface other than SCSI. Another possibility is for it to be connected to the very same SCSI bus but at a different SCSI ID; in other words, the DTE is a separate target. The latter is the standard case (Figure 21.2). Finally, the two might be implemented as individual LUNs of the same SCSI target. This configuration is the least likely since the LUNs belong to different device classes.

Volume tags

Volume tags are used to identify a particular piece of medium. These tags, which are optional, are written on the medium itself and remain with it from element

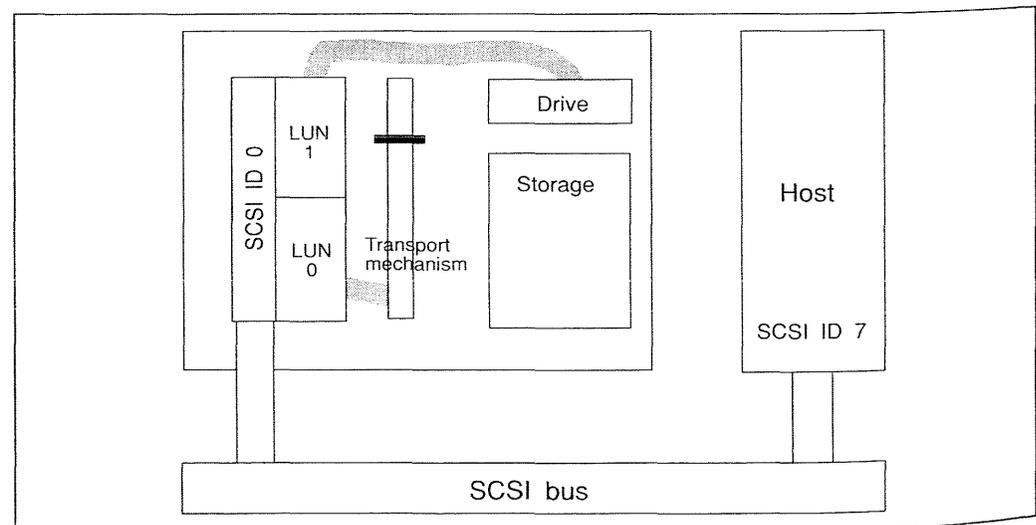

Figure 21.2 SCSI medium-changer configuration.

Table 21.1 Format of a medium volume tag.

Byte	Meaning
0	Volume identification field
...	
31	
32	Reserved
33	
34	(MSB) Volume sequence number
35	(LSB)

to element. Double-sided media have a primary volume tag for the default side and on alternate volume tag for the reverse side.

Tags are assigned using either a bar code reader or with the aid of a special command. Table 21.1 shows the format of a volume tag just as it is used by the commands READ ELEMENT STATUS and SEND VOLUME TAG.

The volume identification field contains ASCII characters. In order to be compatible with most operating systems you should use only numbers, capital letters and the underscore character. In particular, question marks and asterisks, which are wildcards in many systems, should be avoided.

The volume sequence number is 16-bits long and is used, for example, to keep track of the individual pieces of medium that belong to a single volume.

21.2 Commands for medium-changers

Table 21.2 lists the commands defined for medium-changers.

Table 21.2 Commands for medium-changer devices.

Opcode	Name	Opt	Page	ANSI	Description
00h	TEST UNIT READY	M	141	7.2.16	Reflects whether or not the LUN is ready to accept a command
01h	REZERO UNIT	O		8.2.13	Seek track 0
03h	REQUEST SENSE	M	142	7.2.14	Returns detailed error information
07h	INITIALIZE ELEMENT STATUS	O		16.2.2	Initialize element
12h	INQUIRY	M		7.2.5	Returns LUN specific information
15h	MODE SELECT(6)	O	149	7.2.8	Set device parameters
16h	RESERVE	M		16.2.8	Make LUN accessible only to certain initiators
17h	RELEASE	M	146	16.2.6	Make LUN accessible to other initiators
1Ah	MODE SENSE(6)	O	149	7.2.10	Read device parameters
1Ch	RECEIVE DIAGNOSTIC RESULTS	O		7.2.13	Read self-test results

Table 21.2 *continued*

Opcode	Name	Opt	Page	ANSI	Description
1Dh	SEND DIAGNOSTIC	M	147	7.2.1	Initiate self-test
1Eh	PREVENT ALLOW MEDIUM REMOVAL	O		8.2.4	Lock/unlock door
2Bh	POSITION TO ELEMENT	O		16.2.4	
3Bh	WRITE BUFFER	O		7.2.17	Write data buffer
3Ch	READ BUFFER	O		7.2.12	Read data buffer
40h	CHANGE DEFINITION	O	149	7.2.1	Set SCSI version
4Ch	LOG SELECT	O		7.2.6	Read statistics
4Dh	LOG SENSE	O		7.2.7	Read statistics
55h	MODE SELECT(10)	O		7.2.9	Set device parameters
5Ah	MODE SENSE(10)	O		7.2.10	Read device parameters
A5h	MOVE MEDIUM	M	236	16.2.3	
A6h	EXCHANGE MEDIUM	O	237	16.2.1	
B5h	REQUEST VOLUME ELEMENT ADDRESS	O		16.2.7	
B6h	SEND VOLUME TAG	O		16.2.9	Assign volume name
B8h	READ ELEMENT STATUS	O		16.2.5	

**MOVE MEDIUM
(A5h)**

This is the only mandatory command that is device specific. It causes the target to move a piece of medium from one element to another (Table 21.3). The element addresses of the MTE, the source, and the destination are parameters of the command. The Invert bit indicates that the medium should be flipped.

Table 21.3 The MOVE MEDIUM command.

	7	6	5	4	3	2	1	0
0	MOVE MEDIUM (A5h)							
1	LUN				Reserved			
2	(MSB) Element address of							
3	transport device							(LSB)
4	(MSB) Source address							
5	(LSB)							
6	(MSB) Destination address							
7	(LSB)							
8	Reserved							
9								
10								
11	Control byte							

If the source element is empty or the destination element is full the command will abort with a CHECK CONDITION status. This is also the case when an MTE is called for that is not supported in the mode parameter pages.

EXCHANGE MEDIUM (A6h)

This command goes one step further than the MOVE MEDIUM command. The medium in the source element is moved to the destination 1 element and the medium previously in the destination 1 element is moved to the destination 2 element. The source element and the destination 2 element may or may not be the same. When they are the two media are exchanged (Table 21.4).

Table 21.4 The EXCHANGE MEDIUM command.

	7	6	5	4	3	2	1	0	
0	EXCHANGE MEDIUM (A6h)								
1	LUN				Reserved				
2	(MSB)	Element address of							
3		medium transport element						(LSB)	
4	(MSB)	Source address							
5								(LSB)	
6	(MSB)	Final destination address							
7								(LSB)	
8	(MSB)	Second destination address							
9								(LSB)	
10							Inv2	Inv1	
11	Control byte								

21.3 Mode parameter pages for medium-changers

No device independent mode parameter pages are defined for medium-changers. Not even the disconnect-reconnect page exists. There are, however, three device specific pages, listed in Table 21.5.

Table 21.5 Mode parameter pages for medium-changer devices.

Page code	Name	Page	ANSI
1Dh	Element address page	239	16.3.3.2
1Eh	Drive group page	238	16.3.3.3
1Fh	Device capabilities page	238	16.3.3.1

The device capabilities page (1Fh)

Bits 0 through 3 in byte 2 specify whether the corresponding element is capable of independently storing a piece of medium. Bytes 4–7 contain a matrix of a possible sources and destinations for the MOVE MEDIUM command (Table 21.6). A 1 indicates that a transfer between source and destination is supported. Often a direct transfer is not possible between the import/export element and the transfer element. This transfer is accomplished by first moving through the storage element. Bytes 12–15 contain a similar matrix for the command EXCHANGE MEDIUM.

Table 21.6 The device capabilities page.

	7	6	5	4	3	2	1	0
0	PS	Res	Device capabilities page (1Fh)					
1	Page length (12h)							
2	Reserved				StorDT	StorI/E	StorST	StorMT
3	Reserved							
4	Reserved				MT→DT	MT→I/E	MT→ST	MT→MT
5	Reserved				ST→DT	ST→I/E	ST→ST	ST→MT
6	Reserved				I/E→DT	I/E→I/E	I/E→ST	I/E→MT
7	Reserved				DT→DT	DT→I/E	DT→ST	DT→MT
8	Reserved							
...								
11								
12	Reserved				MT↔DT	MT↔I/E	MT↔ST	MT↔MT
13	Reserved				ST↔DT	ST↔I/E	ST↔ST	ST↔MT
14	Reserved				I/E↔DT	I/E↔I/E	I/E↔ST	I/E↔MT
15	Reserved				DT↔DT	DT↔I/E	DT↔ST	DT↔MT

The drive group page (1Eh)

Often a number of DTEs are grouped together in order to take advantage of a single MTE. If there are several MTEs each one is assigned a single DTE. The drive group (transport geometry) page contains information about the assignment of

Table 21.7 The drive group.

	7	6	5	4	3	2	1	0
0	PS	Res	Drive group page (1Eh)					
1	Page length							
	Drive group descriptors							
0	Reserved							Rot
1	Number in group							

DTEs to MTEs and whether the latter has the capability to flip a medium (Table 21.7).

The element address page (1Dh)

The element address assignment page contains the mapping of the various functional elements to their respective element addresses (Table 21.8).

Table 21.8 The element address page.

	7	6	5	4	3	2	1	0
0	PS	Res	Page code (1Dh)					
1	Page length (12h)							
2	(MSB)	Medium transport						
3	element address						(LSB)	
4	(MSB)	Number of medium						
5	transport elements						(LSB)	
6	(MSB)	First storage						
7	element address						(LSB)	
8	(MSB)	Number of storage						
9	elements						(LSB)	
10	(MSB)	First import export						
11	element address						(LSB)	
12	(MSB)	Number of import/						
13	export elements						(LSB)	
14	(MSB)	First data transfer						
15	element address						(LSB)	
16	(MSB)	Number of data						
17	transfer elements						(LSB)	
18	Reserved							
19								

22 The SCSI monitor program

Accompanying this book is a diskette containing a SCSI monitor program. This program allows you to send arbitrary SCSI commands to a SCSI device, including the sending and receiving of data. For users without the necessary SCSI host adapter the program includes a target simulator so that a bit of experimentation is still possible.

The program runs on an IBM PC compatible computer with at least 512 Kbytes of memory running DOS 3.3 or later. A hard disk is not required. Also necessary is a SCSI host adapter and ASPI (developed by Adaptec) manager software supporting the host adapter. It is also possible to integrate the driver software into the program itself. The hooks for this are included in the source code.

A list of tested host adapters is contained in the README.DOC file of the diskette. Please take note that Adaptec host adapters can be configured to send a REQUEST SENSE automatically upon a CHECK CONDITION status. This is not desirable for use with a monitor program since here the user wants to be in full control of the sequence of commands. This feature can be disabled by a switch or jumper on the host adapter board.

Warning This program gives no warning or feedback concerning the outcome of SCSI commands on a target. It allows you to give any and all SCSI commands regardless of their effect. Be extremely careful when sending commands to a disk drive containing important information. A seemingly innocent write command could destroy valuable data.

The program is useful for familiarizing yourself with the many details of SCSI protocol and commands. In order to avoid undesired results reserve the test target using the RESERVE UNIT command.

And a bit of advice: if you aren't exactly sure what something will do, don't do it!

Program design The SCSI monitor program is written in Borland Pascal 7.0. You should also be able to compile it after minimal changes using Turbo Pascal 6.0 or 7.0. There may be problems with versions 4.0 and earlier. In order to make the program easier to port to other systems it is written in standard Pascal. I have not made use of

The command buffer

- Command nn: The current command buffer.
- Id (SCSI ID): The ID of the device to receive the command.
- St: SCSI status of the last executed command. This value remains unchanged until another command is executed. Even if the command buffer, the LUN, or the SCSI ID is edited the status remains unchanged.

Three special symbols are displayed in this field:

- ?? No command has been executed from this buffer.
- ** SCSI command is now being executed.
- The target does not reply.

- Lu: LUN to which the command pertains.
- IN: Length of the command. If this value is zero then the default command length defined for SCSI-2 command groups is used. Otherwise no command is sent. The behavior depends on the hardware employed (see README.DOC).
- nX: Next command buffer to be used when this command has completed.

Monitor commands*C (Command)*

Syntax: C<Number>,<Offset>,<Count> <Byte1> <Byte2> ...

- Number: Number of the command buffer. The current command buffer changes to display this buffer. Default: the current buffer.
- Offset: Byte position in the buffer where the command should be placed. Default: 00h.
- Count: When this parameter is included then only one command byte can be given. This single command byte is then copied into the buffer 'Count' times. Default: 00h.
- Byte1 ... ByteN: The command bytes.

Examples

```
C1 12 00 00 00 FF
```

This example writes '12 00 00 00 FF' starting at byte 0 into command buffer 1 and makes this the current command buffer.

```
C3
```

This command makes command buffer 3 the current command buffer.

```
C,3 AA
```

This command writes AAh into byte 3 of the current command buffer.

```
C,,A 0
```

This command fills the current command buffer with zeros.

I (ID)

Syntax: I <ID>

- ID: The ID for the current command buffer is changed to this value.

L (LUN)

Syntax: L <LUN>

- LUN: The LUN for the current command buffer is changed to this value.

N (leNght)

Syntax: N <Value>

- Value: The command length for the current command buffer is changed to this value.

X (neXt)

Syntax: X <CommandBuffer>

- CommandBuffer: The number of the command buffer, which should be executed automatically after the execution of the current command. The value FFh means that no command is executed afterwards. Looping on the current command buffer is allowed.

D (Data)

Syntax: D<Number>,<Offset>,<Count> <Byte1> <Byte2> ...

This command, along with its arguments, works completely analogously to the 'C' command. It allows modification of the data buffer.

G (Go)

Syntax: G

This command starts the execution of the SCSI command in the current command buffer. When necessary the current data buffer is employed. During the execution time of the command the status will display '**'. The execution of a string of commands linked using the nX field can be aborted by hitting any key.

H or ? (Help)

Syntax: H

This causes a short command overview to be displayed.

R (dRiver)

Syntax: D <Driver>

- R: A for the ASPI driver or S for the target simulator. The target simulator emulates a target at ID 0, LUN 0. The target simulator is capable of executing TEST UNIT READY, INQUIRY and REQUEST SENSE.

Q (Quit)

Syntax: Q

Quit the program.

Getting started Insure that the SCSI monitor is working by sending an INQUIRY command. INQUIRY will return a GOOD status even if an invalid LUN is addressed or if the target is in UNIT ATTENTION.

I assume here that a host adapter has been installed and that the ASPI manager has been successfully loaded. Connect a SCSI target device with ID 0 to the bus. You can easily determine whether your device is recognizable to the host adapter using the program SCSANSCSI.EXE, which is also on the diskette.

Afterwards run the SCSI monitor and enter the following command:

```
Command: C 12 0 0 0 FF
```

You should now see this command in the current command buffer. The ID and LUN should both be zero, the default settings, which need not be modified. The status '??' indicates that a command has yet to be executed.

Now enter:

```
Command: G
```

Now a 00h should be seen in the status field. Furthermore, data returned from the target should now occupy the current data buffer. You should see the product name written to the right of the buffer in ASCII.

If status is '- -' then SCSI ID 0 did not reply. In general this means that the device was not properly installed.

```

SCSI Monitor V1.0 rev 024e 18.7.94 (fs)
SCSI Command 00: 00 00 00 00 00 00 00 00 00 00 00 00 00 00 00 00
ID Lu St lN nX
03 00 02 00 FF
SCSI Data Buffer Nr. 00:
0000: 00 00 00 00 00 00 00 00 00 00 00 00 00 00 00 00
0010: 00 00 00 00 00 00 00 00 00 00 00 00 00 00 00 00
0020: 00 00 00 00 00 00 00 00 00 00 00 00 00 00 00 00
0030: 00 00 00 00 00 00 00 00 00 00 00 00 00 00 00 00
0040: 00 00 00 00 00 00 00 00 00 00 00 00 00 00 00 00
0050: 00 00 00 00 00 00 00 00 00 00 00 00 00 00 00 00
0060: 00 00 00 00 00 00 00 00 00 00 00 00 00 00 00 00
0070: 00 00 00 00 00 00 00 00 00 00 00 00 00 00 00 00
0080: 00 00 00 00 00 00 00 00 00 00 00 00 00 00 00 00
0090: 00 00 00 00 00 00 00 00 00 00 00 00 00 00 00 00
00A0: 00 00 00 00 00 00 00 00 00 00 00 00 00 00 00 00
00B0: 00 00 00 00 00 00 00 00 00 00 00 00 00 00 00 00
00C0: 00 00 00 00 00 00 00 00 00 00 00 00 00 00 00 00
00D0: 00 00 00 00 00 00 00 00 00 00 00 00 00 00 00 00
00E0: 00 00 00 00 00 00 00 00 00 00 00 00 00 00 00 00
00F0: 00 00 00 00 00 00 00 00 00 00 00 00 00 00 00 00
Command: G

```

Figure 22.2 SCSI monitor after TEST UNIT READY.

```

SCSI Monitor V1.0 rev 024e 18.7.94 (fs)
SCSI Command 00: 03 00 00 00 FF 00 00 00 00 00 00 00 00
Id Lu St lN nX
03 00 02 00 FF

SCSI Data Buffer Nr. 00:

0000: 00 00 00 00 00 00 00 00 00 00 00 00 00 00 00 00
0010: 00 00 00 00 00 00 00 00 00 00 00 00 00 00 00 00
0020: 00 00 00 00 00 00 00 00 00 00 00 00 00 00 00 00
0030: 00 00 00 00 00 00 00 00 00 00 00 00 00 00 00 00
0040: 00 00 00 00 00 00 00 00 00 00 00 00 00 00 00 00
0050: 00 00 00 00 00 00 00 00 00 00 00 00 00 00 00 00
0060: 00 00 00 00 00 00 00 00 00 00 00 00 00 00 00 00
0070: 00 00 00 00 00 00 00 00 00 00 00 00 00 00 00 00
0080: 00 00 00 00 00 00 00 00 00 00 00 00 00 00 00 00
0090: 00 00 00 00 00 00 00 00 00 00 00 00 00 00 00 00
00A0: 00 00 00 00 00 00 00 00 00 00 00 00 00 00 00 00
00B0: 00 00 00 00 00 00 00 00 00 00 00 00 00 00 00 00
00C0: 00 00 00 00 00 00 00 00 00 00 00 00 00 00 00 00
00D0: 00 00 00 00 00 00 00 00 00 00 00 00 00 00 00 00
00E0: 00 00 00 00 00 00 00 00 00 00 00 00 00 00 00 00
00F0: 00 00 00 00 00 00 00 00 00 00 00 00 00 00 00 00

Command: K 3 0 0 0 FF

```

Figure 22.3 How REQUEST SENSE is set up.

Examples When working with the SCSI monitor bear in mind that it is possible to send any arbitrary SCSI command, whether valid or not. Therefore, always check the status field after sending a command to see whether it has been successfully executed.

The first example in Figure 22.2 shows a CHECK CONDITION status (02h) after a TEST UNIT READY command. Why was this status returned? To answer this question, the command REQUEST SENSE is set up in the command buffer. This is shown in Figure 22.3.

Finally, the example in Figure 22.4 shows the results of the REQUEST SENSE command. The error code is 70h, indicating that the error pertains to the last executed command. The sense key is 02h (NOT READY). The sense code 29h means POWER-ON OR RESET. This is just what is expected from a LUN receiving its first command after power-up.

In order to observe this with my configuration I had to turn the SCSI target off and on after the system had already booted. In this way I prevented the host adapter from clearing the UNIT ATTENTION when it scans the bus at boot time.

23 Software interfaces

It is fortunate that SCSI-2 defines devices so precisely on the target side. The result is that a SCSI-2 host adapter works well with all SCSI-2 targets. However, what about the relationship between the host and the host adapter? Here the operating system must understand which SCSI commands to send to the target.

For host adapters that emulate a standard disk drive controller this is no problem. The host adapter receives drive commands like any PC disk drive controller and then translates the actions to appropriate SCSI commands. However, this hardly takes advantage of the full functionality of the SCSI bus. Here the controller is dedicated to the disk and cannot, for example, control a scanner or printer on the same bus.

There is much more involved in supporting a so-called transparent host adapter, one capable of sending arbitrary commands to any SCSI target device. There is a large number of such host adapters and each of them is designed differently; each must be supported differently by the operating system.

Help comes in the form of an additional software layer between the host adapter and the operating system or application. This software is delivered with hardware (since it is hardware specific) and provides a standardized software interface to the operating system. The result is that from the operating system's point of view all host adapters using this software interface look the same.

Here there are a number of examples of such an approach in the industry. The VMS operating system for DEC VAX machines uses the concept of class and port drivers. These are already integrated into the system so that the interplay of subsystems is clearly defined. In the PC domain two important software interfaces have emerged specifically for SCSI: the ANSI CAM (Common Access Method) specification and the ASPI interface from Adaptec, Inc.

At the moment ASPI drivers are easier to come by than CAM drivers. In fact, the SCSI monitor program (with source code) included with this book sits on top of ASPI. This application represents a good example of an ASPI implementation and it makes sense to give an overview of ASPI at this time. We will go into just enough detail to understand how ASPI is used in the SCSI monitor. The complete documentation for ASPI under DOS, Windows, OS/2, Novell and UNIX is available from Adaptec.

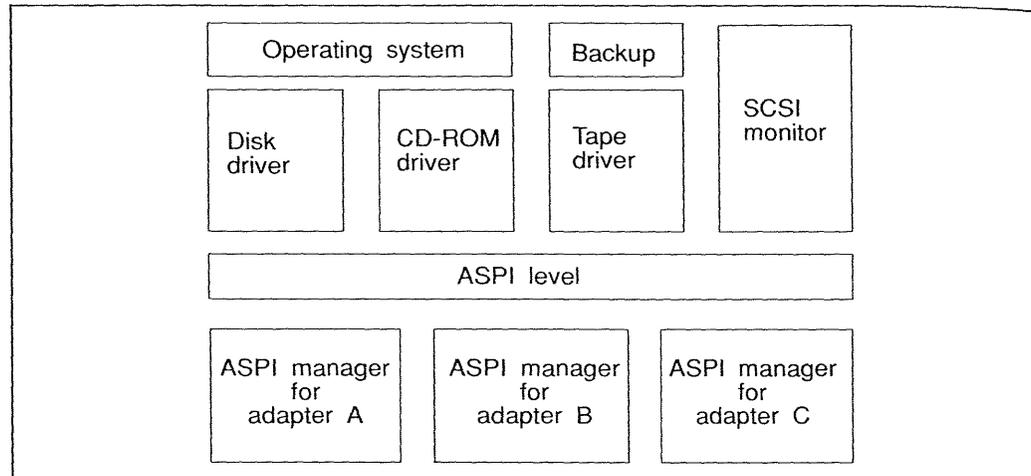

Figure 23.1 ASPI functional overview.

23.1 The concept of ASPI

ASPI stands for Advanced SCSI Programming Interface. Figure 23.1 depicts the functional layers of the interface. Different host adapters use different ASPI managers, and multiple managers can be installed simultaneously. The host software, whether device drivers or applications, talks to the SCSI bus through the ASPI interface. In this way the host software is isolated from the specific hardware details of a given host adapter.

In a DOS environment the ASPI manager is loaded at boot time by the system. Therefore, in order to use ASPI one must first obtain the entry point from DOS. When a call is made to ASPI using the entry point the address of a SCSI request block is put onto the stack. All the information necessary to carry out the SCSI procedure is contained in the request block. In the following section I show how this is done by way of short examples in Turbo Pascal.

23.2 SCSI request blocks

ASPI function calls

ASPI has a set of seven function calls, which are listed in Table 23.1. It is worth pointing out that no hard SCSI reset is included among these. This is certainly due to the fact that ASPI is capable of multi-tasking and allows many active SCSI processes to be active simultaneously. A SCSI reset would abort all of these processes in one fell swoop. On the other hand, a little experience with the SCSI monitor will show that an illegal command causes some host adapters to crash, and only a SCSI reset or system boot will correct this. The ASPI status bytes are shown in Table 23.2.

Table 23.1 ASPI function codes.

<i>Code</i>	<i>Meaning</i>
00h	HOST ADAPTER INQUIRY
01h	GET DEVICE TYPE
02h	EXECUTE SCSI COMMAND
03h	ABORT SCSI COMMAND
04h	RESET SCSI DEVICE
05h	SET HOST ADAPTER PARAMETERS
06h	GET DISK DRIVE INFORMATION

Table 23.2 ASPI status bytes.

<i>Status</i>	<i>Description</i>
00h	In progress
01h	OK
02h	SRB cancelled by host
04h	Error
80h	Invalid SRB
81h	Invalid host adapter
82h	SCSI target not found

SCSI request block (SRB) fields contain either parameters to be set or they deliver information back and can only be read. In the SRBs depicted here the fields that contain information returned from ASPI have a gray background.

SRB header An SRB always includes an 8-byte long header. Following the SRB come a certain number of parameter bytes, depending on the function. The SRB header is shown in Table 23.3:

Table 23.3 Format of an SRB header.

	7	6	5	4	3	2	1	0
0	Function							
1	Status							
2	Host adapter							
3	Flags							
4	Reserved							
5								
6								
7								

- Function: One of the function codes given in Table 23.1.
- Status: This byte takes on the values given in Table 23.2.
- Host adapter: The ASPI number of the host adapter. This number is assigned by the ASPI manager. The first adapter is assigned zero.
- Flags: These flags are independent of the function.

**HOST ADAPTER
INQUIRY (00h)**

This function call returns information on the installed host adapter (Table 23.4). The host adapter number must be provided to the call.

The Host adapter ID field contains the SCSI ID of the host adapter. The Host adapter name and SCSI manager name fields are ASCII.

The function call GET DEVICE TYPE returns information on the SCSI device class. This can be accomplished using the INQUIRY command, so we skip it here.

**EXECUTE SCSI
COMMAND (02h)**

This call is used to send an arbitrary SCSI command (Table 23.5). After the call the SRB status must be polled until a value other than zero appears. The Adaptec documentation describes an alternative to polling which uses a so-called POST routine. This is not recommended for application programs but is preferable for device drivers.

In byte 3 we are only concerned with the Direction bits. A value of 0 here means that the direction of the data transfer is determined by the SCSI command.

- Target ID: The SCSI ID of the target to receive the command.
- LUN: The LUN number sent in the IDENTIFY message.

Table 23.4 HOST ADAPTER INQUIRY.

	7	6	5	4	3	2	1	0
0	HOST ADAPTER INQUIRY (00h)							
1	Status							
2	Host adapter							
3	Reserved							
4 .. 7	Reserved							
8	Number of host adapters							
9	SCSI ID							
10 .. 25	SCSI manager name							
26 .. 41	Host adapter name							
42 .. 57	Host adapter specific							

Table 23.5 EXECUTE SCSI COMMAND.

	7	6	5	4	3	2	1	0
0	EXECUTE SCSI COMMAND (02h)							
1	Status							
2	Host adapter							
3	Reserved	Direction			Res	Link	Post	
4 .. 7	Reserved							
8	Target ID							
9	LUN							
10 .. 13	Data buffer length							
14	Sense data length (n)							
15 .. 16	Data buffer (offset)							
17 .. 18	Data buffer (segment)							
19 .. 20	SRB link pointer (offset)							
21 ... 22	SRB link pointer (segment)							
23	SCSI command length (m)							
24	Host adapter status							
25	Target status							
26 .. 27	POST routine (offset)							
28 .. 29	SRB routine (segment)							
30 .. 63	Reserved							
64 .. 64+m	SCSI command							
64+m .. 64+m+n	Sense data							

- Data buffer length: The number of data bytes to be transferred.
- Sense data length: The number of bytes reserved for sense data at the end of this SRB. For the SCSI monitor this is set to 0 and the automatic requesting of sense data should be turned off at the host adapter.
- Data buffer: Segment and offset of the data buffer.

- SRB link pointer: Pointer to the next SRB in set of linked commands (its use should be avoided).
- SCSI command length: Length of SCSI command.
- Host adapter status: Here five status codes are defined.
 - 00h: OK
 - 11h: Target does not respond
 - 12h: Data overrun
 - 13h: Unexpected BUS FREE
 - 14h: Target bus phase error
- Target status: This is the byte returned during the SCSI status phase.
- SCSI command: The bytes of the SCSI command.
- Sense data: Reserved for sense data when the host adapter is set to automatically request sense.

ABORT SCSI COMMAND (03h)

This function call attempts to abort a SCSI command (Table 23.6). The call itself always returns with a GOOD status. Whether or not the command was actually aborted can be determined only by examining the status of the original SRB.

Table 23.6 ABORT SCSI COMMAND.

	7	6	5	4	3	2	1	0
0	ABORT SCSI COMMAND (03h)							
1	Status							
2	Host adapter							
3	Reserved							
4 .. 7	Reserved							
8 .. 9	SRB address (offset)							
10 .. 11	SRB address (segment)							

23.3 ASPI initialization and function calls

ASPI initialization In order to call ASPI the entry point must be known. This is achieved using DOS interrupt 21h, as shown in the following program sample. First ASPI is opened and the entry point is determined; afterwards ASPI is closed.

```
ASPI open function FileOpen(FileName:string):integer;

const DOS_OPEN_FILE = $3D;

var register: registers;

begin
  FileName:=FileName+chr(0);
  with register
  do
    begin
      ax := DOS_OPEN_FILE shl 8;
      bx:=0;
      cx:=0;
      ds := seg(FileName);
      dx := ofs(FileName)+1; { because Pascal strings
                             carry their length in byte
0 }
    end;
  MSDOS(register);
  if (register.flags and FCarry) 0
  then FileOpen:=-1
  else FileOpen:=register.ax;
end;
```

```
ASPI entry point procedure GetASPIEntry(FileHandle:integer; var
  AspiEntry:MemAdress);

const ASPI_ENTRY_LENGTH = 4;
      DOS_IOCTL_READ = $4402;

var register: registers;

begin
  with register
  do
    begin
      ax := DOS_IOCTL_READ;
      bx := FileHandle;
```

```

        cx := ASPI_ENTRY_LENGTH;
        ds := seg(AspiEntry);
        dx := ofs(AspiEntry);
    end;
    MSDOS(register);
end;

```

ASPI close function FileClose(FileHandle:integer):integer;

```

const DOS_CLOSE_FILE = $3E;

var register: registers;

begin
    with register
    do
        begin
            ax := DOS_CLOSE_FILE shl 8;
            bx:=FileHandle;
        end;
        MSDOS(register);
        if (register.flags and FCarry) = 0
        then FileClose:=0
        else FileClose:=register.ax;
    end;
end;

```

**And all
together ...**

```

function InitializeASPI(var AspiEntrypoint:MemAdress):boolean;

const ASPI_NAME = 'SCSIMGR$';

var result: integer;
    AspiFileHandle: integer; begin
    AspiFileHandle:=FileOpen(ASPI_NAME);
    if AspiFileHandle-1
    then
        begin
            GetASPIEntry(AspiFileHandle,AspiEntryPoint);
            FileClose(AspiFileHandle);
            InitializeASPI:=true;
        end
    else InitializeASPI:=false;
    end;
end;

```

Calling ASPI The following function calls ASPI to execute an SRB. The variable `AspiEntryPoint` is a global variable of the main program:

```

procedure SRBexecute(var SRB: SRBarray);
var SRBsegment, SRBoffset: integer;

begin
  SRBsegment:=seg(SRB);
  SRBoffset:=ofs(SRB);

  asm
  mov ax, SRBsegment
  push ax
  mov ax, SRBoffset
  push ax
  LEA BX, AspiEntryPoint
  call DWORD PTR [bx]
  add sp,4
  end;
end;
```

Afterwards the SRB status must be polled until it changes from 0 to another value

Procedure `HostInquire`;

```

const
  SRB_STATUS      = $01;
  HA_SCSI_ID      = $09;
  ENTRY_LENGTH    = $10;
  MANAGER_NAME    = $0A;
  HA_NAME         = $1A;

var k: integer;
    Status: byte;
    SRB: SRBarray;
    DataBuffer : DataBufferType;

begin
  for k:=0 to high(SRB) do SRB[k]:=0;

  {What is the result of this ASPI call?
  Right! HOST ADAPTER INQUIRY Host adapter number 0}

  SRBexecute(SRB);
  repeat until SRB[SRB_STATUS]0;
  if SRB[SRB_STATUS] = 1
  then
```

```
begin
  writeln('Host Adapter SCSI ID:
         ',SRB[HA_SCISI_ID]);
  write ('Name of Host Adapter: ');
  for k:=0 to ENTRY_LENGTH-1 do
    write(char(SRB[HA_NAME+k]));
  writeln;
end
else writeln('SRB Execution Error!');
end;
```

In Appendix E and on the accompanying diskette you will find the source code to SCANSCSI.PAS. The program is relatively easy to follow and provides a good example using an ASPI interface call to execute a SCSI command.

24 Test equipment

Two components are needed in order to test SCSI targets practically: a SCSI emulator capable of sending arbitrary SCSI commands, and a logic analyzer with which one can monitor the happenings on the SCSI bus. For testing initiators the same set-up is needed except that the emulator must be capable of emulating a target.

24.1 SCSI analyzers

A SCSI analyzer permits the logging of SCSI bus activity and displaying it in a variety of formats. The most basic form of representation is the timing diagram. Such diagrams have been presented throughout this book in schematic form. Here we will see diagrams generated from an actual piece of measurement equipment (Figure 24.1).

Timing diagrams

Timing diagrams of the SCSI bus can, in principle, be made using any logic analyzer. However, the device should have a time resolution of at least 10 ns (that is, 100 MHz). For Fast SCSI this resolution is almost too low. The Fast hold time, the minimal time between the activation of REQ or ACK and the changing of the data lines, is defined to be 10 ns. If I were trying to track down Fast synchronous data transfer problems I would prefer the successor model with a resolution down to 1 ns.

If there are problems with phase sequencing on the SCSI bus there is no way to avoid the need for a timing analysis. Fortunately such problems have become very rare now that bus timing is controlled by protocol chips. Nevertheless, the potential for bus timing problems will always exist, no matter how reliable the protocol chips are.

Another application of a timing diagram is to gain an overview of longer time intervals. For example, how long does a target need from arbitration to the MESSAGE OUT phase? Here, there may be a world of difference in the behavior of different SCSI devices. Alternatively, how long are the gaps between bursts for fast synchronous transfers? Does a device disconnect from the bus and how long does it take to do so? All of these questions can be answered using the timing diagram.

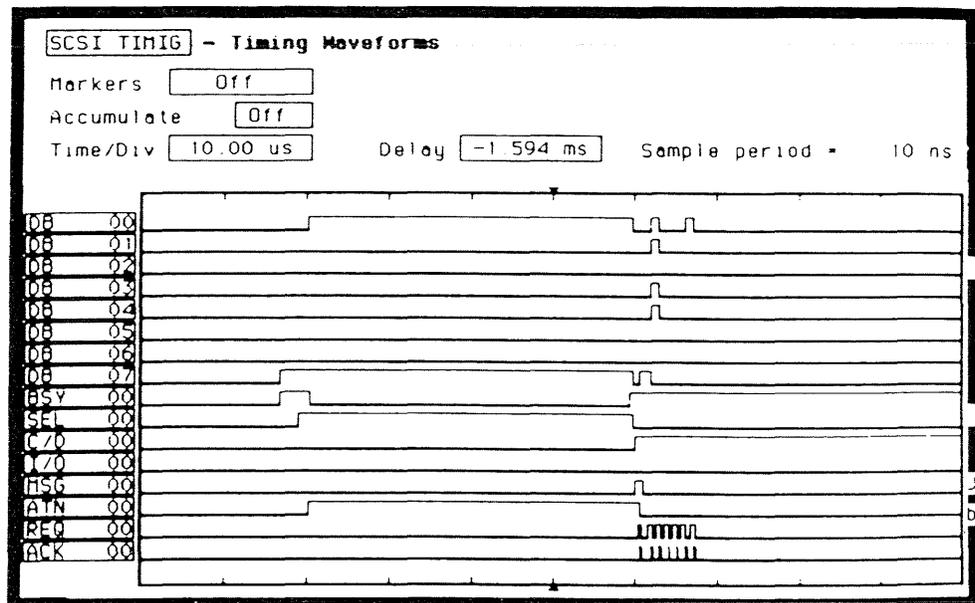

Figure 24.1 SCSI timing diagram.

Bus phase list

Another important representation of bus activity is in the form of a list of bus phases. Here the individual bus phases are listed one after another, usually stamped with a time mark. This representation is especially helpful for software development. Did the host adapter really send the command it was supposed to send? Why was nothing returned? Did the target answer? Was the correct LUN addressed in the MESSAGE OUT phase?

A number of logic analyzers equipped with a SCSI disassembler are capable of delivering a list of bus phases. However, most of these have very small buffers, holding 1 Kbyte or less. Here it becomes extremely important to trigger on an event close enough to the activity of interest, otherwise it will pass through and out of the shallow buffer.

Better still are a number of dedicated SCSI analyzers offered by various manufacturers. Although they may lack timing diagram capabilities, they possess buffers for the bus phase lists of 32 Kbytes and larger.

24.2 SCSI emulators

The SCSI monitor program

The SCSI monitor included with this book is an easy to use program (without rival as far as price is concerned) which allows arbitrary SCSI commands to be sent to any target on the SCSI bus. Although it is really intended as a educational device for the SCSI bus it can also be used for simple evaluation testing of SCSI peripherals.

With a little practice you can modify the MODE parameters and format a disk drive. Such tasks are a little cumbersome without the ability to execute a

series of preprogrammed commands. The source code of the monitor is included on the diskette, so it is easy to modify and extend the original program (but note that this is not allowed for commercial purposes).

Commercial solutions

Commercial SCSI emulators have more flexibility. For example, these are often capable of generating SCSI bus errors and other conflicts that are extremely useful for evaluating SCSI devices. Moreover, they allow lengthy test sequences to be programmed and run, and often come delivered with tests designed for various devices. Target emulation is also possible with some equipment. This makes it possible to put initiators through tests that might be impossible using actual target devices. How do you get a normal target to return more data than was requested? A target emulator is designed to do just that.

24.3 Examples from industry

The intent here is not to give a comprehensive overview of products but rather a feeling for the variety of devices by way of a few examples.

Logic analyzers

Among the classic logic analyzers are the HP 1630 and HP 1650 machines. A SCSI bus adapter, the HP 10343B, is available for both of these. The adapter makes connecting to both single-ended and differential buses very simple. Wide SCSI support, however, is lacking. The adapter comes with SCSI disassembler software, which enables the analyzer to display output in the form of a bus phase list. The analyzer is capable of resolution down to 10 ns which is more than adequate for most situations. The only weak point is the very small event buffer of 512 bytes. The timing diagrams and bus phase lists in this book were generated using the HP 1650B together with the HP 10343B.

The successor to this product is the HP 16500 logic analyzer family. This device is capable of measuring down to 1 ns. The event buffer size has been increased to 16 Kbytes. There is also an HP E2423A SCSI preprocessor available. This adapter, like the HP 10343B, allows access to single-ended and differential SCSI buses. In addition, Wide SCSI is supported.

SCSI analyzers

Adaptec builds an entire family of SCSI analyzers (see Figure 24.2). These are all implemented as PC boards with associated software. The SDS-310 is designed for transfer rates up to 5 Mbytes per second (50 ns resolution) and 8-bit SCSI. The SDS-310F supports fast synchronous transfers (20 ns resolution) and 16-bit SCSI as well. Both devices have a 32 Kbyte buffer. A special adapter is required for differential buses.

I-Tech is a company that specializes in SCSI test systems. It makes the IPC-6500, an analyzer with 20 ns resolution for Fast and Wide SCSI. This device comes with a 64 Kbyte buffer and is capable of timing diagram as well as phase

55.619_293_720	Bus_free			00032
56.611_335_080	Arb_win	7		00034
56.612_463_240		(Atn Assertion)	A	00035
56.612_886_480	Sel_start	5 7	A	00036
56.612_899_440	Sel_end		A	00037
56.614_185_340	Msg_out	C0 01 03 01 32		00038
56.615_214_460		(Atn Deassert)		00039
56.615_227_600	Msg_out	07		00040
56.615_459_880	Msg_in	01 03 01 3E 07		00041
56.623_041_840	Command	00 00 00 00 00 00		00042
56.623_470_080	Status	00		00043
56.623_896_700	Msg_in	00		00044
56.624_697_760	Bus_free			00045
62.382_979_060	Arb_start		7	00046
62.382_981_460	Arb_win	7		00047
62.384_108_860		(Atn Assertion)	A	00048
62.384_530_060	Sel_start	5 7	A	00049
62.384_543_260	Sel_end		A	00050
62.385_669_740		(Atn Deassert)		00051

Figure 24.2 Bus phase list of Adaptec analyzer.

list output. I-Tech also makes SCSI emulators and pocket testers. The latter use LEDs and are useful for diagnosing bus problems, such as a differential device connected to a single-ended bus.

SCSI emulators

Ancot is another important name in the area of SCSI test systems. The INI-350 is a SCSI initiator capable of generating controlled errors. The device is able to test SCSI targets by putting them through strange phase sequences. It is important for a target to be able to recover from improper sequences and, above all, not to lock up the bus. For these reasons the INI-350 is valuable in the design verification process. Of course, it is also fully capable of normal operation and serves well as a SCSI compliant initiator. Ancot also offers the usual assortment of test equipment, with an emphasis on standalone devices.

SCSI development systems

The SDS-3F family of test equipment is ideal for testing the entire range of SCSI options including fast synchronous and 16-bit wide transfers. These products represent an integrated development system complete with SCSI analyzer and emulator. The analyzer component has a configurable event buffer of up to 256 Kbytes. Its time resolution, however, is only good down to 20 ns. Various configurations of the emulator are capable of playing both initiator and target roles.

Adaptec has also announced the SDS-5 series of equipment. Among the improvements are an event buffer of 2 Mbytes and resolution down to 10 ns.

Summary

If you are mainly interested in occasionally testing SCSI targets for overall functionality then the SCSI monitor should be more than adequate for you.

If, on the other hand, you really need to know what is happening on the SCSI bus then there is no way to avoid investing in either a logic analyzer or a

dedicated SCSI analyzer. In general, logic analyzers have better time resolution than dedicated SCSI analyzers, but the latter are less expensive and have larger event buffers.

In most circumstances the combination of a powerful SCSI emulator together with a SCSI analyzer should suffice for the testing and evaluation of SCSI targets.

For professional design work an extensive SCSI development system is an invaluable tool, especially for work on initiators. What is more, targets supporting tagged queues are almost impossible to test without the aid of such a system.

25 SCSI protocol chips

The development of SCSI followed closely the development of the SCSI protocol chips. Without an inexpensive, fast implementation of the bus interface SCSI would have never captured the market in the way it has. In this chapter I introduce three VLSI protocol chips which have helped to make this possible. In general, each of them is suited to a different application.

Chip characteristics

When choosing a protocol chip a number of criteria must be taken into consideration.

Initiator or target?

Most protocol chips are capable of playing either the initiator or the target role. Nevertheless, some chips are better suited to one application or the other. In particular, there are chips for host adapters that require no additional logic for use with the ISA bus. In addition, these chips have a lot of SCSI overhead built in.

SCSI features

By SCSI features I mean, above all, the support of (fast) synchronous transfers as well as Wide SCSI. Here the maximum REQ/ACK offset is of interest. For Wide SCSI, if the second 8-bit data path is not implemented on the chip then there should at least be provision for the REQ_B/ACK_B signals of the B cable.

SCSI bus drivers

Whether or not SCSI line drivers are integrated into the chip represents an important cost consideration. Chips with integrated single-ended drivers are the norm, but they should also provide the control signals for additional differential circuitry.

CPU interface

The CPU interface is key to smooth integration of the SCSI chip into the device design. A SCSI chip designed for an Intel 286 microprocessor will not only require extra 'glue' logic to make it work with a Motorola 68000, but it will also work less efficiently. Since this information is sometimes lacking in the chip's data sheets, you should ask the manufacturer.

Architecture

The architecture of a chip includes various aspects of the hardware, including the data path width, and the number and kinds of registers. Another important point is to what extent the firmware of the SCSI device must intervene in the SCSI bus protocol. Ideally, the firmware should be responsible for setting up transfers, and the rest should be handled by the chip. With respect to this area, there are chips that cover the entire spectrum, beginning with those that need to be led by the firmware through every single bus phase.

Another important architecture issue is the presence of a buffer for SCSI transfers. The larger the buffer is on the chip, the more time the firmware has to react without slowing overall performance.

25.1 The NCR 5385

The NCR 5385 was the original single chip SCSI controller. Over the years it was succeeded by the 5385E and then the 5386. All three versions have fundamentally the same design. You would be hard pressed to find a 5385 in a newly developed product. NCR has since come out with a number of more advanced chips. Nevertheless, here we take a quick look at the very first chip, in order to gain a perspective for the later generations.

The 5385 is equally suited to target and initiator applications. It supports exclusively asynchronous transfers with a maximum transfer rate of approximately 2 Mbytes per second. The 5385 even needs external SCSI line drivers. Additional logic is necessary for differential drivers as well.

The 14 registers of the 5385 (Table 25.1) are selected using four address lines. It is up to the hardware designer whether to map the registers to the memory or I/O space of the processor.

The 5385 is not capable of linking together complex SCSI phase sequences. What is more, every phase change must be controlled by the

Table 25.1 NCR 5385 registers.

<i>Address</i>	<i>Type</i>	<i>Register</i>
0h	R/W	Data register
1h	R/W	Command register
2h	R/W	Control register
3h	R/W	Target ID
4h	R	Extra status
5h	R	ID register
6h	R	Interrupt register
7h	R	Source ID
9h	R	Diagnostic status
Ch	R/W	(MSB)
Dh	R/W	Transfer counter
Eh	R/W	(LSB)

firmware. Here the chip occupies three states: DISCONNECTED, INITIATOR, and TARGET. In each state only certain commands are possible. This keeps the firmware from initiating invalid bus phases. For example, the command RESELECT is only possible in the DISCONNECT state.

25.2 Target applications: EMULEX ESP200

EMULEX ESP SCSI chips are widely used in a variety of target applications (Figure 25.1). Various ESP chips are also sold by NCR under a different name. The ESP family has many members including chips that support Fast and Wide SCSI. As a group the chips are very similar, so that modifying firmware written for one chip for use with another is very straightforward. As a typical example of these chips consider the ESP200.

Characteristics

The ESP200 functions as an initiator as well as a target but is optimal in the target role. It is capable of synchronous and asynchronous transfers but lacks in Fast and Wide support. Nevertheless, it can reach rates as high as 3 Mbytes per second for asynchronous and even 5 Mbytes per second for synchronous transfers. The maximal REQ/ACK offset for synchronous transfers is 15. The ESP200 has built-in single-ended SCSI drivers and the control signals for external differential drivers.

The ESP200 uses an 8-bit architecture; that is, all data paths and registers are 8 bits wide. The microprocessor interface is ideal for microcontrollers like the

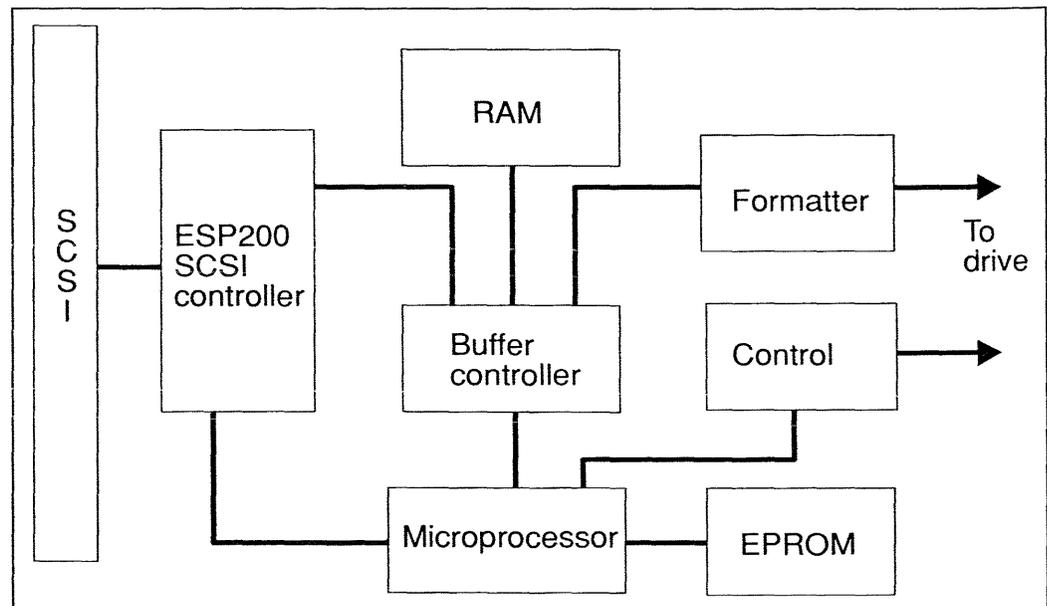

Figure 25.1 Typical target application using ESP200.

Intel 8051, for which minimal additional circuitry is necessary. Moreover, the chip includes DMA circuitry, speeding the transfer of data between memory and the SCSI bus. The chip also contains a 16-byte FIFO, which supports, among other things, the synchronous offset offered by the chip.

An important feature of the chip is that it is capable of handling sequences of SCSI phases without intervention of the microprocessor. The chip can, for example, go through the arbitration, selection, and command phases autonomously. As a target it can allow itself to be selected and receive the command before generating an interrupt to the microprocessor.

Register model and commands

The ESP200 is controlled using a bank of 8-bit registers (Table 25.2). Table 25.3 gives an overview of the chip's capabilities, along with the chip commands. It is worth mentioning that the transfer counter is only 16 bits wide, limiting transfers to 64 Kbytes.

In Table 25.3 the abbreviations Ini, Tar and Dis stand for the initiator, target, and disconnected states. The commands labeled such are only executable when the chip is in that state.

The ESP family also includes the ESP2x6 chips capable of 16-bit DMA and Wide SCSI, as well as FAS2x6 chips which in addition support Fast SCSI.

Table 25.2 ESP200 registers.

Address	Read access	Write access
0	(LSB)	Transfer
1		counter (MSB)
2		Data FIFO
3		Command
4	Status	Select/reselect SCSI ID
5	Interrupt status	Select/reselect timeout
6	Sequencer	Synchronous transfer period
7	FIFO flags	Synchronous offset
8		Configuration 1
9	Reserved	Clock factor
10	Reserved	Test
11		Configuration 2

Table 25.3 ESP200 commands.

Code	Ini/Tar	Command	Code	Ini/Tar	Command
00h		NOP	21h	Tar	Send status
01h		Clear FIFO	22h	Tar	Send data
02h		Chip reset	23h	Tar	Reconnect sequence
03h		SCSI reset	24h	Tar	Terminate sequence
10h	Ini	Data transfer	25h	Tar	Command complete sequence
11h	Ini	Command sequence	27h	Tar	Disconnect
12h	Ini	Acknowledge message	28h	Tar	Receive message
13h	Ini	Transfer	29h	Tar	Receive command
19h	Ini	Set ATN	2Ah	Tar	Receive data
40h	Dis	Reconnect	2Bh	Tar	Command sequence
41h	Dis	Select w/o ATN			
42h	Dis	Select with ATN			
43h	Dis	Select with ATN and halt			
44h	Dis	Enable reselection			
04h	Dis	Disable reselection			

25.3 PC host adapters: FUTURE DOMAIN TMC-950

The TMC-950 is an example of a single chip SCSI host adapter (Figure 25.2). No additional components are necessary to build an ISA to SCSI adapter; only if you wish to integrate a BIOS will an EPROM and decode circuitry be required. This solution is seen on a number of low cost host adapters from the Far East. Because of its popularity we take a closer look now at the workings of the TMC-950. The chip on the Seagate ST01 and ST02 host adapters has a different name but is identical.

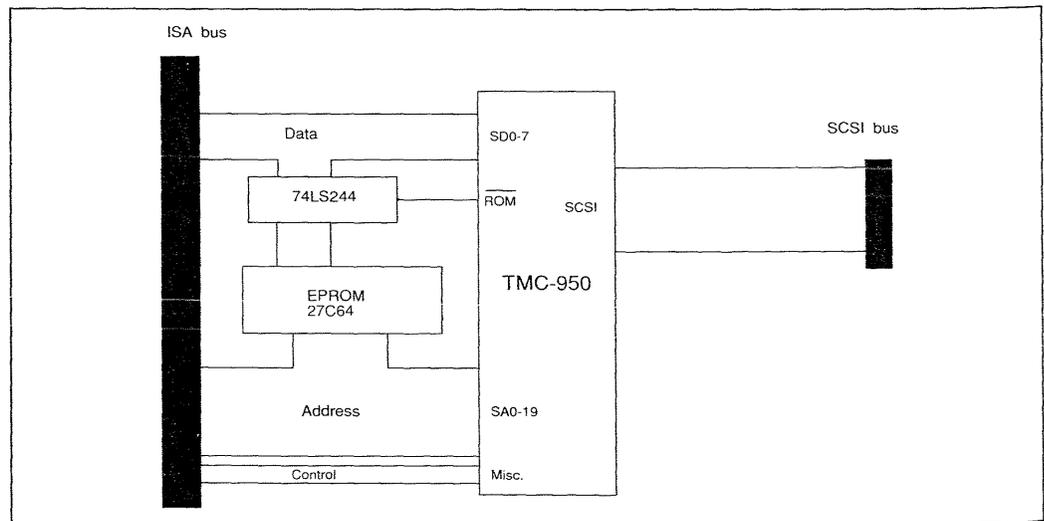

Figure 25.2 Three-chip PC host adaptor using TMC-950.

The chip comes in a JEDEC 68-pin PLCC package. It incorporates both single-ended SCSI drivers and an ISA bus interface. It supports only the initiator role and cannot be used for target applications. Only asynchronous SCSI transfers are possible, and this at a maximum rate of 2 Mbytes per second. Although such features put the chip at the lower end of the performance spectrum, its low cost and simplicity make it very attractive in many applications. It lends itself well to a system where access to a CD-ROM and perhaps a SCSI tape drive is necessary but speed is not crucial. If, on the other hand, access to a number of fast disk drives is called for, the TMC-950 is not recommended.

Programming the chip is very simple. For example, to cause the chip to arbitrate involves the sending of a single command. Afterwards one merely waits until the chip responds that it has succeeded.

Hardware model

The model of the TMC-950 is unusual and differs from those chips designed primarily for target applications (Figure 25.3). From the host's perspective the chip is an 8 Kbyte window in memory above the 640 Kbyte boundary. Four base addresses can be selected, the default of which is CA000h. The lower 6 Kbytes address the external ROM. The ROM holds disk BIOS routines. Above this at base+1800h comes 256 bytes of internal RAM. This is used to store BIOS variables and flags. The area from base+1C00h to base+1DFFh is the control/status register, regardless of which of the 512 bytes is addressed. The same is true for the area from base+1E00H to base+1FFFFH, which addresses the SCSI data register. For the Seagate ST01 and ST02 the control/status register lies in memory between base+1A00h and base+1BFFh, and the SCSI data register lies between base+1C00h and base+1FFFh.

When read, the control/status register returns status information; when written, control bits are set or cleared.

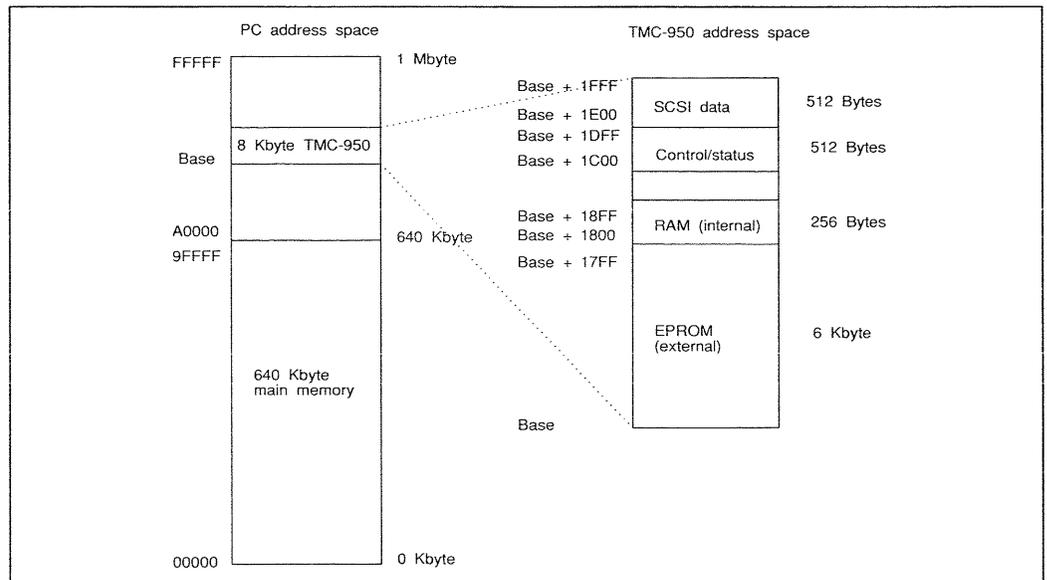

Figure 25.3 Address space of TMC-950.

The control register The bits RST, SEL, BSY and ATN activate the corresponding signals on the SCSI bus. It is the responsibility of the software to assure a proper sequence of bus phases. This allows for the generation of invalid phases in order to test the response of a target.

- Arb (start arbitration): When this bit is set the chip will begin arbitration.
- Par (SCSI parity enable): Turns on the generation of the SCSI parity bit.
- ISel: When this bit is set the chip will generate an interrupt when the SEL signal goes active.
- Dri (SCSI bus drivers enable): The SCSI line drivers of the TMC-950 are only enabled during arbitration or when this bit is set along with an active I/O signal.

The status register The bits BSY, MSG, I/O, C/D and SEL reflect the state of the corresponding signals of the SCSI bus (Table 25.4).

- RnA (request and not acknowledge): This bit is set as long as REQ but not ACK is active. This is the precise moment when the data register must be written or read.
- Par: This bit is set when a SCSI parity error occurs.
- ArbC: This bit is set when the chip wins arbitration.

The SCSI data register The SCSI data register is used to exchange data with the SCSI bus. By program control the signals I/O and REQ are monitored through the status register. As soon as REQ is active the value of I/O determines whether a read or a write is performed. Afterwards the chip activates the ACK signal.

Summary The TMC-950 is a chip designed exclusively for use in PC host adapters. No additional components are necessary for integration in an ISA system. On the SCSI side the chip supports only asynchronous transfers. Single-ended SCSI drivers are incorporated in the chip. To a certain extent SCSI bus phases are handled by the chip autonomously. The lack of a data buffer for SCSI data transfers results in a slower transfer rate.

Table 25.4 The control and status registers of the TMC-950.

Control register

7	6	5	4	3	2	1	0
Dri	ISel	Par	Arb	ATN	BSY	SEL	RST

Status register

7	6	5	4	3	2	1	0
ArbC	Par	SEL	RnA	C/D	I/O	MSG	BSY

APPENDIX A

SCSI commands (by opcode)

Key:

M Mandatory
 O Optional
 V Vendor unique

D Disk drives T Tape drives
 P Printers E Processor drives
 W WORM drives C CD-ROM
 S Scanners O Optical storage
 M Medium-changers U Communication devices

Opcode	D	T	P	E	W	C	S	O	M	U	Command
00	M	M	M	M	M	M	M	M	M	M	TEST UNIT READY
01		M									REWIND
01	O		V		O	O		O	O		REZERO UNIT
02	V	V	V	V	V	V			V		
03	M	M	M	M	M	M	M	M	M	M	REQUEST SENSE
04			O								FORMAT
04	M							O			FORMAT UNIT
05	V	M	V	V	V	V			V		READ BLOCK LIMITS
06	V	V	V	V	V	V			V		
07									O		INITIALIZE ELEMENT STATUS
07	O	V	V		O			O	V		REASSIGN BLOCKS
08										M	GET MESSAGE(06)
08	O	M	V		O	O		O	V		READ(06)
08				O							RECEIVE
09	V	V	V	V	V	V			V		
0A			M								PRINT
0A				M						M	SEND MESSAGE(06)
0A											SEND(06)
0A	O	M			O			O	V		WRITE(06)
0B	O				O	O		O	V		SEEK(06)
0B			O								SLEW AND PRINT

Opcode	D	T	P	E	W	C	S	O	M	U	Command
0C	V	V	V	V	V	V			V		
0D	V	V	V	V	V	V			V		
0E	V	V	V	V	V	V			V		
0F	V	O	V	V	V	V			V		READ REVERSE
10			O		O						SYNCHRONIZE BUFFER
10	V	M		V	V	V					WRITE FILEMARKS
11	V	M	V	V	V	V					SPACE
12	M	M	M	M	M	M	M	M	M	M	INQUIRY
13	V	O	V	V	V	V					VERIFY(06)
14	V	O	O	V	V	V					RECOVER BUFFERED DATA
15	O	M	O		O	O	O	O	O	O	MODE SELECT(06)
16	M				M	M		M	O		RESERVE
16		M	M				M				RESERVE UNIT
17	M				M	M		M	O		RELEASE
17		M	M				M				RELEASE UNIT
18	O	O	O	O	O	O	O	O			COPY
19	V	M	V	V	V	V					ERASE
1A	O	M	O		O	O	O	O	O	O	MODE SENSE(06)
1B		O									LOAD UNLOAD
1B							O				SCAN
1B			O								STOP PRINT
1B	O				O	O		O			STOP START UNIT
1C	O	O	O	O	O	O	O	O	O	O	RECEIVE DIAGNOSTIC RESULTS
1D	M	M	M	M	M	M	M	M	M	M	SEND DIAGNOSTIC
1E	O	O			O	O		O	O		PREVENT ALLOW MEDIUM REMOVAL
20	V				V	V		V	O		
21	V				V	V		V	O		
22	V				V	V		V	O		
23	V				V	V		V	O		
24	V				V	V	M				SET WINDOW
25							O				GET WINDOW
25	M				M			M			READ CAPACITY
25						M					READ CD-ROM CAPACITY
26	V				V	V					
27	V				V	V					
28										O	GET MESSAGE(10)
28	M				M	M	M	M			READ(10)
29	V				V	V		O			READ GENERATION
2A										O	SEND MESSAGE(10)
2A							O				SEND(10)
2A	M				M			M			WRITE(10)
2B		O									LOCATE
2B									O		POSITION TO ELEMENT
2B	O				O	O		O			SEEK(10)

<i>Opcode</i>	<i>D</i>	<i>T</i>	<i>P</i>	<i>E</i>	<i>W</i>	<i>C</i>	<i>S</i>	<i>O</i>	<i>M</i>	<i>U Command</i>
2C	V							O		ERASE(10)
2D	V				O			O		READ UPDATED BLOCK
2E	O				O			O		WRITE AND VERIFY(10)
2F	O				O	O		O		VERIFY(10)
30	O				O	O		O		SEARCH DATA HIGH(10)
31							O			OBJECT POSITION
31	O				O	O		O		SEARCH DATA EQUAL(10)
32	O				O	O		O		SEARCH DATA LOW(10)
33	O				O	O		O		SET LIMITS(10)
34							O			GET DATA BUFFER STATUS
34	O				O	O		O		PRE-FETCH
34		O								READ POSITION
35	O				O	O		O		SYNCHRONIZE CACHE
36	O				O	O		O		LOCK UNLOCK CACHE
37	O							O		READ DEFECT DATA(10)
38					O			O		MEDIUM SCAN
39	O	O	O	O	O	O	O	O		COMPARE
3A	O	O	O	O	O	O	O	O		COPY AND VERIFY
3B	O	O	O	O	O	O	O	O	O	O WRITE BUFFER
3C	O	O	O	O	O	O	O	O	O	O READ BUFFER
3D					O			O		UPDATE BLOCK
3E	O				O	O		O		READ LONG
3F	O				O			O		WRITE LONG
40	O	O	O	O	O	O	O	O	O	O CHANGE DEFINITION
41	O									WRITE SAME
42						O				READ SUB-CHANNEL
43						O				READ TOC
44						O				READ HEADER
45						O				PLAY AUDIO(10)
47						O				PLAY AUDIO MSF
48						O				PLAY AUDIO TRACK INDEX
49						O				PLAY TRACK RELATIVE
4B						O				PAUSE RESUME
4C	O	O	O	O	O	O	O	O	O	O LOG SELECT
4D	O	O	O	O	O	O	O	O	O	O LOG SENSE
55	O	O	O		O	O	O	O	O	O MODE SELECT(10)
5A	O	O	O		O	O	O	O	O	O MODE SENSE(10)
A5									M	MOVE MEDIUM
A5						O				PLAY AUDIO(12)
A6									O	EXCHANGE MEDIUM
A8									O	O GET MESSAGE(12)
A8					O	O		O		READ(12)
A9						O				PLAY TRACK RELATIVE(12)
AA									O	O SEND MESSAGE(12)
AA					O			O		WRITE(12)

Opcode	D	T	P	E	W	C	S	O	M	U Command
AC								O		ERASE(12)
AE					O			O		WRITE AND VERIFY(12)
AF					O	O		O		VERIFY(12)
B0					O	O		O		SEARCH DATA HIGH(12)
B1					O	O		O		SEARCH DATA EQUAL(12)
B2					O	O		O		SEARCH DATA LOW(12)
B3					O	O		O		SET LIMITS(12)
B5									O	REQUEST VOLUME ELEMENT ADDRESS
B6									O	SEND VOLUME TAG
B7								O		READ DEFECT DATA(12)
B8									O	READ ELEMENT STATUS

APPENDIX B

SCSI commands (alphabetically)

<i>Command</i>	<i>Opcode</i>	<i>D</i>	<i>T</i>	<i>P</i>	<i>E</i>	<i>W</i>	<i>C</i>	<i>S</i>	<i>O</i>	<i>M</i>	<i>U</i>
CHANGE DEFINITION	40	O	O	O	O	O	O	O	O	O	O
COMPARE	39	O	O	O	O	O	O	O	O	O	O
COPY	18	O	O	O	O	O	O	O	O	O	O
COPY AND VERIFY	3A	O	O	O	O	O	O	O	O	O	O
ERASE	19	V	M	V	V	V	V				
ERASE(10)	2C	V							O		
ERASE(12)	AC								O		
EXCHANGE MEDIUM	A6									O	
FORMAT	04			O							
FORMAT UNIT	04	M							O		
GET DATA BUFFER STATUS	34							O			
GET MESSAGE(06)	08										M
GET MESSAGE(10)	28										O
GET MESSAGE(12)	A8										O
GET WINDOW	25							O			
INITIALIZE ELEMENT STATUS	07									O	
INQUIRY	12	M	M	M	M	M	M	M	M	M	M
LOAD UNLOAD	1B		O								
LOCATE	2B		O								
LOCK UNLOCK CACHE	36	O				O	O		O		
LOG SELECT	4C	O	O	O	O	O	O	O	O	O	O
LOG SENSE	4D	O	O	O	O	O	O	O	O	O	O
MEDIUM SCAN	38					O			O		
MODE SELECT(06)	15	O	M	O		O	O	O	O	O	O
MODE SELECT(10)	55	O	O	O		O	O	O	O	O	O
MODE SENSE(06)	1A	O	M	O		O	O	O	O	O	O
MODE SENSE(10)	5A	O	O	O		O	O	O	O	O	O
MOVE MEDIUM	A5									M	
OBJECT POSITION	31							O			
PAUSE RESUME	4B						O				
PLAY AUDIO MSF	47						O				
PLAY AUDIO TRACK INDEX	48						O				

Command	Opcode	D	T	P	E	W	C	S	O	M	U
PLAY AUDIO(10)	45						O				
PLAY AUDIO(12)	A5						O				
PLAY TRACK RELATIVE(10)	49						O				
PLAY TRACK RELATIVE(12)	A9						O				
POSITION TO ELEMENT	2B									O	
PRE-FETCH	34	O				O	O		O		
PREVENT ALLOW MEDIUM REMOVAL	1E	O	O			O	O		O	O	
PRINT	0A			M							
READ BLOCK LIMITS	05	V	M	V	V	V	V			V	
READ BUFFER	3C	O	O	O	O	O	O	O	O	O	O
READ CAPACITY	25	M				M			M		
READ CD-ROM CAPACITY	25						M				
READ DEFECT DATA(10)	37	O							O		
READ DEFECT DATA(12)	B7								O		
READ ELEMENT STATUS	B8									O	
READ GENERATION	29	V				V	V		O		
READ HEADER	44						O				
READ LONG	3E	O				O	O		O		
READ POSITION	34		O								
READ REVERSE	0F	V	O	V	V	V	V			V	
READ SUB-CHANNEL	42						O				
READ TOC	43						O				
READ UPDATED BLOCK	2D	V				O	O		O		
READ(06)	08	O	M	V		O	O		O	V	
READ(10)	28	M				M	M	M	M		
READ(12)	A8					O	O		O		
REASSIGN BLOCKS	07	O	V	V		O			O	V	
RECEIVE	08				O						
RECEIVE DIAGNOSTIC RESULTS	1C	O	O	O	O	O	O	O	O	O	O
RECOVER BUFFERED DATA	14	V	O	O	V	V	V				
RELEASE	17	M				M	M		M	O	
RELEASE UNIT	17		M	M				M			
REQUEST SENSE	03	M	M	M	M	M	M	M	M	M	M
REQUEST VOLUME ELEMENT ADDRESS	B5									O	
RESERVE	16	M				M	M		M	O	
RESERVE UNIT	16		M	M				M			
REWIND	01		M								
REZERO UNIT	01	O		V		O	O		O	O	
SCAN	1B							O			
SEARCH DATA EQUAL(10)	31	O				O	O		O		
SEARCH DATA EQUAL(12)	B1					O	O		O		
SEARCH DATA HIGH(10)	30	O				O	O		O		
SEARCH DATA HIGH(12)	B0					O	O		O		

Command	Opcode	D	T	P	E	W	C	S	O	M	U
SEARCH DATA LOW(10)	32	O				O	O		O		
SEARCH DATA LOW(12)	B2					O	O		O		
SEEK(06)	0B	O				O	O		O	V	
SEEK(10)	2B	O				O	O		O		
SEND DIAGNOSTIC	1D	M	M	M	M	M	M	M	M	M	M
SEND MESSAGE(06)	0A										M
SEND MESSAGE(10)	2A										O
SEND MESSAGE(12)	AA										O
SEND VOLUME TAG	B6									O	
SEND(06)	0A				M						
SEND(10)	2A							O			
SET LIMITS(10)	33	O				O	O		O		
SET LIMITS(12)	B3					O	O		O		
SET WINDOW	24	V				V	V	M			
SLEW AND PRINT	0B			O							
SPACE	11	V	M	V	V	V	V				
STOP PRINT	1B			O							
STOP START UNIT	1B	O				O	O		O		
SYCHRONIZE BUFFER	10			O		O	O				
SYNCHRONIZE CACHE	35	O				O	O		O		
TEST UNIT READY	00	M	M	M	M	M	M	M	M	M	M
UPDATE BLOCK	3D					O			O		
VERIFY(06)	13	V	O	V	V	V	V				
VERIFY(10)	2F	O				O	O		O		
VERIFY(12)	AF					O	O		O		
WRITE AND VERIFY(10)	2E	O				O			O		
WRITE AND VERIFY(12)	AE					O			O		
WRITE BUFFER	3B	O	O	O	O	O	O	O	O	O	O
WRITE FILEMARKS	10	V	M		V	V	V				
WRITE LONG	3F	O				O			O		
WRITE SAME	41	O									
WRITE(06)	0A	O	M			O			O	V	
WRITE(10)	2A	M				M			M		
WRITE(12)	AA					O			O		

APPENDIX C

SCSI sense codes

<i>Sense code</i>	<i>Extended sense code</i>	<i>Meaning</i>
00	00	NO ADDITIONAL SENSE INFORMATION
00	01	FILEMARK DETECTED
00	02	END-OF-PARTITION/MEDIUM DETECTED
00	03	SETMARK DETECTED
00	04	BEGINNING-OF-PARTITION/MEDIUM DETECTED
00	05	END-OF-DATA DETECTED
00	06	I/O PROCESS TERMINATED
00	11	AUDIO PLAY OPERATION IN PROGRESS
00	12	AUDIO PLAY OPERATION PAUSED
00	13	AUDIO PLAY OPERATION SUCCESSFULLY COMPLETED
00	14	AUDIO PLAY OPERATION STOPPED DUE TO ERROR
00	15	NO CURRENT AUDIO STATUS TO RETURN
01	00	INDEX/SECTOR SIGNAL
02	00	SEEK COMPLETE
03	00	PERIPHERAL DEVICE WRITE FAULT
03	01	NO WRITE CURRENT
03	02	EXCESSIVE WRITE ERRORS
04	00	LOGICAL UNIT NOT READY
04	01	LOGICAL UNIT IS IN PROCESS OF BECOMING READY
04	02	LOGICAL UNIT NOT READY
04	03	LOGICAL UNIT NOT READY
04	04	LOGICAL UNIT NOT READY
05	00	LOGICAL UNIT DOES NOT RESPOND TO SELECTION
06	00	REFERENCE POSITION FOUND
07	00	MULTIPLE PERIPHERAL DEVICES SELECTED
08	00	LOGICAL UNIT COMMUNICATION FAILURE
08	01	LOGICAL UNIT COMMUNICATION TIME-OUT
08	02	LOGICAL UNIT COMMUNICATION PARITY ERROR
09	00	TRACK FOLLOWING ERROR
09	01	TRACKING SERVO FAILURE
09	02	FOCUS SERVO FAILURE

<i>Sense code</i>	<i>Extended sense code</i>	<i>Meaning</i>
09	03	SPINDLE SERVO FAILURE
0A	00	ERROR LOG OVERFLOW
0C	00	WRITE ERROR
0C	01	WRITE ERROR RECOVERED WITH AUTO REALLOCATION
0C	02	WRITE ERROR – AUTO REALLOCATION FAILED
10	00	CRC OR ECC ERROR
11	00	UNRECOVERED READ ERROR
11	01	READ RETRIES EXHAUSTED
11	02	ERROR TOO LONG TO CORRECT
11	03	MULTIPLE READ ERRORS
11	04	UNRECOVERED READ ERROR – AUTO REALLOCATE FAILED
11	05	L-EC UNCORRECTABLE ERROR
11	06	CIRC UNRECOVERED ERROR
11	07	DATA RESYNCHRONIZATION ERROR
11	08	INCOMPLETE BLOCK READ
11	09	NO GAP FOUND
11	0A	MISCORRECTED ERROR
11	0B	UNRECOVERED READ ERROR – RECOMMEND REASSIGNMENT
11	0C	UNRECOVERED READ ERROR – RECOMMEND REWRITE THE DATA
12	00	ADDRESS MARK NOT FOUND FOR ID FIELD
13	00	ADDRESS MARK NOT FOUND FOR DATA FIELD
14	00	RECORDED ENTITY NOT FOUND
14	01	RECORD NOT FOUND
14	02	FILEMARK OR SETMARK NOT FOUND
14	03	END-OF-DATA NOT FOUND
14	04	BLOCK SEQUENCE ERROR
15	00	RANDOM POSITIONING ERROR
15	01	MECHANICAL POSITIONING ERROR
15	02	POSITIONING ERROR DETECTED BY READ OF MEDIUM
16	00	DATA SYNCHRONIZATION MARK ERROR
17	00	RECOVERED DATA WITH NO ERROR CORRECTION APPLIED
17	01	RECOVERED DATA WITH RETRIES
17	02	RECOVERED DATA WITH POSITIVE HEAD OFFSET
17	03	RECOVERED DATA WITH NEGATIVE HEAD OFFSET
17	04	RECOVERED DATA WITH RETRIES AND/OR CIRC APPLIED
17	05	RECOVERED DATA USING PREVIOUS SECTOR ID
17	06	RECOVERED DATA WITHOUT ECC – DATA AUTO-REALLOCATED
17	07	RECOVERED DATA WITHOUT ECC – RECOMMEND REASSIGNMENT
18	00	RECOVERED DATA WITH ERROR CORRECTION APPLIED
18	01	RECOVERED DATA WITH ERROR CORRECTION AND RETRIES APPLIED
18	02	RECOVERED DATA – DATA AUTO-REALLOCATED
18	03	RECOVERED DATA WITH CIRC
18	04	RECOVERED DATA WITH LEC

<i>Sense code</i>	<i>Extended sense code</i>	<i>Meaning</i>
18	05	RECOVERED DATA – RECOMMEND REASSIGNMENT
19	00	DEFECT LIST ERROR
19	01	DEFECT LIST NOT AVAILABLE
19	02	DEFECT LIST ERROR IN PRIMARY LIST
19	03	DEFECT LIST ERROR IN GROWN LIST
1A	00	PARAMETER LIST LENGTH ERROR
1B	00	SYNCHRONOUS DATA TRANSFER ERROR
1C	00	DEFECT LIST NOT FOUND
1C	01	PRIMARY DEFECT LIST NOT FOUND
1C	02	GROWN DEFECT LIST NOT FOUND
1D	00	MISCOMPARE DURING VERIFY OPERATION
1E	00	RECOVERED ID WITH ECC CORRECTION
20	00	INVALID COMMAND OPERATION MODE
21	00	LOGICAL BLOCK ADDRESS OUT OF RANGE
21	01	INVALID ELEMENT ADDRESS
22	00	ILLEGAL FUNCTION (SHOULD USE 20 00)
24	00	INVALID FIELD IN CDB
25	00	LOGICAL UNIT NOT SUPPORTED
26	00	INVALID FIELD IN PARAMETER LIST
26	01	PARAMETER NOT SUPPORTED
26	02	PARAMETER VALUE INVALID
26	03	THRESHOLD PARAMETERS NOT SUPPORTED
27	00	WRITE PROTECTED
28	00	NOT READY TO READY TRANSITION (MEDIUM MAY HAVE CHANGED)
28	01	IMPORT OR EXPORT ELEMENT ACCESSED
29	00	POWER ON
2A	00	PARAMETERS CHANGED
2A	01	MODE PARAMETERS CHANGED
2A	02	LOG PARAMETERS CHANGED
2B	00	COPY CANNOT EXECUTE SINCE HOST CANNOT DISCONNECT
2C	00	COMMAND SEQUENCE ERROR
2C	01	TOO MANY WINDOWS SPECIFIED
2C	02	INVALID COMBINATION OF WINDOWS SPECIFIED
2D	00	OVERWRITE ERROR ON UPDATE IN PLACE
2F	00	COMMANDS CLEARED BY ANOTHER INITIATOR
30	00	INCOMPATIBLE MEDIUM INSTALLED
30	01	CANNOT READ MEDIUM – UNKNOWN FORMAT
30	02	CANNOT READ MEDIUM – INCOMPATIBLE FORMAT
30	03	CLEANING CARTRIDGE INSTALLED
31	00	MEDIUM FORMAT CORRUPTED
31	01	FORMAT COMMAND FAILED
32	00	NO DEFECT SPARE LOCATION AVAILABLE
32	01	DEFECT LIST UPDATE FAILURE

<i>Sense code</i>	<i>Extended sense code</i>	<i>Meaning</i>
33	00	TAPE LENGTH ERROR
36	00	RIBBON
37	00	ROUNDED PARAMETER
39	00	SAVING PARAMETERS NOT SUPPORTED
3A	00	MEDIUM NOT PRESENT
3B	00	SEQUENTIAL POSITIONING ERROR
3B	01	TAPE POSITION ERROR AT BEGINNING-OF-MEDIUM
3B	02	TAPE POSITION ERROR AT END-OF-MEDIUM
3B	03	TAPE OR ELECTRONIC VERTICAL FORMS UNIT NOT READY
3B	04	SLEW FAILURE
3B	05	PAPER JAM
3B	06	FAILED TO SENSE TOP-OF-FORM
3B	07	FAILED TO SENSE BOTTOM-OF-FORM
3B	08	REPOSITION ERROR
3B	09	READ PAST END OF MEDIUM
3B	0A	READ PAST BEGINNING OF MEDIUM
3B	0B	POSITION PAST END OF MEDIUM
3B	0C	POSITION PAST BEGINNING OF MEDIUM
3B	0D	MEDIUM DESTINATION ELEMENT FULL
3B	0E	MEDIUM SOURCE ELEMENT EMPTY
3D	00	INVALID BITS IN IDENTIFY MESSAGE
3E	00	LOGICAL UNIT HAS NOT SELF-CONFIGURED YET
3F	00	TARGET OPERATING CONDITIONS HAVE CHANGED
3F	01	MICROCODE HAS BEEN CHANGED
3F	02	CHANGED OPERATING DEFINITION
3F	03	INQUIRY DATA HAS CHANGED
40	00	RAM FAILURE (SHOULD USE 40 NN)
40	NN	DIAGNOSTIC FAILURE ON COMPONENT NN (80H–FFH)
41	00	DATA PATH FAILURE (SHOULD USE 40 NN)
42	00	POWER-ON OR SELF-TEST FAILURE (SHOULD USE 40 NN)
43	00	MESSAGE ERROR
44	00	INTERNAL TARGET FAILURE
45	00	SELECT OR RESELECT FAILURE
46	00	UNSUCCESSFUL SOFT RESET
47	00	SCSI PARITY ERROR
48	00	INITIATOR DETECTED ERROR MESSAGE RECEIVED
49	00	INVALID MESSAGE ERROR
4A	00	COMMAND PHASE ERROR
4B	00	DATA PHASE ERROR
4C	00	LOGICAL UNIT FAILED SELF-CONFIGURATION
4E	00	OVERLAPPED COMMANDS ATTEMPTED
50	00	WRITE APPEND ERROR
50	01	WRITE APPEND POSITION ERROR
50	02	POSITION ERROR RELATED TO TIMING

<i>Sense code</i>	<i>Extended sense code</i>	<i>Meaning</i>
51	00	ERASE FAILURE
52	00	CARTRIDGE FAULT
53	00	MEDIA LOAD OR EJECT FAILED
53	01	UNLOAD TAPE FAILURE
53	02	MEDIUM REMOVAL PREVENTED
54	00	SCSI TO HOST SYSTEM INTERFACE FAILURE
55	00	SYSTEM RESOURCE FAILURE
57	00	UNABLE TO RECOVER TABLE-OF-CONTENTS
58	00	GENERATION DOES NOT EXIST
59	00	UPDATED BLOCK READ
5A	00	OPERATOR REQUEST OR STATE CHANGE INPUT (SPECIFIED)
5A	01	OPERATOR MEDIUM REMOVAL REQUEST
5A	02	OPERATOR SELECTED WRITE PROTECT
5A	03	OPERATOR SELECTED WRITE PERMIT
5B	00	LOG EXCEPTION
5B	01	THRESHOLD CONDITION MET
5B	02	LOG COUNTER AT MAXIMUM
5B	03	LOG LIST CODES EXHAUSTED
5C	00	RPL STATUS CHANGE
5C	01	SPINDLES SYNCHRONIZED
5C	02	SPINDLES NOT SYNCHRONIZED
60	00	LAMP FAILURE
61	00	VIDEO ACQUISITION ERROR
61	01	UNABLE TO ACQUIRE VIDEO
61	02	OUT OF FOCUS
62	00	SCAN HEAD POSITIONING ERROR
63	00	END OF USER AREA ENCOUNTERED ON THIS TRACK
64	00	ILLEGAL MODE FOR THIS TRACK

APPENDIX D

The SCSI bulletin board

The ANSI SCSI specification can also be acquired in an electronic format from the SCSI bulletin board (SCSI BBS) in the US. The telephone number (as of February 1993) is:

(719) 574-0424

If you are calling for the first time, you will need to register for a user account. In general it takes a few days to set up the account and the permissions that allow you to access data on the BBS. The SCSI BBS offers access to the various X3T9 documents, among other important documentation and information. You can follow, for example, ongoing discussions concerning the SCSI-3 standard. It is also possible to access information on other X3T domains such as IPI, ATA, or HIPPI.

WILDCAT! Copyright (c) 87,92 Mustang Software, Inc. All Rights Reserved.
Registration Number: 92-3725. Version: 3.55M (MULTI-LINE).
Node:1.

Connected at 2400 bps. ANSI detected.

The SCSI Bulletin Board System
Provided by the NCR Corporation
Using the WildCat! BBS Package Version 3.55M

New User Call limit....60 minutes/call....90 minutes/day
(temporary settings)
Registered Users.....60 minutes/call....90 minutes/day
Modem.....USR Courier HST(tm) Dual
Standard(tm)
Baud rates.....300-14400 (+HST 16800)

What is your first name? friedhelm
What is your last name? schmidt
Looking up "FRIEDHELM SCHMIDT". Please wait...

Your name "FRIEDHELM SCHMIDT" was not found in the user data base.

Hello! You are a new user to the system and we want to welcome you.

There are many features to discover, so please read the HELP files and experiment with new choices.

Check the Bulletin menu and Newsletter file for additional information.

Welcome to The SCSI BBS.

For our BBS records we would like to get some additional information. Please answer as correctly as possible to enable us to provide the best service and support possible.

etc., etc. ...

***** Draft Standard *****

While this BBS is called The SCSI BBS, there are other I/O interfaces covered here as well. I have separated the files for these projects into different file areas in a rather ad hoc fashion. Here is the map:

SCSI-1	File Area 7
SCSI-2	File Area 8
SCSI-3	File Area 20
ATA	File Area 15
CAM	File Area 13
ESDI	File Area 21
HIPPI	File Area 16
IPI	File Area 14
Fibre Channel	File Area 17

Please remember that these files are provided for review and comment purposes only. The final ANSI-approved versions will not be posted here — if you want an ANSI-approved standard, you must purchase the paper copy from ANSI (or Global Engineering Documents). Ordering information is contained in another bulletin.

APPENDIX E

Source code for SCANSCSI.PAS

SCANSCSI is a short utility program that also serves as a good example of an ASPI application. It checks all LUNs of all SCSI IDs to see whether a device is present. It does not rely on the ASPI internal table of devices but rather sends an INQUIRY command to each LUN. In this way devices that have been added to the bus after the loading of the ASPI manager are also discovered.

```
program scanscsi(input,output);
```

```
{** Copyright Notice: This source code belongs to the  
book  
"The SCSI Bus and IDE Interface" from Addison-Wesley.
```

```
It may be ported and modified for non-commercial  
purposes when this copyright notice is included.  
Authorization of the publisher is necessary for  
commercial purposes.
```

```
}
```

```
uses CRT, DOS;
```

```
const  
  PNAM      : string='SCSI-Scanner V1.0 rev 003 25.2.93  
(fs)';
```

```
{ASPI Specific Constants}
```

```
ASPI_SRB_LENGTH = $7F;  
  
SRB_COMMAND_CODE = $00;  
SRB_STATUS       = $01;  
SRB_TARGET_ID   = $08;  
SRB_LUN         = $09;  
SRB_DATA_LENGTH = $0A;  
SRB_BUFFER_OFS  = $0F;
```



```

SRB_BUFFER_SEG   = $11;
SRB_SCSI_LEN     = $17;
SRB_HA_STATUS    = $18;
SRB_TARGET_STATUS= $19;
SRB_SCSI_CMD     = $40;

SRB_X_SCSICMD   = $02;

{SCSI Specific Constants}

SCSI_CMD_LENGTH  = 11;

{Program specific constants}

DATA_LENGTH      = $FF;

{Messages}

ASPI_CONNECTED   = 'ASPI loaded';
ASPI_OPEN_ERROR  = 'Error opening ASPI';

type

{Generic Types}
  MemAdress = record
    Offset: integer;
    Segment: integer;
  end;

{ASPI-Types}

  SRBsize= 0..ASPI_SRB_LENGTH;
  SRBarray = array[SRBsize] of byte;

{SCSI-Types}

  SCSCmdSize = 0..SCSI_CMD_LENGTH;
  SCSCmd = record
    Command: array[SCSCmdSize] of byte;
    Status: byte;
    ID: byte;
    LUN: byte;
    Len: byte;
    Timeout: integer;
  end;
  BufferLength = 0..DATA_LENGTH;
  DataBufferType = array[BufferLength] of byte;

```

```

var
  CommandBuffer : SCSICmd;
  DataBuffer    : DataBufferType;
  ID,LUN        : byte;
  AspiEntryPoint: MemAdress;
  SRB: SRBarray;
  SCSIConnected: string;

{**** Low Level Functions}

function FileOpen(FileName:string):integer;

const DOS_OPEN_FILE = $3D;

var register: registers;

begin
  FileName:=FileName+chr(0);
  with register
  do
    begin
      ax := DOS_OPEN_FILE shl 8;
      bx:=0;
      cx:=0;
      ds := seg(FileName);
      dx := ofs(FileName)+1; { because Pascal strings carry
                             their length in byte 0 }
    end;
    MSDOS(register);
    if (register.flags and FCarry) > 0
    then FileOpen:=-1
    else FileOpen:=register.ax;
  end;

function FileClose(FileHandle:integer):integer;

const DOS_CLOSE_FILE = $3E;

var register: registers;

begin
  with register
  do
    begin
      ax := DOS_CLOSE_FILE shl 8;
      bx:=FileHandle;
    end;
    MSDOS(register);

```

```

        if (register.flags and FCarry) = 0
        then FileClose:=0
        else FileClose:=register.ax;
end;

{**** Miscellaneous Generic Functions}

{**** SCSI generic functions}

function SCISICmdLen(Opcod: byte):byte;
begin
    SCISICmdLen:=0;
    if Opcod and $E0 = $00 then SCISICmdLen:=6;
    if Opcod and $E0 = $20 then SCISICmdLen:=10;
    if Opcod and $E0 = $40 then SCISICmdLen:=10;
    if Opcod and $E0 = $A0 then SCISICmdLen:=12;
end;

{**** ASPI-specific functions}

procedure GetASPIEntry(FileHandle:integer; var
    AspiEntry:MemAdress);

const ASPI_ENTRY_LENGTH = 4;
      DOS_IOCTL_READ    = $4402;

var register: registers;

begin
    with register
    do
        begin
            ax := DOS_IOCTL_READ;
            bx:=FileHandle;
            cx:=ASPI_ENTRY_LENGTH;
            ds := seg(AspiEntry);
            dx := ofs(AspiEntry);
        end;
        MSDOS(register);
end;

procedure SCISI2SRB(var SRB: SRBArray; Command: SCISICmd;
    var DataBuffer: DataBufferType);

var k:integer;
begin
    for k:=0 to High(SRB) do SRB[k]:=0;
    SRB[SRB_COMMAND_CODE]:=SRB_X_SCISICMD;

```

```

with Command do
begin
  SRB[SRB_TARGET_ID]:=ID;
  SRB[SRB_LUN]:=LUN;
  SRB[SRB_SCSI_LEN]:=SCSICmdLen(Command[1]);
  for k:=0 to SRB[SRB_SCSI_LEN]-1 do
SRB[SRB_SCSI_CMD+k]:=Command[k];
  end;

  SRB[SRB_DATA_LENGTH]:=lo(DATA_LENGTH);
  SRB[SRB_DATA_LENGTH+1]:=hi(DATA_LENGTH);
  SRB[SRB_BUFFER_SEG]:=lo(seg(DataBuffer));
  SRB[SRB_BUFFER_SEG+1]:=hi(seg(DataBuffer));
  SRB[SRB_BUFFER_OFS]:=lo(ofs(DataBuffer));
  SRB[SRB_BUFFER_OFS+1]:=hi(ofs(DataBuffer));

end;

procedure SRBexecute(var SRB: SRBarray);
var SRBsegment, SRBoffset: integer;

begin

  SRBsegment:=seg(SRB);
  SRBoffset:=ofs(SRB);

  asm
  mov ax, SRBsegment
  push ax
  mov ax, SRBoffset
  push ax
  LEA BX, AspiEntryPoint
  call DWORD PTR [bx]
  add sp,4
  end;
end;

function InitializeASPI(var AspiEntrypoint:MemAdress):
boolean;

const ASPI_NAME = 'SCSIMGR$';

var result: integer;
    AspiFileHandle: integer;
begin
  AspiFileHandle:=FileOpen(ASPI_NAME);
  if AspiFileHandle>-1
  then

```

```

begin
  GetASPIEntry(AspiFileHandle,AspiEntryPoint);
  FileClose(AspiFileHandle);
  InitializeASPI:=true;
end
else InitializeASPI:=false;
end;

procedure initialize;

var ByteNbr : integer;

begin
  with CommandBuffer do
  begin
    for ByteNbr:=0 to SCSI_CMD_LENGTH do
      Command[ByteNbr]:=0;
      ID:=0;
      LUN:=0;
      Status:=$FF;
    end;
    for ByteNbr:=0 to DATA_LENGTH do DataBuffer[ByteNbr]:=0;
  end;

  Procedure Inquire(ID,LUN:byte);
  const INQUIRY : array [SCSICmdSize] of byte =
    ($12,$0,$0,$0,$ff,$0,$0,$0,$0,$0,$0,$0);

  var k: integer;
      Status: byte;
  begin
    for k:=0 to SCSI_CMD_LENGTH do
    CommandBuffer.command[k]:=INQUIRY[k];
    CommandBuffer.ID:=ID;
    CommandBuffer.LUN:=LUN;
    If LUN=0 then writeln('SCSI-ID ',ID,': ');
    SCSI2SRB(SRB,CommandBuffer,DataBuffer);
    SRBexecute(SRB);
    repeat until SRB[SRB_STATUS]<>0;
    if SRB[SRB_STATUS] = 1 then
      if SRB[SRB_HA_STATUS]= 0 then
        begin
          Status:=DataBuffer[0] and $E0;
          if Status=0 then
            begin
              write(' LUN ',LUN,': ');
              for k:=8 to 35 do write(chr(DataBuffer[k]));
              writeln;
            end;
          end;
        end;
      end;
    end;
  end;
end;

```

```
        end;  
    end  
    else if LUN=0 then writeln;  
end;  
  
begin  
    writeln(PNAM);  
    initialize;  
    if InitializeASPI(AspiEntryPoint)  
    then  
        begin  
            writeln(ASPI_CONNECTED);  
            for ID:=0 to 7 do  
                for LUN:=0 to 7 do Inquire(ID,LUN);  
            end  
        else writeln(ASPI_OPEN_ERROR);  
    end.  
end.
```

Glossary

Active high An electrical signal is active high when it is interpreted as true for high voltage levels. *See also* Active low.

Active low A signal that is interpreted as true in the low voltage state. Often such signals have a bar over the name, such as \overline{DASP} .

SCSI Since all SCSI signals are active low they are not marked in any special way in the SCSI chapters.

IDE Low active signals are marked with a bar in the IDE chapters.

AT bus Refers to either the system bus of IBM AT compatible computers, the ISA bus, or the IDE interface. The term AT bus is not used in this book but instead ISA bus and IDE interface are used.

ATA standard The ANSI version of the IDE interface is called ATA. The name comes from AT Attachment. In this book ATA is used whenever the ANSI standard is meant.

Bandwidth *see* Throughput.

Cache A small storage capable of very fast access. For disk drives such a cache is implemented as RAM, usually at least 1 Mbyte in size. All data read from the medium is stored here. Data that is already in the cache can be read up to 20 times faster. When the cache is full the oldest data is overwritten.

SCSI Contingent allegiance condition This is created for an I_T_x nexus after a CHECK CONDITION or COMMAND TERMINATED status. In this condition a LUN holds sense data pertaining to the I_T_x nexus. If a LUN is only capable of holding data for a single I_T_x nexus then attempts by all other initiators to access the LUN will be met with BUSY status. In the event that a TAGGED QUEUE is implemented for this LUN other commands will not be affected (*see* Extended contingent allegiance condition). The contingent allegiance condition ends when a new command is received from the same initiator or by an ABORT or BUS DEVICE RESET message.

- Controller** In this book a controller is a system component that controls a peripheral device. A controller may reside on the peripheral itself or be integrated into the host system. The term is often used in reference to a subsystem that is actually a combination of a controller and host adapter. As an example, a disk drive controller allows for the attachment of disk drives to the host system.
- SCSI** A SCSI controller allows the connecting of one or more peripheral devices to the SCSI bus. The device that connects the SCSI bus to the host system is called a host adapter.
- CRC (cyclic redundancy check)** A checksum that is written in addition to the data to a sector. With the aid of CRC data errors can be detected with higher confidence than with a simple parity bit.
- Data rate** *see* Throughput.
- DMA (direct memory access)** Refers to the ability of a host adapter to write and read host system memory without host intervention. This not only makes possible very fast data transfers but also frees the host processor to do other tasks. This is especially advantageous in multi-tasking systems where multiple tasks are the norm. Programmed I/O (PIO), on the other hand, is performed entirely by the host processor.
- ECC (error correction code)** Additional bits written with the data that allow, to a certain degree, the recognition and correction of data errors. Disk drives always employ error correction codes.
- SCSI Extended contingent allegiance condition** This extends the normal contingent allegiance condition in that the execution of all commands in the tagged queue of this LUN is also suspended. This condition exists for an I_T_L nexus and is entered by the target in certain error situations. The target sends an INITIATE RECOVERY message after a CHECK CONDITION status. Afterwards the initiator should take appropriate measures to recover from the error. The extended contingent allegiance condition is ended when the initiator sends a RELEASE RECOVERY message.
- Formatted capacity** As opposed to unformatted capacity, this is the amount of space available to store information on a disk drive. The replacement sectors are not included. The formatted capacity of a drive is usually between 10 and 30% less than the unformatted capacity.
- Formatting** A hard disk or replaceable medium disk needs to be formatted before data can be stored on it. Here sectors for data storage are written to the medium. Since the sectors take up more room than just what is needed for data storage there arises a difference between formatted and unformatted drive capacity.

- Geometry** The geometry of a disk drive describes the format of the drive in terms of cylinders, heads, and sectors. For example, two drives with different geometries differ in the number of cylinders.
- Hard sector** A type of disk drive formatting where the beginning of each sector is marked by a pulse generated by the head disk assembly. In comparison, the pulse from a soft sector format is generated from the read/write electronics and requires space on the medium.
- Host adapter** A host adapter allows a controller to be connected to the I/O bus of the host. The host adapter may be integrated on the motherboard of the system or it may be implemented as a separate board.
- I/O bus** A computer bus for the attachment of peripheral devices.
- SCSI I/O process** Any logical connection between two SCSI devices is referred to as an I/O process. It begins with the selection of a target by an initiator. It exists during the entire command execution or command chain including all BUS FREE periods. Normally, the process ends after the message COMMAND COMPLETE with a BUS FREE phase.
- IDE interface** A disk drive interface used primarily in the PC domain. The name comes from integrated disk electronics. Also known as ATA interface.
- Index** A pulse indicating the beginning of a track on a rotating disk.
- SCSI Initiator** One of two possible device types that occupy the SCSI bus. The initiator is the device that initiates the I/O process. As soon as the target device is selected it controls the I/O process as well as the SCSI protocol.
- ISA bus** The original system bus of the IBM AT. The bus has since become a standard and is used by all AT compatible systems. The name comes from industry standard architecture.
- SCSI I_T_x Nexus** Either an I_T_L nexus or an I_T_L_Q nexus.
- SCSI LUN (logical unit)** Each SCSI target contains at least one and up to eight LUNs. A LUN is the actual physical device. For example a SCSI controller connected to three disk drives controls three LUNs.
- Mapping** For disk drives, the correspondence between physical sectors and logical block numbers is accomplished through a mapping. A linear mapping refers to the approach where first sectors of a track, then tracks of a cylinder, and finally cylinders are exhausted for increasing LBN numbers.

This approach insures that the access time for continuous logical blocks is minimal.

Master When two devices or systems are in such a relationship that one of them has control over the other, the controlling device is the master and the other device the slave.

IDE Master drive For IDE, drive 0 is the master drive. The term derives from the fact that when spindle synchronization is used this drive supplies the clock for the second drive. Otherwise the drives are independent.

Mirrored drives Two disk drives that are maintained to hold exactly the same information are said to be mirrored. Mirroring is the responsibility of a controller or special software and is transparent to the user. Mirrored drives are used for redundancy purposes in the event of a hardware failure.

Parity bit Simple error detection for a data byte. A parity bit transferred with the data byte allows the receiver to detect 1-bit errors. Multiple bit errors may not be detected.

PIO (programmed I/O) The exchange of data via a register or port by program control. In contrast to direct memory access (DMA), the processor moves each individual piece of data to memory, which is very time consuming.

Redundancy Insurance against data loss or downtime through the use of duplicate components. In order to guarantee zero downtime some systems allow for replacements 'on-the-fly', or hot swaps.

Rotational position sensing (RPS) A controller connected to multiple disk drives which monitors the relative rotational position of each drive is said to employ RPS. This is accomplished by monitoring the index pulses of the drives. When processing multiple I/O requests this allows the controller to choose the drive that can be accessed with minimal access time.

Slave *see* Master.

IDE Slave drive *see* Master drive.

Soft sectoring A method of formatting for a disk drive. Here the pulse marking the beginning of a sector is written to the medium during formatting and read from the medium during access to the sector, in contrast to hard sectoring, which uses slightly less space on the disk.

Spindle synchronization Two or more disk drives that are synchronized for spindle speed and rotational position are said to employ spindle synchronization. This allows, for example, simultaneous writing of mirrored drives.

SCSI Status A byte sent from the target to the initiator at the end of a command sequence. This byte reflects the success or failure of the command execution. Afterwards the message COMMAND COMPLETE normally follows.

- SCSI Status phase** The SCSI bus phase where a status byte is transferred from the target to the initiator.
- SCSI Target** One of two possible SCSI device types that occupy the SCSI bus. The target is the device that executes commands for the initiator. After the selection phase the target takes control of bus protocol.
- IDE Task file** Another name for the command register block of an IDE controller.

Throughput (bandwidth, data rate) Given in Mbytes per second, throughput relates how much data can be transferred over the bus in a given time. Throughput is the product of the transfer rate in MHz times the bus width in bytes. For example, a 32-bit wide SCSI bus with a transfer rate of 10 MHz results in a throughput of 40 Mbytes per second. As a further differentiation, there is also the peak transfer rate and sustained transfer rate. For example, a disk drive typically has a sustained transfer rate of 3 Mbytes per second. This is how fast the data can be read from the medium. However, a controller using Fast SCSI might be able to reach a peak data rate of 10 Mbytes per second.

Transfer rate The speed at which a data transfer occurs measured in MHz. In the case of 8-bit transfers this is identical to throughput in Mbytes per second. It is often used to express serial rates like that of the data from the head of a drive. Here a transfer rate of 24 MHz corresponds to a throughput of 3 Mbytes per second.

Unformatted capacity The capacity of a disk drive or medium before formatting. Only the formatted capacity is important to the user. Unformatted capacity lies approximately 10 to 30% higher than this. Manufacturers cite unformatted capacity since formatted capacity is a function of the exact method of formatting.

- SCSI Unit attention condition** This condition exists in a LUN relative to certain initiators when a status change has occurred in the LUN that the initiators did not cause. Examples of such status changes are the insertion of a medium in a replaceable medium drive, the setting of MODE parameters from a third-party initiator or a SCSI reset. As long as a unit attention condition exists the LUN will reply to all commands with a CHECK CONDITION status and status key UNIT ATTENTION, with the exception of INQUIRY and REQUEST SENSE, which will be executed normally. After this the LUN enters into a contingent allegiance condition. The unit attention condition ends for an initiator as soon as it receives the CHECK CONDITION status. Unit attention can also hold for all LUNs and all initiators. This occurs, for example, at power-up or after a SCSI reset.

Index

½ inch tape 182
10 byte command 136
12 byte command 136
6 byte command 134

A

A cable 19, 23, 92
ABORT 128, 252
abort command 56
ABORT TAG 128
access time 18
ACKNOWLEDGE MEDIA CHANGE 70
ACTIVE (status) 65
address register 52, 55
addressing
 logical 60
 physical 60
 relative 23, 140
AEN 129, 140, 157, 162, 208
alternate status register 53
ANSI 37, 40
ANSI version 38, 40, 140
asynchronous 8, 12, 25, 81, 109, 111,
 114, 117, 124, 140, 208, 263, 267
asynchronous event 140, 208
AT bus 33, 37, 40, 45, 47, 50, 106,
 122, 125, 128, 133, 268
AT task file 50
ATA interface 37, 40, 44, 47, 50, 52,
 60
audio 214, 222, 227

B

B cable 19, 23, 92
backplane 31
block descriptor 133, 150, 171, 190,
 201, 203, 229
block format 180, 182
BOM 180
BPI 182
bridge controller 40, 79, 90, 132, 156,
 193
buffer 161
 double ported 63
 single ported 63, 259
buffer memory 16
bus 29
 I/O 31
 memory 32
 universal 32, 38
 VME 31, 33
BUS DEVICE RESET 128
BUS FREE phase 105
bytes after index format 15, 27, 223

C

cache 39, 52, 70, 72, 129, 144, 162,
 166, 172, 177, 220, 229
CAM 37, 247
capacity
 formatted 15, 17
 unformatted 17
CCS 78, 84, 140, 149

CD-ROM 4, 14, 86, 91, 154, 158, 214,
 222, 227, 229, 267
 CDC 13
 Centronics 9, 12
 Centronics protocol 12
 CHANGE DEFINITION 149
 channel 210
 CHECK POWER MODE 70
 CHS mode 53, 60
 CLEAR QUEUE 128
 Clist 161
 CLV 222
 command
 control byte 135
 opcode 134
 status 137
 types 136
 command chain 121, 135
 command classes
 class 1: 55
 class 2: 56
 class 3: 57
 class 4: 57
 class 5: 58
 COMMAND COMPLETE 121
 command descriptor block 133, 150,
 152, 171, 190, 203, 229
 command phase (IDE) 57
 command phase (SCSI) 110
 COMMAND phase 110, 252
 command register 54
 commands
 10 byte 136
 12 byte 136
 6 byte 134
 commands, optional 70
 communications devices 129, 210,
 213
 Compaq 37
 connector 96
 Conner Peripherals 59
 control byte 135
 control mode page 157
 controller 18, 79
 CRC 15, 158
 cylinder 14, 60
 cylinder number register 53
 cylinder skew 16, 17, 158, 173

D

DAT 182
 DATA phase 111, 122, 124
 data rate 30
 data registers 50
 data separator 15, 18, 23
 data width 30, 32
 defect descriptor 171
 defect list 23, 26, 66, 78, 84, 160, 168,
 171
 defect management 62, 78, 161
 defects, grown 161
 deferred error 157, 185
 device classes 132
 list of 133
 device control register 54
 diagnostic pages 132, 148
 diagnostics 51, 66, 148
 differential 20, 77, 81, 92, 96, 100,
 259, 262
 direct memory access 47, 163
 DISCONNECT 123
 disconnect-reconnect page 123, 156,
 237
 disconnect privilege 121, 123
 Dlist 161
 DMA 40, 46, 57, 64, 70, 73, 162, 265
 DOOR LOCK 70
 DOOR UNLOCK 70
 draft proposal 77
 drive/head register 53

E

ECB bus 31, 33
 ECC 15, 52, 69, 74, 83, 158, 166
 ECC error 52, 69, 74, 166
 EIA 7
 EISA bus 39
 element 233
 embedded controller 38, 79, 132
 emulation 194, 259
 EOD 183
 EOM 180
 ERASE 10, 187, 219
 error code 66
 error register 51

ESDI commands 27
 EXABYTE 182
 EXCHANGE MEDIUM 237
 EXECUTE DRIVE DIAGNOSTICS 66
 Extends 160

F

fast SCSI 113
 feature register 52
 file mark 183, 186
 flag bit 121, 135, 250, 267
 format 14
 FORMAT 68, 168, 196
 format chip 15
 FORMAT TRACK 68
 FORMAT UNIT 168

G

generation 217
 geometry 14, 60, 68, 70, 175, 238
 GET MESSAGE(10) 211
 GET MESSAGE(12) 211
 GET MESSAGE(6) 211
 Glist 161
 glitch 107

H

handshake 12, 25, 58, 81, 109
 hard disk 14
 hard disk geometry 14, 175
 hard sectoring 15, 23, 175
 hardware reset 58, 72, 248
 HDA 18
 head 60
 HEAD OF QUEUE TAG 127
 header 15
 host adapter 18, 78, 89

I

I/O process 118, 131
 I_T_L nexus 120, 126, 128
 ID 79
 IDE adapter 38

IDE command 66
 IDE command classes 55
 IDE controller 50
 IDE signals 44–7
 IDENTIFY 70, 120
 IDENTIFY DRIVE 70
 IDLE (command) 70
 IDLE (state) 65, 70
 IDLE IMMEDIATE 70
 IGNORE WIDE RESIDUE 126
 index 14
 index format 172
 initialization pattern 171
 INITIALIZE DRIVE PARAMETERS 68
 initiator 79, 89
 INITIATOR DETECTED ERROR 122
 INQUIRY 138, 250, 255
 interface
 ESDI 13
 IDE 37
 peripheral 4, 19, 29, 31, 79, 84
 physical 5, 7, 10, 12
 printer 5, 10
 serial 7
 SMD 13, 28
 ST412 13
 ST506 13, 18
 interleave 16, 64, 68, 158, 169, 173
 interrupt request 32, 46, 52
 IPS 182

L

large frame 223
 LBA mode 53, 61
 LBN 135, 158, 167, 171, 185, 189, 219
 linear mapping 60, 158, 223
 link bit 10, 32, 121, 135, 140, 166
 LINKED COMMAND COMPLETE 121
 LOAD UNLOAD 189
 LOCATE 188
 logic analyzer 58, 107, 257
 logical block 135, 159, 214
 logical block (tape) 183
 logical unit 131
 LUN 120, 131, 135

M

mandatory commands 66, 136
 mapping 55, 60, 70, 158, 168, 223, 239
 mapping, linear 60, 158, 223
 mass storage 3, 31, 84, 163
 master drive 38, 46, 53, 55, 58, 66, 72, 90, 177
 measurement units 205
 medium changer 233, 237
 medium defect 27, 62, 78, 160, 168, 172, 175
 MEDIUM SCAN 218
 message
 format 117
 phase 109
 system 116
 message codes list 119
 MESSAGE PARITY ERROR 129
 MESSAGE REJECT 129
 message, extended 109, 118, 124, 127
 MFM format 19, 22
 mode
 buffered 183, 190, 194, 197
 unbuffered 183, 190, 197
 mode parameter pages
 all device classes 154
 CD-ROM 229
 communications devices 213
 disk drives 173
 medium changers 237
 printers 197
 scanners 204
 tape devices 191
 mode parameters 132
 MODE SELECT 149
 MODE SENSE 149
 model
 disk drive 14
 IDE drive 60
 peripheral device 5
 peripheral interface 5
 MODIFY DATA POINTER 122
 mount 160, 180
 MOVE MEDIUM 236
 multi-initiator 146

N

nexus 119, 126, 128
 NO OPERATION 122
 notch 174, 178

O

offset 114
 opcode 26, 55, 66, 103, 123, 134, 194, 207, 211
 open collector 19, 81
 optical storage 4, 14, 160, 214, 221, 233
 ORDERED QUEUE TAG 127

P

parameter list 133, 148
 parity error 8, 25, 95, 117, 122, 129, 268
 partition 153, 183, 186, 191
 PAUSE/RESUME 227
 PC host adapter 19, 50, 79, 89, 96, 207, 240, 266, 268
 PCMIA 41
 peripheral device page 156
 peripheral device type 140
 peripheral interfaces 5
 peripheral qualifier 141
 phases 102
 pin assignments
 differential 82
 single ended 81
 PIO 47, 50, 55, 64
 PLAY AUDIO(10) 227
 PLAY AUDIO(12) 227
 PLAY AUDIO MSF 227
 PLAY AUDIO TRACK/INDEX 227
 Plist 161
 PostScript 5
 power condition 64, 133, 160, 207, 245
 power-up cycle 46, 149
 pre-fetch 162, 172, 178
 PRINT 194, 196
 printers 4, 9, 79, 132, 193, 196, 247
 priority 31, 89, 178

processor device 129, 140, 206, 210,
259, 262
programmed I/O 47, 64, 123
protocol XON/XOFF 9

Q

Q-22 bus 30, 33
QIC 182
queue 23, 106, 120, 126, 141, 157,
261

R

RAID array 79, 177
READ 185, 203
READ(10) 165
READ(6) 165
READ BLOCK LIMITS 188
READ BUFFER 70
READ CD-ROM CAPACITY 225
READ DMA 70
READ DRIVE STATE 71
READ GENERATION 217
READ LONG 69, 166
READ MULTIPLE 71
READ SECTORS 68
READ TOC 225
READ UPDATED BLOCK 218
READ VERIFY SECTORS 69
read/write head 14
ready condition 180
real time 30
reallocation 62, 161
RECALIBRATE 68
RECEIVE 207
reconnection 123
recording format 4, 158, 160, 174,
180, 222
red book 222
register block 50
register model 50
RELEASE 146
REQ/ACK offset 114, 264
REQ/ACK sequence 109
request/acknowledge handshake
12, 25, 81, 109

RESELECTION phase 108
reselection, unexpected 121
RESERVATION CONFLICT 146
reservation, third-party 147
RESERVE 146
reset, hard 38, 58, 72, 140, 248
REST (command) 72
REST (state) 65
RESTORE DRIVE STATE 62
RESTORE POINTERS 122
REWIND 184
RLL format 19, 22
rotational latency 18, 23, 177
rotational position locking 177
rotational position sensing 23
RPS 23
RS-232 7, 198

S

SASI 77, 91, 165
SAVE DATA POINTER 122
SCAN 203, 218, 256
scan window 201
scanner 4, 132, 200, 203, 247
SCSI
 analyzer 104, 107, 125, 257
 bulletin board 85
 bus timing 104
 chips 262
 configurations 89, 91
 controller 89
 device 79
 differential 100
 emulator 257, 259
 fast 113
 history 41
 messages 117
 pointers 122
 priority 31, 89
 signals 92
 single-ended 96
 standard 85
 synchronous 113
 throughput 82
 wide 78, 80, 82, 92, 125

- SCSI Bus phases
 - ARBITRATION 106
 - BUS FREE 105
 - DATA 111
 - MESSAGE 109
 - RESELECTION 108
 - SELECTION 106
 - STATUS 112
 - SCSI pointers 122
 - SCSI-1 83
 - SCSI-2 difference to SCSI-1 104, 106, 113, 131, 148, 184
 - SCSI-3 5, 78, 84
 - Seagate 13
 - sector 14, 60
 - sector buffer 16, 55, 63, 68, 72, 161
 - sector count register 52
 - sector format 15
 - sector number register 53
 - sector skew 16, 158, 173
 - seek time 18
 - SELECTION 106
 - SEND 208
 - SEND DIAGNOSTIC 147
 - SEND MESSAGE(10) 211
 - SEND MESSAGE(12) 211
 - SEND MESSAGE(6) 211
 - sense code 144
 - sense data 143
 - sense key 144
 - sequential access 4, 61
 - serial transfer 7
 - SET FEATURES 72
 - set mark 183
 - SET MULTIPLE MODE 72
 - SET WINDOW 202
 - setmark 183
 - signal level 5, 9, 46, 97, 117
 - SIMPLE QUEUE TAG 127
 - single ended 81
 - slave drive 38, 46, 55, 58
 - SLEEP (command) 72
 - SLEEP (state) 65
 - SLEW AND PRINT 196
 - soft sectoring 15, 21, 23, 175
 - software interface 7, 52, 78, 83, 194, 247
 - SPACE 186
 - spindle synchronization 176
 - spiral offset 16
 - SRB 248, 255
 - STANDBY (command) 73
 - STANDBY (state) 65, 70
 - STANDBY IMMEDIATE 73
 - status 137
 - CHECK CONDITION 137
 - list of 137
 - RESERVATION CONFLICT 146
 - status byte 137
 - STATUS phase 112
 - status register 53
 - STOP PRINT 196
 - storage medium 4
 - surface 14
 - SYNCHRONIZE BUFFER 196
 - SYNCHRONOUS DATA TRANSFER REQUEST 124
 - synchronous SCSI 113
 - synchronous transfer period 114
 - synchronous transfers 8
- ## T
- tagged queue 120
 - tape device 180
 - tape marks 180, 183, 186
 - target 79, 90, 131
 - target emulator 259
 - target routine 120, 128, 131, 135, 208, 250, 267
 - TERMINATE I/O PROCESS 128
 - termination resistors 19, 97
 - termination, incorrect 99, 127
 - terminator 19, 81, 94, 100
 - TEST UNIT READY 141
 - throughput
 - peak 17
 - sustained 17
 - timing diagrams 257
 - track (CD-ROM) 223
 - track 14
 - track skew 16, 158, 173
 - transfer period 114, 116, 124
 - transfer rate 17
 - transfer rate, peak 8, 18

U

unexpected bus free 121
UNIT ATTENTION condition 133, 157
UPDATE BLOCK 217

V

volume tag 235

W

Western Digital 37
WIDE DATA TRANSFER REQUEST 125
WORM drive 14, 158, 214
WRITE 185
WRITE(10) 165
WRITE(6) 165
WRITE BUFFER 73
write current 16, 21, 23

WRITE DMA 73
WRITE FILEMARKS 187
WRITE LONG 69, 166
WRITE MULTIPLE 73
write precompensation 52
write protection 180
WRITE SAME 73
WRITE SECTORS 69
write splice 16
write-through cache 163
WRITE VERIFY 74

Y

yellow book 222

Z

zone 173
zone bit recording 61, 158, 160

The SCSI Bus and IDE Interface

Protocols, Applications and Programming

Friedhelm Schmidt

Almost all modern computers including PCs, workstations and mainframes are equipped with a SCSI interface. SCSI bus is designed for hard drives, tape drives, CD-

ROMs, scanners and printers, while the IDE hard disk interface is found almost exclusively in the world of IBM PC compatibles.

Outside the ANSI standard documentation, little additional information has been available about either specification – until

now. *The SCSI Bus and IDE Interface* provides an accessible description of both interfaces, including an explanation of essential terminology together with a breakdown of the commands and protocols. This book is the perfect tutor to SCSI and IDE and an invaluable guide to the ANSI literature.

Friedhelm Schmidt is the marketing manager for SEICOM, a networking distributor based in Munich, Germany. An expert in SCSI, he spent eight years as European Technical Manager for EMULEX, one of the pioneers in SCSI development.

Features include:

- A description of peripheral core technologies and device models
- Detailed descriptions of SCSI and IDE, including the physical and logical interfaces, command sets and a summary of the essential terminology.
- Thorough cross-referencing to the previously impenetrable ANSI documentation
- A wealth of program examples with thorough explanations that will enable you either to expand on the source code provided or write your own applications
- A practical chapter on testing SCSI targets that will enable you to check that your SCSI peripherals are working correctly
- A disk containing source code for the program examples listed in the book and a SCSI monitor tool for testing and troubleshooting SCSI devices



X000DJ9X43

Used - Very Good - The Scsi Bus
and Ide Interface: Protocols

DIS
INCLU

