



US006886484B2

(12) **United States Patent**
Thomas

(10) **Patent No.:** **US 6,886,484 B2**
(45) **Date of Patent:** **May 3, 2005**

(54) **COMPOSITE TENSION ROD TERMINAL SYSTEMS**

(76) Inventor: **Georg K. Thomas**, 461 Mill Springs La., Plantation, FL (US) 33325

(*) Notice: Subject to any disclaimer, the term of this patent is extended or adjusted under 35 U.S.C. 154(b) by 0 days.

(21) Appl. No.: **10/366,043**

(22) Filed: **Feb. 12, 2003**

(65) **Prior Publication Data**

US 2004/0156672 A1 Aug. 12, 2004

(51) **Int. Cl.⁷** **B63H 9/04**

(52) **U.S. Cl.** **114/108**; 403/268; 403/334

(58) **Field of Search** 114/108, 105, 114/112; 403/268, 269, 333, 334, 361, 41; 365/174, 189.01, 185.01, 185.23, 226, 230.06

(56) **References Cited**

U.S. PATENT DOCUMENTS

902,673 A	11/1908	Moench	403/184
1,849,067 A	3/1932	Bridges	403/334
1,849,069 A	3/1932	Bridges	403/334
1,950,947 A	3/1934	Mulroyan	285/148.22
2,045,520 A	6/1936	Davison	403/41
2,079,692 A	5/1937	Lapointe	403/334
3,507,949 A	* 4/1970	Campbell	403/268
3,573,346 A	4/1971	Appleby	174/71 R
3,802,373 A	* 4/1974	Lagerquist	114/105
3,851,609 A	* 12/1974	Stearn	114/105
3,958,523 A	* 5/1976	Holmes et al.	114/105
4,023,886 A	5/1977	Nakayama et al.	385/80
4,127,741 A	11/1978	Bauer et al.	174/189
4,130,926 A	* 12/1978	Willem	403/268
4,653,953 A	* 3/1987	Anderson et al.	403/268
4,679,960 A	7/1987	Mizuhara	403/272
4,822,201 A	* 4/1989	Iwasaki et al.	403/268

4,917,530 A	4/1990	Engelhardt et al.	403/334
5,297,077 A	* 3/1994	Imai et al.	365/145
5,415,490 A	* 5/1995	Flory	403/268
5,463,970 A	* 11/1995	Hartlmeier et al.	114/105
5,611,636 A	* 3/1997	Flory	403/269
5,629,888 A	* 5/1997	Saito et al.	365/145
5,713,169 A	2/1998	Meier et al.	52/223.13
6,301,145 B1	* 10/2001	Nishihara	365/145
2003/0010966 A1	1/2003	Sjostedt	254/231

* cited by examiner

Primary Examiner—Lars A. Olson

(74) *Attorney, Agent, or Firm*—Pearne & Gordon LLP

(57) **ABSTRACT**

A composite tension rod is received in the sleeve portion of a shank that forms part of a terminal fitting, and is spaced from the shank sleeve and connected thereto by a potting resin. The shank sleeve wall tapers out from thin at its distal end to thick at the bury depth of the rod. The rod is tapered outwardly from a point of minimum diameter at its inner end to its full diameter a given distance from the end. The shank sleeve and rod have complementary dual tapering along said length such that as the diameter of the rod along said distance increases, the wall thickness of the shank sleeve decreases. The resin layer and the rod are secured to each other against relative longitudinal movement, as are the resin layer and the shank sleeve.

In another aspect of the invention, a tension rod sleeve is fixed to the tension rod and extends over the distal end of the shank sleeve and along all or a majority of the length of the shank sleeve. The rod sleeve is tapered so that its wall thickness decreases to a minimum in the vicinity of the proximal end of the shank sleeve, or the rod sleeve, as it extends along the shank sleeve, is divided, or divides, into two halves or bands which join to form loop extending around a loop-engaging, convex, fiber-turnaround face formed on the terminal fitting. Such face extends transversely from one side to the other of the fitting.

32 Claims, 5 Drawing Sheets

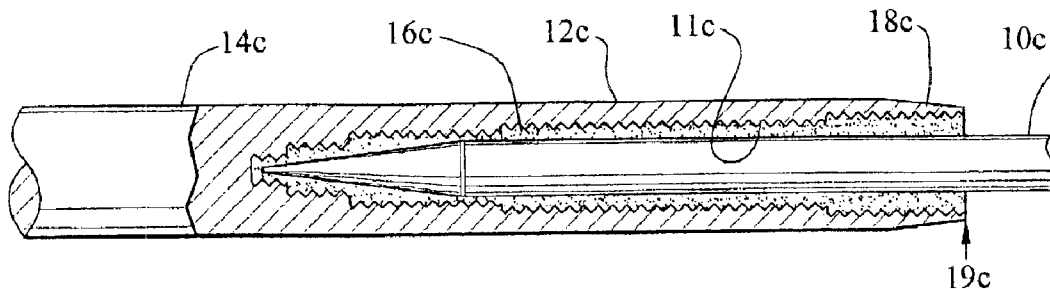

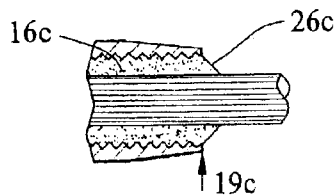
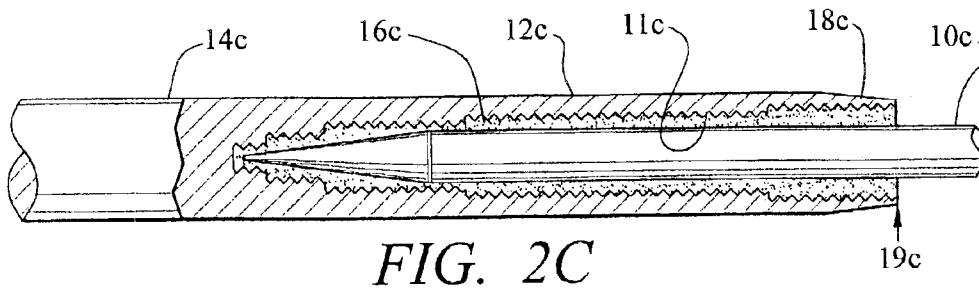
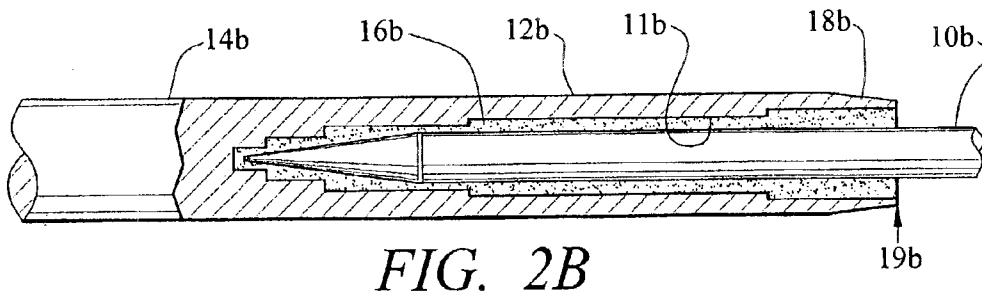
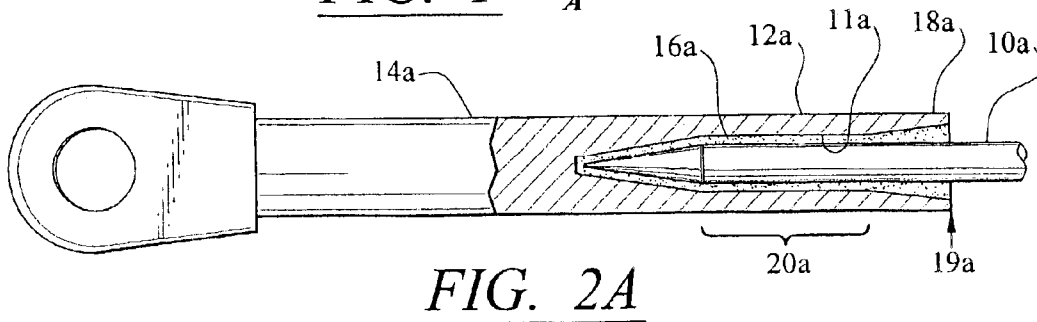
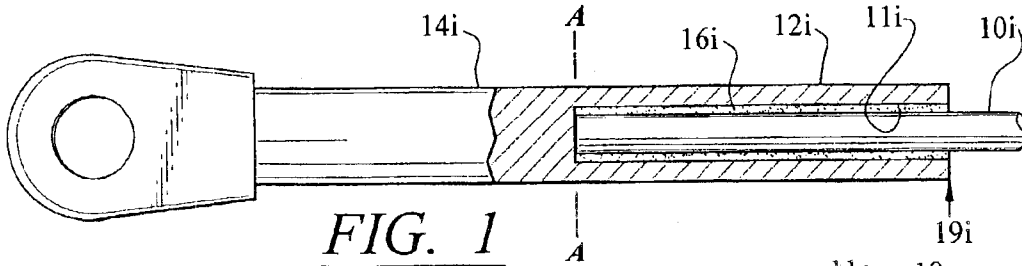

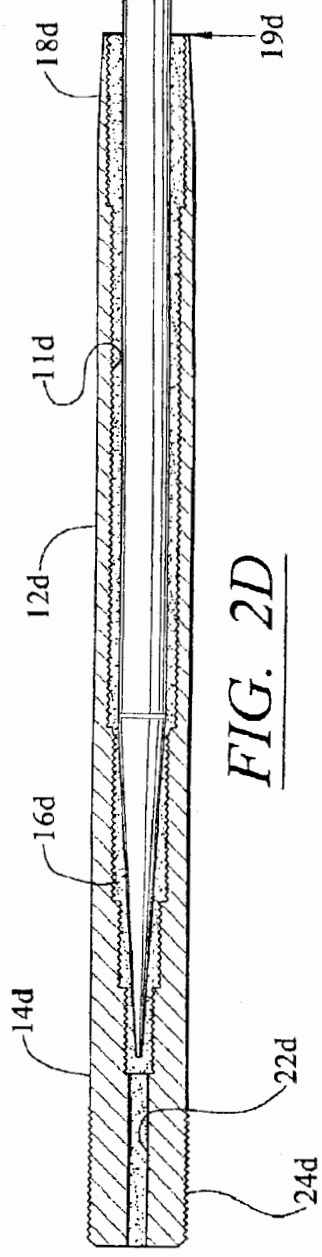

FIG. 2D

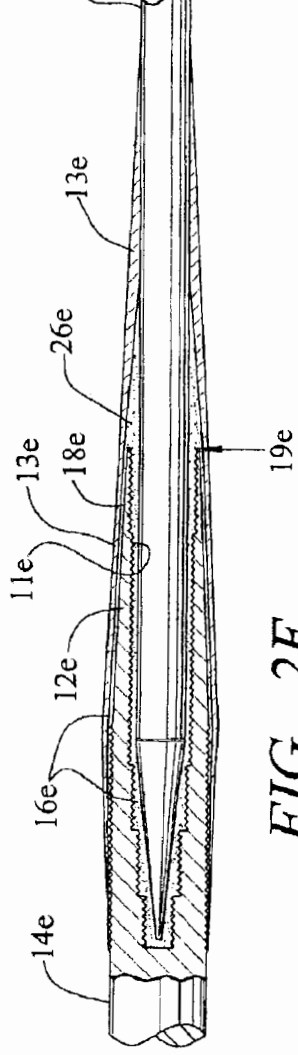

FIG. 2E

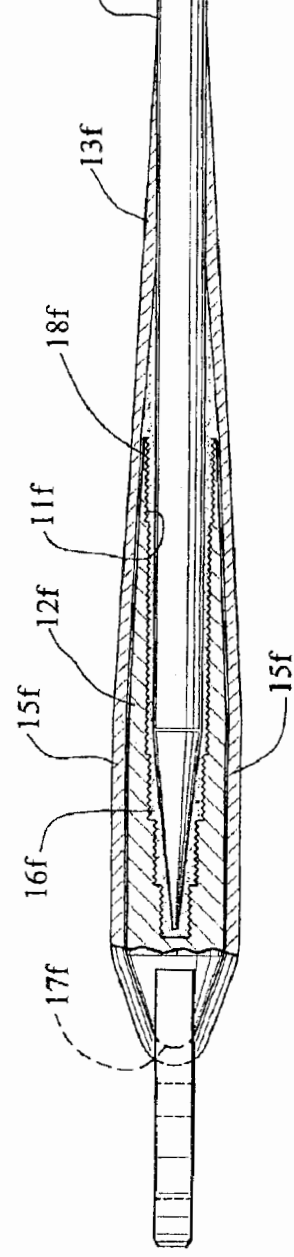

FIG. 2F-1

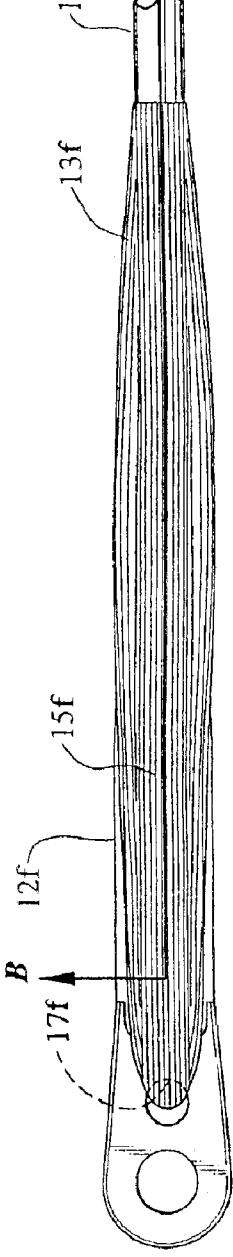

FIG. 2F-2

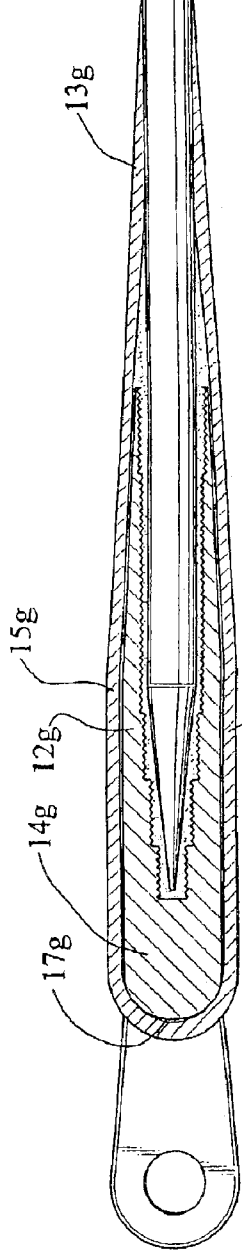

FIG. 2G-1

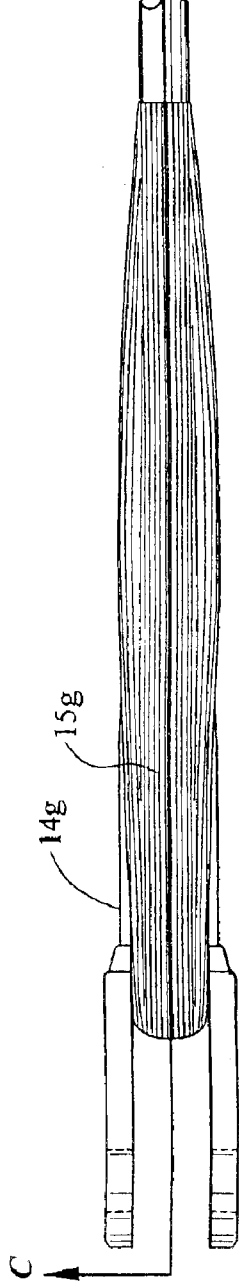
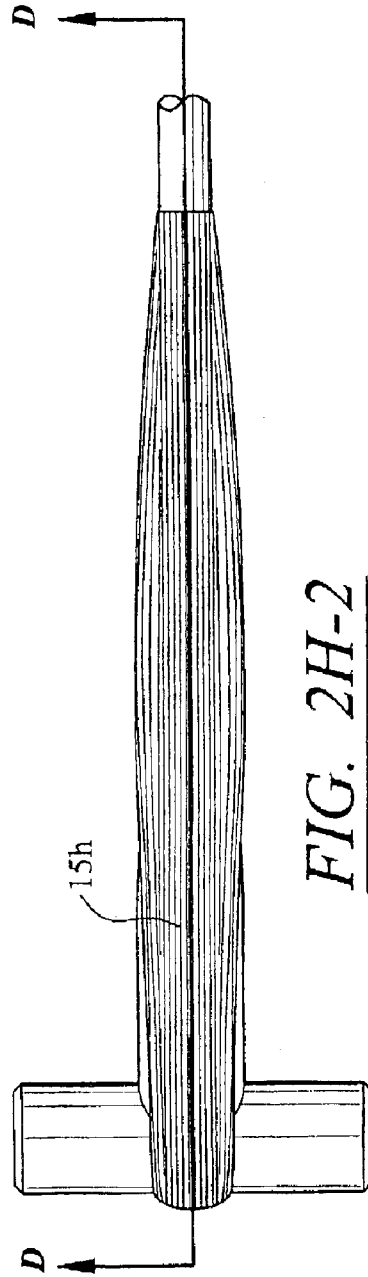
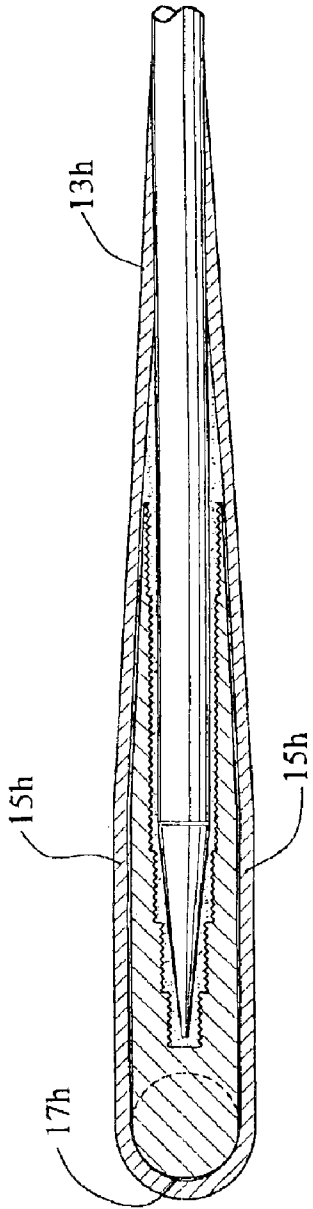

FIG. 2G-2



Explore Litigation Insights

Docket Alarm provides insights to develop a more informed litigation strategy and the peace of mind of knowing you're on top of things.

Real-Time Litigation Alerts



Keep your litigation team up-to-date with **real-time alerts** and advanced team management tools built for the enterprise, all while greatly reducing PACER spend.

Our comprehensive service means we can handle Federal, State, and Administrative courts across the country.

Advanced Docket Research



With over 230 million records, Docket Alarm's cloud-native docket research platform finds what other services can't. Coverage includes Federal, State, plus PTAB, TTAB, ITC and NLRB decisions, all in one place.

Identify arguments that have been successful in the past with full text, pinpoint searching. Link to case law cited within any court document via Fastcase.

Analytics At Your Fingertips



Learn what happened the last time a particular judge, opposing counsel or company faced cases similar to yours.

Advanced out-of-the-box PTAB and TTAB analytics are always at your fingertips.

API

Docket Alarm offers a powerful API (application programming interface) to developers that want to integrate case filings into their apps.

LAW FIRMS

Build custom dashboards for your attorneys and clients with live data direct from the court.

Automate many repetitive legal tasks like conflict checks, document management, and marketing.

FINANCIAL INSTITUTIONS

Litigation and bankruptcy checks for companies and debtors.

E-DISCOVERY AND LEGAL VENDORS

Sync your system to PACER to automate legal marketing.