

<b>Proceeding</b>	<b>Status</b>
<i>Inter Partes</i> Reexamination of U.S. Patent No. 7,714,747 (Control No. 95/001,517)	Petition to Expunge Third Party Requester's Improper Submission of Declarations and Strike Comments Directed to Examiner's Determination filed 06/26/2013; Patent Owner's Comments in Response to Examiner's Determination filed 05/10/2013; Examiner's Determination Under 37 C.F.R. § 41.77(d) mailed 04/10/2013
<i>Inter Partes</i> Reexamination of U.S. Patent No. 7,417,568 (Control No. 95/001,533)	Decision on Petition Under 37 C.F.R. § 1.183 to Request Examiner Enter Evidence mailed 03/20/2013
<i>Inter Partes</i> Reexamination of U.S. Patent No. 7,777,651 (Control No. 95/001,581)	Examiner's Answer to Appeal Brief mailed 03/14/2013
<i>Inter Partes</i> Reexamination of U.S. Patent No. 7,400,274 (Control No. 95/001,544)	Examiner's Answer to Appeal Brief mailed 10/01/2012

Applicants hereby call to the attention of the Patent and Trademark Office the following reexamination proceedings filed by Cellco Partnership d/b/a Verizon Wireless, involving patents that are commonly-assigned with the patent in the above-identified patent application:

<b>Proceeding</b>	<b>Status</b>
<i>Inter Partes</i> Reexamination of U.S. Patent No. 7,321,937 (Control No. 95/001,922)	Patent Owner's Supplemental Response to Action Closing Prosecution filed 05/15/2013; Patent Owner's Response to Action Closing Prosecution filed 05/09/2013
<i>Inter Partes</i> Reexamination of U.S. Patent No. 6,604,158 (Control No. 95/001,923)	Patent Owner's Supplemental Response to Office Action filed 04/29/2013
<i>Inter Partes</i> Reexamination of U.S. Patent No. 7,352,300 (Control No. 95/001,924)	Patent Owner's Response to Action Closing Prosecution filed 05/09/2013; Action Closing Prosecution mailed 04/09/2013
<i>Inter Partes</i> Reexamination of U.S. Patent No. 7,395,345 (Control No. 95/001,925)	Patent Owner's Supplemental Response to Office Action filed 05/06/2013

<b>Proceeding</b>	<b>Status</b>
<i>Inter Partes</i> Reexamination of U.S. Patent No. 7,161,506 (Control No. 95/001,926)	Patent Owner's Reply to Action Closing Prosecution filed 04/05/2013; Action Closing Prosecution mailed 03/05/2013
<i>Inter Partes</i> Reexamination of U.S. Patent No. 7,415,530 (Control No. 95/001,927)	Right of Appeal Notice mailed 05/31/2013; Action Closing Prosecution mailed 04/03/2013
<i>Inter Partes</i> Reexamination of U.S. Patent No. 7,378,992 (Control No. 95/001,928)	Patent Owner's Reply to Action Closing Prosecution filed 04/05/2013; Action Closing Prosecution mailed 03/05/2013

Applicants invite the Examiner to review the Requests for Reexamination, issued Office Actions, replies, and any other papers in the above-identified reexamination proceedings. If the Examiner is unable to obtain copies of papers in any reexamination proceeding, copies can be provided to the Examiner upon request. Those documents which may be material that are not already of record in this patent application are listed on the accompanying Form PTO/SB/08. For example, documents related to the reexaminations are listed at NPL61-NPL109.

Notice of Related Litigation

Applicants notify the Patent and Trademark Office of the following litigation involving U.S. Patents commonly-owned with the current patent application, the subject matter of which may be related to the present patent application:

<b>No.</b>	<b>Case</b>	<b>Status</b>
1	<i>Realtime Data LLC d/b/a IXO v. Packeteer, Inc. et al.</i> , No. 6:08-cv-00144-LED (E.D. Texas)	Dismissed

Applicants also notify the Patent and Trademark Office of the following additional litigation involving U.S. Patents commonly-owned with the current patent application, the subject matter of which may be related to the present patent application:

No.	Case	Status
2	<i>Realtime Data LLC d/b/a IXO v. Thomson Reuters Corporation et al.</i> No. 1:11-cv-06698-RJH (S.D. New York) (transferred from E.D. Texas; 6:09-cv-00333-LED)	Notice of Appeal Filed
3	<i>Realtime Data LLC d/b/a IXO v. Morgan Stanley et al.</i> , No. 1:11-cv-06696-RJH (S.D. New York) (transferred from E.D. Texas; 6:09-cv-00326-LED)	Notice of Appeal Filed
4	<i>Realtime Data LLC d/b/a IXO v. CME Group Inc., et al.</i> , No. 1:11-cv-06697-RJH (S.D. New York) (transferred from E.D. Texas; No. 6:09-cv-00327-LED)	Notice of Appeal Filed
5	<i>Chicago Board Options Exchange, Inc., v. Realtime Data LLC d/b/a IXO</i> , No. 09-cv-4486 (N.D. Ill.)	Dismissed
6	<i>Thomson Reuters Corporation v. Realtime Data, LLC d/b/a IXO</i> , No. 1:09-cv-07868-RMB (S.D.N.Y)	Consolidated with Case No. 2
7	<i>Realtime Data, LLC d/b/a IXO v. CME Group Inc., et al. (II)</i> , No. 6:10-cv-246 (E.D. Texas)	Consolidated with Case No. 4
8	<i>Realtime Data LLC d/b/a IXO v. Thomson Reuters Corporation et al. (II)</i> , No. 6:10-cv-247 (E.D. Texas)	Consolidated with Case No. 2
9	<i>Realtime Data, LLC d/b/a IXO v. Morgan Stanley, et al. (II)</i> , No. 6:10-cv-248 (E.D. Texas)	Consolidated with Case No. 3
10	<i>Realtime Data, LLC d/b/a IXO v. MetroPCS Texas, LLC et al.</i> , No. 6:10-cv-00493 (E.D. Texas)	Notice of Appeal Filed

Updated court docket listings downloaded July 8, 2013 for litigations previously disclosed and pending are submitted herewith as NPL119-NPL122.

*Realtime Data, LLC d/b/a IXO v. MetroPCS Texas, LLC et al.*

Applicants submit herewith documents related to the above-listed litigation as documents NPL27-NPL41.

Realtime Data LLC d/b/a/ IXO v. Morgan Stanley, et al.;  
Realtime Data LLC d/b/a/ IXO v. CME Group Inc., et al.; and  
Realtime Data LLC d/b/a/ IXO v. Thomson Reuters Corp., et al.

Applicants submit herewith documents related to the above-listed litigations as documents US1-US3 and NPL1-NPL26 with confidential information redacted.

Information Disclosure Statement

Listed on accompanying IDS Forms PTO/SB/08a equivalent and/or PTO/SB/08b equivalent are documents that may be considered material to the patentability of this application as defined in 37 C.F.R. §1.56, and in compliance with the duty of disclosure requirements of 37 C.F.R. §§ 1.97 and 1.98.

Applicants have listed publication dates on the attached IDS Forms based on information presently available to the undersigned. However, the listed publication dates should not be construed as an admission that the information was actually published on the date indicated.

Applicants reserve the right to establish the patentability of the claimed invention over any of the information provided herewith, and/or to prove that this information may not be prior art, and/or to prove that this information may not be enabling for the teachings purportedly offered.

This statement should not be construed as a representation that a search has been made, or that information more material to the examination of the present patent application does not exist. The Examiner is specifically requested not to rely solely on the material submitted herewith.

Atty. Dkt. No. 2855.004000B



Filing under 37 C.F.R. § 1.97(b). This Information Disclosure Statement is being filed before the mailing of a first Office Action and after the filing of a request for continued examination under 37 C.F.R. § 1.114. No statement or fee is required.

Documents US1-US8 are cited on the attached form PTO/SB/08A. Documents NPL1-NPL122 are cited on the attached form PTO/SB/08B. Copies of documents NPL1-NPL15 and NPL17-NPL122 are submitted herewith. Due to its file format, document NPL16 cannot be submitted electronically, and is therefore presented on the accompanying CD labeled as document NPL16, submitted via hand-carry. In accordance with 37 C.F.R. § 1.98(a)(2), no copies of U.S. patents and patent application publications cited on the attached IDS Forms are submitted.

Applicants submit herewith actions from the following co-pending, commonly assigned U.S. Patent Application Nos.:

Document NPL42 is a copy of a Notice of Allowance mailed on June 21, 2012 in the prosecution of co-pending, commonly-assigned U.S. Application No. 11/400,008.

Document NPL43 is a copy of a Final Office Action mailed on June 26, 2012 in the prosecution of co-pending, commonly-assigned U.S. Application No. 13/154,239.

Document NPL44 is a copy of a Notice of Allowance mailed on July 12, 2012 in the prosecution of co-pending, commonly-assigned U.S. Application No. 12/857,238.

Document NPL45 is a copy of a Notice of Allowance mailed on July 16, 2012 in the prosecution of co-pending, commonly-assigned U.S. Application No. 12/703,042.

Document NPL46 is a copy of a Non-Final Office Action mailed on July 20, 2012 in the prosecution of co-pending, commonly-assigned U.S. Application No. 13/482,800.

Document NPL47 is a copy of a Notice of Allowance mailed on November 6, 2012 in the prosecution of co-pending, commonly-assigned U.S. Application No. 11/553,427.

Document NPL48 is a copy of a Notice of Allowance mailed on November 15, 2012 in the prosecution of co-pending, commonly-assigned U.S. Application No. 12/703,042.

Document NPL49 is a copy of a Non-Final Office Action mailed on November 29, 2012 in the prosecution of co-pending, commonly-assigned U.S. Application No. 12/857,238.

Document NPL50 is a copy of a Final Office Action mailed on December 4, 2012 in the prosecution of co-pending, commonly-assigned U.S. Application No. 09/969,987.

Document NPL51 is a copy of a Final Office Action mailed on December 13, 2012 in the prosecution of co-pending, commonly-assigned U.S. Application No. 13/101,994.

Document NPL52 is a copy of a Supplemental Notice of Allowability mailed December 18, 2012 in the prosecution of co-pending, commonly-assigned U.S. Application No. 12/703,042.

Document NPL53 is a copy of a Notice of Allowance mailed December 28, 2012 in the prosecution of co-pending, commonly-assigned U.S. Application No. 12/690,125.

Document NPL54 is a copy of a Non-Final Office Action mailed on January 15, 2013 in the prosecution of co-pending, commonly-assigned U.S. Application No. 11/553,419.

Document NPL55 is a copy of a Non-Final Office Action mailed on February 19, 2013 in the prosecution of co-pending, commonly-assigned U.S. Application No. 13/482,800.

Document NPL56 is a copy of a Notice of Allowance mailed on March 4, 2013 in the prosecution of co-pending, commonly-assigned U.S. Application No. 12/703,042.

Document NPL57 is a copy of a Non-Final Office Action mailed on April 15, 2013 in the prosecution of co-pending, commonly-assigned U.S. Application No. 12/690,125.

Document NPL58 is a copy of a Notice of Allowance mailed on April 24, 2013 in the prosecution of co-pending, commonly-assigned U.S. Application No. 13/154,239.

Document NPL59 is a copy of a Notice of Allowance mailed on May 14, 2013 in the prosecution of co-pending, commonly-assigned U.S. Application No. 11/553,427.

Document NPL60 is a copy of a supplemental Notice of Allowance mailed on May 15, 2013 in the prosecution of co-pending, commonly-assigned U.S. Application No. 11/553,427.

Document NPL110 is a copy of a Notice of Allowance mailed on June 17, 2013 in the prosecution of co-pending, commonly-assigned U.S. Application No. 12/857,238.

Document NPL111 is a copy of a supplemental Notice of Allowance mailed on June 18, 2013 in the prosecution of co-pending, commonly-assigned U.S. Application No. 12/703,042.

Document NPL112 is a copy of supplemental Notice of Allowance mailed on July 2, 2013 in the prosecution of co-pending, commonly-assigned U.S. Application No. 11/553,427.

Document NPL113 is a copy of a Non-Final Office Action mailed on July 3, 2013 in the prosecution of co-pending, commonly-assigned U.S. Application No. 09/969,987.

The identification of these actions is not to be construed as a waiver of secrecy as to those applications now or upon issuance of the present application as a patent. The Examiner is respectfully requested to consider the cited applications and the art cited therein during examination.

It is expected that the examiner will review the prosecution and cited art in the parent application nos. 09/776,267, filed February 2, 2001 (now U.S. Patent No. 7,181,608), and 11/551,211, filed October 19, 2006 (now U.S. Patent No. 8,112,619), in accordance with MPEP 2001.06(b), and indicate in the next communication from the office that the art cited in the earlier prosecution history has been reviewed in connection with the present application.

It is respectfully requested that the Examiner initial and return a copy of the enclosed IDS Forms, and indicate in the official file wrapper of this patent application that the documents have been considered.

The U.S. Patent and Trademark Office is hereby authorized to charge any fee deficiency, or credit any overpayment, to our Deposit Account No. 19-0036.

Respectfully submitted,

STERNE KESSLER, GOLDSTEIN & FOX P.L.L.C.

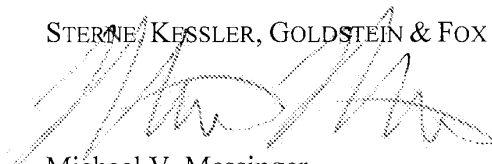

Michael V. Messinger  
Attorney for Applicants  
Registration No. 37,575

Date: July 9, 2013

1100 New York Avenue, N.W.  
Washington, D.C. 20005-3934  
(202) 371-2600

1703825\_1.DOCX

Under the Paperwork Reduction Act of 1995, no persons are required to respond to a collection of information unless it contains a valid OMB control number.

<b>Request for Continued Examination (RCE) Transmittal</b>  Address to: Mail Stop RCE Commissioner for Patents P.O. Box 1450 Alexandria, VA 22313-1450	Application Number	13/118,122
	Filing Date	May 27, 2011
	First Named Inventor	James J. FALLON
	Art Unit	2115
	Examiner Name	SURYAWANSHI, Suresh
	Attorney Docket Number	2855.004000B

**This is a Request for Continued Examination (RCE) under 37 CFR 1.114 of the above-identified application.**  
 Request for Continued Examination (RCE) practice under 37 CFR 1.114 does not apply to any utility or plant application filed prior to June 8, 1995, or to any design application. See Instruction Sheet for RCEs (not to be submitted to the USPTO) on page 2.

1. Submission required under 37 CFR 1.114 Note: If the RCE is proper, any previously filed unentered amendments and amendments enclosed with the RCE will be entered in the order in which they were filed unless applicant instructs otherwise. If applicant does not wish to have any previously filed unentered amendment(s) entered, applicant must request non-entry of such amendment(s).

- a.  Previously submitted. If a final Office action is outstanding, any amendments filed after the final Office action may be considered as a submission even if this box is not checked.
- i.  Consider the arguments in the Appeal Brief or Reply Brief previously filed on \_\_\_\_\_
- ii.  Other \_\_\_\_\_
- b.  Enclosed
- i.  Amendment/Reply
- ii.  Affidavit(s)/ Declaration(s)
- iii.  Information Disclosure Statement (IDS)
- iv.  Other Petition for Extension of Time

2. Miscellaneous

- a.  Suspension of action on the above-identified application is requested under 37 CFR 1.103(c) for a period of \_\_\_\_\_ months. (Period of suspension shall not exceed 3 months; Fee under 37 CFR 1.17(i) required)
- b.  Other \_\_\_\_\_

Terminal Disclaimer

3. Fees

- The RCE fee under 37 CFR 1.17(e) is required by 37 CFR 1.114 when the RCE is filed.
- The Director is hereby authorized to charge the following fees, any underpayment of fees, or credit any overpayments, to Deposit Account No. 19-0036
- i.  RCE fee required under 37 CFR 1.17(e)
- ii.  Extension of time fee (37 CFR 1.136 and 1.17)
- iii.  Other Terminal Disclaimer Fee
- b.  Check in the amount of \$ \_\_\_\_\_ enclosed
- c.  Payment by credit card (Form PTO-2038 enclosed)

**WARNING: Information on this form may become public. Credit card information should not be included on this form. Provide credit card information and authorization on PTO-2038.**

SIGNATURE OF APPLICANT, ATTORNEY, OR AGENT REQUIRED			
Signature		Date	<u>July 9, 2011</u>
Name (Print/Type)	<u>Michael V. Messinger</u>	Registration No.	<u>37,575</u>

CERTIFICATE OF MAILING OR TRANSMISSION	
I hereby certify that this correspondence is being deposited with the United States Postal Service with sufficient postage as first class mail in an envelope addressed to: Mail Stop RCE, Commissioner for Patents, P. O. Box 1450, Alexandria, VA 22313-1450 or facsimile transmitted to the U.S. Patent and Trademark Office on the date shown below.	
Signature	_____
Name (Print/Type)	_____
Date	_____

This collection of information is required by 37 CFR 1.114. The information is required to obtain or retain a benefit by the public which is to file (and by the USPTO to process) an application. Confidentiality is governed by 35 U.S.C. 122 and 37 CFR 1.11 and 1.14. This collection is estimated to take 12 minutes to complete, including gathering, preparing, and submitting the completed application form to the USPTO. Time will vary depending upon the individual case. Any comments on the amount of time you require to complete this form and/or suggestions for reducing this burden, should be sent to the Chief Information Officer, U.S. Patent and Trademark Office, U.S. Department of Commerce, P.O. Box 1450, Alexandria, VA 22313-1450. DO NOT SEND FEES OR COMPLETED FORMS TO THIS ADDRESS. **SEND TO: Mail Stop RCE, Commissioner for Patents, P.O. Box 1450, Alexandria, VA 22313-1450.**  
 If you need assistance in completing the form, call 1-800-PTO-9199 and select option 2.



*FW  
RCE*

PTO/SB/30 (07-09)

Approved for use through 07/31/2012. OMB 0651-0031  
U.S. Patent and Trademark Office; U.S. DEPARTMENT OF COMMERCE

Under the Paperwork Reduction Act of 1995, no persons are required to respond to a collection of information unless it contains a valid OMB control number.

**Request  
for  
Continued Examination (RCE)  
Transmittal**

Address to:  
Mail Stop RCE  
Commissioner for Patents  
P.O. Box 1450  
Alexandria, VA 22313-1450

Application Number	13/118,122
Filing Date	May 27, 2011
First Named Inventor	James J. FALLON
Art Unit	2115
Examiner Name	SURYAWANSHI, Suresh
Attorney Docket Number	2855.004000B

**This is a Request for Continued Examination (RCE) under 37 CFR 1.114 of the above-identified application.**  
Request for Continued Examination (RCE) practice under 37 CFR 1.114 does not apply to any utility or plant application filed prior to June 8, 1995, or to any design application. See Instruction Sheet for RCEs (not to be submitted to the USPTO) on page 2.

1. **Submission required under 37 CFR 1.114** Note: If the RCE is proper, any previously filed unentered amendments and amendments enclosed with the RCE will be entered in the order in which they were filed unless applicant instructs otherwise. If applicant does not wish to have any previously filed unentered amendment(s) entered, applicant must request non-entry of such amendment(s).

a.  Previously submitted. If a final Office action is outstanding, any amendments filed after the final Office action may be considered as a submission even if this box is not checked.

i.  Consider the arguments in the Appeal Brief or Reply Brief previously filed on \_\_\_\_\_

ii.  Other \_\_\_\_\_

b.  Enclosed

i.  Amendment/Reply

ii.  Affidavit(s)/ Declaration(s)

iii.  Information Disclosure Statement (IDS)

iv.  Other Petition for Extension of Time

2. **Miscellaneous** Terminal Disclaimer

a.  Suspension of action on the above-identified application is requested under 37 CFR 1.103(c) for a period of \_\_\_\_\_ months. (Period of suspension shall not exceed 3 months; Fee under 37 CFR 1.17(f) required)

b.  Other \_\_\_\_\_

3. **Fees** The RCE fee under 37 CFR 1.17(e) is required by 37 CFR 1.114 when the RCE is filed.

The Director is hereby authorized to charge the following fees, any underpayment of fees, or credit any overpayments, to Deposit Account No. 19-0036

a.  RCE fee required under 37 CFR 1.17(e)

ii.  Extension of time fee (37 CFR 1.136 and 1.17)

iii.  Other Terminal Disclaimer Fee

b.  Check in the amount of \$ \_\_\_\_\_ enclosed

c.  Payment by credit card (Form PTO-2038 enclosed)

**WARNING: Information on this form may become public. Credit card information should not be included on this form. Provide credit card information and authorization on PTO-2038.**

SIGNATURE OF APPLICANT, ATTORNEY, OR AGENT REQUIRED			
Signature	<i>Michael V. Messinger</i>	Date	<i>July 8, 2013</i>
Name (Print/Type)	Michael V. Messinger	Registration No.	37,575

**CERTIFICATE OF MAILING OR TRANSMISSION**

I hereby certify that this correspondence is being deposited with the United States Postal Service with sufficient postage as first class mail in an envelope addressed to: Mail Stop RCE, Commissioner for Patents, P. O. Box 1450, Alexandria, VA 22313-1450 or facsimile transmitted to the U.S. Patent and Trademark Office on the date shown below.

Signature		Date	
Name (Print/Type)			

This collection of information is required by 37 CFR 1.114. The information is required to obtain or retain a benefit by the public which is to file (and by the USPTO to process) an application. Confidentiality is governed by 35 U.S.C. 122 and 37 CFR 1.11 and 1.14. This collection is estimated to take 12 minutes to complete, including gathering, preparing, and submitting the completed application form to the USPTO. Time will vary depending upon the individual case. Any comments on the amount of time you require to complete this form and/or suggestions for reducing this burden, should be sent to the Chief Information Officer, U.S. Patent and Trademark Office, U.S. Department of Commerce, P.O. Box 1450, Alexandria, VA 22313-1450. DO NOT SEND FEES OR COMPLETED FORMS TO THIS ADDRESS. SEND TO: Mail Stop RCE, Commissioner for Patents, P.O. Box 1450, Alexandria, VA 22313-1450.

If you need assistance in completing the form, call 1-800-PTO-9199 and select option 2.

MICHAEL V. MESSINGER  
DIRECTOR  
(202) 772-8667  
MIKEM@SKGF.COM



RCE  
Sterne Kessler  
Goldstein Fox  
ATTORNEYS AT LAW

July 9, 2013

Commissioner for Patents  
PO Box 1450  
Alexandria, VA 22313-1450

Confirmation No. 8978  
Art Unit 2115  
Attn: Mail Stop RCE

Re: U.S. Utility Patent Application  
Application No. 13/118,122; Filing Date: May 27, 2011  
For: **Systems and Methods for Accelerated Loading of Operating Systems  
and Application Programs**  
Inventors: FALLON *et al.*  
Our Ref: 2855.004000B

Commissioner:

Transmitted herewith for appropriate action are the following documents:

1. Online Credit Card Payment Authorization in the amount of **\$12,300.00** to cover:
  - \$1,400.00 Three-Month Extension of Time Fee;
  - \$1,200.00 Request for Continued Examination Fee;
  - \$ 160.00 Terminal Disclaimer Fee;
  - \$9,120.00 Excess Claims Fee;
  - \$ 420.00 Independent Excess Claim Fee;
2. Petition for Extension of Time Under 37 C.F.R. § 1.136(a) Form (PTO/SB/22);
3. Request for Continued Examination (RCE) under 37 C.F.R. § 1.114(c);
4. Terminal Disclaimer To Obviate A Double Patenting Rejection Over "Prior" Patents;
5. Submission Under 37 C.F.R. § 1.114(c) and Preliminary Amendment Under 37 C.F.R. § 1.115;
6. Third Supplemental Information Disclosure Statement;
7. Form PTO/SB/08a (1 sheet) listing (8) documents (US1-US8);
8. Form PTO/SB/08b (13 sheets) listing (122) documents (NPL1-NPL122);
9. Electronic copies of cited documents (NPL1-NPL15 and NPL17-NPL122);
10. CD-Rom with cited document NPL16 (submitted via hand-carry); and



Commissioner for Patents  
July 9, 2013  
Page 2

11. Return Postcard (submitted via hand-carry).

In the event that extensions of time are necessary to prevent abandonment of this patent application, then such extensions of time are hereby petitioned.

Fee payment is provided through online credit card payment. The U.S. Patent and Trademark Office is hereby authorized to charge any fee deficiency, or credit any overpayment, to our Deposit Account No. 19-0036.

Respectfully submitted,

STERNE, KESSLER, GOLDSTEIN & FOX P.L.L.C.

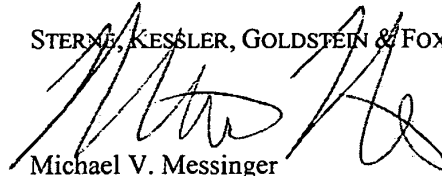

Michael V. Messinger  
Attorney for Applicants  
Registration No. 37,575

MVM/S-B/srb  
Enclosures

1704219\_1.DOCX



Under the Paperwork Reduction Act of 1995, no persons are required to respond to a collection of information unless it displays a valid OMB control number.

<b>PETITION FOR EXTENSION OF TIME UNDER 37 CFR 1.136(a)</b>	Docket Number (Optional) 2855.004000B
---	--

Application Number 13/118,122	Filed May 27, 2011
----------------------------------	-----------------------

For  
Systems and Methods for Accelerated Loading of Operating Systems and Application Programs

Art Unit 2115	Examiner SURYAWANSHI, Suresh
------------------	---------------------------------

This is a request under the provisions of 37 CFR 1.136(a) to extend the period for filing a reply in the above-identified application.

The requested extension and fee are as follows (check time period desired and enter the appropriate fee below):

	Fee	Small Entity Fee	Micro Entity Fee	
<input type="checkbox"/> One month (37 CFR 1.17(a)(1))	\$200	\$100	\$50	\$ _____
<input type="checkbox"/> Two months (37 CFR 1.17(a)(2))	\$600	\$300	\$150	\$ _____
<input checked="" type="checkbox"/> Three months (37 CFR 1.17(a)(3))	\$1,400	\$700	\$350	\$ 1,400.00
<input type="checkbox"/> Four months (37 CFR 1.17(a)(4))	\$2,200	\$1,100	\$550	\$ _____
<input type="checkbox"/> Five months (37 CFR 1.17(a)(5))	\$3,000	\$1,500	\$750	\$ _____

- Applicant asserts small entity status. See 37 CFR 1.27.
- Applicant certifies micro entity status. See 37 CFR 1.29. Form PTO/SB/15A or B or equivalent must either be enclosed or have been submitted previously.
- A check in the amount of the fee is enclosed.
- Payment by credit card. Form PTO-2038 is attached.
- The Director has already been authorized to charge fees in this application to a Deposit Account.
- The Director is hereby authorized to charge any fees which may be required, or credit any overpayment, to Deposit Account Number 19-0036.
- Payment made via EFS-Web.

**WARNING:** Information on this form may become public. Credit card information should not be included on this form. Provide credit card information and authorization on PTO-2038.

I am the

- applicant/inventor.
- assignee of record of the entire interest. See 37 CFR 3.71. 37 CFR 3.73(b) statement is enclosed (Form PTO/SB/96).
- attorney or agent of record. Registration number 37,575
- attorney or agent acting under 37 CFR 1.34. Registration number \_\_\_\_\_

\_\_\_\_\_  
Signature

July 9, 2013  
Date

Michael V. Messinger  
Typed or printed name

(202) 371-2600  
Telephone Number

**NOTE:** This form must be signed in accordance with 37 CFR 1.33. See 37 CFR 1.4 for signature requirements and certifications. Submit multiple forms if more than one signature is required, see below\*.

\* Total of one forms are submitted.

This collection of information is required by 37 CFR 1.136(a). The information is required to obtain or retain a benefit by the public, which is to file (and by the USPTO to process) an application. Confidentiality is governed by 35 U.S.C. 122 and 37 CFR 1.11 and 1.14. This collection is estimated to take 6 minutes to complete, including gathering, preparing, and submitting the completed application form to the USPTO. Time will vary depending upon the individual case. Any comments on the amount of time you require to complete this form and/or suggestions for reducing this burden should be sent to the Chief Information Officer, U.S. Patent and Trademark Office, U.S. Department of Commerce, P.O. Box 1450, Alexandria, VA 22313-1450. DO NOT SEND FEES OR COMPLETED FORMS TO THIS ADDRESS. SEND TO: Commissioner for Patents, P.O. Box 1450, Alexandria, VA 22313-1450.  
If you need assistance in completing the form, call 1-800-PTO-9199 and select option 2.



**TERMINAL DISCLAIMER TO OBVIATE A DOUBLE PATENTING REJECTION OVER "PRIOR" PATENTS**

Docket Number (Optional)  
2855.004000B

In re Application of: FALLON et al.

Application No.: 13/118,122

Filed: May 27, 2011

For: SYSTEMS AND METHODS FOR ACCELERATED LOADING OF OPERATING SYSTEMS AND APPLICATION PROGRAMS

The owner\*, Realtime Data LLC, of 100 percent interest in the instant application hereby disclaims, except as provided below, the terminal part of the statutory term of any patent granted on the instant application which would extend beyond the expiration date of the full statutory terms of **prior patent** Nos. 7,181,608, 8,090,936, and 8,112,619 as the terms of said **prior patents** are defined in 35 U.S.C. 154 and 173, and as the terms of said **prior patents** are presently shortened by any terminal disclaimer. The owner hereby agrees that any patent so granted on the instant application shall be enforceable only for and during such period that it and the **prior patents** are commonly owned. This agreement runs with any patent granted on the instant application and is binding upon the grantee, its successors or assigns.

In making the above disclaimer, the owner does not disclaim the terminal part of the term of any patent granted on the instant application that would extend to the expiration date of the full statutory terms as defined in 35 U.S.C. 154 and 173 of the **prior patents**, "as the terms of said **prior patents** are presently shortened by any terminal disclaimer," in the event that said **prior patents** later:

- expire for failure to pay a maintenance fee;
- are held unenforceable;
- are found invalid by a court of competent jurisdiction;
- are statutorily disclaimed in whole or terminally disclaimed under 37 CFR 1.321;
- have all claims canceled by a reexamination certificate;
- are reissued; or
- are in any manner terminated prior to the expiration of their full statutory term as presently shortened by any terminal disclaimer.

Check either box 1 or 2 below, if appropriate.

1.  For submissions on behalf of a business/organization (e.g., corporation, partnership, university, government agency, etc.), the undersigned is empowered to act on behalf of the organization.

I hereby declare that all statements made herein of my own knowledge are true and that all statements made on information and belief are believed to be true; and further that these statements were made with the knowledge that willful false statements and the like so made are punishable by fine or imprisonment, or both, under Section 1001 of Title 18 of the United States Code and that such willful false statements may jeopardize the validity of the application or any patent issued thereon.

2.  The undersigned is an attorney or agent of record. Reg. No. 37,575

July 9, 2013  
 Signature Date

Michael V. Messinger  
Typed or printed name

(202) 772-8667  
Telephone Number

- Terminal disclaimer fee under 37 CFR 1.20(d) included.

**WARNING: Information on this form may become public. Credit card information should not be included on this form. Provide credit card information and authorization on PTO-2038.**

\*Statement under 37 CFR 3.73(b) is required if terminal disclaimer is signed by the assignee (owner).  
Form PTO/SB/96 may be used for making this certification. See MPEP § 324.



IN THE UNITED STATES PATENT AND TRADEMARK OFFICE

In re application of:

FALLON, James J. *et al*

Appl. No.: 13/118,122

Filed: May 27, 2011

For: **Systems And Methods For  
Accelerated Loading Of Operating  
Systems And Application Programs**

Confirmation No.: 8978

Art Unit: 2115

Examiner: SURYAWANSHI, Suresh

Atty. Docket: 2855.004000B

**Submission Under 37 C.F.R. § 1.114(c) and  
Preliminary Amendment Under 37 C.F.R. § 1.115**

*Mail Stop RCE*

Commissioner for Patents  
PO Box 1450  
Alexandria, VA 22313-1450

Commissioner:

Filed concurrently herewith in the captioned application is a Request for Continued Examination (RCE). Prior to examination of the RCE on the merits, Applicants respectfully request that this Application be further amended as directed herein. Applicants submit the following Remarks in reply to the Office Action dated January 9, 2013 ("Final Action").

It is not believed that extensions of time or fees for net addition of claims are required beyond those that may otherwise be provided for in documents accompanying this paper. However, if additional extensions of time are necessary to prevent abandonment of this application, then such extensions of time are hereby petitioned under 37 C.F.R. § 1.136(a), and any fees required therefor (including fees for net addition of claims) are hereby authorized to be charged to our Deposit Account No. 19-0036.

***Amendments to the Claims***

This listing of claims will replace all prior versions, and listings, of claims in the application.

1. (Currently Amended) A method for providing accelerated loading of an operating system in a computer system, comprising:

maintaining a list of boot data ~~used for booting~~ [[a]] the computer system,

wherein at least a portion of boot data is associated with the list of boot data;

~~preloading~~ loading the at least a portion of boot data into a memory ~~upon initialization of the computer system~~;

accessing the loaded at least a portion of boot data in a compressed form from the memory; and

decompressing, on a just-in-time basis, the at least a portion of boot data in compressed form ~~accessed from the memory at a rate that~~ decreases boot time relative to loading the operating system in an uncompressed form ~~increases the effective access rate of the memory~~ [[:]], and

~~utilizing the decompressed~~ wherein the at least a portion of decompressed boot data ~~in loading~~ is a portion of the operating system for the computer system.

2. (Currently Amended) The method of claim 1, further comprising:

updating the list of boot data by associating additional boot data with the list of boot data ~~list~~ [[:]]

compressing the boot data preloaded into the memory with a data compression engine; and

compressing the additional boot data with ~~a random access~~ an encoder coupled to the data compression engine.

3. (Currently Amended) The method of claim 1, further comprising:

updating the list of boot data list by removing an association of additional boot data from the list of boot data.

4. (Currently Amended) The method of claim 1, further comprising:

updating the list of boot data by associating additional boot data with the list of boot data list; and

compressing at least a portion of the additional boot data with a data compression encoder.

5. (Cancelled)

6. (Currently Amended) A method, comprising:

maintaining a list of compressed boot data used for booting a computer system;

storing ~~the~~ compressed boot data associated with the list of compressed boot data on a boot device non-volatile memory;

~~initializing a central processing unit of the computer system;~~

loading the compressed boot data from the ~~boot device~~ non-volatile memory to a second memory;  
accessing the compressed boot data from the second memory; and  
decompressing the compressed boot data to provide decompressed boot data; and  
utilizing the decompressed boot data to boot the computer system, ~~wherein at least a portion of the boot data is accessed in compressed form~~  
wherein the accessing and the decompressing occur within a period of time which is less than a time to access the boot data from the non-volatile memory in an uncompressed form.

7. (Currently Amended) A system comprising:

a processor;

a memory; and

a non-volatile memory device configured to store [[:]] boot data in compressed form for booting the system ~~stored in compressed form in the non-volatile memory [[:]]~~ and logic code associated with the processor, the logic code stored in the non-volatile memory and comprising including instructions executable by the processor for maintaining a list of boot data used for booting the system, [[:]] and

wherein the processor is configured to load at least a portion of the compressed boot data in compressed form being preloaded into the memory, and to access the at least a portion of the boot data in compressed form and to decompress the at least a portion of the boot data in compressed form at a rate that decreases boot time relative to booting the system with uncompressed boot data being accessed and utilized to boot the system.

Atty. Dkt. No. 2855.004000B

8. (Currently Amended) The system of claim 7, further comprising:  
a data compression engine, coupled to the non-volatile memory, configured to compress the boot data; and  
a ~~random access encoder~~ data compression encoder, coupled to the data compression engine, configured to compress additional boot data.

9. (Currently Amended) A method of ~~preloading~~ loading an operating system for booting a computer system, comprising:  
storing substantially all of the operating system in compressed form on a ~~boot device~~ non-volatile memory;  
loading a first portion of the ~~compressed~~ operating system in compressed form from the ~~boot device~~ non-volatile memory to a second memory;  
accessing the first portion from the second memory in compressed form;  
decompressing the first portion to provide a decompressed first portion of the operating system;  
utilizing the decompressed first portion to partially boot the computer system;  
~~responsive to a request, locating a second portion of the compressed operating system using a boot data list and preloading~~ loading the a second portion of the operating system in compressed form from the ~~boot device~~ non-volatile memory to the second memory;  
accessing the second portion from the memory in compressed form; ~~and~~



decompressing the second portion to provide a decompressed second portion of the operating system; and

utilizing the decompressed second portion to further partially boot the computer system,

wherein the first and second portions are accessed and decompressed at a rate that is faster than accessing the first and second portions from the non-volatile memory in uncompressed form.

10. (Currently Amended) The method of claim 9, further comprising:

compressing additional boot data; and

storing the additional compressed boot data in the ~~boot device~~ non-volatile memory.

11. (Currently Amended) The method of claim 10, further comprising:

compressing the additional boot data with a ~~random access~~ data compression encoder.

12. (Currently Amended) A method for providing accelerated loading of an operating system in a computer system, comprising:

~~maintaining a boot data list;~~

loading boot data in compressed form associated with ~~the a~~ a boot data list ~~in compressed form~~ from a non-volatile boot device into a memory upon initialization of the computer system;

accessing the ~~compressed~~ boot data in compressed form from the memory;  
decompressing ~~as-needed~~ the ~~compressed~~ boot data in compressed form accessed from the memory at a rate that ~~increases the effective access rate of the memory~~ decreases a time to load the operating system relative to loading the operating system with the boot data in uncompressed form; and  
utilizing the decompressed boot data ~~in-loading to load~~ the operating system for the computer system.

13. (Previously Presented) The method of claim 12, further comprising:  
compressing additional boot data with a random access encoder.

14. (Currently Amended) A method for providing accelerated loading of an operating system in a computer system, comprising:  
maintaining a boot data list;  
loading boot data associated with the boot data list from a non-volatile boot device into a memory in compressed form upon initialization of the computer system;  
accessing the compressed boot data from the memory;  
decompressing, on a just-in-time basis, the compressed boot data accessed from the memory at a rate that decreases a time to load the operating system relative to loading the operating system with the boot data in uncompressed form ~~increases the effective access rate of the memory~~; and  
utilizing the decompressed boot data ~~in-loading the operating system for the~~ computer system.

15. (New) A method for providing accelerated loading of an operating system in a computer system, comprising:

accessing boot data for booting the computer system, wherein at least a portion of the boot data is in compressed form;

loading the boot data into a memory;

servicing requests for boot data from the computer system using the loaded compressed boot data, wherein the servicing requests include accessing compressed boot data and decompressing the compressed boot data at a rate that decreases an overall boot time relative to loading the operating system in uncompressed form.

16. (New) The method of claim 15, wherein the boot data comprises program code associated with the operating system.

17. (New) The method of claim 15, wherein the operating system comprises multiple files.

18. (New) The method of claim 15, wherein the boot data comprises program code associated with one or more application programs of the computer system.

19. (New) The method of claim 15, wherein the boot data comprises program code associated with a combination of the operating system and one or more application programs.

20. (New) The method of claim 18, wherein the one or more application programs comprises multiple files.

21. (New) The method of claim 15, further comprising:  
updating the boot data.

22. (New) The method of claim 15, further comprising:  
updating a list of the boot data.

23. (New) The method of claim 22, wherein the updating comprises:  
adding to the list any boot data requested by the computer system not previously stored in the list.

24. (New) The method of claim 22, wherein the updating comprises:  
removing from the list any boot data previously stored in the list and not requested by the computer system.

25. (New) The method of claim 15, further comprising:  
maintaining a boot data list.

26. (New) The method of claim 15, wherein the boot data is accessed from a non-volatile memory device.

27. (New) The method of claim 1, wherein the at least a portion of the boot data in compressed form represents a plurality of files.

28. (New) The method of claim 1, wherein the at least a portion of the boot data in compressed form comprises program code associated with the operating system.

29. (New) The method of claim 1, further comprising:  
compressing the at least a portion of the boot data with one or more advanced compression encoders to provide the at least a portion of the boot data in compressed form.

30. (New) The method of claim 1, wherein the decompressing comprises:  
decompressing the at least a portion of the boot data in compressed form utilizing one or more advanced decompression decoders.

31. (New) The method of claim 1, wherein the loading comprises:  
loading the at least a portion of the boot data in compressed form into a contiguous portion of the memory, and further comprising:  
decompressing the at least a portion of the boot data in compressed form into a different portion of the memory than the contiguous portion.

32. (New) The method of claim 1, wherein the memory is virtual.

33. (New) The method of claim 1, wherein the memory is physical.
34. (New) The method of claim 1, wherein the compressed boot data is larger than 512 kilobytes.
35. (New) The method of claim 1, wherein the at least a portion of the boot data in compressed form is larger than 640 kilobytes.
36. (New) The method of claim 1, wherein the compression ratio of the at least a portion of the boot data in compressed form is greater than 2.5:1.
37. (New) The method of claim 1, wherein the operating system comprises multiple files.
38. (New) The method of claim 1, wherein the boot data includes program code associated with one or more application programs of the computer system.
39. (New) The method of claim 1, wherein the boot data comprises program code associated with a combination of the operating system and one or more application programs.
40. (New) The method of claim 38, wherein the one or more application programs are comprised of multiple files.

41. (New) The method of claim 1, wherein the accessing comprises:  
accessing the at least a portion of the boot data in compressed form via direct  
memory access.

42. (New) The method of claim 1, wherein Huffman encoding is utilized to  
encode the at least a portion of the boot data in compressed form.

43. (New) The method of claim 1, wherein Lempel-Ziv encoding is utilized to  
encode the at least a portion of the boot data in compressed form.

44. (New) The method of claim 1, wherein a plurality of encoders are utilized to  
encode the at least a portion of the boot data in compressed form.

45. (New) The method of claim 6, wherein the compressed boot data represents  
a plurality of files.

46. (New) The method of claim 6, wherein the compressed boot data comprises  
program code associated with an operating system.

47. (New) The method of claim 6, further comprising:  
compressing the boot data with one or more advanced compression encoders to  
provide the compressed boot data.

48. (New) The method of claim 6, wherein the decompressing comprises:  
decompressing the compressed boot data with one or more advanced  
decompression decoders.

49. (New) The method of claim 6, wherein the loading comprises:  
loading the compressed boot data to a contiguous portion of the second memory,  
and wherein the decompressing comprises:  
decompressing the compressed boot data to a different portion of the second  
memory than the contiguous portion.

50. (New) The method of claim 6, wherein the second memory is virtual.

51. (New) The method of claim 6, wherein the second memory is physical.

52. (New) The method of claim 6, wherein the compressed boot data is larger  
than 512 kilobytes.

53. (New) The method of claim 6, wherein the compressed boot data is larger  
than 640 kilobytes.

54. (New) The method of claim 6, wherein the compression ratio of the  
compressed boot data is greater than 2.5:1.



55. (New) The method of claim 46, wherein the operating system comprises multiple files.

56. (New) The method of claim 6, wherein the compressed boot data comprises program code associated with one or more application programs of the computer system.

57. (New) The method of claim 6, wherein the compressed boot data comprises program code associated with a combination of an operating system of the computer system and one or more application programs.

58. (New) The method of claim 56, wherein the one or more application programs includes multiple files.

59. (New) The method of claim 6, wherein the accessing comprises: accessing the compressed boot data via direct memory access.

60. (New) The method of claim 6, wherein Huffman encoding is utilized to encode the compressed boot data.

61. (New) The method of claim 6, wherein Lempel-Ziv encoding is utilized to encode the compressed boot data.

62. (New) The method of claim 6, wherein a plurality of encoders are utilized to encode the compressed boot data.

63. (New) The system of claim 7, wherein the boot data in compressed form represents a plurality of files.

64. (New) The system of claim 7, wherein the boot data comprises program code associated with an operating system.

65. (New) The system of claim 7, further comprising:  
one or more advanced compression encoders configured to compress the boot data to provide the boot data in compressed form.

66. (New) The system of claim 7, further comprising:  
one or more advanced decompression decoders configured to decompress the boot data in compressed form.

67. (New) The system of claim 7, wherein the processor is further configured to load the boot data in compressed form into a contiguous portion of the memory and to decompress the boot data in compressed form to a different portion of the memory than the contiguous portion.

68. (New) The system of claim 7, wherein the memory is virtual.

69. (New) The system of claim 7, wherein the memory is physical.

70. (New) The system of claim 7, wherein the boot data in compressed form is larger than 512 kilobytes.

71. (New) The system of claim 7, wherein the boot data in compressed form is larger than 640 kilobytes.

72. (New) The system of claim 7, wherein the compression ratio of the boot data in compressed form is greater than 2.5:1.

73. (New) The system of claim 7, wherein the boot data in compressed form is comprised of multiple files.

74. (New) The system of claim 7, wherein the boot data comprises program code associated with one or more application programs of the system.

75. (New) The system of claim 7, wherein the boot data comprises program code associated with a combination of an operating system of the system and one or more application programs.

76. (New) The system of claim 74, wherein the one or more application programs are comprised of multiple files.

77. (New) The system of claim 7, wherein the processor is further configured to access the at least a portion of the boot data in compressed form the memory via direct memory access.

78. (New) The system of claim 7, wherein the processor is further configured to utilize Huffman encoding to encode the boot data to provide the boot data in compressed form.

79. (New) The system of claim 7, wherein the processor is further configured to utilize Lempel-Ziv encoding to encode the boot data to provide the boot data in compressed form.

80. (New) The system of claim 7, further comprising:  
a plurality of encoders configured to encode the boot data in compressed form.

81. (New) The method of claim 9, wherein the operating system in compressed form represents a plurality of files.

82. (New) The method of claim 9, wherein the operating system in compressed form comprises program code associated with an operating system.

83. (New) The method of claim 9, further comprising:  
compressing the operating system with one or more advanced compression encoders to provide the operating system in compressed form.

84. (New) The method of claim 9, wherein the decompressing the first and second portions comprise:

decompressing the first and second portions with one or more advanced decompression decoders.

85. (New) The method of claim 9, wherein the loading comprises:

loading the operating system in compressed form into a contiguous portion of the second memory, and wherein the decompressing the first portion comprises:

decompressing the first portion into a different portion of the second memory than the contiguous portion.

86. (New) The method of claim 9, wherein the memory is virtual.

87. (New) The method of claim 9, wherein the memory is physical.

88. (New) The method of claim 9, wherein the operating system in compressed form is larger than 512 kilobytes.

89. (New) The method of claim 9, wherein the operating system in compressed form is larger than 640 kilobytes.

90. (New) The method of claim 9, wherein the compression ratio of the operating system in compressed form is greater than 2.5:1.

91. (New) The method of claim 9, wherein the operating system is comprised of multiple files.

92. (New) The method of claim 9, wherein the operating system comprises program code associated with one or more application programs of the computer system.

93. (New) The method of claim 9, wherein the operating system in compressed form comprises program code associated with a combination of an operating system of the computer system and one or more application programs.

94. (New) The method of claim 92, wherein the one or more application programs are comprised of multiple files.

95. (New) The method of claim 9, wherein the accessing comprises:  
accessing the first portion from the second memory via direct memory access.

96. (New) The method of claim 9, wherein Huffman encoding is utilized to encode the operating system in compressed form.

97. (New) The method of claim 9, wherein Lempel-Ziv encoding is utilized to encode the operating system in compressed form.

98. (New) The method of claim 9, wherein a plurality of encoders are utilized to encode the operating system in compressed form.

99. (New) The method of claim 12, wherein the boot data in compressed form represents a plurality of files.

100. (New) The method of claim 12, wherein the boot data comprises program code associated with the operating system.

101. (New) The method of claim 12, further comprising;  
compressing the boot data in compressed form utilizing one or more advanced compression encoders to provide the boot data in compressed form.

102. (New) The method of claim 12, wherein the decompressing comprises:  
decompressing the boot data in compressed form utilizing one or more advanced decompression decoders.

103. (New) The method of claim 12, wherein the loading comprises:  
loading the boot data in compressed form into a contiguous portion of the  
memory, and wherein the decompressing comprises:  
decompressing the boot data in compressed form into a different portion of the  
memory than the contiguous portion.
104. (New) The method of claim 12, wherein the memory is virtual.
105. (New) The method of claim 12, wherein the memory is physical.
106. (New) The method of claim 12, wherein the boot data in compressed form  
is larger than 512 kilobytes.
107. (New) The method of claim 12, wherein the boot data in compressed form  
is larger than 640 kilobytes.
108. (New) The method of claim 12, wherein the compression ratio of the boot  
data in compressed form is greater than 2.5:1.
109. (New) The method of claim 12, wherein the operating system is comprised  
of multiple files.



110. (New) The method of claim 12, wherein the boot data comprises program code associated with one or more application programs of the computer system.

111. (New) The method of claim 12, wherein the boot data comprises program code associated with a combination of the operating system and one or more application programs.

112. (New) The method of claim 110, wherein the one or more application programs are comprised of multiple files.

113. (New) The method of claim 12, wherein the accessing comprises:  
accessing the boot data in compressed form from the memory via direct memory access.

114. (New) The method of claim 12, wherein Huffman encoding is utilized to encode the boot data in compressed form.

115. (New) The method of claim 12, wherein Lempel-Ziv encoding is utilized to encode the boot data in compressed form.

116. (New) The method of claim 12, wherein a plurality of encoders are utilized to encode the boot data in compressed form.

117. (New) The method of claim 14, wherein the compressed boot data represents a plurality of files.

118. (New) The method of claim 14, wherein the boot data comprises program code associated with the operating system.

119. (New) The method of claim 14, further comprising:  
compressing the boot data with one or more advanced compression encoders to provide the compressed boot data.

120. (New) The method of claim 14, wherein the decompressing comprises:  
decompressing the compressed boot data with one or more advanced decompression decoders.

121. (New) The method of claim 14, wherein the loading comprises:  
loading the compressed boot data into a contiguous portion of the memory, and wherein the decompressing comprises:  
decompressing the compressed boot data into a different portion of the memory than the contiguous portion.

122. (New) The method of claim 14, wherein the memory is virtual.

123. (New) The method of claim 14, wherein the memory is physical.

124. (New) The method of claim 14, wherein the compressed boot data is larger than 512 kilobytes.

125. (New) The method of claim 14, wherein the compressed boot data is larger than 640 kilobytes.

126. (New) The method of claim 14, wherein the compression ratio of the compressed boot data is greater than 2.5:1.

127. (New) The method of claim 14, wherein the operating system is comprised of multiple files.

128. (New) The method of claim 14, wherein the boot data comprises program code associated with one or more application programs of the computer system.

129. (New) The method of claim 14, wherein the boot data comprises program code associated with a combination of the operating system and one or more application programs.

130. (New) The method of claim 128, wherein the one or more application programs are comprised of multiple files.

131. (New) The method of claim 14, wherein the accessing comprises:  
accessing the compressed boot data from the memory via direct memory access.

132. (New) The method of claim 14, wherein Huffman encoding is utilized to  
encode the compressed boot data.

133. (New) The method of claim 14, wherein Lempel-Ziv encoding is utilized to  
encode the compressed boot data.

134. (New) The method of claim 14, wherein a plurality of encoders are utilized  
to encode the compressed boot data

***Remarks***

Reconsideration of this Application is respectfully requested.

Upon entry of the foregoing amendment, claims 1-4 and 6-140 are pending in the application, with claims 1, 6-7, 9, 12, and 14-15 being the independent claims. Claims 1-4 and 6-13 are sought to be amended. Claim 5 is sought to be cancelled without prejudice to or disclaimer of the subject matter therein. Applicants reserve the right to prosecute similar or broader claims, with respect to the cancelled and/or amended claims, in the future. New claims 15-134 are sought to be added. These changes are believed to introduce no new matter, and their entry is respectfully requested.

Based on the above amendment and the following remarks, Applicants respectfully request that the Examiner reconsider all outstanding objections and rejections and that they be withdrawn.

***Double Patenting***

Claims 1-14 stand rejected under the judicially created doctrine of obviousness-type double patenting as being allegedly unpatentable over claims 1-13, claims 1-24, and claims 1-31 of U.S. Patent Nos. 8,112,619; 8,090,936; and 7,181,608, respectively.

Claims 1-4 and 6-14

Applicants are submitting a Terminal Disclaimer concurrently herewith to overcome the double patenting rejection with respect to the claims presented above. The filing of this Terminal Disclaimer is not an admission of the propriety of the rejection. See, *Quad Environmental Technologies Corp. v. Union Sanitary District*, 946 F.2d 870, 20 USPQ2d 1392 (Fed. Cir. 1991). Accordingly, Applicants respectfully request that the

Atty. Dkt. No. 2855.004000B

obviousness-type double patenting rejection of claims 1-4 and 6-14 be reconsidered and withdrawn.

Claim 5

Applicants have cancelled claim without prejudice or disclaimer, thereby rendering the rejection moot. Applicants contend that the cancelling of claim 5 does not give rise to any implication regarding whether Applicants agree with or acquiesce to this rejection.

***Rejections Under 35 U.S.C. § 103***

Claims 6-11 stand rejected under 35 U.S.C. § 103 as allegedly being unpatentable over U.S. Patent No. 6,073,232 to Kroeker ("Kroeker") in view of U.S. Patent No. 6,434,695 to Esfahani ("Esfahani"). Applicants respectfully traverse these rejections.

***Kroeker and Esfahani do not Teach or Suggest Each and Every Feature of Claims 6-7 and 9 as Amended***

Independent claim 6 has been amended to recite, among other features, "*wherein the accessing and the decompressing occur within a period of time which is less than a time to access the boot data from the non-volatile memory in an uncompressed form.*" Independent claim 7 has also been amended to recite, among other features, "*wherein the processor is configured to load at least a portion of the boot data in compressed form into the memory, and to access the at least a portion of the boot data in compressed form and decompress at a rate that decreases boot time relative to booting the system with uncompressed boot data.*" Furthermore, independent claim 9 has been amended to

Atty. Dkt. No. 2855.004000B

recite, among other features, "*wherein the first and second portions are accessed and decompressed at a rate that is faster than accessing the first and second portions from the non-volatile memory in uncompressed form.*" Kroeker and Esfahani, alone or any combination thereof, do not teach or suggest at least these features.

Consequently, Kroeker and Esfahani do not render independent claims 6, 7, and 9 obvious, and thus independent claims 6 and 7 are allowable. Dependent claims 8 and 10-11 are likewise allowable for the same reasons as the independent claims from which they respectively depend and further in view of their own features. Accordingly, Applicants respectfully request that the rejection of claims 6-11 under 35 U.S.C. § 103(a) be reconsidered and withdrawn.

***The Combination of the Kroeker and Esfahani References is Based on Impermissible Hindsight***

The Examiner concedes that "Kroeker does not teach about accessing compressed boot data," in rejecting independent claims 6, 7, and 9. (Office Action, pp. 5-6 and 8). The Examiner alleges that Esfahani cures this deficiency and, through combining Kroeker and Esfahani, that "it would have been obvious to one of ordinary skill in the art at the time of the invention was made to combine the cited references as they are directed to minimize a computer's initial program load time or shortening the load time of the computer programs from a hard disk drive to a hot computer." (*Id.*). Applicants respectfully disagree.

The Examiner is respectfully reminded that "[t]he mere fact that references can be combined or modified does not render the resultant combination obvious." (MPEP §

Atty. Dkt. No. 2855.004000B

2143.01.III). Furthermore, "*it is not enough to simply show that the references disclose the claim limitations*"; in addition, 'it can be important to identify a reason that would have prompted a person of ordinary skill in the art to combine the elements as the new invention does.'" (*Transocean Offshore Deepwater Drilling, Inc. v. Maersk Contractors*, 617 F.3d 1296, (2010) (quoting *KSR International Co. v. Teleflex*, 550 U.S. at 401, Emphasis Added).

To further clarify, Kroeker recognizes that "the transfer of [a] selected program to [a] computer is relatively slow, particularly when the program is a modern large operating system." (Kroeker, 1:29-31). To speed computer boot time, Kroeker "generates a prefetch table that contains pointers to disk locations and lengths of the records of an application program requested by the host computer during an initial power-on/reset." (Kroeker, Abstract).

The boot system of Kroeker, therefore, provides a method whereby "[a] pre fetch table is then generated. . .[t]hen, after a subsequent power-on or reset of the hard disk drive, and during a second power-on or reset of the host computer, the pre fetch table is accessed to read into the data cache the data records. . .[if] records requested by the subsequent read command are stored in the data cache. . .the records are communicated from the cache to the host computer; otherwise, the records are communicated from the disk to the host computer." (Kroeker, 2:36-47). In other words, regardless of whether the records are stored in the data cache, the records are communicated from the cache or the disk to the host computer *without any need to compress the records*. In other words, Kroeker adequately reduces boot load time through the use of prefetch tables, and nowhere does Kroeker or Esfahani teach or suggest deficiencies in the booting system of



Kroeker to cause one skilled in the art to modify this booting system to used compressed data as alleged in the Office Action.

Furthermore, Esfahani is concerned not with boot speed or storage efficiency, but with "facilitating the debugging and upgrading of a computer operating system." (Esfahani, ¶ [0001]). That is, the boot loading system of Esfahani solves different problems entirely than Kroeker. Esfahani further explains the benefits of its boot system. Column 4:55 – Column 5:6 states in full:

The benefits of this approach include the following: When hardware changes are needed, only the hardware-specific code has to be modified, greatly decreasing the turnaround time for new products and software product releases, and reducing testing time and expenses. The higher-level ToolBox and System Software seldom needs to change. This approach further provides high confidence that the higher level software has not been changed when creating a new build as a result of changing the hardware-dependent code. Changing the higher-level software less frequently simplifies testing and reduces the time to develop system software and fix bugs. In addition, the memory footprint may be reduced, since fewer patches may be required as the higher-level software is consolidated and unchanged. Running an OS other than the MacOS, such as Rhapsody, becomes simpler. Also, costs tend to be reduced. Today, RAM and disk space are inexpensive, have high capacity, and are fast compared to the ROM, RAM and disk in the original Macintosh.

One skilled in the art would not add Esfahani's compression functionality to Kroeker's boot system, since Kroeker adequately decreases boot time through the use of prefetch tables. Additionally, Esfahani's use of a compressed ROM image solves problems related not to decreasing boot time, but to simplifying an operating system updating procedure. The reasoning provided in the Office Action to combine the Kroeker and Esfahani references, therefore, cannot be based on the knowledge of one of ordinary skill in the art. The Office Action uses impermissible hindsight to reconstruct Applicants "method for providing accelerated loading of a computer operating system" from the Kroeker and Esfahani references. To guard against impermissible hindsight,

the Office must fully articulate its obviousness rejections. See *In re Kahn*, 441 F.3d 977, 986 (Fed. Cir. 2006). For instance, the Examiner may not use the challenged claims as a roadmap on how or why to combine references. See, e.g., *Ruiz v. A.B. Chance Co.*, 357 F.3d 1270, 1275 (Fed. Cir. 2004).

Instead, the Examiner must rely solely on the prior art teachings and knowledge of a person of ordinary skill at the time the invention was made to determine whether an invention is obvious. See *In re Kahn*, 441 F.3d at 986 and MPEP § 2145.X.A. If anything, it is only when the Specification of this Application is used as a blueprint that a person of ordinary skill in the art would be motivated to combine Kroecker and Esfahani in the manner set forth in the Office Action. But this combination is impermissibly based on hindsight bias. See *KSR*, 127 S.Ct. at 1742 (citing *Graham v. John Deere Co. of Kansas City*, 383 U.S. 1, 36 (1966)) (warning that "[a] factfinder should be aware, of course, of the distortion caused by hindsight bias and must be cautious of arguments reliant on ex post reasoning").

Because the only motivation to combine the Kroecker and Esfahani references is based on impermissible hindsight, the combination is improper. Consequently, the combination of Kroecker and Esfahani does not render claims 6-7 and 9 obvious, and thus claims 6-7 and 9 are allowable based at least upon this impermissible combination. Dependent claims 8 and 10-11 are likewise allowable for the same reasons as the independent claims from which they respectively depend and further in view of their own features. Accordingly, Applicants further request that the rejection of claims 6-11 under 35 U.S.C. § 103(a) be reconsidered and withdrawn.

Atty. Dkt. No. 2855.004000B

***New Claims 15-134***

Independent claim 15 has been added. Independent claim 15 recites, among other features, "*servicing requests for boot data from the computer system using the loaded compressed boot data, wherein the servicing requests include accessing compressed boot data and decompressing the compressed boot data at a rate that decreases an overall boot time relative to loading the operating system in uncompressed form.*" Kroeker and Esfahani, alone or any combination thereof, do not teach or suggest at least these features, and thus new claim 15 is allowable.

Dependent claims 16-134 have also been added, which depend from independent claims 1, 6-7, 9, 12, and 14-15. As independent claims 1, 6-7, 9, 12, and 14-15 are allowable, new claims 16-134 are likewise allowable for the same reasons as the independent claims from which they depend and further in view of their own respective features.

***Conclusion***

As discussed herein, the present application is in condition for allowance. If the Examiner believes, for any reason, that personal communication will expedite prosecution of this application, the Examiner is invited to telephone the undersigned at the number provided.

Prompt and favorable consideration of this Amendment and Reply is respectfully requested.

Respectfully submitted,

STERNE, KESSLER, GOLDSTEIN & FOX P.L.L.C.

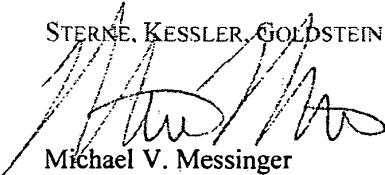
  
Michael V. Messinger  
Attorney for Applicant  
Registration No. 37,575

Date: \_\_\_\_\_

July 9, 2013

1100 New York Avenue, N.W.  
Washington, D.C. 20005-3934  
(202) 371-2600  
1700640\_1.DOCX

Atty. Dkt. No. 2855.004000B



## Electronic Acknowledgement Receipt

<b>EFS ID:</b>	16267160
<b>Application Number:</b>	13118122
<b>International Application Number:</b>	
<b>Confirmation Number:</b>	8978
<b>Title of Invention:</b>	Systems and Methods for Accelerated Loading of Operating Systems and Application Programs
<b>First Named Inventor/Applicant Name:</b>	James J. Fallon
<b>Customer Number:</b>	26111
<b>Filer:</b>	Michael V. Messinger/Amy Norris
<b>Filer Authorized By:</b>	Michael V. Messinger
<b>Attorney Docket Number:</b>	2855.004000B
<b>Receipt Date:</b>	09-JUL-2013
<b>Filing Date:</b>	27-MAY-2011
<b>Time Stamp:</b>	17:00:35
<b>Application Type:</b>	Utility under 35 USC 111(a)

### Payment information:

Submitted with Payment	yes
Payment Type	Credit Card
Payment was successfully received in RAM	\$12300
RAM confirmation Number	4209
Deposit Account	
Authorized User	

### File Listing:

Document Number	Document Description	File Name	File Size(Bytes)/ Message Digest	Multi Part /.zip	Pages (if appl.)
-----------------	----------------------	-----------	-------------------------------------	------------------	------------------

1		2855004000B_Filing.pdf	7939641	yes	62
			31931313ea947edc8264313072c499eff605c7b8		
<b>Multipart Description/PDF files in .zip description</b>					
		<b>Document Description</b>	<b>Start</b>	<b>End</b>	
		Transmittal Letter	1	2	
		Extension of Time	3	3	
		Request for Continued Examination (RCE)	4	4	
		Terminal Disclaimer Filed	5	5	
		Preliminary Amendment	6	6	
		Claims	7	30	
		Applicant Arguments/Remarks Made in an Amendment	31	38	
		Transmittal Letter	39	48	
		Information Disclosure Statement (IDS) Form (SB08)	49	49	
		Information Disclosure Statement (IDS) Form (SB08)	50	62	
<b>Warnings:</b>					
<b>Information:</b>					
2	Fee Worksheet (SB06)	fee-info.pdf	36688	no	2
			61210bb4ba946e72ca8c5c6c1e83b379019db57b		
<b>Warnings:</b>					
<b>Information:</b>					
<b>Total Files Size (in bytes):</b>			7976329		

This Acknowledgement Receipt evidences receipt on the noted date by the USPTO of the indicated documents, characterized by the applicant, and including page counts, where applicable. It serves as evidence of receipt similar to a Post Card, as described in MPEP 503.

**New Applications Under 35 U.S.C. 111**

If a new application is being filed and the application includes the necessary components for a filing date (see 37 CFR 1.53(b)-(d) and MPEP 506), a Filing Receipt (37 CFR 1.54) will be issued in due course and the date shown on this Acknowledgement Receipt will establish the filing date of the application.

**National Stage of an International Application under 35 U.S.C. 371**

If a timely submission to enter the national stage of an international application is compliant with the conditions of 35 U.S.C. 371 and other applicable requirements a Form PCT/DO/EO/903 indicating acceptance of the application as a national stage submission under 35 U.S.C. 371 will be issued in addition to the Filing Receipt, in due course.

**New International Application Filed with the USPTO as a Receiving Office**

If a new international application is being filed and the international application includes the necessary components for an international filing date (see PCT Article 11 and MPEP 1810), a Notification of the International Application Number and of the International Filing Date (Form PCT/RO/105) will be issued in due course, subject to prescriptions concerning national security, and the date shown on this Acknowledgement Receipt will establish the international filing date of the application.





IN THE UNITED STATES PATENT AND TRADEMARK OFFICE

In re application of:

FALLON *et al.*

Appl. No.: 13/118,122

Filed: May 27, 2011

For: **Systems and Methods for  
Accelerated Loading of Operating  
Systems and Application Programs**

Confirmation No.: 8978

Art Unit: 2115

Examiner: SURYAWANSHI, Suresh

Atty. Docket: 2855.004000B

**Third Supplemental Information Disclosure Statement**

*Mail Stop RCE*

Commissioner for Patents  
PO Box 1450  
Alexandria, VA 22313-1450

Sir:

Notice of Prior and Concurrent Proceedings

Applicants hereby call to the attention of the Patent and Trademark Office the following reexamination proceedings involving patents that are commonly-assigned with the patent in the above-identified patent application:

Proceeding	Status
<i>Inter Partes</i> Reexamination of U.S. Patent No. 6,604,158 (Control No. 95/000,486)	<i>Inter Partes</i> Reexamination Certificate issued 10/10/2012
<i>Inter Partes</i> Reexamination of U.S. Patent No. 7,321,937 (Control No. 95/000,466)	<i>Inter Partes</i> Reexamination Certificate issued 05/15/2012
<i>Inter Partes</i> Reexamination of U.S. Patent No. 6,604,158 (Control No. 95/000,453)	Terminated
<i>Ex Parte</i> Reexamination of U.S. Patent No. 6,601,104 (Control No. 90/009,428)	<i>Ex Parte</i> Reexamination Certificate issued 02/28/2012
<i>Inter Partes</i> Reexamination of U.S. Patent No. 7,378,992 (Control No. 95/000,478)	<i>Inter Partes</i> Reexamination Certificate issued 10/04/2012
<i>Inter Partes</i> Reexamination of U.S. Patent No. 6,624,761 (Control No. 95/000,464)	<i>Inter Partes</i> Reexamination Certificate issued 06/12/2012
<i>Inter Partes</i> Reexamination of U.S. Patent No. 7,161,506 (Control No. 95/000,479)	<i>Inter Partes</i> Reexamination Certificate issued 05/22/2012



<b>Proceeding</b>	<b>Status</b>
<i>Inter Partes</i> Reexamination of U.S. Patent No. 7,714,747 (Control No. 95/001,517)	Petition to Expunge Third Party Requester's Improper Submission of Declarations and Strike Comments Directed to Examiner's Determination filed 06/26/2013; Patent Owner's Comments in Response to Examiner's Determination filed 05/10/2013; Examiner's Determination Under 37 C.F.R. § 41.77(d) mailed 04/10/2013
<i>Inter Partes</i> Reexamination of U.S. Patent No. 7,417,568 (Control No. 95/001,533)	Decision on Petition Under 37 C.F.R. § 1.183 to Request Examiner Enter Evidence mailed 03/20/2013
<i>Inter Partes</i> Reexamination of U.S. Patent No. 7,777,651 (Control No. 95/001,581)	Examiner's Answer to Appeal Brief mailed 03/14/2013
<i>Inter Partes</i> Reexamination of U.S. Patent No. 7,400,274 (Control No. 95/001,544)	Examiner's Answer to Appeal Brief mailed 10/01/2012

Applicants hereby call to the attention of the Patent and Trademark Office the following reexamination proceedings filed by Cellco Partnership d/b/a Verizon Wireless, involving patents that are commonly-assigned with the patent in the above-identified patent application:

<b>Proceeding</b>	<b>Status</b>
<i>Inter Partes</i> Reexamination of U.S. Patent No. 7,321,937 (Control No. 95/001,922)	Patent Owner's Supplemental Response to Action Closing Prosecution filed 05/15/2013; Patent Owner's Response to Action Closing Prosecution filed 05/09/2013
<i>Inter Partes</i> Reexamination of U.S. Patent No. 6,604,158 (Control No. 95/001,923)	Patent Owner's Supplemental Response to Office Action filed 04/29/2013
<i>Inter Partes</i> Reexamination of U.S. Patent No. 7,352,300 (Control No. 95/001,924)	Patent Owner's Response to Action Closing Prosecution filed 05/09/2013; Action Closing Prosecution mailed 04/09/2013
<i>Inter Partes</i> Reexamination of U.S. Patent No. 7,395,345 (Control No. 95/001,925)	Patent Owner's Supplemental Response to Office Action filed 05/06/2013

<b>Proceeding</b>	<b>Status</b>
<i>Inter Partes</i> Reexamination of U.S. Patent No. 7,161,506 (Control No. 95/001,926)	Patent Owner's Reply to Action Closing Prosecution filed 04/05/2013; Action Closing Prosecution mailed 03/05/2013
<i>Inter Partes</i> Reexamination of U.S. Patent No. 7,415,530 (Control No. 95/001,927)	Right of Appeal Notice mailed 05/31/2013; Action Closing Prosecution mailed 04/03/2013
<i>Inter Partes</i> Reexamination of U.S. Patent No. 7,378,992 (Control No. 95/001,928)	Patent Owner's Reply to Action Closing Prosecution filed 04/05/2013; Action Closing Prosecution mailed 03/05/2013

Applicants invite the Examiner to review the Requests for Reexamination, issued Office Actions, replies, and any other papers in the above-identified reexamination proceedings. If the Examiner is unable to obtain copies of papers in any reexamination proceeding, copies can be provided to the Examiner upon request. Those documents which may be material that are not already of record in this patent application are listed on the accompanying Form PTO/SB/08. For example, documents related to the reexaminations are listed at NPL61-NPL109.

Notice of Related Litigation

Applicants notify the Patent and Trademark Office of the following litigation involving U.S. Patents commonly-owned with the current patent application, the subject matter of which may be related to the present patent application:

<b>No.</b>	<b>Case</b>	<b>Status</b>
1	<i>Realtime Data LLC d/b/a IXO v. Packeteer, Inc. et al.</i> , No. 6:08-cv-00144-LED (E.D. Texas)	Dismissed

Applicants also notify the Patent and Trademark Office of the following additional litigation involving U.S. Patents commonly-owned with the current patent application, the subject matter of which may be related to the present patent application:

No.	Case	Status
2	<i>Realtime Data LLC d/b/a IXO v. Thomson Reuters Corporation et al.</i> No. 1:11-cv-06698-RJH (S.D. New York) (transferred from E.D. Texas; 6:09-cv-00333-LED)	Notice of Appeal Filed
3	<i>Realtime Data LLC d/b/a IXO v. Morgan Stanley et al.</i> , No. 1:11-cv-06696-RJH (S.D. New York) (transferred from E.D. Texas; 6:09-cv-00326-LED)	Notice of Appeal Filed
4	<i>Realtime Data LLC d/b/a IXO v. CME Group Inc., et al.</i> , No. 1:11-cv-06697-RJH (S.D. New York) (transferred from E.D. Texas; No. 6:09-cv-00327-LED)	Notice of Appeal Filed
5	<i>Chicago Board Options Exchange, Inc., v. Realtime Data LLC d/b/a IXO</i> , No. 09-cv-4486 (N.D. Ill.)	Dismissed
6	<i>Thomson Reuters Corporation v. Realtime Data, LLC d/b/a IXO</i> , No. 1:09-cv-07868-RMB (S.D.N.Y)	Consolidated with Case No. 2
7	<i>Realtime Data, LLC d/b/a IXO v. CME Group Inc., et al. (II)</i> , No. 6:10-cv-246 (E.D. Texas)	Consolidated with Case No. 4
8	<i>Realtime Data LLC d/b/a IXO v. Thomson Reuters Corporation et al. (II)</i> , No. 6:10-cv-247 (E.D. Texas)	Consolidated with Case No. 2
9	<i>Realtime Data, LLC d/b/a IXO v. Morgan Stanley, et al. (II)</i> , No. 6:10-cv-248 (E.D. Texas)	Consolidated with Case No. 3
10	<i>Realtime Data, LLC d/b/a IXO v. MetroPCS Texas, LLC et al.</i> , No. 6:10-cv-00493 (E.D. Texas)	Notice of Appeal Filed

Updated court docket listings downloaded July 8, 2013 for litigations previously disclosed and pending are submitted herewith as NPL119-NPL122.

*Realtime Data, LLC d/b/a IXO v. MetroPCS Texas, LLC et al.*

Applicants submit herewith documents related to the above-listed litigation as documents NPL27-NPL41.

Realtime Data LLC d/b/a/ IXO v. Morgan Stanley, et al.;  
Realtime Data LLC d/b/a/ IXO v. CME Group Inc., et al.; and  
Realtime Data LLC d/b/a/ IXO v. Thomson Reuters Corp., et al.

Applicants submit herewith documents related to the above-listed litigations as documents US1-US3 and NPL1-NPL26 with confidential information redacted.

Information Disclosure Statement

Listed on accompanying IDS Forms PTO/SB/08a equivalent and/or PTO/SB/08b equivalent are documents that may be considered material to the patentability of this application as defined in 37 C.F.R. §1.56, and in compliance with the duty of disclosure requirements of 37 C.F.R. §§ 1.97 and 1.98.

Applicants have listed publication dates on the attached IDS Forms based on information presently available to the undersigned. However, the listed publication dates should not be construed as an admission that the information was actually published on the date indicated.

Applicants reserve the right to establish the patentability of the claimed invention over any of the information provided herewith, and/or to prove that this information may not be prior art, and/or to prove that this information may not be enabling for the teachings purportedly offered.

This statement should not be construed as a representation that a search has been made, or that information more material to the examination of the present patent application does not exist. The Examiner is specifically requested not to rely solely on the material submitted herewith.

Atty. Dkt. No. 2855.004000B

Filing under 37 C.F.R. § 1.97(b). This Information Disclosure Statement is being filed before the mailing of a first Office Action and after the filing of a request for continued examination under 37 C.F.R. § 1.114. No statement or fee is required.

Documents US1-US8 are cited on the attached form PTO/SB/08A. Documents NPL1-NPL122 are cited on the attached form PTO/SB/08B. Copies of documents NPL1-NPL15 and NPL17-NPL122 are submitted herewith. Due to its file format, document NPL16 cannot be submitted electronically, and is therefore presented on the accompanying CD labeled as document NPL16, submitted via hand-carry. In accordance with 37 C.F.R. § 1.98(a)(2), no copies of U.S. patents and patent application publications cited on the attached IDS Forms are submitted.

Applicants submit herewith actions from the following co-pending, commonly assigned U.S. Patent Application Nos.:

Document NPL42 is a copy of a Notice of Allowance mailed on June 21, 2012 in the prosecution of co-pending, commonly-assigned U.S. Application No. 11/400,008.

Document NPL43 is a copy of a Final Office Action mailed on June 26, 2012 in the prosecution of co-pending, commonly-assigned U.S. Application No. 13/154,239.

Document NPL44 is a copy of a Notice of Allowance mailed on July 12, 2012 in the prosecution of co-pending, commonly-assigned U.S. Application No. 12/857,238.

Document NPL45 is a copy of a Notice of Allowance mailed on July 16, 2012 in the prosecution of co-pending, commonly-assigned U.S. Application No. 12/703,042.

Atty. Dkt. No. 2855.004000B

Document NPL46 is a copy of a Non-Final Office Action mailed on July 20, 2012 in the prosecution of co-pending, commonly-assigned U.S. Application No. 13/482,800.

Document NPL47 is a copy of a Notice of Allowance mailed on November 6, 2012 in the prosecution of co-pending, commonly-assigned U.S. Application No. 11/553,427.

Document NPL48 is a copy of a Notice of Allowance mailed on November 15, 2012 in the prosecution of co-pending, commonly-assigned U.S. Application No. 12/703,042.

Document NPL49 is a copy of a Non-Final Office Action mailed on November 29, 2012 in the prosecution of co-pending, commonly-assigned U.S. Application No. 12/857,238.

Document NPL50 is a copy of a Final Office Action mailed on December 4, 2012 in the prosecution of co-pending, commonly-assigned U.S. Application No. 09/969,987.

Document NPL51 is a copy of a Final Office Action mailed on December 13, 2012 in the prosecution of co-pending, commonly-assigned U.S. Application No. 13/101,994.

Document NPL52 is a copy of a Supplemental Notice of Allowability mailed December 18, 2012 in the prosecution of co-pending, commonly-assigned U.S. Application No. 12/703,042.

Document NPL53 is a copy of a Notice of Allowance mailed December 28, 2012 in the prosecution of co-pending, commonly-assigned U.S. Application No. 12/690,125.

Document NPL54 is a copy of a Non-Final Office Action mailed on January 15, 2013 in the prosecution of co-pending, commonly-assigned U.S. Application No. 11/553,419.

Document NPL55 is a copy of a Non-Final Office Action mailed on February 19, 2013 in the prosecution of co-pending, commonly-assigned U.S. Application No. 13/482,800.

Document NPL56 is a copy of a Notice of Allowance mailed on March 4, 2013 in the prosecution of co-pending, commonly-assigned U.S. Application No. 12/703,042.

Document NPL57 is a copy of a Non-Final Office Action mailed on April 15, 2013 in the prosecution of co-pending, commonly-assigned U.S. Application No. 12/690,125.

Document NPL58 is a copy of a Notice of Allowance mailed on April 24, 2013 in the prosecution of co-pending, commonly-assigned U.S. Application No. 13/154,239.

Document NPL59 is a copy of a Notice of Allowance mailed on May 14, 2013 in the prosecution of co-pending, commonly-assigned U.S. Application No. 11/553,427.

Document NPL60 is a copy of a supplemental Notice of Allowance mailed on May 15, 2013 in the prosecution of co-pending, commonly-assigned U.S. Application No. 11/553,427.

Document NPL110 is a copy of a Notice of Allowance mailed on June 17, 2013 in the prosecution of co-pending, commonly-assigned U.S. Application No. 12/857,238.

Document NPL111 is a copy of a supplemental Notice of Allowance mailed on June 18, 2013 in the prosecution of co-pending, commonly-assigned U.S. Application No. 12/703,042.

Document NPL112 is a copy of supplemental Notice of Allowance mailed on July 2, 2013 in the prosecution of co-pending, commonly-assigned U.S. Application No. 11/553,427.

Document NPL113 is a copy of a Non-Final Office Action mailed on July 3, 2013 in the prosecution of co-pending, commonly-assigned U.S. Application No. 09/969,987.

The identification of these actions is not to be construed as a waiver of secrecy as to those applications now or upon issuance of the present application as a patent. The Examiner is respectfully requested to consider the cited applications and the art cited therein during examination.

It is expected that the examiner will review the prosecution and cited art in the parent application nos. 09/776,267, filed February 2, 2001 (now U.S. Patent No. 7,181,608), and 11/551,211, filed October 19, 2006 (now U.S. Patent No. 8,112,619), in accordance with MPEP 2001.06(b), and indicate in the next communication from the office that the art cited in the earlier prosecution history has been reviewed in connection with the present application.

Atty. Dkt. No. 2855.004000B



It is respectfully requested that the Examiner initial and return a copy of the enclosed IDS Forms, and indicate in the official file wrapper of this patent application that the documents have been considered.

The U.S. Patent and Trademark Office is hereby authorized to charge any fee deficiency, or credit any overpayment, to our Deposit Account No. 19-0036.

Respectfully submitted,

STERNE, KESSLER, GOLDSTEIN & FOX P.L.L.C.

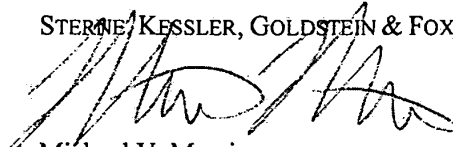

Michael V. Messinger  
Attorney for Applicants  
Registration No. 37,575

Date:

July 9, 2013

1100 New York Avenue, N.W.  
Washington, D.C. 20005-3934  
(202) 371-2600

1703825\_1.DOCX



Equivalent of Form PTO/SB/08a (07-09)

Substitute for form 1449/PTO		<b>Complete if Known</b>	
<b>THIRD SUPPLEMENTAL INFORMATION DISCLOSURE STATEMENT BY APPLICANT</b> <i>(Use as many sheets as necessary)</i>		Application Number	13/118,122
		Filing Date	May 27, 2011
		First Named Inventor	James J. FALLON
		Art Unit	2115
		Examiner Name	SURYAWANSHI, Suresh
Sheet	1	of	1
		Attorney Docket Number	2855.004000B

U.S. PATENT DOCUMENTS						
Examiner initials*	Cite No. <sup>1</sup>	Document Number		Publication Date MM-DD-YYYY	Name of Patentee or Applicant of Cited Document	Pages, Columns, Lines, Where Relevant Passages or Relevant Figures Appear
		Number-Kind Code <sup>2</sup> (if known)				
	US1	5,475,388		12-12-1995	Gormish et al.	
	US2	5,987,432		11-16-1999	Zusman et al.	
	US3	6,909,745		06-21-2005	Puri et al.	
	US4	8,275,897		09-25-2012	Fallon	
	US5	2002/0169950 A1		11-14-2002	Esfahani et al.	
	US6	2009/0125698 A1		05-14-2009	Dye	
	US7	2012/0194362 A1		08-02-2012	Fallon et al.	
	US8	2012/0239921 A1		09-20-2012	Fallon	

FOREIGN PATENT DOCUMENTS							
Examiner initials*	Cite No. <sup>1</sup>	Foreign Patent Document		Publication Date MM-DD-YYYY	Name of Patentee or Applicant of Cited Document	Pages, Columns, Lines, Where Relevant Passages or Relevant Figures Appear	¶6
		Country Code <sup>3</sup> -Number <sup>4</sup> -Kind Code <sup>5</sup> (if known)					

1703542\_1.DOCX

Examiner Signature		Date Considered	
--------------------	--	-----------------	--

\*EXAMINER: Initial if reference considered, whether or not citation is in conformance with MPEP 609. Draw line through citation if not in conformance and not considered. Include copy of this form with next communication to applicant. <sup>1</sup> Applicant's unique citation designation number (optional). <sup>2</sup> See Kinds Codes of USPTO Patent Documents at www.uspto.gov or MPEP 901.04. <sup>3</sup> Enter Office that issued the document, by the two-letter code (WIPO Standard ST.3). <sup>4</sup> For Japanese patent documents, the indication of the year of the reign of the Emperor must precede the serial number of the patent document. <sup>5</sup> Kind of document by the appropriate symbols as indicated on the document under WIPO Standard ST.16 if possible. <sup>6</sup> Applicant is to place a check mark here if English language Translation is attached.

Substitute for form 1449/PTO		<b>Complete if Known</b>	
<b>THIRD SUPPLEMENTAL INFORMATION DISCLOSURE STATEMENT BY APPLICANT</b> <i>(Use as many sheets as necessary)</i>		Application Number	13/118,122
		Filing Date	May 27, 2011
		First Named Inventor	James J. FALLON
		Art Unit	2115
		Examiner Name	SURYAWANSHI, Suresh
Sheet	1	of	13
		Attorney Docket Number	2855.004000B

NON PATENT LITERATURE DOCUMENTS			
Examiner Initials*	Cite No. <sup>1</sup>	Include name of the author (in CAPITAL LETTERS), title of the article (when appropriate), title of the item (book, magazine, journal, serial, symposium, catalog, etc.), date, page(s), volume-issue number(s), publisher, city and/or country where published	T <sup>2</sup>
	NPL1	Defendants' Supplemental Invalidation Contentions, filed in Realtime Data, LLC d/b/a IXO v. Morgan Stanley, et al., Civil Action No. 1:11-cv-6696, Realtime Data, LLC d/b/a IXO v. CME Group Inc., et al., Civil Action No. 1:11-cv-6697, and Realtime Data, LLC d/b/a IXO v. Thomson Reuters, et al., Civil Action No. 1:11-cv-6698, United States District Court Southern District of New York, filed May 17, 2012, 54 pages.	
	NPL2	Expert Report of Michael Brogioli Regarding Asserted Claims of U.S. Patent Nos. 7,417,568 and 7,777,651, with Exhibit A: List of Materials Reviewed, filed in Realtime Data, LLC d/b/a IXO v. Morgan Stanley, et al., Civil Action No. 1:11-cv-6696, Realtime Data, LLC d/b/a IXO v. CME Group Inc., et al., Civil Action No. 1:11-cv-6697, and Realtime Data, LLC d/b/a IXO v. Thomson Reuters, et al., Civil Action No. 1:11-cv-6698, United States District Court Southern District of New York, filed June 15, 2012, 26 pages.	
	NPL3	Exhibit 1, Curriculum Vitae of Michael C. Brogioli, from Expert Report, filed in Realtime Data, LLC d/b/a IXO v. Morgan Stanley, et al., Civil Action No. 1:11-cv-6696, Realtime Data, LLC d/b/a IXO v. CME Group Inc., et al., Civil Action No. 1:11-cv-6697, and Realtime Data, LLC d/b/a IXO v. Thomson Reuters, et al., Civil Action No. 1:11-cv-6698, United States District Court Southern District of New York, filed June 15, 2012, 9 pages.	
	NPL4	Exhibit 2, [Proposed] Order Adopting the Parties' Agreed Claim Constructions, from Expert Report, filed in Realtime Data, LLC d/b/a IXO v. Morgan Stanley, et al., Civil Action No. 1:11-cv-6696, Realtime Data, LLC d/b/a IXO v. CME Group Inc., et al., Civil Action No. 1:11-cv-6697, and Realtime Data, LLC d/b/a IXO v. Thomson Reuters, et al., Civil Action No. 1:11-cv-6698, United States District Court Southern District of New York, filed June 15, 2012, 6 pages.	
	NPL5	Exhibit 3, The Parties' Disputed Claim Constructions, revised May 3, 2012, from Expert Report, filed in Realtime Data, LLC d/b/a IXO v. Morgan Stanley, et al., Civil Action No. 1:11-cv-6696, Realtime Data, LLC d/b/a IXO v. CME Group Inc., et al., Civil Action No. 1:11-cv-6697, and Realtime Data, LLC d/b/a IXO v. Thomson Reuters, et al., Civil Action No. 1:11-cv-6698, United States District Court Southern District of New York, filed June 15, 2012, 6 pages.	
	NPL6	Exhibit 4, E-Mail Correspondence between James Shalek and Brett Cooper, dated May 17 and 18, 2012, from Expert Report, filed in Realtime Data, LLC d/b/a IXO v. Morgan Stanley, et al., Civil Action No. 1:11-cv-6696, Realtime Data, LLC d/b/a IXO v. CME Group Inc., et al., Civil Action No. 1:11-cv-6697, and Realtime Data, LLC d/b/a IXO v. Thomson Reuters, et al., Civil Action No. 1:11-cv-6698, United States District Court Southern District of New York, filed June 15, 2012, 3 pages.	
	NPL7	Exhibit 5, Source Code Chart for U.S. Pat. No. 7,417,568 comparing representative elements of the NQDSLIB source code (April 29, 2002 or earlier), from Expert Report, filed in Realtime Data, LLC d/b/a IXO v. Morgan Stanley, et al., Civil Action No. 1:11-cv-6696, Realtime Data, LLC d/b/a IXO v. CME Group Inc., et al., Civil Action No. 1:11-cv-6697, and Realtime Data, LLC d/b/a IXO v. Thomson Reuters, et al., Civil Action No. 1:11-cv-6698, United States District Court Southern District of New York, filed June 15, 2012, 3 pages.	

The PTO did not receive the following listed item(s) NPL

Examiner Signature	Date Considered	
--------------------	-----------------	--

\*EXAMINER: Initial if reference considered, whether or not citation is in conformance with MPEP 609. Draw line through citation if not in conformance and not considered. Include copy of this form with next communication to applicant.

<sup>1</sup> Applicant's unique citation designation number (optional). <sup>2</sup> Applicant is to place a check mark here if English language Translation is attached.

Substitute for form 1449/PTO  <b>THIRD SUPPLEMENTAL                  INFORMATION DISCLOSURE                  STATEMENT BY APPLICANT</b> <i>(Use as many sheets as necessary)</i>			<i>Complete if Known</i>		
			Application Number	13/118,122	
			Filing Date	May 27, 2011	
			First Named Inventor	James J. FALLON	
			Art Unit	2115	
			Examiner Name	SURYAWANSHI, Suresh	
Sheet	2	of	13	Attorney Docket Number	2855.004000B

NON PATENT LITERATURE DOCUMENTS			
Examiner Initials*	Cite No. <sup>1</sup>	Include name of the author (in CAPITAL LETTERS), title of the article (when appropriate), title of the item (book, magazine, journal, serial, symposium, catalog, etc.), date, page(s), volume number, publisher, city and/or country where published	T <sup>2</sup>
	NPL8	Exhibit 6, Source Code Chart for U.S. Pat. No. 7,417,568 comparing representative elements of the NQDSLIB source code (May 02, 2002 or earlier), from Expert Report, filed in Realtime Data, LLC d/b/a IXO v. Morgan Stanley, et al., Civil Action No. 1:11-cv-6696, Realtime Data, LLC d/b/a IXO v. CME Group Inc., et al., Civil Action No. 1:11-cv-6697, and Realtime Data, LLC d/b/a IXO v. Thomson Reuters, et al., Civil Action No. 1:11-cv-6698, United States District Court Southern District of New York, filed June 15, 2012, 3 pages.	
	NPL9	Exhibit 7, Source Code Chart for U.S. Pat. No. 7,777,651 comparing representative elements of the NQDSLIB source code (April 29, 2002 or earlier), from Expert Report, filed in Realtime Data, LLC d/b/a IXO v. Morgan Stanley, et al., Civil Action No. 1:11-cv-6696, Realtime Data, LLC d/b/a IXO v. CME Group Inc., et al., Civil Action No. 1:11-cv-6697, and Realtime Data, LLC d/b/a IXO v. Thomson Reuters, et al., Civil Action No. 1:11-cv-6698, United States District Court Southern District of New York, filed June 15, 2012, 21 pages.	
	NPL10	Exhibit 8, Source Code Chart for U.S. Pat. No. 7,777,651 comparing representative elements of the NQDSLIB source code (May 02, 2002 or earlier), from Expert Report, filed in Realtime Data, LLC d/b/a IXO v. Morgan Stanley, et al., Civil Action No. 1:11-cv-6696, Realtime Data, LLC d/b/a IXO v. CME Group Inc., et al., Civil Action No. 1:11-cv-6697, and Realtime Data, LLC d/b/a IXO v. Thomson Reuters, et al., Civil Action No. 1:11-cv-6698, United States District Court Southern District of New York, filed June 15, 2012, 21 pages.	
	NPL11	Invalidity Expert Report of Dr. James A. Storer (Redacted), filed in Realtime Data, LLC d/b/a IXO v. Morgan Stanley, et al., Civil Action No. 1:11-cv-6696, Realtime Data, LLC d/b/a IXO v. CME Group Inc., et al., Civil Action No. 1:11-cv-6697, and Realtime Data, LLC d/b/a IXO v. Thomson Reuters, et al., Civil Action No. 1:11-cv-6698, United States District Court Southern District of New York, filed June 15, 2012, 227 pages.	
	NPL12	Defendants' Claim Construction Tutorial, filed in Realtime Data, LLC d/b/a IXO v. Morgan Stanley, et al., Civil Action No. 1:11-cv-6696, Realtime Data, LLC d/b/a IXO v. CME Group Inc., et al., Civil Action No. 1:11-cv-6697, and Realtime Data, LLC d/b/a IXO v. Thomson Reuters, et al., Civil Action No. 1:11-cv-6698, United States District Court Southern District of New York, filed June 15, 2012, 54 pages.	
	NPL13	Opinion and Order (Markman), filed in Realtime Data, LLC d/b/a IXO v. Morgan Stanley, et al., Civil Action No. 1:11-cv-6696, Realtime Data, LLC d/b/a IXO v. CME Group Inc., et al., Civil Action No. 1:11-cv-6697, and Realtime Data, LLC d/b/a IXO v. Thomson Reuters, et al., Civil Action No. 1:11-cv-6698, United States District Court Southern District of New York, filed June 22, 2012, 41 pages.	
	NPL14	Opinion and Order (Partial Motion for Summary Judgment re Written Description: "Data Packets"), filed in Realtime Data, LLC d/b/a IXO v. Morgan Stanley, et al., Civil Action No. 1:11-cv-6696, Realtime Data, LLC d/b/a IXO v. CME Group Inc., et al., Civil Action No. 1:11-cv-6697, and Realtime Data, LLC d/b/a IXO v. Thomson Reuters, et al., Civil Action No. 1:11-cv-6698, United States District Court Southern District of New York, filed June 26, 2012, 8 pages.	

Examiner Signature		Date Considered	
--------------------	--	-----------------	--

\*EXAMINER: Initial if reference considered, whether or not citation is in conformance with MPEP 609. Draw line through citation if not in conformance and not considered. Include copy of this form with next communication to applicant.  
<sup>1</sup> Applicant's unique citation designation number (optional). <sup>2</sup> Applicant is to place a check mark here if English language Translation is attached.

Substitute for form 1449/PTO		<b>Complete if Known</b>	
<b>THIRD SUPPLEMENTAL INFORMATION DISCLOSURE STATEMENT BY APPLICANT</b> <i>(Use as many sheets as necessary)</i>		Application Number	13/118,122
		Filing Date	May 27, 2011
		First Named Inventor	James J. FALLON
		Art Unit	2115
		Examiner Name	SURYAWANSHI, Suresh
		Attorney Docket Number	2855.004000B
Sheet	3	of	13

NON PATENT LITERATURE DOCUMENTS			
Examiner Initials*	Cite No. <sup>1</sup>	Include name of the author (in CAPITAL LETTERS), title of the article (when appropriate), title of the item (book, magazine, journal, serial, symposium, catalog, etc.), date, page(s), volume number, publisher, city and/or country where published	T <sup>2</sup>
	NPL15	Opinion and Order (Partial Motion for Summary Judgment re Data Decompression) filed in Realtime Data, LLC d/b/a IXO v. Morgan Stanley, et al., Civil Action No. 1:11-cv-6696, Realtime Data, LLC d/b/a IXO v. CME Group Inc., et al., Civil Action No. 1:11-cv-6697, and Realtime Data, LLC d/b/a IXO v. Thomson Reuters, et al., Civil Action No. 1:11-cv-6698, United States District Court Southern District of New York, filed June 27, 2012, 21 pages.	
	NPL16	Technology Tutorial (.exe file), presentation filed in Realtime Data, LLC d/b/a IXO v. Morgan Stanley, et al., Civil Action No. 1:11-cv-6696, Realtime Data, LLC d/b/a IXO v. CME Group Inc., et al., Civil Action No. 1:11-cv-6697, and Realtime Data, LLC d/b/a IXO v. Thomson Reuters, et al., Civil Action No. 1:11-cv-6698, United States District Court Southern District of New York, filed June 2012 (submitted on accompanying CD-ROM).	
	NPL17	Lilley, J., et al., "A Unified Header Compression Framework for Low-Bandwidth Links," MobiCom 2000, August 6-11, 2000. Boston, MA, 12 pages.	
	NPL18	"WAN Link Compression on HP Routers," Hewlett Packard Application Note, May 1995, 7 pages.	
	NPL19	"User Manual for XMill," 2001, 21 pages.	
	NPL20	"High Speed Network, Developer's Guide," Standard & Poor's Comstock, Version 1.1, 1994, pages 1-42, and 53-124.	
	NPL21	Larmouth, J., "ASN.1 Complete", Academic Press, 2000, pages xxi-xxvii, 1-45, 115-130, 168-172, 174, 270-276, and 443-472.	
	NPL22	Petty, J., "PPP Hewlett-Packard Packet-by-Packet Compression (HP PPC) Protocol," draft-ietf-ppext-hpppc-00.txt., October 1993, 7 pages.	
	NPL23	Friend, R., et al., "IP Payload Compression Using LZS," Network Working Group, Request for Comments: 2395, Category: Informational, December 1998, 9 pages.	

Examiner Signature	Date Considered
--------------------	-----------------

\*EXAMINER: Initial if reference considered, whether or not citation is in conformance with MPEP 609. Draw line through citation if not in conformance and not considered. Include copy of this form with next communication to applicant.

<sup>1</sup> Applicant's unique citation designation number (optional). <sup>2</sup> Applicant is to place a check mark here if English language Translation is attached.

Substitute for form 1449/PTO		<i>Complete if Known</i>	
<b>THIRD SUPPLEMENTAL INFORMATION DISCLOSURE STATEMENT BY APPLICANT</b> <i>(Use as many sheets as necessary)</i>		Application Number	13/118,122
		Filing Date	May 27, 2011
		First Named Inventor	James J. FALLON
		Art Unit	2115
		Examiner Name	SURYAWANSHI, Suresh
Sheet	4	of	13
		Attorney Docket Number	2855.004000B

NON PATENT LITERATURE DOCUMENTS			
Examiner Initials*	Cite No. <sup>1</sup>	Include name of the author (in CAPITAL LETTERS), title of the article (when appropriate), title of the item (book, magazine, journal, serial, symposium, catalog, etc.), date, page(s), volume number, publisher, city and/or country where published	T <sup>2</sup>
	NPL24	"Information technology - Abstract Syntax Notation One (ASN.1): Specification of basic notation," Series X: Data Networks and Open System Communications, OSI networking and system aspects - Abstract Syntax Notation One (ASN.1), International Telecommunication Union, ITU-T Recommendation X.680, December 1997, 109 pages.	
	NPL25	"Information technology - ASN.1 encoding rules - Specification of Packed Encoding Rules (PER), Series X: Data Networks and Open System Communications, OSI networking and system aspects - Abstract Syntax Notation One (ASN.1), International Telecommunication Union, ITU-T Recommendation X.691, December 1997, 51 pages.	
	NPL26	Opinion and Order, filed in Realtime Data, LLC d/b/a IXO v. Morgan Stanley, et al., Civil Action No. 1:11-cv-6696, Realtime Data, LLC d/b/a IXO v. CME Group Inc., et al., Civil Action No. 1:11-cv-6697, and Realtime Data, LLC d/b/a IXO v. Thomson Reuters, et al., Civil Action No. 1:11-cv-6698, United States District Court Southern District of New York, filed September 24, 2012, 48 pages.	
	NPL27	Memorandum Opinion and Order, filed in Realtime Data, LLC d/b/a IXO, v. MetroPCS Texas, LLC, et al., Civil Action No. 6:10-cv-00493, United States District Court for the Eastern District of Texas, filed October 1, 2012, 22 pages.	
	NPL28	T-Mobile's Motion for Leave to Supplement Trial Witness List & Invalidity Contentions, filed in Realtime Data, LLC d/b/a IXO, v. MetroPCS Texas, LLC, et al., Civil Action No. 6:10-cv-00493, United States District Court for the Eastern District of Texas, filed December 17, 2012, 16 pages.	
	NPL29	Exhibit 2, Defendant T-Mobile's Supplemental Invalidity Contentions, filed in Realtime Data, LLC d/b/a IXO, v. MetroPCS Texas, LLC, et al., Civil Action No. 6:10-cv-00493, United States District Court for the Eastern District of Texas, filed December 17, 2012, 13 pages.	
	NPL30	Exhibit 3, FNLTD-74478, Flash Networks: Commercial Part Written by Flash Networks for Cegetel, filed in Realtime Data, LLC d/b/a IXO, v. MetroPCS Texas, LLC, et al., Civil Action No. 6:10-cv-00493, United States District Court for the Eastern District of Texas, filed December 17, 2012, 6 pages.	
	NPL31	Exhibit 4, FNLTD-74444, Response to Cegetel RFP: Technical Section, filed in Realtime Data, LLC d/b/a IXO, v. MetroPCS Texas, LLC, et al., Civil Action No. 6:10-cv-00493, United States District Court for the Eastern District of Texas, filed December 17, 2012, 5 pages.	
	NPL32	Exhibit 5, FNLTD-74926, Flash Networks Optimization Products Selected by AT&T Wireless, Flash Networks, Inc. Press Release, filed in Realtime Data, LLC d/b/a IXO, v. MetroPCS Texas, LLC, et al., Civil Action No. 6:10-cv-00493, United States District Court for the Eastern District of Texas, filed December 17, 2012, 3 pages.	

Examiner Signature		Date Considered	
-----------------------	--	--------------------	--

\*EXAMINER: Initial if reference considered, whether or not citation is in conformance with MPEP 609. Draw line through citation if not in conformance and not considered. Include copy of this form with next communication to applicant.

<sup>1</sup> Applicant's unique citation designation number (optional). <sup>2</sup> Applicant is to place a check mark here if English language Translation is attached.

Substitute for form 1449/PTO				<i>Complete if Known</i>	
<b>THIRD SUPPLEMENTAL INFORMATION DISCLOSURE STATEMENT BY APPLICANT</b> <i>(Use as many sheets as necessary)</i>				Application Number	13/118,122
				Filing Date	May 27, 2011
				First Named Inventor	James J. FALLON
				Art Unit	2115
				Examiner Name	SURYAWANSHI, Suresh
Sheet	5	of	13	Attorney Docket Number	2855.004000B

NON PATENT LITERATURE DOCUMENTS			
Examiner Initials*	Cite No. <sup>1</sup>	Include name of the author (in CAPITAL LETTERS), title of the article (when appropriate), title of the item (book, magazine, journal, serial, symposium, catalog, etc.), date, page(s), volume number, publisher, city and/or country where published	T <sup>2</sup>
	NPL33	Exhibit 6, Flash Networks: Harmony, filed in Realtime Data, LLC d/b/a IXO, v. MetroPCS Texas, LLC, et al., Civil Action No. 6:10-cv-00493, United States District Court for the Eastern District of Texas, filed December 17, 2012, 6 pages.	
	NPL34	Exhibit 7, Declaration of Adi Weiser, filed in Realtime Data, LLC d/b/a IXO, v. MetroPCS Texas, LLC, et al., Civil Action No. 6:10-cv-00493, United States District Court for the Eastern District of Texas, filed December 17, 2012, 4 pages.	
	NPL35	Exhibit 8, Declaration of Yoav Weiss, filed in Realtime Data, LLC d/b/a IXO, v. MetroPCS Texas, LLC, et al., Civil Action No. 6:10-cv-00493, United States District Court for the Eastern District of Texas, filed December 17, 2012, 4 pages.	
	NPL36	Exhibit 9, Declaration of Richard Luthi, filed in Realtime Data, LLC d/b/a IXO, v. MetroPCS Texas, LLC, et al., Civil Action No. 6:10-cv-00493, United States District Court for the Eastern District of Texas, filed December 17, 2012, 4 pages.	
	NPL37	Exhibit 13, Declaration of Gali Weiss, filed in Realtime Data, LLC d/b/a IXO, v. MetroPCS Texas, LLC, et al., Civil Action No. 6:10-cv-00493, United States District Court for the Eastern District of Texas, filed December 17, 2012, 4 pages.	
	NPL38	Exhibit 17, P.R. 3-1 Claim Chart for T-Mobile, U.S. Patent No. 7,161,506, filed in Realtime Data, LLC d/b/a IXO, v. MetroPCS Texas, LLC, et al., Civil Action No. 6:10-cv-00493, United States District Court for the Eastern District of Texas, filed December 17, 2012, 33 pages.	
	NPL39	"Flash Networks Introduces NetGain 1100, New Products for Carriers & Enterprises that Enables Immediate Deployment of Wireless Data Solutions," Press Release, dated March 20, 2001, 2 pages.	
	NPL40	Amended Expert Report of Dr. Cliff Reader, filed in Realtime Data, LLC d/b/a IXO, v. MetroPCS Texas, LLC, et al., Civil Action No. 6:10-cv-00493, United States District Court for the Eastern District of Texas, filed July 30, 2012, 205 pages.	
	NPL41	Final Judgment, filed in Realtime Data, LLC, d/b/a IXO, v. T-Mobile USA, Inc., Civil Action No. 6:10-cv-00493, United States District Court for the Eastern District of Texas, filed March 28, 2013, 1 page.	
	NPL42	Copy of Notice of Allowance for U.S. Appl. No. 11/400,008, mailed June 21, 2012, 8 pages.	

Examiner Signature		Date Considered	
-----------------------	--	--------------------	--

\*EXAMINER: Initial if reference considered, whether or not citation is in conformance with MPEP 609. Draw line through citation if not in conformance and not considered. Include copy of this form with next communication to applicant.

<sup>1</sup> Applicant's unique citation designation number (optional). <sup>2</sup> Applicant is to place a check mark here if English language Translation is attached.

Substitute for form 1449/PTO  <b>THIRD SUPPLEMENTAL                  INFORMATION DISCLOSURE                  STATEMENT BY APPLICANT</b> (Use as many sheets as necessary)				<i>Complete if Known</i>		
				Application Number	13/118,122	
Sheet		6	of	13	Examiner Name	SURYAWANSHI, Suresh
					Attorney Docket Number	2855.004000B

NON PATENT LITERATURE DOCUMENTS			
Examiner Initials*	Cite No. <sup>1</sup>	Include name of the author (in CAPITAL LETTERS), title of the article (when appropriate), title of the item (book, magazine, journal, serial, symposium, catalog, etc.), date, page(s), volume number, publisher, city and/or country where published	T <sup>2</sup>
	NPL43	Copy of Final Office Action for U.S. Appl. No. 13/154,239, mailed June 26, 2012, 14 pages.	
	NPL44	Copy of Notice of Allowance for U.S. Appl. No. 12/857,238, mailed July 12, 2012, 5 pages.	
	NPL45	Copy of Notice of Allowance for U.S. Appl. No. 12/703,042, mailed July 16, 2012, 8 pages.	
	NPL46	Copy of Non-Final Office Action for U.S. Appl. No. 13/482,800, mailed July 20, 2012, 14 pages.	
	NPL47	Copy of Notice of Allowance for U.S. Appl. No. 11/553,427, mailed November 6, 2012, 5 pages.	
	NPL48	Copy of Notice of Allowance for U.S. Appl. No. 12/703,042, mailed November 15, 2012, 9 pages.	
	NPL49	Copy of Non-Final Office Action for U.S. Appl. No. 12/857,238, mailed November 29, 2012, 17 pages.	
	NPL50	Copy of Final Office Action for U.S. Appl. No. 09/969,987, mailed December 4, 2012, 7 pages.	
	NPL51	Copy of Final Office Action for U.S. Appl. No. 13/101,994, mailed December 13, 2012, 5 pages.	
	NPL52	Copy of Supplemental Notice of Allowability for U.S. Appl. No. 12/703,042, mailed December 18, 2012, 6 pages.	

Examiner Signature		Date Considered	
--------------------	--	-----------------	--

\*EXAMINER: Initial if reference considered, whether or not citation is in conformance with MPEP 609. Draw line through citation if not in conformance and not considered. Include copy of this form with next communication to applicant.

<sup>1</sup> Applicant's unique citation designation number (optional). <sup>2</sup> Applicant is to place a check mark here if English language Translation is attached.



Substitute for form 1449/PTO				<i>Complete if Known</i>	
<b>THIRD SUPPLEMENTAL INFORMATION DISCLOSURE STATEMENT BY APPLICANT</b> <i>(Use as many sheets as necessary)</i>				Application Number	13/118,122
				Filing Date	May 27, 2011
				First Named Inventor	James J. FALLON
				Art Unit	2115
				Examiner Name	SURYAWANSHI, Suresh
Sheet	7	of	13	Attorney Docket Number	2855.004000B

NON PATENT LITERATURE DOCUMENTS			
Examiner Initials*	Cite No. <sup>1</sup>	Include name of the author (in CAPITAL LETTERS), title of the article (when appropriate), title of the item (book, magazine, journal, serial, symposium, catalog, etc.), date, page(s), volume number, publisher, city and/or country where published	T <sup>2</sup>
	NPL53	Copy of Notice of Allowance for U.S. Appl. No. 12/690,125, mailed December 28, 2012, 5 pages.	
	NPL54	Copy of Non-Final Office Action for U.S. Appl. No. 11/553,419, mailed January 15, 2013, 4 pages.	
	NPL55	Copy of Non-Final Office Action for U.S. Appl. No. 13/482,800, mailed February 19, 2013, 15 pages.	
	NPL56	Copy of Notice of Allowance for U.S. Appl. No. 12/703,042, mailed March 4, 2013, 9 pages.	
	NPL57	Copy of Non-Final Office Action for U.S. Appl. No. 12/690,125, mailed April 15, 2013, 11 pages.	
	NPL58	Copy of Notice of Allowance for U.S. Appl. No. 13/154,239, mailed April 24, 2013, 10 pages.	
	NPL59	Copy of Notice of Allowance for U.S. Appl. No. 11/553,427, mailed May 14, 2013, 6 pages.	
	NPL60	Copy of Supplemental Notice of Allowance for U.S. Appl. No. 11/553,427, mailed May 15, 2013, 6 pages.	
	NPL61	Action Closing Prosecution in Inter Partes Reexamination of U.S. Patent No. 7,777,651, Control No. 95/001,581, mailed June 18, 2012, 45 pages.	
	NPL62	Patent Owner's Response to Office Action of April 20, 2012 in Inter Partes Reexamination of U.S. Patent No. 7,321,937, Control No. 95/001,922, filed June 20, 2012, 11 pages.	

Examiner Signature	Date Considered
-----------------------	--------------------

\*EXAMINER: Initial if reference considered, whether or not citation is in conformance with MPEP 609. Draw line through citation if not in conformance and not considered. Include copy of this form with next communication to applicant.

<sup>1</sup> Applicant's unique citation designation number (optional). <sup>2</sup> Applicant is to place a check mark here if English language Translation is attached.

Substitute for form 1449/PTO				<i>Complete if Known</i>	
<b>THIRD SUPPLEMENTAL INFORMATION DISCLOSURE STATEMENT BY APPLICANT</b> <i>(Use as many sheets as necessary)</i>				Application Number	13/118,122
				Filing Date	May 27, 2011
				First Named Inventor	James J. FALLON
				Art Unit	2115
				Examiner Name	SURYAWANSHI, Suresh
Sheet	8	of	13	Attorney Docket Number	2855.004000B

NON PATENT LITERATURE DOCUMENTS			
Examiner Initials*	Cite No. <sup>1</sup>	Include name of the author (in CAPITAL LETTERS), title of the article (when appropriate), title of the item (book, magazine, journal, serial, symposium, catalog, etc.), date, page(s), volume number, publisher, city and/or country where published	T <sup>2</sup>
	NPL63	Patent Owner's Response to Office Action of April 25, 2012 in Inter Partes Reexamination of U.S. Patent No. 7,161,506, Control No. 95/001,926, filed June 25, 2012, 20 pages.	
	NPL64	Patent Owner's Response to Office Action of April 25, 2012 in Inter Partes Reexamination of U.S. Patent No. 7,378,992, Control No. 95/001,928, filed June 25, 2012, 20 pages.	
	NPL65	Patent Owner's Response to Office Action of May 7, 2012 in Inter Partes Reexamination of U.S. Patent No. 6,604,158, Control No. 95/001,923, filed July 9, 2012, 19 pages.	
	NPL66	Patent Owner's Response to Office Action of May 17, 2012 in Inter Partes Reexamination of U.S. Patent No. 7,352,300, Control. No. 95/001,924, filed July 17, 2012, 31 pages.	
	NPL67	New Decision on Appeal after Board Decision in Inter Partes Reexamination of U.S. Patent No. 7,714,747, Control. No. 95/001,517, mailed July 24, 2012, 24 pages.	
	NPL68	Right of Appeal Notice for Inter Partes Reexamination of U.S. Patent No. 7,777,651, Control No. 95/001,581, mailed August 3, 2012, 7 pages.	
	NPL69	Notice of Intent to Issue Inter Partes Reexamination Certificate in Inter Partes Reexamination of U.S. Patent No. 6,604,158, Control No. 95/000,486, mailed August 30, 2012, 5 pages.	
	NPL70	Notice of Intent to Issue Inter Partes Reexamination Certificate in Inter Partes Reexamination of U.S. Patent No. 7,378,992, Control No. 95/000,478, mailed August 31, 2012, 6 pages.	
	NPL71	Decision on Petition for Supervisory Review of Refusal to Order Reexamination for Claims 1-2, 16-21, and 23 (37 CFR §§ 1.927 and 1.181) in Inter Partes Reexamination of U.S. Patent No. 7,415,530, Control No. 95/001,927, mailed August 31, 2012, 10 pages.	
	NPL72	Decision on Petition Under 37 C.F.R. §§ 1.181 and 1.182 for Correction of Notice of Intent to Issue Reexamination Certificate in Inter Partes Reexamination of U.S. Patent No. 7,378,992, Control No. 95/000,478, mailed September 10, 2012, 6 pages.	

Examiner Signature		Date Considered	
-----------------------	--	--------------------	--

\*EXAMINER: Initial if reference considered, whether or not citation is in conformance with MPEP 609. Draw line through citation if not in conformance and not considered. Include copy of this form with next communication to applicant.

<sup>1</sup> Applicant's unique citation designation number (optional). <sup>2</sup> Applicant is to place a check mark here if English language Translation is attached.

Substitute for form 1449/PTO				<i>Complete if Known</i>	
<b>THIRD SUPPLEMENTAL INFORMATION DISCLOSURE STATEMENT BY APPLICANT</b> <i>(Use as many sheets as necessary)</i>				Application Number	13/118,122
				Filing Date	May 27, 2011
				First Named Inventor	James J. FALLON
				Art Unit	2115
				Examiner Name	SURYAWANSHI, Suresh
Sheet	9	of	13	Attorney Docket Number	2855.004000B

NON PATENT LITERATURE DOCUMENTS			
Examiner Initials*	Cite No. <sup>1</sup>	Include name of the author (in CAPITAL LETTERS), title of the article (when appropriate), title of the item (book, magazine, journal, serial, symposium, catalog, etc.), date, page(s), volume number, publisher, city and/or country where published	T <sup>2</sup>
	NPL73	Decision on Petition for Supervisory Review of Refusal to Order Reexamination of Claims 5-7, 14-16, and 18-19 (37 CFR §§ 1.927 and 1.181) in Inter Partes Reexamination of U.S. Patent No. 7,321,937, Control No. 95/001,922, mailed September 10, 2012, 12 pages.	
	NPL74	Decision on Petition for Supervisory Review of Refusal to Order Reexamination for Claims 86, 89, 90, 92-96, and 98 (37 CFR §§ 1.927 and 1.181) in Inter Partes Reexamination of U.S. Patent No. 7,161,506, Control No. 95/001,926, mailed September 21, 2012, 10 pages.	
	NPL75	Non-Final Office Action in Inter Partes Reexamination of U.S. Patent No. 7,415,530, Control No. 95/001,927, mailed September 21, 2012, 15 pages.	
	NPL76	Patent Owner's Request to Reopen Prosecution Before the Examiner Under 37 C.F.R. § 41.77(b) in Inter Partes Reexamination of U.S. Patent No. 7,714,747, Control No. 95/001,517, filed September 24, 2012, 29 pages.	
	NPL77	Examiner's Answer to Appeal Brief in Ex Parte Reexamination of U.S. Patent No. 7,400,274, Control No. 95/001,544, mailed October 1, 2012, 17 pages.	
	NPL78	Inter Partes Reexam Certificate in Inter Partes Reexamination of U.S. Patent No. 7,378,992, Control No. 95/000,478, issued October 4, 2012, 2 pages.	
	NPL79	Inter Partes Reexam Certificate in Inter Partes Reexamination of U.S. Patent No. 6,604,158, Control No. 95/000,486, issued October 10, 2012, 2 pages.	
	NPL80	Examiner's Answer to Appeal Brief in Inter Partes Reexamination of U.S. Patent No. 7,417,568, Control No. 95/001,533, mailed October 15, 2012, 44 pages.	
	NPL81	Non-Final Office Action in Inter Partes Reexamination of U.S. Patent No. 7,321,937, Control No. 95/001,922, mailed October 18, 2012, 10 pages.	
	NPL82	Patent Owner's Rebuttal Brief Under 37 C.F.R. § 41.71 in Inter Partes Reexamination of U.S. Patent No. 7,417,568, Control No. 95/001,533, filed November 15, 2012, 15 pages.	

Examiner Signature		Date Considered	
-----------------------	--	--------------------	--

\*EXAMINER: Initial if reference considered, whether or not citation is in conformance with MPEP 609. Draw line through citation if not in conformance and not considered. Include copy of this form with next communication to applicant.

<sup>1</sup> Applicant's unique citation designation number (optional). <sup>2</sup> Applicant is to place a check mark here if English language Translation is attached.

Substitute for form 1449/PTO				<i>Complete if Known</i>	
<b>THIRD SUPPLEMENTAL INFORMATION DISCLOSURE STATEMENT BY APPLICANT</b> <i>(Use as many sheets as necessary)</i>				Application Number	13/118,122
				Filing Date	May 27, 2011
				First Named Inventor	James J. FALLON
				Art Unit	2115
				Examiner Name	SURYAWANSHI, Suresh
Sheet	10	of	13	Attorney Docket Number	2855.004000B

NON PATENT LITERATURE DOCUMENTS			
Examiner Initials*	Cite No. <sup>1</sup>	Include name of the author (in CAPITAL LETTERS), title of the article (when appropriate), title of the item (book, magazine, journal, serial, symposium, catalog, etc.), date, page(s), volume number, publisher, city and/or country where published	T <sup>2</sup>
	NPL83	Patent Owner's Response to Office Action of October 18, 2012 in Inter Partes Reexamination of U.S. Patent No. 7,321,937, Control No. 95/001,922, filed November 19, 2012, 30 pages.	
	NPL84	Patent Owner's Supplemental Amendment Subsequent to Timely Submission of Response to Office Action of October 18, 2012 in Inter Partes Reexamination of U.S. Patent No. 7,321,937, Control No. 95/001,922, filed November 27, 2012, 6 pages.	
	NPL85	Patent Owner's Response to Office Action of September 21, 2012 in Inter Partes Reexamination of U.S. Patent No. 7,415,530, Control No. 95/001,927, filed December 21, 2012, 51 pages.	
	NPL86	Action Closing Prosecution in Inter Partes Reexamination of U.S. Patent No. 7,161,506, Control No. 95/001,926, mailed March 5, 2013, 23 pages.	
	NPL87	Action Closing Prosecution in Inter Partes Reexamination of U.S. Patent No. 7,378,992, Control No. 95/001,928, mailed March 5, 2013, 29 pages.	
	NPL88	Examiner's Answer to Appeal Brief in Inter Partes Reexamination of U.S. Patent No. 7,777,651, Control No. 95/001,581, mailed March 14, 2013, 21 pages.	
	NPL89	Decision on Petition to Strike Patent Owner's Rebuttal Brief in Inter Partes Reexamination of U.S. Patent No. 7,417,568, Control no. 95/001,533, mailed March 15, 2013, 7 pages.	
	NPL90	Order Remanding Inter Partes Reexamination Under 37 C.F.R. § 41.77(d) to the Examiner in Inter Partes Reexamination of U.S. Patent No. 7,714,747, Control No. 95/001,517, mailed March 18, 2013, 3 pages.	
	NPL91	Decision on Petition Under 37 C.F.R. § 1.183 to Request Examiner Enter Evidence in Inter Partes Reexamination of U.S. Patent No. 7,417,568, Control No. 95/001,533, mailed March 20, 2013, 7 pages.	
	NPL92	Action Closing Prosecution in Inter Partes Reexamination of U.S. Patent No. 7,415,530, Control No. 95/001,927, mailed April 3, 2013, 24 pages.	

Examiner Signature	Date Considered
-----------------------	--------------------

\*EXAMINER: Initial if reference considered, whether or not citation is in conformance with MPEP 609. Draw line through citation if not in conformance and not considered. Include copy of this form with next communication to applicant.

<sup>1</sup> Applicant's unique citation designation number (optional). <sup>2</sup> Applicant is to place a check mark here if English language Translation is attached.

Substitute for form 1449/PTO				<i>Complete if Known</i>	
				Application Number	13/118,122
<b>THIRD SUPPLEMENTAL INFORMATION DISCLOSURE STATEMENT BY APPLICANT</b> <i>(Use as many sheets as necessary)</i>				Filing Date	May 27, 2011
				First Named Inventor	James J. FALLON
				Art Unit	2115
				Examiner Name	SURYAWANSHI, Suresh
				Attorney Docket Number	2855.004000B
				Sheet	11

NON PATENT LITERATURE DOCUMENTS			
Examiner Initials*	Cite No. <sup>1</sup>	Include name of the author (in CAPITAL LETTERS), title of the article (when appropriate), title of the item (book, magazine, journal, serial, symposium, catalog, etc.), date, page(s), volume number, publisher, city and/or country where published	T <sup>2</sup>
	NPL93	Patent Owner's Reply to Action Closing Prosecution of March 5, 2013 in Inter Partes Reexamination of U.S. Patent No. 7,161,506, Control No. 95/001,926, filed April 5, 2013, 19 pages.	
	NPL94	Patent Owner's Reply to Action Closing Prosecution of March 5, 2013 in Inter Partes Reexamination of U.S. Patent No. 7,378,992, Control No. 95/001,928, filed April 5, 2013, 23 pages.	
	NPL95	Action Closing Prosecution in Inter Partes Reexamination of U.S. Patent No. 7,321,937, Control No. 95/001,922, mailed April 9, 2013, 59 pages.	
	NPL96	"Data Transfer Rate (DTR)," accessed at <a href="http://searchunifiedcommunications.techtarget.com/definition/data-transfer-rate">http://searchunifiedcommunications.techtarget.com/definition/data-transfer-rate</a> , published May 18, 2011, 1 page.	
	NPL97	"Bandwidth - technical definition," accessed at <a href="http://computer.yourdictionary.com/bandwidth">http://computer.yourdictionary.com/bandwidth</a> , accessed on March 7, 2013, 4 pages.	
	NPL98	"Bandwidth - Definition," accessed at <a href="http://www.yourdictionary.com/bandwidth">http://www.yourdictionary.com/bandwidth</a> , accessed on March 7, 2013, 2 pages.	
	NPL99	"Bandwidth," accessed at <a href="http://searchenterprise.wan.techtarget.com/definitions/bandwidth">http://searchenterprise.wan.techtarget.com/definitions/bandwidth</a> , published March 24, 2010, 1 page.	
	NPL100	Action Closing Prosecution in Inter Partes Reexamination of U.S. Patent No. 7,352,300, Control No. 95/001,924, mailed April 9, 2013, 30 pages.	
	NPL101	Examiner's Determination Under 37 C.F.R. § 41.77(d) in Inter Partes Reexamination of U.S. Patent No. 7,714,747, Control No. 95/001,517, mailed April 10, 2013, 7 pages.	
	NPL102	Patent Owner's Supplemental Response to Office Action of May 7, 2012 in Inter Partes Reexamination of U.S. Patent No. 6,604,158, Control No. 95/001,923, filed April 29, 2013, 20 pages.	

Examiner Signature		Date Considered	
--------------------	--	-----------------	--

\*EXAMINER: Initial if reference considered, whether or not citation is in conformance with MPEP 609. Draw line through citation if not in conformance and not considered. Include copy of this form with next communication to applicant.

<sup>1</sup> Applicant's unique citation designation number (optional). <sup>2</sup> Applicant is to place a check mark here if English language Translation is attached.

Substitute for form 1449/PTO				<i>Complete if Known</i>	
<b>THIRD SUPPLEMENTAL INFORMATION DISCLOSURE STATEMENT BY APPLICANT</b> <i>(Use as many sheets as necessary)</i>				Application Number	13/118,122
				Filing Date	May 27, 2011
				First Named Inventor	James J. FALLON
				Art Unit	2115
				Examiner Name	SURYAWANSHI, Suresh
Sheet	12	of	13	Attorney Docket Number	2855.004000B

NON PATENT LITERATURE DOCUMENTS			
Examiner Initials*	Cite No. <sup>1</sup>	Include name of the author (in CAPITAL LETTERS), title of the article (when appropriate), title of the item (book, magazine, journal, serial, symposium, catalog, etc.), date, page(s), volume number, publisher, city and/or country where published	T <sup>2</sup>
	NPL103	Patent Owner's Supplemental Response to Office Action of March 19, 2012 in Inter Partes Reexamination of U.S. Patent No. 7,395,345, Control No. 95/001,925, filed May 6, 2013, 24 pages.	
	NPL104	Patent Owner's Response to Action Closing Prosecution of April 9, 2013 in Inter Partes Reexamination of U.S. Patent No. 7,321,937, Control No. 95/001,922, filed May 9, 2013, 13 pages.	
	NPL105	Patent Owner's Response to Action Closing Prosecution of April 9, 2013 in Inter Partes Reexamination of U.S. Patent No. 7,352,300, Control No. 95/001,924, filed May 9, 2013, 29 pages.	
	NPL106	Patent Owner's Comments in Response to Examiner's Determination Under 37 C.F.R. § 41.77(e) in Inter Partes Reexamination of U.S. Patent No. 7,714,747, Control No. 95/001,517, filed May 10, 2013, 20 pages.	
	NPL107	Patent Owner's Supplemental Response to Action Closing Prosecution of April 9, 2013 in Inter Partes Reexamination of U.S. Patent No. 7,321,937, Control No. 95/001,922, filed May 15, 2013, 13 pages.	
	NPL108	Right of Appeal Notice in Inter Partes Reexamination of U.S. Patent No. 7,415,530, Control No. 95/001,927, mailed May 31, 2013, 26 pages.	
	NPL109	Petition Under 37 C.F.R. § 1.181 to Expunge Third Party Requester's Improper Submission of Declarations Under 37 C.F.R. § 1.132 and Strike Comments Directed to Examiner's Determination in Inter Partes Reexamination of U.S. Patent No. 7,714,747, Control No. 95/001,517, filed June 26, 2013, 6 pages.	
	NPL110	Copy of Notice of Allowance for U.S. Appl. No. 12/857,238, mailed June 17, 2013, 6 pages.	
	NPL111	Copy of Supplemental Notice of Allowance for U.S. Appl. No. 12/703,042, mailed June 18, 2013, 6 pages.	
	NPL112	Copy of Supplemental Notice of Allowance for U.S. Appl. No. 11/553,427, mailed July 2, 2013, 2 pages.	

Examiner Signature	Date Considered
--------------------	-----------------

\*EXAMINER: Initial if reference considered, whether or not citation is in conformance with MPEP 609. Draw line through citation if not in conformance and not considered. Include copy of this form with next communication to applicant.

<sup>1</sup> Applicant's unique citation designation number (optional). <sup>2</sup> Applicant is to place a check mark here if English language Translation is attached.

Substitute for form 1449/PTO				<i>Complete if Known</i>	
				Application Number	13/118,122
<b>THIRD SUPPLEMENTAL INFORMATION DISCLOSURE STATEMENT BY APPLICANT</b> <i>(Use as many sheets as necessary)</i>				Filing Date	May 27, 2011
				First Named Inventor	James J. FALLON
				Art Unit	2115
				Examiner Name	SURYAWANSHI, Suresh
				Attorney Docket Number	2855.004000B
Sheet	13	of	13		

NON PATENT LITERATURE DOCUMENTS			
Examiner Initials*	Cite No. <sup>1</sup>	Include name of the author (in CAPITAL LETTERS), title of the article (when appropriate), title of the item (book, magazine, journal, serial, symposium, catalog, etc.), date, page(s), volume number, publisher, city and/or country where published	T <sup>2</sup>
	NPL113	Copy of Non-Final Office Action for U.S. Appl. No. 09/969,987, mailed July 3, 2013, 8 pages.	
	NPL114	ChangeLog file for zlib, zlib.net/ChangeLog.txt file, accessed on May 23, 2013, with date references April 11, 1995 – April 28, 2013, 26 pages.	
	NPL115	2.0.39 Kernel Release History, accessed at lwn.net/2001/1018/a/hist-2.0.39.php3, dated October 14, 2001, 8 pages.	
	NPL116	"Linux Kernel," Wikipedia - the Free Encyclopedia, accessed at en.wikipedia.org/wiki/Linux_kernel, accessed on May 9, 2013, 20 pages.	
	NPL117	RUBINI, A., "Booting the Kernel," accessed at www.linux.it/~rubini/docs/boot/, June 1997, 6 pages.	
	NPL118	ZADOK, E., et al., "Fast Indexing: Support for Size-Changing Algorithms in Stackable File Systems," Proceedings of the 2001 Annual USENIX Technical Conference, June 2001, 16 pages.	
	NPL119	Court Docket History for 6:10-cv-00493-LED-JDL, Realtime Data, LLC D/B/A/ IXO, v. MetroPCS Texas, LLC et al., dated July 8, 2013, 77 pages.	
	NPL120	Court Docket History for 1:11-cv-06696-RJH, Realtime Data, LLC D/B/A/ IXO, v. Morgan Stanley et al., dated July 8, 2013, 80 pages.	
	NPL121	Court Docket History for 1:11-cv-06697-UA, Realtime Data, LLC D/B/A/IXO, v. CME Group Inc. et al., dated July 8, 2013, 105 pages.	
	NPL122	Court Docket History for 1:11-cv-06698-UA, Realtime Data, LLC d/b/a IXO v. Thomson Reuters et al., dated July 8, 2013, 59 pages.	

1703557\_1.DOCX

Examiner Signature	Date Considered
-----------------------	--------------------

\*EXAMINER: Initial if reference considered, whether or not citation is in conformance with MPEP 609. Draw line through citation if not in conformance and not considered. Include copy of this form with next communication to applicant.

<sup>1</sup> Applicant's unique citation designation number (optional). <sup>2</sup> Applicant is to place a check mark here if English language Translation is attached.

## ARTIFACT SHEET

Enter artifact number below. Artifact number is application number + artifact type code (see list below) + sequential letter (A, B, C ...). The first artifact folder for an artifact type receives the letter A, the second B, etc..

Examples: 59123456PA, 59123456PB, 59123456ZA, 59123456ZB

**13118122UA**

Indicate quantity of a single type of artifact received but not scanned. Create individual artifact folder/box and artifact number for each Artifact Type.

<input checked="" type="checkbox"/>	CD(s) containing:	<input type="checkbox"/>
	computer program listing	Artifact Type Code: P
	Doc Code: Computer	
	pages of specification	<input type="checkbox"/>
	and/or sequence listing	Artifact Type Code: S
	and/or table	
	Doc Code: Artifact	
	content unspecified or combined	<input checked="" type="checkbox"/>
	Doc Code: Artifact	Artifact Type Code: U
<input type="checkbox"/>	Stapled Set(s) Color Documents or B/W Photographs	
	Doc Code: Artifact	Artifact Type Code: C
<input type="checkbox"/>	Microfilm(s)	
	Doc Code: Artifact	Artifact Type Code: F
<input type="checkbox"/>	Video tape(s)	
	Doc Code: Artifact	Artifact Type Code: V
<input type="checkbox"/>	Model(s)	
	Doc Code: Artifact	Artifact Type Code: M
<input type="checkbox"/>	Bound Document(s)	
	Doc Code: Artifact	Artifact Type Code: B
<input type="checkbox"/>	Confidential Information Disclosure Statement or Other Documents marked Proprietary, Trade Secrets, Subject to Protective Order, Material Submitted under MPEP 724.02, etc.	
	Doc Code: Artifact	Artifact Type Code X
<input type="checkbox"/>	Other, description: _____	
	Doc Code: Artifact	Artifact Type Code: Z

March 8, 2004



Under the Paperwork Reduction Act of 1995, no persons are required to respond to a collection of information unless it displays a valid OMB control number.

<b>PATENT APPLICATION FEE DETERMINATION RECORD</b> Substitute for Form PTO-875				Application or Docket Number 13/118,122		Filing Date 05/27/2011		<input type="checkbox"/> To be Mailed		
ENTITY: <input checked="" type="checkbox"/> LARGE <input type="checkbox"/> SMALL <input type="checkbox"/> MICRO										
<b>APPLICATION AS FILED – PART I</b>										
(Column 1)			(Column 2)							
FOR		NUMBER FILED	NUMBER EXTRA		RATE (\$)		FEE (\$)			
<input type="checkbox"/> BASIC FEE (37 CFR 1.16(a), (b), or (c))		N/A	N/A		N/A					
<input type="checkbox"/> SEARCH FEE (37 CFR 1.16(k), (l), or (m))		N/A	N/A		N/A					
<input type="checkbox"/> EXAMINATION FEE (37 CFR 1.16(o), (p), or (q))		N/A	N/A		N/A					
TOTAL CLAIMS (37 CFR 1.16(j))		minus 20 =	*		X \$ =					
INDEPENDENT CLAIMS (37 CFR 1.16(h))		minus 3 =	*		X \$ =					
<input type="checkbox"/> APPLICATION SIZE FEE (37 CFR 1.16(s))		If the specification and drawings exceed 100 sheets of paper, the application size fee due is \$310 (\$155 for small entity) for each additional 50 sheets or fraction thereof. See 35 U.S.C. 41(a)(1)(G) and 37 CFR 1.16(s).								
<input type="checkbox"/> MULTIPLE DEPENDENT CLAIM PRESENT (37 CFR 1.16(j))										
* If the difference in column 1 is less than zero, enter "0" in column 2.					TOTAL					
<b>APPLICATION AS AMENDED – PART II</b>										
(Column 1)			(Column 2)			(Column 3)				
AMENDMENT	07/09/2013		CLAIMS REMAINING AFTER AMENDMENT		HIGHEST NUMBER PREVIOUSLY PAID FOR	PRESENT EXTRA	RATE (\$)		ADDITIONAL FEE (\$)	
	Total (37 CFR 1.16(i))		* 133	Minus	** 20	= 113	X \$80 =		9040	
	Independent (37 CFR 1.16(h))		* 7	Minus	***6	= 1	X \$420 =		420	
	<input type="checkbox"/> Application Size Fee (37 CFR 1.16(s))									
	<input type="checkbox"/> FIRST PRESENTATION OF MULTIPLE DEPENDENT CLAIM (37 CFR 1.16(j))									
							TOTAL ADD'L FEE		<b>9460</b>	
(Column 1)			(Column 2)			(Column 3)				
AMENDMENT			CLAIMS REMAINING AFTER AMENDMENT		HIGHEST NUMBER PREVIOUSLY PAID FOR	PRESENT EXTRA	RATE (\$)		ADDITIONAL FEE (\$)	
	Total (37 CFR 1.16(i))		*	Minus	**	=	X \$ =			
	Independent (37 CFR 1.16(h))		*	Minus	***	=	X \$ =			
	<input type="checkbox"/> Application Size Fee (37 CFR 1.16(s))									
	<input type="checkbox"/> FIRST PRESENTATION OF MULTIPLE DEPENDENT CLAIM (37 CFR 1.16(j))									
							TOTAL ADD'L FEE			
<p>* If the entry in column 1 is less than the entry in column 2, write "0" in column 3.                  ** If the "Highest Number Previously Paid For" IN THIS SPACE is less than 20, enter "20".                  *** If the "Highest Number Previously Paid For" IN THIS SPACE is less than 3, enter "3".                  The "Highest Number Previously Paid For" (Total or Independent) is the highest number found in the appropriate box in column 1.</p>										

LIE  
/ROZENIA HARMON/

This collection of information is required by 37 CFR 1.16. The information is required to obtain or retain a benefit by the public which is to file (and by the USPTO to process) an application. Confidentiality is governed by 35 U.S.C. 122 and 37 CFR 1.14. This collection is estimated to take 12 minutes to complete, including gathering, preparing, and submitting the completed application form to the USPTO. Time will vary depending upon the individual case. Any comments on the amount of time you require to complete this form and/or suggestions for reducing this burden, should be sent to the Chief Information Officer, U.S. Patent and Trademark Office, U.S. Department of Commerce, P.O. Box 1450, Alexandria, VA 22313-1450. DO NOT SEND FEES OR COMPLETED FORMS TO THIS ADDRESS. **SEND TO: Commissioner for Patents, P.O. Box 1450, Alexandria, VA 22313-1450.**

If you need assistance in completing the form, call 1-800-PTO-9199 and select option 2.



UNITED STATES PATENT AND TRADEMARK OFFICE

UNITED STATES DEPARTMENT OF COMMERCE  
United States Patent and Trademark Office  
Address: COMMISSIONER FOR PATENTS  
P.O. Box 1450  
Alexandria, Virginia 22313-1450  
www.uspto.gov

APPLICATION NO.	FILING DATE	FIRST NAMED INVENTOR	ATTORNEY DOCKET NO.	CONFIRMATION NO.
-----------------	-------------	----------------------	---------------------	------------------

13/118,122	05/27/2011	James J. Fallon	2855.004000B	8978
------------	------------	-----------------	--------------	------

26111 7590 01/09/2013  
 STERNE, KESSLER, GOLDSTEIN & FOX P.L.L.C.  
 1100 NEW YORK AVENUE, N.W.  
 WASHINGTON, DC 20005

EXAMINER
----------

SURYAWANSHI, SURESH

ART UNIT	PAPER NUMBER
----------	--------------

2115

MAIL DATE	DELIVERY MODE
-----------	---------------

01/09/2013 PAPER

**Please find below and/or attached an Office communication concerning this application or proceeding.**

The time period for reply, if any, is set in the attached communication.

<b>Office Action Summary</b>	<b>Application No.</b> 13/118,122	<b>Applicant(s)</b> FALLON ET AL.
	<b>Examiner</b> SURESH SURYAWANSHI	<b>Art Unit</b> 2115

**-- The MAILING DATE of this communication appears on the cover sheet with the correspondence address --**

**Period for Reply**

A SHORTENED STATUTORY PERIOD FOR REPLY IS SET TO EXPIRE 3 MONTH(S) OR THIRTY (30) DAYS, WHICHEVER IS LONGER, FROM THE MAILING DATE OF THIS COMMUNICATION.

- Extensions of time may be available under the provisions of 37 CFR 1.136(a). In no event, however, may a reply be timely filed after SIX (6) MONTHS from the mailing date of this communication.
- If NO period for reply is specified above, the maximum statutory period will apply and will expire SIX (6) MONTHS from the mailing date of this communication.
- Failure to reply within the set or extended period for reply will, by statute, cause the application to become ABANDONED (35 U.S.C. § 133). Any reply received by the Office later than three months after the mailing date of this communication, even if timely filed, may reduce any earned patent term adjustment. See 37 CFR 1.704(b).

**Status**

- 1)  Responsive to communication(s) filed on 11/16/12 amendments.
- 2a)  This action is **FINAL**.
- 2b)  This action is non-final.
- 3)  An election was made by the applicant in response to a restriction requirement set forth during the interview on \_\_\_\_\_; the restriction requirement and election have been incorporated into this action.
- 4)  Since this application is in condition for allowance except for formal matters, prosecution as to the merits is closed in accordance with the practice under *Ex parte Quayle*, 1935 C.D. 11, 453 O.G. 213.

**Disposition of Claims**

- 5)  Claim(s) 1-14 is/are pending in the application.  
5a) Of the above claim(s) \_\_\_\_\_ is/are withdrawn from consideration.
- 6)  Claim(s) \_\_\_\_\_ is/are allowed.
- 7)  Claim(s) 1-14 is/are rejected.
- 8)  Claim(s) \_\_\_\_\_ is/are objected to.
- 9)  Claim(s) \_\_\_\_\_ are subject to restriction and/or election requirement.

\* If any claims have been determined allowable, you may be eligible to benefit from the **Patent Prosecution Highway** program at a participating intellectual property office for the corresponding application. For more information, please see [http://www.uspto.gov/patents/init\\_events/pph/index.jsp](http://www.uspto.gov/patents/init_events/pph/index.jsp) or send an inquiry to [PPHfeedback@uspto.gov](mailto:PPHfeedback@uspto.gov).

**Application Papers**

- 10)  The specification is objected to by the Examiner.
- 11)  The drawing(s) filed on \_\_\_\_\_ is/are: a)  accepted or b)  objected to by the Examiner.  
Applicant may not request that any objection to the drawing(s) be held in abeyance. See 37 CFR 1.85(a).  
Replacement drawing sheet(s) including the correction is required if the drawing(s) is objected to. See 37 CFR 1.121(d).

**Priority under 35 U.S.C. § 119**

- 12)  Acknowledgment is made of a claim for foreign priority under 35 U.S.C. § 119(a)-(d) or (f).  
a)  All   b)  Some \*   c)  None of:
    - 1.  Certified copies of the priority documents have been received.
    - 2.  Certified copies of the priority documents have been received in Application No. \_\_\_\_\_.
    - 3.  Copies of the certified copies of the priority documents have been received in this National Stage application from the International Bureau (PCT Rule 17.2(a)).
- \* See the attached detailed Office action for a list of the certified copies not received.

**Attachment(s)**

- 1)  Notice of References Cited (PTO-892)
- 2)  Information Disclosure Statement(s) (PTO/SB/08)  
Paper No(s)/Mail Date 6/19/12.
- 3)  Interview Summary (PTO-413)  
Paper No(s)/Mail Date. \_\_\_\_\_.
- 4)  Other: \_\_\_\_\_.

### DETAILED ACTION

1. Claims 1-14 are presented for examination.

#### *Double Patenting*

2. The nonstatutory double patenting rejection is based on a judicially created doctrine grounded in public policy (a policy reflected in the statute) so as to prevent the unjustified or improper timewise extension of the “right to exclude” granted by a patent and to prevent possible harassment by multiple assignees. A nonstatutory obviousness-type double patenting rejection is appropriate where the conflicting claims are not identical, but at least one examined application claim is not patentably distinct from the reference claim(s) because the examined application claim is either anticipated by, or would have been obvious over, the reference claim(s). See, e.g., *In re Berg*, 140 F.3d 1428, 46 USPQ2d 1226 (Fed. Cir. 1998); *In re Goodman*, 11 F.3d 1046, 29 USPQ2d 2010 (Fed. Cir. 1993); *In re Longi*, 759 F.2d 887, 225 USPQ 645 (Fed. Cir. 1985); *In re Van Ornum*, 686 F.2d 937, 214 USPQ 761 (CCPA 1982); *In re Vogel*, 422 F.2d 438, 164 USPQ 619 (CCPA 1970); and *In re Thorington*, 418 F.2d 528, 163 USPQ 644 (CCPA 1969).

A timely filed terminal disclaimer in compliance with 37 CFR 1.321(c) or 1.321(d) may be used to overcome an actual or provisional rejection based on a nonstatutory double patenting ground provided the conflicting application or patent either is shown to be commonly owned with this application, or claims an invention made as a result of activities undertaken within the scope of a joint research agreement.

Effective January 1, 1994, a registered attorney or agent of record may sign a terminal disclaimer. A terminal disclaimer signed by the assignee must fully comply with 37 CFR 3.73(b).

3. Claims 1-14 are rejected on the ground of nonstatutory obviousness-type double patenting as being unpatentable over claims 1-13 of U.S. Patent No. 8,112,619. Although the conflicting claims are not identical, they are not patentably distinct from each other because both claim same invention.

4. Claims 1-14 are rejected on the ground of nonstatutory obviousness-type double patenting as being unpatentable over claims 1-24 of U.S. Patent No. 8,09,936. Although the conflicting claims are not identical, they are not patentably distinct from each other because both claim same invention.

5. Claims 1-14 are rejected on the ground of nonstatutory obviousness-type double patenting as being unpatentable over claims 1-31 of U.S. Patent No. 7,181,608. Although the conflicting claims are not identical, they are not patentably distinct from each other because both claim same invention.

***Claim Rejections - 35 USC § 103***

6. The following is a quotation of 35 U.S.C. 103(a) which forms the basis for all obviousness rejections set forth in this Office action:

(a) A patent may not be obtained though the invention is not identically disclosed or described as set forth in section 102 of this title, if the differences between the subject matter sought to be patented and the prior art are such that the subject matter as a whole would have been obvious at the time the invention was made to a person having ordinary skill in the art to which said subject matter pertains. Patentability shall not be negated by the manner in which the invention was made.

7. Claims 6-11 are rejected under 35 U.S.C. 103(a) as being unpatentable over Kroeker et al (US Patent 6,073,232<sup>1</sup>; hereinafter Kroeker) in view of Esfahani et al (US Patent 6,434,695<sup>1</sup>; hereinafter Esfahani).

8. As per claim 6, Kroeker discloses a method, comprising:

maintaining a list of compressed boot data used for booting a computer system [col. 2, lines 30-47; col. 5, lines 1-7; a prefetch table containing a listing of the disk locations and length of data records that were requested by the host computer in the immediately previous power-on/reset];

initializing a central processing unit of the computer system [col. 2, lines 30-35; inherent to the system during power-up process];

---

<sup>1</sup> Prior art cited by applicants in submitted information disclosure statement (dated 8/2/11).

loading the compressed boot data from the boot device to a memory [col. 1, lines 58-64; col. 2, lines 36-41; col. 3, lines 30-39; col. 5, lines 17-21; data is preloaded into the RAM cache according to the prefetch table prior to completion of initialization of the host computer as shown in Fig. 3].

Kroeker does not disclose about accessing compressed boot data. However, Esfahani clearly discloses about loading a compressed boot data into a RAM cache and then the boot data is decompressed and executed [col. 2, lines 5-13, 63, 67; col. 10, line 65 -- col. 11, line 4]. Therefore, it would have been obvious to one of ordinary skill in the art at the time the invention was made to combine the cited references as they are directed to minimize a computer's initial program load time or shortening the load time of the computer programs from a hard disk drive to a host computer. Moreover, the shortening load time method of Kroeker by loading the program into the RAM cache according to the prefetch table will definitely be benefited with the method of reading compressed data into the RAM cache and then decompressing and executing as needed. This way, one may not only have needed data into a fast access memory but also a large amount of data to avoid frequent accessing the storage device(s).

9. As per claim 7, Kroeker discloses a system comprising:

a processor [col. 4, lines 11-16; a digital processor];

a memory [col. 4, lines 17-28; a memory]; and

a non-volatile memory device [col. 2, lines 30-37; col. 4, lines 17-28; col. 5, lines 1-7 and the title];

logic code associated with the processor stored in the non-volatile memory and comprising instructions executable by the processor for maintaining a list of boot data used for booting the system [col. 2, lines 30-37; col. 4, lines 17-28; col. 5, lines 1-7; a prefetch table containing a listing of the disk locations and length of data records that were requested by the host computer in the immediately previous power-on/reset].

Kroeker does not disclose about accessing compressed boot data. However, Esfahani clearly discloses about loading a compressed boot data into a RAM cache and then the boot data is decompressed and executed [col. 2, lines 5-13, 63, 67; col. 10, line 65 -- col. 11, line 4]. Therefore, it would have been obvious to one of ordinary skill in the art at the time the invention was made to combine the cited references as they are directed to minimize a computer's initial program load time or shortening the load time of the computer programs from a hard disk drive to a host computer. Moreover, the shortening load time method of Kroeker by loading the program into the RAM cache according to the prefetch table will definitely be benefited with the method of reading compressed data into the RAM cache and then decompressing and executing as needed. This way, one may not only have needed data into a fast access memory but also a large amount of data to avoid frequent accessing the storage device(s).



10. As per claim 9, Kroeker discloses a method of preloading an operating system for booting a computer system comprising:

storing substantially all of the operating system in compressed form on a boot device [col. 2, lines 30-47; col. 5, lines 1-7; a prefetch table containing a listing of the disk locations where a disk containing bootable operating system];

loading a first portion of the compressed operating system from the boot device to a memory [col. 1, lines 58-64; col. 2, lines 36-41; col. 3, lines 30-39; col. 5, lines 17-21; data is loaded into the RAM cache according to the prefetch table prior to completion of initialization of the host computer as shown in Fig. 3; further the loading of the operating system happens in portions];

utilizing the first portion to partially boot the computer system [col. 2, lines 30-35; inherent to the system during power-up process];

responsive to a request, locating a second portion of the compressed operating system using a boot data list and preloading the second portion from the boot device to the memory [col. 1, lines 58-64; col. 2, lines 30-47; col. 3, lines 30-39; col. 5, lines 17-21]; and

utilizing the second portion to further partially boot the computer system [col. 2, lines 30-35; inherent to the system during power-up process].

Kroeker does not disclose about accessing compressed boot data. However, Esfahani clearly discloses about loading a compressed boot data into a RAM cache and then the boot data is decompressed and executed [col. 2, lines 5-13, 63, 67; col. 10, line 65 -- col. 11, line 4]. Therefore, it would have been obvious to one of ordinary skill in the art at the time the invention was made to combine the cited references as they are directed to minimize a computer's initial program load time or shortening the load time of the computer programs from a hard disk drive to a host computer. Moreover, the shortening load time method of Kroeker by loading the program into the RAM cache according to the prefetch table will definitely be benefited with the method of reading compressed data into the RAM cache and then decompressing and executing as needed. This way, one may not only have needed data into a fast access memory but also a large amount of data to avoid frequent accessing the storage device(s).

11. As per claims 8 and 10-11, Kroeker does not disclose about accessing compressed boot data. However, Esfahani clearly discloses about loading a compressed boot data into a RAM cache and then the boot data is decompressed and executed [col. 2, lines 5-13, 63, 67; col. 10, line 65 -- col. 11, line 4]. Therefore, it would have been obvious to one of ordinary skill in the art at the time the invention was made to combine the cited references as they are directed to

minimize a computer's initial program load time or shortening the load time of the computer programs from a hard disk drive to a host computer. Moreover, the shortening load time method of Kroeker by loading the program into the RAM cache according to the prefetch table will definitely be benefited with the method of reading compressed data into the RAM cache and then decompressing and executing as needed. This way, one may not only have needed data into a fast access memory but also a large amount of data to avoid frequent accessing the storage device(s).

### *Conclusion*

12. Applicant's amendment necessitated the new ground(s) of rejection presented in this Office action. Accordingly, **THIS ACTION IS MADE FINAL**. See MPEP § 706.07(a). Applicant is reminded of the extension of time policy as set forth in 37 CFR 1.136(a).

A shortened statutory period for reply to this final action is set to expire **THREE MONTHS** from the mailing date of this action. In the event a first reply is filed within **TWO MONTHS** of the mailing date of this final action and the advisory action is not mailed until after the end of the **THREE-MONTH** shortened statutory period, then the shortened statutory period will expire on the date the advisory action is mailed, and any extension fee pursuant to 37 CFR 1.136(a) will be calculated from the mailing date of the advisory action. In no event, however, will the statutory period for reply expire later than **SIX MONTHS** from the date of this final action.

Any inquiry concerning this communication or earlier communications from the examiner should be directed to SURESH SURYAWANSHI whose telephone number is (571)272-3668. The examiner can normally be reached on 9:00am - 5:30pm.

If attempts to reach the examiner by telephone are unsuccessful, the examiner's supervisor, Thomas C. Lee can be reached on 571-272-3667. The fax phone number for the organization where this application or proceeding is assigned is 571-273-8300.

Information regarding the status of an application may be obtained from the Patent Application Information Retrieval (PAIR) system. Status information for published applications may be obtained from either Private PAIR or Public PAIR. Status information for unpublished applications is available through Private PAIR only. For more information about the PAIR system, see <http://pair-direct.uspto.gov>. Should you have questions on access to the Private PAIR system, contact the Electronic Business Center (EBC) at 866-217-9197 (toll-free). If you would like assistance from a USPTO Customer Service Representative or access to the automated information system, call 800-786-9199 (IN USA OR CANADA) or 571-272-1000.

/SURESH SURYAWANSHI/  
Primary Examiner, Art Unit 2115

IN THE UNITED STATES PATENT AND TRADEMARK OFFICE

In re application of:

FALLON *et al.*

Appl. No.: 13/118,122

Filed: May 27, 2011

For: **Systems and Methods for  
Accelerated Loading of Operating  
Systems and Application Programs**

Confirmation No.: 8978

Art Unit: 2115

Examiner: SURYAWANSHI, Suresh

Atty. Docket: 2855.004000B

**Second Supplemental Information Disclosure Statement**

*Mail Stop Amendment*

Commissioner for Patents  
PO Box 1450  
Alexandria, VA 22313-1450

Sir:

Notice of Prior and Concurrent Proceedings

Applicants hereby call to the attention of the Patent and Trademark Office the following reexamination proceedings involving patents that are commonly-assigned with the patent in the above-identified patent application:

<b>Proceeding</b>	<b>Status</b>
<i>Inter Partes</i> Reexamination of U.S. Patent No. 6,604,158 (Control No. 95/000,486)	Patent Owner Notice of Appeal filed 04/26/2012; Right of Appeal Notice mailed 03/26/2012
<i>Inter Partes</i> Reexamination of U.S. Patent No. 7,321,937 (Control No. 95/000,466)	<i>Inter Partes</i> Reexamination Certificate issued 05/15/2012
<i>Inter Partes</i> Reexamination of U.S. Patent No. 6,604,158 (Control No. 95/000,453)	Terminated
<i>Ex Parte</i> Reexamination of U.S. Patent No. 6,601,104 (Control No. 90/009,428)	<i>Ex Parte</i> Reexamination Certificate issued 02/28/2012
<i>Inter Partes</i> Reexamination of U.S. Patent No. 7,378,992 (Control No. 95/000,478)	Petition for Correction of Notice of Intent to Issue Reexamination Certificate filed 05/09/2012; Notice of Intent to Issue <i>Inter Partes</i> Reexamination Certificate mailed 04/06/2012
<i>Inter Partes</i> Reexamination of U.S. Patent No. 6,624,761 (Control No. 95/000,464)	<i>Inter Partes</i> Reexamination Certificate issued 06/12/2012

ALL REFERENCES CONSIDERED EXCEPT WHERE LINED THROUGH. /SKS/

Proceeding	Status
<i>Inter Partes</i> Reexamination of U.S. Patent No. 7,161,506 (Control No. 95/000,479)	Inter Partes Reexamination Certificate issued 05/22/2012
<i>Inter Partes</i> Reexamination of U.S. Patent No. 7,714,747 (Control No. 95/001,517)	Examiner's Answer to Appeal Brief mailed 03/01/2012
<i>Inter Partes</i> Reexamination of U.S. Patent No. 7,417,568 (Control No. 95/001,533)	Right of Appeal Notice mailed 03/01/2012
<i>Inter Partes</i> Reexamination of U.S. Patent No. 7,777,651 (Control No. 95/001,581)	Patent Owner Response to Non-Final Office Action filed 02/24/2012
<i>Inter Partes</i> Reexamination of U.S. Patent No. 7,400,274 (Control No. 95/001,544)	Right of Appeal Notice mailed 03/06/2012

Applicants hereby call to the attention of the Patent and Trademark Office the following reexamination proceedings filed by Cellco Partnership d/b/a Verizon Wireless, involving patents that are commonly-assigned with the patent in the above-identified patent application:

Proceeding	Status
<i>Inter Partes</i> Reexamination of U.S. Patent No. 7,321,937 (Control No. 95/001,922)	Non-Final Office Action mailed 04/20/2012; Official Order Granting <i>Inter Partes</i> Reexam mailed 04/20/2012
<i>Inter Partes</i> Reexamination of U.S. Patent No. 6,604,158 (Control No. 95/001,923)	Non-Final Office Action mailed 05/07/2012; Official Order Granting <i>Inter Partes</i> Reexam mailed 05/07/2012
<i>Inter Partes</i> Reexamination of U.S. Patent No. 7,352,300 (Control No. 95/001,924)	Non-Final Office Action mailed 05/17/2012; Official Order Granting <i>Inter Partes</i> Reexam mailed 05/17/2012
<i>Inter Parte</i> Reexamination of U.S. Patent No. 7,395,345 (Control No. 95/001,925)	Patent Owner Response to Office Action filed 05/21/2012; Non-Final Office Action mailed 03/19/2012; Official Order Granting <i>Inter Partes</i> Reexam mailed 03/19/2012
<i>Inter Partes</i> Reexamination of U.S. Patent No. 7,161,506 (Control No. 95/001,926)	Non-Final Office Action mailed 04/25/2012; Official Order Granting <i>Inter Partes</i> Reexam mailed 4/25/2012
<i>Inter Partes</i> Reexamination of U.S. Patent No. 7,415,530 (Control No. 95/001,927)	Official Order Denying <i>Inter Partes</i> Reexam mailed 04/27/2012

ALL REFERENCES CONSIDERED EXCEPT WHERE LINED THROUGH. /SKS./

Proceeding	Status
<i>Inter Partes</i> Reexamination of U.S. Patent No. 7,378,992 (Control No. 95/001,928)	Non-Final Office Action mailed 04/25/2012; Official Order Granting <i>Inter Partes</i> Reexam mailed 04/25/2012

Applicants invite the Examiner to review the Requests for Reexamination, issued Office Actions, replies, and any other papers in the above-identified reexamination proceedings. If the Examiner is unable to obtain copies of papers in any reexamination proceeding, copies can be provided to the Examiner upon request. Those documents which may be material that are not already of record in this patent application are listed on the accompanying Form PTO/SB/08. For example, documents related to the reexaminations are listed at NPL17-NPL72.

Notice of Related Litigation

Applicants notify the Patent and Trademark Office of the following litigation involving U.S. Patents commonly-owned with the current patent application, the subject matter of which may be related to the present patent application:

No.	Case	Status
1	<i>Realtime Data LLC d/b/a IXO v. Packeteer, Inc. et al.</i> , No. 6:08-cv-00144-LED (E.D. Texas)	Dismissed

Applicants also notify the Patent and Trademark Office of the following additional litigation involving U.S. Patents commonly-owned with the current patent application, the subject matter of which may be related to the present patent application:

No.	Case	Status
2	<i>Realtime Data LLC d/b/a IXO v. Thomson Reuters Corporation et al.</i> No. 1:11-cv-06698-RJH (S.D. New York) (transferred from E.D. Texas; 6:09-cv-00333-LED)	Pending
3	<i>Realtime Data LLC d/b/a IXO v. Morgan Stanley et al.</i> , No. 1:11-cv-06696-RJH (S.D. New York) (transferred	Pending

	from E.D. Texas; 6:09-cv-00326-LED)	
4	<i>Realtime Data LLC d/b/a IXO v. CME Group Inc., et al.</i> , No. 1:11-cv-06697-RJH (S.D. New York) (transferred from E.D. Texas; No. 6:09-cv-00327-LED)	Pending
5	<i>Chicago Board Options Exchange, Inc., v. Realtime Data LLC d/b/a IXO</i> , No. 09-cv-4486 (N.D. Ill.)	Dismissed
6	<i>Thomson Reuters Corporation v. Realtime Data, LLC d/b/a IXO</i> , No. 1:09-cv-07868-RMB (S.D.N.Y)	Consolidated with Case No. 2
7	<i>Realtime Data, LLC d/b/a IXO v. CME Group Inc., et al. (II)</i> , No. 6:10-cv-246 (E.D. Texas)	Consolidated with Case No. 4
8	<i>Realtime Data LLC d/b/a IXO v. Thomson Reuters Corporation et al. (II)</i> , No. 6:10-cv-247 (E.D. Texas)	Consolidated with Case No. 2
9	<i>Realtime Data, LLC d/b/a IXO v. Morgan Stanley, et al. (II)</i> , No. 6:10-cv-248 (E.D. Texas)	Consolidated with Case No. 3
10	<i>Realtime Data, LLC D/B/A IXO v. MetroPCS Texas, LLC et al.</i> , No. 6:10-cv-00493 (E.D. Texas)	Pending

Updated court docket listings downloaded June 19, 2012 for litigations previously disclosed and pending are submitted herewith as NPL73-NPL76.

Information Disclosure Statement

Listed on accompanying IDS Form PTO/SB/08a equivalent and/or PTO/SB/08b equivalent are documents that may be considered material to the patentability of this application as defined in 37 C.F.R. §1.56, and in compliance with the duty of disclosure requirements of 37 C.F.R. §§ 1.97 and 1.98.

Applicants have listed publication dates on the attached IDS Forms based on information presently available to the undersigned. However, the listed publication dates should not be construed as an admission that the information was actually published on the date indicated.



Applicants reserve the right to establish the patentability of the claimed invention over any of the information provided herewith, and/or to prove that this information may not be prior art, and/or to prove that this information may not be enabling for the teachings purportedly offered.

This statement should not be construed as a representation that a search has been made, or that information more material to the examination of the present patent application does not exist. The Examiner is specifically requested not to rely solely on the material submitted herewith.

Filing under 37 C.F.R. § 1.97(b). This Information Disclosure Statement is being filed after the mailing date of a first Office Action on the merits. The required fee is provided through online credit card payment authorization in the amount of \$180.00 in payment of the fee under 37 C.F.R. § 1.17(p).

A concise explanation of the relevance of the non-English language document FP1 appears below in accordance with 37 C.F.R. § 1.98(a)(3).

FP1 (JP 04-241681) is in the Japanese language. An English language abstract is as follows:

PURPOSE: To provide a means which can make optimum compression on data of any kinds of data pattern and can improve the data compressing efficiency.

CONSTITUTION: At the time of storing data, the data are compressed by means of compression circuits 11 and 12 of plural data compressing systems and counted results of the byte numbers of the compressed data are compared with each other after the byte

numbers are counted. Then the compressed data of the smallest amount are selected and stored in a storing section 2 after adding a code indicating the compressing system. At the time of reading out the recorded data, the data are restored to the original data by selecting the corresponding restoration circuit 31 or 32 in accordance with the added code indicating the compressing system.

Documents US1-US13 and FP1 are cited on the attached form PTO/SB/08A. Documents NPL1-NPL76 are cited on the attached form PTO/SB/08B. Copies of documents FP1 and NPL1-NPL76 are submitted. In accordance with 37 C.F.R. § 1.98(a)(2), no copies of U.S. patents and patent application publications cited on the attached IDS Forms are submitted.

Applicants submit herewith actions from the following co-pending, commonly assigned U.S. Patent Application Nos.:

Document NPL2 is a copy of a Notice of Allowance mailed on September 26, 2011 in the prosecution of co-pending, commonly-assigned U.S. Application No. 12/123,081.

Document NPL3 is a copy of a Notice of Allowance mailed on September 28, 2011 in the prosecution of co-pending, commonly-assigned U.S. Application No. 11/551,204.

Document NPL4 is a copy of a Notice of Allowance mailed on October 18, 2011 in the prosecution of co-pending, commonly-assigned U.S. Application No. 11/551,211.

Document NPL5 is a copy of a Non-Final Office Action mailed on November 2, 2011 in the prosecution of co-pending, commonly-assigned U.S. Application No. 13/154,239.

Document NPL6 is a copy of a Notice of Allowance mailed on November 15, 2011 in the prosecution of co-pending, commonly-assigned U.S. Application No. 12/703,042.

Document NPL7 is a copy of a Non-Final Office Action mailed on November 28, 2011 in the prosecution of co-pending, commonly-assigned U.S. Application No. 12/688,413.

Document NPL8 is a copy of a Notice of Allowance mailed on December 30, 2011 in the prosecution of co-pending, commonly-assigned U.S. Application No. 12/857,238.

Document NPL9 is a copy of a Notice of Allowance mailed on February 6, 2012 in the prosecution of co-pending, commonly-assigned U.S. Application No. 11/400,008.

Document NPL10 is a copy of a Non-Final Office Action mailed on March 8, 2012 in the prosecution of co-pending, commonly-assigned U.S. Application No. 12/690,125.

Document NPL11 is a copy of a Notice of Allowance mailed on March 30, 2012 in the prosecution of co-pending, commonly-assigned U.S. Application No. 12/703,042.

Document NPL12 is a copy of a Non-Final Office Action mailed on April 11, 2012 in the prosecution of co-pending, commonly-assigned U.S. Application No. 09/969,987.

Document NPL13 is a copy of a Notice of Allowance mailed on April 23, 2012 in the prosecution of co-pending, commonly-assigned U.S. Application No. 11/553,419.

Document NPL14 is a copy of a Notice of Allowance mailed on May 7, 2012 in the prosecution of co-pending, commonly-assigned U.S. Application No. 11/553,427.

Document NPL15 is a copy of a Non-Final Office Action mailed on May 23, 2012 in the prosecution of co-pending, commonly-assigned U.S. Application No. 13/101,994.

Document NPL16 is a copy of a Notice of Allowance mailed on May 29, 2012 in the prosecution of co-pending, commonly-assigned U.S. Application No. 12/857,238.

The identification of these actions is not to be construed as a waiver of secrecy as to those applications now or upon issuance of the present application as a patent. The Examiner is respectfully requested to consider the cited applications and the art cited therein during examination.

It is expected that the examiner will review the prosecution and cited art in the parent application nos. 09/776,267, filed February 2, 2001 (now U.S. Patent No. 7,181,608), and 11/551,211, filed October 19, 2006 (now U.S. Patent No. 8,112,619), in accordance with MPEP 2001.06(b), and indicate in the next communication from the

/Suresh Suryawanshi/

01/02/2013

ALL REFERENCES CONSIDERED EXCEPT WHERE LINED THROUGH. /SKS./

office that the art cited in the earlier prosecution history has been reviewed in connection with the present application.

It is respectfully requested that the Examiner initial and return a copy of the enclosed IDS Forms, and indicate in the official file wrapper of this patent application that the documents have been considered.

The U.S. Patent and Trademark Office is hereby authorized to charge any fee deficiency, or credit any overpayment, to our Deposit Account No. 19-0036.

Respectfully submitted,

STERNE, KESSLER, GOLDSTEIN & FOX P.L.L.C.



Edward J. Kessler  
Attorney for Applicants  
Registration No. 25,688

Date: 19 June 2012

1100 New York Avenue, N.W.  
Washington, D.C. 20005-3934  
(202) 371-2600

1543284\_1.DOCX

/Suresh Suryawanshi/

12/27/2012

ALL REFERENCES CONSIDERED EXCEPT WHERE LINED THROUGH. /SKS./



## UNITED STATES PATENT AND TRADEMARK OFFICE

UNITED STATES DEPARTMENT OF COMMERCE  
 United States Patent and Trademark Office  
 Address: COMMISSIONER FOR PATENTS  
 P.O. Box 1450  
 Alexandria, Virginia 22313-1450  
 www.uspto.gov

## BIB DATA SHEET

CONFIRMATION NO. 8978

SERIAL NUMBER	FILING or 371(c) DATE RULE	CLASS	GROUP ART UNIT	ATTORNEY DOCKET NO.		
13/118,122	05/27/2011	713	2115	2855.004000B		
<b>APPLICANTS</b> James J. Fallon, Armonk, NY; John Buck, Oceanside, NY; Paul F. Pickel, Bethpage, NY; Stephen J. McErlain, New York, NY;						
<b>** CONTINUING DATA *****</b> This application is a CON of 11/551,211 10/19/2006 PAT 8,112,619 which is a CON of 09/776,267 02/02/2001 PAT 7,181,608 which claims benefit of 60/180,114 02/03/2000 Yes /SKS/						
<b>** FOREIGN APPLICATIONS *****</b> None /SKS/						
<b>** IF REQUIRED, FOREIGN FILING LICENSE GRANTED **</b> 06/10/2011						
Foreign Priority claimed <input type="checkbox"/> Yes <input checked="" type="checkbox"/> No	35 USC 119(a-d) conditions met <input type="checkbox"/> Yes <input type="checkbox"/> No	<input type="checkbox"/> Met after Allowance	<b>STATE OR COUNTRY</b>	<b>SHEETS DRAWINGS</b>	<b>TOTAL CLAIMS</b>	<b>INDEPENDENT CLAIMS</b>
Verified and Acknowledged	/SURESH SURYAWANSHI/ Examiner's Signature	Initials	NY	13	14 4-	6 4-
<b>ADDRESS</b>					/SKS/	/SKS/
STERNE, KESSLER, GOLDSTEIN & FOX P.L.L.C. 1100 NEW YORK AVENUE, N.W. WASHINGTON, DC 20005 UNITED STATES					12/26/12	12/26/12
<b>TITLE</b> Systems and Methods for Accelerated Loading of Operating Systems and Application Programs						
<b>FILING FEE RECEIVED</b> 1840	FEES: Authority has been given in Paper No. _____ to charge/credit DEPOSIT ACCOUNT No. _____ for following:			<input type="checkbox"/> All Fees <input type="checkbox"/> 1.16 Fees (Filing) <input type="checkbox"/> 1.17 Fees (Processing Ext. of time) <input type="checkbox"/> 1.18 Fees (Issue) <input type="checkbox"/> Other _____ <input type="checkbox"/> Credit		

Substitute for form 1449/PTO			<b>Complete if Known</b>		
<b>SECOND SUPPLEMENTAL INFORMATION DISCLOSURE STATEMENT BY APPLICANT</b> <i>(Use as many sheets as necessary)</i>			Application Number	13/118,122	
			Filing Date	May 27, 2011	
			First Named Inventor	James J. FALLON	
			Art Unit	2115	
			Examiner Name	SURYAWANSHI, Suresh	
Sheet	1	of	1	Attorney Docket Number	2855.004000B

U.S. PATENT DOCUMENTS						
Examiner initials*	Cite No. <sup>1</sup>	Document Number		Publication Date MM-DD-YYYY	Name of Patentee or Applicant of Cited Document	Pages, Columns, Lines, Where Relevant Passages or Relevant Figures Appear
		Number-Kind Code <sup>2</sup> (if known)				
	US1	5,331,425		07-19-1994	Ozaki et al.	
	US2	5,987,432		11-16-1999	Zusman et al.	
	US3	6,038,346		03-14-2000	Ratnakar	
	US4	6,097,845		08-01-2000	Ng et al.	
	US5	6,195,125		02-27-2001	Udagawa et al.	
	US6	6,195,391		02-27-2001	Hancock et al.	
	US7	6,198,850		03-06-2001	Banton	
	US8	8,054,879		11-08-2011	Fallon et al.	
	US9	8,073,047		12-06-2011	Fallon et al.	
	US10	8,090,936		01-03-2012	Fallon et al.	
	US11	8,112,619		02-07-2012	Fallon et al.	
	US12	2011/0235697 A1		09-29-2011	Fallon et al.	
	US13	2011/0285559 A1		11-24-2011	Fallon	

FOREIGN PATENT DOCUMENTS							
Examiner initials*	Cite No. <sup>1</sup>	Foreign Patent Document		Publication Date MM-DD-YYYY	Name of Patentee or Applicant of Cited Document	Pages, Columns, Lines, Where Relevant Passages or Relevant Figures Appear	T <sup>6</sup>
		Country Code <sup>3</sup> -Number <sup>4</sup> -Kind Code <sup>5</sup> (if known)					
	FP1	JP	04-241681	08-28-1992	Fujitsu Limited		T

1543148\_1.DOCX

Examiner Signature	/Suresh Suryawanshi/	Date Considered	12/27/2012
--------------------	----------------------	-----------------	------------

\*EXAMINER: Initial if reference considered, whether or not citation is in conformance with MPEP 609. Draw line through citation if not in conformance and not considered. Include copy of this form with next communication to applicant. <sup>1</sup> Applicant's unique citation designation number (optional). <sup>2</sup> See Kinds Codes of USPTO Patent Documents at www.uspto.gov or MPEP 901.04. <sup>3</sup> Enter Office that issued the document, by the two-letter code (WIPO Standard ST.3). <sup>4</sup> For Japanese Patent Documents, use the number of the document. <sup>5</sup> For other documents, use the kind code of the document. <sup>6</sup> Kind of document by the appropriate symbols as indicated on the document under WIPO Standard ST.16 if possible. Applicant is to place a check mark here if English language Translation is attached.

ALL REFERENCE SYMBOLS CONSIDERED EXCEPT WHERE SHOWN OTHERWISE. /SKS/

Substitute for form 1449/PTO		<b>Complete if Known</b>	
<b>SECOND SUPPLEMENTAL INFORMATION DISCLOSURE STATEMENT BY APPLICANT</b> <i>(Use as many sheets as necessary)</i>		Application Number	13/118,122
		Filing Date	May 27, 2011
		First Named Inventor	James J. FALLON
		Art Unit	2115
		Examiner Name	SURYAWANSHI, Suresh
		Attorney Docket Number	2855.004000B
Sheet	1	of	8

NON PATENT LITERATURE DOCUMENTS			
Examiner Initials*	Cite No. <sup>1</sup>	Include name of the author (in CAPITAL LETTERS), title of the article (when appropriate), title of the item (book, magazine, journal, serial, symposium, catalog, etc.), date, page(s), volume-issue number(s), publisher, city and/or country where published	T <sup>2</sup>
	NPL1	"Hard Disk Data Control Method", IBM Technical Disclosure Bulletin NN9302301, Vol. 36, No. 2, February 1993, pages 301-302.	
	NPL2	Copy of Notice of Allowance for U.S. Appl. No. 12/123,081, mailed September 26, 2011, 9 pages.	
	NPL3	Copy of Notice of Allowance for U.S. Appl. No. 11/551,204, mailed September 28, 2011, 5 pages.	
	NPL4	Copy of Notice of Allowance for U.S. Appl. No. 11/551,211, mailed October 18, 2011, 5 pages.	
	NPL5	Copy of Non-Final Office Action for U.S. Appl. No. 13/154,239, mailed November 2, 2011, 6 pages.	
	NPL6	Copy of Notice of Allowance for U.S. Appl. No. 12/703,042, mailed November 15, 2011, 8 pages.	
	NPL7	Copy of Non-Final Office Action for U.S. Appl. No. 12/688,413, mailed November 28, 2011, 14 pages.	
	NPL8	Copy of Notice of Allowance for U.S. Appl. No. 12/857,238, mailed December 30, 2011, 5 pages.	
	NPL9	Copy of Notice of Allowance for U.S. Appl. No. 11/400,008, mailed February 6, 2012, 8 pages.	
	NPL10	Copy of Non-Final Office Action for U.S. Appl. No. 12/690,125, mailed March 8, 2012, 7 pages.	

Examiner Signature	/Suresh Suryawanshi/	Date Considered	01/08/2013
-----------------------	----------------------	--------------------	------------

\*EXAMINER: Initial if reference considered, whether or not citation is in conformance with MPEP 609. Draw line through citation if not in conformance and not considered. Include copy of this form with next communication to applicant.

<sup>1</sup> Applicant's unique citation designation (unique identifier). <sup>2</sup> Applicant is to place a check mark here if English language Translation is attached.

ALL REFERENCES CONSIDERED EXCEPT WHERE LINED THROUGH. /SKS./



Substitute for form 1449/PTO				<b>Complete if Known</b>	
<b>SECOND SUPPLEMENTAL INFORMATION DISCLOSURE STATEMENT BY APPLICANT</b> <i>(Use as many sheets as necessary)</i>				Application Number	13/118,122
				Filing Date	May 27, 2011
				First Named Inventor	James J. FALLON
				Art Unit	2115
				Examiner Name	SURYAWANSHI, Suresh
Sheet	2	of	8	Attorney Docket Number	2855.004000B

NON PATENT LITERATURE DOCUMENTS			
Examiner Initials*	Cite No. <sup>1</sup>	Include name of the author (in CAPITAL LETTERS), title of the article (when appropriate), title of the item (book, magazine, journal, serial, symposium, catalog, etc.), date, page(s), volume number, publisher, city and/or country where published	T <sup>2</sup>
	NPL11	Copy of Notice of Allowance for U.S. Patent Appl. No. 12/703,042, mailed March 30, 2012, 8 pages.	
	NPL12	Copy of Non-Final Office Action for U.S. Appl. No. 09/969,987, mailed April 11, 2012, 6 pages.	
	NPL13	Copy of Notice of Allowance for U.S. Appl. No. 11/553,419, mailed April 23, 2012, 6 pages.	
	NPL14	Copy of Notice of Allowance for U.S. Appl. No. 11/553,427, mailed May 7, 2012, 7 pages.	
	NPL15	Copy of Non-Final Office Action for U.S. Appl. No. 13/101,994, mailed May 23, 2012, 12 pages.	
	NPL16	Copy of Notice of Allowance for U.S. Appl. No. 12/857,238, mailed May 29, 2012, 5 pages.	
	NPL17	Non-Final Action Closing Prosecution in Inter Partes Reexamination of U.S. Patent No. 7,714,747, Control No. 95/001,517, mailed September 21, 2011, 29 pages.	
	NPL18	Definition of "data packet", Academic Press Dictionary of Science and Technology, Copyright 1992, 1996, cited by Examiner in Inter Partes Reexamination of U.S. Patent No. 7,714,747, Control No. 95/001,517, mailed September 21, 2011, 2 pages.	
	NPL19	Patent Owner's Reply to Office Action in Inter Partes Reexamination of U.S. Patent No. 7,777,651, Control No. 95/001,581, mailed September 26, 2011, 44 pages.	
	NPL20	Examiner's Answer to Appeal Brief in Inter Partes Reexamination of U.S. Patent No. 6,624,761, Control No. 95/000,464, mailed September 28, 2011, 20 pages.	

Examiner Signature	/Suresh Suryawanshi/	Date Considered	01/08/2013
--------------------	----------------------	-----------------	------------

\*EXAMINER: Initial if reference considered, whether or not citation is in conformance with MPEP 609. Draw line through citation if not in conformance and not considered. Include copy of this form with next communication to applicant.

<sup>1</sup> Applicant's unique citation designation number (optional). <sup>2</sup> Applicant to place a check mark here if English language Translation is attached.

ALL REFERENCES CONSIDERED EXCEPT WHERE LINED THROUGH. /SKS./

Substitute for form 1449/PTO		<b>Complete if Known</b>	
<b>SECOND SUPPLEMENTAL INFORMATION DISCLOSURE STATEMENT BY APPLICANT</b> <i>(Use as many sheets as necessary)</i>		Application Number	13/118,122
		Filing Date	May 27, 2011
		First Named Inventor	James J. FALLON
		Art Unit	2115
		Examiner Name	SURYAWANSHI, Suresh
Sheet	3	of	8
		Attorney Docket Number	2855.004000B

NON PATENT LITERATURE DOCUMENTS			
Examiner Initials*	Cite No. <sup>1</sup>	Include name of the author (in CAPITAL LETTERS), title of the article (when appropriate), title of the item (book, magazine, journal, serial, symposium, catalog, etc.), date, page(s), volume number, publisher, city and/or country where published	T <sup>2</sup>
	NPL21	Examiner's Answer to Appeal Brief in Inter Partes Reexamination of U.S. Patent No. 7,161,506, Control no. 95/000,479, mailed September 28, 2011, 25 pages.	
	NPL22	Examiner's Answer to Appeal Brief in Inter Partes Reexamination of U.S. Patent No. 7,378,992, Control No. 95/000,478, mailed September 29, 2011, 27 pages.	
	NPL23	Decision on Appeal in Ex parte Reexamination of U.S. Patent No. 6,601,104 B1, Control No. 90/009,428, dated March 18, 2011, 14 pages.	
	NPL24	Patent Owner's Rebuttal Brief Under 37 C.F.R § 41.71 Retracting the Arguments Made to Overcome the Claim Rejections and Thereby Eliminating the Issues on Appeal in Inter Partes Reexamination of U.S. Patent No, 6,624,761, Control No. 95/000,464, dated October 28, 2011, 9 pages.	
	NPL25	Patent Owner's Rebuttal Brief Under 37 C.F.R § 41.71 Retracting the Arguments Made to Overcome the Claim Rejections and Thereby Eliminating the Issues on Appeal in Inter Partes Reexamination of U.S. Patent No, 7,378,992, Control No. 95/000,478, dated October 28, 2011, 10 pages.	
	NPL26	Patent Owner's Rebuttal Brief Under 37 C.F.R § 41.71 Retracting the Arguments Made to Overcome the Claim Rejections and Thereby Eliminating the Issues on Appeal in Inter Partes Reexamination of U.S. Patent No, 7,161,506, Control No. 95/000,479, dated October 28, 2011, 9 pages.	
	NPL27	Non-Final Action Closing Prosecution in Inter Partes Reexamination of U.S. Patent No. 7,400,274, Control No. 95/001,544, mailed November 18, 2011, 39 pages.	
	NPL28	Non-Final Action Closing Prosecution in Inter Partes Reexamination of U.S. Patent No. 7,417,568, Control No. 95/001,533, mailed December 9, 2011, 42 pages.	
	NPL29	Patent Owner's Reply to Action Closing Prosecution of November 18, 2011 in Inter Partes Reexamination of U.S. Patent No. 7,400,274, Control No. 95/001,544, mailed December 19, 2011, 9 pages.	
	NPL30	Patent Owner's Reply to Action Closing Prosecution of December 9, 2011 in Inter Partes Reexamination of U.S. Patent No. 7,417,568, Control No. 95/001,533, mailed December 29, 2011, 14 pages.	

Examiner Signature	/Suresh Suryawanshi/	Date Considered	01/08/2013
-----------------------	----------------------	--------------------	------------

\*EXAMINER: Initial if reference considered, whether or not citation is in conformance with MPEP 609. Draw line through citation if not in conformance and not considered. Include copy of this form with next communication to applicant.

<sup>1</sup> Applicant's unique citation designation number (optional). <sup>2</sup> Applicant is to place a check mark here if English language Translation is attached.

ALL REFERENCES CONSIDERED EXCEPT WHERE LINED THROUGH. /SKS./

Substitute for form 1449/PTO				<b>Complete if Known</b>	
<b>SECOND SUPPLEMENTAL INFORMATION DISCLOSURE STATEMENT BY APPLICANT</b> <i>(Use as many sheets as necessary)</i>				Application Number	13/118,122
				Filing Date	May 27, 2011
				First Named Inventor	James J. FALLON
				Art Unit	2115
				Examiner Name	SURYAWANSHI, Suresh
Sheet	4	of	8	Attorney Docket Number	2855.004000B

NON PATENT LITERATURE DOCUMENTS			
Examiner Initials*	Cite No. <sup>1</sup>	Include name of the author (in CAPITAL LETTERS), title of the article (when appropriate), title of the item (book, magazine, journal, serial, symposium, catalog, etc.), date, page(s), volume number, publisher, city and/or country where published	T <sup>2</sup>
	NPL31	Notice of Intent to Issue Ex Parte Reexamination Certificate in Ex Parte Reexamination of U.S. Patent No. 6,601,104, Control No. 90/009,428, mailed January 13, 2012, 5 pages.	
	NPL32	Decision on Appeal in Inter Partes Reexamination of U.S. Patent No. 6,624,761, Control No. 95/000,464, mailed January 18, 2012, 5 pages.	
	NPL33	Decision on Appeal in Inter Partes Reexamination of U.S. Patent No. 7,321,937, Control No. 95/000,466, mailed January 18, 2012, 8 pages.	
	NPL34	Decision on Appeal in Inter Partes Reexamination of U.S. Patent No. 7,378,992, Control No. 95/000,478, mailed January 18, 2012, 5 pages.	
	NPL35	Decision on Appeal in Inter Partes Reexamination of U.S. Patent No. 7,161,506, Control No. 95/000,479, mailed January 18, 2012, 6 pages.	
	NPL36	Non-Final Office Action in Inter Partes Reexamination of U.S. Patent No. 7,777,651, Control No. 95/001,581, mailed January 27, 2012, 152 pages.	
	NPL37	Patent Owner's Respondent Brief on Appeal Under 37 C.F.R. § 41.68 in Inter Partes Reexamination of U.S. Patent No. 7,714,747, Control No. 95/001,517, filed February 17, 2012, 20 pages.	
	NPL38	Patent Owner's Reply to Second Non-Final Office Action of January 27, 2012 in Inter Partes Reexamination of U.S. Patent No. 7,777,651, Control No. 95/001,581, filed February 24, 2012, 30 pages.	
	NPL39	Ex Parte Reexamination Certificate in Ex Parte Reexamination of U.S. Patent No. 6,601,104, Control No. 90/009,428, issued February 28, 2012, 2 pages.	
	NPL40	Examiner's Answer to Appeal Brief in Inter Partes Reexamination of U.S. Patent No. 7,714,747, Control No. 95/001,517, mailed March 1, 2012, 4 pages.	

Examiner Signature	/Suresh Suryawanshi/	Date Considered	01/08/2013
-----------------------	----------------------	--------------------	------------

\*EXAMINER: Initial if reference considered, whether or not citation is in conformance with MPEP 609. Draw line through citation if not in conformance and not considered. Include copy of this form with next communication to applicant.

<sup>1</sup> Applicant's unique citation designation number (optional). <sup>2</sup> Applicant is to place a check mark here if English language Translation is attached.

ALL REFERENCES CONSIDERED EXCEPT WHERE LINED THROUGH. /SKS./

Substitute for form 1449/PTO		<b>Complete if Known</b>	
<b>SECOND SUPPLEMENTAL INFORMATION DISCLOSURE STATEMENT BY APPLICANT</b> <i>(Use as many sheets as necessary)</i>		Application Number	13/118,122
		Filing Date	May 27, 2011
		First Named Inventor	James J. FALLON
		Art Unit	2115
		Examiner Name	SURYAWANSHI, Suresh
		Attorney Docket Number	2855.004000B
Sheet	5	of	8

NON PATENT LITERATURE DOCUMENTS			
Examiner Initials*	Cite No. <sup>1</sup>	Include name of the author (in CAPITAL LETTERS), title of the article (when appropriate), title of the item (book, magazine, journal, serial, symposium, catalog, etc.), date, page(s), volume number, publisher, city and/or country where published	T <sup>2</sup>
	NPL41	Right of Appeal Notice in Inter Partes Reexamination of U.S. Patent No. 7,417,568, Control No. 95/001,533, mailed March 1, 2012, 8 pages.	
	NPL42	Right of Appeal Notice in Inter Partes Reexamination of U.S. Patent No. 7,400,274, Control No. 95/001,544, mailed March 6, 2012, 7 pages.	
	NPL43	Request for Inter Partes Reexamination of U.S. Patent No. 7,321,937, Control No. 95/001,922, filed March 2, 2012, including accompanying Exhibits PA-A to PA-D, PAT-A to PAT-C, CC-A to CC-D, Oth-A, and Form PTO/SB/08a, 2865 pages.	
	NPL44	Request for Inter Partes Reexamination of U.S. Patent No. 6,604,158, Control No. 95/001,923, filed March 2, 2012, including accompanying Exhibits PA-A to PA-D, PAT-A to PAT-B, CC-A to CC-F, Oth-A, and Form PTO/SB/08a, 560 pages.	
	NPL45	Request for Inter Partes Reexamination of U.S. Patent No. 7,352,300, Control No. 95/001,924, filed March 2, 2012, including accompanying Exhibits PA-A to PA-H, PAT-A to PAT-B, CC-A to CC-F, Oth-A, and Form PTO/SB/08a, 1012 pages.	
	NPL46	Request for Inter Partes Reexamination of U.S. Patent No. 7,395,345, Control No. 95/001,925, filed March 2, 2012, including accompanying Exhibits PA-A to PA-C, PAT-A, CC-A to CC-C, Oth-A, and Form PTO/SB/08a, 204 pages.	
	NPL47	Request for Inter Partes Reexamination of U.S. Patent No. 7,161,506, Control No. 95/001,926, filed March 2, 2012, with accompanying Exhibits PA-A to PA-C, PAT-A to PAT-C, CC-A to CC-B, Oth-A to Oth-B, and Form PTO/SB/08a, 2651 pages.	
	NPL48	Request for Inter Partes Reexamination of U.S. Patent No. 7,415,530, Control No. 95/001,927, filed March 2, 2012, including accompanying Exhibits PA-A to PA-F, PAT-A to PAT-B, CC-A to CC-O, Oth-A, and Form PTO/SB/08a, 700 pages.	
	NPL49	Request for Inter Partes Reexamination of U.S. Patent No. 7,378,992, Control No. 95/001,928, filed March 2, 2012, including Exhibits PA-A to PA-D, PAT-A to PAT-C, CC-A to CC-B, Oth-A, and Form PTO/SB/08a, 2316 pages.	
	NPL50	Official Order Granting Request for Inter Partes Reexamination of U.S. Patent No. 7,395,345, Control No. 95/001,925, mailed March 19, 2012, 11 pages.	

Examiner Signature	/Suresh Suryawanshi/	Date Considered	01/08/2013
-----------------------	----------------------	--------------------	------------

\*EXAMINER: Initial if reference considered, whether or not citation is in conformance with MPEP 609. Draw line through citation if not in conformance and not considered. Include copy of this form with next communication to applicant.

<sup>1</sup> Applicant's unique citation designation number (optional). <sup>2</sup> Applicant is to place a check mark here if English language Translation is attached.

ALL REFERENCES CONSIDERED EXCEPT WHERE LINED THROUGH. /SKS./

Substitute for form 1449/PTO				<b>Complete if Known</b>	
<b>SECOND SUPPLEMENTAL INFORMATION DISCLOSURE STATEMENT BY APPLICANT</b> <i>(Use as many sheets as necessary)</i>				Application Number	13/118,122
				Filing Date	May 27, 2011
				First Named Inventor	James J. FALLON
				Art Unit	2115
				Examiner Name	SURYAWANSHI, Suresh
Sheet	6	of	8	Attorney Docket Number	2855.004000B

NON PATENT LITERATURE DOCUMENTS			
Examiner Initials*	Cite No. <sup>1</sup>	Include name of the author (in CAPITAL LETTERS), title of the article (when appropriate), title of the item (book, magazine, journal, serial, symposium, catalog, etc.), date, page(s), volume number, publisher, city and/or country where published	T <sup>2</sup>
	NPL51	Non-Final Office Action in Inter Partes Reexamination of U.S. Patent No. 7,395,345, Control No. 95/001,925, mailed March 19, 2012, 20 pages.	
	NPL52	Notice of Intent to Issue Inter Partes Reexamination Certificate in Inter Partes Reexamination of U.S. Patent No. 7,321,937, Control No. 95/000,466, mailed March 21, 2012, 7 pages.	
	NPL53	Right of Appeal Notice for Inter Partes Reexamination of U.S. Patent No. 6,604,158, Control No. 95/000,486, mailed March 26, 2012, 253 pages.	
	NPL54	Notice of Intent to Issue Inter Partes Reexamination Certificate in Inter Partes Reexamination of U.S. Patent No. 6,624,761, Control No. 95/000,464, mailed April 3, 2012, 7 pages.	
	NPL55	Notice of Intent to Issue Inter Partes Reexamination Certificate in Inter Partes Reexamination of U.S. Patent No. 7,161,506, Control No. 95/000,479, mailed April 4, 2012, 15 pages.	
	NPL56	Notice of Intent to Issue Inter Partes Reexamination Certificate in Inter Partes Reexamination of U.S. Patent No. 7,378,992, Control No. 95/000,478, mailed April 6, 2012, 5 pages.	
	NPL57	Official Order Granting Request for Inter Partes Reexamination of U.S. Patent No. 7,321,937, Control no. 95/001,922, mailed April 20, 2012, 17 pages.	
	NPL58	Non-Final Office Action in Inter Partes Reexamination of U.S. Patent No. 7,321,937, Control No. 95/001,922, mailed April 20, 2012, 8 pages.	
	NPL59	Official Order Granting Request for Inter Partes Reexamination of U.S. Patent No. 7,161,506, Control No. 95/001,926, mailed April 25, 2012, 9 pages.	
	NPL60	Non-Final Office Action in Inter Partes Reexamination of U.S. Patent No. 7,161,506, Control No. 95/001,926, mailed April 25, 2012, 7 pages.	

Examiner Signature	/Suresh Suryawanshi/	Date Considered	01/08/2013
-----------------------	----------------------	--------------------	------------

\*EXAMINER: Initial if reference considered, whether or not citation is in conformance with MPEP 609. Draw line through citation if not in conformance and not considered. Include copy of this form with next communication to applicant.

<sup>1</sup> Applicant's unique citation designation number (optional). <sup>2</sup> Applicant is to place a check mark here if English language Translation is attached.

ALL REFERENCES CONSIDERED EXCEPT WHERE LINED THROUGH. /SKS./

Substitute for form 1449/PTO				<b>Complete if Known</b>	
<b>SECOND SUPPLEMENTAL INFORMATION DISCLOSURE STATEMENT BY APPLICANT</b> <i>(Use as many sheets as necessary)</i>				Application Number	13/118,122
				Filing Date	May 27, 2011
				First Named Inventor	James J. FALLON
				Art Unit	2115
				Examiner Name	SURYAWANSHI, Suresh
Sheet	7	of	8	Attorney Docket Number	2855.004000B

NON PATENT LITERATURE DOCUMENTS			
Examiner Initials*	Cite No. <sup>1</sup>	Include name of the author (in CAPITAL LETTERS), title of the article (when appropriate), title of the item (book, magazine, journal, serial, symposium, catalog, etc.), date, page(s), volume number, publisher, city and/or country where published	T <sup>2</sup>
	NPL61	Official Order Granting Request for Inter Partes Reexamination of U.S. Patent No. 7,378,992, Control No. 95/001,928, mailed April 25, 2012, 8 pages.	
	NPL62	Non-Final Office Action in Inter Partes Reexamination of U.S. Patent No. 7,378,992, Control No. 95/001,928, mailed April 25, 2012, 8 pages.	
	NPL63	Official Order Denying Request for Inter Partes Reexamination of U.S. Patent No. 7,415,530, Control No. 95/001,927, mailed April 27, 2012, 52 pages.	
	NPL64	Official Order Granting Request for Inter Partes Reexamination of U.S. Patent No. 6,604,158, Control No. 95/001,923, mailed May 7, 2012, 14 pages.	
	NPL65	Non-Final Office Action in Inter Partes Reexamination of U.S. Patent No. 6,604,158, Control No. 95/001,923, mailed May 7, 2012, 8 pages.	
	NPL66	Petition Under 37 C.F.R. §§ 1.181 and 1.182 for Correction of Notice of Intent to Issue Reexamination Certificate in Inter Partes Reexamination of U.S. Patent No. 7,378,992, Control No. 95/000,478, filed May 9, 2012, 8 pages.	
	NPL67	Inter Partes Reexamination Certificate in Inter Partes Reexamination of U.S. Patent No. 7,321,937, Control No. 95/000,466, issued May 15, 2012, 2 pages.	
	NPL68	Official Order Granting Request for Inter Partes Reexamination of U.S. Patent No. 7,352,300, Control No. 95/001,924, mailed May 17, 2012, 12 pages.	
	NPL69	Non-Final Office Action in Inter Partes Reexamination of U.S. Patent No. 7,352,300, Control No. 95/001,924, mailed May 17, 2012, 18 pages.	
	NPL70	Patent Owner's Response to Office Action of March 19, 2012, in Inter Partes Reexamination of U.S. Patent No. 7,395,345, Control No. 95/001,925, filed May 21, 2012, 21 pages.	

Examiner Signature	/Suresh Suryawanshi/	Date Considered	01/08/2013
-----------------------	----------------------	--------------------	------------

\*EXAMINER: Initial if reference considered, whether or not citation is in conformance with MPEP 609. Draw line through citation if not in conformance and not considered. Include copy of this form with next communication to applicant.

<sup>1</sup> Applicant's unique citation designation number (optional). <sup>2</sup> Applicant is to place check marks here if English language Translation is attached.

ALL REFERENCES CONSIDERED EXCEPT WHERE LINED THROUGH. /SKS./

Substitute for form 1449/PTO				<b>Complete if Known</b>	
<b>SECOND SUPPLEMENTAL INFORMATION DISCLOSURE STATEMENT BY APPLICANT</b> <i>(Use as many sheets as necessary)</i>				Application Number	13/118,122
				Filing Date	May 27, 2011
				First Named Inventor	James J. FALLON
				Art Unit	2115
				Examiner Name	SURYAWANSHI, Suresh
				Attorney Docket Number	2855.004000B
Sheet	8	of	8		

NON PATENT LITERATURE DOCUMENTS			
Examiner Initials*	Cite No. <sup>1</sup>	Include name of the author (in CAPITAL LETTERS), title of the article (when appropriate), title of the item (book, magazine, journal, serial, symposium, catalog, etc.), date, page(s), volume number, publisher, city and/or country where published	T <sup>2</sup>
	NPL71	Inter Partes Reexamination Certificate in Inter Partes Reexamination of U.S. Patent No. 7,161,506, Control No. 95/000,479, issued May 22, 2012, 2 pages.	
	NPL72	Inter Partes Reexamination Certificate in Inter Partes Reexamination of U.S. Patent No. 6,624,761, Control No. 95/000,464, issued June 12, 2012, 2 pages.	
	NPL73	Court Docket History for 6:10-cv-00493-LED-JDL, Realtime Data, LLC d/b/a IXO, v. MetroPCS Texas, LLC et al., dated June 19, 2012, 38 pages.	
	NPL74	Court Docket History for 1:11-cv-06696-RJH, Realtime Data, LLC d/b/a IXO, v. Morgan Stanley et al., June 19, 2012, 66 pages.	
	NPL75	Court Docket History for 1:11-cv-06697-UA, Realtime Data, LLC d/b/a IXO, v. CME Group Inc. et al., dated June 19, 2012, 74 pages.	
	NPL76	Court Docket History for 1:11-cv-06698-UA, Realtime Data, LLC d/b/a IXO, v. Thomson Reuters et al., dated June 19, 2012, 45 pages.	

1543152\_1.DOCX

Examiner Signature	/Suresh Suryawanshi/	Date Considered	01/08/2013
--------------------	----------------------	-----------------	------------

\*EXAMINER: Initial if reference considered, whether or not citation is in conformance with MPEP 609. Draw line through citation if not in conformance and not considered. Include copy of this form with next communication to applicant.

<sup>1</sup> Applicant's unique citation designation number (optional). <sup>2</sup> Applicant is to place a check mark here if English language Translation is attached.

ALL REFERENCES CONSIDERED EXCEPT WHERE LINED THROUGH. /SKS./

<b><i>Index of Claims</i></b> 	<b>Application/Control No.</b> 13118122	<b>Applicant(s)/Patent Under Reexamination</b> FALLON ET AL.
	<b>Examiner</b> SURESH SURYAWANSHI	<b>Art Unit</b> 2115

✓	<b>Rejected</b>	-	<b>Cancelled</b>	N	<b>Non-Elected</b>	A	<b>Appeal</b>
=	<b>Allowed</b>	÷	<b>Restricted</b>	I	<b>Interference</b>	O	<b>Objected</b>

Claims renumbered in the same order as presented by applicant
  CPA
  T.D.
  R.1.47

CLAIM		DATE							
Final	Original	05/14/2012	12/26/2012						
	1	✓	✓						
	2		✓						
	3		✓						
	4		✓						
	5		✓						
	6		✓						
	7		✓						
	8		✓						
	9		✓						
	10		✓						
	11		✓						
	12		✓						
	13		✓						
	14		✓						



## EAST Search History

## EAST Search History (Prior Art)

Ref #	Hits	Search Query	DBs	Default Operator	Plurals	Time Stamp
S1	3	("7181608" "8090936" "8112619").pn.	USPAT	OR	OFF	2012/12/26 11:27
S2	1	list near3 compressed near2 boot\$3 adj1 data	USPAT	OR	OFF	2012/12/26 13:10
S3	1	list near3 compressed near2 boot\$3 adj1 data	US- PGPUB	OR	OFF	2012/12/26 13:10
S4	0	list near3 compressed near2 boot\$3 adj1 data	EPO; JPO; IBM_TDB	OR	OFF	2012/12/26 13:10
S5	3	compressed near2 boot\$3 adj1 data	USPAT	OR	OFF	2012/12/26 13:11
S6	3	compressed near2 boot\$3 adj1 data	US- PGPUB	OR	OFF	2012/12/26 13:11
S7	1	compressed near2 boot\$3 adj1 data	EPO; JPO; IBM_TDB	OR	OFF	2012/12/26 13:12
S8	11	("5331425" "5987432" "6038346" "6097845" "6195125" "6195391" "6198850" "8054879" "8073047" "8090936" "8112619").pn.	USPAT	OR	OFF	2012/12/26 14:09
S9	541	("20010031092"   "20010032128"   "20010047473"   "20010052038"   "20010054131"   "20020037035"   "20020069354"   "20020080871"   "20020097172"   "20020101367"   "20020104891"   "20020126755"   "20020191692"   "20030030575"   "20030034905"   "20030084238"   "20030090397"   "20030142874"   "20030191876"   "20040042506"   "20040056783"   "20040073710"   "20040073746"   "20060015650"   "20060181441"   "20060181442"   "20060184687"   "20060184696"   "20060190644"   "20060195601"   "20070043939"   "20070050514"   "20070050515"   "20070067483"   "20070083746"   "20070109154"   "20070109155"   "20070109156"   "20070174209"   "20080232457"   "20090154545"   "20090287839"   "20100316114"   "20100318684"   "20100332700"   "20110037626"   "20110199243"   "20110208833"   "3394352"   "3490690"   "4021782"   "4032893"   "4054951"   "4127518"   "4302775"   "4325085"   "4360840"   "4386416"   "4394774"   "4464650"   "4494108"   "4499499"   "4574351"   "4593324"   "4626829"   "4646061"   "4682150"   "4701745"   "4729020"	US- PGPUB; USPAT; USOCR	OR	OFF	2012/12/26 14:51

"4730348"	"4745559"	"4748638"	
"4750135"	"4754351"	"4804959"	
"4813040"	"4814746"	"4862167"	
"4866601"	"4870415"	"4872009"	
"4876541"	"4888812"	"4890282"	
"4897717"	"4906991"	"4906995"	
"4929946"	"4953324"	"4956808"	
"4965675"	"4988998"	"5003307"	
"5016009"	"5027376"	"5028922"	
"5045848"	"5045852"	"5046027"	
"5049881"	"5079630"	"5091782"	
"5097261"	"5103306"	"5109226"	
"5109433"	"5113522"	"5115309"	
"5121342")	PN. OR ("5126739"   "5128963"		
"5132992"	"5146221"   "5150430"		
"5155484"	"5159336"	"5167034"	
"5175543"	"5179651"	"5187793"	
"5191431"	"5204756"	"5209220"	
"5212742"	"5226176"	"5227893"	
"5231492"	"5237460"	"5237675"	
"5243341"	"5243348"	"5247638"	
"5247646"	"5249053"	"5263168"	
"5267333"	"5270832"	"5280600"	
"5287420"	"5289580"	"5293379"	
"5293576"	"5307497"	"5309555"	
"5319682"	"5341440"	"5347600"	
"5353132"	"5354315"	"5355498"	
"5357614"	"5367629"	"5373290"	
"5374916"	"5379036"	"5379757"	
"5381145"	"5389922"	"5394534"	
"5396228"	"5400401"	"5403639"	
"5406278"	"5406279"	"5410671"	
"5412384"	"5414850"	"5420639"	
"5434983"	"5437020"	"5452287"	
"5454079"	"5454107"	"5455576"	
"5455578"	"5455680"	"5461679"	
"5463390"	"5467087"	"5471206"	
"5479587"	"5479633"	"5483470"	
"5486826"	"5488364"	"5488365"	
"5495244"	"5504842"	"5506844"	
"5506872"	"5506944"	"5521940"	
"5528628"	"5530845"	"5533051"	
"5535311"	"5535356"	"5535369"	
"5537658"	"5539865"	"5542031"	
"5544290"	"5546395"	"5546475"	
"5553160"	"5557551"	"5557668"	
"5557749"	"5561421"	"5561824"	
"5563961"	"5574952"	"5574953"	
"5576953"	"5577248"	"5581715"	
"5583500"	"5586264"	"5586285"	
"5590306"	"5596674"	"5598388"	
"5604824"	"5606706"	"5610657"	
"5611024"	"5612788"	"5613069"	
"5615017"	"5615287"	"5619995"	
"5621820"	"5623623"	"5623701")	PN. OR
("5627534"	"5627995"   "5629732"		
"5630092"	"5635632"	"5635932"	
"5638498"	"5640158"	"5642506"	
"5649032"	"5652795"	"5652857"	
"5652917"	"5654703"	"5655138"	
"5666560"	"5668737"	"5671355"	
"5671389"	"5671413"	"5673370"	
"5675333"	"5675789"	"5686916"	
"5692159"	"5694619"	"5696927"	

"5703793"	"5708511"	"5715477"
"5717393"	"5717394"	"5719862"
"5721958"	"5724475"	"5729228"
"5740395"	"5742773"	"5748904"
"5757852"	"5764774"	"5765027"
"5768445"	"5768525"	"5771340"
"5774715"	"5778411"	"5781767"
"5784572"	"5787487"	"5794229"
"5796864"	"5799110"	"5805834"
"5805932"	"5808660"	"5809176"
"5809299"	"5809337"	"5812195"
"5812789"	"5818368"	"5818369"
"5818530"	"5819215"	"5822781"
"5825424"	"5825830"	"5832037"
"5832126"	"5832443"	"5835788"
"5836003"	"5838821"	"5838927"
"5838996"	"5839100"	"5841979"
"5847762"	"5850565"	"5861824"
"5861920"	"5864342"	"5864678"
"5867167"	"5867602"	"5870036"
"5870087"	"5872530"	"5874907"
"5883975"	"5884269"	"5886655"
"5887165"	"5889961"	"5892847"
"5907801"	"5909557"	"5909559"
"5915079"	"5917438"	"5918068"
"5918225"	"5920326"	"5923860"
"5930358"	"5936616"	"5938737"
"5943692"	"5945933"	"5949355"
"5949968"	"5951623"	"5955976"
"5956490"	"5960465"	"5964842"
"5968149"	"5969927"	"5973630"
"5974235"	"5974387"	"5974471"
"5978483"	"5982360").PN. OR ("5982723"	
"5982937"	"5987022"	"5987590"
"5990884"	"5991515"	"5996033"
"6000009"	"6002411"	"6003115"
"6008743"	"6011901"	"6014694"
"6021433"	"6023755"	"6026217"
"6028725"	"6031939"	"6032148"
"6032197"	"6058459"	"6061398"
"6061473"	"6070179"	"6073232"
"6075470"	"6078958"	"6091777"
"6092123"	"6094634"	"6097520"
"6098114"	"6104389"	"6105130"
"6115384"	"6128412"	"6134631"
"6141053"	"6145020"	"6145069"
"6169241"	"6170007"	"6170047"
"6170049"	"6172936"	"6173381"
"6175650"	"6175856"	"6182125"
"6185625"	"6185659"	"6192082"
"6192155"	"6195024"	"6195465"
"6198842"	"6198850"	"6208273"
"6215904"	"6219754"	"6222886"
"6225922"	"6226667"	"6226740"
"6230223"	"6237054"	"6243829"
"6253264"	"6272178"	"6272627"
"6272628"	"6282641"	"6285458"
"6298408"	"6308311"	"6309424"
"6310563"	"6317714"	"6317818"
"6330622"	"6333745"	"6345307"
"6356589"	"6356937"	"6388584"
"6392567"	"6404931"	"6421387"
"6434168"	"6434695"	"6442659"
"6449658"	"6449682"	"6452602"

		"6452933"   "6459429"   "6463509"   "6487640"   "6489902"   "6505239"   "6513113"   "6523102"   "6526174"   "6529633"   "6532121"   "6539438"   "6539456"   "6542644"   "6577254"   "6590609"   "6597812"   "6601104"   "6604040"   "6604158"   "6606040"   "6606413"   "6609223"   "6618728"   "6624761"   "6633244"   "6633968"   "6650261"   "6661839"   "6661845"   "6704840").PN. OR ("6708220"   "6711709"   "6717534"   "6731814"   "6745282"   "6748457"   "6756922"   "6768749"   "6792151"   "6810434"   "6813689"   "6819271"   "6822589"   "6856651"   "6862278"   "6879266"   "6885316"   "6885319"   "6888893"   "6909383"   "6944740"   "6952409"   "6959359"   "6963608"   "6990247"   "6993597"   "7007099"   "7024460"   "7054493"   "7069342"   "7089391"   "7102544"   "7127518"   "7129860"   "7130913"   "7161506"   "7181608"   "7190284"   "7319667"   "7321937"   "7330912"   "7352300"   "7358867"   "7376772"   "7378992"   "7386046"   "7395345"   "7400274"   "7415530"   "7417568"   "7552069"   "7565441"   "7714747"   "7777651"   "RE40092").PN.				
S10	0	load\$3 near3 compressed adj1 boot\$3 adj1 data	USPAT	OR	OFF	2012/12/26 15:45
S11	0	load\$3 near3 compressed adj1 boot\$3 adj1 data	US-PGPUB	OR	OFF	2012/12/26 15:45
S12	0	load\$3 near3 compressed adj1 boot\$3 adj1 data	EPO; JPO; IBM_TDB	OR	OFF	2012/12/26 15:45
S13	1	operating adj1 system near3 compressed with boot adj1 device	USPAT	OR	OFF	2012/12/26 15:53
S14	1	operating adj1 system near3 compressed with boot adj1 device	US-PGPUB	OR	OFF	2012/12/26 15:54
S15	0	operating adj1 system near3 compressed with boot adj1 device	EPO; JPO; IBM_TDB	OR	OFF	2012/12/26 15:55

12/ 26/ 2012 6:18:50 PM

C:\Users\ssuryawanshi\Documents\EAST\Workspaces\13118122AcceleratedLoadingOfOSPart2.wsp

<b>Search Notes</b>  	<b>Application/Control No.</b>  13118122	<b>Applicant(s)/Patent Under Reexamination</b>  FALLON ET AL.
	<b>Examiner</b>  SURESH SURYAWANSHI	<b>Art Unit</b>  2115

SEARCHED			
Class	Subclass	Date	Examiner
713	2	5/11/12, 5/14/12	SKS
Search updated		12/26/12	SKS

SEARCH NOTES			
Search Notes	Date	Examiner	
EAST; USPAT; US-PGPUB; EPO; JPO; IBM_TDB; NPL	5/11/12, 5/14/12	SKS	
Search updated	12/26/12	SKS	

INTERFERENCE SEARCH			
Class	Subclass	Date	Examiner
713	1	5/11/12, 5/14/12	SKS
711	113	5/11/12, 5/14/12	SKS
Search updated		12/26/12	SKS

--	--

RECEIVED  
CENTRAL FAX CENTER  
NOV 16 2012

IN THE UNITED STATES PATENT AND TRADEMARK OFFICE

In re application of:  
FALLON, James J. *et al*  
Appl. No.: 13/118,122  
Filed: May 27, 2011  
For: **Systems And Methods For  
Accelerated Loading Of Operating  
Systems And Application Programs**

Confirmation No.: 8978  
Art Unit: 2115  
Examiner: SURYAWANSHI, Suresh  
Atty. Docket: 2855.004000B

AMENDMENT UNDER 37 C.F.R. § 1.111

*Mail Stop Amendment*

Commissioner for Patents  
PO Box 1450  
Alexandria, VA 22313-1450

Commissioner:

In reply to the Office Action dated May 16, 2012, Applicants submit the following Amendment and Remarks.

Amendments to the Specification begin on page 2.

The listing of claims begins on page 8 of this paper.

Remarks and Arguments begin on page 13 of this paper.

It is not believed that extensions of time or fees for net addition of claims are required beyond those that may otherwise be provided for in documents accompanying this paper. However, if additional extensions of time are necessary to prevent abandonment of this application, then such extensions of time are hereby petitioned under 37 C.F.R. § 1.136(a), and any fees required therefor (including fees for net addition of claims) are hereby authorized to be charged to our Deposit Account No. 19-0036.

11/19/2012 APEREZAM 00000010 13118122

02 FC:1201

750.00 0P

NOV 16 2012

- 2 -

FALLON *et al*  
Appl. No. 13/118,122*Amendments to the Specification*

Please amend the specification as follows:

[0034] The present invention is directed to data storage controllers that provide increased data storage/retrieval rates that are not otherwise achievable using conventional disk controller systems and protocols to store/retrieve data to/from mass storage devices. The concept of "accelerated" data storage and retrieval was introduced in copending U.S. Application Serial No. 09/266,394, filed March 11, 1999, entitled "System and Methods For Accelerated Data Storage and Retrieval," now U.S. Patent No. 6,601,104, and copending U.S. Application Serial No. 09/481,243 filed January 11, 2000, entitled "System and Methods For Accelerated Data Storage and Retrieval," now U.S. Patent No. 6,604,158, both of which are commonly assigned and incorporated herein by reference. In general, as described in the above-incorporated applications, "accelerated" data storage comprises receiving a digital data stream at a data transmission rate which is greater than the data storage rate of a target storage device, compressing the input stream at a compression rate that increases the effective data storage rate of the target storage device and storing the compressed data in the target storage device. For instance, assume that a mass storage device (such as a hard disk) has a data storage rate of 20 megabytes per second. If a storage controller for the mass storage device is capable of compressing an input data stream with an average compression rate of 3:1, then data can be stored in the mass storage device at a rate of 60 megabytes per second, thereby effectively increasing the storage bandwidth ("storewidth") of the mass storage device by a factor of three. Similarly, accelerated data retrieval comprises retrieving a compressed digital data stream from a target storage device at the rate equal to, e.g., the data access rate of the target storage device and then decompressing the compressed data at a rate that increases the effective data access rate of the target storage device.

1570636\_1

Atty. Dkt. No. 2855.004000B

- 3 -

FALLON *et al*  
Appl. No. 13/118,122

Advantageously, accelerated data storage/retrieval mitigates the traditional bottleneck associated with, e.g., local and network disk accesses.

[0035] Referring now to Fig. 1, a high-level block diagram illustrates a data storage controller 10 according to one embodiment of the present invention. The data storage controller 10 comprises a data compression engine 12 for compressing/decompressing data (preferably in real-time or pseudo real-time) stored/retrieved from a hard disk 11 (or any other type of mass storage device) to provide accelerated data storage/retrieval. The DCE 12 preferably employs the data compression/decompression techniques disclosed in U.S. Serial No. 09/210,491 entitled "Content Independent Data Compression Method and System," filed on December 11, 1998, now U.S. Patent No. 6,195,024, which is commonly assigned and which is fully incorporated herein by reference. It is to be appreciated that the compression and decompression systems and methods disclosed in U.S. Patent No. 6,195,024 ~~Serial No. 09/210,491~~ are suitable for compressing and decompressing data at rates, which provide accelerated data storage and retrieval. A detailed discussion of a preferred "content independent" data compression process will be provided below.

[0041] As discussed in greater detail below, upon host computer power-up or external user reset, the data storage controller 10 initializes the onboard interfaces 14, 15 prior to release of the external host bus 16 from reset. The processor of the host computer then requests initial data from the disk 11 to facilitate the computer's boot-up sequence. The host computer requests disk data over the Bus 16 via a command packet issued from the host computer. Command packets are preferably eight words long (in a preferred embodiment, each word comprises 32 bits). Commands are written from the host computer to the data storage controller 10 with the host computer as the Bus Master and the data storage controller 10 as the slave. The data storage controller 10 includes at least one Base Address Register (BAR) for decoding the address of a command queue of the data storage

1570636\_1

Atty. Dkt. No. 2855.004000B



- 4 -

FALLON *et al*  
Appl. No. 13/118,122

controller 10. The command queue resides within the cache 13 or within onboard memory of the DCE 12.

[0048] The storage controller 20 further comprises computer reset and power up circuitry 28 (or "boot configuration circuit") for controlling initialization (either cold or warm boots) of the host computer system and storage controller 20. A preferred boot configuration circuit and preferred computer initialization systems and protocols are described in U.S. Patent Application Serial No. 09/775,897 (Attorney Docket No. ~~8011-10~~), filed concurrently herewith (~~Express Mail Label No. EL679454245US~~), which is commonly assigned and incorporated herein by reference. Preferably, the boot configuration circuit 28 is employed for controlling the initializing and programming the programmable logic device 22 during configuration of the host computer system (i.e., while the CPU of the host is held in reset). The boot configuration circuit 28 ensures that the programmable logic device 22 (and possibly other volatile or partially volatile logic devices) is initialized and programmed before the bus 16 (such as a PCI bus) is fully reset.

[0055] Fig. 3 illustrates another embodiment of a data storage controller ~~[[30]]~~ 35 wherein the data storage controller 35 is embedded within the motherboard of the host computer system. This architecture provides the same functionality as the system of Fig. 2, and also adds the cost advantage of being embedded on the host motherboard. The system comprises additional RAM and ROM memory devices 23a, 24a, operatively connected to the DSP 21 via a local bus 25a.

[0095] The DSP services request for its external bus from two requestors, the Enhanced Direct Memory Access (EDMA) Controller and an external shared memory device controller. The DSP can typically utilize the full 280 megabytes of bus bandwidth on an 8k through 64K byte (2k word through 16k word) burst basis. It should be noted that the Data Storage and Retrieval Application (DSRA) does not

1570636\_1

Atty. Dkt. No. 2855.004000B

- 5 -

FALLON *et al*  
Appl. No. 13/118,122

utilize the SDRAM memory for interim processing storage, and as such only utilizes bandwidth in direct proportion to disk read and write commands.

[0103] Once the data is preloaded, when the computer system bus issues its first read commands to the data storage controller seeking operating system data, the data will already be available in the cache memory of the data storage controller. The data storage controller will then be able to instantly start transmitting the data to the system bus. Before transmission to the bus, if the data was stored in compressed format on the boot device, the data will be decompressed. The process of preloading required (compressed) portions of the operating system significantly reduces the computer boot process time.

[0117] It is to be understood that any conventional compression/decompression system and method (which comply with the above mentioned constraints) may be employed in the data storage controller for providing accelerated data storage and retrieval in accordance with the present invention. Preferably, the present invention employs the data compression/decompression techniques disclosed in the above-incorporated U.S. Patent No. 6,195,024 Serial No. 09/210,491.

[0118] Referring to FIG. 9, a detailed block diagram illustrates an exemplary data compression system 110 that may be employed herein. Details of this data compression system are provided in U.S. Patent No. 6,195,024 Serial No. 09/210,491. In this embodiment, the data compression system 110 accepts data blocks from an input data stream and stores the input data block in an input buffer or cache 115. It is to be understood that the system processes the input data stream in data blocks that may range in size from individual bits through complete files or collections of multiple files. Additionally, the input data block size may be fixed or variable. A counter 120 counts or otherwise enumerates the size of input data block in any convenient units including bits, bytes, words, and

1570636\_1

Atty. Dkt. No. 2855.004000B

- 6 -

FALLON *et al*  
Appl. No. 13/118,122

double words. It should be noted that the input buffer 115 and counter 120 are not required elements of the present invention. The input data buffer 115 may be provided for buffering the input data stream in order to output an uncompressed data stream in the event that, as discussed in further detail below, every encoder fails to achieve a level of compression that exceeds an a priori specified minimum compression ratio threshold.

[0122] Again, it is to be understood that the embodiment of the data compression engine of Fig. 9 is exemplary of a preferred compression system which may be implemented in the present invention, and that other compression systems and methods known to those skilled in the art may be employed for providing accelerated data storage in accordance with the teachings herein. Indeed, in another embodiment of the compression system disclosed in the above-incorporated U.S. Patent No. 6,195,024 Serial No. 09/210,491, a timer is included to measure the time elapsed during the encoding process against an a priori-specified time limit. When the time limit expires, only the data output from those encoders (in the encoder module 125) that have completed the present encoding cycle are compared to determine the encoded data with the highest compression ratio. The time limit ensures that the real-time or pseudo real-time nature of the data encoding is preserved. In addition, the results from each encoder in the encoder module 125 may be buffered to allow additional encoders to be sequentially applied to the output of the previous encoder, yielding a more optimal lossless data compression ratio. Such techniques are discussed in greater detail in the above-incorporated U.S. Patent No. 6,195,024 Serial No. 09/210,491.

[0123] Referring now to FIG. 10, a detailed block diagram illustrates an exemplary decompression system that may be employed herein or accelerated data retrieval as disclosed in the above-incorporated U.S. Patent No. 6,195,024 Serial No.

1570636\_1

Atty. Dkt. No. 2855.004000B

- 7 -

FALLON *et al*  
Appl. No. 13/118,122

~~09/210,491~~. In this embodiment, the data compression engine 180 retrieves or otherwise accepts compressed data blocks from one or more data storage devices and inputs the data via a data storage interface. It is to be understood that the system processes the input data stream in data blocks that may range in size from individual bits through complete files or collections of multiple files. Additionally, the input data block size may be fixed or variable.

[0126] As with the data compression systems discussed in U.S. Patent No. 6,195,024 ~~Application Serial No. 09/210,491~~, the decoder module 165 may include multiple decoders of the same type applied in parallel so as to reduce the data decoding time. An output data buffer or cache 170 may be included for buffering the decoded data block output from the decoder module 165. The output buffer 170 then provides data to the output data stream. It is to be appreciated by those skilled in the art that the data compression system 180 may also include an input data counter and output data counter operatively coupled to the input and output, respectively, of the decoder module 165. In this manner, the compressed and corresponding decompressed data block may be counted to ensure that sufficient decompression is obtained for the input data block.

1570636\_1

Atty. Dkt. No. 2855.004000B

NOV 16 2012

- 8 -

FALLON *et al*  
Appl. No. 13/118,122*Listing of Claims*

This listing of claims will replace all prior versions, and listings, of claims in the application.

1. (*Currently Amended*) A method for providing accelerated loading of an operating system, comprising the steps of:
  - maintaining a list of boot data used for booting a computer system, wherein at least a portion of boot data is associated with the list of boot data;
  - preloading the at least a portion of boot data into a memory upon initialization of the computer system;
  - ~~servicing requests for boot data from the computer system using the preloaded boot data~~
  - accessing the at least a portion of boot data in a compressed form from the memory;
  - decompressing on a just-in-time basis the at least a portion of boot data in compressed form accessed from the memory at a rate that increases the effective access rate of the memory; and
  - utilizing the decompressed at least a portion of boot data in loading the operating system for the computer system.
  
2. (*New*) The method of claim 1, further comprising:
  - associating additional boot data with the boot data list;

1570636\_1

Atty. Dkt. No. 2855.004000B

- 9 -

FALLON *et al*  
Appl. No. 13/118,122

compressing the boot data preloaded into the memory with a data compression engine; and

compressing the additional boot data with a random access encoder coupled to the data compression engine.

3. (New) The method of claim 1, further comprising:  
updating the boot data list.
  
4. (New) The method of claim 1, further comprising:  
associating additional boot data with the boot data list; and  
compressing at least a portion of the additional boot data with a data compression encoder.
  
5. (New) The method of claim 4, further comprising:  
using at least a portion of the compressed additional boot data to boot the computer system.
  
6. (New) A method, comprising:  
maintaining a list of compressed boot data used for booting a computer system;  
storing the compressed boot data on a boot device;  
initializing a central processing unit of the computer system;  
loading the compressed boot data from the boot device to a memory;

1570636\_1

Atty. Dkt. No. 2855.004000B

- 10 -

FALLON *et al*  
Appl. No. 13/118,122

accessing the compressed boot data from the memory; and  
utilizing the boot data to boot the computer system, wherein at least a portion of the  
boot data is accessed in compressed form.

7. (New) A system comprising:  
a processor;  
a memory; and  
a non-volatile memory device;  
boot data for booting the system stored in compressed form in the non-volatile  
memory;  
logic code associated with the processor stored in the non-volatile memory and  
comprising instructions executable by the processor for maintaining a list of boot  
data used for booting the system; and  
at least a portion of the compressed boot data being preloaded into the memory, and  
being accessed and utilized to boot the system.

8. (New) The system of claim 7, further comprising:  
a data compression engine coupled to the non-volatile memory to compress the boot  
data; and  
a random access encoder coupled to the data compression engine to compress  
additional boot data.

1570636\_1

Atty. Dkt. No. 2855.004000B

- 11 -

FALLON *et al*  
Appl. No. 13/118,122

9. (*New*) A method of preloading an operating system for booting a computer system comprising:  
storing substantially all of the operating system in compressed form on a boot device;  
loading a first portion of the compressed operating system from the boot device to a memory;  
accessing the first portion from the memory in compressed form;  
utilizing the first portion to partially boot the computer system;  
responsive to a request, locating a second portion of the compressed operating system using a boot data list and preloading the second portion from the boot device to the memory;  
accessing the second portion from the memory in compressed form; and  
utilizing the second portion to further partially boot the computer system.
10. (*New*) The method of claim 9, further comprising:  
compressing additional boot data; and  
storing the additional compressed boot data in the boot device.
11. (*New*) The method of claim 10, further comprising:  
compressing the additional boot data with a random access encoder.
12. (*New*) A method for providing accelerated loading of an operating system in a computer system, comprising:

1570636\_1

Atty. Dkt. No. 2855.004000B



- 12 -

FALLON *et al*  
Appl. No. 13/118,122

maintaining a boot data list;  
loading boot data associated with the boot data list in compressed form into a  
memory upon initialization of the computer system;  
accessing the compressed boot data from the memory;  
decompressing as needed the compressed boot data accessed from the memory at a  
rate that increases the effective access rate of the memory; and  
utilizing the decompressed boot data in loading the operating system for the  
computer system.

13. (*New*) The method of claim 12, further comprising: compressing additional boot  
data with a random access encoder.

14. (*New*) A method for providing accelerated loading of an operating system in a  
computer system, comprising:  
maintaining a boot data list;  
loading boot data associated with the boot data list into a memory in compressed  
form upon initialization of the computer system;  
accessing the compressed boot data from the memory;  
decompressing on a just-in-time basis the compressed boot data accessed from the  
memory at a rate that increases the effective access rate of the memory; and  
utilizing the decompressed boot data in loading the operating system for the  
computer system.

1570636\_1

Atty. Dkt. No. 2855.004000B

- 13 -

FALLON *et al*  
Appl. No. 13/118,122*Remarks*

Reconsideration of this Application is respectfully requested.

Claims 1-14 are pending in the application, with claims 1, 6, 7, 9, 12 and 14 being the independent claims. Claim 1 has been amended to more clearly define features of this invention. Claims 2-14 have been added to define further features of this invention. Applicants reserve the right to prosecute similar or broader claims, with respect to the amended claims in the future.

With respect to this Application, Applicant hereby rescinds any and all disclaimers of claim scope made in any related application(s). The Examiner is advised that any previous disclaimer of claim scope, if any, and any references that allegedly caused any previous disclaimer of claim scope, may need to be revisited. Nor should any previous disclaimer of claim scope, if any, in this Application be read back into any related Application. It is understood that throughout examination, the claims presented in this Application are to be given their broadest reasonable meaning in view of the Specification. Any paraphrasing of claim features in remarks during prosecution is not to be interpreted as reading any features into, or characterizing, any claim.

Based on the foregoing amendments and the following remarks, Applicant respectfully requests that the Examiner reconsider all outstanding rejections and that they be withdrawn.

1570636\_1

Atty. Dkt. No. 2855.004000B

- 14 -

FALLON *et al*  
Appl. No. 13/118,122**Rejections under 35 U.S.C. § 102**

Claim 1 was rejected under 35 U.S.C. §102(b) as allegedly being anticipated by U.S. Patent No. 6,073,232 (Kroeker). This ground of rejection is respectfully traversed.

Independent claim 1 recites, inter alia, the following features:

accessing the boot data *in a compressed form* from the memory;

decompressing on a just-in-time basis the at least a portion of boot data in compressed form accessed from the memory at a rate that increases the effective access rate of the memory;

These features are recited in each of independent claims 6, 7, 9, 12, and 14 in the same or substantially the same form.

Kroeker nowhere teaches or suggests accessing at least a portion boot data in a *compressed form from memory*. Similar arguments can be made with respect to each of independent claims 6, 7, 9, 12, and 14. Therefore Kroeker cannot anticipate independent claims 1, 6, 7, 9, 12, and 14.

Claims 2-5, 8, 10, 11, and 13 depend directly or indirectly from one or the other of independent claims 1, 6, 7, 9, 12, and 14. The dependent claims incorporate by reference all of the features of their respective parent claims. Independent claims 1, 6, 7, 9, 12, and 14 are patentable over Kroeker for at least the reasons presented above. Dependent claims 2-5, 8, 10, 11, and 13 are therefore patentable over Kroeker for at least the same reasons, in addition to their own respective features.

1570636\_1

Atty. Dkt. No. 2855:004000B

NOV 16 2012

- 15 -

FALLON *et al*  
Appl. No. 13/118,122**Conclusion**

All of the stated grounds of rejection have been properly traversed, accommodated, or rendered moot. Applicants therefore respectfully request that the Examiner reconsider all presently outstanding rejections and that they be withdrawn. Applicants believe that a full and complete reply has been made to the outstanding Office Action and, as such, the present application is in condition for allowance. If the Examiner believes, for any reason, that personal communication will expedite prosecution of this application, the Examiner is invited to telephone the undersigned at the number provided.

Prompt and favorable consideration of this Amendment and Reply is respectfully requested.

Respectfully submitted,

STERNE, BESSLER, GOLDSTEIN &amp; FOX P.L.L.C.

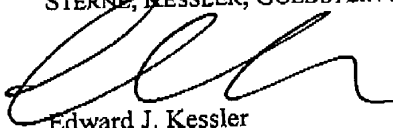
  
Edward J. Kessler  
Attorney for Applicants  
Registration No. 25,688Date: November 16, 20121100 New York Avenue, N.W.  
Washington, D.C. 20005-3934  
(202) 371-2600

1570636\_1

Atty. Dkt. No. 2855.004000B

Best Available Copy

NOV-16-2012 14:10

SKGK

RECEIVED  
CENTRAL FAX CENTER P.01  
NOV 16 2012

EDWARD J. KESSLER  
SENIOR COUNSEL  
(202) 772-8550  
EKESSE1.FR@SKGF.COM

**Fax**     Urgent     Return reply requested     Original will be sent as confirmation.

To: USPTO

Date: November 16, 2012

Attention: Examiner Suresh SURYAWANSHI

Re: Appl. No. 13/118,122; Filed 05/27/11  
For: **Systems and Methods for Accelerated  
Loading of Operating Systems and  
Application Programs**  
Inventors: FALLON *et al.*

From: Edward J. Kessler, Reg. No. 25,688

Pages (including cover sheet): 20

Fax No: 571-273-8300

Our Reference: 2855.004000B

---

## Message

Please see the attached Petition for Extension of Time, Amendment Under 37 C.F.R. § 1.111 and Credit Card Payment Form in connection with U.S. Patent Application No. 13/118,122.

### Certification of Facsimile Transmission

I hereby certify that this paper is being facsimile transmitted to the Patent and Trademark Office on the date shown below.

Elizabeth Kessler  
Name  
Date: 11-16-2012

---

1610487-1

If any portion of this transmission is not received clearly or in full, contact us at the numbers below.

---

This message is intended for the exclusive use of the individual or entity to which it is addressed. The message may contain information that is privileged, confidential, or otherwise exempt from disclosure under applicable law. If the reader of this message is not the intended recipient, you are hereby notified that any dissemination, distribution, copying or use of this communication in any way is strictly prohibited. If you have received this communication in error, please call us collect immediately, and return the original message to us at the above address via the U.S. Postal Service.

---

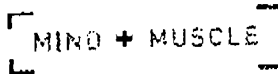

Best Available Copy

NOV-16-2012 14:10

SKGK

RECEIVED  
CENTRAL FAX CENTER

NOV 16 2012

P.02

EDWARD J. KESSLER  
SENIOR COUNSEL  
(202) 772-8550  
EKESSLER@SKGF.COM

 **Sterne Kessler  
Goldstein Fox**  
ATTORNEYS AT LAW

November 16, 2012

Commissioner for Patents  
PO Box 1450  
Alexandria, VA 22313-1450

Confirmation No. 8978  
Art Unit 2115  
Attn: Mail Stop Amendment

Re: U.S. Utility Patent Application  
Appl. No. 13/118,122; Filing Date: May 27, 2011  
For: **Systems and Methods for Accelerated Loading of Operating Systems  
and Application Programs**  
Inventors: **FATLON et al.**  
Our Ref: 2855.004000B

Commissioner:

Transmitted herewith for appropriate action are the following documents:

1. Credit Card Payment in the amount of \$2,040.00 to cover:  
    \$1,290.00 Petition for Extension of Time fee;  
    \$ 750.00 Independent Claims in Excess of Three (3) fee;
2. Petition for Extension of Time Under 37 C.F.R. § 1.136(a);
3. Amendment Under 37 C.F.R. 1.111 and;
4. Credit Card Payment Form (PTO-2038)

The above-listed documents are filed via facsimile.

In the event that extensions of time are necessary to prevent abandonment of this patent application, then such extensions of time are hereby petitioned.

Best Available Copy

NOV-16-2012 14:10

SKGK

P. 03

Commissioner for Patents  
November 16, 2012  
Page 2

Fee payment is provided through credit card payment. The U.S. Patent and Trademark Office is hereby authorized to charge any fee deficiency, or credit any overpayment, to our Deposit Account No. 19-0036.

Respectfully submitted,

STERNE, KESSLER, GOLDSTEIN & FOX P.L.L.C.

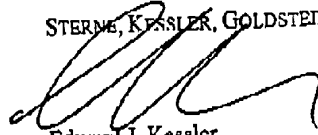

Edward J. Kessler  
Attorney for Applicants  
Registration No. 25.688

EJK/bks  
Enclosure(s)

**PETITION FOR EXTENSION OF TIME UNDER 37 CFR 1.136(a)** Docket Number (Optional) **2855.004000B**

Application Number **13/118,122** Filed **May 27, 2011**

For **Systems and Methods for Accelerated Loading of Operating Systems and Application Programs**

Art Unit **2115** Examiner **SURYAWANSHI, Suresh**

This is a request under the provisions of 37 CFR 1.136(a) to extend the period for filing a reply in the above-identified application.  
The requested extension and fee are as follows (check time period desired and enter the appropriate fee below):

	Fee	Small Entity Fee	
<input type="checkbox"/> One month (37 CFR 1.17(a)(1))	\$150	\$75	\$ _____
<input type="checkbox"/> Two months (37 CFR 1.17(a)(2))	\$570	\$285	\$ _____
<input checked="" type="checkbox"/> Three months (37 CFR 1.17(a)(3))	\$1,290	\$645	\$ <u>1,290.00</u>
<input type="checkbox"/> Four months (37 CFR 1.17(a)(4))	\$2,010	\$1,005	\$ _____
<input type="checkbox"/> Five months (37 CFR 1.17(a)(5))	\$2,730	\$1,365	\$ _____

Applicant claims small entity status. See 37 CFR 1.27. **11/19/2012 APEREZAM 00000010 13118122**

A check in the amount of the fee is enclosed. **01 FC:1253 1298.00 00**

Payment by credit card. Form PTO-2038 is attached.

The Director has already been authorized to charge fees in this application to a Deposit Account.

The Director is hereby authorized to charge any fees which may be required, or credit any overpayment, to Deposit Account Number 19-0036

Payment made via EFS-Web.

**WARNING: Information on this form may become public. Credit card information should not be included on this form. Provide credit card information and authorization on PTO-2038.**

I am the

applicant/inventor.

assignee of record of the entire interest. See 37 CFR 3.71, 37 CFR 3.73(b) statement is enclosed (Form PTO/SB/96).

attorney or agent of record. Registration number 25,688

attorney or agent acting under 37 CFR 1.34. Registration number \_\_\_\_\_

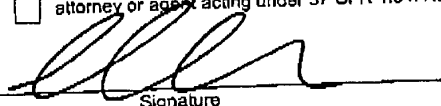
  
Signature

**Edward J. Kessler**  
Typed or printed name

16 Nov. 2012  
Date

**(202) 371-2600**  
Telephone Number

**NOTE:** This form must be signed in accordance with 37 CFR 1.33. See 37 CFR 1.4 for signature requirements and certifications. Submit multiple forms if more than one signature is required. see below\*.

\* Total of 1 forms are submitted.

This collection of information is required by 37 CFR 1.136(a). The information is required to obtain or retain a benefit by the public, which is to file (and by the USPTO to process) an application. Confidentiality is governed by 35 U.S.C. 122 and 37 CFR 1.11 and 1.14. This collection is estimated to take 6 minutes to complete, including gathering, preparing, and submitting the completed application form to the USPTO. Time will vary depending upon the individual case. Any comments on the amount of time you require to complete this form and/or suggestions for reducing this burden should be sent to the Chief Information Officer, U.S. Patent and Trademark Office, U.S. Department of Commerce, P.O. Box 1450, Alexandria, VA 22313-1450. DO NOT SEND FEES OR COMPLETED FORMS TO THIS ADDRESS. SEND TO: Mail Stop PCT, Commissioner for Patents, P.O. Box 1450, Alexandria, VA 22313-1450.



Under the Paperwork Reduction Act of 1995, no persons are required to respond to a collection of information unless it displays a valid OMB control number.

<b>PATENT APPLICATION FEE DETERMINATION RECORD</b> Substitute for Form PTO-875					Application or Docket Number <b>13/118,122</b>		Filing Date <b>05/27/2011</b>		<input type="checkbox"/> To be Mailed									
<b>APPLICATION AS FILED – PART I</b>																		
(Column 1)			(Column 2)			SMALL ENTITY <input type="checkbox"/>		OR			OTHER THAN SMALL ENTITY							
FOR		NUMBER FILED	NUMBER EXTRA		RATE (\$)	FEE (\$)	OR		RATE (\$)	FEE (\$)								
<input type="checkbox"/> BASIC FEE <small>(37 CFR 1.16(a), (b), or (c))</small>		N/A	N/A		N/A		OR		N/A									
<input type="checkbox"/> SEARCH FEE <small>(37 CFR 1.16(k), (i), or (m))</small>		N/A	N/A		N/A		OR		N/A									
<input type="checkbox"/> EXAMINATION FEE <small>(37 CFR 1.16(o), (p), or (q))</small>		N/A	N/A		N/A		OR		N/A									
TOTAL CLAIMS <small>(37 CFR 1.16(j))</small>		minus 20 =	*		X \$ =		OR		X \$ =									
INDEPENDENT CLAIMS <small>(37 CFR 1.16(h))</small>		minus 3 =	*		X \$ =		OR		X \$ =									
<input type="checkbox"/> APPLICATION SIZE FEE <small>(37 CFR 1.16(s))</small>		If the specification and drawings exceed 100 sheets of paper, the application size fee due is \$250 (\$125 for small entity) for each additional 50 sheets or fraction thereof. See 35 U.S.C. 41(a)(1)(G) and 37 CFR 1.16(s).																
<input type="checkbox"/> MULTIPLE DEPENDENT CLAIM PRESENT <small>(37 CFR 1.16(j))</small>																		
* If the difference in column 1 is less than zero, enter "0" in column 2.																		
<b>APPLICATION AS AMENDED – PART II</b>										SMALL ENTITY		OR		OTHER THAN SMALL ENTITY				
(Column 1)			(Column 2)			(Column 3)			RATE (\$)		ADDITIONAL FEE (\$)		OR		RATE (\$)		ADDITIONAL FEE (\$)	
AMENDMENT	<b>11/16/2012</b>		CLAIMS REMAINING AFTER AMENDMENT		HIGHEST NUMBER PREVIOUSLY PAID FOR	PRESENT EXTRA	X \$ =		OR		X \$62=		0					
	Total <small>(37 CFR 1.16(i))</small>		* 14	Minus	** 20	= 0	X \$ =		OR		X \$250=		750					
	Independent <small>(37 CFR 1.16(h))</small>		* 6	Minus	***3	= 3			OR									
	<input type="checkbox"/> Application Size Fee <small>(37 CFR 1.16(s))</small>																	
	<input type="checkbox"/> FIRST PRESENTATION OF MULTIPLE DEPENDENT CLAIM <small>(37 CFR 1.16(j))</small>																	
							TOTAL ADD'L FEE		OR		TOTAL ADD'L FEE		<b>750</b>					
AMENDMENT			CLAIMS REMAINING AFTER AMENDMENT		HIGHEST NUMBER PREVIOUSLY PAID FOR	PRESENT EXTRA	X \$ =		OR		X \$ =							
	Total <small>(37 CFR 1.16(i))</small>		*	Minus	**	=	X \$ =		OR		X \$ =							
	Independent <small>(37 CFR 1.16(h))</small>		*	Minus	***	=			OR									
	<input type="checkbox"/> Application Size Fee <small>(37 CFR 1.16(s))</small>																	
	<input type="checkbox"/> FIRST PRESENTATION OF MULTIPLE DEPENDENT CLAIM <small>(37 CFR 1.16(j))</small>																	
							TOTAL ADD'L FEE		OR		TOTAL ADD'L FEE							
* If the entry in column 1 is less than the entry in column 2, write "0" in column 3.																		
** If the "Highest Number Previously Paid For" IN THIS SPACE is less than 20, enter "20".																		
*** If the "Highest Number Previously Paid For" IN THIS SPACE is less than 3, enter "3".																		
The "Highest Number Previously Paid For" (Total or Independent) is the highest number found in the appropriate box in column 1.																		
										Legal Instrument Examiner: /LAJUAN HICKSON/								

This collection of information is required by 37 CFR 1.16. The information is required to obtain or retain a benefit by the public which is to file (and by the USPTO to process) an application. Confidentiality is governed by 35 U.S.C. 122 and 37 CFR 1.14. This collection is estimated to take 12 minutes to complete, including gathering, preparing, and submitting the completed application form to the USPTO. Time will vary depending upon the individual case. Any comments on the amount of time you require to complete this form and/or suggestions for reducing this burden, should be sent to the Chief Information Officer, U.S. Patent and Trademark Office, U.S. Department of Commerce, P.O. Box 1450, Alexandria, VA 22313-1450. DO NOT SEND FEES OR COMPLETED FORMS TO THIS ADDRESS. **SEND TO: Commissioner for Patents, P.O. Box 1450, Alexandria, VA 22313-1450.**

If you need assistance in completing the form, call 1-800-PTO-9199 and select option 2.

Substitute for form 1449/PTO				<b>Complete if Known</b>	
<b>SECOND SUPPLEMENTAL INFORMATION DISCLOSURE STATEMENT BY APPLICANT</b> <i>(Use as many sheets as necessary)</i>				Application Number	13/118,122
				Filing Date	May 27, 2011
				First Named Inventor	James J. FALLON
				Art Unit	2115
				Examiner Name	SURYAWANSHI, Suresh
Sheet	1	of	1	Attorney Docket Number	2855.004000B

U.S. PATENT DOCUMENTS						
Examiner initials*	Cite No. <sup>1</sup>	Document Number		Publication Date MM-DD-YYYY	Name of Patentee or Applicant of Cited Document	Pages, Columns, Lines, Where Relevant Passages or Relevant Figures Appear
		Number-Kind Code <sup>2</sup> (if known)				
	US1	5,331,425		07-19-1994	Ozaki et al.	
	US2	5,987,432		11-16-1999	Zusman et al.	
	US3	6,038,346		03-14-2000	Ratnakar	
	US4	6,097,845		08-01-2000	Ng et al.	
	US5	6,195,125		02-27-2001	Udagawa et al.	
	US6	6,195,391		02-27-2001	Hancock et al.	
	US7	6,198,850		03-06-2001	Banton	
	US8	8,054,879		11-08-2011	Fallon et al.	
	US9	8,073,047		12-06-2011	Fallon et al.	
	US10	8,090,936		01-03-2012	Fallon et al.	
	US11	8,112,619		02-07-2012	Fallon et al.	
	US12	2011/0235697 A1		09-29-2011	Fallon et al.	
	US13	2011/0285559 A1		11-24-2011	Fallon	

FOREIGN PATENT DOCUMENTS							
Examiner initials*	Cite No. <sup>1</sup>	Foreign Patent Document		Publication Date MM-DD-YYYY	Name of Patentee or Applicant of Cited Document	Pages, Columns, Lines, Where Relevant Passages or Relevant Figures Appear	T <sup>6</sup>
		Country Code <sup>3</sup> -Number <sup>4</sup> -Kind Code <sup>5</sup> (if known)					
	FP1	JP	04-241681	08-28-1992	Fujitsu Limited		T

1543148\_1.DOCX

Examiner Signature		Date Considered	
--------------------	--	-----------------	--

\*EXAMINER: Initial if reference considered, whether or not citation is in conformance with MPEP 609. Draw line through citation if not in conformance and not considered. Include copy of this form with next communication to applicant. <sup>1</sup> Applicant's unique citation designation number (optional). <sup>2</sup> See Kinds Codes of USPTO Patent Documents at www.uspto.gov or MPEP 901.04. <sup>3</sup> Enter Office that issued the document, by the two-letter code (WIPO Standard ST.3). <sup>4</sup> For Japanese patent documents, the indication of the year of the reign of the Emperor must precede the serial number of the patent document. <sup>5</sup> Kind of document by the appropriate symbols as indicated on the document under WIPO Standard ST.16 if possible. <sup>6</sup> Applicant is to place a check mark here if English language Translation is attached.

Substitute for form 1449/PTO		<b>Complete if Known</b>	
<b>SECOND SUPPLEMENTAL INFORMATION DISCLOSURE STATEMENT BY APPLICANT</b> <i>(Use as many sheets as necessary)</i>		Application Number	13/118,122
		Filing Date	May 27, 2011
		First Named Inventor	James J. FALLON
		Art Unit	2115
		Examiner Name	SURYAWANSHI, Suresh
		Attorney Docket Number	2855.004000B
Sheet	1	of	8

NON PATENT LITERATURE DOCUMENTS			
Examiner Initials*	Cite No. <sup>1</sup>	Include name of the author (in CAPITAL LETTERS), title of the article (when appropriate), title of the item (book, magazine, journal, serial, symposium, catalog, etc.), date, page(s), volume-issue number(s), publisher, city and/or country where published	T <sup>2</sup>
	NPL1	"Hard Disk Data Control Method", IBM Technical Disclosure Bulletin NN9302301, Vol. 36, No. 2, February 1993, pages 301-302.	
	NPL2	Copy of Notice of Allowance for U.S. Appl. No. 12/123,081, mailed September 26, 2011, 9 pages.	
	NPL3	Copy of Notice of Allowance for U.S. Appl. No. 11/551,204, mailed September 28, 2011, 5 pages.	
	NPL4	Copy of Notice of Allowance for U.S. Appl. No. 11/551,211, mailed October 18, 2011, 5 pages.	
	NPL5	Copy of Non-Final Office Action for U.S. Appl. No. 13/154,239, mailed November 2, 2011, 6 pages.	
	NPL6	Copy of Notice of Allowance for U.S. Appl. No. 12/703,042, mailed November 15, 2011, 8 pages.	
	NPL7	Copy of Non-Final Office Action for U.S. Appl. No. 12/688,413, mailed November 28, 2011, 14 pages.	
	NPL8	Copy of Notice of Allowance for U.S. Appl. No. 12/857,238, mailed December 30, 2011, 5 pages.	
	NPL9	Copy of Notice of Allowance for U.S. Appl. No. 11/400,008, mailed February 6, 2012, 8 pages.	
	NPL10	Copy of Non-Final Office Action for U.S. Appl. No. 12/690,125, mailed March 8, 2012, 7 pages.	

Examiner Signature	Date Considered
-----------------------	--------------------

\*EXAMINER: Initial if reference considered, whether or not citation is in conformance with MPEP 609. Draw line through citation if not in conformance and not considered. Include copy of this form with next communication to applicant.

<sup>1</sup> Applicant's unique citation designation number (optional). <sup>2</sup> Applicant is to place a check mark here if English language Translation is attached.

Substitute for form 1449/PTO				<b>Complete if Known</b>	
<b>SECOND SUPPLEMENTAL INFORMATION DISCLOSURE STATEMENT BY APPLICANT</b> <i>(Use as many sheets as necessary)</i>				Application Number	13/118,122
				Filing Date	May 27, 2011
				First Named Inventor	James J. FALLON
				Art Unit	2115
				Examiner Name	SURYAWANSHI, Suresh
Sheet	2	of	8	Attorney Docket Number	2855.004000B

NON PATENT LITERATURE DOCUMENTS			
Examiner Initials*	Cite No. <sup>1</sup>	Include name of the author (in CAPITAL LETTERS), title of the article (when appropriate), title of the item (book, magazine, journal, serial, symposium, catalog, etc.), date, page(s), volume number, publisher, city and/or country where published	T <sup>2</sup>
	NPL11	Copy of Notice of Allowance for U.S. Patent Appl. No. 12/703,042, mailed March 30, 2012, 8 pages.	
	NPL12	Copy of Non-Final Office Action for U.S. Appl. No. 09/969,987, mailed April 11, 2012, 6 pages.	
	NPL13	Copy of Notice of Allowance for U.S. Appl. No. 11/553,419, mailed April 23, 2012, 6 pages.	
	NPL14	Copy of Notice of Allowance for U.S. Appl. No. 11/553,427, mailed May 7, 2012, 7 pages.	
	NPL15	Copy of Non-Final Office Action for U.S. Appl. No. 13/101,994, mailed May 23, 2012, 12 pages.	
	NPL16	Copy of Notice of Allowance for U.S. Appl. No. 12/857,238, mailed May 29, 2012, 5 pages.	
	NPL17	Non-Final Action Closing Prosecution in Inter Partes Reexamination of U.S. Patent No. 7,714,747, Control No. 95/001,517, mailed September 21, 2011, 29 pages.	
	NPL18	Definition of "data packet", Academic Press Dictionary of Science and Technology, Copyright 1992, 1996, cited by Examiner in Inter Partes Reexamination of U.S. Patent No. 7,714,747, Control No. 95/001,517, mailed September 21, 2011, 2 pages.	
	NPL19	Patent Owner's Reply to Office Action in Inter Partes Reexamination of U.S. Patent No. 7,777,651, Control No. 95/001,581, mailed September 26, 2011, 44 pages.	
	NPL20	Examiner's Answer to Appeal Brief in Inter Partes Reexamination of U.S. Patent No. 6,624,761, Control No. 95/000,464, mailed September 28, 2011, 20 pages.	

Examiner Signature	Date Considered
--------------------	-----------------

\*EXAMINER: Initial if reference considered, whether or not citation is in conformance with MPEP 609. Draw line through citation if not in conformance and not considered. Include copy of this form with next communication to applicant.

<sup>1</sup> Applicant's unique citation designation number (optional). <sup>2</sup> Applicant is to place a check mark here if English language Translation is attached.

Substitute for form 1449/PTO				<b>Complete if Known</b>	
<b>SECOND SUPPLEMENTAL INFORMATION DISCLOSURE STATEMENT BY APPLICANT</b> <i>(Use as many sheets as necessary)</i>				Application Number	13/118,122
				Filing Date	May 27, 2011
				First Named Inventor	James J. FALLON
				Art Unit	2115
				Examiner Name	SURYAWANSHI, Suresh
Sheet	3	of	8	Attorney Docket Number	2855.004000B

NON PATENT LITERATURE DOCUMENTS			
Examiner Initials*	Cite No. <sup>1</sup>	Include name of the author (in CAPITAL LETTERS), title of the article (when appropriate), title of the item (book, magazine, journal, serial, symposium, catalog, etc.), date, page(s), volume number, publisher, city and/or country where published	T <sup>2</sup>
	NPL21	Examiner's Answer to Appeal Brief in Inter Partes Reexamination of U.S. Patent No. 7,161,506, Control no. 95/000,479, mailed September 28, 2011, 25 pages.	
	NPL22	Examiner's Answer to Appeal Brief in Inter Partes Reexamination of U.S. Patent No. 7,378,992, Control No. 95/000,478, mailed September 29, 2011, 27 pages.	
	NPL23	Decision on Appeal in Ex parte Reexamination of U.S. Patent No. 6,601,104 B1, Control No. 90/009,428, dated March 18, 2011, 14 pages.	
	NPL24	Patent Owner's Rebuttal Brief Under 37 C.F.R § 41.71 Retracting the Arguments Made to Overcome the Claim Rejections and Thereby Eliminating the Issues on Appeal in Inter Partes Reexamination of U.S. Patent No, 6,624,761, Control No. 95/000,464, dated October 28, 2011, 9 pages.	
	NPL25	Patent Owner's Rebuttal Brief Under 37 C.F.R § 41.71 Retracting the Arguments Made to Overcome the Claim Rejections and Thereby Eliminating the Issues on Appeal in Inter Partes Reexamination of U.S. Patent No, 7,378,992, Control No. 95/000,478, dated October 28, 2011, 10 pages.	
	NPL26	Patent Owner's Rebuttal Brief Under 37 C.F.R § 41.71 Retracting the Arguments Made to Overcome the Claim Rejections and Thereby Eliminating the Issues on Appeal in Inter Partes Reexamination of U.S. Patent No, 7,161,506, Control No. 95/000,479, dated October 28, 2011, 9 pages.	
	NPL27	Non-Final Action Closing Prosecution in Inter Partes Reexamination of U.S. Patent No. 7,400,274, Control No. 95/001,544, mailed November 18, 2011, 39 pages.	
	NPL28	Non-Final Action Closing Prosecution in Inter Partes Reexamination of U.S. Patent No. 7,417,568, Control No. 95/001,533, mailed December 9, 2011, 42 pages.	
	NPL29	Patent Owner's Reply to Action Closing Prosecution of November 18, 2011 in Inter Partes Reexamination of U.S. Patent No. 7,400,274, Control No. 95/001,544, mailed December 19, 2011, 9 pages.	
	NPL30	Patent Owner's Reply to Action Closing Prosecution of December 9, 2011 in Inter Partes Reexamination of U.S. Patent No. 7,417,568, Control No. 95/001,533, mailed December 29, 2011, 14 pages.	

Examiner Signature	Date Considered
-----------------------	--------------------

\*EXAMINER: Initial if reference considered, whether or not citation is in conformance with MPEP 609. Draw line through citation if not in conformance and not considered. Include copy of this form with next communication to applicant.

<sup>1</sup> Applicant's unique citation designation number (optional). <sup>2</sup> Applicant is to place a check mark here if English language Translation is attached.

Substitute for form 1449/PTO		<b>Complete if Known</b>	
<b>SECOND SUPPLEMENTAL INFORMATION DISCLOSURE STATEMENT BY APPLICANT</b> <i>(Use as many sheets as necessary)</i>		Application Number	13/118,122
		Filing Date	May 27, 2011
		First Named Inventor	James J. FALLON
		Art Unit	2115
		Examiner Name	SURYAWANSHI, Suresh
Sheet	4	of	8
		Attorney Docket Number	2855.004000B

NON PATENT LITERATURE DOCUMENTS			
Examiner Initials*	Cite No. <sup>1</sup>	Include name of the author (in CAPITAL LETTERS), title of the article (when appropriate), title of the item (book, magazine, journal, serial, symposium, catalog, etc.), date, page(s), volume number, publisher, city and/or country where published	T <sup>2</sup>
	NPL31	Notice of Intent to Issue Ex Parte Reexamination Certificate in Ex Parte Reexamination of U.S. Patent No. 6,601,104, Control No. 90/009,428, mailed January 13, 2012, 5 pages.	
	NPL32	Decision on Appeal in Inter Partes Reexamination of U.S. Patent No. 6,624,761, Control No. 95/000,464, mailed January 18, 2012, 5 pages.	
	NPL33	Decision on Appeal in Inter Partes Reexamination of U.S. Patent No. 7,321,937, Control No. 95/000,466, mailed January 18, 2012, 8 pages.	
	NPL34	Decision on Appeal in Inter Partes Reexamination of U.S. Patent No. 7,378,992, Control No. 95/000,478, mailed January 18, 2012, 5 pages.	
	NPL35	Decision on Appeal in Inter Partes Reexamination of U.S. Patent No. 7,161,506, Control No. 95/000,479, mailed January 18, 2012, 6 pages.	
	NPL36	Non-Final Office Action in Inter Partes Reexamination of U.S. Patent No. 7,777,651, Control No. 95/001,581, mailed January 27, 2012, 152 pages.	
	NPL37	Patent Owner's Respondent Brief on Appeal Under 37 C.F.R. § 41.68 in Inter Partes Reexamination of U.S. Patent No. 7,714,747, Control No. 95/001,517, filed February 17, 2012, 20 pages.	
	NPL38	Patent Owner's Reply to Second Non-Final Office Action of January 27, 2012 in Inter Partes Reexamination of U.S. Patent No. 7,777,651, Control No. 95/001,581, filed February 24, 2012, 30 pages.	
	NPL39	Ex Parte Reexamination Certificate in Ex Parte Reexamination of U.S. Patent No. 6,601,104, Control No. 90/009,428, issued February 28, 2012, 2 pages.	
	NPL40	Examiner's Answer to Appeal Brief in Inter Partes Reexamination of U.S. Patent No. 7,714,747, Control No. 95/001,517, mailed March 1, 2012, 4 pages.	

Examiner Signature	Date Considered
-----------------------	--------------------

\*EXAMINER: Initial if reference considered, whether or not citation is in conformance with MPEP 609. Draw line through citation if not in conformance and not considered. Include copy of this form with next communication to applicant.

<sup>1</sup> Applicant's unique citation designation number (optional). <sup>2</sup> Applicant is to place a check mark here if English language Translation is attached.

Substitute for form 1449/PTO				<b>Complete if Known</b>	
<b>SECOND SUPPLEMENTAL INFORMATION DISCLOSURE STATEMENT BY APPLICANT</b> <i>(Use as many sheets as necessary)</i>				Application Number	13/118,122
				Filing Date	May 27, 2011
				First Named Inventor	James J. FALLON
				Art Unit	2115
				Examiner Name	SURYAWANSHI, Suresh
Sheet	5	of	8	Attorney Docket Number	2855.004000B

NON PATENT LITERATURE DOCUMENTS			
Examiner Initials*	Cite No. <sup>1</sup>	Include name of the author (in CAPITAL LETTERS), title of the article (when appropriate), title of the item (book, magazine, journal, serial, symposium, catalog, etc.), date, page(s), volume number, publisher, city and/or country where published	T <sup>2</sup>
	NPL41	Right of Appeal Notice in Inter Partes Reexamination of U.S. Patent No. 7,417,568, Control No. 95/001,533, mailed March 1, 2012, 8 pages.	
	NPL42	Right of Appeal Notice in Inter Partes Reexamination of U.S. Patent No. 7,400,274, Control No. 95/001,544, mailed March 6, 2012, 7 pages.	
	NPL43	Request for Inter Partes Reexamination of U.S. Patent No. 7,321,937, Control No. 95/001,922, filed March 2, 2012, including accompanying Exhibits PA-A to PA-D, PAT-A to PAT-C, CC-A to CC-D, Oth-A, and Form PTO/SB/08a, 2865 pages.	
	NPL44	Request for Inter Partes Reexamination of U.S. Patent No. 6,604,158, Control No. 95/001,923, filed March 2, 2012, including accompanying Exhibits PA-A to PA-D, PAT-A to PAT-B, CC-A to CC-F, Oth-A, and Form PTO/SB/08a, 560 pages.	
	NPL45	Request for Inter Partes Reexamination of U.S. Patent No. 7,352,300, Control No. 95/001,924, filed March 2, 2012, including accompanying Exhibits PA-A to PA-H, PAT-A to PAT-B, CC-A to CC-F, Oth-A, and Form PTO/SB/08a, 1012 pages.	
	NPL46	Request for Inter Partes Reexamination of U.S. Patent No. 7,395,345, Control No. 95/001,925, filed March 2, 2012, including accompanying Exhibits PA-A to PA-C, PAT-A, CC-A to CC-C, Oth-A, and Form PTO/SB/08a, 204 pages.	
	NPL47	Request for Inter Partes Reexamination of U.S. Patent No. 7,161,506, Control No. 95/001,926, filed March 2, 2012, with accompanying Exhibits PA-A to PA-C, PAT-A to PAT-C, CC-A to CC-B, Oth-A to Oth-B, and Form PTO/SB/08a, 2651 pages.	
	NPL48	Request for Inter Partes Reexamination of U.S. Patent No. 7,415,530, Control No. 95/001,927, filed March 2, 2012, including accompanying Exhibits PA-A to PA-F, PAT-A to PAT-B, CC-A to CC-O, Oth-A, and Form PTO/SB/08a, 700 pages.	
	NPL49	Request for Inter Partes Reexamination of U.S. Patent No. 7,378,992, Control No. 95/001,928, filed March 2, 2012, including Exhibits PA-A to PA-D, PAT-A to PAT-C, CC-A to CC-B, Oth-A, and Form PTO/SB/08a, 2316 pages.	
	NPL50	Official Order Granting Request for Inter Partes Reexamination of U.S. Patent No. 7,395,345, Control No. 95/001,925, mailed March 19, 2012, 11 pages.	

Examiner Signature	Date Considered
-----------------------	--------------------

\*EXAMINER: Initial if reference considered, whether or not citation is in conformance with MPEP 609. Draw line through citation if not in conformance and not considered. Include copy of this form with next communication to applicant.

<sup>1</sup> Applicant's unique citation designation number (optional). <sup>2</sup> Applicant is to place a check mark here if English language Translation is attached.

Substitute for form 1449/PTO				<b>Complete if Known</b>	
<b>SECOND SUPPLEMENTAL INFORMATION DISCLOSURE STATEMENT BY APPLICANT</b> <i>(Use as many sheets as necessary)</i>				Application Number	13/118,122
				Filing Date	May 27, 2011
				First Named Inventor	James J. FALLON
				Art Unit	2115
				Examiner Name	SURYAWANSHI, Suresh
Sheet	6	of	8	Attorney Docket Number	2855.004000B

NON PATENT LITERATURE DOCUMENTS			
Examiner Initials*	Cite No. <sup>1</sup>	Include name of the author (in CAPITAL LETTERS), title of the article (when appropriate), title of the item (book, magazine, journal, serial, symposium, catalog, etc.), date, page(s), volume number, publisher, city and/or country where published	T <sup>2</sup>
	NPL51	Non-Final Office Action in Inter Partes Reexamination of U.S. Patent No. 7,395,345, Control No. 95/001,925, mailed March 19, 2012, 20 pages.	
	NPL52	Notice of Intent to Issue Inter Partes Reexamination Certificate in Inter Partes Reexamination of U.S. Patent No. 7,321,937, Control No. 95/000,466, mailed March 21, 2012, 7 pages.	
	NPL53	Right of Appeal Notice for Inter Partes Reexamination of U.S. Patent No. 6,604,158, Control No. 95/000,486, mailed March 26, 2012, 253 pages.	
	NPL54	Notice of Intent to Issue Inter Partes Reexamination Certificate in Inter Partes Reexamination of U.S. Patent No. 6,624,761, Control No. 95/000,464, mailed April 3, 2012, 7 pages.	
	NPL55	Notice of Intent to Issue Inter Partes Reexamination Certificate in Inter Partes Reexamination of U.S. Patent No. 7,161,506, Control No. 95/000,479, mailed April 4, 2012, 15 pages.	
	NPL56	Notice of Intent to Issue Inter Partes Reexamination Certificate in Inter Partes Reexamination of U.S. Patent No. 7,378,992, Control No. 95/000,478, mailed April 6, 2012, 5 pages.	
	NPL57	Official Order Granting Request for Inter Partes Reexamination of U.S. Patent No. 7,321,937, Control no. 95/001,922, mailed April 20, 2012, 17 pages.	
	NPL58	Non-Final Office Action in Inter Partes Reexamination of U.S. Patent No. 7,321,937, Control No. 95/001,922, mailed April 20, 2012, 8 pages.	
	NPL59	Official Order Granting Request for Inter Partes Reexamination of U.S. Patent No. 7,161,506, Control No. 95/001,926, mailed April 25, 2012, 9 pages.	
	NPL60	Non-Final Office Action in Inter Partes Reexamination of U.S. Patent No. 7,161,506, Control No. 95/001,926, mailed April 25, 2012, 7 pages.	

Examiner Signature		Date Considered	
-----------------------	--	--------------------	--

\*EXAMINER: Initial if reference considered, whether or not citation is in conformance with MPEP 609. Draw line through citation if not in conformance and not considered. Include copy of this form with next communication to applicant.

<sup>1</sup> Applicant's unique citation designation number (optional). <sup>2</sup> Applicant is to place a check mark here if English language Translation is attached.



Substitute for form 1449/PTO				<b>Complete if Known</b>	
<b>SECOND SUPPLEMENTAL INFORMATION DISCLOSURE STATEMENT BY APPLICANT</b> <i>(Use as many sheets as necessary)</i>				Application Number	13/118,122
				Filing Date	May 27, 2011
				First Named Inventor	James J. FALLON
				Art Unit	2115
				Examiner Name	SURYAWANSHI, Suresh
Sheet	7	of	8	Attorney Docket Number	2855.004000B

NON PATENT LITERATURE DOCUMENTS			
Examiner Initials*	Cite No. <sup>1</sup>	Include name of the author (in CAPITAL LETTERS), title of the article (when appropriate), title of the item (book, magazine, journal, serial, symposium, catalog, etc.), date, page(s), volume number, publisher, city and/or country where published	T <sup>2</sup>
	NPL61	Official Order Granting Request for Inter Partes Reexamination of U.S. Patent No. 7,378,992, Control No. 95/001,928, mailed April 25, 2012, 8 pages.	
	NPL62	Non-Final Office Action in Inter Partes Reexamination of U.S. Patent No. 7,378,992, Control No. 95/001,928, mailed April 25, 2012, 8 pages.	
	NPL63	Official Order Denying Request for Inter Partes Reexamination of U.S. Patent No. 7,415,530, Control No. 95/001,927, mailed April 27, 2012, 52 pages.	
	NPL64	Official Order Granting Request for Inter Partes Reexamination of U.S. Patent No. 6,604,158, Control No. 95/001,923, mailed May 7, 2012, 14 pages.	
	NPL65	Non-Final Office Action in Inter Partes Reexamination of U.S. Patent No. 6,604,158, Control No. 95/001,923, mailed May 7, 2012, 8 pages.	
	NPL66	Petition Under 37 C.F.R. §§ 1.181 and 1.182 for Correction of Notice of Intent to Issue Reexamination Certificate in Inter Partes Reexamination of U.S. Patent No. 7,378,992, Control No. 95/000,478, filed May 9, 2012, 8 pages.	
	NPL67	Inter Partes Reexamination Certificate in Inter Partes Reexamination of U.S. Patent No. 7,321,937, Control No. 95/000,466, issued May 15, 2012, 2 pages.	
	NPL68	Official Order Granting Request for Inter Partes Reexamination of U.S. Patent No. 7,352,300, Control No. 95/001,924, mailed May 17, 2012, 12 pages.	
	NPL69	Non-Final Office Action in Inter Partes Reexamination of U.S. Patent No. 7,352,300, Control No. 95/001,924, mailed May 17, 2012, 18 pages.	
	NPL70	Patent Owner's Response to Office Action of March 19, 2012, in Inter Partes Reexamination of U.S. Patent No. 7,395,345, Control No. 95/001,925, filed May 21, 2012, 21 pages.	

Examiner Signature	Date Considered
-----------------------	--------------------

\*EXAMINER: Initial if reference considered, whether or not citation is in conformance with MPEP 609. Draw line through citation if not in conformance and not considered. Include copy of this form with next communication to applicant.

<sup>1</sup> Applicant's unique citation designation number (optional). <sup>2</sup> Applicant is to place a check mark here if English language Translation is attached.

Substitute for form 1449/PTO				<b>Complete if Known</b>	
<b>SECOND SUPPLEMENTAL INFORMATION DISCLOSURE STATEMENT BY APPLICANT</b> <i>(Use as many sheets as necessary)</i>				Application Number	13/118,122
				Filing Date	May 27, 2011
				First Named Inventor	James J. FALLON
				Art Unit	2115
				Examiner Name	SURYAWANSHI, Suresh
				Attorney Docket Number	2855.004000B
Sheet	8	of	8		

NON PATENT LITERATURE DOCUMENTS			
Examiner Initials*	Cite No. <sup>1</sup>	Include name of the author (in CAPITAL LETTERS), title of the article (when appropriate), title of the item (book, magazine, journal, serial, symposium, catalog, etc.), date, page(s), volume number, publisher, city and/or country where published	T <sup>2</sup>
	NPL71	Inter Partes Reexamination Certificate in Inter Partes Reexamination of U.S. Patent No. 7,161,506, Control No. 95/000,479, issued May 22, 2012, 2 pages.	
	NPL72	Inter Partes Reexamination Certificate in Inter Partes Reexamination of U.S. Patent No. 6,624,761, Control No. 95/000,464, issued June 12, 2012, 2 pages.	
	NPL73	Court Docket History for 6:10-cv-00493-LED-JDL, Realtime Data, LLC d/b/a IXO, v. MetroPCS Texas, LLC et al., dated June 19, 2012, 38 pages.	
	NPL74	Court Docket History for 1:11-cv-06696-RJH, Realtime Data, LLC d/b/a IXO, v. Morgan Stanley et al., June 19, 2012, 66 pages.	
	NPL75	Court Docket History for 1:11-cv-06697-UA, Realtime Data, LLC d/b/a IXO, v. CME Group Inc. et al., dated June 19, 2012, 74 pages.	
	NPL76	Court Docket History for 1:11-cv-06698-UA, Realtime Data, LLC d/b/a IXO, v. Thomson Reuters et al., dated June 19, 2012, 45 pages.	

1543152\_1.DOCX

Examiner Signature		Date Considered	
--------------------	--	-----------------	--

\*EXAMINER: Initial if reference considered, whether or not citation is in conformance with MPEP 609. Draw line through citation if not in conformance and not considered. Include copy of this form with next communication to applicant.

<sup>1</sup> Applicant's unique citation designation number (optional). <sup>2</sup> Applicant is to place a check mark here if English language Translation is attached.

## Electronic Patent Application Fee Transmittal

<b>Application Number:</b>	13118122			
<b>Filing Date:</b>	27-May-2011			
<b>Title of Invention:</b>	Systems and Methods for Accelerated Loading of Operating Systems and Application Programs			
<b>First Named Inventor/Applicant Name:</b>	James J. Fallon			
<b>Filer:</b>	Edward J. Kessler/Stacy Jen			
<b>Attorney Docket Number:</b>	2855.004000B			
Filed as Large Entity				
<b>Utility under 35 USC 111(a) Filing Fees</b>				
<b>Description</b>	<b>Fee Code</b>	<b>Quantity</b>	<b>Amount</b>	<b>Sub-Total in USD(\$)</b>
<b>Basic Filing:</b>				
<b>Pages:</b>				
<b>Claims:</b>				
<b>Miscellaneous-Filing:</b>				
<b>Petition:</b>				
<b>Patent-Appeals-and-Interference:</b>				
<b>Post-Allowance-and-Post-Issuance:</b>				
<b>Extension-of-Time:</b>				

Description	Fee Code	Quantity	Amount	Sub-Total in USD(\$)
<b>Miscellaneous:</b>				
Submission- Information Disclosure Stmt	1806	1	180	180
<b>Total in USD (\$)</b>				<b>180</b>

## Electronic Acknowledgement Receipt

<b>EFS ID:</b>	13037338
<b>Application Number:</b>	13118122
<b>International Application Number:</b>	
<b>Confirmation Number:</b>	8978
<b>Title of Invention:</b>	Systems and Methods for Accelerated Loading of Operating Systems and Application Programs
<b>First Named Inventor/Applicant Name:</b>	James J. Fallon
<b>Customer Number:</b>	26111
<b>Filer:</b>	Edward J. Kessler/Stacy Jen
<b>Filer Authorized By:</b>	Edward J. Kessler
<b>Attorney Docket Number:</b>	2855.004000B
<b>Receipt Date:</b>	19-JUN-2012
<b>Filing Date:</b>	27-MAY-2011
<b>Time Stamp:</b>	18:01:08
<b>Application Type:</b>	Utility under 35 USC 111(a)

### Payment information:

Submitted with Payment	yes
Payment Type	Credit Card
Payment was successfully received in RAM	\$180
RAM confirmation Number	5401
Deposit Account	
Authorized User	

### File Listing:

Document Number	Document Description	File Name	File Size(Bytes)/ Message Digest	Multi Part /.zip	Pages (if appl.)
-----------------	----------------------	-----------	-------------------------------------	------------------	------------------

1	Non Patent Literature	NPL47_Reexam_Request_9500 1926_03022012_Part1.pdf	25471412 0993fc23d05a13517e5e7bae988ac0aa8f7 b69c	no	490
<b>Warnings:</b>					
<b>Information:</b>					
2	Non Patent Literature	NPL47_Reexam_Request_9500 1926_03022012_Part2.pdf	24203591 86489ea9aa006cde8024b782501191bb6f 7ce70	no	643
<b>Warnings:</b>					
<b>Information:</b>					
3	Non Patent Literature	NPL47_Reexam_Request_9500 1926_03022012_Part3.pdf	23881899 46b3bb79ca86a68a4cd62c8e8c7497b3e5f 06a5	no	545
<b>Warnings:</b>					
<b>Information:</b>					
4	Non Patent Literature	NPL47_Reexam_Request_9500 1926_03022012_Part4.pdf	22143842 2686077ba438c301752af6e4420c635bbd 38a6d	no	534
<b>Warnings:</b>					
<b>Information:</b>					
5	Non Patent Literature	NPL47_Reexam_Request_9500 1926_03022012_Part5.pdf	21376376 871430b46e7c42310ffd8d6f143e1a8bc94a 9a8a	no	439
<b>Warnings:</b>					
<b>Information:</b>					
6	Non Patent Literature	NPL48_Reexam_Request_9500 1927_03022012_Part1.pdf	20670337 ad20960a5cf7b228a11e05b7aee847e0c98 b6bd1	no	361
<b>Warnings:</b>					
<b>Information:</b>					
7	Non Patent Literature	NPL48_Reexam_Request_9500 1927_03022012_Part2.pdf	11955576 353e690b5d6d37e339baa3d2e14d4e89c4 0ad2bd	no	339
<b>Warnings:</b>					
<b>Information:</b>					
8	Non Patent Literature	NPL49_Reexam_Request_9500 1928_03022012_Part1.pdf	24473374 bd91fb4aa6ea4ac628d1e152c13ca1de37e 583d9	no	603
<b>Warnings:</b>					
<b>Information:</b>					
9	Non Patent Literature	NPL49_Reexam_Request_9500 1928_03022012_Part2.pdf	24561358 3f69614066845cfa62410e97b3492e00d13 d9cd4	no	447
<b>Warnings:</b>					
<b>Information:</b>					

10	Non Patent Literature	NPL49_Reexam_Request_9500 1928_03022012_Part3.pdf	22813883 ee93db498103447b25f474da67aa4606a1916d75	no	519
<b>Warnings:</b>					
<b>Information:</b>					
11	Non Patent Literature	NPL49_Reexam_Request_9500 1928_03022012_Part4.pdf	14777374 f578cc2a3e4ea8297ec1389be4b70ce3135436a3	no	352
<b>Warnings:</b>					
<b>Information:</b>					
12	Non Patent Literature	NPL49_Reexam_Request_9500 1928_03022012_Part5.pdf	22209387 3f95fdda212a19a072700b2a68a6ae693df72172	no	395
<b>Warnings:</b>					
<b>Information:</b>					
13	Non Patent Literature	NPL50_Order_Granteeing_Reexam_95001925_03192012.pdf	419900 bbdc7fa092201d2a3414cea3d97da7b220dcee83	no	11
<b>Warnings:</b>					
<b>Information:</b>					
14	Non Patent Literature	NPL51_NFOA_95001925_0319 2012.pdf	991126 50fd15ced17586425da1c83fee486ebf84e3be89	no	20
<b>Warnings:</b>					
<b>Information:</b>					
15	Non Patent Literature	NPL52_NIIRC_95000466_03212 012.pdf	200019 bdd48ebcbfeede1b4b307946b4a1ce7873962420	no	7
<b>Warnings:</b>					
<b>Information:</b>					
16	Non Patent Literature	NPL53_Right_of_Appeal_Notice_95000486_03262012.pdf	9486737 926d4d82c6ee2dccb6ee67118cd82a31cbcd71c62	no	253
<b>Warnings:</b>					
<b>Information:</b>					
17	Non Patent Literature	NPL54_NIIRC_95000464_04032 012.pdf	202880 6e9aeeef933f222d48f66599b4611b136c1a55a	no	7
<b>Warnings:</b>					
<b>Information:</b>					
18	Non Patent Literature	NPL55_NIIRC_95000479_04042 012.pdf	410294 fcceb78ec3205bd726cb30c5b29f2bf87d3e16b5	no	15
<b>Warnings:</b>					
<b>Information:</b>					

19	Non Patent Literature	NPL56_NIIRC_95000478_04062012.pdf	170538 0c19e7dc2fe56275732cf58bb0c04886ee9144b	no	5
<b>Warnings:</b>					
<b>Information:</b>					
20	Non Patent Literature	NPL57_Order_Granteeing_Request_95001922_04202012.pdf	605307 013b3f5e58c5ccdf8da2d603daaabdc9a3e7843a0	no	17
<b>Warnings:</b>					
<b>Information:</b>					
21	Non Patent Literature	NPL58_NFOA_95001922_04202012.pdf	241546 be3e824ebb55ddfdef5de2a077ce726db14aa50e	no	8
<b>Warnings:</b>					
<b>Information:</b>					
22	Non Patent Literature	NPL59_Order_Granteeing_Request_95001926_04252012.pdf	272711 f2f7c9df708a09e06df54805c994ee32a1a66e63	no	9
<b>Warnings:</b>					
<b>Information:</b>					
23	Non Patent Literature	NPL60_NFOA_95001926_04252012.pdf	242897 4ebc018e5164f8ff28c15e66369aa4c63ef42ab7	no	7
<b>Warnings:</b>					
<b>Information:</b>					
24	Non Patent Literature	NPL61_Order_Granteeing_Request_95001928_04252012.pdf	251040 e47d19dd4c8955a63276c4b33e175adffdc2ebb1	no	8
<b>Warnings:</b>					
<b>Information:</b>					
25	Non Patent Literature	NPL62_NFOA_95001928_04252012.pdf	274094 af7848e2b982cfd53dd4b8d9e0bdc18991661b80	no	8
<b>Warnings:</b>					
<b>Information:</b>					
26	Non Patent Literature	NPL63_Order_Denying_Request_95001927_04272012.pdf	2145233 43da6b8816eb51246ee438500dafa091e45bd18	no	52
<b>Warnings:</b>					
<b>Information:</b>					
27	Non Patent Literature	NPL64_Order_Granteeing_Request_95001923_05072012.pdf	523792 30fba479567d159ec4a20cbc536869c1e3843aea	no	14
<b>Warnings:</b>					
<b>Information:</b>					



28	Non Patent Literature	NPL65_NFOA_95001923_0507 2012.pdf	278835 3aa33e02a23cd4be3d1ddb04a79578d0c0 e5336e	no	8
<b>Warnings:</b>					
<b>Information:</b>					
29	Non Patent Literature	NPL66_Petition_Correct_NIIRC _95000478_05092012.pdf	298104 9305621c4db9dd1feae80766fd0fa90e60d 958c	no	8
<b>Warnings:</b>					
<b>Information:</b>					
30	Non Patent Literature	NPL67_Reexam_Certificate_95 000466_05152012.pdf	64522 5609efcf0753f4089edd40321ad158002e5d 86d7	no	2
<b>Warnings:</b>					
<b>Information:</b>					
31	Non Patent Literature	NPL68_Order_Granting_Reque st_95001924_05172012.pdf	394656 08786a3ff01f571f09eb98c263097ac6190d7 6e4	no	12
<b>Warnings:</b>					
<b>Information:</b>					
32	Non Patent Literature	NPL69_NFOA_95001924_0517 2012.pdf	648138 27968db89a0708d83c428571fbb3cb61e47 c9e08	no	18
<b>Warnings:</b>					
<b>Information:</b>					
33	Non Patent Literature	NPL70_Patent_Owner_Respon se_95001925_05212012.pdf	1635571 93c0fc45c70edf17c5c20f02cda5600d1a0ac 8ef	no	21
<b>Warnings:</b>					
<b>Information:</b>					
34	Non Patent Literature	NPL71_Reexam_Certificate_95 000479_05222012.pdf	62650 66ae75c0c24547f55c64b276e4b8fd51fd0 3782	no	2
<b>Warnings:</b>					
<b>Information:</b>					
35	Non Patent Literature	NPL72_Reexam_Certificate_95 000464_06122012.pdf	54746 6fa80861632adff6b413abee44350d0d8ec5 1da1f	no	2
<b>Warnings:</b>					
<b>Information:</b>					
36	Non Patent Literature	NPL73_Court_Docket_MetroPC S_06192012.pdf	368324 c0acead499832085da19158016f02043f2397 3bd3	no	38
<b>Warnings:</b>					
<b>Information:</b>					

37	Non Patent Literature	NPL74_Court_Docket_Morgan_Stanley_111cv06696_06192012.pdf	482219 fd77b943f1d9c4c2ad6e0ec8650e0bd0a0301aa	no	66
<b>Warnings:</b>					
<b>Information:</b>					
38	Non Patent Literature	NPL75_Court_Docket_CME_111cv06697_06192012.pdf	571511 ab80f7914936302dbad259ca7e4e21f580750913	no	74
<b>Warnings:</b>					
<b>Information:</b>					
39	Non Patent Literature	NPL76_Court_Docket_Reuters_111cv06698_06192012.pdf	392213 d38c01fc623bb20a0033a56754d72f8b5e150013	no	45
<b>Warnings:</b>					
<b>Information:</b>					
40		2855004000B_2SIDS.pdf	2884369 e2d13aeb0b2db33dec3768d27a6dba40305dfb8	yes	20
<b>Multipart Description/PDF files in .zip description</b>					
		<b>Document Description</b>	<b>Start</b>	<b>End</b>	
		Miscellaneous Incoming Letter	1	2	
		Transmittal Letter	3	11	
		Information Disclosure Statement (IDS) Form (SB08)	12	20	
<b>Warnings:</b>					
<b>Information:</b>					
41	Fee Worksheet (SB06)	fee-info.pdf	30110 75edf6074bae7acd61ca9020e8cd03d36649e0e	no	2
<b>Warnings:</b>					
<b>Information:</b>					
<b>Total Files Size (in bytes):</b>			283142491		

This Acknowledgement Receipt evidences receipt on the noted date by the USPTO of the indicated documents, characterized by the applicant, and including page counts, where applicable. It serves as evidence of receipt similar to a Post Card, as described in MPEP 503.

**New Applications Under 35 U.S.C. 111**

If a new application is being filed and the application includes the necessary components for a filing date (see 37 CFR 1.53(b)-(d) and MPEP 506), a Filing Receipt (37 CFR 1.54) will be issued in due course and the date shown on this Acknowledgement Receipt will establish the filing date of the application.

**National Stage of an International Application under 35 U.S.C. 371**

If a timely submission to enter the national stage of an international application is compliant with the conditions of 35 U.S.C. 371 and other applicable requirements a Form PCT/DO/EO/903 indicating acceptance of the application as a national stage submission under 35 U.S.C. 371 will be issued in addition to the Filing Receipt, in due course.

**New International Application Filed with the USPTO as a Receiving Office**

If a new international application is being filed and the international application includes the necessary components for an international filing date (see PCT Article 11 and MPEP 1810), a Notification of the International Application Number and of the International Filing Date (Form PCT/RO/105) will be issued in due course, subject to prescriptions concerning national security, and the date shown on this Acknowledgement Receipt will establish the international filing date of the application.



US007321937C1

(12) **INTER PARTES REEXAMINATION CERTIFICATE (0379th)**  
**United States Patent**  
**Fallon** (10) **Number: US 7,321,937 C1**  
(45) **Certificate Issued: \*May 15, 2012**

(54) **SYSTEM AND METHODS FOR ACCELERATED DATA STORAGE AND RETRIEVAL**

(75) Inventor: **James J. Fallon**, Bronxville, NY (US)

(73) Assignee: **Realtime Data LLC**, New York, NY (US)

**Reexamination Request:**  
No. 95/000,466, May 7, 2009

**Reexamination Certificate for:**  
Patent No.: **7,321,937**  
Issued: **Jan. 22, 2008**  
Appl. No.: **11/400,674**  
Filed: **Apr. 8, 2006**

(\*) Notice: This patent is subject to a terminal disclaimer.

**Related U.S. Application Data**

(63) Continuation of application No. 10/628,795, filed on Jul. 28, 2003, now Pat. No. 7,130,913, which is a continuation of application No. 09/266,354, filed on Mar. 11, 1999, now Pat. No. 6,601,104.

(51) **Int. Cl.**  
**G06F 13/00** (2006.01)

(52) **U.S. Cl.** ..... **709/231**

(58) **Field of Classification Search** ..... None  
See application file for complete search history.

(56) **References Cited**

To view the complete listing of prior art documents cited during the proceeding for Reexamination Control Number 95/000,466, please refer to the USPTO's public Patent Application Information Retrieval (PAIR) system under the Display References tab.

*Primary Examiner*—Matthew Heneghan

(57) **ABSTRACT**

Systems and methods for providing accelerated data storage and retrieval utilizing lossless data compression and decompression. A data storage accelerator includes one or a plurality of high speed data compression encoders that are configured to simultaneously or sequentially losslessly compress data at a rate equivalent to or faster than the transmission rate of an input data stream. The compressed data is subsequently stored in a target memory or other storage device whose input data storage bandwidth is lower than the original input data stream bandwidth. Similarly, a data retrieval accelerator includes one or a plurality of high speed data decompression decoders that are configured to simultaneously or sequentially losslessly decompress data at a rate equivalent to or faster than the input data stream from the target memory or storage device. The decompressed data is then output at rate data that is greater than the output rate from the target memory or data storage device. The data storage and retrieval accelerator method and system may employed: in a disk storage adapter to reduce the time required to store and retrieve data from computer to disk; in conjunction with random access memory to reduce the time required to store and retrieve data from random access memory; in a display controller to reduce the time required to send display data to the display controller or processor; and/or in an input/output controller to reduce the time required to store, retrieve, or transmit data.

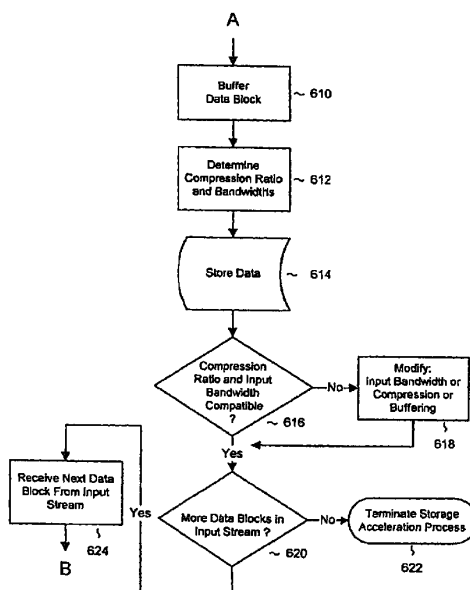

**1**  
**INTER PARTES**  
**REEXAMINATION CERTIFICATE**  
**ISSUED UNDER 35 U.S.C. 316**

THE PATENT IS HEREBY AMENDED AS  
INDICATED BELOW.

**2**  
AS A RESULT OF REEXAMINATION, IT HAS BEEN  
DETERMINED THAT:  
Claims 17-20 are cancelled.  
5 Claims 1-16 were not reexamined.

\* \* \* \* \*



US007161506C1

(12) **INTER PARTES REEXAMINATION CERTIFICATE** (0381st)  
**United States Patent**  
**Fallon** (10) **Number:** **US 7,161,506 C1**  
(45) **Certificate Issued:** **\*May 22, 2012**

(54) **SYSTEM AND METHODS FOR DATA COMPRESSION SUCH AS CONTENT DEPENDENT DATA COMPRESSION**

(58) **Field of Classification Search** ..... 341/51  
See application file for complete search history.

(75) Inventor: **James J. Fallon**, Armonk, NY (US)

(56) **References Cited**

(73) Assignee: **Realtime Data, LLC**, New York, NY (US)

To view the complete listing of prior art documents cited during the proceeding for Reexamination Control Number 95/000,479, please refer to the USPTO's public Patent Application Information Retrieval (PAIR) system under the Display References tab.

*Primary Examiner*—Christina Y Leung

**Reexamination Request:**  
No. 95/000,479, May 28, 2009

(57) **ABSTRACT**

**Reexamination Certificate for:**  
Patent No.: **7,161,506**  
Issued: **Jan. 9, 2007**  
Appl. No.: **10/668,768**  
Filed: **Sep. 22, 2003**

Systems and methods for providing fast and efficient data compression using a combination of content independent data compression and content dependent data compression. In one aspect, a method for compressing data comprises the steps of: analyzing a data block of an input data stream to identify a data type of the data block, the input data stream comprising a plurality of disparate data types; performing content dependent data compression on the data block; if the data type of the data block is identified; performing content independent data compression on the data block, if the data type of the data block is not identified.

(\*) Notice: This patent is subject to a terminal disclaimer.

**Related U.S. Application Data**

(63) Continuation of application No. 10/016,355, filed on Oct. 29, 2001, now Pat. No. 6,624,761, which is a continuation-in-part of application No. 09/705,446, filed on Nov. 3, 2000, now Pat. No. 6,309,424, which is a continuation of application No. 09/210,491, filed on Dec. 11, 1998, now Pat. No. 6,195,024.

**At the time of issuance and publication of this certificate, the patent remains subject to pending reexamination control number 95/001,926 filed Mar. 2, 2012. The claim content of this patent may be subsequently revised if a reexamination certificate issues from the reexamination proceeding.**

(51) **Int. Cl.**  
**H03M 7/34** (2006.01)

(52) **U.S. Cl.** ..... 341/51; 341/79

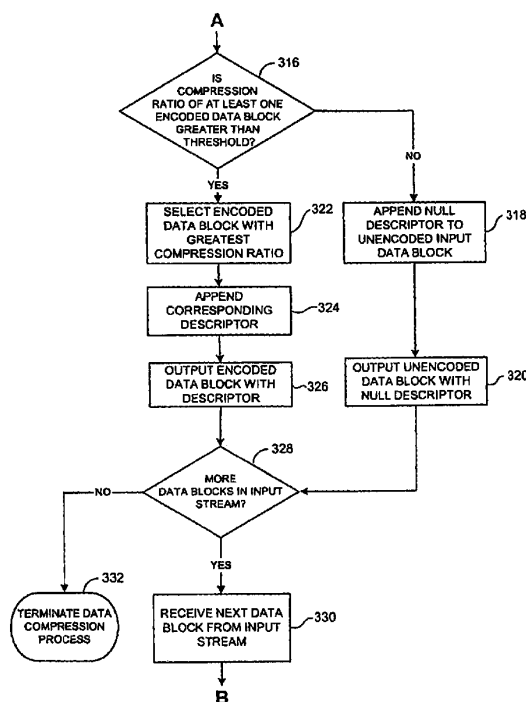

**1**  
**INTER PARTES**  
**REEXAMINATION CERTIFICATE**  
**ISSUED UNDER 35 U.S.C. 316**

THE PATENT IS HEREBY AMENDED AS  
INDICATED BELOW.

AS A RESULT OF REEXAMINATION, IT HAS BEEN  
DETERMINED THAT:

**2**

The patentability of claims 6, 7, 16, 41 and 42 is con-  
firmed.

Claims 1-5, 8, 9, 11, 17, 20-23, 27, 39, 43, 69-73, 79, 81,  
5 82, 84-90, 96 and 98 are cancelled.

Claims 10, 12-15, 18, 19, 24-26, 28-38, 40, 44-68, 74-78,  
80, 83, 91-95, 97 and 99 were not reexamined.

\* \* \* \* \*



US006624761C1

(12) **INTER PARTES REEXAMINATION CERTIFICATE** (0386th)  
**United States Patent**  
**Fallon**

(10) **Number:** **US 6,624,761 C1**

(45) **Certificate Issued:** **\*Jun. 12, 2012**

(54) **CONTENT INDEPENDENT DATA COMPRESSION METHOD AND SYSTEM**

(75) **Inventor:** **James J. Fallon**, Armonk, NY (US)

(73) **Assignee:** **Realtime Data, LLC**, New York, NY (US)

(52) **U.S. Cl.** ..... 341/51; 710/68

(58) **Field of Classification Search** ..... None  
See application file for complete search history.

(56) **References Cited**

To view the complete listing of prior art documents cited during the proceeding for Reexamination Control Number 95/000,464, please refer to the USPTO's public Patent Application Information Retrieval (PAIR) system under the Display References tab.

*Primary Examiner*—Christina Y Leung

**Reexamination Request:**

No. 95/000,464, Jun. 15, 2009

**Reexamination Certificate for:**

**Patent No.:** **6,624,761**  
**Issued:** **Sep. 23, 2003**  
**Appl. No.:** **10/016,355**  
**Filed:** **Oct. 29, 2001**

(\*) **Notice:** This patent is subject to a terminal disclaimer.

(57) **ABSTRACT**

Systems and methods for providing fast and efficient data compression using a combination of content independent data compression and content dependent data compression. In one aspect, a method for compression data comprises the steps of: analyzing a data block of an input data stream to identify a data type of the data block, the input data stream comprising a plurality of disparate data types; performing content dependent data compression on the data block, if the data type of the data block is identified; performing content independent data compression on the data block, if the data type of the data block is not identified.

**Related U.S. Application Data**

(63) Continuation-in-part of application No. 09/705,446, filed on Nov. 13, 2000, now Pat. No. 6,309,424, which is a continuation of application No. 09/210,491, filed on Dec. 11, 1998, now Pat. No. 6,195,024.

(51) **Int. Cl.**  
**G06T 9/00** (2006.01)  
**H03M 7/30** (2006.01)

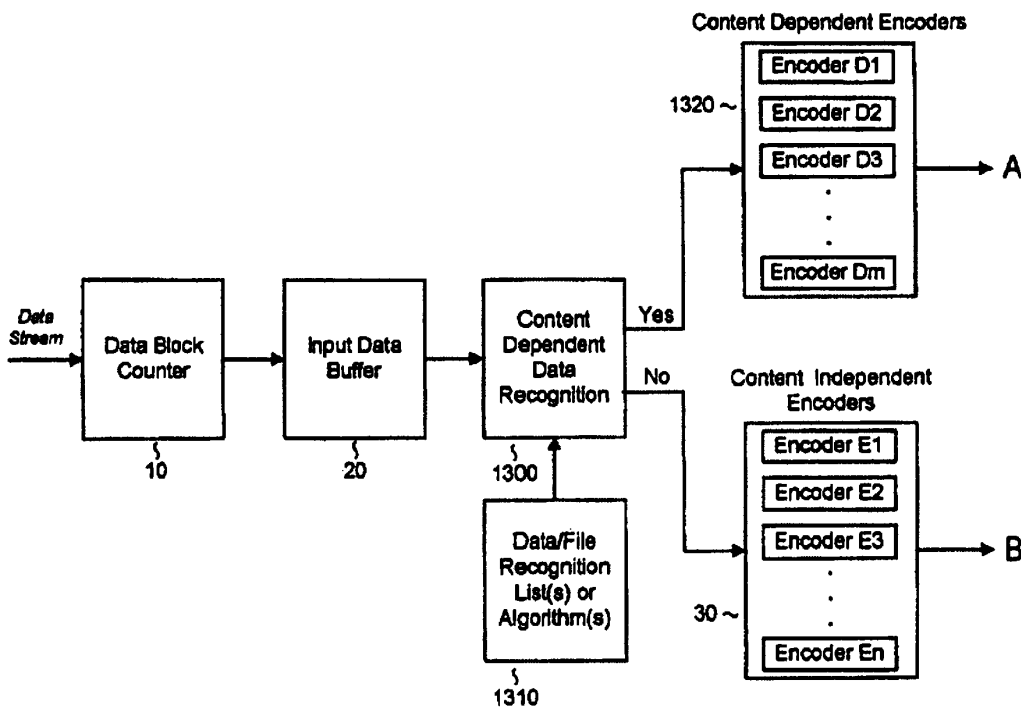



**1**  
**INTER PARTES**  
**REEXAMINATION CERTIFICATE**  
**ISSUED UNDER 35 U.S.C. 316**

THE PATENT IS HEREBY AMENDED AS  
INDICATED BELOW.

**2**  
AS A RESULT OF REEXAMINATION, IT HAS BEEN  
DETERMINED THAT:  
Claims 1-3, 7, 17 and 21 are cancelled.  
5 Claims 4-6, 8-16, 18-20 and 22 were not reexamined.

\* \* \* \* \*

EDWARD J. KESSLER  
OF COUNSEL  
(202) 772-8550  
EKESLER@SKGF.COM



June 19, 2012

Commissioner for Patents  
PO Box 1450  
Alexandria, VA 22313-1450

Confirmation No. 8978  
Art Unit 2115  
*Attn: Mail Stop Amendment*

Re: U.S. Utility Patent Application  
Application No. 13/118,122; Filing Date: May 27, 2011  
For: **Systems and Methods for Accelerated Loading of Operating Systems  
and Application Programs**  
Inventors: FALLON *et al.*  
Our Ref: 2855.004000B

Commissioner:

Transmitted herewith for appropriate action are the following documents:

1. Online Credit Card Payment Authorization in the amount of \$180.00 in payment of the fee under 37 C.F.R. § 1.17(p);
2. Second Supplemental Information Disclosure Statement;
3. Form PTO/SB/08a (1 sheet) listing 14 documents (**US1-US13** and **FP1**);
4. Form PTO/SB/08b (8 sheets) listing 76 documents (**NPL1-NPL76**); and
5. Copies of cited documents (**FP1** and **NPL1-NPL76**).

*The above-listed documents are filed electronically through EFS-Web.*

In the event that extensions of time are necessary to prevent abandonment of this patent application, then such extensions of time are hereby petitioned.

Commissioner for Patents  
June 19, 2012  
Page 2

Fee payment is provided through online credit card payment. The U.S. Patent and Trademark Office is hereby authorized to charge any fee deficiency, or credit any overpayment, to our Deposit Account No. 19-0036.

Respectfully submitted,

STERNE, KESSLER, GOLDSTEIN & FOX P.L.L.C.

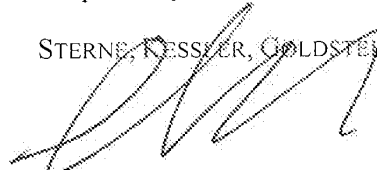

Edward J. Kessler  
Attorney for Applicants  
Registration No. 25,688

EJK/MVM/ssj  
Enclosures

1543351\_1.DOCX

IN THE UNITED STATES PATENT AND TRADEMARK OFFICE

In re application of:

FALLON *et al.*

Appl. No.: 13/118,122

Filed: May 27, 2011

For: **Systems and Methods for  
Accelerated Loading of Operating  
Systems and Application Programs**

Confirmation No.: 8978

Art Unit: 2115

Examiner: SURYAWANSHI, Suresh

Atty. Docket: 2855.004000B

**Second Supplemental Information Disclosure Statement**

*Mail Stop Amendment*

Commissioner for Patents  
PO Box 1450  
Alexandria, VA 22313-1450

Sir:

Notice of Prior and Concurrent Proceedings

Applicants hereby call to the attention of the Patent and Trademark Office the following reexamination proceedings involving patents that are commonly-assigned with the patent in the above-identified patent application:

<b>Proceeding</b>	<b>Status</b>
<i>Inter Partes</i> Reexamination of U.S. Patent No. 6,604,158 (Control No. 95/000,486)	Patent Owner Notice of Appeal filed 04/26/2012; Right of Appeal Notice mailed 03/26/2012
<i>Inter Partes</i> Reexamination of U.S. Patent No. 7,321,937 (Control No. 95/000,466)	<i>Inter Partes</i> Reexamination Certificate issued 05/15/2012
<i>Inter Partes</i> Reexamination of U.S. Patent No. 6,604,158 (Control No. 95/000,453)	Terminated
<i>Ex Parte</i> Reexamination of U.S. Patent No. 6,601,104 (Control No. 90/009,428)	<i>Ex Parte</i> Reexamination Certificate issued 02/28/2012
<i>Inter Partes</i> Reexamination of U.S. Patent No. 7,378,992 (Control No. 95/000,478)	Petition for Correction of Notice of Intent to Issue Reexamination Certificate filed 05/09/2012; Notice of Intent to Issue <i>Inter Partes</i> Reexamination Certificate mailed 04/06/2012
<i>Inter Partes</i> Reexamination of U.S. Patent No. 6,624,761 (Control No. 95/000,464)	<i>Inter Partes</i> Reexamination Certificate issued 06/12/2012

Proceeding	Status
<i>Inter Partes</i> Reexamination of U.S. Patent No. 7,161,506 (Control No. 95/000,479)	Inter Partes Reexamination Certificate issued 05/22/2012
<i>Inter Partes</i> Reexamination of U.S. Patent No. 7,714,747 (Control No. 95/001,517)	Examiner's Answer to Appeal Brief mailed 03/01/2012
<i>Inter Partes</i> Reexamination of U.S. Patent No. 7,417,568 (Control No. 95/001,533)	Right of Appeal Notice mailed 03/01/2012
<i>Inter Partes</i> Reexamination of U.S. Patent No. 7,777,651 (Control No. 95/001,581)	Patent Owner Response to Non-Final Office Action filed 02/24/2012
<i>Inter Partes</i> Reexamination of U.S. Patent No. 7,400,274 (Control No. 95/001,544)	Right of Appeal Notice mailed 03/06/2012

Applicants hereby call to the attention of the Patent and Trademark Office the following reexamination proceedings filed by Cellco Partnership d/b/a Verizon Wireless, involving patents that are commonly-assigned with the patent in the above-identified patent application:

Proceeding	Status
<i>Inter Partes</i> Reexamination of U.S. Patent No. 7,321,937 (Control No. 95/001,922)	Non-Final Office Action mailed 04/20/2012; Official Order Granting Inter Partes Reexam mailed 04/20/2012
<i>Inter Partes</i> Reexamination of U.S. Patent No. 6,604,158 (Control No. 95/001,923)	Non-Final Office Action mailed 05/07/2012; Official Order Granting Inter Partes Reexam mailed 05/07/2012
<i>Inter Partes</i> Reexamination of U.S. Patent No. 7,352,300 (Control No. 95/001,924)	Non-Final Office Action mailed 05/17/2012; Official Order Granting Inter Partes Reexam mailed 05/17/2012
<i>Inter Parte</i> Reexamination of U.S. Patent No. 7,395,345 (Control No. 95/001,925)	Patent Owner Response to Office Action filed 05/21/2012; Non-Final Office Action mailed 03/19/2012; Official Order Granting Inter Partes Reexam mailed 03/19/2012
<i>Inter Partes</i> Reexamination of U.S. Patent No. 7,161,506 (Control No. 95/001,926)	Non-Final Office Action mailed 04/25/2012; Official Order Granting Inter Partes Reexam mailed 4/25/2012
<i>Inter Partes</i> Reexamination of U.S. Patent No. 7,415,530 (Control No. 95/001,927)	Official Order Denying Inter Partes Reexam mailed 04/27/2012

Proceeding	Status
<i>Inter Partes</i> Reexamination of U.S. Patent No. 7,378,992 (Control No. 95/001,928)	Non-Final Office Action mailed 04/25/2012; Official Order Granting <i>Inter Partes</i> Reexam mailed 04/25/2012

Applicants invite the Examiner to review the Requests for Reexamination, issued Office Actions, replies, and any other papers in the above-identified reexamination proceedings. If the Examiner is unable to obtain copies of papers in any reexamination proceeding, copies can be provided to the Examiner upon request. Those documents which may be material that are not already of record in this patent application are listed on the accompanying Form PTO/SB/08. For example, documents related to the reexaminations are listed at NPL17-NPL72.

Notice of Related Litigation

Applicants notify the Patent and Trademark Office of the following litigation involving U.S. Patents commonly-owned with the current patent application, the subject matter of which may be related to the present patent application:

No.	Case	Status
1	<i>Realtime Data LLC d/b/a IXO v. Packeteer, Inc. et al.</i> , No. 6:08-cv-00144-LED (E.D. Texas)	Dismissed

Applicants also notify the Patent and Trademark Office of the following additional litigation involving U.S. Patents commonly-owned with the current patent application, the subject matter of which may be related to the present patent application:

No.	Case	Status
2	<i>Realtime Data LLC d/b/a IXO v. Thomson Reuters Corporation et al.</i> No. 1:11-cv-06698-RJH (S.D. New York) (transferred from E.D. Texas; 6:09-cv-00333-LED)	Pending
3	<i>Realtime Data LLC d/b/a IXO v. Morgan Stanley et al.</i> , No. 1:11-cv-06696-RJH (S.D. New York) (transferred	Pending

	from E.D. Texas; 6:09-cv-00326-LED)	
4	<i>Realtime Data LLC d/b/a IXO v. CME Group Inc., et al.</i> , No. 1:11-cv-06697-RJH (S.D. New York) (transferred from E.D. Texas; No. 6:09-cv-00327-LED)	Pending
5	<i>Chicago Board Options Exchange, Inc., v. Realtime Data LLC d/b/a IXO</i> , No. 09-cv-4486 (N.D. Ill.)	Dismissed
6	<i>Thomson Reuters Corporation v. Realtime Data, LLC d/b/a IXO</i> , No. 1:09-cv-07868-RMB (S.D.N.Y)	Consolidated with Case No. 2
7	<i>Realtime Data, LLC d/b/a IXO v. CME Group Inc., et al. (II)</i> , No. 6:10-cv-246 (E.D. Texas)	Consolidated with Case No. 4
8	<i>Realtime Data LLC d/b/a IXO v. Thomson Reuters Corporation et al. (II)</i> , No. 6:10-cv-247 (E.D. Texas)	Consolidated with Case No. 2
9	<i>Realtime Data, LLC d/b/a IXO v. Morgan Stanley, et al. (II)</i> , No. 6:10-cv-248 (E.D. Texas)	Consolidated with Case No. 3
10	<i>Realtime Data, LLC D/B/A IXO v. MetroPCS Texas, LLC et al.</i> , No. 6:10-cv-00493 (E.D. Texas)	Pending

Updated court docket listings downloaded June 19, 2012 for litigations previously disclosed and pending are submitted herewith as NPL73-NPL76.

Information Disclosure Statement

Listed on accompanying IDS Form PTO/SB/08a equivalent and/or PTO/SB/08b equivalent are documents that may be considered material to the patentability of this application as defined in 37 C.F.R. §1.56, and in compliance with the duty of disclosure requirements of 37 C.F.R. §§ 1.97 and 1.98.

Applicants have listed publication dates on the attached IDS Forms based on information presently available to the undersigned. However, the listed publication dates should not be construed as an admission that the information was actually published on the date indicated.

Applicants reserve the right to establish the patentability of the claimed invention over any of the information provided herewith, and/or to prove that this information may not be prior art, and/or to prove that this information may not be enabling for the teachings purportedly offered.

This statement should not be construed as a representation that a search has been made, or that information more material to the examination of the present patent application does not exist. The Examiner is specifically requested not to rely solely on the material submitted herewith.

Filing under 37 C.F.R. § 1.97(b). This Information Disclosure Statement is being filed after the mailing date of a first Office Action on the merits. The required fee is provided through online credit card payment authorization in the amount of \$180.00 in payment of the fee under 37 C.F.R. § 1.17(p).

A concise explanation of the relevance of the non-English language document FP1 appears below in accordance with 37 C.F.R. § 1.98(a)(3).

FP1 (JP 04-241681) is in the Japanese language. An English language abstract is as follows:

PURPOSE: To provide a means which can make optimum compression on data of any kinds of data pattern and can improve the data compressing efficiency.

CONSTITUTION: At the time of storing data, the data are compressed by means of compression circuits 11 and 12 of plural data compressing systems and counted results of the byte numbers of the compressed data are compared with each other after the byte



numbers are counted. Then the compressed data of the smallest amount are selected and stored in a storing section 2 after adding a code indicating the compressing system. At the time of reading out the recorded data, the data are restored to the original data by selecting the corresponding restoration circuit 31 or 32 in accordance with the added code indicating the compressing system.

Documents US1-US13 and FP1 are cited on the attached form PTO/SB/08A. Documents NPL1-NPL76 are cited on the attached form PTO/SB/08B. Copies of documents FP1 and NPL1-NPL76 are submitted. In accordance with 37 C.F.R. § 1.98(a)(2), no copies of U.S. patents and patent application publications cited on the attached IDS Forms are submitted.

Applicants submit herewith actions from the following co-pending, commonly assigned U.S. Patent Application Nos.:

Document NPL2 is a copy of a Notice of Allowance mailed on September 26, 2011 in the prosecution of co-pending, commonly-assigned U.S. Application No. 12/123,081.

Document NPL3 is a copy of a Notice of Allowance mailed on September 28, 2011 in the prosecution of co-pending, commonly-assigned U.S. Application No. 11/551,204.

Document NPL4 is a copy of a Notice of Allowance mailed on October 18, 2011 in the prosecution of co-pending, commonly-assigned U.S. Application No. 11/551,211.

Document NPL5 is a copy of a Non-Final Office Action mailed on November 2, 2011 in the prosecution of co-pending, commonly-assigned U.S. Application No. 13/154,239.

Document NPL6 is a copy of a Notice of Allowance mailed on November 15, 2011 in the prosecution of co-pending, commonly-assigned U.S. Application No. 12/703,042.

Document NPL7 is a copy of a Non-Final Office Action mailed on November 28, 2011 in the prosecution of co-pending, commonly-assigned U.S. Application No. 12/688,413.

Document NPL8 is a copy of a Notice of Allowance mailed on December 30, 2011 in the prosecution of co-pending, commonly-assigned U.S. Application No. 12/857,238.

Document NPL9 is a copy of a Notice of Allowance mailed on February 6, 2012 in the prosecution of co-pending, commonly-assigned U.S. Application No. 11/400,008.

Document NPL10 is a copy of a Non-Final Office Action mailed on March 8, 2012 in the prosecution of co-pending, commonly-assigned U.S. Application No. 12/690,125.

Document NPL11 is a copy of a Notice of Allowance mailed on March 30, 2012 in the prosecution of co-pending, commonly-assigned U.S. Application No. 12/703,042.

Document NPL12 is a copy of a Non-Final Office Action mailed on April 11, 2012 in the prosecution of co-pending, commonly-assigned U.S. Application No. 09/969,987.

Document NPL13 is a copy of a Notice of Allowance mailed on April 23, 2012 in the prosecution of co-pending, commonly-assigned U.S. Application No. 11/553,419.

Document NPL14 is a copy of a Notice of Allowance mailed on May 7, 2012 in the prosecution of co-pending, commonly-assigned U.S. Application No. 11/553,427.

Document NPL15 is a copy of a Non-Final Office Action mailed on May 23, 2012 in the prosecution of co-pending, commonly-assigned U.S. Application No. 13/101,994.

Document NPL16 is a copy of a Notice of Allowance mailed on May 29, 2012 in the prosecution of co-pending, commonly-assigned U.S. Application No. 12/857,238.

The identification of these actions is not to be construed as a waiver of secrecy as to those applications now or upon issuance of the present application as a patent. The Examiner is respectfully requested to consider the cited applications and the art cited therein during examination.

It is expected that the examiner will review the prosecution and cited art in the parent application nos. 09/776,267, filed February 2, 2001 (now U.S. Patent No. 7,181,608), and 11/551,211, filed October 19, 2006 (now U.S. Patent No. 8,112,619), in accordance with MPEP 2001.06(b), and indicate in the next communication from the

office that the art cited in the earlier prosecution history has been reviewed in connection with the present application.

It is respectfully requested that the Examiner initial and return a copy of the enclosed IDS Forms, and indicate in the official file wrapper of this patent application that the documents have been considered.

The U.S. Patent and Trademark Office is hereby authorized to charge any fee deficiency, or credit any overpayment, to our Deposit Account No. 19-0036.

Respectfully submitted,

STERNE, KESSLER, GOLDSTEIN & FOX P.L.L.C.

  
Edward J. Kessler  
Attorney for Applicants  
Registration No. 25,688

Date: 19 June 2012

1100 New York Avenue, N.W.  
Washington, D.C. 20005-3934  
(202) 371-2600

1543284\_1.DOCX



US006601104C1

(12) **EX PARTE REEXAMINATION CERTIFICATE** (8871st)  
**United States Patent**  
**Fallon**

(10) **Number:** **US 6,601,104 C1**  
(45) **Certificate Issued:** **Feb. 28, 2012**

(54) **SYSTEM AND METHODS FOR ACCELERATED DATA STORAGE AND RETRIEVAL**

*Primary Examiner*—Matthew Heneghan

(57) **ABSTRACT**

(75) Inventor: **James J. Fallon**, Bronxville, NY (US)  
(73) Assignee: **Realtime Data LLC**, New York, NY (US)

Systems and methods for providing accelerated data storage and retrieval utilizing lossless data compression and decompression. A data storage accelerator includes one or a plurality of high speed data compression encoders that are configured to simultaneously or sequentially losslessly compress data at a rate equivalent to or faster than the transmission rate of an input data stream. The compressed data is subsequently stored in a target memory or other storage device whose input data storage bandwidth is lower than the original input data stream bandwidth. Similarly, a data retrieval accelerator includes one or a plurality of high speed data decompression decoders that are configured to simultaneously or sequentially losslessly decompress data at a rate equivalent to or faster than the input data stream from the target memory or storage device. The decompressed data is then output at rate data that is greater than the output rate from the target memory or data storage device. The data storage and retrieval accelerator method and system may employed: in a disk storage adapter to reduce the time required to store and retrieve data from computer to disk; in conjunction with random access memory to reduce the time required to store and retrieve data from random access memory; in a display controller to reduce the time required to send display data to the display controller or processor; and/or in an input/output controller to reduce the time required to store, retrieve, or transmit data.

**Reexamination Request:**  
No. 90/009,428, Apr. 7, 2009

**Reexamination Certificate for:**  
Patent No.: **6,601,104**  
Issued: **Jul. 29, 2003**  
Appl. No.: **09/266,394**  
Filed: **Mar. 11, 1999**

(51) **Int. Cl.**  
**G06F 13/00** (2006.01)  
**G06F 13/12** (2006.01)

(52) **U.S. Cl.** ..... **709/231**

(58) **Field of Classification Search** ..... None  
See application file for complete search history.

(56) **References Cited**

To view the complete listing of prior art documents cited during the proceeding for Reexamination Control Number 90/009,428, please refer to the USPTO's public Patent Application Information Retrieval (PAIR) system under the Display References tab.

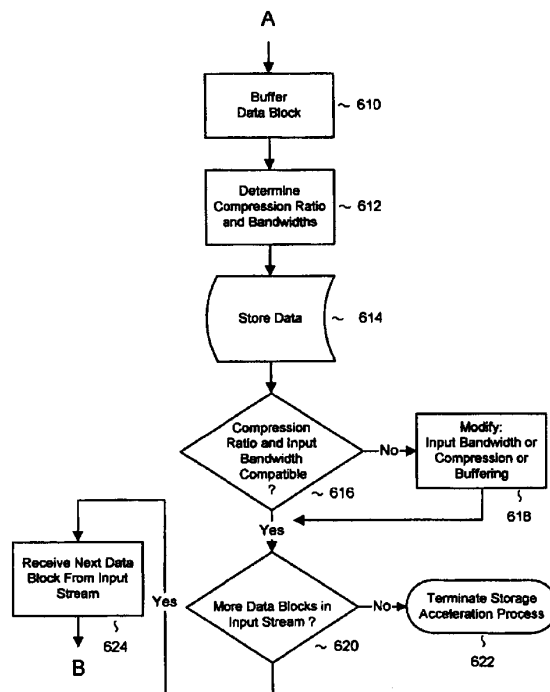

**1**  
**EX PARTE**  
**REEXAMINATION CERTIFICATE**  
**ISSUED UNDER 35 U.S.C. 307**

THE PATENT IS HEREBY AMENDED AS  
INDICATED BELOW.

**2**  
AS A RESULT OF REEXAMINATION, IT HAS BEEN  
DETERMINED THAT:  
Claims 1, 2, 12, 13, 18, 24 and 25 are cancelled.  
5 Claims 3-11, 14-17, 19-23 and 26-35 were not reexam-  
ined.

\* \* \* \* \*

## Electronic Acknowledgement Receipt

<b>EFS ID:</b>	13036953
<b>Application Number:</b>	13118122
<b>International Application Number:</b>	
<b>Confirmation Number:</b>	8978
<b>Title of Invention:</b>	Systems and Methods for Accelerated Loading of Operating Systems and Application Programs
<b>First Named Inventor/Applicant Name:</b>	James J. Fallon
<b>Customer Number:</b>	26111
<b>Filer:</b>	Edward J. Kessler/Stacy Jen
<b>Filer Authorized By:</b>	Edward J. Kessler
<b>Attorney Docket Number:</b>	2855.004000B
<b>Receipt Date:</b>	19-JUN-2012
<b>Filing Date:</b>	27-MAY-2011
<b>Time Stamp:</b>	18:03:33
<b>Application Type:</b>	Utility under 35 USC 111(a)

### Payment information:

Submitted with Payment	no
------------------------	----

### File Listing:

Document Number	Document Description	File Name	File Size(Bytes)/ Message Digest	Multi Part /.zip	Pages (if appl.)
1	Foreign Reference	FP1_JP4241681.pdf	337934 <small>f51df416d418f98d0811913280a6a0b11c6c9216</small>	no	5

### Warnings:

### Information:

2	Non Patent Literature	NPL1_IBM_Tech_Bulletin_Hard_Disk_Data.pdf	98703 bcaeb2254acc0975d7e2987b004edeb2c8a2b0f	no	3
<b>Warnings:</b>					
<b>Information:</b>					
3	Non Patent Literature	NPL2_NOA_12123081_09_26_2011.pdf	1735301 0900bdeleb854effe449bd489e5b886dbcf3016	no	9
<b>Warnings:</b>					
<b>Information:</b>					
4	Non Patent Literature	NPL3_NOA_11551204_09_28_2011.pdf	1305115 858cc9cce7fd8db0de29bb53d319f9601cbf9e74	no	5
<b>Warnings:</b>					
<b>Information:</b>					
5	Non Patent Literature	NPL4_NOA_11551211_10_18_2011.pdf	1304705 7c3962aea265f736b7f91707a4f64716d39d0ae5f	no	5
<b>Warnings:</b>					
<b>Information:</b>					
6	Non Patent Literature	NPL5_NFOA_13154239_11022011.pdf	192089 2af9b2293425a84af818d096f4627dc02952cc5c	no	6
<b>Warnings:</b>					
<b>Information:</b>					
7	Non Patent Literature	NPL6_NOA_11152011_12703042.pdf	419043 f912fff1d0f827634a103fff43f397973075d55	no	8
<b>Warnings:</b>					
<b>Information:</b>					
8	Non Patent Literature	NPL7_NFOA_11282011_12688413.pdf	526635 38b447c63b628b1b3f5f7ba1c9430539da71a16f	no	14
<b>Warnings:</b>					
<b>Information:</b>					
9	Non Patent Literature	NPL8_NOA_12857238_12302011.pdf	329997 4eb75b51ca8ce1ef064dbce6876cedd481ef74b0	no	5
<b>Warnings:</b>					
<b>Information:</b>					
10	Non Patent Literature	NPL9_NOA_11400008_02062012.pdf	402924 cd9fb66af0784290bf98cc76a8cc643093d3531	no	8
<b>Warnings:</b>					
<b>Information:</b>					



11	Non Patent Literature	NPL10_NFOA_12690125_0308 2012.pdf	259976 8a5b9cd5c53de21ccd096dbb6102743f6f4 b29d8	no	7
<b>Warnings:</b>					
<b>Information:</b>					
12	Non Patent Literature	NPL11_NOA_12703042_03302 012.pdf	421712 a1f85a7793ffc3d31e29db8d9a779d225e0b d68e	no	8
<b>Warnings:</b>					
<b>Information:</b>					
13	Non Patent Literature	NPL12_NFOA_09969987_0411 2012.pdf	225187 e6834d6ccc8b6d7428c654fb22378165803 159d9	no	6
<b>Warnings:</b>					
<b>Information:</b>					
14	Non Patent Literature	NPL13_NOA_11553419_04232 012.pdf	333496 762678b7085e6c997a0c2aed7ee6912760f a17f	no	6
<b>Warnings:</b>					
<b>Information:</b>					
15	Non Patent Literature	NPL14_NOA_11553427_05072 012.pdf	347364 ba750b1ec19f959efc139406c608284e598 f6f6	no	7
<b>Warnings:</b>					
<b>Information:</b>					
16	Non Patent Literature	NPL15_NFOA_13101994_0523 2012.pdf	374117 11f714e4522b306fdb3ba7bd1025f4612bd c2c8	no	12
<b>Warnings:</b>					
<b>Information:</b>					
17	Non Patent Literature	NPL16_NOA_12857238_05292 012.pdf	328931 a09acc1b5f6a29df03d879bad6810ac59437 1a43	no	5
<b>Warnings:</b>					
<b>Information:</b>					
18	Non Patent Literature	NPL17_Action_Closing_Prosec ution_95001517_09212011.pdf	983820 51761c2e7a9533d2d9067c9f4a198541d02 69961	no	29
<b>Warnings:</b>					
<b>Information:</b>					
19	Non Patent Literature	NPL18_Data_Packet_Definition _09212011.pdf	24258 b97e86bcb743f6589d3bd087480d4130fdd 66952	no	2
<b>Warnings:</b>					
<b>Information:</b>					

20	Non Patent Literature	NPL19_Patent_Owner_Response_95001581_09262011.pdf	4110260 f66dabc9c37f5feb343455d0d114f46a3c38234	no	44
<b>Warnings:</b>					
<b>Information:</b>					
21	Non Patent Literature	NPL20_Examiner_Answer_to_Appeal_Brief_95000464_09282011.pdf	736607 eb85ca2dcb71b3c04ac86eaeec624db92eb9e59	no	20
<b>Warnings:</b>					
<b>Information:</b>					
22	Non Patent Literature	NPL21_Examiner_Answer_to_Appeal_Brief_95000479_09282011.pdf	932964 0d2a4239e8bb7d5274e52f36ab26a9301f5526f1	no	25
<b>Warnings:</b>					
<b>Information:</b>					
23	Non Patent Literature	NPL22_Examiner_Answer_to_Appeal_Brief_95000478_09292011.pdf	946746 df883a80221e1b079da4bc8d185887c909c75d4	no	27
<b>Warnings:</b>					
<b>Information:</b>					
24	Non Patent Literature	NPL23_Decision_on_Appeal_2011003299.pdf	494024 ec23b059615460de291fd9f92ce0e5556b57cdcc	no	14
<b>Warnings:</b>					
<b>Information:</b>					
25	Non Patent Literature	NPL24_RebuttalBrief_10282011_95000464.pdf	382328 0d58e45e96c8c144ad4acb2578a275b07d6b9118	no	9
<b>Warnings:</b>					
<b>Information:</b>					
26	Non Patent Literature	NPL25_RebuttalBrief_10282011_95000478.pdf	409831 566df5cf2531d78b4071ccba9087e50f188f891f	no	10
<b>Warnings:</b>					
<b>Information:</b>					
27	Non Patent Literature	NPL26_RebuttalBrief_10282011_95000479.pdf	630912 b9cff143cce61b066047c319e8ad4f009c831e90	no	9
<b>Warnings:</b>					
<b>Information:</b>					
28	Non Patent Literature	NPL27_Action_Closing_Prosecution_95001544_11182011.pdf	1485134 e439389c27f88c562bbd26ada4e8e13c30eb0c0	no	39
<b>Warnings:</b>					
<b>Information:</b>					

29	Non Patent Literature	NPL28_Action_Closing_Prosecution_12092011_95001533.pdf	1508694 c9b6b463355de0ebf0adaa0a37583257f3e17b	no	42
<b>Warnings:</b>					
<b>Information:</b>					
30	Non Patent Literature	NPL29_Patent_Owner_Reply_to_ACP_095001544_12192011.pdf	357512 77d2b9c128ef500dbc90a1e7eab45d5ba9f17b79	no	9
<b>Warnings:</b>					
<b>Information:</b>					
31	Non Patent Literature	NPL30_Patent_Owner_Reply_to_ACP_95001533_12292011.pdf	531043 ae1dd32d121822f662f2d3c8b3c67a69724ed1	no	14
<b>Warnings:</b>					
<b>Information:</b>					
32	Non Patent Literature	NPL31_Notice_Intent_to_Issue_Reexam_Certificate_90009428_01132012.pdf	108998 18ed2b1a7fb6b40f0a56158e9cb2cc658bea37f9	no	5
<b>Warnings:</b>					
<b>Information:</b>					
33	Non Patent Literature	NPL32_BPAl_Decision_Affirmed_95000464_01182012.pdf	122528 a33819f874b519db408a820cd3b9d2eb2b0dca	no	5
<b>Warnings:</b>					
<b>Information:</b>					
34	Non Patent Literature	NPL33_BPAl_Decision_Affirmed_95000466_01182012.pdf	284775 9eb7f8061a78b946762ff58e5a9e51a10ef0d7e4	no	8
<b>Warnings:</b>					
<b>Information:</b>					
35	Non Patent Literature	NPL34_BPAl_Decision_Affirmed_95000478_01182012.pdf	139666 c225fbf89523aff1d1289c81a9978464121ef0e8	no	5
<b>Warnings:</b>					
<b>Information:</b>					
36	Non Patent Literature	NPL35_BPAl_Decision_Affirmed_95000479_01182012.pdf	153385 bba2e9f72ddb9d53849966a68f84adabebc625f9	no	6
<b>Warnings:</b>					
<b>Information:</b>					
37	Non Patent Literature	NPL36_NFOA_95001581_01272012.pdf	5127671 3d68306a35bee7dec194929293ddeb1d066726156	no	152
<b>Warnings:</b>					
<b>Information:</b>					

38	Non Patent Literature	NPL37_RespondentBrief_Owner_95001517_02172012.pdf	1561592 125fdea75c7bfa9b36b28905a8cedfc778e74035	no	20
<b>Warnings:</b>					
<b>Information:</b>					
39	Non Patent Literature	NPL38_Reply_to_NonFinal_OA_95001581_02242012.pdf	1407187 e8ad86a89273c6ec3d2da614ad7c4e62bbdee24	no	30
<b>Warnings:</b>					
<b>Information:</b>					
40	Non Patent Literature	NPL39_Reexam_Certificate_90009428_02282012.pdf	61587 600ff60476dafb709858e8c435d46a46aad056b	no	2
<b>Warnings:</b>					
<b>Information:</b>					
41	Non Patent Literature	NPL40_Examiner_Answer_to_AppealBrief_95001517_033012012.pdf	151151 222f39ac465843cd400dfc9cb34a25907b1bba9b	no	4
<b>Warnings:</b>					
<b>Information:</b>					
42	Non Patent Literature	NPL41_Right_of_Appeal_Notice_95001533_03012012.pdf	250657 85d4494be9de8f0cfdff8b2f196951c6c275b6417	no	8
<b>Warnings:</b>					
<b>Information:</b>					
43	Non Patent Literature	NPL42_Right_of_Appeal_Notice_95001544_03062012.pdf	241600 1cab3279808613ab82cf43a6af4395404e5554b8	no	7
<b>Warnings:</b>					
<b>Information:</b>					
44	Non Patent Literature	NPL43_Reexam_Request_95001922_03022012_Part1.pdf	21092079 c6275ceb028995a04a1196c60bdac74366508365	no	511
<b>Warnings:</b>					
<b>Information:</b>					
45	Non Patent Literature	NPL43_Reexam_Request_95001922_03022012_Part2.pdf	21376676 a796ff750ef7481de8da3cc5e866dc5fa54cc46f	no	169
<b>Warnings:</b>					
<b>Information:</b>					
46	Non Patent Literature	NPL43_Reexam_Request_95001922_03022012_Part3.pdf	24077059 4e7b73e2549600d2687a1f418a1f8a96cbe1a8b6	no	120
<b>Warnings:</b>					
<b>Information:</b>					

47	Non Patent Literature	NPL43_Reexam_Request_9500 1922_03022012_Part4.pdf	22047228 8a4d9f1ab9c121cb6a19a8dea10dd4611b0 747b9	no	301
<b>Warnings:</b>					
<b>Information:</b>					
48	Non Patent Literature	NPL43_Reexam_Request_9500 1922_03022012_Part5.pdf	21694894 7bf78e70d48069799c4ff5f8633f783a47b651 aaa	no	506
<b>Warnings:</b>					
<b>Information:</b>					
49	Non Patent Literature	NPL43_Reexam_Request_9500 1922_03022012_Part6.pdf	24774429 bdf7d5fd489e7e9626174105cb4dd4a1140 87fb6	no	180
<b>Warnings:</b>					
<b>Information:</b>					
50	Non Patent Literature	NPL43_Reexam_Request_9500 1922_03022012_Part7.pdf	24128275 29726a3747078681afa3d8ebbbcb8d116f6 7d2cd	no	120
<b>Warnings:</b>					
<b>Information:</b>					
51	Non Patent Literature	NPL43_Reexam_Request_9500 1922_03022012_Part8.pdf	25304406 f272ec7a78abe83f3938b56c1f334e112b1 5707	no	398
<b>Warnings:</b>					
<b>Information:</b>					
52	Non Patent Literature	NPL43_Reexam_Request_9500 1922_03022012_Part9.pdf	23587416 30ea97cd37034cbc20afa09cd9c70ed930 901d	no	560
<b>Warnings:</b>					
<b>Information:</b>					
53	Non Patent Literature	NPL44_Reexam_Request_9500 1923_03022012_Part1.pdf	14062601 19b21ac01dec1dbf57a5939325d21b34614 1d4ec	no	225
<b>Warnings:</b>					
<b>Information:</b>					
54	Non Patent Literature	NPL44_Reexam_Request_9500 1923_03022012_Part2.pdf	24072404 0231be708de8973ca5defb85d0863919214 61d32	no	335
<b>Warnings:</b>					
<b>Information:</b>					
55	Non Patent Literature	NPL45_Reexam_Request_9500 1924_03022012_Part1.pdf	20634249 d87a272c463cfcdbd84fc2a61eb671ea8b7 626	no	327
<b>Warnings:</b>					
<b>Information:</b>					

56	Non Patent Literature	NPL45_Reexam_Request_9500 1924_03022012_Part2.pdf	24818831 b08d8314d30eff94e3d02a1607b3ccf4aae1bc05	no	361
<b>Warnings:</b>					
<b>Information:</b>					
57	Non Patent Literature	NPL45_Reexam_Request_9500 1924_03022012_Part3.pdf	15801455 250d10385d454fd65740e6aeaf9a4802c3d16eb4	no	324
<b>Warnings:</b>					
<b>Information:</b>					
58	Non Patent Literature	NPL46_Reexam_Request_9500 1925_03022012.pdf	11164493 22d1c22262324fad2bb6afdf69c3d67c64cf281	no	204
<b>Warnings:</b>					
<b>Information:</b>					
<b>Total Files Size (in bytes):</b>				350724654	
<p><b>This Acknowledgement Receipt evidences receipt on the noted date by the USPTO of the indicated documents, characterized by the applicant, and including page counts, where applicable. It serves as evidence of receipt similar to a Post Card, as described in MPEP 503.</b></p> <p><b><u>New Applications Under 35 U.S.C. 111</u></b>  If a new application is being filed and the application includes the necessary components for a filing date (see 37 CFR 1.53(b)-(d) and MPEP 506), a Filing Receipt (37 CFR 1.54) will be issued in due course and the date shown on this Acknowledgement Receipt will establish the filing date of the application.</p> <p><b><u>National Stage of an International Application under 35 U.S.C. 371</u></b>  If a timely submission to enter the national stage of an international application is compliant with the conditions of 35 U.S.C. 371 and other applicable requirements a Form PCT/DO/EO/903 indicating acceptance of the application as a national stage submission under 35 U.S.C. 371 will be issued in addition to the Filing Receipt, in due course.</p> <p><b><u>New International Application Filed with the USPTO as a Receiving Office</u></b>  If a new international application is being filed and the international application includes the necessary components for an international filing date (see PCT Article 11 and MPEP 1810), a Notification of the International Application Number and of the International Filing Date (Form PCT/RO/105) will be issued in due course, subject to prescriptions concerning national security, and the date shown on this Acknowledgement Receipt will establish the international filing date of the application.</p>					



UNITED STATES PATENT AND TRADEMARK OFFICE

UNITED STATES DEPARTMENT OF COMMERCE  
United States Patent and Trademark Office  
Address: COMMISSIONER FOR PATENTS  
P.O. Box 1450  
Alexandria, Virginia 22313-1450  
www.uspto.gov

APPLICATION NO.	FILING DATE	FIRST NAMED INVENTOR	ATTORNEY DOCKET NO.	CONFIRMATION NO.
-----------------	-------------	----------------------	---------------------	------------------

13/118,122	05/27/2011	James J. Fallon	2855.004000B	8978
------------	------------	-----------------	--------------	------

26111 7590 05/16/2012  
 STERNE, KESSLER, GOLDSTEIN & FOX P.L.L.C.  
 1100 NEW YORK AVENUE, N.W.  
 WASHINGTON, DC 20005

EXAMINER
----------

SURYAWANSHI, SURESH

ART UNIT	PAPER NUMBER
----------	--------------

2115

MAIL DATE	DELIVERY MODE
-----------	---------------

05/16/2012	PAPER
------------	-------

**Please find below and/or attached an Office communication concerning this application or proceeding.**

The time period for reply, if any, is set in the attached communication.

<b>Office Action Summary</b>	<b>Application No.</b> 13/118,122	<b>Applicant(s)</b> FALLON ET AL.	
	<b>Examiner</b> SURESH SURYAWANSHI	<b>Art Unit</b> 2115	

**-- The MAILING DATE of this communication appears on the cover sheet with the correspondence address --**  
**Period for Reply**

A SHORTENED STATUTORY PERIOD FOR REPLY IS SET TO EXPIRE 3 MONTH(S) OR THIRTY (30) DAYS, WHICHEVER IS LONGER, FROM THE MAILING DATE OF THIS COMMUNICATION.

- Extensions of time may be available under the provisions of 37 CFR 1.136(a). In no event, however, may a reply be timely filed after SIX (6) MONTHS from the mailing date of this communication.
- If NO period for reply is specified above, the maximum statutory period will apply and will expire SIX (6) MONTHS from the mailing date of this communication.
- Failure to reply within the set or extended period for reply will, by statute, cause the application to become ABANDONED (35 U.S.C. § 133). Any reply received by the Office later than three months after the mailing date of this communication, even if timely filed, may reduce any earned patent term adjustment. See 37 CFR 1.704(b).

**Status**

- 1)  Responsive to communication(s) filed on 27 May 2011.
- 2a)  This action is **FINAL**.
- 2b)  This action is non-final.
- 3)  An election was made by the applicant in response to a restriction requirement set forth during the interview on \_\_\_\_\_; the restriction requirement and election have been incorporated into this action.
- 4)  Since this application is in condition for allowance except for formal matters, prosecution as to the merits is closed in accordance with the practice under *Ex parte Quayle*, 1935 C.D. 11, 453 O.G. 213.

**Disposition of Claims**

- 5)  Claim(s) 1 is/are pending in the application.
- 5a) Of the above claim(s) \_\_\_\_\_ is/are withdrawn from consideration.
- 6)  Claim(s) \_\_\_\_\_ is/are allowed.
- 7)  Claim(s) 1 is/are rejected.
- 8)  Claim(s) \_\_\_\_\_ is/are objected to.
- 9)  Claim(s) \_\_\_\_\_ are subject to restriction and/or election requirement.

**Application Papers**

- 10)  The specification is objected to by the Examiner.
- 11)  The drawing(s) filed on 27 May 2011 is/are: a)  accepted or b)  objected to by the Examiner.  
Applicant may not request that any objection to the drawing(s) be held in abeyance. See 37 CFR 1.85(a).  
Replacement drawing sheet(s) including the correction is required if the drawing(s) is objected to. See 37 CFR 1.121(d).
- 12)  The oath or declaration is objected to by the Examiner. Note the attached Office Action or form PTO-152.

**Priority under 35 U.S.C. § 119**

- 13)  Acknowledgment is made of a claim for foreign priority under 35 U.S.C. § 119(a)-(d) or (f).  
a)  All    b)  Some \*    c)  None of:  
1.  Certified copies of the priority documents have been received.  
2.  Certified copies of the priority documents have been received in Application No. \_\_\_\_\_.  
3.  Copies of the certified copies of the priority documents have been received in this National Stage application from the International Bureau (PCT Rule 17.2(a)).  
\* See the attached detailed Office action for a list of the certified copies not received.

**Attachment(s)**

- 1)  Notice of References Cited (PTO-892)
- 2)  Notice of Draftsperson's Patent Drawing Review (PTO-948)
- 3)  Information Disclosure Statement(s) (PTO/SB/08)  
Paper No(s)/Mail Date 8/2/11,9/16/11.
- 4)  Interview Summary (PTO-413)  
Paper No(s)/Mail Date. \_\_\_\_\_.
- 5)  Notice of Informal Patent Application
- 6)  Other: \_\_\_\_\_.



**DETAILED ACTION**

1. Claim 1 is presented for examination.

*Specification*

2. The disclosure is objected to because of the following informalities: U.S. Patent Application Serial No. 09/266,394 is now Patent 6,601,103 in paragraph [0034].

Appropriate correction is required.

3. The disclosure is objected to because of the following informalities: U.S. Patent Application Serial No. 09/481,243 is now Patent 6,604,158 in paragraph [0034].

Appropriate correction is required.

4. The disclosure is objected to because of the following informalities: "greater that" should be "greater than" at page 8, line 2.

Appropriate correction is required.

5. The disclosure is objected to because of the following informalities: U.S. Patent Serial No. 09/210,491 is now Patent 6,195,024 in paragraphs [0035], [0117], 0118], [0122], [0123], [0126].

Appropriate correction is required.

6. The disclosure is objected to because of the following informalities: symbol “5” in paragraph [0041] is not in any figure.

Appropriate correction is required.

7. The disclosure is objected to because of the following informalities: blank space should be filled with Serial No. “09/775,897” in paragraph [0048].

Appropriate correction is required.

8. The disclosure is objected to because of the following informalities: symbol “30” in paragraph [0055] should be “35”.

Appropriate correction is required.

9. The disclosure is objected to because of the following informalities: symbol “DSRA” is used without any definition in specification in paragraph [0097].

Appropriate correction is required.

10. The disclosure is objected to because of the following informalities: “if the was stored” should have been “if the data was stored” in paragraph [0103].

Appropriate correction is required.

### ***Double Patenting***

11. The nonstatutory double patenting rejection is based on a judicially created doctrine grounded in public policy (a policy reflected in the statute) so as to prevent the unjustified or improper timewise extension of the “right to exclude” granted by a patent and to prevent possible harassment by multiple assignees. A nonstatutory obviousness-type double patenting rejection is appropriate where the conflicting claims are not identical, but at least one examined application claim is not patentably distinct from the reference claim(s) because the examined application claim is either anticipated by, or would have been obvious over, the reference claim(s). See, e.g., *In re Berg*, 140 F.3d 1428, 46 USPQ2d 1226 (Fed. Cir. 1998); *In re Goodman*, 11 F.3d 1046, 29 USPQ2d 2010 (Fed. Cir. 1993); *In re Longi*, 759 F.2d 887, 225 USPQ 645 (Fed. Cir. 1985); *In re Van Ornum*, 686 F.2d 937, 214 USPQ 761 (CCPA 1982); *In re Vogel*, 422 F.2d 438, 164 USPQ 619 (CCPA 1970); and *In re Thorington*, 418 F.2d 528, 163 USPQ 644 (CCPA 1969).

A timely filed terminal disclaimer in compliance with 37 CFR 1.321(c) or 1.321(d) may be used to overcome an actual or provisional rejection based on a nonstatutory double patenting ground provided the conflicting application or patent either is shown to be commonly owned with this application, or claims an invention made as a result of activities undertaken within the scope of a joint research agreement.

Effective January 1, 1994, a registered attorney or agent of record may sign a terminal disclaimer. A terminal disclaimer signed by the assignee must fully comply with 37 CFR 3.73(b).

12. Claim 1 is rejected on the ground of nonstatutory obviousness-type double patenting as being unpatentable over claim 1 of U.S. Patent No. 7,181,608. Although the conflicting claims are not identical, they are not patentably distinct from each other because both are directed to a method for providing accelerated loading of an operating system by maintaining a boot data list, preloading the boot data upon initialization of the computer system.

13. Claim 1 is rejected on the ground of nonstatutory obviousness-type double patenting as being unpatentable over claim 1 of U.S. Patent No. 8,090,936. Although the conflicting claims are not identical, they are not patentably distinct from each other because both are directed to a method for providing accelerated loading of an operating system by maintaining a boot data list, preloading the boot data upon initialization of the computer system.

14. Claim 1 is rejected on the ground of nonstatutory obviousness-type double patenting as being unpatentable over claim 1 of U.S. Patent No. 8,112,619. Although the conflicting claims are not identical, they are not patentably distinct from each other because both are directed to a method for providing accelerated loading of an operating system by maintaining a boot data list, preloading the boot data upon initialization of the computer system.

***Claim Rejections - 35 USC § 102***

15. The following is a quotation of the appropriate paragraphs of 35 U.S.C. 102 that form the basis for the rejections under this section made in this Office action:

A person shall be entitled to a patent unless –

(e) the invention was described in (1) an application for patent, published under section 122(b), by another filed in the United States before the invention by the applicant for patent or (2) a patent granted on an application for patent by another filed in the United States before the invention by the applicant for patent, except that an international application filed under the treaty defined in section 351(a) shall have the effects for purposes of this subsection of an application filed in the United States only if the international application designated the United States and was published under Article 21(2) of such treaty in the English language.

16. Claim 1 is rejected under 35 U.S.C. 102(e) as being anticipated by Krockner et al (US Patent 6,073,232<sup>1</sup>; hereinafter Krockner).

17. As per claim 1, Krockner discloses a method for providing accelerated loading of an operating system, comprising the steps of:

---

<sup>1</sup> Prior art cited by applicants in information disclosure statement submitted on 8/2/11.

maintaining a list of boot data used for booting a computer system [col. 2, lines 30-47; col. 5, lines 1-7; a prefetch table containing a listing of the disk location and length of data records that were requested by the host computer in the immediately previous power-on/reset];

preloading the boot data upon initialization of the computer system [col. 2, lines 36-41; col. 3, lines 30-39; col. 5, lines 17-21; data is prefetched into the cache according to the prefetch table]; and

servicing requests for boot data from the computer system using the preloaded boot data [col. 2, lines 41-47; col. 3, lines 3—39; data is communicated from the cache to the host computer].

### ***Conclusion***

Any inquiry concerning this communication or earlier communications from the examiner should be directed to SURESH SURYAWANSHI whose telephone number is (571)272-3668. The examiner can normally be reached on 9:00am - 5:30pm.

If attempts to reach the examiner by telephone are unsuccessful, the examiner's supervisor, Thomas C. Lee can be reached on 571-272-3667. The fax phone number for the organization where this application or proceeding is assigned is 571-273-8300.

Information regarding the status of an application may be obtained from the Patent Application Information Retrieval (PAIR) system. Status information for published applications may be obtained from either Private PAIR or Public PAIR. Status information for unpublished applications is available through Private PAIR only. For more information about the PAIR system, see <http://pair-direct.uspto.gov>. Should you have questions on access to the Private PAIR system, contact the Electronic Business Center (EBC) at 866-217-9197 (toll-free). If you would like assistance from a USPTO Customer Service Representative or access to the automated information system, call 800-786-9199 (IN USA OR CANADA) or 571-272-1000.

/SURESH SURYAWANSHI/  
Primary Examiner, Art Unit 2115

## EAST Search History

## EAST Search History (Prior Art)

Ref #	Hits	Search Query	DBs	Default Operator	Plurals	Time Stamp
S1	20	("3394352" "3490690" "4021782" "4032893" "4054951" "4127518" "4302775" "4325085" "4360840" "4386416" "4394774" "4464650" "4494108" "4499499" "4574351" "4593324" "4626829" "4646061" "4682150" "4701745").pn.	USPAT	OR	OFF	2012/05/11 14:36
S2	20	("4729020" "4730348" "4745559" "4748638" "4750135" "4754351" "4804959" "4813040" "4814746" "4862167" "4866601" "4870415" "4872009" "4876541" "4888812" "4890282" "4897717" "4906991" "4906995" "4929946").pn.	USPAT	OR	OFF	2012/05/11 14:48
S3	20	("4953324" "4956808" "4965675" "4988998" "5003307" "5016009" "5027376" "5028922" "5045848" "5045852" "5046027" "5049881" "5091782" "5097261" "5109226" "5109433" "5113522" "5115309" "5121342" "5126739").pn.	USPAT	OR	OFF	2012/05/11 14:54
S4	20	("5128963" "5132992" "5146221" "5150430" "5155484" "5159336" "5167034" "5175543" "5179651" "5187793" "5191431" "5204756" "5209220" "5212742" "5226176" "5227893" "5231492" "5237460" "5237675" "5243341").pn.	USPAT	OR	OFF	2012/05/11 15:00
S5	20	("5243348" "5247638" "5247646" "5249053" "5263168" "5267333" "5270832" "5280600" "5287420" "5289580" "5293379" "5293576" "5307497" "5309555" "5319682" "5341440" "5347600" "5353132" "5354315" "5355498").pn.	USPAT	OR	OFF	2012/05/11 15:12
S6	20	("5357614" "5367629" "5373290" "5374916" "5379036" "5379757" "5381145" "5389922" "5394534" "5396228" "5400401" "5403639" "5406278" "5406279" "5410671" "5412384" "5414850" "5420639" "5434983" "5437020").pn.	USPAT	OR	OFF	2012/05/11 15:25
S7	20	("5452287" "5454079" "5454107" "5455576" "5455578" "5455680" "5461679" "5463390" "5467087" "5471206" "5479587" "5479633" "5483470" "5486826" "5488364" "5488365" "5492244" "5504842" "5506844" "5506872").pn.	USPAT	OR	OFF	2012/05/11 15:32
S8	20	("5506944" "5521940" "5528628" "5530845" "5533051" "5535311" "5535356" "5535369" "5537658" "5539865" "5542031" "5544290" "5546395" "5546475" "5553160" "5557551" "5557668" "5557749" "5561421" "5561824").pn.	USPAT	OR	OFF	2012/05/11 15:40
S9	20	("5563961" "5574952" "5574953" "5576953" "5577248" "5581715" "5583500" "5586264"	USPAT	OR	OFF	2012/05/11 16:01



## EAST Search History

		"5586285" "5590306" "5596674" "5598388" "5604824" "5606706" "5610657" "5611024" "5612788" "5613069" "5615017" "5615287").pn.				
S10	20	("5619995" "5621820" "5623623" "5623701" "5627534" "5627995" "5629732" "5630092" "5635632" "5635932" "5638498" "5640158" "5642506" "5649032" "5652795" "5652857" "5652917" "5654703" "5655138" "5666560").pn.	USPAT	OR	OFF	2012/05/11 16:06
S11	20	("5668737" "5671355" "5671389" "5671416" "5675333" "5675789" "5686916" "5692159" "5694619" "5696927" "5703793" "5708511" "5715477" "5717393" "5717394" "5719862" "5721958" "5724475" "5729228" "5740395").pn.	USPAT	OR	OFF	2012/05/11 16:09
S12	20	("5742773" "5748904" "5757852" "5765027" "5767898" "5768445" "5768525" "5771340" "5774715" "5778411" "5781767" "5784572" "5787487" "5794229" "5796864" "5799110" "5805834" "5805932" "5808660" "5809176").pn.	USPAT	OR	OFF	2012/05/11 16:12
S13	20	("5809299" "5809337" "5812195" "5812789" "5818368" "5818369" "5818530" "5819215" "5822781" "5825424" "5825830" "5832037" "5832126" "5832443" "5835788" "5836003" "5838821" "5838927" "5838996" "5839100").pn.	USPAT	OR	OFF	2012/05/11 16:23
S14	20	("5841979" "5847762" "5850565" "5861824" "5861920" "5864342" "5864678" "5867167" "5867602" "5870036" "5870087" "5872530" "5874907" "5883975" "5884269" "5886655" "5887165" "5889961" "5892847" "5907801").pn.	USPAT	OR	OFF	2012/05/11 16:30
S15	20	("5909557" "5909559" "5915079" "5917438" "5918068" "5918225" "5902326" "5923860" "5930358" "5936616" "5938737" "5943692" "5945933" "5949355" "5949968" "5951623" "5955976" "5956490" "5960465" "5964842").pn.	USPAT	OR	OFF	2012/05/11 16:38
S16	20	("5968149" "5969927" "5973630" "5974235" "5974387" "5974471" "5978483" "5982360" "5982723" "5987022" "5987590" "5990884" "5991515" "5996033" "6000009" "6002411" "6003115" "6008743" "6011901" "6014694").pn.	USPAT	OR	OFF	2012/05/11 16:48
S17	20	("6021433" "6023755" "6026217" "6028725" "6031939" "6032148" "6032197" "6058459" "6061398" "6061473" "6070179" "6073232" "6075470" "6078958" "6091777" "6092123" "6094634" "6097520" "6098114" "6104389").pn.	USPAT	OR	OFF	2012/05/11 16:51
S18	20	("6105130" "6115384" "6128412" "6134631" "6141053" "6145020" "6145069" "6169241" "6170007" "6170047" "6170049" "6172936" "6173381" "6175650" "6175856" "6182125" "6185625" "6185659" "6192082" "6192155").pn.	USPAT	OR	OFF	2012/05/11 17:00
S19	20	("6195024" "6195465" "6208273" "6215904" "6219754" "6222886" "6225922" "6226667"	USPAT	OR	OFF	2012/05/11 17:06

EAST Search History

		"6226740" "6230223" "6237054" "6243829" "6253264" "6272178" "6272627" "6272628" "6282641" "6285458" "6298408" "6308311").pn.				
S20	20	("6309424" "6310563" "6317714" "6330622" "6333745" "6345307" "6356589" "6356937" "6388584" "6392567" "6404931" "6421387" "6434168" "6434695" "6442659" "6449658" "6449682" "6452602" "6452933" "6459429").pn.	USPAT	OR	OFF	2012/05/11 17:21
S21	20	("6463509" "6487640" "6489902" "6513113" "6523102" "6526174" "6529633" "6532121" "6539438" "6539456" "6542644" "6577254" "6590609" "6597812" "6601104" "6604040" "6604158" "6606040" "6606413" "6609223").pn.	USPAT	OR	OFF	2012/05/11 17:23
S22	20	("6618728" "6624761" "6633244" "6650261" "6661839" "6661845" "6704840" "6708220" "6711709" "6717534" "6731814" "6745282" "6748457" "6756922" "6768749" "6792151" "6810434" "6813689" "6819271" "6822589").pn.	USPAT	OR	OFF	2012/05/11 17:32
S23	20	("6856651" "6862278" "6879266" "6885316" "6885319" "6888893" "6909383" "6944740" "6952409" "6959359" "6963608" "6990247" "6993597" "7007099" "7024460" "7054493" "7069342" "7089391" "7102544" "7127518").pn.	USPAT	OR	OFF	2012/05/11 17:38
S24	20	("7129860" "7130913" "7161506" "7181608" "7190284" "7319667" "7321937" "7330912" "7352300" "7358867" "7376772" "7378992" "7386046" "7395345" "7400274" "7415530" "7417568" "7552069" "7565441" "7714747").pn.	USPAT	OR	OFF	2012/05/11 17:40
S25	9	("7777651" "5103306" "5764774" "5673370" "6505239" "5982937" "5079630" "6198850" "6198842").pn.	USPAT	OR	OFF	2012/05/11 17:42
S26	11	"20010031092" "20010032128" "20010047473" "20010052038" "20010054131" "20020037035" "20020069354" "20020080871" "20020097172" "20020101367" "20020104891"	US- PGPUB	OR	OFF	2012/05/11 17:45
S27	20	"20020126755" "20020191692" "20030034905" "20030084238" "20030030575" "20030090397" "20030142874" "20030191876" "20040042506" "20040056783" "20040073710" "20040073746" "20060015650" "20060181441" "20060181442" "20060184687" "20060190644" "20060195601" "20070043939" "20070050514"	US- PGPUB	OR	OFF	2012/05/11 17:48
S28	10	"20070050515" "20070067483" "20070083746" "20070109154" "20070109155" "20070109156" "20070174209" "20080232457" "20090154545" "20090287839"	US- PGPUB	OR	OFF	2012/05/11 17:53
S29	3	("6317818" "6633968" RE40092).pn.	USPAT	OR	OFF	2012/05/14 09:32

S30	6	"20100316114" "20100318684" "20100332700" "20110037626" "20110199243" "20110208833"	US- PGPUB	OR	OFF	2012/05/14 09:37
S31	1	"8090936".pn.	USPAT	OR	OFF	2012/05/14 10:34
S32	3	maintain\$3 near3 list near2 boot adj1 data	USPAT	OR	OFF	2012/05/14 12:53
S33	4	maintain\$3 near3 list near2 boot adj1 data	US- PGPUB	OR	OFF	2012/05/14 12:54
S34	0	maintain\$3 near3 list near2 boot adj1 data	EPO; JPO; IBM_TDB	OR	OFF	2012/05/14 12:54
S35	5	boot adj1 list with computer	USPAT	OR	OFF	2012/05/14 13:00
S36	5	boot adj1 list with computer	US- PGPUB	OR	OFF	2012/05/14 13:05
S37	0	boot adj1 list with computer	EPO; JPO; IBM_TDB	OR	OFF	2012/05/14 13:09
S38	5	accelerated near2 loading with operating adj1 system	USPAT	OR	OFF	2012/05/14 13:13
S39	9	accelerated near2 loading with operating adj1 system	US- PGPUB	OR	OFF	2012/05/14 13:17
S40	0	accelerated near2 loading with operating adj1 system	EPO; JPO; IBM_TDB	OR	OFF	2012/05/14 13:17
S41	3	(preload\$3 pre\$1load\$3) near3 boot near2 (data files information configuration) with (initializ\$5 power\$1on power adj1 on) with (computer system device)	USPAT	OR	OFF	2012/05/14 13:21
S42	4	(preload\$3 pre\$1load\$3) near3 boot near2 (data files information configuration) with (initializ\$5 power\$1on power adj1 on) with (computer system device)	US- PGPUB	OR	OFF	2012/05/14 13:26
S43	0	(preload\$3 pre\$1load\$3) near3 boot near2 (data files information configuration) with (initializ\$5 power\$1on power adj1 on) with (computer system device)	EPO; JPO; IBM_TDB	OR	OFF	2012/05/14 13:26
S44	68	("6073232").URPN.	USPAT	OR	OFF	2012/05/14 13:49
S45	9	("4663707"   "5210875"   "5230052"   "5269022"   "5307497"   "5325532"   "5355498"   "5404527"   "5410699").PN.	US- PGPUB; USPAT; USOCR	OR	OFF	2012/05/14 14:21

5/14/2012 4:52:32 PM

C:\Users\ssuryawanshi\Documents\EAST\Workspaces\13118122AcceleratedLoadingOfOS.wsp

Substitute for form 1449/PTO		<i>Complete if Known</i>	
<b>INFORMATION DISCLOSURE STATEMENT BY APPLICANT</b> <i>(Use as many sheets as necessary)</i>		Application Number	13/118,122
		Filing Date	May 27, 2011
		First Named Inventor	James J. FALLON
		Art Unit	2115
		Examiner Name	To Be Assigned
Sheet	1	of	27
		Attorney Docket Number	2855.004000B

U.S. PATENT DOCUMENTS						
Examiner initials*	Cite No. <sup>1</sup>	Document Number		Publication Date MM-DD-YYYY	Name of Patentee or Applicant of Cited Document	Pages, Columns, Lines, Where Relevant Passages or Relevant Figures Appear
		Number-Kind Code <sup>2</sup> (if known)				
	US1	3,394,352		07-23-1968	Wernikoff et al.	
	US2	3,490,690		01-20-1970	Apple et al.	
	US3	4,021,782		05-03-1977	Hoerning	
	US4	4,032,893		06-28-1977	Moran	
	US5	4,054,951		10-18-1977	Jackson et al.	
	US6	4,127,518		11-28-1978	Coy et al.	
	US7	4,302,775		11-24-1981	Widergren et al.	
	US8	4,325,085		04-13-1982	Gooch	
	US9	4,360,840		11-23-1982	Wolfrun et al.	
	US10	4,386,416		05-31-1983	Giltner et al.	
	US11	4,394,774		07-19-1983	Widergren et al.	
	US12	4,464,650		08-07-1984	Eastman	
	US13	4,494,108		01-15-1985	Langdon, Jr. et al.	
	US14	4,499,499		02-12-1985	Brickman et al.	
	US15	4,574,351		03-04-1986	Dang et al.	
	US16	4,593,324		06-03-1986	Ohkubo et al.	
	US17	4,626,829		12-02-1986	Hauck	
	US18	4,646,061		02-24-1987	Biedsoe	
	US19	4,682,150		07-21-1987	Mathes et al.	
	US20	4,701,745		10-20-1987	Waterworth	

FOREIGN PATENT DOCUMENTS							
Examiner initials*	Cite No. <sup>1</sup>	Foreign Patent Document		Publication Date MM-DD-YYYY	Name of Patentee or Applicant of Cited Document	Pages, Columns, Lines, Where Relevant Passages or Relevant Figures Appear	T <sup>6</sup>
		Country Code <sup>3</sup> -Number <sup>4</sup> -Kind Code <sup>5</sup> (if known)					
	FP1	DE	4127518	02-27-1992	Tokico Ltd		
	FP2	EP	0164677	12-18-1985	Texas Instruments Inc		
	FP3	EP	0185098	06-25-1986	Hitachi Ltd		
	FP4	EP	0283798	09-28-1988	International Business Machines Corporation		
	FP5	EP	0405572	01-02-1991	Fujitsu Limited		
	FP6	EP	0493130	07-01-1992	Canon Kabushiki Kaisha		
	FP7	EP	0587437	03-16-1994	International Business Machines Corporation		
	FP8	EP	0595406	05-04-1994	Philips Electronics		

Examiner Signature	/Suresh Suryawanshi/	Date Considered	05/14/2012
-----------------------	----------------------	--------------------	------------

\*EXAMINER: Initial if reference considered, whether or not citation is in conformance with MPEP 609. Draw line through citation if not in conformance and not considered. Include copy of this form with next communication to applicant. <sup>1</sup> Applicant's unique citation designation number (optional). <sup>2</sup> See Kinds Codes of USPTO Patent Documents at www.uspto.gov or MPEP 901.04. <sup>3</sup> Enter Office that issued the document, by the two-letter code (WIPO Standard ST.3). <sup>4</sup> For Japanese patent documents, the indication of the year of the reign of the Emperor must precede the serial number of the patent document. <sup>5</sup> Kind of document by the appropriate symbols as indicated on the document under WIPO Standard ST.16 if possible. <sup>6</sup> Applicant is to place a check mark here if English language Translation is attached.

ALL REFERENCES CONSIDERED EXCEPT WHERE LINED THROUGH. /SKS./

Substitute for form 1449/PTO		<b>Complete if Known</b>	
<b>INFORMATION DISCLOSURE STATEMENT BY APPLICANT</b> <i>(Use as many sheets as necessary)</i>		Application Number	13/118,122
		Filing Date	May 27, 2011
		First Named Inventor	James J. FALLON
		Art Unit	2115
		Examiner Name	To Be Assigned
Sheet	2	of	27
		Attorney Docket Number	2855.004000B

U.S. PATENT DOCUMENTS						
Examiner Initials*	Cite No. <sup>1</sup>	Document Number		Publication Date MM-DD-YYYY	Name of Patentee or Applicant of Cited Document	Pages, Columns, Lines, Where Relevant Passages or Relevant Figures Appear
		Number-Kind Code <sup>2</sup> (if known)				
	US21	4,729,020		03-01-1988	Schaphorst et al.	
	US22	4,730,348		03-08-1988	MacCrisken	
	US23	4,745,559		05-17-1988	Willis et al.	
	US24	4,748,638		05-31-1988	Freidman et al.	
	US25	4,750,135		06-07-1988	Boilen	
	US26	4,754,351		06-28-1988	Wright	
	US27	4,804,959		02-14-1989	Makansi et al.	
	US28	4,813,040		03-14-1989	Futato	
	US29	4,814,746		03-21-1989	Miller et al.	
	US30	4,862,167		08-29-1989	Copeland, III	
	US31	4,866,601		09-12-1989	DuLac et al.	
	US32	4,870,415		09-26-1989	Van Maren et al.	
	US33	4,872,009		10-03-1989	Tsukiyama et al.	
	US34	4,876,541		10-24-1989	Storer	
	US35	4,888,812		12-19-1989	Dinan et al.	
	US36	4,890,282		12-26-1989	Lambert et al.	
	US37	4,897,717		01-30-1990	Hamilton et al.	
	US38	4,906,991		03-06-1990	Fiala et al.	
	US39	4,906,995		03-06-1990	Swanson	
	US40	4,929,946		05-29-1990	O'Brien et al.	

FOREIGN PATENT DOCUMENTS							
Examiner Initials*	Cite No. <sup>1</sup>	Foreign Patent Document		Publication Date MM-DD-YYYY	Name of Patentee or Applicant of Cited Document	Pages, Columns, Lines, Where Relevant Passages or Relevant Figures Appear	T <sup>6</sup>
		Country Code <sup>3</sup> -Number <sup>4</sup> -Kind Code <sup>5</sup> (if known)					
	FP9	EP 0718751		06-26-1996	International Business Machines Corporation		
	FP10	EP 0928070		07-07-1999	Unwired Planet, Inc		
	FP11	GB 2162025		01-22-1986	King Reginald Alfred		
	FP12	JP 6051989		02-25-1994	NEC Corp		
	FP13	JP 9188009		07-22-1997	Canon Inc		
	FP14	JP 11149376		06-02-1999	Toyo Commun Equip Co. Ltd		
	FP15	WO 94/14273		06-23-1994	Voxson International Pty Ltd		
	FP16	WO 94/29852		12-22-1994	Maxtor Corp		

Examiner Signature	/Suresh Suryawanshi/	Date Considered	05/14/2012
--------------------	----------------------	-----------------	------------

\*EXAMINER: Initial if reference considered, whether or not citation is in conformance with MPEP 609. Draw line through citation if not in conformance and not considered. Include copy of this form with next communication to applicant. <sup>1</sup> Applicant's unique citation designation number (optional). <sup>2</sup> See Kinds Codes of USPTO Patent Documents at www.uspto.gov or MPEP 901.04. <sup>3</sup> Enter Office that issued the document, by the two-letter code (WIPO Standard ST.3). <sup>4</sup> For Japanese patent documents, the indication of the year of the reign of the Emperor must precede the serial number of the patent document. <sup>5</sup> Kind of document by the appropriate symbols as indicated on the document under WIPO Standard ST.16 if possible. <sup>6</sup> Applicant is to place a check mark here if English language Translation is attached.

ALL REFERENCES CONSIDERED EXCEPT WHERE LINED THROUGH. /SKS./

<b>INFORMATION DISCLOSURE STATEMENT BY APPLICANT</b> <i>(Use as many sheets as necessary)</i>		<i>Complete if Known</i>	
		Application Number	13/118,122
		Filing Date	May 27, 2011
		First Named Inventor	James J. FALLON
		Art Unit	2115
		Examiner Name	To Be Assigned
Sheet	3	of	27
		Attorney Docket Number	2855.004000B

U.S. PATENT DOCUMENTS						
Examiner Initials*	Cite No. <sup>1</sup>	Document Number		Publication Date MM-DD-YYYY	Name of Patentee or Applicant of Cited Document	Pages, Columns, Lines, Where Relevant Passages or Relevant Figures Appear
		Number-Kind Code <sup>2</sup> (if known)				
	US41	4,953,324		09-04-1990	Hermann	
	US42	4,956,808		09-11-1990	Aakre et al.	
	US43	4,965,675		10-23-1990	Hori et al.	
	US44	4,988,998		01-29-1991	O'Brien	
	US45	5,003,307		03-26-1991	Whiting et al.	
	US46	5,016,009		05-14-1991	Whiting et al.	
	US47	5,027,376		06-25-1991	Freidman et al.	
	US48	5,028,922		07-02-1991	Huang	
	US49	5,045,848		09-03-1991	Fascenda	
	US50	5,045,852		09-03-1991	Mitchell et al.	
	US51	5,046,027		09-03-1991	Taaffe et al.	
	US52	5,049,881		09-17-1991	Gibson et al.	
	US53	5,091,782		02-25-1992	Krause et al.	
	US54	5,097,261		03-17-1992	Langdon, Jr. et al.	
	US55	5,109,226		04-28-1992	MacLean, Jr. et al.	
	US56	5,109,433		04-28-1992	Notenboom	
	US57	5,113,522		05-12-1992	Dinwiddie, Jr. et al.	
	US58	5,115,309		05-19-1992	Hang	
	US59	5,121,342		06-09-1992	Szymborski	
	US60	5,126,739		06-30-1992	Whiting et al.	

FOREIGN PATENT DOCUMENTS							
Examiner Initials*	Cite No. <sup>1</sup>	Foreign Patent Document		Publication Date MM-DD-YYYY	Name of Patentee or Applicant of Cited Document	Pages, Columns, Lines, Where Relevant Passages or Relevant Figures Appear	T <sup>6</sup>
		Country Code <sup>3</sup> -Number <sup>4</sup> -Kind Code <sup>5</sup> (if known)					
	FP17	WO 95/02873		01-26-1995	Philips Electronics		
	FP18	WO 95/29437 A1		11-02-1995	Sony Corp		
	FP19	WO 97/48212		12-18-1997	Nokia Telecommunications		
	FP20	WO 98/39699 A2		09-11-1998	Intelligent Compression Technologies		
	FP21	WO 99/08186		02-18-1999	Macronix International Co, Ltd		
	FP22	WO 00/36754 A1		06-22-2000	Microsoft Corporation		
	FP23	WO 01/057642		08-09-2001	Realtime Data LLC		
	FP24	WO 01/057659		08-09-2001	Realtime Data LLC		

Examiner Signature	/Suresh Suryawanshi/	Date Considered	05/14/2012
--------------------	----------------------	-----------------	------------

\*EXAMINER: Initial if reference considered, whether or not citation is in conformance with MPEP 609. Draw line through citation if not in conformance and not considered. Include copy of this form with next communication to applicant. <sup>1</sup> Applicant's unique citation designation number (optional). <sup>2</sup> See Kinds Codes of USPTO Patent Documents at www.uspto.gov or MPEP 901.04. <sup>3</sup> Enter Office that issued the document, by the two-letter code (WIPO Standard ST.3). <sup>4</sup> For Japanese patent documents, the indication of the year of the reign of the Emperor must precede the serial number of the patent document. <sup>5</sup> Kind of document by the appropriate symbols as indicated on the document under WIPO Standard ST.16 if possible. <sup>6</sup> Applicant is to place a check mark here if English language Translation is attached.

ALL REFERENCES CONSIDERED EXCEPT WHERE LINED THROUGH. /SKS./

<b>INFORMATION DISCLOSURE STATEMENT BY APPLICANT</b> <i>(Use as many sheets as necessary)</i>		<i>Complete if Known</i>	
		Application Number	13/118,122
		Filing Date	May 27, 2011
		First Named Inventor	James J. FALLON
		Art Unit	2115
		Examiner Name	To Be Assigned
Sheet	4	of	27
		Attorney Docket Number	2855.004000B

U.S. PATENT DOCUMENTS						
Examiner Initials*	Cite No. <sup>1</sup>	Document Number		Publication Date MM-DD-YYYY	Name of Patentee or Applicant of Cited Document	Pages, Columns, Lines, Where Relevant Passages or Relevant Figures Appear
		Number-Kind Code <sup>2</sup> (if known)				
	US61	5,128,963		07-07-1992	Akagiri	
	US62	5,132,992		07-21-1992	Yurt et al.	
	US63	5,146,221		09-08-1992	Whiting et al.	
	US64	5,150,430		09-22-1992	Chu	
	US65	5,155,484		10-13-1992	Chambers, IV	
	US66	5,159,336		10-27-1992	Rabin et al.	
	US67	5,167,034		11-24-1992	MacLean, Jr. et al.	
	US68	5,175,543		12-29-1992	Lantz	
	US69	5,179,651		01-12-1993	Taaffe et al.	
	US70	5,187,793		02-16-1993	Keith et al.	
	US71	5,191,431		03-02-1993	Hasegawa et al.	
	US72	5,204,756		04-20-1993	Chevion et al.	
	US73	5,209,220		05-11-1993	Hiyama et al.	
	US74	5,212,742		05-18-1993	Normile et al.	
	US75	5,226,176		07-06-1993	Westaway et al.	
	US76	5,227,893		07-13-1993	Ett	
	US77	5,231,492		07-27-1993	Dangi et al.	
	US78	5,237,460		08-17-1993	Miller et al.	
	US79	5,237,675		08-17-1993	Hannon, Jr.	
	US80	5,243,341		09-07-1993	Seroussi et al.	

FOREIGN PATENT DOCUMENTS							
Examiner Initials*	Cite No. <sup>1</sup>	Foreign Patent Document		Publication Date MM-DD-YYYY	Name of Patentee or Applicant of Cited Document	Pages, Columns, Lines, Where Relevant Passages or Relevant Figures Appear	T <sup>6</sup>
		Country Code <sup>3</sup> -Number <sup>4</sup> -Kind Code <sup>5</sup> (if known)					
	FP25	WO	01/63772	08-30-2001	Physical Optics Corporation		
	FP26	WO	02/39591	05-16-2002	Realtime Data LLC		

Examiner Signature	/Suresh Suryawanshi/	Date Considered	05/14/2012
--------------------	----------------------	-----------------	------------

\*EXAMINER: Initial if reference considered, whether or not citation is in conformance with MPEP 609. Draw line through citation if not in conformance and not considered. Include copy of this form with next communication to applicant. <sup>1</sup> Applicant's unique citation designation number (optional). <sup>2</sup> See Kinds Codes of USPTO Patent Documents at www.uspto.gov or MPEP 901.04. <sup>3</sup> Enter Office that issued the document, by the two-letter code (WIPO Standard ST.3). <sup>4</sup> For Japanese patent documents, the indication of the year of the reign of the Emperor must precede the serial number of the patent document. <sup>5</sup> Kind of document by the appropriate symbols as indicated on the document under WIPO Standard ST.16 if possible. <sup>6</sup> Applicant is to place a check mark here if English language Translation is attached.

ALL REFERENCES CONSIDERED EXCEPT WHERE LINED THROUGH. /SKS./

Substitute for form 1449/PTO		<i>Complete if Known</i>	
<b>INFORMATION DISCLOSURE STATEMENT BY APPLICANT</b> <i>(Use as many sheets as necessary)</i>		Application Number	13/118,122
		Filing Date	May 27, 2011
		First Named Inventor	James J. FALLON
		Art Unit	2115
		Examiner Name	To Be Assigned
Sheet	5 of 27	Attorney Docket Number	2855.004000B

U.S. PATENT DOCUMENTS						
Examiner Initials*	Cite No. <sup>1</sup>	Document Number		Publication Date MM-DD-YYYY	Name of Patentee or Applicant of Cited Document	Pages, Columns, Lines, Where Relevant Passages or Relevant Figures Appear
		Number	Kind Code 2 (if known)			
	US81	5,243,348		09-07-1993	Jackson	
	US82	5,247,638		09-21-1993	O'Brien et al.	
	US83	5,247,646		09-21-1993	Osterlund et al.	
	US84	5,249,053		09-28-1993	Jain	
	US85	5,263,168		11-16-1993	Toms et al.	
	US86	5,267,333		11-30-1993	Aono	
	US87	5,270,832		12-14-1993	Balkanski et al.	
	US88	5,280,600		01-18-1994	Van Maren et al.	
	US89	5,287,420		02-15-1994	Barrett	
	US90	5,289,580		02-22-1994	Latif et al.	
	US91	5,293,379		03-08-1994	Carr	
	US92	5,293,576		03-08-1994	Mihm, Jr. et al.	
	US93	5,307,497		04-26-1994	Feigenbaum et al.	
	US94	5,309,555		05-03-1994	Akins et al.	
	US95	5,319,682		06-07-1994	Clark	
	US96	5,341,440		08-23-1994	Earl et al.	
	US97	5,347,600		09-13-1994	Barnsley et al.	
	US98	5,353,132		10-04-1994	Katsuma	
	US99	5,354,315		10-11-1994	Armstrong	
	US100	5,355,498		10-11-1994	Provino et al.	

FOREIGN PATENT DOCUMENTS							
Examiner Initials*	Cite No. <sup>1</sup>	Foreign Patent Document		Publication Date MM-DD-YYYY	Name of Patentee or Applicant of Cited Document	Pages, Columns, Lines, Where Relevant Passages or Relevant Figures Appear	T <sup>6</sup>
		Country Code <sup>3</sup>	Number <sup>4</sup> -Kind Code <sup>5</sup> (if known)				

Examiner Signature	/Suresh Suryawanshi/	Date Considered	05/14/2012
--------------------	----------------------	-----------------	------------

\*EXAMINER: Initial if reference considered, whether or not citation is in conformance with MPEP 609. Draw line through citation if not in conformance and not considered. Include copy of this form with next communication to applicant. <sup>1</sup> Applicant's unique citation designation number (optional). <sup>2</sup> See Kinds Codes of USPTO Patent Documents at www.uspto.gov or MPEP 901.04. <sup>3</sup> Enter Office that issued the document, by the two-letter code (WIPO Standard ST.3). <sup>4</sup> For Japanese patent documents, the indication of the year of the reign of the Emperor must precede the serial number of the patent document. <sup>5</sup> Kind of document by the appropriate symbols as indicated on the document under WIPO Standard ST.16 if possible. <sup>6</sup> Applicant is to place a check mark here if English language Translation is attached.

ALL REFERENCES CONSIDERED EXCEPT WHERE LINED THROUGH. /SKS./



Substitute for form 1449/PTO		<b>Complete if Known</b>	
<b>INFORMATION DISCLOSURE STATEMENT BY APPLICANT</b> <i>(Use as many sheets as necessary)</i>		Application Number	13/118,122
		Filing Date	May 27, 2011
		First Named Inventor	James J. FALLON
		Art Unit	2115
		Examiner Name	To Be Assigned
Sheet	6 of 27	Attorney Docket Number	2855.004000B

U.S. PATENT DOCUMENTS						
Examiner Initials*	Cite No. <sup>1</sup>	Document Number		Publication Date MM-DD-YYYY	Name of Patentee or Applicant of Cited Document	Pages, Columns, Lines, Where Relevant Passages or Relevant Figures Appear
		Number	Kind Code <sup>2</sup> (if known)			
	US101	5,357,614		10-18-1994	Pattisan et al.	
	US102	5,367,629		11-22-1994	Chu et al.	
	US103	5,373,290		12-13-1994	Lempel et al.	
	US104	5,374,916		12-20-1994	Chu	
	US105	5,379,036		01-03-1995	Storer	
	US106	5,379,757		01-10-1995	Hiyama et al.	
	US107	5,381,145		01-10-1995	Allen et al.	
	US108	5,389,922		02-14-1995	Seroussi et al.	
	US109	5,394,534		02-28-1995	Kulakowski et al.	
	US110	5,396,228		03-07-1995	Garahi	
	US111	5,400,401		03-21-1995	Wasilewski et al.	
	US112	5,403,639		04-04-1995	Belsan et al.	
	US113	5,406,278		04-11-1995	Graybill et al.	
	US114	5,406,279		04-11-1995	Anderson et al.	
	US115	5,410,671		04-25-1995	Elgamal et al.	
	US116	5,412,384		05-02-1995	Chang et al.	
	US117	5,414,850		05-09-1995	Whiting	
	US118	5,420,639		05-30-1995	Perkins	
	US119	5,434,983		07-18-1995	Yaso et al.	
	US120	5,437,020		07-25-1995	Wells et al.	

FOREIGN PATENT DOCUMENTS							
Examiner Initials*	Cite No. <sup>1</sup>	Foreign Patent Document		Publication Date MM-DD-YYYY	Name of Patentee or Applicant of Cited Document	Pages, Columns, Lines, Where Relevant Passages or Relevant Figures Appear	T <sup>6</sup>
		Country Code <sup>3</sup>	Number <sup>4</sup> -Kind Code <sup>5</sup> (if known)				

Examiner Signature	/Suresh Suryawanshi/	Date Considered	05/14/2012
--------------------	----------------------	-----------------	------------

\*EXAMINER: Initial if reference considered, whether or not citation is in conformance with MPEP 609. Draw line through citation if not in conformance and not considered. Include copy of this form with next communication to applicant. <sup>1</sup> Applicant's unique citation designation number (optional). <sup>2</sup> See Kinds Codes of USPTO Patent Documents at www.uspto.gov or MPEP 901.04. <sup>3</sup> Enter Office that issued the document, by the two-letter code (WIPO Standard ST.3). <sup>4</sup> For Japanese patent documents, the indication of the year of the reign of the Emperor must precede the serial number of the patent document. <sup>5</sup> Kind of document by the appropriate symbols as indicated on the document under WIPO Standard ST.16 if possible. <sup>6</sup> Applicant is to place a check mark here if English language Translation is attached.

ALL REFERENCES CONSIDERED EXCEPT WHERE LINED THROUGH. /SKS./

Substitute for form 1449/PTO  <b>INFORMATION DISCLOSURE STATEMENT BY APPLICANT</b> <i>(Use as many sheets as necessary)</i>		<i>Complete if Known</i>			
		Application Number	13/118,122		
		Filing Date	May 27, 2011		
		First Named Inventor	James J. FALLON		
		Art Unit	2115		
		Examiner Name	To Be Assigned		
Sheet	7	of	27	Attorney Docket Number	2855.004000B

U.S. PATENT DOCUMENTS						
Examiner initials*	Cite No. <sup>1</sup>	Document Number		Publication Date MM-DD-YYYY	Name of Patentee or Applicant of Cited Document	Pages, Columns, Lines, Where Relevant Passages or Relevant Figures Appear
		Number-Kind Code <sup>2</sup> (if known)				
	US121	5,452,287		09-19-1995	Dicecco et al.	
	US122	5,454,079		09-26-1995	Roper et al.	
	US123	5,454,107		09-26-1995	Lehman et al.	
	US124	5,455,576		10-03-1995	Clark, II et al.	
	US125	5,455,578		10-03-1995	Bhandari	
	US126	5,455,680		10-03-1995	Shin	
	US127	5,461,679		10-24-1995	Normile et al.	
	US128	5,463,390		10-31-1995	Whiting et al.	
	US129	5,467,087		11-14-1995	Chu	
	US130	5,471,206		11-28-1995	Allen et al.	
	US131	5,479,587		12-26-1995	Campbell et al.	
	US132	5,479,633		12-26-1995	Wells et al.	
	US133	5,483,470		01-09-1996	Alur et al.	
	US134	5,486,826		01-23-1996	Remillard	
	US135	5,488,364		01-30-1996	Cole	
	US136	5,488,365		01-30-1996	Seroussi et al.	
	US137	5,495,244		02-27-1996	Jeong et al.	
	US138	5,504,842		04-02-1996	Gentile	
	US139	5,506,844		04-09-1996	Rao	
	US140	5,506,872		04-09-1996	Mobler	

FOREIGN PATENT DOCUMENTS							
Examiner initials*	Cite No. <sup>1</sup>	Foreign Patent Document		Publication Date MM-DD-YYYY	Name of Patentee or Applicant of Cited Document	Pages, Columns, Lines, Where Relevant Passages or Relevant Figures Appear	T <sup>6</sup>
		Country Code <sup>3</sup> -Number <sup>4</sup> -Kind Code <sup>5</sup> (if known)					

Examiner Signature	/Suresh Suryawanshi/	Date Considered	05/14/2012
--------------------	----------------------	-----------------	------------

\*EXAMINER: Initial if reference considered, whether or not citation is in conformance with MPEP 609. Draw line through citation if not in conformance and not considered. Include copy of this form with next communication to applicant. <sup>1</sup> Applicant's unique citation designation number (optional). <sup>2</sup> See Kinds Codes of USPTO Patent Documents at www.uspto.gov or MPEP 901.04. <sup>3</sup> Enter Office that issued the document, by the two-letter code (WIPO Standard ST.3). <sup>4</sup> For Japanese patent documents, the indication of the year of the reign of the Emperor must precede the serial number of the patent document. <sup>5</sup> Kind of document by the appropriate symbols as indicated on the document under WIPO Standard ST.16 if possible. <sup>6</sup> Applicant is to place a check mark here if English language Translation is attached.

ALL REFERENCES CONSIDERED EXCEPT WHERE LINED THROUGH. /SKS./

Substitute for form 1449/PTO			<b>Complete if Known</b>		
<b>INFORMATION DISCLOSURE STATEMENT BY APPLICANT</b> <i>(Use as many sheets as necessary)</i>			Application Number	13/118,122	
			Filing Date	May 27, 2011	
			First Named Inventor	James J. FALLON	
			Art Unit	2115	
			Examiner Name	To Be Assigned	
Sheet	8	of	27	Attorney Docket Number	2855.004000B

<b>U.S. PATENT DOCUMENTS</b>						
Examiner Initials*	Cite No. <sup>1</sup>	Document Number		Publication Date MM-DD-YYYY	Name of Patentee or Applicant of Cited Document	Pages, Columns, Lines, Where Relevant Passages or Relevant Figures Appear
		Number	Kind Code <sup>2</sup> (if known)			
	US141	5,506,944		04-09-1996	Gentile	
	US142	5,521,940		05-28-1996	Lane et al.	
	US143	5,528,628		06-18-1996	Park et al.	
	US144	5,530,845		06-25-1996	Hiatt et al.	
	US145	5,533,051		07-02-1996	James	
	US146	5,535,311		07-09-1996	Zimmerman	
	US147	5,535,356		07-09-1996	Kim et al.	
	US148	5,535,369		07-09-1996	Wells et al.	
	US149	5,537,658		07-16-1996	Bakke et al.	
	US150	5,539,865		07-23-1996	Gentile	
	US151	5,542,031		07-30-1996	Douglass et al.	
	US152	5,544,290		08-06-1996	Gentile	
	US153	5,546,395		08-13-1996	Sharma et al.	
	US154	5,546,475		08-13-1996	Bolle et al.	
	US155	5,553,160		09-03-1996	Dawson	
	US156	5,557,551		09-17-1996	Craft	
	US157	5,557,668		09-17-1996	Brady	
	US158	5,557,749		09-17-1996	Norris	
	US159	5,561,421		10-01-1996	Smith et al.	
	US160	5,561,824		10-01-1996	Carreiro et al.	

<b>FOREIGN PATENT DOCUMENTS</b>							
Examiner Initials*	Cite No. <sup>1</sup>	Foreign Patent Document		Publication Date MM-DD-YYYY	Name of Patentee or Applicant of Cited Document	Pages, Columns, Lines, Where Relevant Passages or Relevant Figures Appear	T <sup>6</sup>
		Country Code <sup>3</sup>	Number <sup>4</sup> -Kind Code <sup>5</sup> (if known)				

Examiner Signature	/Suresh Suryawanshi/	Date Considered	05/14/2012
-----------------------	----------------------	--------------------	------------

\*EXAMINER: Initial if reference considered, whether or not citation is in conformance with MPEP 609. Draw line through citation if not in conformance and not considered. Include copy of this form with next communication to applicant. <sup>1</sup> Applicant's unique citation designation number (optional). <sup>2</sup> See Kinds Codes of USPTO Patent Documents at [www.uspto.gov](http://www.uspto.gov) or MPEP 901.04. <sup>3</sup> Enter Office that issued the document, by the two-letter code (WIPO Standard ST.3). <sup>4</sup> For Japanese patent documents, the indication of the year of the reign of the Emperor must precede the serial number of the patent document. <sup>5</sup> Kind of document by the appropriate symbols as indicated on the document under WIPO Standard ST.16 if possible. <sup>6</sup> Applicant is to place a check mark here if English language Translation is attached.

ALL REFERENCES CONSIDERED EXCEPT WHERE LINED THROUGH. /SKS./

Substitute for form 1449/PTO		<i>Complete if Known</i>	
<b>INFORMATION DISCLOSURE STATEMENT BY APPLICANT</b> <i>(Use as many sheets as necessary)</i>		Application Number	13/118,122
		Filing Date	May 27, 2011
		First Named Inventor	James J. FALLON
		Art Unit	2115
		Examiner Name	To Be Assigned
Sheet	9	of	27
		Attorney Docket Number	2855.004000B

U.S. PATENT DOCUMENTS						
Examiner initials*	Cite No. <sup>1</sup>	Document Number		Publication Date MM-DD-YYYY	Name of Patentee or Applicant of Cited Document	Pages, Columns, Lines, Where Relevant Passages or Relevant Figures Appear
		Number	Kind Code 2 (if known)			
	US161	5,563,961		10-08-1996	Rynderman et al.	
	US162	5,574,952		11-12-1996	Brady et al.	
	US163	5,574,953		11-12-1996	Rust et al.	
	US164	5,576,953		11-19-1996	Hugentobler	
	US165	5,577,248		11-19-1996	Chambers, IV	
	US166	5,581,715		12-03-1996	Verinsky et al.	
	US167	5,583,500		12-10-1996	Allen et al.	
	US168	5,586,264		12-17-1996	Belknap et al.	
	US169	5,586,285		12-17-1996	Hasbun et al.	
	US170	5,590,306		12-31-1996	Watanabe et al.	
	US171	5,596,674		01-21-1997	Bhandari et al.	
	US172	5,598,388		01-28-1997	Van Maren et al.	
	US173	5,604,824		02-18-1997	Chui et al.	
	US174	5,606,706		02-25-1997	Takamoto et al.	
	US175	5,610,657		03-11-1997	Zhang	
	US176	5,611,024		03-11-1997	Campbell et al.	
	US177	5,612,788		03-18-1997	Stone	
	US178	5,613,069		03-18-1997	Walker	
	US179	5,615,017		03-25-1997	Choi	
	US180	5,615,287		03-25-1997	Fu et al.	

FOREIGN PATENT DOCUMENTS							
Examiner initials*	Cite No. <sup>1</sup>	Foreign Patent Document		Publication Date MM-DD-YYYY	Name of Patentee or Applicant of Cited Document	Pages, Columns, Lines, Where Relevant Passages or Relevant Figures Appear	T <sup>6</sup>
		Country Code <sup>3</sup> -Number <sup>4</sup> -Kind Code <sup>5</sup> (if known)					

Examiner Signature	/Suresh Suryawanshi/	Date Considered	05/14/2012
-----------------------	----------------------	--------------------	------------

\*EXAMINER: Initial if reference considered, whether or not citation is in conformance with MPEP 609. Draw line through citation if not in conformance and not considered. Include copy of this form with next communication to applicant. <sup>1</sup> Applicant's unique citation designation number (optional). <sup>2</sup> See Kinds Codes of USPTO Patent Documents at www.uspto.gov or MPEP 901.04. <sup>3</sup> Enter Office that issued the document, by the two-letter code (WIPO Standard ST.3). <sup>4</sup> For Japanese patent documents, the indication of the year of the reign of the Emperor must precede the serial number of the patent document. <sup>5</sup> Kind of document by the appropriate symbols as indicated on the document under WIPO Standard ST.16 if possible. <sup>6</sup> Applicant is to place a check mark here if English language Translation is attached.

ALL REFERENCES CONSIDERED EXCEPT WHERE LINED THROUGH. /SKS./

Substitute for form 1449/PTO  <b>INFORMATION DISCLOSURE STATEMENT BY APPLICANT</b> <i>(Use as many sheets as necessary)</i>		<i>Complete if Known</i>			
		Application Number	13/118,122		
		Filing Date	May 27, 2011		
		First Named Inventor	James J. FALLON		
		Art Unit	2115		
		Examiner Name	To Be Assigned		
Sheet	10	of	27	Attorney Docket Number	2855.004000B

U.S. PATENT DOCUMENTS						
Examiner initials*	Cite No. <sup>1</sup>	Document Number		Publication Date MM-DD-YYYY	Name of Patentee or Applicant of Cited Document	Pages, Columns, Lines, Where Relevant Passages or Relevant Figures Appear
		Number	Kind Code 2 (if known)			
	US181	5,619,995		04-15-1997	Lobodzinski	
	US182	5,621,820		04-15-1997	Rynderman et al.	
	US183	5,623,623		04-22-1997	Kim et al.	
	US184	5,623,701		04-22-1997	Bakke et al.	
	US185	5,627,534		05-06-1997	Craft	
	US186	5,627,995		05-06-1997	Miller et al.	
	US187	5,629,732		05-13-1997	Moskowitz et al.	
	US188	5,630,092		05-13-1997	Carreiro et al.	
	US189	5,635,632		06-03-1997	Fay et al.	
	US190	5,635,932		06-03-1997	Shinagawa et al.	
	US191	5,638,498		06-10-1997	Tyler et al.	
	US192	5,640,158		06-17-1997	Okayama et al.	
	US193	5,642,506		06-24-1997	Lee	
	US194	5,649,032		07-15-1997	Burt et al.	
	US195	5,652,795		07-29-1997	Dillon et al.	
	US196	5,652,857		07-29-1997	Shimoi et al.	
	US197	5,652,917		07-29-1997	Maupin et al.	
	US198	5,654,703		08-05-1997	Clark, II	
	US199	5,655,138		08-05-1997	Kikinis	
	US200	5,666,560		09-09-1997	Moertl et al.	

FOREIGN PATENT DOCUMENTS							
Examiner initials*	Cite No. <sup>1</sup>	Foreign Patent Document		Publication Date MM-DD-YYYY	Name of Patentee or Applicant of Cited Document	Pages, Columns, Lines, Where Relevant Passages or Relevant Figures Appear	T <sup>6</sup>
		Country Code <sup>3</sup> -Number <sup>4</sup> -Kind Code <sup>5</sup> (if known)					

Examiner Signature	/Suresh Suryawanshi/	Date Considered	05/14/2012
--------------------	----------------------	-----------------	------------

\*EXAMINER: Initial if reference considered, whether or not citation is in conformance with MPEP 609. Draw line through citation if not in conformance and not considered. Include copy of this form with next communication to applicant. <sup>1</sup> Applicant's unique citation designation number (optional). <sup>2</sup> See Kinds Codes of USPTO Patent Documents at www.uspto.gov or MPEP 901.04. <sup>3</sup> Enter Office that issued the document, by the two-letter code (WIPO Standard ST.3). <sup>4</sup> For Japanese patent documents, the indication of the year of the reign of the Emperor must precede the serial number of the patent document. <sup>5</sup> Kind of document by the appropriate symbols as indicated on the document under WIPO Standard ST.16 if possible. <sup>6</sup> Applicant is to place a check mark here if English language Translation is attached.

ALL REFERENCES CONSIDERED EXCEPT WHERE LINED THROUGH. /SKS./

Substitute for form 1449/PTO  <b>INFORMATION DISCLOSURE STATEMENT BY APPLICANT</b> (Use as many sheets as necessary)		<i>Complete if Known</i>			
		Application Number	13/118,122		
		Filing Date	May 27, 2011		
		First Named Inventor	James J. FALLON		
		Art Unit	2115		
		Examiner Name	To Be Assigned		
Sheet	11	of	27	Attorney Docket Number	2855.004000B

U.S. PATENT DOCUMENTS						
Examiner initials*	Cite No. <sup>1</sup>	Document Number		Publication Date MM-DD-YYYY	Name of Patentee or Applicant of Cited Document	Pages, Columns, Lines, Where Relevant Passages or Relevant Figures Appear
		Number-Kind Code 2 (if known)				
	US201	5,668,737		09-16-1997	Iler	
	US202	5,671,355		09-23-1997	Collins	
	US203	5,671,389		09-23-1997	Saliba	
	US204	5,671,413		09-23-1997	Shipman et al.	
	US205	5,675,333		10-07-1997	Boursier et al.	
	US206	5,675,789		10-07-1997	Ishii et al.	
	US207	5,686,916		11-11-1997	Bakhrmutsky	
	US208	5,692,159		11-25-1997	Shand	
	US209	5,694,619		12-02-1997	Konno	
	US210	5,696,927		12-09-1997	MacDonald et al.	
	US211	5,703,793		12-30-1997	Wise et al.	
	US212	5,708,511		01-13-1998	Gandhi et al.	
	US213	5,715,477		02-03-1998	Kikinis	
	US214	5,717,393		02-10-1998	Nakano et al.	
	US215	5,717,394		02-10-1998	Schwartz et al.	
	US216	5,719,862		02-17-1998	Lee et al.	
	US217	5,721,958		02-24-1998	Kikinis	
	US218	5,724,475		03-03-1998	Kirsten	
	US219	5,729,228		03-17-1998	Franaszek et al.	
	US220	5,740,395		04-14-1998	Wells et al.	

FOREIGN PATENT DOCUMENTS							
Examiner initials*	Cite No. <sup>1</sup>	Foreign Patent Document		Publication Date MM-DD-YYYY	Name of Patentee or Applicant of Cited Document	Pages, Columns, Lines, Where Relevant Passages or Relevant Figures Appear	T <sup>6</sup>
		Country Code <sup>3</sup> -Number <sup>4</sup> -Kind Code <sup>5</sup> (if known)					

Examiner Signature	/Suresh Suryawanshi/	Date Considered	05/14/2012
--------------------	----------------------	-----------------	------------

\*EXAMINER: Initial if reference considered, whether or not citation is in conformance with MPEP 609. Draw line through citation if not in conformance and not considered. Include copy of this form with next communication to applicant. <sup>1</sup> Applicant's unique citation designation number (optional). <sup>2</sup> See Kinds Codes of USPTO Patent Documents at www.uspto.gov or MPEP 901.04. <sup>3</sup> Enter Office that issued the document, by the two-letter code (WIPO Standard ST.3). <sup>4</sup> For Japanese patent documents, the indication of the year of the reign of the Emperor must precede the serial number of the patent document. <sup>5</sup> Kind of document by the appropriate symbols as indicated on the document under WIPO Standard ST.16 if possible. <sup>6</sup> Applicant is to place a check mark here if English language Translation is attached.

ALL REFERENCES CONSIDERED EXCEPT WHERE LINED THROUGH. /SKS./

Substitute for form 1449/PTO		<i>Complete if Known</i>	
<b>INFORMATION DISCLOSURE STATEMENT BY APPLICANT</b> <i>(Use as many sheets as necessary)</i>		Application Number	13/118,122
		Filing Date	May 27, 2011
		First Named Inventor	James J. FALLON
		Art Unit	2115
		Examiner Name	To Be Assigned
Sheet	12	of	27
		Attorney Docket Number	2855.004000B

U.S. PATENT DOCUMENTS						
Examiner initials*	Cite No. <sup>1</sup>	Document Number		Publication Date MM-DD-YYYY	Name of Patentee or Applicant of Cited Document	Pages, Columns, Lines, Where Relevant Passages or Relevant Figures Appear
		Number	Kind Code <sup>2</sup> (if known)			
	US221	5,742,773		04-21-1998	Blomfield-Brown et al.	
	US222	5,748,904		05-05-1998	Huang et al.	
	US223	5,757,852		05-26-1998	Jericevic et al.	
	US224	5,765,027		06-09-1998	Wang et al.	
	US225	5,767,898		06-16-1998	Urano et al.	
	US226	5,768,445		06-16-1998	Troeller et al.	
	US227	5,768,525		06-16-1998	Kralowetz et al.	
	US228	5,771,340		06-23-1998	Nakazato et al.	
	US229	5,774,715		06-30-1998	Madany et al.	
	US230	5,778,411		07-07-1998	DeMoss et al.	
	US231	5,781,767		07-14-1998	Inoue et al.	
	US232	5,784,572		07-21-1998	Rostoker et al.	
	US233	5,787,487		07-28-1998	Hashimoto et al.	
	US234	5,794,229		08-11-1998	French et al.	
	US235	5,796,864		08-18-1998	Callahan	
	US236	5,799,110		08-25-1998	Israelsen et al.	
	US237	5,805,834		09-08-1998	McKinley et al.	
	US238	5,805,932		09-08-1998	Kawashima et al.	
	US239	5,808,660		09-15-1998	Sekine et al.	
	US240	5,809,176		09-15-1998	Yajima	

FOREIGN PATENT DOCUMENTS							
Examiner initials*	Cite No. <sup>1</sup>	Foreign Patent Document		Publication Date MM-DD-YYYY	Name of Patentee or Applicant of Cited Document	Pages, Columns, Lines, Where Relevant Passages or Relevant Figures Appear	T <sup>6</sup>
		Country Code <sup>3</sup>	Number <sup>4</sup> -Kind Code <sup>5</sup> (if known)				

Examiner Signature	/Suresh Suryawanshi/	Date Considered	05/14/2012
--------------------	----------------------	-----------------	------------

\*EXAMINER: Initial if reference considered, whether or not citation is in conformance with MPEP 609. Draw line through citation if not in conformance and not considered. Include copy of this form with next communication to applicant. <sup>1</sup> Applicant's unique citation designation number (optional). <sup>2</sup> See Kinds Codes of USPTO Patent Documents at www.uspto.gov or MPEP 901.04. <sup>3</sup> Enter Office that issued the document, by the two-letter code (WIPO Standard ST.3). <sup>4</sup> For Japanese patent documents, the indication of the year of the reign of the Emperor must precede the serial number of the patent document. <sup>5</sup> Kind of document by the appropriate symbols as indicated on the document under WIPO Standard ST.16 if possible. <sup>6</sup> Applicant is to place a check mark here if English language Translation is attached.

ALL REFERENCES CONSIDERED EXCEPT WHERE LINED THROUGH. /SKS./

<b>INFORMATION DISCLOSURE STATEMENT BY APPLICANT</b> <i>(Use as many sheets as necessary)</i>		<i>Complete if Known</i>			
		Application Number	13/118,122		
		Filing Date	May 27, 2011		
		First Named Inventor	James J. FALLON		
		Art Unit	2115		
		Examiner Name	To Be Assigned		
Sheet	13	of	27	Attorney Docket Number	2855.004000B

U.S. PATENT DOCUMENTS						
Examiner initials*	Cite No. <sup>1</sup>	Document Number		Publication Date MM-DD-YYYY	Name of Patentee or Applicant of Cited Document	Pages, Columns, Lines, Where Relevant Passages or Relevant Figures Appear
		Number	Kind Code <sup>2</sup> (if known)			
	US241	5,809,299		09-15-1998	Cloutier et al.	
	US242	5,809,337		09-15-1998	Hannah et al.	
	US243	5,812,195		09-22-1998	Zhang	
	US244	5,812,789		09-22-1998	Diaz et al.	
	US245	5,818,368		10-06-1998	Langley	
	US246	5,818,369		10-06-1998	Withers	
	US247	5,818,530		10-06-1998	Canfield et al.	
	US248	5,819,215		10-06-1998	Dobson et al.	
	US249	5,822,781		10-13-1998	Wells et al.	
	US250	5,825,424		10-20-1998	Canfield et al.	
	US251	5,825,830		10-20-1998	Kopf	
	US252	5,832,037		11-03-1998	Park	
	US253	5,832,126		11-03-1998	Tanaka	
	US254	5,832,443		11-03-1998	Kolesnik et al.	
	US255	5,835,788		11-10-1998	Blumer et al.	
	US256	5,836,003		11-10-1998	Sadeh	
	US257	5,838,821		11-17-1998	Matsubara et al.	
	US258	5,838,927		11-17-1998	Gillon	
	US259	5,838,996		11-17-1998	deCarmo	
	US260	5,839,100		11-17-1998	Wegener	

FOREIGN PATENT DOCUMENTS							
Examiner initials*	Cite No. <sup>1</sup>	Foreign Patent Document		Publication Date MM-DD-YYYY	Name of Patentee or Applicant of Cited Document	Pages, Columns, Lines, Where Relevant Passages or Relevant Figures Appear	T <sup>6</sup>
		Country Code <sup>3</sup>	Number <sup>4</sup> -Kind Code <sup>5</sup> (if known)				

Examiner Signature	/Suresh Suryawanshi/	Date Considered	05/14/2012
--------------------	----------------------	-----------------	------------

\*EXAMINER: Initial if reference considered, whether or not citation is in conformance with MPEP 609. Draw line through citation if not in conformance and not considered. Include copy of this form with next communication to applicant. <sup>1</sup> Applicant's unique citation designation number (optional). <sup>2</sup> See Kinds Codes of USPTO Patent Documents at www.uspto.gov or MPEP 901.04. <sup>3</sup> Enter Office that issued the document, by the two-letter code (WIPO Standard ST.3). <sup>4</sup> For Japanese patent documents, the indication of the year of the reign of the Emperor must precede the serial number of the patent document. <sup>5</sup> Kind of document by the appropriate symbols as indicated on the document under WIPO Standard ST.16 if possible. <sup>6</sup> Applicant is to place a check mark here if English language Translation is attached.

ALL REFERENCES CONSIDERED EXCEPT WHERE LINED THROUGH. /SKS./



Substitute for form 1449/PTO		<i>Complete if Known</i>	
<b>INFORMATION DISCLOSURE STATEMENT BY APPLICANT</b> (Use as many sheets as necessary)		Application Number	13/118,122
		Filing Date	May 27, 2011
		First Named Inventor	James J. FALLON
		Art Unit	2115
		Examiner Name	To Be Assigned
Sheet	14 of 27	Attorney Docket Number	2855.004000B

U.S. PATENT DOCUMENTS						
Examiner Initials*	Cite No. <sup>1</sup>	Document Number		Publication Date MM-DD-YYYY	Name of Patentee or Applicant of Cited Document	Pages, Columns, Lines, Where Relevant Passages or Relevant Figures Appear
		Number-Kind Code <sup>2</sup> (if known)				
	US261	5,841,979		11-24-1998	Schulhof et al.	
	US262	5,847,762		12-08-1998	Canfield et al.	
	US263	5,850,565		12-15-1998	Wightman	
	US264	5,861,824		01-19-1999	Ryu et al.	
	US265	5,861,920		01-19-1999	Mead et al.	
	US266	5,864,342		01-26-1999	Kajiya et al.	
	US267	5,864,678		01-26-1999	Riddle	
	US268	5,867,167		02-02-1999	Deering	
	US269	5,867,602		02-02-1999	Zandi et al.	
	US270	5,870,036		02-09-1999	Franaszek et al.	
	US271	5,870,087		02-09-1999	Chau	
	US272	5,872,530		02-16-1999	Domyo et al.	
	US273	5,874,907		02-23-1999	Craft	
	US274	5,883,975		03-16-1999	Narita et al.	
	US275	5,884,269		03-16-1999	Cellier et al.	
	US276	5,886,655		03-23-1999	Rust	
	US277	5,887,165		03-23-1999	Martel et al.	
	US278	5,889,961		03-30-1999	Dobbek	
	US279	5,892,847		04-06-1999	Johnson	
	US280	5,907,801		05-15-1999	Albert et al.	

FOREIGN PATENT DOCUMENTS							
Examiner Initials*	Cite No. <sup>1</sup>	Foreign Patent Document		Publication Date MM-DD-YYYY	Name of Patentee or Applicant of Cited Document	Pages, Columns, Lines, Where Relevant Passages or Relevant Figures Appear	T <sup>6</sup>
		Country Code <sup>3</sup> -Number <sup>4</sup> -Kind Code <sup>5</sup> (if known)					

Examiner Signature	/Suresh Suryawanshi/	Date Considered	05/14/2012
-----------------------	----------------------	--------------------	------------

\*EXAMINER: Initial if reference considered, whether or not citation is in conformance with MPEP 609. Draw line through citation if not in conformance and not considered. Include copy of this form with next communication to applicant. <sup>1</sup> Applicant's unique citation designation number (optional). <sup>2</sup> See Kinds Codes of USPTO Patent Documents at www.uspto.gov or MPEP 901.04. <sup>3</sup> Enter Office that issued the document, by the two-letter code (WIPO Standard ST.3). <sup>4</sup> For Japanese patent documents, the indication of the year of the reign of the Emperor must precede the serial number of the patent document. <sup>5</sup> Kind of document by the appropriate symbols as indicated on the document under WIPO Standard ST.16 if possible. <sup>6</sup> Applicant is to place a check mark here if English language Translation is attached.

ALL REFERENCES CONSIDERED EXCEPT WHERE LINED THROUGH. /SKS./

Substitute for form 1449/PTO				<i>Complete if Known</i>	
<b>INFORMATION DISCLOSURE STATEMENT BY APPLICANT</b> <i>(Use as many sheets as necessary)</i>				Application Number	13/118,122
				Filing Date	May 27, 2011
				First Named Inventor	James J. FALLON
				Art Unit	2115
				Examiner Name	To Be Assigned
Sheet	15	of	27	Attorney Docket Number	2855.004000B

U.S. PATENT DOCUMENTS						
Examiner Initials*	Cite No. <sup>1</sup>	Document Number		Publication Date MM-DD-YYYY	Name of Patentee or Applicant of Cited Document	Pages, Columns, Lines, Where Relevant Passages or Relevant Figures Appear
		Number-Kind Code <sup>2</sup> (if known)				
	US281	5,909,557		06-01-1999	Betker et al.	
	US282	5,909,559		06-01-1999	So	
	US283	5,915,079		06-22-1999	Vondran, Jr. et al.	
	US284	5,917,438		06-29-1999	Ando	
	US285	5,918,068		06-29-1999	Shafe	
	US286	5,918,225		06-29-1999	White et al.	
	US287	5,920,326		07-06-1999	Rentschler et al.	
	US288	5,923,860		07-13-1999	Olarig	
	US289	5,930,358		07-27-1999	Rao	
	US290	5,936,616		08-10-1999	Torborg, Jr. et al.	
	US291	5,938,737		08-17-1999	Smallcomb et al.	
	US292	5,943,692		08-24-1999	Marberg	
	US293	5,945,933		08-31-1999	Kalkstein	
	US294	5,949,355		09-07-1999	Panaoussis	
	US295	5,949,968		09-07-1999	Gentile	
	US296	5,951,623		09-14-1999	Reynar et al.	
	US297	5,955,976		09-21-1999	Heath	
	US298	5,956,490		09-21-1999	Buchholz et al.	
	US299	5,960,465		09-28-1999	Adams	
	US300	5,964,842		10-12-1999	Packard	

FOREIGN PATENT DOCUMENTS							
Examiner Initials*	Cite No. <sup>1</sup>	Foreign Patent Document		Publication Date MM-DD-YYYY	Name of Patentee or Applicant of Cited Document	Pages, Columns, Lines, Where Relevant Passages or Relevant Figures Appear	T <sup>6</sup>
		Country Code <sup>3</sup> -Number <sup>4</sup> -Kind Code <sup>5</sup> (if known)					

Examiner Signature	/Suresh Suryawanshi/	Date Considered	05/14/2012
--------------------	----------------------	-----------------	------------

\*EXAMINER: Initial if reference considered, whether or not citation is in conformance with MPEP 609. Draw line through citation if not in conformance and not considered. Include copy of this form with next communication to applicant. <sup>1</sup> Applicant's unique citation designation number (optional). <sup>2</sup> See Kinds Codes of USPTO Patent Documents at www.uspto.gov or MPEP 901.04. <sup>3</sup> Enter Office that issued the document, by the two-letter code (WIPO Standard ST.3). <sup>4</sup> For Japanese patent documents, the indication of the year of the reign of the Emperor must precede the serial number of the patent document. <sup>5</sup> Kind of document by the appropriate symbols as indicated on the document under WIPO Standard ST.16 if possible. <sup>6</sup> Applicant is to place a check mark here if English language Translation is attached.

ALL REFERENCES CONSIDERED EXCEPT WHERE LINED THROUGH. /SKS./

<b>INFORMATION DISCLOSURE STATEMENT BY APPLICANT</b> <i>(Use as many sheets as necessary)</i>			<i>Complete if Known</i>		
			Application Number	13/118,122	
			Filing Date	May 27, 2011	
			First Named Inventor	James J. FALLON	
			Art Unit	2115	
			Examiner Name	To Be Assigned	
Sheet	16	of	27	Attorney Docket Number	2855.004000B

U.S. PATENT DOCUMENTS						
Examiner initials*	Cite No. <sup>1</sup>	Document Number		Publication Date MM-DD-YYYY	Name of Patentee or Applicant of Cited Document	Pages, Columns, Lines, Where Relevant Passages or Relevant Figures Appear
		Number-Kind Code <sup>2</sup> (if known)				
	US301	5,968,149		10-19-1999	Jaquette et al.	
	US302	5,969,927		10-19-1999	Schirmer et al.	
	US303	5,973,630		10-26-1999	Heath	
	US304	5,974,235		10-26-1999	Numally et al.	
	US305	5,974,387		10-26-1999	Kageyama	
	US306	5,974,471		10-26-1999	Belt	
	US307	5,978,483		11-02-1999	Thompson, Jr. et al.	
	US308	5,982,360		11-09-1999	Wu et al.	
	US309	5,982,723		11-09-1999	Kamatani	
	US310	5,987,022		11-16-1999	Geiger et al.	
	US311	5,987,590		11-16-1999	Wing So	
	US312	5,990,884		11-23-1999	Douma et al.	
	US313	5,991,515		11-23-1999	Fall et al.	
	US314	5,996,033		11-30-1999	Chiu-Hao	
	US315	6,000,009		12-07-1999	Brady	
	US316	6,002,411		12-14-1999	Dye	
	US317	6,003,115		12-14-1999	Spear et al.	
	US318	6,008,743		12-28-1999	Jaquette	
	US319	6,011,901		01-04-2000	Kirsten	
	US320	6,014,694		01-11-2000	Aharoni et al.	

FOREIGN PATENT DOCUMENTS							
Examiner initials*	Cite No. <sup>1</sup>	Foreign Patent Document		Publication Date MM-DD-YYYY	Name of Patentee or Applicant of Cited Document	Pages, Columns, Lines, Where Relevant Passages or Relevant Figures Appear	T <sup>6</sup>
		Country Code <sup>3</sup> -Number <sup>4</sup> -Kind Code <sup>5</sup> (if known)					

Examiner Signature	/Suresh Suryawanshi/	Date Considered	05/14/2012
--------------------	----------------------	-----------------	------------

\*EXAMINER: Initial if reference considered, whether or not citation is in conformance with MPEP 609. Draw line through citation if not in conformance and not considered. Include copy of this form with next communication to applicant. <sup>1</sup> Applicant's unique citation designation number (optional). <sup>2</sup> See Kinds Codes of USPTO Patent Documents at www.uspto.gov or MPEP 901.04. <sup>3</sup> Enter Office that issued the document, by the two-letter code (WIPO Standard ST.3). <sup>4</sup> For Japanese patent documents, the indication of the year of the reign of the Emperor must precede the serial number of the patent document. <sup>5</sup> Kind of document by the appropriate symbols as indicated on the document under WIPO Standard ST.16 if possible. <sup>6</sup> Applicant is to place a check mark here if English language Translation is attached.

ALL REFERENCES CONSIDERED EXCEPT WHERE LINED THROUGH. /SKS./

Substitute for form 1449/PTO		<i>Complete if Known</i>	
		Application Number	13/118,122
<b>INFORMATION DISCLOSURE STATEMENT BY APPLICANT</b> <i>(Use as many sheets as necessary)</i>		Filing Date	May 27, 2011
		First Named Inventor	James J. FALLON
		Art Unit	2115
		Examiner Name	To Be Assigned
		Attorney Docket Number	2855.004000B
Sheet	17	of	27

U.S. PATENT DOCUMENTS						
Examiner Initials*	Cite No. <sup>1</sup>	Document Number		Publication Date MM-DD-YYYY	Name of Patentee or Applicant of Cited Document	Pages, Columns, Lines, Where Relevant Passages or Relevant Figures Appear
		Number-Kind Code <sup>2</sup> (if known)				
	US321	6,021,433		02-01-2000	Payne	
	US322	6,023,755		02-08-2000	Casselman	
	US323	6,026,217		02-15-2000	Adiletta	
	US324	6,028,725		02-22-2000	Blumenau	
	US325	6,031,939		02-29-2000	Gilbert et al.	
	US326	6,032,148		02-29-2000	Wilkes	
	US327	6,032,197		02-29-2000	Birdwell et al.	
	US328	6,058,459		05-02-2000	Owen et al.	
	US329	6,061,398		05-09-2000	Satoh et al.	
	US330	6,061,473		05-09-2000	Chen et al.	
	US331	6,070,179		05-30-2000	Craft	
	US332	6,073,232		06-06-2000	Kroeker et al.	
	US333	6,075,470		06-13-2000	Little et al.	
	US334	6,078,958		06-20-2000	Echeita et al.	
	US335	6,091,777		07-18-2000	Guetz et al.	
	US336	6,092,123		07-18-2000	Steffan et al.	
	US337	6,094,634		07-25-2000	Yabagi et al.	
	US338	6,097,520		08-01-2000	Kadnier	
	US339	6,098,114		08-01-2000	McDonald et al.	
	US340	6,104,389		08-15-2000	Ando	

FOREIGN PATENT DOCUMENTS							
Examiner Initials*	Cite No. <sup>1</sup>	Foreign Patent Document		Publication Date MM-DD-YYYY	Name of Patentee or Applicant of Cited Document	Pages, Columns, Lines, Where Relevant Passages or Relevant Figures Appear	T <sup>6</sup>
		Country Code <sup>3</sup> -Number <sup>4</sup> -Kind Code <sup>5</sup> (if known)					

Examiner Signature	/Suresh Suryawanshi/	Date Considered	05/14/2012
--------------------	----------------------	-----------------	------------

\*EXAMINER: Initial if reference considered, whether or not citation is in conformance with MPEP 609. Draw line through citation if not in conformance and not considered. Include copy of this form with next communication to applicant. <sup>1</sup> Applicant's unique citation designation number (optional). <sup>2</sup> See Kinds Codes of USPTO Patent Documents at www.uspto.gov or MPEP 901.04. <sup>3</sup> Enter Office that issued the document, by the two-letter code (WIPO Standard ST.3). <sup>4</sup> For Japanese patent documents, the indication of the year of the reign of the Emperor must precede the serial number of the patent document. <sup>5</sup> Kind of document by the appropriate symbols as indicated on the document under WIPO Standard ST.16 if possible. <sup>6</sup> Applicant is to place a check mark here if English language Translation is attached.

ALL REFERENCES CONSIDERED EXCEPT WHERE LINED THROUGH. /SKS./

Substitute for form 1449/PTO			<i>Complete if Known</i>	
			Application Number	13/118,122
<b>INFORMATION DISCLOSURE STATEMENT BY APPLICANT</b> <i>(Use as many sheets as necessary)</i>			Filing Date	May 27, 2011
			First Named Inventor	James J. FALLON
			Art Unit	2115
			Examiner Name	To Be Assigned
			Attorney Docket Number	2855.004000B
Sheet	18	of	27	

U.S. PATENT DOCUMENTS						
Examiner initials*	Cite No. <sup>1</sup>	Document Number		Publication Date MM-DD-YYYY	Name of Patentee or Applicant of Cited Document	Pages, Columns, Lines, Where Relevant Passages or Relevant Figures Appear
		Number-Kind Code <sup>2</sup> (if known)				
	US341	6,105,130		08-15-2000	Wu et al.	
	US342	6,115,384		09-05-2000	Parzych	
	US343	6,128,412		10-03-2000	Satoh	
	US344	6,134,631		10-17-2000	Jennings, III	
	US345	6,141,053		10-31-2000	Saukkonen	
	US346	6,145,020		11-07-2000	Barnett	
	US347	6,145,069		11-07-2000	Dye	
	US348	6,169,241		01-02-2001	Shimizu	
	US349	6,170,007		01-02-2001	Venkatraman et al.	
	US350	6,170,047		01-02-2001	Dye	
	US351	6,170,049		01-02-2001	So	
	US352	6,172,936		01-09-2001	Kitazaki	
	US353	6,173,381		01-09-2001	Dye	
	US354	6,175,650		01-16-2001	Sindhu et al.	
	US355	6,175,856		01-16-2001	Riddle	
	US356	6,182,125		01-30-2001	Borella et al.	
	US357	6,185,625		02-06-2001	Tso et al.	
	US358	6,185,659		02-06-2001	Milillo et al.	
	US359	6,192,082		02-20-2001	Moriarty et al.	
	US360	6,192,155		02-20-2001	Fan	

FOREIGN PATENT DOCUMENTS							
Examiner initials*	Cite No. <sup>1</sup>	Foreign Patent Document		Publication Date MM-DD-YYYY	Name of Patentee or Applicant of Cited Document	Pages, Columns, Lines, Where Relevant Passages or Relevant Figures Appear	T <sup>6</sup>
		Country Code <sup>3</sup> -Number <sup>4</sup> -Kind Code <sup>5</sup> (if known)					

Examiner Signature	/Suresh Suryawanshi/	Date Considered	05/14/2012
--------------------	----------------------	-----------------	------------

\*EXAMINER: Initial if reference considered, whether or not citation is in conformance with MPEP 609. Draw line through citation if not in conformance and not considered. Include copy of this form with next communication to applicant. <sup>1</sup> Applicant's unique citation designation number (optional). <sup>2</sup> See Kinds Codes of USPTO Patent Documents at www.uspto.gov or MPEP 901.04. <sup>3</sup> Enter Office that issued the document, by the two-letter code (WIPO Standard ST.3). <sup>4</sup> For Japanese patent documents, the indication of the year of the reign of the Emperor must precede the serial number of the patent document. <sup>5</sup> Kind of document by the appropriate symbols as indicated on the document under WIPO Standard ST.16 if possible. <sup>6</sup> Applicant is to place a check mark here if English language Translation is attached.

ALL REFERENCES CONSIDERED EXCEPT WHERE LINED THROUGH. /SKS./

Substitute for form 1449/PTO  <b>INFORMATION DISCLOSURE STATEMENT BY APPLICANT</b> (Use as many sheets as necessary)		<i>Complete if Known</i>			
		Application Number	13/118,122		
		Filing Date	May 27, 2011		
		First Named Inventor	James J. FALLON		
		Art Unit	2115		
Examiner Name	To Be Assigned				
Sheet	19	of	27	Attorney Docket Number	2855.004000B

U.S. PATENT DOCUMENTS						
Examiner Initials*	Cite No. <sup>1</sup>	Document Number		Publication Date MM-DD-YYYY	Name of Patentee or Applicant of Cited Document	Pages, Columns, Lines, Where Relevant Passages or Relevant Figures Appear
		Number	Kind Code <sup>2</sup> (if known)			
	US361	6,195,024		02-27-2001	Fallon	
	US362	6,195,465		02-27-2001	Zandi et al.	
	US363	6,208,273		03-27-2001	Dye et al.	
	US364	6,215,904		04-10-2001	Lavellee	
	US365	6,219,754		04-17-2001	Belt et al.	
	US366	6,222,886		04-24-2001	Yogeshwar	
	US367	6,225,922		05-01-2001	Norton	
	US368	6,226,667		05-01-2001	Matthews et al.	
	US369	6,226,740		05-01-2001	Iga	
	US370	6,230,223		05-08-2001	Olarig	
	US371	6,237,054		05-22-2001	Freitag, Jr.	
	US372	6,243,829		06-05-2001	Chan	
	US373	6,253,264		06-26-2001	Sebastian	
	US374	6,272,178		08-07-2001	Niewegowski et al.	
	US375	6,272,627		08-07-2001	Mann	
	US376	6,272,628		08-07-2001	Aguilar et al.	
	US377	6,282,641		08-28-2001	Christensen	
	US378	6,285,458		09-04-2001	Yada	
	US379	6,298,408		10-02-2001	Park	
	US380	6,308,311		10-23-2001	Carmichael et al.	

FOREIGN PATENT DOCUMENTS							
Examiner Initials*	Cite No. <sup>1</sup>	Foreign Patent Document		Publication Date MM-DD-YYYY	Name of Patentee or Applicant of Cited Document	Pages, Columns, Lines, Where Relevant Passages or Relevant Figures Appear	T <sup>6</sup>
		Country Code <sup>3</sup>	Number <sup>4</sup> -Kind Code <sup>5</sup> (if known)				

Examiner Signature	/Suresh Suryawanshi/	Date Considered	05/14/2012
--------------------	----------------------	-----------------	------------

\*EXAMINER: Initial if reference considered, whether or not citation is in conformance with MPEP 609. Draw line through citation if not in conformance and not considered. Include copy of this form with next communication to applicant. <sup>1</sup> Applicant's unique citation designation number (optional). <sup>2</sup> See Kinds Codes of USPTO Patent Documents at www.uspto.gov or MPEP 901.04. <sup>3</sup> Enter Office that issued the document, by the two-letter code (WIPO Standard ST.3). <sup>4</sup> For Japanese patent documents, the indication of the year of the reign of the Emperor must precede the serial number of the patent document. <sup>5</sup> Kind of document by the appropriate symbols as indicated on the document under WIPO Standard ST.16 if possible. <sup>6</sup> Applicant is to place a check mark here if English language Translation is attached.

ALL REFERENCES CONSIDERED EXCEPT WHERE LINED THROUGH. /SKS./

Substitute for form 1449/PTO		<i>Complete if Known</i>	
<b>INFORMATION DISCLOSURE STATEMENT BY APPLICANT</b> <i>(Use as many sheets as necessary)</i>		Application Number	13/118,122
		Filing Date	May 27, 2011
		First Named Inventor	James J. FALLON
		Art Unit	2115
		Examiner Name	To Be Assigned
Sheet	20	of	27
		Attorney Docket Number	2855.004000B

U.S. PATENT DOCUMENTS						
Examiner Initials*	Cite No. <sup>1</sup>	Document Number		Publication Date MM-DD-YYYY	Name of Patentee or Applicant of Cited Document	Pages, Columns, Lines, Where Relevant Passages or Relevant Figures Appear
		Number-Kind Code <sup>2</sup> (if known)				
	US381	6,309,424		10-30-2001	Fallon	
	US382	6,310,563		10-30-2001	Har et al.	
	US383	6,317,714		11-13-2001	Del Castillo et al.	
	US384	6,330,622		12-11-2001	Shaefer	
	US385	6,333,745		12-25-2001	Shimomura et al.	
	US386	6,345,307		02-05-2002	Booth	
	US387	6,356,589		03-12-2002	Gebler et al.	
	US388	6,356,937		03-12-2002	Montville et al.	
	US389	6,388,584		05-14-2002	Dorward et al.	
	US390	6,392,567		05-21-2002	Satoh	
	US391	6,404,931		06-11-2002	Chen et al.	
	US392	6,421,387		07-16-2002	Rhee	
	US393	6,434,168		08-13-2002	Kari	
	US394	6,434,695		08-13-2002	Esfahani et al.	
	US395	6,442,659		08-27-2002	Blumenau	
	US396	6,449,658		09-10-2002	Lafe et al.	
	US397	6,449,682		09-10-2002	Toorians	
	US398	6,452,602		09-17-2002	Morein	
	US399	6,452,933		09-17-2002	Duffield et al.	
	US400	6,459,429		10-01-2002	Deering	

FOREIGN PATENT DOCUMENTS							
Examiner Initials*	Cite No. <sup>1</sup>	Foreign Patent Document		Publication Date MM-DD-YYYY	Name of Patentee or Applicant of Cited Document	Pages, Columns, Lines, Where Relevant Passages or Relevant Figures Appear	T <sup>6</sup>
		Country Code <sup>3</sup> -Number <sup>4</sup> -Kind Code <sup>5</sup> (if known)					

Examiner Signature	/Suresh Suryawanshi/	Date Considered	05/14/2012
--------------------	----------------------	-----------------	------------

\*EXAMINER: Initial if reference considered, whether or not citation is in conformance with MPEP 609. Draw line through citation if not in conformance and not considered. Include copy of this form with next communication to applicant. <sup>1</sup> Applicant's unique citation designation number (optional). <sup>2</sup> See Kinds Codes of USPTO Patent Documents at www.uspto.gov or MPEP 901.04. <sup>3</sup> Enter Office that issued the document, by the two-letter code (WIPO Standard ST.3). <sup>4</sup> For Japanese patent documents, the indication of the year of the reign of the Emperor must precede the serial number of the patent document. <sup>5</sup> Kind of document by the appropriate symbols as indicated on the document under WIPO Standard ST.16 if possible. <sup>6</sup> Applicant is to place a check mark here if English language Translation is attached.

ALL REFERENCES CONSIDERED EXCEPT WHERE LINED THROUGH. /SKS./

<b>INFORMATION DISCLOSURE STATEMENT BY APPLICANT</b> <i>(Use as many sheets as necessary)</i>		<i>Complete if Known</i>	
		Application Number	13/118,122
		Filing Date	May 27, 2011
		First Named Inventor	James J. FALLON
		Art Unit	2115
		Examiner Name	To Be Assigned
Sheet	21	of	27
		Attorney Docket Number	2855.004000B

U.S. PATENT DOCUMENTS						
Examiner Initials*	Cite No. <sup>1</sup>	Document Number		Publication Date MM-DD-YYYY	Name of Patentee or Applicant of Cited Document	Pages, Columns, Lines, Where Relevant Passages or Relevant Figures Appear
		Number-Kind Code <sup>2</sup> (if known)				
	US401	6,463,509		10-08-2002	Teoman et al.	
	US402	6,487,640		11-26-2002	Lipasti	
	US403	6,489,902		12-03-2002	Heath	
	US404	6,513,113		01-28-2003	Kobayashi	
	US405	6,523,102		02-18-2003	Dye et al.	
	US406	6,526,174		02-25-2003	Graffagnino	
	US407	6,529,633		03-04-2003	Easwar et al.	
	US408	6,532,121		03-11-2003	Rust et al.	
	US409	6,539,438		03-25-2003	Ledzius et al.	
	US410	6,539,456		03-25-2003	Stewart	
	US411	6,542,644		04-01-2003	Satoh	
	US412	6,577,254		06-10-2003	Rasmussen	
	US413	6,590,609		07-08-2003	Kitade et al.	
	US414	6,597,812		07-22-2003	Fallon et al.	
	US415	6,601,104		07-29-2003	Fallon	
	US416	6,604,040		08-05-2003	Kawasaki et al.	
	US417	6,604,158		08-05-2003	Fallon	
	US418	6,606,040		08-12-2003	Abdat	
	US419	6,606,413		08-12-2003	Zeineh	
	US420	6,609,223		08-19-2003	Wolfgang	

FOREIGN PATENT DOCUMENTS							
Examiner Initials*	Cite No. <sup>1</sup>	Foreign Patent Document		Publication Date MM-DD-YYYY	Name of Patentee or Applicant of Cited Document	Pages, Columns, Lines, Where Relevant Passages or Relevant Figures Appear	T <sup>6</sup>
		Country Code <sup>3</sup> -Number <sup>4</sup> -Kind Code <sup>5</sup> (if known)					

Examiner Signature	/Suresh Suryawanshi/	Date Considered	05/14/2012
--------------------	----------------------	-----------------	------------

\*EXAMINER: Initial if reference considered, whether or not citation is in conformance with MPEP 609. Draw line through citation if not in conformance and not considered. Include copy of this form with next communication to applicant. <sup>1</sup> Applicant's unique citation designation number (optional). <sup>2</sup> See Kinds Codes of USPTO Patent Documents at www.uspto.gov or MPEP 901.04. <sup>3</sup> Enter Office that issued the document, by the two-letter code (WIPO Standard ST.3). <sup>4</sup> For Japanese patent documents, the indication of the year of the reign of the Emperor must precede the serial number of the patent document. <sup>5</sup> Kind of document by the appropriate symbols as indicated on the document under WIPO Standard ST.16 if possible. <sup>6</sup> Applicant is to place a check mark here if English language Translation is attached.

ALL REFERENCES CONSIDERED EXCEPT WHERE LINED THROUGH. /SKS./



Substitute for form 1449/PTO		<i>Complete if Known</i>	
<b>INFORMATION DISCLOSURE STATEMENT BY APPLICANT</b> <i>(Use as many sheets as necessary)</i>		Application Number	13/118,122
		Filing Date	May 27, 2011
		First Named Inventor	James J. FALLON
		Art Unit	2115
		Examiner Name	To Be Assigned
Sheet	22 of 27	Attorney Docket Number	2855.004000B

U.S. PATENT DOCUMENTS						
Examiner initials*	Cite No. <sup>1</sup>	Document Number		Publication Date MM-DD-YYYY	Name of Patentee or Applicant of Cited Document	Pages, Columns, Lines, Where Relevant Passages or Relevant Figures Appear
		Number	Kind Code 2 (if known)			
	US421	6,618,728		09-09-2003	Rail	
	US422	6,624,761		09-23-2003	Fallon	
	US423	6,633,244		10-14-2003	Avery	
	US424	6,650,261		11-18-2003	Nelson et al.	
	US425	6,661,839		12-09-2003	Ishida et al.	
	US426	6,661,845		12-09-2003	Herath	
	US427	6,704,840		03-09-2004	Nalawadi et al.	
	US428	6,708,220		03-16-2004	Olin	
	US429	6,711,709		03-23-2004	York	
	US430	6,717,534		04-06-2004	Yokose	
	US431	6,731,814		05-04-2004	Zeck et al.	
	US432	6,745,282		06-01-2004	Okada et al.	
	US433	6,748,457		06-08-2004	Fallon et al.	
	US434	6,756,922		06-29-2004	Ossia	
	US435	6,768,749		07-27-2004	Osler et al.	
	US436	6,792,151		09-14-2004	Barnes et al.	
	US437	6,810,434		10-26-2004	Muthujumaraswathy et al.	
	US438	6,813,689		11-02-2004	Baxter, III	
	US439	6,819,271		11-16-2004	Geiger et al.	
	US440	6,822,589		11-23-2004	Dye et al.	

FOREIGN PATENT DOCUMENTS							
Examiner initials*	Cite No. <sup>1</sup>	Foreign Patent Document		Publication Date MM-DD-YYYY	Name of Patentee or Applicant of Cited Document	Pages, Columns, Lines, Where Relevant Passages or Relevant Figures Appear	T <sup>6</sup>
		Country Code <sup>3</sup>	Number <sup>4</sup> -Kind Code <sup>5</sup> (if known)				

Examiner Signature	/Suresh Suryawanshi/	Date Considered	05/14/2012
--------------------	----------------------	-----------------	------------

\*EXAMINER: Initial if reference considered, whether or not citation is in conformance with MPEP 609. Draw line through citation if not in conformance and not considered. Include copy of this form with next communication to applicant. <sup>1</sup> Applicant's unique citation designation number (optional). <sup>2</sup> See Kinds Codes of USPTO Patent Documents at www.uspto.gov or MPEP 901.04. <sup>3</sup> Enter Office that issued the document, by the two-letter code (WIPO Standard ST.3). <sup>4</sup> For Japanese patent documents, the indication of the year of the reign of the Emperor must precede the serial number of the patent document. <sup>5</sup> Kind of document by the appropriate symbols as indicated on the document under WIPO Standard ST.16 if possible. <sup>6</sup> Applicant is to place a check mark here if English language Translation is attached.

ALL REFERENCES CONSIDERED EXCEPT WHERE LINED THROUGH. /SKS./

Substitute for form 1449/PTO		<i>Complete if Known</i>	
<b>INFORMATION DISCLOSURE STATEMENT BY APPLICANT</b> (Use as many sheets as necessary)		Application Number	13/118,122
		Filing Date	May 27, 2011
		First Named Inventor	James J. FALLON
		Art Unit	2115
		Examiner Name	To Be Assigned
Sheet	23	of	27
		Attorney Docket Number	2855.004000B

U.S. PATENT DOCUMENTS						
Examiner initials*	Cite No. <sup>1</sup>	Document Number		Publication Date MM-DD-YYYY	Name of Patentee or Applicant of Cited Document	Pages, Columns, Lines, Where Relevant Passages or Relevant Figures Appear
		Number-Kind Code 2 (if known)				
	US441	6,856,651		02-15-2005	Singh	
	US442	6,862,278		03-01-2005	Chang et al.	
	US443	6,879,266		04-12-2005	Dye et al.	
	US444	6,885,316		04-26-2005	Mehring	
	US445	6,885,319		04-26-2005	Geiger et al.	
	US446	6,888,893		05-03-2005	Li et al.	
	US447	6,909,383		06-21-2005	Shokrollahi et al.	
	US448	6,944,740		09-13-2005	Abali et al.	
	US449	6,952,409		10-04-2002	Jolitz	
	US450	6,959,359		10-25-2005	Suzuki et al.	
	US451	6,963,608		11-08-2005	Wu	
	US452	6,990,247		01-24-2006	Schwartz	
	US453	6,993,597		01-31-2006	Nakagawa et al.	
	US454	7,007,099		02-28-2006	Donati et al.	
	US455	7,024,460		04-04-2006	Koopmas	
	US456	7,054,493		05-30-2006	Schwartz	
	US457	7,069,342		06-27-2006	Biederman	
	US458	7,089,391		08-08-2006	Geiger et al.	
	US459	7,102,544		09-05-2006	Liu	
	US460	7,127,518		10-24-2006	Vange et al.	

FOREIGN PATENT DOCUMENTS							
Examiner initials*	Cite No. <sup>1</sup>	Foreign Patent Document		Publication Date MM-DD-YYYY	Name of Patentee or Applicant of Cited Document	Pages, Columns, Lines, Where Relevant Passages or Relevant Figures Appear	T <sup>6</sup>
		Country Code <sup>3</sup> -Number <sup>4</sup> -Kind Code <sup>5</sup> (if known)					

Examiner Signature	/Suresh Suryawanshi/	Date Considered	05/14/2012
-----------------------	----------------------	--------------------	------------

\*EXAMINER: Initial if reference considered, whether or not citation is in conformance with MPEP 609. Draw line through citation if not in conformance and not considered. Include copy of this form with next communication to applicant. <sup>1</sup> Applicant's unique citation designation number (optional). <sup>2</sup> See Kinds Codes of USPTO Patent Documents at www.uspto.gov or MPEP 901.04. <sup>3</sup> Enter Office that issued the document, by the two-letter code (WIPO Standard ST.3). <sup>4</sup> For Japanese patent documents, the indication of the year of the reign of the Emperor must precede the serial number of the patent document. <sup>5</sup> Kind of document by the appropriate symbols as indicated on the document under WIPO Standard ST.16 if possible. <sup>6</sup> Applicant is to place a check mark here if English language Translation is attached.

**ALL REFERENCES CONSIDERED EXCEPT WHERE LINED THROUGH. /SKS./**

Substitute for form 1449/PTO		<i>Complete if Known</i>	
<b>INFORMATION DISCLOSURE STATEMENT BY APPLICANT</b> <i>(Use as many sheets as necessary)</i>		Application Number	13/118,122
		Filing Date	May 27, 2011
		First Named Inventor	James J. FALLON
		Art Unit	2115
		Examiner Name	To Be Assigned
Sheet	24 of 27	Attorney Docket Number	2855.004000B

U.S. PATENT DOCUMENTS						
Examiner initials*	Cite No. <sup>1</sup>	Document Number		Publication Date MM-DD-YYYY	Name of Patentee or Applicant of Cited Document	Pages, Columns, Lines, Where Relevant Passages or Relevant Figures Appear
		Number-Kind Code <sup>2</sup> (if known)				
	US461	7,129,860		10-31-2006	Alvarez, II	
	US462	7,130,913		10-31-2006	Fallon	
	US463	7,161,506		01-09-2007	Fallon	
	US464	7,181,608		02-20-2007	Fallon et al.	
	US465	7,190,284		03-13-2007	Dye et al.	
	US466	7,319,667		01-15-2008	Biederman	
	US467	7,321,937		01-22-2008	Fallon	
	US468	7,330,912		02-12-2008	Fox et al.	
	US469	7,352,300		04-01-2008	Fallon	
	US470	7,358,867		04-15-2008	Fallon	
	US471	7,376,772		05-20-2008	Fallon	
	US472	7,378,992		05-27-2008	Fallon	
	US473	7,386,046		06-10-2008	Fallon et al.	
	US474	7,395,345		07-01-2008	Fallon	
	US475	7,400,274		07-15-2008	Fallon et al.	
	US476	7,415,530		08-19-2008	Fallon	
	US477	7,417,568		08-26-2008	Fallon et al.	
	US478	7,552,069		06-23-2009	Kepecs	
	US479	7,565,441		07-21-2009	Romanik et al.	
	US480	7,714,747		05-11-2010	Fallon	

FOREIGN PATENT DOCUMENTS							
Examiner initials*	Cite No. <sup>1</sup>	Foreign Patent Document		Publication Date MM-DD-YYYY	Name of Patentee or Applicant of Cited Document	Pages, Columns, Lines, Where Relevant Passages or Relevant Figures Appear	T <sup>6</sup>
		Country Code <sup>3</sup> -Number <sup>4</sup> -Kind Code <sup>5</sup> (if known)					

Examiner Signature	/Suresh Suryawanshi/	Date Considered	05/14/2012
--------------------	----------------------	-----------------	------------

\*EXAMINER: Initial if reference considered, whether or not citation is in conformance with MPEP 609. Draw line through citation if not in conformance and not considered. Include copy of this form with next communication to applicant. <sup>1</sup> Applicant's unique citation designation number (optional). <sup>2</sup> See Kinds Codes of USPTO Patent Documents at www.uspto.gov or MPEP 901.04. <sup>3</sup> Enter Office that issued the document, by the two-letter code (WIPO Standard ST.3). <sup>4</sup> For Japanese patent documents, the indication of the year of the reign of the Emperor must precede the serial number of the patent document. <sup>5</sup> Kind of document by the appropriate symbols as indicated on the document under WIPO Standard ST.16 if possible. <sup>6</sup> Applicant is to place a check mark here if English language Translation is attached.

ALL REFERENCES CONSIDERED EXCEPT WHERE LINED THROUGH. /SKS./

Substitute for form 1449/PTO		<i>Complete if Known</i>	
<b>INFORMATION DISCLOSURE STATEMENT BY APPLICANT</b> <i>(Use as many sheets as necessary)</i>		Application Number	13/118,122
		Filing Date	May 27, 2011
		First Named Inventor	James J. FALLON
		Art Unit	2115
		Examiner Name	To Be Assigned
Sheet	25 of 27	Attorney Docket Number	2855.004000B

U.S. PATENT DOCUMENTS						
Examiner Initials*	Cite No. <sup>1</sup>	Document Number		Publication Date MM-DD-YYYY	Name of Patentee or Applicant of Cited Document	Pages, Columns, Lines, Where Relevant Passages or Relevant Figures Appear
		Number	Kind Code <sup>2</sup> (if known)			
	US481	7,777,651		08-17-2010	Fallon et al.	
	US482	5,103,306		04-07-1992	Weiman	
	US483	5,764,774		06-09-1998	Liu	
	US484	5,673,370		09-30-1997	Laney	
	US485	6,505,239		01-07-2003	Kobata	
	US486	5,982,937		11-09-1999	Accad	
	US487	5,079,630		01-07-1992	Golin	
	US488	6,198,850		03-06-2001	Banton	
	US489	6,198,842		03-06-2001	Yeo	
	US490	2001/0031092 A1		10-18-2001	Zeck et al.	
	US491	2001/0032128 A1		10-18-2001	Kepecs	
	US492	2001/0047473 A1		11-29-2001	Fallon	
	US493	2001/0052038 A1		12-13-2001	Fallon et al.	
	US494	2001/0054131 A1		12-20-2001	Alvarez, II et al.	
	US495	2002/0037035 A1		03-28-2002	Singh	
	US496	2002/0069354 A1		06-06-2002	Fallon et al.	
	US497	2002/0080871 A1		06-27-2002	Fallon et al.	
	US498	2002/0097172 A1		07-25-2002	Fallon	
	US499	2002/0101367 A1		08-01-2002	Geiger et al.	
	US500	2002/0104891 A1		08-08-2002	Otto	

FOREIGN PATENT DOCUMENTS							
Examiner Initials*	Cite No. <sup>1</sup>	Foreign Patent Document		Publication Date MM-DD-YYYY	Name of Patentee or Applicant of Cited Document	Pages, Columns, Lines, Where Relevant Passages or Relevant Figures Appear	T <sup>6</sup>
		Country Code <sup>3</sup>	Number <sup>4</sup> -Kind Code <sup>5</sup> (if known)				

Examiner Signature	/Suresh Suryawanshi/	Date Considered	05/14/2012
--------------------	----------------------	-----------------	------------

\*EXAMINER: Initial if reference considered, whether or not citation is in conformance with MPEP 609. Draw line through citation if not in conformance and not considered. Include copy of this form with next communication to applicant. <sup>1</sup> Applicant's unique citation designation number (optional). <sup>2</sup> See Kinds Codes of USPTO Patent Documents at www.uspto.gov or MPEP 901.04. <sup>3</sup> Enter Office that issued the document, by the two-letter code (WIPO Standard ST.3). <sup>4</sup> For Japanese patent documents, the indication of the year of the reign of the Emperor must precede the serial number of the patent document. <sup>5</sup> Kind of document by the appropriate symbols as indicated on the document under WIPO Standard ST.16 if possible. <sup>6</sup> Applicant is to place a check mark here if English language Translation is attached.

ALL REFERENCES CONSIDERED EXCEPT WHERE LINED THROUGH. /SKS./

<p>Substitute for form 1449/PTO</p> <p style="text-align: center;"><b>INFORMATION DISCLOSURE STATEMENT BY APPLICANT</b></p> <p style="text-align: center;"><i>(Use as many sheets as necessary)</i></p>		<i>Complete if Known</i>			
		Application Number	13/118,122		
		Filing Date	May 27, 2011		
		First Named Inventor	James J. FALLON		
		Art Unit	2115		
		Examiner Name	To Be Assigned		
Sheet	26	of	27	Attorney Docket Number	2855.004000B

U.S. PATENT DOCUMENTS					
Examiner initials*	Cite No. <sup>1</sup>	Document Number	Publication Date MM-DD-YYYY	Name of Patentee or Applicant of Cited Document	Pages, Columns, Lines, Where Relevant Passages or Relevant Figures Appear
		Number-Kind Code <sup>2</sup> (if known)			
	US501	2002/0126755 A1	09-12-2002	Li et al.	
	US502	2002/0191692 A1	12-19-2002	Fallon et al.	
	US503	2003/0034905 A1	02-20-2003	Anton et al.	
	US504	2003/0084238 A1	05-01-2003	Okada et al.	
	US505	2003/0030575 A1	02-13-2003	Frachtenberg et al.	
	US506	2003/0090397 A1	05-15-2003	Rasmussen	
	US507	2003/0142874 A1	07-31-2003	Schwartz	
	US508	2003/0191876 A1	10-09-2003	Fallon	
	US509	2004/0042506 A1	03-04-2004	Fallon et al.	
	US510	2004/0056783 A1	03-25-2004	Fallon	
	US511	2004/0073710 A1	04-15-2004	Fallon	
	US512	2004/0073746 A1	04-15-2004	Fallon	
	US513	2006/0015650 A1	01-19-2006	Fallon	
	US514	2006/0181441 A1	08-17-2006	Fallon	
	US515	2006/0181442 A1	08-17-2006	Fallon	
	US516	2006/0184687 A1	08-17-2006	Fallon	
	US517	2006/0190644 A1	08-24-2006	Fallon	
	US518	2006/0195601 A1	08-31-2006	Fallon	
	US519	2007/0043939 A1	02-22-2007	Fallon et al.	
	US520	2007/0050514 A1	03-01-2007	Fallon	

FOREIGN PATENT DOCUMENTS						
Examiner initials*	Cite No. <sup>1</sup>	Foreign Patent Document	Publication Date MM-DD-YYYY	Name of Patentee or Applicant of Cited Document	Pages, Columns, Lines, Where Relevant Passages or Relevant Figures Appear	T <sup>6</sup>
		Country Code <sup>3</sup> -Number <sup>4</sup> -Kind Code <sup>5</sup> (if known)				

Examiner Signature	/Suresh Suryawanshi/	Date Considered	05/14/2012
--------------------	----------------------	-----------------	------------

\*EXAMINER: Initial if reference considered, whether or not citation is in conformance with MPEP 609. Draw line through citation if not in conformance and not considered. Include copy of this form with next communication to applicant. <sup>1</sup> Applicant's unique citation designation number (optional). <sup>2</sup> See Kinds Codes of USPTO Patent Documents at www.uspto.gov or MPEP 901.04. <sup>3</sup> Enter Office that issued the document, by the two-letter code (WIPO Standard ST.3). <sup>4</sup> For Japanese patent documents, the indication of the year of the reign of the Emperor must precede the serial number of the patent document. <sup>5</sup> Kind of document by the appropriate symbols as indicated on the document under WIPO Standard ST.16 if possible. <sup>6</sup> Applicant is to place a check mark here if English language Translation is attached.

ALL REFERENCES CONSIDERED EXCEPT WHERE LINED THROUGH. /SKS./

Substitute for form 1449/PTO		<i>Complete if Known</i>	
<b>INFORMATION DISCLOSURE STATEMENT BY APPLICANT</b> <i>(Use as many sheets as necessary)</i>		Application Number	13/118,122
		Filing Date	May 27, 2011
		First Named Inventor	James J. FALLON
		Art Unit	2115
		Examiner Name	To Be Assigned
Sheet	27	of	27
		Attorney Docket Number	2855.004000B

U.S. PATENT DOCUMENTS						
Examiner initials*	Cite No. <sup>1</sup>	Document Number		Publication Date MM-DD-YYYY	Name of Patentee or Applicant of Cited Document	Pages, Columns, Lines, Where Relevant Passages or Relevant Figures Appear
		Number	Kind Code <sup>2</sup> (if known)			
	US521	2007/0050515	A1	03-01-2007	Fallon	
	US522	2007/0067483	A1	03-22-2007	Fallon	
	US523	2007/0083746	A1	04-12-2007	Fallon et al.	
	US524	2007/0109154	A1	05-17-2007	Fallon	
	US525	2007/0109155	A1	05-17-2007	Fallon	
	US526	2007/0109156	A1	05-17-2007	Fallon	
	US527	2007/0174209	A1	07-26-2007	Fallon	
	US528	2008/0232457	A1	09-25-2008	Fallon et al.	
	US529	2009/0154545	A1	06-18-2009	Fallon et al.	
	US530	2009/0287839	A1	11-19-2009	Fallon et al.	

FOREIGN PATENT DOCUMENTS							
Examiner initials*	Cite No. <sup>1</sup>	Foreign Patent Document		Publication Date MM-DD-YYYY	Name of Patentee or Applicant of Cited Document	Pages, Columns, Lines, Where Relevant Passages or Relevant Figures Appear	T <sup>6</sup>
		Country Code <sup>3</sup>	Number <sup>4</sup> -Kind Code <sup>5</sup> (if known)				

1391806\_1.DOCX

Examiner Signature	/Suresh Suryawanshi/	Date Considered	05/14/2012
--------------------	----------------------	-----------------	------------

\*EXAMINER: Initial if reference considered, whether or not citation is in conformance with MPEP 609. Draw line through citation if not in conformance and not considered. Include copy of this form with next communication to applicant. <sup>1</sup> Applicant's unique citation designation number (optional). <sup>2</sup> See Kinds Codes of USPTO Patent Documents at www.uspto.gov or MPEP 901.04. <sup>3</sup> Enter Office that issued the document, by the two-letter code (WIPO Standard ST.3). <sup>4</sup> For Japanese patent documents, the indication of the year of the reign of the Emperor must precede the serial number of the patent document. <sup>5</sup> Kind of document by the appropriate symbols as indicated on the document under WIPO Standard ST.16 if possible. <sup>6</sup> Applicant is to place a check mark here if English language Translation is attached.

ALL REFERENCES CONSIDERED EXCEPT WHERE LINED THROUGH. /SKS./

Substitute for form 1449/PTO				<b>Complete if Known</b>	
<b>INFORMATION DISCLOSURE STATEMENT BY APPLICANT</b> <i>(Use as many sheets as necessary)</i>				Application Number	13/118,122
				Filing Date	May 27, 2011
				First Named Inventor	James J. FALLON
				Art Unit	2115
				Examiner Name	To Be Assigned
Sheet	1	of	66	Attorney Docket Number	2855.004000B

NON PATENT LITERATURE DOCUMENTS			
Examiner Initials*	Cite No. <sup>1</sup>	Include name of the author (in CAPITAL LETTERS), title of the article (when appropriate), title of the item (book, magazine, journal, serial, symposium, catalog, etc.), date, page(s), volume-issue number(s), publisher, city and/or country where published	T <sup>2</sup>
	NPL1	"A-T Financial Offers Manipulation, Redistribution of Ticker III", Inside Market Data, Vol. 4 No. 14, September 5, 1989, 1 page.	
	NPL2	"Add-on Options for the XpressFiles", Intelligent Compression Technologies, <a href="http://web.archive.org/web/19980518053418/ictcompress.com/options_X.html">http://web.archive.org/web/19980518053418/ictcompress.com/options_X.html</a> , 1998, 2 pages.	
	NPL3	ANDREWS et al., "A Mean-Removed Variation of Weighted Universal Vector Quantization for Image Coding", IEEE, 1993, pages 302-309.	
	NPL4	Asserted Claims Chart for U.S. Patent No. 6,624,761, Realtime Data, LLC D/B/A IXO v. CME Group Inc., et al. , 6:09-cv-327-LED-JDL, 6:10-cv-246-LED-JDL, United States District Court for the Eastern District of Texas Tyler Division, October 19, 2010, 4 pages.	
	NPL5	Asserted Claims Chart for U.S. Patent No. 7,161,506, Realtime Data, LLC D/B/A IXO v. CME Group Inc., et al. , 6:09-cv-327-LED-JDL, 6:10-cv-246-LED-JDL, United States District Court for the Eastern District of Texas Tyler Division, October 19, 2010, 5 pages.	
	NPL6	Asserted Claims Chart for U.S. Patent No. 7,400,274, Realtime Data, LLC D/B/A IXO v. CME Group Inc., et al. , 6:09-cv-327-LED-JDL, 6:10-cv-246-LED-JDL, United States District Court for the Eastern District of Texas Tyler Division, October 19, 2010, 6 pages.	
	NPL7	Asserted Claims Chart for U.S. Patent No. 7,417,568, Realtime Data, LLC D/B/A IXO v. CME Group Inc., et al. , 6:09-cv-327-LED-JDL, 6:10-cv-246-LED-JDL, United States District Court for the Eastern District of Texas Tyler Division, October 19, 2010, 13 pages.	
	NPL8	Asserted Claims Chart for U.S. Patent No. 7,714,747, Realtime Data, LLC D/B/A IXO v. CME Group Inc., et al. , 6:09-cv-327-LED-JDL, 6:10-cv-246-LED-JDL, United States District Court for the Eastern District of Texas Tyler Division, October 19, 2010, 19 pages.	
	NPL9	BARTON, Rich, S&P ComStock Network Character Set Definition, 19.2 KB Network, Version 1.7.0, February 10, 1995, 29 pages.	
	NPL10	BEECH et al., AX.25 Link Access Protocol for Amateur Packet Radio, Version 2.2, Revision: July 1998, 143 pages.	

Examiner Signature	/Suresh Suryawanshi/	Date Considered	05/14/2012
-----------------------	----------------------	--------------------	------------

\*EXAMINER: Initial if reference considered, whether or not citation is in conformance with MPEP 609. Draw line through citation if not in conformance and not considered. Include copy of this form with next communication to applicant.

<sup>1</sup> Applicant's unique citation designation number (optional). <sup>2</sup> Applicant is to place a check mark here if English language Translation is attached.

ALL REFERENCES CONSIDERED EXCEPT WHERE LINED THROUGH. /SKS./

Substitute for form 1449/PTO				<b>Complete if Known</b>	
<b>INFORMATION DISCLOSURE STATEMENT BY APPLICANT</b> <i>(Use as many sheets as necessary)</i>				Application Number	13/118,122
				Filing Date	May 27, 2011
				First Named Inventor	James J. FALLON
				Art Unit	2115
				Examiner Name	To Be Assigned
Sheet	2	of	66	Attorney Docket Number	2855.004000B

NON PATENT LITERATURE DOCUMENTS			
Examiner Initials*	Cite No. <sup>1</sup>	Include name of the author (in CAPITAL LETTERS), title of the article (when appropriate), title of the item (book, magazine, journal, serial, symposium, catalog, etc.), date, page(s), volume number, publisher, city and/or country where published	T <sup>2</sup>
	NPL11	BORMANN, Carsten, "Providing Integrated Services over Low-bitrate Links", Network Working Group Request for Comments: 2689, Category: Informational, September 1999, 14 pages.	
	NPL12	ComStock Services Pamphlet, McGraw-Hill Financial Services Company, purportedly published by July 19, 1995, 6 pages.	
	NPL13	CORMACK, Gordon V., "Data Compression on a Database System", Communications of the ACM, Volume 28, Number 12, December, 1985, pages 1336-1342.	
	NPL14	DANSKIN, John Moffatt, Compressing the X Graphics Protocol: A Dissertation Presented to the Facult of Princeton University in Candidacy for the Degree of Doctor of Philosophy, January 1995, 147 pages.	
	NPL15	"Data Networks and Open System Communications", Information Technology - Abstract Syntax Notation One (ASN. 1) Specification of Basic Notation, International Telecommunication Union, ITU-T Telecommunication Standardization Sector of ITU X.680, July 1994,	
	NPL16	Defendants' Invalidation Contentions, Realtime Data, LLC D/B/A IXO v. CME Group Inc., et al., 6:09-cv-327-LED-JDL, 6:10-cv-246-LED-JDL, United States District Court for the Eastern District of Texas Tyler Division, October 19, 2010, 19 pages.	
	NPL17	DEGERMARK, Mikael, "IP Header Compression", Network Working Group Request for Comments: 2507, Category: Standards Track, February 1999, 47 pages.	
	NPL18	Developer's Guide, Version 1.0.2, S&P ComStock, February 15, 1994, 186 pages.	
	NPL19	DOMANSKI, Dr. Bernie, "All the news you can eat, Department: Dr. Bernie's Digestions and Digressions", Demand Technology's Capacity Management Review, Volume 25, No. 7, July 1997, pages 24, 18-22.	
	NPL20	EFFROS, Michelle and Philip A. Chou, "Weighted Universal Transform Coding: Universal Image Compression with the Karhunen-Loeve Transform", IEEE, 1995, pages 61-64.	

Examiner Signature	/Suresh Suryawanshi/	Date Considered	05/14/2012
-----------------------	----------------------	--------------------	------------

\*EXAMINER: Initial if reference considered, whether or not citation is in conformance with MPEP 609. Draw line through citation if not in conformance and not considered. Include copy of this form with next communication to applicant.

<sup>1</sup> Applicant's unique citation designation number (optional). <sup>2</sup> Applicant is to place a check mark here if English language Translation is attached.

ALL REFERENCES CONSIDERED EXCEPT WHERE LINED THROUGH. /SKS./



Substitute for form 1449/PTO				<i>Complete if Known</i>	
<b>INFORMATION DISCLOSURE STATEMENT BY APPLICANT</b> <i>(Use as many sheets as necessary)</i>				Application Number	13/118,122
				Filing Date	May 27, 2011
				First Named Inventor	James J. FALLON
				Art Unit	2115
				Examiner Name	To Be Assigned
Sheet	3	of	66	Attorney Docket Number	2855.004000B

NON PATENT LITERATURE DOCUMENTS			
Examiner Initials*	Cite No. <sup>1</sup>	Include name of the author (in CAPITAL LETTERS), title of the article (when appropriate), title of the item (book, magazine, journal, serial, symposium, catalog, etc.), date, page(s), volume number, publisher, city and/or country where published	T <sup>2</sup>
	NPL21	ENGAN, Mathias, "IP Header Compression over PPP", Network Working Group Request for Comments: 2509, Category: 2509, February 1999, 10 pages.	
	NPL22	Exhibit A, Invalidity Claim Charts A1-A45 for U.S. Patent 6,624,761, Realtime Data, LLC D/B/A IXO v. CME Group Inc., et al. , 6:09-cv-327-LED-JDL, 6:10-cv-246-LED-JDL, United States District Court for the Eastern District of Texas Tyler Division, October 19, 2010, 616 pages.	
	NPL23	Exhibit B, Invalidity Claim Charts B1-B45 for U.S. Patent 7,161,506, Realtime Data, LLC D/B/A IXO v. CME Group Inc., et al. , 6:09-cv-327-LED-JDL, 6:10-cv-246-LED-JDL, United States District Court for the Eastern District of Texas Tyler Division, October 19, 2010, 1513 pages.	
	NPL24	Exhibit C, Invalidity Claim Charts C1-C7, C9-C31, C33-C45 for U.S. Patent 7,400,274, Realtime Data, LLC D/B/A IXO v. CME Group Inc., et al. , 6:09-cv-327-LED-JDL, 6:10-cv-246-LED-JDL, United States District Court for the Eastern District of Texas Tyler Division, October 19, 2010, 1528 pages.	
	NPL25	Exhibit D, Invalidity Claim Charts D1-D7, D9-D45 for U.S. Patent 7,417,568, Realtime Data, LLC D/B/A IXO v. CME Group Inc., et al. , 6:09-cv-327-LED-JDL, 6:10-cv-246-LED-JDL, United States District Court for the Eastern District of Texas Tyler Division, October 19, 2010, 2458 pages.	
	NPL26	Exhibit E, Invalidity Claim Charts E1-E7, E9, E11, E13-E15, E17-E30, E32-E45 for U.S. Patent 7,714,747, Realtime Data, LLC D/B/A IXO v. CME Group Inc., et al. , 6:09-cv-327-LED-JDL, 6:10-cv-246-LED-JDL, United States District Court for the Eastern District of Texas Tyler Division, October 19, 2010, 3312 pages.	
	NPL27	GREENE, Tim, "Squeeze your 'Net links", NetworkWorld, Volume 14, Number 28, July 14, 1997, pages 1 and 56.	
	NPL28	HELCK, Christopher J., "Encapsulated Ticker: Ver 1.0", July 14, 1993, 22 pages.	
	NPL29	"High-performance schema-specific compression for XML data formats.", XML-Xpress: Product Overview, Intelligent Compression Technologies, <a href="http://web.archive.org/web/20020818002535/www.ictcompress.com/products_xmlxpress">http://web.archive.org/web/20020818002535/www.ictcompress.com/products_xmlxpress</a> , 2001, 2 pages.	
	NPL30	HSU, William H. and Amy E. Zwarico, "Automatic Synthesis of Compression Techniques for Heterogeneous Files", Software - Practice and Experience, Volume 25 (10), October 1995, pages 1097-1116.	

Examiner Signature	/Suresh Suryawanshi/	Date Considered	05/14/2012
-----------------------	----------------------	--------------------	------------

\*EXAMINER: Initial if reference considered, whether or not citation is in conformance with MPEP 609. Draw line through citation if not in conformance and not considered. Include copy of this form with next communication to applicant.

<sup>1</sup> Applicant's unique citation designation number (optional). <sup>2</sup> Applicant is to place a check mark here if English language Translation is attached.

ALL REFERENCES CONSIDERED EXCEPT WHERE LINED THROUGH. /SKS./

Substitute for form 1449/PTO				<i>Complete if Known</i>	
<b>INFORMATION DISCLOSURE STATEMENT BY APPLICANT</b> <i>(Use as many sheets as necessary)</i>				Application Number	13/118,122
				Filing Date	May 27, 2011
				First Named Inventor	James J. FALLON
				Art Unit	2115
				Examiner Name	To Be Assigned
Sheet	4	of	66	Attorney Docket Number	2855.004000B

NON PATENT LITERATURE DOCUMENTS			
Examiner Initials*	Cite No. <sup>1</sup>	Include name of the author (in CAPITAL LETTERS), title of the article (when appropriate), title of the item (book, magazine, journal, serial, symposium, catalog, etc.), date, page(s), volume number, publisher, city and/or country where published	T <sup>2</sup>
	NPL31	"ICT's XML-Xpress", Intelligent Compression Technologies, December, 2000, 6 pages.	
	NPL32	"Information processing systems - Data communication - High-level data link control procedures - Frame structure", UNI ISO 3309, 1984, 11 pages.	
	NPL33	Installing and Administering PPP, Edition 1, Hewlett-Packard Company, 1997, 169 pages.	
	NPL34	"Introducing XpressFiles", Intelligent Compression Technologies, <a href="http://web.archive.org/web/19980518053310/ictcompress.com/xpressfiles.html">http://web.archive.org/web/19980518053310/ictcompress.com/xpressfiles.html</a> , 1998, 1 page.	
	NPL35	"Ioni's RemoteScript speeds transmission", Seybold Report on Publishing Systems, Volume 22 Number 5, November 9, 1992, pages 21-23.	
	NPL36	JACOBSON, Compressing TCP/IP Headers for Low-Speed Serial Links, February 1990, 43 pages.	
	NPL37	KULKOSKY, Victor, "Upping the Ante", Wall Street & Technology, Volume 11 Number 5, October 1993, pages 8-11.	
	NPL38	LIEFKE, Hartmut and Dan Suci, An Extensible Compressor for XML Data, SIGMOD Record, Vol. 29, No. 1, March 2000, pages 57-62.	
	NPL39	LIEFKE, Hartmut and Dan Suci, Xmill: an Efficient Compressor for XML Data, 2000, pages 153-164.	
	NPL40	LIEFKE, Hartmut and Dan Suci, Xmill: an Efficient Compressor for XML Data, October 18, 1999, 25 pages.	

Examiner Signature	/Suresh Suryawanshi/	Date Considered	05/14/2012
-----------------------	----------------------	--------------------	------------

\*EXAMINER: Initial if reference considered, whether or not citation is in conformance with MPEP 609. Draw line through citation if not in conformance and not considered. Include copy of this form with next communication to applicant.

<sup>1</sup> Applicant's unique citation designation number (optional). <sup>2</sup> Applicant is to place a check mark here if English language Translation is attached.

ALL REFERENCES CONSIDERED EXCEPT WHERE LINED THROUGH. /SKS./

Substitute for form 1449/PTO				<i>Complete if Known</i>	
<b>INFORMATION DISCLOSURE STATEMENT BY APPLICANT</b> <i>(Use as many sheets as necessary)</i>				Application Number	13/118,122
				Filing Date	May 27, 2011
				First Named Inventor	James J. FALLON
				Art Unit	2115
				Examiner Name	To Be Assigned
Sheet	5	of	66	Attorney Docket Number	2855.004000B

NON PATENT LITERATURE DOCUMENTS			
Examiner Initials*	Cite No. <sup>1</sup>	Include name of the author (in CAPITAL LETTERS), title of the article (when appropriate), title of the item (book, magazine, journal, serial, symposium, catalog, etc.), date, page(s), volume number, publisher, city and/or country where published	T <sup>2</sup>
	NPL41	McGREGOR, Glenn, "The PPP Internet Protocol Control Protocol (IPCP)", Network Working Group Request for Comments: 1332, Obsoletes: RFC 1172, May 1992, 14 pages.	
	NPL42	Obviousness Chart for U.S. Pat. No. 6,624,761, Realtime Data, LLC D/B/A IXO v. CME Group Inc., et al., 6:09-cv-327-LED-JDL, 6:10-cv-246-LED-JDL, United States District Court for the Eastern District of Texas Tyler Division, October 19, 2010, 19 pages.	
	NPL43	Obviousness Chart for U.S. Pat. No. 7,161,506, Realtime Data, LLC D/B/A IXO v. CME Group Inc., et al., 6:09-cv-327-LED-JDL, 6:10-cv-246-LED-JDL, United States District Court for the Eastern District of Texas Tyler Division, October 19, 2010, 49 pages.	
	NPL44	Obviousness Chart for U.S. Pat. No. 7,400,274, Realtime Data, LLC D/B/A IXO v. CME Group Inc., et al., 6:09-cv-327-LED-JDL, 6:10-cv-246-LED-JDL, United States District Court for the Eastern District of Texas Tyler Division, October 19, 2010, 41 pages.	
	NPL45	Obviousness Chart for U.S. Pat. No. 7,417,568, Realtime Data, LLC D/B/A IXO v. CME Group Inc., et al., 6:09-cv-327-LED-JDL, 6:10-cv-246-LED-JDL, United States District Court for the Eastern District of Texas Tyler Division, October 19, 2010, 75 pages.	
	NPL46	Obviousness Chart for U.S. Pat. No. 7,714,747, Realtime Data, LLC D/B/A IXO v. CME Group Inc., et al., 6:09-cv-327-LED-JDL, 6:10-cv-246-LED-JDL, United States District Court for the Eastern District of Texas Tyler Division, October 19, 2010, 97 pages.	
	NPL47	Open Financial Exchange Specification 2.0, Intuit Inc., Microsoft Corp., April 28, 2000, 537 pages.	
	NPL48	RAND, Dave, "The PPP Compression Control Protocol (CCP)", Network Working Group Request for Comments: 1962, Category: Standards Track, June 1996, 9 pages.	
	NPL49	ROGERS, Amy, "Bandwidth Bargain IT hot on products that squeeze more out of the pipe", Number 673, July 21, 1997, pages 1 and 65.	
	NPL50	ROTH, Mark A. and Scott J. Van Horn, "Database Compression", SIGMOD Record, Vol. 22, No. 3, September 1993, pages 31-39.	

Examiner Signature	/Suresh Suryawanshi/	Date Considered	05/14/2012
-----------------------	----------------------	--------------------	------------

\*EXAMINER: Initial if reference considered, whether or not citation is in conformance with MPEP 609. Draw line through citation if not in conformance and not considered. Include copy of this form with next communication to applicant.

<sup>1</sup> Applicant's unique citation designation number (optional). <sup>2</sup> Applicant is to place a check mark here if English language Translation is attached.

ALL REFERENCES CONSIDERED EXCEPT WHERE LINED THROUGH. /SKS./

Substitute for form 1449/PTO				<i>Complete if Known</i>	
<b>INFORMATION DISCLOSURE STATEMENT BY APPLICANT</b> <i>(Use as many sheets as necessary)</i>				Application Number	13/118,122
				Filing Date	May 27, 2011
				First Named Inventor	James J. FALLON
				Art Unit	2115
				Examiner Name	To Be Assigned
Sheet	6	of	66	Attorney Docket Number	2855.004000B

NON PATENT LITERATURE DOCUMENTS			
Examiner Initials*	Cite No. <sup>1</sup>	Include name of the author (in CAPITAL LETTERS), title of the article (when appropriate), title of the item (book, magazine, journal, serial, symposium, catalog, etc.), date, page(s), volume number, publisher, city and/or country where published	T <sup>2</sup>
	NPL51	SCHMERKEN, Ivy, "Time Running Out for Old Technologies", Wall Street Computer Review, April 1990, pages 14-16, 23-24, 28, 56.	
	NPL52	"Scrolling News", Inside Market Data, February 27, 1995, 2 pages.	
	NPL53	SIMPSON, W., "PPP in HDLC-like Framing", Network Working Group Request for Comments: 1662, STD 51, Obsoletes 1549, Category: Standards Track, July 1994, 26 pages.	
	NPL54	SUCIU, Dan, Data Management on the Web, AT&T Labs, April 4, 2000, 52 slides.	
	NPL55	SUCIU, Dan, Data Management on the Web: Abstract, University of Washington Computer Science & Engineering, April 4, 2000, 1 page.	
	NPL56	"Telekurs Buys S&P Trading Systems And Its Ticker III Feed", Inside Market Data, Vol. 4, No. 11, July 10, 1989, 1 page.	
	NPL57	"Telekurs May Debut 128 KPS Ticker By Year's End", Inside Market Data, July 18, 1994, 2 pages.	
	NPL58	"Telekurs Now Carries All Dow Jones' News on 56-Kbps Ticker," Inside Market Data, December 20, 1993, 2 pages.	
	NPL59	"Telekurs Sells No. American Division in Mgmt. Buyout", Inside Market Data, October 23, 1995, 2 pages.	
	NPL60	"Telekurs to Launch New Int'l Feed/Internet Server", Wall Street & Technology, Volume 15, No. 1, January 1997, page 14.	

Examiner Signature	/Suresh Suryawanshi/	Date Considered	05/14/2012
-----------------------	----------------------	--------------------	------------

\*EXAMINER: Initial if reference considered, whether or not citation is in conformance with MPEP 609. Draw line through citation if not in conformance and not considered. Include copy of this form with next communication to applicant.

<sup>1</sup> Applicant's unique citation designation number (optional). <sup>2</sup> Applicant is to place a check mark here if English language Translation is attached.

ALL REFERENCES CONSIDERED EXCEPT WHERE LINED THROUGH. /SKS./

Substitute for form 1449/PTO			<i>Complete if Known</i>		
<b>INFORMATION DISCLOSURE STATEMENT BY APPLICANT</b> <i>(Use as many sheets as necessary)</i>			Application Number	13/118,122	
			Filing Date	May 27, 2011	
			First Named Inventor	James J. FALLON	
			Art Unit	2115	
			Examiner Name	To Be Assigned	
Sheet	7	of	66	Attorney Docket Number	2855.004000B

NON PATENT LITERATURE DOCUMENTS			
Examiner Initials*	Cite No. <sup>1</sup>	Include name of the author (in CAPITAL LETTERS), title of the article (when appropriate), title of the item (book, magazine, journal, serial, symposium, catalog, etc.), date, page(s), volume number, publisher, city and/or country where published	T <sup>2</sup>
	NPL61	<u>"The Technology Behind XpressFiles," Intelligent Compression Technologies, <a href="http://web.archive.org/web/19980518053634/ictcompress.com/technical_X.html">http://web.archive.org/web/19980518053634/ictcompress.com/technical_X.html</a>, 1998, 1 page.</u>	
	NPL62	TID Information: Revisions to TID Program Since the Dawn of Time!!! Version 1.0, 23 pages, TID Codes 1, 1 page; TID Codes 2, 1 page, purportedly by July 19, 1995.	
	NPL63	TypeWorld: The First and Only Newspaper for Electronic Publishing, Volume 16 Number 9, June 17, 1992, 3 pages.	
	NPL64	"XpressFiles White Paper", Intelligent Compression Technologies, 1999-2001, 3 pages.	
	NPL65	United States Provisional Patent Application No. 60/309,218, filed July 31, 2001, 58 pgs.	
	NPL66	Telekurs Manual, January 11, 1993, 184 pages.	
	NPL67	DANSKIN, et al., "Fast Higher Bandwidth X," Dartmouth College, Hanover, NH, 1995, 8 pages.	
	NPL68	HOFFMAN, Roy, "Data Compression in Digital Systems," Digital Multimedia Standards Series, Chapman & Hall, 1997, 426 pages.	
	NPL69	Defendants' Invalidation Contentions, Realtime Data, LLC D/B/A IXO v. Morgan Stanley, et al., 6:09-cv-326-LED-JDL, 6:10-cv-248-LED-JDL, 6:10-cv-426-LED-JDL, Realtime Data, LLC D/B/A IXO v. CME Group Inc., et al., 6:09-cv-327-LED-JDL, 6:10-cv-246-LED-JDL, 6:10-cv-424-LED-JDL, Realtime Data, LLC D/B/A IXO v. Thomson Reuters Corp., et al., 6:09-cv-333-LED-JDL, 6:10-cv-247-LED-JDL, 6:10-cv-425-LED-JDL, United States District Court for the Eastern District of Texas Tyler Division, February 4, 2011, 34 pages.	
	NPL70	Appendix A, Obviousness Chart for U.S. Patent No. 7,777,651, not dated, Realtime Data, LLC D/B/A IXO v. Morgan Stanley, et al., 6:09-cv-326-LED-JDL, 6:10-cv-248-LED-JDL, 6:10-cv-426-LED-JDL, Realtime Data, LLC D/B/A IXO v. CME Group Inc., et al., 6:09-cv-327-LED-JDL, 6:10-cv-246-LED-JDL, 6:10-cv-424-LED-JDL, Realtime Data, LLC D/B/A IXO v. Thomson Reuters Corp., et al., 6:09-cv-333-LED-JDL, 6:10-cv-247-LED-JDL, 6:10-cv-425-LED-JDL, United States District Court for the Eastern District of Texas Tyler Division, February 4, 2011, 466 pages.	

Examiner Signature	/Suresh Suryawanshi/	Date Considered	05/14/2012
-----------------------	----------------------	--------------------	------------

\*EXAMINER: Initial if reference considered, whether or not citation is in conformance with MPEP 609. Draw line through citation if not in conformance and not considered. Include copy of this form with next communication to applicant.

<sup>1</sup> Applicant's unique citation designation number (optional). <sup>2</sup> Applicant is to place a check mark here if English language Translation is attached.

ALL REFERENCES CONSIDERED EXCEPT WHERE LINED THROUGH. /SKS./

Substitute for form 1449/PTO				<i>Complete if Known</i>	
<b>INFORMATION DISCLOSURE STATEMENT BY APPLICANT</b> <i>(Use as many sheets as necessary)</i>				Application Number	13/118,122
				Filing Date	May 27, 2011
				First Named Inventor	James J. FALLON
				Art Unit	2115
				Examiner Name	To Be Assigned
Sheet	8	of	66	Attorney Docket Number	2855.004000B

NON PATENT LITERATURE DOCUMENTS			
Examiner Initials*	Cite No. <sup>1</sup>	Include name of the author (in CAPITAL LETTERS), title of the article (when appropriate), title of the item (book, magazine, journal, serial, symposium, catalog, etc.), date, page(s), volume number, publisher, city and/or country where published	T <sup>2</sup>
	NPL71	Appendix B, § 112 Invalidity Arguments for U.S. Pat. No. 7,777,651, Realtime Data, LLC D/B/A IXO v. Morgan Stanley, et al., 6:09-cv-326-LED-JDL, 6:10-cv-248-LED-JDL, 6:10-cv-426-LED-JDL, Realtime Data, LLC D/B/A IXO v. CME Group Inc., et al., 6:09-cv-327-LED-JDL, 6:10-cv-246-LED-JDL, 6:10-cv-424-LED-JDL, Realtime Data, LLC D/B/A IXO v. Thomson Reuters Corp., et al., 6:09-cv-333-LED-JDL, 6:10-cv-247-LED-JDL, 6:10-cv-425-LED-JDL, United States District Court for the Eastern District of Texas Tyler Division, February 4, 2011, 75 pages.	
	NPL72	Exhibit 1, Prior Art Chart for U.S. Pat. No. 7,777,651, Realtime Data, LLC D/B/A IXO v. Morgan Stanley, et al., 6:09-cv-326-LED-JDL, 6:10-cv-248-LED-JDL, 6:10-cv-426-LED-JDL, Realtime Data, LLC D/B/A IXO v. CME Group Inc., et al., 6:09-cv-327-LED-JDL, 6:10-cv-246-LED-JDL, 6:10-cv-424-LED-JDL, Realtime Data, LLC D/B/A IXO v. Thomson Reuters Corp., et al., 6:09-cv-333-LED-JDL, 6:10-cv-247-LED-JDL, 6:10-cv-425-LED-JDL, United States District Court for the Eastern District of Texas Tyler Division, February 4, 2011, 161 pages, citing Aakre et al., U.S. Patent No. 4,956,808.	
	NPL73	Exhibit 2, Prior Art Chart for U.S. Pat. No. 7,777,651, Realtime Data, LLC D/B/A IXO v. Morgan Stanley, et al., 6:09-cv-326-LED-JDL, 6:10-cv-248-LED-JDL, 6:10-cv-426-LED-JDL, Realtime Data, LLC D/B/A IXO v. CME Group Inc., et al., 6:09-cv-327-LED-JDL, 6:10-cv-246-LED-JDL, 6:10-cv-424-LED-JDL, Realtime Data, LLC D/B/A IXO v. Thomson Reuters Corp., et al., 6:09-cv-333-LED-JDL, 6:10-cv-247-LED-JDL, 6:10-cv-425-LED-JDL, United States District Court for the Eastern District of Texas Tyler Division, February 4, 2011, 206 pages, citing Albert et al., U.S. Patent No. 5,907,801.	
	NPL74	Exhibit 3, Prior Art Chart for U.S. Pat. No. 7,777,651, Realtime Data, LLC D/B/A IXO v. Morgan Stanley, et al., 6:09-cv-326-LED-JDL, 6:10-cv-248-LED-JDL, 6:10-cv-426-LED-JDL, Realtime Data, LLC D/B/A IXO v. CME Group Inc., et al., 6:09-cv-327-LED-JDL, 6:10-cv-246-LED-JDL, 6:10-cv-424-LED-JDL, Realtime Data, LLC D/B/A IXO v. Thomson Reuters Corp., et al., 6:09-cv-333-LED-JDL, 6:10-cv-247-LED-JDL, 6:10-cv-425-LED-JDL, United States District Court for the Eastern District of Texas Tyler Division, February 4, 2011, 95 pages, citing B. Andrews, P. Chou, M. Effros and R. Gray "A Mean-Removed Variation of Weighted Universal Vector Quantization for Image Coding," IEEE 0-8186-3392-1/93, 302-309 (1993).	
	NPL75	Exhibit 4, Prior Art Chart for U.S. Pat. No. 7,777,651, 144 pages, Realtime Data, LLC D/B/A IXO v. Morgan Stanley, et al., 6:09-cv-326-LED-JDL, 6:10-cv-248-LED-JDL, 6:10-cv-426-LED-JDL, Realtime Data, LLC D/B/A IXO v. CME Group Inc., et al., 6:09-cv-327-LED-JDL, 6:10-cv-246-LED-JDL, 6:10-cv-424-LED-JDL, Realtime Data, LLC D/B/A IXO v. Thomson Reuters Corp., et al., 6:09-cv-333-LED-JDL, 6:10-cv-247-LED-JDL, 6:10-cv-425-LED-JDL, United States District Court for the Eastern District of Texas Tyler Division, February 4, 2011, citing Barnes et al., U.S. Patent No. 6,792,151.	
	NPL76	Exhibit 5, Prior Art Chart for U.S. Pat. No. 7,777,651, 216 pages, Realtime Data, LLC D/B/A IXO v. Morgan Stanley, et al., 6:09-cv-326-LED-JDL, 6:10-cv-248-LED-JDL, 6:10-cv-426-LED-JDL, Realtime Data, LLC D/B/A IXO v. CME Group Inc., et al., 6:09-cv-327-LED-JDL, 6:10-cv-246-LED-JDL, 6:10-cv-424-LED-JDL, Realtime Data, LLC D/B/A IXO v. Thomson Reuters Corp., et al., 6:09-cv-333-LED-JDL, 6:10-cv-247-LED-JDL, 6:10-cv-425-LED-JDL, United States District Court for the Eastern District of Texas Tyler Division, February 4, 2011, citing Birdwell et al., U.S. Patent No. 6,032,197.	

Examiner Signature	/Suresh Suryawanshi/	Date Considered	05/14/2012
-----------------------	----------------------	--------------------	------------

\*EXAMINER: Initial if reference considered, whether or not citation is in conformance with MPEP 609. Draw line through citation if not in conformance and not considered. Include copy of this form with next communication to applicant.

<sup>1</sup> Applicant's unique citation designation number (optional). <sup>2</sup> Applicant is to place a check mark here if English language Translation is attached.

ALL REFERENCES CONSIDERED EXCEPT WHERE LINED THROUGH. /SKS./

Substitute for form 1449/PTO				<b>Complete if Known</b>	
<b>INFORMATION DISCLOSURE STATEMENT BY APPLICANT</b> <i>(Use as many sheets as necessary)</i>				Application Number	13/118,122
				Filing Date	May 27, 2011
				First Named Inventor	James J. FALLON
				Art Unit	2115
				Examiner Name	To Be Assigned
Sheet	9	of	66	Attorney Docket Number	2855.004000B

NON PATENT LITERATURE DOCUMENTS			
Examiner Initials*	Cite No. <sup>1</sup>	Include name of the author (in CAPITAL LETTERS), title of the article (when appropriate), title of the item (book, magazine, journal, serial, symposium, catalog, etc.), date, page(s), volume number, publisher, city and/or country where published	T <sup>2</sup>
	NPL77	Exhibit 6, Prior Art Chart for U.S. Pat. No. 7,777,651, 257 pages, Realtime Data, LLC D/B/A IXO v. Morgan Stanley, et al., 6:09-cv-326-LED-JDL, 6:10-cv-248-LED-JDL, 6:10-cv-426-LED-JDL, Realtime Data, LLC D/B/A IXO v. CME Group Inc., et al., 6:09-cv-327-LED-JDL, 6:10-cv-246-LED-JDL, 6:10-cv-424-LED-JDL, Realtime Data, LLC D/B/A IXO v. Thomson Reuters Corp., et al., 6:09-cv-333-LED-JDL, 6:10-cv-247-LED-JDL, 6:10-cv-425-LED-JDL, United States District Court for the Eastern District of Texas Tyler Division, February 4, 2011, citing Bledsoe, U.S. Patent No. 4,646,061.	
	NPL78	Exhibit 7, Prior Art Chart for U.S. Pat. No. 7,777,651, 169 pages, Realtime Data, LLC D/B/A IXO v. Morgan Stanley, et al., 6:09-cv-326-LED-JDL, 6:10-cv-248-LED-JDL, 6:10-cv-426-LED-JDL, Realtime Data, LLC D/B/A IXO v. CME Group Inc., et al., 6:09-cv-327-LED-JDL, 6:10-cv-246-LED-JDL, 6:10-cv-424-LED-JDL, Realtime Data, LLC D/B/A IXO v. Thomson Reuters Corp., et al., 6:09-cv-333-LED-JDL, 6:10-cv-247-LED-JDL, 6:10-cv-425-LED-JDL, United States District Court for the Eastern District of Texas Tyler Division, February 4, 2011, citing Brickman et al., U.S. Patent No. 4,499,499.	
	NPL79	Exhibit 8, Prior Art Chart for U.S. Pat. No. 7,777,651, 396 pages, Realtime Data, LLC D/B/A IXO v. Morgan Stanley, et al., 6:09-cv-326-LED-JDL, 6:10-cv-248-LED-JDL, 6:10-cv-426-LED-JDL, Realtime Data, LLC D/B/A IXO v. CME Group Inc., et al., 6:09-cv-327-LED-JDL, 6:10-cv-246-LED-JDL, 6:10-cv-424-LED-JDL, Realtime Data, LLC D/B/A IXO v. Thomson Reuters Corp., et al., 6:09-cv-333-LED-JDL, 6:10-cv-247-LED-JDL, 6:10-cv-425-LED-JDL, United States District Court for the Eastern District of Texas Tyler Division, February 4, 2011, citing C. Bormann et al., "Robust Header Compression (ROHC)," Network Working Group Internet-Draft Sept. 18, 2000.	
	NPL80	Exhibit 9, Prior Art Chart for U.S. Pat. No. 7,777,651, 253 pages, Realtime Data, LLC D/B/A IXO v. Morgan Stanley, et al., 6:09-cv-326-LED-JDL, 6:10-cv-248-LED-JDL, 6:10-cv-426-LED-JDL, Realtime Data, LLC D/B/A IXO v. CME Group Inc., et al., 6:09-cv-327-LED-JDL, 6:10-cv-246-LED-JDL, 6:10-cv-424-LED-JDL, Realtime Data, LLC D/B/A IXO v. Thomson Reuters Corp., et al., 6:09-cv-333-LED-JDL, 6:10-cv-247-LED-JDL, 6:10-cv-425-LED-JDL, United States District Court for the Eastern District of Texas Tyler Division, February 4, 2011, citing Carr, U.S. Patent No. 5,293,379.	
	NPL81	Exhibit 10, Prior Art Chart for U.S. Pat. No. 7,777,651, 205 pages, Realtime Data, LLC D/B/A IXO v. Morgan Stanley, et al., 6:09-cv-326-LED-JDL, 6:10-cv-248-LED-JDL, 6:10-cv-426-LED-JDL, Realtime Data, LLC D/B/A IXO v. CME Group Inc., et al., 6:09-cv-327-LED-JDL, 6:10-cv-246-LED-JDL, 6:10-cv-424-LED-JDL, Realtime Data, LLC D/B/A IXO v. Thomson Reuters Corp., et al., 6:09-cv-333-LED-JDL, 6:10-cv-247-LED-JDL, 6:10-cv-425-LED-JDL, United States District Court for the Eastern District of Texas Tyler Division, February 4, 2011, citing Cellier et al., U.S. Patent No. 5,884,269.	
	NPL82	Exhibit 11, Prior Art Chart for U.S. Pat. No. 7,777,651, 181 pages, Realtime Data, LLC D/B/A IXO v. Morgan Stanley, et al., 6:09-cv-326-LED-JDL, 6:10-cv-248-LED-JDL, 6:10-cv-426-LED-JDL, Realtime Data, LLC D/B/A IXO v. CME Group Inc., et al., 6:09-cv-327-LED-JDL, 6:10-cv-246-LED-JDL, 6:10-cv-424-LED-JDL, Realtime Data, LLC D/B/A IXO v. Thomson Reuters Corp., et al., 6:09-cv-333-LED-JDL, 6:10-cv-247-LED-JDL, 6:10-cv-425-LED-JDL, United States District Court for the Eastern District of Texas Tyler Division, February 4, 2011, citing Chu, U.S. Patent Nos. 5,374,916 & 5,467,087.	

Examiner Signature	/Suresh Suryawanshi/	Date Considered	05/14/2012
--------------------	----------------------	-----------------	------------

\*EXAMINER: Initial if reference considered, whether or not citation is in conformance with MPEP 609. Draw line through citation if not in conformance and not considered. Include copy of this form with next communication to applicant.

<sup>1</sup> Applicant's unique citation designation number (optional). <sup>2</sup> Applicant is to place a check mark here if English language Translation is attached.

ALL REFERENCES CONSIDERED EXCEPT WHERE LINED THROUGH. /SKS./

Substitute for form 1449/PTO				<i>Complete if Known</i>	
<b>INFORMATION DISCLOSURE STATEMENT BY APPLICANT</b> <i>(Use as many sheets as necessary)</i>				Application Number	13/118,122
				Filing Date	May 27, 2011
				First Named Inventor	James J. FALLON
				Art Unit	2115
				Examiner Name	To Be Assigned
Sheet	10	of	66	Attorney Docket Number	2855.004000B

NON PATENT LITERATURE DOCUMENTS			
Examiner Initials*	Cite No. <sup>1</sup>	Include name of the author (in CAPITAL LETTERS), title of the article (when appropriate), title of the item (book, magazine, journal, serial, symposium, catalog, etc.), date, page(s), volume number, publisher, city and/or country where published	T <sup>2</sup>
	NPL83	Exhibit 12, Prior Art Chart for U.S. Pat. No. 7,777,651, 175 pages, Realtime Data, LLC D/B/A IXO v. Morgan Stanley, et al., 6:09-cv-326-LED-JDL, 6:10-cv-248-LED-JDL, 6:10-cv-426-LED-JDL, Realtime Data, LLC D/B/A IXO v. CME Group Inc., et al., 6:09-cv-327-LED-JDL, 6:10-cv-246-LED-JDL, 6:10-cv-424-LED-JDL, Realtime Data, LLC D/B/A IXO v. Thomson Reuters Corp., et al., 6:09-cv-333-LED-JDL, 6:10-cv-247-LED-JDL, 6:10-cv-425-LED-JDL, United States District Court for the Eastern District of Texas Tyler Division, February 4, 2011, citing Cisco IOS Data Compression White Paper (Cisco Systems Inc., 1997).	
	NPL84	Exhibit 13, Prior Art Chart for U.S. Pat. No. 7,777,651, 590 pages, Realtime Data, LLC D/B/A IXO v. Morgan Stanley, et al., 6:09-cv-326-LED-JDL, 6:10-cv-248-LED-JDL, 6:10-cv-426-LED-JDL, Realtime Data, LLC D/B/A IXO v. CME Group Inc., et al., 6:09-cv-327-LED-JDL, 6:10-cv-246-LED-JDL, 6:10-cv-424-LED-JDL, Realtime Data, LLC D/B/A IXO v. Thomson Reuters Corp., et al., 6:09-cv-333-LED-JDL, 6:10-cv-247-LED-JDL, 6:10-cv-425-LED-JDL, United States District Court for the Eastern District of Texas Tyler Division, February 4, 2011, citing Comstock - S&P ComStock Developers Guides (McGraw-Hill, 1994); Rich Barton, "S&P ComStock Network Character Set Definition" (February 10, 1995).	
	NPL85	Exhibit 14, Prior Art Chart for U.S. Pat. No. 7,777,651, 186 pages, Realtime Data, LLC D/B/A IXO v. Morgan Stanley, et al., 6:09-cv-326-LED-JDL, 6:10-cv-248-LED-JDL, 6:10-cv-426-LED-JDL, Realtime Data, LLC D/B/A IXO v. CME Group Inc., et al., 6:09-cv-327-LED-JDL, 6:10-cv-246-LED-JDL, 6:10-cv-424-LED-JDL, Realtime Data, LLC D/B/A IXO v. Thomson Reuters Corp., et al., 6:09-cv-333-LED-JDL, 6:10-cv-247-LED-JDL, 6:10-cv-425-LED-JDL, United States District Court for the Eastern District of Texas Tyler Division, February 4, 2011, citing D.J. Craft, "A fast hardware data compression algorithm and some algorithmic extensions," IBM J. Res. Develop. Vol. 42, No. 6 (November 1998).	
	NPL86	Exhibit 15, Prior Art Chart for U.S. Pat. No. 7,777,651, 142 pages, Realtime Data, LLC D/B/A IXO v. Morgan Stanley, et al., 6:09-cv-326-LED-JDL, 6:10-cv-248-LED-JDL, 6:10-cv-426-LED-JDL, Realtime Data, LLC D/B/A IXO v. CME Group Inc., et al., 6:09-cv-327-LED-JDL, 6:10-cv-246-LED-JDL, 6:10-cv-424-LED-JDL, Realtime Data, LLC D/B/A IXO v. Thomson Reuters Corp., et al., 6:09-cv-333-LED-JDL, 6:10-cv-247-LED-JDL, 6:10-cv-425-LED-JDL, United States District Court for the Eastern District of Texas Tyler Division, February 4, 2011, citing Deering, U.S. Patent No. 6,459,429.	
	NPL87	Exhibit 16, Prior Art Chart for U.S. Pat. No. 7,777,651, 284 pages, Realtime Data, LLC D/B/A IXO v. Morgan Stanley, et al., 6:09-cv-326-LED-JDL, 6:10-cv-248-LED-JDL, 6:10-cv-426-LED-JDL, Realtime Data, LLC D/B/A IXO v. CME Group Inc., et al., 6:09-cv-327-LED-JDL, 6:10-cv-246-LED-JDL, 6:10-cv-424-LED-JDL, Realtime Data, LLC D/B/A IXO v. Thomson Reuters Corp., et al., 6:09-cv-333-LED-JDL, 6:10-cv-247-LED-JDL, 6:10-cv-425-LED-JDL, United States District Court for the Eastern District of Texas Tyler Division, February 4, 2011, citing Dye et al., U.S. Patent No. 7,190,284 and International Publication No. WO 00/45516.	
	NPL88	Exhibit 17, Prior Art Chart for U.S. Pat. No. 7,777,651, 269 pages, Realtime Data, LLC D/B/A IXO v. Morgan Stanley, et al., 6:09-cv-326-LED-JDL, 6:10-cv-248-LED-JDL, 6:10-cv-426-LED-JDL, Realtime Data, LLC D/B/A IXO v. CME Group Inc., et al., 6:09-cv-327-LED-JDL, 6:10-cv-246-LED-JDL, 6:10-cv-424-LED-JDL, Realtime Data, LLC D/B/A IXO v. Thomson Reuters Corp., et al., 6:09-cv-333-LED-JDL, 6:10-cv-247-LED-JDL, 6:10-cv-425-LED-JDL, United States District Court for the Eastern District of Texas Tyler Division, February 4, 2011, citing Earl et al., U.S. Patent No. 5,341,440.	

Examiner Signature	/Suresh Suryawanshi/	Date Considered	05/14/2012
-----------------------	----------------------	--------------------	------------

\*EXAMINER: Initial if reference considered, whether or not citation is in conformance with MPEP 609. Draw line through citation if not in conformance and not considered. Include copy of this form with next communication to applicant.

<sup>1</sup> Applicant's unique citation designation number (optional). <sup>2</sup> Applicant is to place a check mark here if English language Translation is attached.

ALL REFERENCES CONSIDERED EXCEPT WHERE LINED THROUGH. /SKS./



Substitute for form 1449/PTO				<i>Complete if Known</i>	
<b>INFORMATION DISCLOSURE STATEMENT BY APPLICANT</b> <i>(Use as many sheets as necessary)</i>				Application Number	13/118,122
				Filing Date	May 27, 2011
				First Named Inventor	James J. FALLON
				Art Unit	2115
				Examiner Name	To Be Assigned
Sheet	11	of	66	Attorney Docket Number	2855.004000B

NON PATENT LITERATURE DOCUMENTS			
Examiner Initials*	Cite No. <sup>1</sup>	Include name of the author (in CAPITAL LETTERS), title of the article (when appropriate), title of the item (book, magazine, journal, serial, symposium, catalog, etc.), date, page(s), volume number, publisher, city and/or country where published	T <sup>2</sup>
	NPL89	Exhibit 18, Prior Art Chart for U.S. Pat. No. 7,777,651, 132 pages, Realtime Data, LLC D/B/A IXO v. Morgan Stanley, et al., 6:09-cv-326-LED-JDL, 6:10-cv-248-LED-JDL, 6:10-cv-426-LED-JDL, Realtime Data, LLC D/B/A IXO v. CME Group Inc., et al., 6:09-cv-327-LED-JDL, 6:10-cv-246-LED-JDL, 6:10-cv-424-LED-JDL, Realtime Data, LLC D/B/A IXO v. Thomson Reuters Corp., et al., 6:09-cv-333-LED-JDL, 6:10-cv-247-LED-JDL, 6:10-cv-425-LED-JDL, United States District Court for the Eastern District of Texas Tyler Division, February 4, 2011, citing Eastman et al., U.S. Patent No. 4,464,650.	
	NPL90	Exhibit 19, Prior Art Chart for U.S. Pat. No. 7,777,651, 125 pages, Realtime Data, LLC D/B/A IXO v. Morgan Stanley, et al., 6:09-cv-326-LED-JDL, 6:10-cv-248-LED-JDL, 6:10-cv-426-LED-JDL, Realtime Data, LLC D/B/A IXO v. CME Group Inc., et al., 6:09-cv-327-LED-JDL, 6:10-cv-246-LED-JDL, 6:10-cv-424-LED-JDL, Realtime Data, LLC D/B/A IXO v. Thomson Reuters Corp., et al., 6:09-cv-333-LED-JDL, 6:10-cv-247-LED-JDL, 6:10-cv-425-LED-JDL, United States District Court for the Eastern District of Texas Tyler Division, February 4, 2011, citing Elgamal et al., U.S. Patent No. 5,410,671.	
	NPL91	Exhibit 20, Prior Art Chart for U.S. Pat. No. 7,777,651, 122 pages, Realtime Data, LLC D/B/A IXO v. Morgan Stanley, et al., 6:09-cv-326-LED-JDL, 6:10-cv-248-LED-JDL, 6:10-cv-426-LED-JDL, Realtime Data, LLC D/B/A IXO v. CME Group Inc., et al., 6:09-cv-327-LED-JDL, 6:10-cv-246-LED-JDL, 6:10-cv-424-LED-JDL, Realtime Data, LLC D/B/A IXO v. Thomson Reuters Corp., et al., 6:09-cv-333-LED-JDL, 6:10-cv-247-LED-JDL, 6:10-cv-425-LED-JDL, United States District Court for the Eastern District of Texas Tyler Division, February 4, 2011, citing Enari et al., European Patent Application No. 0493130 A2.	
	NPL92	Exhibit 21, Prior Art Chart for U.S. Pat. No. 7,777,651, 379 pages, Realtime Data, LLC D/B/A IXO v. Morgan Stanley, et al., 6:09-cv-326-LED-JDL, 6:10-cv-248-LED-JDL, 6:10-cv-426-LED-JDL, Realtime Data, LLC D/B/A IXO v. CME Group Inc., et al., 6:09-cv-327-LED-JDL, 6:10-cv-246-LED-JDL, 6:10-cv-424-LED-JDL, Realtime Data, LLC D/B/A IXO v. Thomson Reuters Corp., et al., 6:09-cv-333-LED-JDL, 6:10-cv-247-LED-JDL, 6:10-cv-425-LED-JDL, United States District Court for the Eastern District of Texas Tyler Division, February 4, 2011, citing Fascenda, U.S. Patent No. 5,045,848.	
	NPL93	Exhibit 22, Prior Art Chart for U.S. Pat. No. 7,777,651, 218 pages, Realtime Data, LLC D/B/A IXO v. Morgan Stanley, et al., 6:09-cv-326-LED-JDL, 6:10-cv-248-LED-JDL, 6:10-cv-426-LED-JDL, Realtime Data, LLC D/B/A IXO v. CME Group Inc., et al., 6:09-cv-327-LED-JDL, 6:10-cv-246-LED-JDL, 6:10-cv-424-LED-JDL, Realtime Data, LLC D/B/A IXO v. Thomson Reuters Corp., et al., 6:09-cv-333-LED-JDL, 6:10-cv-247-LED-JDL, 6:10-cv-425-LED-JDL, United States District Court for the Eastern District of Texas Tyler Division, February 4, 2011, citing Frachtenberg et al., U.S. Patent. Pub. 2003/0030575.	
	NPL94	Exhibit 23, Prior Art Chart for U.S. Pat. No. 7,777,651, 247 pages, Realtime Data, LLC D/B/A IXO v. Morgan Stanley, et al., 6:09-cv-326-LED-JDL, 6:10-cv-248-LED-JDL, 6:10-cv-426-LED-JDL, Realtime Data, LLC D/B/A IXO v. CME Group Inc., et al., 6:09-cv-327-LED-JDL, 6:10-cv-246-LED-JDL, 6:10-cv-424-LED-JDL, Realtime Data, LLC D/B/A IXO v. Thomson Reuters Corp., et al., 6:09-cv-333-LED-JDL, 6:10-cv-247-LED-JDL, 6:10-cv-425-LED-JDL, United States District Court for the Eastern District of Texas Tyler Division, February 4, 2011, citing Franaszek et al., U. S. Patent No. 5,870,036.	

Examiner Signature	/Suresh Suryawanshi/	Date Considered	05/14/2012
-----------------------	----------------------	--------------------	------------

\*EXAMINER: Initial if reference considered, whether or not citation is in conformance with MPEP 609. Draw line through citation if not in conformance and not considered. Include copy of this form with next communication to applicant.

<sup>1</sup> Applicant's unique citation designation number (optional). <sup>2</sup> Applicant is to place a check mark here if English language Translation is attached.

ALL REFERENCES CONSIDERED EXCEPT WHERE LINED THROUGH. /SKS./

Substitute for form 1449/PTO				<i>Complete if Known</i>	
<b>INFORMATION DISCLOSURE STATEMENT BY APPLICANT</b> <i>(Use as many sheets as necessary)</i>				Application Number	13/118,122
				Filing Date	May 27, 2011
				First Named Inventor	James J. FALLON
				Art Unit	2115
				Examiner Name	To Be Assigned
Sheet	12	of	66	Attorney Docket Number	2855.004000B

NON PATENT LITERATURE DOCUMENTS			
Examiner Initials*	Cite No. <sup>1</sup>	Include name of the author (in CAPITAL LETTERS), title of the article (when appropriate), title of the item (book, magazine, journal, serial, symposium, catalog, etc.), date, page(s), volume number, publisher, city and/or country where published	T <sup>2</sup>
	NPL95	Exhibit 24, Prior Art Chart for U.S. Pat. No. 7,777,651, 327 pages, Realtime Data, LLC D/B/A IXO v. Morgan Stanley, et al., 6:09-cv-326-LED-JDL, 6:10-cv-248-LED-JDL, 6:10-cv-426-LED-JDL, Realtime Data, LLC D/B/A IXO v. CME Group Inc., et al., 6:09-cv-327-LED-JDL, 6:10-cv-246-LED-JDL, 6:10-cv-424-LED-JDL, Realtime Data, LLC D/B/A IXO v. Thomson Reuters Corp., et al., 6:09-cv-333-LED-JDL, 6:10-cv-247-LED-JDL, 6:10-cv-425-LED-JDL, United States District Court for the Eastern District of Texas Tyler Division, February 4, 2011, citing French et al., U.S. Patent No. 5,794,229.	
	NPL96	Exhibit 25, Prior Art Chart for U.S. Pat. No. 7,777,651, 225 pages, Exhibit 24, Prior Art Chart for U.S. Pat. No. 7,777,651, 327 pages, Realtime Data, LLC D/B/A IXO v. Morgan Stanley, et al., 6:09-cv-326-LED-JDL, 6:10-cv-248-LED-JDL, 6:10-cv-426-LED-JDL, Realtime Data, LLC D/B/A IXO v. CME Group Inc., et al., 6:09-cv-327-LED-JDL, 6:10-cv-246-LED-JDL, 6:10-cv-424-LED-JDL, Realtime Data, LLC D/B/A IXO v. Thomson Reuters Corp., et al., 6:09-cv-333-LED-JDL, 6:10-cv-247-LED-JDL, 6:10-cv-425-LED-JDL, United States District Court for the Eastern District of Texas Tyler Division, February 4, 2011, citing Geiger et al., U.S. Patent No. 5,987,022.	
	NPL97	Exhibit 26, Prior Art Chart for U.S. Pat. No. 7,777,651, 219 pages, Realtime Data, LLC D/B/A IXO v. Morgan Stanley, et al., 6:09-cv-326-LED-JDL, 6:10-cv-248-LED-JDL, 6:10-cv-426-LED-JDL, Realtime Data, LLC D/B/A IXO v. CME Group Inc., et al., 6:09-cv-327-LED-JDL, 6:10-cv-246-LED-JDL, 6:10-cv-424-LED-JDL, Realtime Data, LLC D/B/A IXO v. Thomson Reuters Corp., et al., 6:09-cv-333-LED-JDL, 6:10-cv-247-LED-JDL, 6:10-cv-425-LED-JDL, United States District Court for the Eastern District of Texas Tyler Division, February 4, 2011, citing Gentile, U.S. Patent No. 5,504,842.	
	NPL98	Exhibit 27, Prior Art Chart for U.S. Pat. No. 7,777,651, Realtime Data, LLC D/B/A IXO v. Morgan Stanley, et al., 6:09-cv-326-LED-JDL, 6:10-cv-248-LED-JDL, 6:10-cv-426-LED-JDL, Realtime Data, LLC D/B/A IXO v. CME Group Inc., et al., 6:09-cv-327-LED-JDL, 6:10-cv-246-LED-JDL, 6:10-cv-424-LED-JDL, Realtime Data, LLC D/B/A IXO v. Thomson Reuters Corp., et al., 6:09-cv-333-LED-JDL, 6:10-cv-247-LED-JDL, 6:10-cv-425-LED-JDL, United States District Court for the Eastern District of Texas Tyler Division, February 4, 2011, 167 pages, citing Giltner et al., U.S. Patent No. 4,386,416.	
	NPL99	Exhibit 28, Prior Art Chart for U.S. Pat. No. 7,777,651, 156 pages, Realtime Data, LLC D/B/A IXO v. Morgan Stanley, et al., 6:09-cv-326-LED-JDL, 6:10-cv-248-LED-JDL, 6:10-cv-426-LED-JDL, Realtime Data, LLC D/B/A IXO v. CME Group Inc., et al., 6:09-cv-327-LED-JDL, 6:10-cv-246-LED-JDL, 6:10-cv-424-LED-JDL, Realtime Data, LLC D/B/A IXO v. Thomson Reuters Corp., et al., 6:09-cv-333-LED-JDL, 6:10-cv-247-LED-JDL, 6:10-cv-425-LED-JDL, United States District Court for the Eastern District of Texas Tyler Division, February 4, 2011, citing Gooch, U.S. Patent No. 4,325,085.	
	NPL100	Exhibit 29, Prior Art Chart for U.S. Pat. No. 7,777,651, 132 pages, Realtime Data, LLC D/B/A IXO v. Morgan Stanley, et al., 6:09-cv-326-LED-JDL, 6:10-cv-248-LED-JDL, 6:10-cv-426-LED-JDL, Realtime Data, LLC D/B/A IXO v. CME Group Inc., et al., 6:09-cv-327-LED-JDL, 6:10-cv-246-LED-JDL, 6:10-cv-424-LED-JDL, Realtime Data, LLC D/B/A IXO v. Thomson Reuters Corp., et al., 6:09-cv-333-LED-JDL, 6:10-cv-247-LED-JDL, 6:10-cv-425-LED-JDL, United States District Court for the Eastern District of Texas Tyler Division, February 4, 2011, citing Hauck, U.S. Patent No. 4,626,829.	

Examiner Signature	/Suresh Suryawanshi/	Date Considered	05/14/2012
--------------------	----------------------	-----------------	------------

\*EXAMINER: Initial if reference considered, whether or not citation is in conformance with MPEP 609. Draw line through citation if not in conformance and not considered. Include copy of this form with next communication to applicant.

<sup>1</sup> Applicant's unique citation designation number (optional). <sup>2</sup> Applicant is to place a check mark here if English language Translation is attached.

ALL REFERENCES CONSIDERED EXCEPT WHERE LINED THROUGH. /SKS./

Substitute for form 1449/PTO				<b>Complete if Known</b>	
<b>INFORMATION DISCLOSURE STATEMENT BY APPLICANT</b> <i>(Use as many sheets as necessary)</i>				Application Number	13/118,122
				Filing Date	May 27, 2011
				First Named Inventor	James J. FALLON
				Art Unit	2115
				Examiner Name	To Be Assigned
Sheet	13	of	66	Attorney Docket Number	2855.004000B

NON PATENT LITERATURE DOCUMENTS			
Examiner Initials*	Cite No. <sup>1</sup>	Include name of the author (in CAPITAL LETTERS), title of the article (when appropriate), title of the item (book, magazine, journal, serial, symposium, catalog, etc.), date, page(s), volume number, publisher, city and/or country where published	T <sup>2</sup>
	NPL101	Exhibit 30, Prior Art Chart for U.S. Pat. No. 7,777,651, 161 pages, Realtime Data, LLC D/B/A IXO v. Morgan Stanley, et al., 6:09-cv-326-LED-JDL, 6:10-cv-248-LED-JDL, 6:10-cv-426-LED-JDL, Realtime Data, LLC D/B/A IXO v. CME Group Inc., et al., 6:09-cv-327-LED-JDL, 6:10-cv-246-LED-JDL, 6:10-cv-424-LED-JDL, Realtime Data, LLC D/B/A IXO v. Thomson Reuters Corp., et al., 6:09-cv-333-LED-JDL, 6:10-cv-247-LED-JDL, 6:10-cv-425-LED-JDL, United States District Court for the Eastern District of Texas Tyler Division, February 4, 2011, citing Heath, U.S. Patent No. 5,955,976.	
	NPL102	Exhibit 31, Prior Art Chart for U.S. Pat. No. 7,777,651, 359 pages, Realtime Data, LLC D/B/A IXO v. Morgan Stanley, et al., 6:09-cv-326-LED-JDL, 6:10-cv-248-LED-JDL, 6:10-cv-426-LED-JDL, Realtime Data, LLC D/B/A IXO v. CME Group Inc., et al., 6:09-cv-327-LED-JDL, 6:10-cv-246-LED-JDL, 6:10-cv-424-LED-JDL, Realtime Data, LLC D/B/A IXO v. Thomson Reuters Corp., et al., 6:09-cv-333-LED-JDL, 6:10-cv-247-LED-JDL, 6:10-cv-425-LED-JDL, United States District Court for the Eastern District of Texas Tyler Division, February 4, 2011, citing Hewlett-Packard Company, "Installing and Administering PPP," B2355-90137, HP 9000 Networking, E0948 (1st Ed. 1997).	
	NPL103	Exhibit 32, Prior Art Chart for U.S. Pat. No. 7,777,651, 229 pages, Realtime Data, LLC D/B/A IXO v. Morgan Stanley, et al., 6:09-cv-326-LED-JDL, 6:10-cv-248-LED-JDL, 6:10-cv-426-LED-JDL, Realtime Data, LLC D/B/A IXO v. CME Group Inc., et al., 6:09-cv-327-LED-JDL, 6:10-cv-246-LED-JDL, 6:10-cv-424-LED-JDL, Realtime Data, LLC D/B/A IXO v. Thomson Reuters Corp., et al., 6:09-cv-333-LED-JDL, 6:10-cv-247-LED-JDL, 6:10-cv-425-LED-JDL, United States District Court for the Eastern District of Texas Tyler Division, February 4, 2011, citing Hsu & Zwarico, Automatic Synthesis of Compression Techniques for Heterogeneous Files, Software-Practice & Experience, vol. 25(10), pp.1097-1116 (October 1995).	
	NPL104	Exhibit 33, Prior Art Chart for U.S. Pat. No. 7,777,651, 206 pages, Realtime Data, LLC D/B/A IXO v. Morgan Stanley, et al., 6:09-cv-326-LED-JDL, 6:10-cv-248-LED-JDL, 6:10-cv-426-LED-JDL, Realtime Data, LLC D/B/A IXO v. CME Group Inc., et al., 6:09-cv-327-LED-JDL, 6:10-cv-246-LED-JDL, 6:10-cv-424-LED-JDL, Realtime Data, LLC D/B/A IXO v. Thomson Reuters Corp., et al., 6:09-cv-333-LED-JDL, 6:10-cv-247-LED-JDL, 6:10-cv-425-LED-JDL, United States District Court for the Eastern District of Texas Tyler Division, February 4, 2011, citing ICT XML-Xpress White Paper (Intelligent Compression Technologies Inc., 2000) & website.	
	NPL105	Exhibit 34, Prior Art Chart for U.S. Pat. No. 7,777,651, 138 pages, Realtime Data, LLC D/B/A IXO v. Morgan Stanley, et al., 6:09-cv-326-LED-JDL, 6:10-cv-248-LED-JDL, 6:10-cv-426-LED-JDL, Realtime Data, LLC D/B/A IXO v. CME Group Inc., et al., 6:09-cv-327-LED-JDL, 6:10-cv-246-LED-JDL, 6:10-cv-424-LED-JDL, Realtime Data, LLC D/B/A IXO v. Thomson Reuters Corp., et al., 6:09-cv-333-LED-JDL, 6:10-cv-247-LED-JDL, 6:10-cv-425-LED-JDL, United States District Court for the Eastern District of Texas Tyler Division, February 4, 2011, citing ICT XpressFiles White Paper (Intelligent Compression Technologies Inc., 1999) & website.	
	NPL106	Exhibit 35, Prior Art Chart for U.S. Pat. No. 7,777,651, 128 pages, Realtime Data, LLC D/B/A IXO v. Morgan Stanley, et al., 6:09-cv-326-LED-JDL, 6:10-cv-248-LED-JDL, 6:10-cv-426-LED-JDL, Realtime Data, LLC D/B/A IXO v. CME Group Inc., et al., 6:09-cv-327-LED-JDL, 6:10-cv-246-LED-JDL, 6:10-cv-424-LED-JDL, Realtime Data, LLC D/B/A IXO v. Thomson Reuters Corp., et al., 6:09-cv-333-LED-JDL, 6:10-cv-247-LED-JDL, 6:10-cv-425-LED-JDL, United States District Court for the Eastern District of Texas Tyler Division, February 4, 2011, citing Iseda et al., E.P. 0405572 A2.	

Examiner Signature	/Suresh Suryawanshi/	Date Considered	05/14/2012
--------------------	----------------------	-----------------	------------

\*EXAMINER: Initial if reference considered, whether or not citation is in conformance with MPEP 609. Draw line through citation if not in conformance and not considered. Include copy of this form with next communication to applicant.

<sup>1</sup> Applicant's unique citation designation number (optional). <sup>2</sup> Applicant is to place a check mark here if English language Translation is attached.

ALL REFERENCES CONSIDERED EXCEPT WHERE LINED THROUGH. /SKS./

Substitute for form 1449/PTO				<i>Complete if Known</i>	
<b>INFORMATION DISCLOSURE STATEMENT BY APPLICANT</b> <i>(Use as many sheets as necessary)</i>				Application Number	13/118,122
				Filing Date	May 27, 2011
				First Named Inventor	James J. FALLON
				Art Unit	2115
				Examiner Name	To Be Assigned
Sheet	14	of	66	Attorney Docket Number	2855.004000B

NON PATENT LITERATURE DOCUMENTS			
Examiner Initials*	Cite No. <sup>1</sup>	Include name of the author (in CAPITAL LETTERS), title of the article (when appropriate), title of the item (book, magazine, journal, serial, symposium, catalog, etc.), date, page(s), volume number, publisher, city and/or country where published	T <sup>2</sup>
	NPL107	Exhibit 36, Prior Art Chart for U.S. Pat. No. 7,777,651, 205 pages, Realtime Data, LLC D/B/A IXO v. Morgan Stanley, et al., 6:09-cv-326-LED-JDL, 6:10-cv-248-LED-JDL, 6:10-cv-426-LED-JDL, Realtime Data, LLC D/B/A IXO v. CME Group Inc., et al., 6:09-cv-327-LED-JDL, 6:10-cv-246-LED-JDL, 6:10-cv-424-LED-JDL, Realtime Data, LLC D/B/A IXO v. Thomson Reuters Corp., et al., 6:09-cv-333-LED-JDL, 6:10-cv-247-LED-JDL, 6:10-cv-425-LED-JDL, United States District Court for the Eastern District of Texas Tyler Division, February 4, 2011, citing J. Danskin, "Compressing the X Graphics Protocol," Princeton University (Jan. 1995).	
	NPL108	Exhibit 37, Prior Art Chart for U.S. Pat. No. 7,777,651, 159 pages, Realtime Data, LLC D/B/A IXO v. Morgan Stanley, et al., 6:09-cv-326-LED-JDL, 6:10-cv-248-LED-JDL, 6:10-cv-426-LED-JDL, Realtime Data, LLC D/B/A IXO v. CME Group Inc., et al., 6:09-cv-327-LED-JDL, 6:10-cv-246-LED-JDL, 6:10-cv-424-LED-JDL, Realtime Data, LLC D/B/A IXO v. Thomson Reuters Corp., et al., 6:09-cv-333-LED-JDL, 6:10-cv-247-LED-JDL, 6:10-cv-425-LED-JDL, United States District Court for the Eastern District of Texas Tyler Division, February 4, 2011, citing Kalkstein, U.S. Patent No. 5,945,933.	
	NPL109	Exhibit 38, Prior Art Chart for U.S. Pat. No. 7,777,651, 402 pages, Realtime Data, LLC D/B/A IXO v. Morgan Stanley, et al., 6:09-cv-326-LED-JDL, 6:10-cv-248-LED-JDL, 6:10-cv-426-LED-JDL, Realtime Data, LLC D/B/A IXO v. CME Group Inc., et al., 6:09-cv-327-LED-JDL, 6:10-cv-246-LED-JDL, 6:10-cv-424-LED-JDL, Realtime Data, LLC D/B/A IXO v. Thomson Reuters Corp., et al., 6:09-cv-333-LED-JDL, 6:10-cv-247-LED-JDL, 6:10-cv-425-LED-JDL, United States District Court for the Eastern District of Texas Tyler Division, February 4, 2011, citing Kari, U.S. Patent No. 6,434,168; International Publication No. WO97/48212 A1.	
	NPL110	Exhibit 39, Prior Art Chart for U.S. Pat. No. 7,777,651, 209 pages, Realtime Data, LLC D/B/A IXO v. Morgan Stanley, et al., 6:09-cv-326-LED-JDL, 6:10-cv-248-LED-JDL, 6:10-cv-426-LED-JDL, Realtime Data, LLC D/B/A IXO v. CME Group Inc., et al., 6:09-cv-327-LED-JDL, 6:10-cv-246-LED-JDL, 6:10-cv-424-LED-JDL, Realtime Data, LLC D/B/A IXO v. Thomson Reuters Corp., et al., 6:09-cv-333-LED-JDL, 6:10-cv-247-LED-JDL, 6:10-cv-425-LED-JDL, United States District Court for the Eastern District of Texas Tyler Division, February 4, 2011, citing Koopmas et al., U.S. Patent No. 7,024,460.	
	NPL111	Exhibit 40, Prior Art Chart for U.S. Pat. No. 7,777,651, 214 pages, Realtime Data, LLC D/B/A IXO v. Morgan Stanley, et al., 6:09-cv-326-LED-JDL, 6:10-cv-248-LED-JDL, 6:10-cv-426-LED-JDL, Realtime Data, LLC D/B/A IXO v. CME Group Inc., et al., 6:09-cv-327-LED-JDL, 6:10-cv-246-LED-JDL, 6:10-cv-424-LED-JDL, Realtime Data, LLC D/B/A IXO v. Thomson Reuters Corp., et al., 6:09-cv-333-LED-JDL, 6:10-cv-247-LED-JDL, 6:10-cv-425-LED-JDL, United States District Court for the Eastern District of Texas Tyler Division, February 4, 2011, citing Kopf, U.S. Patent No. 5,825,830.	
	NPL112	Exhibit 41, Prior Art Chart for U.S. Pat. No. 7,777,651, 281 pages, Realtime Data, LLC D/B/A IXO v. Morgan Stanley, et al., 6:09-cv-326-LED-JDL, 6:10-cv-248-LED-JDL, 6:10-cv-426-LED-JDL, Realtime Data, LLC D/B/A IXO v. CME Group Inc., et al., 6:09-cv-327-LED-JDL, 6:10-cv-246-LED-JDL, 6:10-cv-424-LED-JDL, Realtime Data, LLC D/B/A IXO v. Thomson Reuters Corp., et al., 6:09-cv-333-LED-JDL, 6:10-cv-247-LED-JDL, 6:10-cv-425-LED-JDL, United States District Court for the Eastern District of Texas Tyler Division, February 4, 2011, citing Kopf, U.S. Patent No. 5,825,830.	

Examiner Signature	/Suresh Suryawanshi/	Date Considered	05/14/2012
-----------------------	----------------------	--------------------	------------

\*EXAMINER: Initial if reference considered, whether or not citation is in conformance with MPEP 609. Draw line through citation if not in conformance and not considered. Include copy of this form with next communication to applicant.

<sup>1</sup> Applicant's unique citation designation number (optional). <sup>2</sup> Applicant is to place a check mark here if English language Translation is attached.

ALL REFERENCES CONSIDERED EXCEPT WHERE LINED THROUGH. /SKS./

Substitute for form 1449/PTO				<i>Complete if Known</i>	
<b>INFORMATION DISCLOSURE STATEMENT BY APPLICANT</b> <i>(Use as many sheets as necessary)</i>				Application Number	13/118,122
				Filing Date	May 27, 2011
				First Named Inventor	James J. FALLON
				Art Unit	2115
				Examiner Name	To Be Assigned
Sheet	15	of	66	Attorney Docket Number	2855.004000B

NON PATENT LITERATURE DOCUMENTS			
Examiner Initials*	Cite No. <sup>1</sup>	Include name of the author (in CAPITAL LETTERS), title of the article (when appropriate), title of the item (book, magazine, journal, serial, symposium, catalog, etc.), date, page(s), volume number, publisher, city and/or country where published	T <sup>2</sup>
	NPL113	Exhibit 42, Prior Art Chart for U.S. Pat. No. 7,777,651, 340 pages, Realtime Data, LLC D/B/A IXO v. Morgan Stanley, et al., 6:09-cv-326-LED-JDL, 6:10-cv-248-LED-JDL, 6:10-cv-426-LED-JDL, Realtime Data, LLC D/B/A IXO v. CME Group Inc., et al., 6:09-cv-327-LED-JDL, 6:10-cv-246-LED-JDL, 6:10-cv-424-LED-JDL, Realtime Data, LLC D/B/A IXO v. Thomson Reuters Corp., et al., 6:09-cv-333-LED-JDL, 6:10-cv-247-LED-JDL, 6:10-cv-425-LED-JDL, United States District Court for the Eastern District of Texas Tyler Division, February 4, 2011, citing Lane et al., U.S. Patent No. 5,521,940.	
	NPL114	Exhibit 43, Prior Art Chart for U.S. Pat. No. 7,777,651, 164 pages, Realtime Data, LLC D/B/A IXO v. Morgan Stanley, et al., 6:09-cv-326-LED-JDL, 6:10-cv-248-LED-JDL, 6:10-cv-426-LED-JDL, Realtime Data, LLC D/B/A IXO v. CME Group Inc., et al., 6:09-cv-327-LED-JDL, 6:10-cv-246-LED-JDL, 6:10-cv-424-LED-JDL, Realtime Data, LLC D/B/A IXO v. Thomson Reuters Corp., et al., 6:09-cv-333-LED-JDL, 6:10-cv-247-LED-JDL, 6:10-cv-425-LED-JDL, United States District Court for the Eastern District of Texas Tyler Division, February 4, 2011, citing Langdon, Jr. et al., U.S. Patent No. 4,494,108.	
	NPL115	Exhibit 44, Prior Art Chart for U.S. Pat. No. 7,777,651, 211 pages, Realtime Data, LLC D/B/A IXO v. Morgan Stanley, et al., 6:09-cv-326-LED-JDL, 6:10-cv-248-LED-JDL, 6:10-cv-426-LED-JDL, Realtime Data, LLC D/B/A IXO v. CME Group Inc., et al., 6:09-cv-327-LED-JDL, 6:10-cv-246-LED-JDL, 6:10-cv-424-LED-JDL, Realtime Data, LLC D/B/A IXO v. Thomson Reuters Corp., et al., 6:09-cv-333-LED-JDL, 6:10-cv-247-LED-JDL, 6:10-cv-425-LED-JDL, United States District Court for the Eastern District of Texas Tyler Division, February 4, 2011, citing Lavallec, U.S. Patent No. 6,215,904.	
	NPL116	Exhibit 45, Prior Art Chart for U.S. Pat. No. 7,777,651, 103 pages, Realtime Data, LLC D/B/A IXO v. Morgan Stanley, et al., 6:09-cv-326-LED-JDL, 6:10-cv-248-LED-JDL, 6:10-cv-426-LED-JDL, Realtime Data, LLC D/B/A IXO v. CME Group Inc., et al., 6:09-cv-327-LED-JDL, 6:10-cv-246-LED-JDL, 6:10-cv-424-LED-JDL, Realtime Data, LLC D/B/A IXO v. Thomson Reuters Corp., et al., 6:09-cv-333-LED-JDL, 6:10-cv-247-LED-JDL, 6:10-cv-425-LED-JDL, United States District Court for the Eastern District of Texas Tyler Division, February 4, 2011, citing M. Effros, P. Chou & R.M. Gray, "Variable Dimension Weighted Universal Vector Quantization and Noiseless Coding," IEEE 1068-0314/94 (1994).	
	NPL117	Exhibit 46, Prior Art Chart for U.S. Pat. No. 7,777,651, 414 pages, Realtime Data, LLC D/B/A IXO v. Morgan Stanley, et al., 6:09-cv-326-LED-JDL, 6:10-cv-248-LED-JDL, 6:10-cv-426-LED-JDL, Realtime Data, LLC D/B/A IXO v. CME Group Inc., et al., 6:09-cv-327-LED-JDL, 6:10-cv-246-LED-JDL, 6:10-cv-424-LED-JDL, Realtime Data, LLC D/B/A IXO v. Thomson Reuters Corp., et al., 6:09-cv-333-LED-JDL, 6:10-cv-247-LED-JDL, 6:10-cv-425-LED-JDL, United States District Court for the Eastern District of Texas Tyler Division, February 4, 2011, citing MacCrisken, U.S. Patent No. 4,730,348.	
	NPL118	Exhibit 47, Prior Art Chart for U.S. Pat. No. 7,777,651, 319 pages, Realtime Data, LLC D/B/A IXO v. Morgan Stanley, et al., 6:09-cv-326-LED-JDL, 6:10-cv-248-LED-JDL, 6:10-cv-426-LED-JDL, Realtime Data, LLC D/B/A IXO v. CME Group Inc., et al., 6:09-cv-327-LED-JDL, 6:10-cv-246-LED-JDL, 6:10-cv-424-LED-JDL, Realtime Data, LLC D/B/A IXO v. Thomson Reuters Corp., et al., 6:09-cv-333-LED-JDL, 6:10-cv-247-LED-JDL, 6:10-cv-425-LED-JDL, United States District Court for the Eastern District of Texas Tyler Division, February 4, 2011, citing Madany et al., U.S. Patent No. 5,774,715.	

Examiner Signature	/Suresh Suryawanshi/	Date Considered	05/14/2012
-----------------------	----------------------	--------------------	------------

\*EXAMINER: Initial if reference considered, whether or not citation is in conformance with MPEP 609. Draw line through citation if not in conformance and not considered. Include copy of this form with next communication to applicant.

<sup>1</sup> Applicant's unique citation designation number (optional). <sup>2</sup> Applicant is to place a check mark here if English language Translation is attached.

ALL REFERENCES CONSIDERED EXCEPT WHERE LINED THROUGH. /SKS./

Substitute for form 1449/PTO				<i>Complete if Known</i>	
<b>INFORMATION DISCLOSURE STATEMENT BY APPLICANT</b> <i>(Use as many sheets as necessary)</i>				Application Number	13/118,122
				Filing Date	May 27, 2011
				First Named Inventor	James J. FALLON
				Art Unit	2115
				Examiner Name	To Be Assigned
Sheet	16	of	66	Attorney Docket Number	2855.004000B

NON PATENT LITERATURE DOCUMENTS			
Examiner Initials*	Cite No. <sup>1</sup>	Include name of the author (in CAPITAL LETTERS), title of the article (when appropriate), title of the item (book, magazine, journal, serial, symposium, catalog, etc.), date, page(s), volume number, publisher, city and/or country where published	T <sup>2</sup>
	NPL119	Exhibit 48, Prior Art Chart for U.S. Pat. No. 7,777,651, 228 pages, Realtime Data, LLC D/B/A IXO v. Morgan Stanley, et al., 6:09-cv-326-LED-JDL, 6:10-cv-248-LED-JDL, 6:10-cv-426-LED-JDL, Realtime Data, LLC D/B/A IXO v. CME Group Inc., et al., 6:09-cv-327-LED-JDL, 6:10-cv-246-LED-JDL, 6:10-cv-424-LED-JDL, Realtime Data, LLC D/B/A IXO v. Thomson Reuters Corp., et al., 6:09-cv-333-LED-JDL, 6:10-cv-247-LED-JDL, 6:10-cv-425-LED-JDL, United States District Court for the Eastern District of Texas Tyler Division, February 4, 2011, citing Mark A. Roth and Scott J. Van Horn, "Database Compression" SIGMOD Record, Vol. 22, No. 3 (1993).	
	NPL120	Exhibit 49, Prior Art Chart for U.S. Pat. No. 7,777,651, 235 pages, Realtime Data, LLC D/B/A IXO v. Morgan Stanley, et al., 6:09-cv-326-LED-JDL, 6:10-cv-248-LED-JDL, 6:10-cv-426-LED-JDL, Realtime Data, LLC D/B/A IXO v. CME Group Inc., et al., 6:09-cv-327-LED-JDL, 6:10-cv-246-LED-JDL, 6:10-cv-424-LED-JDL, Realtime Data, LLC D/B/A IXO v. Thomson Reuters Corp., et al., 6:09-cv-333-LED-JDL, 6:10-cv-247-LED-JDL, 6:10-cv-425-LED-JDL, United States District Court for the Eastern District of Texas Tyler Division, February 4, 2011, citing Miller et al., U.S. Patent No. 4,814,746.	
	NPL121	Exhibit 50, Prior Art Chart for U.S. Pat. No. 7,777,651, 172 pages, Realtime Data, LLC D/B/A IXO v. Morgan Stanley, et al., 6:09-cv-326-LED-JDL, 6:10-cv-248-LED-JDL, 6:10-cv-426-LED-JDL, Realtime Data, LLC D/B/A IXO v. CME Group Inc., et al., 6:09-cv-327-LED-JDL, 6:10-cv-246-LED-JDL, 6:10-cv-424-LED-JDL, Realtime Data, LLC D/B/A IXO v. Thomson Reuters Corp., et al., 6:09-cv-333-LED-JDL, 6:10-cv-247-LED-JDL, 6:10-cv-425-LED-JDL, United States District Court for the Eastern District of Texas Tyler Division, February 4, 2011, citing O'Brien et al., U.S. Patent No. 4,929,946.	
	NPL122	Exhibit 51, Prior Art Chart for U.S. Pat. No. 7,777,651, 30 pages, Realtime Data, LLC D/B/A IXO v. Morgan Stanley, et al., 6:09-cv-326-LED-JDL, 6:10-cv-248-LED-JDL, 6:10-cv-426-LED-JDL, Realtime Data, LLC D/B/A IXO v. CME Group Inc., et al., 6:09-cv-327-LED-JDL, 6:10-cv-246-LED-JDL, 6:10-cv-424-LED-JDL, Realtime Data, LLC D/B/A IXO v. Thomson Reuters Corp., et al., 6:09-cv-333-LED-JDL, 6:10-cv-247-LED-JDL, 6:10-cv-425-LED-JDL, United States District Court for the Eastern District of Texas Tyler Division, February 4, 2011, citing Osler et al., U.S. Patent No. 6,768,749.	
	NPL123	Exhibit 52, Prior Art Chart for U.S. Pat. No. 7,777,651, 103 pages, Realtime Data, LLC D/B/A IXO v. Morgan Stanley, et al., 6:09-cv-326-LED-JDL, 6:10-cv-248-LED-JDL, 6:10-cv-426-LED-JDL, Realtime Data, LLC D/B/A IXO v. CME Group Inc., et al., 6:09-cv-327-LED-JDL, 6:10-cv-246-LED-JDL, 6:10-cv-424-LED-JDL, Realtime Data, LLC D/B/A IXO v. Thomson Reuters Corp., et al., 6:09-cv-333-LED-JDL, 6:10-cv-247-LED-JDL, 6:10-cv-425-LED-JDL, United States District Court for the Eastern District of Texas Tyler Division, February 4, 2011, citing P. G. Howard, F. Kossenti, S. Forchammer, and W. J. Rucklidge [1998]. "The Emerging JBIG2 Standard", IEEE Transactions On Circuits And Systems For Video Technology 8:7, 838-848.	
	NPL124	Exhibit 53, Prior Art Chart for U.S. Pat. No. 7,777,651, 218 pages, Realtime Data, LLC D/B/A IXO v. Morgan Stanley, et al., 6:09-cv-326-LED-JDL, 6:10-cv-248-LED-JDL, 6:10-cv-426-LED-JDL, Realtime Data, LLC D/B/A IXO v. CME Group Inc., et al., 6:09-cv-327-LED-JDL, 6:10-cv-246-LED-JDL, 6:10-cv-424-LED-JDL, Realtime Data, LLC D/B/A IXO v. Thomson Reuters Corp., et al., 6:09-cv-333-LED-JDL, 6:10-cv-247-LED-JDL, 6:10-cv-425-LED-JDL, United States District Court for the Eastern District of Texas Tyler Division, February 4, 2011, citing Panaoussis, U.S. Patent No. 5,949,355.	

Examiner Signature	/Suresh Suryawanshi/	Date Considered	05/14/2012
--------------------	----------------------	-----------------	------------

\*EXAMINER: Initial if reference considered, whether or not citation is in conformance with MPEP 609. Draw line through citation if not in conformance and not considered. Include copy of this form with next communication to applicant.

<sup>1</sup> Applicant's unique citation designation number (optional). <sup>2</sup> Applicant is to place a check mark here if English language Translation is attached.

ALL REFERENCES CONSIDERED EXCEPT WHERE LINED THROUGH. /SKS./

Substitute for form 1449/PTO				<i>Complete if Known</i>	
<b>INFORMATION DISCLOSURE STATEMENT BY APPLICANT</b> <i>(Use as many sheets as necessary)</i>				Application Number	13/118,122
				Filing Date	May 27, 2011
				First Named Inventor	James J. FALLON
				Art Unit	2115
				Examiner Name	To Be Assigned
Sheet	17	of	66	Attorney Docket Number	2855.004000B

NON PATENT LITERATURE DOCUMENTS			
Examiner Initials*	Cite No. <sup>1</sup>	Include name of the author (in CAPITAL LETTERS), title of the article (when appropriate), title of the item (book, magazine, journal, serial, symposium, catalog, etc.), date, page(s), volume number, publisher, city and/or country where published	T <sup>2</sup>
	NPL125	Exhibit 54, Prior Art Chart for U.S. Pat. No. 7,777,651, 335 pages, Realtime Data, LLC D/B/A IXO v. Morgan Stanley, et al., 6:09-cv-326-LED-JDL, 6:10-cv-248-LED-JDL, 6:10-cv-426-LED-JDL, Realtime Data, LLC D/B/A IXO v. CME Group Inc., et al., 6:09-cv-327-LED-JDL, 6:10-cv-246-LED-JDL, 6:10-cv-424-LED-JDL, Realtime Data, LLC D/B/A IXO v. Thomson Reuters Corp., et al., 6:09-cv-333-LED-JDL, 6:10-cv-247-LED-JDL, 6:10-cv-425-LED-JDL, United States District Court for the Eastern District of Texas Tyler Division, February 4, 2011, citing Payne et al, U.S. Patent No. 6,021,433.	
	NPL126	Exhibit 55, Prior Art Chart for U.S. Pat. No. 7,777,651, 273 pages, Realtime Data, LLC D/B/A IXO v. Morgan Stanley, et al., 6:09-cv-326-LED-JDL, 6:10-cv-248-LED-JDL, 6:10-cv-426-LED-JDL, Realtime Data, LLC D/B/A IXO v. CME Group Inc., et al., 6:09-cv-327-LED-JDL, 6:10-cv-246-LED-JDL, 6:10-cv-424-LED-JDL, Realtime Data, LLC D/B/A IXO v. Thomson Reuters Corp., et al., 6:09-cv-333-LED-JDL, 6:10-cv-247-LED-JDL, 6:10-cv-425-LED-JDL, United States District Court for the Eastern District of Texas Tyler Division, February 4, 2011, citing Reynar et al, U. S. Patent No. 5,951,623.	
	NPL127	Exhibit 56, Prior Art Chart for U.S. Pat. No. 7,777,651, 399 pages, Realtime Data, LLC D/B/A IXO v. Morgan Stanley, et al., 6:09-cv-326-LED-JDL, 6:10-cv-248-LED-JDL, 6:10-cv-426-LED-JDL, Realtime Data, LLC D/B/A IXO v. CME Group Inc., et al., 6:09-cv-327-LED-JDL, 6:10-cv-246-LED-JDL, 6:10-cv-424-LED-JDL, Realtime Data, LLC D/B/A IXO v. Thomson Reuters Corp., et al., 6:09-cv-333-LED-JDL, 6:10-cv-247-LED-JDL, 6:10-cv-425-LED-JDL, United States District Court for the Eastern District of Texas Tyler Division, February 4, 2011, citing RFC 1144: V. Jacobson, "Compressing TCP/IP Headers for Low-Speed Serial Links," Network Working Group, Request for Comments: 1144 (February 1990).	
	NPL128	Exhibit 57, Prior Art Chart for U.S. Pat. No. 7,777,651, 103 pages, Realtime Data, LLC D/B/A IXO v. Morgan Stanley, et al., 6:09-cv-326-LED-JDL, 6:10-cv-248-LED-JDL, 6:10-cv-426-LED-JDL, Realtime Data, LLC D/B/A IXO v. CME Group Inc., et al., 6:09-cv-327-LED-JDL, 6:10-cv-246-LED-JDL, 6:10-cv-424-LED-JDL, Realtime Data, LLC D/B/A IXO v. Thomson Reuters Corp., et al., 6:09-cv-333-LED-JDL, 6:10-cv-247-LED-JDL, 6:10-cv-425-LED-JDL, United States District Court for the Eastern District of Texas Tyler Division, February 4, 2011, citing RFC 1661: Point-to-Point Protocol Working Group, "The Point-to-Point Protocol," RFC 1661 (William Simpson ed., Internet Engineering Task Force 1994); RFC 1662: Point-to-Point Protocol Working Group, "PPP in HDLC-like Framing," RFC 1662 (William Simpson ed., Internet Engineering Task Force 1994); RFC 1962: Dave Rand, "The PPP compression Control Protocol (CCP)," RFC 1962 (Internet Engineering Task Force 1996); RFC 1332: Glenn McGregor, "The PPP Internet Protocol Control Protocol (IPCP)," RFC 1332 (Internet Engineering Task Force 1992); RFC 2509: Mathias Engan et al., "IP Header Compression over IP," RFC 2509 (Internet Society 1999).	
	NPL129	Exhibit 58, Prior Art Chart for U.S. Pat. No. 7,777,651, 218 pages, Realtime Data, LLC D/B/A IXO v. Morgan Stanley, et al., 6:09-cv-326-LED-JDL, 6:10-cv-248-LED-JDL, 6:10-cv-426-LED-JDL, Realtime Data, LLC D/B/A IXO v. CME Group Inc., et al., 6:09-cv-327-LED-JDL, 6:10-cv-246-LED-JDL, 6:10-cv-424-LED-JDL, Realtime Data, LLC D/B/A IXO v. Thomson Reuters Corp., et al., 6:09-cv-333-LED-JDL, 6:10-cv-247-LED-JDL, 6:10-cv-425-LED-JDL, United States District Court for the Eastern District of Texas Tyler Division, February 4, 2011, citing RFC 2507: Mikael Degermark et al., "IP Header Compression," RFC 2507 (Internet Society 1999).	

Examiner Signature	/Suresh Suryawanshi/	Date Considered	05/14/2012
-----------------------	----------------------	--------------------	------------

\*EXAMINER: Initial if reference considered, whether or not citation is in conformance with MPEP 609. Draw line through citation if not in conformance and not considered. Include copy of this form with next communication to applicant.

<sup>1</sup> Applicant's unique citation designation number (optional). <sup>2</sup> Applicant is to place a check mark here if English language Translation is attached.

ALL REFERENCES CONSIDERED EXCEPT WHERE LINED THROUGH. /SKS./

Substitute for form 1449/PTO				<i>Complete if Known</i>	
<b>INFORMATION DISCLOSURE STATEMENT BY APPLICANT</b> <i>(Use as many sheets as necessary)</i>				Application Number	13/118,122
				Filing Date	May 27, 2011
				First Named Inventor	James J. FALLON
				Art Unit	2115
				Examiner Name	To Be Assigned
Sheet	18	of	66	Attorney Docket Number	2855.004000B

NON PATENT LITERATURE DOCUMENTS			
Examiner Initials*	Cite No. <sup>1</sup>	Include name of the author (in CAPITAL LETTERS), title of the article (when appropriate), title of the item (book, magazine, journal, serial, symposium, catalog, etc.), date, page(s), volume number, publisher, city and/or country where published	T <sup>2</sup>
	NPL130	Exhibit 59, Prior Art Chart for U.S. Pat. No. 7,777,651, 335 pages, Realtime Data, LLC D/B/A IXO v. Morgan Stanley, et al., 6:09-cv-326-LED-JDL, 6:10-cv-248-LED-JDL, 6:10-cv-426-LED-JDL, Realtime Data, LLC D/B/A IXO v. CME Group Inc., et al., 6:09-cv-327-LED-JDL, 6:10-cv-246-LED-JDL, 6:10-cv-424-LED-JDL, Realtime Data, LLC D/B/A IXO v. Thomson Reuters Corp., et al., 6:09-cv-333-LED-JDL, 6:10-cv-247-LED-JDL, 6:10-cv-425-LED-JDL, United States District Court for the Eastern District of Texas Tyler Division, February 4, 2011, citing Roper et al., U.S. Patent No. 5,454,079.	
	NPL131	Exhibit 60, Prior Art Chart for U.S. Pat. No. 7,777,651, 273 pages, Realtime Data, LLC D/B/A IXO v. Morgan Stanley, et al., 6:09-cv-326-LED-JDL, 6:10-cv-248-LED-JDL, 6:10-cv-426-LED-JDL, Realtime Data, LLC D/B/A IXO v. CME Group Inc., et al., 6:09-cv-327-LED-JDL, 6:10-cv-246-LED-JDL, 6:10-cv-424-LED-JDL, Realtime Data, LLC D/B/A IXO v. Thomson Reuters Corp., et al., 6:09-cv-333-LED-JDL, 6:10-cv-247-LED-JDL, 6:10-cv-425-LED-JDL, United States District Court for the Eastern District of Texas Tyler Division, February 4, 2011, citing Sebastian, U.S. Patent No. 6,253,264 and International Publication No. WO/1998/039699.	
	NPL132	Exhibit 61, Prior Art Chart for U.S. Pat. No. 7,777,651, 399 pages, Realtime Data, LLC D/B/A IXO v. Morgan Stanley, et al., 6:09-cv-326-LED-JDL, 6:10-cv-248-LED-JDL, 6:10-cv-426-LED-JDL, Realtime Data, LLC D/B/A IXO v. CME Group Inc., et al., 6:09-cv-327-LED-JDL, 6:10-cv-246-LED-JDL, 6:10-cv-424-LED-JDL, Realtime Data, LLC D/B/A IXO v. Thomson Reuters Corp., et al., 6:09-cv-333-LED-JDL, 6:10-cv-247-LED-JDL, 6:10-cv-425-LED-JDL, United States District Court for the Eastern District of Texas Tyler Division, February 4, 2011, citing Seroussi et al., U.S. Patent No. 5,243,341.	
	NPL133	Exhibit 62, Prior Art Chart for U.S. Pat. No. 7,777,651, 322 pages, Realtime Data, LLC D/B/A IXO v. Morgan Stanley, et al., 6:09-cv-326-LED-JDL, 6:10-cv-248-LED-JDL, 6:10-cv-426-LED-JDL, Realtime Data, LLC D/B/A IXO v. CME Group Inc., et al., 6:09-cv-327-LED-JDL, 6:10-cv-246-LED-JDL, 6:10-cv-424-LED-JDL, Realtime Data, LLC D/B/A IXO v. Thomson Reuters Corp., et al., 6:09-cv-333-LED-JDL, 6:10-cv-247-LED-JDL, 6:10-cv-425-LED-JDL, United States District Court for the Eastern District of Texas Tyler Division, February 4, 2011, citing Seroussi et al., U.S. Patent No. 5,389,922.	
	NPL134	Exhibit 63, Prior Art Chart for U.S. Pat. No. 7,777,651, 102 pages, Realtime Data, LLC D/B/A IXO v. Morgan Stanley, et al., 6:09-cv-326-LED-JDL, 6:10-cv-248-LED-JDL, 6:10-cv-426-LED-JDL, Realtime Data, LLC D/B/A IXO v. CME Group Inc., et al., 6:09-cv-327-LED-JDL, 6:10-cv-246-LED-JDL, 6:10-cv-424-LED-JDL, Realtime Data, LLC D/B/A IXO v. Thomson Reuters Corp., et al., 6:09-cv-333-LED-JDL, 6:10-cv-247-LED-JDL, 6:10-cv-425-LED-JDL, United States District Court for the Eastern District of Texas Tyler Division, February 4, 2011, citing Shin, U.S. Patent No. 5,455,680.	
	NPL135	Exhibit 64, Prior Art Chart for U.S. Pat. No. 7,777,651, 126 pages, Realtime Data, LLC D/B/A IXO v. Morgan Stanley, et al., 6:09-cv-326-LED-JDL, 6:10-cv-248-LED-JDL, 6:10-cv-426-LED-JDL, Realtime Data, LLC D/B/A IXO v. CME Group Inc., et al., 6:09-cv-327-LED-JDL, 6:10-cv-246-LED-JDL, 6:10-cv-424-LED-JDL, Realtime Data, LLC D/B/A IXO v. Thomson Reuters Corp., et al., 6:09-cv-333-LED-JDL, 6:10-cv-247-LED-JDL, 6:10-cv-425-LED-JDL, United States District Court for the Eastern District of Texas Tyler Division, February 4, 2011, citing Taaffe et al., U.S. Patent No. 5,179,651.	

Examiner Signature	/Suresh Suryawanshi/	Date Considered	05/14/2012
-----------------------	----------------------	--------------------	------------

\*EXAMINER: Initial if reference considered, whether or not citation is in conformance with MPEP 609. Draw line through citation if not in conformance and not considered. Include copy of this form with next communication to applicant.

<sup>1</sup> Applicant's unique citation designation number (optional). <sup>2</sup> Applicant is to place a check mark here if English language Translation is attached.

ALL REFERENCES CONSIDERED EXCEPT WHERE LINED THROUGH. /SKS./



Substitute for form 1449/PTO				<i>Complete if Known</i>	
<b>INFORMATION DISCLOSURE STATEMENT BY APPLICANT</b> <i>(Use as many sheets as necessary)</i>				Application Number	13/118,122
				Filing Date	May 27, 2011
				First Named Inventor	James J. FALLON
				Art Unit	2115
				Examiner Name	To Be Assigned
Sheet	19	of	66	Attorney Docket Number	2855.004000B

NON PATENT LITERATURE DOCUMENTS			
Examiner Initials*	Cite No. <sup>1</sup>	Include name of the author (in CAPITAL LETTERS), title of the article (when appropriate), title of the item (book, magazine, journal, serial, symposium, catalog, etc.), date, page(s), volume number, publisher, city and/or country where published	T <sup>2</sup>
	NPL136	Exhibit 65, Prior Art Chart for U.S. Pat. No. 7,777,651, 313 pages, Realtime Data, LLC D/B/A IXO v. Morgan Stanley, et al., 6:09-cv-326-LED-JDL, 6:10-cv-248-LED-JDL, 6:10-cv-426-LED-JDL, Realtime Data, LLC D/B/A IXO v. CME Group Inc., et al., 6:09-cv-327-LED-JDL, 6:10-cv-246-LED-JDL, 6:10-cv-424-LED-JDL, Realtime Data, LLC D/B/A IXO v. Thomson Reuters Corp., et al., 6:09-cv-333-LED-JDL, 6:10-cv-247-LED-JDL, 6:10-cv-425-LED-JDL, United States District Court for the Eastern District of Texas Tyler Division, February 4, 2011, citing Telekurs Ticker - "Telekurs Ticker Service: Programmer's Reference," Telekurs (North America), Inc. (January 11, 1993); C. Helck, "Encapsulated Ticker: Ver. 1.0," Telekurs NA, 1-22 (July 14, 1993); A-T FINANCIAL OFFERS MANIPULATION, REDISTRIBUTION OF TICKER III, Micro Ticker Report, v 4, n 14 (Sept 5, 1989); V. Kulkosky, "Upping the Ante" Wall Street & Technology, v11 n5 pp: 8-11 (Oct 1993); "Telekurs to Launch New Int'l Feed/Internet Server," Wall Street & Technology, v15 n1 pp: 14 (Jan 1997); I. Schmerken, "Time running out for old technologies", Wall Street Computer Review, v7 n7 p14(7) (April, 1990); SCROLLING NEWS, Inside Market Data, v 10, n 11 (Feb 27, 1995); TELEKURS BUYS S&P TRADING SYSTEMS AND ITS TICKER III FEED, Micro Ticker Report, v 4, n 11 (July 10, 1989); TELEKURS MAY DEBUT 128 KPS TICKER BY YEAR'S END, Inside Market Data, v 9, n 21 (July 18, 1994); TELEKURS NOW CARRIES ALL DOW JONES' NEWS ON 56-KBPS TICKER, Inside Market Data, v9, n7 (Dec 20, 1993); TELEKURS SELLS NO. AMERICAN DIVISION IN MGMT. BUYOUT, Inside Market Data, v11, n3 (Oct 23, 1995).	
	NPL137	Exhibit 66, Prior Art Chart for U.S. Pat. No. 7,777,651, 265 pages, Realtime Data, LLC D/B/A IXO v. Morgan Stanley, et al., 6:09-cv-326-LED-JDL, 6:10-cv-248-LED-JDL, 6:10-cv-426-LED-JDL, Realtime Data, LLC D/B/A IXO v. CME Group Inc., et al., 6:09-cv-327-LED-JDL, 6:10-cv-246-LED-JDL, 6:10-cv-424-LED-JDL, Realtime Data, LLC D/B/A IXO v. Thomson Reuters Corp., et al., 6:09-cv-333-LED-JDL, 6:10-cv-247-LED-JDL, 6:10-cv-425-LED-JDL, United States District Court for the Eastern District of Texas Tyler Division, February 4, 2011, citing Tyler et al., U.S. Patent No. 5,638,498.	
	NPL138	Exhibit 67, Prior Art Chart for U.S. Pat. No. 7,777,651, 86 pages, Realtime Data, LLC D/B/A IXO v. Morgan Stanley, et al., 6:09-cv-326-LED-JDL, 6:10-cv-248-LED-JDL, 6:10-cv-426-LED-JDL, Realtime Data, LLC D/B/A IXO v. CME Group Inc., et al., 6:09-cv-327-LED-JDL, 6:10-cv-246-LED-JDL, 6:10-cv-424-LED-JDL, Realtime Data, LLC D/B/A IXO v. Thomson Reuters Corp., et al., 6:09-cv-333-LED-JDL, 6:10-cv-247-LED-JDL, 6:10-cv-425-LED-JDL, United States District Court for the Eastern District of Texas Tyler Division, February 4, 2011, citing UNI International Standard ISO 3309-1984 (E) [1984], "Information Processing Systems -- Data Communication -- High-level Data Link Control Procedures --Frame Structure," 1-6 (1984).	
	NPL139	Exhibit 68, Prior Art Chart for U.S. Pat. No. 7,777,651, 236 pages, Realtime Data, LLC D/B/A IXO v. Morgan Stanley, et al., 6:09-cv-326-LED-JDL, 6:10-cv-248-LED-JDL, 6:10-cv-426-LED-JDL, Realtime Data, LLC D/B/A IXO v. CME Group Inc., et al., 6:09-cv-327-LED-JDL, 6:10-cv-246-LED-JDL, 6:10-cv-424-LED-JDL, Realtime Data, LLC D/B/A IXO v. Thomson Reuters Corp., et al., 6:09-cv-333-LED-JDL, 6:10-cv-247-LED-JDL, 6:10-cv-425-LED-JDL, United States District Court for the Eastern District of Texas Tyler Division, February 4, 2011, citing Unwired Planet, EP 0928070 A2.	

Examiner Signature	/Suresh Suryawanshi/	Date Considered	05/14/2012
--------------------	----------------------	-----------------	------------

\*EXAMINER: Initial if reference considered, whether or not citation is in conformance with MPEP 609. Draw line through citation if not in conformance and not considered. Include copy of this form with next communication to applicant.

<sup>1</sup> Applicant's unique citation designation number (optional). <sup>2</sup> Applicant is to place a check mark here if English language Translation is attached.

ALL REFERENCES CONSIDERED EXCEPT WHERE LINED THROUGH. /SKS./

Substitute for form 1449/PTO				<i>Complete if Known</i>	
<b>INFORMATION DISCLOSURE STATEMENT BY APPLICANT</b> <i>(Use as many sheets as necessary)</i>				Application Number	13/118,122
				Filing Date	May 27, 2011
				First Named Inventor	James J. FALLON
				Art Unit	2115
				Examiner Name	To Be Assigned
Sheet	20	of	66	Attorney Docket Number	2855.004000B

NON PATENT LITERATURE DOCUMENTS			
Examiner Initials*	Cite No. <sup>1</sup>	Include name of the author (in CAPITAL LETTERS), title of the article (when appropriate), title of the item (book, magazine, journal, serial, symposium, catalog, etc.), date, page(s), volume number, publisher, city and/or country where published	T <sup>2</sup>
	NPL140	Exhibit 69, Prior Art Chart for U.S. Pat. No. 7,777,651, 80 pages, Realtime Data, LLC D/B/A IXO v. Morgan Stanley, et al., 6:09-cv-326-LED-JDL, 6:10-cv-248-LED-JDL, 6:10-cv-426-LED-JDL, Realtime Data, LLC D/B/A IXO v. CME Group Inc., et al., 6:09-cv-327-LED-JDL, 6:10-cv-246-LED-JDL, 6:10-cv-424-LED-JDL, Realtime Data, LLC D/B/A IXO v. Thomson Reuters Corp., et al., 6:09-cv-333-LED-JDL, 6:10-cv-247-LED-JDL, 6:10-cv-425-LED-JDL, United States District Court for the Eastern District of Texas Tyler Division, February 4, 2011, citing Vange et al., U.S. Patent No. 7,127,518.	
	NPL141	Exhibit 70, Prior Art Chart for U.S. Pat. No. 7,777,651, 197 pages, Realtime Data, LLC D/B/A IXO v. Morgan Stanley, et al., 6:09-cv-326-LED-JDL, 6:10-cv-248-LED-JDL, 6:10-cv-426-LED-JDL, Realtime Data, LLC D/B/A IXO v. CME Group Inc., et al., 6:09-cv-327-LED-JDL, 6:10-cv-246-LED-JDL, 6:10-cv-424-LED-JDL, Realtime Data, LLC D/B/A IXO v. Thomson Reuters Corp., et al., 6:09-cv-333-LED-JDL, 6:10-cv-247-LED-JDL, 6:10-cv-425-LED-JDL, United States District Court for the Eastern District of Texas Tyler Division, February 4, 2011, citing Wermikoff et al., U.S. Patent No. 3,394,352.	
	NPL142	Exhibit 71, Prior Art Chart for U.S. Pat. No. 7,777,651, 253 pages, Exhibit 70, Prior Art Chart for U.S. Pat. No. 7,777,651, 197 pages, Realtime Data, LLC D/B/A IXO v. Morgan Stanley, et al., 6:09-cv-326-LED-JDL, 6:10-cv-248-LED-JDL, 6:10-cv-426-LED-JDL, Realtime Data, LLC D/B/A IXO v. CME Group Inc., et al., 6:09-cv-327-LED-JDL, 6:10-cv-246-LED-JDL, 6:10-cv-424-LED-JDL, Realtime Data, LLC D/B/A IXO v. Thomson Reuters Corp., et al., 6:09-cv-333-LED-JDL, 6:10-cv-247-LED-JDL, 6:10-cv-425-LED-JDL, United States District Court for the Eastern District of Texas Tyler Division, February 4, 2011, citing Willis et al., U.S. Patent No. 4,745,559; Boilen, U.S. Patent No. 4,750,135.	
	NPL143	Exhibit 72, Prior Art Chart for U.S. Pat. No. 7,777,651, 277 pages, Exhibit 71, Prior Art Chart for U.S. Pat. No. 7,777,651, 253 pages, Exhibit 70, Prior Art Chart for U.S. Pat. No. 7,777,651, 197 pages, Realtime Data, LLC D/B/A IXO v. Morgan Stanley, et al., 6:09-cv-326-LED-JDL, 6:10-cv-248-LED-JDL, 6:10-cv-426-LED-JDL, Realtime Data, LLC D/B/A IXO v. CME Group Inc., et al., 6:09-cv-327-LED-JDL, 6:10-cv-246-LED-JDL, 6:10-cv-424-LED-JDL, Realtime Data, LLC D/B/A IXO v. Thomson Reuters Corp., et al., 6:09-cv-333-LED-JDL, 6:10-cv-247-LED-JDL, 6:10-cv-425-LED-JDL, United States District Court for the Eastern District of Texas Tyler Division, February 4, 2011, citing XMill - Hartmut Liefke & Dan Suciu, "XMill: an Efficient Compressor for XML Data," University of Pennsylvania, Philadelphia, Pennsylvania, MS-CIS-99-26 (October 18, 1999); Hartmut Liefke & Dan Suciu, "XMill: an Efficient Compressor for XML Data," Proceedings of SIGMOD, 2000; Hartmut Liefke & Dan Suciu, "An Extensible Compressor for XML Data," SIGMOD Record, Vol. 29, No. 1 (March 2000); Dan Suciu, "Data Management on the Web," Presentation at University of Washington College of Computer Science & Engineering, Seattle, WA (April 4, 2000).	
	NPL144	BORMANN et al., "Robust Header Compression (ROHC)," Network Working Group Internet-Draft, September 18, 2000, 111 pages.	
	NPL145	EFFROS, M., P.A. CHOU and R.M. GRAY, "Variable Dimension Weighted Universal Vector Quantization and Noiseless Coding," IEEE 1068-0314/94, 1994, pages 2-11.	

Examiner Signature	/Suresh Suryawanshi/	Date Considered	05/14/2012
--------------------	----------------------	-----------------	------------

\*EXAMINER: Initial if reference considered, whether or not citation is in conformance with MPEP 609. Draw line through citation if not in conformance and not considered. Include copy of this form with next communication to applicant.

<sup>1</sup> Applicant's unique citation designation number (optional). <sup>2</sup> Applicant is to place a check mark here if English language Translation is attached.

ALL REFERENCES CONSIDERED EXCEPT WHERE LINED THROUGH. /SKS./

Substitute for form 1449/PTO				<i>Complete if Known</i>	
<b>INFORMATION DISCLOSURE STATEMENT BY APPLICANT</b> <i>(Use as many sheets as necessary)</i>				Application Number	13/118,122
				Filing Date	May 27, 2011
				First Named Inventor	James J. FALLON
				Art Unit	2115
				Examiner Name	To Be Assigned
Sheet	21	of	66	Attorney Docket Number	2855.004000B

NON PATENT LITERATURE DOCUMENTS			
Examiner Initials*	Cite No. <sup>1</sup>	Include name of the author (in CAPITAL LETTERS), title of the article (when appropriate), title of the item (book, magazine, journal, serial, symposium, catalog, etc.), date, page(s), volume number, publisher, city and/or country where published	T <sup>2</sup>
	NPL146	Defendant Bloomberg L.P.'s Invalidation Contentions Pursuant to Patent Local Rule 3-3, Realtime Data, LLC d/b/a IXO vs. Thomson Reuters Corp., et al., 6:2009-cv-00333 LED-JDL, 6:2010-cv-00247 LED-JDL, 6:2010-cv-00425 LED-JDL, October 29, 2010, 17 pages.	
	NPL147	Appendix A: U.S. Patent No. 6,624,761 (The "761 Patent"), from Defendant Bloomberg L.P.'s Invalidation Contentions Pursuant to Patent Local Rule 3-3, Realtime Data, LLC d/b/a IXO vs. Thomson Reuters Corp., et al., 6:2009-cv-00333 LED-JDL, 6:2010-cv-00247 LED-JDL, 6:2010-cv-00425 LED-JDL, October 29, 2010, 37 pages.	
	NPL148	Appendix B: U.S. Patent No. 7,161,506 (The "506 Patent"), from Defendant Bloomberg L.P.'s Invalidation Contentions Pursuant to Patent Local Rule 3-3, Realtime Data, LLC d/b/a IXO vs. Thomson Reuters Corp., et al., 6:2009-cv-00333 LED-JDL, 6:2010-cv-00247 LED-JDL, 6:2010-cv-00425 LED-JDL, October 29, 2010, 63 pages.	
	NPL149	Appendix C: U.S. Patent No. 7,400,274 (The 274 Patent), from Defendant Bloomberg L.P.'s Invalidation Contentions Pursuant to Patent Local Rule 3-3, Realtime Data, LLC d/b/a IXO vs. Thomson Reuters Corp., et al., 6:2009-cv-00333 LED-JDL, 6:2010-cv-00247 LED-JDL, 6:2010-cv-00425 LED-JDL, October 29, 2010, 95 pages.	
	NPL150	Appendix D: U.S. Patent No. 7,417,568 (The 568 Patent), from Defendant Bloomberg L.P.'s Invalidation Contentions Pursuant to Patent Local Rule 3-3, Realtime Data, LLC d/b/a IXO vs. Thomson Reuters Corp., et al., 6:2009-cv-00333 LED-JDL, 6:2010-cv-00247 LED-JDL, 6:2010-cv-00425 LED-JDL, October 29, 2010, 147 pages.	
	NPL151	Appendix E: U.S. Patent No. 7,714,747 (The "747 Patent"), from Defendant Bloomberg L.P.'s Invalidation Contentions Pursuant to Patent Local Rule 3-3, Realtime Data, LLC d/b/a IXO vs. Thomson Reuters Corp., et al., 6:2009-cv-00333 LED-JDL, 6:2010-cv-00247 LED-JDL, 6:2010-cv-00425 LED-JDL, October 29, 2010, 137 pages.	
	NPL152	Appendix F: Comparison of FAST to the Prior Art, from Defendant Bloomberg L.P.'s Invalidation Contentions Pursuant to Patent Local Rule 3-3, Realtime Data, LLC d/b/a IXO vs. Thomson Reuters Corp., et al., 6:2009-cv-00333 LED-JDL, 6:2010-cv-00247 LED-JDL, 6:2010-cv-00425 LED-JDL, October 29, 2010, 7 pages.	
	NPL153	Defendant Bloomberg L.P.'s Invalidation Contentions Pursuant to Patent Local Rule 3-3 Regarding U.S. Patent No. 7,777,651, Realtime Data, LLC d/b/a IXO vs. Thomson Reuters Corp., et al., 6:2009-cv-00333 LED-JDL, 6:2010-cv-00247 LED-JDL, 6:2010-cv-00425 LED-JDL, February 4, 2011, 21 pages.	
	NPL154	Appendix G: U.S. Patent No. 7,777,651 (The 651 Patent), Defendant Bloomberg L.P.'s Invalidation Contentions Pursuant to Patent Local Rule 3-3 Regarding U.S. Patent No. 7,777,651, Realtime Data, LLC d/b/a IXO vs. Thomson Reuters Corp., et al., 6:2009-cv-00333 LED-JDL, 6:2010-cv-00247 LED-JDL, 6:2010-cv-00425 LED-JDL, February 4, 2011, 480 pages.	
	NPL155	RICE, ROBERT F., "Some Practical Universal Noiseless Coding Techniques", Jet Propulsion Laboratory, Pasadena, California, JPL Publication 79-22, March 15, 1979, 140 pgs.	

Examiner Signature	/Suresh Suryawanshi/	Date Considered	05/14/2012
-----------------------	----------------------	--------------------	------------

\*EXAMINER: Initial if reference considered, whether or not citation is in conformance with MPEP 609. Draw line through citation if not in conformance and not considered. Include copy of this form with next communication to applicant.

<sup>1</sup> Applicant's unique citation designation number (optional). <sup>2</sup> Applicant is to place a check mark here if English language Translation is attached.

ALL REFERENCES CONSIDERED EXCEPT WHERE LINED THROUGH. /SKS./

Substitute for form 1449/PTO				<i>Complete if Known</i>	
<b>INFORMATION DISCLOSURE STATEMENT BY APPLICANT</b> <i>(Use as many sheets as necessary)</i>				Application Number	13/118,122
				Filing Date	May 27, 2011
				First Named Inventor	James J. FALLON
				Art Unit	2115
				Examiner Name	To Be Assigned
Sheet	22	of	66	Attorney Docket Number	2855.00400B

NON PATENT LITERATURE DOCUMENTS			
Examiner Initials*	Cite No. <sup>1</sup>	Include name of the author (in CAPITAL LETTERS), title of the article (when appropriate), title of the item (book, magazine, journal, serial, symposium, catalog, etc.), date, page(s), volume number, publisher, city and/or country where published	T <sup>2</sup>
	NPL156	ANDERSON, J., et al. "Codec squeezes color teleconferencing through digital telephone lines," Electronics 1984, pp. 13-15.	
	NPL157	VENBRUX, JACK, "A VLSI Chip Set for High-Speed Lossless Data Compression", IEEE Trans. On Circuits and Systems for Video Technology, Vol. 2, No. 4, December 1992, pp. 381-391.	
	NPL158	"Fast Dos Soft Boot", IBM Technical Disclosure Bulletin, Feb. 1994, Vol. 37, Issue No. 2B, pp. 185-186.	
	NPL159	"Operating System Platform Abstraction Method", IBM Technical Disclosure Bulletin, Feb. 1995, Vol. 38, Issue No. 2, pp 343-344.	
	NPL160	MURASHITA, K., et al., "High-Speed Statistical Compression using Self-Organized Rules and Predetermined Code Tables", IEEE, 1996 Data Compression Conference.	
	NPL161	COENE, W., et al. "A Fast Route For Application of Rate-distortion Optimal Quantization in an MPEG Video Encoder" Proceedings of the International Conference on Image Processing, US., New York, IEEE, 16 September 1996, pp. 825-828.	
	NPL162	RICE, ROBERT, "Lossless Coding Standards for Space Data Systems", IEEE 1058-6393197, Nov. 3-6, 1996, pp. 577-585.	
	NPL163	MILLMAN, HOWARD, "Image and video compression", Computerworld, Vol. 33, Issue No. 3, January 18, 1999, pp. 78.	
	NPL164	"IBM boosts your memory", Geek.com [online], June 26, 2000 [retrieved on July 6, 2007], www.geek.com/ibm-boosts-your-memory/, 7 pages.	
	NPL165	"IBM Research Breakthrough Doubles Computer Memory Capacity", IBM Press Release [online], June 26, 2000 [retrieved on July 6, 2007], www-03.ibm.com/press/us/en/pressrelease/1653.wss, 3 pages.	

Examiner Signature	/Suresh Suryawanshi/	Date Considered	05/14/2012
-----------------------	----------------------	--------------------	------------

\*EXAMINER: Initial if reference considered, whether or not citation is in conformance with MPEP 609. Draw line through citation if not in conformance and not considered. Include copy of this form with next communication to applicant.

<sup>1</sup> Applicant's unique citation designation number (optional). <sup>2</sup> Applicant is to place a check mark here if English language Translation is attached.

ALL REFERENCES CONSIDERED EXCEPT WHERE LINED THROUGH. /SKS./

Substitute for form 1449/PTO				<i>Complete if Known</i>	
<b>INFORMATION DISCLOSURE STATEMENT BY APPLICANT</b> <i>(Use as many sheets as necessary)</i>				Application Number	13/118,122
				Filing Date	May 27, 2011
				First Named Inventor	James J. FALLON
				Art Unit	2115
				Examiner Name	To Be Assigned
Sheet	23	of	66	Attorney Docket Number	2855.004000B

NON PATENT LITERATURE DOCUMENTS			
Examiner Initials*	Cite No. <sup>1</sup>	Include name of the author (in CAPITAL LETTERS), title of the article (when appropriate), title of the item (book, magazine, journal, serial, symposium, catalog, etc.), date, page(s), volume number, publisher, city and/or country where published	T <sup>2</sup>
	NPL166	"ServerWorks To Deliver IBM's Memory expansion Technology in Next-Generation Core Logic for Servers", ServerWorks Press Release [online], June 27, 2000 [retrieved on July 14, 2000], <a href="http://www.serverworks.com/news/press/000627.html">http://www.serverworks.com/news/press/000627.html</a> , 1 page.	
	NPL167	ABALI, B., et al., "Memory Expansion Technology (MXT) Software support and performance", IBM Journal of Research and Development, Vol. 45, Issue No. 2, March 2001, pp. 287-301.	
	NPL168	FRANASZEK, P. A., et al., "Algorithms and data structures for compressed-memory machines", IBM Journal of Research and Development, Vol. 45, Issue No. 2, March 2001, pp. 245-258.	
	NPL169	FRANASZEK, P. A., et al., "On internal organization in compressed random-access memories", IBM Journal of Research and Development, Vol. 45, Issue No. 2, March 2001, pp. 259-270.	
	NPL170	SMITH, T.B., et al., "Memory Expansion Technology (MXT) Competitive impact", IBM Journal of Research and Development, Vol. 45, Issue No. 2, March 2001, pp. 303-309.	
	NPL171	TREMAINE, R. B., et al., "IBM Memory Expansion Technology (MXT)", IBM Journal of Research and Development, Vol. 45, Issue No. 2, March 2001, pp. 271-285.	
	NPL172	YEH, PEN-SHU, "The CCSDS Lossless Data Compression Recommendation for Space Applications", Chapter 16, Lossless Compression Handbook, Elsevier Science (USA), 2003, pp. 311-326.	
	NPL173	Expand Networks Accelerator 4000 Series User's Guide, 1999, 101 pgs.	
	NPL174	Tridgell, Andrew; "Efficient Algorithms for Sorting and Synchronization"; A thesis submitted for the degree of Doctor of Philosophy at The Australian National University; February 1999; pages iii-106	
	NPL175	Jung, et al.; "Performance optimization of wireless local area networks through VLSI data compression"; Wireless Networks, Volume 4, 1998; pages 27-39.	

Examiner Signature	/Suresh Suryawanshi/	Date Considered	05/14/2012
-----------------------	----------------------	--------------------	------------

\*EXAMINER: Initial if reference considered, whether or not citation is in conformance with MPEP 609. Draw line through citation if not in conformance and not considered. Include copy of this form with next communication to applicant.

<sup>1</sup> Applicant's unique citation designation number (optional). <sup>2</sup> Applicant is to place a check mark here if English language Translation is attached.

ALL REFERENCES CONSIDERED EXCEPT WHERE LINED THROUGH. /SKS./

Substitute for form 1449/PTO				<i>Complete if Known</i>	
<b>INFORMATION DISCLOSURE STATEMENT BY APPLICANT</b> <i>(Use as many sheets as necessary)</i>				Application Number	13/118,122
				Filing Date	May 27, 2011
				First Named Inventor	James J. FALLON
				Art Unit	2115
				Examiner Name	To Be Assigned
Sheet	24	of	66	Attorney Docket Number	2855.004000B

NON PATENT LITERATURE DOCUMENTS			
Examiner Initials*	Cite No. <sup>1</sup>	Include name of the author (in CAPITAL LETTERS), title of the article (when appropriate), title of the item (book, magazine, journal, serial, symposium, catalog, etc.), date, page(s), volume number, publisher, city and/or country where published	T <sup>2</sup>
	NPL176	Baker, K. et al., "Lossless Data Compression for Short Duration 3D Frames in Positron Emission Tomography," 0-7803-1487, May 1994, pages 1831-1834.	
	NPL177	Maier, Mark W.; "Algorithm Evaluation for the Synchronous Data Compression Standard"; University of Alabama: 1995, pages 1-10.	
	NPL178	Bassiouni, et al.; "A Scheme for Data Compression in Supercomputers"; IEEE; 1988; pages 272-278.	
	NPL179	Welch, Terry A.; "A Technique for High-Performance Data Compression"; IEEE; June 1984; pages 8-19.	
	NPL180	ALDC: Adaptive Lossless Data Compression; IBM; 1994, 2 pgs.	
	NPL181	ALDC-Macro: Adaptive Lossless Data Compression; IBM Corporation; 1994, 2 pgs.	
	NPL182	ALDC1-20S: Adaptive Lossless Data Compression; IBM Corporation; 1994, 2 pgs.	
	NPL183	ALDC1-40S: Adaptive Lossless Data Compression; IBM Corporation; 1994, 2 pgs.	
	NPL184	ALDC1-5S: Adaptive Lossless Data Compression; IBM Corporation; 1994, 2 pgs.	
	NPL185	Craft, David J.; "Data Compression Choice No Easy Call"; Computer Technology Review; Volume XIV, Number 1; January 1994, 2 pgs.	

Examiner Signature	/Suresh Suryawanshi/	Date Considered	05/14/2012
-----------------------	----------------------	--------------------	------------

\*EXAMINER: Initial if reference considered, whether or not citation is in conformance with MPEP 609. Draw line through citation if not in conformance and not considered. Include copy of this form with next communication to applicant.

<sup>1</sup> Applicant's unique citation designation number (optional). <sup>2</sup> Applicant is to place a check mark here if English language Translation is attached.

ALL REFERENCES CONSIDERED EXCEPT WHERE LINED THROUGH. /SKS./

Substitute for form 1449/PTO				<i>Complete if Known</i>	
<b>INFORMATION DISCLOSURE STATEMENT BY APPLICANT</b> <i>(Use as many sheets as necessary)</i>				Application Number	13/118,122
				Filing Date	May 27, 2011
				First Named Inventor	James J. FALLON
				Art Unit	2115
				Examiner Name	To Be Assigned
Sheet	25	of	66	Attorney Docket Number	2855.004000B

NON PATENT LITERATURE DOCUMENTS			
Examiner Initials*	Cite No. <sup>1</sup>	Include name of the author (in CAPITAL LETTERS), title of the article (when appropriate), title of the item (book, magazine, journal, serial, symposium, catalog, etc.), date, page(s), volume number, publisher, city and/or country where published	T <sup>2</sup>
	NPL186	Costlow, Terry; "Sony designs faster, denser tape drive"; Electronic Engineering Times; May 20, 1996, pages 86-87.	
	NPL187	Wilson, Ron; "IBM ups compression ante"; Electronic Engineering Times; August 16, 1993; pages 1-94.	
	NPL188	"IBM Announces New Feature for 3480 Subsystem"; Tucson Today; Volume 12, Number 337, July 25, 1989, 1 pg.	
	NPL189	Syngress Media, Inc.; "CCA Citrix Certified Administrator for MetaFrame 1.8 Study Guide"; 2000, 568 pgs.	
	NPL190	International Telecommunication Union; "Data Compression Procedures for Data Circuit Terminating Equipment (DCE) Using Error Correction Procedures"; Geneva, 1990, 29 pgs.	
	NPL191	Cheng, et al.; "A fast, highly reliable data compression chip and algorithm for storage systems"; IBM J. Res. Develop.; Vol. 40, No. 6, November 1996; pages 603-613.	
	NPL192	Cisco Systems; "Cisco IOS Data Compression"; 1997; pages 1-10.	
	NPL193	Craft, D. J.; "A fast hardware data compression algorithm and some algorithmic extensions"; IBM J. Res. Develop.; Vol. 42; No. 6; November 6, 1998; pages 733-746.	
	NPL194	Rustici, Robert; "Enhanced CU-SeeMe"1995, Zero In Technologies, Inc., 308 pgs.	
	NPL195	White Pine Software; "CU-SeeMe Pro: Quick Start Guide"; Version 4.0 for Windows; 1999, 86 pgs.	

Examiner Signature	/Suresh Suryawanshi/	Date Considered	05/14/2012
-----------------------	----------------------	--------------------	------------

\*EXAMINER: Initial if reference considered, whether or not citation is in conformance with MPEP 609. Draw line through citation if not in conformance and not considered. Include copy of this form with next communication to applicant.

<sup>1</sup> Applicant's unique citation designation number (optional). <sup>2</sup> Applicant is to place a check mark here if English language Translation is attached.

ALL REFERENCES CONSIDERED EXCEPT WHERE LINED THROUGH. /SKS./

Substitute for form 1449/PTO				<i>Complete if Known</i>	
<b>INFORMATION DISCLOSURE STATEMENT BY APPLICANT</b> <i>(Use as many sheets as necessary)</i>				Application Number	13/118,122
				Filing Date	May 27, 2011
				First Named Inventor	James J. FALLON
				Art Unit	2115
				Examiner Name	To Be Assigned
Sheet	26	of	66	Attorney Docket Number	2855.004000B

NON PATENT LITERATURE DOCUMENTS			
Examiner Initials*	Cite No. <sup>1</sup>	Include name of the author (in CAPITAL LETTERS), title of the article (when appropriate), title of the item (book, magazine, journal, serial, symposium, catalog, etc.), date, page(s), volume number, publisher, city and/or country where published	T <sup>2</sup>
	NPL196	"CU-SeeMe Reflector"; <a href="http://www.geektimes.com/michael/CU-SeeMe/fags/reflectors.html">www.geektimes.com/michael/CU-SeeMe/fags/reflectors.html</a> ; accessed on December 2, 2008, 5 pgs.	
	NPL197	Daniels, et al.; "Citrix WinFrame 1.6 Beta"; May 1 1996; <a href="http://license.icopyright.net/user/downloadLicense.act?lic=3.7009-9123">license.icopyright.net/user/downloadLicense.act?lic=3.7009-9123</a> ; accessed December 2, 2008, 4 pgs.	
	NPL198	Held, et al.; "Data Compression"; Third Edition; John Wiley & Sons Ltd.; 1991, 150 pgs.	
	NPL199	Data Compression Applications and Innovations Workshop; Proceedings of a Workshop held in Conjunction with the IEEE Data Compression Conference; Snowbird, Utah; March 31, 1995, 64 pgs.	
	NPL200	Britton, et al.; "Discovery Desktop Conferencing with NetMeeting 2.0"; IDG Books Worldwide, inc.; 1997, 244 pgs.	
	NPL201	Sattler, Michael; "Internet TV with CU-SeeMe"; Sams.Net Publishing; 1995; First Edition, 80 pgs.	
	NPL202	IBM Microelectronics Comdex Fall '93 Booth Location, 1 pg.	
	NPL203	Disz, et al.; "Performance Model of the Argonne Voyager Multimedia Server"; IEEE; 1997; pages 316-327.	
	NPL204	"Downloading and Installing NetMeeting"; <a href="http://www.w4mq.com/help/h3.htm">www.w4mq.com/help/h3.htm</a> ; accessed on December 2, 2008; 6 pgs.	
	NPL205	Fox, et al.; "Adapting to Network and Client Variability via On-Demand Dynamic Distillation"; ASPLOS VII; October 1996; pages 160-170.	

Examiner Signature	/Suresh Suryawanshi/	Date Considered	05/14/2012
-----------------------	----------------------	--------------------	------------

\*EXAMINER: Initial if reference considered, whether or not citation is in conformance with MPEP 609. Draw line through citation if not in conformance and not considered. Include copy of this form with next communication to applicant.

<sup>1</sup> Applicant's unique citation designation number (optional). <sup>2</sup> Applicant is to place a check mark here if English language Translation is attached.

ALL REFERENCES CONSIDERED EXCEPT WHERE LINED THROUGH. /SKS./



Substitute for form 1449/PTO				<i>Complete if Known</i>	
<b>INFORMATION DISCLOSURE STATEMENT BY APPLICANT</b> <i>(Use as many sheets as necessary)</i>				Application Number	13/118,122
				Filing Date	May 27, 2011
				First Named Inventor	James J. FALLON
				Art Unit	2115
				Examiner Name	To Be Assigned
Sheet	27	of	66	Attorney Docket Number	2855.004000B

NON PATENT LITERATURE DOCUMENTS			
Examiner Initials*	Cite No. <sup>1</sup>	Include name of the author (in CAPITAL LETTERS), title of the article (when appropriate), title of the item (book, magazine, journal, serial, symposium, catalog, etc.), date, page(s), volume number, publisher, city and/or country where published	T <sup>2</sup>
	NPL206	Fox, et al.; "Adapting to Network and Client Variation Using Infrastructural Proxies: Lessons and Perspectives"; IEEE Personal Communications, August 1998; pages 10-19.	
	NPL207	Han, et al.; "CU-SeeMe VR Immersive Desktop Teleconferencing"; Department of Computer Science; Cornell University; To appear in ACM Multimedia 1996, 9 pgs.	
	NPL208	Howard, et al.; "Parallel Lossless Image Compression Using Huffman and Arithmetic Coding"; 1992; pages 1-9.	
	NPL209	Howard, Paul G.; "Text Image Compression Using Soft Pattern Matching"; The Computer Journal; Vol. 40, No. 213; 1997; pages 146-156.	
	NPL210	Howard, et al.; "The Emerging JBIG2 Standard"; IEEE Transactions on Circuits and Systems for Video Technology, Vol. 8, No. 7, November 1998; pages 838-848.	
	NPL211	Craft, D. J.; "A fast hardware data compression algorithm and some algorithmic extensions"; Journal of Research and Development; Vol. 42, No. 6, November 1998; pages 733-745.	
	NPL212	"Direct Access Storage Device Compression and Decompression Data Flow"; IBM Technical Disclosure Bulletin; Vol. 38, No. 11; November 1995; pages 291-295.	
	NPL213	ICA Timeline, September 24, 2007, 3 pgs.	
	NPL214	Converse, et al.; "Low Bandwidth X Extension"; Protocol Version 1.0; X Consortium; December 21, 1996, 55 pgs.	
	NPL215	Magstar and IBM 3590 High Performance Tape Subsystem Technical Guide; November 1996; IBM International Technical Support Organization, 288 pgs.	

Examiner Signature	/Suresh Suryawanshi/	Date Considered	05/14/2012
-----------------------	----------------------	--------------------	------------

\*EXAMINER: Initial if reference considered, whether or not citation is in conformance with MPEP 609. Draw line through citation if not in conformance and not considered. Include copy of this form with next communication to applicant.

<sup>1</sup> Applicant's unique citation designation number (optional). <sup>2</sup> Applicant is to place a check mark here if English language Translation is attached.

ALL REFERENCES CONSIDERED EXCEPT WHERE LINED THROUGH. /SKS./

Substitute for form 1449/PTO				<i>Complete if Known</i>	
<b>INFORMATION DISCLOSURE STATEMENT BY APPLICANT</b> <i>(Use as many sheets as necessary)</i>				Application Number	13/118,122
				Filing Date	May 27, 2011
				First Named Inventor	James J. FALLON
				Art Unit	2115
				Examiner Name	To Be Assigned
Sheet	28	of	66	Attorney Docket Number	2855.004000B

NON PATENT LITERATURE DOCUMENTS			
Examiner Initials*	Cite No. <sup>1</sup>	Include name of the author (in CAPITAL LETTERS), title of the article (when appropriate), title of the item (book, magazine, journal, serial, symposium, catalog, etc.), date, page(s), volume number, publisher, city and/or country where published	T <sup>2</sup>
	NPL216	MetaFrame Administration Student Workbook; June 1998; Citrix Professional Courseware; Citrix Systems, Inc., 113 pgs.	
	NPL217	NCD Wincenter 3.1 : Bringing Windows to Every Desktop, 1998; 2 pgs.	
	NPL218	Overview NetMeeting 2.1; Microsoft TechNet; technet.microsoft.com/en-us/library/cc767141(printer).aspx; accessed December 2, 2008; 7 pgs.	
	NPL219	NetMeeting 2.1 Resource Kit; Microsoft TechNet; technet.microsoft.com/en-us/library/cc767142(printer).aspx; accessed on December 2, 2008, 34 pgs.	
	NPL220	Conferencing Standards: NetMeeting 2.1 Resource Kit: Microsoft TechNet; technet.microsoft.com/en-us/library/cc767150(printer).aspx; accessed December 2, 2008, 14 pgs.	
	NPL221	Summers, Bob; "Official Microsoft NetMeeting Book"; Microsoft Press; 1998, 374 pgs.	
	NPL222	Zebrose, Katherine L.; "Integrating Hardware Accelerators into Internetworking Switches"; Telco Systems, 10 pgs (no date listed).	
	NPL223	Simpson, et al.; "A Multiple Processor Approach to Data Compression"; ACM; 1998; pages 641-649, 9 pgs.	
	NPL224	"IBM Technology Products Introduces New Family of High-Performance Data Compression Products"; IBM; August 16, 1993, 6 pgs.	
	NPL225	ReadMe; PowerQuest Drive Image Pro; Version 3.00; 1994-1999; PowerQuest Corporation, pages 1-6.	

Examiner Signature	/Suresh Suryawanshi/	Date Considered	05/14/2012
-----------------------	----------------------	--------------------	------------

\*EXAMINER: Initial if reference considered, whether or not citation is in conformance with MPEP 609. Draw line through citation if not in conformance and not considered. Include copy of this form with next communication to applicant.

<sup>1</sup> Applicant's unique citation designation number (optional). <sup>2</sup> Applicant is to place a check mark here if English language Translation is attached.

ALL REFERENCES CONSIDERED EXCEPT WHERE LINED THROUGH. /SKS./

Substitute for form 1449/PTO				<i>Complete if Known</i>	
<b>INFORMATION DISCLOSURE STATEMENT BY APPLICANT</b> <i>(Use as many sheets as necessary)</i>				Application Number	13/118,122
				Filing Date	May 27, 2011
				First Named Inventor	James J. FALLON
				Art Unit	2115
				Examiner Name	To Be Assigned
Sheet	29	of	66	Attorney Docket Number	2855.004000B

NON PATENT LITERATURE DOCUMENTS			
Examiner Initials*	Cite No. <sup>1</sup>	Include name of the author (in CAPITAL LETTERS), title of the article (when appropriate), title of the item (book, magazine, journal, serial, symposium, catalog, etc.), date, page(s), volume number, publisher, city and/or country where published	T <sup>2</sup>
	NPL226	<u>Schulzrinne, et al., "RTP Profile for Audio and Video Conferences with Minimal Control," January 1996, www.ietf.org/rfc/rfc1890.txt, accessed on December 3, 2008; 17 pgs.</u>	
	NPL227	Zhu, C.; "RTP Payload Format for H.263 Video Streams"; Standards Track; September 1997; pages 1-12.	
	NPL228	Simpson, W.; "The Point-To-Point Protocol (PPP)," Standards Track, July 1994, pages i-52.	
	NPL229	Reynolds, et al.; "Assigned Numbers," Standards Track; October 1994, pages 1-230.	
	NPL230	Deutsch, et al.; "ZLIB Compressed Data Format Specification version 3.3," Informational, May 1996, pages 1-10.	
	NPL231	Deutsch, P., "DEFLATE Compressed Data Format Specification version 1.3," Informational, May 1996, pages 1-15.	
	NPL232	Rand, D., "The PPP Compression Control Protocol (CCP)," Standards Track, June 1996, pages 1-9.	
	NPL233	Schneider, et al., "PPP LZS-DCP Compression Protocol (LZS-DCP)," Informational, August 1996, pages 1-18.	
	NPL234	Friend, et al., "PPP Stac LZS Compression Protocol," Informational, August 1996; pages 1-20.	
	NPL235	Schneider, et al., "PPP for Data Compression in Data Circuit-Terminating Equipment (DCE)," Informational, August 1996, pages 1-10.	

Examiner Signature	/Suresh Suryawanshi/	Date Considered	05/14/2012
-----------------------	----------------------	--------------------	------------

\*EXAMINER: Initial if reference considered, whether or not citation is in conformance with MPEP 609. Draw line through citation if not in conformance and not considered. Include copy of this form with next communication to applicant.

<sup>1</sup> Applicant's unique citation designation number (optional). <sup>2</sup> Applicant is to place a check mark here if English language Translation is attached.

ALL REFERENCES CONSIDERED EXCEPT WHERE LINED THROUGH. /SKS./

Substitute for form 1449/PTO				<i>Complete if Known</i>	
<b>INFORMATION DISCLOSURE STATEMENT BY APPLICANT</b> <i>(Use as many sheets as necessary)</i>				Application Number	13/118,122
				Filing Date	May 27, 2011
				First Named Inventor	James J. FALLON
				Art Unit	2115
				Examiner Name	To Be Assigned
Sheet	30	of	66	Attorney Docket Number	2855.00400B

NON PATENT LITERATURE DOCUMENTS			
Examiner Initials*	Cite No. <sup>1</sup>	Include name of the author (in CAPITAL LETTERS), title of the article (when appropriate), title of the item (book, magazine, journal, serial, symposium, catalog, etc.), date, page(s), volume number, publisher, city and/or country where published	T <sup>2</sup>
	NPL236	Atkins, et al., "PGP Message Exchange Formats," Informational, August 1996, pages 1-21.	
	NPL237	Castineyra, et al., "The Nimrod Routing Architecture," Informational, August 1996, pages 1-27.	
	NPL238	Freed, et al., "Multipurpose Internet Mail Extensions (MIME) Part Four: Registration Procedures," Best Current Practice, November 1996, pages 1-21.	
	NPL239	Shacham, et al., "IP Payload Compression Protocol (IPComp)," Standards Track, December 1998, pages 1-10.	
	NPL240	Sidewinder 50 Product Manual, Seagate Technology, Inc., 1997, 189 pgs.	
	NPL241	IBM RAMAC Virtual Array, IBM, July 1997, 490 pgs.	
	NPL242	Bruni, et al., "DB2 for OS/390 and Data Compression" IBM Corporation, November 1998, 172 pgs.	
	NPL243	Smith, Mark, "Thin Client/Server Computing Works," WindowsITPro, November 1, 1998, pages 1-13, license.icopyright.net/user/downloadLicense.act?lic=3.7009-8355, accessed December 2, 2008.	
	NPL244	International Telecommunication Union, "Information Technology - Digital Compression and Coding of Continuous-Tone Still Images-Requirements and Guidelines," 1993, 186 pgs.	
	NPL245	International Telecommunications Union, "Information technology - Lossless and near-lossless compression of continuous-tone still images - Baseline," 1999, 75 pgs.	

Examiner Signature	/Suresh Suryawanshi/	Date Considered	05/14/2012
-----------------------	----------------------	--------------------	------------

\*EXAMINER: Initial if reference considered, whether or not citation is in conformance with MPEP 609. Draw line through citation if not in conformance and not considered. Include copy of this form with next communication to applicant.

<sup>1</sup> Applicant's unique citation designation number (optional). <sup>2</sup> Applicant is to place a check mark here if English language Translation is attached.

ALL REFERENCES CONSIDERED EXCEPT WHERE LINED THROUGH. /SKS./

Substitute for form 1449/PTO				<i>Complete if Known</i>	
<b>INFORMATION DISCLOSURE STATEMENT BY APPLICANT</b> <i>(Use as many sheets as necessary)</i>				Application Number	13/118,122
				Filing Date	May 27, 2011
				First Named Inventor	James J. FALLON
				Art Unit	2115
				Examiner Name	To Be Assigned
Sheet	31	of	66	Attorney Docket Number	2855.004000B

NON PATENT LITERATURE DOCUMENTS			
Examiner Initials*	Cite No. <sup>1</sup>	Include name of the author (in CAPITAL LETTERS), title of the article (when appropriate), title of the item (book, magazine, journal, serial, symposium, catalog, etc.), date, page(s), volume number, publisher, city and/or country where published	T <sup>2</sup>
	NPL246	Davis, Andrew W., "The Video Answering Machine: Intel Proshare's Next Step," Advanced Imaging, Vol. 12, No. 3, March 1997, pages 28, 30.	
	NPL247	Abbott, III, Walter D., "A Simple, Low Overhead Data Compression Algorithm for Converting Lossy Compression Processes to Lossless," Naval Postgraduate School Thesis; December 1993, 93 pgs.	
	NPL248	Thomborson, Clark, "V.42bis and Other Ziv-Lemoel Variants," IEEE, 1991, page 460.	
	NPL249	Thomborson, Clark, "The V.42bis Standard for Data-Compressing Modems," IEEE, October 1992, pages 41-53.	
	NPL250	Sun, Andrew, "Using and Managing PPP," O'Reilly & Associates, Inc., 1999, 89 pgs.	
	NPL251	"What is the V42bis Standard?," <a href="http://www.faqs.org/faqs/compression-faq/part1/section-10.html">www.faqs.org/faqs/compression-faq/part1/section-10.html</a> , accessed on December 2, 2008, 2 pgs.	
	NPL252	"The WSDC Download Guide: Drive Image Professional for DOS, OS/2, and Windows," <a href="http://wsdc01.watson.ibm.com/WSDC.nsf/Guides/Download/Applications-DriveImage.htm">wsdc01.watson.ibm.com/WSDC.nsf/Guides/Download/Applications-DriveImage.htm</a> , Accessed November 22, 1999, 4 pgs.	
	NPL253	"The WSDC Download Guide: Drive Image Professional," <a href="http://wsdc01.watson.ibm.com/wsdc.nsf/Guides/Download/Applications-DriveImage.htm">wsdc01.watson.ibm.com/wsdc.nsf/Guides/Download/Applications-DriveImage.htm</a> , accessed on May 3, 2001, 5 pgs.	
	NPL254	APPNOTE-TXT from pkware.txt, Version 6.3.2, PKWARE Inc., 1989, 52 pgs.	
	NPL255	CU-SeeMe readme.txt, December 2, 1995, 9 pgs.	

Examiner Signature	/Suresh Suryawanshi/	Date Considered	05/14/2012
-----------------------	----------------------	--------------------	------------

\*EXAMINER: Initial if reference considered, whether or not citation is in conformance with MPEP 609. Draw line through citation if not in conformance and not considered. Include copy of this form with next communication to applicant.

<sup>1</sup> Applicant's unique citation designation number (optional). <sup>2</sup> Applicant is to place a check mark here if English language Translation is attached.

ALL REFERENCES CONSIDERED EXCEPT WHERE LINED THROUGH. /SKS./

Substitute for form 1449/PTO				<i>Complete if Known</i>	
<b>INFORMATION DISCLOSURE STATEMENT BY APPLICANT</b> <i>(Use as many sheets as necessary)</i>				Application Number	13/118,122
				Filing Date	May 27, 2011
				First Named Inventor	James J. FALLON
				Art Unit	2115
				Examiner Name	To Be Assigned
Sheet	32	of	66	Attorney Docket Number	2855.004000B

NON PATENT LITERATURE DOCUMENTS			
Examiner Initials*	Cite No. <sup>1</sup>	Include name of the author (in CAPITAL LETTERS), title of the article (when appropriate), title of the item (book, magazine, journal, serial, symposium, catalog, etc.), date, page(s), volume number, publisher, city and/or country where published	T <sup>2</sup>
	NPL256	CU-seeme txt from indstate.txt, README.TXT for CU-SeeMe version 0.90bl, March 23, 1997, 5 pgs.	
	NPL257	Cuseeme txt 19960221 .txt; CUSEEME.TXT, February 21, 1996, 9 pgs.	
	NPL258	Citrix Technology Guide, 1997, 413 pgs.	
	NPL259	Lettieri, et al., "Data Compression in the V.42bis Modems," 1992, pages 398-403.	
	NPL260	High Performance x2/V.34+N.42bis 56K BPS Plug & Play External Voice/FAX/Data Modem User's Manual, 1997, 27 pgs.	
	NPL261	H.323 Protocols Suite, www.protocols.com/pbook-h323.htm, 26 pgs., identified in Defendants' Joint Preliminary Invalidation Contentions filed in Realtime Data, LLC D/B/A IXO v. Packeteer, Inc., et al., Civil Action No. 6:08-cv-144-LED, United States District Court for the Eastern District of Texas Tyler Division, December 8, 2008.	
	NPL262	LBX X Consortium Algorithms; rzdocs.uni-hohenheim.de/aix~4.33/ext~doc/usr/share/man/info/en-US/a~doc~lib/.x."1;1 X I R 6 Technical Specifications, 3 pgs.	
	NPL263	Basics of Images; www.geom.uiuc.edu/events/courses/1996/cmwh/Stills/basics.html, 1996, 5 pgs.	
	NPL264	Parties' Joint Claim Construction and Prehearing Statement Pursuant to P.R. 4-3, filed in Realtime Data, LLC d/b/a/IXO v. Packeteer, Inc. et al., Civil Action No. 6:08-cv-00144-LED; U.S. District Court for the Eastern District of Texas, February 18, 2009, 168 pages.	
	NPL265	Declaration of Professor James A. Storer, Ph.D., relating to U.S. Patent No. 6,604,158, March 18, 2009, 10 pgs.	

Examiner Signature	/Suresh Suryawanshi/	Date Considered	05/14/2012
--------------------	----------------------	-----------------	------------

\*EXAMINER: Initial if reference considered, whether or not citation is in conformance with MPEP 609. Draw line through citation if not in conformance and not considered. Include copy of this form with next communication to applicant.

<sup>1</sup> Applicant's unique citation designation number (optional). <sup>2</sup> Applicant is to place a check mark here if English language Translation is attached.

ALL REFERENCES CONSIDERED EXCEPT WHERE LINED THROUGH. /SKS./

Substitute for form 1449/PTO				<i>Complete if Known</i>	
<b>INFORMATION DISCLOSURE STATEMENT BY APPLICANT</b> <i>(Use as many sheets as necessary)</i>				Application Number	13/118,122
				Filing Date	May 27, 2011
				First Named Inventor	James J. FALLON
				Art Unit	2115
				Examiner Name	To Be Assigned
Sheet	33	of	66	Attorney Docket Number	2855.00400B

NON PATENT LITERATURE DOCUMENTS			
Examiner Initials*	Cite No. <sup>1</sup>	Include name of the author (in CAPITAL LETTERS), title of the article (when appropriate), title of the item (book, magazine, journal, serial, symposium, catalog, etc.), date, page(s), volume number, publisher, city and/or country where published	T <sup>2</sup>
	NPL266	Declaration of Professor James A. Storer, Ph.D., relating to U.S. Patent No. 6,601,104, March 18, 2009, 8 pgs.	
	NPL267	Declaration of Professor James A. Storer, Ph.D., relating to U.S. Patent No. 7,321,937, May 4, 2009, 15 pgs.	
	NPL268	Declaration of Professor James A. Storer, Ph.D., relating to U.S. Patent No. 6,624,761, May 4, 2009, 6 pgs.	
	NPL269	Declaration of Professor James A. Storer, Ph.D., relating to U.S. Patent No. 7,378,992, May 20, 2009, 6 pgs.	
	NPL270	Declaration of Professor James A. Storer, Ph.D., relating to U.S. Patent No. 7,161,506, May 26, 2009, 5 pgs.	
	NPL271	"Video Coding for Low Bit Rate Communication", International Telecommunication Union (ITU), Recommendation H.263, §3.4 (March 1996) ("ITU H.263"), 52 pgs.	
	NPL272	Order Adopting Report and Recommendation of United States Magistrate Judge, Realtime Data, LLC D/B/A Ixo v. Packeteer, Inc., et al., District Court for the Eastern District of Texas, No. 6:08cv144, August 24, 2009, 2 pgs.	
	NPL273	Second Amended Answer filed on behalf of Citrix Systems, Inc, (includes allegations of inequitable conduct on at least pages 24-43) filed in Realtime Data, LLC d/b/a/IXO v. Packeteer, Inc. et al., Civil Action No. 6:08-cv-00144-LED; U.S. District Court for the Eastern District of Texas, February 10, 2009, 45 pgs.	
	NPL274	Expert Report of James B. Gambrell on Inequitable Conduct filed on behalf of some of the defendants [Includes Appendices - Exhibits A-I] filed in Realtime Data, LLC d/b/a/IXO v. Packeteer, Inc. et al., Civil Action No. 6:08-cv-00144-LED; U.S. District Court for the Eastern District of Texas, June 10, 2009, 199 pgs.	
	NPL275	Expert Report of Dr. James A. Storer on Invalidity filed on behalf of some of the defendants [Includes Appendices - Exhibits A-K (Exhibit A has been redacted pursuant to a protective order)] filed in Realtime Data, LLC d/b/a/IXO v. Packeteer, Inc. et al., Civil Action No. 6:08-cv-00144-LED; U.S. District Court for the Eastern District of Texas, June 10, 2009, 1090 pgs.	

Examiner Signature	/Suresh Suryawanshi/	Date Considered	05/14/2012
--------------------	----------------------	-----------------	------------

\*EXAMINER: Initial if reference considered, whether or not citation is in conformance with MPEP 609. Draw line through citation if not in conformance and not considered. Include copy of this form with next communication to applicant.

<sup>1</sup> Applicant's unique citation designation number (optional). <sup>2</sup> Applicant is to place a check mark here if English language Translation is attached.

ALL REFERENCES CONSIDERED EXCEPT WHERE LINED THROUGH. /SKS./

Substitute for form 1449/PTO				<i>Complete if Known</i>	
<b>INFORMATION DISCLOSURE STATEMENT BY APPLICANT</b> <i>(Use as many sheets as necessary)</i>				Application Number	13/118,122
				Filing Date	May 27, 2011
				First Named Inventor	James J. FALLON
				Art Unit	2115
				Examiner Name	To Be Assigned
Sheet	34	of	66	Attorney Docket Number	2855.004000B

**NON PATENT LITERATURE DOCUMENTS**

Examiner Initials*	Cite No. <sup>1</sup>	Include name of the author (in CAPITAL LETTERS), title of the article (when appropriate), title of the item (book, magazine, journal, serial, symposium, catalog, etc.), date, page(s), volume number, publisher, city and/or country where published	T <sup>2</sup>
	NPL276	Supplemental Expert Report of Dr. James A. Storer on Invalidity filed on behalf of some of the defendants [Includes Appendices - Exhibits 1-8] filed in Realtime Data, LLC d/b/a/IXO v. Packeteer, Inc. et al., Civil Action No. 6:08-cv-00144-LED; U.S. District Court for the Eastern District of Texas, June 19, 2009, 301 pgs.	
	NPL277	Deposition of Dr. James A. Storer conducted on behalf of the plaintiffs filed in Realtime Data, LLC d/b/a/IXO v. Packeteer, Inc. et al., Civil Action No. 6:08-cv-00144-LED; U.S. District Court for the Eastern District of Texas, February 27, 2009, 242 pgs.	
	NPL278	Deposition of Brian Von Herzen conducted on behalf of the plaintiffs filed in Realtime Data, LLC d/b/a/IXO v. Packeteer, Inc. et al., Civil Action No. 6:08-cv-00144-LED; U.S. District Court for the Eastern District of Texas, February 26, 2009, 241 pgs.	
	NPL279	Second Amended Complaint filed on behalf of the Plaintiff in Realtime Data, LLC d/b/a/IXO v. Packeteer, Inc. et al., Civil Action No. 6:08-cv-00144-LED; U.S. District Court for the Eastern District of Texas, February 10, 2009, 28 pgs.	
	NPL280	Answers to the Second Amended Complaint and Counterclaims filed by Citrix Systems, Inc. in Realtime Data, LLC d/b/a/IXO v. Packeteer, Inc. et al., Civil Action No. 6:08-cv-00144-LED; U.S. District Court for the Eastern District of Texas, February 17, 2009, 46 pgs.	
	NPL281	Answers to the Second Amended Complaint and Counterclaims filed by F5 Networks, Inc. in Realtime Data, LLC d/b/a/IXO v. Packeteer, Inc. et al., Civil Action No. 6:08-cv-00144-LED; U.S. District Court for the Eastern District of Texas, February 17, 2009, 17 pgs.	
	NPL282	Answers to the Second Amended Complaint and Counterclaims filed by Averitt Express, Inc. in Realtime Data, LLC d/b/a/IXO v. Packeteer, Inc. et al., Civil Action No. 6:08-cv-00144-LED; U.S. District Court for the Eastern District of Texas, February 17, 2009, 17 pgs.	
	NPL283	Answers to the Second Amended Complaint and Counterclaims filed by DHL Express, Inc. in Realtime Data, LLC d/b/a/IXO v. Packeteer, Inc. et al., Civil Action No. 6:08-cv-00144-LED; U.S. District Court for the Eastern District of Texas, February 17, 2009, 37 pgs.	
	NPL284	Answers to the Second Amended Complaint and Counterclaims filed by Expand Networks, Inc., Interstate Battery System of America, Inc., and O'Reilly Automotive, Inc. in Realtime Data, LLC d/b/a/IXO v. Packeteer, Inc. et al., Civil Action No. 6:08-cv-00144-LED; U.S. District Court for the Eastern District of Texas, February 17, 2009, 21 pgs.	
	NPL285	Answers to the Second Amended Complaint and Counterclaims filed by Blue Coat Systems, Inc., Packeteer, Inc., 7-Eleven, Inc., ABM Industries, Inc., ABM Janitorial Services-South Central, Inc., and Build-A-Bear Workshop, Inc. in Realtime Data, LLC d/b/a/IXO v. Packeteer, Inc. et al., Civil Action No. 6:08-cv-00144-LED; U.S. District Court for the Eastern District of Texas, February 18, 2009, 84 pgs.	

Examiner Signature	/Suresh Suryawanshi/	Date Considered	05/14/2012
--------------------	----------------------	-----------------	------------

\*EXAMINER: Initial if reference considered, whether or not citation is in conformance with MPEP 609. Draw line through citation if not in conformance and not considered. Include copy of this form with next communication to applicant.

<sup>1</sup> Applicant's unique citation designation number (optional). <sup>2</sup> Applicant is to place a check mark here if English language Translation is attached.

ALL REFERENCES CONSIDERED EXCEPT WHERE LINED THROUGH. /SKS./



Substitute for form 1449/PTO				<i>Complete if Known</i>	
<b>INFORMATION DISCLOSURE STATEMENT BY APPLICANT</b> <i>(Use as many sheets as necessary)</i>				Application Number	13/118,122
				Filing Date	May 27, 2011
				First Named Inventor	James J. FALLON
				Art Unit	2115
				Examiner Name	To Be Assigned
Sheet	35	of	66	Attorney Docket Number	2855.004000B

NON PATENT LITERATURE DOCUMENTS			
Examiner Initials*	Cite No. <sup>1</sup>	Include name of the author (in CAPITAL LETTERS), title of the article (when appropriate), title of the item (book, magazine, journal, serial, symposium, catalog, etc.), date, page(s), volume number, publisher, city and/or country where published	T <sup>2</sup>
	NPL286	Plaintiff's Response to the Answers to the Second Amended Complaint and Counterclaims filed by Citrix Systems, Inc, in Realtime Data, LLC d/b/a/IXO v. Packeteer, Inc. et al., Civil Action No. 6:08-cv-00144-LED; U.S. District Court for the Eastern District of Texas, March 4, 2009, 24 pgs.	
	NPL287	Plaintiff's Responses to the Answers to the Second Amended Complaint and Counterclaims filed by F5 Networks, Inc, in Realtime Data, LLC d/b/a/IXO v. Packeteer, Inc. et al., Civil Action No. 6:08-cv-00144-LED; U.S. District Court for the Eastern District of Texas, March 4, 2009, 5 pgs.	
	NPL288	Plaintiff's Responses to the Answers to the Second Amended Complaint and Counterclaims filed by Averitt Express, Inc, in Realtime Data, LLC d/b/a/IXO v. Packeteer, Inc. et al., Civil Action No. 6:08-cv-00144-LED; U.S. District Court for the Eastern District of Texas, March 4, 2009, 5 pgs.	
	NPL289	Plaintiff's Responses to the Answers to the Second Amended Complaint and Counterclaims filed by DHL Express, Inc, in Realtime Data, LLC d/b/a/IXO v. Packeteer, Inc. et al., Civil Action No. 6:08-cv-00144-LED; U.S. District Court for the Eastern District of Texas, March 4, 2009, 17 pgs.	
	NPL290	Plaintiff's Responses to the Answers to the Second Amended Complaint and Counterclaims filed by Expand Networks, Inc, Interstate Battery System of America, Inc., and O'Reilly Automotive, Inc. in Realtime Data, LLC d/b/a/IXO v. Packeteer, Inc. et al., Civil Action No. 6:08-cv-00144-LED; U.S. District Court for the Eastern District of Texas, March 4, 2009, 15 pgs.	
	NPL291	Plaintiff's Responses to the Answers to the Second Amended Complaint and Counterclaims filed by Blue Coat Systems, Inc., Packeteer, Inc., 7-Eleven, Inc., ABM Industries, Inc., ABM Janitorial Services-South Central, Inc., and Build -A-Bear Workshop, Inc. in Realtime Data, LLC d/b/a/IXO v. Packeteer, Inc. et al., Civil Action No. 6:08-cv-00144-LED; U.S. District Court for the Eastern District of Texas, March 4, 2009, 34 pgs.	
	NPL292	Opening Claim Construction Brief filed in Realtime Data, LLC d/b/a/IXO v. Packeteer, Inc. et al., Civil Action No. 6:08-cv-00144-LED; U.S. District Court for the Eastern District of Texas, March 5, 2009, 36 pgs.	
	NPL293	Declaration of Jordan Adler in support of the Opening Claim Construction Brief filed in Realtime Data, LLC d/b/a/IXO v. Packeteer, Inc. et al., Civil Action No. 6:08-cv-00144-LED; U.S. District Court for the Eastern District of Texas, March 5, 2009, 214 pgs.	
	NPL294	Motion for Partial Summary Judgment for Invalidity of some of the Patents in Suit for Indefiniteness, including the '104 patent, filed on behalf of the defendants in Realtime Data, LLC d/b/a/IXO v. Packeteer, Inc. et al., Civil Action No. 6:08-cv-00144-LED; U.S. District Court for the Eastern District of Texas, March 16, 2009, 22 pgs.	
	NPL295	Declaration of Michele E. Moreland in support Motion for Partial Summary Judgment for Invalidity of some of the Patents in Suit for Indefiniteness, including the '104 patent, filed on behalf of the defendants in Realtime Data, LLC d/b/a/IXO v. Packeteer, Inc. et al., Civil Action No. 6:08-cv-00144-LE, March 16, 2009, 168 pgs.	

Examiner Signature	/Suresh Suryawanshi/	Date Considered	05/14/2012
--------------------	----------------------	-----------------	------------

\*EXAMINER: Initial if reference considered, whether or not citation is in conformance with MPEP 609. Draw line through citation if not in conformance and not considered. Include copy of this form with next communication to applicant.

<sup>1</sup> Applicant's unique citation designation number (optional). <sup>2</sup> Applicant is to place a check mark here if English language Translation is attached.

ALL REFERENCES CONSIDERED EXCEPT WHERE LINED THROUGH. /SKS./

Substitute for form 1449/PTO				<i>Complete if Known</i>	
<b>INFORMATION DISCLOSURE STATEMENT BY APPLICANT</b> <i>(Use as many sheets as necessary)</i>				Application Number	13/118,122
				Filing Date	May 27, 2011
				First Named Inventor	James J. FALLON
				Art Unit	2115
				Examiner Name	To Be Assigned
Sheet	36	of	66	Attorney Docket Number	2855.004000B

NON PATENT LITERATURE DOCUMENTS			
Examiner Initials*	Cite No. <sup>1</sup>	Include name of the author (in CAPITAL LETTERS), title of the article (when appropriate), title of the item (book, magazine, journal, serial, symposium, catalog, etc.), date, page(s), volume number, publisher, city and/or country where published	T <sup>2</sup>
	NPL296	Declaration of James A. Storer in support Motion for Partial Summary Judgment for Invalidity of some of the Patents in Suit for Indefiniteness, including the '104 patent, filed on behalf of the defendants in Realtime Data, LLC d/b/a/IXO v. Packeteer, Inc. et al., Civil Action No. 6:08-cv-00144-LE, March 16, 2009, 27 pgs.	
	NPL297	Joint Defendants Reply regarding Motion for Partial Summary Judgment for Invalidity of some of the Patents in Suit for Indefiniteness, including the '104 patent, filed on behalf of the defendants in Realtime Data, LLC d/b/a/IXO v. Packeteer, Inc. et al., Civil Action No. 6:08-cv-00144-LE, April 2, 2009, 20 pgs.	
	NPL298	Responsive Briefs in Support of Claim Construction filed by Blue Coats Systems, Inc., Packeteer, Inc., 7-Eleven, Inc., ABM Industries, Inc., ABM Janitorial Services-South Central, Inc. and Build-A-Bear Workshop, Inc. in Realtime Data, LLC d/b/a/IXO v. Packeteer, Inc. et al., Civil Action No. 6:08-cv-00144-LED; U.S. District Court for the Eastern District of Texas, March 19, 2009, 451 pgs.	
	NPL299	Responsive Briefs in Support of Claim Construction filed by F5 Networks, Inc. and Averitt Express, Inc. in Realtime Data, LLC d/b/a/IXO v. Packeteer, Inc. et al., Civil Action No. 6:08-cv-00144-LED; U.S. District Court for the Eastern District of Texas, March 19, 2009, 20 pgs.	
	NPL300	Responsive Briefs in Support of Claim Construction filed by Citrix Systems, Inc., Expand Networks, Inc., DHL Express (USA), Inc., Interstate Battery System of America, Inc., and O'Reilly Automotive Inc. in Realtime Data, LLC d/b/a/IXO v. Packeteer, Inc. et al., Civil Action No. 6:08-cv-00144-LED; U.S. District Court for the Eastern District of Texas, March 19, 2009, 377 pgs.	
	NPL301	Declaration of Dr. James A. Storer filed in Support of the Brief in Support of Claim Construction filed on behalf of F5 Networks, Inc. in Realtime Data, LLC d/b/a/IXO v. Packeteer, Inc. et al., Civil Action No. 6:08-cv-00144-LED; U.S. District Court for the Eastern District of Texas, March 19, 2009, 778 pgs.	
	NPL302	Defendant Citrix Systems, Inc.'s Motion to Exclude Dr. Brian Von Herzen's Opinions Regarding Claim Construction filed in Realtime Data, LLC d/b/a/IXO v. Packeteer, Inc. et al., Civil Action No. 6:08-cv-00144-LED; U.S. District Court for the Eastern District of Texas, March 20, 2009, 244 pgs.	
	NPL303	Plaintiff's Opposition to Defendant Citrix Systems, Inc.'s Motion to Exclude Dr. Brian Von Herzen's Opinions Regarding Claim Construction filed in Realtime Data, LLC d/b/a/IXO v. Packeteer, Inc. et al., Civil Action No. 6:08-cv-00144-LED; U.S. District Court for the Eastern District of Texas, April 6, 2009, 20 pgs.	
	NPL304	Declaration of Karim Oussayef submitted in support of the Opposition of Plaintiff's Opposition to Defendant Citrix Systems, Inc.'s Motion to Exclude Dr. Brian Von Herzen's Opinions Regarding Claim Construction filed in Realtime Data, LLC d/b/a/IXO v. Packeteer, Inc. et al., Civil Action No. 6:08-cv-00144-LED; U.S. District Court for the Eastern District of Texas, April 6, 2009, 119 pgs.	
	NPL305	Order of the Court Denying Defendant Citrix Systems, Inc.'s Motion to Exclude Dr. Brian Von Herzen's Opinions Regarding Claim Construction, Realtime Data, LLC D/B/A Ixo v. Packeteer, Inc., et al., District Court for the Eastern District of Texas, No. 6:08cv144, April 6, 2009, 1 pg.	

Examiner Signature	/Suresh Suryawanshi/	Date Considered	05/14/2012
--------------------	----------------------	-----------------	------------

\*EXAMINER: Initial if reference considered, whether or not citation is in conformance with MPEP 609. Draw line through citation if not in conformance and not considered. Include copy of this form with next communication to applicant.

<sup>1</sup> Applicant's unique citation designation number (optional). <sup>2</sup> Applicant is to place a check mark here if English language Translation is attached.

ALL REFERENCES CONSIDERED EXCEPT WHERE LINED THROUGH. /SKS./

Substitute for form 1449/PTO				<i>Complete if Known</i>	
<b>INFORMATION DISCLOSURE STATEMENT BY APPLICANT</b> <i>(Use as many sheets as necessary)</i>				Application Number	13/118,122
				Filing Date	May 27, 2011
				First Named Inventor	James J. FALLON
				Art Unit	2115
				Examiner Name	To Be Assigned
Sheet	37	of	66	Attorney Docket Number	2855.004000B

NON PATENT LITERATURE DOCUMENTS			
Examiner Initials*	Cite No. <sup>1</sup>	Include name of the author (in CAPITAL LETTERS), title of the article (when appropriate), title of the item (book, magazine, journal, serial, symposium, catalog, etc.), date, page(s), volume number, publisher, city and/or country where published	T <sup>2</sup>
	NPL306	Parties Joint Submission of Terms to be Heard at the Markman Hearing filed in Realtime Data, LLC d/b/a/IXO v. Packeteer, Inc. et al., Civil Action No. 6:08-cv-00144-LED; U.S. District Court for the Eastern District of Texas, March 24, 2009, 5 pgs.	
	NPL307	Order of the Court Regarding the terms to be heard at the Markman Hearing in Realtime Data, LLC d/b/a/IXO v. Packeteer, Inc. et al., Civil Action No. 6:08-cv-00144-LED; U.S. District Court for the Eastern District of Texas, March 24, 2009, 2 pgs.	
	NPL308	Transcript of the Markman Hearing held on April 9, 2009 in Realtime Data, LLC d/b/a/IXO v. Packeteer, Inc. et al., Civil Action No. 6:08-cv-00144-LED; U.S. District Court for the Eastern District of Texas, 174 pgs.	
	NPL309	Plaintiff's Reply Claim Construction Brief filed in Realtime Data, LLC d/b/a/IXO v. Packeteer, Inc. et al., Civil Action No. 6:08-cv-00144-LED; U.S. District Court for the Eastern District of Texas, March 30, 2009, 30 pgs.	
	NPL310	Declaration of Brian von Herzen in Support of the Plaintiff's Reply Claim Construction Brief filed in Realtime Data, LLC d/b/a/IXO v. Packeteer, Inc. et al., Civil Action No. 6:08-cv-00144-LED; U.S. District Court for the Eastern District of Texas, March 30, 2009, 25 pgs.	
	NPL311	F5 Sur-Reply to Plaintiff's Claim Construction Brief filed by some of the defendants in Realtime Data, LLC d/b/a/IXO v. Packeteer, Inc. et al., Civil Action No. 6:08-cv-00144-LED; U.S. District Court for the Eastern District of Texas, April 3, 2009, 12 pg	
	NPL312	Citrix Sur-Reply to Plaintiff's Claim Construction Brief filed by some of the defendants in Realtime Data, LLC d/b/a/IXO v. Packeteer, Inc. et al., Civil Action No. 6:08-cv-00144-LED; U.S. District Court for the Eastern District of Texas, April 3, 2009, 13 pgs.	
	NPL313	Blue Coat Sur-Reply to Plaintiff's Claim Construction Brief filed by some of the defendants in Realtime Data, LLC d/b/a/IXO v. Packeteer, Inc. et al., Civil Action No. 6:08-cv-00144-LED; U.S. District Court for the Eastern District of Texas, April 3, 2009, 12 pgs.	
	NPL314	Declaration of Michele Moreland in Support of Sur-Replies to Plaintiff's Claim Construction Brief filed by some of the defendants in Realtime Data, LLC d/b/a/IXO v. Packeteer, Inc. et al., Civil Action No. 6:08-cv-00144-LED; U.S. District Court for the Eastern District of Texas, April 3, 2009, 8 pgs.	
	NPL315	Declaration of James Storer in Support of Sur-Replies to Plaintiff's Claim Construction Brief filed by some of the defendants in Realtime Data, LLC d/b/a/IXO v. Packeteer, Inc. et al., Civil Action No. 6:08-cv-00144-LED; U.S. District Court for the Eastern District of Texas, April 7, 2009, 6 pgs.	

Examiner Signature	/Suresh Suryawanshi/	Date Considered	05/14/2012
--------------------	----------------------	-----------------	------------

\*EXAMINER: Initial if reference considered, whether or not citation is in conformance with MPEP 609. Draw line through citation if not in conformance and not considered. Include copy of this form with next communication to applicant.

<sup>1</sup> Applicant's unique citation designation number (optional). <sup>2</sup> Applicant is to place a check mark here if English language Translation is attached.

ALL REFERENCES CONSIDERED EXCEPT WHERE LINED THROUGH. /SKS./

Substitute for form 1449/PTO				<i>Complete if Known</i>	
<b>INFORMATION DISCLOSURE STATEMENT BY APPLICANT</b> <i>(Use as many sheets as necessary)</i>				Application Number	13/118,122
				Filing Date	May 27, 2011
				First Named Inventor	James J. FALLON
				Art Unit	2115
				Examiner Name	To Be Assigned
Sheet	38	of	66	Attorney Docket Number	2855.004000B

NON PATENT LITERATURE DOCUMENTS			
Examiner Initials*	Cite No. <sup>1</sup>	Include name of the author (in CAPITAL LETTERS), title of the article (when appropriate), title of the item (book, magazine, journal, serial, symposium, catalog, etc.), date, page(s), volume number, publisher, city and/or country where published	T <sup>2</sup>
	NPL316	Plaintiff's Motion for Leave to Supplement the Parties' Joint Claim Construction and Prehearing Statement filed in Realtime Data, LLC d/b/a/IXO v. Packeteer, Inc. et al., Civil Action No. 6:08-cv-00144-LED; U.S. District Court for the Eastern District of Texas, April 8, 2009, 123 pgs.	
	NPL317	Motion for Reconsideration of the Court's Order Denying Plaintiff's Motion for Leave to Supplement the Parties' Joint Claim Construction and Prehearing Statement filed in Realtime Data, LLC d/b/a/IXO v. Packeteer, Inc. et al., Civil Action No. 6:08-cv-00144-LED; U.S. District Court for the Eastern District of Texas, July 13, 2009, 3 pgs.	
	NPL318	Citrix Systems' Opposition to Realtime Data's Motion for Reconsideration of Realtime's Motion for Leave to Supplement the Parties' Joint Claim Construction, filed in Realtime Data, LLC d/b/a/IXO v. Packeteer, Inc. et al., Civil Action No. 6:08-cv-00144-LED; U.S. District Court for the Eastern District of Texas, July 27, 2009, 6 pgs.	
	NPL319	Notice of Agreement to Claim Term between Plaintiff and Defendant filed in Realtime Data, LLC d/b/a/IXO v. Packeteer, Inc. et al., Civil Action No. 6:08-cv-00144-LED; U.S. District Court for the Eastern District of Texas, April 22, 2009, 3 pgs.	
	NPL320	Provisional Claim Construction Order issued by the Court on June 2, 2009 in Realtime Data, LLC d/b/a/IXO v. Packeteer, Inc. et al., Civil Action No. 6:08-cv-00144-LED; U.S. District Court for the Eastern District of Texas, 28 pgs.	
	NPL321	Citrix Request for Consideration and Objections to the Provisional Claim Construction Order issued by the Court on June 22, 2009 filed on behalf of some of the defendants in Realtime Data, LLC d/b/a/IXO v. Packeteer, Inc. et al., Civil Action No. 6:08-cv-00144-LED; U.S. District Court for the Eastern District of Texas, July 9, 2009, 22 pgs.	
	NPL322	Blue Coat Request for Consideration and Objections to the Provisional Claim Construction Order issued by the Court on June 22, 2009 filed on behalf of some of the defendants in Realtime Data, LLC d/b/a/IXO v. Packeteer, Inc. et al., Civil Action No. 6:08-cv-00144-LED, U.S. District Court for the Eastern District of Texas, July 10, 2009, 9 pgs.	
	NPL323	F5 Request for Consideration and Objections to the Provisional Claim Construction Order issued by the Court on June 22, 2009 filed on behalf of some of the defendants in Realtime Data, LLC d/b/a/IXO v. Packeteer, Inc. et al., Civil Action No. 6:08-cv-00144-LED; U.S. District Court for the Eastern District of Texas, July 10, 2009, 15 pgs.	
	NPL324	Comtech AHA Corporation's Complaint in Intervention against the Plaintiff filed in Realtime Data, LLC d/b/a/IXO v. Packeteer, Inc. et al., Civil Action No. 6:08-cv-00144-LED; U.S. District Court for the Eastern District of Texas, April 6, 2009, 8 pgs.	
	NPL325	Report and Recommendation of United States Magistrate Judge on Motion for Partial Summary Judgment issued on June 23, 2009, in Realtime Data, LLC d/b/a/IXO v. Packeteer, Inc. et al., Civil Action No. 6:08-cv-00144-LED; U.S. District Court for the Eastern District of Texas, 22 pgs.	

Examiner Signature	/Suresh Suryawanshi/	Date Considered	05/14/2012
--------------------	----------------------	-----------------	------------

\*EXAMINER: Initial if reference considered, whether or not citation is in conformance with MPEP 609. Draw line through citation if not in conformance and not considered. Include copy of this form with next communication to applicant.

<sup>1</sup> Applicant's unique citation designation number (optional). <sup>2</sup> Applicant is to place a check mark here if English language Translation is attached.

ALL REFERENCES CONSIDERED EXCEPT WHERE LINED THROUGH. /SKS./

Substitute for form 1449/PTO				<i>Complete if Known</i>	
<b>INFORMATION DISCLOSURE STATEMENT BY APPLICANT</b> <i>(Use as many sheets as necessary)</i>				Application Number	13/118,122
				Filing Date	May 27, 2011
				First Named Inventor	James J. FALLON
				Art Unit	2115
				Examiner Name	To Be Assigned
Sheet	39	of	66	Attorney Docket Number	2855.004000B

NON PATENT LITERATURE DOCUMENTS			
Examiner Initials*	Cite No. <sup>1</sup>	Include name of the author (in CAPITAL LETTERS), title of the article (when appropriate), title of the item (book, magazine, journal, serial, symposium, catalog, etc.), date, page(s), volume number, publisher, city and/or country where published	T <sup>2</sup>
	NPL326	Blue Coat Defendants' Report and Recommendations Regarding Motion for Partial Summary Judgment of Invalidity for Indefiniteness in Realtime Data, LLC d/b/a/IXO v. Packeteer, Inc. et al., Civil Action No. 6:08-cv-00144-LED; U.S. District Court for the Eastern District of Texas, July 8, 2009, 18 pgs.	
	NPL327	Plaintiff's Objections To and Partially Unopposed Motion for Reconsideration of United States Magistrate Judge's Claim Construction Memorandum and Order, in Realtime Data, LLC d/b/a/IXO v. Packeteer, Inc. et al., Civil Action No. 6:08-cv-00144-LED; U.S. District Court for the Eastern District of Texas, July 13, 2009, 11 pgs.	
	NPL328	Defendant Citrix Opposition to Realtime's Objections to and Partially Unopposed Motion for Reconsideration of Magistrate Love's Claim Construction Memorandum and Order filed by Citrix Systems, Inc., filed on behalf of some of the defendants in Realtime Data, LLC d/b/a/IXO v. Packeteer, Inc. et al., Civil Action No. 6:08-cv-00144-LED; U.S. District Court for the Eastern District of Texas, July 27, 2009, 8 pgs.	
	NPL329	Defendant F5 Networks, Inc.'s Opposition to Plaintiff's Objections and Partially Unopposed Motion for Reconsideration of Magistrate Judge Love's Claim Construction and Order, filed on behalf of some of the defendants in Realtime Data, LLC d/b/a/IXO v. Packeteer, Inc. et al., Civil Action No. 6:08-cv-00144-LED; U.S. District Court for the Eastern District of Texas, July 27, 2009, 4 pgs.	
	NPL330	Defendants' Response in Opposition to Realtime Data's Objections to and Partially Unopposed Motion for Reconsideration of Magistrate Judge Love's Claim Construction Memorandum and Order, filed on behalf of some of the defendants in Realtime Data, LLC d/b/a/IXO v. Packeteer, Inc. et al., Civil Action No. 6:08-cv-00144-LED; U.S. District Court for the Eastern District of Texas, July 27, 2009, 9 pgs.	
	NPL331	Realtime Data's Response in Opposition to Defendant Citrix Systems Objections to and Request for Reconsideration of Magistrate's Order Regarding Claim Construction, in Realtime Data, LLC d/b/a/IXO v. Packeteer, Inc. et al., Civil Action No. 6:08-cv-00144-LED; U.S. District Court for the Eastern District of Texas, July 27, 2009, 13 pgs.	
	NPL332	Plaintiff Realtime Data's Response in Opposition to Blue Coat Defendants' Objection to Magistrate's Memorandum Opinion and Order Regarding Claim Construction, in Realtime Data, LLC d/b/a/IXO v. Packeteer, Inc. et al., Civil Action No. 6:08-cv-00144-LED; U.S. District Court for the Eastern District of Texas, July 27, 2009, 9 pgs.	
	NPL333	Plaintiff's selected Responses to Defendant Citrix System's Interrogatories and First Set of Requests for Admission filed in Realtime Data, LLC d/b/a/IXO v. Packeteer, Inc. et al., Civil Action No. 6:08-cv-00144-LED; U.S. District Court for the Eastern District of Texas, July 15, 2009, 151 pgs.	
	NPL334	Script for Defendants' Joint Claim Construction Technology Tutorial Presented to the Magistrate Judge in Realtime Data, LLC d/b/a/IXO v. Packeteer, Inc. et al., Civil Action No. 6:08-cv-00144-LED; U.S. District Court for the Eastern District of Texas, filed on April 18, 2008 and terminated February 2, 95 pgs.	
	NPL335	Preliminary Data Sheet, 9600 Data Compressor Processor, HI/fi, 1997-99, HIFN 000001-68, 68 pgs.	

Examiner Signature	/Suresh Suryawanshi/	Date Considered	05/14/2012
--------------------	----------------------	-----------------	------------

\*EXAMINER: Initial if reference considered, whether or not citation is in conformance with MPEP 609. Draw line through citation if not in conformance and not considered. Include copy of this form with next communication to applicant.

<sup>1</sup> Applicant's unique citation designation number (optional). <sup>2</sup> Applicant is to place a check mark here if English language Translation is attached.

ALL REFERENCES CONSIDERED EXCEPT WHERE LINED THROUGH. /SKS./

Substitute for form 1449/PTO				<i>Complete if Known</i>	
<b>INFORMATION DISCLOSURE STATEMENT BY APPLICANT</b> <i>(Use as many sheets as necessary)</i>				Application Number	13/118,122
				Filing Date	May 27, 2011
				First Named Inventor	James J. FALLON
				Art Unit	2115
				Examiner Name	To Be Assigned
Sheet	40	of	66	Attorney Docket Number	2855.004000B

NON PATENT LITERATURE DOCUMENTS			
Examiner Initials*	Cite No. <sup>1</sup>	Include name of the author (in CAPITAL LETTERS), title of the article (when appropriate), title of the item (book, magazine, journal, serial, symposium, catalog, etc.), date, page(s), volume number, publisher, city and/or country where published	T <sup>2</sup>
	NPL336	Data Sheet, 9751 Data Compression Processor, 1997-99, HIFN 000069-187, 119 pgs.	
	NPL337	Signal Termination Guide, Application Note, Hi/fn, 1997-98, HIFN 000188-194, 7 pgs.	
	NPL338	How LZS Data Compression Works, Application Note, Hi/fn, 1997-99, HIFN 000195-207, 13 pgs.	
	NPL339	Reference Hardware, 9751 Compression Processor, Hi/fn, 1997-99, HIFN 000208-221, 14 pgs.	
	NPL340	Using 9751 in Big Endian Systems, Application Note, Hi/fn, 1997-99, HIFN 000222-234, 13 pgs.	
	NPL341	Specification Update, 9751 Compression Processor, Hi/fn, 1997-2000, HIFN 000235-245, 11 pgs.	
	NPL342	9732AM Product Release, Hi/fn, 1994-99, HIFN 000246-302, 57 pgs.	
	NPL343	Data Sheet, 9732A Data Compression Processor, Hi/fn, 1997-99, HIFN 000303-353, 51 pgs.	
	NPL344	9711 to 7711 Migration, Application Note, Hi/fn, 1997-99, HIFN 000354-361, 8 pgs.	
	NPL345	Specification Update, 9711 Data Compression Processor, Hi/fn, 1997-99, HIFN 000362-370, 9 pgs.	

Examiner Signature	/Suresh Suryawanshi/	Date Considered	05/14/2012
-----------------------	----------------------	--------------------	------------

\*EXAMINER: Initial if reference considered, whether or not citation is in conformance with MPEP 609. Draw line through citation if not in conformance and not considered. Include copy of this form with next communication to applicant.

<sup>1</sup> Applicant's unique citation designation number (optional). <sup>2</sup> Applicant is to place a check mark here if English language Translation is attached.

ALL REFERENCES CONSIDERED EXCEPT WHERE LINED THROUGH. /SKS./

Substitute for form 1449/PTO				<i>Complete if Known</i>	
<b>INFORMATION DISCLOSURE STATEMENT BY APPLICANT</b> <i>(Use as many sheets as necessary)</i>				Application Number	13/118,122
				Filing Date	May 27, 2011
				First Named Inventor	James J. FALLON
				Art Unit	2115
				Examiner Name	To Be Assigned
Sheet	41	of	66	Attorney Docket Number	2855.004000B

NON PATENT LITERATURE DOCUMENTS			
Examiner Initials*	Cite No. <sup>1</sup>	Include name of the author (in CAPITAL LETTERS), title of the article (when appropriate), title of the item (book, magazine, journal, serial, symposium, catalog, etc.), date, page(s), volume number, publisher, city and/or country where published	T <sup>2</sup>
	NPL346	Differences Between the 9710 & 9711 Processors, Application Note, Hi/fn, 1997-99, HIFN 000371-77, 7 pgs.	
	NPL347	Specification Update, 9710 Data Compression Processor, Hi/fn, 1997-99, HIFN 000378-388, 11 pgs.	
	NPL348	9706/9706A Data Compression Coprocessor Data Sheet, Stac Electronics, 1991-97, HIFN 000389-473, 85 pgs.	
	NPL349	9705/9705A Data Compression Coprocessor, Stac Electronics, 1988-96, HIFN 000474-562, 88 pgs.	
	NPL350	9705/9705A Data Compression Coprocessor Data Sheet, Stac Electronics, 1988-96, HIFN 000563-649, 87 pgs.	
	NPL351	9700/9701 Compression Coprocessors, Hi/fn, 1997, HIFN 000650-702, 53 pgs.	
	NPL352	Data Sheet 9610 Data Compression Processor, Hi/fn, 1997-98, HIFN 000703-744, 42 pgs.	
	NPL353	Specification Update 9610 Data Compression Processor, Hi/fn, 1997-99, HIFN 000745-751, 7 pgs.	
	NPL354	9705 Data Compression Coprocessor, Stac Electronics, 1988-92, HIFN 000752-831, 80 pgs.	
	NPL355	9705 Network Software Design Guide, Application Note, Stac Electronics, 1990-91, HIFN 000832-861, 30 pgs.	

Examiner Signature	/Suresh Suryawanshi/	Date Considered	05/14/2012
-----------------------	----------------------	--------------------	------------

\*EXAMINER: Initial if reference considered, whether or not citation is in conformance with MPEP 609. Draw line through citation if not in conformance and not considered. Include copy of this form with next communication to applicant.

<sup>1</sup> Applicant's unique citation designation number (optional). <sup>2</sup> Applicant is to place a check mark here if English language Translation is attached.

ALL REFERENCES CONSIDERED EXCEPT WHERE LINED THROUGH. /SKS./

Substitute for form 1449/PTO				<i>Complete if Known</i>	
<b>INFORMATION DISCLOSURE STATEMENT BY APPLICANT</b> <i>(Use as many sheets as necessary)</i>				Application Number	13/118,122
				Filing Date	May 27, 2011
				First Named Inventor	James J. FALLON
				Art Unit	2115
				Examiner Name	To Be Assigned
Sheet	42	of	66	Attorney Docket Number	2855.004000B

NON PATENT LITERATURE DOCUMENTS			
Examiner Initials*	Cite No. <sup>1</sup>	Include name of the author (in CAPITAL LETTERS), title of the article (when appropriate), title of the item (book, magazine, journal, serial, symposium, catalog, etc.), date, page(s), volume number, publisher, city and/or country where published	T <sup>2</sup>
	NPL356	Data Sheet 9601 Data Compression Processor, Hi/fn, May 21, 1998, HIFN 000862-920, 59 pgs.	
	NPL357	7751 Encryption Processor Reference Kit, Hi/fn, April 1999, HIFN 000921-1114, 194 pgs.	
	NPL358	Hardware Data Book, Hi/fn, November 1998, HIFN 001115-1430, 316 pgs.	
	NPL359	Data Compression Data Book, Hi/fn, January 1999, HIFN 001431-1889, 459 pgs.	
	NPL360	Reference Software 7751 Encryption Processor, Hi/fn, November 1998, HIFN 002164-2201, 38 pgs.	
	NPL361	Interface Specification for Synergize Encoding/Decoding Program, JPB, October 10, 1997, HIFN 002215-2216, 2 pgs.	
	NPL362	Anderson, Chip, Extended Memory Specification Driver, 1998, HIFN 002217-2264, 48 pgs.	
	NPL363	Whiting, Doug, LZS Hardware API, March 12, 1993, HIFN 002265-68, 4 pgs.	
	NPL364	Whiting, Doug, Encryption in Sequoia, April 28, 1997, HIFN 002309-2313, 5 pgs.	
	NPL365	LZS221-C Version 4 Data Compression Software, Data Sheet, Hi/fn, 1994-97, HIFN 002508-2525, 18 pgs.	

Examiner Signature	/Suresh Suryawanshi/	Date Considered	05/14/2012
-----------------------	----------------------	--------------------	------------

\*EXAMINER: Initial if reference considered, whether or not citation is in conformance with MPEP 609. Draw line through citation if not in conformance and not considered. Include copy of this form with next communication to applicant.

<sup>1</sup> Applicant's unique citation designation number (optional). <sup>2</sup> Applicant is to place a check mark here if English language Translation is attached.

ALL REFERENCES CONSIDERED EXCEPT WHERE LINED THROUGH. /SKS./



Substitute for form 1449/PTO				<i>Complete if Known</i>	
<b>INFORMATION DISCLOSURE STATEMENT BY APPLICANT</b> <i>(Use as many sheets as necessary)</i>				Application Number	13/118,122
				Filing Date	May 27, 2011
				First Named Inventor	James J. FALLON
				Art Unit	2115
				Examiner Name	To Be Assigned
Sheet	43	of	66	Attorney Docket Number	2855.004000B

NON PATENT LITERATURE DOCUMENTS			
Examiner Initials*	Cite No. <sup>1</sup>	Include name of the author (in CAPITAL LETTERS), title of the article (when appropriate), title of the item (book, magazine, journal, serial, symposium, catalog, etc.), date, page(s), volume number, publisher, city and/or country where published	T <sup>2</sup>
	NPL366	eXtended Memory Specification (XMS), ver. 2.0, Microsoft, July 19, 1988, HIFN 002670-2683, 14 pgs.	
	NPL367	King, Stanley, Just for Your Info -- From Microsoft 2, May 4, 1992, HIFN 002684-2710, 27 pgs.	
	NPL368	eXtended Memory Specification (XMS), ver. 2.0, Microsoft, July 19, 1988, HIFN 002711-2724, 14 pgs.	
	NPL369	Advanced LZS Technology (ALZS), Whitepaper, Hi/fn, June 1, 1998, HIFN 002725-2727, 3 pgs.	
	NPL370	Secure Tape Technology (STT) Whitepaper, Hi/fn, June 1, 1998, HIFN 002728-2733, 6 pgs.	
	NPL371	SSLRef 3.0 API Details, Netscape, November 19, 1996, HIFN 002734-2778, 45 pgs.	
	NPL372	LZS221-C Version 4 Data Compression Software Data Sheet , Hi/fn, 1994-97, HIFN 002779-2796, 18 pgs.	
	NPL373	MPPC-C Version 4 Data Compression Software Data Sheet, Hi/fn, 1994-1997, HIFN 002797-2810, 14 pgs.	
	NPL374	Magstar MP Hardware Reference B Series Models Document GA32-0365-01, 1996-1997, [IBM_1_601 pages 1-338], 338 pages.	
	NPL375	Magstar MP 3570 Tape Subsystem, Operator Guide, B-Series Models, 1998-1999, [IBM_1_601 pages 339-525], 188 pages.	

Examiner Signature	/Suresh Suryawanshi/	Date Considered	05/14/2012
-----------------------	----------------------	--------------------	------------

\*EXAMINER: Initial if reference considered, whether or not citation is in conformance with MPEP 609. Draw line through citation if not in conformance and not considered. Include copy of this form with next communication to applicant.

<sup>1</sup> Applicant's unique citation designation number (optional). <sup>2</sup> Applicant is to place a check mark here if English language Translation is attached.

ALL REFERENCES CONSIDERED EXCEPT WHERE LINED THROUGH. /SKS./

Substitute for form 1449/PTO				<i>Complete if Known</i>	
<b>INFORMATION DISCLOSURE STATEMENT BY APPLICANT</b> <i>(Use as many sheets as necessary)</i>				Application Number	13/118,122
				Filing Date	May 27, 2011
				First Named Inventor	James J. FALLON
				Art Unit	2115
				Examiner Name	To Be Assigned
Sheet	44	of	66	Attorney Docket Number	2855.00400B

NON PATENT LITERATURE DOCUMENTS			
Examiner Initials*	Cite No. <sup>1</sup>	Include name of the author (in CAPITAL LETTERS), title of the article (when appropriate), title of the item (book, magazine, journal, serial, symposium, catalog, etc.), date, page(s), volume number, publisher, city and/or country where published	T <sup>2</sup>
	NPL376	Preview, IBM Magstar 3590 Tape System Enhancements, Hardware Announcement, February 16, 1999, [IBM_1_601 pages 526-527], 2 pgs.	
	NPL377	New IBM Magstar 3590 Models E11 and E1A Enhance Tape Drive Performance, Hardware Announcement, April 20, 1999, [IBM_1_601 pages 528-540] 13 pgs.	
	NPL378	NEW IBM Magstar 3590 Model A60 Dramatically Enhances Tape Drive Performance, Hardware Announcement July 27, 1999, [IBM_1_601 pages 541-550] 10 pgs.	
	NPL379	The IBM Magstar MP Tape Subsystem Provides Fast Access to Data, September 3, 1996, Announcement No. 196-176, [IBM_1_601 pages 551-563] 13 pgs.	
	NPL380	IBM 3590 High Performance Tape Subsystem, April 10, 1995, Announcement 195-106, [IBM_1_601 pages 564-581] 18 pgs.	
	NPL381	Standard ECMA-222 (June 1995): ECMA – Standardizing Information and Communications Systems, Adaptive Lossless Data Compression Algorithm, [IBM_1_601 pages 582-601] 20 pgs.	
	NPL382	IBM 3590 and 3494 Revised Availability, Hardware Announcement August 8, 1995, [IBM_743_1241 page 1] 1 pg.	
	NPL383	Direct Delivery of IBM 3494, 3466, and 3590 Storage Products, Hardware Announcement, September 30, 1997, Announcement 197-297, [IBM_743_1241 pages 2-3] 2 pgs.	
	NPL384	IBM Magstar 3590 Enhances Open Systems, Hardware Announcement February 9, 1996, Announcement 198-014, [IBM_743_1241 pages 4-7] 4 pgs.	
	NPL385	Hardware Withdrawal: IBM Magstar 3590 A00 Controller – Replacement Available, Announcement Number 197-267, Withdrawal Announcement, December 9, 1997, [IBM_743_1241 page 9] 1 pg.	

Examiner Signature	/Suresh Suryawanshi/	Date Considered	05/14/2012
-----------------------	----------------------	--------------------	------------

\*EXAMINER: Initial if reference considered, whether or not citation is in conformance with MPEP 609. Draw line through citation if not in conformance and not considered. Include copy of this form with next communication to applicant.

<sup>1</sup> Applicant's unique citation designation number (optional). <sup>2</sup> Applicant is to place a check mark here if English language Translation is attached.

ALL REFERENCES CONSIDERED EXCEPT WHERE LINED THROUGH. /SKS./

Substitute for form 1449/PTO				<i>Complete if Known</i>	
<b>INFORMATION DISCLOSURE STATEMENT BY APPLICANT</b> <i>(Use as many sheets as necessary)</i>				Application Number	13/118,122
				Filing Date	May 27, 2011
				First Named Inventor	James J. FALLON
				Art Unit	2115
				Examiner Name	To Be Assigned
Sheet	45	of	66	Attorney Docket Number	2855.004000B

NON PATENT LITERATURE DOCUMENTS			
Examiner Initials*	Cite No. <sup>1</sup>	Include name of the author (in CAPITAL LETTERS), title of the article (when appropriate), title of the item (book, magazine, journal, serial, symposium, catalog, etc.), date, page(s), volume number, publisher, city and/or country where published	T <sup>2</sup>
	NPL386	IBM Magstar 3590 Tape Subsystem, Introduction and Planning Guide, Document No. GA32-0329007, [IBM_743_1241 pages 10-499] 490 pgs.	
	NPL387	NetMeeting 2.0 Reviewers Guide, April 1997, [MSCS_298_339] 42 pgs.	
	NPL388	Microsoft NetMeeting Compatible Products and Services Directory, April 1997, [MSCS_242_297] 56 pgs.	
	NPL389	Microsoft NetMeeting "Try This!" Guide, 1997, [MSCS_340_345] 6 pgs.	
	NPL390	The Professional Companion to NetMeeting 2 – The Technical Guide to Installing, Configuring, and Supporting NetMeeting 2.0 in Your Organization -Microsoft NetMeeting 2.0, 1996-97, [MSCS_2_241] 240 pgs.	
	NPL391	CUSeeMe 3.1.2 User Guide, November 1998, [RAD_1_220] 220 pgs.	
	NPL392	MeetingPoint Conference Server Users Guide 3.0, November 1997, [RAD_221_548] 328 pgs.	
	NPL393	MeetingPoint Conference Server Users Guide 4.0.2, December 1999, [RAD_549_818] 270 pgs.	
	NPL394	MeetingPoint Conference Service Users Guide 3.5.1, December 1998, [RAD_819_1062] 244 pgs.	
	NPL395	Enhanced CUSeeMe – Authorized Guide, 1995-1996, [RAD_1063_1372] 310 pgs.	

Examiner Signature	/Suresh Suryawanshi/	Date Considered	05/14/2012
-----------------------	----------------------	--------------------	------------

\*EXAMINER: Initial if reference considered, whether or not citation is in conformance with MPEP 609. Draw line through citation if not in conformance and not considered. Include copy of this form with next communication to applicant.

<sup>1</sup> Applicant's unique citation designation number (optional). <sup>2</sup> Applicant is to place a check mark here if English language Translation is attached.

ALL REFERENCES CONSIDERED EXCEPT WHERE LINED THROUGH. /SKS./

Substitute for form 1449/PTO				<i>Complete if Known</i>	
<b>INFORMATION DISCLOSURE STATEMENT BY APPLICANT</b> <i>(Use as many sheets as necessary)</i>				Application Number	13/118,122
				Filing Date	May 27, 2011
				First Named Inventor	James J. FALLON
				Art Unit	2115
				Examiner Name	To Be Assigned
Sheet	46	of	66	Attorney Docket Number	2855.004000B

NON PATENT LITERATURE DOCUMENTS			
Examiner Initials*	Cite No. <sup>1</sup>	Include name of the author (in CAPITAL LETTERS), title of the article (when appropriate), title of the item (book, magazine, journal, serial, symposium, catalog, etc.), date, page(s), volume number, publisher, city and/or country where published	T <sup>2</sup>
	NPL396	Meeting Point Reader File, June 1999, [RAD_1437_1445] 9 pgs.	
	NPL397	Press Release - White Pine Announces Launch of MeetingPoint Conferences Server, October 9, 1997, [RAD_1738_1739] 2 pgs.	
	NPL398	Press Release - Leading Network Service Providers Line Up to Support White Pine's MeetingPoint Conference Server Technology, October 9, 1997, [RAD_1740_1743] 4 pgs.	
	NPL399	BYTE - A New MeetingPoint for Videoconferencing, October 9, 1997, [RAD_1744_1750] 7 pgs.	
	NPL400	Declaration of Patrick Gogerty, Realtime Data, LLC D/B/A Ixo v. Packeteer, Inc., et al., District Court for the Eastern District of Texas, No. 6:08cv144, executed May 8, 2009, 3 pgs.	
	NPL401	Other Responses to Interrogatories, Requests for Admission, and Objections to Requests for Admission filed in Realtime Data, LLC d/b/a/IXO v. Packeteer, Inc. et al., Civil Action No. 6:08-cv-00144-LED; U.S. District Court for the Eastern District of Texas. (PTO Notified -- Document NOT submitted)	
	NPL402	Deposition Transcript of persons involved in litigation, including inventor James Fallon, and third-party witnesses Jim Karp, Ke-Chiang Chu, and Frank V. DeRosa filed in Realtime Data, LLC d/b/a/IXO v. Packeteer, Inc. et al., Civil Action No. 6:08-cv-00144-LED; U.S. District Court for the Eastern District of Texas. (PTO Notified -- Document NOT submitted)	
	NPL403	Office of Rebuttal Expert Reports of Dr. Brian Von Herzen, Lester L. Hewitt and Dr. James A. Storer, and Expert Reports of Dr. James A. Storer and Dr. Nathaniel Polish filed in Realtime Data, LLC d/b/a/IXO v. Packeteer, Inc. et al., Civil Action No. 6:08-cv-00144-LED; U.S. District Court for the Eastern District of Texas. (PTO Notified -- Document NOT submitted)	
	NPL404	Proposed Amended Infringement Contentions filed in Realtime Data, LLC d/b/a/IXO v. Packeteer, Inc. et al., Civil Action No. 6:08-cv-00144-LED; U.S. District Court for the Eastern District of Texas. (PTO Notified -- Document NOT submitted)	
	NPL405	Documents Concerning Agreements for Mediations and Mediation Proceedings Between Plaintiffs and Some of the Defendants filed in Realtime Data, LLC d/b/a/IXO v. Packeteer, Inc. et al., Civil Action No. 6:08-cv-00144-LED; U.S. District Court for the Eastern District of Texas. (PTO Notified -- Document NOT submitted)	

Examiner Signature	/Suresh Suryawanshi/	Date Considered	05/14/2012
-----------------------	----------------------	--------------------	------------

\*EXAMINER: Initial if reference considered, whether or not citation is in conformance with MPEP 609. Draw line through citation if not in conformance and not considered. Include copy of this form with next communication to applicant.

<sup>1</sup> Applicant's unique citation designation number (optional). <sup>2</sup> Applicant is to place a check mark here if English language Translation is attached.

ALL REFERENCES CONSIDERED EXCEPT WHERE LINED THROUGH. /SKS./

Substitute for form 1449/PTO				<i>Complete if Known</i>	
<b>INFORMATION DISCLOSURE STATEMENT BY APPLICANT</b> <i>(Use as many sheets as necessary)</i>				Application Number	13/118,122
				Filing Date	May 27, 2011
				First Named Inventor	James J. FALLON
				Art Unit	2115
				Examiner Name	To Be Assigned
Sheet	47	of	66	Attorney Docket Number	2855.004000B

NON PATENT LITERATURE DOCUMENTS			
Examiner Initials*	Cite No. <sup>1</sup>	Include name of the author (in CAPITAL LETTERS), title of the article (when appropriate), title of the item (book, magazine, journal, serial, symposium, catalog, etc.), date, page(s), volume number, publisher, city and/or country where published	T <sup>2</sup>
	NPL406	Plaintiff's Opposition to Joint Defendants' Motion for Partial Summary Judgment of Invalidity of some of the patents in Suit for indefiniteness, including the '104 patent, Blue Coat's response to this objection, Blue Coat's Reply to Plaintiff's response and Plaintiff's Sur-Reply to Blue Coat's Reply filed in Realtime Data, LLC d/b/a/IXO v. Packeteer, Inc. et al., Civil Action No. 6:08-cv-00144-LED; U.S. District Court for the Eastern District of Texas. (PTO Notified -- Document NOT submitted)	
	NPL407	Plaintiff's Amended P.R. 3-1 Disclosures and Infringement Contentions, Defendants' Motions to Strick unauthorized portions of these disclosures, and Sur-Replies to these Motions filed in Realtime Data, LLC d/b/a/IXO v. Packeteer, Inc. et al., Civil Action No. 6:08-cv-00144-LED; U.S. District Court for the Eastern District of Texas. (PTO Notified -- Document NOT submitted)	
	NPL408	Expert Report of Dr. James A. Storer Regarding Non-Infringement that contains positions related to the validity of the patents in suit filed in Realtime Data, LLC d/b/a/IXO v. Packeteer, Inc. et al., Civil Action No. 6:08-cv-00144-LED; U.S. District Court for the Eastern District of Texas. (PTO Notified -- Document NOT submitted)	
	NPL409	Thomson Reuters Corporation v. Realtime Data, LLC D/B/A IXO, No. 09 CV 7868 (S.D.N.Y.) 2009.09.23 Order Dismissing Case in Favor of Texas Action, 1 pg.	
	NPL410	Thomson Reuters Corporation v. Realtime Data, LLC D/B/A IXO, No. 09 CV 7868 (S.D.N.Y.) 2009.09.30 Response to Order re Transfer, 103 pgs.	
	NPL411	Thomson Reuters Corporation v. Realtime Data, LLC D/B/A IXO, No. 09 CV 7868 (S.D.N.Y.) 2009.10.07 Reply Letter regarding Judge Berman 2009.09.23 Order re Transfer, 182 pgs.	
	NPL412	Thomson Reuters Corporation v. Realtime Data, LLC D/B/A IXO, No. 09 CV 7868 (S.D.N.Y.) 2009.10.15 Order Staying Case Until TX Action Decided, 3 pgs.	
	NPL413	Thomson Reuters Corporation v. Realtime Data, LLC D/B/A IXO, No. 09 CV 7868 (S.D.N.Y.) 2009.09.11 Complaint - DJ SD NY, 41 pgs.	
	NPL414	Thomson Reuters Corporation v. Realtime Data, LLC D/B/A IXO, No. 09 CV 7868 (S.D.N.Y.) 2009.09.11 Rule 7.1 Disclosure Statement for Thomson Reuters, 1 pg.	
	NPL415	Thomson Reuters Corporation v. Realtime Data, LLC D/B/A IXO, No. 09 CV 7868 (S.D.N.Y.) Order- Stay Pending Transfer Motion Confirmed 10_15_09, 3 pgs.	

Examiner Signature	/Suresh Suryawanshi/	Date Considered	05/14/2012
-----------------------	----------------------	--------------------	------------

\*EXAMINER: Initial if reference considered, whether or not citation is in conformance with MPEP 609. Draw line through citation if not in conformance and not considered. Include copy of this form with next communication to applicant.

<sup>1</sup> Applicant's unique citation designation number (optional). <sup>2</sup> Applicant is to place a check mark here if English language Translation is attached.

ALL REFERENCES CONSIDERED EXCEPT WHERE LINED THROUGH. /SKS./

Substitute for form 1449/PTO				<i>Complete if Known</i>	
<b>INFORMATION DISCLOSURE STATEMENT BY APPLICANT</b> <i>(Use as many sheets as necessary)</i>				Application Number	13/118,122
				Filing Date	May 27, 2011
				First Named Inventor	James J. FALLON
				Art Unit	2115
				Examiner Name	To Be Assigned
Sheet	48	of	66	Attorney Docket Number	2855.004000B

NON PATENT LITERATURE DOCUMENTS			
Examiner Initials*	Cite No. <sup>1</sup>	Include name of the author (in CAPITAL LETTERS), title of the article (when appropriate), title of the item (book, magazine, journal, serial, symposium, catalog, etc.), date, page(s), volume number, publisher, city and/or country where published	T <sup>2</sup>
	NPL416	Opinion and Order of United States Magistrate Judge regarding Claim Construction, Realtime Data, LLC D/B/A Ixo v. Packeteer, Inc., et al., District Court for the Eastern District of Texas, No. 6:08cv144, issued June 22, 2009, 75 pgs.	
	NPL417	Script for Realties' Technology Tutorial Presented to the Magistrate Judge in Realtime Data, LLC d/b/a/IXO v. Packeteer, Inc. et al., Civil Action No. 6:08-cv-00144-LED; U.S. District Court for the Eastern District of Texas, March 16, 2009, 69 pgs.	
	NPL418	Opinion and Order of United States Magistrate Judge regarding Plaintiff's Motion to Strike Unauthorized New Invalidity Theories from Defendant Citrix's Opening and Reply Briefs in Support of its Motion for Summary Judgment of Invalidity, Realtime Data, LLC D/B/A Ixo v. Packeteer, Inc., et al., District Court for the Eastern District of Texas, No. 6:08cv144, issued Dec. 8, 2009, 10 pgs	
	NPL419	Defendant Citrix Systems, Inc.'s Notice Pursuant to 35 U.S.C. Section 282 Disclosures, Realtime Data, LLC D/B/A Ixo v. Packeteer, Inc., et al., District Court for the Eastern District of Texas, No. 6:08cv144, filed December 11, 2009, 7 pgs.	
	NPL420	Blue Coat Defendants' Notice Pursuant to 35 U.S.C. Section 282 Disclosures, Realtime Data, LLC D/B/A Ixo v. Packeteer, Inc., et al., District Court for the Eastern District of Texas, No. 6:08cv144, filed December 11, 2009, 7 pgs.	
	NPL421	Expand Networks' 35 U.S.C. Section 282 Disclosures, Realtime Data, LLC D/B/A Ixo v. Packeteer, Inc., et al., District Court for the Eastern District of Texas, No. 6:08cv144, filed December 11, 2009, 4 pgs.	
	NPL422	Expand Networks' 35 U.S.C. Section 282 Disclosures (Amended), Realtime Data, LLC D/B/A Ixo v. Packeteer, Inc., et al., District Court for the Eastern District of Texas, No. 6:08cv144, filed December 11, 2009, 5 pgs.	
	NPL423	Defendant Citrix Systems, Inc.'s Notice of Obviousness Combinations Pursuant to Court Order, Realtime Data, LLC D/B/A Ixo v. Packeteer, Inc., et al., District Court for the Eastern District of Texas, No. 6:08cv144, filed December 11, 2009, 3 pgs.	
	NPL424	Order of United States Magistrate Judge regarding Motion to Limit the Number of Prior Art References to be Asserted at Trial, Realtime Data, LLC D/B/A Ixo v. Packeteer, Inc., et al., District Court for the Eastern District of Texas, No. 6:08cv144, filed December 21, 2009, 6 pgs.	
	NPL425	Expand Defendants' Notice of Obviousness Combinations Pursuant to Court Order, Realtime Data, LLC D/B/A Ixo v. Packeteer, Inc., et al., District Court for the Eastern District of Texas, No. 6:08cv144, filed December 22, 2009, 3 pgs.	

Examiner Signature	/Suresh Suryawanshi/	Date Considered	05/14/2012
-----------------------	----------------------	--------------------	------------

\*EXAMINER: Initial if reference considered, whether or not citation is in conformance with MPEP 609. Draw line through citation if not in conformance and not considered. Include copy of this form with next communication to applicant.

<sup>1</sup> Applicant's unique citation designation number (optional). <sup>2</sup> Applicant is to place a check mark here if English language Translation is attached.

ALL REFERENCES CONSIDERED EXCEPT WHERE LINED THROUGH. /SKS./

Substitute for form 1449/PTO				<i>Complete if Known</i>	
<b>INFORMATION DISCLOSURE STATEMENT BY APPLICANT</b> <i>(Use as many sheets as necessary)</i>				Application Number	13/118,122
				Filing Date	May 27, 2011
				First Named Inventor	James J. FALLON
				Art Unit	2115
				Examiner Name	To Be Assigned
Sheet	49	of	66	Attorney Docket Number	2855.004000B

NON PATENT LITERATURE DOCUMENTS			
Examiner Initials*	Cite No. <sup>1</sup>	Include name of the author (in CAPITAL LETTERS), title of the article (when appropriate), title of the item (book, magazine, journal, serial, symposium, catalog, etc.), date, page(s), volume number, publisher, city and/or country where published	T <sup>2</sup>
	NPL426	Blue Coat Systems, Inc. and 7-Eleven, Inc.'s Notice of Obviousness Combinations to be Used at Trial, Realtime Data, LLC D/B/A Ixo v. Packeteer, Inc., et al., District Court for the Eastern District of Texas, No. 6:08cv144, filed December 22, 2009, 38 pgs.	
	NPL427	Defendant Citrix Systems, Inc's Notice of Other Prior Art References Within the Scope of the References Discussed at the Dec. 17, 2009 Hearing, Realtime Data, LLC D/B/A Ixo v. Packeteer, Inc., et al., District Court for the Eastern District of Texas, No. 6:08cv144, filed December 29, 2009, 6 pgs.	
	NPL428	Docket Listing downloaded March 10, 2010 for Realtime Data, LLC D/B/A Ixo v. Packeteer, Inc., et al., District Court for the Eastern District of Texas, No. 6:08cv144, filed April 18, 2008, 165 pgs.	
	NPL429	CCITT Draft Recommendation T.4, RFC 804, January 1981, 12 pgs.	
	NPL430	SNA Formats, IBM Corporation, 14th Ed., November 1993, 3 pgs.	
	NPL431	Munteanu et al, "Wavelet-Based Lossless Compression Scheme with Progressive Transmission Capability," John Wiley & Sons, Inc., Int'l J. Imaging Sys. Tech., vol. 10, (1999) pgs 76-85.	
	NPL432	Forchhammer and Jensen, "Data Compression of Scanned Halftone Images," IEEE Trans. Commun., vol. 42, Feb.-Apr. 1994, pgs 1881-1893.	
	NPL433	Christopher Eoyang et al., "The Birth of the Second Generation: The Hitachi S-820/80," Proceedings of the 1998 ACM/IEEE Conference on Supercomputing, pgs 296-303 (1998)	
	NPL434	Transcript for Hearing on Motions for Summary Judgment, Realtime Data, LLC d/b/a IXO v. Packeteer, Inc. et al, Civil Action No. 6:08-cv-00144-LED; U.S. District Court for the Eastern District of Texas, 133 pgs, November 8, 2009.	
	NPL435	Transcript for Motions Hearing (Including Supplemental Claim Construction Hearing), Realtime Data, LLC d/b/a IXO v. Packeteer, Inc. et al, Civil Action No. 6:08-cv-00144-LED; U.S. District Court for the Eastern District of Texas, 88 pgs, November 10, 2009	

Examiner Signature	/Suresh Suryawanshi/	Date Considered	05/14/2012
--------------------	----------------------	-----------------	------------

\*EXAMINER: Initial if reference considered, whether or not citation is in conformance with MPEP 609. Draw line through citation if not in conformance and not considered. Include copy of this form with next communication to applicant.

<sup>1</sup> Applicant's unique citation designation number (optional). <sup>2</sup> Applicant is to place a check mark here if English language Translation is attached.

ALL REFERENCES CONSIDERED EXCEPT WHERE LINED THROUGH. /SKS./

Substitute for form 1449/PTO				<i>Complete if Known</i>	
<b>INFORMATION DISCLOSURE STATEMENT BY APPLICANT</b> <i>(Use as many sheets as necessary)</i>				Application Number	13/118,122
				Filing Date	May 27, 2011
				First Named Inventor	James J. FALLON
				Art Unit	2115
				Examiner Name	To Be Assigned
Sheet	50	of	66	Attorney Docket Number	2855.004000B

NON PATENT LITERATURE DOCUMENTS			
Examiner Initials*	Cite No. <sup>1</sup>	Include name of the author (in CAPITAL LETTERS), title of the article (when appropriate), title of the item (book, magazine, journal, serial, symposium, catalog, etc.), date, page(s), volume number, publisher, city and/or country where published	T <sup>2</sup>
	NPL436	Nelson, "The Data Compression Book," M&T Books (2nd Ed. 1996), 283 pgs.	
	NPL437	"The Authoritative Dictionary of IEEE Standards Terms," 7th Ed. 2000, pg. 273.	
	NPL438	Larousse Dictionary of Science and Technology, 1st Ed., 1995, pg. 916.	
	NPL439	Plaintiff Realtime Data's Motion to Strike Unauthorized New Invalidity Theories from Defendant Citrix's Opening and Reply Briefs in Support Its Motion for Summary Judgment of Invalidity of U.S. Patent No. 7,352,300 (September 22, 2009), 14 pgs.	
	NPL440	Realtime Data's Reply in Support of Its Motion to Strike Unauthorized New Invalidity Theories from Defendant Citrix's Opening and Reply Briefs in Support of Its Motion for Summary Judgment of Invalidity of U.S. Patent No. 7,352,300 (October 19, 2009), 17 pgs.	
	NPL441	Defendant Citrix Systems, Inc.'s Sur-Reply in Opposition to Realtime Data LLC's Motion to Strike Unauthorized New Invalidity Theories from Citrix's Opening and Reply Briefs in Support of Its Motion for Summary Judgment of Invalidity of U.S. Patent No. 7,352,300 (October 30, 2009), 9 pgs.	
	NPL442	Blue Coat Defendants' Response to Realtime Data, LLC's Notice Re Proposed Construction of "Data Storage Rate" (November 11, 2009), 3 pgs.	
	NPL443	Order for Supplemental Briefing on Blue Coat 7-11 Motion for Partial SJ on Non-infringement of Pat 6,601,104 (November 13, 2009), 6 pgs.	
	NPL444	Memorandum Opinion and Order, Realtime Data, LLC D/B/A IXO v. Packeteer, Inc., et al., Civil No. 6:08-cv-144-LED-JDL, U.S. District Court for the Eastern District of Texas, 15 pages, November 23, 2009.	
	NPL445	Memorandum Opinion and Order, Realtime Data, LLC, v. Packeteer, Inc., et al., Civil No. 6:08-cv-144-LED-JDL, U.S. District Court for the Eastern District of Texas, 10 pages, December 8, 2009.	

Examiner Signature	/Suresh Suryawanshi/	Date Considered	05/14/2012
-----------------------	----------------------	--------------------	------------

\*EXAMINER: Initial if reference considered, whether or not citation is in conformance with MPEP 609. Draw line through citation if not in conformance and not considered. Include copy of this form with next communication to applicant.

<sup>1</sup> Applicant's unique citation designation number (optional). <sup>2</sup> Applicant is to place a check mark here if English language Translation is attached.

ALL REFERENCES CONSIDERED EXCEPT WHERE LINED THROUGH. /SKS./



Substitute for form 1449/PTO				<i>Complete if Known</i>	
<b>INFORMATION DISCLOSURE STATEMENT BY APPLICANT</b> <i>(Use as many sheets as necessary)</i>				Application Number	13/118,122
				Filing Date	May 27, 2011
				First Named Inventor	James J. FALLON
				Art Unit	2115
				Examiner Name	To Be Assigned
Sheet	51	of	66	Attorney Docket Number	2855.004000B

NON PATENT LITERATURE DOCUMENTS			
Examiner Initials*	Cite No. <sup>1</sup>	Include name of the author (in CAPITAL LETTERS), title of the article (when appropriate), title of the item (book, magazine, journal, serial, symposium, catalog, etc.), date, page(s), volume number, publisher, city and/or country where published	T <sup>2</sup>
	NPL446	Expand's Conclusions of Fact and Law Regarding Defense of Inequitable Conduct Concerning the Unenforceability of U.S. Patent No. 7,321,937 (November 12, 2009), 3 pgs.	
	NPL447	Realtime Data's Sur-reply Supplemental Claim Construction Brief Concerning Whether the Asserted Claims of the '104 Patent are Product Claims (December 23, 2009), 6 pgs.	
	NPL448	Order regarding Defendant Citrix Systems, Inc's Notice of Other Prior Art References Within the Scope of the References Discussed at the December 17, 2009 Hearing (December 30, 2009), 3 pgs.	
	NPL449	Network Working group RFC 2068 (Jan. 1997), 163 pgs.	
	NPL450	Network Working group RFC 2616 (Jun. 1999), 114 pgs.	
	NPL451	Network Working group RFC 1945 (May 1996), 61 pgs.	
	NPL452	Network Working group RFC 1950 (May 1996), 10 pgs.	
	NPL453	Network Working group RFC 1951 (May 1996), 15 pgs.	
	NPL454	Network Working group RFC 1952 (May 1996), 12 pgs.	
	NPL455	Notice of Plaintiff Realtime Data LLC's Proposed Supplemental Construction of "Data Storage Rate" In Response to the Court's Comments During the November 10, 2009 Supplemental Claim Construction Hearing (November 10, 2009), 4 pgs.	

Examiner Signature	/Suresh Suryawanshi/	Date Considered	05/14/2012
-----------------------	----------------------	--------------------	------------

\*EXAMINER: Initial if reference considered, whether or not citation is in conformance with MPEP 609. Draw line through citation if not in conformance and not considered. Include copy of this form with next communication to applicant.

<sup>1</sup> Applicant's unique citation designation number (optional). <sup>2</sup> Applicant is to place a check mark here if English language Translation is attached.

ALL REFERENCES CONSIDERED EXCEPT WHERE LINED THROUGH. /SKS./

Substitute for form 1449/PTO				<i>Complete if Known</i>	
<b>INFORMATION DISCLOSURE STATEMENT BY APPLICANT</b> <i>(Use as many sheets as necessary)</i>				Application Number	13/118,122
				Filing Date	May 27, 2011
				First Named Inventor	James J. FALLON
				Art Unit	2115
				Examiner Name	To Be Assigned
Sheet	52	of	66	Attorney Docket Number	2855.004000B

NON PATENT LITERATURE DOCUMENTS			
Examiner Initials*	Cite No. <sup>1</sup>	Include name of the author (in CAPITAL LETTERS), title of the article (when appropriate), title of the item (book, magazine, journal, serial, symposium, catalog, etc.), date, page(s), volume number, publisher, city and/or country where published	T <sup>2</sup>
	NPL456	Citrix's Amended Invalidity Contentions, Including Appendices G2-G8 (December 15, 2009), 509 pgs.	
	NPL457	"Plaintiff Realtime Data's Opposition to Defendant F5 Networks' Motion for Summary Judgment that Claims 18-20 of U.S. Patent No. 7,321,937 are Invalid (August 25, 2009)" Civil Action No. 6:08-cv-00144-LED Jury Trial Demanded Filed Under Seal; In the United States District Court for the Eastern District of Texas Tyler Division. [Under Seal - Document NOT Submitted]	
	NPL458	Declaration of Dr. James W. Modestino relating to U.S. Patent No. 7,161,506, March 15, 2010, 49 pgs.	
	NPL459	Second Declaration of Dr. George T. Ligler under 37 C.F.R. §1.132 relating to U.S. Patent No. 6,601,104, executed May 5, 2010, 3 pgs.	
	NPL460	Realtime Data, LLC Complaint for Patent Infringement, Realtime Data, LLC D/B/A IXO v. CME Group Inc., et al. (II), District Court for the Eastern District of Texas, No. 6:10-cv-246, filed May 11, 2010, 24 pages.	
	NPL461	Realtime Data, LLC Complaint for Patent Infringement, Realtime Data, LLC D/B/A IXO v. Thomson Reuters Corporation, et al. (II), District Court for the Eastern District of Texas, No. 6:10-cv-247, filed May 11, 2010, 15 pages.	
	NPL462	Realtime Data, LLC Complaint for Patent Infringement, Realtime Data, LLC D/B/A IXO v. Morgan Stanley, et al. (II), District Court for the Eastern District of Texas, No. 6:10-cv-248, filed May 11, 2010, 27 pages.	
	NPL463	Declaration of Padmaja Chinta In Support of Realtime Data's Reply Claim Construction Brief (including Exhibits A-S), Realtime Data, LLC D/B/A IXO v. Packeteer, Inc., et al., District Court for the Eastern District of Texas, No. 6:08-cv-00144-LED, dated March 30, 2009, 217 pgs.	
	NPL464	Extended European search report issuing from European Patent Application 09150508.1, A August 3, 2010, 5 pgs.	
	NPL465	Complaint, Thomson Reuters Corporation v. Realtime Data, LLC D/B/A IXO, Southern District of New York, No. 2:09-cv-7868-RMB, filed September 11, 2009, 6 pages.	

Examiner Signature	/Suresh Suryawanshi/	Date Considered	05/14/2012
-----------------------	----------------------	--------------------	------------

\*EXAMINER: Initial if reference considered, whether or not citation is in conformance with MPEP 609. Draw line through citation if not in conformance and not considered. Include copy of this form with next communication to applicant.

<sup>1</sup> Applicant's unique citation designation number (optional). <sup>2</sup> Applicant is to place a check mark here if English language Translation is attached.

ALL REFERENCES CONSIDERED EXCEPT WHERE LINED THROUGH. /SKS./

Substitute for form 1449/PTO				<i>Complete if Known</i>	
<b>INFORMATION DISCLOSURE STATEMENT BY APPLICANT</b> <i>(Use as many sheets as necessary)</i>				Application Number	13/118,122
				Filing Date	May 27, 2011
				First Named Inventor	James J. FALLON
				Art Unit	2115
				Examiner Name	To Be Assigned
Sheet	53	of	66	Attorney Docket Number	2855.004000B

NON PATENT LITERATURE DOCUMENTS			
Examiner Initials*	Cite No. <sup>1</sup>	Include name of the author (in CAPITAL LETTERS), title of the article (when appropriate), title of the item (book, magazine, journal, serial, symposium, catalog, etc.), date, page(s), volume number, publisher, city and/or country where published	T <sup>2</sup>
	NPL466	Realtime Data, LLC Complaint for Patent Infringement, Realtime Data, LLC D/B/A IXO v. MetroPCS Texas, LLC et al., District Court for the Eastern District of Texas, No. 6:10-cv-00493, filed September 23, 2010, 14 pages.	
	NPL467	Complaint and Demand for Jury Trial, Chicago Board Options Exchange, Incorporated v. Realtime Data, LLC D/B/A IXO, United States District Court for the Northern District of Illinois, No. 09 CV 4486, filed July 24, 2009, 6 pages.	
	NPL468	Realtime's Response in Opposition to the Defendants' Joint Objections to Report and Recommendation of Magistrate Regarding Motion for Partial Summary Judgment of Invalidity for Indefiniteness, in Realtime Data, LLC d/b/a/IXO v. Packeteer, Inc. et al., Civil Action No. 6:08-cv-00144-LED; U.S. District Court for the Eastern District of Texas, July 27, 2009, 15 pgs.	
	NPL469	Reply to Realtime's Response to Blue Coat Defendants' Objections to Report and Recommendation of United States Magistrate Judge Regarding Motion for Partial Summary Judgment of Invalidity for Indefiniteness Entered June 23, 2009, in Realtime Data, LLC d/b/a/IXO v. Packeteer, Inc. et al., Civil Action No. 6:08-cv-00144-LED; U.S. District Court for the Eastern District of Texas, July 31, 2009, 3 pgs.	
	NPL470	Realtime Data's Sur-Reply in Opposition to the Defendants' Joint Objections to Report and Recommendation of Magistrate Regarding Motion for Partial Summary Judgment of Invalidity for Indefiniteness, in Realtime Data, LLC d/b/a/IXO v. Packeteer, Inc. et al., Civil Action No. 6:08-cv-00144-LED; U.S. District Court for the Eastern District of Texas, August 3, 2009, 3 pgs.	
	NPL471	Defendants' Invalidity Contentions, Realtime Data, LLC d/b/a IXO, vs. MetroPCS Texas, LLC, et al., Case No. 6:10-CV-00493-LED, In the United States District Court Eastern District of Texas Tyler Division, June 17, 2011, 138 pages.	
	NPL472	Appendix A, Claim Charts A-1 to A-25, from Invalidity Contentions, Realtime Data LLC v. MetroPCS Texas, LLC, et al., Case No. 6:10-CV-00493-LED, June 17, 2011, 173 pages.	
	NPL473	Appendix B, Claim Charts B-1 to B-23, from Realtime Data LLC v. MetroPCS Texas, LLC et al., Case No. 6:10-CV-00493-LED, June 17, 2011, 809 pages.	
	NPL474	Appendix C, Claim Charts C-1 to C-22, from Realtime Data LLC v. MetroPCS Texas, LLC et al., Case No. 6:10-CV-00493-LED, June 17, 2011, 530 pages.	
	NPL475	Appendix D, Claim Charts D-1 to D-16, from Realtime Data LLC v. MetroPCS Texas, LLC et al., Case No. 6:10-CV-00493-LED, June 17, 2011, 253 pages.	

Examiner Signature	/Suresh Suryawanshi/	Date Considered	05/14/2012
--------------------	----------------------	-----------------	------------

\*EXAMINER: Initial if reference considered, whether or not citation is in conformance with MPEP 609. Draw line through citation if not in conformance and not considered. Include copy of this form with next communication to applicant.

<sup>1</sup> Applicant's unique citation designation number (optional). <sup>2</sup> Applicant is to place a check mark here if English language Translation is attached.

ALL REFERENCES CONSIDERED EXCEPT WHERE LINED THROUGH. /SKS./

Substitute for form 1449/PTO				<i>Complete if Known</i>	
<b>INFORMATION DISCLOSURE STATEMENT BY APPLICANT</b> <i>(Use as many sheets as necessary)</i>				Application Number	13/118,122
				Filing Date	May 27, 2011
				First Named Inventor	James J. FALLON
				Art Unit	2115
				Examiner Name	To Be Assigned
Sheet	54	of	66	Attorney Docket Number	2855.004000B

NON PATENT LITERATURE DOCUMENTS			
Examiner Initials*	Cite No. <sup>1</sup>	Include name of the author (in CAPITAL LETTERS), title of the article (when appropriate), title of the item (book, magazine, journal, serial, symposium, catalog, etc.), date, page(s), volume number, publisher, city and/or country where published	T <sup>2</sup>
	NPL476	Appendix E, Claim Charts E-1 to E-20, from Realtime Data LLC v. MetroPCS Texas, LLC et al., Case No. 6:10-CV-00493-LED, June 17, 2011, 397 pages.	
	NPL477	Appendix F, Claim Charts F-1 to F-19, from Realtime Data LLC v. MetroPCS Texas, LLC et al., Case No. 6:10-CV-00493-LED, June 17, 2011, 462 pages.	
	NPL478	Appendix G, Claim Charts G-1 to G-18, from Realtime Data LLC v. MetroPCS Texas, LLC et al., Case No. 6:10-CV-00493-LED, June 17, 2011, 548 pages.	
	NPL479	Appendix H, Claim Charts H-1 to H-22, from Realtime Data LLC v. MetroPCS Texas, LLC et al., Case No. 6:10-CV-00493-LED, June 17, 2011, 151 pages.	
	NPL480	AMIR et al., "An Application Level Video Gateway," 1995, 11 pages.	
	NPL481	KATZ, Randy H. and Eric A. Brewer, "The Bay Area Research Wireless Access Network: Towards a Wireless Overlay Internetworking Architecture," Computer Science Division, EECS Department, U.C. Berkeley, 1995, 56 pages.	
	NPL482	KATZ, R.H. and E.A. Brewer, "The Bay Area Research Wireless Access Network (BARWAN)," UC Berkeley, 1995, 68 pages.	
	NPL483	BRUCKMAN, Alfred and Andreas UHL, "Selective Medical Image Compression Using Wavelet Techniques," June 1998, 23 pages.	
	NPL484	CROWLEY et al., "Dynamic Compression During System Save Operations," May 1, 1984, 3 pages.	
	NPL485	HERSHKOVITS, "Universal Data Compression with Finite-Memory," February 1995, 99 pages.	

Examiner Signature	/Suresh Suryawanshi/	Date Considered	05/14/2012
-----------------------	----------------------	--------------------	------------

\*EXAMINER: Initial if reference considered, whether or not citation is in conformance with MPEP 609. Draw line through citation if not in conformance and not considered. Include copy of this form with next communication to applicant.

<sup>1</sup> Applicant's unique citation designation number (optional). <sup>2</sup> Applicant is to place a check mark here if English language Translation is attached.

ALL REFERENCES CONSIDERED EXCEPT WHERE LINED THROUGH. /SKS./

Substitute for form 1449/PTO				<i>Complete if Known</i>	
<b>INFORMATION DISCLOSURE STATEMENT BY APPLICANT</b> <i>(Use as many sheets as necessary)</i>				Application Number	13/118,122
				Filing Date	May 27, 2011
				First Named Inventor	James J. FALLON
				Art Unit	2115
				Examiner Name	To Be Assigned
Sheet	55	of	66	Attorney Docket Number	2855.004000B

NON PATENT LITERATURE DOCUMENTS			
Examiner Initials*	Cite No. <sup>1</sup>	Include name of the author (in CAPITAL LETTERS), title of the article (when appropriate), title of the item (book, magazine, journal, serial, symposium, catalog, etc.), date, page(s), volume number, publisher, city and/or country where published	T <sup>2</sup>
	NPL486	KATZ et al., "The Bay Area Research Wireless Access Networks (BARWAN)," 1996, 6 pages.	
	NPL487	KLEIN, "Compression and Coding in Information Retrieval Systems," June 1987, pages vii-viii, 1-4, 10-15, 22-30, 43-48, 62-66, 86-89, 108-111.	
	NPL488	REGHBATI, "An Overview of Data Compression Techniques," April 1981, pages 71-75.	
	NPL489	Court Docket Listing for 6:10-cv-00493-LED Realtime Data, LLC D/B/A/IXO, v. MetroPCS Texas, LLC et al., dated July 20, 2011, 13 pages.	
	NPL490	Court Docket History for 1:09-cv-04486 Chicago Board Options Exchange, Incorporated v. Realtime Data, LLC, dated July 20, 2011, 7 pages.	
	NPL491	Court Docket History for 6:08-cv-00144-LED-JDL Realtime Data, LLC d/b/a IXO v. Packeteer, Inc. et al, dated July 20, 2011, 119 pages.	
	NPL492	Court Docket History for 6:09-cv-00326-LED-JDL Realtime Data, LLC D/B/A/ IXO, v. Morgan Stanley et al, dated July 20, 2011, 44 pages.	
	NPL493	Court Docket History for 6:09-cv-00327-LED-JDL Realtime Data, LLC D/B/A/IXO, v. CME Group Inc. et al, dated July 20, 2011, 55 pages.	
	NPL494	Court Docket History for 6:09-cv-00333-LED-JDL Realtime Data, LLC d/b/a IXO v. Thomson Reuters et al, dated July 20, 2011, 29 pages.	
	NPL495	Court Docket History for 1:09-cv-07868-RMB Thomson Reuters Corporation v. Realtime Data, LLC, dated July 20, 2011, 3 pages.	

Examiner Signature	/Suresh Suryawanshi/	Date Considered	05/14/2012
-----------------------	----------------------	--------------------	------------

\*EXAMINER: Initial if reference considered, whether or not citation is in conformance with MPEP 609. Draw line through citation if not in conformance and not considered. Include copy of this form with next communication to applicant.

<sup>1</sup> Applicant's unique citation designation number (optional). <sup>2</sup> Applicant is to place a check mark here if English language Translation is attached.

ALL REFERENCES CONSIDERED EXCEPT WHERE LINED THROUGH. /SKS./

Substitute for form 1449/PTO				<i>Complete if Known</i>	
<b>INFORMATION DISCLOSURE STATEMENT BY APPLICANT</b> <i>(Use as many sheets as necessary)</i>				Application Number	13/118,122
				Filing Date	May 27, 2011
				First Named Inventor	James J. FALLON
				Art Unit	2115
				Examiner Name	To Be Assigned
Sheet	56	of	66	Attorney Docket Number	2855.004000B

NON PATENT LITERATURE DOCUMENTS			
Examiner Initials*	Cite No. <sup>1</sup>	Include name of the author (in CAPITAL LETTERS), title of the article (when appropriate), title of the item (book, magazine, journal, serial, symposium, catalog, etc.), date, page(s), volume number, publisher, city and/or country where published	T <sup>2</sup>
	NPL496	Notice of Allowance in Commonly-Assigned U.S. Application. No. 11/651,366, issued April 10, 2009, 7 pgs.	
	NPL497	Copy of Non-Final Office Action for U.S. Appl. No. 12/684,624, mailed November 10, 2010, 5 pgs.	
	NPL498	Copy of Notice of Allowance for U.S. Appl. No. 12/123,081, mailed February 17, 2011, 7 pgs.	
	NPL499	Copy of Non-Final Office Action for U.S. Appl. No. 12/688,413, mailed September 27, 2010, 13 pgs.	
	NPL500	Copy of Notice of Allowance for U.S. Appl. No. 11/551,211, mailed January 31, 2011, 4 pgs.	
	NPL501	Copy of Notice of Allowance for U.S. Appl. No. 11/551,211, mailed September 22, 2010, 4 pgs.	
	NPL502	Copy of Notice of Allowance for U.S. Appl. No. 11/551,204, mailed January 11, 2011, 4 pgs.	
	NPL503	Copy of Notice of Allowance for U.S. Appl. No. 11/553,419, mailed September 22, 2010, 4 pgs.	
	NPL504	Copy of Non-Final Office Action for U.S. Appl. No. 11/400,008, mailed November 23, 2010, 7 pgs.	
	NPL505	Copy of Notice of Allowance for U.S. Appl. No. 11/651,365, mailed February 4, 2010, 8 pgs.	

Examiner Signature	/Suresh Suryawanshi/	Date Considered	05/14/2012
-----------------------	----------------------	--------------------	------------

\*EXAMINER: Initial if reference considered, whether or not citation is in conformance with MPEP 609. Draw line through citation if not in conformance and not considered. Include copy of this form with next communication to applicant.

<sup>1</sup> Applicant's unique citation designation number (optional). <sup>2</sup> Applicant is to place a check mark here if English language Translation is attached.

ALL REFERENCES CONSIDERED EXCEPT WHERE LINED THROUGH. /SKS./

Substitute for form 1449/PTO				<i>Complete if Known</i>	
<b>INFORMATION DISCLOSURE STATEMENT BY APPLICANT</b> <i>(Use as many sheets as necessary)</i>				Application Number	13/118,122
				Filing Date	May 27, 2011
				First Named Inventor	James J. FALLON
				Art Unit	2115
				Examiner Name	To Be Assigned
Sheet	57	of	66	Attorney Docket Number	2855.004000B

NON PATENT LITERATURE DOCUMENTS			
Examiner Initials*	Cite No. <sup>1</sup>	Include name of the author (in CAPITAL LETTERS), title of the article (when appropriate), title of the item (book, magazine, journal, serial, symposium, catalog, etc.), date, page(s), volume number, publisher, city and/or country where published	T <sup>2</sup>
	NPL506	Copy of Notice of Allowance for U.S. Appl. No. 11/651,365, mailed November 19, 2009, 8 pgs.	
	NPL507	Copy of Non-Final Office Action for U.S. Appl. No. 09/969,987, mailed August 27, 2010, 13 pgs.	
	NPL508	Copy of Final Office Action for U.S. Appl. No. 09/969,987, mailed January 28, 2010, 11 pgs.	
	NPL509	Copy of Notice of Allowance for U.S. Appl. No. 12/131,631, mailed June 22, 2010, 5 pgs.	
	NPL510	Copy of Final Office Action for U.S. Appl. No. 11/400,008, mailed October 30, 2009, 7 pgs.	
	NPL511	Copy of Final Office Action for U.S. Appl. No. 11/400,008, mailed May 11, 2010, 7 pgs.	
	NPL512	Copy of Notice of Allowance for U.S. Appl. No. 11/551,204, mailed September 30, 2010; 4 pages	
	NPL513	Copy of Non-Final Office Action for U.S. Appl. No. 11/551,204, mailed June 16, 2009, 5 pgs.	
	NPL514	Copy of Notice of Allowance for U.S. Appl. No. 11/551,204, mailed June 21, 2010, 4 pgs.	
	NPL515	Copy of Non-Final Office Action for U.S. Appl. No. 11/551,204, mailed September 22, 2008, 9 pgs.	

Examiner Signature	/Suresh Suryawanshi/	Date Considered	05/14/2012
-----------------------	----------------------	--------------------	------------

\*EXAMINER: Initial if reference considered, whether or not citation is in conformance with MPEP 609. Draw line through citation if not in conformance and not considered. Include copy of this form with next communication to applicant.

<sup>1</sup> Applicant's unique citation designation number (optional). <sup>2</sup> Applicant is to place a check mark here if English language Translation is attached.

ALL REFERENCES CONSIDERED EXCEPT WHERE LINED THROUGH. /SKS./

Substitute for form 1449/PTO				<i>Complete if Known</i>	
<b>INFORMATION DISCLOSURE STATEMENT BY APPLICANT</b> <i>(Use as many sheets as necessary)</i>				Application Number	13/118,122
				Filing Date	May 27, 2011
				First Named Inventor	James J. FALLON
				Art Unit	2115
				Examiner Name	To Be Assigned
Sheet	58	of	66	Attorney Docket Number	2855.004000B

NON PATENT LITERATURE DOCUMENTS			
Examiner Initials*	Cite No. <sup>1</sup>	Include name of the author (in CAPITAL LETTERS), title of the article (when appropriate), title of the item (book, magazine, journal, serial, symposium, catalog, etc.), date, page(s), volume number, publisher, city and/or country where published	T <sup>2</sup>
	NPL516	Copy of Notice of Allowance for U.S. Appl. No. 11/551,204, mailed January 27, 2010, 4 pgs.	
	NPL517	Copy of Non-Final Office Action for U.S. Appl. No.12/690,125, mailed September 21, 2010, 12 pgs.	
	NPL518	Copy of Final Office Action for U.S. Appl. No. 09/969,987, mailed May 24, 2011, 17 pgs.	
	NPL519	Copy of Notice of Allowance for U.S. Appl. No 11/551,211, mailed May 6, 2011, 5 pages	
	NPL520	Copy of Notice of Allowance for U.S. Appl. No 12/703,042, mailed May 5, 2011, 8 pages.	
	NPL521	Copy of Notice of Allowance for U.S. Appl. No 11/553,427, mailed March 24, 2011, 5 pages	
	NPL522	Copy of Notice of Allowance for U.S. Appl. No 11/553,419, mailed May 20, 2011, 5 pages	
	NPL523	Copy of Final Office Action for U.S. Appl. No. 11/400,008, mailed June 27, 2011, 6 pages.	
	NPL524	Copy of Notice of Allowance for U.S. Appl. No. 11/553,427, mailed May 31, 2011, 5 pages.	
	NPL525	Copy of Final Office Action for U.S. Appl. No. 12/690,125, mailed June 7, 2011, 11 pages.	

Examiner Signature	/Suresh Suryawanshi/	Date Considered	05/14/2012
-----------------------	----------------------	--------------------	------------

\*EXAMINER: Initial if reference considered, whether or not citation is in conformance with MPEP 609. Draw line through citation if not in conformance and not considered. Include copy of this form with next communication to applicant.

<sup>1</sup> Applicant's unique citation designation number (optional). <sup>2</sup> Applicant is to place a check mark here if English language Translation is attached.

ALL REFERENCES CONSIDERED EXCEPT WHERE LINED THROUGH. /SKS./



Substitute for form 1449/PTO				<i>Complete if Known</i>	
<b>INFORMATION DISCLOSURE STATEMENT BY APPLICANT</b> <i>(Use as many sheets as necessary)</i>				Application Number	13/118,122
				Filing Date	May 27, 2011
				First Named Inventor	James J. FALLON
				Art Unit	2115
				Examiner Name	To Be Assigned
Sheet	59	of	66	Attorney Docket Number	2855.004000B

NON PATENT LITERATURE DOCUMENTS			
Examiner Initials*	Cite No. <sup>1</sup>	Include name of the author (in CAPITAL LETTERS), title of the article (when appropriate), title of the item (book, magazine, journal, serial, symposium, catalog, etc.), date, page(s), volume number, publisher, city and/or country where published	T <sup>2</sup>
	NPL526	Copy of Final Office Action for U.S. Appl. No. 12/688,413, mailed June 7, 2011, 15 pages.	
	NPL527	International Search Report for PCT/US00/42018, mailed July 31, 2001, 3 pages.	
	NPL528	International Search Report for PCT/US01/03712, mailed May 10, 2002, 2 pages.	
	NPL529	International Search Report for PCT/US01/03711, mailed January 28, 2001, 5 pages.	
	NPL530	Copy of submission of prior art under 37 CFR 1.501, for U.S. Pat. No. 6,604,158, March 3, 2011, 5 pgs.	
	NPL531	Copy of submission of prior art under 37 CFR 1.501, for U.S. Pat. No. 7,415,530, March 3, 2011, 14 pgs.	
	NPL532	Copy of submission of prior art under 37 CFR 1.501, for U.S. Pat. No. 6,601,104, March 3, 2011, 5 pgs.	
	NPL533	Copy of submission of prior art under 37 CFR 1.501, for U.S. Pat. No. 7,161,506, March 3, 2011, 12 pgs.	
	NPL534	Copy of submission of prior art under 37 CFR 1.501, for U.S. Pat. No. 7,395,345, March 3, 2011, 14 pgs.	
	NPL535	Copy of submission of prior art under 37 CFR 1.501, for U.S. Pat. No. 7,321,937, March 3, 2011, 14 pgs.	

Examiner Signature	/Suresh Suryawanshi/	Date Considered	05/14/2012
-----------------------	----------------------	--------------------	------------

\*EXAMINER: Initial if reference considered, whether or not citation is in conformance with MPEP 609. Draw line through citation if not in conformance and not considered. Include copy of this form with next communication to applicant.

<sup>1</sup> Applicant's unique citation designation number (optional). <sup>2</sup> Applicant is to place a check mark here if English language Translation is attached.

ALL REFERENCES CONSIDERED EXCEPT WHERE LINED THROUGH. /SKS./

Substitute for form 1449/PTO				<i>Complete if Known</i>	
<b>INFORMATION DISCLOSURE STATEMENT BY APPLICANT</b> <i>(Use as many sheets as necessary)</i>				Application Number	13/118,122
				Filing Date	May 27, 2011
				First Named Inventor	James J. FALLON
				Art Unit	2115
				Examiner Name	To Be Assigned
Sheet	60	of	66	Attorney Docket Number	2855.004000B

NON PATENT LITERATURE DOCUMENTS			
Examiner Initials*	Cite No. <sup>1</sup>	Include name of the author (in CAPITAL LETTERS), title of the article (when appropriate), title of the item (book, magazine, journal, serial, symposium, catalog, etc.), date, page(s), volume number, publisher, city and/or country where published	T <sup>2</sup>
	NPL536	Copy of submission of prior art under 37 CFR 1.501, for U.S. Pat. No. 7,352,300, March 3, 2011, 14 pgs.	
	NPL537	Copy of submission of prior art under 37 CFR 1.501, for U.S. Pat. No. 7,378,992, March 3, 2011, 14 pgs.	
	NPL538	Ex Parte Reexamination Interview Summary, mailed December 3, 2009, for U.S. Reexam App. No. 90/009,428, 4 pgs.	
	NPL539	Request for Inter Partes Reexamination of U.S. Patent No. 7,714,747, Control No. 95/001,517, filed December 30, 2010, 696 pages.	
	NPL540	Replacement Request for Inter Partes Reexamination of U.S. Patent No. 7,417,568, Control No. 95/001,533, filed March 1, 2011, 357 pages.	
	NPL541	L. Gannoun, "RTP Payload Format for X Protocol Media Streams," Audio-Visual Transport WG Internet Draft, Internet Engineering Task Force, March 11, 1998, 15 pgs.	
	NPL542	Official Order Granting Request for Inter Partes Reexamination of U.S. Pat. No. 6,624,761, Control No. 95/000,464, issued July 24, 2009, 29 pgs.	
	NPL543	Non-Final Office Action in Inter Partes Reexamination of U.S. Pat. No. 6,624,761, Control No. 95/000,464, issued December 15, 2009, 20 pgs.	
	NPL544	Non-Final Office Action in Inter Partes Reexamination of U.S. Pat. No. 7,321,937, Control No. 95/000,466, issued June 22, 2009, 11 pgs.	
	NPL545	Official Order Granting Request for Inter Partes Reexamination of U.S. Pat. No. 7,321,937, Control No. 95/000,466, issued June 22, 2009, 16 pgs.	

Examiner Signature	/Suresh Suryawanshi/	Date Considered	05/14/2012
--------------------	----------------------	-----------------	------------

\*EXAMINER: Initial if reference considered, whether or not citation is in conformance with MPEP 609. Draw line through citation if not in conformance and not considered. Include copy of this form with next communication to applicant.

<sup>1</sup> Applicant's unique citation designation number (optional). <sup>2</sup> Applicant is to place a check mark here if English language Translation is attached.

ALL REFERENCES CONSIDERED EXCEPT WHERE LINED THROUGH. /SKS./

Substitute for form 1449/PTO				<i>Complete if Known</i>	
<b>INFORMATION DISCLOSURE STATEMENT BY APPLICANT</b> <i>(Use as many sheets as necessary)</i>				Application Number	13/118,122
				Filing Date	May 27, 2011
				First Named Inventor	James J. FALLON
				Art Unit	2115
				Examiner Name	To Be Assigned
Sheet	61	of	66	Attorney Docket Number	2855.004000B

NON PATENT LITERATURE DOCUMENTS			
Examiner Initials*	Cite No. <sup>1</sup>	Include name of the author (in CAPITAL LETTERS), title of the article (when appropriate), title of the item (book, magazine, journal, serial, symposium, catalog, etc.), date, page(s), volume number, publisher, city and/or country where published	T <sup>2</sup>
	NPL546	Official Action Closing Prosecution for Inter Partes Reexamination of U.S. Pat. No. 7,321,937, Control No. 95/000,466, issued December 22, 2009, 20 pgs.	
	NPL547	Comments by Third Party Requester to Patent Owner's Response Inter Partes Reexamination of U.S. Patent No. 7,321,937, Control No. 95/000,466, filed November 10, 2009, 30 pgs.	
	NPL548	Supplemental Declaration of Professor James A. Storer, Ph.D. under 37 C.F.R. §1.132 in Inter Partes Reexamination of U.S. Patent No. 7,321,937, Control No. 95/000,466, executed on November 10, 2009, 16 pgs.	
	NPL549	Examiner Interview Summary in Ex Parte Reexamination of U.S. Pat. No. 6,601,104, Control No. 90/009,428, issued December 3, 2009, 3 pgs.	
	NPL550	Non-Final Office Action in Ex Parte Reexamination of U.S. Pat. No. 6,601,104, Control No. 90/009,428, issued November 2, 2009, 13 pgs.	
	NPL551	Official Order Granting Request for Ex Parte Reexamination of U.S. Pat. No. 6,601,104, Control No. 90/009,428, issued June 1, 2009, 12 pgs.	
	NPL552	Declaration of Dr. George T. Ligler under 37 C.F.R. §1.132 in Ex Parte Reexamination of U.S. Pat. No. 6,601,104, Control No. 90/009,428, executed December 28, 2009 16 pgs.	
	NPL553	Supplementary Declaration of Dr. George T. Ligler under 37 C.F.R. §1.132 in Ex Parte Reexamination of U.S. Pat. No. 6,601,104, Control No. 90/009,428, executed December 30, 2009 1 pg.	
	NPL554	Declaration of Dr. George T. Ligler under 37 C.F.R. §1.132 in Inter Partes Reexamination of U.S. Pat. No. 7,321,937, Control No. 95/000,466, executed August 24, 2009, 30 pgs.	
	NPL555	Official Order Granting Request for Inter Partes Reexamination of U.S. Pat. No. 7,161,506, Control No. 95/000,479, issued August 14, 2009, 41 pgs.	

Examiner Signature	/Suresh Suryawanshi/	Date Considered	05/14/2012
-----------------------	----------------------	--------------------	------------

\*EXAMINER: Initial if reference considered, whether or not citation is in conformance with MPEP 609. Draw line through citation if not in conformance and not considered. Include copy of this form with next communication to applicant.

<sup>1</sup> Applicant's unique citation designation number (optional). <sup>2</sup> Applicant is to place a check mark here if English language Translation is attached.

ALL REFERENCES CONSIDERED EXCEPT WHERE LINED THROUGH. /SKS./

Substitute for form 1449/PTO				<i>Complete if Known</i>	
<b>INFORMATION DISCLOSURE STATEMENT BY APPLICANT</b> <i>(Use as many sheets as necessary)</i>				Application Number	13/118,122
				Filing Date	May 27, 2011
				First Named Inventor	James J. FALLON
				Art Unit	2115
				Examiner Name	To Be Assigned
Sheet	62	of	66	Attorney Docket Number	2855.004000B

NON PATENT LITERATURE DOCUMENTS			
Examiner Initials*	Cite No. <sup>1</sup>	Include name of the author (in CAPITAL LETTERS), title of the article (when appropriate), title of the item (book, magazine, journal, serial, symposium, catalog, etc.), date, page(s), volume number, publisher, city and/or country where published	T <sup>2</sup>
	NPL556	Non-Final Office Action in Inter Partes Reexamination of U.S. Pat. No. 7,161,506, Control No. 95/000,479, issued December 15, 2009, 37 pgs.	
	NPL557	Official Order Granting Request for Inter Partes Reexamination of U.S. Pat. No. 7,378,992, Control No. 95/000,478, issued August 13, 2009, 60 pgs.	
	NPL558	Non-Final Office Action in Inter Partes Reexamination of U.S. Pat. No. 7,378,992, Control No. 95/000,478, issued December 15, 2009, 27 pgs.	
	NPL559	Official Order Granting Request for Inter Partes Reexamination of U.S. Pat. No. 6,604,158 Control No. 95/000,486, issued August 14, 2009, 35 pgs.	
	NPL560	Non-Final Office Action in Inter Partes Reexamination of U.S. Pat. No. 6,604,158, Control No. 95/000,486, issued November 12, 2009, 199 pgs.	
	NPL561	Right of Appeal Notice in Inter Partes Reexamination of U.S. Pat. No. 6,624,761, Control No. 95/000,464, issued January 6, 2011, 15 pgs.	
	NPL562	Action Closing Prosecution in Inter Partes Reexamination of U.S. Pat. No. 6,624,761, Control No. 95/000,464, issued August 27, 2010, 25 pgs.	
	NPL563	Right of Appeal Notice in Inter Partes Reexamination of U.S. Pat. No. 7,321,937, Control No. 95/000,466, issued May 24, 2010, 23 pgs.	
	NPL564	Final Office Action in Ex Parte Reexamination of U.S. Pat. No. 6,601,104, Control No. 90/009,428, issued February 5, 2010, 16 pgs.	
	NPL565	Right of Appeal Notice for Inter Partes Reexamination of U.S. Pat. No. 7,161,506, Control No. 95/000,479, issued January 6, 2011, 18 pgs.	

Examiner Signature	/Suresh Suryawanshi/	Date Considered	05/14/2012
--------------------	----------------------	-----------------	------------

\*EXAMINER: Initial if reference considered, whether or not citation is in conformance with MPEP 609. Draw line through citation if not in conformance and not considered. Include copy of this form with next communication to applicant.

<sup>1</sup> Applicant's unique citation designation number (optional). <sup>2</sup> Applicant is to place a check mark here if English language Translation is attached.

ALL REFERENCES CONSIDERED EXCEPT WHERE LINED THROUGH. /SKS./

Substitute for form 1449/PTO				<i>Complete if Known</i>	
<b>INFORMATION DISCLOSURE STATEMENT BY APPLICANT</b> <i>(Use as many sheets as necessary)</i>				Application Number	13/118,122
				Filing Date	May 27, 2011
				First Named Inventor	James J. FALLON
				Art Unit	2115
				Examiner Name	To Be Assigned
Sheet	63	of	66	Attorney Docket Number	2855.004000B

NON PATENT LITERATURE DOCUMENTS			
Examiner Initials*	Cite No. <sup>1</sup>	Include name of the author (in CAPITAL LETTERS), title of the article (when appropriate), title of the item (book, magazine, journal, serial, symposium, catalog, etc.), date, page(s), volume number, publisher, city and/or country where published	T <sup>2</sup>
	NPL566	Action Closing Prosecution in Inter Partes Reexamination of U.S. Pat. No. 7,161,506, Control No. 95/000,479, issued August 27, 2010, 34 pgs.	
	NPL567	Right of Appeal Notice for Inter Partes Reexamination of U.S. Pat. No. 7,378,992, Control No. 95/000,478, issued January 6, 2011, 15 pgs.	
	NPL568	Action Closing Prosecution in Inter Partes Reexamination of U.S. Pat. No. 7,378,992, Control No. 95/000,478, issued August 23, 2010, 31 pgs.	
	NPL569	Action Closing Prosecution in Inter Partes Reexamination of U.S. Pat. No. 6,604,158 Control No. 95/000,486, issued March 7, 2011, 257 pgs.	
	NPL570	Patent Owner's reply to Office Action in Inter Partes Reexamination of U.S. Patent No. 7,378,992, mailed March 15, 2010, 23 pages.	
	NPL571	Patent Owner's reply to Office Action in Inter Partes Reexamination of U.S. Patent No. 7,161,506, mailed March 15, 2010, 23 pages.	
	NPL572	Patent Owner's reply to Action Closing Prosecution of August 23, 2010 in Inter Partes Reexamination of U.S. Patent 7,378,992, mailed September 23, 2010, 23 pages.	
	NPL573	Patent Owner's reply to Action Closing Prosecution of August 27, 2010 in Inter Partes Reexamination of U.S. Patent No. 7,161,506, mailed September 27, 2010, 26 pages.	
	NPL574	Patent Owner's reply to Action Closing Prosecution of August 27, 2010 in Inter Partes Reexamination of U.S. Patent No. 6,624,761, mailed September 27, 2010, 20 pages.	
	NPL575	Corrected Request for Inter Partes Reexamination of U.S. Patent No. 6,624,761, filed June 15, 2009, 241 pages.	

Examiner Signature	/Suresh Suryawanshi/	Date Considered	05/14/2012
-----------------------	----------------------	--------------------	------------

\*EXAMINER: Initial if reference considered, whether or not citation is in conformance with MPEP 609. Draw line through citation if not in conformance and not considered. Include copy of this form with next communication to applicant.

<sup>1</sup> Applicant's unique citation designation number (optional). <sup>2</sup> Applicant is to place a check mark here if English language Translation is attached.

ALL REFERENCES CONSIDERED EXCEPT WHERE LINED THROUGH. /SKS./

Substitute for form 1449/PTO				<i>Complete if Known</i>	
<b>INFORMATION DISCLOSURE STATEMENT BY APPLICANT</b> <i>(Use as many sheets as necessary)</i>				Application Number	13/118,122
				Filing Date	May 27, 2011
				First Named Inventor	James J. FALLON
				Art Unit	2115
				Examiner Name	To Be Assigned
Sheet	64	of	66	Attorney Docket Number	2855.004000B

NON PATENT LITERATURE DOCUMENTS			
Examiner Initials*	Cite No. <sup>1</sup>	Include name of the author (in CAPITAL LETTERS), title of the article (when appropriate), title of the item (book, magazine, journal, serial, symposium, catalog, etc.), date, page(s), volume number, publisher, city and/or country where published	T <sup>2</sup>
	NPL576	Request for Inter Partes Reexamination of U.S. Patent No. 7,378,992, filed May 21, 2009, 255 pages.	
	NPL577	Request for Inter Partes Reexamination of U.S. Patent No. 7,161,506, filed May 28, 2009, 455 pages.	
	NPL578	Request for Inter Partes Reexamination of U.S. Patent No. 7,777,651, Control No. 95/001,581, filed March 21, 2011, 2,136 pages.	
	NPL579	Request for Inter Partes Reexamination of U.S. Patent No. 7,400,274, Control No. 95/001,544, filed February 14, 2011, 420 pages.	
	NPL580	Action Closing Prosecution in Inter Partes Reexamination of U.S. Pat. No. 7,321,937, Control No. 95/000,466 issued December 22, 2009, 20 pages.	
	NPL581	Order Granting request for inter partes reexamination of U.S. Patent No. 7,400,274 and Non-Final Office Action in Inter Partes reexam of U.S. Patent No. 7,400,274, Control No. 95/001,544, issued March 25, 2011, 47 pages.	
	NPL582	Non-Final Office Action in Inter Partes Reexamination of U.S. Patent No. 7,400,274, Control No. 95/001,544, mailed May 20, 2011, 47 pages.	
	NPL583	Order Granting Request for Inter Partes Reexamination of U.S. Patent No. 7,777,651, Control No. 95/001,581, mailed June 15, 2011, 22 pages.	
	NPL584	Non-Final Office Action in Inter Partes Reexamination of U.S. Patent No. 7,417,568, Control No. 95/001,553, mailed May 6, 2011, 105 pages.	
	NPL585	Order Granting Reexamination of U.S. Patent No. 7,714,747, Control No. 95/001,517, mailed March 9, 2011, 21 pages.	

Examiner Signature	/Suresh Suryawanshi/	Date Considered	05/14/2012
--------------------	----------------------	-----------------	------------

\*EXAMINER: Initial if reference considered, whether or not citation is in conformance with MPEP 609. Draw line through citation if not in conformance and not considered. Include copy of this form with next communication to applicant.

<sup>1</sup> Applicant's unique citation designation number (optional). <sup>2</sup> Applicant is to place a check mark here if English language Translation is attached.

ALL REFERENCES CONSIDERED EXCEPT WHERE LINED THROUGH. /SKS./

Substitute for form 1449/PTO				<i>Complete if Known</i>	
<b>INFORMATION DISCLOSURE STATEMENT BY APPLICANT</b> <i>(Use as many sheets as necessary)</i>				Application Number	13/118,122
				Filing Date	May 27, 2011
				First Named Inventor	James J. FALLON
				Art Unit	2115
				Examiner Name	To Be Assigned
Sheet	65	of	66	Attorney Docket Number	2855.004000B

NON PATENT LITERATURE DOCUMENTS			
Examiner Initials*	Cite No. <sup>1</sup>	Include name of the author (in CAPITAL LETTERS), title of the article (when appropriate), title of the item (book, magazine, journal, serial, symposium, catalog, etc.), date, page(s), volume number, publisher, city and/or country where published	T <sup>2</sup>
	NPL586	Appeal Brief filed in Inter Partes Reexamination of U.S. Patent No. 6,601,104, Control no. 90/009,428, mailed September 2, 2010, 28 pages.	
	NPL587	Defendants' Joint Preliminary Invalidity Contentions filed in Realtime Data, LLC D/B/A IXO v. Packeteer, Inc., et al., Civil Action No. 6:08-cv-144-LED, United States District Court for the Eastern District of Texas Tyler Division, December 8, 2008, 19 pages.	
	NPL588	Appendix A, Claim Charts A-1 to A-46, from Realtime Data, LLC v. Packeteer, Inc., et al., Civil Action No. 6:08-cv-144-LED, December 8, 2008, 345 pages.	
	NPL589	Appendix B, Claim Charts B-1 to B-17, from Realtime Data, LLC v. Packeteer, Inc., et al., Civil Action No. 6:08-cv-144-LED, December 8, 2008, 1893 pages.	
	NPL590	Appendix C, Claim Charts C-1 to C-34, from Realtime Data, LLC v. Packeteer, Inc., et al., Civil Action No. 6:08-cv-144-LED, December 8, 2008, 993 pages.	
	NPL591	Appendix D, Claim Charts D-1 to D-14, from Realtime Data, LLC v. Packeteer, Inc., et al., Civil Action No. 6:08-cv-144-LED, December 8, 2008, 197 pages.	
	NPL592	Appendix E, Claim Charts E-1 to E-11, from Realtime Data, LLC v. Packeteer, Inc., et al., Civil Action No. 6:08-cv-144-LED, December 8, 2008, 735 pages.	
	NPL593	Appendix F, Claim Charts F-1 to F-11, from Realtime Data, LLC v. Packeteer, Inc., et al., Civil Action No. 6:08-cv-144-LED, December 8, 2008, 775 pages.	
	NPL594	Appendix G Claim Charts G-1 to G-8 from Realtime Data, LLC v. Packeteer, Inc., et al., Civil Action No. 6:08-cv-144-LED, December 8, 2008, 567 pages.	
	NPL595	Appendix H, Claim Charts H-1 to H-18, from Realtime Data, LLC v. Packeteer, Inc., et al., Civil Action No. 6:08-cv-144-LED, December 8, 2008, 94 pages.	

Examiner Signature	/Suresh Suryawanshi/	Date Considered	05/14/2012
--------------------	----------------------	-----------------	------------

\*EXAMINER: Initial if reference considered, whether or not citation is in conformance with MPEP 609. Draw line through citation if not in conformance and not considered. Include copy of this form with next communication to applicant.

<sup>1</sup> Applicant's unique citation designation number (optional). <sup>2</sup> Applicant is to place a check mark here if English language Translation is attached.

ALL REFERENCES CONSIDERED EXCEPT WHERE LINED THROUGH. /SKS./

Substitute for form 1449/PTO				<i>Complete if Known</i>	
<b>INFORMATION DISCLOSURE STATEMENT BY APPLICANT</b> <i>(Use as many sheets as necessary)</i>				Application Number	13/118,122
				Filing Date	May 27, 2011
				First Named Inventor	James J. FALLON
				Art Unit	2115
				Examiner Name	To Be Assigned
Sheet	66	of	66	Attorney Docket Number	2855.004000B

NON PATENT LITERATURE DOCUMENTS			
Examiner Initials*	Cite No. <sup>1</sup>	Include name of the author (in CAPITAL LETTERS), title of the article (when appropriate), title of the item (book, magazine, journal, serial, symposium, catalog, etc.), date, page(s), volume number, publisher, city and/or country where published	T <sup>2</sup>
	NPL596	Appendix I, Claim Charts I-1 to I-18, from Realtime Data, LLC v. Packeteer, Inc., et al., Civil Action No. 6:08-cv-144-LED, December 8, 2008, 145 pages.	
	NPL597	Appendix J, Prior Art Chart, from Realtime Data, LLC v. Packeteer, Inc., et al., Civil Action No. 6:08-cv-144-LED, December 8, 2008, 25 pages.	
	NPL598	Realtime Data, LLC's [Corrected] P.R. 3-1 Disclosures and Preliminary Infringement Contentions filed in Realtime Data, LLC D/B/A/IXO v. Packeteer, Inc., et al., Civil Action No. 6:08-cv-00144-LED, United States District Court for the Eastern District of Texas Tyler Division, October 8, 2008, 591 pages.	

1391940\_1.DOCX

Examiner Signature	/Suresh Suryawanshi/	Date Considered	05/14/2012
--------------------	----------------------	-----------------	------------

\*EXAMINER: Initial if reference considered, whether or not citation is in conformance with MPEP 609. Draw line through citation if not in conformance and not considered. Include copy of this form with next communication to applicant.

<sup>1</sup> Applicant's unique citation designation number (optional). <sup>2</sup> Applicant is to place a check mark here if English language Translation is attached.

ALL REFERENCES CONSIDERED EXCEPT WHERE LINED THROUGH. /SKS./



<b><i>Index of Claims</i></b>  	<b>Application/Control No.</b> 13118122	<b>Applicant(s)/Patent Under Reexamination</b> FALLON ET AL.
	<b>Examiner</b> SURESH SURYAWANSHI	<b>Art Unit</b> 2115

✓	<b>Rejected</b>	-	<b>Cancelled</b>	N	<b>Non-Elected</b>	A	<b>Appeal</b>
=	<b>Allowed</b>	÷	<b>Restricted</b>	I	<b>Interference</b>	O	<b>Objected</b>

<input type="checkbox"/> Claims renumbered in the same order as presented by applicant		<input type="checkbox"/> CPA		<input type="checkbox"/> T.D.		<input type="checkbox"/> R.1.47			
<b>CLAIM</b>			<b>DATE</b>						
Final	Original	05/14/2012							
	1	✓							

<b>Search Notes</b>  	<b>Application/Control No.</b>  13118122	<b>Applicant(s)/Patent Under Reexamination</b>  FALLON ET AL.
	<b>Examiner</b>  SURESH SURYAWANSHI	<b>Art Unit</b>  2115

<b>SEARCHED</b>			
<b>Class</b>	<b>Subclass</b>	<b>Date</b>	<b>Examiner</b>
713	2	5/11/12, 5/14/12	SKS

<b>SEARCH NOTES</b>		
<b>Search Notes</b>	<b>Date</b>	<b>Examiner</b>
EAST; USPAT; US-PGPUB; EPO; JPO; IBM_TDB; NPL	5/11/12, 5/14/12	SKS

<b>INTERFERENCE SEARCH</b>			
<b>Class</b>	<b>Subclass</b>	<b>Date</b>	<b>Examiner</b>
713	1	5/11/12, 5/14/12	SKS
711	113	5/11/12, 5/14/12	SKS

--	--

IN THE UNITED STATES PATENT AND TRADEMARK OFFICE

In re application of:

FALLON *et al.*

Appl. No.: 13/118,122

Filed: May 27, 2011

For: **Systems and Methods for  
Accelerated Loading of Operating  
Systems and Application Programs**

Confirmation No.: 8978

Art Unit: 2115

Examiner: To Be Assigned

Atty. Docket: 2855.004000B

**First Supplemental Information Disclosure Statement**

***Mail Stop Amendment***

Commissioner for Patents  
PO Box 1450  
Alexandria, VA 22313-1450

Sir:

Notice of Prior and Concurrent Proceedings

Applicants hereby call to the attention of the Patent and Trademark Office the following reexamination proceedings involving patents that are commonly-assigned with the patent in the above-identified patent application:

<b>Proceeding</b>	<b>Status</b>
<i>Inter Partes</i> Reexamination of U.S. Patent No. 6,604,158 (Control No. 95/000,486)	Patent Owner Comments after Action Closing Prosecution filed May 9, 2011; Non-Final Action Closing Prosecution mailed March 7, 2011; Decision Dismissing Petition mailed January 26, 2011; Petition filed August 25, 2010
<i>Inter Partes</i> Reexamination of U.S. Patent No. 7,321,937 (Control No. 95/000,466)	Examiner's Answer issued July 18, 2011; Decision Dismissing Petition mailed January 26, 2011; Appeal Brief filed Oct. 25, 2010
<i>Inter Partes</i> Reexamination of U.S. Patent No. 6,604,158 (Control No. 95/000,453)	Terminated

ALL REFERENCES CONSIDERED EXCEPT WHERE LINED THROUGH. /SKS./

Proceeding	Status
<i>Ex Parte</i> Reexamination of U.S. Patent No. 6,601,104 (Control No. 90/009,428)	Miscellaneous Action with SSP 6/7/2011; Request for Rehearing after Board Decision 5/18/2011; BPAI Decision mailed March 18, 2011; Notification of Appeal Hearing issued January 14, 2011; Examiner's Answer issued Oct. 6, 2010
<i>Inter Partes</i> Reexamination of U.S. Patent No. 7,378,992 (Control No. 95/000,478)	Appeal-Brief Filed 4/21/2011; Notice of Appeal filed February 8, 2011; Decision Dismissing Petition mailed January 25, 2011; Patent Owner Comments on Action Closing Prosecution filed September 23, 2010
<i>Inter Partes</i> Reexamination of U.S. Patent No. 6,624,761 (Control No. 95/000,464)	Appeal Brief Filed 4/21/2011; Notice of Appeal filed February 8, 2011; Decision Dismissing Petition mailed January 25, 2011; Patent Owner Comments on Action Closing Prosecution filed September 28, 2010
<i>Inter Partes</i> Reexamination of U.S. Patent No. 7,161,506 (Control No. 95/000,479)	Appeal Brief Filed 4/21/2011; Notice of Appeal filed February 10, 2011; Decision Dismissing Petition mailed January 25, 2011; Patent Owner Comments on Action Closing Prosecution filed September 27, 2010
<i>Inter Partes</i> Reexamination of U.S. Patent No. 7,714,747 (Control No. 95/001,517)	Order Granting Reexam received 3/9/2011; Notice of Assignment of Reexamination Request Issued 1/13/2011; Filed 12/30/2010
<i>Inter Partes</i> Reexamination of U.S. Patent No. 7,417,568 (Control No. 95/001,533)	Non-Final Office Action mailed 5/6/2011; Replacement Reexam Request filed 3/1/2011; Notification of Incomplete <i>Inter Partes</i> Reexam Request issued 2/22/2011; Reexam Request originally filed 1/31/2011;

<b>Proceeding</b>	<b>Status</b>
<i>Inter Partes Reexamination of U.S. Patent No. 7,777,651 (Control No. 95/001,581)</i>	Non-Final Office Action mailed 7/25/2011; Order Granting Reexam Request mailed 6/15/2011; Filed 3/21/2011
<i>Inter Partes Reexamination of U.S. Patent No. 7,400,274 (Control No. 95/001,544)</i>	Non-Final Office Action mailed 5/20/2011; Filed 2/14/2011

Applicants invite the Examiner to review the Requests for Reexamination, issued Office Actions, replies, and any other papers in the above-identified reexamination proceedings. If the Examiner is unable to obtain copies of papers in any reexamination proceeding, copies can be provided to the Examiner upon request. Those documents which may be material that are not already of record in this patent application are listed on the accompanying Form PTO/SB/08. For example, documents related to the reexaminations are listed at NPL24-NPL25.

Notice of Related Litigation

Applicants notify the Patent and Trademark Office of the following litigation involving U.S. Patents commonly-owned with the current patent application, the subject matter of which may be related to the present patent application:

<b>No.</b>	<b>Case</b>	<b>Status</b>
1	<i>Realtime Data LLC d/b/a IXO v. Packeteer, Inc. et al.</i> , No. 6:08-cv-00144-LED (E.D. Texas)	Dismissed

Applicants also notify the Patent and Trademark Office of the following additional litigation involving U.S. Patents commonly-owned with the current patent application, the subject matter of which may be related to the present patent application:

<b>No.</b>	<b>Case</b>	<b>Status</b>
2	<i>Realtime Data LLC d/b/a IXO v. Thomson Reuters Corporation et al.</i> No. 6:09-cv-00333-LED (E.D. Texas)	Pending, Order denying Motion to Expedite Briefing, Order granting writ of mandamus to transfer to the Southern District of New York.
3	<i>Realtime Data LLC d/b/a IXO v. Morgan Stanley et al.</i> ,	Pending, Order

	No. 6:09-cv-00326-LED (E.D. Texas)	denying Motion to Expedite Briefing, Order granting writ of mandamus to transfer to the Southern District of New York.
4	<i>Realtime Data LLC d/b/a IXO v. CME Group Inc., et al.</i> , No. 6:09-cv-00327-LED (E.D. Texas)	Pending, Order denying Motion to Expedite Briefing, Order granting writ of mandamus to transfer to the Southern District of New York.
5	<i>Chicago Board Options Exchange, Inc., v. Realtime Data LLC d/b/a IXO</i> , No. 09-cv-4486 (N.D. Ill.)	Dismissed
6	<i>Thomson Reuters Corporation v. Realtime Data, LLC d/b/a IXO</i> , No. 1:09-cv-07868-RMB (S.D.N.Y)	Consolidated with Case No. 2
7	<i>Realtime Data, LLC d/b/a IXO v. CME Group Inc., et al. (II)</i> , No. 6:10-cv-246 (E.D. Texas)	Consolidated with Case No. 4
8	<i>Realtime Data LLC d/b/a IXO v. Thomson Reuters Corporation et al. (II)</i> , No. 6:10-cv-247 (E.D. Texas)	Consolidated with Case No. 2
9	<i>Realtime Data, LLC d/b/a IXO v. Morgan Stanley, et al. (II)</i> , No. 6:10-cv-248 (E.D. Texas)	Consolidated with Case No. 3
10	<i>Realtime Data, LLC D/B/A IXO v. MetroPCS Texas, LLC et al.</i> , No. 6:10-cv-00493 (E.D. Texas)	Pending

*Realtime Data LLC d/b/a/ IXO v. Packeteer, Inc. et al.*

Applicants hereby advise the Patent and Trademark Office that this action has been dismissed with prejudice pursuant to a settlement and license agreement.

Applicants submit herewith documents related to this litigation as documents NPL1-NPL13.

In addition, updated court docket listings downloaded September 2, 2011 for litigations previously disclosed and pending are submitted herewith as NPL27-NPL30.

Information Disclosure Statement

Listed on accompanying IDS Forms PTO/SB/08a equivalent and/or PTO/SB/08b equivalent are documents that may be considered material to the patentability of this

application as defined in 37 C.F.R. §1.56, and in compliance with the duty of disclosure requirements of 37 C.F.R. §§ 1.97 and 1.98.

Applicants have listed publication dates on the attached IDS Forms based on information presently available to the undersigned. However, the listed publication dates should not be construed as an admission that the information was actually published on the date indicated.

Applicants reserve the right to establish the patentability of the claimed invention over any of the information provided herewith, and/or to prove that this information may not be prior art, and/or to prove that this information may not be enabling for the teachings purportedly offered.

This statement should not be construed as a representation that a search has been made, or that information more material to the examination of the present patent application does not exist. The Examiner is specifically requested not to rely solely on the material submitted herewith.

Filing under 37 C.F.R. § 1.97(b). This Information Disclosure Statement is being filed within before the mailing date of a first Office Action on the merits. No statement or fee is required.

Documents US1-US9 are cited on the attached form PTO/SB/08A. Documents NPL1-NPL30 are cited on the attached form PTO/SB/08B. Copies of documents NPL1-NPL30 are submitted. In accordance with 37 C.F.R. § 1.98(a)(2), no copies of U.S.

patents and patent application publications cited on the attached IDS Forms are submitted.

Applicants submit herewith Office Actions from the following co-pending, commonly assigned U.S. Patent Application Nos.:

Document NPL17 is a copy of a Notice of Allowance mailed on July 11, 2011 in the prosecution of co-pending, commonly-assigned U.S. Application No. 11/551,204.

Document NPL18 is a copy of a Notice of Allowance mailed on July 25, 2011 in the prosecution of co-pending, commonly-assigned U.S. Application No. 12/684,624.

Document NPL19 is a copy of a Non-Final Office Action mailed on July 28, 2011 in the prosecution of co-pending, commonly-assigned U.S. Application No. 12/703,042.

Document NPL20 is a copy of a Non-Final Office Action mailed on August 10, 2011 in the prosecution of co-pending, commonly-assigned U.S. Application No. 12/857,238.

Document NPL21 is a copy of a Non-Final Office Action mailed on August 16, 2011 in the prosecution of co-pending, commonly-assigned U.S. Application No. 13/101,994.

Document NPL22 is a copy of a Notice of Allowance mailed on August 24, 2011 in the prosecution of co-pending, commonly-assigned U.S. Application No. 11/551,211.



Document NPL23 is a copy of a Notice of Allowance mailed on September 1, 2011 in the prosecution of co-pending, commonly-assigned U.S. Application No. 12/684,624.

The identification of these Office Actions is not to be construed as a waiver of secrecy as to those applications now or upon issuance of the present application as a patent. The Examiner is respectfully requested to consider the cited applications and the art cited therein during examination.

It is expected that the examiner will review the prosecution and cited art in the parent application nos. 11/551,211, filed October 19, 2006, and 09/776,267, filed February 2, 2001 (now U.S. Patent No. 7,181,608), in accordance with MPEP 2001.06(b), and indicate in the next communication from the office that the art cited in the earlier prosecution history has been reviewed in connection with the present application.

It is respectfully requested that the Examiner initial and return a copy of the enclosed IDS Forms, and indicate in the official file wrapper of this patent application that the documents have been considered.

The U.S. Patent and Trademark Office is hereby authorized to charge any fee deficiency, or credit any overpayment, to our Deposit Account No. 19-0036.

Respectfully submitted,

STERNE, KESSLER, GOLDSSTEIN & FOX P.L.L.C.

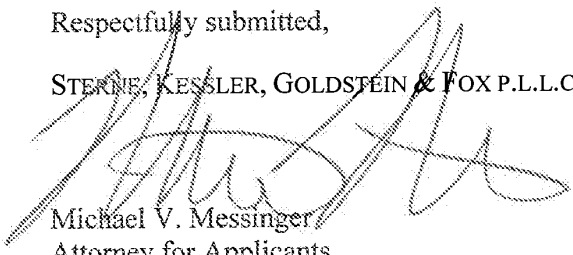

Michael V. Messinger  
Attorney for Applicants  
Registration No. 37,575

Date:

Sept. 16, 2011

1100 New York Avenue, N.W.  
Washington, D.C. 20005-3934  
(202) 371-2600

1417411\_1.DOCX

Substitute for form 1449/PTO				<b>Complete if Known</b>	
				Application Number	13/118,122
<b>FIRST SUPPLEMENTAL INFORMATION DISCLOSURE STATEMENT BY APPLICANT</b> <i>(Use as many sheets as necessary)</i>				Filing Date	May 27, 2011
				First Named Inventor	James J. FALLON
				Art Unit	2115
				Examiner Name	To Be Assigned
				Attorney Docket Number	2855.004000B
				Sheet	1

U.S. PATENT DOCUMENTS						
Examiner initials*	Cite No. <sup>1</sup>	Document Number		Publication Date MM-DD-YYYY	Name of Patentee or Applicant of Cited Document	Pages, Columns, Lines, Where Relevant Passages or Relevant Figures Appear
		Number-Kind Code <sup>2</sup> (if known)				
	US1	6,317,818		11-13-2001	Zwiegincew et al.	
	US2	6,633,968		10-14-2003	Zwiegincew et al.	
	US3	RE40,092		02-19-2008	Kang	
	US4	2010/0316114 A1		12-16-2010	Fallon et al.	
	US5	2010/0318684 A1		12-16-2010	Fallon	
	US6	2010/0332700 A1		12-30-2010	Fallon	
	US7	2011/0037626 A1		02-17-2011	Fallon	
	US8	2011/0199243 A1		08-18-2011	Fallon et al.	
	US9	2011/0208833 A1		08-25-2011	Fallon	

FOREIGN PATENT DOCUMENTS							
Examiner initials*	Cite No. <sup>1</sup>	Foreign Patent Document		Publication Date MM-DD-YYYY	Name of Patentee or Applicant of Cited Document	Pages, Columns, Lines, Where Relevant Passages or Relevant Figures Appear	7 <sup>6</sup>
		Country Code <sup>3</sup> -Number <sup>4</sup> -Kind Code <sup>5</sup> (if known)					

1417405\_1.DOCX

Examiner Signature	/Suresh Suryawanshi/	Date Considered	05/14/2012
--------------------	----------------------	-----------------	------------

\*EXAMINER: Initial if reference considered, whether or not citation is in conformance with MPEP 609. Draw line through citation if not in conformance and not considered. Include copy of this form with next communication to applicant. <sup>1</sup> Applicant's unique citation designation number (optional). <sup>2</sup> See Kinds Codes of USPTO Patent Documents at www.uspto.gov or MPEP 901.04. <sup>3</sup> Enter Office that issued the document, by the two-letter code (WIPO Standard ST.3). <sup>4</sup> For Japanese patent documents, the number of the Japanese Patent Office (JPO) must precede the kind code. <sup>5</sup> Enter the number of the patent document of document by the appropriate symbols as indicated on the document under WIPO Standard ST.16 if possible. <sup>6</sup> Applicant is to place a check mark here if English language Translation is attached.

ALL REFERENCES CONSIDERED EXCEPT WHERE LINED THROUGH. /SKS/

Substitute for form 1449/PTO		<b>Complete if Known</b>	
<b>FIRST SUPPLEMENTAL INFORMATION DISCLOSURE STATEMENT BY APPLICANT</b> <i>(Use as many sheets as necessary)</i>		Application Number	13/118,122
		Filing Date	May 27, 2011
		First Named Inventor	James J. FALLON
		Art Unit	2115
		Examiner Name	To Be Assigned
Sheet	1 of 3	Attorney Docket Number	2855.004000B

NON PATENT LITERATURE DOCUMENTS			
Examiner Initials*	Cite No. <sup>1</sup>	Include name of the author (in CAPITAL LETTERS), title of the article (when appropriate), title of the item (book, magazine, journal, serial, symposium, catalog, etc.), date, page(s), volume-issue number(s), publisher, city and/or country where published	T <sup>2</sup>
	NPL1	Defendants' Joint Preliminary Invalidation Contentions filed in Realtime Data, LLC D/B/A IXO v. Packeteer, Inc., et al., Civil Action No. 6:08-cv-144-LED, United States District Court for the Eastern District of Texas Tyler Division, December 8, 2008, 19 pages.	
	NPL2	Appendix A, Claim Charts A-1 to A-46, from Realtime Data, LLC v. Packeteer, Inc., et al., Civil Action No. 6:08-cv-144-LED, December 8, 2008, 345 pages.	
	NPL3	Appendix B, Claim Charts B-1 to B-17, from Realtime Data, LLC v. Packeteer, Inc., et al., Civil Action No. 6:08-cv-144-LED, December 8, 2008, 1,893 pages.	
	NPL4	Appendix C, Claim Charts C-1 to C-34, from Realtime Data, LLC v. Packeteer, Inc., et al., Civil Action No. 6:08-cv-144-LED, December 8, 2008, 1,055 pages.	
	NPL5	Appendix D, Claim Charts D-1 to D-14, from Realtime Data, LLC v. Packeteer, Inc., et al., Civil Action No. 6:08-cv-144-LED, December 8, 2008, 197 pages.	
	NPL6	Appendix E, Claim Charts E-1 to E-11, from Realtime Data, LLC v. Packeteer, Inc., et al., Civil Action No. 6:08-cv-144-LED, December 8, 2008, 735 pages.	
	NPL7	Appendix F, Claim Charts F-1 to F-11, from Realtime Data, LLC v. Packeteer, Inc., et al., Civil Action No. 6:08-cv-144-LED, December 8, 2008, 775 pages.	
	NPL8	Appendix G Claim Charts G-1 to G-8 from Realtime Data, LLC v. Packeteer, Inc., et al., Civil Action No. 6:08-cv-144-LED, December 8, 2008, 567 pages.	
	NPL9	Appendix H, Claim Charts H-1 to H-18, from Realtime Data, LLC v. Packeteer, Inc., et al., Civil Action No. 6:08-cv-144-LED, December 8, 2008, 97 pages.	
	NPL10	Appendix I, Claim Charts I-1 to I-18, from Realtime Data, LLC v. Packeteer, Inc., et al., Civil Action No. 6:08-cv-144-LED, December 8, 2008, 146 pages.	

Examiner Signature	/Suresh Suryawanshi/	Date Considered	05/14/2012
--------------------	----------------------	-----------------	------------

\*EXAMINER: Initial if reference considered, whether or not citation is in conformance with MPEP 609. Draw line through citation if not in conformance and not considered. Include copy of this form with next communication to applicant.

<sup>1</sup> Applicant's unique identification number for this document. Applicant's in place a check mark here if English language translation is attached.

ALL REFERENCES CONSIDERED EXCEPT WHERE LINED THROUGH. /SKS/

Substitute for form 1449/PTO		<b>Complete if Known</b>	
<b>FIRST SUPPLEMENTAL INFORMATION DISCLOSURE STATEMENT BY APPLICANT</b> <i>(Use as many sheets as necessary)</i>		Application Number	13/118,122
		Filing Date	May 27, 2011
		First Named Inventor	James J. FALLON
		Art Unit	2115
		Examiner Name	To Be Assigned
Sheet	2 of 3	Attorney Docket Number	2855.004000B

NON PATENT LITERATURE DOCUMENTS			
Examiner Initials*	Cite No. <sup>1</sup>	Include name of the author (in CAPITAL LETTERS), title of the article (when appropriate), title of the item (book, magazine, journal, serial, symposium, catalog, etc.), date, page(s), volume number, publisher, city and/or country where published	T <sup>2</sup>
	NPL11	Appendix J, Prior Art Chart, from Realtime Data, LLC v. Packeteer, Inc., et al., Civil Action No. 6:08-cv-144-LED, December 8, 2008, 25 pages.	
	NPL12	Realtime Data, LLC's [Corrected] P.R. 3-1 Disclosures and Preliminary Infringement Contentions filed in Realtime Data, LLC D/B/A/IXO v. Packeteer, Inc., et al., Civil Action No. 6:08-cv-00144-LED, United States District Court for the Eastern District of Texas Tyler Division, October 8, 2008, 300 pages.	
	NPL13	Amended Answer and Counterclaims of Defendants Blue Coat Systems, Inc., Packeteer, Inc., 7-Eleven, Inc., ABM Industries, Inc., ABM Janitorial Services-South Central, Inc., and Build-A-Bear Workshop, Inc. to Plaintiff's First Amended Complaint for Patent Infringement filed in Realtime Data, LLC d/b/a/IXO v. Packeteer, Inc., et al., Civil Action No. 6:08cv144-LED, United States District Court for the Eastern District of Texas Tyler Division, October 8, 2008, 81 pages.	
	NPL14	"Packeteer iShaper, PacketShaper and iShared Appliances Drive Intelligent Application Acceleration Across Coogee Resources Wide Area Network", Business Wire, accessed on August 25, 2008, 2 pages.	
	NPL15	WHITING, Doug, "Deflate vs. LZS", November, 2000, 2 pages.	
	NPL16	"The Packeteer Q4 2005 Financial Conference Call", January 26, 2006, 9 pages.	
	NPL17	Copy of Notice of Allowance for U.S. Appl. No. 11/551,204, mailed July 11, 2011, 5 pages.	
	NPL18	Copy of Notice of Allowance for U.S. Appl. No. 12/684,624, mailed July 25, 2011, 5 pages.	
	NPL19	Copy of Non-Final Office Action for U.S. Appl. No. 12/703,042, mailed July 28, 2011, 5 pages.	
	NPL20	Copy of Non-Final Office Action for U.S. Appl. No. 12/857,238, mailed August 10, 2011, 6 pages.	

Examiner Signature	/Suresh Suryawanshi/	Date Considered	05/14/2012
--------------------	----------------------	-----------------	------------

\*EXAMINER: Initial if reference considered, whether or not citation is in conformance with MPEP 609. Draw line through citation if not in conformance and not considered. Include copy of this form with next communication to applicant.

<sup>1</sup> Applicant's unique citation designation number (optional). <sup>2</sup> Applicant to place a check mark here if English language translation is attached.

ALL REFERENCES CONSIDERED EXCEPT WHERE LINED THROUGH. /SKS./

Substitute for form 1449/PTO		<b>Complete if Known</b>	
<b>FIRST SUPPLEMENTAL INFORMATION DISCLOSURE STATEMENT BY APPLICANT</b> <i>(Use as many sheets as necessary)</i>		Application Number	13/118,122
		Filing Date	May 27, 2011
		First Named Inventor	James J. FALLON
		Art Unit	2115
		Examiner Name	To Be Assigned
		Attorney Docket Number	2855.004000B
Sheet	3	of	3

NON PATENT LITERATURE DOCUMENTS			
Examiner Initials*	Cite No. <sup>1</sup>	Include name of the author (in CAPITAL LETTERS), title of the article (when appropriate), title of the item (book, magazine, journal, serial, symposium, catalog, etc.), date, page(s), volume number, publisher, city and/or country where published	T <sup>2</sup>
	NPL21	Copy of Non-Final Office Action for U.S. Appl. No. 13/101,994, mailed August 16, 2011, 10 pages.	
	NPL22	Copy of Notice of Allowance for U.S. Appl. No. 11/551,211, mailed August 24, 2011, 5 pages.	
	NPL23	Copy of Notice of Allowance for U.S. Appl. No. 12/684,624, mailed September 1, 2011, 9 pages.	
	NPL24	Examiner's Answer to Appeal Brief in Inter Partes Reexamination of U.S. Patent No. 7,321,937, Control No. 95/000,466, mailed July 18, 2011, 33 pages.	
	NPL25	Non-Final Office Action in Inter Partes Reexamination of U.S. Patent No. 7,777,651, Control No. 95/001,581, mailed July 25, 2011, 274 pages.	
	NPL26	"Data Compression Ratio", Wikipedia, the free encyclopedia, accessed on August 10, 2011 from <a href="http://en.wikipedia.org/wiki/Data_compression_ratio">http://en.wikipedia.org/wiki/Data_compression_ratio</a> , 2 pages.	
	NPL27	Court Docket History for 6:10-cv-00493-LED-JDL Realtime Data, LLC D/B/A/ IXO, v. MetroPCS Texas, LLC et al., dated September 2, 2011, 16 pages.	
	NPL28	Court Docket History for 6:09-cv-00326-LED-JDL Realtime Data, LLC D/B/A/ IXO, v. Morgan Stanley et al., dated September 2, 2011, 45 pages.	
	NPL29	Court Docket History for 6:09-cv-00327-LED-JDL Realtime Data, LLC D/B/A/IXO, v. CME Group Inc. et al., dated September 2, 2011, 56 pages.	
	NPL30	Court Docket History for 6:09-cv-00333-LED-JDL Realtime Data, LLC d/b/a IXO v. Thomson Reuters et al., dated September 2, 2011, 30 pages.	

1417407\_1.DOCX

Examiner Signature	/Suresh Suryawanshi/	Date Considered	05/14/2012
-----------------------	----------------------	--------------------	------------

\*EXAMINER: Initial if reference considered, whether or not citation is in conformance with MPEP 609. Draw line through citation if not in conformance and not considered. Include copy of this form with next communication to applicant.

<sup>1</sup> Applicant's Unique Identification Number (UIN) is required to be marked here if English language translation is attached.

ALL REFERENCES CONSIDERED EXCEPT WHERE LINED THROUGH. /SKS./



UNITED STATES PATENT AND TRADEMARK OFFICE

UNITED STATES DEPARTMENT OF COMMERCE  
 United States Patent and Trademark Office  
 Address: COMMISSIONER FOR PATENTS  
 P.O. Box 1450  
 Alexandria, Virginia 22313-1450  
 www.uspto.gov

BIB DATA SHEET

CONFIRMATION NO. 8978

<b>SERIAL NUMBER</b> 13/118,122	<b>FILING or 371(c) DATE</b> 05/27/2011 <b>RULE</b>	<b>CLASS</b> 713	<b>GROUP ART UNIT</b> 2115	<b>ATTORNEY DOCKET NO.</b> 2855.004000B		
<b>APPLICANTS</b> James J. Fallon, Armonk, NY; John Buck, Oceanside, NY; Paul F. Pickel, Bethpage, NY; Stephen J. McErlain, New York, NY;						
<b>** CONTINUING DATA *****</b> This application is a CON of 11/551,211 10/19/2006 PAT 8,112,619 which is a CON of 09/776,267 02/02/2001 PAT 7,181,608 Yes /SKS/ which claims benefit of 60/180,114 02/03/2000						
<b>** FOREIGN APPLICATIONS *****</b> None /SKS/						
<b>** IF REQUIRED, FOREIGN FILING LICENSE GRANTED **</b> 06/10/2011						
Foreign Priority claimed <input type="checkbox"/> Yes <input checked="" type="checkbox"/> No	35 USC 119(a-d) conditions met <input type="checkbox"/> Yes <input type="checkbox"/> No	<input type="checkbox"/> Met after Allowance	<b>STATE OR COUNTRY</b> NY	<b>SHEETS DRAWINGS</b> 13	<b>TOTAL CLAIMS</b> 1	<b>INDEPENDENT CLAIMS</b> 1
Verified and Acknowledged	/SURESH SURYAWANSHI/ Examiner's Signature	Initials				
<b>ADDRESS</b> STERNE, KESSLER, GOLDSTEIN & FOX P.L.L.C. 1100 NEW YORK AVENUE, N.W. WASHINGTON, DC 20005 UNITED STATES						
<b>TITLE</b> Systems and Methods for Accelerated Loading of Operating Systems and Application Programs						
<b>FILING FEE RECEIVED</b> 1090	FEES: Authority has been given in Paper No. _____ to charge/credit DEPOSIT ACCOUNT No. _____ for following:		<input type="checkbox"/> All Fees <input type="checkbox"/> 1.16 Fees (Filing) <input type="checkbox"/> 1.17 Fees (Processing Ext. of time) <input type="checkbox"/> 1.18 Fees (Issue) <input type="checkbox"/> Other _____ <input type="checkbox"/> Credit			



UNITED STATES PATENT AND TRADEMARK OFFICE

UNITED STATES DEPARTMENT OF COMMERCE
United States Patent and Trademark Office
Address: COMMISSIONER FOR PATENTS
P.O. Box 1450
Alexandria, Virginia 22313-1450
www.uspto.gov

Table with 4 columns: APPLICATION NUMBER (13/118,122), FILING OR 371(C) DATE (05/27/2011), FIRST NAMED APPLICANT (James J. Fallon), ATTY. DOCKET NO./TITLE (2855.004000B)

CONFIRMATION NO. 8978

26111
STERNE, KESSLER, GOLDSTEIN & FOX P.L.L.C.
1100 NEW YORK AVENUE, N.W.
WASHINGTON, DC 20005

PUBLICATION NOTICE



Title: Systems and Methods for Accelerated Loading of Operating Systems and Application Programs

Publication No. US-2011-0231642-A1

Publication Date: 09/22/2011

NOTICE OF PUBLICATION OF APPLICATION

The above-identified application will be electronically published as a patent application publication pursuant to 37 CFR 1.211, et seq. The patent application publication number and publication date are set forth above.

The publication may be accessed through the USPTO's publically available Searchable Databases via the Internet at www.uspto.gov. The direct link to access the publication is currently http://www.uspto.gov/patft/.

The publication process established by the Office does not provide for mailing a copy of the publication to applicant. A copy of the publication may be obtained from the Office upon payment of the appropriate fee set forth in 37 CFR 1.19(a)(1). Orders for copies of patent application publications are handled by the USPTO's Office of Public Records. The Office of Public Records can be reached by telephone at (703) 308-9726 or (800) 972-6382, by facsimile at (703) 305-8759, by mail addressed to the United States Patent and Trademark Office, Office of Public Records, Alexandria, VA 22313-1450 or via the Internet.

In addition, information on the status of the application, including the mailing date of Office actions and the dates of receipt of correspondence filed in the Office, may also be accessed via the Internet through the Patent Electronic Business Center at www.uspto.gov using the public side of the Patent Application Information and Retrieval (PAIR) system. The direct link to access this status information is currently http://pair.uspto.gov/. Prior to publication, such status information is confidential and may only be obtained by applicant using the private side of PAIR.

Further assistance in electronically accessing the publication, or about PAIR, is available by calling the Patent Electronic Business Center at 1-866-217-9197.

Office of Data Management, Application Assistance Unit (571) 272-4000, or (571) 272-4200, or 1-888-786-0101



IN THE UNITED STATES PATENT AND TRADEMARK OFFICE

In re application of:

FALLON *et al.*

Appl. No.: 13/118,122

Filed: May 27, 2011

For: **Systems and Methods for  
Accelerated Loading of Operating  
Systems and Application Programs**

Confirmation No.: 8978

Art Unit: 2115

Examiner: To Be Assigned

Atty. Docket: 2855.004000B

**First Supplemental Information Disclosure Statement**

***Mail Stop Amendment***

Commissioner for Patents  
PO Box 1450  
Alexandria, VA 22313-1450

Sir:

Notice of Prior and Concurrent Proceedings

Applicants hereby call to the attention of the Patent and Trademark Office the following reexamination proceedings involving patents that are commonly-assigned with the patent in the above-identified patent application:

<b>Proceeding</b>	<b>Status</b>
<i>Inter Partes</i> Reexamination of U.S. Patent No. 6,604,158 (Control No. 95/000,486)	Patent Owner Comments after Action Closing Prosecution filed May 9, 2011; Non-Final Action Closing Prosecution mailed March 7, 2011; Decision Dismissing Petition mailed January 26, 2011; Petition filed August 25, 2010
<i>Inter Partes</i> Reexamination of U.S. Patent No. 7,321,937 (Control No. 95/000,466)	Examiner's Answer issued July 18, 2011; Decision Dismissing Petition mailed January 26, 2011; Appeal Brief filed Oct. 25, 2010
<i>Inter Partes</i> Reexamination of U.S. Patent No. 6,604,158 (Control No. 95/000,453)	Terminated

Proceeding	Status
<i>Ex Parte</i> Reexamination of U.S. Patent No. 6,601,104 (Control No. 90/009,428)	Miscellaneous Action with SSP 6/7/2011; Request for Rehearing after Board Decision 5/18/2011; BPAI Decision mailed March 18, 2011; Notification of Appeal Hearing issued January 14, 2011; Examiner's Answer issued Oct. 6, 2010
<i>Inter Partes</i> Reexamination of U.S. Patent No. 7,378,992 (Control No. 95/000,478)	Appeal-Brief Filed 4/21/2011; Notice of Appeal filed February 8, 2011; Decision Dismissing Petition mailed January 25, 2011; Patent Owner Comments on Action Closing Prosecution filed September 23, 2010
<i>Inter Partes</i> Reexamination of U.S. Patent No. 6,624,761 (Control No. 95/000,464)	Appeal Brief Filed 4/21/2011; Notice of Appeal filed February 8, 2011; Decision Dismissing Petition mailed January 25, 2011; Patent Owner Comments on Action Closing Prosecution filed September 28, 2010
<i>Inter Partes</i> Reexamination of U.S. Patent No. 7,161,506 (Control No. 95/000,479)	Appeal Brief Filed 4/21/2011; Notice of Appeal filed February 10, 2011; Decision Dismissing Petition mailed January 25, 2011; Patent Owner Comments on Action Closing Prosecution filed September 27, 2010
<i>Inter Partes</i> Reexamination of U.S. Patent No. 7,714,747 (Control No. 95/001,517)	Order Granting Reexam received 3/9/2011; Notice of Assignment of Reexamination Request Issued 1/13/2011; Filed 12/30/2010
<i>Inter Partes</i> Reexamination of U.S. Patent No. 7,417,568 (Control No. 95/001,533)	Non-Final Office Action mailed 5/6/2011; Replacement Reexam Request filed 3/1/2011; Notification of Incomplete <i>Inter Partes</i> Reexam Request issued 2/22/2011; Reexam Request originally filed 1/31/2011;

<b>Proceeding</b>	<b>Status</b>
<i>Inter Partes Reexamination of U.S. Patent No. 7,777,651 (Control No. 95/001,581)</i>	Non-Final Office Action mailed 7/25/2011; Order Granting Reexam Request mailed 6/15/2011; Filed 3/21/2011
<i>Inter Partes Reexamination of U.S. Patent No. 7,400,274 (Control No. 95/001,544)</i>	Non-Final Office Action mailed 5/20/2011; Filed 2/14/2011

Applicants invite the Examiner to review the Requests for Reexamination, issued Office Actions, replies, and any other papers in the above-identified reexamination proceedings. If the Examiner is unable to obtain copies of papers in any reexamination proceeding, copies can be provided to the Examiner upon request. Those documents which may be material that are not already of record in this patent application are listed on the accompanying Form PTO/SB/08. For example, documents related to the reexaminations are listed at NPL24-NPL25.

Notice of Related Litigation

Applicants notify the Patent and Trademark Office of the following litigation involving U.S. Patents commonly-owned with the current patent application, the subject matter of which may be related to the present patent application:

<b>No.</b>	<b>Case</b>	<b>Status</b>
1	<i>Realtime Data LLC d/b/a IXO v. Packeteer, Inc. et al.</i> , No. 6:08-cv-00144-LED (E.D. Texas)	Dismissed

Applicants also notify the Patent and Trademark Office of the following additional litigation involving U.S. Patents commonly-owned with the current patent application, the subject matter of which may be related to the present patent application:

<b>No.</b>	<b>Case</b>	<b>Status</b>
2	<i>Realtime Data LLC d/b/a IXO v. Thomson Reuters Corporation et al.</i> No. 6:09-cv-00333-LED (E.D. Texas)	Pending, Order denying Motion to Expedite Briefing, Order granting writ of mandamus to transfer to the Southern District of New York.
3	<i>Realtime Data LLC d/b/a IXO v. Morgan Stanley et al.</i> ,	Pending, Order

	No. 6:09-cv-00326-LED (E.D. Texas)	denying Motion to Expedite Briefing, Order granting writ of mandamus to transfer to the Southern District of New York.
4	<i>Realtime Data LLC d/b/a IXO v. CME Group Inc., et al.</i> , No. 6:09-cv-00327-LED (E.D. Texas)	Pending, Order denying Motion to Expedite Briefing, Order granting writ of mandamus to transfer to the Southern District of New York.
5	<i>Chicago Board Options Exchange, Inc., v. Realtime Data LLC d/b/a IXO</i> , No. 09-cv-4486 (N.D. Ill.)	Dismissed
6	<i>Thomson Reuters Corporation v. Realtime Data, LLC d/b/a IXO</i> , No. 1:09-cv-07868-RMB (S.D.N.Y)	Consolidated with Case No. 2
7	<i>Realtime Data, LLC d/b/a IXO v. CME Group Inc., et al. (II)</i> , No. 6:10-cv-246 (E.D. Texas)	Consolidated with Case No. 4
8	<i>Realtime Data LLC d/b/a IXO v. Thomson Reuters Corporation et al. (II)</i> , No. 6:10-cv-247 (E.D. Texas)	Consolidated with Case No. 2
9	<i>Realtime Data, LLC d/b/a IXO v. Morgan Stanley, et al. (II)</i> , No. 6:10-cv-248 (E.D. Texas)	Consolidated with Case No. 3
10	<i>Realtime Data, LLC D/B/A IXO v. MetroPCS Texas, LLC et al.</i> , No. 6:10-cv-00493 (E.D. Texas)	Pending

*Realtime Data LLC d/b/a/ IXO v. Packeteer, Inc. et al.*

Applicants hereby advise the Patent and Trademark Office that this action has been dismissed with prejudice pursuant to a settlement and license agreement.

Applicants submit herewith documents related to this litigation as documents NPL1-NPL13.

In addition, updated court docket listings downloaded September 2, 2011 for litigations previously disclosed and pending are submitted herewith as NPL27-NPL30.

Information Disclosure Statement

Listed on accompanying IDS Forms PTO/SB/08a equivalent and/or PTO/SB/08b equivalent are documents that may be considered material to the patentability of this

application as defined in 37 C.F.R. §1.56, and in compliance with the duty of disclosure requirements of 37 C.F.R. §§ 1.97 and 1.98.

Applicants have listed publication dates on the attached IDS Forms based on information presently available to the undersigned. However, the listed publication dates should not be construed as an admission that the information was actually published on the date indicated.

Applicants reserve the right to establish the patentability of the claimed invention over any of the information provided herewith, and/or to prove that this information may not be prior art, and/or to prove that this information may not be enabling for the teachings purportedly offered.

This statement should not be construed as a representation that a search has been made, or that information more material to the examination of the present patent application does not exist. The Examiner is specifically requested not to rely solely on the material submitted herewith.

Filing under 37 C.F.R. § 1.97(b). This Information Disclosure Statement is being filed within before the mailing date of a first Office Action on the merits. No statement or fee is required.

Documents US1-US9 are cited on the attached form PTO/SB/08A. Documents NPL1-NPL30 are cited on the attached form PTO/SB/08B. Copies of documents NPL1-NPL30 are submitted. In accordance with 37 C.F.R. § 1.98(a)(2), no copies of U.S.

patents and patent application publications cited on the attached IDS Forms are submitted.

Applicants submit herewith Office Actions from the following co-pending, commonly assigned U.S. Patent Application Nos.:

Document NPL17 is a copy of a Notice of Allowance mailed on July 11, 2011 in the prosecution of co-pending, commonly-assigned U.S. Application No. 11/551,204.

Document NPL18 is a copy of a Notice of Allowance mailed on July 25, 2011 in the prosecution of co-pending, commonly-assigned U.S. Application No. 12/684,624.

Document NPL19 is a copy of a Non-Final Office Action mailed on July 28, 2011 in the prosecution of co-pending, commonly-assigned U.S. Application No. 12/703,042.

Document NPL20 is a copy of a Non-Final Office Action mailed on August 10, 2011 in the prosecution of co-pending, commonly-assigned U.S. Application No. 12/857,238.

Document NPL21 is a copy of a Non-Final Office Action mailed on August 16, 2011 in the prosecution of co-pending, commonly-assigned U.S. Application No. 13/101,994.

Document NPL22 is a copy of a Notice of Allowance mailed on August 24, 2011 in the prosecution of co-pending, commonly-assigned U.S. Application No. 11/551,211.

Document NPL23 is a copy of a Notice of Allowance mailed on September 1, 2011 in the prosecution of co-pending, commonly-assigned U.S. Application No. 12/684,624.

The identification of these Office Actions is not to be construed as a waiver of secrecy as to those applications now or upon issuance of the present application as a patent. The Examiner is respectfully requested to consider the cited applications and the art cited therein during examination.

It is expected that the examiner will review the prosecution and cited art in the parent application nos. 11/551,211, filed October 19, 2006, and 09/776,267, filed February 2, 2001 (now U.S. Patent No. 7,181,608), in accordance with MPEP 2001.06(b), and indicate in the next communication from the office that the art cited in the earlier prosecution history has been reviewed in connection with the present application.

It is respectfully requested that the Examiner initial and return a copy of the enclosed IDS Forms, and indicate in the official file wrapper of this patent application that the documents have been considered.

The U.S. Patent and Trademark Office is hereby authorized to charge any fee deficiency, or credit any overpayment, to our Deposit Account No. 19-0036.

Respectfully submitted,

STERNE, KESSLER, GOLDSSTEIN & FOX P.L.L.C.

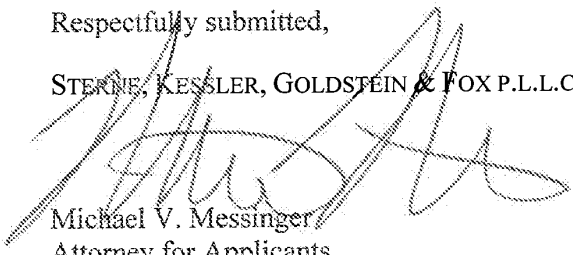

Michael V. Messinger  
Attorney for Applicants  
Registration No. 37,575

Date:

Sept. 16, 2011

1100 New York Avenue, N.W.  
Washington, D.C. 20005-3934  
(202) 371-2600

1417411\_1.DOCX



Substitute for form 1449/PTO  <b>FIRST SUPPLEMENTAL                  INFORMATION DISCLOSURE                  STATEMENT BY APPLICANT</b> <i>(Use as many sheets as necessary)</i>			<b>Complete if Known</b>	
			Application Number	13/118,122
			Filing Date	May 27, 2011
			First Named Inventor	James J. FALLON
			Art Unit	2115
			Examiner Name	To Be Assigned
			Attorney Docket Number	2855.004000B
Sheet	1	of	1	

U.S. PATENT DOCUMENTS						
Examiner initials*	Cite No. <sup>1</sup>	Document Number		Publication Date MM-DD-YYYY	Name of Patentee or Applicant of Cited Document	Pages, Columns, Lines, Where Relevant Passages or Relevant Figures Appear
		Number-Kind Code <sup>2</sup> (if known)				
	US1	6,317,818		11-13-2001	Zwiegincew et al.	
	US2	6,633,968		10-14-2003	Zwiegincew et al.	
	US3	RE40,092		02-19-2008	Kang	
	US4	2010/0316114 A1		12-16-2010	Fallon et al.	
	US5	2010/0318684 A1		12-16-2010	Fallon	
	US6	2010/0332700 A1		12-30-2010	Fallon	
	US7	2011/0037626 A1		02-17-2011	Fallon	
	US8	2011/0199243 A1		08-18-2011	Fallon et al.	
	US9	2011/0208833 A1		08-25-2011	Fallon	

FOREIGN PATENT DOCUMENTS							
Examiner initials*	Cite No. <sup>1</sup>	Foreign Patent Document		Publication Date MM-DD-YYYY	Name of Patentee or Applicant of Cited Document	Pages, Columns, Lines, Where Relevant Passages or Relevant Figures Appear	7 <sup>6</sup>
		Country Code <sup>3</sup> -Number <sup>4</sup> -Kind Code <sup>5</sup> (if known)					

1417405\_1.DOCX

Examiner Signature		Date Considered	
--------------------	--	-----------------	--

\*EXAMINER: Initial if reference considered, whether or not citation is in conformance with MPEP 609. Draw line through citation if not in conformance and not considered. Include copy of this form with next communication to applicant. <sup>1</sup> Applicant's unique citation designation number (optional). <sup>2</sup> See Kinds Codes of USPTO Patent Documents at www.uspto.gov or MPEP 901.04. <sup>3</sup> Enter Office that issued the document, by the two-letter code (WIPO Standard ST.3). <sup>4</sup> For Japanese patent documents, the indication of the year of the reign of the Emperor must precede the serial number of the patent document. <sup>5</sup> Kind of document by the appropriate symbols as indicated on the document under WIPO Standard ST.16 if possible. <sup>6</sup> Applicant is to place a check mark here if English language Translation is attached.

Substitute for form 1449/PTO		<b>Complete if Known</b>	
<b>FIRST SUPPLEMENTAL INFORMATION DISCLOSURE STATEMENT BY APPLICANT</b> <i>(Use as many sheets as necessary)</i>		Application Number	13/118,122
		Filing Date	May 27, 2011
		First Named Inventor	James J. FALLON
		Art Unit	2115
		Examiner Name	To Be Assigned
Sheet	1 of 3	Attorney Docket Number	2855.004000B

NON PATENT LITERATURE DOCUMENTS			
Examiner Initials*	Cite No. <sup>1</sup>	Include name of the author (in CAPITAL LETTERS), title of the article (when appropriate), title of the item (book, magazine, journal, serial, symposium, catalog, etc.), date, page(s), volume-issue number(s), publisher, city and/or country where published	T <sup>2</sup>
	NPL1	Defendants' Joint Preliminary Invalidity Contentions filed in Realtime Data, LLC D/B/A IXO v. Packeteer, Inc., et al., Civil Action No. 6:08-cv-144-LED, United States District Court for the Eastern District of Texas Tyler Division, December 8, 2008, 19 pages.	
	NPL2	Appendix A, Claim Charts A-1 to A-46, from Realtime Data, LLC v. Packeteer, Inc., et al., Civil Action No. 6:08-cv-144-LED, December 8, 2008, 345 pages.	
	NPL3	Appendix B, Claim Charts B-1 to B-17, from Realtime Data, LLC v. Packeteer, Inc., et al., Civil Action No. 6:08-cv-144-LED, December 8, 2008, 1,893 pages.	
	NPL4	Appendix C, Claim Charts C-1 to C-34, from Realtime Data, LLC v. Packeteer, Inc., et al., Civil Action No. 6:08-cv-144-LED, December 8, 2008, 1,055 pages.	
	NPL5	Appendix D, Claim Charts D-1 to D-14, from Realtime Data, LLC v. Packeteer, Inc., et al., Civil Action No. 6:08-cv-144-LED, December 8, 2008, 197 pages.	
	NPL6	Appendix E, Claim Charts E-1 to E-11, from Realtime Data, LLC v. Packeteer, Inc., et al., Civil Action No. 6:08-cv-144-LED, December 8, 2008, 735 pages.	
	NPL7	Appendix F, Claim Charts F-1 to F-11, from Realtime Data, LLC v. Packeteer, Inc., et al., Civil Action No. 6:08-cv-144-LED, December 8, 2008, 775 pages.	
	NPL8	Appendix G Claim Charts G-1 to G-8 from Realtime Data, LLC v. Packeteer, Inc., et al., Civil Action No. 6:08-cv-144-LED, December 8, 2008, 567 pages.	
	NPL9	Appendix H, Claim Charts H-1 to H-18, from Realtime Data, LLC v. Packeteer, Inc., et al., Civil Action No. 6:08-cv-144-LED, December 8, 2008, 97 pages.	
	NPL10	Appendix I, Claim Charts I-1 to I-18, from Realtime Data, LLC v. Packeteer, Inc., et al., Civil Action No. 6:08-cv-144-LED, December 8, 2008, 146 pages.	

Examiner Signature	Date Considered
-----------------------	--------------------

\*EXAMINER: Initial if reference considered, whether or not citation is in conformance with MPEP 609. Draw line through citation if not in conformance and not considered. Include copy of this form with next communication to applicant.

<sup>1</sup> Applicant's unique citation designation number (optional). <sup>2</sup> Applicant is to place a check mark here if English language Translation is attached.

Substitute for form 1449/PTO		<b>Complete if Known</b>	
<b>FIRST SUPPLEMENTAL INFORMATION DISCLOSURE STATEMENT BY APPLICANT</b> <i>(Use as many sheets as necessary)</i>		Application Number	13/118,122
		Filing Date	May 27, 2011
		First Named Inventor	James J. FALLON
		Art Unit	2115
		Examiner Name	To Be Assigned
Sheet	2	of	3
		Attorney Docket Number	2855.004000B

NON PATENT LITERATURE DOCUMENTS			
Examiner Initials*	Cite No. <sup>1</sup>	Include name of the author (in CAPITAL LETTERS), title of the article (when appropriate), title of the item (book, magazine, journal, serial, symposium, catalog, etc.), date, page(s), volume number, publisher, city and/or country where published	T <sup>2</sup>
	NPL11	Appendix J, Prior Art Chart, from Realtime Data, LLC v. Packeteer, Inc., et al., Civil Action No. 6:08-cv-144-LED, December 8, 2008, 25 pages.	
	NPL12	Realtime Data, LLC's [Corrected] P.R. 3-1 Disclosures and Preliminary Infringement Contentions filed in Realtime Data, LLC D/B/A/IXO v. Packeteer, Inc., et al., Civil Action No. 6:08-cv-00144-LED, United States District Court for the Eastern District of Texas Tyler Division, October 8, 2008, 300 pages.	
	NPL13	Amended Answer and Counterclaims of Defendants Blue Coat Systems, Inc., Packeteer, Inc., 7-Eleven, Inc., ABM Industries, Inc., ABM Janitorial Services-South Central, Inc., and Build-A-Bear Workshop, Inc. to Plaintiff's First Amended Complaint for Patent Infringement filed in Realtime Data, LLC d/b/a/IXO v. Packeteer, Inc., et al., Civil Action No. 6:08cv144-LED, United States District Court for the Eastern District of Texas Tyler Division, October 8, 2008, 81 pages.	
	NPL14	"Packeteer iShaper, PacketShaper and iShared Appliances Drive Intelligent Application Acceleration Across Coogee Resources Wide Area Network", Business Wire, accessed on August 25, 2008, 2 pages.	
	NPL15	WHITING, Doug, "Deflate vs. LZS", November, 2000, 2 pages.	
	NPL16	"The Packeteer Q4 2005 Financial Conference Call", January 26, 2006, 9 pages.	
	NPL17	Copy of Notice of Allowance for U.S. Appl. No. 11/551,204, mailed July 11, 2011, 5 pages.	
	NPL18	Copy of Notice of Allowance for U.S. Appl. No. 12/684,624, mailed July 25, 2011, 5 pages.	
	NPL19	Copy of Non-Final Office Action for U.S. Appl. No. 12/703,042, mailed July 28, 2011, 5 pages.	
	NPL20	Copy of Non-Final Office Action for U.S. Appl. No. 12/857,238, mailed August 10, 2011, 6 pages.	

Examiner Signature		Date Considered	
-----------------------	--	--------------------	--

\*EXAMINER: Initial if reference considered, whether or not citation is in conformance with MPEP 609. Draw line through citation if not in conformance and not considered. Include copy of this form with next communication to applicant.

<sup>1</sup> Applicant's unique citation designation number (optional). <sup>2</sup> Applicant is to place a check mark here if English language Translation is attached.

Substitute for form 1449/PTO		<b>Complete if Known</b>	
<b>FIRST SUPPLEMENTAL INFORMATION DISCLOSURE STATEMENT BY APPLICANT</b> <i>(Use as many sheets as necessary)</i>		Application Number	13/118,122
		Filing Date	May 27, 2011
		First Named Inventor	James J. FALLON
		Art Unit	2115
		Examiner Name	To Be Assigned
Sheet	3 of 3	Attorney Docket Number	2855.004000B

NON PATENT LITERATURE DOCUMENTS			
Examiner Initials*	Cite No. <sup>1</sup>	Include name of the author (in CAPITAL LETTERS), title of the article (when appropriate), title of the item (book, magazine, journal, serial, symposium, catalog, etc.), date, page(s), volume number, publisher, city and/or country where published	T <sup>2</sup>
	NPL21	Copy of Non-Final Office Action for U.S. Appl. No. 13/101,994, mailed August 16, 2011, 10 pages.	
	NPL22	Copy of Notice of Allowance for U.S. Appl. No. 11/551,211, mailed August 24, 2011, 5 pages.	
	NPL23	Copy of Notice of Allowance for U.S. Appl. No. 12/684,624, mailed September 1, 2011, 9 pages.	
	NPL24	Examiner's Answer to Appeal Brief in Inter Partes Reexamination of U.S. Patent No. 7,321,937, Control No. 95/000,466, mailed July 18, 2011, 33 pages.	
	NPL25	Non-Final Office Action in Inter Partes Reexamination of U.S. Patent No. 7,777,651, Control No. 95/001,581, mailed July 25, 2011, 274 pages.	
	NPL26	"Data Compression Ratio", Wikipedia, the free encyclopedia, accessed on August 10, 2011 from <a href="http://en.wikipedia.org/wiki/Data_compression_ratio">http://en.wikipedia.org/wiki/Data_compression_ratio</a> , 2 pages.	
	NPL27	Court Docket History for 6:10-cv-00493-LED-JDL Realtime Data, LLC D/B/A/ IXO, v. MetroPCS Texas, LLC et al., dated September 2, 2011, 16 pages.	
	NPL28	Court Docket History for 6:09-cv-00326-LED-JDL Realtime Data, LLC D/B/A/ IXO, v. Morgan Stanley et al., dated September 2, 2011, 45 pages.	
	NPL29	Court Docket History for 6:09-cv-00327-LED-JDL Realtime Data, LLC D/B/A/IXO, v. CME Group Inc. et al., dated September 2, 2011, 56 pages.	
	NPL30	Court Docket History for 6:09-cv-00333-LED-JDL Realtime Data, LLC d/b/a IXO v. Thomson Reuters et al., dated September 2, 2011, 30 pages.	

1417407\_1.DOCX

Examiner Signature	Date Considered
-----------------------	--------------------

\*EXAMINER: Initial if reference considered, whether or not citation is in conformance with MPEP 609. Draw line through citation if not in conformance and not considered. Include copy of this form with next communication to applicant.

<sup>1</sup> Applicant's unique citation designation number (optional). <sup>2</sup> Applicant is to place a check mark here if English language Translation is attached.

## Electronic Acknowledgement Receipt

<b>EFS ID:</b>	10969407
<b>Application Number:</b>	13118122
<b>International Application Number:</b>	
<b>Confirmation Number:</b>	8978
<b>Title of Invention:</b>	Systems and Methods for Accelerated Loading of Operating Systems and Application Programs
<b>First Named Inventor/Applicant Name:</b>	James J. Fallon
<b>Customer Number:</b>	26111
<b>Filer:</b>	Michael V. Messinger/Halley Pack
<b>Filer Authorized By:</b>	Michael V. Messinger
<b>Attorney Docket Number:</b>	2855.004000B
<b>Receipt Date:</b>	16-SEP-2011
<b>Filing Date:</b>	27-MAY-2011
<b>Time Stamp:</b>	17:19:42
<b>Application Type:</b>	Utility under 35 USC 111(a)

### Payment information:

Submitted with Payment	no
------------------------	----

### File Listing:

Document Number	Document Description	File Name	File Size(Bytes)/ Message Digest	Multi Part /.zip	Pages (if appl.)
1		2855_004000B_IDS.pdf	1736908 <small>335fc4dbbc49688b13829c68ecaac62b55618fc6</small>	yes	14

Multipart Description/PDF files in .zip description					
Document Description			Start	End	
Miscellaneous Incoming Letter			1	2	
Information Disclosure Statement (IDS) Form (SB08)			3	14	
<b>Warnings:</b>					
<b>Information:</b>					
2	Non Patent Literature	NPL1_Invalidity_Contentions_1 2082008.pdf	2756926	no	19
			10a482cd24aa030f0613db2346f84265233a aad6		
<b>Warnings:</b>					
<b>Information:</b>					
3	Non Patent Literature	NPL2_Appendix_A_Part_1.pdf	19365987	no	115
			6f8e0938661ad7c97ae571801f21a27a4acd 26e1		
<b>Warnings:</b>					
<b>Information:</b>					
4	Non Patent Literature	NPL2_Appendix_A_Part_2.pdf	20335060	no	116
			75b7520d081adb6dc312e4eda2f811eca16 11f12		
<b>Warnings:</b>					
<b>Information:</b>					
5	Non Patent Literature	NPL2_Appendix_A_Part_3.pdf	19852968	no	114
			f822d1e03ef0b57a56efb7c4b3ce8ae76446 650e		
<b>Warnings:</b>					
<b>Information:</b>					
6	Non Patent Literature	NPL3_Appendix_B_Part_1.pdf	21525181	no	468
			24121397966c2bff31798e6b97eb94b4287 b86a3		
<b>Warnings:</b>					
<b>Information:</b>					
7	Non Patent Literature	NPL3_Appendix_B_Part_2.pdf	21812633	no	478
			1ca0ef814dc57d3338155689e9630610f1e7 7ac2		
<b>Warnings:</b>					
<b>Information:</b>					
8	Non Patent Literature	NPL3_Appendix_B_Part_3.pdf	22513082	no	489
			361caeb8ca8b99d7daa5d6623eb9b100c00 f396d		
<b>Warnings:</b>					
<b>Information:</b>					

9	Non Patent Literature	NPL3_Appendix_B_Part_4.pdf	21297203 9cac2493eb793ee1f441ed78697bdf1032c17caf	no	458
<b>Warnings:</b>					
<b>Information:</b>					
10	Non Patent Literature	NPL4_Appendix_C_Part_1.pdf	22520151 7760cd6193f2582208ee9f71b1e1c84f31cb6ccf	no	507
<b>Warnings:</b>					
<b>Information:</b>					
11	Non Patent Literature	NPL4_Appendix_C_Part_2.pdf	24506911 01818f94ecfeba715d1a65d74e54dd2d4ca5c04f	no	548
<b>Warnings:</b>					
<b>Information:</b>					
12	Non Patent Literature	NPL5_Appendix_D.pdf	9923724 9d083cdea40ab81e3c9f71900ea1b5b34afe3477c	no	197
<b>Warnings:</b>					
<b>Information:</b>					
13	Non Patent Literature	NPL6_Appendix_E_Part_1.pdf	20169728 e2747ee45dc577c5d9f21e3e03e195c23c2dfe5	no	362
<b>Warnings:</b>					
<b>Information:</b>					
14	Non Patent Literature	NPL6_Appendix_E_Part_2.pdf	18976740 a302cc867324ee43950735c290095a285d3c4e9d	no	373
<b>Warnings:</b>					
<b>Information:</b>					
15	Non Patent Literature	NPL7_Appendix_F_Part_1.pdf	22376042 f73e31af1a68f61716636f5519368347171e5746	no	399
<b>Warnings:</b>					
<b>Information:</b>					
16	Non Patent Literature	NPL7_Appendix_F_Part_2.pdf	20018710 fc8c7402008431fdca7b1420770b46fd4152742	no	376
<b>Warnings:</b>					
<b>Information:</b>					
17	Non Patent Literature	NPL8_Appendix_G_Part_1.pdf	15540556 7b2fc38ae18aa651d98eb7e0d7a05e730883fb80	no	309
<b>Warnings:</b>					
<b>Information:</b>					

18	Non Patent Literature	NPL8_Appendix_G_Part_2.pdf	13108307 611c9055d55ae3896372261182e622d49e1fd135	no	258
<b>Warnings:</b>					
<b>Information:</b>					
19	Non Patent Literature	NPL9_Appendix_H.pdf	5178978 2ea5f759e8b7a26bdc8dc5f38d83de752964661b	no	97
<b>Warnings:</b>					
<b>Information:</b>					
20	Non Patent Literature	NPL10_Appendix_I.pdf	9661669 8bdb6d455e05248ab7fc9fbee573313ab4e93a4f	no	146
<b>Warnings:</b>					
<b>Information:</b>					
21	Non Patent Literature	NPL11_Appendix_J.pdf	920985 2847c0010236d82ffc6141e17479400c32fc219	no	25
<b>Warnings:</b>					
<b>Information:</b>					
22	Non Patent Literature	NPL12_Infringement_Contentions_Amended_Answer_and_Counterclaims_Pt1.pdf	14325509 a3ce162d7ef34314d12a34ecaac9c412e3cf47b4	no	300
<b>Warnings:</b>					
<b>Information:</b>					
23	Non Patent Literature	NPL13_Amended_Answer_10_08_2008.pdf	3371952 d9560ab44624347a7150134a80f53870101eebaa	no	81
<b>Warnings:</b>					
<b>Information:</b>					
24	Non Patent Literature	NPL14_Business_Wire.pdf	451401 65d73cd9a0bf2ae3cb535951551f14c72a6b22a9	no	2
<b>Warnings:</b>					
<b>Information:</b>					
25	Non Patent Literature	NPL15_WHITING_Deflate.pdf	390576 6d986b262d8f5437a952aae9561f78c25cfff6538	no	2
<b>Warnings:</b>					
<b>Information:</b>					
26	Non Patent Literature	NPL16_Packeteer_Q4_Financial_Conf_Call.pdf	552207 6fd74c252c9714cf790bfd939bfe2b9feafec2004	no	9
<b>Warnings:</b>					
<b>Information:</b>					



27	Non Patent Literature	NPL17_NOA_11551204_07112 011.pdf	332043 fd98b5b83d51a1397fadfde4a467afe3a185 687f	no	5
<b>Warnings:</b>					
<b>Information:</b>					
28	Non Patent Literature	NPL18_NOA_12684624_07252 011.pdf	174517 9e53713a9639ad7cf04820143158d52917e 09569	no	5
<b>Warnings:</b>					
<b>Information:</b>					
29	Non Patent Literature	NPL19_NFOA_12703042_0728 2011.pdf	176976 617e979a892a068b06705bca4ee3c8d7a1 06ee2	no	5
<b>Warnings:</b>					
<b>Information:</b>					
30	Non Patent Literature	NPL20_NFOA_12857238_0810 2011.pdf	197154 8b393a717c3d00daa9f1b85f20bed459f584 6723	no	6
<b>Warnings:</b>					
<b>Information:</b>					
31	Non Patent Literature	NPL21_NFOA_13101994_08_1 6_2011.pdf	1546415 80cbc725373bdc99f632e6577435f4cc4bce adbb	no	10
<b>Warnings:</b>					
<b>Information:</b>					
32	Non Patent Literature	NPL22_NOA_11551211_08242 011.pdf	1304155 62fa3f73ce9b1b2f44d8de7dad5cfc8130a1 c4be	no	5
<b>Warnings:</b>					
<b>Information:</b>					
33	Non Patent Literature	NPL23_NOA_12684624_09012 011.pdf	441259 237c56a9cfd560aaf827e96b2c10e232ee84 de68	no	9
<b>Warnings:</b>					
<b>Information:</b>					
34	Non Patent Literature	NPL24_ExaminerAnswer_9500 466_07182011.pdf	1357960 defd2ce22da971713144de72a2ce0127182 4bdb	no	33
<b>Warnings:</b>					
<b>Information:</b>					
35	Non Patent Literature	NPL25_NFOA_95001581_0725 2011.pdf	9322212 28d1299f23a46997e77442ad968ec73030b 4f20f	no	274
<b>Warnings:</b>					
<b>Information:</b>					

36	Non Patent Literature	NPL26_Wiki_08162011.pdf	124905 f3ccbe115d25c20c00707b55eaa04d07ab095b813	no	2
<b>Warnings:</b>					
<b>Information:</b>					
37	Non Patent Literature	NPL27_Court_Docket_MetroPCS_09022011.pdf	258855 2bfca924531bcdff49f75e04ec94f6e08b843b3	no	16
<b>Warnings:</b>					
<b>Information:</b>					
38	Non Patent Literature	NPL28_Court_Docket_MorganStanley_09022011.pdf	387835 8e9e0f357eb54baad71096eb7874f4797c6569eb	no	45
<b>Warnings:</b>					
<b>Information:</b>					
39	Non Patent Literature	NPL29_Court_Docket_CME_09022011.pdf	436293 8b70794fa8f64fd4d2d44bcd86a2b11ab601ce53c	no	56
<b>Warnings:</b>					
<b>Information:</b>					
40	Non Patent Literature	NPL30_Court_Docket_Reuters_09022011.pdf	321143 6d1b2a36e9fe29737a7a27362ad51362f7c7277e	no	30
<b>Warnings:</b>					
<b>Information:</b>					
<b>Total Files Size (in bytes):</b>			369571816		
<p><b>This Acknowledgement Receipt evidences receipt on the noted date by the USPTO of the indicated documents, characterized by the applicant, and including page counts, where applicable. It serves as evidence of receipt similar to a Post Card, as described in MPEP 503.</b></p> <p><b><u>New Applications Under 35 U.S.C. 111</u></b>  <b>If a new application is being filed and the application includes the necessary components for a filing date (see 37 CFR 1.53(b)-(d) and MPEP 506), a Filing Receipt (37 CFR 1.54) will be issued in due course and the date shown on this Acknowledgement Receipt will establish the filing date of the application.</b></p> <p><b><u>National Stage of an International Application under 35 U.S.C. 371</u></b>  <b>If a timely submission to enter the national stage of an international application is compliant with the conditions of 35 U.S.C. 371 and other applicable requirements a Form PCT/DO/EO/903 indicating acceptance of the application as a national stage submission under 35 U.S.C. 371 will be issued in addition to the Filing Receipt, in due course.</b></p> <p><b><u>New International Application Filed with the USPTO as a Receiving Office</u></b>  <b>If a new international application is being filed and the international application includes the necessary components for an international filing date (see PCT Article 11 and MPEP 1810), a Notification of the International Application Number and of the International Filing Date (Form PCT/RO/105) will be issued in due course, subject to prescriptions concerning national security, and the date shown on this Acknowledgement Receipt will establish the international filing date of the application.</b></p>					

MICHAEL V. MESSINGER  
DIRECTOR  
(202) 772-8667  
MIKEM@SKGF.COM



September 16, 2011

Commissioner for Patents  
PO Box 1450  
Alexandria, VA 22313-1450

Confirmation No. 8978  
Art Unit 2115  
*Attn: Mail Stop Amendment*

Re: U.S. Utility Patent Application  
Application No. 13/118,122; Filing Date: May 27, 2011  
For: **Systems and Methods for Accelerated Loading of Operating Systems  
and Application Programs**  
Inventors: FALLON *et al.*  
Our Ref: 2855.004000B

Sir:

Transmitted herewith for appropriate action are the following documents:

1. First Supplemental Information Disclosure Statement;
2. Form PTO/SB/08a (1 sheet) listing 9 documents (US1-US9);
3. Form PTO/SB/08b (3 sheets) listing 30 documents (NPL1-NPL30); and
4. Copies of cited documents (NPL1-NPL30).

The above-listed documents are filed electronically through EFS-Web.

In the event that extensions of time are necessary to prevent abandonment of this patent application, then such extensions of time are hereby petitioned.

Commissioner for Patents  
September 16, 2011  
Page 2

The U.S. Patent and Trademark Office is hereby authorized to charge any fee deficiency, or credit any overpayment, to our Deposit Account No. 19-0036.

Respectfully submitted,

STERNE, KESSLER, GOLDSTEIN & FOX P.L.L.C.

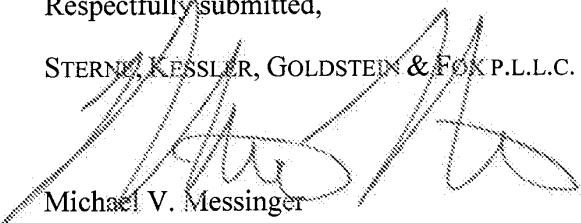

Michael V. Messinger  
Attorney for Applicants  
Registration No. 37,575

MVM/EJK/sj  
Enclosures

1417414\_1.DOCX

## Electronic Acknowledgement Receipt

<b>EFS ID:</b>	10597309
<b>Application Number:</b>	13118122
<b>International Application Number:</b>	
<b>Confirmation Number:</b>	8978
<b>Title of Invention:</b>	Systems and Methods for Accelerated Loading of Operating Systems and Application Programs
<b>First Named Inventor/Applicant Name:</b>	James J. Fallon
<b>Customer Number:</b>	26111
<b>Filer:</b>	Michael V. Messinger/Stacy Jen
<b>Filer Authorized By:</b>	Michael V. Messinger
<b>Attorney Docket Number:</b>	2855.004000B
<b>Receipt Date:</b>	02-AUG-2011
<b>Filing Date:</b>	27-MAY-2011
<b>Time Stamp:</b>	16:29:34
<b>Application Type:</b>	Utility under 35 USC 111(a)

### Payment information:

Submitted with Payment	no
------------------------	----

### File Listing:

Document Number	Document Description	File Name	File Size(Bytes)/ Message Digest	Multi Part /.zip	Pages (if appl.)
1	Non Patent Literature	NPL146_Bloomberg_Invalidity_Contentions_Realtime_v_Thomson.pdf	621627 <small>bd09591fa68909600b078ea70a7064829e3097b9</small>	no	17

### Warnings:

### Information:

2	Non Patent Literature	NPL147_Appendix_A_Bloomber g_Invalidity_Contentions_Reali time_v_Thomson.pdf	1825625 3173bfb244a51a90faf1fc57eafd115b20b1 e29	no	37
<b>Warnings:</b>					
<b>Information:</b>					
3	Non Patent Literature	NPL148_Appendix_B_Bloomber g_Invalidity_Contentions_Reali time_v_Thomson.pdf	2897791 afb8de438675ef19ff107199e6a026293665f 910	no	63
<b>Warnings:</b>					
<b>Information:</b>					
4	Non Patent Literature	NPL149_Appendix_C_Bloomber g_Invalidity_Contentions_Reali time_v_Thomson.pdf	4208847 329782212c1699bd733cbcccb1eb96a2ad9 fa484	no	95
<b>Warnings:</b>					
<b>Information:</b>					
5	Non Patent Literature	NPL150_Appendix_D_Bloomber g_Invalidity_Contentions_Reali time_v_Thomson.pdf	6662528 90c6b973a884fc6f2b8f5be8e558f00bf35a2 7de	no	147
<b>Warnings:</b>					
<b>Information:</b>					
6	Non Patent Literature	NPL151_Appendix_E_Bloomber g_Invalidity_Contentions_Reali time_v_Thomson.pdf	6098563 ad62a9d0aa7e99932343186390eb58dc7e7 2a7ba	no	137
<b>Warnings:</b>					
<b>Information:</b>					
7	Non Patent Literature	NPL152_AppendixF.pdf	439011 ad482b62bf2e7576e7993c92f7589e58a7d 77d27	no	7
<b>Warnings:</b>					
<b>Information:</b>					
8	Non Patent Literature	NPL153_Bloomberg_Invalidity_ Contentions_PLR_3_3_Realtim e_v_Thomson.pdf	852310 5510d742bec3ad96397c0ed337633ecdd 1edd76	no	21
<b>Warnings:</b>					
<b>Information:</b>					
9	Non Patent Literature	NPL154_Appendix_G_Bloomber g_Invalidity_Contentions_Reali time_v_Thomson.pdf	21601466 28ee59ec81a23c42a2f1d59b6378ec407ed 2ec3f	no	480
<b>Warnings:</b>					
<b>Information:</b>					
10	Non Patent Literature	NPL155_Rice_Some_Practical_ Universal.pdf	15520819 ea5c161dc503bc5ed2d7d481cabb9c92d92 63335	no	140
<b>Warnings:</b>					
<b>Information:</b>					

11	Non Patent Literature	NPL156_Anderson_Codec_Squ eezes_Color_Teleconferencing. pdf	3180001 db0c7fe9638fec6bcb337bb90f16bc0391b d8f12	no	8
<b>Warnings:</b>					
<b>Information:</b>					
12	Non Patent Literature	NPL157_Venbrux_A_VLSI_Chip _Set_for_High_Speed.pdf	2916606 a583d8f6b05b2ec4fd858e1dd70db274d21 73cf1	no	12
<b>Warnings:</b>					
<b>Information:</b>					
13	Non Patent Literature	NPL158_Fast_Dos_Soft_Boot_I BM_Technical.pdf	494035 7e5713a3fdd7b2b0867972786ff46633d57 a361	no	3
<b>Warnings:</b>					
<b>Information:</b>					
14	Non Patent Literature	NPL159_Operating_System_Pl atform.pdf	671840 a605beef8613a3e1ec7c3185f0f1565422c2 a47f	no	4
<b>Warnings:</b>					
<b>Information:</b>					
15	Non Patent Literature	NPL160_Murashita_High_Spee d_Statistical_Compression.pdf	671840 a64758d20f8227ac891c279ea3eca1e0b57 db729	no	4
<b>Warnings:</b>					
<b>Information:</b>					
16	Non Patent Literature	NPL161_Coene_A_Fast_Route for_Applications.pdf	958758 bb2ba7127dd70fd7f1e8de28edce8d0e0d0 0f5d	no	5
<b>Warnings:</b>					
<b>Information:</b>					
17	Non Patent Literature	NPL162_Rice_Lossless_Coding _Standards_for_Space.pdf	2639087 2537d454d2fdee893931e829b5036e79575 914a7	no	12
<b>Warnings:</b>					
<b>Information:</b>					
18	Non Patent Literature	NPL163_Millman_ImageandVid eo_Compression_Computerwo rld.pdf	1651899 513505f3abec1027dfc5bb4a79b9b4b6029 618ee	no	7
<b>Warnings:</b>					
<b>Information:</b>					
19	Non Patent Literature	NPL164_IBM_Boosts_Your_Me mory.pdf	1219603 add80eeecf23ac0c6fcd729c224f1422afc93 9c	no	7
<b>Warnings:</b>					
<b>Information:</b>					

20	Non Patent Literature	NPL165_IBM_Research_Breakthrough.pdf	1122237 7a89014df7697c100558e21b6b5fb5a42195327f	no	7
<b>Warnings:</b>					
<b>Information:</b>					
21	Non Patent Literature	NPL166_Serverworks_To_Deliver.pdf	957909 bf31712c5c2856381f9e866dc98b1bb7cf132d	no	5
<b>Warnings:</b>					
<b>Information:</b>					
22	Non Patent Literature	NPL167_Abali_Memory_Expansion_Tech.pdf	5054570 6d92234b680bd68203fb8f135f5f399d260e1846	no	19
<b>Warnings:</b>					
<b>Information:</b>					
23	Non Patent Literature	NPL168_Franaszek_Algorithms_and_data_Structures.pdf	4755640 990ab838500534029de7df028479c7ad3f20c6e	no	18
<b>Warnings:</b>					
<b>Information:</b>					
24	Non Patent Literature	NPL169_Franaszek_On_International_Organization.pdf	3187970 346404ab76c895d066e9980a85b2b7cf0fb72e77	no	12
<b>Warnings:</b>					
<b>Information:</b>					
25	Non Patent Literature	NPL170_Smith_Memory_Expansion_Technology.pdf	1755668 de709cb34f8597fb9180a8622b65a803146e4ec3	no	7
<b>Warnings:</b>					
<b>Information:</b>					
26	Non Patent Literature	NPL171_Tremaine_IBM_Memory_Expansion.pdf	3918277 72862517e954e66c78417a7393a99611cf0fedfd	no	15
<b>Warnings:</b>					
<b>Information:</b>					
27	Non Patent Literature	NPL172_Yeh_The_CCSDS_Lossless_Data.pdf	2722212 bdb7ed00b0359a0dd26345b7568c94db779e9006	no	18
<b>Warnings:</b>					
<b>Information:</b>					
28	Non Patent Literature	NPL173_ExpandNetworks.pdf	3164055 5e0232dbd81be4148daa4164d9459825021875dd	no	101
<b>Warnings:</b>					
<b>Information:</b>					



29	Non Patent Literature	NPL174_Tridgell_Efficient_Algorithms_for_Sorting_and_Synchronization.pdf	6343050 e1602978b49593be6928d6a36decdf987db4734	no	115
<b>Warnings:</b>					
<b>Information:</b>					
30	Non Patent Literature	NPL175_Jung_Performance_Optimization_of_Wireless_Local_Area_Network.pdf	1229533 6ccf8cd02ddee744b0e8ace9866ea34321821213	no	13
<b>Warnings:</b>					
<b>Information:</b>					
31	Non Patent Literature	NPL176_Baker_Lossless_Data_Compression_for_Short.pdf	1216110 8bf6362e63eda31df44915d54d06c1a2bd1c7c1c	no	4
<b>Warnings:</b>					
<b>Information:</b>					
32	Non Patent Literature	NPL177_Maier_Algorithm_Evaluation_for_the_Synchronous_Data_Compression.pdf	2158833 e8f9b3e228713f12e01e4b0088ec536ae9aeac1	no	10
<b>Warnings:</b>					
<b>Information:</b>					
33	Non Patent Literature	NPL178_Bassiouni_A_Scheme_for_Data_Compression_in_Super_Computers.pdf	2445064 fee6093f2d3ce7d373d161caf7478f40d1589df6f	no	12
<b>Warnings:</b>					
<b>Information:</b>					
34	Non Patent Literature	NPL179_Welch_A_Technique_for_High_Performance_Data_Compression.pdf	2922628 d6233bfe3fdcdf2d6fb5342929a1fb51b0c97a65	no	12
<b>Warnings:</b>					
<b>Information:</b>					
35	Non Patent Literature	NPL180_ALDC.pdf	230880 0c954814e7652935c462637e6351dc661ed0925c	no	2
<b>Warnings:</b>					
<b>Information:</b>					
36	Non Patent Literature	NPL181_ALDC_Macro.pdf	300494 9dd2464df60fcbf571b55498620365649ccdb3b5	no	2
<b>Warnings:</b>					
<b>Information:</b>					
37	Non Patent Literature	NPL182_ALDC1_20S.pdf	241524 0c8fc81d7a82d1de187d451d8fec4a0d5cc199ee	no	2
<b>Warnings:</b>					
<b>Information:</b>					

38	Non Patent Literature	NPL183_ALDC1_40S.pdf	427036	no	2
			084274a265ea57ada368a05ad67deb83449f5505		
<b>Warnings:</b>					
<b>Information:</b>					
39	Non Patent Literature	NPL184_ALDC1_5S.pdf	240635	no	2
			5acd67d8f605ae043b9f2b87a4e003775c8580cb		
<b>Warnings:</b>					
<b>Information:</b>					
40	Non Patent Literature	NPL185_Craft_Data_Compression_Choice_No_Easy_Call.pdf	485070	no	2
			053c07b9bcc55c23cbefdd21da2878c2b96cc392		
<b>Warnings:</b>					
<b>Information:</b>					
41	Non Patent Literature	NPL186_Costlow.pdf	2009211	no	2
			fb8c04d61c33c0b8d5602977b23f95878d6722		
<b>Warnings:</b>					
<b>Information:</b>					
42	Non Patent Literature	NPL187_IBMupscompressionante.pdf	11049998	no	37
			07b9ca055e64f5ef786d1cd29269eac8b44f04d4		
<b>Warnings:</b>					
<b>Information:</b>					
43	Non Patent Literature	NPL188_IBMAnnouncesNewFeaturefor3480Subsystem.pdf	314870	no	1
			dc9a9ecfc00e3fab4ad7ea6aa7b37edc3b3ee8		
<b>Warnings:</b>					
<b>Information:</b>					
44	Non Patent Literature	NPL189_CCACitrix_Part1.pdf	23808796	no	200
			7137f5358c36baaf64fff372634767c1724fa15		
<b>Warnings:</b>					
<b>Information:</b>					
45	Non Patent Literature	NPL189_CCACitrix_Part2.pdf	21703189	no	162
			269b43ae493e03c3a06e7c2ba0b7a93062f86352		
<b>Warnings:</b>					
<b>Information:</b>					
46	Non Patent Literature	NPL189_CCACitrix_Part3.pdf	15228462	no	102
			52de0412750f6fb582f711cca7de15761485d255		
<b>Warnings:</b>					
<b>Information:</b>					

47	Non Patent Literature	NPL189_CCACitrix_Part4.pdf	14787550 2fb7c78f11a59c652800e10bd49ff4f36259ac9	no	104
<b>Warnings:</b>					
<b>Information:</b>					
48	Non Patent Literature	NPL190_DataCircuitTerminatingEquipment.pdf	1340832 b1b45ff94720e680243eb53a40e412618e321148	no	29
<b>Warnings:</b>					
<b>Information:</b>					
49	Non Patent Literature	NPL191_Cheng.pdf	1945018 04c7951f3bba47e9924145044b4eed02605781ca	no	11
<b>Warnings:</b>					
<b>Information:</b>					
50	Non Patent Literature	NPL192_CiscoIOSDataCompression.pdf	1470410 b3a502a9ed2b8e0f4befc88726d901a834c98800	no	10
<b>Warnings:</b>					
<b>Information:</b>					
51	Non Patent Literature	NPL193_Afasthardwaredatacompressionalgorithm.pdf	1921060 73b253ac51e0db74cc400d5a1846e9c36bb6a910	no	14
<b>Warnings:</b>					
<b>Information:</b>					
52	Non Patent Literature	NPL194_Rustici_Enhanced_Part1.pdf	19812287 b1517b4557137c10b23114ea52d34aa8a0a9a81e	no	155
<b>Warnings:</b>					
<b>Information:</b>					
53	Non Patent Literature	NPL194_Rustici_Enhanced_Part2.pdf	18999633 1a15b79cd0e8e88ffbb09add1b1c95bea83d30e4	no	153
<b>Warnings:</b>					
<b>Information:</b>					
54	Non Patent Literature	NPL195_WhitePineSoftware.pdf	11116418 27c26e7189cc2e3f6be9e9191f43282d0836affc	no	86
<b>Warnings:</b>					
<b>Information:</b>					
55	Non Patent Literature	NPL196_CUSeeMeReflector.pdf	814776 49f545ad91ae78b7d9278a703515ff60f0881bf8	no	5
<b>Warnings:</b>					
<b>Information:</b>					

56	Non Patent Literature	NPL197_Daniels.pdf	510336 515a4180aa5f65050e553c7871cbee4917c b8bd	no	4
<b>Warnings:</b>					
<b>Information:</b>					
57	Non Patent Literature	NPL198_Held.pdf	14453140 0220d7c6bc37b97baec20a44b42aa840369 94986	no	150
<b>Warnings:</b>					
<b>Information:</b>					
58	Non Patent Literature	NPL199_IEEEDataCompression.pdf	7617359 76044f6d862ebef1015e5d2b0b3481f5419 9bce3	no	64
<b>Warnings:</b>					
<b>Information:</b>					
59	Non Patent Literature	NPL200_Britton_Part1.pdf	16038754 f1933e3c220755b2d7f8a7f803a4fb6c2b1f8 ab0	no	122
<b>Warnings:</b>					
<b>Information:</b>					
60	Non Patent Literature	NPL200_Britton_Part2.pdf	13958933 b480223e5920ae01c05f013019e077c5749f 48e8	no	122
<b>Warnings:</b>					
<b>Information:</b>					
<b>Total Files Size (in bytes):</b>				318912683	
<p><b>This Acknowledgement Receipt evidences receipt on the noted date by the USPTO of the indicated documents, characterized by the applicant, and including page counts, where applicable. It serves as evidence of receipt similar to a Post Card, as described in MPEP 503.</b></p> <p><b><u>New Applications Under 35 U.S.C. 111</u></b>  <b>If a new application is being filed and the application includes the necessary components for a filing date (see 37 CFR 1.53(b)-(d) and MPEP 506), a Filing Receipt (37 CFR 1.54) will be issued in due course and the date shown on this Acknowledgement Receipt will establish the filing date of the application.</b></p> <p><b><u>National Stage of an International Application under 35 U.S.C. 371</u></b>  <b>If a timely submission to enter the national stage of an international application is compliant with the conditions of 35 U.S.C. 371 and other applicable requirements a Form PCT/DO/EO/903 indicating acceptance of the application as a national stage submission under 35 U.S.C. 371 will be issued in addition to the Filing Receipt, in due course.</b></p> <p><b><u>New International Application Filed with the USPTO as a Receiving Office</u></b>  <b>If a new international application is being filed and the international application includes the necessary components for an international filing date (see PCT Article 11 and MPEP 1810), a Notification of the International Application Number and of the International Filing Date (Form PCT/RO/105) will be issued in due course, subject to prescriptions concerning national security, and the date shown on this Acknowledgement Receipt will establish the international filing date of the application.</b></p>					

## Electronic Acknowledgement Receipt

<b>EFS ID:</b>	10605069
<b>Application Number:</b>	13118122
<b>International Application Number:</b>	
<b>Confirmation Number:</b>	8978
<b>Title of Invention:</b>	Systems and Methods for Accelerated Loading of Operating Systems and Application Programs
<b>First Named Inventor/Applicant Name:</b>	James J. Fallon
<b>Customer Number:</b>	26111
<b>Filer:</b>	Michael V. Messinger/Stacy Jen
<b>Filer Authorized By:</b>	Michael V. Messinger
<b>Attorney Docket Number:</b>	2855.004000B
<b>Receipt Date:</b>	02-AUG-2011
<b>Filing Date:</b>	27-MAY-2011
<b>Time Stamp:</b>	16:33:15
<b>Application Type:</b>	Utility under 35 USC 111(a)

### Payment information:

Submitted with Payment	no
------------------------	----

### File Listing:

Document Number	Document Description	File Name	File Size(Bytes)/ Message Digest	Multi Part /.zip	Pages (if appl.)
1	Non Patent Literature	NPL201_Sattler.pdf	9885689 341eaa84f6030279bbe5d7ac9c496d5e176a5e4	no	80

### Warnings:

### Information:

2	Non Patent Literature	NPL202_IBMMicroelectronicsComdexFall93BoothLocation.pdf	52479 b500d5fb114e317f75e717ad012361f1fdfe46cd	no	1
<b>Warnings:</b>					
<b>Information:</b>					
3	Non Patent Literature	NPL203_Disz.pdf	691644 dda3901212c0a5e1164e41d52466b8e382546fbc	no	12
<b>Warnings:</b>					
<b>Information:</b>					
4	Non Patent Literature	NPL204_NetMeeting2.pdf	662221 44de7e15cda0ff65f852a285d678af1cec29da97	no	6
<b>Warnings:</b>					
<b>Information:</b>					
5	Non Patent Literature	NPL205_OnDemandDynamicDistillation.pdf	2383083 3a14833e56c863b18f4d26f6e706140088f104a6	no	11
<b>Warnings:</b>					
<b>Information:</b>					
6	Non Patent Literature	NPL206_InfrastructuralProxies.pdf	1840013 d4ec3e038c2a0f35e89550d215b203a9597f872c	no	10
<b>Warnings:</b>					
<b>Information:</b>					
7	Non Patent Literature	NPL207_Han.pdf	1567173 4de137900192000ed5dffdf17b881883a36f5631	no	9
<b>Warnings:</b>					
<b>Information:</b>					
8	Non Patent Literature	NPL208_ParallelLosslessImageCompression.pdf	1205291 7955a779a30cb6fe80230ec38ab4150ea524fd1	no	11
<b>Warnings:</b>					
<b>Information:</b>					
9	Non Patent Literature	NPL209_TextImageCompression.pdf	1522710 74aea3c891625dae3cc7a91888d5a29b9f9f0a7b	no	11
<b>Warnings:</b>					
<b>Information:</b>					
10	Non Patent Literature	NPL210_EmergingJBIG2Standard.pdf	2311583 376bb3dca47b6b5fad2b958a411423287e71c6aa	no	11
<b>Warnings:</b>					
<b>Information:</b>					

11	Non Patent Literature	NPL211_Craft_Fast_Hardware.pdf	1921060 541ed5db528be3c733a85c31ced29f6497a64c50	no	14
<b>Warnings:</b>					
<b>Information:</b>					
12	Non Patent Literature	NPL212_DirectAccessStorageDeviceCompression.pdf	318372 110fb99fa746cd51297338543013cfd725270558	no	4
<b>Warnings:</b>					
<b>Information:</b>					
13	Non Patent Literature	NPL213_ICATimeline.pdf	158699 729b297f30e81dec737c9ce1a0dfdc39c125a56	no	3
<b>Warnings:</b>					
<b>Information:</b>					
14	Non Patent Literature	NPL214_Converse.pdf	3382763 518e1956db948dda0bfb87e8eae50b910893e33	no	55
<b>Warnings:</b>					
<b>Information:</b>					
15	Non Patent Literature	NPL215_MagstarIBMGuide_Part1.pdf	23547535 2f1a3107611fd67045d0d1fd74094ee427d6ce3	no	50
<b>Warnings:</b>					
<b>Information:</b>					
16	Non Patent Literature	NPL215_MagstarIBMGuide_Part2.pdf	24183391 68cfafdce5e3dc909508250fb42b6fcd59a3a60d	no	50
<b>Warnings:</b>					
<b>Information:</b>					
17	Non Patent Literature	NPL215_MagstarIBMGuide_Part3.pdf	22074425 a34d406f0770350233683f98c843d296f2e641e9	no	50
<b>Warnings:</b>					
<b>Information:</b>					
18	Non Patent Literature	NPL215_MagstarIBMGuide_Part4.pdf	25118773 9a0a14cab741262a4415e85ba3bf86dcd0241f45	no	50
<b>Warnings:</b>					
<b>Information:</b>					
19	Non Patent Literature	NPL215_MagstarIBMGuide_Part5.pdf	19959734 3eb82999774677efd69831f5aeaad4768e89169e	no	40
<b>Warnings:</b>					
<b>Information:</b>					

20	Non Patent Literature	NPL215_MagstarIBMGuide_Part6.pdf	20303104 abffe5d622cf70b5f687d3f01b154f46f68dd38	no	48
<b>Warnings:</b>					
<b>Information:</b>					
21	Non Patent Literature	NPL216_MetaFrame.pdf	6567559 4b399b4f5d8692b8cf31e7ec045cf499e10c26	no	113
<b>Warnings:</b>					
<b>Information:</b>					
22	Non Patent Literature	NPL217_NCDWincenter3.pdf	283755 f189dd7cbfd9030927769e94174448e9f95dc39a9	no	2
<b>Warnings:</b>					
<b>Information:</b>					
23	Non Patent Literature	NPL218_OverviewNetMeeting.pdf	926756 44debb96c19b27da22c7f5046a70a9f45ed931b	no	7
<b>Warnings:</b>					
<b>Information:</b>					
24	Non Patent Literature	NPL219_ResourceKit.pdf	2798049 a9ea0a343abc87f0a54505e603fbf1a3d334f03c	no	34
<b>Warnings:</b>					
<b>Information:</b>					
25	Non Patent Literature	NPL220_ConferencingStandards.pdf	1797390 11b7771e1ae0555a148ba5d8fa96095296c05969	no	14
<b>Warnings:</b>					
<b>Information:</b>					
26	Non Patent Literature	NPL221_Summers_Part1.pdf	20789938 9763b87b043250718e883cbf2800cdf6e8be3e1	no	190
<b>Warnings:</b>					
<b>Information:</b>					
27	Non Patent Literature	NPL221_Summers_Part2.pdf	16826229 8451b0b5b1672cbfa5c32e2b3a84690aba1af589	no	184
<b>Warnings:</b>					
<b>Information:</b>					
28	Non Patent Literature	NPL222_Zebroze.pdf	943297 ef106b91d0628ca44c8bf48465918048350da243	no	10
<b>Warnings:</b>					
<b>Information:</b>					



29	Non Patent Literature	NPL223_Simpson.pdf	1358736 0b3f38d8dba8bd8085ca3ab66a303a8e3ff0100a	no	9
<b>Warnings:</b>					
<b>Information:</b>					
30	Non Patent Literature	NPL224_IBMTechnologyProductsIntroducesNewFamilyofHighPerformance.pdf	462555 dad71c375661be9e2fe11aff997318f0049fb237	no	6
<b>Warnings:</b>					
<b>Information:</b>					
31	Non Patent Literature	NPL225_PowerQuestDriveImagePro.pdf	410242 2fed9e3cccb10c61a8afca4e0d0beb978749af0da	no	6
<b>Warnings:</b>					
<b>Information:</b>					
32	Non Patent Literature	NPL226_Schulzrinne.pdf	1081732 6ba95ad682b794b26d0d09ec1b3cc16047067ed35	no	17
<b>Warnings:</b>					
<b>Information:</b>					
33	Non Patent Literature	NPL227_Zhu.pdf	744650 f4ebbbfc1b50c95f8b0032204a9cf66b30037e75	no	12
<b>Warnings:</b>					
<b>Information:</b>					
34	Non Patent Literature	NPL228_PointToPointProtocol.pdf	2890585 c8d3ef5fdac258cf84b4cacc9f7f3256b88ddc8	no	54
<b>Warnings:</b>					
<b>Information:</b>					
35	Non Patent Literature	NPL229_Reynolds.pdf	11990467 6b95b9101625263470c26b8fb2e4de74ab29bc58	no	230
<b>Warnings:</b>					
<b>Information:</b>					
36	Non Patent Literature	NPL230_ZLIBCompressedDataFormatSpecification.pdf	717887 cca9aff2f7bc79c5f63b1a0db0138157b4d5d5ca	no	10
<b>Warnings:</b>					
<b>Information:</b>					
37	Non Patent Literature	NPL231_Deutsch.pdf	1098980 35406bac3b78416fa9f3fc1417465c327b6097f4	no	15
<b>Warnings:</b>					
<b>Information:</b>					

38	Non Patent Literature	NPL232_RANDPPPCompressionControlProtocol.pdf	593581	no	9
			507011e85b234e6b36bb5aef15d37e86f777abae		
<b>Warnings:</b>					
<b>Information:</b>					
39	Non Patent Literature	NPL233_Schneider.pdf	1124419	no	18
			9d0efb0e67e96a6a9a2da0620a693a6893e20369		
<b>Warnings:</b>					
<b>Information:</b>					
40	Non Patent Literature	NPL234_Friend.pdf	1267254	no	20
			70a3306c22d43d7e436c58bce63b460c517f5845		
<b>Warnings:</b>					
<b>Information:</b>					
41	Non Patent Literature	NPL235_Schneider_PPP.pdf	570339	no	10
			70b8a1ed5a238736c200a505f1b5fbf64edd69c		
<b>Warnings:</b>					
<b>Information:</b>					
42	Non Patent Literature	NPL236_Atkins.pdf	1388739	no	21
			4589087648285e51c542cec707a10c625ec45e55		
<b>Warnings:</b>					
<b>Information:</b>					
43	Non Patent Literature	NPL237_Castineyra.pdf	1606041	no	27
			cb646ffce1cfbd59d814af487001c8e8fa56e517		
<b>Warnings:</b>					
<b>Information:</b>					
44	Non Patent Literature	NPL238_Freed_Multipurpose_Internet_Mail_Ext.pdf	3217857	no	21
			44aa1afc39668ac355dd9b51280dd13e3a48e5af		
<b>Warnings:</b>					
<b>Information:</b>					
45	Non Patent Literature	NPL239_Shacham.pdf	694858	no	10
			cb1985a5965e565e459cc5d61b14805d87a7abae		
<b>Warnings:</b>					
<b>Information:</b>					
46	Non Patent Literature	NPL240_Sidewinder.pdf	14572249	no	189
			4b929943ac6b3bc4cf2ac9af201c7fd6075b4457		
<b>Warnings:</b>					
<b>Information:</b>					

47	Non Patent Literature	NPL241_IBM_RAMAC_Part1.pdf	16799030 e50b5e44c2522a9e033cd68e90a3689ba1f3c5e4	no	245
<b>Warnings:</b>					
<b>Information:</b>					
48	Non Patent Literature	NPL241_IBM_RAMAC_Part2.pdf	15627785 2889804911feaf9ccda9363f8d76d01c9419150ae	no	245
<b>Warnings:</b>					
<b>Information:</b>					
49	Non Patent Literature	NPL242_Bruni.pdf	10075645 d8a96477eccf1228e9b30307de4b271bc5094bd1	no	172
<b>Warnings:</b>					
<b>Information:</b>					
50	Non Patent Literature	NPL243_Smith.pdf	1840185 841d7b7bac477c169ee69a033ec48555329c5e0	no	13
<b>Warnings:</b>					
<b>Information:</b>					
51	Non Patent Literature	NPL244_DigitalCompressionandCoding.pdf	8432180 52296e267f4cbacd55d671db0a51d6c5b3ae8414	no	186
<b>Warnings:</b>					
<b>Information:</b>					
52	Non Patent Literature	NPL255_CUSeeMereadme.pdf	1003783 ff5082c4c0289f24b527df5f6ec7989742ace99	no	9
<b>Warnings:</b>					
<b>Information:</b>					
53	Non Patent Literature	NPL266_Storer_Dec_104_Patent_March_18_2009.pdf	290365 4a14c57501c54d16f607230250bc0efa4f21e32c	no	8
<b>Warnings:</b>					
<b>Information:</b>					
54	Non Patent Literature	NPL267_Storer_Dec_937_Patent_May_4_2009.pdf	676478 9d892a7f097ca940df8433cdbebb1edbe5e8a3a94	no	15
<b>Warnings:</b>					
<b>Information:</b>					
55	Non Patent Literature	NPL268_Storer_Dec_761_Patent_May_4_2009.pdf	210397 6ed339b99b7b04430ccb931764fb7f009f127e83	no	6
<b>Warnings:</b>					
<b>Information:</b>					

56	Non Patent Literature	NPL269_Storer_Dec_992_Patent_May_20_2009.pdf	210124 58decba7101c59f31bd8535272a93b0c345c9fb	no	6
<b>Warnings:</b>					
<b>Information:</b>					
57	Non Patent Literature	NPL270_Storer_Dec_506_Patent_May_26_2009.pdf	177437 1e0833cfd5b988408e67235ba6cf9083218702f6	no	5
<b>Warnings:</b>					
<b>Information:</b>					
58	Non Patent Literature	NPL271_Video_Coding.pdf	2240561 57fd0d698c28580b36de9f064d853cd849eed0e	no	52
<b>Warnings:</b>					
<b>Information:</b>					
59	Non Patent Literature	NPL272_Order_Adopting_Report.pdf	191748 b9533006558211ba395aced5bea7e23c54dc484fd	no	2
<b>Warnings:</b>					
<b>Information:</b>					
60	Non Patent Literature	NPL273_Citrix_Second_Amended_Answer.pdf	118465 be93a53fcc78b4e722631106a60e3e39a145f0e9	no	45
<b>Warnings:</b>					
<b>Information:</b>					
<b>Total Files Size (in bytes):</b>			317708069		
<p><b>This Acknowledgement Receipt evidences receipt on the noted date by the USPTO of the indicated documents, characterized by the applicant, and including page counts, where applicable. It serves as evidence of receipt similar to a Post Card, as described in MPEP 503.</b></p> <p><b><u>New Applications Under 35 U.S.C. 111</u></b>  <b>If a new application is being filed and the application includes the necessary components for a filing date (see 37 CFR 1.53(b)-(d) and MPEP 506), a Filing Receipt (37 CFR 1.54) will be issued in due course and the date shown on this Acknowledgement Receipt will establish the filing date of the application.</b></p> <p><b><u>National Stage of an International Application under 35 U.S.C. 371</u></b>  <b>If a timely submission to enter the national stage of an international application is compliant with the conditions of 35 U.S.C. 371 and other applicable requirements a Form PCT/DO/EO/903 indicating acceptance of the application as a national stage submission under 35 U.S.C. 371 will be issued in addition to the Filing Receipt, in due course.</b></p> <p><b><u>New International Application Filed with the USPTO as a Receiving Office</u></b>  <b>If a new international application is being filed and the international application includes the necessary components for an international filing date (see PCT Article 11 and MPEP 1810), a Notification of the International Application Number and of the International Filing Date (Form PCT/RO/105) will be issued in due course, subject to prescriptions concerning national security, and the date shown on this Acknowledgement Receipt will establish the international filing date of the application.</b></p>					

# INTERNATIONAL SEARCH REPORT

Inte      I Application No

PCT/US 00/42018

<b>A. CLASSIFICATION OF SUBJECT MATTER</b> IPC 7    H03M7/30				
According to International Patent Classification (IPC) or to both national classification and IPC				
<b>B. FIELDS SEARCHED</b>				
Minimum documentation searched (classification system followed by classification symbols) IPC 7    H03M    H04N				
Documentation searched other than minimum documentation to the extent that such documents are included in the fields searched				
Electronic data base consulted during the international search (name of data base and, where practical, search terms used) EPO-Internal, WPI Data, INSPEC				
<b>C. DOCUMENTS CONSIDERED TO BE RELEVANT</b>				
Category °	Citation of document, with indication, where appropriate, of the relevant passages	Relevant to claim No.		
X    Y   A	EP 0 405 572 A (FUJITSU LTD) 2 January 1991 (1991-01-02)  page 5, line 22 -page 9, line 35  ---  -/--	1-4, 7-9, 12, 15, 23-29, 36, 37 5, 6, 10, 11, 13, 14, 30 16-22, 31-35		
<input checked="" type="checkbox"/> Further documents are listed in the continuation of box C.				
<input checked="" type="checkbox"/> Patent family members are listed in annex.				
° Special categories of cited documents :				
<table style="width: 100%; border: none;"> <tr> <td style="width: 50%; vertical-align: top; border: none;">                     *A* document defining the general state of the art which is not considered to be of particular relevance                      *E* earlier document but published on or after the international filing date                      *L* document which may throw doubts on priority claim(s) or which is cited to establish the publication date of another citation or other special reason (as specified)                      *O* document referring to an oral disclosure, use, exhibition or other means                      *P* document published prior to the international filing date but later than the priority date claimed                 </td> <td style="width: 50%; vertical-align: top; border: none;">                     *T* later document published after the international filing date or priority date and not in conflict with the application but cited to understand the principle or theory underlying the invention                      *X* document of particular relevance; the claimed invention cannot be considered novel or cannot be considered to involve an inventive step when the document is taken alone                      *Y* document of particular relevance; the claimed invention cannot be considered to involve an inventive step when the document is combined with one or more other such documents, such combination being obvious to a person skilled in the art.                      *&amp;* document member of the same patent family                 </td> </tr> </table>			*A* document defining the general state of the art which is not considered to be of particular relevance *E* earlier document but published on or after the international filing date *L* document which may throw doubts on priority claim(s) or which is cited to establish the publication date of another citation or other special reason (as specified) *O* document referring to an oral disclosure, use, exhibition or other means *P* document published prior to the international filing date but later than the priority date claimed	*T* later document published after the international filing date or priority date and not in conflict with the application but cited to understand the principle or theory underlying the invention *X* document of particular relevance; the claimed invention cannot be considered novel or cannot be considered to involve an inventive step when the document is taken alone *Y* document of particular relevance; the claimed invention cannot be considered to involve an inventive step when the document is combined with one or more other such documents, such combination being obvious to a person skilled in the art. *&* document member of the same patent family
*A* document defining the general state of the art which is not considered to be of particular relevance *E* earlier document but published on or after the international filing date *L* document which may throw doubts on priority claim(s) or which is cited to establish the publication date of another citation or other special reason (as specified) *O* document referring to an oral disclosure, use, exhibition or other means *P* document published prior to the international filing date but later than the priority date claimed	*T* later document published after the international filing date or priority date and not in conflict with the application but cited to understand the principle or theory underlying the invention *X* document of particular relevance; the claimed invention cannot be considered novel or cannot be considered to involve an inventive step when the document is taken alone *Y* document of particular relevance; the claimed invention cannot be considered to involve an inventive step when the document is combined with one or more other such documents, such combination being obvious to a person skilled in the art. *&* document member of the same patent family			
Date of the actual completion of the international search  <p style="text-align: center;">29 June 2001</p>	Date of mailing of the international search report  <p style="text-align: center;">31/07/2001</p>			
Name and mailing address of the ISA European Patent Office, P.B. 5818 Patentlaan 2 NL - 2280 HV Rijswijk Tel. (+31-70) 340-2040, Tx. 31 651 epo nl, Fax: (+31-70) 340-3016	Authorized officer  <p style="text-align: center;">Lombardi, G</p>			

INTERNATIONAL SEARCH REPORT

Inte Application No  
PCT/US 00/42018

C.(Continuation) DOCUMENTS CONSIDERED TO BE RELEVANT		
Category °	Citation of document, with indication, where appropriate, of the relevant passages	Relevant to claim No.
X	WO 97 48212 A (NOKIA TELECOMMUNICATIONS OY ;KARI HANNU H (FI)) 18 December 1997 (1997-12-18)	1-3, 23, 25, 36
Y	page 3, line 28 -page 8, line 22; figures 2A, 2B	5, 6, 10, 11, 13, 14, 30
A		4, 7-9, 12, 16-22, 24, 26-29, 31-35, 37
X	EP 0 493 130 A (CANON KK) 1 July 1992 (1992-07-01)	1, 2
A	page 11, line 35 -page 12, line 7  figure 16	8, 9, 19, 21, 26, 27, 33, 34
E	US 6 195 024 B1 (FALLON JAMES J) 27 February 2001 (2001-02-27) the whole document	1-37
A	COENE W ET AL: "A FAST ROUTE FOR APPLICATION OF RATE-DISTORTION OPTIMAL QUANTIZATION IN AN MPEG VIDEO ENCODER" PROCEEDINGS OF THE INTERNATIONAL CONFERENCE ON IMAGE PROCESSING (ICIP), US, NEW YORK, IEEE, 16 September 1996 (1996-09-16), pages 825-828, XP000733350 ISBN: 0-7803-3259-8 the whole document	16-22, 31-35

**INTERNATIONAL SEARCH REPORT**

Information on patent family members

International Application No

PCT/US 00/42018

Patent document cited in search report		Publication date	Patent family member(s)	Publication date
EP 0405572	A	02-01-1991	CA 2020084	A, C 30-12-1990
			DE 69014440	D 12-01-1995
			DE 69014440	T 11-05-1995
			JP 2046130	C 25-04-1996
			JP 3108824	A 09-05-1991
			JP 7073249	B 02-08-1995
			US 5091955	A 25-02-1992
			-----	
WO 9748212	A	18-12-1997	FI 962381	A 08-12-1997
			AU 2965697	A 07-01-1998
			EP 0898825	A 03-03-1999
			JP 2000513519	T 10-10-2000
-----				
EP 0493130	A	01-07-1992	JP 4315369	A 06-11-1992
			JP 3082957	B 04-09-2000
			JP 4315370	A 06-11-1992
			JP 3143487	B 07-03-2001
			JP 4317264	A 09-11-1992
			JP 3015112	B 06-03-2000
			JP 4233373	A 21-08-1992
			DE 69126512	D 17-07-1997
			DE 69126512	T 06-11-1997
			DE 69132063	D 20-04-2000
			DE 69132063	T 14-09-2000
			EP 0763925	A 19-03-1997
			ES 2101730	T 16-07-1997
			ES 2143137	T 01-05-2000
			SG 72650	A 23-05-2000
			US 5838826	A 17-11-1998
-----				
US 6195024	B	27-02-2001	NONE	
-----				

**INTERNATIONAL SEARCH REPORT**

International Application No  
PCT/US 01/03712

<b>A. CLASSIFICATION OF SUBJECT MATTER</b> IPC 7 G06F9/445		
According to International Patent Classification (IPC) or to both national classification and IPC		
<b>B. FIELDS SEARCHED</b>		
Minimum documentation searched (classification system followed by classification symbols) IPC 7 G06F		
Documentation searched other than minimum documentation to the extent that such documents are included in the fields searched		
Electronic data base consulted during the international search (name of data base and, where practical, search terms used) EPO-Internal, WPI Data, PAJ, IBM-TDB, INSPEC		
<b>C. DOCUMENTS CONSIDERED TO BE RELEVANT</b>		
Category *	Citation of document, with indication, where appropriate, of the relevant passages	Relevant to claim No.
A	US 5 263 168 A (JELEMENSKY JOSEPH ET AL) 16 November 1993 (1993-11-16) abstract; claims 1,6 ---	1-14, 19-23
A	US 5 642 506 A (LEE VAN HOA) 24 June 1997 (1997-06-24) abstract -----	1-14, 19-23
<input type="checkbox"/> Further documents are listed in the continuation of box C. <input checked="" type="checkbox"/> Patent family members are listed in annex.		
* Special categories of cited documents : *A* document defining the general state of the art which is not considered to be of particular relevance *E* earlier document but published on or after the international filing date *L* document which may throw doubts on priority claim(s) or which is cited to establish the publication date of another citation or other special reason (as specified) *O* document referring to an oral disclosure, use, exhibition or other means *P* document published prior to the international filing date but later than the priority date claimed *T* later document published after the international filing date or priority date and not in conflict with the application but cited to understand the principle or theory underlying the invention *X* document of particular relevance; the claimed invention cannot be considered novel or cannot be considered to involve an inventive step when the document is taken alone *Y* document of particular relevance; the claimed invention cannot be considered to involve an inventive step when the document is combined with one or more other such documents, such combination being obvious to a person skilled in the art. *&* document member of the same patent family		
Date of the actual completion of the international search  2 May 2002		Date of mailing of the international search report  10/05/2002
Name and mailing address of the ISA European Patent Office, P.B. 5818 Patentlaan 2 NL - 2280 HV Rijswijk Tel. (+31-70) 340-2040, Tx. 31 651 epo nl, Fax: (+31-70) 340-3016		Authorized officer  Renault, S



# INTERNATIONAL SEARCH REPORT

Information on patent family members

International Application No

PCT/US 01/03712

Patent document cited in search report		Publication date	Patent family member(s)	Publication date
US 5263168	A	16-11-1993	NONE	
US 5642506	A	24-06-1997	US 5867702 A	02-02-1999

INTERNATIONAL SEARCH REPORT

International Application No  
PCT/US 01/03711

<b>A. CLASSIFICATION OF SUBJECT MATTER</b> IPC 7 G06F3/06 G06F9/445		
According to International Patent Classification (IPC) or to both national classification and IPC		
<b>B. FIELDS SEARCHED</b> Minimum documentation searched (classification system followed by classification symbols) IPC 7 G06F G11B		
Documentation searched other than minimum documentation to the extent that such documents are included in the fields searched		
Electronic data base consulted during the international search (name of data base and, where practical, search terms used) EPO-Internal, PAJ, WPI Data, INSPEC		
<b>C. DOCUMENTS CONSIDERED TO BE RELEVANT</b>		
Category *	Citation of document with indication, where appropriate, of the relevant passages	Relevant to claim No.
A	EP 0 718 751 A (IBM) 26 June 1996 (1996-06-26) column 5, line 56 -column 7, line 13 column 10, line 31 -column 12, line 6; figures 1B,6 ---	1, 32
A	US 5 652 857 A (KANEKO SATORU ET AL) 29 July 1997 (1997-07-29) column 7, line 65 -column 9, line 28; figures 1,2 ---	1, 2, 27, 30, 32, 33
X	DE 41 27 518 A (TOKICO LTD) 27 February 1992 (1992-02-27) column 1, line 1 -column 3, line 24 ---	20-28
X	US 5 226 176 A (WESTAWAY WILLIAM D ET AL) 6 July 1993 (1993-07-06) abstract; figure 3 ---	29-31
	-/--	
<input checked="" type="checkbox"/> Further documents are listed in the continuation of box C. <input checked="" type="checkbox"/> Patent family members are listed in annex.		
* Special categories of cited documents:		
*A* document defining the general state of the art which is not considered to be of particular relevance *E* earlier document but published on or after the international filing date *L* document which may throw doubts on priority claim(s) or which is cited to establish the publication date of another citation or other special reason (as specified) *O* document referring to an oral disclosure, use, exhibition or other means *P* document published prior to the international filing date but later than the priority date claimed		*T* later document published after the international filing date or priority date and not in conflict with the application but cited to understand the principle or theory underlying the invention *X* document of particular relevance: the claimed invention cannot be considered novel or cannot be considered to involve an inventive step when the document is taken alone *Y* document of particular relevance: the claimed invention cannot be considered to involve an inventive step when the document is combined with one or more other such documents, such combination being obvious to a person skilled in the art. *&* document member of the same patent family
Date of the actual completion of the international search  10 January 2002		Date of mailing of the international search report  28.01.2001
Name and mailing address of the ISA European Patent Office, P.B. 5818 Patentlaan 2 NL - 2280 HW Rijswijk Tel. (+31-70) 340-2040, Tx. 31 651 epo nl. Fax: (+31-70) 340-3016		Authorized officer  Kingma, Y

2

INTERNATIONAL SEARCH REPORT

International Application No  
PCT/US 01/03711

C.(Continuation) DOCUMENTS CONSIDERED TO BE RELEVANT		
Category *	Citation of document, with indication, where appropriate, of the relevant passages	Relevant to claim No.
X	US 5 187 793 A (SIMON ALLEN H ET AL) 16 February 1993 (1993-02-16) column 2, line 1 - line 51 -----	29-31

2

Form PCT/ISA/210 (continuation of second sheet) (July 1992)

# INTERNATIONAL SEARCH REPORT

International application No.  
PCT/US 01/03711

## Box I Observations where certain claims were found unsearchable (Continuation of item 1 of first sheet)

This International Search Report has not been established in respect of certain claims under Article 17(2)(a) for the following reasons:

1.  Claims Nos.:  
because they relate to subject matter not required to be searched by this Authority, namely:
  
2.  Claims Nos.:  
because they relate to parts of the International Application that do not comply with the prescribed requirements to such an extent that no meaningful International Search can be carried out, specifically
  
3.  Claims Nos.:  
because they are dependent claims and are not drafted in accordance with the second and third sentences of Rule 6.4(a).

## Box II Observations where unity of invention is lacking (Continuation of item 2 of first sheet)

This International Searching Authority found multiple inventions in this international application, as follows:

see additional sheet

1.  As all required additional search fees were timely paid by the applicant, this International Search Report covers all searchable claims.
2.  As all searchable claims could be searched without effort justifying an additional fee, this Authority did not invite payment of any additional fee.
3.  As only some of the required additional search fees were timely paid by the applicant, this International Search Report covers only those claims for which fees were paid, specifically claims Nos.:
4.  No required additional search fees were timely paid by the applicant. Consequently, this International Search Report is restricted to the invention first mentioned in the claims; it is covered by claims Nos.:

### Remark on Protest

- The additional search fees were accompanied by the applicant's protest.
- No protest accompanied the payment of additional search fees.

**FURTHER INFORMATION CONTINUED FROM PCT/ISA/ 210**

This International Searching Authority found multiple (groups of) inventions in this international application, as follows:

1. Claims: 1-19.32-35

Architecture of a storage controller comprising a DSP, a PLD and NV-memory.

2. Claims: 20-31

Technique of data preloading for accelerated loading of a program

**INTERNATIONAL SEARCH REPORT**

Information on patent family members

International Application No

PCT/US 01/03711

Patent document cited in search report		Publication date	Patent family member(s)	Publication date
EP 0718751	A	26-06-1996	EP 0718751 A2	26-06-1996
			JP 8249127 A	27-09-1996
			KR 238370 B1	15-01-2000
			US 5918068 A	29-06-1999
-----				
US 5652857	A	29-07-1997	JP 8249159 A	27-09-1996
-----				
DE 4127518	A	27-02-1992	JP 4102201 A	03-04-1992
			DE 4127518 A1	27-02-1992
-----				
US 5226176	A	06-07-1993	NONE	
-----				
US 5187793	A	16-02-1993	NONE	
-----				

## Electronic Acknowledgement Receipt

<b>EFS ID:</b>	10608097
<b>Application Number:</b>	13118122
<b>International Application Number:</b>	
<b>Confirmation Number:</b>	8978
<b>Title of Invention:</b>	Systems and Methods for Accelerated Loading of Operating Systems and Application Programs
<b>First Named Inventor/Applicant Name:</b>	James J. Fallon
<b>Customer Number:</b>	26111
<b>Filer:</b>	Michael V. Messinger/Stacy Jen
<b>Filer Authorized By:</b>	Michael V. Messinger
<b>Attorney Docket Number:</b>	2855.004000B
<b>Receipt Date:</b>	02-AUG-2011
<b>Filing Date:</b>	27-MAY-2011
<b>Time Stamp:</b>	16:46:33
<b>Application Type:</b>	Utility under 35 USC 111(a)

### Payment information:

Submitted with Payment	no
------------------------	----

### File Listing:

Document Number	Document Description	File Name	File Size(Bytes)/ Message Digest	Multi Part /.zip	Pages (if appl.)
1	Non Patent Literature	NPL518_09969987_FOA_5_23 11.pdf	670664 <small>2c6774ac4122d9ae300699cf8b0d575985d4d18d</small>	no	17

### Warnings:

### Information:

2	Non Patent Literature	NPL519_11551211NOA5_6_11.pdf	332300 27076da513a467755c5e6a448fa876deb7e76c5	no	5
<b>Warnings:</b>					
<b>Information:</b>					
3	Non Patent Literature	NPL520_12703042NOA5_5_11.pdf	419944 b37bd7909da6a4907a437a1c340ad844583225d3	no	8
<b>Warnings:</b>					
<b>Information:</b>					
4	Non Patent Literature	NPL521_11553427NOA_3_24_11.pdf	330548 749065fb8e1896c3df7b176a70b975b348502589	no	5
<b>Warnings:</b>					
<b>Information:</b>					
5	Non Patent Literature	NPL522_11553419NOA5_20_11.pdf	330517 e43b3c01419f2bd3448d30c0036d666d31162922	no	5
<b>Warnings:</b>					
<b>Information:</b>					
6	Non Patent Literature	NPL523_11400008_FOA_6_27_11.pdf	201400 f84ce30a7d7d7f0a7b9b4ece2909a33afab059279	no	6
<b>Warnings:</b>					
<b>Information:</b>					
7	Non Patent Literature	NPL524_11553427_NOA_5_31_2011.pdf	330103 3bc4a42a74292c55e788b5d6540c85a59d86a3dd	no	5
<b>Warnings:</b>					
<b>Information:</b>					
8	Non Patent Literature	NPL525_12690125_FOA_6_7_2011.pdf	416465 d3d9752061d9e89d814f2552a596111964805cb9	no	11
<b>Warnings:</b>					
<b>Information:</b>					
9	Non Patent Literature	NPL526_12688413_FOA_6_7_2011.pdf	569790 8c1c3344ad8f6f8d11df948d13ca68b93f48d66d	no	15
<b>Warnings:</b>					
<b>Information:</b>					
10	Non Patent Literature	NPL527_ISR_PCTUS0042018.pdf	112128 a892a303e4dff8b30d8dcb8ea61042269bfe41	no	3
<b>Warnings:</b>					
<b>Information:</b>					



11	Non Patent Literature	NPL528_ISR_PCTUS0103712.pdf	60352 30165e016f4f139f30abb10dbef066518e505f7	no	2
<b>Warnings:</b>					
<b>Information:</b>					
12	Non Patent Literature	NPL529_ISR_PCTUS0103711.pdf	122445 2b885fae8cdaa9238fd48b5293e779d3c62f2a6	no	5
<b>Warnings:</b>					
<b>Information:</b>					
13	Non Patent Literature	NPL530_PriorArt_6604158.pdf	1242482 91750e174f04f0ba92fa5857ad03991d3be98044	no	5
<b>Warnings:</b>					
<b>Information:</b>					
14	Non Patent Literature	NPL531_PriorArt_7415530.pdf	4425166 411a0d14b96520df03e2d4f0f680004c089e2fc2	no	14
<b>Warnings:</b>					
<b>Information:</b>					
15	Non Patent Literature	NPL532_PriorArt_6601104.pdf	1576741 e95da3c6f9dfe98850aec340d4f9d6d7bd8c3e8	no	5
<b>Warnings:</b>					
<b>Information:</b>					
16	Non Patent Literature	NPL533_PriorArt_7161506.pdf	4194965 e2d6e4a6d7a392b760dc6568b77a3b96060c168d	no	12
<b>Warnings:</b>					
<b>Information:</b>					
17	Non Patent Literature	NPL534_PriorArt_7395345.pdf	4731228 495b2e10fbb6a9508d074138902498aba57c3121	no	14
<b>Warnings:</b>					
<b>Information:</b>					
18	Non Patent Literature	NPL535_PriorArt_7321937.pdf	4496601 df799222421586f5fe9993123d88dccc54e7b0b7	no	14
<b>Warnings:</b>					
<b>Information:</b>					
19	Non Patent Literature	NPL536_PriorArt_7352300.pdf	4800002 87b19a3cdeeb27c40099cd3029f6d78644d22c4	no	14
<b>Warnings:</b>					
<b>Information:</b>					

20	Non Patent Literature	NPL537_PriorArt_7378992.pdf	4134679 43f67d89a796437d5ec4535641e8141b04d c1865	no	14
<b>Warnings:</b>					
<b>Information:</b>					
21	Non Patent Literature	NPL538_Examiner_Interview_S ummary_for_90009428.pdf	159707 144f5e50d68102058218135e37c46452584 687fe	no	4
<b>Warnings:</b>					
<b>Information:</b>					
22	Non Patent Literature	NPL539_95001517ReqforREexa m_Part_1.pdf	22507197 580b710f9568954c9fca1a9c32b6a845e3a5 9da6	no	448
<b>Warnings:</b>					
<b>Information:</b>					
23	Non Patent Literature	NPL539_95001517ReqforREexa m_Part_2.pdf	12224878 32f688a88356a7224234387a39df46e2a17b d6a1	no	248
<b>Warnings:</b>					
<b>Information:</b>					
24	Non Patent Literature	NPL540_95001533ReqforReexa m.pdf	18759045 22f7dabffa1ae9050a1c5696b1286bf65a1f4 841	no	357
<b>Warnings:</b>					
<b>Information:</b>					
25	Non Patent Literature	NPL541_Gannoun.pdf	1316942 13864962e5b89dc825cdd2efc1e8cbab66 9be00	no	15
<b>Warnings:</b>					
<b>Information:</b>					
26	Non Patent Literature	NPL542_95000464_Reexam_Or der.pdf	953175 da28d210d8b051276ab2e463c3866de3e3 0ee02e	no	29
<b>Warnings:</b>					
<b>Information:</b>					
27	Non Patent Literature	NPL543_95000464_NFOA.pdf	760476 b8f10fa9b038539e6ac7fe535e4c006e76e d14d	no	20
<b>Warnings:</b>					
<b>Information:</b>					
28	Non Patent Literature	NPL544_95000466_NFOA_6_2 2_09.pdf	380369 c12a5680c6562c815ca3c69987ddd77f141 b99c7	no	11
<b>Warnings:</b>					
<b>Information:</b>					

29	Non Patent Literature	NPL545_95000466_Reexam_Ordered.pdf	508161 16e6db1bbf16a2f2e89e86498eba05cd660f36a	no	16
<b>Warnings:</b>					
<b>Information:</b>					
30	Non Patent Literature	NPL546_95000466_Action_Closing_Prosecution.pdf	670971 b714fbb0c4844a90f2b676c906b5fa7f3480a51	no	20
<b>Warnings:</b>					
<b>Information:</b>					
31	Non Patent Literature	NPL547_ThirdPartyCommentsOnFirstReply.pdf	1736919 4de432ca8c60530114d9a2100db4b54401254589	no	30
<b>Warnings:</b>					
<b>Information:</b>					
32	Non Patent Literature	NPL548_StorerDeclforThirdPartyComments.pdf	698984 6dc2ea6d0477c01b50f768c9c974519355a1f80	no	16
<b>Warnings:</b>					
<b>Information:</b>					
33	Non Patent Literature	NPL549_90009428_Examiner_Interview.pdf	96337 5ee1da4a5fcb0489de7097c4aa9159feb242f6c9	no	3
<b>Warnings:</b>					
<b>Information:</b>					
34	Non Patent Literature	NPL550_90009428_NFOA.pdf	384366 45af012b2c2106624439470a6ed8ea22f93db824	no	13
<b>Warnings:</b>					
<b>Information:</b>					
35	Non Patent Literature	NPL551_90009428_Official_Order_Granteeing_Request_for_Ex Parte_Reexamination.pdf	346028 640fbdc2e2de595057477d49f90ff67905819	no	12
<b>Warnings:</b>					
<b>Information:</b>					
36	Non Patent Literature	NPL552_Dec_Ligler_Filed122809_90009428.pdf	805764 c689c08ebe463e651ead400f631340fba7c60c56	no	16
<b>Warnings:</b>					
<b>Information:</b>					
37	Non Patent Literature	NPL553_SuppDec_Ligler_Filed123009_90009428.pdf	26262 8ad66a6f289310d695b9081cea3f99abc21cc3dc	no	1
<b>Warnings:</b>					
<b>Information:</b>					

38	Non Patent Literature	NPL554_liglerdecl_95000466.pdf	1473299 f9b7431a49d9d1c6d81d420fb90b07424a9a10a	no	30
<b>Warnings:</b>					
<b>Information:</b>					
39	Non Patent Literature	NPL555_95000479ReexamOrdered.pdf	1081947 d37872efd7e512a7cf3f3a7078012507d05b373	no	41
<b>Warnings:</b>					
<b>Information:</b>					
40	Non Patent Literature	NPL556_95000479NFOA.pdf	1383697 da37de3aef4cc5fe36af92f903281bbe9f589c2d	no	37
<b>Warnings:</b>					
<b>Information:</b>					
41	Non Patent Literature	NPL557_95000478ReexamOrdered.pdf	2137204 4b1db911e2a3914b4427e99e23f710906baec563	no	60
<b>Warnings:</b>					
<b>Information:</b>					
42	Non Patent Literature	NPL558_95000478NFOA.pdf	957060 d00c40cc3a63a2ba487ed49f6b10a6171b399df8	no	27
<b>Warnings:</b>					
<b>Information:</b>					
43	Non Patent Literature	NPL559_95000486OrderforReexam.pdf	1066587 43c4367c9606e5e6695e8d7afa7a3c2b2172f87	no	35
<b>Warnings:</b>					
<b>Information:</b>					
44	Non Patent Literature	NPL560_95000486NFOA.pdf	7199431 7c654689d13c7b1b1f33652e453a4dd3c6aeb1f0	no	199
<b>Warnings:</b>					
<b>Information:</b>					
45	Non Patent Literature	NPL561_95000464ROAN1_6_11.pdf	571307 301e94e95bb4aaa86ffdf8db4745bf09442e79e	no	15
<b>Warnings:</b>					
<b>Information:</b>					
46	Non Patent Literature	NPL562_95000464ACP8_27_10.pdf	989220 66852c196f3893c7fcea186ebc8ea0d66910b24	no	25
<b>Warnings:</b>					
<b>Information:</b>					

47	Non Patent Literature	NPL563_95000466ROAN_5242010.pdf	788005 04c87f5ac8870276cdaefb39d5e1b0ef1799d4b0	no	23
<b>Warnings:</b>					
<b>Information:</b>					
48	Non Patent Literature	NPL564_FinaRejection_90009428.pdf	496750 c209c0a1496f094719b785c877f0c1841ecf0f1	no	16
<b>Warnings:</b>					
<b>Information:</b>					
49	Non Patent Literature	NPL565_95000479_ROAN1_27_11.pdf	636891 41417d7c68c062a925f9c0845c5dd890f432ace6	no	18
<b>Warnings:</b>					
<b>Information:</b>					
50	Non Patent Literature	NPL566_95000479ACP8_27_10.pdf	1329164 b275ce561c2454c64985249abca356749b0d6e6	no	34
<b>Warnings:</b>					
<b>Information:</b>					
51	Non Patent Literature	NPL567_95000478ROAN1_16_11.pdf	567515 9b3645b969e8a77d2bc488e107fce5fc44a98aa	no	15
<b>Warnings:</b>					
<b>Information:</b>					
52	Non Patent Literature	NPL568_95000478ACP_8_23_10.pdf	1103209 1f33a8ebc6336f1c0c2d68c2539e579733bca127	no	31
<b>Warnings:</b>					
<b>Information:</b>					
53	Non Patent Literature	NPL569_95000486_ACP.pdf	9436668 d36839437bac67a337828ea8e4390f717ab8f3d2	no	257
<b>Warnings:</b>					
<b>Information:</b>					
54	Non Patent Literature	NPL570_95000478_PatentOwnerReply_3152010.pdf	1388202 8a6df0fb8692b7e1cf03d3b7bb481e3c4ddc35ab	no	23
<b>Warnings:</b>					
<b>Information:</b>					
55	Non Patent Literature	NPL571_95000479_PatentOwnerReply_3152010.pdf	1406559 135da859cf50d2568f41a26d9a3ad38e210e9b7	no	23
<b>Warnings:</b>					
<b>Information:</b>					

56	Non Patent Literature	NPL572_95000478_PatentOwnerReplytoACP_9232010.pdf	1784350 905a1a0200427bbd215d630fedb23a08620956cc	no	23
<b>Warnings:</b>					
<b>Information:</b>					
57	Non Patent Literature	NPL573_95000479_PatentOwnerReplytoACP_mailed9272010.pdf	1765358 2efe328e105cc8405f64dadd11ee5877d0559c47	no	26
<b>Warnings:</b>					
<b>Information:</b>					
58	Non Patent Literature	NPL574_95000464_PatentOwnerReplytoACP_9272010.pdf	1586523 3d5ebfc64696b150b9be3fec802e6d57c9d45cbc	no	20
<b>Warnings:</b>					
<b>Information:</b>					
59	Non Patent Literature	NPL575_95000464_ReexamRequest_6624761_6152009.pdf	9946993 9c3e7db29464d87b1355e16d16ab51229259d610	no	241
<b>Warnings:</b>					
<b>Information:</b>					
60	Non Patent Literature	NPL576_95000478_reexamRequest_5212009.pdf	11048145 2a178534db291ec85a0314ccedd312a85a4273bb	no	255
<b>Warnings:</b>					
<b>Information:</b>					
<b>Total Files Size (in bytes):</b>				155978185	
<p><b>This Acknowledgement Receipt evidences receipt on the noted date by the USPTO of the indicated documents, characterized by the applicant, and including page counts, where applicable. It serves as evidence of receipt similar to a Post Card, as described in MPEP 503.</b></p> <p><b><u>New Applications Under 35 U.S.C. 111</u></b>  <b>If a new application is being filed and the application includes the necessary components for a filing date (see 37 CFR 1.53(b)-(d) and MPEP 506), a Filing Receipt (37 CFR 1.54) will be issued in due course and the date shown on this Acknowledgement Receipt will establish the filing date of the application.</b></p> <p><b><u>National Stage of an International Application under 35 U.S.C. 371</u></b>  <b>If a timely submission to enter the national stage of an international application is compliant with the conditions of 35 U.S.C. 371 and other applicable requirements a Form PCT/DO/EO/903 indicating acceptance of the application as a national stage submission under 35 U.S.C. 371 will be issued in addition to the Filing Receipt, in due course.</b></p> <p><b><u>New International Application Filed with the USPTO as a Receiving Office</u></b>  <b>If a new international application is being filed and the international application includes the necessary components for an international filing date (see PCT Article 11 and MPEP 1810), a Notification of the International Application Number and of the International Filing Date (Form PCT/RO/105) will be issued in due course, subject to prescriptions concerning national security, and the date shown on this Acknowledgement Receipt will establish the international filing date of the application.</b></p>					

## Electronic Acknowledgement Receipt

<b>EFS ID:</b>	10606550
<b>Application Number:</b>	13118122
<b>International Application Number:</b>	
<b>Confirmation Number:</b>	8978
<b>Title of Invention:</b>	Systems and Methods for Accelerated Loading of Operating Systems and Application Programs
<b>First Named Inventor/Applicant Name:</b>	James J. Fallon
<b>Customer Number:</b>	26111
<b>Filer:</b>	Michael V. Messinger/Stacy Jen
<b>Filer Authorized By:</b>	Michael V. Messinger
<b>Attorney Docket Number:</b>	2855.004000B
<b>Receipt Date:</b>	02-AUG-2011
<b>Filing Date:</b>	27-MAY-2011
<b>Time Stamp:</b>	16:42:08
<b>Application Type:</b>	Utility under 35 USC 111(a)

### Payment information:

Submitted with Payment	no
------------------------	----

### File Listing:

Document Number	Document Description	File Name	File Size(Bytes)/ Message Digest	Multi Part /.zip	Pages (if appl.)
1	Non Patent Literature	NPL393_RAD_549_818.pdf	16789591 <small>639e342d0525badbab09da50ad81cbf648952683</small>	no	270

### Warnings:

### Information:

2	Non Patent Literature	NPL394_RAD_819_1062.pdf	16616459 8cf9e2500e378128427a766f5416580b9547d526	no	244
<b>Warnings:</b>					
<b>Information:</b>					
3	Non Patent Literature	NPL395_RAD_1063_1372.pdf	15162482 d6324a1fbc333c9dd956b4c0fa38585028655b2	no	310
<b>Warnings:</b>					
<b>Information:</b>					
4	Non Patent Literature	NPL396_RAD_1437_45.pdf	479283 50056e25b809cc0061eb886bc8c5376fd5b75bc7	no	9
<b>Warnings:</b>					
<b>Information:</b>					
5	Non Patent Literature	NPL397_RAD_1738_39.pdf	90190 f54fdcd5f7d4dacb13b8f9dcc0396e40d19cdd7	no	2
<b>Warnings:</b>					
<b>Information:</b>					
6	Non Patent Literature	NPL398_RAD_1740_43.pdf	163836 65c47c12ef280cf1405931e72d8f896bd19a89a6	no	4
<b>Warnings:</b>					
<b>Information:</b>					
7	Non Patent Literature	NPL399_RAD_1744_50.pdf	557050 475ef610a4800edee2c128f3a801b89db7b7b3d9	no	7
<b>Warnings:</b>					
<b>Information:</b>					
8	Non Patent Literature	NPL400_Declaration_Of_Patrick_Gogerty_RE_Microsoft_Production.pdf	128878 bc6a348c28d9b4b2daa26c1125cfae8fb8e004e8	no	3
<b>Warnings:</b>					
<b>Information:</b>					
9	Non Patent Literature	NPL409_Order_Dismissing_Case_in_Favor_of_Texas_Action.pdf	43309 fabe85a0f52dee0e207c80716789fb26d0386727	no	1
<b>Warnings:</b>					
<b>Information:</b>					
10	Non Patent Literature	NPL410_Reuters_Response_re_Transfer.pdf	2586423 adabbd167d74d7b56617a03808488735165a0244	no	103
<b>Warnings:</b>					
<b>Information:</b>					



11	Non Patent Literature	NPL411_Reuters_Judge_Bernan.pdf	2318391 0a61a1e53518042fe68cb85277d6cdacfedc57f9	no	182
<b>Warnings:</b>					
<b>Information:</b>					
12	Non Patent Literature	NPL412_Reuters.pdf	92156 5cc39cfbd3538716056a75e14d49d0d84ba27911	no	3
<b>Warnings:</b>					
<b>Information:</b>					
13	Non Patent Literature	NPL413_ComplaintDJSJDNY.pdf	1303339 815727b1f1326946b4a75b615fc52559409ea3b4	no	41
<b>Warnings:</b>					
<b>Information:</b>					
14	Non Patent Literature	NPL414_Rule_7_1_Disclosure_Statement_for_Thomson_Reuters.pdf	42154 5a4e9b489e73bbd6f9dcd5c6bd138010b9dfa28	no	1
<b>Warnings:</b>					
<b>Information:</b>					
15	Non Patent Literature	NPL415_09cv7868_Order_10_15_09.pdf	92154 81abb2a43c9de3f35843aca8c4bbc8b59743587	no	3
<b>Warnings:</b>					
<b>Information:</b>					
16	Non Patent Literature	NPL416_Claim_Construction_Memorandum_and_Order.pdf	388523 3f5cbc6508406d9e46ce22d8a161503f44ba4a3c	no	75
<b>Warnings:</b>					
<b>Information:</b>					
17	Non Patent Literature	NPL417_RealTime_Technology_Tutorial.pdf	11482114 0c481ddf629c27750c9723d7dd40e47175668581	no	69
<b>Warnings:</b>					
<b>Information:</b>					
18	Non Patent Literature	NPL418_CourtMemoOrderDec82009.pdf	350501 98ecb7d1187c744dd76abff8c36aa1734d626c19	no	10
<b>Warnings:</b>					
<b>Information:</b>					
19	Non Patent Literature	NPL419_Citrix286.pdf	53276 7148dc3bb704f3268595fc62872764049ea3f75b	no	7
<b>Warnings:</b>					
<b>Information:</b>					

20	Non Patent Literature	NPL420_BLUECOAT_DEFENDANTS_NOTICE.pdf	53244 ab8079899a328c1e8d8f015f99cc60e226c19e8e	no	7
<b>Warnings:</b>					
<b>Information:</b>					
21	Non Patent Literature	NPL421_Expand_282Disclosure.pdf	42620 a054e55c2c9365b164921be74ce738877560ac50	no	4
<b>Warnings:</b>					
<b>Information:</b>					
22	Non Patent Literature	NPL422_Expand_Network_Disclosure_Amended.pdf	678681 0220b480b5454412044f8e05e2dff6fdda4d6a6a	no	5
<b>Warnings:</b>					
<b>Information:</b>					
23	Non Patent Literature	NPL423_Defendant_CitrixSystems_Notice_of_Obviousness.pdf	32150 4429b2dc5489a6c1fe7691025c4238f4c4b78018	no	3
<b>Warnings:</b>					
<b>Information:</b>					
24	Non Patent Literature	NPL424_Order_Motion_to_Limit_No_of_refs_12_21_09.pdf	66648 3464df46447ad16a62f6754c03274b37ffdf6478	no	6
<b>Warnings:</b>					
<b>Information:</b>					
25	Non Patent Literature	NPL425_Expand_Defendants_Notice_of_Obviousness.pdf	404567 4a049a90cebb6db0c273807be1a575996b52a71	no	3
<b>Warnings:</b>					
<b>Information:</b>					
26	Non Patent Literature	NPL426_Bluecoat_Systems_and_7_Eleven_Notice_of_Obviousness.pdf	101718 946ab4c2aa557fc215ad40c219f7269dbd7ce3f0	no	38
<b>Warnings:</b>					
<b>Information:</b>					
27	Non Patent Literature	NPL428_PacketeerDocketlisting.pdf	9024982 58e9df82a659010e97ef96762386ad6613ec366	no	165
<b>Warnings:</b>					
<b>Information:</b>					
28	Non Patent Literature	NPL429_ccitt.pdf	231546 f1607811e1bd2c64ad4bebb77bf934b34880b174	no	12
<b>Warnings:</b>					
<b>Information:</b>					

29	Non Patent Literature	NPL430_SNAFormats.pdf	128668	no	3
			8ed8a21c6ef732737794460de83f253d492bf3b6		
<b>Warnings:</b>					
<b>Information:</b>					
30	Non Patent Literature	NPL431_Munteau.pdf	190546	no	10
			79c47f911982fe4f4f7f5215836891cd56231		
<b>Warnings:</b>					
<b>Information:</b>					
31	Non Patent Literature	NPL432_Forchhammer_Jensen_Article.pdf	2273064	no	13
			2a45b6e94aea54ef3ca224381d37804e8992fd88		
<b>Warnings:</b>					
<b>Information:</b>					
32	Non Patent Literature	NPL433_Eaoyang_article_embedded.pdf	1639788	no	8
			fbe117deb2cd9411ab5521cb92a77062654b34eb1		
<b>Warnings:</b>					
<b>Information:</b>					
33	Non Patent Literature	NPL434_2009-10-06_Transcript.pdf	340629	no	133
			f298ecfe0cd366e96d2b5f637ba1a724f2d548a		
<b>Warnings:</b>					
<b>Information:</b>					
34	Non Patent Literature	NPL435_2009-11-10_Transcript.pdf	232862	no	88
			5266fd212590c45f203ae813660c3069c442d8ad		
<b>Warnings:</b>					
<b>Information:</b>					
35	Non Patent Literature	NPL436_Nelson_DataCompression_Book_PT1.pdf	9153102	no	283
			9177050670a3bcc9e5829f3e7f17ca12505cca0c		
<b>Warnings:</b>					
<b>Information:</b>					
36	Non Patent Literature	NPL437_IEEEDictionaryD.pdf	36846	no	1
			7e59f28a2f2dbf833b1e8740cbe9c8545269d62d		
<b>Warnings:</b>					
<b>Information:</b>					
37	Non Patent Literature	NPL438_Larousse_Dictionary.pdf	179324	no	2
			797e7fa38a2c131b9090815a0dcf27f597a2d2c		
<b>Warnings:</b>					
<b>Information:</b>					

38	Non Patent Literature	NPL439_RTS_Motion_to_Strike_9_22_09.pdf	7831751 a60738282b8363ca2ec298dd38ef11272ea74d7c	no	14
<b>Warnings:</b>					
<b>Information:</b>					
39	Non Patent Literature	NPL440_RT_Reply_Support_Motion_to_Strike.pdf	119936 f53750080fceb4ea63d64d959411cf76cc4305d2	no	17
<b>Warnings:</b>					
<b>Information:</b>					
40	Non Patent Literature	NPL427_CitrixNoticeofPriorArt Refs.pdf	45922 8bb0cd2ebc248ec511734d3fbc177eda156a6a7a	no	6
<b>Warnings:</b>					
<b>Information:</b>					
41	Non Patent Literature	NPL441_Citrix_Sur_reply_in_opp_10_30_09.pdf	61950 24c79c86afdc9f9ac55467ba25b3afe71f2ad16	no	9
<b>Warnings:</b>					
<b>Information:</b>					
42	Non Patent Literature	NPL442_BC_Response_11_11_09.pdf	31062 881615b4051dace9a25ee4017e0cfe10ed1addc5	no	3
<b>Warnings:</b>					
<b>Information:</b>					
43	Non Patent Literature	NPL443_2009-11-13_Order_for_Suppl_Briefing_BlueCoat.pdf	332560 76896b84b14863e25cd31f05017b48b14d1811e0	no	6
<b>Warnings:</b>					
<b>Information:</b>					
44	Non Patent Literature	NPL444_2009-11-23_MemoOpinion_Order_re_Suppl_Claim_Con.pdf	386801 8361e8e512d17f02b3949ba6a82730dad8abcad4	no	15
<b>Warnings:</b>					
<b>Information:</b>					
45	Non Patent Literature	NPL445_Memorandum_12_8_09.pdf	81596 0ea6e521530906920b00ed4f84d71395c8794453	no	10
<b>Warnings:</b>					
<b>Information:</b>					
46	Non Patent Literature	NPL446_Expands_Conculsion_of_Fact_11_12_09.pdf	37384 956798e452c7695d2512f931d33159873c685c38	no	3
<b>Warnings:</b>					
<b>Information:</b>					

47	Non Patent Literature	NPL447_Realttime_Datas_Sur-Reply_12_23_09.pdf	887192 b1246e9d475579cdd4e24a10e74de0047a6a356	no	6
<b>Warnings:</b>					
<b>Information:</b>					
48	Non Patent Literature	NPL448_Order_re_Def_Citrix_Notice_of_other_Priorart_12_30_09.pdf	355946 ce72c4f673a6dd910c87e335d662d8bae28298d	no	3
<b>Warnings:</b>					
<b>Information:</b>					
49	Non Patent Literature	NPL449_Networking_Group_RFC_2068.pdf	271926 e2c024298eba01dd31a48f3b8a2e561abdc523f3	no	163
<b>Warnings:</b>					
<b>Information:</b>					
50	Non Patent Literature	NPL450_Networking_Group_RFC_2616.pdf	6944957 7dd77f457318e5b9b707e7cc37f94aa85504a469	no	114
<b>Warnings:</b>					
<b>Information:</b>					
51	Non Patent Literature	NPL451_Networking_Group_RFC_1945.pdf	107744 f0ce55fb0d239d878ce8ae15e775b288dd32ecfd	no	61
<b>Warnings:</b>					
<b>Information:</b>					
52	Non Patent Literature	NPL452_Networking_Group_RFC_1950.pdf	598703 dd095766ea300f2a0cffe70e0c430a93a06a2d7b	no	10
<b>Warnings:</b>					
<b>Information:</b>					
53	Non Patent Literature	NPL453_Networking_Group_RFC_1951.pdf	579304 3a0872c0a9f5bcb2939d36a58a677f5c4bc7c94f	no	15
<b>Warnings:</b>					
<b>Information:</b>					
54	Non Patent Literature	NPL454_Networking_Group_RFC_1952.pdf	69020 d4f4e07e26250b1b8a905075f1002cf881c269f3	no	12
<b>Warnings:</b>					
<b>Information:</b>					
55	Non Patent Literature	NPL455_Notice_of_Plaintiff_RT_Proposed_11_10_09.pdf	38906 2674267b8085bd5edf313877e9186d7643b43d79	no	4
<b>Warnings:</b>					
<b>Information:</b>					

56	Non Patent Literature	NPL456_Amended_Appendix.pdf	1924049 8a1065c0c25e718f1b935ee28bec94a9ac813dbc	no	509
<b>Warnings:</b>					
<b>Information:</b>					
57	Non Patent Literature	NPL458_Modestino.pdf	10433290 d49c3a815e13782113e1450176fcd5a80cc89a	no	49
<b>Warnings:</b>					
<b>Information:</b>					
58	Non Patent Literature	NPL459_LiglerSecondDec.pdf	36653 0d6d15a738dfb4d4c5f3277129651d5c3e0be14f	no	3
<b>Warnings:</b>					
<b>Information:</b>					
59	Non Patent Literature	NPL460_ComplaintCMEgroup.pdf	180762 48604451bf9a64681665f1390a71f18cf680676	no	24
<b>Warnings:</b>					
<b>Information:</b>					
60	Non Patent Literature	NPL461_ComplaintThomasReuters.pdf	132724 ae3f49c01eeb22f2c56e8a561da7d9ecff61aca7	no	15
<b>Warnings:</b>					
<b>Information:</b>					
<b>Total Files Size (in bytes):</b>				125041232	
<p><b>This Acknowledgement Receipt evidences receipt on the noted date by the USPTO of the indicated documents, characterized by the applicant, and including page counts, where applicable. It serves as evidence of receipt similar to a Post Card, as described in MPEP 503.</b></p> <p><b><u>New Applications Under 35 U.S.C. 111</u></b>  <b>If a new application is being filed and the application includes the necessary components for a filing date (see 37 CFR 1.53(b)-(d) and MPEP 506), a Filing Receipt (37 CFR 1.54) will be issued in due course and the date shown on this Acknowledgement Receipt will establish the filing date of the application.</b></p> <p><b><u>National Stage of an International Application under 35 U.S.C. 371</u></b>  <b>If a timely submission to enter the national stage of an international application is compliant with the conditions of 35 U.S.C. 371 and other applicable requirements a Form PCT/DO/EO/903 indicating acceptance of the application as a national stage submission under 35 U.S.C. 371 will be issued in addition to the Filing Receipt, in due course.</b></p> <p><b><u>New International Application Filed with the USPTO as a Receiving Office</u></b>  <b>If a new international application is being filed and the international application includes the necessary components for an international filing date (see PCT Article 11 and MPEP 1810), a Notification of the International Application Number and of the International Filing Date (Form PCT/RO/105) will be issued in due course, subject to prescriptions concerning national security, and the date shown on this Acknowledgement Receipt will establish the international filing date of the application.</b></p>					

## Electronic Acknowledgement Receipt

<b>EFS ID:</b>	10605499
<b>Application Number:</b>	13118122
<b>International Application Number:</b>	
<b>Confirmation Number:</b>	8978
<b>Title of Invention:</b>	Systems and Methods for Accelerated Loading of Operating Systems and Application Programs
<b>First Named Inventor/Applicant Name:</b>	James J. Fallon
<b>Customer Number:</b>	26111
<b>Filer:</b>	Michael V. Messinger/Stacy Jen
<b>Filer Authorized By:</b>	Michael V. Messinger
<b>Attorney Docket Number:</b>	2855.004000B
<b>Receipt Date:</b>	02-AUG-2011
<b>Filing Date:</b>	27-MAY-2011
<b>Time Stamp:</b>	16:38:16
<b>Application Type:</b>	Utility under 35 USC 111(a)

### Payment information:

Submitted with Payment	no
------------------------	----

### File Listing:

Document Number	Document Description	File Name	File Size(Bytes)/ Message Digest	Multi Part /.zip	Pages (if appl.)
1	Non Patent Literature	NPL274_ExpertReportofJamesB Gambrell.pdf	9284517  18db5e2b98e197bfa6516f7549a5021ab1c 3dd73	no	199

### Warnings:

### Information:

2	Non Patent Literature	NPL275_Storer_Invalidity_Report.pdf	11137048 47e7b98621de7c624acfea2e9d669de7ddd1ffaa	no	1090
<b>Warnings:</b>					
<b>Information:</b>					
3	Non Patent Literature	NPL276_Storer_Supp_Report_Invalidity_772_PatentwithExhibits1-8_.pdf	16782069 e886396adfd86354981b0c072b8573cda9a36d06	no	301
<b>Warnings:</b>					
<b>Information:</b>					
4	Non Patent Literature	NPL277_Storer_Deposition_Transcript_2009-02-27_.pdf	501078 d2703a02656cc87e724212f954d1bfc6f57ec6d4	no	242
<b>Warnings:</b>					
<b>Information:</b>					
5	Non Patent Literature	NPL278_Von_Herzen_Deposition_Transcript_2009-02-26_.pdf	519439 438d861471b6ec4b5529184b1c1d77e86bd96bf	no	241
<b>Warnings:</b>					
<b>Information:</b>					
6	Non Patent Literature	NPL279_Second_Amended_Complaint.pdf	76011 7dd15fd9d3af291a146400a7da76221acc24ccc	no	28
<b>Warnings:</b>					
<b>Information:</b>					
7	Non Patent Literature	NPL280_Citrix_Answer_to_Second_Amended_Complaint.pdf	119460 156e56991bc9a6e582207e8080a433fc21db1899	no	46
<b>Warnings:</b>					
<b>Information:</b>					
8	Non Patent Literature	NPL281_F5_Answer_to_Second_Amended_Complaint.pdf	80839 f355785dc87d172b1f1469860d483081cddaabdd	no	17
<b>Warnings:</b>					
<b>Information:</b>					
9	Non Patent Literature	NPL282_Averitt_Answer_to_Second_Amended_Complaint.pdf	80124 15d1e97bc84318ecd4647037d369851feec04a6a	no	17
<b>Warnings:</b>					
<b>Information:</b>					
10	Non Patent Literature	NPL283_DHL_Answer_to_Second_Amended_Complaint.pdf	78686 34a5213421870999bda73f5a91c4d32981d72cd8f	no	37
<b>Warnings:</b>					
<b>Information:</b>					



11	Non Patent Literature	NPL284_Expand_Answer_to_Second_Amended_Complaint.pdf	66266 cc884705e5c3b1a6b6566cde2860692493f1191e	no	21
<b>Warnings:</b>					
<b>Information:</b>					
12	Non Patent Literature	NPL285_Blue_Coat_Answer_to_Second_Amended_Complaint.pdf	248798 886de75eddd6b79c4a30029dbc1b70cd0c2690df	no	84
<b>Warnings:</b>					
<b>Information:</b>					
13	Non Patent Literature	NPL286_Response_to_Citrix_Answer_and_Counterclaims.pdf	68575 769a072379e85c2b202aad58d9c8e8060b893beb	no	24
<b>Warnings:</b>					
<b>Information:</b>					
14	Non Patent Literature	NPL287_Response_to_F5_Answer_and_Counterclaims.pdf	36580 844b58726b5e9e44605a2655c86754f13bd47685	no	5
<b>Warnings:</b>					
<b>Information:</b>					
15	Non Patent Literature	NPL288_Response_to_Averitt_Answer_and_Counterclaims.pdf	36321 e10feaad255875b7f40f78869f97124090eb0095	no	5
<b>Warnings:</b>					
<b>Information:</b>					
16	Non Patent Literature	NPL289_Reponse_to_DHL_Answer_and_Counterclaims.pdf	61019 069593c497003e3a0500f468ca1770e10339770c	no	17
<b>Warnings:</b>					
<b>Information:</b>					
17	Non Patent Literature	NPL290_Response_to_Expand_Answer_and_Counterclaims.pdf	56636 b6f692a807fae9612dd258ddf8c34b74ffc4d54	no	15
<b>Warnings:</b>					
<b>Information:</b>					
18	Non Patent Literature	NPL291_Response_to_Blue_Coat_Answer_and_Counterclaims.pdf	83429 32b1c769832ef1966e7998bfdda86c27b6249b6	no	34
<b>Warnings:</b>					
<b>Information:</b>					
19	Non Patent Literature	NPL292_Realtime_Opening_Claim_Construction_Brief.pdf	167224 3ca5607e80d17fb3ebfed83055bc3a988d600131	no	36
<b>Warnings:</b>					
<b>Information:</b>					

20	Non Patent Literature	NPL293_Part1.pdf	20704254	no	107
			7641975c9882ac8572dd57d48d56d8edea403a78		
<b>Warnings:</b>					
<b>Information:</b>					
21	Non Patent Literature	NPL293_Part2.PDF	21721850	no	107
			03e4037f594702160fcaed925e9123445619029		
<b>Warnings:</b>					
<b>Information:</b>					
22	Non Patent Literature	NPL294_Defendants_MOTION_For_Partial_summary_judgment.pdf	114928	no	22
			1a986efa59c7a3f56876b182d168381467ee6999		
<b>Warnings:</b>					
<b>Information:</b>					
23	Non Patent Literature	NPL295_Moreland_declaration_ISO_Motion_Partial_Summary_Judgment.pdf	8388895	no	168
			1648b2632916bc19a261654367709f1e95de417d		
<b>Warnings:</b>					
<b>Information:</b>					
24	Non Patent Literature	NPL296_Storer_declaration_ISO_Motion_Partial_Summary_Judgment.pdf	412991	no	27
			9d96f52c417007b11b203bb0d90856f2dab11928		
<b>Warnings:</b>					
<b>Information:</b>					
25	Non Patent Literature	NPL297_Defendants_Reply_brief_ISO_Mot_Partial_Summary_Judgment.pdf	423233	no	20
			4534bab843ab9870866ca9f4e7e3bb320ee42c48		
<b>Warnings:</b>					
<b>Information:</b>					
26	Non Patent Literature	NPL298_BlueCoatDefendants_Responsive_Claim_Construction_Brief.pdf	20939221	no	451
			b687873477a4b613343846697c46de8b36cde79		
<b>Warnings:</b>					
<b>Information:</b>					
27	Non Patent Literature	NPL299_F5Defendants_Responsive_Claim_Construction_Brief.pdf	714013	no	20
			4a0966521f93944fd1ad82538b65f6f53d53b066		
<b>Warnings:</b>					
<b>Information:</b>					
28	Non Patent Literature	NPL300_CitrixDefendant_Responsive_Claim_Construction_Brief.pdf	24623481	no	377
			e4dd5639e64debe8fe5b4051c555d6f3c2528518		
<b>Warnings:</b>					
<b>Information:</b>					

29	Non Patent Literature	NPL301_Storer_Declaration_F5_Responsive_Claim_Construction_Brief.pdf	5911842 8ce554615c9432b8470d144981e29b2dd21c6dce	no	778
<b>Warnings:</b>					
<b>Information:</b>					
30	Non Patent Literature	NPL302_ExcludeVonHerzenPart1.pdf	3665992 b0c1ea3c47c586ced973d42d5f3b7e09ae0c9a11	no	122
<b>Warnings:</b>					
<b>Information:</b>					
31	Non Patent Literature	NPL303_Realtime_Opposition_Brief_To_Motion_To_Exclude_Von_Herzen_Opinions.pdf	83729 2fa2c8902cf666e27f8d91e0bf8416dc864a746	no	20
<b>Warnings:</b>					
<b>Information:</b>					
32	Non Patent Literature	NPL304_Oussayef_Declaration_Opposition_Brief_To_Motion_To_Exclude_Von_Herzen_Opinions.pdf	768962 7972878b8a643824dec50594c66378144741476d	no	119
<b>Warnings:</b>					
<b>Information:</b>					
33	Non Patent Literature	NPL305_Order_Denying_Citrix_Motion_To_Exclude_Von_Herzen_Opinions.pdf	26569 e29e84ee094ec04dcdcaab992e44230e568bdabf	no	1
<b>Warnings:</b>					
<b>Information:</b>					
34	Non Patent Literature	NPL306_Joint_Submission_of_terms_to_be_heard_at_Markman_Hearing.pdf	38014 9e957d111322d1c4805a76dfdc4c2a31c900a1	no	5
<b>Warnings:</b>					
<b>Information:</b>					
35	Non Patent Literature	NPL307_Order_regarding_terms_to_be_heard_at_Markman_Hearing.pdf	60910 18a837c206ad169ddceba76f0c00a58ce04c47c5	no	2
<b>Warnings:</b>					
<b>Information:</b>					
36	Non Patent Literature	NPL308_Markman_Hearing_Transcript.pdf	246556 f56d53c5f5add14a788d4bf6b9b4382531c05cda0	no	174
<b>Warnings:</b>					
<b>Information:</b>					
37	Non Patent Literature	NPL309_Realtime_Reply_Claim_Construction_Brief.pdf	151817 b6d08d4acec89aff5fe966304902ca3d7f0d2b4b	no	30
<b>Warnings:</b>					
<b>Information:</b>					

38	Non Patent Literature	NPL310_Von_Herzen_Deposition_ISO_Realtime_Reply_Claim_Construction.pdf	1931428 7ea753e99720d7e686a0db6300e3648344738ce6	no	25
<b>Warnings:</b>					
<b>Information:</b>					
39	Non Patent Literature	NPL311_F5_Sur_Reply_Claim_Construction_brief.pdf	133172 907ae1301e5e2d8c1b85bc766c819f9105a9724a	no	12
<b>Warnings:</b>					
<b>Information:</b>					
40	Non Patent Literature	NPL312_Citrix_Sur_Reply_Brief_on_Claim_Construction.pdf	63555 1feea31d2200643c22888874ffebed7be716c40f	no	13
<b>Warnings:</b>					
<b>Information:</b>					
41	Non Patent Literature	NPL313_Blue_Coat_Sur_Reply_Claim_Construction_Brief.pdf	83075 4c19bfd583d4a550c9934efdd008bf2727df3bc	no	12
<b>Warnings:</b>					
<b>Information:</b>					
42	Non Patent Literature	NPL314_Dec_of_Moreland_ISO_Blue_Coat_Sur_Reply_Claim_Construction_Brief.pdf	243925 ef7478296f1ac18cdfab8a51c33e7e939814a112	no	8
<b>Warnings:</b>					
<b>Information:</b>					
43	Non Patent Literature	NPL315_Dec_of_Storer_ISO_F5_Sur_Reply_Claim_Construction_brief.pdf	62800 6b03ee353c1dac15770e41576e42b186a473b3a	no	6
<b>Warnings:</b>					
<b>Information:</b>					
44	Non Patent Literature	NPL316_REALT12.pdf	412596 efd08471f946a418255e61b24476a6b236dee303	no	123
<b>Warnings:</b>					
<b>Information:</b>					
45	Non Patent Literature	NPL317_Realtime_Reconsideration_for_Leave_to_Supplement_Claim_Construction_Statement.pdf	34050 8d4a707fb2d471bf1c1231b2aedf0c65bec6503	no	3
<b>Warnings:</b>					
<b>Information:</b>					
46	Non Patent Literature	NPL318_Citrix_Opposition_to_Realtime_Request_for_Reconstruction_of_Claim_Construction_order.pdf	51852 7be21989373536afaf8f0ca0a2cef6a225dc6279c	no	6
<b>Warnings:</b>					
<b>Information:</b>					

47	Non Patent Literature	NPL319_Realttime_F5_Joint_Notice_of_Agreement_to_claim_termination.pdf	35624 ddcb66badc1b7a1897db328a3d97084ee64c3064	no	3
<b>Warnings:</b>					
<b>Information:</b>					
48	Non Patent Literature	NPL320_Provisional_Claim_Construction_Order.pdf	146629 eb545a2c60ccd0fbfa0fc046704dc12b4dad86a1	no	28
<b>Warnings:</b>					
<b>Information:</b>					
49	Non Patent Literature	NPL321_CITRIX_REQUEST_FOR_Recon_REGARDING_CLAIM_CONSTRUCTION_Order.pdf	85064 56b1c83360d09a7ca7846436328ab6c31a107958	no	22
<b>Warnings:</b>					
<b>Information:</b>					
50	Non Patent Literature	NPL322_BLUE_COAT_OBJECTIION_REGARDING_CLAIM_CONSTRUCTION_Order.pdf	61030 0a5eef0f53aec791abc8e995d630f662f4f5d2f	no	9
<b>Warnings:</b>					
<b>Information:</b>					
51	Non Patent Literature	NPL323_F5s_Motion_for_Recon_REGARDING_CLAIM_CONSTRUCTION_Order.pdf	104593 b77eeb2b034a86ddb1bb1bcc8666ca5fc74a6ffa	no	15
<b>Warnings:</b>					
<b>Information:</b>					
52	Non Patent Literature	NPL324_Comtech_AHA_Intervenor_Complaint.pdf	46927 351fcd7704b366a360eb38a6c1eca7a2fcb009c	no	8
<b>Warnings:</b>					
<b>Information:</b>					
53	Non Patent Literature	NPL325_Report_and_Recommendation_Regarding_Mot_partial_summary_judgment.pdf	134111 04b8d13ec38a8d01844592b30243802e9c54c2b2	no	22
<b>Warnings:</b>					
<b>Information:</b>					
54	Non Patent Literature	NPL326_BlueCoat_Obj_Regarding_Mot_Partial_Summary_Judgment.pdf	208456 8a3b4fe559cedce7446ad8e720d9470e7c65428	no	18
<b>Warnings:</b>					
<b>Information:</b>					
55	Non Patent Literature	NPL327_Realtimes_Motion_for_Reconsideration_Claim_Construction_Order.pdf	58091 3502af9803d87aa82d8e46c3e33087cba5d6748d	no	11
<b>Warnings:</b>					
<b>Information:</b>					

56	Non Patent Literature	NPL328_CitrixOppositiontoClaimConstruction.pdf	80381 096d9a4b6663e751e7ae5a36a106d98f9202b1d8	no	8
<b>Warnings:</b>					
<b>Information:</b>					
57	Non Patent Literature	NPL329_F5_Opposition_To_Realtime_Request_for_Reconstruction_of_Claim_Construction_order.pdf	51256 34658cb6e22746d4e207aad5be4e23e5b7d48b9	no	4
<b>Warnings:</b>					
<b>Information:</b>					
58	Non Patent Literature	NPL330_DefendantsResponse to Claim Construction.pdf	61583 75e8d6b3f298b933cb7b7b3df47116b25cb0370	no	9
<b>Warnings:</b>					
<b>Information:</b>					
59	Non Patent Literature	NPL331_Realtime_Opposition_To_Citrix_Request_for_Reconstruction_of_Claim_Construction_order.pdf	62233 9018445a59c8fc442328c2917a7e84fc099c485	no	13
<b>Warnings:</b>					
<b>Information:</b>					
60	Non Patent Literature	NPL302_ExcludeVonHerzenPart2.pdf	22002040 767c1ed18b3095fdfa2e3570b12ae9b75feab387	no	122
<b>Warnings:</b>					
<b>Information:</b>					
<b>Total Files Size (in bytes):</b>				174635847	
<p><b>This Acknowledgement Receipt evidences receipt on the noted date by the USPTO of the indicated documents, characterized by the applicant, and including page counts, where applicable. It serves as evidence of receipt similar to a Post Card, as described in MPEP 503.</b></p> <p><b><u>New Applications Under 35 U.S.C. 111</u></b>  <b>If a new application is being filed and the application includes the necessary components for a filing date (see 37 CFR 1.53(b)-(d) and MPEP 506), a Filing Receipt (37 CFR 1.54) will be issued in due course and the date shown on this Acknowledgement Receipt will establish the filing date of the application.</b></p> <p><b><u>National Stage of an International Application under 35 U.S.C. 371</u></b>  <b>If a timely submission to enter the national stage of an international application is compliant with the conditions of 35 U.S.C. 371 and other applicable requirements a Form PCT/DO/EO/903 indicating acceptance of the application as a national stage submission under 35 U.S.C. 371 will be issued in addition to the Filing Receipt, in due course.</b></p> <p><b><u>New International Application Filed with the USPTO as a Receiving Office</u></b>  <b>If a new international application is being filed and the international application includes the necessary components for an international filing date (see PCT Article 11 and MPEP 1810), a Notification of the International Application Number and of the International Filing Date (Form PCT/RO/105) will be issued in due course, subject to prescriptions concerning national security, and the date shown on this Acknowledgement Receipt will establish the international filing date of the application.</b></p>					

## Electronic Acknowledgement Receipt

<b>EFS ID:</b>	10607439
<b>Application Number:</b>	13118122
<b>International Application Number:</b>	
<b>Confirmation Number:</b>	8978
<b>Title of Invention:</b>	Systems and Methods for Accelerated Loading of Operating Systems and Application Programs
<b>First Named Inventor/Applicant Name:</b>	James J. Fallon
<b>Customer Number:</b>	26111
<b>Filer:</b>	Michael V. Messinger/Stacy Jen
<b>Filer Authorized By:</b>	Michael V. Messinger
<b>Attorney Docket Number:</b>	2855.004000B
<b>Receipt Date:</b>	02-AUG-2011
<b>Filing Date:</b>	27-MAY-2011
<b>Time Stamp:</b>	16:44:44
<b>Application Type:</b>	Utility under 35 USC 111(a)

### Payment information:

Submitted with Payment	no
------------------------	----

### File Listing:

Document Number	Document Description	File Name	File Size(Bytes)/ Message Digest	Multi Part /.zip	Pages (if appl.)
1	Non Patent Literature	NPL462_ComplaintMorganStanley.pdf	195832 f9923968f1074c1b78d4b89c2de1755e8b6f1b64	no	27

### Warnings:

### Information:

2	Non Patent Literature	NPL463_CHINTAPt1.pdf	21435866	no	80
			f27e344d7cdc447aab2f504d0376ff7639621456		
<b>Warnings:</b>					
<b>Information:</b>					
3	Non Patent Literature	NPL463_CHINTAPt2.pdf	25952440	no	80
			f54ac0947920ec6405d0d7e1254823b867396ebf		
<b>Warnings:</b>					
<b>Information:</b>					
4	Non Patent Literature	NPL463_CHINTAPt3.pdf	23369107	no	80
			7da12201f72e1185b5cc58111046e73bb7c7c7c2		
<b>Warnings:</b>					
<b>Information:</b>					
5	Non Patent Literature	NPL463_CHINTAPt4.pdf	14293526	no	80
			00b26884df0c8c982ee0ff372643993d31f26c72		
<b>Warnings:</b>					
<b>Information:</b>					
6	Non Patent Literature	NPL463_CHINTAPt5.pdf	24162093	no	110
			2b4b247a2ca82b7f41cd30c021e257e4f7310671		
<b>Warnings:</b>					
<b>Information:</b>					
7	Non Patent Literature	NPL464_ISREP091505081.pdf	166450	no	5
			9b0686718a2791f4ae731a49575aa8065c129229		
<b>Warnings:</b>					
<b>Information:</b>					
8	Non Patent Literature	NPL465_Reuters_v_Realtim_C V_7868__complaint.pdf	4933691	no	6
			95fd8e302c641303d528c40ad96bca25bed5a4c		
<b>Warnings:</b>					
<b>Information:</b>					
9	Non Patent Literature	NPL466_RealtimvMedPCS.pdf	86290	no	14
			8f844a02264d40db932f87883aeeb506b1c24c7a		
<b>Warnings:</b>					
<b>Information:</b>					
10	Non Patent Literature	NPL467_CBOcomplaint.pdf	53607	no	6
			1b6216f42b762ad501aae921545b80fd873671ac		
<b>Warnings:</b>					
<b>Information:</b>					



11	Non Patent Literature	NPL468_RealttimeResptoDefen dObjPartialSumm.pdf	102351 1be54414435ce600b3ed67e3f81f33dfe0e e2b7	no	15
<b>Warnings:</b>					
<b>Information:</b>					
12	Non Patent Literature	NPL469_PACER458.pdf	33359 e27d74e6988478baf6e31df772e334e73541 263a4	no	3
<b>Warnings:</b>					
<b>Information:</b>					
13	Non Patent Literature	NPL470_PACER460.pdf	54577 0dea6b627442cd7fd6c03c3f94bfd4c056cf 1ed	no	3
<b>Warnings:</b>					
<b>Information:</b>					
14	Non Patent Literature	NPL471_Defendants_Inval_Co ntentions_MetroPCS.pdf	474432 8bb58290b77f4bdce0e46d4e90f11276f53 416db	no	138
<b>Warnings:</b>					
<b>Information:</b>					
15	Non Patent Literature	NPL472_AppendixA_ClaimChar ts_MetroPCS.pdf	633158 14c481c6d3f125d37d055b3d85b486544a 96097	no	173
<b>Warnings:</b>					
<b>Information:</b>					
16	Non Patent Literature	NPL473_AppendixB_ClaimChar ts_MetroPCS.pdf	2051962 98e82df4794afe68b8c21ce753d018bb24fd e335	no	809
<b>Warnings:</b>					
<b>Information:</b>					
17	Non Patent Literature	NPL474_AppendixC_ClaimChar ts_MetroPCS.pdf	1399348 2996026978491d9e72ff3969bf31a2a3ada5 9eb4	no	530
<b>Warnings:</b>					
<b>Information:</b>					
18	Non Patent Literature	NPL475_AppendixD_ClaimCha rts_MetroPCS.pdf	816941 9fc50b3e417a55817861d8e3c464298ad49 19ff1	no	253
<b>Warnings:</b>					
<b>Information:</b>					
19	Non Patent Literature	NPL476_AppendixE_ClaimChar ts_MetroPCS.pdf	1232064 4bad0b7ce54851fb2b56345730d1bd6745f b4175	no	397
<b>Warnings:</b>					
<b>Information:</b>					

20	Non Patent Literature	NPL477_AppendixF_ClaimCharts_MetroPCS.pdf	1375365 cda45646d12133cc7c0ee7c3595e8db3aa15edc	no	462
<b>Warnings:</b>					
<b>Information:</b>					
21	Non Patent Literature	NPL478_AppendixG_ClaimCharts_MetroPCS.pdf	1573910 79609b22beeb071354a758cc0d5f819a3554fdd6	no	548
<b>Warnings:</b>					
<b>Information:</b>					
22	Non Patent Literature	NPL479_AppendixH_ClaimCharts_MetroPCS.pdf	659502 bac7b4674c92bfcdcb777dc838efcba23129e47a	no	151
<b>Warnings:</b>					
<b>Information:</b>					
23	Non Patent Literature	NPL480_AMIR_ApplicationLevel_DEF200419.pdf	3481339 4dee4d2898d9048e708b8b9429029e67b3d0377	no	11
<b>Warnings:</b>					
<b>Information:</b>					
24	Non Patent Literature	NPL481_KATZandBREWERS_BayArea56pgs_DEF201563.pdf	17225629 9d53057e2ed03842dd3db5ea5adff8e033799ef9	no	56
<b>Warnings:</b>					
<b>Information:</b>					
25	Non Patent Literature	NPL482_KATZandBREWERS_BayArea68pgs_DEF200934.pdf	15037623 9326c8dee243d05ceafcb0c66cb1126f0832dbd	no	68
<b>Warnings:</b>					
<b>Information:</b>					
26	Non Patent Literature	NPL483_BRUCKMAN_SelectiveMedical_DEF202641.pdf	5032102 9e1436775e4548b2b7b19f78ec544dba438f3941	no	23
<b>Warnings:</b>					
<b>Information:</b>					
27	Non Patent Literature	NPL484_CROWLEY_DynamicCompression.pdf	123620 c24b5aa31103cc2684f42bc4b7f906eb11f136d0	no	3
<b>Warnings:</b>					
<b>Information:</b>					
28	Non Patent Literature	NPL485_HERSHKOVITS_UniversalData.pdf	2866835 3fec317d9f634e0801458c2a895eb147de66e2c3	no	99
<b>Warnings:</b>					
<b>Information:</b>					

29	Non Patent Literature	NPL486_KATZ_BayAreaResearch_DEF200394.pdf	2201220 fde62de9ed2ca3fc0e4b8dcd3a7f31612a c435	no	6
<b>Warnings:</b>					
<b>Information:</b>					
30	Non Patent Literature	NPL487_KLEIN_CompressionAndCoding.pdf	2356644 f51bce8dabfe12e94dc1b7c564932130546 3708	no	41
<b>Warnings:</b>					
<b>Information:</b>					
31	Non Patent Literature	NPL488_REGHBATI_AnOverview_DEF200384.pdf	3030542 4195da316ab3c3d6343cecf694c2fc880064 ddbb	no	5
<b>Warnings:</b>					
<b>Information:</b>					
32	Non Patent Literature	NPL489_MetroPCS_CourtDocket.pdf	259251 119a8126d7f9d29d0c28d5655e5d8d118bc 4fd8b	no	13
<b>Warnings:</b>					
<b>Information:</b>					
33	Non Patent Literature	NPL490_ChicagoBoardOptions_CourtDocket.pdf	225364 a5e9d30a8245b4be1508f9df1516cd7049 acff	no	7
<b>Warnings:</b>					
<b>Information:</b>					
34	Non Patent Literature	NPL491_Packeteer_CourtDocket.pdf	838453 1f1712b66b61dcd39c26eb82687579688c 04c2d	no	119
<b>Warnings:</b>					
<b>Information:</b>					
35	Non Patent Literature	NPL492_MorganStanley_CourtDocket.pdf	421592 4cbe43a0315b7280c78b48a2132e017d8df 9c994	no	44
<b>Warnings:</b>					
<b>Information:</b>					
36	Non Patent Literature	NPL493_CME_CourtDocket.pdf	476319 e2d6e9c85427255255e7545f19514901190 8857b	no	55
<b>Warnings:</b>					
<b>Information:</b>					
37	Non Patent Literature	NPL494_ThomsonReutersetal_CourtDocket.pdf	340969 e7cd222c7dc416ee28d451ed39c3c314dc 13b61	no	29
<b>Warnings:</b>					
<b>Information:</b>					

38	Non Patent Literature	NPL495_ThomsonReuters_CourtDocket.pdf	200889 2c01e7e2377c1ed713750e2f30d9a865c8215505	no	3
<b>Warnings:</b>					
<b>Information:</b>					
39	Non Patent Literature	NPL496_11651366NOA4_10_09.pdf	330239 2ef13aa786c817387438bce4acfd00c8ddb7bfb7	no	7
<b>Warnings:</b>					
<b>Information:</b>					
40	Non Patent Literature	NPL497_NFOA_12684624.pdf	172941 113adc9d1a24650c5fd69d07bb8dd8ab69100513	no	5
<b>Warnings:</b>					
<b>Information:</b>					
41	Non Patent Literature	NPL498_NOA_12123081.pdf	396481 f71aa18b6529dfb621b7c748f5c7a12856b522bc	no	7
<b>Warnings:</b>					
<b>Information:</b>					
42	Non Patent Literature	NPL499_NFOA_12688413.pdf	502936 2c27ebc7934087c649ec3a7ca209cac42272ad0d	no	13
<b>Warnings:</b>					
<b>Information:</b>					
43	Non Patent Literature	NPL500_NOA_11551211.pdf	255508 ab24bc98cb3e789b33f24ab320101cb36ecf798c	no	4
<b>Warnings:</b>					
<b>Information:</b>					
44	Non Patent Literature	NPL501_NOA_11551211.pdf	255429 a62469858c4b6b4a1b2068996ad346b4819bb8d80	no	4
<b>Warnings:</b>					
<b>Information:</b>					
45	Non Patent Literature	NPL502_11551204_NOA.pdf	255458 8866ce37a63ea99e0cb72a9f68b312060142c220	no	4
<b>Warnings:</b>					
<b>Information:</b>					
46	Non Patent Literature	NPL503_NOA_11553419.pdf	254241 4cd41a6ea52b7dc3475e09f28839f4ac6cbb46bd	no	4
<b>Warnings:</b>					
<b>Information:</b>					

47	Non Patent Literature	NPL504_11400008_NFOA.pdf	233034 22f03ae08b458012a93f78d263338b93ec6 10656	no	7
<b>Warnings:</b>					
<b>Information:</b>					
48	Non Patent Literature	NPL505_11651365_NOA.pdf	370921 6d6dad86f641c88a5d2cd642fe6daede4f 64ae	no	8
<b>Warnings:</b>					
<b>Information:</b>					
49	Non Patent Literature	NPL506_NOA_11651365.pdf	373615 3c58fa248b27fed05369a129b28bb8de37a 64b48	no	8
<b>Warnings:</b>					
<b>Information:</b>					
50	Non Patent Literature	NPL507_NFOA_09969987.pdf	502541 9a59cd5cd23faee3368e56c72b99936397f6 05fc	no	13
<b>Warnings:</b>					
<b>Information:</b>					
51	Non Patent Literature	NPL508_FOA_09969987_01282 010.pdf	400260 6591576bb8728a92dbd79d26a8e0e9e77 144e4d	no	11
<b>Warnings:</b>					
<b>Information:</b>					
52	Non Patent Literature	NPL509_NOA_12131631_0622 2010.pdf	259407 cf2d1c9b3d04805e5265ecldb9673ad1a19 6ac50	no	5
<b>Warnings:</b>					
<b>Information:</b>					
53	Non Patent Literature	NPL510_FOA_11400008_10302 009.pdf	243454 b1282ec1de3f8bc910fbee07c75750595 b7b60	no	7
<b>Warnings:</b>					
<b>Information:</b>					
54	Non Patent Literature	NPL511_FOA_11400008_05112 010.pdf	250349 dbc9bd4554f658502e4ed11b8ed79e5700d 6b1201	no	7
<b>Warnings:</b>					
<b>Information:</b>					
55	Non Patent Literature	NPL512_11551204NO9_30_10. pdf	255474 0bd2691742528228ee2261f8d6b917338ae 3677d	no	4
<b>Warnings:</b>					
<b>Information:</b>					

56	Non Patent Literature	NPL513_NFOA_11551204.pdf	183270 3ec4f7a83a34a92cf6da2d42082eaffeb923efc1	no	5
<b>Warnings:</b>					
<b>Information:</b>					
57	Non Patent Literature	NPL514_NOA_11551204.pdf	256414 f0acbbe8d989ed67b05ddc5a1e9254ca45a333e	no	4
<b>Warnings:</b>					
<b>Information:</b>					
58	Non Patent Literature	NPL515_NFOA_11551204.pdf	275662 fc99aea7d5f43d7e01470e9913dd79ebfc38a8b7	no	9
<b>Warnings:</b>					
<b>Information:</b>					
59	Non Patent Literature	NPL516_NOA_11551204.pdf	256948 2938922f653716f2952a673d485964fa77df0f7	no	4
<b>Warnings:</b>					
<b>Information:</b>					
60	Non Patent Literature	NPL517_NFOA_12690125.pdf	442639 416dc1f2fb3bb0e635dc67c7a894d39a3979d0c0	no	12
<b>Warnings:</b>					
<b>Information:</b>					
<b>Total Files Size (in bytes):</b>			185901483		
<p><b>This Acknowledgement Receipt evidences receipt on the noted date by the USPTO of the indicated documents, characterized by the applicant, and including page counts, where applicable. It serves as evidence of receipt similar to a Post Card, as described in MPEP 503.</b></p> <p><b><u>New Applications Under 35 U.S.C. 111</u></b>  <b>If a new application is being filed and the application includes the necessary components for a filing date (see 37 CFR 1.53(b)-(d) and MPEP 506), a Filing Receipt (37 CFR 1.54) will be issued in due course and the date shown on this Acknowledgement Receipt will establish the filing date of the application.</b></p> <p><b><u>National Stage of an International Application under 35 U.S.C. 371</u></b>  <b>If a timely submission to enter the national stage of an international application is compliant with the conditions of 35 U.S.C. 371 and other applicable requirements a Form PCT/DO/EO/903 indicating acceptance of the application as a national stage submission under 35 U.S.C. 371 will be issued in addition to the Filing Receipt, in due course.</b></p> <p><b><u>New International Application Filed with the USPTO as a Receiving Office</u></b>  <b>If a new international application is being filed and the international application includes the necessary components for an international filing date (see PCT Article 11 and MPEP 1810), a Notification of the International Application Number and of the International Filing Date (Form PCT/RO/105) will be issued in due course, subject to prescriptions concerning national security, and the date shown on this Acknowledgement Receipt will establish the international filing date of the application.</b></p>					

## Electronic Acknowledgement Receipt

<b>EFS ID:</b>	10651129
<b>Application Number:</b>	13118122
<b>International Application Number:</b>	
<b>Confirmation Number:</b>	8978
<b>Title of Invention:</b>	Systems and Methods for Accelerated Loading of Operating Systems and Application Programs
<b>First Named Inventor/Applicant Name:</b>	James J. Fallon
<b>Customer Number:</b>	26111
<b>Filer:</b>	Michael V. Messinger/Stacy Jen
<b>Filer Authorized By:</b>	Michael V. Messinger
<b>Attorney Docket Number:</b>	2855.004000B
<b>Receipt Date:</b>	02-AUG-2011
<b>Filing Date:</b>	27-MAY-2011
<b>Time Stamp:</b>	17:02:58
<b>Application Type:</b>	Utility under 35 USC 111(a)

### Payment information:

Submitted with Payment	no
------------------------	----

### File Listing:

Document Number	Document Description	File Name	File Size(Bytes)/ Message Digest	Multi Part /.zip	Pages (if appl.)
1	Non Patent Literature	NPL332_Realtime_Opposition_To_BlueCoat_Request_for_Rec_on_Of_Claim_Const_order.pdf	48739 <small>5a70b93629b209b99330904076affe496fa763be</small>	no	9

### Warnings:

### Information:

2	Non Patent Literature	NPL256_CUseeemetxtfromindstate.pdf	528727	no	5
			946003690f1305f3c3c9933844ff436e73abb403		
<b>Warnings:</b>					
<b>Information:</b>					
3	Non Patent Literature	NPL257_Cuseemetxt19960221.pdf	890740	no	9
			8d01c86806fdea01742dbfec4973761d895ce7f0		
<b>Warnings:</b>					
<b>Information:</b>					
4	Non Patent Literature	NPL258_Part1.PDF	19638746	no	206
			618d8fa922f9f890cf374794c20644d3168046		
<b>Warnings:</b>					
<b>Information:</b>					
5	Non Patent Literature	NPL258_Part2.pdf	24819916	no	206
			97cadd30fb52c94ec04f762daee921fd5631586		
<b>Warnings:</b>					
<b>Information:</b>					
6	Non Patent Literature	NPL259_Lettieri.pdf	1492886	no	6
			496576add6e33d9782f2fbb56b8ea154130c7ea		
<b>Warnings:</b>					
<b>Information:</b>					
7	Non Patent Literature	NPL260_HighPerformance.pdf	2579876	no	27
			e1de0e3d05db80952be31e61cb5efef8cb4ed034		
<b>Warnings:</b>					
<b>Information:</b>					
8	Non Patent Literature	NPL261_h323.PDF	5356715	no	26
			c33fb594481c4536e678aeedfc618d23cd418e1f		
<b>Warnings:</b>					
<b>Information:</b>					
9	Non Patent Literature	NPL262_LBXXConsortiumAlgorithms.pdf	169068	no	3
			b7e91740730111f53b087b8b8e7017a934efdc7		
<b>Warnings:</b>					
<b>Information:</b>					
10	Non Patent Literature	NPL263_BasicsofImages.pdf	433312	no	5
			f1269594ec1abea25217e0de0e58c41a2b545f8f		
<b>Warnings:</b>					
<b>Information:</b>					



11	Non Patent Literature	NPL264_Parties_Joint_Claim_Construction.pdf	8504397 95f55aa63b0bde0ed148aeb76ff0c5a24aff594d	no	168
<b>Warnings:</b>					
<b>Information:</b>					
12	Non Patent Literature	NPL265_Storer_Dec_158_Patent_March_18_2009.pdf	398457 d39a214676701d58ee57937d4b83cbac713900b	no	10
<b>Warnings:</b>					
<b>Information:</b>					
13	Non Patent Literature	NPL245__Losslessandnearlosslesscompression.pdf	5678204 bf61f9efdfef5f2654b102e5ed7dfe332c60a465	no	75
<b>Warnings:</b>					
<b>Information:</b>					
14	Non Patent Literature	NPL246_Davis.pdf	1418564 ac20d2bb1fd965285f83f11193ca29d48780e4ec	no	4
<b>Warnings:</b>					
<b>Information:</b>					
15	Non Patent Literature	NPL247_Abbott.pdf	9057087 9bdd58b84c14cddff48f6f220d6248bc38f3231c63	no	93
<b>Warnings:</b>					
<b>Information:</b>					
16	Non Patent Literature	NPL248_V42bisandOtherZivLeimoelVariants.pdf	45797 bd3b780adfc98470a4e00b310ecb7bbaebdf6bbb	no	1
<b>Warnings:</b>					
<b>Information:</b>					
17	Non Patent Literature	NPL249_Thomborson_Modems.pdf	1081204 21b31312c80e8fe7f66749e934097c213a3d00cf	no	11
<b>Warnings:</b>					
<b>Information:</b>					
18	Non Patent Literature	NPL250_Sun.pdf	10351862 87afd011a16d9076a131da0f9e7a11ba2c0152de	no	89
<b>Warnings:</b>					
<b>Information:</b>					
19	Non Patent Literature	NPL251_WhatistheV42bisStandard.pdf	197303 f260c23b8a794486608c65e60b149e48f625406	no	2
<b>Warnings:</b>					
<b>Information:</b>					

20	Non Patent Literature	NPL252_WSDC_Image_Pro_DOS.pdf	502252 f385a7c49ade817a69c5617521c9773da8bbcb83	no	4
<b>Warnings:</b>					
<b>Information:</b>					
21	Non Patent Literature	NPL253_WSDC_Download_Guide.pdf	678503 4d412863a55bb95cbf4687b4a271fb891566481f	no	5
<b>Warnings:</b>					
<b>Information:</b>					
22	Non Patent Literature	NPL254APPNOTETXT.pdf	4904090 8f8842142a2d7a7eb6cfa8b31525e1de94349fa	no	52
<b>Warnings:</b>					
<b>Information:</b>					
<b>Total Files Size (in bytes):</b>				98776445	
<p><b>This Acknowledgement Receipt evidences receipt on the noted date by the USPTO of the indicated documents, characterized by the applicant, and including page counts, where applicable. It serves as evidence of receipt similar to a Post Card, as described in MPEP 503.</b></p> <p><b><u>New Applications Under 35 U.S.C. 111</u></b>  <b>If a new application is being filed and the application includes the necessary components for a filing date (see 37 CFR 1.53(b)-(d) and MPEP 506), a Filing Receipt (37 CFR 1.54) will be issued in due course and the date shown on this Acknowledgement Receipt will establish the filing date of the application.</b></p> <p><b><u>National Stage of an International Application under 35 U.S.C. 371</u></b>  <b>If a timely submission to enter the national stage of an international application is compliant with the conditions of 35 U.S.C. 371 and other applicable requirements a Form PCT/DO/EO/903 indicating acceptance of the application as a national stage submission under 35 U.S.C. 371 will be issued in addition to the Filing Receipt, in due course.</b></p> <p><b><u>New International Application Filed with the USPTO as a Receiving Office</u></b>  <b>If a new international application is being filed and the international application includes the necessary components for an international filing date (see PCT Article 11 and MPEP 1810), a Notification of the International Application Number and of the International Filing Date (Form PCT/RO/105) will be issued in due course, subject to prescriptions concerning national security, and the date shown on this Acknowledgement Receipt will establish the international filing date of the application.</b></p>					

## Electronic Acknowledgement Receipt

<b>EFS ID:</b>	10609590
<b>Application Number:</b>	13118122
<b>International Application Number:</b>	
<b>Confirmation Number:</b>	8978
<b>Title of Invention:</b>	Systems and Methods for Accelerated Loading of Operating Systems and Application Programs
<b>First Named Inventor/Applicant Name:</b>	James J. Fallon
<b>Customer Number:</b>	26111
<b>Filer:</b>	Michael V. Messinger/Stacy Jen
<b>Filer Authorized By:</b>	Michael V. Messinger
<b>Attorney Docket Number:</b>	2855.004000B
<b>Receipt Date:</b>	02-AUG-2011
<b>Filing Date:</b>	27-MAY-2011
<b>Time Stamp:</b>	16:49:33
<b>Application Type:</b>	Utility under 35 USC 111(a)

### Payment information:

Submitted with Payment	no
------------------------	----

### File Listing:

Document Number	Document Description	File Name	File Size(Bytes)/ Message Digest	Multi Part /.zip	Pages (if appl.)
1	Non Patent Literature	NPL577_95000479_ReexamRequest_5282009.pdf	20763704 <small>7ebb9e7c8f6149ef32bf71b28e64614aae5a7dfb</small>	no	455

### Warnings:

### Information:

2	Non Patent Literature	NPL578_95001581RequestforReexam_pt1.pdf	19498678 105bf4364a2faa7a7277438bd10671da66788e1b	no	100
<b>Warnings:</b>					
<b>Information:</b>					
3	Non Patent Literature	NPL578_95001581RequestforReexam_pt2.pdf	17623960 3b86f2c855ce7fe26da0e868949a118a82e8d726	no	100
<b>Warnings:</b>					
<b>Information:</b>					
4	Non Patent Literature	NPL578_95001581RequestforReexam_pt3.pdf	18295952 54a041ccfc29b6552c4d00be849bd53724ccf232	no	100
<b>Warnings:</b>					
<b>Information:</b>					
5	Non Patent Literature	NPL578_95001581RequestforReexam_pt4.pdf	18225453 807f459cde67ad04e277a57f582b82ebfd9e55b	no	100
<b>Warnings:</b>					
<b>Information:</b>					
6	Non Patent Literature	NPL578_95001581RequestforReexam_pt5.pdf	18641199 bb0dee30973548330c2c38799e85229b815f7669	no	100
<b>Warnings:</b>					
<b>Information:</b>					
7	Non Patent Literature	NPL578_95001581RequestforReexam_pt6.pdf	17806572 ec71a8c5b35de098eaa597874ea180605d26d8b	no	100
<b>Warnings:</b>					
<b>Information:</b>					
8	Non Patent Literature	NPL578_95001581RequestforReexam_pt7.pdf	16963390 adb6e6ff2c9a11b013a8a8076c16fcc02bc79c15	no	100
<b>Warnings:</b>					
<b>Information:</b>					
9	Non Patent Literature	NPL578_95001581RequestforReexam_pt8.pdf	18677520 d76ef9b1587a9e4e5a74f1882e2b2c7d964149b2	no	100
<b>Warnings:</b>					
<b>Information:</b>					
10	Non Patent Literature	NPL578_95001581RequestforReexam_pt9.pdf	21104770 7ef713907631736771114263de4cb74d59e3841d	no	100
<b>Warnings:</b>					
<b>Information:</b>					

11	Non Patent Literature	NPL578_95001581RequestforR eexam_pt10.pdf	21058725 0539f585ec1b03d028f5a7fa0f32eddee676f 06b	no	101
<b>Warnings:</b>					
<b>Information:</b>					
12	Non Patent Literature	NPL578_95001581RequestforR eexam_pt11.pdf	21815199 5e7d61c6549bd257ded22390599b7baa8c 5c827f	no	100
<b>Warnings:</b>					
<b>Information:</b>					
13	Non Patent Literature	NPL578_95001581RequestforR eexam_pt12.pdf	21563306 36c2135bec762a959436159b6b897f58eee b7d47	no	100
<b>Warnings:</b>					
<b>Information:</b>					
14	Non Patent Literature	NPL578_95001581RequestforR eexam_pt13.pdf	21553590 0e8d98474948b5785608bd8edeb6b35cd a96a87	no	100
<b>Warnings:</b>					
<b>Information:</b>					
15	Non Patent Literature	NPL578_95001581RequestforR eexam_pt14.pdf	21325271 a5f27293efd3c4f4fce783e7e0eb7771ecfaf18 82	no	100
<b>Warnings:</b>					
<b>Information:</b>					
16	Non Patent Literature	NPL578_95001581RequestforR eexam_pt15.pdf	21039390 75c762a4fbf77bc649ac096c740d5baec735 91eb	no	100
<b>Warnings:</b>					
<b>Information:</b>					
17	Non Patent Literature	NPL578_95001581RequestforR eexam_pt16.pdf	21480477 98d38b3a3be25721cc8437f1a26ef3055b4 52eb2	no	100
<b>Warnings:</b>					
<b>Information:</b>					
18	Non Patent Literature	NPL578_95001581RequestforR eexam_pt17.pdf	21364354 adcb046f13129b5cdd8c45bde3f2e5b03b0 80d1a	no	100
<b>Warnings:</b>					
<b>Information:</b>					
19	Non Patent Literature	NPL578_95001581RequestforR eexam_pt18.pdf	21558859 c284e695401d1b4433adb6bd1e3c796f038 d4f5e	no	100
<b>Warnings:</b>					
<b>Information:</b>					

20	Non Patent Literature	NPL578_95001581RequestforR eexam_pt19.pdf	19879024 0492154d35ed1e8ff748fce32bcbbe35904e 3c5b	no	100
<b>Warnings:</b>					
<b>Information:</b>					
21	Non Patent Literature	NPL578_95001581RequestforR eexam_pt20.pdf	19083218 b94c3b9626fd32881ad9222b7c49053da0d 21876	no	100
<b>Warnings:</b>					
<b>Information:</b>					
22	Non Patent Literature	NPL578_95001581RequestforR eexam_pt21.pdf	18524241 623472acae100e438fe4b9f39dd0d2adbe2 8289	no	100
<b>Warnings:</b>					
<b>Information:</b>					
23	Non Patent Literature	NPL578_95001581RequestforR eexam_pt22.pdf	19480674 2aae205f7ac25ff8996f20143750c37a2257 248	no	100
<b>Warnings:</b>					
<b>Information:</b>					
24	Non Patent Literature	NPL578_95001581RequestforR eexam_pt23.pdf	17968755 c0374a16abf0472c855ec533432f83952382 7c85	no	100
<b>Warnings:</b>					
<b>Information:</b>					
25	Non Patent Literature	NPL578_95001581RequestforR eexam_pt24.pdf	18120717 b8aa05bc753791c1d62715599a60b5264a9 8f2fd	no	100
<b>Warnings:</b>					
<b>Information:</b>					
26	Non Patent Literature	NPL578_95001581RequestforR eexam_pt25.pdf	12794486 7a0478f46b5472bc2b6465c4199714654cc 93c60	no	57
<b>Warnings:</b>					
<b>Information:</b>					
27	Non Patent Literature	NPL579_95001544RequestforR eexam.pdf	22497285 6cca1158408d13bd455f10fa856b84d889d b635	no	420
<b>Warnings:</b>					
<b>Information:</b>					
28	Non Patent Literature	NPL580_95000466ACP.pdf	670969 b6dc80faccfb863808090a6825a6fd6459a1 68f4	no	20
<b>Warnings:</b>					
<b>Information:</b>					

29	Non Patent Literature	NPL581_95001544OrderandNFOA.pdf	1628814 5f0a4b7783f472f6b16cd53713fbf8ca3fc8d85a	no	47
<b>Warnings:</b>					
<b>Information:</b>					
30	Non Patent Literature	NPL582_95001544_NFOA_5_20_2011.pdf	1481104 30d314ace8ddf27df84a3842960bbad960c9df	no	47
<b>Warnings:</b>					
<b>Information:</b>					
31	Non Patent Literature	NPL583_95001581_OrderGrantingReexam_6_15_2011.pdf	705130 e4b811f5881f82f037c54209e25ea87e18aad199	no	22
<b>Warnings:</b>					
<b>Information:</b>					
32	Non Patent Literature	NPL584_95001533_NFOA_5_6_2011.pdf	3725308 053457e6db32915fe4fd509b99827e22104c36	no	105
<b>Warnings:</b>					
<b>Information:</b>					
33	Non Patent Literature	NPL585_95001517_OrderGrantingReexam_3_9_2011.pdf	768029 4e9f9cd846a6ff76acf5c0106b24ae12405a7fe	no	21
<b>Warnings:</b>					
<b>Information:</b>					
34	Non Patent Literature	NPL586_AppealBrief_90009428.pdf	1823365 c3a6d795b58db170b9a8ee17df02a71b1a93c74d	no	28
<b>Warnings:</b>					
<b>Information:</b>					
35	Non Patent Literature	NPL587_Invalidity_Contentions_12082008.pdf	1222673 57f70f19d772e08a1f256f0ca249a5b1868afcd	no	19
<b>Warnings:</b>					
<b>Information:</b>					
36	Non Patent Literature	NPL588_Appendix_A.pdf	17513973 665dac99a405cb2371be2284713f5c7af345d0c7	no	345
<b>Warnings:</b>					
<b>Information:</b>					
37	Non Patent Literature	NPL589_Appendix_B_Part_1.pdf	21525181 2412139796c2bfff31798e6b97eb94b4287b86a3	no	468
<b>Warnings:</b>					
<b>Information:</b>					

38	Non Patent Literature	NPL589_Appendix_B_Part_2.pdf	21812633 1ca0ef814dc57d3338155689e9630610f1e77ac2	no	478
<b>Warnings:</b>					
<b>Information:</b>					
39	Non Patent Literature	NPL589_Appendix_B_Part_3.pdf	22513082 361cae88ca8b99d7daa5d6623eb9b100c00f396d	no	489
<b>Warnings:</b>					
<b>Information:</b>					
40	Non Patent Literature	NPL589_Appendix_B_Part_4.pdf	21297203 9cac2493eb793ee1f441ed78697bdf1032c17caf	no	458
<b>Warnings:</b>					
<b>Information:</b>					
41	Non Patent Literature	NPL590_Appendix_C_Part_1.pdf	22520151 7760cd6193f2582208ee9f71b1e1c84f31db6ccf	no	507
<b>Warnings:</b>					
<b>Information:</b>					
42	Non Patent Literature	NPL590_Appendix_C_Part_2.pdf	24506911 01818f94ecfeba715d1a65d74e54dd2d4ca5c04f	no	548
<b>Warnings:</b>					
<b>Information:</b>					
43	Non Patent Literature	NPL591_Appendix_D.pdf	9923724 9d083cdea40ab81e3c9f71900ea1b5b34af3477c	no	197
<b>Warnings:</b>					
<b>Information:</b>					
44	Non Patent Literature	NPL592_Appendix_E_Part_1.pdf	20169728 e2747ee45dd577c5d9f21e3e03e195c23c2dfe5	no	362
<b>Warnings:</b>					
<b>Information:</b>					
45	Non Patent Literature	NPL592_Appendix_E_Part_2.pdf	18976740 a302cc867324ee43950735c290095a285d3c4c9d	no	373
<b>Warnings:</b>					
<b>Information:</b>					
46	Non Patent Literature	NPL593_Appendix_F_Part_1.pdf	22376042 f73e31af1a6861716636f5519368347171e5746	no	399
<b>Warnings:</b>					
<b>Information:</b>					



47	Non Patent Literature	NPL593_Appendix_F_Part_2.pdf	20018710 f6bc7402008431fde27b1420770b466d4152742	no	376
<b>Warnings:</b>					
<b>Information:</b>					
48	Non Patent Literature	NPL594_Appendix_G_Part_1.pdf	15540556 7b2fe38ae18aa651d98eb7e0d7a05e730883fb80	no	309
<b>Warnings:</b>					
<b>Information:</b>					
49	Non Patent Literature	NPL594_Appendix_G_Part_2.pdf	13108307 611c9055d55ae3896372261182e622d49e1fd135	no	258
<b>Warnings:</b>					
<b>Information:</b>					
50	Non Patent Literature	NPL595_Appendix_H.pdf	5178978 2ea5f759e8b7a26bdc8dc5f38d83de752964661b	no	97
<b>Warnings:</b>					
<b>Information:</b>					
51	Non Patent Literature	NPL596_Appendix_I.pdf	9661669 8dbd6d455e05248ab7fc9fbee573313ab4e93a4f	no	146
<b>Warnings:</b>					
<b>Information:</b>					
52	Non Patent Literature	NPL597_Appendix_J.pdf	920985 2847cf0010236d82ffc6141e17479400c32fc219	no	25
<b>Warnings:</b>					
<b>Information:</b>					
53	Non Patent Literature	NPL598_Infringement_Contentions_Amended_Answer_and_Counterclaims_Pt1.pdf	14331098 0c23955d80d7be1b4b4f495e30aa2f0581174bb5	no	300
<b>Warnings:</b>					
<b>Information:</b>					
54	Non Patent Literature	NPL598_Infringement_Contentions_Amended_Answer_and_Counterclaims_pt2.pdf	14699182 c5b7c76e3bef193280958752f0cf21b495e14734	no	291
<b>Warnings:</b>					
<b>Information:</b>					
<b>Total Files Size (in bytes):</b>			857329014		

This Acknowledgement Receipt evidences receipt on the noted date by the USPTO of the indicated documents, characterized by the applicant, and including page counts, where applicable. It serves as evidence of receipt similar to a Post Card, as described in MPEP 503.

**New Applications Under 35 U.S.C. 111**

If a new application is being filed and the application includes the necessary components for a filing date (see 37 CFR 1.53(b)-(d) and MPEP 506), a Filing Receipt (37 CFR 1.54) will be issued in due course and the date shown on this Acknowledgement Receipt will establish the filing date of the application.

**National Stage of an International Application under 35 U.S.C. 371**

If a timely submission to enter the national stage of an international application is compliant with the conditions of 35 U.S.C. 371 and other applicable requirements a Form PCT/DO/EO/903 indicating acceptance of the application as a national stage submission under 35 U.S.C. 371 will be issued in addition to the Filing Receipt, in due course.

**New International Application Filed with the USPTO as a Receiving Office**

If a new international application is being filed and the international application includes the necessary components for an international filing date (see PCT Article 11 and MPEP 1810), a Notification of the International Application Number and of the International Filing Date (Form PCT/RO/105) will be issued in due course, subject to prescriptions concerning national security, and the date shown on this Acknowledgement Receipt will establish the international filing date of the application.

IN THE UNITED STATES PATENT AND TRADEMARK OFFICE

In re application of:

FALLON *et al.*

Appl. No.: 13/118,122

Filed: May 27, 2011

For: **Systems and Methods for  
Accelerated Loading of Operating  
Systems and Application Programs**

Confirmation No.: 8978

Art Unit: 2115

Examiner: To Be Assigned

Atty. Docket: 2855.004000B

**Information Disclosure Statement**

*Mail Stop Amendment*

Commissioner for Patents  
PO Box 1450  
Alexandria, VA 22313-1450

Sir:

Notice of Prior and Concurrent Proceedings

Applicants hereby call to the attention of the Patent and Trademark Office the following reexamination proceedings involving patents that are commonly-assigned with the patent in the above-identified patent application:

Proceeding	Status
<i>Inter Partes</i> Reexamination of U.S. Patent No. 6,604,158 (Control No. 95/000,486)	Non-Final Action Closing Prosecution mailed March 7, 2011; Decision Dismissing Petition mailed January 26, 2011; Petition filed August 25, 2010
<i>Inter Partes</i> Reexamination of U.S. Patent No. 7,321,937 (Control No. 95/000,466)	Decision Dismissing Petition mailed January 26, 2011; Appeal Brief filed Oct. 25, 2010
<i>Inter Partes</i> Reexamination of U.S. Patent No. 6,604,158 (Control No. 95/000,453)	Terminated
<i>Ex Parte</i> Reexamination of U.S. Patent No. 6,601,104 (Control No. 90/009,428)	Miscellaneous Action with SSP 6/7/2011; Request for Rehearing after Board Decision 5/18/2011; BPAI Decision mailed March 18, 2011; Notification of Appeal Hearing issued January 14, 2011; Examiner's Answer issued Oct. 6, 2010

Proceeding	Status
<i>Inter Partes</i> Reexamination of U.S. Patent No. 7,378,992 (Control No. 95/000,478)	Appeal-Brief Filed 4/21/2011; Notice of Appeal filed February 8, 2011; Decision Dismissing Petition mailed January 25, 2011; Patent Owner Comments on Action Closing Prosecution filed September 23, 2010
<i>Inter Partes</i> Reexamination of U.S. Patent No. 6,624,761 (Control No. 95/000,464)	Appeal Brief Filed 4/21/2011; Notice of Appeal filed February 8, 2011; Decision Dismissing Petition mailed January 25, 2011; Patent Owner Comments on Action Closing Prosecution filed September 28, 2010
<i>Inter Partes</i> Reexamination of U.S. Patent No. 7,161,506 (Control No. 95/000,479)	Appeal Brief Filed 4/21/2011; Notice of Appeal filed February 10, 2011; Decision Dismissing Petition mailed January 25, 2011; Patent Owner Comments on Action Closing Prosecution filed September 27, 2010
<i>Inter Partes</i> Reexamination of U.S. Patent No. 7,714,747 (Control No. 95/001,517)	Order Granting Reexam received 3/9/2011; Notice of Assignment of Reexamination Request Issued 1/13/2011; Filed 12/30/2010
<i>Inter Partes</i> Reexamination of U.S. Patent No. 7,417,568 (Control No. 95/001,533)	Non-Final Office Action mailed 5/6/2011; Replacement Reexam Request filed 3/1/2011; Notification of Incomplete <i>Inter Partes</i> Reexam Request issued 2/22/2011; Reexam Request originally filed 1/31/2011;
<i>Inter Partes</i> Reexamination of U.S. Patent No. 7,777,651 (Control No. 95/001,581)	Order Granting Reexam Request mailed 6/15/2011; Filed 3/21/2011
<i>Inter Partes</i> Reexamination of U.S. Patent No. 7,400,274 (Control No. 95/001,544)	Non-Final Office Action mailed 5/20/2011; Filed 2/14/2011

Applicants invite the Examiner to review the Requests for Reexamination, issued Office Actions, replies, and any other papers in the above-identified reexamination proceedings. If the Examiner is unable to obtain copies of papers in any reexamination

proceeding, copies can be provided to the Examiner upon request. Those documents which may be material that are not already of record in this patent application are listed on the accompanying Form PTO/SB/08. For example, documents related to the reexaminations are listed at NPL538-NPL586.

Notice of Related Litigation

Applicants notify the Patent and Trademark Office of the following litigation involving U.S. Patents commonly-owned with the current patent application, the subject matter of which may be related to the present patent application:

No.	Case	Status
1	<i>Realtime Data LLC d/b/a IXO v. Packeteer, Inc. et al.</i> , No. 6:08-cv-00144-LED (E.D. Texas)	Dismissed

Applicants also notify the Patent and Trademark Office of the following additional litigation involving U.S. Patents commonly-owned with the current patent application, the subject matter of which may be related to the present patent application:

No.	Case	Status
2	<i>Realtime Data LLC d/b/a IXO v. Thomson Reuters Corporation et al.</i> No. 6:09-cv-00333-LED (E.D. Texas)	Pending, Order denying Motion to Expedite Briefing, Order granting writ of mandamus to transfer to the Southern District of New York.
3	<i>Realtime Data LLC d/b/a IXO v. Morgan Stanley et al.</i> , No. 6:09-cv-00326-LED (E.D. Texas)	Pending, Order denying Motion to Expedite Briefing, Order granting writ of mandamus to transfer to the Southern District of New York.
4	<i>Realtime Data LLC d/b/a IXO v. CME Group Inc., et al.</i> , No. 6:09-cv-00327-LED (E.D. Texas)	Pending, Order denying Motion to Expedite Briefing, Order granting writ of mandamus to transfer to the Southern District of New York.

5	<i>Chicago Board Options Exchange, Inc., v. Realtime Data LLC d/b/a IXO</i> , No. 09-cv-4486 (N.D. Ill.)	Dismissed
6	<i>Thomson Reuters Corporation v. Realtime Data, LLC d/b/a IXO</i> , No. 1:09-cv-07868-RMB (S.D.N.Y)	Consolidated with Case No. 2
7	<i>Realtime Data, LLC d/b/a IXO v. CME Group Inc., et al. (II)</i> , No. 6:10-cv-246 (E.D. Texas)	Consolidated with Case No. 4
8	<i>Realtime Data LLC d/b/a IXO v. Thomson Reuters Corporation et al. (II)</i> , No. 6:10-cv-247 (E.D. Texas)	Consolidated with Case No. 2
9	<i>Realtime Data, LLC d/b/a IXO v. Morgan Stanley, et al. (II)</i> , No. 6:10-cv-248 (E.D. Texas)	Consolidated with Case No. 3
10	<i>Realtime Data, LLC D/B/A IXO v. MetroPCS Texas, LLC et al.</i> , No. 6:10-cv-00493 (E.D. Texas)	Pending

*Realtime Data LLC d/b/a IXO v. Packeteer, Inc. et al.*

Applicants hereby advise the Patent and Trademark Office that this action has been dismissed with prejudice pursuant to a settlement and license agreement. Documents NPL264, NPL272-NPL334, NPL416-NPL428, NPL434-NPL435, NPL439-NPL448, NPL455-NPL456, NPL463, NPL468-NPL470, and NPL587-NPL598 are additional information related to the *Packeteer* litigation including certain expert reports, court orders, plaintiff's and defendants' technology tutorials, and notices.

Applicants notify the Patent and Trademark Office the following additional executable software program referenced in this *Packeteer* litigation:

- MetaFrame 1.8
- Winframe 1.5
- Winframe 1.6
- CU-SeeMe 0.961
- CU-SeeMe Pro 4.0.1

Applicants can submit executable copies of the above-identified software at the request of the Examiner.

Applicants notify the Patent and Trademark Office of the existence of a number of confidential documents, hearings, and transcripts related to the *Packeteer* litigation. In particular, confidential documents are listed as NPL401-NPL408 and NPL457 on the attached form PTO/SB/08B. The subject matter of these documents may be related to this patent application. Applicants are prepared, at the request of the Examiner, to

attempt to obtain a waiver of confidentiality so that copies may be provided to the Patent and Trademark Office.

Documents NPL335-NPL399 relate to product information that was produced in the *Packeteer* litigation. This product information includes products provided by Hi/fn, Inc., IBM Corp., Microsoft Corp., RADVision Ltd., and other companies. A declaration of Patrick Gogerty describing the documents from Microsoft Corp. is also submitted herewith (NPL400).

*Realtime Data LLC d/b/a/ IXO v. Thomson Reuters Corporation et al.*

Applicants' assignee is the plaintiff in *Realtime Data LLC d/b/a/ IXO v. Thomson Reuters Corporation et al.*, filed in the U.S. District Court for the Eastern District of Texas under Civil Action No. 6:09-cv-00333-LED (now consolidated with Civil Action Nos. 1:09-cv-07868 (S.D.N.Y) and 6:10-cv-00247 (E.D. Texas)), which involves the enforcement of the following U.S. Patents:

6,624,761	Fallon	09-23-2003
7,161,506	Fallon	01-09-2007
7,400,274	Fallon	07-15-2008
7,417,568	Fallon	08-26-2008
7,714,747	Fallon	05-11-2010
7,777,651	Fallon	08-17-2010

Applicants submit herewith documents related to this litigation at NPL146-NPL154.

*Realtime Data LLC d/b/a/ IXO v. Morgan Stanley et al.*

Applicants' assignee is the plaintiff in *Realtime Data LLC d/b/a/ IXO v. Morgan Stanley et al.*, filed in the U.S. District Court for the Eastern District of Texas under Civil Action No. 6:09-cv-00326-LED (now consolidated with Civil Action No. 6:10-cv-00248 (E.D. Texas) and Civil Action No. 6:10-cv-00247 (E.D. Texas)), which involves the enforcement of the following U.S. Patents:

6,624,761	Fallon	09-23-2003
7,161,506	Fallon	01-09-2007

7,400,274	Fallon	07-15-2008
7,417,568	Fallon	08-26-2008
7,714,747	Fallon	05-11-2010
7,777,651	Fallon	08-17-2010

Applicants submit herewith documents related to this litigation at US13, US80, US125, US172, US241, US267, US333, US389, US400, and NPL69-NPL145.

Realtime Data LLC d/b/a/ IXO v. CME Group Inc., et al.

Applicants' assignee is the plaintiff in *Realtime Data LLC d/b/a/ IXO v. CME Group Inc., et al.*, filed in the U.S. District Court for the Eastern District of Texas under Civil Action No. 6:09-cv-00327-LED (now consolidated with Civil Action No. 6:10-cv-00246 (E.D. Texas) which involves the enforcement of the following U.S. Patents:

6,624,761	Fallon	09-23-2003
7,161,506	Fallon	01-09-2007
7,400,274	Fallon	07-15-2008
7,417,568	Fallon	08-26-2008
7,714,747	Fallon	05-11-2010
7,777,651	Fallon	08-17-2010

Applicants submit herewith documents related to this litigation as US86, US98, US104, US142, US165, US257-US258, US280, US291, US295, US321, US327, US342, US423, US428, US455, US460, FP10, FP20, FP22, NPL1-NPL66, NPL460. While the Defendants' Invalidity Contentions (NPL16) listed claim charts C1-45, D1-45, and E1-45, the defendants did not provide claim charts C8, D8, E8, C32, E10, E12, E16 or E31. Thus, they are not included in this disclosure. This is reflected in the citations of NPL24-NPL26 on the SB/08b forms.

Chicago Board Options Exchange, Inc., v. Realtime Data LLC d/b/a/ IXO

Applicants' assignee is the defendant in *Chicago Board Options Exchange, Inc., v. Realtime Data LLC d/b/a/ IXO*, filed in the U.S. District Court for the Northern District of Illinois under Civil Action No. 09 CV 4486, which involves a request for a



declaratory judgment that the following U.S. Patents are not infringed and/or not valid and/or not enforceable against plaintiff:

6,624,761	Fallon	09-23-2003
7,161,506	Fallon	01-09-2007
7,400,274	Fallon	07-15-2008
7,417,568	Fallon	08-26-2008

Applicants submit herewith a document related to this litigation at NPL467. Applicants hereby notify the Patent Office that this litigation has been dismissed, and that the case has been terminated.

Realtime Data, LLC D/B/A IXO v. MetroPCS Texas, LLC et al.

Applicants' assignee is the plaintiff in *Realtime Data LLC d/b/a/ IXO v. MetroPCS Texas, LLC, et al.*, filed in the U.S. District Court for the Eastern District of Texas under Civil Action No. 6:10-cv-00493, which involves the enforcement of the following U.S. Patents:

6,601,104	Fallon	09-23-2003
6,604,158	Fallon	08-05-2003
7,161,506	Fallon	01-09-2007
7,321,937	Fallon	01-22-2008
7,352,300	Fallon	04-01-2008
7,378,992	Fallon	05-27-2008
7,395,345	Fallon	07-01-2008
7,415,530	Fallon	08-19-2008

Applicants submit herewith a document related to this litigation as US482-US489, FP25, NPL466 and NPL471-NPL488.

In addition, updated court docket listings downloaded July 20, 2011 for litigations previously disclosed are submitted herewith as NPL489-NPL495.

Information Disclosure Statement

Listed on accompanying IDS Forms PTO/SB/08a equivalent and/or PTO/SB/08b equivalent are documents that may be considered material to the patentability of this

application as defined in 37 C.F.R. §1.56, and in compliance with the duty of disclosure requirements of 37 C.F.R. §§ 1.97 and 1.98.

Applicants have listed publication dates on the attached IDS Forms based on information presently available to the undersigned. However, the listed publication dates should not be construed as an admission that the information was actually published on the date indicated.

Applicants reserve the right to establish the patentability of the claimed invention over any of the information provided herewith, and/or to prove that this information may not be prior art, and/or to prove that this information may not be enabling for the teachings purportedly offered.

This statement should not be construed as a representation that a search has been made, or that information more material to the examination of the present patent application does not exist. The Examiner is specifically requested not to rely solely on the material submitted herewith.

Filing under 37 C.F.R. § 1.97(b). This Information Disclosure Statement is being filed within before the mailing date of a first Office Action on the merits. No statement or fee is required.

A concise explanation of the relevance of the non-English language document(s) appears below in accordance with 37 C.F.R. § 1.98(a)(3).

**FP1** (DE 4127518) is in the German language. An English language abstract is as follows:

The magnetic disc storage device is connected to a host processor (5) and contains at least one magnetic disc for the storage of data with system startup data in a startup data region, a buffer memory (2) for data to be transferred from the disc/host computer and a data communication device (1). The data communication device transfers the startup data from the startup data region into the buffer memory at the time of system startup. The storage device can be used as an external memory device. **ADVANTAGE** - Enables very short startup times to be achieved for memory systems.

**FP12** (JP 6051989) is in the Japanese language. An English language abstract is as follows:

**PURPOSE:** To perform the fast load processing of an operating system without performing the read processing of volume information for the whole device in spite of the presence/absence of a restore command in the initial load processing of the operating system. **CONSTITUTION:** This system is provided with the device name instruction means 2 of a system storage file volume which instructs a volume in which a system storage file is stored in a device name by a REST command to instruct the generation of a system residence volume, the acquiring means 3 of the correspondence table of the device name with a channel number, a channel number acquiring means 4 to acquire the channel number from the device name of the volume, a restore processing means 5 which performs the generation processing of the system residence volume based

on the device name and the channel number, and a device name/channel number correspondence table 6.

**FP13** (JP 9188009) is in the Japanese language. An English language abstract is as follows:

**PROBLEM TO BE SOLVED:** To provide a printer capable of enhancing a compression ratio by selecting a compression method fitted to data from a plurality of compression methods to perform compression and the data compressing method in the printer. **SOLUTION:** A laser beam printer is equipped with an ROM 4 storing a plurality of preset compression methods and a CPU 3 having a data kind discriminating function analyzing the command of received data and discriminating the kind of data on the basis of the analytical result, a compression method selecting function selecting the compression method fitted to the kind of the discriminated data from a plurality of the compression methods stored in the ROM 4 and data compressing function compressing the data on the basis of the selected compression method.

**FP14** (JP 11149376) is in the Japanese language. An English language abstract is as follows:

**PROBLEM TO BE SOLVED:** To provide a more flexible software development environment by realizing the same function with a circuit mounting an Initial Program Loader ROM in circuit constitution of a smaller scale. **SOLUTION:** A BOOT loader circuit is provided with a BOOT detection part 4 for detecting whether a system becomes a BOOT mode or not, an address decoder 5 for generating a selection signal for each

device, switch parts 6 and 7 for selecting ROM and the external input interface and a CPU stop control part 8 for instructing the stop of CPU various conditions.

FP18 (WO 95/29437) is in the Japanese language. An English language abstract is as follows:

A differential value and compressibility calculating means (76) of a data processing means (71) of a data transmitter calculates the actual differential value and the actual compressibility based on the data length of uncompressed data received from a data outputting source (2) through an uncompressed data receiving means (74) and the data length of compressed data from a data compressing circuit (67). When the actual differential value is equal to or larger than a set differential value  $\alpha$ , at the same time, the actual compressibility is equal to or larger than a set compressibility  $\beta$ , the means (76) transmits the compressed data to a destination (3) through a transfer-requested data outputting means (79), and, in the other cases, transmits the uncompressed data to the destination (3). Therefore, such a phenomenon that the area occupied by compressed data in the memory area in the destination (3) is almost equal to the area occupied by uncompressed data in the memory area can be prevented, and useless data expansion can be avoided at the destination (3).

Documents US1-US530 and FP1-FP26 are cited on the attached form PTO/SB/08A. Documents NPL1-NPL598 are cited on the attached form PTO/SB/08B. Copies of documents FP1-FP26 and NPL1-NPL400, NPL409-NPL456, and NPL458-NPL598 are submitted. Documents NPL401-NPL408 and NPL457 are confidential, as previously noted, and therefore are not submitted. In accordance with 37 C.F.R. §

Atty. Dkt. No. 2855.004000B

1.98(a)(2), no copies of U.S. patents and patent application publications cited on the attached IDS Forms are submitted.

Applicants submit herewith Office Actions from the following co-pending, commonly assigned U.S. Patent Application Nos.:

Document NPL496 is a copy of a notice of allowance mailed on April 10, 2009 in the prosecution of co-pending, commonly-assigned U.S. Application No. 11/651,366.

Document NPL497 is a copy of a Non-Final Office Action mailed on November 10, 2010 in the prosecution of co-pending, commonly-assigned U.S. Application No. 12/684,624.

Document NPL498 is a copy of a Notice of Allowance mailed on February 17, 2011 in the prosecution of co-pending, commonly-assigned U.S. Application No. 12/123,081.

Document NPL499 is a copy of a Non-Final Office Action mailed on September 27, 2010 in the prosecution of co-pending, commonly-assigned U.S. Application No. 12/688,413.

Document NPL500 is a copy of a Notice of Allowance mailed on January 31, 2011 in the prosecution of co-pending, commonly-assigned U.S. Application No. 11/551,211.

Document NPL501 is a copy of a Notice of Allowance mailed on September 22, 2010 in the prosecution of co-pending, commonly-assigned U.S. Application No. 11/551,211.

Document NPL502 is a copy of a Notice of Allowance mailed on January 11, 2011 in the prosecution of co-pending, commonly-assigned U.S. Application No. 11/551,204.

Document NPL503 is a copy of a Notice of Allowance mailed on September 22, 2010 in the prosecution of co-pending, commonly-assigned U.S. Application No. 11/553,419.

Document NPL504 is a copy of a Notice of Allowance mailed on November 23, 2010 in the prosecution of co-pending, commonly-assigned U.S. Application No. 11/400,008.

Document NPL505 is a copy of a Notice of Allowance mailed on February 4, 2010 in the prosecution of co-pending, commonly-assigned U.S. Application No. 11/651,365.

Document NPL506 is a copy of a Notice of Allowance mailed on November 19, 2009 in the prosecution of co-pending, commonly-assigned U.S. Application No. 11/651,365.

Document NPL507 is a copy of a Non-Final Office Action mailed on August 27, 2010 in the prosecution of co-pending, commonly-assigned U.S. Application No. 09/969,987.

Document NPL508 is a copy of a Final Office Action mailed on January 28, 2010 in the prosecution of co-pending, commonly-assigned U.S. Application No. 09/969,987.

Document NPL509 is a copy of a Notice of Allowance mailed on June 22, 2010 in the prosecution of co-pending, commonly-assigned U.S. Application No. 12/131,631.

Document NPL510 is a copy of a Final Office Action mailed on October 30, 2009 in the prosecution of co-pending, commonly-assigned U.S. Application No. 11/400,008.

Document NPL511 is a copy of a Final Office Action mailed on May 11, 2010 in the prosecution of co-pending, commonly-assigned U.S. Application No. 11/400,008.

Document NPL512 is a copy of a Notice of Allowance mailed on September 30, 2010 in the prosecution of co-pending, commonly-assigned U.S. Application No. 11/551,204.

Document NPL513 is a copy of a Non-Final Office Action mailed on June 16, 2009 in the prosecution of co-pending, commonly-assigned U.S. Application No. 11/551,204.

Document NPL514 is a copy of a Notice of Allowance mailed on June 21, 2010 in the prosecution of co-pending, commonly-assigned U.S. Application No. 11/551,204.

Document NPL515 is a copy of a Non-Final Office Action mailed on September 22, 2008 in the prosecution of co-pending, commonly-assigned U.S. Application No. 11/551,204.



Document NPL516 is a copy of a Notice of Allowance mailed on January 27, 2010 in the prosecution of co-pending, commonly-assigned U.S. Application No. 11/551,204.

Document NPL517 is a copy of a Non-Final Office Action mailed on September 21, 2010 in the prosecution of co-pending, commonly-assigned U.S. Application No. 12/690,125.

Document NPL518 is a copy of a Final Office Action mailed May 24, 2011 in the prosecution of co-pending, commonly-assigned U.S. Application No. 09/969,987.

Document NPL519 is a copy of a Notice of Allowance mailed on May 6, 2011 in the prosecution of co-pending, commonly-assigned U.S. Application No. 11/551,211.

Document NPL520 is a copy of a Notice of Allowance mailed on May 5, 2011 in the prosecution of co-pending, commonly-assigned U.S. Application No. 12/703,042.

Document NPL521 is a copy of a Notice of Allowance mailed on March 24, 2011 in the prosecution of co-pending, commonly-assigned U.S. Application No. 11/553,427.

Document NPL522 is a copy of a Notice of Allowance mailed on May 20, 2011 in the prosecution of co-pending, commonly-assigned U.S. Application No. 11/553,419.

Document NPL523 is a copy of a Final Office Action mailed on June 27, 2011 in the prosecution of co-pending, commonly-assigned U.S. Application No. 11/400,008.

Document NPL524 is a copy of a Notice of Allowance mailed on May 31, 2011 in the prosecution of co-pending, commonly-assigned U.S. Application No. 11/553,427.

Document NPL525 is a copy of a Final Office Action mailed on June 7, 2011 in the prosecution of co-pending, commonly-assigned U.S. Application No. 12/690,125.

Document NPL526 is a copy of a Final Office Action mailed on June 7, 2011 in the prosecution of co-pending, commonly-assigned U.S. Application No. 12/688,413.

The identification of these Office Actions is not to be construed as a waiver of secrecy as to those applications now or upon issuance of the present application as a patent. The Examiner is respectfully requested to consider the cited applications and the art cited therein during examination.

Applicants submit copies of prior art submissions received from a third party, M-CAM, Inc. (NPL530-NPL537). These submissions were filed under 37 C.F.R. 1.501 in commonly-assigned patents.

It is expected that the examiner will review the prosecution and cited art in the parent application nos. 11/551,211, filed October 19, 2006, and 09/776,267, filed February 2, 2001 (now U.S. Pat. No. 7,181,608), in accordance with MPEP 2001.06(b), and indicate in the next communication from the office that the art cited in the earlier prosecution history has been reviewed in connection with the present application.

It is respectfully requested that the Examiner initial and return a copy of the enclosed IDS Forms, and indicate in the official file wrapper of this patent application that the documents have been considered.

Atty. Dkt. No. 2855.004000B

It is respectfully requested that the Examiner initial and return a copy of the enclosed IDS Forms, and indicate in the official file wrapper of this patent application that the documents have been considered.

The U.S. Patent and Trademark Office is hereby authorized to charge any fee deficiency, or credit any overpayment, to our Deposit Account No. 19-0036.

Respectfully submitted,

STERNE, KESSLER, GOLDSTEIN & FOX P.L.L.C.

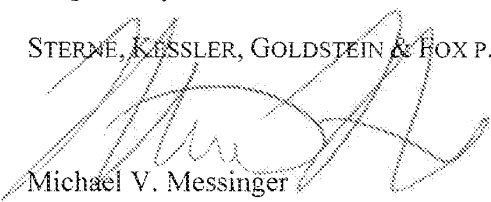

Michael V. Messinger  
Attorney for Applicants  
Registration No. 37,575

Date:

*August 7, 2011*

1100 New York Avenue, N.W.  
Washington, D.C. 20005-3934  
(202) 371-2600

1391949\_1.DOCX

Atty. Dkt. No. 2855.0050005

Substitute for form 1449/PTO		<i>Complete if Known</i>	
<b>INFORMATION DISCLOSURE STATEMENT BY APPLICANT</b> <i>(Use as many sheets as necessary)</i>		Application Number	13/118,122
		Filing Date	May 27, 2011
		First Named Inventor	James J. FALLON
		Art Unit	2115
		Examiner Name	To Be Assigned
Sheet	1	of	27
		Attorney Docket Number	2855.004000B

U.S. PATENT DOCUMENTS						
Examiner initials*	Cite No. <sup>1</sup>	Document Number		Publication Date MM-DD-YYYY	Name of Patentee or Applicant of Cited Document	Pages, Columns, Lines, Where Relevant Passages or Relevant Figures Appear
		Number	Kind Code <sup>2</sup> (if known)			
	US1	3,394,352		07-23-1968	Wernikoff et al.	
	US2	3,490,690		01-20-1970	Apple et al.	
	US3	4,021,782		05-03-1977	Hoerning	
	US4	4,032,893		06-28-1977	Moran	
	US5	4,054,951		10-18-1977	Jackson et al.	
	US6	4,127,518		11-28-1978	Coy et al.	
	US7	4,302,775		11-24-1981	Widergren et al.	
	US8	4,325,085		04-13-1982	Gooch	
	US9	4,360,840		11-23-1982	Wolfrun et al.	
	US10	4,386,416		05-31-1983	Giltner et al.	
	US11	4,394,774		07-19-1983	Widergren et al.	
	US12	4,464,650		08-07-1984	Eastman	
	US13	4,494,108		01-15-1985	Langdon, Jr. et al.	
	US14	4,499,499		02-12-1985	Brickman et al.	
	US15	4,574,351		03-04-1986	Dang et al.	
	US16	4,593,324		06-03-1986	Ohkubo et al.	
	US17	4,626,829		12-02-1986	Hauck	
	US18	4,646,061		02-24-1987	Biedsoe	
	US19	4,682,150		07-21-1987	Mathes et al.	
	US20	4,701,745		10-20-1987	Waterworth	

FOREIGN PATENT DOCUMENTS							
Examiner initials*	Cite No. <sup>1</sup>	Foreign Patent Document		Publication Date MM-DD-YYYY	Name of Patentee or Applicant of Cited Document	Pages, Columns, Lines, Where Relevant Passages or Relevant Figures Appear	T <sup>6</sup>
		Country Code <sup>3</sup> -Number <sup>4</sup> -Kind Code <sup>5</sup> (if known)					
	FP1	DE	4127518	02-27-1992	Tokico Ltd		
	FP2	EP	0164677	12-18-1985	Texas Instruments Inc		
	FP3	EP	0185098	06-25-1986	Hitachi Ltd		
	FP4	EP	0283798	09-28-1988	International Business Machines Corporation		
	FP5	EP	0405572	01-02-1991	Fujitsu Limited		
	FP6	EP	0493130	07-01-1992	Canon Kabushiki Kaisha		
	FP7	EP	0587437	03-16-1994	International Business Machines Corporation		
	FP8	EP	0595406	05-04-1994	Philips Electronics		

Examiner Signature		Date Considered	
--------------------	--	-----------------	--

\*EXAMINER: Initial if reference considered, whether or not citation is in conformance with MPEP 609. Draw line through citation if not in conformance and not considered. Include copy of this form with next communication to applicant. <sup>1</sup> Applicant's unique citation designation number (optional). <sup>2</sup> See Kinds Codes of USPTO Patent Documents at [www.uspto.gov](http://www.uspto.gov) or MPEP 901.04. <sup>3</sup> Enter Office that issued the document, by the two-letter code (WIPO Standard ST.3). <sup>4</sup> For Japanese patent documents, the indication of the year of the reign of the Emperor must precede the serial number of the patent document. <sup>5</sup> Kind of document by the appropriate symbols as indicated on the document under WIPO Standard ST.16 if possible. <sup>6</sup> Applicant is to place a check mark here if English language Translation is attached.

Substitute for form 1449/PTO		<b>Complete if Known</b>	
<b>INFORMATION DISCLOSURE STATEMENT BY APPLICANT</b> <i>(Use as many sheets as necessary)</i>		Application Number	13/118,122
		Filing Date	May 27, 2011
		First Named Inventor	James J. FALLON
		Art Unit	2115
		Examiner Name	To Be Assigned
Sheet	2	of	27
		Attorney Docket Number	2855.004000B

U.S. PATENT DOCUMENTS						
Examiner Initials*	Cite No. <sup>1</sup>	Document Number		Publication Date MM-DD-YYYY	Name of Patentee or Applicant of Cited Document	Pages, Columns, Lines, Where Relevant Passages or Relevant Figures Appear
		Number-Kind Code <sup>2</sup> (if known)				
	US21	4,729,020		03-01-1988	Schaphorst et al.	
	US22	4,730,348		03-08-1988	MacCrisken	
	US23	4,745,559		05-17-1988	Willis et al.	
	US24	4,748,638		05-31-1988	Freidman et al.	
	US25	4,750,135		06-07-1988	Boilen	
	US26	4,754,351		06-28-1988	Wright	
	US27	4,804,959		02-14-1989	Makansi et al.	
	US28	4,813,040		03-14-1989	Futato	
	US29	4,814,746		03-21-1989	Miller et al.	
	US30	4,862,167		08-29-1989	Copeland, III	
	US31	4,866,601		09-12-1989	DuLac et al.	
	US32	4,870,415		09-26-1989	Van Maren et al.	
	US33	4,872,009		10-03-1989	Tsukiyama et al.	
	US34	4,876,541		10-24-1989	Storer	
	US35	4,888,812		12-19-1989	Dinan et al.	
	US36	4,890,282		12-26-1989	Lambert et al.	
	US37	4,897,717		01-30-1990	Hamilton et al.	
	US38	4,906,991		03-06-1990	Fiala et al.	
	US39	4,906,995		03-06-1990	Swanson	
	US40	4,929,946		05-29-1990	O'Brien et al.	

FOREIGN PATENT DOCUMENTS							
Examiner Initials*	Cite No. <sup>1</sup>	Foreign Patent Document		Publication Date MM-DD-YYYY	Name of Patentee or Applicant of Cited Document	Pages, Columns, Lines, Where Relevant Passages or Relevant Figures Appear	T <sup>6</sup>
		Country Code <sup>3</sup> -Number <sup>4</sup> -Kind Code <sup>5</sup> (if known)					
	FP9	EP 0718751		06-26-1996	International Business Machines Corporation		
	FP10	EP 0928070		07-07-1999	Unwired Planet, Inc		
	FP11	GB 2162025		01-22-1986	King Reginald Alfred		
	FP12	JP 6051989		02-25-1994	NEC Corp		
	FP13	JP 9188009		07-22-1997	Canon Inc		
	FP14	JP 11149376		06-02-1999	Toyo Commun Equip Co. Ltd		
	FP15	WO 94/14273		06-23-1994	Voxson International Pty Ltd		
	FP16	WO 94/29852		12-22-1994	Maxtor Corp		

Examiner Signature		Date Considered	
-----------------------	--	--------------------	--

\*EXAMINER: Initial if reference considered, whether or not citation is in conformance with MPEP 609. Draw line through citation if not in conformance and not considered. Include copy of this form with next communication to applicant. <sup>1</sup> Applicant's unique citation designation number (optional). <sup>2</sup> See Kinds Codes of USPTO Patent Documents at [www.uspto.gov](http://www.uspto.gov) or MPEP 901.04. <sup>3</sup> Enter Office that issued the document, by the two-letter code (WIPO Standard ST.3). <sup>4</sup> For Japanese patent documents, the indication of the year of the reign of the Emperor must precede the serial number of the patent document. <sup>5</sup> Kind of document by the appropriate symbols as indicated on the document under WIPO Standard ST.16 if possible. <sup>6</sup> Applicant is to place a check mark here if English language Translation is attached.

Substitute for form 1449/PTO				<b>Complete if Known</b>	
<b>INFORMATION DISCLOSURE STATEMENT BY APPLICANT</b> <i>(Use as many sheets as necessary)</i>				Application Number	13/118,122
				Filing Date	May 27, 2011
				First Named Inventor	James J. FALLON
				Art Unit	2115
				Examiner Name	To Be Assigned
Sheet	3	of	27	Attorney Docket Number	2855.004000B

U.S. PATENT DOCUMENTS						
Examiner Initials*	Cite No. <sup>1</sup>	Document Number		Publication Date MM-DD-YYYY	Name of Patentee or Applicant of Cited Document	Pages, Columns, Lines, Where Relevant Passages or Relevant Figures Appear
		Number-Kind Code <sup>2</sup> (if known)				
	US41	4,953,324		09-04-1990	Hermann	
	US42	4,956,808		09-11-1990	Aakre et al.	
	US43	4,965,675		10-23-1990	Hori et al.	
	US44	4,988,998		01-29-1991	O'Brien	
	US45	5,003,307		03-26-1991	Whiting et al.	
	US46	5,016,009		05-14-1991	Whiting et al.	
	US47	5,027,376		06-25-1991	Freidman et al.	
	US48	5,028,922		07-02-1991	Huang	
	US49	5,045,848		09-03-1991	Fascenda	
	US50	5,045,852		09-03-1991	Mitchell et al.	
	US51	5,046,027		09-03-1991	Taaffe et al.	
	US52	5,049,881		09-17-1991	Gibson et al.	
	US53	5,091,782		02-25-1992	Krause et al.	
	US54	5,097,261		03-17-1992	Langdon, Jr. et al.	
	US55	5,109,226		04-28-1992	MacLean, Jr. et al.	
	US56	5,109,433		04-28-1992	Notenboom	
	US57	5,113,522		05-12-1992	Dinwiddie, Jr. et al.	
	US58	5,115,309		05-19-1992	Hang	
	US59	5,121,342		06-09-1992	Szymborski	
	US60	5,126,739		06-30-1992	Whiting et al.	

FOREIGN PATENT DOCUMENTS							
Examiner Initials*	Cite No. <sup>1</sup>	Foreign Patent Document		Publication Date MM-DD-YYYY	Name of Patentee or Applicant of Cited Document	Pages, Columns, Lines, Where Relevant Passages or Relevant Figures Appear	T <sup>6</sup>
		Country Code <sup>3</sup> -Number <sup>4</sup> -Kind Code <sup>5</sup> (if known)					
	FP17	WO 95/02873		01-26-1995	Philips Electronics		
	FP18	WO 95/29437 A1		11-02-1995	Sony Corp		
	FP19	WO 97/48212		12-18-1997	Nokia Telecommunications		
	FP20	WO 98/39699 A2		09-11-1998	Intelligent Compression Technologies		
	FP21	WO 99/08186		02-18-1999	Macronix International Co, Ltd		
	FP22	WO 00/36754 A1		06-22-2000	Microsoft Corporation		
	FP23	WO 01/057642		08-09-2001	Realtime Data LLC		
	FP24	WO 01/057659		08-09-2001	Realtime Data LLC		

Examiner Signature		Date Considered	
--------------------	--	-----------------	--

\*EXAMINER: Initial if reference considered, whether or not citation is in conformance with MPEP 609. Draw line through citation if not in conformance and not considered. Include copy of this form with next communication to applicant. <sup>1</sup> Applicant's unique citation designation number (optional). <sup>2</sup> See Kinds Codes of USPTO Patent Documents at [www.uspto.gov](http://www.uspto.gov) or MPEP 901.04. <sup>3</sup> Enter Office that issued the document, by the two-letter code (WIPO Standard ST.3). <sup>4</sup> For Japanese patent documents, the indication of the year of the reign of the Emperor must precede the serial number of the patent document. <sup>5</sup> Kind of document by the appropriate symbols as indicated on the document under WIPO Standard ST.16 if possible. <sup>6</sup> Applicant is to place a check mark here if English language Translation is attached.

<b>INFORMATION DISCLOSURE STATEMENT BY APPLICANT</b> <i>(Use as many sheets as necessary)</i>				<i>Complete if Known</i>	
				Application Number	13/118,122
				Filing Date	May 27, 2011
				First Named Inventor	James J. FALLON
				Art Unit	2115
				Examiner Name	To Be Assigned
Sheet	4	of	27	Attorney Docket Number	2855.004000B

U.S. PATENT DOCUMENTS						
Examiner Initials*	Cite No. <sup>1</sup>	Document Number		Publication Date MM-DD-YYYY	Name of Patentee or Applicant of Cited Document	Pages, Columns, Lines, Where Relevant Passages or Relevant Figures Appear
		Number-Kind Code <sup>2</sup> (if known)				
	US61	5,128,963		07-07-1992	Akagiri	
	US62	5,132,992		07-21-1992	Yurt et al.	
	US63	5,146,221		09-08-1992	Whiting et al.	
	US64	5,150,430		09-22-1992	Chu	
	US65	5,155,484		10-13-1992	Chambers, IV	
	US66	5,159,336		10-27-1992	Rabin et al.	
	US67	5,167,034		11-24-1992	MacLean, Jr. et al.	
	US68	5,175,543		12-29-1992	Lantz	
	US69	5,179,651		01-12-1993	Taaffe et al.	
	US70	5,187,793		02-16-1993	Keith et al.	
	US71	5,191,431		03-02-1993	Hasegawa et al.	
	US72	5,204,756		04-20-1993	Chevion et al.	
	US73	5,209,220		05-11-1993	Hiyama et al.	
	US74	5,212,742		05-18-1993	Normile et al.	
	US75	5,226,176		07-06-1993	Westaway et al.	
	US76	5,227,893		07-13-1993	Ett	
	US77	5,231,492		07-27-1993	Dangi et al.	
	US78	5,237,460		08-17-1993	Miller et al.	
	US79	5,237,675		08-17-1993	Hannon, Jr.	
	US80	5,243,341		09-07-1993	Seroussi et al.	

FOREIGN PATENT DOCUMENTS							
Examiner Initials*	Cite No. <sup>1</sup>	Foreign Patent Document		Publication Date MM-DD-YYYY	Name of Patentee or Applicant of Cited Document	Pages, Columns, Lines, Where Relevant Passages or Relevant Figures Appear	T <sup>6</sup>
		Country Code <sup>3</sup> -Number <sup>4</sup> -Kind Code <sup>5</sup> (if known)					
	FP25	WO	01/63772	08-30-2001	Physical Optics Corporation		
	FP26	WO	02/39591	05-16-2002	Realtime Data LLC		

Examiner Signature		Date Considered	
--------------------	--	-----------------	--

\*EXAMINER: Initial if reference considered, whether or not citation is in conformance with MPEP 609. Draw line through citation if not in conformance and not considered. Include copy of this form with next communication to applicant. <sup>1</sup> Applicant's unique citation designation number (optional). <sup>2</sup> See Kinds Codes of USPTO Patent Documents at [www.uspto.gov](http://www.uspto.gov) or MPEP 901.04. <sup>3</sup> Enter Office that issued the document, by the two-letter code (WIPO Standard ST.3). <sup>4</sup> For Japanese patent documents, the indication of the year of the reign of the Emperor must precede the serial number of the patent document. <sup>5</sup> Kind of document by the appropriate symbols as indicated on the document under WIPO Standard ST.16 if possible. <sup>6</sup> Applicant is to place a check mark here if English language Translation is attached.

Substitute for form 1449/PTO  <b>INFORMATION DISCLOSURE STATEMENT BY APPLICANT</b> (Use as many sheets as necessary)		<i>Complete if Known</i>			
		Application Number	13/118,122		
		Filing Date	May 27, 2011		
		First Named Inventor	James J. FALLON		
		Art Unit	2115		
		Examiner Name	To Be Assigned		
Sheet	5	of	27	Attorney Docket Number	2855.004000B

U.S. PATENT DOCUMENTS						
Examiner initials*	Cite No. <sup>1</sup>	Document Number		Publication Date MM-DD-YYYY	Name of Patentee or Applicant of Cited Document	Pages, Columns, Lines, Where Relevant Passages or Relevant Figures Appear
		Number	Kind Code 2 (if known)			
	US81	5,243,348		09-07-1993	Jackson	
	US82	5,247,638		09-21-1993	O'Brien et al.	
	US83	5,247,646		09-21-1993	Osterlund et al.	
	US84	5,249,053		09-28-1993	Jain	
	US85	5,263,168		11-16-1993	Toms et al.	
	US86	5,267,333		11-30-1993	Aono	
	US87	5,270,832		12-14-1993	Balkanski et al.	
	US88	5,280,600		01-18-1994	Van Maren et al.	
	US89	5,287,420		02-15-1994	Barrett	
	US90	5,289,580		02-22-1994	Latif et al.	
	US91	5,293,379		03-08-1994	Carr	
	US92	5,293,576		03-08-1994	Mihm, Jr. et al.	
	US93	5,307,497		04-26-1994	Feigenbaum et al.	
	US94	5,309,555		05-03-1994	Akins et al.	
	US95	5,319,682		06-07-1994	Clark	
	US96	5,341,440		08-23-1994	Earl et al.	
	US97	5,347,600		09-13-1994	Barnsley et al.	
	US98	5,353,132		10-04-1994	Katsuma	
	US99	5,354,315		10-11-1994	Armstrong	
	US100	5,355,498		10-11-1994	Provino et al.	

FOREIGN PATENT DOCUMENTS							
Examiner initials*	Cite No. <sup>1</sup>	Foreign Patent Document		Publication Date MM-DD-YYYY	Name of Patentee or Applicant of Cited Document	Pages, Columns, Lines, Where Relevant Passages or Relevant Figures Appear	T <sup>6</sup>
		Country Code <sup>3</sup>	Number <sup>4</sup> -Kind Code <sup>5</sup> (if known)				

Examiner Signature		Date Considered	
--------------------	--	-----------------	--

\*EXAMINER: Initial if reference considered, whether or not citation is in conformance with MPEP 609. Draw line through citation if not in conformance and not considered. Include copy of this form with next communication to applicant. <sup>1</sup> Applicant's unique citation designation number (optional). <sup>2</sup> See Kinds Codes of USPTO Patent Documents at www.uspto.gov or MPEP 901.04. <sup>3</sup> Enter Office that issued the document, by the two-letter code (WIPO Standard ST.3). <sup>4</sup> For Japanese patent documents, the indication of the year of the reign of the Emperor must precede the serial number of the patent document. <sup>5</sup> Kind of document by the appropriate symbols as indicated on the document under WIPO Standard ST.16 if possible. <sup>6</sup> Applicant is to place a check mark here if English language Translation is attached.



Substitute for form 1449/PTO  <b>INFORMATION DISCLOSURE STATEMENT BY APPLICANT</b> (Use as many sheets as necessary)		<b>Complete if Known</b>			
		Application Number	13/118,122		
		Filing Date	May 27, 2011		
		First Named Inventor	James J. FALLON		
		Art Unit	2115		
		Examiner Name	To Be Assigned		
Sheet	6	of	27	Attorney Docket Number	2855.004000B

U.S. PATENT DOCUMENTS						
Examiner Initials*	Cite No. <sup>1</sup>	Document Number		Publication Date MM-DD-YYYY	Name of Patentee or Applicant of Cited Document	Pages, Columns, Lines, Where Relevant Passages or Relevant Figures Appear
		Number	Kind Code <sup>2</sup> (if known)			
	US101	5,357,614		10-18-1994	Pattisam et al.	
	US102	5,367,629		11-22-1994	Chu et al.	
	US103	5,373,290		12-13-1994	Lempel et al.	
	US104	5,374,916		12-20-1994	Chu	
	US105	5,379,036		01-03-1995	Storer	
	US106	5,379,757		01-10-1995	Hiyama et al.	
	US107	5,381,145		01-10-1995	Allen et al.	
	US108	5,389,922		02-14-1995	Seroussi et al.	
	US109	5,394,534		02-28-1995	Kulakowski et al.	
	US110	5,396,228		03-07-1995	Garahi	
	US111	5,400,401		03-21-1995	Wasilewski et al.	
	US112	5,403,639		04-04-1995	Belsan et al.	
	US113	5,406,278		04-11-1995	Graybill et al.	
	US114	5,406,279		04-11-1995	Anderson et al.	
	US115	5,410,671		04-25-1995	Elgamal et al.	
	US116	5,412,384		05-02-1995	Chang et al.	
	US117	5,414,850		05-09-1995	Whiting	
	US118	5,420,639		05-30-1995	Perkins	
	US119	5,434,983		07-18-1995	Yaso et al.	
	US120	5,437,020		07-25-1995	Wells et al.	

FOREIGN PATENT DOCUMENTS							
Examiner Initials*	Cite No. <sup>1</sup>	Foreign Patent Document		Publication Date MM-DD-YYYY	Name of Patentee or Applicant of Cited Document	Pages, Columns, Lines, Where Relevant Passages or Relevant Figures Appear	T <sup>6</sup>
		Country Code <sup>3</sup>	Number <sup>4</sup> -Kind Code <sup>5</sup> (if known)				

Examiner Signature		Date Considered	
--------------------	--	-----------------	--

\*EXAMINER: Initial if reference considered, whether or not citation is in conformance with MPEP 609. Draw line through citation if not in conformance and not considered. Include copy of this form with next communication to applicant. <sup>1</sup> Applicant's unique citation designation number (optional). <sup>2</sup> See Kinds Codes of USPTO Patent Documents at www.uspto.gov or MPEP 901.04. <sup>3</sup> Enter Office that issued the document, by the two-letter code (WIPO Standard ST.3). <sup>4</sup> For Japanese patent documents, the indication of the year of the reign of the Emperor must precede the serial number of the patent document. <sup>5</sup> Kind of document by the appropriate symbols as indicated on the document under WIPO Standard ST.16 if possible. <sup>6</sup> Applicant is to place a check mark here if English language Translation is attached.

Substitute for form 1449/PTO		<b>Complete if Known</b>	
<b>INFORMATION DISCLOSURE STATEMENT BY APPLICANT</b> <i>(Use as many sheets as necessary)</i>		Application Number	13/118,122
		Filing Date	May 27, 2011
		First Named Inventor	James J. FALLON
		Art Unit	2115
		Examiner Name	To Be Assigned
Sheet	7 of 27	Attorney Docket Number	2855.004000B

<b>U.S. PATENT DOCUMENTS</b>						
Examiner initials*	Cite No. <sup>1</sup>	Document Number		Publication Date MM-DD-YYYY	Name of Patentee or Applicant of Cited Document	Pages, Columns, Lines, Where Relevant Passages or Relevant Figures Appear
		Number	Kind Code 2 (if known)			
	US121	5,452,287		09-19-1995	Dicecco et al.	
	US122	5,454,079		09-26-1995	Roper et al.	
	US123	5,454,107		09-26-1995	Lehman et al.	
	US124	5,455,576		10-03-1995	Clark, II et al.	
	US125	5,455,578		10-03-1995	Bhandari	
	US126	5,455,680		10-03-1995	Shin	
	US127	5,461,679		10-24-1995	Normile et al.	
	US128	5,463,390		10-31-1995	Whiting et al.	
	US129	5,467,087		11-14-1995	Chu	
	US130	5,471,206		11-28-1995	Allen et al.	
	US131	5,479,587		12-26-1995	Campbell et al.	
	US132	5,479,633		12-26-1995	Wells et al.	
	US133	5,483,470		01-09-1996	Alur et al.	
	US134	5,486,826		01-23-1996	Remillard	
	US135	5,488,364		01-30-1996	Cole	
	US136	5,488,365		01-30-1996	Seroussi et al.	
	US137	5,495,244		02-27-1996	Jeong et al.	
	US138	5,504,842		04-02-1996	Gentile	
	US139	5,506,844		04-09-1996	Rao	
	US140	5,506,872		04-09-1996	Mobler	

<b>FOREIGN PATENT DOCUMENTS</b>							
Examiner initials*	Cite No. <sup>1</sup>	Foreign Patent Document		Publication Date MM-DD-YYYY	Name of Patentee or Applicant of Cited Document	Pages, Columns, Lines, Where Relevant Passages or Relevant Figures Appear	T <sup>6</sup>
		Country Code <sup>3</sup>	Number <sup>4</sup> -Kind Code <sup>5</sup> (if known)				

Examiner Signature		Date Considered	
--------------------	--	-----------------	--

\*EXAMINER: Initial if reference considered, whether or not citation is in conformance with MPEP 609. Draw line through citation if not in conformance and not considered. Include copy of this form with next communication to applicant. <sup>1</sup> Applicant's unique citation designation number (optional). <sup>2</sup> See Kinds Codes of USPTO Patent Documents at [www.uspto.gov](http://www.uspto.gov) or MPEP 901.04. <sup>3</sup> Enter Office that issued the document, by the two-letter code (WIPO Standard ST.3). <sup>4</sup> For Japanese patent documents, the indication of the year of the reign of the Emperor must precede the serial number of the patent document. <sup>5</sup> Kind of document by the appropriate symbols as indicated on the document under WIPO Standard ST.16 if possible. <sup>6</sup> Applicant is to place a check mark here if English language Translation is attached.

Substitute for form 1449/PTO			<i>Complete if Known</i>		
<b>INFORMATION DISCLOSURE STATEMENT BY APPLICANT</b> <i>(Use as many sheets as necessary)</i>			Application Number	13/118,122	
			Filing Date	May 27, 2011	
			First Named Inventor	James J. FALLON	
			Art Unit	2115	
			Examiner Name	To Be Assigned	
Sheet	8	of	27	Attorney Docket Number	2855.004000B

U.S. PATENT DOCUMENTS						
Examiner Initials*	Cite No. <sup>1</sup>	Document Number		Publication Date MM-DD-YYYY	Name of Patentee or Applicant of Cited Document	Pages, Columns, Lines, Where Relevant Passages or Relevant Figures Appear
		Number-Kind Code 2 (if known)				
	US141	5,506,944		04-09-1996	Gentile	
	US142	5,521,940		05-28-1996	Lane et al.	
	US143	5,528,628		06-18-1996	Park et al.	
	US144	5,530,845		06-25-1996	Hiatt et al.	
	US145	5,533,051		07-02-1996	James	
	US146	5,535,311		07-09-1996	Zimmerman	
	US147	5,535,356		07-09-1996	Kim et al.	
	US148	5,535,369		07-09-1996	Wells et al.	
	US149	5,537,658		07-16-1996	Bakke et al.	
	US150	5,539,865		07-23-1996	Gentile	
	US151	5,542,031		07-30-1996	Douglass et al.	
	US152	5,544,290		08-06-1996	Gentile	
	US153	5,546,395		08-13-1996	Sharma et al.	
	US154	5,546,475		08-13-1996	Bolle et al.	
	US155	5,553,160		09-03-1996	Dawson	
	US156	5,557,551		09-17-1996	Craft	
	US157	5,557,668		09-17-1996	Brady	
	US158	5,557,749		09-17-1996	Norris	
	US159	5,561,421		10-01-1996	Smith et al.	
	US160	5,561,824		10-01-1996	Carreiro et al.	

FOREIGN PATENT DOCUMENTS							
Examiner Initials*	Cite No. <sup>1</sup>	Foreign Patent Document		Publication Date MM-DD-YYYY	Name of Patentee or Applicant of Cited Document	Pages, Columns, Lines, Where Relevant Passages or Relevant Figures Appear	T <sup>6</sup>
		Country Code <sup>3</sup>	Number <sup>4</sup> -Kind Code <sup>5</sup> (if known)				

Examiner Signature		Date Considered	
-----------------------	--	--------------------	--

\*EXAMINER: Initial if reference considered, whether or not citation is in conformance with MPEP 609. Draw line through citation if not in conformance and not considered. Include copy of this form with next communication to applicant. <sup>1</sup> Applicant's unique citation designation number (optional). <sup>2</sup> See Kinds Codes of USPTO Patent Documents at www.uspto.gov or MPEP 901.04. <sup>3</sup> Enter Office that issued the document, by the two-letter code (WIPO Standard ST.3). <sup>4</sup> For Japanese patent documents, the indication of the year of the reign of the Emperor must precede the serial number of the patent document. <sup>5</sup> Kind of document by the appropriate symbols as indicated on the document under WIPO Standard ST.16 if possible. <sup>6</sup> Applicant is to place a check mark here if English language Translation is attached.

Substitute for form 1449/PTO		<b>Complete if Known</b>	
<b>INFORMATION DISCLOSURE STATEMENT BY APPLICANT</b> <i>(Use as many sheets as necessary)</i>		Application Number	13/118,122
		Filing Date	May 27, 2011
		First Named Inventor	James J. FALLON
		Art Unit	2115
		Examiner Name	To Be Assigned
Sheet	9 of 27	Attorney Docket Number	2855.004000B

<b>U.S. PATENT DOCUMENTS</b>						
Examiner Initials*	Cite No. <sup>1</sup>	Document Number		Publication Date MM-DD-YYYY	Name of Patentee or Applicant of Cited Document	Pages, Columns, Lines, Where Relevant Passages or Relevant Figures Appear
		Number	Kind Code 2 (if known)			
	US161	5,563,961		10-08-1996	Rynderman et al.	
	US162	5,574,952		11-12-1996	Brady et al.	
	US163	5,574,953		11-12-1996	Rust et al.	
	US164	5,576,953		11-19-1996	Hugentobler	
	US165	5,577,248		11-19-1996	Chambers, IV	
	US166	5,581,715		12-03-1996	Verinsky et al.	
	US167	5,583,500		12-10-1996	Allen et al.	
	US168	5,586,264		12-17-1996	Belknap et al.	
	US169	5,586,285		12-17-1996	Hasbun et al.	
	US170	5,590,306		12-31-1996	Watanabe et al.	
	US171	5,596,674		01-21-1997	Bhandari et al.	
	US172	5,598,388		01-28-1997	Van Maren et al.	
	US173	5,604,824		02-18-1997	Chui et al.	
	US174	5,606,706		02-25-1997	Takamoto et al.	
	US175	5,610,657		03-11-1997	Zhang	
	US176	5,611,024		03-11-1997	Campbell et al.	
	US177	5,612,788		03-18-1997	Stone	
	US178	5,613,069		03-18-1997	Walker	
	US179	5,615,017		03-25-1997	Choi	
	US180	5,615,287		03-25-1997	Fu et al.	

<b>FOREIGN PATENT DOCUMENTS</b>							
Examiner Initials*	Cite No. <sup>1</sup>	Foreign Patent Document		Publication Date MM-DD-YYYY	Name of Patentee or Applicant of Cited Document	Pages, Columns, Lines, Where Relevant Passages or Relevant Figures Appear	T <sup>6</sup>
		Country Code <sup>3</sup>	Number <sup>4</sup> -Kind Code <sup>5</sup> (if known)				

Examiner Signature		Date Considered	
--------------------	--	-----------------	--

\*EXAMINER: Initial if reference considered, whether or not citation is in conformance with MPEP 609. Draw line through citation if not in conformance and not considered. Include copy of this form with next communication to applicant. <sup>1</sup> Applicant's unique citation designation number (optional). <sup>2</sup> See Kinds Codes of USPTO Patent Documents at [www.uspto.gov](http://www.uspto.gov) or MPEP 901.04. <sup>3</sup> Enter Office that issued the document, by the two-letter code (WIPO Standard ST.3). <sup>4</sup> For Japanese patent documents, the indication of the year of the reign of the Emperor must precede the serial number of the patent document. <sup>5</sup> Kind of document by the appropriate symbols as indicated on the document under WIPO Standard ST.16 if possible. <sup>6</sup> Applicant is to place a check mark here if English language Translation is attached.

Substitute for form 1449/PTO				<b>Complete if Known</b>	
<b>INFORMATION DISCLOSURE STATEMENT BY APPLICANT</b> <i>(Use as many sheets as necessary)</i>				Application Number	13/118,122
				Filing Date	May 27, 2011
				First Named Inventor	James J. FALLON
				Art Unit	2115
				Examiner Name	To Be Assigned
Sheet	10	of	27	Attorney Docket Number	2855.004000B

U.S. PATENT DOCUMENTS						
Examiner Initials*	Cite No. <sup>1</sup>	Document Number		Publication Date MM-DD-YYYY	Name of Patentee or Applicant of Cited Document	Pages, Columns, Lines, Where Relevant Passages or Relevant Figures Appear
		Number-Kind Code 2 (if known)				
	US181	5,619,995		04-15-1997	Lobodzinski	
	US182	5,621,820		04-15-1997	Rynderman et al.	
	US183	5,623,623		04-22-1997	Kim et al.	
	US184	5,623,701		04-22-1997	Bakke et al.	
	US185	5,627,534		05-06-1997	Craft	
	US186	5,627,995		05-06-1997	Miller et al.	
	US187	5,629,732		05-13-1997	Moskowitz et al.	
	US188	5,630,092		05-13-1997	Carreiro et al.	
	US189	5,635,632		06-03-1997	Fay et al.	
	US190	5,635,932		06-03-1997	Shinagawa et al.	
	US191	5,638,498		06-10-1997	Tyler et al.	
	US192	5,640,158		06-17-1997	Okayama et al.	
	US193	5,642,506		06-24-1997	Lee	
	US194	5,649,032		07-15-1997	Burt et al.	
	US195	5,652,795		07-29-1997	Dillon et al.	
	US196	5,652,857		07-29-1997	Shimoi et al.	
	US197	5,652,917		07-29-1997	Maupin et al.	
	US198	5,654,703		08-05-1997	Clark, II	
	US199	5,655,138		08-05-1997	Kikinis	
	US200	5,666,560		09-09-1997	Moertl et al.	

FOREIGN PATENT DOCUMENTS							
Examiner Initials*	Cite No. <sup>1</sup>	Foreign Patent Document		Publication Date MM-DD-YYYY	Name of Patentee or Applicant of Cited Document	Pages, Columns, Lines, Where Relevant Passages or Relevant Figures Appear	T <sup>6</sup>
		Country Code <sup>3</sup> -Number <sup>4</sup> -Kind Code <sup>5</sup> (if known)					

Examiner Signature		Date Considered	
--------------------	--	-----------------	--

\*EXAMINER: Initial if reference considered, whether or not citation is in conformance with MPEP 609. Draw line through citation if not in conformance and not considered. Include copy of this form with next communication to applicant. <sup>1</sup> Applicant's unique citation designation number (optional). <sup>2</sup> See Kinds Codes of USPTO Patent Documents at www.uspto.gov or MPEP 901.04. <sup>3</sup> Enter Office that issued the document, by the two-letter code (WIPO Standard ST.3). <sup>4</sup> For Japanese patent documents, the indication of the year of the reign of the Emperor must precede the serial number of the patent document. <sup>5</sup> Kind of document by the appropriate symbols as indicated on the document under WIPO Standard ST.16 if possible. <sup>6</sup> Applicant is to place a check mark here if English language Translation is attached.

Substitute for form 1449/PTO				<b>Complete if Known</b>	
				Application Number	13/118,122
<b>INFORMATION DISCLOSURE STATEMENT BY APPLICANT</b> (Use as many sheets as necessary)				Filing Date	May 27, 2011
				First Named Inventor	James J. FALLON
				Art Unit	2115
				Examiner Name	To Be Assigned
				Attorney Docket Number	2855.004000B
Sheet	11	of	27		

U.S. PATENT DOCUMENTS						
Examiner Initials*	Cite No. <sup>1</sup>	Document Number		Publication Date MM-DD-YYYY	Name of Patentee or Applicant of Cited Document	Pages, Columns, Lines, Where Relevant Passages or Relevant Figures Appear
		Number-Kind Code <sup>2</sup> (if known)				
	US201	5,668,737		09-16-1997	Iler	
	US202	5,671,355		09-23-1997	Collins	
	US203	5,671,389		09-23-1997	Saliba	
	US204	5,671,413		09-23-1997	Shipman et al.	
	US205	5,675,333		10-07-1997	Boursier et al.	
	US206	5,675,789		10-07-1997	Ishii et al.	
	US207	5,686,916		11-11-1997	Bakhrmutsky	
	US208	5,692,159		11-25-1997	Shand	
	US209	5,694,619		12-02-1997	Konno	
	US210	5,696,927		12-09-1997	MacDonald et al.	
	US211	5,703,793		12-30-1997	Wise et al.	
	US212	5,708,511		01-13-1998	Gandhi et al.	
	US213	5,715,477		02-03-1998	Kikinis	
	US214	5,717,393		02-10-1998	Nakano et al.	
	US215	5,717,394		02-10-1998	Schwartz et al.	
	US216	5,719,862		02-17-1998	Lee et al.	
	US217	5,721,958		02-24-1998	Kikinis	
	US218	5,724,475		03-03-1998	Kirsten	
	US219	5,729,228		03-17-1998	Franaszek et al.	
	US220	5,740,395		04-14-1998	Wells et al.	

FOREIGN PATENT DOCUMENTS							
Examiner Initials*	Cite No. <sup>1</sup>	Foreign Patent Document		Publication Date MM-DD-YYYY	Name of Patentee or Applicant of Cited Document	Pages, Columns, Lines, Where Relevant Passages or Relevant Figures Appear	T <sup>6</sup>
		Country Code <sup>3</sup> -Number <sup>4</sup> -Kind Code <sup>5</sup> (if known)					

Examiner Signature		Date Considered	
-----------------------	--	--------------------	--

\*EXAMINER: Initial if reference considered, whether or not citation is in conformance with MPEP 609. Draw line through citation if not in conformance and not considered. Include copy of this form with next communication to applicant. <sup>1</sup> Applicant's unique citation designation number (optional). <sup>2</sup> See Kinds Codes of USPTO Patent Documents at www.uspto.gov or MPEP 901.04. <sup>3</sup> Enter Office that issued the document, by the two-letter code (WIPO Standard ST.3). <sup>4</sup> For Japanese patent documents, the indication of the year of the reign of the Emperor must precede the serial number of the patent document. <sup>5</sup> Kind of document by the appropriate symbols as indicated on the document under WIPO Standard ST.16 if possible. <sup>6</sup> Applicant is to place a check mark here if English language Translation is attached.

Substitute for form 1449/PTO		<i>Complete if Known</i>	
<b>INFORMATION DISCLOSURE STATEMENT BY APPLICANT</b> <i>(Use as many sheets as necessary)</i>		Application Number	13/118,122
		Filing Date	May 27, 2011
		First Named Inventor	James J. FALLON
		Art Unit	2115
		Examiner Name	To Be Assigned
Sheet	12 of 27	Attorney Docket Number	2855.004000B

U.S. PATENT DOCUMENTS						
Examiner Initials*	Cite No. <sup>1</sup>	Document Number		Publication Date MM-DD-YYYY	Name of Patentee or Applicant of Cited Document	Pages, Columns, Lines, Where Relevant Passages or Relevant Figures Appear
		Number	Kind Code <sup>2</sup> (if known)			
	US221	5,742,773		04-21-1998	Blomfield-Brown et al.	
	US222	5,748,904		05-05-1998	Huang et al.	
	US223	5,757,852		05-26-1998	Jericevic et al.	
	US224	5,765,027		06-09-1998	Wang et al.	
	US225	5,767,898		06-16-1998	Urano et al.	
	US226	5,768,445		06-16-1998	Troeller et al.	
	US227	5,768,525		06-16-1998	Kralowetz et al.	
	US228	5,771,340		06-23-1998	Nakazato et al.	
	US229	5,774,715		06-30-1998	Madany et al.	
	US230	5,778,411		07-07-1998	DeMoss et al.	
	US231	5,781,767		07-14-1998	Inoue et al.	
	US232	5,784,572		07-21-1998	Rostoker et al.	
	US233	5,787,487		07-28-1998	Hashimoto et al.	
	US234	5,794,229		08-11-1998	French et al.	
	US235	5,796,864		08-18-1998	Callahan	
	US236	5,799,110		08-25-1998	Israelsen et al.	
	US237	5,805,834		09-08-1998	McKinley et al.	
	US238	5,805,932		09-08-1998	Kawashima et al.	
	US239	5,808,660		09-15-1998	Sekine et al.	
	US240	5,809,176		09-15-1998	Yajima	

FOREIGN PATENT DOCUMENTS							
Examiner Initials*	Cite No. <sup>1</sup>	Foreign Patent Document		Publication Date MM-DD-YYYY	Name of Patentee or Applicant of Cited Document	Pages, Columns, Lines, Where Relevant Passages or Relevant Figures Appear	T <sup>6</sup>
		Country Code <sup>3</sup>	Number <sup>4</sup> -Kind Code <sup>5</sup> (if known)				

Examiner Signature		Date Considered	
--------------------	--	-----------------	--

\*EXAMINER: Initial if reference considered, whether or not citation is in conformance with MPEP 609. Draw line through citation if not in conformance and not considered. Include copy of this form with next communication to applicant. <sup>1</sup> Applicant's unique citation designation number (optional). <sup>2</sup> See Kinds Codes of USPTO Patent Documents at www.uspto.gov or MPEP 901.04. <sup>3</sup> Enter Office that issued the document, by the two-letter code (WIPO Standard ST.3). <sup>4</sup> For Japanese patent documents, the indication of the year of the reign of the Emperor must precede the serial number of the patent document. <sup>5</sup> Kind of document by the appropriate symbols as indicated on the document under WIPO Standard ST.16 if possible. <sup>6</sup> Applicant is to place a check mark here if English language Translation is attached.

Substitute for form 1449/PTO				<b>Complete if Known</b>	
<b>INFORMATION DISCLOSURE STATEMENT BY APPLICANT</b> <i>(Use as many sheets as necessary)</i>				Application Number	13/118,122
				Filing Date	May 27, 2011
				First Named Inventor	James J. FALLON
				Art Unit	2115
				Examiner Name	To Be Assigned
Sheet	13	of	27	Attorney Docket Number	2855.004000B

<b>U.S. PATENT DOCUMENTS</b>						
Examiner Initials*	Cite No. <sup>1</sup>	Document Number		Publication Date MM-DD-YYYY	Name of Patentee or Applicant of Cited Document	Pages, Columns, Lines, Where Relevant Passages or Relevant Figures Appear
		Number	Kind Code 2 (if known)			
	US241	5,809,299		09-15-1998	Cloutier et al.	
	US242	5,809,337		09-15-1998	Hannah et al.	
	US243	5,812,195		09-22-1998	Zhang	
	US244	5,812,789		09-22-1998	Diaz et al.	
	US245	5,818,368		10-06-1998	Langley	
	US246	5,818,369		10-06-1998	Withers	
	US247	5,818,530		10-06-1998	Canfield et al.	
	US248	5,819,215		10-06-1998	Dobson et al.	
	US249	5,822,781		10-13-1998	Wells et al.	
	US250	5,825,424		10-20-1998	Canfield et al.	
	US251	5,825,830		10-20-1998	Kopf	
	US252	5,832,037		11-03-1998	Park	
	US253	5,832,126		11-03-1998	Tanaka	
	US254	5,832,443		11-03-1998	Kolesnik et al.	
	US255	5,835,788		11-10-1998	Blumer et al.	
	US256	5,836,003		11-10-1998	Sadeh	
	US257	5,838,821		11-17-1998	Matsubara et al.	
	US258	5,838,927		11-17-1998	Gillon	
	US259	5,838,996		11-17-1998	deCarmo	
	US260	5,839,100		11-17-1998	Wegener	

<b>FOREIGN PATENT DOCUMENTS</b>							
Examiner Initials*	Cite No. <sup>1</sup>	Foreign Patent Document		Publication Date MM-DD-YYYY	Name of Patentee or Applicant of Cited Document	Pages, Columns, Lines, Where Relevant Passages or Relevant Figures Appear	T <sup>6</sup>
		Country Code <sup>3</sup>	Number <sup>4</sup> -Kind Code <sup>5</sup> (if known)				

Examiner Signature		Date Considered	
--------------------	--	-----------------	--

\*EXAMINER: Initial if reference considered, whether or not citation is in conformance with MPEP 609. Draw line through citation if not in conformance and not considered. Include copy of this form with next communication to applicant. <sup>1</sup> Applicant's unique citation designation number (optional). <sup>2</sup> See Kinds Codes of USPTO Patent Documents at www.uspto.gov or MPEP 901.04. <sup>3</sup> Enter Office that issued the document, by the two-letter code (WIPO Standard ST.3). <sup>4</sup> For Japanese patent documents, the indication of the year of the reign of the Emperor must precede the serial number of the patent document. <sup>5</sup> Kind of document by the appropriate symbols as indicated on the document under WIPO Standard ST.16 if possible. <sup>6</sup> Applicant is to place a check mark here if English language Translation is attached.



Substitute for form 1449/PTO				<i>Complete if Known</i>	
<b>INFORMATION DISCLOSURE STATEMENT BY APPLICANT</b> <i>(Use as many sheets as necessary)</i>				Application Number	13/118,122
				Filing Date	May 27, 2011
				First Named Inventor	James J. FALLON
				Art Unit	2115
				Examiner Name	To Be Assigned
Sheet	14	of	27	Attorney Docket Number	2855.004000B

U.S. PATENT DOCUMENTS						
Examiner Initials*	Cite No. <sup>1</sup>	Document Number		Publication Date MM-DD-YYYY	Name of Patentee or Applicant of Cited Document	Pages, Columns, Lines, Where Relevant Passages or Relevant Figures Appear
		Number	Kind Code <sup>2</sup> (if known)			
	US261	5,841,979		11-24-1998	Schulhof et al.	
	US262	5,847,762		12-08-1998	Canfield et al.	
	US263	5,850,565		12-15-1998	Wightman	
	US264	5,861,824		01-19-1999	Ryu et al.	
	US265	5,861,920		01-19-1999	Mead et al.	
	US266	5,864,342		01-26-1999	Kajiya et al.	
	US267	5,864,678		01-26-1999	Riddle	
	US268	5,867,167		02-02-1999	Deering	
	US269	5,867,602		02-02-1999	Zandi et al.	
	US270	5,870,036		02-09-1999	Franaszek et al.	
	US271	5,870,087		02-09-1999	Chau	
	US272	5,872,530		02-16-1999	Domyo et al.	
	US273	5,874,907		02-23-1999	Craft	
	US274	5,883,975		03-16-1999	Narita et al.	
	US275	5,884,269		03-16-1999	Cellier et al.	
	US276	5,886,655		03-23-1999	Rust	
	US277	5,887,165		03-23-1999	Martel et al.	
	US278	5,889,961		03-30-1999	Dobbek	
	US279	5,892,847		04-06-1999	Johnson	
	US280	5,907,801		05-15-1999	Albert et al.	

FOREIGN PATENT DOCUMENTS							
Examiner Initials*	Cite No. <sup>1</sup>	Foreign Patent Document		Publication Date MM-DD-YYYY	Name of Patentee or Applicant of Cited Document	Pages, Columns, Lines, Where Relevant Passages or Relevant Figures Appear	T <sup>6</sup>
		Country Code <sup>3</sup>	Number <sup>4</sup> -Kind Code <sup>5</sup> (if known)				

Examiner Signature		Date Considered	
--------------------	--	-----------------	--

\*EXAMINER: Initial if reference considered, whether or not citation is in conformance with MPEP 609. Draw line through citation if not in conformance and not considered. Include copy of this form with next communication to applicant. <sup>1</sup> Applicant's unique citation designation number (optional). <sup>2</sup> See Kind Codes of USPTO Patent Documents at [www.uspto.gov](http://www.uspto.gov) or MPEP 901.04. <sup>3</sup> Enter Office that issued the document, by the two-letter code (WIPO Standard ST.3). <sup>4</sup> For Japanese patent documents, the indication of the year of the reign of the Emperor must precede the serial number of the patent document. <sup>5</sup> Kind of document by the appropriate symbols as indicated on the document under WIPO Standard ST.16 if possible. <sup>6</sup> Applicant is to place a check mark here if English language Translation is attached.

Substitute for form 1449/PTO		<b>Complete if Known</b>	
<b>INFORMATION DISCLOSURE STATEMENT BY APPLICANT</b> <i>(Use as many sheets as necessary)</i>		Application Number	13/118,122
		Filing Date	May 27, 2011
		First Named Inventor	James J. FALLON
		Art Unit	2115
		Examiner Name	To Be Assigned
Sheet	15	of	27
		Attorney Docket Number	2855.004000B

U.S. PATENT DOCUMENTS					
Examiner Initials*	Cite No. <sup>1</sup>	Document Number	Publication Date MM-DD-YYYY	Name of Patentee or Applicant of Cited Document	Pages, Columns, Lines, Where Relevant Passages or Relevant Figures Appear
		Number-Kind Code 2 (if known)			
	US281	5,909,557	06-01-1999	Betker et al.	
	US282	5,909,559	06-01-1999	So	
	US283	5,915,079	06-22-1999	Vondran, Jr. et al.	
	US284	5,917,438	06-29-1999	Ando	
	US285	5,918,068	06-29-1999	Shafe	
	US286	5,918,225	06-29-1999	White et al.	
	US287	5,920,326	07-06-1999	Rentschler et al.	
	US288	5,923,860	07-13-1999	Olarig	
	US289	5,930,358	07-27-1999	Rao	
	US290	5,936,616	08-10-1999	Torborg, Jr. et al.	
	US291	5,938,737	08-17-1999	Smallcomb et al.	
	US292	5,943,692	08-24-1999	Marberg	
	US293	5,945,933	08-31-1999	Kalkstein	
	US294	5,949,355	09-07-1999	Panaoussis	
	US295	5,949,968	09-07-1999	Gentile	
	US296	5,951,623	09-14-1999	Reynar et al.	
	US297	5,955,976	09-21-1999	Heath	
	US298	5,956,490	09-21-1999	Buchholz et al.	
	US299	5,960,465	09-28-1999	Adams	
	US300	5,964,842	10-12-1999	Packard	

FOREIGN PATENT DOCUMENTS						
Examiner Initials*	Cite No. <sup>1</sup>	Foreign Patent Document	Publication Date MM-DD-YYYY	Name of Patentee or Applicant of Cited Document	Pages, Columns, Lines, Where Relevant Passages or Relevant Figures Appear	T <sup>6</sup>
		Country Code <sup>3</sup> -Number <sup>4</sup> -Kind Code <sup>5</sup> (if known)				

Examiner Signature		Date Considered	
-----------------------	--	--------------------	--

\*EXAMINER: Initial if reference considered, whether or not citation is in conformance with MPEP 609. Draw line through citation if not in conformance and not considered. Include copy of this form with next communication to applicant. <sup>1</sup> Applicant's unique citation designation number (optional). <sup>2</sup> See Kinds Codes of USPTO Patent Documents at www.uspto.gov or MPEP 901.04. <sup>3</sup> Enter Office that issued the document, by the two-letter code (WIPO Standard ST.3). <sup>4</sup> For Japanese patent documents, the indication of the year of the reign of the Emperor must precede the serial number of the patent document. <sup>5</sup> Kind of document by the appropriate symbols as indicated on the document under WIPO Standard ST.16 if possible. <sup>6</sup> Applicant is to place a check mark here if English language Translation is attached.

Substitute for form 1449/PTO  <b>INFORMATION DISCLOSURE STATEMENT BY APPLICANT</b> <i>(Use as many sheets as necessary)</i>		<i>Complete if Known</i>			
		Application Number	13/118,122		
		Filing Date	May 27, 2011		
		First Named Inventor	James J. FALLON		
		Art Unit	2115		
		Examiner Name	To Be Assigned		
Sheet	16	of	27	Attorney Docket Number	2855.004000B

U.S. PATENT DOCUMENTS						
Examiner Initials*	Cite No. <sup>1</sup>	Document Number		Publication Date MM-DD-YYYY	Name of Patentee or Applicant of Cited Document	Pages, Columns, Lines, Where Relevant Passages or Relevant Figures Appear
		Number	Kind Code 2 (if known)			
	US301	5,968,149		10-19-1999	Jaquette et al.	
	US302	5,969,927		10-19-1999	Schirmer et al.	
	US303	5,973,630		10-26-1999	Heath	
	US304	5,974,235		10-26-1999	Nunally et al.	
	US305	5,974,387		10-26-1999	Kageyama	
	US306	5,974,471		10-26-1999	Belt	
	US307	5,978,483		11-02-1999	Thompson, Jr. et al.	
	US308	5,982,360		11-09-1999	Wu et al.	
	US309	5,982,723		11-09-1999	Kamatani	
	US310	5,987,022		11-16-1999	Geiger et al.	
	US311	5,987,590		11-16-1999	Wing So	
	US312	5,990,884		11-23-1999	Douma et al.	
	US313	5,991,515		11-23-1999	Fall et al.	
	US314	5,996,033		11-30-1999	Chiu-Hao	
	US315	6,000,009		12-07-1999	Brady	
	US316	6,002,411		12-14-1999	Dye	
	US317	6,003,115		12-14-1999	Spear et al.	
	US318	6,008,743		12-28-1999	Jaquette	
	US319	6,011,901		01-04-2000	Kirsten	
	US320	6,014,694		01-11-2000	Aharoni et al.	

FOREIGN PATENT DOCUMENTS							
Examiner Initials*	Cite No. <sup>1</sup>	Foreign Patent Document		Publication Date MM-DD-YYYY	Name of Patentee or Applicant of Cited Document	Pages, Columns, Lines, Where Relevant Passages or Relevant Figures Appear	T <sup>6</sup>
		Country Code <sup>3</sup>	Number <sup>4</sup> Kind Code <sup>5</sup> (if known)				

Examiner Signature		Date Considered	
--------------------	--	-----------------	--

\*EXAMINER: Initial if reference considered, whether or not citation is in conformance with MPEP 609. Draw line through citation if not in conformance and not considered. Include copy of this form with next communication to applicant. <sup>1</sup> Applicant's unique citation designation number (optional). <sup>2</sup> See Kinds Codes of USPTO Patent Documents at www.uspto.gov or MPEP 901.04. <sup>3</sup> Enter Office that issued the document, by the two-letter code (WIPO Standard ST.3). <sup>4</sup> For Japanese patent documents, the indication of the year of the reign of the Emperor must precede the serial number of the patent document. <sup>5</sup> Kind of document by the appropriate symbols as indicated on the document under WIPO Standard ST.16 if possible. <sup>6</sup> Applicant is to place a check mark here if English language Translation is attached.

Substitute for form 1449/PTO  <b>INFORMATION DISCLOSURE STATEMENT BY APPLICANT</b> <i>(Use as many sheets as necessary)</i>		<i>Complete if Known</i>			
		Application Number	13/118,122		
		Filing Date	May 27, 2011		
		First Named Inventor	James J. FALLON		
		Art Unit	2115		
		Examiner Name	To Be Assigned		
Sheet	17	of	27	Attorney Docket Number	2855.004000B

U.S. PATENT DOCUMENTS						
Examiner initials*	Cite No. <sup>1</sup>	Document Number		Publication Date MM-DD-YYYY	Name of Patentee or Applicant of Cited Document	Pages, Columns, Lines, Where Relevant Passages or Relevant Figures Appear
		Number	Kind Code 2 (if known)			
	US321	6,021,433		02-01-2000	Payne	
	US322	6,023,755		02-08-2000	Casselman	
	US323	6,026,217		02-15-2000	Adiletta	
	US324	6,028,725		02-22-2000	Blumenau	
	US325	6,031,939		02-29-2000	Gilbert et al.	
	US326	6,032,148		02-29-2000	Wilkes	
	US327	6,032,197		02-29-2000	Birdwell et al.	
	US328	6,058,459		05-02-2000	Owen et al.	
	US329	6,061,398		05-09-2000	Satoh et al.	
	US330	6,061,473		05-09-2000	Chen et al.	
	US331	6,070,179		05-30-2000	Craft	
	US332	6,073,232		06-06-2000	Kroeker et al.	
	US333	6,075,470		06-13-2000	Little et al.	
	US334	6,078,958		06-20-2000	Echeita et al.	
	US335	6,091,777		07-18-2000	Guetz et al.	
	US336	6,092,123		07-18-2000	Steffan et al.	
	US337	6,094,634		07-25-2000	Yahagi et al.	
	US338	6,097,520		08-01-2000	Kadnier	
	US339	6,098,114		08-01-2000	McDonald et al.	
	US340	6,104,389		08-15-2000	Ando	

FOREIGN PATENT DOCUMENTS							
Examiner initials*	Cite No. <sup>1</sup>	Foreign Patent Document		Publication Date MM-DD-YYYY	Name of Patentee or Applicant of Cited Document	Pages, Columns, Lines, Where Relevant Passages or Relevant Figures Appear	T <sup>6</sup>
		Country Code <sup>3</sup> -Number <sup>4</sup> -Kind Code <sup>5</sup> (if known)					

Examiner Signature		Date Considered	
--------------------	--	-----------------	--

\*EXAMINER: Initial if reference considered, whether or not citation is in conformance with MPEP 609. Draw line through citation if not in conformance and not considered. Include copy of this form with next communication to applicant. <sup>1</sup> Applicant's unique citation designation number (optional). <sup>2</sup> See Kinds Codes of USPTO Patent Documents at www.uspto.gov or MPEP 901.04. <sup>3</sup> Enter Office that issued the document, by the two-letter code (WIPO Standard ST.3). <sup>4</sup> For Japanese patent documents, the indication of the year of the reign of the Emperor must precede the serial number of the patent document. <sup>5</sup> Kind of document by the appropriate symbols as indicated on the document under WIPO Standard ST.16 if possible. <sup>6</sup> Applicant is to place a check mark here if English language Translation is attached.

Substitute for form 1449/PTO				<b>Complete if Known</b>	
<b>INFORMATION DISCLOSURE STATEMENT BY APPLICANT</b> <i>(Use as many sheets as necessary)</i>				Filing Date	May 27, 2011
				First Named Inventor	James J. FALLON
				Art Unit	2115
				Examiner Name	To Be Assigned
				Attorney Docket Number	2855.004000B
				Sheet	18

U.S. PATENT DOCUMENTS						
Examiner initials*	Cite No. <sup>1</sup>	Document Number		Publication Date MM-DD-YYYY	Name of Patentee or Applicant of Cited Document	Pages, Columns, Lines, Where Relevant Passages or Relevant Figures Appear
		Number	Kind Code 2 (if known)			
	US341	6,105,130		08-15-2000	Wu et al.	
	US342	6,115,384		09-05-2000	Parzych	
	US343	6,128,412		10-03-2000	Satoh	
	US344	6,134,631		10-17-2000	Jennings, III	
	US345	6,141,053		10-31-2000	Saukkonen	
	US346	6,145,020		11-07-2000	Barnett	
	US347	6,145,069		11-07-2000	Dye	
	US348	6,169,241		01-02-2001	Shimizu	
	US349	6,170,007		01-02-2001	Venkatraman et al.	
	US350	6,170,047		01-02-2001	Dye	
	US351	6,170,049		01-02-2001	So	
	US352	6,172,936		01-09-2001	Kitazaki	
	US353	6,173,381		01-09-2001	Dye	
	US354	6,175,650		01-16-2001	Sindhu et al.	
	US355	6,175,856		01-16-2001	Riddle	
	US356	6,182,125		01-30-2001	Borella et al.	
	US357	6,185,625		02-06-2001	Tso et al.	
	US358	6,185,659		02-06-2001	Milillo et al.	
	US359	6,192,082		02-20-2001	Moriarty et al.	
	US360	6,192,155		02-20-2001	Fan	

FOREIGN PATENT DOCUMENTS							
Examiner initials*	Cite No. <sup>1</sup>	Foreign Patent Document		Publication Date MM-DD-YYYY	Name of Patentee or Applicant of Cited Document	Pages, Columns, Lines, Where Relevant Passages or Relevant Figures Appear	T <sup>6</sup>
		Country Code <sup>3</sup>	Number <sup>4</sup> -Kind Code <sup>5</sup> (if known)				

Examiner Signature		Date Considered	
--------------------	--	-----------------	--

\*EXAMINER: Initial if reference considered, whether or not citation is in conformance with MPEP 609. Draw line through citation if not in conformance and not considered. Include copy of this form with next communication to applicant. <sup>1</sup> Applicant's unique citation designation number (optional). <sup>2</sup> See Kinds Codes of USPTO Patent Documents at www.uspto.gov or MPEP 901.04. <sup>3</sup> Enter Office that issued the document, by the two-letter code (WIPO Standard ST.3). <sup>4</sup> For Japanese patent documents, the indication of the year of the reign of the Emperor must precede the serial number of the patent document. <sup>5</sup> Kind of document by the appropriate symbols as indicated on the document under WIPO Standard ST.16 if possible. <sup>6</sup> Applicant is to place a check mark here if English language Translation is attached.

Substitute for form 1449/PTO				<i>Complete if Known</i>	
				Application Number	13/118,122
<b>INFORMATION DISCLOSURE STATEMENT BY APPLICANT</b> <i>(Use as many sheets as necessary)</i>				Filing Date	May 27, 2011
				First Named Inventor	James J. FALLON
				Art Unit	2115
				Examiner Name	To Be Assigned
				Attorney Docket Number	2855.004000B
Sheet	19	of	27		

U.S. PATENT DOCUMENTS						
Examiner Initials*	Cite No. <sup>1</sup>	Document Number		Publication Date MM-DD-YYYY	Name of Patentee or Applicant of Cited Document	Pages, Columns, Lines, Where Relevant Passages or Relevant Figures Appear
		Number	Kind Code 2 (if known)			
	US361	6,195,024		02-27-2001	Fallon	
	US362	6,195,465		02-27-2001	Zandi et al.	
	US363	6,208,273		03-27-2001	Dye et al.	
	US364	6,215,904		04-10-2001	Lavellee	
	US365	6,219,754		04-17-2001	Belt et al.	
	US366	6,222,886		04-24-2001	Yogeshwar	
	US367	6,225,922		05-01-2001	Norton	
	US368	6,226,667		05-01-2001	Matthews et al.	
	US369	6,226,740		05-01-2001	Iga	
	US370	6,230,223		05-08-2001	Olarig	
	US371	6,237,054		05-22-2001	Freitag, Jr.	
	US372	6,243,829		06-05-2001	Chan	
	US373	6,253,264		06-26-2001	Sebastian	
	US374	6,272,178		08-07-2001	Niewegowski et al.	
	US375	6,272,627		08-07-2001	Mann	
	US376	6,272,628		08-07-2001	Aguilar et al.	
	US377	6,282,641		08-28-2001	Christensen	
	US378	6,285,458		09-04-2001	Yada	
	US379	6,298,408		10-02-2001	Park	
	US380	6,308,311		10-23-2001	Carmichael et al.	

FOREIGN PATENT DOCUMENTS							
Examiner Initials*	Cite No. <sup>1</sup>	Foreign Patent Document		Publication Date MM-DD-YYYY	Name of Patentee or Applicant of Cited Document	Pages, Columns, Lines, Where Relevant Passages or Relevant Figures Appear	T <sup>6</sup>
		Country Code <sup>3</sup>	Number <sup>4</sup> -Kind Code <sup>5</sup> (if known)				

Examiner Signature		Date Considered	
--------------------	--	-----------------	--

\*EXAMINER: Initial if reference considered, whether or not citation is in conformance with MPEP 609. Draw line through citation if not in conformance and not considered. Include copy of this form with next communication to applicant. <sup>1</sup> Applicant's unique citation designation number (optional). <sup>2</sup> See Kinds Codes of USPTO Patent Documents at www.uspto.gov or MPEP 901.04. <sup>3</sup> Enter Office that issued the document, by the two-letter code (WIPO Standard ST.3). <sup>4</sup> For Japanese patent documents, the indication of the year of the reign of the Emperor must precede the serial number of the patent document. <sup>5</sup> Kind of document by the appropriate symbols as indicated on the document under WIPO Standard ST.16 if possible. <sup>6</sup> Applicant is to place a check mark here if English language Translation is attached.

Substitute for form 1449/PTO		<b>Complete if Known</b>	
<b>INFORMATION DISCLOSURE STATEMENT BY APPLICANT</b> <i>(Use as many sheets as necessary)</i>		Filing Date	May 27, 2011
		First Named Inventor	James J. FALLON
		Art Unit	2115
		Examiner Name	To Be Assigned
		Attorney Docket Number	2855.004000B
Sheet	20	of	27

U.S. PATENT DOCUMENTS						
Examiner initials*	Cite No. <sup>1</sup>	Document Number		Publication Date MM-DD-YYYY	Name of Patentee or Applicant of Cited Document	Pages, Columns, Lines, Where Relevant Passages or Relevant Figures Appear
		Number	Kind Code 2 (if known)			
	US381	6,309,424		10-30-2001	Fallon	
	US382	6,310,563		10-30-2001	Har et al.	
	US383	6,317,714		11-13-2001	Del Castillo et al.	
	US384	6,330,622		12-11-2001	Shaefer	
	US385	6,333,745		12-25-2001	Shimomura et al.	
	US386	6,345,307		02-05-2002	Booth	
	US387	6,356,589		03-12-2002	Gebler et al.	
	US388	6,356,937		03-12-2002	Montville et al.	
	US389	6,388,584		05-14-2002	Dorward et al.	
	US390	6,392,567		05-21-2002	Satoh	
	US391	6,404,931		06-11-2002	Chen et al.	
	US392	6,421,387		07-16-2002	Rhee	
	US393	6,434,168		08-13-2002	Kari	
	US394	6,434,695		08-13-2002	Esfahani et al.	
	US395	6,442,659		08-27-2002	Blurnenau	
	US396	6,449,658		09-10-2002	Lafe et al.	
	US397	6,449,682		09-10-2002	Toorians	
	US398	6,452,602		09-17-2002	Morein	
	US399	6,452,933		09-17-2002	Duffield et al.	
	US400	6,459,429		10-01-2002	Deering	

FOREIGN PATENT DOCUMENTS							
Examiner initials*	Cite No. <sup>1</sup>	Foreign Patent Document		Publication Date MM-DD-YYYY	Name of Patentee or Applicant of Cited Document	Pages, Columns, Lines, Where Relevant Passages or Relevant Figures Appear	T <sup>6</sup>
		Country Code <sup>3</sup>	Number <sup>4</sup> -Kind Code <sup>5</sup> (if known)				

Examiner Signature		Date Considered	
-----------------------	--	--------------------	--

\*EXAMINER: Initial if reference considered, whether or not citation is in conformance with MPEP 609. Draw line through citation if not in conformance and not considered. Include copy of this form with next communication to applicant. <sup>1</sup> Applicant's unique citation designation number (optional). <sup>2</sup> See Kinds Codes of USPTO Patent Documents at [www.uspto.gov](http://www.uspto.gov) or MPEP 901.04. <sup>3</sup> Enter Office that issued the document, by the two-letter code (WIPO Standard ST.3). <sup>4</sup> For Japanese patent documents, the indication of the year of the reign of the Emperor must precede the serial number of the patent document. <sup>5</sup> Kind of document by the appropriate symbols as indicated on the document under WIPO Standard ST.16 if possible. <sup>6</sup> Applicant is to place a check mark here if English language Translation is attached.

Substitute for form 1449/PTO  <b>INFORMATION DISCLOSURE STATEMENT BY APPLICANT</b> (Use as many sheets as necessary)		<i>Complete if Known</i>			
		Application Number	13/118,122		
		Filing Date	May 27, 2011		
		First Named Inventor	James J. FALLON		
		Art Unit	2115		
		Examiner Name	To Be Assigned		
Sheet	21	of	27	Attorney Docket Number	2855.004000B

U.S. PATENT DOCUMENTS						
Examiner Initials*	Cite No. <sup>1</sup>	Document Number		Publication Date MM-DD-YYYY	Name of Patentee or Applicant of Cited Document	Pages, Columns, Lines, Where Relevant Passages or Relevant Figures Appear
		Number	Kind Code 2 (if known)			
	US401	6,463,509		10-08-2002	Teoman et al.	
	US402	6,487,640		11-26-2002	Lipasti	
	US403	6,489,902		12-03-2002	Heath	
	US404	6,513,113		01-28-2003	Kobayashi	
	US405	6,523,102		02-18-2003	Dye et al.	
	US406	6,526,174		02-25-2003	Graffagnino	
	US407	6,529,633		03-04-2003	Easwar et al.	
	US408	6,532,121		03-11-2003	Rust et al.	
	US409	6,539,438		03-25-2003	Ledzius et al.	
	US410	6,539,456		03-25-2003	Stewart	
	US411	6,542,644		04-01-2003	Satoh	
	US412	6,577,254		06-10-2003	Rasmussen	
	US413	6,590,609		07-08-2003	Kitade et al.	
	US414	6,597,812		07-22-2003	Fallon et al.	
	US415	6,601,104		07-29-2003	Fallon	
	US416	6,604,040		08-05-2003	Kawasaki et al.	
	US417	6,604,158		08-05-2003	Fallon	
	US418	6,606,040		08-12-2003	Abdat	
	US419	6,606,413		08-12-2003	Zeineh	
	US420	6,609,223		08-19-2003	Wolfgang	

FOREIGN PATENT DOCUMENTS							
Examiner Initials*	Cite No. <sup>1</sup>	Foreign Patent Document		Publication Date MM-DD-YYYY	Name of Patentee or Applicant of Cited Document	Pages, Columns, Lines, Where Relevant Passages or Relevant Figures Appear	T <sup>6</sup>
		Country Code <sup>3</sup> -Number <sup>4</sup> -Kind Code <sup>5</sup> (if known)					

Examiner Signature		Date Considered	
--------------------	--	-----------------	--

\*EXAMINER: Initial if reference considered, whether or not citation is in conformance with MPEP 609. Draw line through citation if not in conformance and not considered. Include copy of this form with next communication to applicant. <sup>1</sup> Applicant's unique citation designation number (optional). <sup>2</sup> See Kinds Codes of USPTO Patent Documents at www.uspto.gov or MPEP 901.04. <sup>3</sup> Enter Office that issued the document, by the two-letter code (WIPO Standard ST.3). <sup>4</sup> For Japanese patent documents, the indication of the year of the reign of the Emperor must precede the serial number of the patent document. <sup>5</sup> Kind of document by the appropriate symbols as indicated on the document under WIPO Standard ST.16 if possible. <sup>6</sup> Applicant is to place a check mark here if English language Translation is attached.



Substitute for form 1449/PTO  <b>INFORMATION DISCLOSURE STATEMENT BY APPLICANT</b> (Use as many sheets as necessary)		<b>Complete if Known</b>			
		Application Number	13/118,122		
		Filing Date	May 27, 2011		
		First Named Inventor	James J. FALLON		
		Art Unit	2115		
Examiner Name	To Be Assigned				
Sheet	22	of	27	Attorney Docket Number	2855.004000B

U.S. PATENT DOCUMENTS						
Examiner initials*	Cite No. <sup>1</sup>	Document Number		Publication Date MM-DD-YYYY	Name of Patentee or Applicant of Cited Document	Pages, Columns, Lines, Where Relevant Passages or Relevant Figures Appear
		Number	Kind Code 2 (if known)			
	US421	6,618,728		09-09-2003	Rail	
	US422	6,624,761		09-23-2003	Fallon	
	US423	6,633,244		10-14-2003	Avery	
	US424	6,650,261		11-18-2003	Nelson et al.	
	US425	6,661,839		12-09-2003	Ishida et al.	
	US426	6,661,845		12-09-2003	Herath	
	US427	6,704,840		03-09-2004	Nalawadi et al.	
	US428	6,708,220		03-16-2004	Olin	
	US429	6,711,709		03-23-2004	York	
	US430	6,717,534		04-06-2004	Yokose	
	US431	6,731,814		05-04-2004	Zeck et al.	
	US432	6,745,282		06-01-2004	Okada et al.	
	US433	6,748,457		06-08-2004	Fallon et al.	
	US434	6,756,922		06-29-2004	Ossia	
	US435	6,768,749		07-27-2004	Osler et al.	
	US436	6,792,151		09-14-2004	Barnes et al.	
	US437	6,810,434		10-26-2004	Muthujumaraswathy et al.	
	US438	6,813,689		11-02-2004	Baxter, III	
	US439	6,819,271		11-16-2004	Geiger et al.	
	US440	6,822,589		11-23-2004	Dye et al.	

FOREIGN PATENT DOCUMENTS							
Examiner initials*	Cite No. <sup>1</sup>	Foreign Patent Document		Publication Date MM-DD-YYYY	Name of Patentee or Applicant of Cited Document	Pages, Columns, Lines, Where Relevant Passages or Relevant Figures Appear	T <sup>6</sup>
		Country Code <sup>3</sup>	Number <sup>4</sup> -Kind Code <sup>5</sup> (if known)				

Examiner Signature		Date Considered	
--------------------	--	-----------------	--

\*EXAMINER: Initial if reference considered, whether or not citation is in conformance with MPEP 609. Draw line through citation if not in conformance and not considered. Include copy of this form with next communication to applicant. <sup>1</sup> Applicant's unique citation designation number (optional). <sup>2</sup> See Kinds Codes of USPTO Patent Documents at www.uspto.gov or MPEP 901.04. <sup>3</sup> Enter Office that issued the document, by the two-letter code (WIPO Standard ST.3). <sup>4</sup> For Japanese patent documents, the indication of the year of the reign of the Emperor must precede the serial number of the patent document. <sup>5</sup> Kind of document by the appropriate symbols as indicated on the document under WIPO Standard ST.16 if possible. <sup>6</sup> Applicant is to place a check mark here if English language Translation is attached.

Substitute for form 1449/PTO  <b>INFORMATION DISCLOSURE STATEMENT BY APPLICANT</b> (Use as many sheets as necessary)		<i>Complete if Known</i>			
		Application Number	13/118,122		
		Filing Date	May 27, 2011		
		First Named Inventor	James J. FALLON		
		Art Unit	2115		
		Examiner Name	To Be Assigned		
Sheet	23	of	27	Attorney Docket Number	2855.004000B

U.S. PATENT DOCUMENTS						
Examiner Initials*	Cite No. <sup>1</sup>	Document Number		Publication Date MM-DD-YYYY	Name of Patentee or Applicant of Cited Document	Pages, Columns, Lines, Where Relevant Passages or Relevant Figures Appear
		Number	Kind Code 2 (if known)			
	US441	6,856,651		02-15-2005	Singh	
	US442	6,862,278		03-01-2005	Chang et al.	
	US443	6,879,266		04-12-2005	Dye et al.	
	US444	6,885,316		04-26-2005	Mehring	
	US445	6,885,319		04-26-2005	Geiger et al.	
	US446	6,888,893		05-03-2005	Li et al.	
	US447	6,909,383		06-21-2005	Shokrollahi et al.	
	US448	6,944,740		09-13-2005	Abali et al.	
	US449	6,952,409		10-04-2002	Jolitz	
	US450	6,959,359		10-25-2005	Suzuki et al.	
	US451	6,963,608		11-08-2005	Wu	
	US452	6,990,247		01-24-2006	Schwartz	
	US453	6,993,597		01-31-2006	Nakagawa et al.	
	US454	7,007,099		02-28-2006	Donati et al.	
	US455	7,024,460		04-04-2006	Koopmas	
	US456	7,054,493		05-30-2006	Schwartz	
	US457	7,069,342		06-27-2006	Biederman	
	US458	7,089,391		08-08-2006	Geiger et al.	
	US459	7,102,544		09-05-2006	Liu	
	US460	7,127,518		10-24-2006	Vange et al.	

FOREIGN PATENT DOCUMENTS							
Examiner Initials*	Cite No. <sup>1</sup>	Foreign Patent Document		Publication Date MM-DD-YYYY	Name of Patentee or Applicant of Cited Document	Pages, Columns, Lines, Where Relevant Passages or Relevant Figures Appear	T <sup>6</sup>
		Country Code <sup>3</sup>	Number <sup>4</sup> -Kind Code <sup>5</sup> (if known)				

Examiner Signature		Date Considered	
--------------------	--	-----------------	--

\*EXAMINER: Initial if reference considered, whether or not citation is in conformance with MPEP 609. Draw line through citation if not in conformance and not considered. Include copy of this form with next communication to applicant. <sup>1</sup> Applicant's unique citation designation number (optional). <sup>2</sup> See Kinds Codes of USPTO Patent Documents at www.uspto.gov or MPEP 901.04. <sup>3</sup> Enter Office that issued the document, by the two-letter code (WIPO Standard ST.3). <sup>4</sup> For Japanese patent documents, the indication of the year of the reign of the Emperor must precede the serial number of the patent document. <sup>5</sup> Kind of document by the appropriate symbols as indicated on the document under WIPO Standard ST.16 if possible. <sup>6</sup> Applicant is to place a check mark here if English language Translation is attached.

Substitute for form 1449/PTO		<i>Complete if Known</i>	
<b>INFORMATION DISCLOSURE STATEMENT BY APPLICANT</b> <i>(Use as many sheets as necessary)</i>		Application Number	13/118,122
		Filing Date	May 27, 2011
		First Named Inventor	James J. FALLON
		Art Unit	2115
		Examiner Name	To Be Assigned
Sheet	24 of 27	Attorney Docket Number	2855.004000B

<b>U.S. PATENT DOCUMENTS</b>						
Examiner Initials*	Cite No. <sup>1</sup>	Document Number		Publication Date MM-DD-YYYY	Name of Patentee or Applicant of Cited Document	Pages, Columns, Lines, Where Relevant Passages or Relevant Figures Appear
		Number	Kind Code 2 (if known)			
	US461	7,129,860		10-31-2006	Alvarez, II	
	US462	7,130,913		10-31-2006	Fallon	
	US463	7,161,506		01-09-2007	Fallon	
	US464	7,181,608		02-20-2007	Fallon et al.	
	US465	7,190,284		03-13-2007	Dye et al.	
	US466	7,319,667		01-15-2008	Biederman	
	US467	7,321,937		01-22-2008	Fallon	
	US468	7,330,912		02-12-2008	Fox et al.	
	US469	7,352,300		04-01-2008	Fallon	
	US470	7,358,867		04-15-2008	Fallon	
	US471	7,376,772		05-20-2008	Fallon	
	US472	7,378,992		05-27-2008	Fallon	
	US473	7,386,046		06-10-2008	Fallon et al.	
	US474	7,395,345		07-01-2008	Fallon	
	US475	7,400,274		07-15-2008	Fallon et al.	
	US476	7,415,530		08-19-2008	Fallon	
	US477	7,417,568		08-26-2008	Fallon et al.	
	US478	7,552,069		06-23-2009	Kepecs	
	US479	7,565,441		07-21-2009	Romanik et al.	
	US480	7,714,747		05-11-2010	Fallon	

<b>FOREIGN PATENT DOCUMENTS</b>							
Examiner Initials*	Cite No. <sup>1</sup>	Foreign Patent Document		Publication Date MM-DD-YYYY	Name of Patentee or Applicant of Cited Document	Pages, Columns, Lines, Where Relevant Passages or Relevant Figures Appear	T <sup>6</sup>
		Country Code <sup>3</sup> -Number <sup>4</sup> -Kind Code <sup>5</sup> (if known)					

Examiner Signature		Date Considered	
--------------------	--	-----------------	--

\*EXAMINER: Initial if reference considered, whether or not citation is in conformance with MPEP 609. Draw line through citation if not in conformance and not considered. Include copy of this form with next communication to applicant. <sup>1</sup> Applicant's unique citation designation number (optional). <sup>2</sup> See Kinds Codes of USPTO Patent Documents at www.uspto.gov or MPEP 901.04. <sup>3</sup> Enter Office that issued the document, by the two-letter code (WIPO Standard ST.3). <sup>4</sup> For Japanese patent documents, the indication of the year of the reign of the Emperor must precede the serial number of the patent document. <sup>5</sup> Kind of document by the appropriate symbols as indicated on the document under WIPO Standard ST.16 if possible. <sup>6</sup> Applicant is to place a check mark here if English language Translation is attached.

Substitute for form 1449/PTO		<i>Complete if Known</i>	
<b>INFORMATION DISCLOSURE STATEMENT BY APPLICANT</b> <i>(Use as many sheets as necessary)</i>		Application Number	13/118,122
		Filing Date	May 27, 2011
		First Named Inventor	James J. FALLON
		Art Unit	2115
		Examiner Name	To Be Assigned
Sheet	25 of 27	Attorney Docket Number	2855.004000B

U.S. PATENT DOCUMENTS						
Examiner initials*	Cite No. <sup>1</sup>	Document Number		Publication Date MM-DD-YYYY	Name of Patentee or Applicant of Cited Document	Pages, Columns, Lines, Where Relevant Passages or Relevant Figures Appear
		Number	Kind Code 2 (if known)			
	US481	7,777,651		08-17-2010	Fallon et al.	
	US482	5,103,306		04-07-1992	Weiman	
	US483	5,764,774		06-09-1998	Liu	
	US484	5,673,370		09-30-1997	Laney	
	US485	6,505,239		01-07-2003	Kobata	
	US486	5,982,937		11-09-1999	Accad	
	US487	5,079,630		01-07-1992	Golin	
	US488	6,198,850		03-06-2001	Banton	
	US489	6,198,842		03-06-2001	Yeo	
	US490	2001/0031092 A1		10-18-2001	Zeck et al.	
	US491	2001/0032128 A1		10-18-2001	Kepecs	
	US492	2001/0047473 A1		11-29-2001	Fallon	
	US493	2001/0052038 A1		12-13-2001	Fallon et al.	
	US494	2001/0054131 A1		12-20-2001	Alvarez, II et al.	
	US495	2002/0037035 A1		03-28-2002	Singh	
	US496	2002/0069354 A1		06-06-2002	Fallon et al.	
	US497	2002/0080871 A1		06-27-2002	Fallon et al.	
	US498	2002/0097172 A1		07-25-2002	Fallon	
	US499	2002/0101367 A1		08-01-2002	Geiger et al.	
	US500	2002/0104891 A1		08-08-2002	Otto	

FOREIGN PATENT DOCUMENTS							
Examiner initials*	Cite No. <sup>1</sup>	Foreign Patent Document		Publication Date MM-DD-YYYY	Name of Patentee or Applicant of Cited Document	Pages, Columns, Lines, Where Relevant Passages or Relevant Figures Appear	T <sup>6</sup>
		Country Code <sup>3</sup>	Number <sup>4</sup> -Kind Code <sup>5</sup> (if known)				

Examiner Signature		Date Considered	
--------------------	--	-----------------	--

\*EXAMINER: Initial if reference considered, whether or not citation is in conformance with MPEP 609. Draw line through citation if not in conformance and not considered. Include copy of this form with next communication to applicant. <sup>1</sup> Applicant's unique citation designation number (optional). <sup>2</sup> See Kinds Codes of USPTO Patent Documents at www.uspto.gov or MPEP 901.04. <sup>3</sup> Enter Office that issued the document, by the two-letter code (WIPO Standard ST.3). <sup>4</sup> For Japanese patent documents, the indication of the year of the reign of the Emperor must precede the serial number of the patent document. <sup>5</sup> Kind of document by the appropriate symbols as indicated on the document under WIPO Standard ST.16 if possible. <sup>6</sup> Applicant is to place a check mark here if English language Translation is attached.

Substitute for form 1449/PTO		<b>Complete if Known</b>	
<b>INFORMATION DISCLOSURE STATEMENT BY APPLICANT</b> <i>(Use as many sheets as necessary)</i>		Application Number	13/118,122
		Filing Date	May 27, 2011
		First Named Inventor	James J. FALLON
		Art Unit	2115
		Examiner Name	To Be Assigned
Sheet	26	of	27
		Attorney Docket Number	2855.004000B

<b>U.S. PATENT DOCUMENTS</b>						
Examiner initials*	Cite No. <sup>1</sup>	Document Number		Publication Date MM-DD-YYYY	Name of Patentee or Applicant of Cited Document	Pages, Columns, Lines, Where Relevant Passages or Relevant Figures Appear
		Number-Kind Code <sup>2</sup> (if known)				
	US501	2002/0126755	A1	09-12-2002	Li et al.	
	US502	2002/0191692	A1	12-19-2002	Fallon et al.	
	US503	2003/0034905	A1	02-20-2003	Anton et al.	
	US504	2003/0084238	A1	05-01-2003	Okada et al.	
	US505	2003/0030575	A1	02-13-2003	Frachtenberg et al.	
	US506	2003/0090397	A1	05-15-2003	Rasmussen	
	US507	2003/0142874	A1	07-31-2003	Schwartz	
	US508	2003/0191876	A1	10-09-2003	Fallon	
	US509	2004/0042506	A1	03-04-2004	Fallon et al.	
	US510	2004/0056783	A1	03-25-2004	Fallon	
	US511	2004/0073710	A1	04-15-2004	Fallon	
	US512	2004/0073746	A1	04-15-2004	Fallon	
	US513	2006/0015650	A1	01-19-2006	Fallon	
	US514	2006/0181441	A1	08-17-2006	Fallon	
	US515	2006/0181442	A1	08-17-2006	Fallon	
	US516	2006/0184687	A1	08-17-2006	Fallon	
	US517	2006/0190644	A1	08-24-2006	Fallon	
	US518	2006/0195601	A1	08-31-2006	Fallon	
	US519	2007/0043939	A1	02-22-2007	Fallon et al.	
	US520	2007/0050514	A1	03-01-2007	Fallon	

<b>FOREIGN PATENT DOCUMENTS</b>							
Examiner initials*	Cite No. <sup>1</sup>	Foreign Patent Document		Publication Date MM-DD-YYYY	Name of Patentee or Applicant of Cited Document	Pages, Columns, Lines, Where Relevant Passages or Relevant Figures Appear	T <sup>6</sup>
		Country Code <sup>3</sup> -Number <sup>4</sup> -Kind Code <sup>5</sup> (if known)					

Examiner Signature		Date Considered	
--------------------	--	-----------------	--

\*EXAMINER: Initial if reference considered, whether or not citation is in conformance with MPEP 609. Draw line through citation if not in conformance and not considered. Include copy of this form with next communication to applicant. <sup>1</sup> Applicant's unique citation designation number (optional). <sup>2</sup> See Kinds Codes of USPTO Patent Documents at [www.uspto.gov](http://www.uspto.gov) or MPEP 901.04. <sup>3</sup> Enter Office that issued the document, by the two-letter code (WIPO Standard ST.3). <sup>4</sup> For Japanese patent documents, the indication of the year of the reign of the Emperor must precede the serial number of the patent document. <sup>5</sup> Kind of document by the appropriate symbols as indicated on the document under WIPO Standard ST.16 if possible. <sup>6</sup> Applicant is to place a check mark here if English language Translation is attached.

Substitute for form 1449/PTO		<i>Complete if Known</i>	
<b>INFORMATION DISCLOSURE STATEMENT BY APPLICANT</b> <i>(Use as many sheets as necessary)</i>		Application Number	13/118,122
		Filing Date	May 27, 2011
		First Named Inventor	James J. FALLON
		Art Unit	2115
		Examiner Name	To Be Assigned
Sheet	27 of 27	Attorney Docket Number	2855.004000B

U.S. PATENT DOCUMENTS						
Examiner initials*	Cite No. <sup>1</sup>	Document Number		Publication Date MM-DD-YYYY	Name of Patentee or Applicant of Cited Document	Pages, Columns, Lines, Where Relevant Passages or Relevant Figures Appear
		Number-Kind Code 2 (if known)				
	US521	2007/0050515	A1	03-01-2007	Fallon	
	US522	2007/0067483	A1	03-22-2007	Fallon	
	US523	2007/0083746	A1	04-12-2007	Fallon et al.	
	US524	2007/0109154	A1	05-17-2007	Fallon	
	US525	2007/0109155	A1	05-17-2007	Fallon	
	US526	2007/0109156	A1	05-17-2007	Fallon	
	US527	2007/0174209	A1	07-26-2007	Fallon	
	US528	2008/0232457	A1	09-25-2008	Fallon et al.	
	US529	2009/0154545	A1	06-18-2009	Fallon et al.	
	US530	2009/0287839	A1	11-19-2009	Fallon et al.	

FOREIGN PATENT DOCUMENTS							
Examiner initials*	Cite No. <sup>1</sup>	Foreign Patent Document		Publication Date MM-DD-YYYY	Name of Patentee or Applicant of Cited Document	Pages, Columns, Lines, Where Relevant Passages or Relevant Figures Appear	✓ <sup>6</sup>
		Country Code <sup>3</sup> -Number <sup>4</sup> -Kind Code <sup>5</sup> (if known)					

1391806\_1.DOCX

Examiner Signature		Date Considered	
--------------------	--	-----------------	--

\*EXAMINER: Initial if reference considered, whether or not citation is in conformance with MPEP 609. Draw line through citation if not in conformance and not considered. Include copy of this form with next communication to applicant. <sup>1</sup> Applicant's unique citation designation number (optional). <sup>2</sup> See Kinds Codes of USPTO Patent Documents at [www.uspto.gov](http://www.uspto.gov) or MPEP 901.04. <sup>3</sup> Enter Office that issued the document, by the two-letter code (WIPO Standard ST.3). <sup>4</sup> For Japanese patent documents, the indication of the year of the reign of the Emperor must precede the serial number of the patent document. <sup>5</sup> Kind of document by the appropriate symbols as indicated on the document under WIPO Standard ST.16 if possible. <sup>6</sup> Applicant is to place a check mark here if English language Translation is attached.

Substitute for form 1449/PTO				<i>Complete if Known</i>	
<b>INFORMATION DISCLOSURE STATEMENT BY APPLICANT</b> <i>(Use as many sheets as necessary)</i>				Application Number	13/118,122
				Filing Date	May 27, 2011
				First Named Inventor	James J. FALLON
				Art Unit	2115
				Examiner Name	To Be Assigned
Sheet	1	of	66	Attorney Docket Number	2855.004000B

NON PATENT LITERATURE DOCUMENTS			
Examiner Initials*	Cite No. <sup>1</sup>	Include name of the author (in CAPITAL LETTERS), title of the article (when appropriate), title of the item (book, magazine, journal, serial, symposium, catalog, etc.), date, page(s), volume-issue number(s), publisher, city and/or country where published	T <sup>2</sup>
	NPL1	"A-T Financial Offers Manipulation, Redistribution of Ticker III", Inside Market Data, Vol. 4 No. 14, September 5, 1989, 1 page.	
	NPL2	"Add-on Options for the XpressFiles", Intelligent Compression Technologies, <a href="http://web.archive.org/web/19980518053418/ictcompress.com/options_X.html">http://web.archive.org/web/19980518053418/ictcompress.com/options_X.html</a> , 1998, 2 pages.	
	NPL3	ANDREWS et al., "A Mean-Removed Variation of Weighted Universal Vector Quantization for Image Coding", IEEE, 1993, pages 302-309.	
	NPL4	Asserted Claims Chart for U.S. Patent No. 6,624,761, Realtime Data, LLC D/B/A IXO v. CME Group Inc., et al. , 6:09-cv-327-LED-JDL, 6:10-cv-246-LED-JDL, United States District Court for the Eastern District of Texas Tyler Division, October 19, 2010, 4 pages.	
	NPL5	Asserted Claims Chart for U.S. Patent No. 7,161,506, Realtime Data, LLC D/B/A IXO v. CME Group Inc., et al. , 6:09-cv-327-LED-JDL, 6:10-cv-246-LED-JDL, United States District Court for the Eastern District of Texas Tyler Division, October 19, 2010, 5 pages.	
	NPL6	Asserted Claims Chart for U.S. Patent No. 7,400,274, Realtime Data, LLC D/B/A IXO v. CME Group Inc., et al. , 6:09-cv-327-LED-JDL, 6:10-cv-246-LED-JDL, United States District Court for the Eastern District of Texas Tyler Division, October 19, 2010, 6 pages.	
	NPL7	Asserted Claims Chart for U.S. Patent No. 7,417,568, Realtime Data, LLC D/B/A IXO v. CME Group Inc., et al. , 6:09-cv-327-LED-JDL, 6:10-cv-246-LED-JDL, United States District Court for the Eastern District of Texas Tyler Division, October 19, 2010, 13 pages.	
	NPL8	Asserted Claims Chart for U.S. Patent No. 7,714,747, Realtime Data, LLC D/B/A IXO v. CME Group Inc., et al. , 6:09-cv-327-LED-JDL, 6:10-cv-246-LED-JDL, United States District Court for the Eastern District of Texas Tyler Division, October 19, 2010, 19 pages.	
	NPL9	BARTON, Rich, S&P ComStock Network Character Set Definition, 19.2 KB Network, Version 1.7.0, February 10, 1995, 29 pages.	
	NPL10	BEECH et al., AX.25 Link Access Protocol for Amateur Packet Radio, Version 2.2, Revision: July 1998, 143 pages.	

Examiner Signature	Date Considered
--------------------	-----------------

\*EXAMINER: Initial if reference considered, whether or not citation is in conformance with MPEP 609. Draw line through citation if not in conformance and not considered. Include copy of this form with next communication to applicant.

<sup>1</sup> Applicant's unique citation designation number (optional). <sup>2</sup> Applicant is to place a check mark here if English language Translation is attached.

Substitute for form 1449/PTO				<i>Complete if Known</i>	
<b>INFORMATION DISCLOSURE STATEMENT BY APPLICANT</b> <i>(Use as many sheets as necessary)</i>				Application Number	13/118,122
				Filing Date	May 27, 2011
				First Named Inventor	James J. FALLON
				Art Unit	2115
				Examiner Name	To Be Assigned
Sheet	2	of	66	Attorney Docket Number	2855.004000B

NON PATENT LITERATURE DOCUMENTS			
Examiner Initials*	Cite No. <sup>1</sup>	Include name of the author (in CAPITAL LETTERS), title of the article (when appropriate), title of the item (book, magazine, journal, serial, symposium, catalog, etc.), date, page(s), volume number, publisher, city and/or country where published	T <sup>2</sup>
	NPL11	BORMANN, Carsten, "Providing Integrated Services over Low-bitrate Links", Network Working Group Request for Comments: 2689, Category: Informational, September 1999, 14 pages.	
	NPL12	ComStock Services Pamphlet, McGraw-Hill Financial Services Company, purportedly published by July 19, 1995, 6 pages.	
	NPL13	CORMACK, Gordon V., "Data Compression on a Database System", Communications of the ACM, Volume 28, Number 12, December, 1985, pages 1336-1342.	
	NPL14	DANSKIN, John Moffatt, Compressing the X Graphics Protocol: A Dissertation Presented to the Facult of Princeton University in Candidacy for the Degree of Doctor of Philosophy, January 1995, 147 pages.	
	NPL15	"Data Networks and Open System Communications", Information Technology - Abstract Syntax Notation One (ASN. 1) Specification of Basic Notation, International Telecommunication Union, ITU-T Telecommunication Standardization Sector of ITU X.680, July 1994,	
	NPL16	Defendants' Invalidity Contentions, Realtime Data, LLC D/B/A IXO v. CME Group Inc., et al., 6:09-cv-327-LED-JDL, 6:10-cv-246-LED-JDL, United States District Court for the Eastern District of Texas Tyler Division, October 19, 2010, 19 pages.	
	NPL17	DEGERMARK, Mikael, "IP Header Compression", Network Working Group Request for Comments: 2507, Category: Standards Track, February 1999, 47 pages.	
	NPL18	Developer's Guide, Version 1.0.2, S&P ComStock, February 15, 1994, 186 pages.	
	NPL19	DOMANSKI, Dr. Bernie, "All the news you can eat, Department: Dr. Bernie's Digestions and Digressions", Demand Technology's Capacity Management Review, Volume 25, No. 7, July 1997, pages 24, 18-22.	
	NPL20	EPFROS, Michelle and Philip A. Chou, "Weighted Universal Transform Coding: Universal Image Compression with the Karhunen-Loeve Transform", IEEE, 1995, pages 61-64.	

Examiner Signature		Date Considered	
-----------------------	--	--------------------	--

\*EXAMINER: Initial if reference considered, whether or not citation is in conformance with MPEP 609. Draw line through citation if not in conformance and not considered. Include copy of this form with next communication to applicant.

<sup>1</sup> Applicant's unique citation designation number (optional). <sup>2</sup> Applicant is to place a check mark here if English language Translation is attached.



Substitute for form 1449/PTO				<i>Complete if Known</i>	
<b>INFORMATION DISCLOSURE STATEMENT BY APPLICANT</b> <i>(Use as many sheets as necessary)</i>				Application Number	13/118,122
				Filing Date	May 27, 2011
				First Named Inventor	James J. FALLON
				Art Unit	2115
				Examiner Name	To Be Assigned
Sheet	3	of	66	Attorney Docket Number	2855.004000B

NON PATENT LITERATURE DOCUMENTS			
Examiner Initials*	Cite No. <sup>1</sup>	Include name of the author (in CAPITAL LETTERS), title of the article (when appropriate), title of the item (book, magazine, journal, serial, symposium, catalog, etc.), date, page(s), volume number, publisher, city and/or country where published	T <sup>2</sup>
	NPL21	ENGAN, Mathias, "IP Header Compression over PPP", Network Working Group Request for Comments: 2509, Category: 2509, February 1999, 10 pages.	
	NPL22	Exhibit A, Invalidity Claim Charts A1-A45 for U.S. Patent 6,624,761, Realtime Data, LLC D/B/A IXO v. CME Group Inc., et al. , 6:09-cv-327-LED-JDL, 6:10-cv-246-LED-JDL, United States District Court for the Eastern District of Texas Tyler Division, October 19, 2010, 616 pages.	
	NPL23	Exhibit B, Invalidity Claim Charts B1-B45 for U.S. Patent 7,161,506, Realtime Data, LLC D/B/A IXO v. CME Group Inc., et al. , 6:09-cv-327-LED-JDL, 6:10-cv-246-LED-JDL, United States District Court for the Eastern District of Texas Tyler Division, October 19, 2010, 1513 pages.	
	NPL24	Exhibit C, Invalidity Claim Charts C1-C7, C9-C31, C33-C45 for U.S. Patent 7,400,274, Realtime Data, LLC D/B/A IXO v. CME Group Inc., et al. , 6:09-cv-327-LED-JDL, 6:10-cv-246-LED-JDL, United States District Court for the Eastern District of Texas Tyler Division, October 19, 2010, 1528 pages.	
	NPL25	Exhibit D, Invalidity Claim Charts D1-D7, D9-D45 for U.S. Patent 7,417,568, Realtime Data, LLC D/B/A IXO v. CME Group Inc., et al. , 6:09-cv-327-LED-JDL, 6:10-cv-246-LED-JDL, United States District Court for the Eastern District of Texas Tyler Division, October 19, 2010, 2458 pages.	
	NPL26	Exhibit E, Invalidity Claim Charts E1-E7, E9, E11, E13-E15, E17-E30, E32-E45 for U.S. Patent 7,714,747, Realtime Data, LLC D/B/A IXO v. CME Group Inc., et al. , 6:09-cv-327-LED-JDL, 6:10-cv-246-LED-JDL, United States District Court for the Eastern District of Texas Tyler Division, October 19, 2010, 3312 pages.	
	NPL27	GREENE, Tim, "Squeeze your 'Net links", NetworkWorld, Volume 14, Number 28, July 14, 1997, pages 1 and 56.	
	NPL28	HELCK, Christopher J., "Encapsulated Ticker: Ver 1.0", July 14, 1993, 22 pages.	
	NPL29	"High-performance schema-specific compression for XML data formats.", XML-Xpress: Product Overview, Intelligent Compression Technologies, <a href="http://web.archive.org/web/20020818002535/www.ictcompress.com/products_xmlxpress">http://web.archive.org/web/20020818002535/www.ictcompress.com/products_xmlxpress</a> , 2001, 2 pages.	
	NPL30	HSU, William H. and Amy E. Zwarico, "Automatic Synthesis of Compression Techniques for Heterogeneous Files", Software - Practice and Experience, Volume 25 (10), October 1995, pages 1097-1116.	

Examiner Signature	Date Considered
--------------------	-----------------

\*EXAMINER: Initial if reference considered, whether or not citation is in conformance with MPEP 609. Draw line through citation if not in conformance and not considered. Include copy of this form with next communication to applicant.

<sup>1</sup> Applicant's unique citation designation number (optional). <sup>2</sup> Applicant is to place a check mark here if English language Translation is attached.

Substitute for form 1449/PTO				<i>Complete if Known</i>	
<b>INFORMATION DISCLOSURE STATEMENT BY APPLICANT</b> <i>(Use as many sheets as necessary)</i>				Application Number	13/118,122
				Filing Date	May 27, 2011
				First Named Inventor	James J. FALLON
				Art Unit	2115
				Examiner Name	To Be Assigned
Sheet	4	of	66	Attorney Docket Number	2855.004000B

NON PATENT LITERATURE DOCUMENTS			
Examiner Initials*	Cite No. <sup>1</sup>	Include name of the author (in CAPITAL LETTERS), title of the article (when appropriate), title of the item (book, magazine, journal, serial, symposium, catalog, etc.), date, page(s), volume number, publisher, city and/or country where published	T <sup>2</sup>
	NPL31	"ICT's XML-Xpress", Intelligent Compression Technologies, December, 2000, 6 pages.	
	NPL32	"Information processing systems - Data communication - High-level data link control procedures - Frame structure", UNI ISO 3309, 1984, 11 pages.	
	NPL33	Installing and Administering PPP, Edition 1, Hewlett-Packard Company, 1997, 169 pages.	
	NPL34	"Introducing XpressFiles", Intelligent Compression Technologies, <a href="http://web.archive.org/web/19980518053310/ictcompress.com/xpressfiles.html">http://web.archive.org/web/19980518053310/ictcompress.com/xpressfiles.html</a> , 1998, 1 page.	
	NPL35	"Ion's RemoteScript speeds transmission", Seybold Report on Publishing Systems, Volume 22 Number 5, November 9, 1992, pages 21-23.	
	NPL36	JACOBSON, Compressing TCP/IP Headers for Low-Speed Serial Links, February 1990, 43 pages.	
	NPL37	KULKOSKY, Victor, "Upping the Ante", Wall Street & Technology, Volume 11 Number 5, October 1993, pages 8-11.	
	NPL38	LIEFKE, Hartmut and Dan Suci, An Extensible Compressor for XML Data, SIGMOD Record, Vol. 29, No. 1, March 2000, pages 57-62.	
	NPL39	LIEFKE, Hartmut and Dan Suci, Xmill: an Efficient Compressor for XML Data, 2000, pages 153-164.	
	NPL40	LIEFKE, Hartmut and Dan Suci, Xmill: an Efficient Compressor for XML Data, October 18, 1999, 25 pages.	

Examiner Signature		Date Considered	
-----------------------	--	--------------------	--

\*EXAMINER: Initial if reference considered, whether or not citation is in conformance with MPEP 609. Draw line through citation if not in conformance and not considered. Include copy of this form with next communication to applicant.

<sup>1</sup> Applicant's unique citation designation number (optional). <sup>2</sup> Applicant is to place a check mark here if English language Translation is attached.

Substitute for form 1449/PTO				<i>Complete if Known</i>	
<b>INFORMATION DISCLOSURE STATEMENT BY APPLICANT</b> <i>(Use as many sheets as necessary)</i>				Application Number	13/118,122
				Filing Date	May 27, 2011
				First Named Inventor	James J. FALLON
				Art Unit	2115
				Examiner Name	To Be Assigned
Sheet	5	of	66	Attorney Docket Number	2855.004000B

NON PATENT LITERATURE DOCUMENTS			
Examiner Initials*	Cite No. <sup>1</sup>	Include name of the author (in CAPITAL LETTERS), title of the article (when appropriate), title of the item (book, magazine, journal, serial, symposium, catalog, etc.), date, page(s), volume number, publisher, city and/or country where published	T <sup>2</sup>
	NPL41	McGREGOR, Glenn, "The PPP Internet Protocol Control Protocol (IPCP)", Network Working Group Request for Comments: 1332, Obsoletes: RFC 1172, May 1992, 14 pages.	
	NPL42	Obviousness Chart for U.S. Pat. No. 6,624,761, Realtime Data, LLC D/B/A IXO v. CME Group Inc., et al., 6:09-cv-327-LED-JDL, 6:10-cv-246-LED-JDL, United States District Court for the Eastern District of Texas Tyler Division, October 19, 2010, 19 pages.	
	NPL43	Obviousness Chart for U.S. Pat. No. 7,161,506, Realtime Data, LLC D/B/A IXO v. CME Group Inc., et al., 6:09-cv-327-LED-JDL, 6:10-cv-246-LED-JDL, United States District Court for the Eastern District of Texas Tyler Division, October 19, 2010, 49 pages.	
	NPL44	Obviousness Chart for U.S. Pat. No. 7,400,274, Realtime Data, LLC D/B/A IXO v. CME Group Inc., et al., 6:09-cv-327-LED-JDL, 6:10-cv-246-LED-JDL, United States District Court for the Eastern District of Texas Tyler Division, October 19, 2010, 41 pages.	
	NPL45	Obviousness Chart for U.S. Pat. No. 7,417,568, Realtime Data, LLC D/B/A IXO v. CME Group Inc., et al., 6:09-cv-327-LED-JDL, 6:10-cv-246-LED-JDL, United States District Court for the Eastern District of Texas Tyler Division, October 19, 2010, 75 pages.	
	NPL46	Obviousness Chart for U.S. Pat. No. 7,714,747, Realtime Data, LLC D/B/A IXO v. CME Group Inc., et al., 6:09-cv-327-LED-JDL, 6:10-cv-246-LED-JDL, United States District Court for the Eastern District of Texas Tyler Division, October 19, 2010, 97 pages.	
	NPL47	Open Financial Exchange Specification 2.0, Intuit Inc., Microsoft Corp., April 28, 2000, 537 pages.	
	NPL48	RAND, Dave, "The PPP Compression Control Protocol (CCP)", Network Working Group Request for Comments: 1962, Category: Standards Track, June 1996, 9 pages.	
	NPL49	ROGERS, Amy, "Bandwidth Bargain IT hot on products that squeeze more out of the pipe", Number 673, July 21, 1997, pages 1 and 65.	
	NPL50	ROTH, Mark A. and Scott J. Van Horn, "Database Compression", SIGMOD Record, Vol. 22, No. 3, September 1993, pages 31-39.	

Examiner Signature		Date Considered	
-----------------------	--	--------------------	--

\*EXAMINER: Initial if reference considered, whether or not citation is in conformance with MPEP 609. Draw line through citation if not in conformance and not considered. Include copy of this form with next communication to applicant.

<sup>1</sup> Applicant's unique citation designation number (optional). <sup>2</sup> Applicant is to place a check mark here if English language Translation is attached.

Substitute for form 1449/PTO				<i>Complete if Known</i>	
<b>INFORMATION DISCLOSURE STATEMENT BY APPLICANT</b> <i>(Use as many sheets as necessary)</i>				Application Number	13/118,122
				Filing Date	May 27, 2011
				First Named Inventor	James J. FALLON
				Art Unit	2115
				Examiner Name	To Be Assigned
Sheet	6	of	66	Attorney Docket Number	2855.004000B

NON PATENT LITERATURE DOCUMENTS			
Examiner Initials*	Cite No. <sup>1</sup>	Include name of the author (in CAPITAL LETTERS), title of the article (when appropriate), title of the item (book, magazine, journal, serial, symposium, catalog, etc.), date, page(s), volume number, publisher, city and/or country where published	T <sup>2</sup>
	NPL51	SCHMERKEN, Ivy, "Time Running Out for Old Technologies", Wall Street Computer Review, April 1990, pages 14-16, 23-24, 28, 56.	
	NPL52	"Scrolling News", Inside Market Data, February 27, 1995, 2 pages.	
	NPL53	SIMPSON, W., "PPP in HDLC-like Framing", Network Working Group Request for Comments: 1662, STD 51, Obsoletes 1549, Category: Standards Track, July 1994, 26 pages.	
	NPL54	SUCIU, Dan, Data Management on the Web, AT&T Labs, April 4, 2000, 52 slides.	
	NPL55	SUCIU, Dan, Data Management on the Web: Abstract, University of Washington Computer Science & Engineering, April 4, 2000, 1 page.	
	NPL56	"Telekurs Buys S&P Trading Systems And Its Ticker III Feed", Inside Market Data, Vol. 4, No. 11, July 10, 1989, 1 page.	
	NPL57	"Telekurs May Debut 128 KPS Ticker By Year's End", Inside Market Data, July 18, 1994, 2 pages.	
	NPL58	"Telekurs Now Carries All Dow Jones' News on 56-Kbps Ticker," Inside Market Data, December 20, 1993, 2 pages.	
	NPL59	"Telekurs Sells No. American Division in Mgmt. Buyout", Inside Market Data, October 23, 1995, 2 pages.	
	NPL60	"Telekurs to Launch New Int'l Feed/Internet Server", Wall Street & Technology, Volume 15, No. 1, January 1997, page 14.	

Examiner Signature	Date Considered
-----------------------	--------------------

\*EXAMINER: Initial if reference considered, whether or not citation is in conformance with MPEP 609. Draw line through citation if not in conformance and not considered. Include copy of this form with next communication to applicant.

<sup>1</sup> Applicant's unique citation designation number (optional). <sup>2</sup> Applicant is to place a check mark here if English language Translation is attached.

Substitute for form 1449/PTO				<i>Complete if Known</i>	
<b>INFORMATION DISCLOSURE STATEMENT BY APPLICANT</b> <i>(Use as many sheets as necessary)</i>				Application Number	13/118,122
				Filing Date	May 27, 2011
				First Named Inventor	James J. FALLON
				Art Unit	2115
				Examiner Name	To Be Assigned
Sheet	7	of	66	Attorney Docket Number	2855.004000B

NON PATENT LITERATURE DOCUMENTS			
Examiner Initials*	Cite No. <sup>1</sup>	Include name of the author (in CAPITAL LETTERS), title of the article (when appropriate), title of the item (book, magazine, journal, serial, symposium, catalog, etc.), date, page(s), volume number, publisher, city and/or country where published	T <sup>2</sup>
	NPL61	<u>"The Technology Behind XpressFiles," Intelligent Compression Technologies, <a href="http://web.archive.org/web/19980518053634/ictcompress.com/technical_X.html">http://web.archive.org/web/19980518053634/ictcompress.com/technical_X.html</a>, 1998, 1 page.</u>	
	NPL62	TID Information: Revisions to TID Program Since the Dawn of Time!!! Version 1.0, 23 pages, TID Codes 1, 1 page; TID Codes 2, 1 page, purportedly by July 19, 1995.	
	NPL63	TypeWorld: The First and Only Newspaper for Electronic Publishing, Volume 16 Number 9, June 17, 1992, 3 pages.	
	NPL64	"XpressFiles White Paper", Intelligent Compression Technologies, 1999-2001, 3 pages.	
	NPL65	United States Provisional Patent Application No. 60/309,218, filed July 31, 2001, 58 pgs.	
	NPL66	Telekurs Manual, January 11, 1993, 184 pages.	
	NPL67	DANSKIN, et al., "Fast Higher Bandwidth X," Dartmouth College, Hanover, NH, 1995, 8 pages.	
	NPL68	HOFFMAN, Roy, "Data Compression in Digital Systems," Digital Multimedia Standards Series, Chapman & Hall, 1997, 426 pages.	
	NPL69	Defendants' Invalidity Contentions, Realtime Data, LLC D/B/A IXO v. Morgan Stanley, et al., 6:09-cv-326-LED-JDL, 6:10-cv-248-LED-JDL, 6:10-cv-426-LED-JDL, Realtime Data, LLC D/B/A IXO v. CME Group Inc., et al., 6:09-cv-327-LED-JDL, 6:10-cv-246-LED-JDL, 6:10-cv-424-LED-JDL, Realtime Data, LLC D/B/A IXO v. Thomson Reuters Corp., et al., 6:09-cv-333-LED-JDL, 6:10-cv-247-LED-JDL, 6:10-cv-425-LED-JDL, United States District Court for the Eastern District of Texas Tyler Division, February 4, 2011, 34 pages.	
	NPL70	Appendix A, Obviousness Chart for U.S. Patent No. 7,777,651, not dated, Realtime Data, LLC D/B/A IXO v. Morgan Stanley, et al., 6:09-cv-326-LED-JDL, 6:10-cv-248-LED-JDL, 6:10-cv-426-LED-JDL, Realtime Data, LLC D/B/A IXO v. CME Group Inc., et al., 6:09-cv-327-LED-JDL, 6:10-cv-246-LED-JDL, 6:10-cv-424-LED-JDL, Realtime Data, LLC D/B/A IXO v. Thomson Reuters Corp., et al., 6:09-cv-333-LED-JDL, 6:10-cv-247-LED-JDL, 6:10-cv-425-LED-JDL, United States District Court for the Eastern District of Texas Tyler Division, February 4, 2011, 466 pages.	

Examiner Signature		Date Considered	
-----------------------	--	--------------------	--

\*EXAMINER: Initial if reference considered, whether or not citation is in conformance with MPEP 609. Draw line through citation if not in conformance and not considered. Include copy of this form with next communication to applicant.

<sup>1</sup> Applicant's unique citation designation number (optional). <sup>2</sup> Applicant is to place a check mark here if English language Translation is attached.

Substitute for form 1449/PTO				<b>Complete if Known</b>	
<b>INFORMATION DISCLOSURE STATEMENT BY APPLICANT</b> <i>(Use as many sheets as necessary)</i>				Application Number	13/118,122
				Filing Date	May 27, 2011
				First Named Inventor	James J. FALLON
				Art Unit	2115
				Examiner Name	To Be Assigned
Sheet	8	of	66	Attorney Docket Number	2855.004000B

NON PATENT LITERATURE DOCUMENTS			
Examiner Initials*	Cite No. <sup>1</sup>	Include name of the author (in CAPITAL LETTERS), title of the article (when appropriate), title of the item (book, magazine, journal, serial, symposium, catalog, etc.), date, page(s), volume number, publisher, city and/or country where published	T <sup>2</sup>
	NPL71	Appendix B, § 112 Invalidity Arguments for U.S. Pat. No. 7,777,651, Realtime Data, LLC D/B/A IXO v. Morgan Stanley, et al., 6:09-cv-326-LED-JDL, 6:10-cv-248-LED-JDL, 6:10-cv-426-LED-JDL, Realtime Data, LLC D/B/A IXO v. CME Group Inc., et al., 6:09-cv-327-LED-JDL, 6:10-cv-246-LED-JDL, 6:10-cv-424-LED-JDL, Realtime Data, LLC D/B/A IXO v. Thomson Reuters Corp., et al., 6:09-cv-333-LED-JDL, 6:10-cv-247-LED-JDL, 6:10-cv-425-LED-JDL, United States District Court for the Eastern District of Texas Tyler Division, February 4, 2011, 75 pages.	
	NPL72	Exhibit 1, Prior Art Chart for U.S. Pat. No. 7,777,651, Realtime Data, LLC D/B/A IXO v. Morgan Stanley, et al., 6:09-cv-326-LED-JDL, 6:10-cv-248-LED-JDL, 6:10-cv-426-LED-JDL, Realtime Data, LLC D/B/A IXO v. CME Group Inc., et al., 6:09-cv-327-LED-JDL, 6:10-cv-246-LED-JDL, 6:10-cv-424-LED-JDL, Realtime Data, LLC D/B/A IXO v. Thomson Reuters Corp., et al., 6:09-cv-333-LED-JDL, 6:10-cv-247-LED-JDL, 6:10-cv-425-LED-JDL, United States District Court for the Eastern District of Texas Tyler Division, February 4, 2011, 161 pages, citing Aakre et al., U.S. Patent No. 4,956,808.	
	NPL73	Exhibit 2, Prior Art Chart for U.S. Pat. No. 7,777,651, Realtime Data, LLC D/B/A IXO v. Morgan Stanley, et al., 6:09-cv-326-LED-JDL, 6:10-cv-248-LED-JDL, 6:10-cv-426-LED-JDL, Realtime Data, LLC D/B/A IXO v. CME Group Inc., et al., 6:09-cv-327-LED-JDL, 6:10-cv-246-LED-JDL, 6:10-cv-424-LED-JDL, Realtime Data, LLC D/B/A IXO v. Thomson Reuters Corp., et al., 6:09-cv-333-LED-JDL, 6:10-cv-247-LED-JDL, 6:10-cv-425-LED-JDL, United States District Court for the Eastern District of Texas Tyler Division, February 4, 2011, 206 pages, citing Albert et al., U.S. Patent No. 5,907,801.	
	NPL74	Exhibit 3, Prior Art Chart for U.S. Pat. No. 7,777,651, Realtime Data, LLC D/B/A IXO v. Morgan Stanley, et al., 6:09-cv-326-LED-JDL, 6:10-cv-248-LED-JDL, 6:10-cv-426-LED-JDL, Realtime Data, LLC D/B/A IXO v. CME Group Inc., et al., 6:09-cv-327-LED-JDL, 6:10-cv-246-LED-JDL, 6:10-cv-424-LED-JDL, Realtime Data, LLC D/B/A IXO v. Thomson Reuters Corp., et al., 6:09-cv-333-LED-JDL, 6:10-cv-247-LED-JDL, 6:10-cv-425-LED-JDL, United States District Court for the Eastern District of Texas Tyler Division, February 4, 2011, 95 pages, citing B. Andrews, P. Chou, M. Effros and R. Gray "A Mean-Removed Variation of Weighted Universal Vector Quantization for Image Coding," IEEE 0-8186-3392-1/93, 302-309 (1993).	
	NPL75	Exhibit 4, Prior Art Chart for U.S. Pat. No. 7,777,651, 144 pages, Realtime Data, LLC D/B/A IXO v. Morgan Stanley, et al., 6:09-cv-326-LED-JDL, 6:10-cv-248-LED-JDL, 6:10-cv-426-LED-JDL, Realtime Data, LLC D/B/A IXO v. CME Group Inc., et al., 6:09-cv-327-LED-JDL, 6:10-cv-246-LED-JDL, 6:10-cv-424-LED-JDL, Realtime Data, LLC D/B/A IXO v. Thomson Reuters Corp., et al., 6:09-cv-333-LED-JDL, 6:10-cv-247-LED-JDL, 6:10-cv-425-LED-JDL, United States District Court for the Eastern District of Texas Tyler Division, February 4, 2011, citing Barnes et al., U.S. Patent No. 6,792,151.	
	NPL76	Exhibit 5, Prior Art Chart for U.S. Pat. No. 7,777,651, 216 pages, Realtime Data, LLC D/B/A IXO v. Morgan Stanley, et al., 6:09-cv-326-LED-JDL, 6:10-cv-248-LED-JDL, 6:10-cv-426-LED-JDL, Realtime Data, LLC D/B/A IXO v. CME Group Inc., et al., 6:09-cv-327-LED-JDL, 6:10-cv-246-LED-JDL, 6:10-cv-424-LED-JDL, Realtime Data, LLC D/B/A IXO v. Thomson Reuters Corp., et al., 6:09-cv-333-LED-JDL, 6:10-cv-247-LED-JDL, 6:10-cv-425-LED-JDL, United States District Court for the Eastern District of Texas Tyler Division, February 4, 2011, citing Birdwell et al., U.S. Patent No. 6,032,197.	

Examiner Signature	Date Considered
-----------------------	--------------------

\*EXAMINER: Initial if reference considered, whether or not citation is in conformance with MPEP 609. Draw line through citation if not in conformance and not considered. Include copy of this form with next communication to applicant.

<sup>1</sup> Applicant's unique citation designation number (optional). <sup>2</sup> Applicant is to place a check mark here if English language Translation is attached.

Substitute for form 1449/PTO				<b>Complete if Known</b>	
<b>INFORMATION DISCLOSURE STATEMENT BY APPLICANT</b> <i>(Use as many sheets as necessary)</i>				Application Number	13/118,122
				Filing Date	May 27, 2011
				First Named Inventor	James J. FALLON
				Art Unit	2115
				Examiner Name	To Be Assigned
Sheet	9	of	66	Attorney Docket Number	2855.004000B

NON PATENT LITERATURE DOCUMENTS			
Examiner Initials*	Cite No. <sup>1</sup>	Include name of the author (in CAPITAL LETTERS), title of the article (when appropriate), title of the item (book, magazine, journal, serial, symposium, catalog, etc.), date, page(s), volume number, publisher, city and/or country where published	T <sup>2</sup>
	NPL77	Exhibit 6, Prior Art Chart for U.S. Pat. No. 7,777,651, 257 pages, Realtime Data, LLC D/B/A IXO v. Morgan Stanley, et al., 6:09-cv-326-LED-JDL, 6:10-cv-248-LED-JDL, 6:10-cv-426-LED-JDL, Realtime Data, LLC D/B/A IXO v. CME Group Inc., et al., 6:09-cv-327-LED-JDL, 6:10-cv-246-LED-JDL, 6:10-cv-424-LED-JDL, Realtime Data, LLC D/B/A IXO v. Thomson Reuters Corp., et al., 6:09-cv-333-LED-JDL, 6:10-cv-247-LED-JDL, 6:10-cv-425-LED-JDL, United States District Court for the Eastern District of Texas Tyler Division, February 4, 2011, citing Bledsoe, U.S. Patent No. 4,646,061.	
	NPL78	Exhibit 7, Prior Art Chart for U.S. Pat. No. 7,777,651, 169 pages, Realtime Data, LLC D/B/A IXO v. Morgan Stanley, et al., 6:09-cv-326-LED-JDL, 6:10-cv-248-LED-JDL, 6:10-cv-426-LED-JDL, Realtime Data, LLC D/B/A IXO v. CME Group Inc., et al., 6:09-cv-327-LED-JDL, 6:10-cv-246-LED-JDL, 6:10-cv-424-LED-JDL, Realtime Data, LLC D/B/A IXO v. Thomson Reuters Corp., et al., 6:09-cv-333-LED-JDL, 6:10-cv-247-LED-JDL, 6:10-cv-425-LED-JDL, United States District Court for the Eastern District of Texas Tyler Division, February 4, 2011, citing Brickman et al., U.S. Patent No. 4,499,499	
	NPL79	Exhibit 8, Prior Art Chart for U.S. Pat. No. 7,777,651, 396 pages, Realtime Data, LLC D/B/A IXO v. Morgan Stanley, et al., 6:09-cv-326-LED-JDL, 6:10-cv-248-LED-JDL, 6:10-cv-426-LED-JDL, Realtime Data, LLC D/B/A IXO v. CME Group Inc., et al., 6:09-cv-327-LED-JDL, 6:10-cv-246-LED-JDL, 6:10-cv-424-LED-JDL, Realtime Data, LLC D/B/A IXO v. Thomson Reuters Corp., et al., 6:09-cv-333-LED-JDL, 6:10-cv-247-LED-JDL, 6:10-cv-425-LED-JDL, United States District Court for the Eastern District of Texas Tyler Division, February 4, 2011, citing C. Bormann et al., "Robust Header Compression (ROHC)," Network Working Group Internet-Draft Sept. 18, 2000.	
	NPL80	Exhibit 9, Prior Art Chart for U.S. Pat. No. 7,777,651, 253 pages, Realtime Data, LLC D/B/A IXO v. Morgan Stanley, et al., 6:09-cv-326-LED-JDL, 6:10-cv-248-LED-JDL, 6:10-cv-426-LED-JDL, Realtime Data, LLC D/B/A IXO v. CME Group Inc., et al., 6:09-cv-327-LED-JDL, 6:10-cv-246-LED-JDL, 6:10-cv-424-LED-JDL, Realtime Data, LLC D/B/A IXO v. Thomson Reuters Corp., et al., 6:09-cv-333-LED-JDL, 6:10-cv-247-LED-JDL, 6:10-cv-425-LED-JDL, United States District Court for the Eastern District of Texas Tyler Division, February 4, 2011, citing Carr, U.S. Patent No. 5,293,379.	
	NPL81	Exhibit 10, Prior Art Chart for U.S. Pat. No. 7,777,651, 205 pages, Realtime Data, LLC D/B/A IXO v. Morgan Stanley, et al., 6:09-cv-326-LED-JDL, 6:10-cv-248-LED-JDL, 6:10-cv-426-LED-JDL, Realtime Data, LLC D/B/A IXO v. CME Group Inc., et al., 6:09-cv-327-LED-JDL, 6:10-cv-246-LED-JDL, 6:10-cv-424-LED-JDL, Realtime Data, LLC D/B/A IXO v. Thomson Reuters Corp., et al., 6:09-cv-333-LED-JDL, 6:10-cv-247-LED-JDL, 6:10-cv-425-LED-JDL, United States District Court for the Eastern District of Texas Tyler Division, February 4, 2011, citing Cellier et al., U.S. Patent No. 5,884,269.	
	NPL82	Exhibit 11, Prior Art Chart for U.S. Pat. No. 7,777,651, 181 pages, Realtime Data, LLC D/B/A IXO v. Morgan Stanley, et al., 6:09-cv-326-LED-JDL, 6:10-cv-248-LED-JDL, 6:10-cv-426-LED-JDL, Realtime Data, LLC D/B/A IXO v. CME Group Inc., et al., 6:09-cv-327-LED-JDL, 6:10-cv-246-LED-JDL, 6:10-cv-424-LED-JDL, Realtime Data, LLC D/B/A IXO v. Thomson Reuters Corp., et al., 6:09-cv-333-LED-JDL, 6:10-cv-247-LED-JDL, 6:10-cv-425-LED-JDL, United States District Court for the Eastern District of Texas Tyler Division, February 4, 2011, citing Chu, U.S. Patent Nos. 5,374,916 & 5,467,087.	

Examiner Signature	Date Considered
--------------------	-----------------

\*EXAMINER: Initial if reference considered, whether or not citation is in conformance with MPEP 609. Draw line through citation if not in conformance and not considered. Include copy of this form with next communication to applicant.

<sup>1</sup> Applicant's unique citation designation number (optional). <sup>2</sup> Applicant is to place a check mark here if English language Translation is attached.

Substitute for form 1449/PTO				<i>Complete if Known</i>	
<b>INFORMATION DISCLOSURE STATEMENT BY APPLICANT</b> <i>(Use as many sheets as necessary)</i>				Application Number	13/118,122
				Filing Date	May 27, 2011
				First Named Inventor	James J. FALLON
				Art Unit	2115
				Examiner Name	To Be Assigned
Sheet	10	of	66	Attorney Docket Number	2855.004000B

NON PATENT LITERATURE DOCUMENTS			
Examiner Initials*	Cite No. <sup>1</sup>	Include name of the author (in CAPITAL LETTERS), title of the article (when appropriate), title of the item (book, magazine, journal, serial, symposium, catalog, etc.), date, page(s), volume number, publisher, city and/or country where published	T <sup>2</sup>
	NPL83	Exhibit 12, Prior Art Chart for U.S. Pat. No. 7,777,651, 175 pages, Realtime Data, LLC D/B/A IXO v. Morgan Stanley, et al., 6:09-cv-326-LED-JDL, 6:10-cv-248-LED-JDL, 6:10-cv-426-LED-JDL, Realtime Data, LLC D/B/A IXO v. CME Group Inc., et al., 6:09-cv-327-LED-JDL, 6:10-cv-246-LED-JDL, 6:10-cv-424-LED-JDL, Realtime Data, LLC D/B/A IXO v. Thomson Reuters Corp., et al., 6:09-cv-333-LED-JDL, 6:10-cv-247-LED-JDL, 6:10-cv-425-LED-JDL, United States District Court for the Eastern District of Texas Tyler Division, February 4, 2011, citing Cisco IOS Data Compression White Paper (Cisco Systems Inc., 1997).	
	NPL84	Exhibit 13, Prior Art Chart for U.S. Pat. No. 7,777,651, 590 pages, Realtime Data, LLC D/B/A IXO v. Morgan Stanley, et al., 6:09-cv-326-LED-JDL, 6:10-cv-248-LED-JDL, 6:10-cv-426-LED-JDL, Realtime Data, LLC D/B/A IXO v. CME Group Inc., et al., 6:09-cv-327-LED-JDL, 6:10-cv-246-LED-JDL, 6:10-cv-424-LED-JDL, Realtime Data, LLC D/B/A IXO v. Thomson Reuters Corp., et al., 6:09-cv-333-LED-JDL, 6:10-cv-247-LED-JDL, 6:10-cv-425-LED-JDL, United States District Court for the Eastern District of Texas Tyler Division, February 4, 2011, citing Comstock - S&P ComStock Developers Guides (McGraw-Hill, 1994); Rich Barton, "S&P ComStock Network Character Set Definition" (February 10, 1995).	
	NPL85	Exhibit 14, Prior Art Chart for U.S. Pat. No. 7,777,651, 186 pages, Realtime Data, LLC D/B/A IXO v. Morgan Stanley, et al., 6:09-cv-326-LED-JDL, 6:10-cv-248-LED-JDL, 6:10-cv-426-LED-JDL, Realtime Data, LLC D/B/A IXO v. CME Group Inc., et al., 6:09-cv-327-LED-JDL, 6:10-cv-246-LED-JDL, 6:10-cv-424-LED-JDL, Realtime Data, LLC D/B/A IXO v. Thomson Reuters Corp., et al., 6:09-cv-333-LED-JDL, 6:10-cv-247-LED-JDL, 6:10-cv-425-LED-JDL, United States District Court for the Eastern District of Texas Tyler Division, February 4, 2011, citing D.J. Craft, "A fast hardware data compression algorithm and some algorithmic extensions," IBM J. Res. Develop. Vol. 42, No. 6 (6November 1998).	
	NPL86	Exhibit 15, Prior Art Chart for U.S. Pat. No. 7,777,651, 142 pages, Realtime Data, LLC D/B/A IXO v. Morgan Stanley, et al., 6:09-cv-326-LED-JDL, 6:10-cv-248-LED-JDL, 6:10-cv-426-LED-JDL, Realtime Data, LLC D/B/A IXO v. CME Group Inc., et al., 6:09-cv-327-LED-JDL, 6:10-cv-246-LED-JDL, 6:10-cv-424-LED-JDL, Realtime Data, LLC D/B/A IXO v. Thomson Reuters Corp., et al., 6:09-cv-333-LED-JDL, 6:10-cv-247-LED-JDL, 6:10-cv-425-LED-JDL, United States District Court for the Eastern District of Texas Tyler Division, February 4, 2011, citing Deering, U.S. Patent No. 6,459,429.	
	NPL87	Exhibit 16, Prior Art Chart for U.S. Pat. No. 7,777,651, 284 pages, Realtime Data, LLC D/B/A IXO v. Morgan Stanley, et al., 6:09-cv-326-LED-JDL, 6:10-cv-248-LED-JDL, 6:10-cv-426-LED-JDL, Realtime Data, LLC D/B/A IXO v. CME Group Inc., et al., 6:09-cv-327-LED-JDL, 6:10-cv-246-LED-JDL, 6:10-cv-424-LED-JDL, Realtime Data, LLC D/B/A IXO v. Thomson Reuters Corp., et al., 6:09-cv-333-LED-JDL, 6:10-cv-247-LED-JDL, 6:10-cv-425-LED-JDL, United States District Court for the Eastern District of Texas Tyler Division, February 4, 2011, citing Dye et al., U.S. Patent No. 7,190,284 and International Publication No. WO 00/45516.	
	NPL88	Exhibit 17, Prior Art Chart for U.S. Pat. No. 7,777,651, 269 pages, Realtime Data, LLC D/B/A IXO v. Morgan Stanley, et al., 6:09-cv-326-LED-JDL, 6:10-cv-248-LED-JDL, 6:10-cv-426-LED-JDL, Realtime Data, LLC D/B/A IXO v. CME Group Inc., et al., 6:09-cv-327-LED-JDL, 6:10-cv-246-LED-JDL, 6:10-cv-424-LED-JDL, Realtime Data, LLC D/B/A IXO v. Thomson Reuters Corp., et al., 6:09-cv-333-LED-JDL, 6:10-cv-247-LED-JDL, 6:10-cv-425-LED-JDL, United States District Court for the Eastern District of Texas Tyler Division, February 4, 2011, citing Earl et al., U.S. Patent No. 5,341,440.	

Examiner Signature	Date Considered
-----------------------	--------------------

\*EXAMINER: Initial if reference considered, whether or not citation is in conformance with MPEP 609. Draw line through citation if not in conformance and not considered. Include copy of this form with next communication to applicant.

<sup>1</sup> Applicant's unique citation designation number (optional). <sup>2</sup> Applicant is to place a check mark here if English language Translation is attached.



Substitute for form 1449/PTO			<i>Complete if Known</i>		
<b>INFORMATION DISCLOSURE STATEMENT BY APPLICANT</b> <i>(Use as many sheets as necessary)</i>			Application Number	13/118,122	
			Filing Date	May 27, 2011	
			First Named Inventor	James J. FALLON	
			Art Unit	2115	
			Examiner Name	To Be Assigned	
Sheet	11	of	66	Attorney Docket Number	2855.004000B

NON PATENT LITERATURE DOCUMENTS			
Examiner Initials*	Cite No. <sup>1</sup>	Include name of the author (in CAPITAL LETTERS), title of the article (when appropriate), title of the item (book, magazine, journal, serial, symposium, catalog, etc.), date, page(s), volume number, publisher, city and/or country where published	T <sup>2</sup>
	NPL89	Exhibit 18, Prior Art Chart for U.S. Pat. No. 7,777,651, 132 pages, Realtime Data, LLC D/B/A IXO v. Morgan Stanley, et al., 6:09-cv-326-LED-JDL, 6:10-cv-248-LED-JDL, 6:10-cv-426-LED-JDL, Realtime Data, LLC D/B/A IXO v. CME Group Inc., et al., 6:09-cv-327-LED-JDL, 6:10-cv-246-LED-JDL, 6:10-cv-424-LED-JDL, Realtime Data, LLC D/B/A IXO v. Thomson Reuters Corp., et al., 6:09-cv-333-LED-JDL, 6:10-cv-247-LED-JDL, 6:10-cv-425-LED-JDL, United States District Court for the Eastern District of Texas Tyler Division, February 4, 2011, citing Eastman et al., U.S. Patent No. 4,464,650.	
	NPL90	Exhibit 19, Prior Art Chart for U.S. Pat. No. 7,777,651, 125 pages, Realtime Data, LLC D/B/A IXO v. Morgan Stanley, et al., 6:09-cv-326-LED-JDL, 6:10-cv-248-LED-JDL, 6:10-cv-426-LED-JDL, Realtime Data, LLC D/B/A IXO v. CME Group Inc., et al., 6:09-cv-327-LED-JDL, 6:10-cv-246-LED-JDL, 6:10-cv-424-LED-JDL, Realtime Data, LLC D/B/A IXO v. Thomson Reuters Corp., et al., 6:09-cv-333-LED-JDL, 6:10-cv-247-LED-JDL, 6:10-cv-425-LED-JDL, United States District Court for the Eastern District of Texas Tyler Division, February 4, 2011, citing Elgamal et al., U.S. Patent No. 5,410,671.	
	NPL91	Exhibit 20, Prior Art Chart for U.S. Pat. No. 7,777,651, 122 pages, Realtime Data, LLC D/B/A IXO v. Morgan Stanley, et al., 6:09-cv-326-LED-JDL, 6:10-cv-248-LED-JDL, 6:10-cv-426-LED-JDL, Realtime Data, LLC D/B/A IXO v. CME Group Inc., et al., 6:09-cv-327-LED-JDL, 6:10-cv-246-LED-JDL, 6:10-cv-424-LED-JDL, Realtime Data, LLC D/B/A IXO v. Thomson Reuters Corp., et al., 6:09-cv-333-LED-JDL, 6:10-cv-247-LED-JDL, 6:10-cv-425-LED-JDL, United States District Court for the Eastern District of Texas Tyler Division, February 4, 2011, citing Enari et al., European Patent Application No. 0493130 A2.	
	NPL92	Exhibit 21, Prior Art Chart for U.S. Pat. No. 7,777,651, 379 pages, Realtime Data, LLC D/B/A IXO v. Morgan Stanley, et al., 6:09-cv-326-LED-JDL, 6:10-cv-248-LED-JDL, 6:10-cv-426-LED-JDL, Realtime Data, LLC D/B/A IXO v. CME Group Inc., et al., 6:09-cv-327-LED-JDL, 6:10-cv-246-LED-JDL, 6:10-cv-424-LED-JDL, Realtime Data, LLC D/B/A IXO v. Thomson Reuters Corp., et al., 6:09-cv-333-LED-JDL, 6:10-cv-247-LED-JDL, 6:10-cv-425-LED-JDL, United States District Court for the Eastern District of Texas Tyler Division, February 4, 2011, citing Fascenda, U.S. Patent No. 5,045,848.	
	NPL93	Exhibit 22, Prior Art Chart for U.S. Pat. No. 7,777,651, 218 pages, Realtime Data, LLC D/B/A IXO v. Morgan Stanley, et al., 6:09-cv-326-LED-JDL, 6:10-cv-248-LED-JDL, 6:10-cv-426-LED-JDL, Realtime Data, LLC D/B/A IXO v. CME Group Inc., et al., 6:09-cv-327-LED-JDL, 6:10-cv-246-LED-JDL, 6:10-cv-424-LED-JDL, Realtime Data, LLC D/B/A IXO v. Thomson Reuters Corp., et al., 6:09-cv-333-LED-JDL, 6:10-cv-247-LED-JDL, 6:10-cv-425-LED-JDL, United States District Court for the Eastern District of Texas Tyler Division, February 4, 2011, citing Frachtenberg et al., U.S. Patent, Pub. 2003/0030575.	
	NPL94	Exhibit 23, Prior Art Chart for U.S. Pat. No. 7,777,651, 247 pages, Realtime Data, LLC D/B/A IXO v. Morgan Stanley, et al., 6:09-cv-326-LED-JDL, 6:10-cv-248-LED-JDL, 6:10-cv-426-LED-JDL, Realtime Data, LLC D/B/A IXO v. CME Group Inc., et al., 6:09-cv-327-LED-JDL, 6:10-cv-246-LED-JDL, 6:10-cv-424-LED-JDL, Realtime Data, LLC D/B/A IXO v. Thomson Reuters Corp., et al., 6:09-cv-333-LED-JDL, 6:10-cv-247-LED-JDL, 6:10-cv-425-LED-JDL, United States District Court for the Eastern District of Texas Tyler Division, February 4, 2011, citing Franaszek et al., U. S. Patent No. 5,870,036.	

Examiner Signature	Date Considered
--------------------	-----------------

\*EXAMINER: Initial if reference considered, whether or not citation is in conformance with MPEP 609. Draw line through citation if not in conformance and not considered. Include copy of this form with next communication to applicant.

<sup>1</sup> Applicant's unique citation designation number (optional). <sup>2</sup> Applicant is to place a check mark here if English language Translation is attached.

Substitute for form 1449/PTO				<i>Complete if Known</i>	
<b>INFORMATION DISCLOSURE STATEMENT BY APPLICANT</b> <i>(Use as many sheets as necessary)</i>				Application Number	13/118,122
				Filing Date	May 27, 2011
				First Named Inventor	James J. FALLON
				Art Unit	2115
				Examiner Name	To Be Assigned
Sheet	12	of	66	Attorney Docket Number	2855.004000B

NON PATENT LITERATURE DOCUMENTS			
Examiner Initials*	Cite No. <sup>1</sup>	Include name of the author (in CAPITAL LETTERS), title of the article (when appropriate), title of the item (book, magazine, journal, serial, symposium, catalog, etc.), date, page(s), volume number, publisher, city and/or country where published	T <sup>2</sup>
	NPL95	Exhibit 24, Prior Art Chart for U.S. Pat. No. 7,777,651, 327 pages, Realtime Data, LLC D/B/A IXO v. Morgan Stanley, et al., 6:09-cv-326-LED-JDL, 6:10-cv-248-LED-JDL, 6:10-cv-426-LED-JDL, Realtime Data, LLC D/B/A IXO v. CME Group Inc., et al., 6:09-cv-327-LED-JDL, 6:10-cv-246-LED-JDL, 6:10-cv-424-LED-JDL, Realtime Data, LLC D/B/A IXO v. Thomson Reuters Corp., et al., 6:09-cv-333-LED-JDL, 6:10-cv-247-LED-JDL, 6:10-cv-425-LED-JDL, United States District Court for the Eastern District of Texas Tyler Division, February 4, 2011, citing French et al., U.S. Patent No. 5,794,229.	
	NPL96	Exhibit 25, Prior Art Chart for U.S. Pat. No. 7,777,651, 225 pages, Exhibit 24, Prior Art Chart for U.S. Pat. No. 7,777,651, 327 pages, Realtime Data, LLC D/B/A IXO v. Morgan Stanley, et al., 6:09-cv-326-LED-JDL, 6:10-cv-248-LED-JDL, 6:10-cv-426-LED-JDL, Realtime Data, LLC D/B/A IXO v. CME Group Inc., et al., 6:09-cv-327-LED-JDL, 6:10-cv-246-LED-JDL, 6:10-cv-424-LED-JDL, Realtime Data, LLC D/B/A IXO v. Thomson Reuters Corp., et al., 6:09-cv-333-LED-JDL, 6:10-cv-247-LED-JDL, 6:10-cv-425-LED-JDL, United States District Court for the Eastern District of Texas Tyler Division, February 4, 2011, citing Geiger et al., U.S. Patent No. 5,987,022.	
	NPL97	Exhibit 26, Prior Art Chart for U.S. Pat. No. 7,777,651, 219 pages, Realtime Data, LLC D/B/A IXO v. Morgan Stanley, et al., 6:09-cv-326-LED-JDL, 6:10-cv-248-LED-JDL, 6:10-cv-426-LED-JDL, Realtime Data, LLC D/B/A IXO v. CME Group Inc., et al., 6:09-cv-327-LED-JDL, 6:10-cv-246-LED-JDL, 6:10-cv-424-LED-JDL, Realtime Data, LLC D/B/A IXO v. Thomson Reuters Corp., et al., 6:09-cv-333-LED-JDL, 6:10-cv-247-LED-JDL, 6:10-cv-425-LED-JDL, United States District Court for the Eastern District of Texas Tyler Division, February 4, 2011, citing Gentile, U.S. Patent No. 5,504,842.	
	NPL98	Exhibit 27, Prior Art Chart for U.S. Pat. No. 7,777,651, Realtime Data, LLC D/B/A IXO v. Morgan Stanley, et al., 6:09-cv-326-LED-JDL, 6:10-cv-248-LED-JDL, 6:10-cv-426-LED-JDL, Realtime Data, LLC D/B/A IXO v. CME Group Inc., et al., 6:09-cv-327-LED-JDL, 6:10-cv-246-LED-JDL, 6:10-cv-424-LED-JDL, Realtime Data, LLC D/B/A IXO v. Thomson Reuters Corp., et al., 6:09-cv-333-LED-JDL, 6:10-cv-247-LED-JDL, 6:10-cv-425-LED-JDL, United States District Court for the Eastern District of Texas Tyler Division, February 4, 2011, 167 pages, citing Giltner et al., U.S. Patent No. 4,386,416.	
	NPL99	Exhibit 28, Prior Art Chart for U.S. Pat. No. 7,777,651, 156 pages, Realtime Data, LLC D/B/A IXO v. Morgan Stanley, et al., 6:09-cv-326-LED-JDL, 6:10-cv-248-LED-JDL, 6:10-cv-426-LED-JDL, Realtime Data, LLC D/B/A IXO v. CME Group Inc., et al., 6:09-cv-327-LED-JDL, 6:10-cv-246-LED-JDL, 6:10-cv-424-LED-JDL, Realtime Data, LLC D/B/A IXO v. Thomson Reuters Corp., et al., 6:09-cv-333-LED-JDL, 6:10-cv-247-LED-JDL, 6:10-cv-425-LED-JDL, United States District Court for the Eastern District of Texas Tyler Division, February 4, 2011, citing Gooch, U.S. Patent No. 4,325,085.	
	NPL100	Exhibit 29, Prior Art Chart for U.S. Pat. No. 7,777,651, 132 pages, Realtime Data, LLC D/B/A IXO v. Morgan Stanley, et al., 6:09-cv-326-LED-JDL, 6:10-cv-248-LED-JDL, 6:10-cv-426-LED-JDL, Realtime Data, LLC D/B/A IXO v. CME Group Inc., et al., 6:09-cv-327-LED-JDL, 6:10-cv-246-LED-JDL, 6:10-cv-424-LED-JDL, Realtime Data, LLC D/B/A IXO v. Thomson Reuters Corp., et al., 6:09-cv-333-LED-JDL, 6:10-cv-247-LED-JDL, 6:10-cv-425-LED-JDL, United States District Court for the Eastern District of Texas Tyler Division, February 4, 2011, citing Hauck, U.S. Patent No. 4,626,829.	

Examiner Signature	Date Considered
-----------------------	--------------------

\*EXAMINER: Initial if reference considered, whether or not citation is in conformance with MPEP 609. Draw line through citation if not in conformance and not considered. Include copy of this form with next communication to applicant.

<sup>1</sup> Applicant's unique citation designation number (optional). <sup>2</sup> Applicant is to place a check mark here if English language Translation is attached.

Substitute for form 1449/PTO				<i>Complete if Known</i>	
<b>INFORMATION DISCLOSURE STATEMENT BY APPLICANT</b> <i>(Use as many sheets as necessary)</i>				Application Number	13/118,122
				Filing Date	May 27, 2011
				First Named Inventor	James J. FALLON
				Art Unit	2115
				Examiner Name	To Be Assigned
Sheet	13	of	66	Attorney Docket Number	2855.004000B

NON PATENT LITERATURE DOCUMENTS			
Examiner Initials*	Cite No. <sup>1</sup>	Include name of the author (in CAPITAL LETTERS), title of the article (when appropriate), title of the item (book, magazine, journal, serial, symposium, catalog, etc.), date, page(s), volume number, publisher, city and/or country where published	T <sup>2</sup>
	NPL101	Exhibit 30, Prior Art Chart for U.S. Pat. No. 7,777,651, 161 pages, Realtime Data, LLC D/B/A IXO v. Morgan Stanley, et al., 6:09-cv-326-LED-JDL, 6:10-cv-248-LED-JDL, 6:10-cv-426-LED-JDL, Realtime Data, LLC D/B/A IXO v. CME Group Inc., et al., 6:09-cv-327-LED-JDL, 6:10-cv-246-LED-JDL, 6:10-cv-424-LED-JDL, Realtime Data, LLC D/B/A IXO v. Thomson Reuters Corp., et al., 6:09-cv-333-LED-JDL, 6:10-cv-247-LED-JDL, 6:10-cv-425-LED-JDL, United States District Court for the Eastern District of Texas Tyler Division, February 4, 2011, citing Heath, U.S. Patent No. 5,955,976.	
	NPL102	Exhibit 31, Prior Art Chart for U.S. Pat. No. 7,777,651, 359 pages, Realtime Data, LLC D/B/A IXO v. Morgan Stanley, et al., 6:09-cv-326-LED-JDL, 6:10-cv-248-LED-JDL, 6:10-cv-426-LED-JDL, Realtime Data, LLC D/B/A IXO v. CME Group Inc., et al., 6:09-cv-327-LED-JDL, 6:10-cv-246-LED-JDL, 6:10-cv-424-LED-JDL, Realtime Data, LLC D/B/A IXO v. Thomson Reuters Corp., et al., 6:09-cv-333-LED-JDL, 6:10-cv-247-LED-JDL, 6:10-cv-425-LED-JDL, United States District Court for the Eastern District of Texas Tyler Division, February 4, 2011, citing Hewlett-Packard Company, "Installing and Administering PPP," B2355-90137, HP 9000 Networking, E0948 (1st Ed. 1997).	
	NPL103	Exhibit 32, Prior Art Chart for U.S. Pat. No. 7,777,651, 229 pages, Realtime Data, LLC D/B/A IXO v. Morgan Stanley, et al., 6:09-cv-326-LED-JDL, 6:10-cv-248-LED-JDL, 6:10-cv-426-LED-JDL, Realtime Data, LLC D/B/A IXO v. CME Group Inc., et al., 6:09-cv-327-LED-JDL, 6:10-cv-246-LED-JDL, 6:10-cv-424-LED-JDL, Realtime Data, LLC D/B/A IXO v. Thomson Reuters Corp., et al., 6:09-cv-333-LED-JDL, 6:10-cv-247-LED-JDL, 6:10-cv-425-LED-JDL, United States District Court for the Eastern District of Texas Tyler Division, February 4, 2011, citing Hsu & Zwarico, Automatic Synthesis of Compression Techniques for Heterogeneous Files, Software-Practice & Experience, vol. 25(10), pp.1097-1116 (October 1995).	
	NPL104	Exhibit 33, Prior Art Chart for U.S. Pat. No. 7,777,651, 206 pages, Realtime Data, LLC D/B/A IXO v. Morgan Stanley, et al., 6:09-cv-326-LED-JDL, 6:10-cv-248-LED-JDL, 6:10-cv-426-LED-JDL, Realtime Data, LLC D/B/A IXO v. CME Group Inc., et al., 6:09-cv-327-LED-JDL, 6:10-cv-246-LED-JDL, 6:10-cv-424-LED-JDL, Realtime Data, LLC D/B/A IXO v. Thomson Reuters Corp., et al., 6:09-cv-333-LED-JDL, 6:10-cv-247-LED-JDL, 6:10-cv-425-LED-JDL, United States District Court for the Eastern District of Texas Tyler Division, February 4, 2011, citing ICT XML-Xpress White Paper (Intelligent Compression Technologies Inc., 2000) & website.	
	NPL105	Exhibit 34, Prior Art Chart for U.S. Pat. No. 7,777,651, 138 pages, Realtime Data, LLC D/B/A IXO v. Morgan Stanley, et al., 6:09-cv-326-LED-JDL, 6:10-cv-248-LED-JDL, 6:10-cv-426-LED-JDL, Realtime Data, LLC D/B/A IXO v. CME Group Inc., et al., 6:09-cv-327-LED-JDL, 6:10-cv-246-LED-JDL, 6:10-cv-424-LED-JDL, Realtime Data, LLC D/B/A IXO v. Thomson Reuters Corp., et al., 6:09-cv-333-LED-JDL, 6:10-cv-247-LED-JDL, 6:10-cv-425-LED-JDL, United States District Court for the Eastern District of Texas Tyler Division, February 4, 2011, citing ICT XpressFiles White Paper (Intelligent Compression Technologies Inc., 1999) & website.	
	NPL106	Exhibit 35, Prior Art Chart for U.S. Pat. No. 7,777,651, 128 pages, Realtime Data, LLC D/B/A IXO v. Morgan Stanley, et al., 6:09-cv-326-LED-JDL, 6:10-cv-248-LED-JDL, 6:10-cv-426-LED-JDL, Realtime Data, LLC D/B/A IXO v. CME Group Inc., et al., 6:09-cv-327-LED-JDL, 6:10-cv-246-LED-JDL, 6:10-cv-424-LED-JDL, Realtime Data, LLC D/B/A IXO v. Thomson Reuters Corp., et al., 6:09-cv-333-LED-JDL, 6:10-cv-247-LED-JDL, 6:10-cv-425-LED-JDL, United States District Court for the Eastern District of Texas Tyler Division, February 4, 2011, citing Iseda et al., E.P. 0405572 A2.	

Examiner Signature	Date Considered
-----------------------	--------------------

\*EXAMINER: Initial if reference considered, whether or not citation is in conformance with MPEP 609. Draw line through citation if not in conformance and not considered. Include copy of this form with next communication to applicant.

<sup>1</sup> Applicant's unique citation designation number (optional). <sup>2</sup> Applicant is to place a check mark here if English language Translation is attached.

Substitute for form 1449/PTO				<i>Complete if Known</i>	
<b>INFORMATION DISCLOSURE STATEMENT BY APPLICANT</b> <i>(Use as many sheets as necessary)</i>				Application Number	13/118,122
				Filing Date	May 27, 2011
				First Named Inventor	James J. FALLON
				Art Unit	2115
				Examiner Name	To Be Assigned
Sheet	14	of	66	Attorney Docket Number	2855.004000B

NON PATENT LITERATURE DOCUMENTS			
Examiner Initials*	Cite No. <sup>1</sup>	Include name of the author (in CAPITAL LETTERS), title of the article (when appropriate), title of the item (book, magazine, journal, serial, symposium, catalog, etc.), date, page(s), volume number, publisher, city and/or country where published	T <sup>2</sup>
	NPL107	Exhibit 36, Prior Art Chart for U.S. Pat. No. 7,777,651, 205 pages, Realtime Data, LLC D/B/A IXO v. Morgan Stanley, et al., 6:09-cv-326-LED-JDL, 6:10-cv-248-LED-JDL, 6:10-cv-426-LED-JDL, Realtime Data, LLC D/B/A IXO v. CME Group Inc., et al., 6:09-cv-327-LED-JDL, 6:10-cv-246-LED-JDL, 6:10-cv-424-LED-JDL, Realtime Data, LLC D/B/A IXO v. Thomson Reuters Corp., et al., 6:09-cv-333-LED-JDL, 6:10-cv-247-LED-JDL, 6:10-cv-425-LED-JDL, United States District Court for the Eastern District of Texas Tyler Division, February 4, 2011, citing J. Danskin, "Compressing the X Graphics Protocol," Princeton University (Jan. 1995).	
	NPL108	Exhibit 37, Prior Art Chart for U.S. Pat. No. 7,777,651, 159 pages, Realtime Data, LLC D/B/A IXO v. Morgan Stanley, et al., 6:09-cv-326-LED-JDL, 6:10-cv-248-LED-JDL, 6:10-cv-426-LED-JDL, Realtime Data, LLC D/B/A IXO v. CME Group Inc., et al., 6:09-cv-327-LED-JDL, 6:10-cv-246-LED-JDL, 6:10-cv-424-LED-JDL, Realtime Data, LLC D/B/A IXO v. Thomson Reuters Corp., et al., 6:09-cv-333-LED-JDL, 6:10-cv-247-LED-JDL, 6:10-cv-425-LED-JDL, United States District Court for the Eastern District of Texas Tyler Division, February 4, 2011, citing Kalkstein, U.S. Patent No. 5,945,933.	
	NPL109	Exhibit 38, Prior Art Chart for U.S. Pat. No. 7,777,651, 402 pages, Realtime Data, LLC D/B/A IXO v. Morgan Stanley, et al., 6:09-cv-326-LED-JDL, 6:10-cv-248-LED-JDL, 6:10-cv-426-LED-JDL, Realtime Data, LLC D/B/A IXO v. CME Group Inc., et al., 6:09-cv-327-LED-JDL, 6:10-cv-246-LED-JDL, 6:10-cv-424-LED-JDL, Realtime Data, LLC D/B/A IXO v. Thomson Reuters Corp., et al., 6:09-cv-333-LED-JDL, 6:10-cv-247-LED-JDL, 6:10-cv-425-LED-JDL, United States District Court for the Eastern District of Texas Tyler Division, February 4, 2011, citing Kari, U.S. Patent No. 6,434,168; International Publication No. WO97/48212 A1.	
	NPL110	Exhibit 39, Prior Art Chart for U.S. Pat. No. 7,777,651, 209 pages, Realtime Data, LLC D/B/A IXO v. Morgan Stanley, et al., 6:09-cv-326-LED-JDL, 6:10-cv-248-LED-JDL, 6:10-cv-426-LED-JDL, Realtime Data, LLC D/B/A IXO v. CME Group Inc., et al., 6:09-cv-327-LED-JDL, 6:10-cv-246-LED-JDL, 6:10-cv-424-LED-JDL, Realtime Data, LLC D/B/A IXO v. Thomson Reuters Corp., et al., 6:09-cv-333-LED-JDL, 6:10-cv-247-LED-JDL, 6:10-cv-425-LED-JDL, United States District Court for the Eastern District of Texas Tyler Division, February 4, 2011, citing Koopmas et al., U.S. Patent No. 7,024,460.	
	NPL111	Exhibit 40, Prior Art Chart for U.S. Pat. No. 7,777,651, 214 pages, Realtime Data, LLC D/B/A IXO v. Morgan Stanley, et al., 6:09-cv-326-LED-JDL, 6:10-cv-248-LED-JDL, 6:10-cv-426-LED-JDL, Realtime Data, LLC D/B/A IXO v. CME Group Inc., et al., 6:09-cv-327-LED-JDL, 6:10-cv-246-LED-JDL, 6:10-cv-424-LED-JDL, Realtime Data, LLC D/B/A IXO v. Thomson Reuters Corp., et al., 6:09-cv-333-LED-JDL, 6:10-cv-247-LED-JDL, 6:10-cv-425-LED-JDL, United States District Court for the Eastern District of Texas Tyler Division, February 4, 2011, citing Kopf, U.S. Patent No. 5,825,830.	
	NPL112	Exhibit 41, Prior Art Chart for U.S. Pat. No. 7,777,651, 281 pages, Realtime Data, LLC D/B/A IXO v. Morgan Stanley, et al., 6:09-cv-326-LED-JDL, 6:10-cv-248-LED-JDL, 6:10-cv-426-LED-JDL, Realtime Data, LLC D/B/A IXO v. CME Group Inc., et al., 6:09-cv-327-LED-JDL, 6:10-cv-246-LED-JDL, 6:10-cv-424-LED-JDL, Realtime Data, LLC D/B/A IXO v. Thomson Reuters Corp., et al., 6:09-cv-333-LED-JDL, 6:10-cv-247-LED-JDL, 6:10-cv-425-LED-JDL, United States District Court for the Eastern District of Texas Tyler Division, February 4, 2011, citing Kopf, U.S. Patent No. 5,825,830.	

Examiner Signature	Date Considered
--------------------	-----------------

\*EXAMINER: Initial if reference considered, whether or not citation is in conformance with MPEP 609. Draw line through citation if not in conformance and not considered. Include copy of this form with next communication to applicant.

<sup>1</sup> Applicant's unique citation designation number (optional). <sup>2</sup> Applicant is to place a check mark here if English language Translation is attached.

Substitute for form 1449/PTO				<i>Complete if Known</i>	
<b>INFORMATION DISCLOSURE STATEMENT BY APPLICANT</b> <i>(Use as many sheets as necessary)</i>				Application Number	13/118,122
				Filing Date	May 27, 2011
				First Named Inventor	James J. FALLON
				Art Unit	2115
				Examiner Name	To Be Assigned
Sheet	15	of	66	Attorney Docket Number	2855.004000B

NON PATENT LITERATURE DOCUMENTS			
Examiner Initials*	Cite No. <sup>1</sup>	Include name of the author (in CAPITAL LETTERS), title of the article (when appropriate), title of the item (book, magazine, journal, serial, symposium, catalog, etc.), date, page(s), volume number, publisher, city and/or country where published	T <sup>2</sup>
	NPL113	Exhibit 42, Prior Art Chart for U.S. Pat. No. 7,777,651, 340 pages, Realtime Data, LLC D/B/A IXO v. Morgan Stanley, et al., 6:09-cv-326-LED-JDL, 6:10-cv-248-LED-JDL, 6:10-cv-426-LED-JDL, Realtime Data, LLC D/B/A IXO v. CME Group Inc., et al., 6:09-cv-327-LED-JDL, 6:10-cv-246-LED-JDL, 6:10-cv-424-LED-JDL, Realtime Data, LLC D/B/A IXO v. Thomson Reuters Corp., et al., 6:09-cv-333-LED-JDL, 6:10-cv-247-LED-JDL, 6:10-cv-425-LED-JDL, United States District Court for the Eastern District of Texas Tyler Division, February 4, 2011, citing Lane et al., U.S. Patent No. 5,521,940.	
	NPL114	Exhibit 43, Prior Art Chart for U.S. Pat. No. 7,777,651, 164 pages, Realtime Data, LLC D/B/A IXO v. Morgan Stanley, et al., 6:09-cv-326-LED-JDL, 6:10-cv-248-LED-JDL, 6:10-cv-426-LED-JDL, Realtime Data, LLC D/B/A IXO v. CME Group Inc., et al., 6:09-cv-327-LED-JDL, 6:10-cv-246-LED-JDL, 6:10-cv-424-LED-JDL, Realtime Data, LLC D/B/A IXO v. Thomson Reuters Corp., et al., 6:09-cv-333-LED-JDL, 6:10-cv-247-LED-JDL, 6:10-cv-425-LED-JDL, United States District Court for the Eastern District of Texas Tyler Division, February 4, 2011, citing Langdon, Jr. et al., U.S. Patent No. 4,494,108.	
	NPL115	Exhibit 44, Prior Art Chart for U.S. Pat. No. 7,777,651, 211 pages, Realtime Data, LLC D/B/A IXO v. Morgan Stanley, et al., 6:09-cv-326-LED-JDL, 6:10-cv-248-LED-JDL, 6:10-cv-426-LED-JDL, Realtime Data, LLC D/B/A IXO v. CME Group Inc., et al., 6:09-cv-327-LED-JDL, 6:10-cv-246-LED-JDL, 6:10-cv-424-LED-JDL, Realtime Data, LLC D/B/A IXO v. Thomson Reuters Corp., et al., 6:09-cv-333-LED-JDL, 6:10-cv-247-LED-JDL, 6:10-cv-425-LED-JDL, United States District Court for the Eastern District of Texas Tyler Division, February 4, 2011, citing Lavallec, U.S. Patent No. 6,215,904.	
	NPL116	Exhibit 45, Prior Art Chart for U.S. Pat. No. 7,777,651, 103 pages, Realtime Data, LLC D/B/A IXO v. Morgan Stanley, et al., 6:09-cv-326-LED-JDL, 6:10-cv-248-LED-JDL, 6:10-cv-426-LED-JDL, Realtime Data, LLC D/B/A IXO v. CME Group Inc., et al., 6:09-cv-327-LED-JDL, 6:10-cv-246-LED-JDL, 6:10-cv-424-LED-JDL, Realtime Data, LLC D/B/A IXO v. Thomson Reuters Corp., et al., 6:09-cv-333-LED-JDL, 6:10-cv-247-LED-JDL, 6:10-cv-425-LED-JDL, United States District Court for the Eastern District of Texas Tyler Division, February 4, 2011, citing M. Effros, P. Chou & R.M. Gray, "Variable Dimension Weighted Universal Vector Quantization and Noiseless Coding," IEEE 1068-0314/94 (1994).	
	NPL117	Exhibit 46, Prior Art Chart for U.S. Pat. No. 7,777,651, 414 pages, Realtime Data, LLC D/B/A IXO v. Morgan Stanley, et al., 6:09-cv-326-LED-JDL, 6:10-cv-248-LED-JDL, 6:10-cv-426-LED-JDL, Realtime Data, LLC D/B/A IXO v. CME Group Inc., et al., 6:09-cv-327-LED-JDL, 6:10-cv-246-LED-JDL, 6:10-cv-424-LED-JDL, Realtime Data, LLC D/B/A IXO v. Thomson Reuters Corp., et al., 6:09-cv-333-LED-JDL, 6:10-cv-247-LED-JDL, 6:10-cv-425-LED-JDL, United States District Court for the Eastern District of Texas Tyler Division, February 4, 2011, citing MacCrisken, U.S. Patent No. 4,730,348.	
	NPL118	Exhibit 47, Prior Art Chart for U.S. Pat. No. 7,777,651, 319 pages, Realtime Data, LLC D/B/A IXO v. Morgan Stanley, et al., 6:09-cv-326-LED-JDL, 6:10-cv-248-LED-JDL, 6:10-cv-426-LED-JDL, Realtime Data, LLC D/B/A IXO v. CME Group Inc., et al., 6:09-cv-327-LED-JDL, 6:10-cv-246-LED-JDL, 6:10-cv-424-LED-JDL, Realtime Data, LLC D/B/A IXO v. Thomson Reuters Corp., et al., 6:09-cv-333-LED-JDL, 6:10-cv-247-LED-JDL, 6:10-cv-425-LED-JDL, United States District Court for the Eastern District of Texas Tyler Division, February 4, 2011, citing Madany et al., U.S. Patent No. 5,774,715.	

Examiner Signature	Date Considered
-----------------------	--------------------

\*EXAMINER: Initial if reference considered, whether or not citation is in conformance with MPEP 609. Draw line through citation if not in conformance and not considered. Include copy of this form with next communication to applicant.

<sup>1</sup> Applicant's unique citation designation number (optional). <sup>2</sup> Applicant is to place a check mark here if English language Translation is attached.

Substitute for form 1449/PTO				<i>Complete if Known</i>	
<b>INFORMATION DISCLOSURE STATEMENT BY APPLICANT</b> <i>(Use as many sheets as necessary)</i>				Application Number	13/118,122
				Filing Date	May 27, 2011
				First Named Inventor	James J. FALLON
				Art Unit	2115
				Examiner Name	To Be Assigned
Sheet	16	of	66	Attorney Docket Number	2855.004000B

NON PATENT LITERATURE DOCUMENTS			
Examiner Initials*	Cite No. <sup>1</sup>	Include name of the author (in CAPITAL LETTERS), title of the article (when appropriate), title of the item (book, magazine, journal, serial, symposium, catalog, etc.), date, page(s), volume number, publisher, city and/or country where published	T <sup>2</sup>
	NPL119	Exhibit 48, Prior Art Chart for U.S. Pat. No. 7,777,651, 228 pages, Realtime Data, LLC D/B/A IXO v. Morgan Stanley, et al., 6:09-cv-326-LED-JDL, 6:10-cv-248-LED-JDL, 6:10-cv-426-LED-JDL, Realtime Data, LLC D/B/A IXO v. CME Group Inc., et al., 6:09-cv-327-LED-JDL, 6:10-cv-246-LED-JDL, 6:10-cv-424-LED-JDL, Realtime Data, LLC D/B/A IXO v. Thomson Reuters Corp., et al., 6:09-cv-333-LED-JDL, 6:10-cv-247-LED-JDL, 6:10-cv-425-LED-JDL, United States District Court for the Eastern District of Texas Tyler Division, February 4, 2011, citing Mark A. Roth and Scott J. Van Horn, "Database Compression" SIGMOD Record, Vol. 22, No. 3 (1993).	
	NPL120	Exhibit 49, Prior Art Chart for U.S. Pat. No. 7,777,651, 235 pages, Realtime Data, LLC D/B/A IXO v. Morgan Stanley, et al., 6:09-cv-326-LED-JDL, 6:10-cv-248-LED-JDL, 6:10-cv-426-LED-JDL, Realtime Data, LLC D/B/A IXO v. CME Group Inc., et al., 6:09-cv-327-LED-JDL, 6:10-cv-246-LED-JDL, 6:10-cv-424-LED-JDL, Realtime Data, LLC D/B/A IXO v. Thomson Reuters Corp., et al., 6:09-cv-333-LED-JDL, 6:10-cv-247-LED-JDL, 6:10-cv-425-LED-JDL, United States District Court for the Eastern District of Texas Tyler Division, February 4, 2011, citing Miller et al., U.S. Patent No. 4,814,746.	
	NPL121	Exhibit 50, Prior Art Chart for U.S. Pat. No. 7,777,651, 172 pages, Realtime Data, LLC D/B/A IXO v. Morgan Stanley, et al., 6:09-cv-326-LED-JDL, 6:10-cv-248-LED-JDL, 6:10-cv-426-LED-JDL, Realtime Data, LLC D/B/A IXO v. CME Group Inc., et al., 6:09-cv-327-LED-JDL, 6:10-cv-246-LED-JDL, 6:10-cv-424-LED-JDL, Realtime Data, LLC D/B/A IXO v. Thomson Reuters Corp., et al., 6:09-cv-333-LED-JDL, 6:10-cv-247-LED-JDL, 6:10-cv-425-LED-JDL, United States District Court for the Eastern District of Texas Tyler Division, February 4, 2011, citing O'Brien et al., U.S. Patent No. 4,929,946.	
	NPL122	Exhibit 51, Prior Art Chart for U.S. Pat. No. 7,777,651, 30 pages, Realtime Data, LLC D/B/A IXO v. Morgan Stanley, et al., 6:09-cv-326-LED-JDL, 6:10-cv-248-LED-JDL, 6:10-cv-426-LED-JDL, Realtime Data, LLC D/B/A IXO v. CME Group Inc., et al., 6:09-cv-327-LED-JDL, 6:10-cv-246-LED-JDL, 6:10-cv-424-LED-JDL, Realtime Data, LLC D/B/A IXO v. Thomson Reuters Corp., et al., 6:09-cv-333-LED-JDL, 6:10-cv-247-LED-JDL, 6:10-cv-425-LED-JDL, United States District Court for the Eastern District of Texas Tyler Division, February 4, 2011, citing Osler et al., U.S. Patent No. 6,768,749.	
	NPL123	Exhibit 52, Prior Art Chart for U.S. Pat. No. 7,777,651, 103 pages, Realtime Data, LLC D/B/A IXO v. Morgan Stanley, et al., 6:09-cv-326-LED-JDL, 6:10-cv-248-LED-JDL, 6:10-cv-426-LED-JDL, Realtime Data, LLC D/B/A IXO v. CME Group Inc., et al., 6:09-cv-327-LED-JDL, 6:10-cv-246-LED-JDL, 6:10-cv-424-LED-JDL, Realtime Data, LLC D/B/A IXO v. Thomson Reuters Corp., et al., 6:09-cv-333-LED-JDL, 6:10-cv-247-LED-JDL, 6:10-cv-425-LED-JDL, United States District Court for the Eastern District of Texas Tyler Division, February 4, 2011, citing P. G. Howard, F. Kossenti, S. Forchammer, and W. J. Rucklidge [1998]. "The Emerging JBIG2 Standard", IEEE Transactions On Circuits And Systems For Video Technology 8:7, 838-848.	
	NPL124	Exhibit 53, Prior Art Chart for U.S. Pat. No. 7,777,651, 218 pages, Realtime Data, LLC D/B/A IXO v. Morgan Stanley, et al., 6:09-cv-326-LED-JDL, 6:10-cv-248-LED-JDL, 6:10-cv-426-LED-JDL, Realtime Data, LLC D/B/A IXO v. CME Group Inc., et al., 6:09-cv-327-LED-JDL, 6:10-cv-246-LED-JDL, 6:10-cv-424-LED-JDL, Realtime Data, LLC D/B/A IXO v. Thomson Reuters Corp., et al., 6:09-cv-333-LED-JDL, 6:10-cv-247-LED-JDL, 6:10-cv-425-LED-JDL, United States District Court for the Eastern District of Texas Tyler Division, February 4, 2011, citing Panaoussis, U.S. Patent No. 5,949,355.	

Examiner Signature	Date Considered
-----------------------	--------------------

\*EXAMINER: Initial if reference considered, whether or not citation is in conformance with MPEP 609. Draw line through citation if not in conformance and not considered. Include copy of this form with next communication to applicant.

<sup>1</sup> Applicant's unique citation designation number (optional). <sup>2</sup> Applicant is to place a check mark here if English language Translation is attached.

Substitute for form 1449/PTO				<b>Complete if Known</b>	
<b>INFORMATION DISCLOSURE STATEMENT BY APPLICANT</b> <i>(Use as many sheets as necessary)</i>				Application Number	13/118,122
				Filing Date	May 27, 2011
				First Named Inventor	James J. FALLON
				Art Unit	2115
				Examiner Name	To Be Assigned
Sheet	17	of	66	Attorney Docket Number	2855.004000B

NON PATENT LITERATURE DOCUMENTS			
Examiner Initials*	Cite No. <sup>1</sup>	Include name of the author (in CAPITAL LETTERS), title of the article (when appropriate), title of the item (book, magazine, journal, serial, symposium, catalog, etc.), date, page(s), volume number, publisher, city and/or country where published	T <sup>2</sup>
	NPL125	Exhibit 54, Prior Art Chart for U.S. Pat. No. 7,777,651, 335 pages, Realtime Data, LLC D/B/A IXO v. Morgan Stanley, et al., 6:09-cv-326-LED-JDL, 6:10-cv-248-LED-JDL, 6:10-cv-426-LED-JDL, Realtime Data, LLC D/B/A IXO v. CME Group Inc., et al., 6:09-cv-327-LED-JDL, 6:10-cv-246-LED-JDL, 6:10-cv-424-LED-JDL, Realtime Data, LLC D/B/A IXO v. Thomson Reuters Corp., et al., 6:09-cv-333-LED-JDL, 6:10-cv-247-LED-JDL, 6:10-cv-425-LED-JDL, United States District Court for the Eastern District of Texas Tyler Division, February 4, 2011, citing Payne et al, U.S. Patent No. 6,021,433.	
	NPL126	Exhibit 55, Prior Art Chart for U.S. Pat. No. 7,777,651, 273 pages, Realtime Data, LLC D/B/A IXO v. Morgan Stanley, et al., 6:09-cv-326-LED-JDL, 6:10-cv-248-LED-JDL, 6:10-cv-426-LED-JDL, Realtime Data, LLC D/B/A IXO v. CME Group Inc., et al., 6:09-cv-327-LED-JDL, 6:10-cv-246-LED-JDL, 6:10-cv-424-LED-JDL, Realtime Data, LLC D/B/A IXO v. Thomson Reuters Corp., et al., 6:09-cv-333-LED-JDL, 6:10-cv-247-LED-JDL, 6:10-cv-425-LED-JDL, United States District Court for the Eastern District of Texas Tyler Division, February 4, 2011, citing Reynar et al, U. S. Patent No. 5,951,623.	
	NPL127	Exhibit 56, Prior Art Chart for U.S. Pat. No. 7,777,651, 399 pages, Realtime Data, LLC D/B/A IXO v. Morgan Stanley, et al., 6:09-cv-326-LED-JDL, 6:10-cv-248-LED-JDL, 6:10-cv-426-LED-JDL, Realtime Data, LLC D/B/A IXO v. CME Group Inc., et al., 6:09-cv-327-LED-JDL, 6:10-cv-246-LED-JDL, 6:10-cv-424-LED-JDL, Realtime Data, LLC D/B/A IXO v. Thomson Reuters Corp., et al., 6:09-cv-333-LED-JDL, 6:10-cv-247-LED-JDL, 6:10-cv-425-LED-JDL, United States District Court for the Eastern District of Texas Tyler Division, February 4, 2011, citing RFC 1144: V. Jacobson, "Compressing TCP/IP Headers for Low-Speed Serial Links," Network Working Group, Request for Comments: 1144 (February 1990).	
	NPL128	Exhibit 57, Prior Art Chart for U.S. Pat. No. 7,777,651, 103 pages, Realtime Data, LLC D/B/A IXO v. Morgan Stanley, et al., 6:09-cv-326-LED-JDL, 6:10-cv-248-LED-JDL, 6:10-cv-426-LED-JDL, Realtime Data, LLC D/B/A IXO v. CME Group Inc., et al., 6:09-cv-327-LED-JDL, 6:10-cv-246-LED-JDL, 6:10-cv-424-LED-JDL, Realtime Data, LLC D/B/A IXO v. Thomson Reuters Corp., et al., 6:09-cv-333-LED-JDL, 6:10-cv-247-LED-JDL, 6:10-cv-425-LED-JDL, United States District Court for the Eastern District of Texas Tyler Division, February 4, 2011, citing RFC 1661: Point-to-Point Protocol Working Group, "The Point-to-Point Protocol," RFC 1661 (William Simpson ed., Internet Engineering Task Force 1994); RFC 1662: Point-to-Point Protocol Working Group, "PPP in HDLC-like Framing," RFC 1662 (William Simpson ed., Internet Engineering Task Force 1994); RFC 1962: Dave Rand, "The PPP compression Control Protocol (CCP)," RFC 1962 (Internet Engineering Task Force 1996); RFC 1332: Glenn McGregor, "The PPP Internet Protocol Control Protocol (IPCP)," RFC 1332 (Internet Engineering Task Force 1992); RFC 2509: Mathias Engan et al., "IP Header Compression over IP," RFC 2509 (Internet Society 1999).	
	NPL129	Exhibit 58, Prior Art Chart for U.S. Pat. No. 7,777,651, 218 pages, Realtime Data, LLC D/B/A IXO v. Morgan Stanley, et al., 6:09-cv-326-LED-JDL, 6:10-cv-248-LED-JDL, 6:10-cv-426-LED-JDL, Realtime Data, LLC D/B/A IXO v. CME Group Inc., et al., 6:09-cv-327-LED-JDL, 6:10-cv-246-LED-JDL, 6:10-cv-424-LED-JDL, Realtime Data, LLC D/B/A IXO v. Thomson Reuters Corp., et al., 6:09-cv-333-LED-JDL, 6:10-cv-247-LED-JDL, 6:10-cv-425-LED-JDL, United States District Court for the Eastern District of Texas Tyler Division, February 4, 2011, citing RFC 2507: Mikael Degermark et al., "IP Header Compression," RFC 2507 (Internet Society 1999).	

Examiner Signature	Date Considered
-----------------------	--------------------

\*EXAMINER: Initial if reference considered, whether or not citation is in conformance with MPEP 609. Draw line through citation if not in conformance and not considered. Include copy of this form with next communication to applicant.

<sup>1</sup> Applicant's unique citation designation number (optional). <sup>2</sup> Applicant is to place a check mark here if English language Translation is attached.

Substitute for form 1449/PTO				<i>Complete if Known</i>	
<b>INFORMATION DISCLOSURE STATEMENT BY APPLICANT</b> <i>(Use as many sheets as necessary)</i>				Application Number	13/118,122
				Filing Date	May 27, 2011
				First Named Inventor	James J. FALLON
				Art Unit	2115
				Examiner Name	To Be Assigned
Sheet	18	of	66	Attorney Docket Number	2855.004000B

NON PATENT LITERATURE DOCUMENTS			
Examiner Initials*	Cite No. <sup>1</sup>	Include name of the author (in CAPITAL LETTERS), title of the article (when appropriate), title of the item (book, magazine, journal, serial, symposium, catalog, etc.), date, page(s), volume number, publisher, city and/or country where published	T <sup>2</sup>
	NPL130	Exhibit 59, Prior Art Chart for U.S. Pat. No. 7,777,651, 335 pages, Realtime Data, LLC D/B/A IXO v. Morgan Stanley, et al., 6:09-cv-326-LED-JDL, 6:10-cv-248-LED-JDL, 6:10-cv-426-LED-JDL, Realtime Data, LLC D/B/A IXO v. CME Group Inc., et al., 6:09-cv-327-LED-JDL, 6:10-cv-246-LED-JDL, 6:10-cv-424-LED-JDL, Realtime Data, LLC D/B/A IXO v. Thomson Reuters Corp., et al., 6:09-cv-333-LED-JDL, 6:10-cv-247-LED-JDL, 6:10-cv-425-LED-JDL, United States District Court for the Eastern District of Texas Tyler Division, February 4, 2011, citing Roper et al., U.S. Patent No. 5,454,079.	
	NPL131	Exhibit 60, Prior Art Chart for U.S. Pat. No. 7,777,651, 273 pages, Realtime Data, LLC D/B/A IXO v. Morgan Stanley, et al., 6:09-cv-326-LED-JDL, 6:10-cv-248-LED-JDL, 6:10-cv-426-LED-JDL, Realtime Data, LLC D/B/A IXO v. CME Group Inc., et al., 6:09-cv-327-LED-JDL, 6:10-cv-246-LED-JDL, 6:10-cv-424-LED-JDL, Realtime Data, LLC D/B/A IXO v. Thomson Reuters Corp., et al., 6:09-cv-333-LED-JDL, 6:10-cv-247-LED-JDL, 6:10-cv-425-LED-JDL, United States District Court for the Eastern District of Texas Tyler Division, February 4, 2011, citing Sebastian, U.S. Patent No. 6,253,264 and International Publication No. WO/1998/039699.	
	NPL132	Exhibit 61, Prior Art Chart for U.S. Pat. No. 7,777,651, 399 pages, Realtime Data, LLC D/B/A IXO v. Morgan Stanley, et al., 6:09-cv-326-LED-JDL, 6:10-cv-248-LED-JDL, 6:10-cv-426-LED-JDL, Realtime Data, LLC D/B/A IXO v. CME Group Inc., et al., 6:09-cv-327-LED-JDL, 6:10-cv-246-LED-JDL, 6:10-cv-424-LED-JDL, Realtime Data, LLC D/B/A IXO v. Thomson Reuters Corp., et al., 6:09-cv-333-LED-JDL, 6:10-cv-247-LED-JDL, 6:10-cv-425-LED-JDL, United States District Court for the Eastern District of Texas Tyler Division, February 4, 2011, citing Seroussi et al., U.S. Patent No. 5,243,341.	
	NPL133	Exhibit 62, Prior Art Chart for U.S. Pat. No. 7,777,651, 322 pages, Realtime Data, LLC D/B/A IXO v. Morgan Stanley, et al., 6:09-cv-326-LED-JDL, 6:10-cv-248-LED-JDL, 6:10-cv-426-LED-JDL, Realtime Data, LLC D/B/A IXO v. CME Group Inc., et al., 6:09-cv-327-LED-JDL, 6:10-cv-246-LED-JDL, 6:10-cv-424-LED-JDL, Realtime Data, LLC D/B/A IXO v. Thomson Reuters Corp., et al., 6:09-cv-333-LED-JDL, 6:10-cv-247-LED-JDL, 6:10-cv-425-LED-JDL, United States District Court for the Eastern District of Texas Tyler Division, February 4, 2011, citing Seroussi et al., U.S. Patent No. 5,389,922.	
	NPL134	Exhibit 63, Prior Art Chart for U.S. Pat. No. 7,777,651, 102 pages, Realtime Data, LLC D/B/A IXO v. Morgan Stanley, et al., 6:09-cv-326-LED-JDL, 6:10-cv-248-LED-JDL, 6:10-cv-426-LED-JDL, Realtime Data, LLC D/B/A IXO v. CME Group Inc., et al., 6:09-cv-327-LED-JDL, 6:10-cv-246-LED-JDL, 6:10-cv-424-LED-JDL, Realtime Data, LLC D/B/A IXO v. Thomson Reuters Corp., et al., 6:09-cv-333-LED-JDL, 6:10-cv-247-LED-JDL, 6:10-cv-425-LED-JDL, United States District Court for the Eastern District of Texas Tyler Division, February 4, 2011, citing Shin, U.S. Patent No. 5,455,680.	
	NPL135	Exhibit 64, Prior Art Chart for U.S. Pat. No. 7,777,651, 126 pages, Realtime Data, LLC D/B/A IXO v. Morgan Stanley, et al., 6:09-cv-326-LED-JDL, 6:10-cv-248-LED-JDL, 6:10-cv-426-LED-JDL, Realtime Data, LLC D/B/A IXO v. CME Group Inc., et al., 6:09-cv-327-LED-JDL, 6:10-cv-246-LED-JDL, 6:10-cv-424-LED-JDL, Realtime Data, LLC D/B/A IXO v. Thomson Reuters Corp., et al., 6:09-cv-333-LED-JDL, 6:10-cv-247-LED-JDL, 6:10-cv-425-LED-JDL, United States District Court for the Eastern District of Texas Tyler Division, February 4, 2011, citing Taaffe et al., U.S. Patent No. 5,179,651.	

Examiner Signature	Date Considered
-----------------------	--------------------

\*EXAMINER: Initial if reference considered, whether or not citation is in conformance with MPEP 609. Draw line through citation if not in conformance and not considered. Include copy of this form with next communication to applicant.

<sup>1</sup> Applicant's unique citation designation number (optional). <sup>2</sup> Applicant is to place a check mark here if English language Translation is attached.



Substitute for form 1449/PTO				<i>Complete if Known</i>	
<b>INFORMATION DISCLOSURE STATEMENT BY APPLICANT</b> <i>(Use as many sheets as necessary)</i>				Application Number	13/118,122
				Filing Date	May 27, 2011
				First Named Inventor	James J. FALLON
				Art Unit	2115
				Examiner Name	To Be Assigned
Sheet	19	of	66	Attorney Docket Number	2855.004000B

NON PATENT LITERATURE DOCUMENTS			
Examiner Initials*	Cite No. <sup>1</sup>	Include name of the author (in CAPITAL LETTERS), title of the article (when appropriate), title of the item (book, magazine, journal, serial, symposium, catalog, etc.), date, page(s), volume number, publisher, city and/or country where published	T <sup>2</sup>
	NPL136	Exhibit 65, Prior Art Chart for U.S. Pat. No. 7,777,651, 313 pages, Realtime Data, LLC D/B/A IXO v. Morgan Stanley, et al., 6:09-cv-326-LED-JDL, 6:10-cv-248-LED-JDL, 6:10-cv-426-LED-JDL, Realtime Data, LLC D/B/A IXO v. CME Group Inc., et al., 6:09-cv-327-LED-JDL, 6:10-cv-246-LED-JDL, 6:10-cv-424-LED-JDL, Realtime Data, LLC D/B/A IXO v. Thomson Reuters Corp., et al., 6:09-cv-333-LED-JDL, 6:10-cv-247-LED-JDL, 6:10-cv-425-LED-JDL, United States District Court for the Eastern District of Texas Tyler Division, February 4, 2011, citing Telekurs Ticker - "Telekurs Ticker Service: Programmer's Reference," Telekurs (North America), Inc. (January 11, 1993); C. Helck, "Encapsulated Ticker: Ver. 1.0," Telekurs NA, 1-22 (July 14, 1993); A-T FINANCIAL OFFERS MANIPULATION, REDISTRIBUTION OF TICKER III, Micro Ticker Report, v 4, n 14 (Sept 5, 1989); V. Kulkosky, "Upping the Ante" Wall Street & Technology, v11 n5 pp: 8-11 (Oct 1993); "Telekurs to Launch New Int'l Feed/Internet Server," Wall Street & Technology, v15 n1 pp: 14 (Jan 1997); I. Schmerken, "Time running out for old technologies", Wall Street Computer Review, v7 n7 p14(7) (April, 1990); SCROLLING NEWS, Inside Market Data, v 10, n 11 (Feb 27, 1995); TELEKURS BUYS S&P TRADING SYSTEMS AND ITS TICKER III FEED, Micro Ticker Report, v 4, n 11 (July 10, 1989); TELEKURS MAY DEBUT 128 KPS TICKER BY YEAR'S END, Inside Market Data, v 9, n 21 (July 18, 1994); TELEKURS NOW CARRIES ALL DOW JONES' NEWS ON 56-KBPS TICKER, Inside Market Data, v9, n7 (Dec 20, 1993); TELEKURS SELLS NO. AMERICAN DIVISION IN MGMT. BUYOUT, Inside Market Data, v11, n3 (Oct 23, 1995).	
	NPL137	Exhibit 66, Prior Art Chart for U.S. Pat. No. 7,777,651, 265 pages, Realtime Data, LLC D/B/A IXO v. Morgan Stanley, et al., 6:09-cv-326-LED-JDL, 6:10-cv-248-LED-JDL, 6:10-cv-426-LED-JDL, Realtime Data, LLC D/B/A IXO v. CME Group Inc., et al., 6:09-cv-327-LED-JDL, 6:10-cv-246-LED-JDL, 6:10-cv-424-LED-JDL, Realtime Data, LLC D/B/A IXO v. Thomson Reuters Corp., et al., 6:09-cv-333-LED-JDL, 6:10-cv-247-LED-JDL, 6:10-cv-425-LED-JDL, United States District Court for the Eastern District of Texas Tyler Division, February 4, 2011, citing Tyler et al., U.S. Patent No. 5,638,498.	
	NPL138	Exhibit 67, Prior Art Chart for U.S. Pat. No. 7,777,651, 86 pages, Realtime Data, LLC D/B/A IXO v. Morgan Stanley, et al., 6:09-cv-326-LED-JDL, 6:10-cv-248-LED-JDL, 6:10-cv-426-LED-JDL, Realtime Data, LLC D/B/A IXO v. CME Group Inc., et al., 6:09-cv-327-LED-JDL, 6:10-cv-246-LED-JDL, 6:10-cv-424-LED-JDL, Realtime Data, LLC D/B/A IXO v. Thomson Reuters Corp., et al., 6:09-cv-333-LED-JDL, 6:10-cv-247-LED-JDL, 6:10-cv-425-LED-JDL, United States District Court for the Eastern District of Texas Tyler Division, February 4, 2011, citing UNI International Standard ISO 3309-1984 (E) [1984], "Information Processing Systems -- Data Communication -- High-level Data Link Control Procedures --Frame Structure," 1-6 (1984).	
	NPL139	Exhibit 68, Prior Art Chart for U.S. Pat. No. 7,777,651, 236 pages, Realtime Data, LLC D/B/A IXO v. Morgan Stanley, et al., 6:09-cv-326-LED-JDL, 6:10-cv-248-LED-JDL, 6:10-cv-426-LED-JDL, Realtime Data, LLC D/B/A IXO v. CME Group Inc., et al., 6:09-cv-327-LED-JDL, 6:10-cv-246-LED-JDL, 6:10-cv-424-LED-JDL, Realtime Data, LLC D/B/A IXO v. Thomson Reuters Corp., et al., 6:09-cv-333-LED-JDL, 6:10-cv-247-LED-JDL, 6:10-cv-425-LED-JDL, United States District Court for the Eastern District of Texas Tyler Division, February 4, 2011, citing Unwired Planet, EP 0928070 A2.	

Examiner Signature	Date Considered
--------------------	-----------------

\*EXAMINER: Initial if reference considered, whether or not citation is in conformance with MPEP 609. Draw line through citation if not in conformance and not considered. Include copy of this form with next communication to applicant.

<sup>1</sup> Applicant's unique citation designation number (optional). <sup>2</sup> Applicant is to place a check mark here if English language Translation is attached.

Substitute for form 1449/PTO				<i>Complete if Known</i>	
<b>INFORMATION DISCLOSURE STATEMENT BY APPLICANT</b> <i>(Use as many sheets as necessary)</i>				Application Number	13/118,122
				Filing Date	May 27, 2011
				First Named Inventor	James J. FALLON
				Art Unit	2115
				Examiner Name	To Be Assigned
Sheet	20	of	66	Attorney Docket Number	2855.004000B

NON PATENT LITERATURE DOCUMENTS			
Examiner Initials*	Cite No. <sup>1</sup>	Include name of the author (in CAPITAL LETTERS), title of the article (when appropriate), title of the item (book, magazine, journal, serial, symposium, catalog, etc.), date, page(s), volume number, publisher, city and/or country where published	T <sup>2</sup>
	NPL140	Exhibit 69, Prior Art Chart for U.S. Pat. No. 7,777,651, 80 pages, Realtime Data, LLC D/B/A IXO v. Morgan Stanley, et al., 6:09-cv-326-LED-JDL, 6:10-cv-248-LED-JDL, 6:10-cv-426-LED-JDL, Realtime Data, LLC D/B/A IXO v. CME Group Inc., et al., 6:09-cv-327-LED-JDL, 6:10-cv-246-LED-JDL, 6:10-cv-424-LED-JDL, Realtime Data, LLC D/B/A IXO v. Thomson Reuters Corp., et al., 6:09-cv-333-LED-JDL, 6:10-cv-247-LED-JDL, 6:10-cv-425-LED-JDL, United States District Court for the Eastern District of Texas Tyler Division, February 4, 2011, citing Vange et al., U.S. Patent No. 7,127,518.	
	NPL141	Exhibit 70, Prior Art Chart for U.S. Pat. No. 7,777,651, 197 pages, Realtime Data, LLC D/B/A IXO v. Morgan Stanley, et al., 6:09-cv-326-LED-JDL, 6:10-cv-248-LED-JDL, 6:10-cv-426-LED-JDL, Realtime Data, LLC D/B/A IXO v. CME Group Inc., et al., 6:09-cv-327-LED-JDL, 6:10-cv-246-LED-JDL, 6:10-cv-424-LED-JDL, Realtime Data, LLC D/B/A IXO v. Thomson Reuters Corp., et al., 6:09-cv-333-LED-JDL, 6:10-cv-247-LED-JDL, 6:10-cv-425-LED-JDL, United States District Court for the Eastern District of Texas Tyler Division, February 4, 2011, citing Wernikoff et al., U.S. Patent No. 3,394,352.	
	NPL142	Exhibit 71, Prior Art Chart for U.S. Pat. No. 7,777,651, 253 pages, Exhibit 70, Prior Art Chart for U.S. Pat. No. 7,777,651, 197 pages, Realtime Data, LLC D/B/A IXO v. Morgan Stanley, et al., 6:09-cv-326-LED-JDL, 6:10-cv-248-LED-JDL, 6:10-cv-426-LED-JDL, Realtime Data, LLC D/B/A IXO v. CME Group Inc., et al., 6:09-cv-327-LED-JDL, 6:10-cv-246-LED-JDL, 6:10-cv-424-LED-JDL, Realtime Data, LLC D/B/A IXO v. Thomson Reuters Corp., et al., 6:09-cv-333-LED-JDL, 6:10-cv-247-LED-JDL, 6:10-cv-425-LED-JDL, United States District Court for the Eastern District of Texas Tyler Division, February 4, 2011, citing Willis et al., U.S. Patent No. 4,745,559; Boilen, U.S. Patent No. 4,750,135.	
	NPL143	Exhibit 72, Prior Art Chart for U.S. Pat. No. 7,777,651, 277 pages, Exhibit 71, Prior Art Chart for U.S. Pat. No. 7,777,651, 253 pages, Exhibit 70, Prior Art Chart for U.S. Pat. No. 7,777,651, 197 pages, Realtime Data, LLC D/B/A IXO v. Morgan Stanley, et al., 6:09-cv-326-LED-JDL, 6:10-cv-248-LED-JDL, 6:10-cv-426-LED-JDL, Realtime Data, LLC D/B/A IXO v. CME Group Inc., et al., 6:09-cv-327-LED-JDL, 6:10-cv-246-LED-JDL, 6:10-cv-424-LED-JDL, Realtime Data, LLC D/B/A IXO v. Thomson Reuters Corp., et al., 6:09-cv-333-LED-JDL, 6:10-cv-247-LED-JDL, 6:10-cv-425-LED-JDL, United States District Court for the Eastern District of Texas Tyler Division, February 4, 2011, citing XMill - Hartmut Liefke & Dan Suciu, "XMill: an Efficient Compressor for XML Data," University of Pennsylvania, Philadelphia, Pennsylvania, MS-CIS-99-26 (October 18, 1999); Hartmut Liefke & Dan Suciu, "XMill: an Efficient Compressor for XML Data," Proceedings of SIGMOD, 2000; Hartmut Liefke & Dan Suciu, "An Extensible Compressor for XML Data," SIGMOD Record, Vol. 29, No. 1 (March 2000); Dan Suciu, "Data Management on the Web," Presentation at University of Washington College of Computer Science & Engineering, Seattle, WA (April 4, 2000).	
	NPL144	BORMANN et al., "Robust Header Compression (ROHC)," Network Working Group Internet-Draft, September 18, 2000, 111 pages.	
	NPL145	EFFROS, M., P.A. CHOU and R.M. GRAY, "Variable Dimension Weighted Universal Vector Quantization and Noiseless Coding," IEEE 1068-0314/94, 1994, pages 2-11.	

Examiner Signature	Date Considered
-----------------------	--------------------

\*EXAMINER: Initial if reference considered, whether or not citation is in conformance with MPEP 609. Draw line through citation if not in conformance and not considered. Include copy of this form with next communication to applicant.

<sup>1</sup> Applicant's unique citation designation number (optional). <sup>2</sup> Applicant is to place a check mark here if English language Translation is attached.

Substitute for form 1449/PTO				<i>Complete if Known</i>	
<b>INFORMATION DISCLOSURE STATEMENT BY APPLICANT</b> <i>(Use as many sheets as necessary)</i>				Application Number	13/118,122
				Filing Date	May 27, 2011
				First Named Inventor	James J. FALLON
				Art Unit	2115
				Examiner Name	To Be Assigned
Sheet	21	of	66	Attorney Docket Number	2855.004000B

NON PATENT LITERATURE DOCUMENTS			
Examiner Initials*	Cite No. <sup>1</sup>	Include name of the author (in CAPITAL LETTERS), title of the article (when appropriate), title of the item (book, magazine, journal, serial, symposium, catalog, etc.), date, page(s), volume number, publisher, city and/or country where published	T <sup>2</sup>
	NPL146	Defendant Bloomberg L.P.'s Invalidity Contentions Pursuant to Patent Local Rule 3-3, Realtime Data, LLC d/b/a IXO vs. Thomson Reuters Corp., et al., 6:2009-cv-00333 LED-JDL, 6:2010-cv-00247 LED-JDL, 6:2010-cv-00425 LED-JDL, October 29, 2010, 17 pages.	
	NPL147	Appendix A: U.S. Patent No. 6,624,761 (The "761 Patent"), from Defendant Bloomberg L.P.'s Invalidity Contentions Pursuant to Patent Local Rule 3-3, Realtime Data, LLC d/b/a IXO vs. Thomson Reuters Corp., et al., 6:2009-cv-00333 LED-JDL, 6:2010-cv-00247 LED-JDL, 6:2010-cv-00425 LED-JDL, October 29, 2010, 37 pages.	
	NPL148	Appendix B: U.S. Patent No. 7,161,506 (The "506 Patent"), from Defendant Bloomberg L.P.'s Invalidity Contentions Pursuant to Patent Local Rule 3-3, Realtime Data, LLC d/b/a IXO vs. Thomson Reuters Corp., et al., 6:2009-cv-00333 LED-JDL, 6:2010-cv-00247 LED-JDL, 6:2010-cv-00425 LED-JDL, October 29, 2010, 63 pages.	
	NPL149	Appendix C: U.S. Patent No. 7,400,274 (The 274 Patent), from Defendant Bloomberg L.P.'s Invalidity Contentions Pursuant to Patent Local Rule 3-3, Realtime Data, LLC d/b/a IXO vs. Thomson Reuters Corp., et al., 6:2009-cv-00333 LED-JDL, 6:2010-cv-00247 LED-JDL, 6:2010-cv-00425 LED-JDL, October 29, 2010, 95 pages.	
	NPL150	Appendix D: U.S. Patent No. 7,417,568 (The 568 Patent), from Defendant Bloomberg L.P.'s Invalidity Contentions Pursuant to Patent Local Rule 3-3, Realtime Data, LLC d/b/a IXO vs. Thomson Reuters Corp., et al., 6:2009-cv-00333 LED-JDL, 6:2010-cv-00247 LED-JDL, 6:2010-cv-00425 LED-JDL, October 29, 2010, 147 pages.	
	NPL151	Appendix E: U.S. Patent No. 7,714,747 (The "747 Patent"), from Defendant Bloomberg L.P.'s Invalidity Contentions Pursuant to Patent Local Rule 3-3, Realtime Data, LLC d/b/a IXO vs. Thomson Reuters Corp., et al., 6:2009-cv-00333 LED-JDL, 6:2010-cv-00247 LED-JDL, 6:2010-cv-00425 LED-JDL, October 29, 2010, 137 pages.	
	NPL152	Appendix F: Comparison of FAST to the Prior Art, from Defendant Bloomberg L.P.'s Invalidity Contentions Pursuant to Patent Local Rule 3-3, Realtime Data, LLC d/b/a IXO vs. Thomson Reuters Corp., et al., 6:2009-cv-00333 LED-JDL, 6:2010-cv-00247 LED-JDL, 6:2010-cv-00425 LED-JDL, October 29, 2010, 7 pages.	
	NPL153	Defendant Bloomberg L.P.'s Invalidity Contentions Pursuant to Patent Local Rule 3-3 Regarding U.S. Patent No. 7,777,651, Realtime Data, LLC d/b/a IXO vs. Thomson Reuters Corp., et al., 6:2009-cv-00333 LED-JDL, 6:2010-cv-00247 LED-JDL, 6:2010-cv-00425 LED-JDL, February 4, 2011, 21 pages.	
	NPL154	Appendix G: U.S. Patent No. 7,777,651 (The 651 Patent), Defendant Bloomberg L.P.'s Invalidity Contentions Pursuant to Patent Local Rule 3-3 Regarding U.S. Patent No. 7,777,651, Realtime Data, LLC d/b/a IXO vs. Thomson Reuters Corp., et al., 6:2009-cv-00333 LED-JDL, 6:2010-cv-00247 LED-JDL, 6:2010-cv-00425 LED-JDL, February 4, 2011, 480 pages.	
	NPL155	RICE, ROBERT F., "Some Practical Universal Noiseless Coding Techniques", Jet Propulsion Laboratory, Pasadena, California, JPL Publication 79-22, March 15, 1979, 140 pgs.	

Examiner Signature		Date Considered	
--------------------	--	-----------------	--

\*EXAMINER: Initial if reference considered, whether or not citation is in conformance with MPEP 609. Draw line through citation if not in conformance and not considered. Include copy of this form with next communication to applicant.

<sup>1</sup> Applicant's unique citation designation number (optional). <sup>2</sup> Applicant is to place a check mark here if English language Translation is attached.

Substitute for form 1449/PTO				<i>Complete if Known</i>	
<b>INFORMATION DISCLOSURE STATEMENT BY APPLICANT</b> <i>(Use as many sheets as necessary)</i>				Application Number	13/118,122
				Filing Date	May 27, 2011
				First Named Inventor	James J. FALLON
				Art Unit	2115
				Examiner Name	To Be Assigned
Sheet	22	of	66	Attorney Docket Number	2855.004000B

NON PATENT LITERATURE DOCUMENTS			
Examiner Initials*	Cite No. <sup>1</sup>	Include name of the author (in CAPITAL LETTERS), title of the article (when appropriate), title of the item (book, magazine, journal, serial, symposium, catalog, etc.), date, page(s), volume number, publisher, city and/or country where published	T <sup>2</sup>
	NPL156	ANDERSON, J., et al. "Codec squeezes color teleconferencing through digital telephone lines," Electronics 1984, pp. 13-15.	
	NPL157	VENBRUX, JACK, "A VLSI Chip Set for High-Speed Lossless Data Compression", IEEE Trans. On Circuits and Systems for Video Technology, Vol. 2, No. 4, December 1992, pp. 381-391.	
	NPL158	"Fast Dos Soft Boot", IBM Technical Disclosure Bulletin, Feb. 1994, Vol. 37, Issue No. 2B, pp. 185-186.	
	NPL159	"Operating System Platform Abstraction Method", IBM Technical Disclosure Bulletin, Feb. 1995, Vol. 38, Issue No. 2, pp 343-344.	
	NPL160	MURASHITA, K., et al., "High-Speed Statistical Compression using Self-Organized Rules and Predetermined Code Tables", IEEE, 1996 Data Compression Conference.	
	NPL161	COENE, W., et al. "A Fast Route For Application of Rate-distortion Optimal Quantization in an MPEG Video Encoder" Proceedings of the International Conference on Image Processing, US., New York, IEEE, 16 September 1996, pp. 825-828.	
	NPL162	RICE, ROBERT, "Lossless Coding Standards for Space Data Systems", IEEE 1058-6393197, Nov. 3-6, 1996, pp. 577-585.	
	NPL163	MILLMAN, HOWARD, "Image and video compression", Computerworld, Vol. 33, Issue No. 3, January 18, 1999, pp. 78.	
	NPL164	"IBM boosts your memory", Geek.com [online], June 26, 2000 [retrieved on July 6, 2007], www.geek.com/ibm-boosts-your-memory/, 7 pages.	
	NPL165	"IBM Research Breakthrough Doubles Computer Memory Capacity", IBM Press Release [online], June 26, 2000 [retrieved on July 6, 2007], www-03.ibm.com/press/us/en/pressrelease/1653.wss, 3 pages.	

Examiner Signature		Date Considered	
-----------------------	--	--------------------	--

\*EXAMINER: Initial if reference considered, whether or not citation is in conformance with MPEP 609. Draw line through citation if not in conformance and not considered. Include copy of this form with next communication to applicant.

<sup>1</sup> Applicant's unique citation designation number (optional). <sup>2</sup> Applicant is to place a check mark here if English language Translation is attached.

Substitute for form 1449/PTO				<i>Complete if Known</i>	
<b>INFORMATION DISCLOSURE STATEMENT BY APPLICANT</b> <i>(Use as many sheets as necessary)</i>				Application Number	13/118,122
				Filing Date	May 27, 2011
				First Named Inventor	James J. FALLON
				Art Unit	2115
				Examiner Name	To Be Assigned
Sheet	23	of	66	Attorney Docket Number	2855.004000B

NON PATENT LITERATURE DOCUMENTS			
Examiner Initials*	Cite No. <sup>1</sup>	Include name of the author (in CAPITAL LETTERS), title of the article (when appropriate), title of the item (book, magazine, journal, serial, symposium, catalog, etc.), date, page(s), volume number, publisher, city and/or country where published	T <sup>2</sup>
	NPL166	"ServerWorks To Deliver IBM's Memory expansion Technology in Next-Generation Core Logic for Servers", ServerWorks Press Release [online], June 27, 2000 [retrieved on July 14, 2000], <a href="http://www.serverworks.com/news/press/000627.html">http://www.serverworks.com/news/press/000627.html</a> , 1 page.	
	NPL167	ABALI, B., et al., "Memory Expansion Technology (MXT) Software support and performance", IBM Journal of Research and Development, Vol. 45, Issue No. 2, March 2001, pp. 287-301.	
	NPL168	FRANASZEK, P. A., et al., "Algorithms and data structures for compressed-memory machines", IBM Journal of Research and Development, Vol. 45, Issue No. 2, March 2001, pp. 245-258.	
	NPL169	FRANASZEK, P. A., et al., "On internal organization in compressed random-access memories", IBM Journal of Research and Development, Vol. 45, Issue No. 2, March 2001, pp. 259-270.	
	NPL170	SMITH, T.B., et al., "Memory Expansion Technology (MXT) Competitive impact", IBM Journal of Research and Development, Vol. 45, Issue No. 2, March 2001, pp. 303-309.	
	NPL171	TREMAINE, R. B., et al., "IBM Memory Expansion Technology (MXT)", IBM Journal of Research and Development, Vol. 45, Issue No. 2, March 2001, pp. 271-285.	
	NPL172	YEH, PEN-SHU, "The CCSDS Lossless Data Compression Recommendation for Space Applications", Chapter 16, Lossless Compression Handbook, Elsevier Science (USA), 2003, pp. 311-326.	
	NPL173	Expand Networks Accelerator 4000 Series User's Guide, 1999, 101 pgs.	
	NPL174	Tridgell, Andrew; "Efficient Algorithms for Sorting and Synchronization"; A thesis submitted for the degree of Doctor of Philosophy at The Australian National University; February 1999; pages iii-106	
	NPL175	Jung, et al.; "Performance optimization of wireless local area networks through VLSI data compression"; Wireless Networks, Volume 4, 1998, pages 27-39.	

Examiner Signature		Date Considered	
-----------------------	--	--------------------	--

\*EXAMINER: Initial if reference considered, whether or not citation is in conformance with MPEP 609. Draw line through citation if not in conformance and not considered. Include copy of this form with next communication to applicant.

<sup>1</sup> Applicant's unique citation designation number (optional). <sup>2</sup> Applicant is to place a check mark here if English language Translation is attached.

Substitute for form 1449/PTO				<i>Complete if Known</i>	
<b>INFORMATION DISCLOSURE STATEMENT BY APPLICANT</b> <i>(Use as many sheets as necessary)</i>				Application Number	13/118,122
				Filing Date	May 27, 2011
				First Named Inventor	James J. FALLON
				Art Unit	2115
				Examiner Name	To Be Assigned
Sheet	24	of	66	Attorney Docket Number	2855.004000B

NON PATENT LITERATURE DOCUMENTS			
Examiner Initials*	Cite No. <sup>1</sup>	Include name of the author (in CAPITAL LETTERS), title of the article (when appropriate), title of the item (book, magazine, journal, serial, symposium, catalog, etc.), date, page(s), volume number, publisher, city and/or country where published	T <sup>2</sup>
	NPL176	Baker, K. et al., "Lossless Data Compression for Short Duration 3D Frames in Positron Emission Tomography," 0-7803-1487, May 1994, pages 1831-1834.	
	NPL177	Maier, Mark W.; "Algorithm Evaluation for the Synchronous Data Compression Standard"; University of Alabama: 1995, pages 1-10.	
	NPL178	Bassiouni, et al.; "A Scheme for Data Compression in Supercomputers"; IEEE; 1988; pages 272-278.	
	NPL179	Welch, Terry A.; "A Technique for High-Performance Data Compression"; IEEE; June 1984; pages 8-19.	
	NPL180	ALDC: Adaptive Lossless Data Compression; IBM; 1994, 2 pgs.	
	NPL181	ALDC-Macro: Adaptive Lossless Data Compression; IBM Corporation; 1994, 2 pgs.	
	NPL182	ALDC1-20S: Adaptive Lossless Data Compression; IBM Corporation; 1994, 2 pgs.	
	NPL183	ALDC1-40S: Adaptive Lossless Data Compression; IBM Corporation; 1994, 2 pgs.	
	NPL184	ALDC1-5S: Adaptive Lossless Data Compression; IBM Corporation; 1994, 2 pgs.	
	NPL185	Craft, David J.; "Data Compression Choice No Easy Call"; Computer Technology Review; Volume XIV, Number 1; January 1994, 2 pgs.	

Examiner Signature		Date Considered	
-----------------------	--	--------------------	--

\*EXAMINER: Initial if reference considered, whether or not citation is in conformance with MPEP 609. Draw line through citation if not in conformance and not considered. Include copy of this form with next communication to applicant.

<sup>1</sup> Applicant's unique citation designation number (optional). <sup>2</sup> Applicant is to place a check mark here if English language Translation is attached.

Substitute for form 1449/PTO				<i>Complete if Known</i>	
<b>INFORMATION DISCLOSURE STATEMENT BY APPLICANT</b> <i>(Use as many sheets as necessary)</i>				Application Number	13/118,122
				Filing Date	May 27, 2011
				First Named Inventor	James J. FALLON
				Art Unit	2115
				Examiner Name	To Be Assigned
Sheet	25	of	66	Attorney Docket Number	2855.004000B

NON PATENT LITERATURE DOCUMENTS			
Examiner Initials*	Cite No. <sup>1</sup>	Include name of the author (in CAPITAL LETTERS), title of the article (when appropriate), title of the item (book, magazine, journal, serial, symposium, catalog, etc.), date, page(s), volume number, publisher, city and/or country where published	T <sup>2</sup>
	NPL186	Costlow, Terry; "Sony designs faster, denser tape drive"; Electronic Engineering Times; May 20, 1996, pages 86-87.	
	NPL187	Wilson, Ron; "IBM ups compression ante"; Electronic Engineering Times; August 16, 1993; pages 1-94.	
	NPL188	"IBM Announces New Feature for 3480 Subsystem"; Tucson Today; Volume 12, Number 337, July 25, 1989, 1 pg.	
	NPL189	Syngress Media, Inc.; "CCA Citrix Certified Administrator for MetaFrame 1.8 Study Guide"; 2000, 568 pgs.	
	NPL190	International Telecommunication Union; "Data Compression Procedures for Data Circuit Terminating Equipment (DCE) Using Error Correction Procedures"; Geneva, 1990, 29 pgs.	
	NPL191	Cheng, et al.; "A fast, highly reliable data compression chip and algorithm for storage systems"; IBM J. Res. Develop.; Vol. 40, No. 6, November 1996; pages 603-613.	
	NPL192	Cisco Systems; "Cisco IOS Data Compression"; 1997; pages 1-10.	
	NPL193	Craft, D. J.; "A fast hardware data compression algorithm and some algorithmic extensions"; IBM J. Res. Develop.; Vol. 42; No. 6; November 6, 1998; pages 733-746.	
	NPL194	Rustici, Robert; "Enhanced CU-SeeMe"1995, Zero In Technologies, Inc., 308 pgs.	
	NPL195	White Pine Software; "CU-SeeMe Pro: Quick Start Guide"; Version 4.0 for Windows; 1999, 86 pgs.	

Examiner Signature		Date Considered	
-----------------------	--	--------------------	--

\*EXAMINER: Initial if reference considered, whether or not citation is in conformance with MPEP 609. Draw line through citation if not in conformance and not considered. Include copy of this form with next communication to applicant.

<sup>1</sup> Applicant's unique citation designation number (optional). <sup>2</sup> Applicant is to place a check mark here if English language Translation is attached.

Substitute for form 1449/PTO				<i>Complete if Known</i>	
<b>INFORMATION DISCLOSURE STATEMENT BY APPLICANT</b> <i>(Use as many sheets as necessary)</i>				Application Number	13/118,122
				Filing Date	May 27, 2011
				First Named Inventor	James J. FALLON
				Art Unit	2115
				Examiner Name	To Be Assigned
Sheet	26	of	66	Attorney Docket Number	2855.004000B

NON PATENT LITERATURE DOCUMENTS			
Examiner Initials*	Cite No. <sup>1</sup>	Include name of the author (in CAPITAL LETTERS), title of the article (when appropriate), title of the item (book, magazine, journal, serial, symposium, catalog, etc.), date, page(s), volume number, publisher, city and/or country where published	T <sup>2</sup>
	NPL196	"CU-SeeMe Reflector"; <a href="http://www.geektimes.com/michael/CU-SeeMe/faqs/reflectors.html">www.geektimes.com/michael/CU-SeeMe/faqs/reflectors.html</a> ; accessed on December 2, 2008, 5 pgs.	
	NPL197	Daniels, et al.; "Citrix WinFrame 1.6 Beta"; May 1 1996; <a href="http://license.icopyright.net/user/downloadLicense.act?lic=3.7009-9123">license.icopyright.net/user/downloadLicense.act?lic=3.7009-9123</a> ; accessed December 2, 2008, 4 pgs.	
	NPL198	Held, et al.; "Data Compression"; Third Edition; John Wiley & Sons Ltd.; 1991, 150 pgs.	
	NPL199	Data Compression Applications and Innovations Workshop; Proceedings of a Workshop held in Conjunction with the IEEE Data Compression Conference; Snowbird, Utah; March 31, 1995, 64 pgs.	
	NPL200	Britton, et al.; "Discovery Desktop Conferencing with NetMeeting 2.0"; IDG Books Worldwide, inc.; 1997, 244 pgs.	
	NPL201	Sattler, Michael; "Internet TV with CU-SeeMe"; Sams.Net Publishing; 1995; First Edition, 80 pgs.	
	NPL202	IBM Microelectronics Comdex Fall '93 Booth Location, 1 pg.	
	NPL203	Disz, et al.; "Performance Model of the Argonne Voyager Multimedia Server"; IEEE; 1997; pages 316-327.	
	NPL204	"Downloading and Installing NetMeeting"; <a href="http://www.w4mq.com/help/h3.htm">www.w4mq.com/help/h3.htm</a> ; accessed on December 2, 2008; 6 pgs.	
	NPL205	Fox, et al.; "Adapting to Network and Client Variability via On-Demand Dynamic Distillation"; ASPLOS VII; October 1996; pages 160-170.	

Examiner Signature	Date Considered
-----------------------	--------------------

\*EXAMINER: Initial if reference considered, whether or not citation is in conformance with MPEP 609. Draw line through citation if not in conformance and not considered. Include copy of this form with next communication to applicant.

<sup>1</sup> Applicant's unique citation designation number (optional). <sup>2</sup> Applicant is to place a check mark here if English language Translation is attached.



Substitute for form 1449/PTO				<i>Complete if Known</i>	
<b>INFORMATION DISCLOSURE STATEMENT BY APPLICANT</b> <i>(Use as many sheets as necessary)</i>				Application Number	13/118,122
				Filing Date	May 27, 2011
				First Named Inventor	James J. FALLON
				Art Unit	2115
				Examiner Name	To Be Assigned
Sheet	27	of	66	Attorney Docket Number	2855.004000B

NON PATENT LITERATURE DOCUMENTS			
Examiner Initials*	Cite No. <sup>1</sup>	Include name of the author (in CAPITAL LETTERS), title of the article (when appropriate), title of the item (book, magazine, journal, serial, symposium, catalog, etc.), date, page(s), volume number, publisher, city and/or country where published	T <sup>2</sup>
	NPL206	Fox, et al.; "Adapting to Network and Client Variation Using Infrastructural Proxies: Lessons and Perspectives"; IEEE Personal Communications, August 1998; pages 10-19.	
	NPL207	Han, et al.; "CU-SeeMe VR Immersive Desktop Teleconferencing"; Department of Computer Science; Cornell University; To appear in ACM Multimedia 1996, 9 pgs.	
	NPL208	Howard, et al.; "Parallel Lossless Image Compression Using Huffman and Arithmetic Coding"; 1992; pages 1-9.	
	NPL209	Howard, Paul G.; "Text Image Compression Using Soft Pattern Matching"; The Computer Journal; Vol. 40, No. 213; 1997; pages 146-156.	
	NPL210	Howard, et al.; "The Emerging JBIG2 Standard"; IEEE Transactions on Circuits and Systems for Video Technology, Vol. 8, No. 7, November 1998; pages 838-848.	
	NPL211	Craft, D. J.; "A fast hardware data compression algorithm and some algorithmic extensions"; Journal of Research and Development; Vol. 42, No. 6, November 1998; pages 733-745.	
	NPL212	"Direct Access Storage Device Compression and Decompression Data Flow"; IBM Technical Disclosure Bulletin; Vol. 38, No. 11; November 1995; pages 291-295.	
	NPL213	ICA Timeline, September 24, 2007, 3 pgs.	
	NPL214	Converse, et al.; "Low Bandwidth X Extension"; Protocol Version 1.0; X Consortium; December 21, 1996, 55 pgs.	
	NPL215	Magstar and IBM 3590 High Performance Tape Subsystem Technical Guide; November 1996; IBM International Technical Support Organization, 288 pgs.	

Examiner Signature		Date Considered	
-----------------------	--	--------------------	--

\*EXAMINER: Initial if reference considered, whether or not citation is in conformance with MPEP 609. Draw line through citation if not in conformance and not considered. Include copy of this form with next communication to applicant.

<sup>1</sup> Applicant's unique citation designation number (optional). <sup>2</sup> Applicant is to place a check mark here if English language Translation is attached.

Substitute for form 1449/PTO				<i>Complete if Known</i>	
<b>INFORMATION DISCLOSURE STATEMENT BY APPLICANT</b> <i>(Use as many sheets as necessary)</i>				Application Number	13/118,122
				Filing Date	May 27, 2011
				First Named Inventor	James J. FALLON
				Art Unit	2115
				Examiner Name	To Be Assigned
Sheet	28	of	66	Attorney Docket Number	2855.004000B

NON PATENT LITERATURE DOCUMENTS			
Examiner Initials*	Cite No. <sup>1</sup>	Include name of the author (in CAPITAL LETTERS), title of the article (when appropriate), title of the item (book, magazine, journal, serial, symposium, catalog, etc.), date, page(s), volume number, publisher, city and/or country where published	T <sup>2</sup>
	NPL216	MetaFrame Administration Student Workbook; June 1998; Citrix Professional Courseware; Citrix Systems, Inc., 113 pgs.	
	NPL217	NCD Wincenter 3.1 : Bringing Windows to Every Desktop, 1998; 2 pgs.	
	NPL218	Overview NetMeeting 2.1; Microsoft TechNet; technet.microsoft.com/en-us/library/cc767141 (printer).aspx; accessed December 2, 2008; 7 pgs.	
	NPL219	NetMeeting 2.1 Resource Kit; Microsoft TechNet; technet.microsoft.com/en-us/library/cc767142(printer).aspx; accessed on December 2, 2008, 34 pgs.	
	NPL220	Conferencing Standards: NetMeeting 2.1 Resource Kit: Microsoft TechNet; technet.microsoft.com/—us/library/cc767150(printer).aspx; accessed December 2, 2008, 14 pgs.	
	NPL221	Summers, Bob; "Official Microsoft NetMeeting Book"; Microsoft Press; 1998, 374 pgs.	
	NPL222	Zebrose, Katherine L.; "Integrating Hardware Accelerators into Internetworking Switches"; Telco Systems, 10 pgs (no date listed).	
	NPL223	Simpson, et al.; "A Multiple Processor Approach to Data Compression"; ACM; 1998; pages 641-649, 9 pgs.	
	NPL224	"IBM Technology Products Introduces New Family of High-Performance Data Compression Products"; IBM; August 16, 1993, 6 pgs.	
	NPL225	ReadMe; PowerQuest Drive Image Pro; Version 3.00; 1994-1999; PowerQuest Corporation, pages 1-6.	

Examiner Signature		Date Considered	
-----------------------	--	--------------------	--

\*EXAMINER: Initial if reference considered, whether or not citation is in conformance with MPEP 609. Draw line through citation if not in conformance and not considered. Include copy of this form with next communication to applicant.

<sup>1</sup> Applicant's unique citation designation number (optional). <sup>2</sup> Applicant is to place a check mark here if English language Translation is attached.

Substitute for form 1449/PTO				<i>Complete if Known</i>	
<b>INFORMATION DISCLOSURE STATEMENT BY APPLICANT</b> <i>(Use as many sheets as necessary)</i>				Application Number	13/118,122
				Filing Date	May 27, 2011
				First Named Inventor	James J. FALLON
				Art Unit	2115
				Examiner Name	To Be Assigned
Sheet	29	of	66	Attorney Docket Number	2855.004000B

NON PATENT LITERATURE DOCUMENTS			
Examiner Initials*	Cite No. <sup>1</sup>	Include name of the author (in CAPITAL LETTERS), title of the article (when appropriate), title of the item (book, magazine, journal, serial, symposium, catalog, etc.), date, page(s), volume number, publisher, city and/or country where published	T <sup>2</sup>
	NPL226	<u>Schulzrinne, et al., "RTP Profile for Audio and Video Conferences with Minimal Control," January 1996; www.ietf.org/rfc/rfc1890.txt, accessed on December 3, 2008; 17 pgs.</u>	
	NPL227	Zhu, C.; "RTP Payload Format for H.263 Video Streams"; Standards Track; September 1997; pages 1-12.	
	NPL228	Simpson, W.; "The Point-To-Point Protocol (PPP)," Standards Track, July 1994, pages i-52.	
	NPL229	Reynolds, et al.; "Assigned Numbers," Standards Track; October 1994, pages 1-230.	
	NPL230	Deutsch, et al.; "ZLIB Compressed Data Format Specification version 3.3," Informational, May 1996, pages 1-10.	
	NPL231	Deutsch, P., "DEFLATE Compressed Data Format Specification version 1.3," Informational, May 1996, pages 1-15.	
	NPL232	Rand, D., "The PPP Compression Control Protocol (CCP)," Standards Track, June 1996, pages 1-9.	
	NPL233	Schneider, et al., "PPP LZS-DCP Compression Protocol (LZS-DCP)," Informational, August 1996, pages 1-18.	
	NPL234	Friend, et al., "PPP Stac LZS Compression Protocol," Informational, August 1996; pages 1-20.	
	NPL235	Schneider, et al., "PPP for Data Compression in Data Circuit-Terminating Equipment (DCE)," Informational, August 1996, pages 1-10.	

Examiner Signature	Date Considered
-----------------------	--------------------

\*EXAMINER: Initial if reference considered, whether or not citation is in conformance with MPEP 609. Draw line through citation if not in conformance and not considered. Include copy of this form with next communication to applicant.

<sup>1</sup> Applicant's unique citation designation number (optional). <sup>2</sup> Applicant is to place a check mark here if English language Translation is attached.

Substitute for form 1449/PTO				<i>Complete if Known</i>	
<b>INFORMATION DISCLOSURE STATEMENT BY APPLICANT</b> <i>(Use as many sheets as necessary)</i>				Application Number	13/118,122
				Filing Date	May 27, 2011
				First Named Inventor	James J. FALLON
				Art Unit	2115
				Examiner Name	To Be Assigned
Sheet	30	of	66	Attorney Docket Number	2855.004000B

NON PATENT LITERATURE DOCUMENTS			
Examiner Initials*	Cite No. <sup>1</sup>	Include name of the author (in CAPITAL LETTERS), title of the article (when appropriate), title of the item (book, magazine, journal, serial, symposium, catalog, etc.), date, page(s), volume number, publisher, city and/or country where published	T <sup>2</sup>
	NPL236	Atkins, et al., "PGP Message Exchange Formats," Informational, August 1996, pages 1-21.	
	NPL237	Castineyra, et al., "The Nimrod Routing Architecture," Informational, August 1996, pages 1-27.	
	NPL238	Freed, et al., "Multipurpose Internet Mail Extensions (MIME) Part Four: Registration Procedures," Best Current Practice, November 1996, pages 1-21.	
	NPL239	Shacham, et al., "IP Payload Compression Protocol (IPComp)," Standards Track, December 1998, pages 1-10.	
	NPL240	Sidewinder 50 Product Manual, Seagate Technology, Inc., 1997, 189 pgs.	
	NPL241	IBM RAMAC Virtual Array, IBM, July 1997, 490 pgs.	
	NPL242	Bruni, et al., "DB2 for OS/390 and Data Compression" IBM Corporation, November 1998, 172 pgs.	
	NPL243	Smith, Mark, "Thin Client/Server Computing Works," WindowsITPro, November 1, 1998, pages 1-13, license.icopyright.net/user/downloadLicense.act?lic=3.7009-8355, accessed December 2, 2008.	
	NPL244	International Telecommunication Union, "Information Technology - Digital Compression and Coding of Continuous-Tone Still Images-Requirements and Guidelines," 1993, 186 pgs.	
	NPL245	International Telecommunications Union, "Information technology - Lossless and near-lossless compression of continuous-tone still images - Baseline," 1999, 75 pgs.	

Examiner Signature		Date Considered	
-----------------------	--	--------------------	--

\*EXAMINER: Initial if reference considered, whether or not citation is in conformance with MPEP 609. Draw line through citation if not in conformance and not considered. Include copy of this form with next communication to applicant.

<sup>1</sup> Applicant's unique citation designation number (optional). <sup>2</sup> Applicant is to place a check mark here if English language Translation is attached.

Substitute for form 1449/PTO				<i>Complete if Known</i>	
<b>INFORMATION DISCLOSURE STATEMENT BY APPLICANT</b> <i>(Use as many sheets as necessary)</i>				Application Number	13/118,122
				Filing Date	May 27, 2011
				First Named Inventor	James J. FALLON
				Art Unit	2115
				Examiner Name	To Be Assigned
Sheet	31	of	66	Attorney Docket Number	2855.004000B

NON PATENT LITERATURE DOCUMENTS			
Examiner Initials*	Cite No. <sup>1</sup>	Include name of the author (in CAPITAL LETTERS), title of the article (when appropriate), title of the item (book, magazine, journal, serial, symposium, catalog, etc.), date, page(s), volume number, publisher, city and/or country where published	T <sup>2</sup>
	NPL246	Davis, Andrew W., "The Video Answering Machine: Intel Proshare's Next Step," Advanced Imaging, Vol. 12, No. 3, March 1997, pages 28, 30.	
	NPL247	Abbott, III, Walter D., "A Simple, Low Overhead Data Compression Algorithm for Converting Lossy Compression Processes to Lossless," Naval Postgraduate School Thesis; December 1993, 93 pgs.	
	NPL248	Thomborson, Clark, "V.42bis and Other Ziv-Lemoel Variants," IEEE, 1991, page 460.	
	NPL249	Thomborson, Clark, "The V.42bis Standard for Data-Compressing Modems," IEEE, October 1992, pages 41-53.	
	NPL250	Sun, Andrew, "Using and Managing PPP," O'Reilly & Associates, Inc., 1999, 89 pgs.	
	NPL251	"What is the V42bis Standard?," <a href="http://www.faqs.org/faqs/compression-faq/part1/section-10.html">www.faqs.org/faqs/compression-faq/part1/section-10.html</a> , accessed on December 2, 2008, 2 pgs.	
	NPL252	"The WSDC Download Guide: Drive Image Professional for DOS, OS/2, and Windows," <a href="http://wsdc01.watson.ibm.com/WSDC.nsf/Guides/Download/Applications-DriveImage.htm">wsdc01.watson.ibm.com/WSDC.nsf/Guides/Download/Applications-DriveImage.htm</a> , Accessed November 22, 1999, 4 pgs.	
	NPL253	"The WSDC Download Guide: Drive Image Professional," <a href="http://wsdc01.watson.ibm.com/wsd01.nsf/Guides/Download/Applications-DriveImage.htm">wsdc01.watson.ibm.com/wsd01.nsf/Guides/Download/Applications-DriveImage.htm</a> , accessed on May 3, 2001, 5 pgs.	
	NPL254	APPNOTE-TXT from pkware.txt, Version 6.3.2, PKWARE Inc., 1989, 52 pgs.	
	NPL255	CU-SeeMe readme.txt, December 2, 1995, 9 pgs.	

Examiner Signature		Date Considered	
-----------------------	--	--------------------	--

\*EXAMINER: Initial if reference considered, whether or not citation is in conformance with MPEP 609. Draw line through citation if not in conformance and not considered. Include copy of this form with next communication to applicant.

<sup>1</sup> Applicant's unique citation designation number (optional). <sup>2</sup> Applicant is to place a check mark here if English language Translation is attached.

Substitute for form 1449/PTO				<i>Complete if Known</i>	
<b>INFORMATION DISCLOSURE STATEMENT BY APPLICANT</b> <i>(Use as many sheets as necessary)</i>				Application Number	13/118,122
				Filing Date	May 27, 2011
				First Named Inventor	James J. FALLON
				Art Unit	2115
				Examiner Name	To Be Assigned
Sheet	32	of	66	Attorney Docket Number	2855.004000B

NON PATENT LITERATURE DOCUMENTS			
Examiner Initials*	Cite No. <sup>1</sup>	Include name of the author (in CAPITAL LETTERS), title of the article (when appropriate), title of the item (book, magazine, journal, serial, symposium, catalog, etc.), date, page(s), volume number, publisher, city and/or country where published	T <sup>2</sup>
	NPL256	CU-seeme txt from indstate.txt, README.TXT for CU-SeeMe version 0.90bl, March 23, 1997, 5 pgs.	
	NPL257	Cuseeme txt 19960221 .txt; CUSEEME.TXT, February 21, 1996, 9 pgs.	
	NPL258	Citrix Technology Guide, 1997, 413 pgs.	
	NPL259	Lettieri, et al., "Data Compression in the V.42bis Modems," 1992, pages 398-403.	
	NPL260	High Performance x2/V.34+N.42bis 56K BPS Plug & Play External Voice/FAX/Data Modem User's Manual, 1997, 27 pgs.	
	NPL261	H.323 Protocols Suite, www.protocols.com/pbook~h323.htm, 26 pgs., identified in Defendants' Joint Preliminary Invalidation Contentions filed in Realtime Data, LLC D/B/A IXO v. Packeteer, Inc., et al., Civil Action No. 6:08-cv-144-LED, United States District Court for the Eastern District of Texas Tyler Division, December 8, 2008.	
	NPL262	LBX X Consortium Algorithms; rzdocs.uni-hohenheim.de/aix~4.33/ext~doc/usr/share/man/info/en-US/a~doc~lib/.x."!;1 X I I R 6 Technical Specifications, 3 pgs.	
	NPL263	Basics of Images; www.geom.uiuc.edu/events/courses/1996/cmwh/SuIIIs/basics.html, 1996, 5 pgs.	
	NPL264	Parties' Joint Claim Construction and Prehearing Statement Pursuant to P.R. 4-3, filed in Realtime Data, LLC d/b/a/IXO v. Packeteer, Inc. et al., Civil Action No. 6:08-cv-00144-LED; U.S. District Court for the Eastern District of Texas, February 18, 2009, 168 pages.	
	NPL265	Declaration of Professor James A. Storer, Ph.D., relating to U.S. Patent No. 6,604,158, March 18, 2009, 10 pgs.	

Examiner Signature	Date Considered
-----------------------	--------------------

\*EXAMINER: Initial if reference considered, whether or not citation is in conformance with MPEP 609. Draw line through citation if not in conformance and not considered. Include copy of this form with next communication to applicant.

<sup>1</sup> Applicant's unique citation designation number (optional). <sup>2</sup> Applicant is to place a check mark here if English language Translation is attached.

Substitute for form 1449/PTO				<i>Complete if Known</i>	
<b>INFORMATION DISCLOSURE STATEMENT BY APPLICANT</b> <i>(Use as many sheets as necessary)</i>				Application Number	13/118,122
				Filing Date	May 27, 2011
				First Named Inventor	James J. FALLON
				Art Unit	2115
				Examiner Name	To Be Assigned
Sheet	33	of	66	Attorney Docket Number	2855.004000B

NON PATENT LITERATURE DOCUMENTS			
Examiner Initials*	Cite No. <sup>1</sup>	Include name of the author (in CAPITAL LETTERS), title of the article (when appropriate), title of the item (book, magazine, journal, serial, symposium, catalog, etc.), date, page(s), volume number, publisher, city and/or country where published	T <sup>2</sup>
	NPL266	Declaration of Professor James A. Storer, Ph.D., relating to U.S. Patent No. 6,601,104, March 18, 2009, 8 pgs.	
	NPL267	Declaration of Professor James A. Storer, Ph.D., relating to U.S. Patent No. 7,321,937, May 4, 2009, 15 pgs.	
	NPL268	Declaration of Professor James A. Storer, Ph.D., relating to U.S. Patent No. 6,624,761, May 4, 2009, 6 pgs.	
	NPL269	Declaration of Professor James A. Storer, Ph.D., relating to U.S. Patent No. 7,378,992, May 20, 2009, 6 pgs.	
	NPL270	Declaration of Professor James A. Storer, Ph.D., relating to U.S. Patent No. 7,161,506, May 26, 2009, 5 pgs.	
	NPL271	"Video Coding for Low Bit Rate Communication", International Telecommunication Union (ITU), Recommendation H.263, §3.4 (March 1996) ("ITU H.263"), 52 pgs.	
	NPL272	Order Adopting Report and Recommendation of United States Magistrate Judge, Realtime Data, LLC D/B/A Ixo v. Packeteer, Inc., et al., District Court for the Eastern District of Texas, No. 6:08cv144, August 24, 2009, 2 pgs.	
	NPL273	Second Amended Answer filed on behalf of Citrix Systems, Inc, (includes allegations of inequitable conduct on at least pages 24-43) filed in Realtime Data, LLC d/b/a/IXO v. Packeteer, Inc. et al., Civil Action No. 6:08-cv-00144-LED; U.S. District Court for the Eastern District of Texas, February 10, 2009, 45 pgs.	
	NPL274	Expert Report of James B. Gambrell on Inequitable Conduct filed on behalf of some of the defendants [Includes Appendices - Exhibits A-I] filed in Realtime Data, LLC d/b/a/IXO v. Packeteer, Inc. et al., Civil Action No. 6:08-cv-00144-LED; U.S. District Court for the Eastern District of Texas, June 10, 2009, 199 pgs.	
	NPL275	Expert Report of Dr. James A. Storer on Invalidity filed on behalf of some of the defendants [Includes Appendices - Exhibits A-K (Exhibit A has been redacted pursuant to a protective order)] filed in Realtime Data, LLC d/b/a/IXO v. Packeteer, Inc. et al., Civil Action No. 6:08-cv-00144-LED; U.S. District Court for the Eastern District of Texas, June 10, 2009, 1090 pgs.	

Examiner Signature		Date Considered	
-----------------------	--	--------------------	--

\*EXAMINER: Initial if reference considered, whether or not citation is in conformance with MPEP 609. Draw line through citation if not in conformance and not considered. Include copy of this form with next communication to applicant.

<sup>1</sup> Applicant's unique citation designation number (optional). <sup>2</sup> Applicant is to place a check mark here if English language Translation is attached.

Substitute for form 1449/PTO				<i>Complete if Known</i>	
<b>INFORMATION DISCLOSURE STATEMENT BY APPLICANT</b> <i>(Use as many sheets as necessary)</i>				Application Number	13/118,122
				Filing Date	May 27, 2011
				First Named Inventor	James J. FALLON
				Art Unit	2115
				Examiner Name	To Be Assigned
Sheet	34	of	66	Attorney Docket Number	2855.004000B

**NON PATENT LITERATURE DOCUMENTS**

Examiner Initials*	Cite No. <sup>1</sup>	Include name of the author (in CAPITAL LETTERS), title of the article (when appropriate), title of the item (book, magazine, journal, serial, symposium, catalog, etc.), date, page(s), volume number, publisher, city and/or country where published	T <sup>2</sup>
	NPL276	Supplemental Expert Report of Dr. James A. Storer on Invalidity filed on behalf of some of the defendants [Includes Appendices - Exhibits 1-8] filed in Realtime Data, LLC d/b/a/IXO v. Packeteer, Inc. et al., Civil Action No. 6:08-cv-00144-LED; U.S. District Court for the Eastern District of Texas, June 19, 2009, 301 pgs.	
	NPL277	Deposition of Dr. James A. Storer conducted on behalf of the plaintiffs filed in Realtime Data, LLC d/b/a/IXO v. Packeteer, Inc. et al., Civil Action No. 6:08-cv-00144-LED; U.S. District Court for the Eastern District of Texas, February 27, 2009, 242 pgs.	
	NPL278	Deposition of Brian Von Herzen conducted on behalf of the plaintiffs filed in Realtime Data, LLC d/b/a/IXO v. Packeteer, Inc. et al., Civil Action No. 6:08-cv-00144-LED; U.S. District Court for the Eastern District of Texas, February 26, 2009, 241 pgs.	
	NPL279	Second Amended Complaint filed on behalf of the Plaintiff in Realtime Data, LLC d/b/a/IXO v. Packeteer, Inc. et al., Civil Action No. 6:08-cv-00144-LED; U.S. District Court for the Eastern District of Texas, February 10, 2009, 28 pgs.	
	NPL280	Answers to the Second Amended Complaint and Counterclaims filed by Citrix Systems, Inc. in Realtime Data, LLC d/b/a/IXO v. Packeteer, Inc. et al., Civil Action No. 6:08-cv-00144-LED; U.S. District Court for the Eastern District of Texas, February 17, 2009, 46 pgs.	
	NPL281	Answers to the Second Amended Complaint and Counterclaims filed by F5 Networks, Inc. in Realtime Data, LLC d/b/a/IXO v. Packeteer, Inc. et al., Civil Action No. 6:08-cv-00144-LED; U.S. District Court for the Eastern District of Texas, February 17, 2009, 17 pgs.	
	NPL282	Answers to the Second Amended Complaint and Counterclaims filed by Averitt Express, Inc. in Realtime Data, LLC d/b/a/IXO v. Packeteer, Inc. et al., Civil Action No. 6:08-cv-00144-LED; U.S. District Court for the Eastern District of Texas, February 17, 2009, 17 pgs.	
	NPL283	Answers to the Second Amended Complaint and Counterclaims filed by DHL Express, Inc. in Realtime Data, LLC d/b/a/IXO v. Packeteer, Inc. et al., Civil Action No. 6:08-cv-00144-LED; U.S. District Court for the Eastern District of Texas, February 17, 2009, 37 pgs.	
	NPL284	Answers to the Second Amended Complaint and Counterclaims filed by Expand Networks, Inc., Interstate Battery System of America, Inc., and O'Reilly Automotive, Inc. in Realtime Data, LLC d/b/a/IXO v. Packeteer, Inc. et al., Civil Action No. 6:08-cv-00144-LED; U.S. District Court for the Eastern District of Texas, February 17, 2009, 21 pgs.	
	NPL285	Answers to the Second Amended Complaint and Counterclaims filed by Blue Coat Systems, Inc., Packeteer, Inc., 7-Eleven, Inc., ABM Industries, Inc., ABM Janitorial Services-South Central, Inc., and Build-A-Bear Workshop, Inc. in Realtime Data, LLC d/b/a/IXO v. Packeteer, Inc. et al., Civil Action No. 6:08-cv-00144-LED; U.S. District Court for the Eastern District of Texas, February 18, 2009, 84 pgs.	

Examiner Signature		Date Considered	
--------------------	--	-----------------	--

\*EXAMINER: Initial if reference considered, whether or not citation is in conformance with MPEP 609. Draw line through citation if not in conformance and not considered. Include copy of this form with next communication to applicant.

<sup>1</sup> Applicant's unique citation designation number (optional). <sup>2</sup> Applicant is to place a check mark here if English language Translation is attached.



Substitute for form 1449/PTO				<i>Complete if Known</i>	
<b>INFORMATION DISCLOSURE STATEMENT BY APPLICANT</b> <i>(Use as many sheets as necessary)</i>				Application Number	13/118,122
				Filing Date	May 27, 2011
				First Named Inventor	James J. FALLON
				Art Unit	2115
				Examiner Name	To Be Assigned
Sheet	35	of	66	Attorney Docket Number	2855.004000B

NON PATENT LITERATURE DOCUMENTS			
Examiner Initials*	Cite No. <sup>1</sup>	Include name of the author (in CAPITAL LETTERS), title of the article (when appropriate), title of the item (book, magazine, journal, serial, symposium, catalog, etc.), date, page(s), volume number, publisher, city and/or country where published	T <sup>2</sup>
	NPL286	Plaintiff's Response to the Answers to the Second Amended Complaint and Counterclaims filed by Citrix Systems, Inc, in Realtime Data, LLC d/b/a/IXO v. Packeteer, Inc. et al., Civil Action No. 6:08-cv-00144-LED; U.S. District Court for the Eastern District of Texas, March 4, 2009, 24 pgs.	
	NPL287	Plaintiff's Responses to the Answers to the Second Amended Complaint and Counterclaims filed by F5 Networks, Inc, in Realtime Data, LLC d/b/a/IXO v. Packeteer, Inc. et al., Civil Action No. 6:08-cv-00144-LED; U.S. District Court for the Eastern District of Texas, March 4, 2009, 5 pgs.	
	NPL288	Plaintiff's Responses to the Answers to the Second Amended Complaint and Counterclaims filed by Averitt Express, Inc, in Realtime Data, LLC d/b/a/IXO v. Packeteer, Inc. et al., Civil Action No. 6:08-cv-00144-LED; U.S. District Court for the Eastern District of Texas, March 4, 2009, 5 pgs.	
	NPL289	Plaintiff's Responses to the Answers to the Second Amended Complaint and Counterclaims filed by DHL Express, Inc, in Realtime Data, LLC d/b/a/IXO v. Packeteer, Inc. et al., Civil Action No. 6:08-cv-00144-LED; U.S. District Court for the Eastern District of Texas, March 4, 2009, 17 pgs.	
	NPL290	Plaintiff's Responses to the Answers to the Second Amended Complaint and Counterclaims filed by Expand Networks, Inc, Interstate Battery System of America, Inc., and O'Reilly Automotive, Inc. in Realtime Data, LLC d/b/a/IXO v. Packeteer, Inc. et al., Civil Action No. 6:08-cv-00144-LED; U.S. District Court for the Eastern District of Texas, March 4, 2009, 15 pgs.	
	NPL291	Plaintiff's Responses to the Answers to the Second Amended Complaint and Counterclaims filed by Blue Coat Systems, Inc., Packeteer, Inc., 7-Eleven, Inc., ABM Industries, Inc., ABM Janitorial Services-South Central, Inc., and Build -A-Bear Workshop, Inc. in Realtime Data, LLC d/b/a/IXO v. Packeteer, Inc. et al., Civil Action No. 6:08-cv-00144-LED; U.S. District Court for the Eastern District of Texas, March 4, 2009, 34 pgs.	
	NPL292	Opening Claim Construction Brief filed in Realtime Data, LLC d/b/a/IXO v. Packeteer, Inc. et al., Civil Action No. 6:08-cv-00144-LED; U.S. District Court for the Eastern District of Texas, March 5, 2009, 36 pgs.	
	NPL293	Declaration of Jordan Adler in support of the Opening Claim Construction Brief filed in Realtime Data, LLC d/b/a/IXO v. Packeteer, Inc. et al., Civil Action No. 6:08-cv-00144-LED; U.S. District Court for the Eastern District of Texas, March 5, 2009, 214 pgs.	
	NPL294	Motion for Partial Summary Judgment for Invalidity of some of the Patents in Suit for Indefiniteness, including the '104 patent, filed on behalf of the defendants in Realtime Data, LLC d/b/a/IXO v. Packeteer, Inc. et al., Civil Action No. 6:08-cv-00144-LED; U.S. District Court for the Eastern District of Texas, March 16, 2009, 22 pgs.	
	NPL295	Declaration of Michele E. Moreland in support Motion for Partial Summary Judgment for Invalidity of some of the Patents in Suit for Indefiniteness, including the '104 patent, filed on behalf of the defendants in Realtime Data, LLC d/b/a/IXO v. Packeteer, Inc. et al., Civil Action No. 6:08-cv-00144-LE, March 16, 2009, 168 pgs.	

Examiner Signature		Date Considered	
--------------------	--	-----------------	--

\*EXAMINER: Initial if reference considered, whether or not citation is in conformance with MPEP 609. Draw line through citation if not in conformance and not considered. Include copy of this form with next communication to applicant.

<sup>1</sup> Applicant's unique citation designation number (optional). <sup>2</sup> Applicant is to place a check mark here if English language Translation is attached.

Substitute for form 1449/PTO				<i>Complete if Known</i>	
<b>INFORMATION DISCLOSURE STATEMENT BY APPLICANT</b> <i>(Use as many sheets as necessary)</i>				Application Number	13/118,122
				Filing Date	May 27, 2011
				First Named Inventor	James J. FALLON
				Art Unit	2115
				Examiner Name	To Be Assigned
Sheet	36	of	66	Attorney Docket Number	2855.004000B

NON PATENT LITERATURE DOCUMENTS			
Examiner Initials*	Cite No. <sup>1</sup>	Include name of the author (in CAPITAL LETTERS), title of the article (when appropriate), title of the item (book, magazine, journal, serial, symposium, catalog, etc.), date, page(s), volume number, publisher, city and/or country where published	T <sup>2</sup>
	NPL296	Declaration of James A. Storer in support Motion for Partial Summary Judgment for Invalidity of some of the Patents in Suit for Indefiniteness, including the '104 patent, filed on behalf of the defendants in Realtime Data, LLC d/b/a/IXO v. Packeteer, Inc. et al., Civil Action No. 6:08-cv-00144-LE, March 16, 2009, 27 pgs.	
	NPL297	Joint Defendants Reply regarding Motion for Partial Summary Judgment for Invalidity of some of the Patents in Suit for Indefiniteness, including the '104 patent, filed on behalf of the defendants in Realtime Data, LLC d/b/a/IXO v. Packeteer, Inc. et al., Civil Action No. 6:08-cv-00144-LE, April 2, 2009, 20 pgs.	
	NPL298	Responsive Briefs in Support of Claim Construction filed by Blue Coats Systems, Inc., Packeteer, Inc., 7-Eleven, Inc., ABM Industries, Inc., ABM Janitorial Services-South Central, Inc. and Build-A-Bear Workshop, Inc. in Realtime Data, LLC d/b/a/IXO v. Packeteer, Inc. et al., Civil Action No. 6:08-cv-00144-LED; U.S. District Court for the Eastern District of Texas, March 19, 2009, 451 pgs.	
	NPL299	Responsive Briefs in Support of Claim Construction filed by F5 Networks, Inc. and Averitt Express, Inc. in Realtime Data, LLC d/b/a/IXO v. Packeteer, Inc. et al., Civil Action No. 6:08-cv-00144-LED; U.S. District Court for the Eastern District of Texas, March 19, 2009, 20 pgs.	
	NPL300	Responsive Briefs in Support of Claim Construction filed by Citrix Systems, Inc., Expand Networks, Inc., DHL Express (USA), Inc., Interstate Battery System of America, Inc., and O'Reilly Automotive Inc. in Realtime Data, LLC d/b/a/IXO v. Packeteer, Inc. et al., Civil Action No. 6:08-cv-00144-LED; U.S. District Court for the Eastern District of Texas, March 19, 2009, 377 pgs.	
	NPL301	Declaration of Dr. James A. Storer filed in Support of the Brief in Support of Claim Construction filed on behalf of F5 Networks, Inc. in Realtime Data, LLC d/b/a/IXO v. Packeteer, Inc. et al., Civil Action No. 6:08-cv-00144-LED; U.S. District Court for the Eastern District of Texas, March 19, 2009, 778 pgs.	
	NPL302	Defendant Citrix Systems, Inc.'s Motion to Exclude Dr. Brian Von Herzen's Opinions Regarding Claim Construction filed in Realtime Data, LLC d/b/a/IXO v. Packeteer, Inc. et al., Civil Action No. 6:08-cv-00144-LED; U.S. District Court for the Eastern District of Texas, March 20, 2009, 244 pgs.	
	NPL303	Plaintiff's Opposition to Defendant Citrix Systems, Inc.'s Motion to Exclude Dr. Brian Von Herzen's Opinions Regarding Claim Construction filed in Realtime Data, LLC d/b/a/IXO v. Packeteer, Inc. et al., Civil Action No. 6:08-cv-00144-LED; U.S. District Court for the Eastern District of Texas, April 6, 2009, 20 pgs.	
	NPL304	Declaration of Karim Oussayef submitted in support of the Opposition of Plaintiff's Opposition to Defendant Citrix Systems, Inc.'s Motion to Exclude Dr. Brian Von Herzen's Opinions Regarding Claim Construction filed in Realtime Data, LLC d/b/a/IXO v. Packeteer, Inc. et al., Civil Action No. 6:08-cv-00144-LED; U.S. District Court for the Eastern District of Texas, April 6, 2009, 119 pgs.	
	NPL305	Order of the Court Denying Defendant Citrix Systems, Inc.'s Motion to Exclude Dr. Brian Von Herzen's Opinions Regarding Claim Construction, Realtime Data, LLC D/B/A Ixo v. Packeteer, Inc., et al., District Court for the Eastern District of Texas, No. 6:08cv144, April 6, 2009, 1 pg.	

Examiner Signature		Date Considered	
-----------------------	--	--------------------	--

\*EXAMINER: Initial if reference considered, whether or not citation is in conformance with MPEP 609. Draw line through citation if not in conformance and not considered. Include copy of this form with next communication to applicant.

<sup>1</sup> Applicant's unique citation designation number (optional). <sup>2</sup> Applicant is to place a check mark here if English language Translation is attached.

Substitute for form 1449/PTO				<i>Complete if Known</i>	
<b>INFORMATION DISCLOSURE STATEMENT BY APPLICANT</b> <i>(Use as many sheets as necessary)</i>				Application Number	13/118,122
				Filing Date	May 27, 2011
				First Named Inventor	James J. FALLON
				Art Unit	2115
				Examiner Name	To Be Assigned
Sheet	37	of	66	Attorney Docket Number	2855.004000B

NON PATENT LITERATURE DOCUMENTS			
Examiner Initials*	Cite No. <sup>1</sup>	Include name of the author (in CAPITAL LETTERS), title of the article (when appropriate), title of the item (book, magazine, journal, serial, symposium, catalog, etc.), date, page(s), volume number, publisher, city and/or country where published	T <sup>2</sup>
	NPL306	Parties Joint Submission of Terms to be Heard at the Markman Hearing filed in Realtime Data, LLC d/b/a/IXO v. Packeteer, Inc. et al., Civil Action No. 6:08-cv-00144-LED; U.S. District Court for the Eastern District of Texas, March 24, 2009, 5 pgs.	
	NPL307	Order of the Court Regarding the terms to be heard at the Markman Hearing in Realtime Data, LLC d/b/a/IXO v. Packeteer, Inc. et al., Civil Action No. 6:08-cv-00144-LED; U.S. District Court for the Eastern District of Texas, March 24, 2009, 2 pgs.	
	NPL308	Transcript of the Markman Hearing held on April 9, 2009 in Realtime Data, LLC d/b/a/IXO v. Packeteer, Inc. et al., Civil Action No. 6:08-cv-00144-LED; U.S. District Court for the Eastern District of Texas, 174 pgs.	
	NPL309	Plaintiff's Reply Claim Construction Brief filed in Realtime Data, LLC d/b/a/IXO v. Packeteer, Inc. et al., Civil Action No. 6:08-cv-00144-LED; U.S. District Court for the Eastern District of Texas, March 30, 2009, 30 pgs.	
	NPL310	Declaration of Brian von Herzen in Support of the Plaintiff's Reply Claim Construction Brief filed in Realtime Data, LLC d/b/a/IXO v. Packeteer, Inc. et al., Civil Action No. 6:08-cv-00144-LED; U.S. District Court for the Eastern District of Texas, March 30, 2009, 25 pgs.	
	NPL311	F5 Sur-Reply to Plaintiff's Claim Construction Brief filed by some of the defendants in Realtime Data, LLC d/b/a/IXO v. Packeteer, Inc. et al., Civil Action No. 6:08-cv-00144-LED; U.S. District Court for the Eastern District of Texas, April 3, 2009, 12 pg	
	NPL312	Citrix Sur-Reply to Plaintiff's Claim Construction Brief filed by some of the defendants in Realtime Data, LLC d/b/a/IXO v. Packeteer, Inc. et al., Civil Action No. 6:08-cv-00144-LED; U.S. District Court for the Eastern District of Texas, April 3, 2009, 13 pgs.	
	NPL313	Blue Coat Sur-Reply to Plaintiff's Claim Construction Brief filed by some of the defendants in Realtime Data, LLC d/b/a/IXO v. Packeteer, Inc. et al., Civil Action No. 6:08-cv-00144-LED; U.S. District Court for the Eastern District of Texas, April 3, 2009, 12 pgs.	
	NPL314	Declaration of Michele Moreland in Support of Sur-Replies to Plaintiff's Claim Construction Brief filed by some of the defendants in Realtime Data, LLC d/b/a/IXO v. Packeteer, Inc. et al., Civil Action No. 6:08-cv-00144-LED; U.S. District Court for the Eastern District of Texas, April 3, 2009, 8 pgs.	
	NPL315	Declaration of James Storer in Support of Sur-Replies to Plaintiff's Claim Construction Brief filed by some of the defendants in Realtime Data, LLC d/b/a/IXO v. Packeteer, Inc. et al., Civil Action No. 6:08-cv-00144-LED; U.S. District Court for the Eastern District of Texas, April 7, 2009, 6 pgs.	

Examiner Signature		Date Considered	
--------------------	--	-----------------	--

\*EXAMINER: Initial if reference considered, whether or not citation is in conformance with MPEP 609. Draw line through citation if not in conformance and not considered. Include copy of this form with next communication to applicant.

<sup>1</sup> Applicant's unique citation designation number (optional). <sup>2</sup> Applicant is to place a check mark here if English language Translation is attached.

Substitute for form 1449/PTO				<i>Complete if Known</i>	
<b>INFORMATION DISCLOSURE STATEMENT BY APPLICANT</b> <i>(Use as many sheets as necessary)</i>				Application Number	13/118,122
				Filing Date	May 27, 2011
				First Named Inventor	James J. FALLON
				Art Unit	2115
				Examiner Name	To Be Assigned
Sheet	38	of	66	Attorney Docket Number	2855.004000B

NON PATENT LITERATURE DOCUMENTS			
Examiner Initials*	Cite No. <sup>1</sup>	Include name of the author (in CAPITAL LETTERS), title of the article (when appropriate), title of the item (book, magazine, journal, serial, symposium, catalog, etc.), date, page(s), volume number, publisher, city and/or country where published	T <sup>2</sup>
	NPL316	Plaintiff's Motion for Leave to Supplement the Parties' Joint Claim Construction and Prehearing Statement filed in Realtime Data, LLC d/b/a/IXO v. Packeteer, Inc. et al., Civil Action No. 6:08-cv-00144-LED; U.S. District Court for the Eastern District of Texas, April 8, 2009, 123 pgs.	
	NPL317	Motion for Reconsideration of the Court's Order Denying Plaintiff's Motion for Leave to Supplement the Parties' Joint Claim Construction and Prehearing Statement filed in Realtime Data, LLC d/b/a/IXO v. Packeteer, Inc. et al., Civil Action No. 6:08-cv-00144-LED; U.S. District Court for the Eastern District of Texas, July 13, 2009, 3 pgs.	
	NPL318	Citrix Systems' Opposition to Realtime Data's Motion for Reconsideration of Realtime's Motion for Leave to Supplement the Parties' Joint Claim Construction, filed in Realtime Data, LLC d/b/a/IXO v. Packeteer, Inc. et al., Civil Action No. 6:08-cv-00144-LED; U.S. District Court for the Eastern District of Texas, July 27, 2009, 6 pgs.	
	NPL319	Notice of Agreement to Claim Term between Plaintiff and Defendant filed in Realtime Data, LLC d/b/a/IXO v. Packeteer, Inc. et al., Civil Action No. 6:08-cv-00144-LED; U.S. District Court for the Eastern District of Texas, April 22, 2009, 3 pgs.	
	NPL320	Provisional Claim Construction Order issued by the Court on June 2, 2009 in Realtime Data, LLC d/b/a/IXO v. Packeteer, Inc. et al., Civil Action No. 6:08-cv-00144-LED; U.S. District Court for the Eastern District of Texas, 28 pgs.	
	NPL321	Citrix Request for Consideration and Objections to the Provisional Claim Construction Order issued by the Court on June 22, 2009 filed on behalf of some of the defendants in Realtime Data, LLC d/b/a/IXO v. Packeteer, Inc. et al., Civil Action No. 6:08-cv-00144-LED; U.S. District Court for the Eastern District of Texas, July 9, 2009, 22 pgs.	
	NPL322	Blue Coat Request for Consideration and Objections to the Provisional Claim Construction Order issued by the Court on June 22, 2009 filed on behalf of some of the defendants in Realtime Data, LLC d/b/a/IXO v. Packeteer, Inc. et al., Civil Action No. 6:08-cv-00144-LED, U.S. District Court for the Eastern District of Texas, July 10, 2009, 9 pgs.	
	NPL323	F5 Request for Consideration and Objections to the Provisional Claim Construction Order issued by the Court on June 22, 2009 filed on behalf of some of the defendants in Realtime Data, LLC d/b/a/IXO v. Packeteer, Inc. et al., Civil Action No. 6:08-cv-00144-LED; U.S. District Court for the Eastern District of Texas, July 10, 2009, 15 pgs.	
	NPL324	Comtech AHA Corporation's Complaint in Intervention against the Plaintiff filed in Realtime Data, LLC d/b/a/IXO v. Packeteer, Inc. et al., Civil Action No. 6:08-cv-00144-LED; U.S. District Court for the Eastern District of Texas, April 6, 2009, 8 pgs.	
	NPL325	Report and Recommendation of United States Magistrate Judge on Motion for Partial Summary Judgment issued on June 23, 2009, in Realtime Data, LLC d/b/a/IXO v. Packeteer, Inc. et al., Civil Action No. 6:08-cv-00144-LED; U.S. District Court for the Eastern District of Texas, 22 pgs.	

Examiner Signature	Date Considered
-----------------------	--------------------

\*EXAMINER: Initial if reference considered, whether or not citation is in conformance with MPEP 609. Draw line through citation if not in conformance and not considered. Include copy of this form with next communication to applicant.

<sup>1</sup> Applicant's unique citation designation number (optional). <sup>2</sup> Applicant is to place a check mark here if English language Translation is attached.

Substitute for form 1449/PTO				<i>Complete if Known</i>	
<b>INFORMATION DISCLOSURE STATEMENT BY APPLICANT</b> <i>(Use as many sheets as necessary)</i>				Application Number	13/118,122
				Filing Date	May 27, 2011
				First Named Inventor	James J. FALLON
				Art Unit	2115
				Examiner Name	To Be Assigned
Sheet	39	of	66	Attorney Docket Number	2855.004000B

NON PATENT LITERATURE DOCUMENTS			
Examiner Initials*	Cite No. <sup>1</sup>	Include name of the author (in CAPITAL LETTERS), title of the article (when appropriate), title of the item (book, magazine, journal, serial, symposium, catalog, etc.), date, page(s), volume number, publisher, city and/or country where published	T <sup>2</sup>
	NPL326	Blue Coat Defendants' Report and Recommendations Regarding Motion for Partial Summary Judgment of Invalidity for Indefiniteness in Realtime Data, LLC d/b/a/IXO v. Packeteer, Inc. et al., Civil Action No. 6:08-cv-00144-LED; U.S. District Court for the Eastern District of Texas, July 8, 2009, 18 pgs.	
	NPL327	Plaintiff's Objections To and Partially Unopposed Motion for Reconsideration of United States Magistrate Judge's Claim Construction Memorandum and Order, in Realtime Data, LLC d/b/a/IXO v. Packeteer, Inc. et al., Civil Action No. 6:08-cv-00144-LED; U.S. District Court for the Eastern District of Texas, July 13, 2009, 11 pgs.	
	NPL328	Defendant Citrix Opposition to Realtime's Objections to and Partially Unopposed Motion for Reconsideration of Magistrate Love's Claim Construction Memorandum and Order filed by Citrix Systems, Inc., filed on behalf of some of the defendants in Realtime Data, LLC d/b/a/IXO v. Packeteer, Inc. et al., Civil Action No. 6:08-cv-00144-LED; U.S. District Court for the Eastern District of Texas, July 27, 2009, 8 pgs.	
	NPL329	Defendant F5 Networks, Inc.'s Opposition to Plaintiff's Objections and Partially Unopposed Motion for Reconsideration of Magistrate Judge Love's Claim Construction and Order, filed on behalf of some of the defendants in Realtime Data, LLC d/b/a/IXO v. Packeteer, Inc. et al., Civil Action No. 6:08-cv-00144-LED; U.S. District Court for the Eastern District of Texas, July 27, 2009, 4 pgs.	
	NPL330	Defendants' Response in Opposition to Realtime Data's Objections to and Partially Unopposed Motion for Reconsideration of Magistrate Judge Love's Claim Construction Memorandum and Order, filed on behalf of some of the defendants in Realtime Data, LLC d/b/a/IXO v. Packeteer, Inc. et al., Civil Action No. 6:08-cv-00144-LED; U.S. District Court for the Eastern District of Texas, July 27, 2009, 9 pgs.	
	NPL331	Realtime Data's Response in Opposition to Defendant Citrix Systems Objections to and Request for Reconsideration of Magistrate's Order Regarding Claim Construction, in Realtime Data, LLC d/b/a/IXO v. Packeteer, Inc. et al., Civil Action No. 6:08-cv-00144-LED; U.S. District Court for the Eastern District of Texas, July 27, 2009, 13 pgs.	
	NPL332	Plaintiff Realtime Data's Response in Opposition to Blue Coat Defendants' Objection to Magistrate's Memorandum Opinion and Order Regarding Claim Construction, in Realtime Data, LLC d/b/a/IXO v. Packeteer, Inc. et al., Civil Action No. 6:08-cv-00144-LED; U.S. District Court for the Eastern District of Texas, July 27, 2009, 9 pgs.	
	NPL333	Plaintiff's selected Responses to Defendant Citrix System's Interrogatories and First Set of Requests for Admission filed in Realtime Data, LLC d/b/a/IXO v. Packeteer, Inc. et al., Civil Action No. 6:08-cv-00144-LED; U.S. District Court for the Eastern District of Texas, July 15, 2009, 151 pgs.	
	NPL334	Script for Defendants' Joint Claim Construction Technology Tutorial Presented to the Magistrate Judge in Realtime Data, LLC d/b/a/IXO v. Packeteer, Inc. et al., Civil Action No. 6:08-cv-00144-LED; U.S. District Court for the Eastern District of Texas, filed on April 18, 2008 and terminated February 2, 95 pgs.	
	NPL335	Preliminary Data Sheet, 9600 Data Compressor Processor, HI/hi, 1997-99, HIFN 000001-68, 68 pgs.	

Examiner Signature		Date Considered	
-----------------------	--	--------------------	--

\*EXAMINER: Initial if reference considered, whether or not citation is in conformance with MPEP 609. Draw line through citation if not in conformance and not considered. Include copy of this form with next communication to applicant.

<sup>1</sup> Applicant's unique citation designation number (optional). <sup>2</sup> Applicant is to place a check mark here if English language Translation is attached.

Substitute for form 1449/PTO				<i>Complete if Known</i>	
<b>INFORMATION DISCLOSURE STATEMENT BY APPLICANT</b> <i>(Use as many sheets as necessary)</i>				Application Number	13/118,122
				Filing Date	May 27, 2011
				First Named Inventor	James J. FALLON
				Art Unit	2115
				Examiner Name	To Be Assigned
Sheet	40	of	66	Attorney Docket Number	2855.004000B

NON PATENT LITERATURE DOCUMENTS			
Examiner Initials*	Cite No. <sup>1</sup>	Include name of the author (in CAPITAL LETTERS), title of the article (when appropriate), title of the item (book, magazine, journal, serial, symposium, catalog, etc.), date, page(s), volume number, publisher, city and/or country where published	T <sup>2</sup>
	NPL336	Data Sheet, 9751 Data Compression Processor, 1997-99, HIFN 000069-187, 119 pgs.	
	NPL337	Signal Termination Guide, Application Note, Hi/fn, 1997-98, HIFN 000188-194, 7 pgs.	
	NPL338	How LZS Data Compression Works, Application Note, Hi/fn, 1997-99, HIFN 000195-207, 13 pgs.	
	NPL339	Reference Hardware, 9751 Compression Processor, Hi/fn, 1997-99, HIFN 000208-221, 14 pgs.	
	NPL340	Using 9751 in Big Endian Systems, Application Note, Hi/fn, 1997-99, HIFN 000222-234, 13 pgs.	
	NPL341	Specification Update, 9751 Compression Processor, Hi/fn, 1997-2000, HIFN 000235-245, 11 pgs.	
	NPL342	9732AM Product Release, Hi/fn, 1994-99, HIFN 000246-302, 57 pgs.	
	NPL343	Data Sheet, 9732A Data Compression Processor, Hi/fn, 1997-99, HIFN 000303-353, 51 pgs.	
	NPL344	9711 to 7711 Migration, Application Note, Hi/fn, 1997-99, HIFN 000354-361, 8 pgs.	
	NPL345	Specification Update, 9711 Data Compression Processor, Hi/fn, 1997-99, HIFN 000362-370, 9 pgs.	

Examiner Signature	Date Considered
-----------------------	--------------------

\*EXAMINER: Initial if reference considered, whether or not citation is in conformance with MPEP 609. Draw line through citation if not in conformance and not considered. Include copy of this form with next communication to applicant.

<sup>1</sup> Applicant's unique citation designation number (optional). <sup>2</sup> Applicant is to place a check mark here if English language Translation is attached.

Substitute for form 1449/PTO				<i>Complete if Known</i>	
<b>INFORMATION DISCLOSURE STATEMENT BY APPLICANT</b> <i>(Use as many sheets as necessary)</i>				Application Number	13/118,122
				Filing Date	May 27, 2011
				First Named Inventor	James J. FALLON
				Art Unit	2115
				Examiner Name	To Be Assigned
Sheet	41	of	66	Attorney Docket Number	2855.004000B

NON PATENT LITERATURE DOCUMENTS			
Examiner Initials*	Cite No. <sup>1</sup>	Include name of the author (in CAPITAL LETTERS), title of the article (when appropriate), title of the item (book, magazine, journal, serial, symposium, catalog, etc.), date, page(s), volume number, publisher, city and/or country where published	T <sup>2</sup>
	NPL346	Differences Between the 9710 & 9711 Processors, Application Note, Hi/fn, 1997-99, HIFN 000371-77, 7 pgs.	
	NPL347	Specification Update, 9710 Data Compression Processor, Hi/fn, 1997-99, HIFN 000378-388, 11 pgs.	
	NPL348	9706/9706A Data Compression Coprocessor Data Sheet, Stac Electronics, 1991-97, HIFN 000389-473, 85 pgs.	
	NPL349	9705/9705A Data Compression Coprocessor, Stac Electronics, 1988-96, HIFN 000474-562, 88 pgs.	
	NPL350	9705/9705A Data Compression Coprocessor Data Sheet, Stac Electronics, 1988-96, HIFN 000563-649, 87 pgs.	
	NPL351	9700/9701 Compression Coprocessors, Hi/fn, 1997, HIFN 000650-702, 53 pgs.	
	NPL352	Data Sheet 9610 Data Compression Processor, Hi/fn, 1997-98, HIFN 000703-744, 42 pgs.	
	NPL353	Specification Update 9610 Data Compression Processor, Hi/fn, 1997-99, HIFN 000745-751, 7 pgs.	
	NPL354	9705 Data Compression Coprocessor, Stac Electronics, 1988-92, HIFN 000752-831, 80 pgs.	
	NPL355	9705 Network Software Design Guide, Application Note, Stac Electronics, 1990-91, HIFN 000832-861, 30 pgs.	

Examiner Signature		Date Considered	
-----------------------	--	--------------------	--

\*EXAMINER: Initial if reference considered, whether or not citation is in conformance with MPEP 609. Draw line through citation if not in conformance and not considered. Include copy of this form with next communication to applicant.

<sup>1</sup> Applicant's unique citation designation number (optional). <sup>2</sup> Applicant is to place a check mark here if English language Translation is attached.

Substitute for form 1449/PTO				<i>Complete if Known</i>	
<b>INFORMATION DISCLOSURE STATEMENT BY APPLICANT</b> <i>(Use as many sheets as necessary)</i>				Application Number	13/118,122
				Filing Date	May 27, 2011
				First Named Inventor	James J. FALLON
				Art Unit	2115
				Examiner Name	To Be Assigned
Sheet	42	of	66	Attorney Docket Number	2855.004000B

NON PATENT LITERATURE DOCUMENTS			
Examiner Initials*	Cite No. <sup>1</sup>	Include name of the author (in CAPITAL LETTERS), title of the article (when appropriate), title of the item (book, magazine, journal, serial, symposium, catalog, etc.), date, page(s), volume number, publisher, city and/or country where published	T <sup>2</sup>
	NPL356	Data Sheet 9601 Data Compression Processor, Hi/fn, May 21, 1998, HIFN 000862-920, 59 pgs.	
	NPL357	7751 Encryption Processor Reference Kit, Hi/fn, April 1999, HIFN 000921-1114, 194 pgs.	
	NPL358	Hardware Data Book, Hi/fn, November 1998, HIFN 001115-1430, 316 pgs.	
	NPL359	Data Compression Data Book, Hi/fn, January 1999, HIFN 001431-1889, 459 pgs.	
	NPL360	Reference Software 7751 Encryption Processor, Hi/fn, November 1998, HIFN 002164-2201, 38 pgs.	
	NPL361	Interface Specification for Synergize Encoding/Decoding Program, JPB, October 10, 1997, HIFN 002215-2216, 2 pgs.	
	NPL362	Anderson, Chip, Extended Memory Specification Driver, 1998, HIFN 002217-2264, 48 pgs.	
	NPL363	Whiting, Doug, LZS Hardware API, March 12, 1993, HIFN 002265-68, 4 pgs.	
	NPL364	Whiting, Doug, Encryption in Sequoia, April 28, 1997, HIFN 002309-2313, 5 pgs.	
	NPL365	LZS221-C Version 4 Data Compression Software, Data Sheet, Hi/fn, 1994-97, HIFN 002508-2525, 18 pgs.	

Examiner Signature		Date Considered	
-----------------------	--	--------------------	--

\*EXAMINER: Initial if reference considered, whether or not citation is in conformance with MPEP 609. Draw line through citation if not in conformance and not considered. Include copy of this form with next communication to applicant.

<sup>1</sup> Applicant's unique citation designation number (optional). <sup>2</sup> Applicant is to place a check mark here if English language Translation is attached.



Substitute for form 1449/PTO				<i>Complete if Known</i>	
<b>INFORMATION DISCLOSURE STATEMENT BY APPLICANT</b> <i>(Use as many sheets as necessary)</i>				Application Number	13/118,122
				Filing Date	May 27, 2011
				First Named Inventor	James J. FALLON
				Art Unit	2115
				Examiner Name	To Be Assigned
Sheet	43	of	66	Attorney Docket Number	2855.004000B

NON PATENT LITERATURE DOCUMENTS			
Examiner Initials*	Cite No. <sup>1</sup>	Include name of the author (in CAPITAL LETTERS), title of the article (when appropriate), title of the item (book, magazine, journal, serial, symposium, catalog, etc.), date, page(s), volume number, publisher, city and/or country where published	T <sup>2</sup>
	NPL366	eXtended Memory Specification (XMS), ver. 2.0, Microsoft, July 19, 1988, HIFN 002670-2683, 14 pgs.	
	NPL367	King, Stanley, Just for Your Info -- From Microsoft 2, May 4, 1992, HIFN 002684-2710, 27 pgs.	
	NPL368	eXtended Memory Specification (XMS), ver. 2.0, Microsoft, July 19, 1988, HIFN 002711-2724, 14 pgs.	
	NPL369	Advanced LZS Technology (ALZS), Whitepaper, Hi/fn, June 1, 1998, HIFN 002725-2727, 3 pgs.	
	NPL370	Secure Tape Technology (STT) Whitepaper, Hi/fn, June 1, 1998, HIFN 002728-2733, 6 pgs.	
	NPL371	SSLRef 3.0 API Details, Netscape, November 19, 1996, HIFN 002734-2778, 45 pgs.	
	NPL372	LZS221-C Version 4 Data Compression Software Data Sheet , Hi/fn, 1994-97, HIFN 002779-2796, 18 pgs.	
	NPL373	MPPC-C Version 4 Data Compression Software Data Sheet, Hi/fn, 1994-1997, HIFN 002797-2810, 14 pgs.	
	NPL374	Magstar MP Hardware Reference B Series Models Document GA32-0365-01, 1996-1997, [IBM_1_601 pages 1-338], 338 pages.	
	NPL375	Magstar MP 3570 Tape Subsystem, Operator Guide, B-Series Models, 1998-1999, [IBM_1_601 pages 339-525], 188 pages.	

Examiner Signature	Date Considered
-----------------------	--------------------

\*EXAMINER: Initial if reference considered, whether or not citation is in conformance with MPEP 609. Draw line through citation if not in conformance and not considered. Include copy of this form with next communication to applicant.

<sup>1</sup> Applicant's unique citation designation number (optional). <sup>2</sup> Applicant is to place a check mark here if English language Translation is attached.

Substitute for form 1449/PTO				<i>Complete if Known</i>	
<b>INFORMATION DISCLOSURE STATEMENT BY APPLICANT</b> <i>(Use as many sheets as necessary)</i>				Application Number	13/118,122
				Filing Date	May 27, 2011
				First Named Inventor	James J. FALLON
				Art Unit	2115
				Examiner Name	To Be Assigned
Sheet	44	of	66	Attorney Docket Number	2855.004000B

NON PATENT LITERATURE DOCUMENTS			
Examiner Initials*	Cite No. <sup>1</sup>	Include name of the author (in CAPITAL LETTERS), title of the article (when appropriate), title of the item (book, magazine, journal, serial, symposium, catalog, etc.), date, page(s), volume number, publisher, city and/or country where published	T <sup>2</sup>
	NPL376	Preview, IBM Magstar 3590 Tape System Enhancements, Hardware Announcement, February 16, 1999, [IBM_1_601 pages 526-527], 2 pgs.	
	NPL377	New IBM Magstar 3590 Models E11 and E1A Enhance Tape Drive Performance, Hardware Announcement, April 20, 1999, [IBM_1_601 pages 528-540] 13 pgs.	
	NPL378	NEW IBM Magstar 3590 Model A60 Dramatically Enhances Tape Drive Performance, Hardware Announcement July 27, 1999, [IBM_1_601 pages 541-550] 10 pgs.	
	NPL379	The IBM Magstar MP Tape Subsystem Provides Fast Access to Data, September 3, 1996, Announcement No. 196-176, [IBM_1_601 pages 551-563] 13 pgs.	
	NPL380	IBM 3590 High Performance Tape Subsystem, April 10, 1995, Announcement 195-106, [IBM_1_601 pages 564-581] 18 pgs.	
	NPL381	Standard ECMA-222 (June 1995): ECMA – Standardizing Information and Communications Systems, Adaptive Lossless Data Compression Algorithm, [IBM_1_601 pages 582-601] 20 pgs.	
	NPL382	IBM 3590 and 3494 Revised Availability, Hardware Announcement August 8, 1995, [IBM_743_1241 page 1] 1 pg.	
	NPL383	Direct Delivery of IBM 3494, 3466, and 3590 Storage Products, Hardware Announcement, September 30, 1997, Announcement 197-297, [IBM_743_1241 pages 2-3] 2 pgs.	
	NPL384	IBM Magstar 3590 Enhances Open Systems, Hardware Announcement February 9, 1996, Announcement 198-014, [IBM_743_1241 pages 4-7] 4 pgs.	
	NPL385	Hardware Withdrawal: IBM Magstar 3590 A00 Controller – Replacement Available, Announcement Number 197-267, Withdrawal Announcement, December 9, 1997, [IBM_743_1241 page 9] 1 pg.	

Examiner Signature		Date Considered	
-----------------------	--	--------------------	--

\*EXAMINER: Initial if reference considered, whether or not citation is in conformance with MPEP 609. Draw line through citation if not in conformance and not considered. Include copy of this form with next communication to applicant.

<sup>1</sup> Applicant's unique citation designation number (optional). <sup>2</sup> Applicant is to place a check mark here if English language Translation is attached.

Substitute for form 1449/PTO				<i>Complete if Known</i>	
<b>INFORMATION DISCLOSURE STATEMENT BY APPLICANT</b> <i>(Use as many sheets as necessary)</i>				Application Number	13/118,122
				Filing Date	May 27, 2011
				First Named Inventor	James J. FALLON
				Art Unit	2115
				Examiner Name	To Be Assigned
Sheet	45	of	66	Attorney Docket Number	2855.004000B

NON PATENT LITERATURE DOCUMENTS			
Examiner Initials*	Cite No. <sup>1</sup>	Include name of the author (in CAPITAL LETTERS), title of the article (when appropriate), title of the item (book, magazine, journal, serial, symposium, catalog, etc.), date, page(s), volume number, publisher, city and/or country where published	T <sup>2</sup>
	NPL386	IBM Magstar 3590 Tape Subsystem, Introduction and Planning Guide, Document No. GA32-0329007, [IBM_743_1241] pages 10-499] 490 pgs.	
	NPL387	NetMeeting 2.0 Reviewers Guide, April 1997, [MSCS_298_339] 42 pgs.	
	NPL388	Microsoft NetMeeting Compatible Products and Services Directory, April 1997, [MSCS_242_297] 56 pgs.	
	NPL389	Microsoft NetMeeting "Try This!" Guide, 1997, [MSCS_340_345] 6 pgs.	
	NPL390	The Professional Companion to NetMeeting 2 – The Technical Guide to Installing, Configuring, and Supporting NetMeeting 2.0 in Your Organization -Microsoft NetMeeting 2.0, 1996-97, [MSCS_2_241] 240 pgs.	
	NPL391	CUSecMe 3.1.2 User Guide, November 1998, [RAD_1_220] 220 pgs.	
	NPL392	MeetingPoint Conference Server Users Guide 3.0, November 1997, [RAD_221_548] 328 pgs.	
	NPL393	MeetingPoint Conference Server Users Guide 4.0.2, December 1999, [RAD_549_818] 270 pgs.	
	NPL394	MeetingPoint Conference Service Users Guide 3.5.1, December 1998, [RAD_819_1062] 244 pgs.	
	NPL395	Enhanced CUSecMe – Authorized Guide, 1995-1996, [RAD_1063_1372] 310 pgs.	

Examiner Signature		Date Considered	
-----------------------	--	--------------------	--

\*EXAMINER: Initial if reference considered, whether or not citation is in conformance with MPEP 609. Draw line through citation if not in conformance and not considered. Include copy of this form with next communication to applicant.

<sup>1</sup> Applicant's unique citation designation number (optional). <sup>2</sup> Applicant is to place a check mark here if English language Translation is attached.

Substitute for form 1449/PTO				<i>Complete if Known</i>	
<b>INFORMATION DISCLOSURE STATEMENT BY APPLICANT</b> <i>(Use as many sheets as necessary)</i>				Application Number	13/118,122
				Filing Date	May 27, 2011
				First Named Inventor	James J. FALLON
				Art Unit	2115
				Examiner Name	To Be Assigned
Sheet	46	of	66	Attorney Docket Number	2855.004000B

NON PATENT LITERATURE DOCUMENTS			
Examiner Initials*	Cite No. <sup>1</sup>	Include name of the author (in CAPITAL LETTERS), title of the article (when appropriate), title of the item (book, magazine, journal, serial, symposium, catalog, etc.), date, page(s), volume number, publisher, city and/or country where published	T <sup>2</sup>
	NPL396	Meeting Point Reader File, June 1999, [RAD_1437_1445] 9 pgs.	
	NPL397	Press Release - White Pine Announces Launch of MeetingPoint Conferences Server, October 9, 1997, [RAD_1738_1739] 2 pgs.	
	NPL398	Press Release - Leading Network Service Providers Line Up to Support White Pine's MeetingPoint Conference Server Technology, October 9, 1997, [RAD_1740_1743] 4 pgs.	
	NPL399	BYTE - A New MeetingPoint for Videoconferencing, October 9, 1997, [RAD_1744_1750] 7 pgs.	
	NPL400	Declaration of Patrick Gogerty, Realtime Data, LLC D/B/A Ixo v. Packeteer, Inc., et al., District Court for the Eastern District of Texas, No. 6:08cv144, executed May 8, 2009, 3 pgs.	
	NPL401	Other Responses to Interrogatories, Requests for Admission, and Objections to Requests for Admission filed in Realtime Data, LLC d/b/a/IXO v. Packeteer, Inc. et al., Civil Action No. 6:08-cv-00144-LED; U.S. District Court for the Eastern District of Texas. (PTO Notified -- Document NOT submitted)	
	NPL402	Deposition Transcript of persons involved in litigation, including inventor James Fallon, and third-party witnesses Jim Karp, Ke-Chiang Chu, and Frank V. DeRosa filed in Realtime Data, LLC d/b/a/IXO v. Packeteer, Inc. et al., Civil Action No. 6:08-cv-00144-LED; U.S. District Court for the Eastern District of Texas. (PTO Notified -- Document NOT submitted)	
	NPL403	Office of Rebuttal Expert Reports of Dr. Brian Von Herzen, Lester L. Hewitt and Dr. James A. Storer, and Expert Reports of Dr. James A. Storer and Dr. Nathaniel Polish filed in Realtime Data, LLC d/b/a/IXO v. Packeteer, Inc. et al., Civil Action No. 6:08-cv-00144-LED; U.S. District Court for the Eastern District of Texas. (PTO Notified -- Document NOT submitted)	
	NPL404	Proposed Amended Infringement Contentions filed in Realtime Data, LLC d/b/a/IXO v. Packeteer, Inc. et al., Civil Action No. 6:08-cv-00144-LED; U.S. District Court for the Eastern District of Texas. (PTO Notified -- Document NOT submitted)	
	NPL405	Documents Concerning Agreements for Mediations and Mediation Proceedings Between Plaintiffs and Some of the Defendants filed in Realtime Data, LLC d/b/a/IXO v. Packeteer, Inc. et al., Civil Action No. 6:08-cv-00144-LED; U.S. District Court for the Eastern District of Texas. (PTO Notified -- Document NOT submitted)	

Examiner Signature		Date Considered	
-----------------------	--	--------------------	--

\*EXAMINER: Initial if reference considered, whether or not citation is in conformance with MPEP 609. Draw line through citation if not in conformance and not considered. Include copy of this form with next communication to applicant.

<sup>1</sup> Applicant's unique citation designation number (optional). <sup>2</sup> Applicant is to place a check mark here if English language Translation is attached.

Substitute for form 1449/PTO				<i>Complete if Known</i>	
<b>INFORMATION DISCLOSURE STATEMENT BY APPLICANT</b> <i>(Use as many sheets as necessary)</i>				Application Number	13/118,122
				Filing Date	May 27, 2011
				First Named Inventor	James J. FALLON
				Art Unit	2115
				Examiner Name	To Be Assigned
Sheet	47	of	66	Attorney Docket Number	2855.004000B

NON PATENT LITERATURE DOCUMENTS			
Examiner Initials*	Cite No. <sup>1</sup>	Include name of the author (in CAPITAL LETTERS), title of the article (when appropriate), title of the item (book, magazine, journal, serial, symposium, catalog, etc.), date, page(s), volume number, publisher, city and/or country where published	T <sup>2</sup>
	NPL406	Plaintiff's Opposition to Joint Defendants' Motion for Partial Summary Judgment of Invalidity of some of the patents in Suit for indefiniteness, including the '104 patent, Blue Coat's response to this objection, Blue Coat's Reply to Plaintiff's response and Plaintiff's Sur-Reply to Blue Coat's Reply filed in Realtime Data, LLC d/b/a/IXO v. Packeteer, Inc. et al., Civil Action No. 6:08-cv-00144-LED; U.S. District Court for the Eastern District of Texas. (PTO Notified -- Document NOT submitted)	
	NPL407	Plaintiff's Amended P.R. 3-1 Disclosures and Infringement Contentions, Defendants' Motions to Strick unauthorized portions of these disclosures, and Sur-Replies to these Motions filed in Realtime Data, LLC d/b/a/IXO v. Packeteer, Inc. et al., Civil Action No. 6:08-cv-00144-LED; U.S. District Court for the Eastern District of Texas. (PTO Notified -- Document NOT submitted)	
	NPL408	Expert Report of Dr. James A. Storer Regarding Non-Infringement that contains positions related to the validity of the patents in suit filed in Realtime Data, LLC d/b/a/IXO v. Packeteer, Inc. et al., Civil Action No. 6:08-cv-00144-LED; U.S. District Court for the Eastern District of Texas. (PTO Notified -- Document NOT submitted)	
	NPL409	Thomson Reuters Corporation v. Realtime Data, LLC D/B/A IXO, No. 09 CV 7868 (S.D.N.Y.) 2009.09.23 Order Dismissing Case in Favor of Texas Action, 1 pg.	
	NPL410	Thomson Reuters Corporation v. Realtime Data, LLC D/B/A IXO, No. 09 CV 7868 (S.D.N.Y.) 2009.09.30 Response to Order re Transfer, 103 pgs.	
	NPL411	Thomson Reuters Corporation v. Realtime Data, LLC D/B/A IXO, No. 09 CV 7868 (S.D.N.Y.) 2009.10.07 Reply Letter regarding Judge Berman 2009.09.23 Order re Transfer, 182 pgs.	
	NPL412	Thomson Reuters Corporation v. Realtime Data, LLC D/B/A IXO, No. 09 CV 7868 (S.D.N.Y.) 2009.10.15 Order Staying Case Until TX Action Decided, 3 pgs.	
	NPL413	Thomson Reuters Corporation v. Realtime Data, LLC D/B/A IXO, No. 09 CV 7868 (S.D.N.Y.) 2009.09.11 Complaint - DJ SD NY, 41 pgs.	
	NPL414	Thomson Reuters Corporation v. Realtime Data, LLC D/B/A IXO, No. 09 CV 7868 (S.D.N.Y.) 2009.09.11 Rule 7.1 Disclosure Statement for Thomson Reuters, 1 pg.	
	NPL415	Thomson Reuters Corporation v. Realtime Data, LLC D/B/A IXO, No. 09 CV 7868 (S.D.N.Y.) Order- Stay Pending Transfer Motion Confirmed 10_15_09, 3 pgs.	

Examiner Signature	Date Considered
-----------------------	--------------------

\*EXAMINER: Initial if reference considered, whether or not citation is in conformance with MPEP 609. Draw line through citation if not in conformance and not considered. Include copy of this form with next communication to applicant.

<sup>1</sup> Applicant's unique citation designation number (optional). <sup>2</sup> Applicant is to place a check mark here if English language Translation is attached.

Substitute for form 1449/PTO				<i>Complete if Known</i>	
<b>INFORMATION DISCLOSURE STATEMENT BY APPLICANT</b> <i>(Use as many sheets as necessary)</i>				Application Number	13/118,122
				Filing Date	May 27, 2011
				First Named Inventor	James J. FALLON
				Art Unit	2115
				Examiner Name	To Be Assigned
Sheet	48	of	66	Attorney Docket Number	2855.004000B

NON PATENT LITERATURE DOCUMENTS			
Examiner Initials*	Cite No. <sup>1</sup>	Include name of the author (in CAPITAL LETTERS), title of the article (when appropriate), title of the item (book, magazine, journal, serial, symposium, catalog, etc.), date, page(s), volume number, publisher, city and/or country where published	T <sup>2</sup>
	NPL416	Opinion and Order of United States Magistrate Judge regarding Claim Construction, Realtime Data, LLC D/B/A Ixo v. Packeteer, Inc., et al., District Court for the Eastern District of Texas, No. 6:08cv144, issued June 22, 2009, 75 pgs.	
	NPL417	Script for Realties' Technology Tutorial Presented to the Magistrate Judge in Realtime Data, LLC d/b/a/IXO v. Packeteer, Inc. et al., Civil Action No. 6:08-cv-00144-LED; U.S. District Court for the Eastern District of Texas, March 16, 2009, 69 pgs.	
	NPL418	Opinion and Order of United States Magistrate Judge regarding Plaintiff's Motion to Strike Unauthorized New Invalidity Theories from Defendant Citrix's Opening and Reply Briefs in Support of its Motion for Summary Judgment of Invalidity, Realtime Data, LLC D/B/A Ixo v. Packeteer, Inc., et al., District Court for the Eastern District of Texas, No. 6:08cv144, issued Dec. 8, 2009, 10 pgs.	
	NPL419	Defendant Citrix Systems, Inc.'s Notice Pursuant to 35 U.S.C. Section 282 Disclosures, Realtime Data, LLC D/B/A Ixo v. Packeteer, Inc., et al., District Court for the Eastern District of Texas, No. 6:08cv144, filed December 11, 2009, 7 pgs.	
	NPL420	Blue Coat Defendants' Notice Pursuant to 35 U.S.C. Section 282 Disclosures, Realtime Data, LLC D/B/A Ixo v. Packeteer, Inc., et al., District Court for the Eastern District of Texas, No. 6:08cv144, filed December 11, 2009, 7 pgs.	
	NPL421	Expand Networks' 35 U.S.C. Section 282 Disclosures, Realtime Data, LLC D/B/A Ixo v. Packeteer, Inc., et al., District Court for the Eastern District of Texas, No. 6:08cv144, filed December 11, 2009, 4 pgs.	
	NPL422	Expand Networks' 35 U.S.C. Section 282 Disclosures (Amended), Realtime Data, LLC D/B/A Ixo v. Packeteer, Inc., et al., District Court for the Eastern District of Texas, No. 6:08cv144, filed December 11, 2009, 5 pgs.	
	NPL423	Defendant Citrix Systems, Inc.'s Notice of Obviousness Combinations Pursuant to Court Order, Realtime Data, LLC D/B/A Ixo v. Packeteer, Inc., et al., District Court for the Eastern District of Texas, No. 6:08cv144, filed December 11, 2009, 3 pgs.	
	NPL424	Order of United States Magistrate Judge regarding Motion to Limit the Number of Prior Art References to be Asserted at Trial, Realtime Data, LLC D/B/A Ixo v. Packeteer, Inc., et al., District Court for the Eastern District of Texas, No. 6:08cv144, filed December 21, 2009, 6 pgs.	
	NPL425	Expand Defendants' Notice of Obviousness Combinations Pursuant to Court Order, Realtime Data, LLC D/B/A Ixo v. Packeteer, Inc., et al., District Court for the Eastern District of Texas, No. 6:08cv144, filed December 22, 2009, 3 pgs.	

Examiner Signature		Date Considered	
-----------------------	--	--------------------	--

\*EXAMINER: Initial if reference considered, whether or not citation is in conformance with MPEP 609. Draw line through citation if not in conformance and not considered. Include copy of this form with next communication to applicant.

<sup>1</sup> Applicant's unique citation designation number (optional). <sup>2</sup> Applicant is to place a check mark here if English language Translation is attached.

Substitute for form 1449/PTO				<i>Complete if Known</i>	
<b>INFORMATION DISCLOSURE STATEMENT BY APPLICANT</b> <i>(Use as many sheets as necessary)</i>				Application Number	13/118,122
				Filing Date	May 27, 2011
				First Named Inventor	James J. FALLON
				Art Unit	2115
				Examiner Name	To Be Assigned
Sheet	49	of	66	Attorney Docket Number	2855.004000B

NON PATENT LITERATURE DOCUMENTS			
Examiner Initials*	Cite No. <sup>1</sup>	Include name of the author (in CAPITAL LETTERS), title of the article (when appropriate), title of the item (book, magazine, journal, serial, symposium, catalog, etc.), date, page(s), volume number, publisher, city and/or country where published	T <sup>2</sup>
	NPL426	Blue Coat Systems, Inc. and 7-Eleven, Inc.'s Notice of Obviousness Combinations to be Used at Trial, Realtime Data, LLC D/B/A Ixo v. Packeteer, Inc., et al., District Court for the Eastern District of Texas, No. 6:08cv144, filed December 22, 2009, 38 pgs.	
	NPL427	Defendant Citrix Systems, Inc.'s Notice of Other Prior Art References Within the Scope of the References Discussed at the Dec. 17, 2009 Hearing, Realtime Data, LLC D/B/A Ixo v. Packeteer, Inc., et al., District Court for the Eastern District of Texas, No. 6:08cv144, filed December 29, 2009, 6 pgs.	
	NPL428	Docket Listing downloaded March 10, 2010 for Realtime Data, LLC D/B/A Ixo v. Packeteer, Inc., et al., District Court for the Eastern District of Texas, No. 6:08cv144, filed April 18, 2008, 165 pgs.	
	NPL429	CCITT Draft Recommendation T.4, RFC 804, January 1981, 12 pgs.	
	NPL430	SNA Formats, IBM Corporation, 14th Ed., November 1993, 3 pgs.	
	NPL431	Munteanu et al, "Wavelet-Based Lossless Compression Scheme with Progressive Transmission Capability," John Wiley & Sons, Inc., Int'l J. Imaging Sys. Tech., vol. 10, (1999) pgs 76-85.	
	NPL432	Forchhammer and Jensen, "Data Compression of Scanned Halftone Images," IEEE Trans. Commun., vol. 42, Feb.-Apr. 1994, pgs 1881-1893.	
	NPL433	Christopher Eoyang et al., "The Birth of the Second Generation: The Hitachi S-820/80," Proceedings of the 1998 ACM/IEEE Conference on Supercomputing, pgs 296-303 (1998)	
	NPL434	Transcript for Hearing on Motions for Summary Judgment, Realtime Data, LLC d/b/a IXO v. Packeteer, Inc. et al, Civil Action No. 6:08-cv-00144-LED; U.S. District Court for the Eastern District of Texas, 133 pgs, November 8, 2009.	
	NPL435	Transcript for Motions Hearing (Including Supplemental Claim Construction Hearing), Realtime Data, LLC d/b/a IXO v. Packeteer, Inc. et al, Civil Action No. 6:08-cv-00144-LED; U.S. District Court for the Eastern District of Texas, 88 pgs, November 10, 2009	

Examiner Signature		Date Considered	
--------------------	--	-----------------	--

\*EXAMINER: Initial if reference considered, whether or not citation is in conformance with MPEP 609. Draw line through citation if not in conformance and not considered. Include copy of this form with next communication to applicant.

<sup>1</sup> Applicant's unique citation designation number (optional). <sup>2</sup> Applicant is to place a check mark here if English language Translation is attached.

Substitute for form 1449/PTO				<i>Complete if Known</i>	
<b>INFORMATION DISCLOSURE STATEMENT BY APPLICANT</b> <i>(Use as many sheets as necessary)</i>				Application Number	13/118,122
				Filing Date	May 27, 2011
				First Named Inventor	James J. FALLON
				Art Unit	2115
				Examiner Name	To Be Assigned
Sheet	50	of	66	Attorney Docket Number	2855.004000B

NON PATENT LITERATURE DOCUMENTS			
Examiner Initials*	Cite No. <sup>1</sup>	Include name of the author (in CAPITAL LETTERS), title of the article (when appropriate), title of the item (book, magazine, journal, serial, symposium, catalog, etc.), date, page(s), volume number, publisher, city and/or country where published	T <sup>2</sup>
	NPL436	Nelson, "The Data Compression Book," M&T Books (2nd Ed. 1996), 283 pgs.	
	NPL437	"The Authoritative Dictionary of IEEE Standards Terms," 7th Ed. 2000, pg. 273.	
	NPL438	Larousse Dictionary of Science and Technology, 1st Ed., 1995, pg. 916.	
	NPL439	Plaintiff Realtime Data's Motion to Strike Unauthorized New Invalidity Theories from Defendant Citrix's Opening and Reply Briefs in Support Its Motion for Summary Judgment of Invalidity of U.S. Patent No. 7,352,300 (September 22, 2009), 14 pgs.	
	NPL440	Realtime Data's Reply in Support of Its Motion to Strike Unauthorized New Invalidity Theories from Defendant Citrix's Opening and Reply Briefs in Support of Its Motion for Summary Judgment of Invalidity of U.S. Patent No. 7,352,300 (October 19, 2009), 17 pgs.	
	NPL441	Defendant Citrix Systems, Inc.'s Sur-Reply in Opposition to Realtime Data LLC's Motion to Strike Unauthorized New Invalidity Theories from Citrix's Opening and Reply Briefs in Support of Its Motion for Summary Judgment of Invalidity of U.S. Patent No. 7,352,300 (October 30, 2009), 9 pgs.	
	NPL442	Blue Coat Defendants' Response to Realtime Data, LLC's Notice Re Proposed Construction of "Data Storage Rate" (November 11, 2009), 3 pgs.	
	NPL443	Order for Supplemental Briefing on Blue Coat 7-11 Motion for Partial SJ on Non-infringement of Pat 6,601,104 (November 13, 2009), 6 pgs.	
	NPL444	Memorandum Opinion and Order, Realtime Data, LLC D/B/A IXO v. Packeteer, Inc., et al., Civil No. 6:08-cv-144-LED-JDL, U.S. District Court for the Eastern District of Texas, 15 pages, November 23, 2009.	
	NPL445	Memorandum Opinion and Order, Realtime Data, LLC, v. Packeteer, Inc., et al., Civil No. 6:08-cv-144-LED-JDL, U.S. District Court for the Eastern District of Texas, 10 pages, December 8, 2009.	

Examiner Signature		Date Considered	
-----------------------	--	--------------------	--

\*EXAMINER: Initial if reference considered, whether or not citation is in conformance with MPEP 609. Draw line through citation if not in conformance and not considered. Include copy of this form with next communication to applicant.

<sup>1</sup> Applicant's unique citation designation number (optional). <sup>2</sup> Applicant is to place a check mark here if English language Translation is attached.



Substitute for form 1449/PTO				<i>Complete if Known</i>	
<b>INFORMATION DISCLOSURE STATEMENT BY APPLICANT</b> <i>(Use as many sheets as necessary)</i>				Application Number	13/118,122
				Filing Date	May 27, 2011
				First Named Inventor	James J. FALLON
				Art Unit	2115
				Examiner Name	To Be Assigned
Sheet	51	of	66	Attorney Docket Number	2855.004000B

NON PATENT LITERATURE DOCUMENTS			
Examiner Initials*	Cite No. <sup>1</sup>	Include name of the author (in CAPITAL LETTERS), title of the article (when appropriate), title of the item (book, magazine, journal, serial, symposium, catalog, etc.), date, page(s), volume number, publisher, city and/or country where published	T <sup>2</sup>
	NPL446	Expand's Conclusions of Fact and Law Regarding Defense of Inequitable Conduct Concerning the Unenforceability of U.S. Patent No. 7,321,937 (November 12, 2009), 3 pgs.	
	NPL447	Realtime Data's Sur-reply Supplemental Claim Construction Brief Concerning Whether the Asserted Claims of the '104 Patent are Product Claims (December 23, 2009), 6 pgs.	
	NPL448	Order regarding Defendant Citrix Systems, Inc's Notice of Other Prior Art References Within the Scope of the References Discussed at the December 17, 2009 Hearing (December 30, 2009), 3 pgs.	
	NPL449	Network Working group RFC 2068 (Jan. 1997), 163 pgs.	
	NPL450	Network Working group RFC 2616 (Jun. 1999), 114 pgs.	
	NPL451	Network Working group RFC 1945 (May 1996), 61 pgs.	
	NPL452	Network Working group RFC 1950 (May 1996), 10 pgs.	
	NPL453	Network Working group RFC 1951 (May 1996), 15 pgs.	
	NPL454	Network Working group RFC 1952 (May 1996), 12 pgs.	
	NPL455	Notice of Plaintiff Realtime Data LLC's Proposed Supplemental Construction of "Data Storage Rate" In Response to the Court's Comments During the November 10, 2009 Supplemental Claim Construction Hearing (November 10, 2009), 4 pgs.	

Examiner Signature		Date Considered	
-----------------------	--	--------------------	--

\*EXAMINER: Initial if reference considered, whether or not citation is in conformance with MPEP 609. Draw line through citation if not in conformance and not considered. Include copy of this form with next communication to applicant.

<sup>1</sup> Applicant's unique citation designation number (optional). <sup>2</sup> Applicant is to place a check mark here if English language Translation is attached.

Substitute for form 1449/PTO				<i>Complete if Known</i>	
<b>INFORMATION DISCLOSURE STATEMENT BY APPLICANT</b> <i>(Use as many sheets as necessary)</i>				Application Number	13/118,122
				Filing Date	May 27, 2011
				First Named Inventor	James J. FALLON
				Art Unit	2115
				Examiner Name	To Be Assigned
Sheet	52	of	66	Attorney Docket Number	2855.004000B

NON PATENT LITERATURE DOCUMENTS			
Examiner Initials*	Cite No. <sup>1</sup>	Include name of the author (in CAPITAL LETTERS), title of the article (when appropriate), title of the item (book, magazine, journal, serial, symposium, catalog, etc.), date, page(s), volume number, publisher, city and/or country where published	T <sup>2</sup>
	NPL456	Citrix's Amended Invalidity Contentions, Including Appendices G2-G8 (December 15, 2009), 509 pgs.	
	NPL457	"Plaintiff Realtime Data's Opposition to Defendant F5 Networks' Motion for Summary Judgment that Claims 18-20 of U.S. Patent No. 7,321,937 are Invalid (August 25, 2009)" Civil Action No. 6:08-cv-00144-LED Jury Trial Demanded Filed Under Seal; In the United States District Court for the Eastern District of Texas Tyler Division. [Under Seal - Document NOT Submitted]	
	NPL458	Declaration of Dr. James W. Modestino relating to U.S. Patent No. 7,161,506, March 15, 2010, 49 pgs.	
	NPL459	Second Declaration of Dr. George T. Ligler under 37 C.F.R. §1.132 relating to U.S. Patent No. 6,601,104, executed May 5, 2010, 3 pgs.	
	NPL460	Realtime Data, LLC Complaint for Patent Infringement, Realtime Data, LLC D/B/A IXO v. CME Group Inc., et al. (II), District Court for the Eastern District of Texas, No. 6:10-cv-246, filed May 11, 2010, 24 pages.	
	NPL461	Realtime Data, LLC Complaint for Patent Infringement, Realtime Data, LLC D/B/A IXO v. Thompson Reuters Corporation, et al. (II), District Court for the Eastern District of Texas, No. 6:10-cv-247, filed May 11, 2010, 15 pages.	
	NPL462	Realtime Data, LLC Complaint for Patent Infringement, Realtime Data, LLC D/B/A IXO v. Morgan Stanley, et al. (II), District Court for the Eastern District of Texas, No. 6:10-cv-248, filed May 11, 2010, 27 pages.	
	NPL463	Declaration of Padmaja Chinta In Support of Realtime Data's Reply Claim Construction Brief (including Exhibits A-S), Realtime Data, LLC D/B/A IXO v. Packeteer, Inc., et al., District Court for the Eastern District of Texas, No. 6:08-cv-00144-LED, dated March 30, 2009, 217 pgs.	
	NPL464	Extended European search report issuing from European Patent Application 09150508.1, A August 3, 2010, 5 pgs.	
	NPL465	Complaint, Thomson Reuters Corporation v. Realtime Data, LLC D/B/A IXO, Southern District of New York, No. 2:09-cv-7868-RMB, filed September 11, 2009, 6 pages.	

Examiner Signature		Date Considered	
-----------------------	--	--------------------	--

\*EXAMINER: Initial if reference considered, whether or not citation is in conformance with MPEP 609. Draw line through citation if not in conformance and not considered. Include copy of this form with next communication to applicant.

<sup>1</sup> Applicant's unique citation designation number (optional). <sup>2</sup> Applicant is to place a check mark here if English language Translation is attached.

Substitute for form 1449/PTO				<i>Complete if Known</i>	
<b>INFORMATION DISCLOSURE STATEMENT BY APPLICANT</b> <i>(Use as many sheets as necessary)</i>				Application Number	13/118,122
				Filing Date	May 27, 2011
				First Named Inventor	James J. FALLON
				Art Unit	2115
				Examiner Name	To Be Assigned
Sheet	53	of	66	Attorney Docket Number	2855.004000B

NON PATENT LITERATURE DOCUMENTS			
Examiner Initials*	Cite No. <sup>1</sup>	Include name of the author (in CAPITAL LETTERS), title of the article (when appropriate), title of the item (book, magazine, journal, serial, symposium, catalog, etc.), date, page(s), volume number, publisher, city and/or country where published	T <sup>2</sup>
	NPL466	Realtime Data, LLC Complaint for Patent Infringement, Realtime Data, LLC D/B/A IXO v. MetroPCS Texas, LLC et al., District Court for the Eastern District of Texas, No. 6:10-cv-00493, filed September 23, 2010, 14 pages.	
	NPL467	Complaint and Demand for Jury Trial, Chicago Board Options Exchange, Incorporated v. Realtime Data, LLC D/B/A IXO, United States District Court for the Northern District of Illinois, No. 09 CV 4486, filed July 24, 2009, 6 pages.	
	NPL468	Realtime's Response in Opposition to the Defendants' Joint Objections to Report and Recommendation of Magistrate Regarding Motion for Partial Summary Judgment of Invalidity for Indefiniteness, in Realtime Data, LLC d/b/a/IXO v. Packeteer, Inc. et al., Civil Action No. 6:08-cv-00144-LED; U.S. District Court for the Eastern District of Texas, July 27, 2009, 15 pgs.	
	NPL469	Reply to Realtime's Response to Blue Coat Defendants' Objections to Report and Recommendation of United States Magistrate Judge Regarding Motion for Partial Summary Judgment of Invalidity for Indefiniteness Entered June 23, 2009, in Realtime Data, LLC d/b/a/IXO v. Packeteer, Inc. et al., Civil Action No. 6:08-cv-00144-LED; U.S. District Court for the Eastern District of Texas, July 31, 2009, 3 pgs.	
	NPL470	Realtime Data's Sur-Reply in Opposition to the Defendants' Joint Objections to Report and Recommendation of Magistrate Regarding Motion for Partial Summary Judgment of Invalidity for Indefiniteness, in Realtime Data, LLC d/b/a/IXO v. Packeteer, Inc. et al., Civil Action No. 6:08-cv-00144-LED; U.S. District Court for the Eastern District of Texas, August 3, 2009, 3 pgs.	
	NPL471	Defendants' Invalidity Contentions, Realtime Data, LLC d/b/a IXO, vs. MetroPCS Texas, LLC, et al., Case No. 6:10-CV-00493-LED, In the United States District Court Eastern District of Texas Tyler Division, June 17, 2011, 138 pages.	
	NPL472	Appendix A, Claim Charts A-1 to A-25, from Invalidity Contentions, Realtime Data LLC v. MetroPCS Texas, LLC, et al., Case No. 6:10-CV-00493-LED, June 17, 2011, 173 pages.	
	NPL473	Appendix B, Claim Charts B-1 to B-23, from Realtime Data LLC v. MetroPCS Texas, LLC et al., Case No. 6:10-CV-00493-LED, June 17, 2011, 809 pages.	
	NPL474	Appendix C, Claim Charts C-1 to C-22, from Realtime Data LLC v. MetroPCS Texas, LLC et al., Case No. 6:10-CV-00493-LED, June 17, 2011, 530 pages.	
	NPL475	Appendix D, Claim Charts D-1 to D-16, from Realtime Data LLC v. MetroPCS Texas, LLC et al., Case No. 6:10-CV-00493-LED, June 17, 2011, 253 pages.	

Examiner Signature		Date Considered	
--------------------	--	-----------------	--

\*EXAMINER: Initial if reference considered, whether or not citation is in conformance with MPEP 609. Draw line through citation if not in conformance and not considered. Include copy of this form with next communication to applicant.

<sup>1</sup> Applicant's unique citation designation number (optional). <sup>2</sup> Applicant is to place a check mark here if English language Translation is attached.

Substitute for form 1449/PTO				<i>Complete if Known</i>	
<b>INFORMATION DISCLOSURE STATEMENT BY APPLICANT</b> <i>(Use as many sheets as necessary)</i>				Application Number	13/118,122
				Filing Date	May 27, 2011
				First Named Inventor	James J. FALLON
				Art Unit	2115
				Examiner Name	To Be Assigned
Sheet	54	of	66	Attorney Docket Number	2855.004000B

NON PATENT LITERATURE DOCUMENTS			
Examiner Initials*	Cite No. <sup>1</sup>	Include name of the author (in CAPITAL LETTERS), title of the article (when appropriate), title of the item (book, magazine, journal, serial, symposium, catalog, etc.), date, page(s), volume number, publisher, city and/or country where published	T <sup>2</sup>
	NPL476	Appendix E, Claim Charts E-1 to E-20, from Realtime Data LLC v. MetroPCS Texas, LLC et al., Case No. 6:10-CV-00493-LED, June 17, 2011, 397 pages.	
	NPL477	Appendix F, Claim Charts F-1 to F-19, from Realtime Data LLC v. MetroPCS Texas, LLC et al., Case No. 6:10-CV-00493-LED, June 17, 2011, 462 pages.	
	NPL478	Appendix G, Claim Charts G-1 to G-18, from Realtime Data LLC v. MetroPCS Texas, LLC et al., Case No. 6:10-CV-00493-LED, June 17, 2011, 548 pages.	
	NPL479	Appendix H, Claim Charts H-1 to H-22, from Realtime Data LLC v. MetroPCS Texas, LLC et al., Case No. 6:10-CV-00493-LED, June 17, 2011, 151 pages.	
	NPL480	AMIR et al., "An Application Level Video Gateway," 1995, 11 pages.	
	NPL481	KATZ, Randy H. and Eric A. Brewer, "The Bay Area Research Wireless Access Network: Towards a Wireless Overlay Internetworking Architecture," Computer Science Division, EECS Department, U.C. Berkeley, 1995, 56 pages.	
	NPL482	KATZ, R.H. and E.A. Brewer, "The Bay Area Research Wireless Access Network (BARWAN)," UC Berkeley, 1995, 68 pages.	
	NPL483	BRUCKMAN, Alfred and Andreas UHL, "Selective Medical Image Compression Using Wavelet Techniques," June 1998, 23 pages.	
	NPL484	CROWLEY et al., "Dynamic Compression During System Save Operations," May 1, 1984, 3 pages.	
	NPL485	HERSHKOVITS, "Universal Data Compression with Finite-Memory," February 1995, 99 pages.	

Examiner Signature		Date Considered	
-----------------------	--	--------------------	--

\*EXAMINER: Initial if reference considered, whether or not citation is in conformance with MPEP 609. Draw line through citation if not in conformance and not considered. Include copy of this form with next communication to applicant.

<sup>1</sup> Applicant's unique citation designation number (optional). <sup>2</sup> Applicant is to place a check mark here if English language Translation is attached.

Substitute for form 1449/PTO				<i>Complete if Known</i>	
<b>INFORMATION DISCLOSURE STATEMENT BY APPLICANT</b> <i>(Use as many sheets as necessary)</i>				Application Number	13/118,122
				Filing Date	May 27, 2011
				First Named Inventor	James J. FALLON
				Art Unit	2115
				Examiner Name	To Be Assigned
Sheet	55	of	66	Attorney Docket Number	2855.004000B

NON PATENT LITERATURE DOCUMENTS			
Examiner Initials*	Cite No. <sup>1</sup>	Include name of the author (in CAPITAL LETTERS), title of the article (when appropriate), title of the item (book, magazine, journal, serial, symposium, catalog, etc.), date, page(s), volume number, publisher, city and/or country where published	T <sup>2</sup>
	NPL486	KATZ et al., "The Bay Area Research Wireless Access Networks (BARWAN)," 1996, 6 pages.	
	NPL487	KLEIN, "Compression and Coding in Information Retrieval Systems," June 1987, pages vii-viii, 1-4, 10-15, 22-30, 43-48, 62-66, 86-89, 108-111.	
	NPL488	REGHBATI, "An Overview of Data Compression Techniques," April 1981, pages 71-75.	
	NPL489	Court Docket Listing for 6:10-cv-00493-LED Realtime Data, LLC D/B/A/IXO, v. MetroPCS Texas, LLC et al., dated July 20, 2011, 13 pages.	
	NPL490	Court Docket History for 1:09-cv-04486 Chicago Board Options Exchange, Incorporated v. Realtime Data, LLC, dated July 20, 2011, 7 pages.	
	NPL491	Court Docket History for 6:08-cv-00144-LED-JDL Realtime Data, LLC d/b/a IXO v. Packeteer, Inc. et al, dated July 20, 2011, 119 pages.	
	NPL492	Court Docket History for 6:09-cv-00326-LED-JDL Realtime Data, LLC D/B/A/ IXO, v. Morgan Stanley et al, dated July 20, 2011, 44 pages.	
	NPL493	Court Docket History for 6:09-cv-00327-LED-JDL Realtime Data, LLC D/B/A/IXO, v. CME Group Inc. et al, dated July 20, 2011, 55 pages.	
	NPL494	Court Docket History for 6:09-cv-00333-LED-JDL Realtime Data, LLC d/b/a IXO v. Thomson Reuters et al, dated July 20, 2011, 29 pages.	
	NPL495	Court Docket History for 1:09-cv-07868-RMB Thomson Reuters Corporation v. Realtime Data, LLC, dated July 20, 2011, 3 pages.	

Examiner Signature		Date Considered	
-----------------------	--	--------------------	--

\*EXAMINER: Initial if reference considered, whether or not citation is in conformance with MPEP 609. Draw line through citation if not in conformance and not considered. Include copy of this form with next communication to applicant.

<sup>1</sup> Applicant's unique citation designation number (optional). <sup>2</sup> Applicant is to place a check mark here if English language Translation is attached.

Substitute for form 1449/PTO				<i>Complete if Known</i>	
<b>INFORMATION DISCLOSURE STATEMENT BY APPLICANT</b> <i>(Use as many sheets as necessary)</i>				Application Number	13/118,122
				Filing Date	May 27, 2011
				First Named Inventor	James J. FALLON
				Art Unit	2115
				Examiner Name	To Be Assigned
Sheet	56	of	66	Attorney Docket Number	2855.004000B

NON PATENT LITERATURE DOCUMENTS			
Examiner Initials*	Cite No. <sup>1</sup>	Include name of the author (in CAPITAL LETTERS), title of the article (when appropriate), title of the item (book, magazine, journal, serial, symposium, catalog, etc.), date, page(s), volume number, publisher, city and/or country where published	T <sup>2</sup>
	NPL496	Notice of Allowance in Commonly-Assigned U.S. Application. No. 11/651,366, issued April 10, 2009, 7 pgs.	
	NPL497	Copy of Non-Final Office Action for U.S. Appl. No. 12/684,624, mailed November 10, 2010, 5 pgs.	
	NPL498	Copy of Notice of Allowance for U.S. Appl. No. 12/123,081, mailed February 17, 2011, 7 pgs.	
	NPL499	Copy of Non-Final Office Action for U.S. Appl. No. 12/688,413, mailed September 27, 2010, 13 pgs.	
	NPL500	Copy of Notice of Allowance for U.S. Appl. No. 11/551,211, mailed January 31, 2011, 4 pgs.	
	NPL501	Copy of Notice of Allowance for U.S. Appl. No. 11/551,211, mailed September 22, 2010, 4 pgs.	
	NPL502	Copy of Notice of Allowance for U.S. Appl. No. 11/551,204, mailed January 11, 2011, 4 pgs.	
	NPL503	Copy of Notice of Allowance for U.S. Appl. No. 11/553,419, mailed September 22, 2010, 4 pgs.	
	NPL504	Copy of Non-Final Office Action for U.S. Appl. No. 11/400,008, mailed November 23, 2010, 7 pgs.	
	NPL505	Copy of Notice of Allowance for U.S. Appl. No. 11/651,365, mailed February 4, 2010, 8 pgs.	

Examiner Signature		Date Considered	
-----------------------	--	--------------------	--

\*EXAMINER: Initial if reference considered, whether or not citation is in conformance with MPEP 609. Draw line through citation if not in conformance and not considered. Include copy of this form with next communication to applicant.

<sup>1</sup> Applicant's unique citation designation number (optional). <sup>2</sup> Applicant is to place a check mark here if English language Translation is attached.

Substitute for form 1449/PTO				<i>Complete if Known</i>	
<b>INFORMATION DISCLOSURE STATEMENT BY APPLICANT</b> <i>(Use as many sheets as necessary)</i>				Application Number	13/118,122
				Filing Date	May 27, 2011
				First Named Inventor	James J. FALLON
				Art Unit	2115
				Examiner Name	To Be Assigned
Sheet	57	of	66	Attorney Docket Number	2855.004000B

NON PATENT LITERATURE DOCUMENTS			
Examiner Initials*	Cite No. <sup>1</sup>	Include name of the author (in CAPITAL LETTERS), title of the article (when appropriate), title of the item (book, magazine, journal, serial, symposium, catalog, etc.), date, page(s), volume number, publisher, city and/or country where published	T <sup>2</sup>
	NPL506	Copy of Notice of Allowance for U.S. Appl. No. 11/651,365, mailed November 19, 2009, 8 pgs.	
	NPL507	Copy of Non-Final Office Action for U.S. Appl. No. 09/969,987, mailed August 27, 2010, 13 pgs.	
	NPL508	Copy of Final Office Action for U.S. Appl. No. 09/969,987, mailed January 28, 2010, 11 pgs.	
	NPL509	Copy of Notice of Allowance for U.S. Appl. No. 12/131,631, mailed June 22, 2010, 5 pgs.	
	NPL510	Copy of Final Office Action for U.S. Appl. No. 11/400,008, mailed October 30, 2009, 7 pgs.	
	NPL511	Copy of Final Office Action for U.S. Appl. No. 11/400,008, mailed May 11, 2010, 7 pgs.	
	NPL512	Copy of Notice of Allowance for U.S. Appl. No. 11/551,204, mailed September 30, 2010; 4 pages	
	NPL513	Copy of Non-Final Office Action for U.S. Appl. No. 11/551,204, mailed June 16, 2009, 5 pgs.	
	NPL514	Copy of Notice of Allowance for U.S. Appl. No. 11/551,204, mailed June 21, 2010, 4 pgs.	
	NPL515	Copy of Non-Final Office Action for U.S. Appl. No. 11/551,204, mailed September 22, 2008, 9 pgs.	

Examiner Signature		Date Considered	
-----------------------	--	--------------------	--

\*EXAMINER: Initial if reference considered, whether or not citation is in conformance with MPEP 609. Draw line through citation if not in conformance and not considered. Include copy of this form with next communication to applicant.

<sup>1</sup> Applicant's unique citation designation number (optional). <sup>2</sup> Applicant is to place a check mark here if English language Translation is attached.

Substitute for form 1449/PTO				<i>Complete if Known</i>	
<b>INFORMATION DISCLOSURE STATEMENT BY APPLICANT</b> <i>(Use as many sheets as necessary)</i>				Application Number	13/118,122
				Filing Date	May 27, 2011
				First Named Inventor	James J. FALLON
				Art Unit	2115
				Examiner Name	To Be Assigned
Sheet	58	of	66	Attorney Docket Number	2855.004000B

NON PATENT LITERATURE DOCUMENTS			
Examiner Initials*	Cite No. <sup>1</sup>	Include name of the author (in CAPITAL LETTERS), title of the article (when appropriate), title of the item (book, magazine, journal, serial, symposium, catalog, etc.), date, page(s), volume number, publisher, city and/or country where published	T <sup>2</sup>
	NPL516	Copy of Notice of Allowance for U.S. Appl. No. 11/551,204, mailed January 27, 2010, 4 pgs.	
	NPL517	Copy of Non-Final Office Action for U.S. Appl. No.12/690,125, mailed September 21, 2010, 12 pgs.	
	NPL518	Copy of Final Office Action for U.S. Appl. No. 09/969,987, mailed May 24, 2011, 17 pgs.	
	NPL519	Copy of Notice of Allowance for U.S. Appl. No 11/551,211, mailed May 6, 2011, 5 pages	
	NPL520	Copy of Notice of Allowance for U.S. Appl. No 12/703,042, mailed May 5, 2011, 8 pages.	
	NPL521	Copy of Notice of Allowance for U.S. Appl. No 11/553,427, mailed March 24, 2011, 5 pages	
	NPL522	Copy of Notice of Allowance for U.S. Appl. No 11/553,419, mailed May 20, 2011, 5 pages	
	NPL523	Copy of Final Office Action for U.S. Appl. No. 11/400,008, mailed June 27, 2011, 6 pages.	
	NPL524	Copy of Notice of Allowance for U.S. Appl. No. 11/553,427, mailed May 31, 2011, 5 pages.	
	NPL525	Copy of Final Office Action for U.S. Appl. No. 12/690,125, mailed June 7, 2011, 11 pages.	

Examiner Signature		Date Considered	
-----------------------	--	--------------------	--

\*EXAMINER: Initial if reference considered, whether or not citation is in conformance with MPEP 609. Draw line through citation if not in conformance and not considered. Include copy of this form with next communication to applicant.

<sup>1</sup> Applicant's unique citation designation number (optional). <sup>2</sup> Applicant is to place a check mark here if English language Translation is attached.



Substitute for form 1449/PTO				<i>Complete if Known</i>	
<b>INFORMATION DISCLOSURE STATEMENT BY APPLICANT</b> <i>(Use as many sheets as necessary)</i>				Application Number	13/118,122
				Filing Date	May 27, 2011
				First Named Inventor	James J. FALLON
				Art Unit	2115
				Examiner Name	To Be Assigned
Sheet	59	of	66	Attorney Docket Number	2855.004000B

NON PATENT LITERATURE DOCUMENTS			
Examiner Initials*	Cite No. <sup>1</sup>	Include name of the author (in CAPITAL LETTERS), title of the article (when appropriate), title of the item (book, magazine, journal, serial, symposium, catalog, etc.), date, page(s), volume number, publisher, city and/or country where published	T <sup>2</sup>
	NPL526	Copy of Final Office Action for U.S. Appl. No. 12/688,413, mailed June 7, 2011, 15 pages.	
	NPL527	International Search Report for PCT/US00/42018, mailed July 31, 2001, 3 pages.	
	NPL528	International Search Report for PCT/US01/03712, mailed May 10, 2002, 2 pages.	
	NPL529	International Search Report for PCT/US01/03711, mailed January 28, 2001, 5 pages.	
	NPL530	Copy of submission of prior art under 37 CFR 1.501, for U.S. Pat. No. 6,604,158, March 3, 2011, 5 pgs.	
	NPL531	Copy of submission of prior art under 37 CFR 1.501, for U.S. Pat. No. 7,415,530, March 3, 2011, 14 pgs.	
	NPL532	Copy of submission of prior art under 37 CFR 1.501, for U.S. Pat. No. 6,601,104, March 3, 2011, 5 pgs.	
	NPL533	Copy of submission of prior art under 37 CFR 1.501, for U.S. Pat. No. 7,161,506, March 3, 2011, 12 pgs.	
	NPL534	Copy of submission of prior art under 37 CFR 1.501, for U.S. Pat. No. 7,395,345, March 3, 2011, 14 pgs.	
	NPL535	Copy of submission of prior art under 37 CFR 1.501, for U.S. Pat. No. 7,321,937, March 3, 2011, 14 pgs.	

Examiner Signature		Date Considered	
-----------------------	--	--------------------	--

\*EXAMINER: Initial if reference considered, whether or not citation is in conformance with MPEP 609. Draw line through citation if not in conformance and not considered. Include copy of this form with next communication to applicant.

<sup>1</sup> Applicant's unique citation designation number (optional). <sup>2</sup> Applicant is to place a check mark here if English language Translation is attached.

Substitute for form 1449/PTO				<i>Complete if Known</i>	
<b>INFORMATION DISCLOSURE STATEMENT BY APPLICANT</b> <i>(Use as many sheets as necessary)</i>				Application Number	13/118,122
				Filing Date	May 27, 2011
				First Named Inventor	James J. FALLON
				Art Unit	2115
				Examiner Name	To Be Assigned
Sheet	60	of	66	Attorney Docket Number	2855.004000B

NON PATENT LITERATURE DOCUMENTS			
Examiner Initials*	Cite No. <sup>1</sup>	Include name of the author (in CAPITAL LETTERS), title of the article (when appropriate), title of the item (book, magazine, journal, serial, symposium, catalog, etc.), date, page(s), volume number, publisher, city and/or country where published	T <sup>2</sup>
	NPL536	Copy of submission of prior art under 37 CFR 1.501, for U.S. Pat. No. 7,352,300, March 3, 2011, 14 pgs.	
	NPL537	Copy of submission of prior art under 37 CFR 1.501, for U.S. Pat. No. 7,378,992, March 3, 2011, 14 pgs.	
	NPL538	Ex Parte Reexamination Interview Summary, mailed December 3, 2009, for U.S. Reexam App. No. 90/009,428, 4 pgs.	
	NPL539	Request for Inter Partes Reexamination of U.S. Patent No. 7,714,747, Control No. 95/001,517, filed December 30, 2010, 696 pages.	
	NPL540	Replacement Request for Inter Partes Reexamination of U.S. Patent No. 7,417,568, Control No. 95/001,533, filed March 1, 2011, 357 pages.	
	NPL541	L. Gannoun, "RTP Payload Format for X Protocol Media Streams," Audio-Visual Transport WG Internet Draft, Internet Engineering Task Force, March 11, 1998, 15 pgs.	
	NPL542	Official Order Granting Request for Inter Partes Reexamination of U.S. Pat. No. 6,624,761, Control No. 95/000,464, issued July 24, 2009, 29 pgs.	
	NPL543	Non-Final Office Action in Inter Partes Reexamination of U.S. Pat. No. 6,624,761, Control No. 95/000,464, issued December 15, 2009, 20 pgs.	
	NPL544	Non-Final Office Action in Inter Partes Reexamination of U.S. Pat. No. 7,321,937, Control No. 95/000,466, issued June 22, 2009, 11 pgs.	
	NPL545	Official Order Granting Request for Inter Partes Reexamination of U.S. Pat. No. 7,321,937, Control No. 95/000,466, issued June 22, 2009, 16 pgs.	

Examiner Signature		Date Considered	
-----------------------	--	--------------------	--

\*EXAMINER: Initial if reference considered, whether or not citation is in conformance with MPEP 609. Draw line through citation if not in conformance and not considered. Include copy of this form with next communication to applicant.

<sup>1</sup> Applicant's unique citation designation number (optional). <sup>2</sup> Applicant is to place a check mark here if English language Translation is attached.

Substitute for form 1449/PTO				<i>Complete if Known</i>	
<b>INFORMATION DISCLOSURE STATEMENT BY APPLICANT</b> <i>(Use as many sheets as necessary)</i>				Application Number	13/118,122
				Filing Date	May 27, 2011
				First Named Inventor	James J. FALLON
				Art Unit	2115
				Examiner Name	To Be Assigned
Sheet	61	of	66	Attorney Docket Number	2855.004000B

NON PATENT LITERATURE DOCUMENTS			
Examiner Initials*	Cite No. <sup>1</sup>	Include name of the author (in CAPITAL LETTERS), title of the article (when appropriate), title of the item (book, magazine, journal, serial, symposium, catalog, etc.), date, page(s), volume number, publisher, city and/or country where published	T <sup>2</sup>
	NPL546	Official Action Closing Prosecution for Inter Partes Reexamination of U.S. Pat. No. 7,321,937, Control No. 95/000,466, issued December 22, 2009, 20 pgs.	
	NPL547	Comments by Third Party Requester to Patent Owner's Response Inter Partes Reexamination of U.S. Patent No. 7,321,937, Control No. 95/000,466, filed November 10, 2009, 30 pgs.	
	NPL548	Supplemental Declaration of Professor James A. Storer, Ph.D. under 37 C.F.R. §1.132 in Inter Partes Reexamination of U.S. Patent No. 7,321,937, Control No. 95/000,466, executed on November 10, 2009, 16 pgs.	
	NPL549	Examiner Interview Summary in Ex Parte Reexamination of U.S. Pat. No. 6,601,104, Control No. 90/009,428, issued December 3, 2009, 3 pgs.	
	NPL550	Non-Final Office Action in Ex Parte Reexamination of U.S. Pat. No. 6,601,104, Control No. 90/009,428, issued November 2, 2009, 13 pgs.	
	NPL551	Official Order Granting Request for Ex Parte Reexamination of U.S. Pat. No. 6,601,104, Control No. 90/009,428, issued June 1, 2009, 12 pgs.	
	NPL552	Declaration of Dr. George T. Ligler under 37 C.F.R. §1.132 in Ex Parte Reexamination of U.S. Pat. No. 6,601,104, Control No. 90/009,428, executed December 28, 2009 16 pgs.	
	NPL553	Supplementary Declaration of Dr. George T. Ligler under 37 C.F.R. §1.132 in Ex Parte Reexamination of U.S. Pat. No. 6,601,104, Control No. 90/009,428, executed December 30, 2009 1 pg.	
	NPL554	Declaration of Dr. George T. Ligler under 37 C.F.R. §1.132 in Inter Partes Reexamination of U.S. Pat. No. 7,321,937, Control No. 95/000,466, executed August 24, 2009, 30 pgs.	
	NPL555	Official Order Granting Request for Inter Partes Reexamination of U.S. Pat. No. 7,161,506, Control No. 95/000,479, issued August 14, 2009, 41 pgs.	

Examiner Signature		Date Considered	
-----------------------	--	--------------------	--

\*EXAMINER: Initial if reference considered, whether or not citation is in conformance with MPEP 609. Draw line through citation if not in conformance and not considered. Include copy of this form with next communication to applicant.

<sup>1</sup> Applicant's unique citation designation number (optional). <sup>2</sup> Applicant is to place a check mark here if English language Translation is attached.

Substitute for form 1449/PTO				<i>Complete if Known</i>	
<b>INFORMATION DISCLOSURE STATEMENT BY APPLICANT</b> <i>(Use as many sheets as necessary)</i>				Application Number	13/118,122
				Filing Date	May 27, 2011
				First Named Inventor	James J. FALLON
				Art Unit	2115
				Examiner Name	To Be Assigned
Sheet	62	of	66	Attorney Docket Number	2855.004000B

NON PATENT LITERATURE DOCUMENTS			
Examiner Initials*	Cite No. <sup>1</sup>	Include name of the author (in CAPITAL LETTERS), title of the article (when appropriate), title of the item (book, magazine, journal, serial, symposium, catalog, etc.), date, page(s), volume number, publisher, city and/or country where published	T <sup>2</sup>
	NPL556	Non-Final Office Action in Inter Partes Reexamination of U.S. Pat. No. 7,161,506, Control No. 95/000,479, issued December 15, 2009, 37 pgs.	
	NPL557	Official Order Granting Request for Inter Partes Reexamination of U.S. Pat. No. 7,378,992, Control No. 95/000,478, issued August 13, 2009, 60 pgs.	
	NPL558	Non-Final Office Action in Inter Partes Reexamination of U.S. Pat. No. 7,378,992, Control No. 95/000,478, issued December 15, 2009, 27 pgs.	
	NPL559	Official Order Granting Request for Inter Partes Reexamination of U.S. Pat. No. 6,604,158 Control No. 95/000,486, issued August 14, 2009, 35 pgs.	
	NPL560	Non-Final Office Action in Inter Partes Reexamination of U.S. Pat. No. 6,604,158, Control No. 95/000,486, issued November 12, 2009, 199 pgs.	
	NPL561	Right of Appeal Notice in Inter Partes Reexamination of U.S. Pat. No. 6,624,761, Control No. 95/000,464, issued January 6, 2011, 15 pgs.	
	NPL562	Action Closing Prosecution in Inter Partes Reexamination of U.S. Pat. No. 6,624,761, Control No. 95/000,464, issued August 27, 2010, 25 pgs.	
	NPL563	Right of Appeal Notice in Inter Partes Reexamination of U.S. Pat. No. 7,321,937, Control No. 95/000,466, issued May 24, 2010, 23 pgs.	
	NPL564	Final Office Action in Ex Parte Reexamination of U.S. Pat. No. 6,601,104, Control No. 90/009,428, issued February 5, 2010, 16 pgs.	
	NPL565	Right of Appeal Notice for Inter Partes Reexamination of U.S. Pat. No. 7,161,506, Control No. 95/000,479, issued January 6, 2011, 18 pgs.	

Examiner Signature		Date Considered	
-----------------------	--	--------------------	--

\*EXAMINER: Initial if reference considered, whether or not citation is in conformance with MPEP 609. Draw line through citation if not in conformance and not considered. Include copy of this form with next communication to applicant.

<sup>1</sup> Applicant's unique citation designation number (optional). <sup>2</sup> Applicant is to place a check mark here if English language Translation is attached.

Substitute for form 1449/PTO				<i>Complete if Known</i>	
<b>INFORMATION DISCLOSURE STATEMENT BY APPLICANT</b> <i>(Use as many sheets as necessary)</i>				Application Number	13/118,122
				Filing Date	May 27, 2011
				First Named Inventor	James J. FALLON
				Art Unit	2115
				Examiner Name	To Be Assigned
Sheet	63	of	66	Attorney Docket Number	2855.004000B

NON PATENT LITERATURE DOCUMENTS			
Examiner Initials*	Cite No. <sup>1</sup>	Include name of the author (in CAPITAL LETTERS), title of the article (when appropriate), title of the item (book, magazine, journal, serial, symposium, catalog, etc.), date, page(s), volume number, publisher, city and/or country where published	T <sup>2</sup>
	NPL566	Action Closing Prosecution in Inter Partes Reexamination of U.S. Pat. No. 7,161,506, Control No. 95/000,479, issued August 27, 2010, 34 pgs.	
	NPL567	Right of Appeal Notice for Inter Partes Reexamination of U.S. Pat. No. 7,378,992, Control No. 95/000,478, issued January 6, 2011, 15 pgs.	
	NPL568	Action Closing Prosecution in Inter Partes Reexamination of U.S. Pat. No. 7,378,992, Control No. 95/000,478, issued August 23, 2010, 31 pgs.	
	NPL569	Action Closing Prosecution in Inter Partes Reexamination of U.S. Pat. No. 6,604,158 Control No. 95/000,486, issued March 7, 2011, 257 pgs.	
	NPL570	Patent Owner's reply to Office Action in Inter Partes Reexamination of U.S. Patent No. 7,378,992, mailed March 15, 2010, 23 pages.	
	NPL571	Patent Owner's reply to Office Action in Inter Partes Reexamination of U.S. Patent No. 7,161,506, mailed March 15, 2010, 23 pages.	
	NPL572	Patent Owner's reply to Action Closing Prosecution of August 23, 2010 in Inter Partes Reexamination of U.S. Patent 7,378,992, mailed September 23, 2010, 23 pages.	
	NPL573	Patent Owner's reply to Action Closing Prosecution of August 27, 2010 in Inter Partes Reexamination of U.S. Patent No. 7,161,506, mailed September 27, 2010, 26 pages.	
	NPL574	Patent Owner's reply to Action Closing Prosecution of August 27, 2010 in Inter Partes Reexamination of U.S. Patent No. 6,624,761, mailed September 27, 2010, 20 pages.	
	NPL575	Corrected Request for Inter Partes Reexamination of U.S. Patent No. 6,624,761, filed June 15, 2009, 241 pages.	

Examiner Signature		Date Considered	
-----------------------	--	--------------------	--

\*EXAMINER: Initial if reference considered, whether or not citation is in conformance with MPEP 609. Draw line through citation if not in conformance and not considered. Include copy of this form with next communication to applicant.

<sup>1</sup> Applicant's unique citation designation number (optional). <sup>2</sup> Applicant is to place a check mark here if English language Translation is attached.

Substitute for form 1449/PTO				<i>Complete if Known</i>	
<b>INFORMATION DISCLOSURE STATEMENT BY APPLICANT</b> <i>(Use as many sheets as necessary)</i>				Application Number	13/118,122
				Filing Date	May 27, 2011
				First Named Inventor	James J. FALLON
				Art Unit	2115
				Examiner Name	To Be Assigned
Sheet	64	of	66	Attorney Docket Number	2855.004000B

NON PATENT LITERATURE DOCUMENTS			
Examiner Initials*	Cite No. <sup>1</sup>	Include name of the author (in CAPITAL LETTERS), title of the article (when appropriate), title of the item (book, magazine, journal, serial, symposium, catalog, etc.), date, page(s), volume number, publisher, city and/or country where published	T <sup>2</sup>
	NPL576	Request for Inter Partes Reexamination of U.S. Patent No. 7,378,992, filed May 21, 2009, 255 pages.	
	NPL577	Request for Inter Partes Reexamination of U.S. Patent No. 7,161,506, filed May 28, 2009, 455 pages.	
	NPL578	Request for Inter Partes Reexamination of U.S. Patent No. 7,777,651, Control No. 95/001,581, filed March 21, 2011, 2,136 pages.	
	NPL579	Request for Inter Partes Reexamination of U.S. Patent No. 7,400,274, Control No. 95/001,544, filed February 14, 2011, 420 pages.	
	NPL580	Action Closing Prosecution in Inter Partes Reexamination of U.S. Pat. No. 7,321,937, Control No. 95/000,466 issued December 22, 2009, 20 pages.	
	NPL581	Order Granting request for inter partes reexamination of U.S. Patent No. 7,400,274 and Non-Final Office Action in Inter Partes reexam of U.S. Patent No. 7,400,274, Control No. 95/001,544, issued March 25, 2011, 47 pages.	
	NPL582	Non-Final Office Action in Inter Partes Reexamination of U.S. Patent No. 7,400,274, Control No. 95/001,544, mailed May 20, 2011, 47 pages.	
	NPL583	Order Granting Request for Inter Partes Reexamination of U.S. Patent No. 7,777,651, Control No. 95/001,581, mailed June 15, 2011, 22 pages.	
	NPL584	Non-Final Office Action in Inter Partes Reexamination of U.S. Patent No. 7,417,568, Control No. 95/001,553, mailed May 6, 2011, 105 pages.	
	NPL585	Order Granting Reexamination of U.S. Patent No. 7,714,747, Control No. 95/001,517, mailed March 9, 2011, 21 pages.	

Examiner Signature		Date Considered	
-----------------------	--	--------------------	--

\*EXAMINER: Initial if reference considered, whether or not citation is in conformance with MPEP 609. Draw line through citation if not in conformance and not considered. Include copy of this form with next communication to applicant.

<sup>1</sup> Applicant's unique citation designation number (optional). <sup>2</sup> Applicant is to place a check mark here if English language Translation is attached.

Substitute for form 1449/PTO				<i>Complete if Known</i>	
<b>INFORMATION DISCLOSURE STATEMENT BY APPLICANT</b> <i>(Use as many sheets as necessary)</i>				Application Number	13/118,122
				Filing Date	May 27, 2011
				First Named Inventor	James J. FALLON
				Art Unit	2115
				Examiner Name	To Be Assigned
Sheet	65	of	66	Attorney Docket Number	2855.004000B

NON PATENT LITERATURE DOCUMENTS			
Examiner Initials*	Cite No. <sup>1</sup>	Include name of the author (in CAPITAL LETTERS), title of the article (when appropriate), title of the item (book, magazine, journal, serial, symposium, catalog, etc.), date, page(s), volume number, publisher, city and/or country where published	T <sup>2</sup>
	NPL586	Appeal Brief filed in Inter Partes Reexamination of U.S. Patent No. 6,601,104, Control no. 90/009,428, mailed September 2, 2010, 28 pages.	
	NPL587	Defendants' Joint Preliminary Invalidity Contentions filed in Realtime Data, LLC D/B/A IXO v. Packeteer, Inc., et al., Civil Action No. 6:08-cv-144-LED, United States District Court for the Eastern District of Texas Tyler Division, December 8, 2008, 19 pages.	
	NPL588	Appendix A, Claim Charts A-1 to A-46, from Realtime Data, LLC v. Packeteer, Inc., et al., Civil Action No. 6:08-cv-144-LED, December 8, 2008, 345 pages.	
	NPL589	Appendix B, Claim Charts B-1 to B-17, from Realtime Data, LLC v. Packeteer, Inc., et al., Civil Action No. 6:08-cv-144-LED, December 8, 2008, 1893 pages.	
	NPL590	Appendix C, Claim Charts C-1 to C-34, from Realtime Data, LLC v. Packeteer, Inc., et al., Civil Action No. 6:08-cv-144-LED, December 8, 2008, 993 pages.	
	NPL591	Appendix D, Claim Charts D-1 to D-14, from Realtime Data, LLC v. Packeteer, Inc., et al., Civil Action No. 6:08-cv-144-LED, December 8, 2008, 197 pages.	
	NPL592	Appendix E, Claim Charts E-1 to E-11, from Realtime Data, LLC v. Packeteer, Inc., et al., Civil Action No. 6:08-cv-144-LED, December 8, 2008, 735 pages.	
	NPL593	Appendix F, Claim Charts F-1 to F-11, from Realtime Data, LLC v. Packeteer, Inc., et al., Civil Action No. 6:08-cv-144-LED, December 8, 2008, 775 pages.	
	NPL594	Appendix G Claim Charts G-1 to G-8 from Realtime Data, LLC v. Packeteer, Inc., et al., Civil Action No. 6:08-cv-144-LED, December 8, 2008, 567 pages.	
	NPL595	Appendix H, Claim Charts H-1 to H-18, from Realtime Data, LLC v. Packeteer, Inc., et al., Civil Action No. 6:08-cv-144-LED, December 8, 2008, 94 pages.	

Examiner Signature	Date Considered
-----------------------	--------------------

\*EXAMINER: Initial if reference considered, whether or not citation is in conformance with MPEP 609. Draw line through citation if not in conformance and not considered. Include copy of this form with next communication to applicant.

<sup>1</sup> Applicant's unique citation designation number (optional). <sup>2</sup> Applicant is to place a check mark here if English language Translation is attached.

Substitute for form 1449/PTO				<i>Complete if Known</i>	
<b>INFORMATION DISCLOSURE STATEMENT BY APPLICANT</b> <i>(Use as many sheets as necessary)</i>				Application Number	13/118,122
				Filing Date	May 27, 2011
				First Named Inventor	James J. FALLON
				Art Unit	2115
				Examiner Name	To Be Assigned
Sheet	66	of	66	Attorney Docket Number	2855.004000B

NON PATENT LITERATURE DOCUMENTS			
Examiner Initials*	Cite No. <sup>1</sup>	Include name of the author (in CAPITAL LETTERS), title of the article (when appropriate), title of the item (book, magazine, journal, serial, symposium, catalog, etc.), date, page(s), volume number, publisher, city and/or country where published	T <sup>2</sup>
	NPL596	Appendix I, Claim Charts I-1 to I-18, from Realtime Data, LLC v. Packeteer, Inc., et al., Civil Action No. 6:08-cv-144-LED, December 8, 2008, 145 pages.	
	NPL597	Appendix J, Prior Art Chart, from Realtime Data, LLC v. Packeteer, Inc., et al., Civil Action No. 6:08-cv-144-LED, December 8, 2008, 25 pages.	
	NPL598	Realtime Data, LLC's [Corrected] P.R. 3-1 Disclosures and Preliminary Infringement Contentions filed in Realtime Data, LLC D/B/A/IXO v. Packeteer, Inc., et al., Civil Action No. 6:08-cv-00144-LED, United States District Court for the Eastern District of Texas Tyler Division, October 8, 2008, 591 pages.	

1391940\_1.DOCX

Examiner Signature		Date Considered	
--------------------	--	-----------------	--

\*EXAMINER: Initial if reference considered, whether or not citation is in conformance with MPEP 609. Draw line through citation if not in conformance and not considered. Include copy of this form with next communication to applicant.

<sup>1</sup> Applicant's unique citation designation number (optional). <sup>2</sup> Applicant is to place a check mark here if English language Translation is attached.



## Electronic Acknowledgement Receipt

<b>EFS ID:</b>	10645042
<b>Application Number:</b>	13118122
<b>International Application Number:</b>	
<b>Confirmation Number:</b>	8978
<b>Title of Invention:</b>	Systems and Methods for Accelerated Loading of Operating Systems and Application Programs
<b>First Named Inventor/Applicant Name:</b>	James J. Fallon
<b>Customer Number:</b>	26111
<b>Filer:</b>	Michael V. Messinger/Stacy Jen
<b>Filer Authorized By:</b>	Michael V. Messinger
<b>Attorney Docket Number:</b>	2855.004000B
<b>Receipt Date:</b>	02-AUG-2011
<b>Filing Date:</b>	27-MAY-2011
<b>Time Stamp:</b>	16:25:01
<b>Application Type:</b>	Utility under 35 USC 111(a)

### Payment information:

Submitted with Payment	no
------------------------	----

### File Listing:

Document Number	Document Description	File Name	File Size(Bytes)/ Message Digest	Multi Part /.zip	Pages (if appl.)
1	Non Patent Literature	NPL35_Ins_RemoteScript_Speeds_Transmission.pdf	1562524 c400be37095386ce3c93e210096e464f06d5a48c	no	5

### Warnings:

### Information:

2	Non Patent Literature	NPL36_Jacobson_Compressing_TCP_IP_Headers.pdf	420308 45c63cb4460147686b2b108deed98e3a9fd2983	no	45
<b>Warnings:</b>					
<b>Information:</b>					
3	Non Patent Literature	NPL37_Kulkosky_Upping_the_Ante.pdf	2259121 78d30311a654c22905feeab407fa5c2ed9d5168b	no	6
<b>Warnings:</b>					
<b>Information:</b>					
4	Non Patent Literature	NPL38_Liefke_Extensible_Compressor_for_XML_Data.pdf	1709317 add2551926feb56c8dd9eeff9fb0d7c599ca78	no	6
<b>Warnings:</b>					
<b>Information:</b>					
5	Non Patent Literature	NPL39_Liefke_Efficient_Compressor_for_XML_Data_2000.pdf	900548 fcb154457aeb0306fd7b3a1ba6a594fa38007ee	no	12
<b>Warnings:</b>					
<b>Information:</b>					
6	Non Patent Literature	NPL40_Liefke_Efficient_Compressor_for_XML_Data_1999.pdf	1557452 f6bf4a85b8b03a1c7eca91f143c2f6a68ad8047c	no	25
<b>Warnings:</b>					
<b>Information:</b>					
7	Non Patent Literature	NPL41_McGregor_PPP_Internet_Protocol_Control_Protocol.pdf	31408 89dc877fdda01068c6f1a8ec3afc252dec9a3b37	no	15
<b>Warnings:</b>					
<b>Information:</b>					
8	Non Patent Literature	NPL42_Obviousness_Chart_761.pdf	90440 340c711a80f180243a1ac5a9cd36844f2362e013	no	19
<b>Warnings:</b>					
<b>Information:</b>					
9	Non Patent Literature	NPL43_Obviousness_Chart_506.pdf	135843 c58b3f3b8c0969f667feb01916acc9470f324f	no	49
<b>Warnings:</b>					
<b>Information:</b>					
10	Non Patent Literature	NPL44_Obviousness_Chart_274.pdf	125188 388cf162d9150f8bfe246ad04b1319e2123a0fa4	no	41
<b>Warnings:</b>					
<b>Information:</b>					

11	Non Patent Literature	NPL45_Obviousness_Chart_568.pdf	179850 cbeda9c37a8b935a5b460fb2a790f1bde2581356	no	75
<b>Warnings:</b>					
<b>Information:</b>					
12	Non Patent Literature	NPL46_Obviousness_Chart_747.pdf	225582 476955280b2f9b75f2fa716881dfb7c327b6f718	no	97
<b>Warnings:</b>					
<b>Information:</b>					
13	Non Patent Literature	NPL47_Open_Financial_Exchange.pdf	1798783 50a7a749a3748009337ab719b8323b7253dad6ef	no	537
<b>Warnings:</b>					
<b>Information:</b>					
14	Non Patent Literature	NPL48_Rand_PPP_Compression_Control_Protocol.pdf	28662 4e604af21c96bad9b7822adaf53255aea9a1c33	no	10
<b>Warnings:</b>					
<b>Information:</b>					
15	Non Patent Literature	NPL49_Rogers_Bandwidth_Bargain.pdf	1112187 1be6e0a8ff681e101a492b7a354a50238024c3ed	no	4
<b>Warnings:</b>					
<b>Information:</b>					
16	Non Patent Literature	NPL50_Roth_Database_Compression.pdf	2770980 b8b4233a47ea9312979240e6c829e4b4bfafec39c	no	9
<b>Warnings:</b>					
<b>Information:</b>					
17	Non Patent Literature	NPL51_Schmerken_Time_Running_Out_for_Old_Technologies.pdf	4244844 a897591784e490dbc789218ea06692a6ee0b45e	no	9
<b>Warnings:</b>					
<b>Information:</b>					
18	Non Patent Literature	NPL52_Scrolling_News.pdf	262778 bbd5788bd2dbc315b8609fad00604b8f77cb46	no	2
<b>Warnings:</b>					
<b>Information:</b>					
19	Non Patent Literature	NPL53_Simpson_PPP_in_HDLC_like_Framing.pdf	54053 a3eb8155cdf2f8c0328bb57881194ab82f5a24b	no	27
<b>Warnings:</b>					
<b>Information:</b>					

20	Non Patent Literature	NPL54_Suciu_Data_Management_on_the_web_ATT.pdf	535207 127cb4d669b33e2b4aec953ce8234a5da9f6a8a5	no	52
<b>Warnings:</b>					
<b>Information:</b>					
21	Non Patent Literature	NPL55_Suciu_Data_Management_on_the_web_Abstract.pdf	129418 2f6496f1d8d3df250b5fc9f21bd0ab1f96c3a486	no	1
<b>Warnings:</b>					
<b>Information:</b>					
22	Non Patent Literature	NPL56_Telekurs_Buys_S_P_Trading_Systems.pdf	172465 c919280e912a9e3f71d658e1d4176474dd267f20	no	1
<b>Warnings:</b>					
<b>Information:</b>					
23	Non Patent Literature	NPL57_Telekurs_May_Debut_128_KPS_Ticker_By_Years_End.pdf	410481 4f1dae77fb80df2740c848dfad0ad21e48fca9	no	2
<b>Warnings:</b>					
<b>Information:</b>					
24	Non Patent Literature	NPL58_Telekurs_Now_Carries_All_Dow_Jones_News.pdf	429252 07740fae1467770a4013110da4784fce500d411	no	2
<b>Warnings:</b>					
<b>Information:</b>					
25	Non Patent Literature	NPL59_Telekurs_Sells_No_american_Division_In_Management_Buyout.pdf	429171 a757b0a978c8ecca35a98afb89fede3067d68ca	no	2
<b>Warnings:</b>					
<b>Information:</b>					
26	Non Patent Literature	NPL60_Telekurs_to_Launch_New_Intl_Feed.pdf	1280933 05195d1c725ac38f679dfaf11ab6c07b1c593e46	no	3
<b>Warnings:</b>					
<b>Information:</b>					
27	Non Patent Literature	NPL61_The_Technology_Behind_Xpress_Files.pdf	63401 4303c8bdfd75e0f82c69d9e90ed4c12d54c38638	no	1
<b>Warnings:</b>					
<b>Information:</b>					
28	Non Patent Literature	NPL62_TID_Information.pdf	156327 e60c9e93ecfc637571be6114223e249a4dd5185	no	25
<b>Warnings:</b>					
<b>Information:</b>					

29	Non Patent Literature	NPL63_Typeworld.pdf	922053	no	3
			ba4e90972674ecddce6da62588935645253ec313		
<b>Warnings:</b>					
<b>Information:</b>					
30	Non Patent Literature	NPL64_XpressFiles_White_Paper.pdf	145297	no	3
			e35ea25b7105d61fafdf56abb1e1aaf634d777a		
<b>Warnings:</b>					
<b>Information:</b>					
31	Non Patent Literature	NPL65_US_Provisional_Pat_Ap p_60309218.pdf	10795867	no	58
			9b6b2b85677f00f4a4ea31818e1cd7aa96d8a6f4		
<b>Warnings:</b>					
<b>Information:</b>					
32	Non Patent Literature	NPL66_Telekurs_Manual_Part_1.pdf	23158142	no	92
			c21d4ba91a71b66174d4088fe6a837b57257e135		
<b>Warnings:</b>					
<b>Information:</b>					
33	Non Patent Literature	NPL66_Telekurs_Manual_Part_2.pdf	24026098	no	92
			c0514bf776d215f1481f0b346fac85461ccad7d		
<b>Warnings:</b>					
<b>Information:</b>					
34	Non Patent Literature	NPL67_Danskin_Fast_Higher_Bandwidth.pdf	2069823	no	8
			aa4e7b4a44074d88060942c8c711fc8265fb88b6		
<b>Warnings:</b>					
<b>Information:</b>					
35	Non Patent Literature	NPL68_Hoffman_Data_Compression_in_Digital_Systems_Part_1.pdf	19050685	no	107
			efb7c383e1a2a1488b72183fee3065340887a0b7		
<b>Warnings:</b>					
<b>Information:</b>					
36	Non Patent Literature	NPL68_Hoffman_Data_Compression_in_Digital_Systems_Part_2.pdf	21325770	no	108
			87303ba713521ed04ec6c4e611aced853313f3b3		
<b>Warnings:</b>					
<b>Information:</b>					
37	Non Patent Literature	NPL68_Hoffman_Data_Compression_in_Digital_Systems_Part_3.pdf	22366531	no	108
			b7cb4d28bb051d1c815a1db4e0fd5c27b1873564		
<b>Warnings:</b>					
<b>Information:</b>					

38	Non Patent Literature	NPL68_Hoffman_Data_Compression_in_Digital_Systems_Part_4.pdf	20137712 de7eea3cf2e3ce810e76dae06a87fde9e98375a9	no	103
<b>Warnings:</b>					
<b>Information:</b>					
39	Non Patent Literature	NPL69_Defendants_Invalidity_Contentions_Realtime_v_Morgan_Stanley.pdf	109261 c6848b1f9d297df30dd01d78c5c237c9ea30d7aa	no	34
<b>Warnings:</b>					
<b>Information:</b>					
40	Non Patent Literature	NPL70_Appendix_A_Obviousness_Chart_651.pdf	917426 703f22b84fb03fb655186d9206dfa4ea45a0a022	no	466
<b>Warnings:</b>					
<b>Information:</b>					
41	Non Patent Literature	NPL71_Appendix_B_Invalidity_Arguments_651.pdf	273432 453b66634769dd4407e4df935401cbf3ec3727ad	no	75
<b>Warnings:</b>					
<b>Information:</b>					
42	Non Patent Literature	NPL72_Exhibit_1_Prior_Art_Chart_651.pdf	568308 79b337b8ec3d96677e932b401b0fba1e3b6aea2f	no	161
<b>Warnings:</b>					
<b>Information:</b>					
43	Non Patent Literature	NPL73_Exhibit_2_Prior_Art_Chart_651_2.pdf	801824 3d68523842d88ce56e603b08885c1ea636c8149f	no	206
<b>Warnings:</b>					
<b>Information:</b>					
44	Non Patent Literature	NPL74_Exhibit_3_Prior_Art_Chart_651_3.pdf	351351 263f9db9c6d1f50608ec1fed4072e6c2a9fa81e5	no	95
<b>Warnings:</b>					
<b>Information:</b>					
45	Non Patent Literature	NPL75_Exhibit_4_Prior_Art_Chart_4.pdf	443703 8de43330fc9a5210023665b6699c12b072bcd0cb	no	144
<b>Warnings:</b>					
<b>Information:</b>					
46	Non Patent Literature	NPL76_Exhibit_5_Prior_Art_Chart_5.pdf	675043 02c9e1587b7e89c160248d33834fc03af4e256f3	no	216
<b>Warnings:</b>					
<b>Information:</b>					

47	Non Patent Literature	NPL77_Exhibit_6_Prior_Art_Chart_6.pdf	799463 48c478d74948fe3e45b2b7a2f8c3f129a5166b54	no	257
<b>Warnings:</b>					
<b>Information:</b>					
48	Non Patent Literature	NPL78_Exhibit_7_Prior_Art_Chart_7.pdf	591944 cdfedcb06fd2c4db1d7f271c88d9eea33877947e	no	169
<b>Warnings:</b>					
<b>Information:</b>					
49	Non Patent Literature	NPL79_Exhibit_8_Prior_Art_Chart_8.pdf	2054059 4c6050884fad302b496d8a31120c780028655c9	no	396
<b>Warnings:</b>					
<b>Information:</b>					
50	Non Patent Literature	NPL80_Exhibit_9_Prior_Art_Chart_9.pdf	862564 30e7605cc64c73025a6c1f6ab39cc9485c6bcb8c	no	253
<b>Warnings:</b>					
<b>Information:</b>					
51	Non Patent Literature	NPL81_Exhibit_10_Prior_Art_Chart_10.pdf	1075868 c0c43f9398715a29828f1e500d56ec2b183164bc	no	205
<b>Warnings:</b>					
<b>Information:</b>					
52	Non Patent Literature	NPL82_Exhibit_11_Prior_Art_Chart_11.pdf	1027759 3972b5d0250e24515c154baba771510128e815af	no	181
<b>Warnings:</b>					
<b>Information:</b>					
53	Non Patent Literature	NPL83_Exhibit_12_Prior_Art_Chart_12.pdf	570202 3d2a20128646243de87bfb82f2898b67c0a5c529	no	175
<b>Warnings:</b>					
<b>Information:</b>					
54	Non Patent Literature	NPL84_Exhibit_13_Prior_Art_Chart_13.pdf	2290695 8d46bd078bfd62363cec12f527beb07c0810c81a	no	590
<b>Warnings:</b>					
<b>Information:</b>					
55	Non Patent Literature	NPL85_Exhibit_14_Prior_Art_Chart_14.pdf	638199 d53f110b7a56c37e06277f2286ec3276c715e4f3	no	186
<b>Warnings:</b>					
<b>Information:</b>					

56		2855_004000B_All_IDS_Forms.pdf	2888363 784bf0a25effccec8699d96acba587b5adcf54c	yes	112
<b>Multipart Description/PDF files in .zip description</b>					
<b>Document Description</b>		<b>Start</b>	<b>End</b>		
Transmittal Letter		1	2		
Information Disclosure Statement (IDS) Form (SB08)		3	19		
Information Disclosure Statement (IDS) Form (SB08)		20	112		
<b>Warnings:</b>					
<b>Information:</b>					
<b>Total Files Size (in bytes):</b>			184013965		
<p><b>This Acknowledgement Receipt evidences receipt on the noted date by the USPTO of the indicated documents, characterized by the applicant, and including page counts, where applicable. It serves as evidence of receipt similar to a Post Card, as described in MPEP 503.</b></p> <p><b><u>New Applications Under 35 U.S.C. 111</u></b> If a new application is being filed and the application includes the necessary components for a filing date (see 37 CFR 1.53(b)-(d) and MPEP 506), a Filing Receipt (37 CFR 1.54) will be issued in due course and the date shown on this Acknowledgement Receipt will establish the filing date of the application.</p> <p><b><u>National Stage of an International Application under 35 U.S.C. 371</u></b> If a timely submission to enter the national stage of an international application is compliant with the conditions of 35 U.S.C. 371 and other applicable requirements a Form PCT/DO/EO/903 indicating acceptance of the application as a national stage submission under 35 U.S.C. 371 will be issued in addition to the Filing Receipt, in due course.</p> <p><b><u>New International Application Filed with the USPTO as a Receiving Office</u></b> If a new international application is being filed and the international application includes the necessary components for an international filing date (see PCT Article 11 and MPEP 1810), a Notification of the International Application Number and of the International Filing Date (Form PCT/RO/105) will be issued in due course, subject to prescriptions concerning national security, and the date shown on this Acknowledgement Receipt will establish the international filing date of the application.</p>					



MICHAEL V. MESSINGER  
DIRECTOR  
(202) 772-8667  
MIKEM@SKGF.COM



August 2, 2011

Commissioner for Patents  
PO Box 1450  
Alexandria, VA 22313-1450

Confirmation No. 8978  
Art Unit 2115  
*Attn: Mail Stop Amendment*

Re: U.S. Utility Patent Application  
Application No. 13/118,122; Filing Date: May 27, 2011  
For: **Systems and Methods for Accelerated Loading of Operating Systems  
and Application Programs**  
Inventors: FALLON *et al.*  
Our Ref: 2855.004000B

Sir:

Transmitted herewith for appropriate action are the following documents:

1. Information Disclosure Statement;
2. Form PTO/SB/08a (27 sheets) listing 556 documents (US1-US530 and FP1-FP26);
3. Form PTO/SB/08b (66 sheets) listing 598 documents (NPL1-NPL598); and
4. Copies of cited documents (FP1-FP26, NPL1-NPL400, NPL409-NPL456 and NPL458-NPL598).

The above-listed documents are filed electronically through EFS-Web.

In the event that extensions of time are necessary to prevent abandonment of this patent application, then such extensions of time are hereby petitioned.

Commissioner for Patents  
August 2, 2011  
Page 2

The U.S. Patent and Trademark Office is hereby authorized to charge any fee deficiency, or credit any overpayment, to our Deposit Account No. 19-0036.

Respectfully submitted,

STERNE, KESSLER, GOLDSTEIN & FOX P.L.L.C.

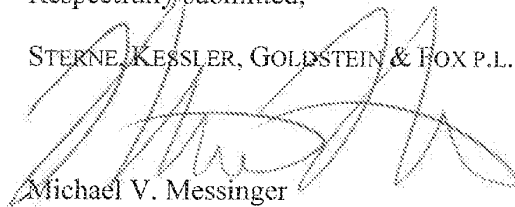

Michael V. Messinger  
Attorney for Applicants  
Registration No. 37,575

MVM/V-R/ssj  
Enclosures

I393627\_1.DOCX

## Electronic Acknowledgement Receipt

<b>EFS ID:</b>	10605513
<b>Application Number:</b>	13118122
<b>International Application Number:</b>	
<b>Confirmation Number:</b>	8978
<b>Title of Invention:</b>	Systems and Methods for Accelerated Loading of Operating Systems and Application Programs
<b>First Named Inventor/Applicant Name:</b>	James J. Fallon
<b>Customer Number:</b>	26111
<b>Filer:</b>	Michael V. Messinger/Stacy Jen
<b>Filer Authorized By:</b>	Michael V. Messinger
<b>Attorney Docket Number:</b>	2855.004000B
<b>Receipt Date:</b>	02-AUG-2011
<b>Filing Date:</b>	27-MAY-2011
<b>Time Stamp:</b>	16:40:01
<b>Application Type:</b>	Utility under 35 USC 111(a)

### Payment information:

Submitted with Payment	no
------------------------	----

### File Listing:

Document Number	Document Description	File Name	File Size(Bytes)/ Message Digest	Multi Part /.zip	Pages (if appl.)
1	Non Patent Literature	NPL333_REALTIME_RESP_TO_DEFENDANT_CITRIX_1st_SET_OF_REQ_FOR_ADMISSION.pdf	580188 4b54b228b62a10eb6d04cfc30b11fa80708541c2	no	151

### Warnings:

### Information:

2	Non Patent Literature	NPL334_Defendant_s_Technology_Tutorial.pdf	9344735 0685d8aa84c2e1dc6e8fd800087d93e2a3483ea1	no	95
<b>Warnings:</b>					
<b>Information:</b>					
3	Non Patent Literature	NPL335_HIFN_1_68.pdf	3069951 a8c4f69d8a0eaf47b89ca9708951f0c8dec dce4	no	68
<b>Warnings:</b>					
<b>Information:</b>					
4	Non Patent Literature	NPL336_HIFN_69_187.pdf	5004076 b224ad60140472cfe643fcc625f1b97b6766 b971	no	119
<b>Warnings:</b>					
<b>Information:</b>					
5	Non Patent Literature	NPL337_HIFN_188_194.pdf	190702 2834b8a1d93f80f0aa4f40c40ad2cbe70a56 09c5	no	7
<b>Warnings:</b>					
<b>Information:</b>					
6	Non Patent Literature	NPL338_HIFN_195_207.pdf	521105 2d78f9187da6ec725fc03cc9a9425ee45036 568d	no	13
<b>Warnings:</b>					
<b>Information:</b>					
7	Non Patent Literature	NPL339_HIFN_208_221.pdf	475030 65fb8ffa2d8b2b3657aae2f5b7b13c4342b2 684a	no	14
<b>Warnings:</b>					
<b>Information:</b>					
8	Non Patent Literature	NPL340_HIFN_222_234.pdf	446801 bc06fa264419cb7495b4f642870ebe33031c 0f8d	no	13
<b>Warnings:</b>					
<b>Information:</b>					
9	Non Patent Literature	NPL341_HIFN_235_245.pdf	396768 29c5a5f4952ba52eb4a078c491bb95368a8 1152c	no	11
<b>Warnings:</b>					
<b>Information:</b>					
10	Non Patent Literature	NPL342_HIFN_246_302.pdf	2138766 6dd65ed38cc61b9ab792df2582aa5b8086b 8bbaf	no	57
<b>Warnings:</b>					
<b>Information:</b>					

11	Non Patent Literature	NPL343_HIFN_303_353.pdf	2246047 943f3e34ebb6cc1503a15b1ae7b6dd9834848735	no	51
<b>Warnings:</b>					
<b>Information:</b>					
12	Non Patent Literature	NPL344_HIFN_354_361.pdf	319232 8166c349a3d9428bd700e64aed237f5192d39811	no	8
<b>Warnings:</b>					
<b>Information:</b>					
13	Non Patent Literature	NPL345_HIFN_362_370.pdf	359640 d4cb147e7fc9ed423be9a819c011f307c82bfb3a	no	9
<b>Warnings:</b>					
<b>Information:</b>					
14	Non Patent Literature	NPL346_HIFN_371_77.pdf	212530 c88a63eb5830da948eb45b0009435198223850d	no	7
<b>Warnings:</b>					
<b>Information:</b>					
15	Non Patent Literature	NPL347_HIFN_378_88.pdf	378625 fd6a25631ec5e8398590a6b25a5f3d414aac514	no	11
<b>Warnings:</b>					
<b>Information:</b>					
16	Non Patent Literature	NPL348_HIFN_389_473.pdf	2936007 9f942577db289a53327590ac6ec498976cd8fe5	no	85
<b>Warnings:</b>					
<b>Information:</b>					
17	Non Patent Literature	NPL349_HIFN_475_562.pdf	3606800 c7848f77fdb7d553b2d6b046e3124602e36434b1	no	88
<b>Warnings:</b>					
<b>Information:</b>					
18	Non Patent Literature	NPL350_HIFN_563_649.pdf	8580328 5335bbd9df82d42ec73af0b67a4881a613a64719	no	87
<b>Warnings:</b>					
<b>Information:</b>					
19	Non Patent Literature	NPL351_HIFN_650_702.pdf	2288075 ccec2ab1b19ccc8469e7aa5b5a45d44b2c566294	no	53
<b>Warnings:</b>					
<b>Information:</b>					

20	Non Patent Literature	NPL352_HIFN_703_44.pdf	1675307 4ed934cd36eda67f95f3d2e9e40887ad7a7518ce	no	42
<b>Warnings:</b>					
<b>Information:</b>					
21	Non Patent Literature	NPL353_HIFN_745_51.pdf	251593 7a2c6dd76497640cf76c28569920bf874b754a0e	no	7
<b>Warnings:</b>					
<b>Information:</b>					
22	Non Patent Literature	NPL354_HIFN_752_831.pdf	3466259 e5dd715cc20552a92aeda90aab4c99ba602ea417	no	80
<b>Warnings:</b>					
<b>Information:</b>					
23	Non Patent Literature	NPL355_HIFN_832_61.pdf	1463626 3125ca548cfc3a6e8abb70a8c66d6ed7424f0d43	no	30
<b>Warnings:</b>					
<b>Information:</b>					
24	Non Patent Literature	NPL356_HIFN_862_920.pdf	2489131 e6ba1a1321ea3c45ca33938911671f808d559ff3	no	59
<b>Warnings:</b>					
<b>Information:</b>					
25	Non Patent Literature	NPL357_HIFN_921_1114.pdf	9628073 acc1929d0551a87eeb6b1187531d872ed3baf3e6	no	194
<b>Warnings:</b>					
<b>Information:</b>					
26	Non Patent Literature	NPL358_HIFN_1115_1430.pdf	14195491 baf3996a7e4251239102e00836956485729c5688	no	316
<b>Warnings:</b>					
<b>Information:</b>					
27	Non Patent Literature	NPL359_HIFN_1431_1889.pdf	19533352 c1fc3f146f7767056b1053436cac1f1a5c0b6a0	no	459
<b>Warnings:</b>					
<b>Information:</b>					
28	Non Patent Literature	NPL360_HIFN_2164_2201.pdf	1728632 8c18a042465e9f1f9941d8207a1c87def984434d	no	38
<b>Warnings:</b>					
<b>Information:</b>					

29	Non Patent Literature	NPL361_HIFN_2215_16.pdf	80446 d5b4c8144c214417d0ead937721229139e1b3837	no	2
<b>Warnings:</b>					
<b>Information:</b>					
30	Non Patent Literature	NPL362_HIFN_2217_64.pdf	1402231 7a267f17e12a1a1d5b9e77371f0c1338174458d9	no	48
<b>Warnings:</b>					
<b>Information:</b>					
31	Non Patent Literature	NPL363_HIFN_2265_68.pdf	129676 02c297ed89b6f789ebb173c7bd0a885c07420230	no	4
<b>Warnings:</b>					
<b>Information:</b>					
32	Non Patent Literature	NPL364_HIFN_2309_13.pdf	390461 b130f40991415d19ca56a5d12538025e216438e	no	5
<b>Warnings:</b>					
<b>Information:</b>					
33	Non Patent Literature	NPL365_HIFN_2508_25.pdf	725599 0603722e89d2d91b90379718a44f74db1300fddc4	no	18
<b>Warnings:</b>					
<b>Information:</b>					
34	Non Patent Literature	NPL366_HIFN_2670_83.pdf	614830 f6a02681f14df95f9c96c7beee622664bae3fd33	no	14
<b>Warnings:</b>					
<b>Information:</b>					
35	Non Patent Literature	NPL367_HIFN_2684_710.pdf	792929 d2d210e572061a42509df51767e1da148723b1c	no	27
<b>Warnings:</b>					
<b>Information:</b>					
36	Non Patent Literature	NPL368_HIFN_2711_24.pdf	612779 c945cec9a1331c6995e60115ec3311601da89fa8	no	14
<b>Warnings:</b>					
<b>Information:</b>					
37	Non Patent Literature	NPL369_HIFN_2725_27.pdf	123161 6c8e12b89cb40c297ef4250c94ebf73830b277b	no	3
<b>Warnings:</b>					
<b>Information:</b>					

38	Non Patent Literature	NPL370_HIFN_2728_33.pdf	376126 6fde15e08f513819bc49b7e47646dfbd72a07b1	no	6
<b>Warnings:</b>					
<b>Information:</b>					
39	Non Patent Literature	NPL371_HIFN_2734_78.pdf	1807806 69a6fe5f33ea50c4050393712022a3b4164a596b	no	45
<b>Warnings:</b>					
<b>Information:</b>					
40	Non Patent Literature	NPL372_HIFN_2779_96.pdf	725626 2868f93231457583ed164cd049ef94a03da8c	no	18
<b>Warnings:</b>					
<b>Information:</b>					
41	Non Patent Literature	NPL373_HIFN_2797_810.pdf	405324 9f1b377d11a42cebda9c9f299d7c9be8d5916c8c	no	14
<b>Warnings:</b>					
<b>Information:</b>					
42	Non Patent Literature	NPL374_Magstar_MP_Hardware_B_Series_338_Pages.pdf	10896770 6749a11df18e6bf3c2f84f2e3cea557a0a6322cf	no	338
<b>Warnings:</b>					
<b>Information:</b>					
43	Non Patent Literature	NPL375_IBM_1_601.pdf	7922540 18042536017b8f4b5bfe7944ae766be3d34ba4b5	no	188
<b>Warnings:</b>					
<b>Information:</b>					
44	Non Patent Literature	NPL376_IBM_1_601.pdf	181248 91f90b5ccb4b825b3a6df2e83083242e522f1d6	no	2
<b>Warnings:</b>					
<b>Information:</b>					
45	Non Patent Literature	NPL377_IBM_1_601.pdf	891906 ae398322a99ebd8fc47a4f67d9ecfccdd0b44775	no	13
<b>Warnings:</b>					
<b>Information:</b>					
46	Non Patent Literature	NPL378_IBM_1_601.pdf	770643 a5e0a859d9e7861ccb82b36a66a07d209df6ecc48	no	10
<b>Warnings:</b>					
<b>Information:</b>					



47	Non Patent Literature	NPL379_IBM_1_601.pdf	642516	no	13
			10ba64caafbab1583b5126825324b8c1e66cd884		
<b>Warnings:</b>					
<b>Information:</b>					
48	Non Patent Literature	NPL380_IBM_1_601.pdf	907755	no	18
			b9842aede10e1f0399685dee7f77a49d3df6adb3		
<b>Warnings:</b>					
<b>Information:</b>					
49	Non Patent Literature	NPL381_IBM_1_601.pdf	412376	no	20
			70f1034b0fd9aef76bd6d53b4f4c4eff096a2298		
<b>Warnings:</b>					
<b>Information:</b>					
50	Non Patent Literature	NPL382_IBM_743_1241.pdf	46444	no	1
			aebd110e9de03ee68dc2d91a4b991b9dfac711d3		
<b>Warnings:</b>					
<b>Information:</b>					
51	Non Patent Literature	NPL383_IBM_743_1241.pdf	52374	no	2
			caa757e1b611e3f64677014119fe405133f29fdf		
<b>Warnings:</b>					
<b>Information:</b>					
52	Non Patent Literature	NPL384_IBM_743_1241.pdf	213136	no	4
			d2e72fce1978aa8478da97ddcab9f4adb33b00c2		
<b>Warnings:</b>					
<b>Information:</b>					
53	Non Patent Literature	NPL385_IBM_743_1241.pdf	23961	no	1
			96c1d0f96e03233d9f92cc06cb57543c3cbcb51		
<b>Warnings:</b>					
<b>Information:</b>					
54	Non Patent Literature	NPL386_IBM_743_1241.pdf	12464054	no	490
			ce5786ee7cb2f11921ace8418ba64bc644dc87ab		
<b>Warnings:</b>					
<b>Information:</b>					
55	Non Patent Literature	NPL387_MSCS_298_339.pdf	1895787	no	42
			6368c9feb94629f78228fd49528722f8cd99629		
<b>Warnings:</b>					
<b>Information:</b>					

56	Non Patent Literature	NPL388_MSCS_242_297.pdf	1822803 f6e81d3f96885ec88d800a6ebe5c952226dd 7c63	no	56
<b>Warnings:</b>					
<b>Information:</b>					
57	Non Patent Literature	NPL389_MSCS_340_345.pdf	416541 60cd06e31bf6d2f900b63dab647d06f2923 4ba49	no	6
<b>Warnings:</b>					
<b>Information:</b>					
58	Non Patent Literature	NPL390_MSCS_2_241.pdf	11574997 5cb2aac509c20a326cbaf88ea5f1f917d2d 6eb8	no	240
<b>Warnings:</b>					
<b>Information:</b>					
59	Non Patent Literature	NPL391_RAD_1_220.pdf	9735959 22a12ce51b248f80d7d618ea26eb619c830 4faae	no	220
<b>Warnings:</b>					
<b>Information:</b>					
60	Non Patent Literature	NPL392_RAD_221_548.pdf	14243921 7706d18457ece44a3ea9a69471fffb36d1a7 04ad	no	328
<b>Warnings:</b>					
<b>Information:</b>					
<b>Total Files Size (in bytes):</b>				180829595	
<p><b>This Acknowledgement Receipt evidences receipt on the noted date by the USPTO of the indicated documents, characterized by the applicant, and including page counts, where applicable. It serves as evidence of receipt similar to a Post Card, as described in MPEP 503.</b></p> <p><b><u>New Applications Under 35 U.S.C. 111</u></b>  <b>If a new application is being filed and the application includes the necessary components for a filing date (see 37 CFR 1.53(b)-(d) and MPEP 506), a Filing Receipt (37 CFR 1.54) will be issued in due course and the date shown on this Acknowledgement Receipt will establish the filing date of the application.</b></p> <p><b><u>National Stage of an International Application under 35 U.S.C. 371</u></b>  <b>If a timely submission to enter the national stage of an international application is compliant with the conditions of 35 U.S.C. 371 and other applicable requirements a Form PCT/DO/EO/903 indicating acceptance of the application as a national stage submission under 35 U.S.C. 371 will be issued in addition to the Filing Receipt, in due course.</b></p> <p><b><u>New International Application Filed with the USPTO as a Receiving Office</u></b>  <b>If a new international application is being filed and the international application includes the necessary components for an international filing date (see PCT Article 11 and MPEP 1810), a Notification of the International Application Number and of the International Filing Date (Form PCT/RO/105) will be issued in due course, subject to prescriptions concerning national security, and the date shown on this Acknowledgement Receipt will establish the international filing date of the application.</b></p>					



UNITED STATES PATENT AND TRADEMARK OFFICE

UNITED STATES DEPARTMENT OF COMMERCE  
United States Patent and Trademark Office  
Address: COMMISSIONER FOR PATENTS  
P.O. Box 1450  
Alexandria, Virginia 22313-1450  
www.uspto.gov

APPLICATION NUMBER	FILING OR 371(C) DATE	FIRST NAMED APPLICANT	ATTY. DOCKET NO./TITLE
13/118,122	05/27/2011	James J. Fallon	2855.004000B

**CONFIRMATION NO. 8978**

**POA ACCEPTANCE LETTER**

26111  
STERNE, KESSLER, GOLDSTEIN & FOX P.L.L.C.  
1100 NEW YORK AVENUE, N.W.  
WASHINGTON, DC 20005



Date Mailed: 06/13/2011

**NOTICE OF ACCEPTANCE OF POWER OF ATTORNEY**

This is in response to the Power of Attorney filed 05/27/2011.

The Power of Attorney in this application is accepted. Correspondence in this application will be mailed to the above address as provided by 37 CFR 1.33.

/yli/

Office of Data Management, Application Assistance Unit (571) 272-4000, or (571) 272-4200, or 1-888-786-0101

<b>PATENT APPLICATION FEE DETERMINATION RECORD</b> Substitute for Form PTO-875	Application or Docket Number 13/118,122
---	--

APPLICATION AS FILED - PART I			SMALL ENTITY		OR	OTHER THAN SMALL ENTITY	
	(Column 1)	(Column 2)					
FOR	NUMBER FILED	NUMBER EXTRA	RATE(\$)	FEE(\$)		RATE(\$)	FEE(\$)
BASIC FEE <small>(37 CFR 1.16(a), (b), or (c))</small>	N/A	N/A	N/A			N/A	330
SEARCH FEE <small>(37 CFR 1.16(k), (l), or (m))</small>	N/A	N/A	N/A			N/A	540
EXAMINATION FEE <small>(37 CFR 1.16(o), (p), or (q))</small>	N/A	N/A	N/A			N/A	220
TOTAL CLAIMS <small>(37 CFR 1.16(i))</small>	1	minus 20 = *				x 52 =	0.00
INDEPENDENT CLAIMS <small>(37 CFR 1.16(h))</small>	1	minus 3 = *				x 220 =	0.00
APPLICATION SIZE FEE <small>(37 CFR 1.16(s))</small>	If the specification and drawings exceed 100 sheets of paper, the application size fee due is \$270 (\$135 for small entity) for each additional 50 sheets or fraction thereof. See 35 U.S.C. 41(a)(1)(G) and 37 CFR 1.16(s).						0.00
MULTIPLE DEPENDENT CLAIM PRESENT <small>(37 CFR 1.16(j))</small>							0.00
* If the difference in column 1 is less than zero, enter "0" in column 2.			TOTAL			TOTAL	1090

APPLICATION AS AMENDED - PART II					SMALL ENTITY		OR	OTHER THAN SMALL ENTITY		
	(Column 1)	(Column 2)	(Column 3)							
AMENDMENT A	CLAIMS REMAINING AFTER AMENDMENT	HIGHEST NUMBER PREVIOUSLY PAID FOR	PRESENT EXTRA		RATE(\$)	ADDITIONAL FEE(\$)		RATE(\$)	ADDITIONAL FEE(\$)	
	Total <small>(37 CFR 1.16(i))</small>	*	Minus	**	=			x	=	
	Independent <small>(37 CFR 1.16(h))</small>	*	Minus	***	=			x	=	
	Application Size Fee <small>(37 CFR 1.16(s))</small>									
	FIRST PRESENTATION OF MULTIPLE DEPENDENT CLAIM <small>(37 CFR 1.16(j))</small>									
					TOTAL ADD'L FEE			TOTAL ADD'L FEE		
AMENDMENT B	CLAIMS REMAINING AFTER AMENDMENT	HIGHEST NUMBER PREVIOUSLY PAID FOR	PRESENT EXTRA		RATE(\$)	ADDITIONAL FEE(\$)		RATE(\$)	ADDITIONAL FEE(\$)	
	Total <small>(37 CFR 1.16(i))</small>	*	Minus	**	=			x	=	
	Independent <small>(37 CFR 1.16(h))</small>	*	Minus	***	=			x	=	
	Application Size Fee <small>(37 CFR 1.16(s))</small>									
	FIRST PRESENTATION OF MULTIPLE DEPENDENT CLAIM <small>(37 CFR 1.16(j))</small>									
					TOTAL ADD'L FEE			TOTAL ADD'L FEE		
<p>* If the entry in column 1 is less than the entry in column 2, write "0" in column 3.</p> <p>** If the "Highest Number Previously Paid For" IN THIS SPACE is less than 20, enter "20".</p> <p>*** If the "Highest Number Previously Paid For" IN THIS SPACE is less than 3, enter "3".</p> <p>The "Highest Number Previously Paid For" (Total or Independent) is the highest found in the appropriate box in column 1.</p>										



UNITED STATES PATENT AND TRADEMARK OFFICE

UNITED STATES DEPARTMENT OF COMMERCE
United States Patent and Trademark Office
Address: COMMISSIONER FOR PATENTS
P.O. Box 1450
Alexandria, Virginia 22313-1450
www.uspto.gov

Table with 7 columns: APPLICATION NUMBER, FILING or 371(c) DATE, GRP ART UNIT, FIL FEE REC'D, ATTY.DOCKET.NO, TOT CLAIMS, IND CLAIMS. Row 1: 13/118,122, 05/27/2011, 2827, 1090, 2855.004000B, 1, 1

CONFIRMATION NO. 8978

26111
STERNE, KESSLER, GOLDSTEIN & FOX P.L.L.C.
1100 NEW YORK AVENUE, N.W.
WASHINGTON, DC 20005

FILING RECEIPT



Date Mailed: 06/13/2011

Receipt is acknowledged of this non-provisional patent application. The application will be taken up for examination in due course. Applicant will be notified as to the results of the examination. Any correspondence concerning the application must include the following identification information: the U.S. APPLICATION NUMBER, FILING DATE, NAME OF APPLICANT, and TITLE OF INVENTION. Fees transmitted by check or draft are subject to collection. Please verify the accuracy of the data presented on this receipt. If an error is noted on this Filing Receipt, please submit a written request for a Filing Receipt Correction. Please provide a copy of this Filing Receipt with the changes noted thereon. If you received a "Notice to File Missing Parts" for this application, please submit any corrections to this Filing Receipt with your reply to the Notice. When the USPTO processes the reply to the Notice, the USPTO will generate another Filing Receipt incorporating the requested corrections

Applicant(s)

James J. Fallon, Armonk, NY;
John Buck, Oceanside, NY;
Paul F. Pickel, Bethpage, NY;
Stephen J. McErlain, New York, NY;

Assignment For Published Patent Application

Realtime Data LLC dba IXO, Armonk, NY

Power of Attorney: The patent practitioners associated with Customer Number 26111

Domestic Priority data as claimed by applicant

This application is a CON of 11/551,211 10/19/2006
which is a CON of 09/776,267 02/02/2001 PAT 7,181,608
which claims benefit of 60/180,114 02/03/2000

Foreign Applications (You may be eligible to benefit from the Patent Prosecution Highway program at the USPTO. Please see http://www.uspto.gov for more information.)

Permission to Access - A proper Authorization to Permit Access to Application by Participating Offices (PTO/SB/39 or its equivalent) has been received by the USPTO.

If Required, Foreign Filing License Granted: 06/10/2011

The country code and number of your priority application, to be used for filing abroad under the Paris Convention, is US 13/118,122

Projected Publication Date: 09/22/2011

Non-Publication Request: No

**Early Publication Request:** No  
**Title**

Systems and Methods for Accelerated Loading of Operating Systems and Application Programs

**Preliminary Class**

365

## **PROTECTING YOUR INVENTION OUTSIDE THE UNITED STATES**

Since the rights granted by a U.S. patent extend only throughout the territory of the United States and have no effect in a foreign country, an inventor who wishes patent protection in another country must apply for a patent in a specific country or in regional patent offices. Applicants may wish to consider the filing of an international application under the Patent Cooperation Treaty (PCT). An international (PCT) application generally has the same effect as a regular national patent application in each PCT-member country. The PCT process **simplifies** the filing of patent applications on the same invention in member countries, but **does not result** in a grant of "an international patent" and does not eliminate the need of applicants to file additional documents and fees in countries where patent protection is desired.

Almost every country has its own patent law, and a person desiring a patent in a particular country must make an application for patent in that country in accordance with its particular laws. Since the laws of many countries differ in various respects from the patent law of the United States, applicants are advised to seek guidance from specific foreign countries to ensure that patent rights are not lost prematurely.

Applicants also are advised that in the case of inventions made in the United States, the Director of the USPTO must issue a license before applicants can apply for a patent in a foreign country. The filing of a U.S. patent application serves as a request for a foreign filing license. The application's filing receipt contains further information and guidance as to the status of applicant's license for foreign filing.

Applicants may wish to consult the USPTO booklet, "General Information Concerning Patents" (specifically, the section entitled "Treaties and Foreign Patents") for more information on timeframes and deadlines for filing foreign patent applications. The guide is available either by contacting the USPTO Contact Center at 800-786-9199, or it can be viewed on the USPTO website at <http://www.uspto.gov/web/offices/pac/doc/general/index.html>.

For information on preventing theft of your intellectual property (patents, trademarks and copyrights), you may wish to consult the U.S. Government website, <http://www.stopfakes.gov>. Part of a Department of Commerce initiative, this website includes self-help "toolkits" giving innovators guidance on how to protect intellectual property in specific countries such as China, Korea and Mexico. For questions regarding patent enforcement issues, applicants may call the U.S. Government hotline at 1-866-999-HALT (1-866-999-4158).

### **LICENSE FOR FOREIGN FILING UNDER**

**Title 35, United States Code, Section 184**

**Title 37, Code of Federal Regulations, 5.11 & 5.15**

#### **GRANTED**

The applicant has been granted a license under 35 U.S.C. 184, if the phrase "IF REQUIRED, FOREIGN FILING LICENSE GRANTED" followed by a date appears on this form. Such licenses are issued in all applications where

the conditions for issuance of a license have been met, regardless of whether or not a license may be required as set forth in 37 CFR 5.15. The scope and limitations of this license are set forth in 37 CFR 5.15(a) unless an earlier license has been issued under 37 CFR 5.15(b). The license is subject to revocation upon written notification. The date indicated is the effective date of the license, unless an earlier license of similar scope has been granted under 37 CFR 5.13 or 5.14.

This license is to be retained by the licensee and may be used at any time on or after the effective date thereof unless it is revoked. This license is automatically transferred to any related applications(s) filed under 37 CFR 1.53(d). This license is not retroactive.

The grant of a license does not in any way lessen the responsibility of a licensee for the security of the subject matter as imposed by any Government contract or the provisions of existing laws relating to espionage and the national security or the export of technical data. Licensees should apprise themselves of current regulations especially with respect to certain countries, of other agencies, particularly the Office of Defense Trade Controls, Department of State (with respect to Arms, Munitions and Implements of War (22 CFR 121-128)); the Bureau of Industry and Security, Department of Commerce (15 CFR parts 730-774); the Office of Foreign Assets Control, Department of Treasury (31 CFR Parts 500+) and the Department of Energy.

**NOT GRANTED**

No license under 35 U.S.C. 184 has been granted at this time, if the phrase "IF REQUIRED, FOREIGN FILING LICENSE GRANTED" DOES NOT appear on this form. Applicant may still petition for a license under 37 CFR 5.12, if a license is desired before the expiration of 6 months from the filing date of the application. If 6 months has lapsed from the filing date of this application and the licensee has not received any indication of a secrecy order under 35 U.S.C. 181, the licensee may foreign file the application pursuant to 37 CFR 5.15(b).

Under the Paperwork Reduction Act of 1995, no persons are required to respond to a collection of information unless it displays a valid OMB control number.

**UTILITY  
PATENT APPLICATION  
TRANSMITTAL**

(Only for new nonprovisional applications under 37 CFR 1.53(b))

Attorney Docket No.	2855.004000B
First Inventor	James J. Fallon
Title	Systems and Methods for Accelerated Loading of Operating Systems and Application Programs
Express Mail Label No.	

**APPLICATION ELEMENTS**

See MPEP chapter 600 concerning utility patent application contents.

1.  Fee Transmittal Form (e.g., PTO/SB/17)
2.  Applicant claims small entity status. See 37 CFR 1.27.
3.  Specification [Total Pages 40]  
Both the claims and abstract must start on a new page  
(For information on the preferred arrangement, see MPEP 608.01(a))
4.  Drawing(s) (35 U.S.C. 113) [Total Sheets 13]
5. Oath or Declaration [Total Sheets 2]  
a.  Newly executed (original or copy)  
b.  A copy from a prior application (37 CFR 1.63(d))  
(for continuation/divisional with Box 18 completed)  
i.  DELETION OF INVENTOR(S)  
Signed statement attached deleting inventor(s)  
name in the prior application, see 37 CFR 1.63(d)(2) and 1.33(b).
6.  Application Data Sheet. See 37 CFR 1.76
7.  CD-ROM or CD-R in duplicate, large table or Computer Program (Appendix)  
 Landscape Table on CD
8. Nucleotide and/or Amino Acid Sequence Submission (if applicable, items a. - c. are required)  
a.  Computer Readable Form (CRF)  
b. Specification Sequence Listing on:  
i.  CD-ROM or CD-R (2 copies); or  
ii.  Paper  
c.  Statements verifying identity of above copies

**ADDRESS TO:**Commissioner for Patents  
P.O. Box 1450  
Alexandria VA 22313-1450**ACCOMPANYING APPLICATION PARTS**

9.  Assignment Papers (cover sheet (PTO-1595) & document(s))  
Name of Assignee Realtime Data LLC
10.  37 CFR 3.73(b) Statement (when there is an assignee)  Power of Attorney
11.  English Translation Document (if applicable)
12.  Information Disclosure Statement (PTO/SB/08 or PTO-1449)  
 Copies of foreign patent documents, publications, & other information
13.  Preliminary Amendment
14.  Return Receipt Postcard (MPEP 503)  
(Should be specifically itemized)
15.  Certified Copy of Priority Document(s)  
(if foreign priority is claimed)
16.  Nonpublication Request under 35 U.S.C. 122(b)(2)(B)(i).  
Applicant must attach form PTO/SB/35 or equivalent.
17.  Other: Authorization under 37 CFR 1.136(a)(3)  
Authorization to Permit Access to Application  
by Participating Offices (PTO/SB/39)

18. If a CONTINUING APPLICATION, check appropriate box, and supply the requisite information below and in the first sentence of the specification following the title, or in an Application Data Sheet under 37 CFR 1.76:

 Continuation  Divisional  Continuation-in-part (CIP) of prior application No. 11/551,211Prior application information: Examiner SURYAWANSHI, Suresh Art Unit: 2115**19. CORRESPONDENCE ADDRESS** The address associated with Customer Number: 26111 OR  Correspondence address below

Name			
Address			
City	State	Zip Code	
Country	Telephone	Email	
Signature	Date		
Name (Print/Type)	Registration No. (Attorney/Agent)		
<u>Michael V. Messinger</u>	<u>37,575</u>	<u>May 27, 2011</u>	

This collection of information is required by 37 CFR 1.53(b). The information is required to obtain or retain a benefit by the public which is to file (and by the USPTO to process) an application. Confidentiality is governed by 35 U.S.C. 122 and 37 CFR 1.11 and 1.14. This collection is estimated to take 12 minutes to complete, including gathering, preparing, and submitting the completed application form to the USPTO. Time will vary depending upon the individual case. Any comments on the amount of time you require to complete this form and/or suggestions for reducing this burden, should be sent to the Chief Information Officer, U.S. Patent and Trademark Office, U.S. Department of Commerce, P.O. Box 1450, Alexandria, VA 22313-1450. DO NOT SEND FEES OR COMPLETED FORMS TO THIS ADDRESS. SEND TO: Commissioner for Patents, P.O. Box 1450, Alexandria, VA 22313-1450.

If you need assistance in completing the form, call 1-800-PTO-9199 and select option 2.



IN THE UNITED STATES PATENT AND TRADEMARK OFFICE

In re application of:

Fallon *et al.*

Appl. No.: To Be Assigned

(Continuation of Appl. No. 11/551,211; Filed  
October 19, 2006)

Filed: Herewith

**For: Systems and Methods for Accelerated  
Loading of Operating Systems and  
Application Programs**

Confirmation No.: To Be Assigned

Art Unit: To Be Assigned

Examiner: To Be Assigned

Atty. Docket: 2855.004000B

**Authorization to Treat a Reply as Incorporating an  
Extension of Time Under 37 C.F.R. § 1.136(a)(3)**

Commissioner for Patents  
PO Box 1450  
Alexandria, VA 22313-1450

Sir:

The U.S. Patent and Trademark Office is hereby authorized to treat any concurrent or future reply that requires a petition for an extension of time under this paragraph for its timely submission, as incorporating a petition for extension of time for the appropriate length of time. The U.S. Patent and Trademark Office is hereby authorized to charge all required extension of time fees to our Deposit Account No. 19-0036, if such fees are not otherwise provided for in such reply.

Respectfully submitted,

STERNE, KESSLER, GOLDSTEIN & FOX P.L.L.C.

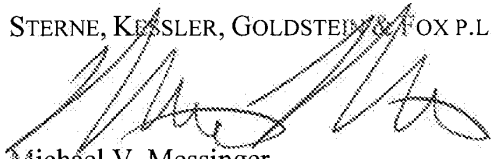
  
Michael V. Messinger  
Attorney for Applicants  
Registration No. 37,575

Date: \_\_\_\_\_

*May 27, 2011*

1100 New York Avenue, N.W.  
Washington, D.C. 20005-3934  
(202) 371-2600

MVM/V-R/ms  
1367462\_1.DOCX

Under the Paperwork Reduction Act of 1995, no persons are required to respond to a collection of information unless it displays a valid OMB control number.

**POWER OF ATTORNEY TO PROSECUTE APPLICATIONS BEFORE THE USPTO**

I hereby revoke all previous powers of attorney given in the application identified in the attached statement under 37 CFR 3.73(b).

I hereby appoint:

Practitioners associated with the Customer Number: 26111

OR

Practitioner(s) named below (if more than ten patent practitioners are to be named, then a customer number must be used):

Name	Registration Number	Name	Registration Number

as attorney(s) or agent(s) to represent the undersigned before the United States Patent and Trademark Office (USPTO) in connection with any and all patent applications assigned only to the undersigned according to the USPTO assignment records or assignment documents attached to this form in accordance with 37 CFR 3.73(b).

Please change the correspondence address for the application identified in the attached statement under 37 CFR 3.73(b) to:

The address associated with Customer Number: 26111

OR

<input type="checkbox"/> Firm or Individual Name			
Address			
City	State	Zip	
Country			
Telephone	Email		

Assignee Name and Address:

Realtime Data LLC DBA IXO  
 11 Wampus Close  
 Armonk, New York 10504

A copy of this form, together with a statement under 37 CFR 3.73(b) (Form PTO/SB/96 or equivalent) is required to be filed in each application in which this form is used. The statement under 37 CFR 3.73(b) may be completed by one of the practitioners appointed in this form if the appointed practitioner is authorized to act on behalf of the assignee, and must identify the application in which this Power of Attorney is to be filed.

**SIGNATURE of Assignee of Record**

The individual whose signature and title is supplied below is authorized to act on behalf of the assignee

Signature		Date	9/13/10
Name	James J. Fallon	Telephone	(914) 438-0233
Title	Chairman		

This collection of information is required by 37 CFR 1.31, 1.32 and 1.33. The information is required to obtain or retain a benefit by the public which is to file (and by the USPTO to process) an application. Confidentiality is governed by 35 U.S.C. 122 and 37 CFR 1.11 and 1.14. This collection is estimated to take 3 minutes to complete, including gathering, preparing, and submitting the completed application form to the USPTO. Time will vary depending upon the individual case. Any comments on the amount of time you require to complete this form and/or suggestions for reducing this burden, should be sent to the Chief Information Officer, U.S. Patent and Trademark Office, U.S. Department of Commerce, P.O. Box 1450, Alexandria, VA 22313-1450. DO NOT SEND FEES OR COMPLETED FORMS TO THIS ADDRESS. SEND TO: Commissioner for Patents, P.O. Box 1450, Alexandria, VA 22313-1450.

If you need assistance in completing the form, call 1-800-PTO-9199 and select option 2.

Under the Paperwork Reduction Act of 1995, no persons are required to respond to a collection of information unless it displays a valid OMB control number.

**STATEMENT UNDER 37 CFR 3.73(b)**

Atty. Docket No. 2855.004000B

Applicant/Patent Owner: Fallon et al.

Application No./Patent No.: To Be Assigned Filed/Issue Date: May 27, 2011 (herewith)

Titled: Systems and Methods for Accelerated Loading of Operating Systems and Application Programs

Realtime Data LLC, a limited liability company

(Name of Assignee) (Type of Assignee, e.g., corporation, partnership, university, government agency, etc.)

states that it is:

1.  the assignee of the entire right, title, and interest in;
2.  an assignee of less than the entire right, title, and interest in (The extent (by percentage) of its ownership interest is \_\_\_\_\_ %); or
3.  the assignee of an undivided interest in the entirety of (a complete assignment from one of the joint inventors was made)

the patent application/patent identified above, by virtue of either:

A.  An assignment from the inventor(s) of the patent application/patent identified above. The assignment was recorded in the United States Patent and Trademark Office at Reel 011797, Frame 0735, or for which a copy therefore is attached.

OR

B.  A chain of title from the inventor(s), of the patent application/patent identified above, to the current assignee as follows:

1. From: \_\_\_\_\_ To: \_\_\_\_\_

The document was recorded in the United States Patent and Trademark Office at Reel \_\_\_\_\_, Frame \_\_\_\_\_, or for which a copy thereof is attached.

2. From: \_\_\_\_\_ To: \_\_\_\_\_

The document was recorded in the United States Patent and Trademark Office at Reel \_\_\_\_\_, Frame \_\_\_\_\_, or for which a copy thereof is attached.

3. From: \_\_\_\_\_ To: \_\_\_\_\_

The document was recorded in the United States Patent and Trademark Office at Reel \_\_\_\_\_, Frame \_\_\_\_\_, or for which a copy thereof is attached.

Additional documents in the chain of title are listed on a supplemental sheet(s).

As required by 37 CFR 3.73(b)(1)(i), the documentary evidence of the chain of title from the original owner to the assignee was, or concurrently is being, submitted for recordation pursuant to 37 CFR 3.11.

[NOTE: A separate copy (i.e., a true copy of the original assignment document(s)) must be submitted to Assignment Division in accordance with 37 CFR Part 3, to record the assignment in the records of the USPTO. See MPEP 302.08]

The undersigned (whose title is supplied below) is authorized to act on behalf of the assignee.

Signature

Date

Michael V. Messinger, Reg. No. 37,575

Attorney for Applicants

Printed or Typed Name

Title

This collection of information is required by 37 CFR 3.73(b). The information is required to obtain or retain a benefit by the public which is to file (and by the USPTO to process) an application. Confidentiality is governed by 35 U.S.C. 122 and 37 CFR 1.11 and 1.14. This collection is estimated to take 12 minutes to complete, including gathering, preparing, and submitting the completed application form to the USPTO. Time will vary depending upon the individual case. Any comments on the amount of time you require to complete this form and/or suggestions for reducing this burden, should be sent to the Chief Information Officer, U.S. Patent and Trademark Office, U.S. Department of Commerce, P.O. Box 1450, Alexandria, VA 22313-1450. DO NOT SEND FEES OR COMPLETED FORMS TO THIS ADDRESS. SEND TO: Commissioner for Patents, P.O. Box 1450, Alexandria, VA 22313-1450.

If you need assistance in completing the form, call 1-800-PTO-9199 and select option 2.

## Electronic Patent Application Fee Transmittal

<b>Application Number:</b>					
<b>Filing Date:</b>					
<b>Title of Invention:</b>	Systems and Methods for Accelerated Loading of Operating Systems and Application Programs				
<b>First Named Inventor/Applicant Name:</b>	James J. Fallon				
<b>Filer:</b>	Michael V. Messinger				
<b>Attorney Docket Number:</b>	2855.004000B				
Filed as Large Entity					
<b>Utility under 35 USC 111(a) Filing Fees</b>					
<b>Description</b>	<b>Fee Code</b>	<b>Quantity</b>	<b>Amount</b>	<b>Sub-Total in USD(\$)</b>	
<b>Basic Filing:</b>					
Utility application filing	1011	1	330	330	
Utility Search Fee	1111	1	540	540	
Utility Examination Fee	1311	1	220	220	
<b>Pages:</b>					
<b>Claims:</b>					
<b>Miscellaneous-Filing:</b>					
<b>Petition:</b>					
<b>Patent-Appeals-and-Interference:</b>					

Description	Fee Code	Quantity	Amount	Sub-Total in USD(\$)
<b>Post-Allowance-and-Post-Issuance:</b>				
<b>Extension-of-Time:</b>				
<b>Miscellaneous:</b>				
<b>Total in USD (\$)</b>				<b>1090</b>

## Electronic Acknowledgement Receipt

<b>EFS ID:</b>	10188737
<b>Application Number:</b>	13118122
<b>International Application Number:</b>	
<b>Confirmation Number:</b>	8978
<b>Title of Invention:</b>	Systems and Methods for Accelerated Loading of Operating Systems and Application Programs
<b>First Named Inventor/Applicant Name:</b>	James J. Fallon
<b>Customer Number:</b>	26111
<b>Filer:</b>	Michael V. Messinger/Raiza Singh
<b>Filer Authorized By:</b>	Michael V. Messinger
<b>Attorney Docket Number:</b>	2855.004000B
<b>Receipt Date:</b>	27-MAY-2011
<b>Filing Date:</b>	
<b>Time Stamp:</b>	18:11:07
<b>Application Type:</b>	Utility under 35 USC 111(a)

### Payment information:

Submitted with Payment	yes
Payment Type	Credit Card
Payment was successfully received in RAM	\$1090
RAM confirmation Number	4456
Deposit Account	
Authorized User	

### File Listing:

Document Number	Document Description	File Name	File Size(Bytes)/ Message Digest	Multi Part /.zip	Pages (if appl.)
-----------------	----------------------	-----------	-------------------------------------	------------------	------------------

1		2855004000B_Continuation.pdf	8523427 40b13cdb4dc23a514526f849cbc77737e7d9022e	yes	67
<b>Multipart Description/PDF files in .zip description</b>					
		<b>Document Description</b>	<b>Start</b>	<b>End</b>	
		Miscellaneous Incoming Letter	1	2	
		Transmittal of New Application	3	3	
		Authorization for Extension of Time all replies	4	4	
		Authorization to access Appl. by Trilateral Office	5	5	
		Application Data Sheet	6	10	
		Specification	11	48	
		Claims	49	49	
		Abstract	50	50	
		Drawings-only black and white line drawings	51	63	
		Oath or Declaration filed	64	65	
		Power of Attorney	66	66	
		Assignee showing of ownership per 37 CFR 3.73(b).	67	67	
<b>Warnings:</b>					
<b>Information:</b>					
2	Fee Worksheet (PTO-875)	fee-info.pdf	32365 3a20f9c2f55ae2c96081a4698c3c6a2e34885e21	no	2
<b>Warnings:</b>					
<b>Information:</b>					
<b>Total Files Size (in bytes):</b>			8555792		

**This Acknowledgement Receipt evidences receipt on the noted date by the USPTO of the indicated documents, characterized by the applicant, and including page counts, where applicable. It serves as evidence of receipt similar to a Post Card, as described in MPEP 503.**

**New Applications Under 35 U.S.C. 111**

**If a new application is being filed and the application includes the necessary components for a filing date (see 37 CFR 1.53(b)-(d) and MPEP 506), a Filing Receipt (37 CFR 1.54) will be issued in due course and the date shown on this Acknowledgement Receipt will establish the filing date of the application.**

**National Stage of an International Application under 35 U.S.C. 371**

**If a timely submission to enter the national stage of an international application is compliant with the conditions of 35 U.S.C. 371 and other applicable requirements a Form PCT/DO/EO/903 indicating acceptance of the application as a national stage submission under 35 U.S.C. 371 will be issued in addition to the Filing Receipt, in due course.**

**New International Application Filed with the USPTO as a Receiving Office**

**If a new international application is being filed and the international application includes the necessary components for an international filing date (see PCT Article 11 and MPEP 1810), a Notification of the International Application Number and of the International Filing Date (Form PCT/RO/105) will be issued in due course, subject to prescriptions concerning national security, and the date shown on this Acknowledgement Receipt will establish the international filing date of the application.**



**MICHAEL V. MESSINGER**  
DIRECTOR  
(202) 772-8667  
MIKEM@SKGF.COM



May 27, 2011

Commissioner for Patents  
PO Box 1450  
Alexandria, VA 22313-1450

Re: U.S. Non-Provisional Utility Patent Application under 37 C.F.R. § 1.53(b)  
(Continuation of Appl. No. 11/551,211; Filed October 19, 2006)  
Appl. No. To Be Assigned; Filed: Herewith  
For: **Systems and Methods for Accelerated Loading of Operating Systems  
and Application Programs**  
Inventors: Fallon *et al.*  
Our Ref: 2855.004000B

Sir:

The following documents are transmitted herewith for appropriate action by the U.S. Patent and Trademark Office:

1. Utility Patent Application Transmittal Form (PTO/SB/05);
2. Online Credit Card Payment Authorization for **\$1,090.00** to cover:  

\$1,090.00 Patent Application fee (including basic filing, search, and examination fees);
3. Authorization to Treat a Reply As Incorporating An Extension of Time Under 37 C.F.R. § 1.136(a)(3);
4. Authorization to Permit Access to Application by Participating Offices (PTO/SB/39);
5. U.S. Utility Patent Application entitled:  

**Systems and Methods for Accelerated Loading of Operating Systems and Application Programs**

and naming as inventors:  
**James J. Fallon, John Buck, Paul F. Pickel and Stephen J. McErlain**

the application consisting of:

Commissioner for Patents  
May 27, 2011  
Page 2

- a. An Application Data Sheet (37 C.F.R. § 1.76);
  - b. A specification containing:
    - i. 38 pages of description prior to the claims;
    - ii. 1 page listing 1 claim;
    - iii. a one (1) page abstract;
  - c. 13 sheets of drawings: (FIGS. 1-5, 6A, 6B, 7A, 7B, 8A, 8B and 9-10);
  - d. A copy of the executed Declaration, as originally filed in U.S. Appl. No. 11/551,211;
6. Power of Attorney to Prosecute Applications Before the USPTO (PTO/SB/80); and
  7. Statement under 37 C.F.R. § 3.73(b) (PTO/SB/96).

The above-listed documents are filed electronically through EFS-Web.

Fee payment is provided through online credit card payment. The U.S. Patent and Trademark Office is hereby authorized to charge any fee deficiency, or credit any overpayment, to our Deposit Account No. 19-0036.

Respectfully submitted,

STERNE, KESSLER, GOLDSTEIN & FOX P.L.L.C.



Michael V. Messinger  
Attorney for Applicants  
Registration No. 37,575

MVM/V-R/rms  
Enclosures

Under the Paperwork Reduction Act of 1995, no persons are required to respond to a collection of information unless it displays a valid OMB control number.

<b>AUTHORIZATION TO PERMIT                  ACCESS TO APPLICATION BY                  PARTICIPATING OFFICES</b>	COMPLETE IF KNOWN	
	Application Number	To Be Assigned
	Filing Date	Herewith
	First Named Inventor	James J. Fallon
	Attorney Docket Number	2855 004000B
Title (Required)	Systems and Methods for Accelerated Loading of Operating Systems and Application Programs	

Send completed form to: Commissioner for Patents  
 P.O. Box 1450, Alexandria, VA 22313-1450

The undersigned hereby grants the USPTO authority to provide the European Patent Office (EPO), the Japan Patent Office (JPO), the Korean Intellectual Property Office (KIPO), the World Intellectual Property Office (WIPO), and any other intellectual property offices in which a foreign application claiming priority to the above-identified patent application is filed access to the above-identified patent application. See 37 CFR 1.14(c) and (h).

In accordance with 37 CFR 1.14(h)(3), access will be provided to a copy of the above-identified application with respect to: 1) the above-identified patent application-as-filed; 2) any foreign application to which the above-identified patent application claims priority under 35 U.S.C. 119(a)-(d) if a copy of the foreign application that satisfies the certified copy requirement of 37 CFR 1.55 has been filed in the above-identified patent application; and 3) any U.S. application-as-filed from which benefit is sought in the above-identified patent application.

In accordance with 37 CFR 1.14(c), access may be provided to information concerning the date of filing the Authorization to Permit Access to Application by Participating Offices.

This written authorization should be submitted prior to the filing of a subsequent foreign application, in which priority is claimed to the above-identified patent application, with any intellectual property office (e.g., the EPO, JPO, KIPO, or DAS Accessing Office). However, if applicant does not wish the EPO, JPO, KIPO, WIPO, or other intellectual property office in which a foreign application claiming priority to the above-identified patent application is filed to have access to the above-identified patent application, this written authorization should not be filed.

No fee will be charged under 37 CFR 1.19(b)(1) for providing a participating intellectual property office with an electronic copy of the above-identified patent application.

**This form must be signed by an authorized party in accordance with 37 CFR 1.14(c).**

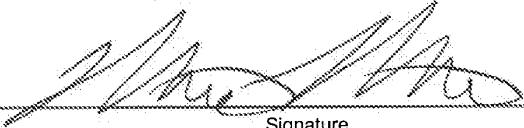
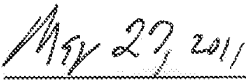
 _____ Signature	 _____ Date
Michael V. Messinger _____ Printed or Typed Name	(202) 371-2600 _____ Telephone Number
Attorney for Applicants _____ Title	37,575 _____ Registration Number, if applicable

This collection of information is required by 37 CFR 1.14(h). The information is required to obtain or retain a benefit by the public which is to file (and by the USPTO to process an application). Confidentiality is governed by 35 U.S.C. 122 and 37 CFR 1.11 and 1.14. This collection is estimated to take 6 minutes to complete, including gathering, preparing, and submitting the completed application form to the USPTO. Time will vary depending upon the individual case. Any comments on the amount of time you require to complete this form and/or suggestions for reducing this burden, should be sent to the Chief Information Officer, U.S. Patent and Trademark Office, U.S. Department of Commerce, P.O. Box 1450, Alexandria, VA 22313-1450. DO NOT SEND FEES OR COMPLETED FORMS TO THIS ADDRESS. **SEND TO: Commissioner for Patents, P.O. Box 1450, Alexandria, VA 22313-1450.**

If you need assistance in completing the form, call 1-800-PTO-9199 and select option 2.

**APPLICATION DATA SHEET**

Electronic Version v14  
Stylesheet Version v14.1

***Applicant Information:***

Inventor 1:

<b>Applicant Authority Type:</b>	Inventor
<b>Citizenship:</b>	US
<b>Given Name:</b>	James
<b>Middle Name:</b>	J.
<b>Family Name:</b>	Fallon
<b>City of Residence:</b>	Armonk
<b>State of Residence:</b>	NY
<b>Country of Residence:</b>	US
<b>Address-1 of Mailing Address:</b>	11 Wampus Close
<b>Address-2 of Mailing Address:</b>	
<b>City of Mailing Address:</b>	Armonk
<b>State of Mailing Address:</b>	NY
<b>Postal Code of Mailing Address:</b>	10504
<b>Country of Mailing Address:</b>	US
<b>Phone:</b>	
<b>Fax:</b>	
<b>E-mail:</b>	

Inventor 2:

<b>Applicant Authority Type:</b>	Inventor
<b>Citizenship:</b>	US
<b>Given Name:</b>	John
<b>Family Name:</b>	Buck
<b>City of Residence:</b>	Oceanside
<b>State of Residence:</b>	NY
<b>Country of Residence:</b>	US
<b>Address-1 of Mailing Address:</b>	362 Christopher Street
<b>Address-2 of Mailing Address:</b>	
<b>City of Mailing Address:</b>	Oceanside
<b>State of Mailing Address:</b>	NY

**Postal Code of Mailing Address:** 11572  
**Country of Mailing Address:** US  
**Phone:**  
**Fax:**  
**E-mail:**

Inventor 3:

**Applicant Authority Type:** Inventor  
**Citizenship:** US  
**Given Name:** Paul  
**Middle Name:** F.  
**Family Name:** Pickel  
**City of Residence:** Bethpage  
**State of Residence:** NY  
**Country of Residence:** US  
**Address-1 of Mailing Address:** 225 Stewart Avenue  
**Address-2 of Mailing Address:**  
**City of Mailing Address:** Bethpage  
**State of Mailing Address:** NY  
**Postal Code of Mailing Address:** 11714  
**Country of Mailing Address:** US  
**Phone:**  
**Fax:**  
**E-mail:**

Inventor 4:

**Applicant Authority Type:** Inventor  
**Citizenship:** US  
**Given Name:** Stephen  
**Middle Name:** J.  
**Family Name:** McErlain  
**City of Residence:** New York  
**State of Residence:** NY  
**Country of Residence:** US  
**Address-1 of Mailing Address:** 325 East 17th Street  
**Address-2 of Mailing Address:**

**City of Mailing Address:** New York  
**State of Mailing Address:** NY  
**Postal Code of Mailing Address:** 10003  
**Country of Mailing Address:** US  
**Phone:**  
**Fax:**  
**E-mail:**

*Correspondence Information:*

**Customer Number:** 26111 \*26111\*

*Application Information:*

**Title of Invention:** Systems and Methods for Accelerated Loading of Operating Systems and Application Programs

**Application Type:** regular, utility

**Attorney Docket Number:** 2855.004000B

Botanic Information:

Publication Information:

**Suggested Figure for Publication -**

**Suggested Classification -**

**Suggested Technology Center -**

**Total Number of Drawing Sheets - 13**

*Representative Information:*

practitioner(s) at Customer Number:

26111 \*26111\*

as our attorney(s) or agent(s) to prosecute the application identified above, and to transact all business in the United States Patent and Trademark Office connected therewith.

***Domestic Priority Information:***

This is a Continuation of US application number 11/551,211, filed 2006-10-19, now allowed.

US application number 11/551,211, filed 2006-10-19 is a Continuation of US application number 09/776,267, filed 2001-02-02, now US patent number 7,181,608, B2, issued 2007-02-20.

US application number 09/776,267, filed 2001-02-02 is a Non-Provisional of US application number 60/180,114, filed 2000-02-03, now expired.

***Foreign Priority Information:***

***Assignee Information:***

Assignee 1:

**Organization Name:** Realtime Data LLC dba IXO  
**Address-1 of Mailing Address:** 11 Wampus Close  
**Address-2 of Mailing Address:**  
**City of Mailing Address:** Armonk  
**State of Mailing Address:** NY  
**Postal Code of Mailing Address:** 10504  
**Country of Mailing Address:** US  
**Phone:**  
**Fax:**  
**E-mail:**

Respectfully submitted,

STERNE, KESSLER, GOLDSTEIN & FOX P.L.L.C.



Michael V. Messinger  
Attorney for Applicants  
Registration No. 37,575

Date: May 27, 2011

1100 New York Avenue, N.W.  
Washington, D.C. 20005-3934  
(202) 371-2600

MVM/V-R/ms  
1367486\_1.DOCX



WHAT IS CLAIMED IS:

1. A method for providing accelerated loading of an operating system, comprising the steps of:  
maintaining a list of boot data used for booting a computer system;  
preloading the boot data upon initialization of the computer system; and  
servicing requests for boot data from the computer system using the preloaded boot data.

## ABSTRACT

Systems and methods for providing accelerated loading of operating system and application programs upon system boot or application launch are disclosed. In one aspect, a method for providing accelerated loading of an operating system comprises the steps of: maintaining a list of boot data used for booting a computer system; preloading the boot data upon initialization of the computer system; and servicing requests for boot data from the computer system using the preloaded boot data. In another aspect, a method for providing accelerated launching of an application program comprises the steps of: maintaining a list of application data associated with an application program; preloading the application data upon launching the application program; and servicing requests for application data from a computer system using the preloaded application data.

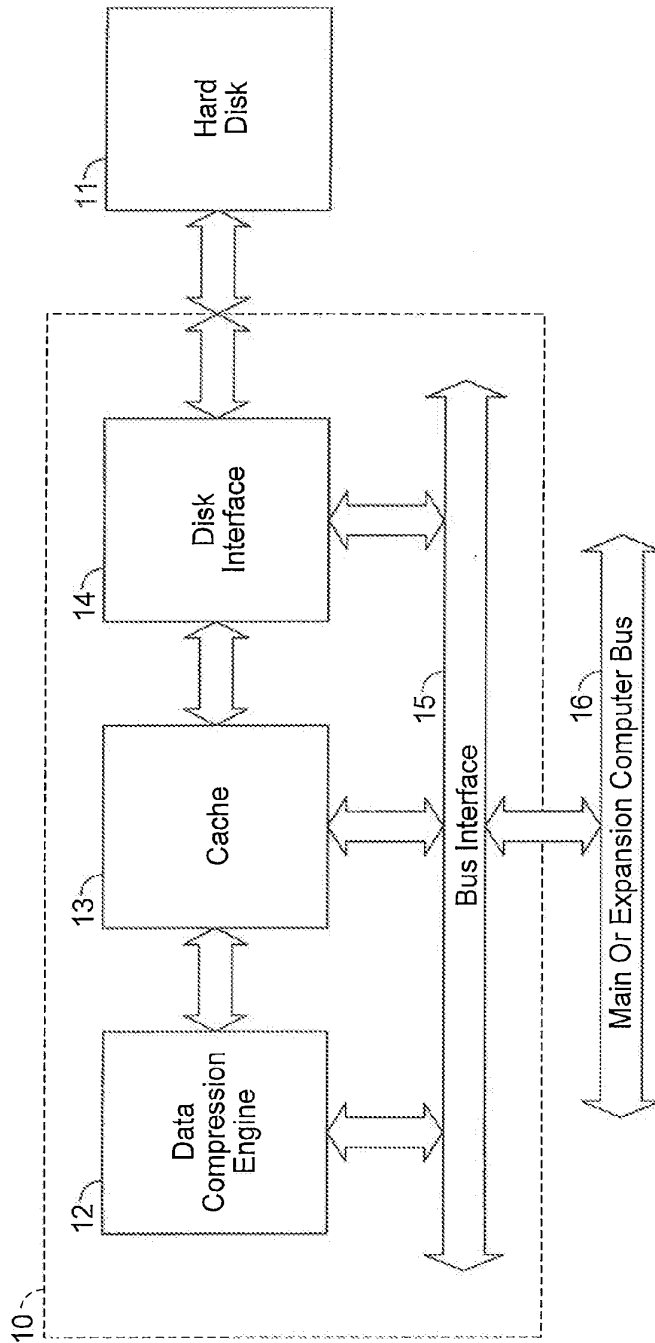

FIG. 1

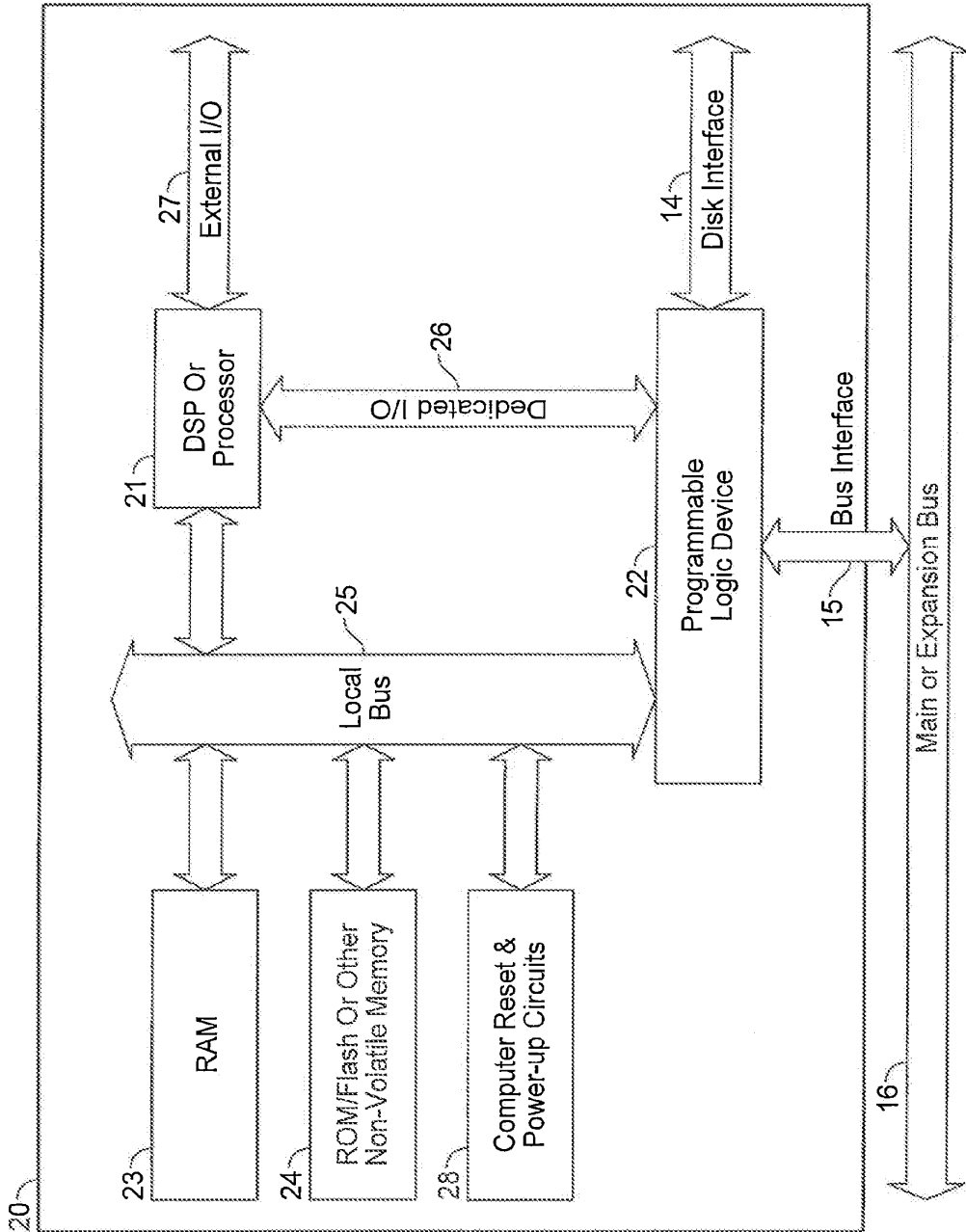

FIG. 2

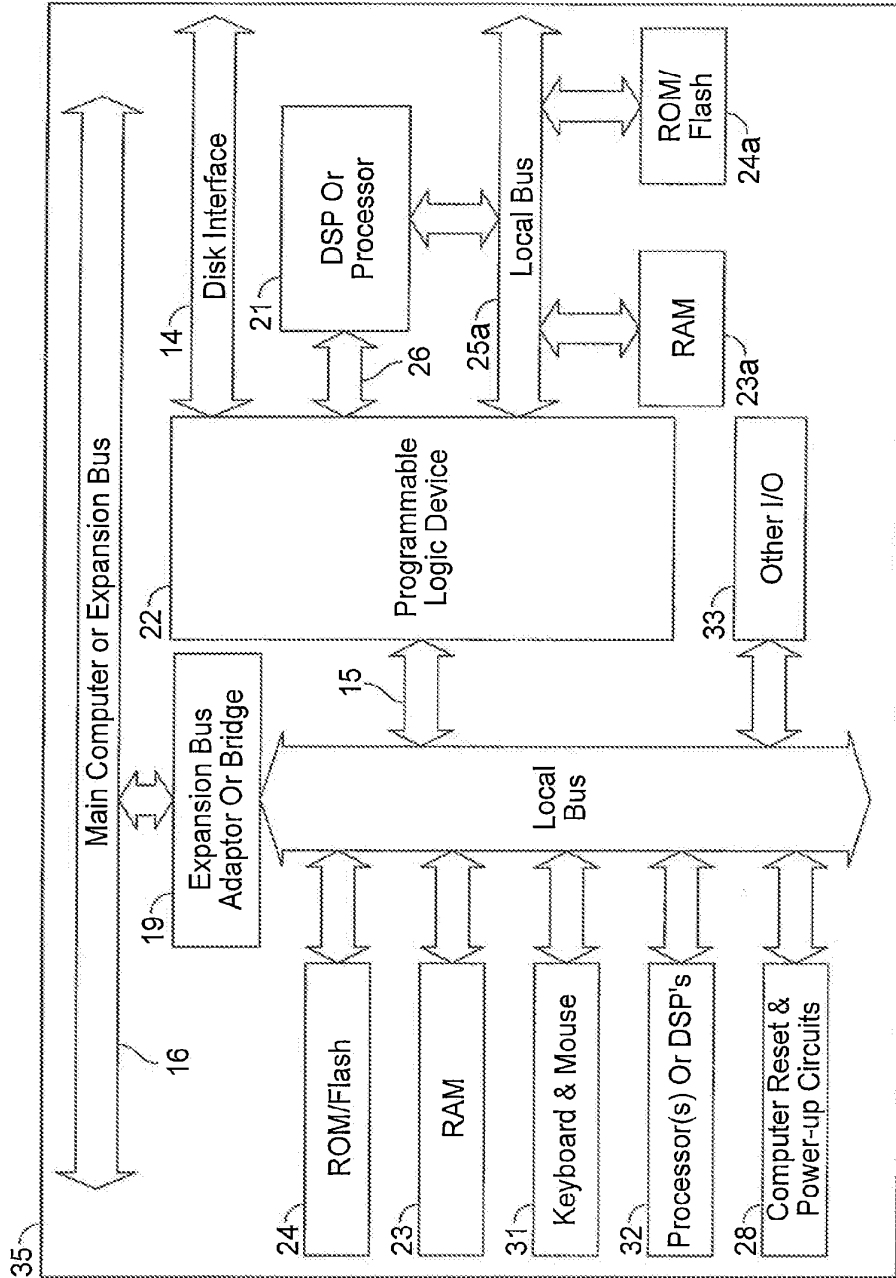

FIG. 3

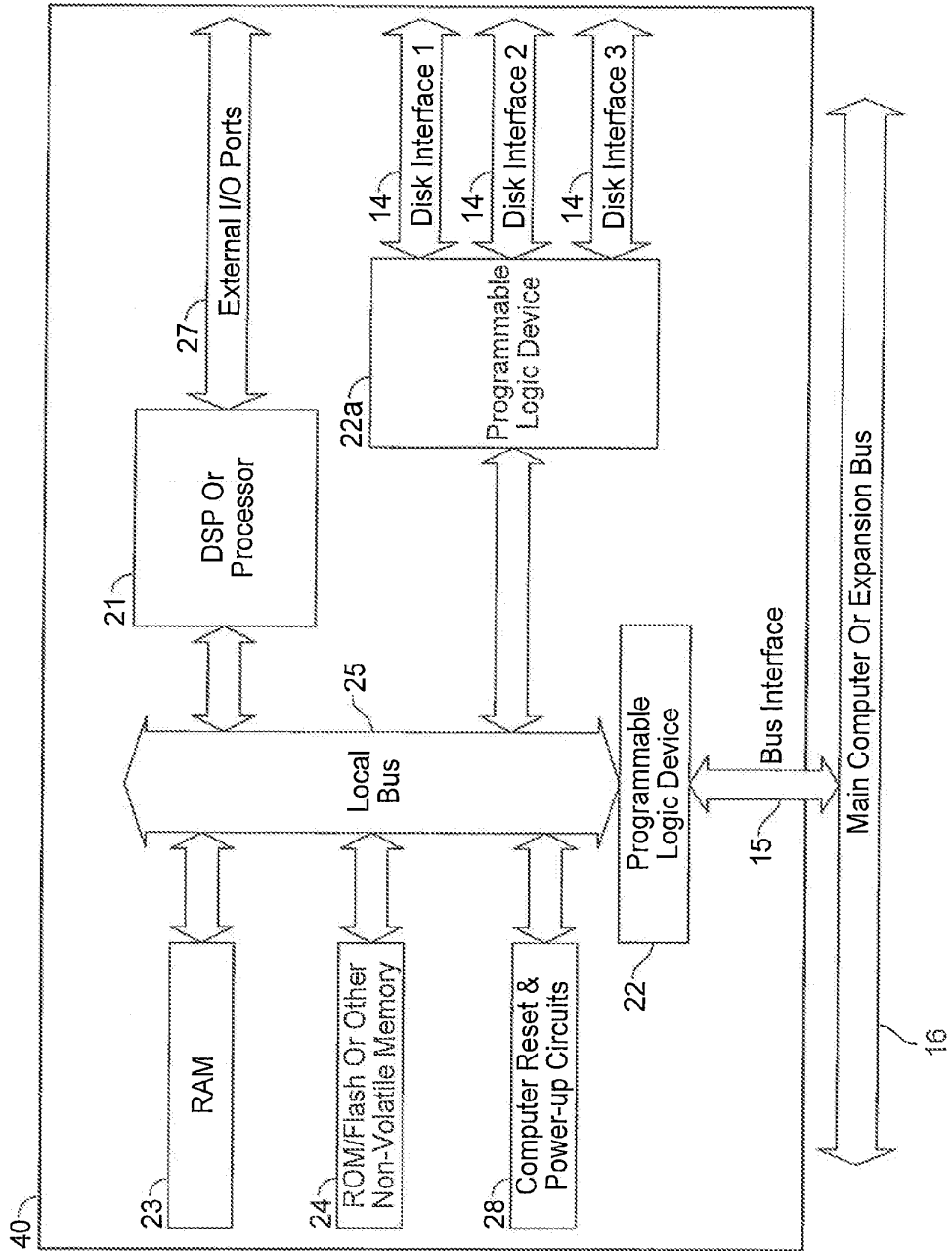

FIG. 4

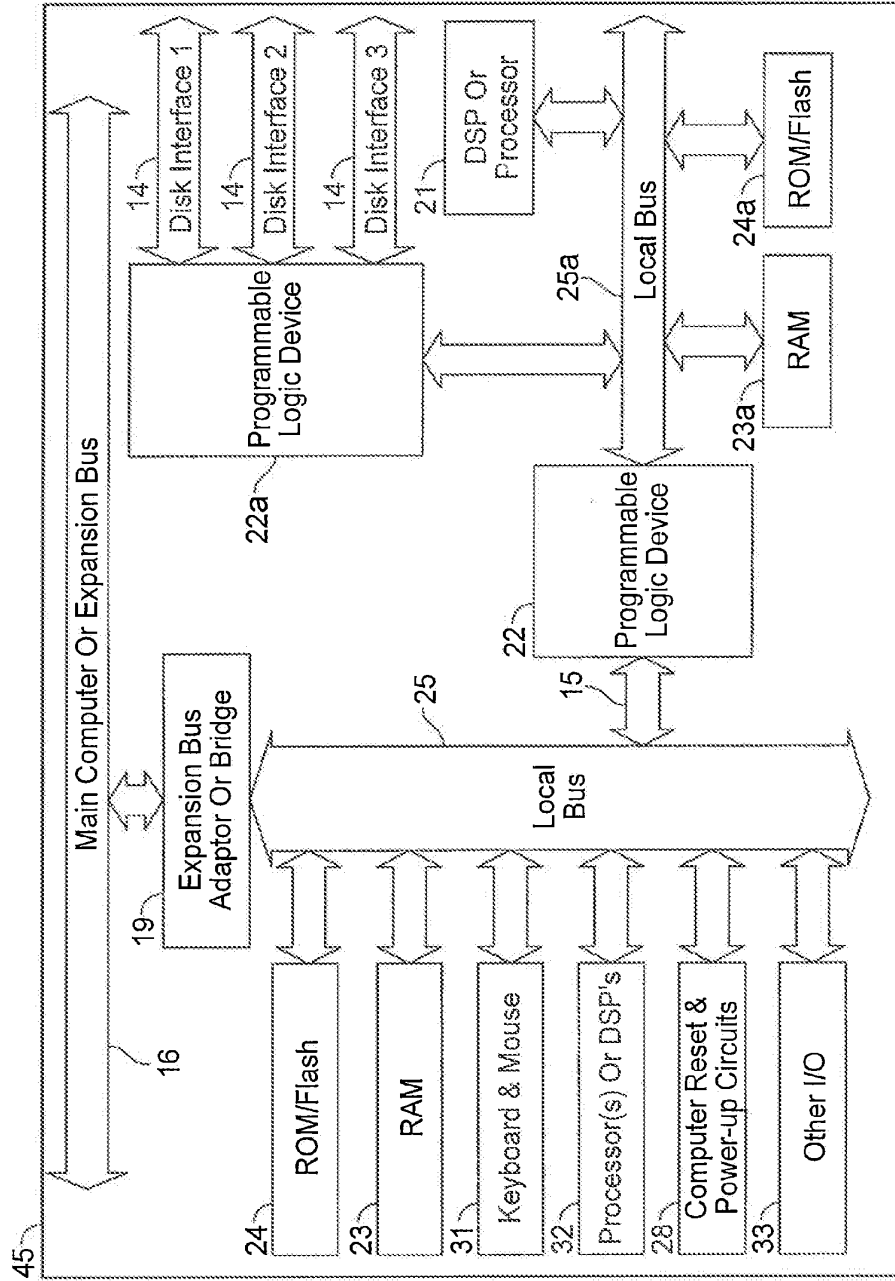

FIG. 5

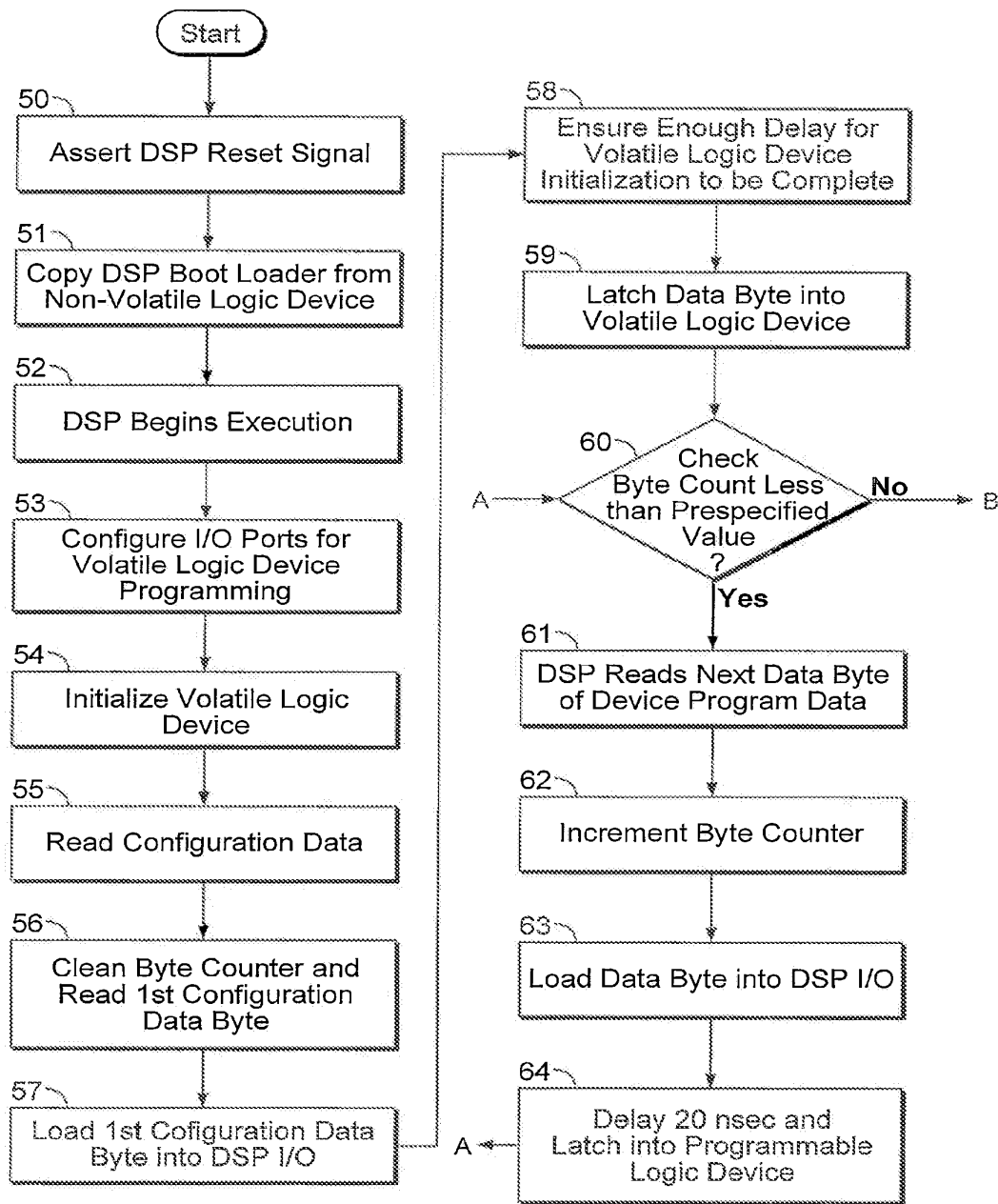

FIG. 6A



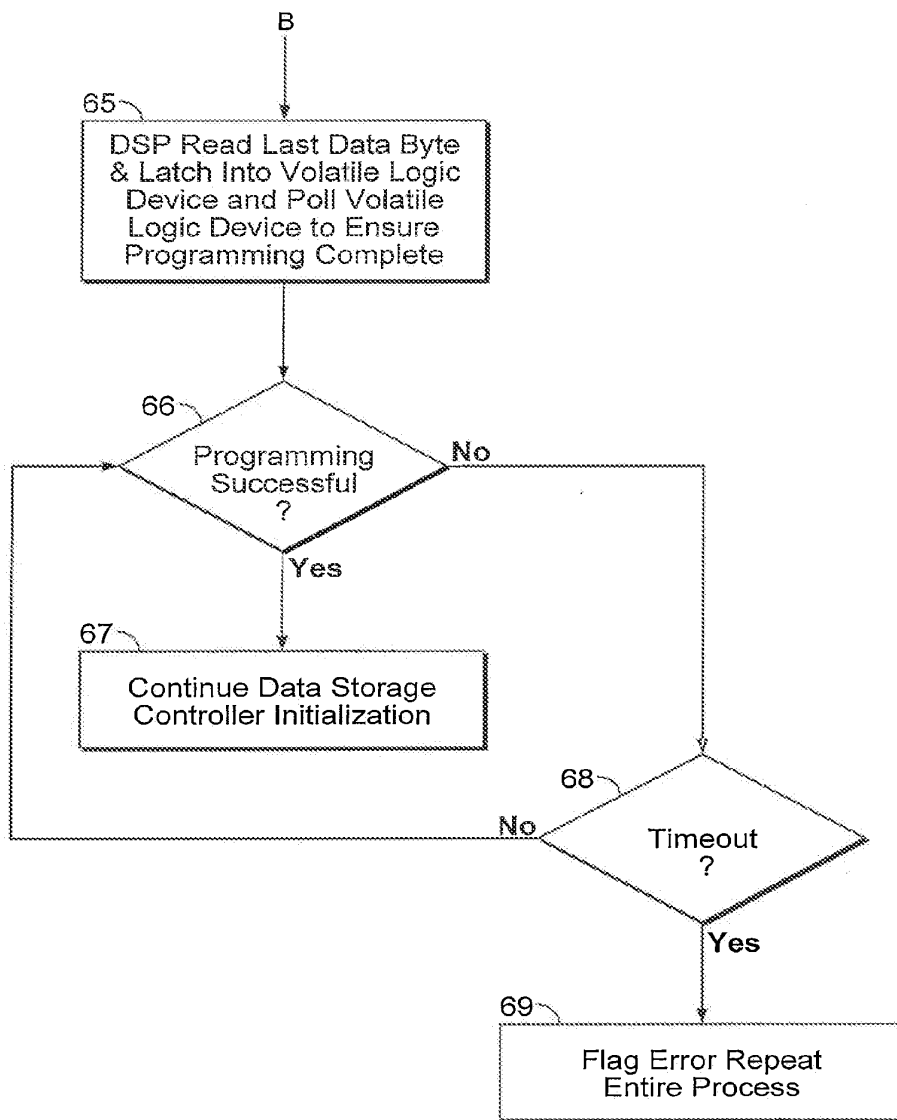

FIG. 6B

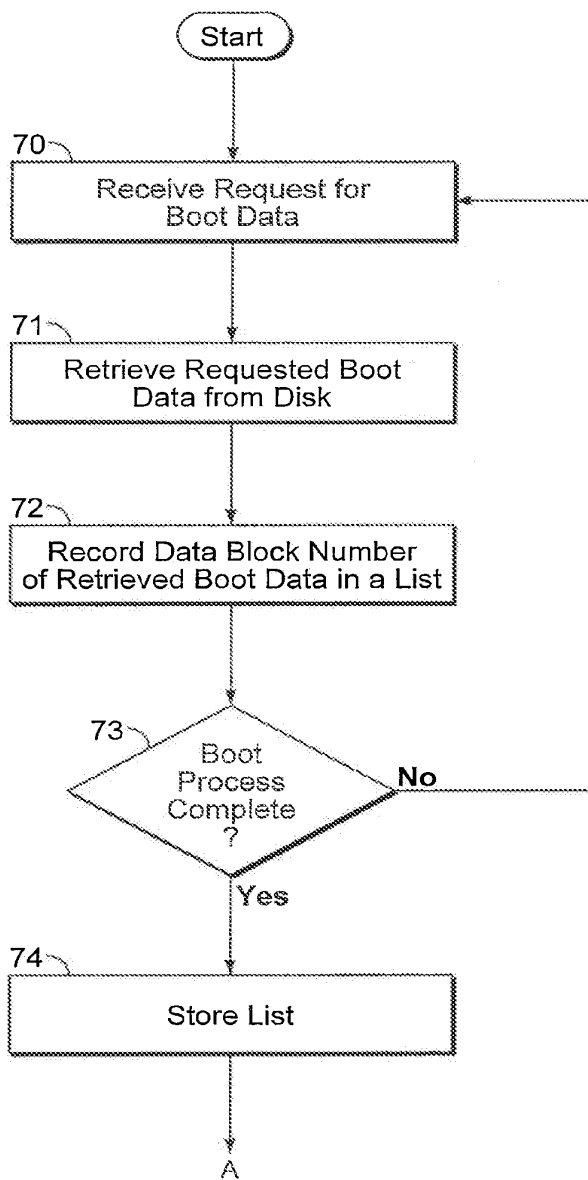

FIG. 7A

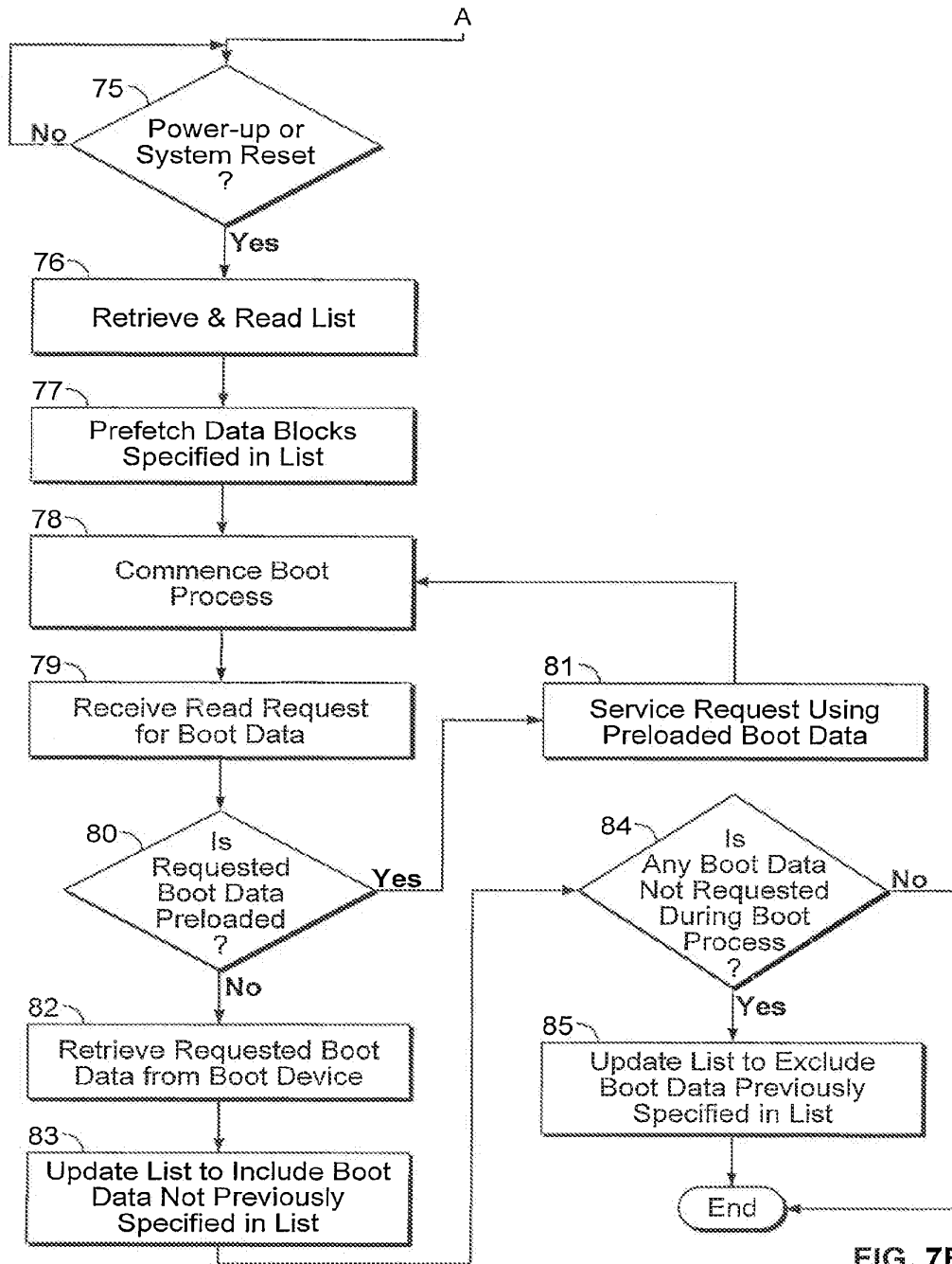

FIG. 7B

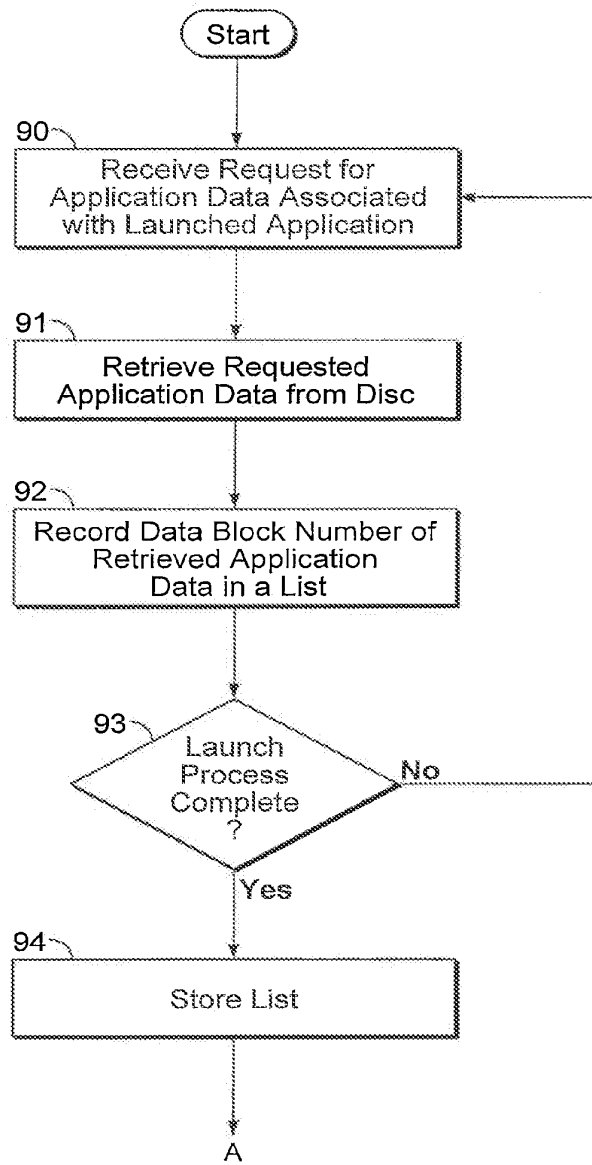

FIG. 8A

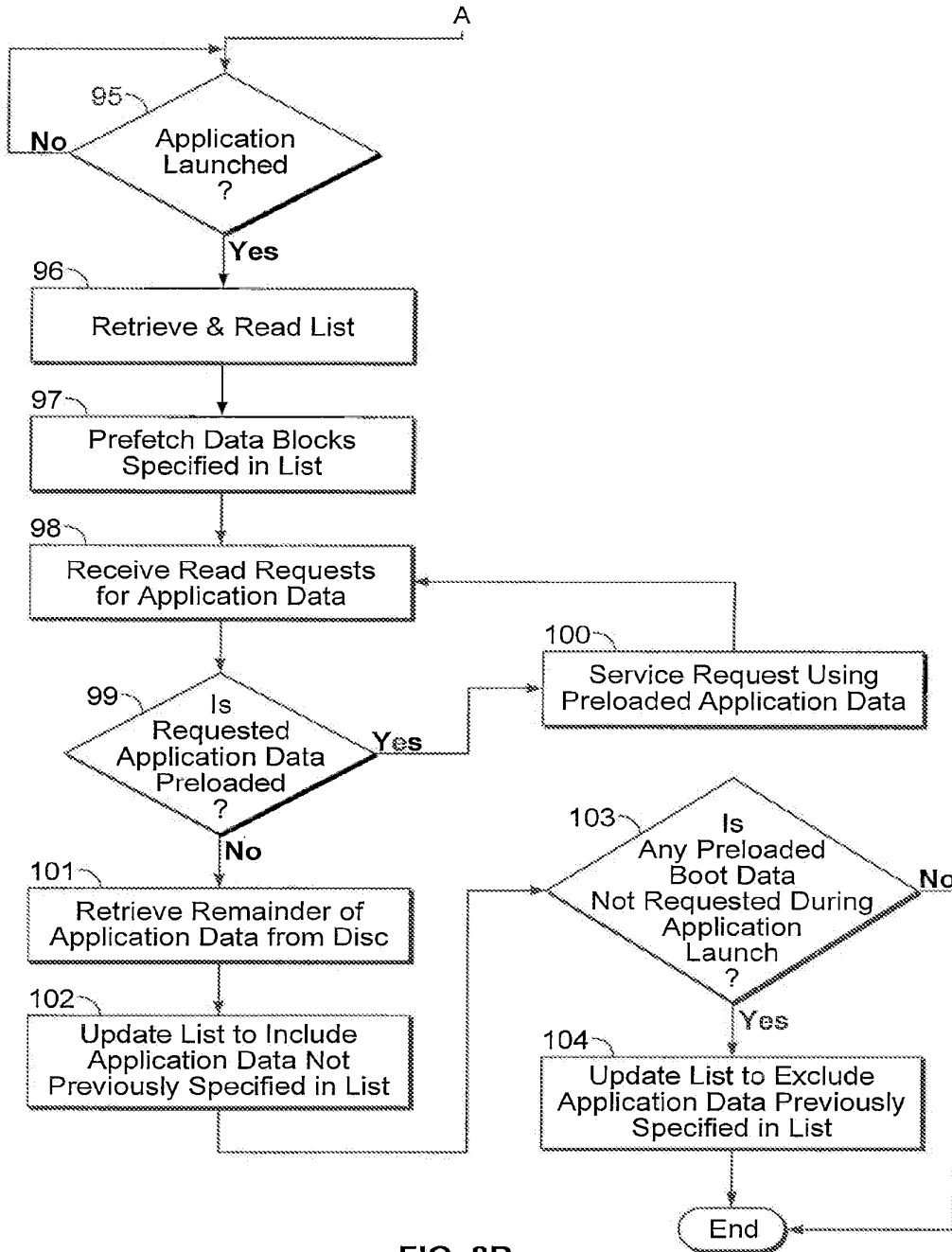

FIG. 8B

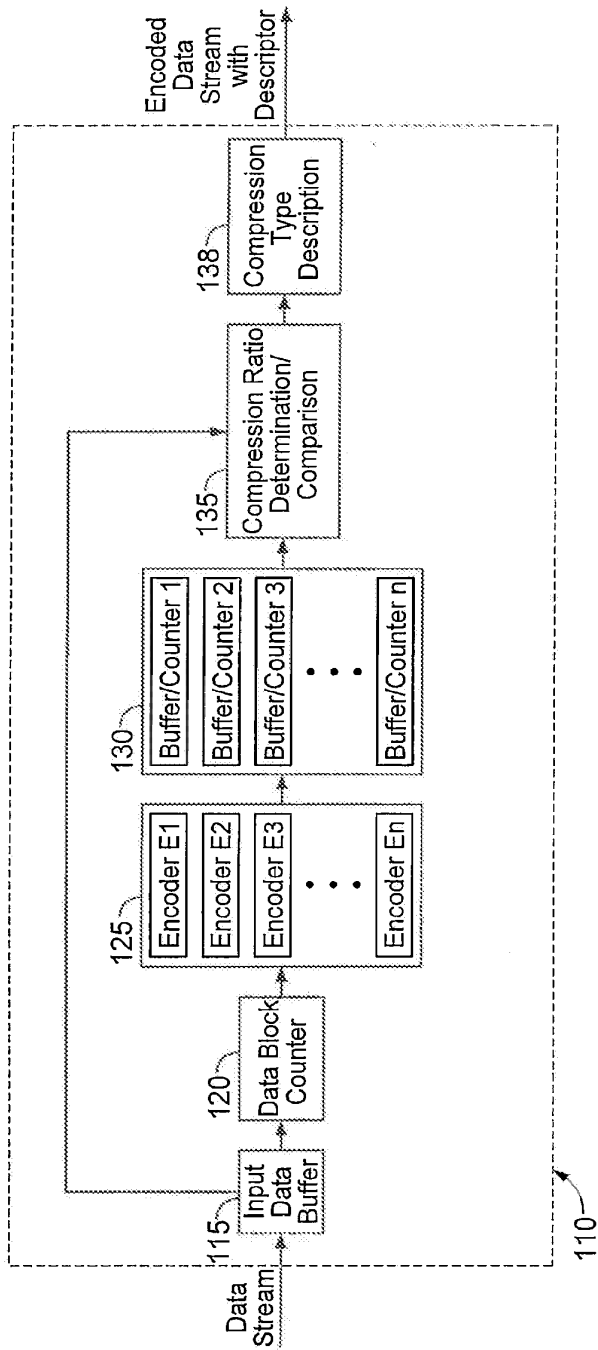

FIG. 9

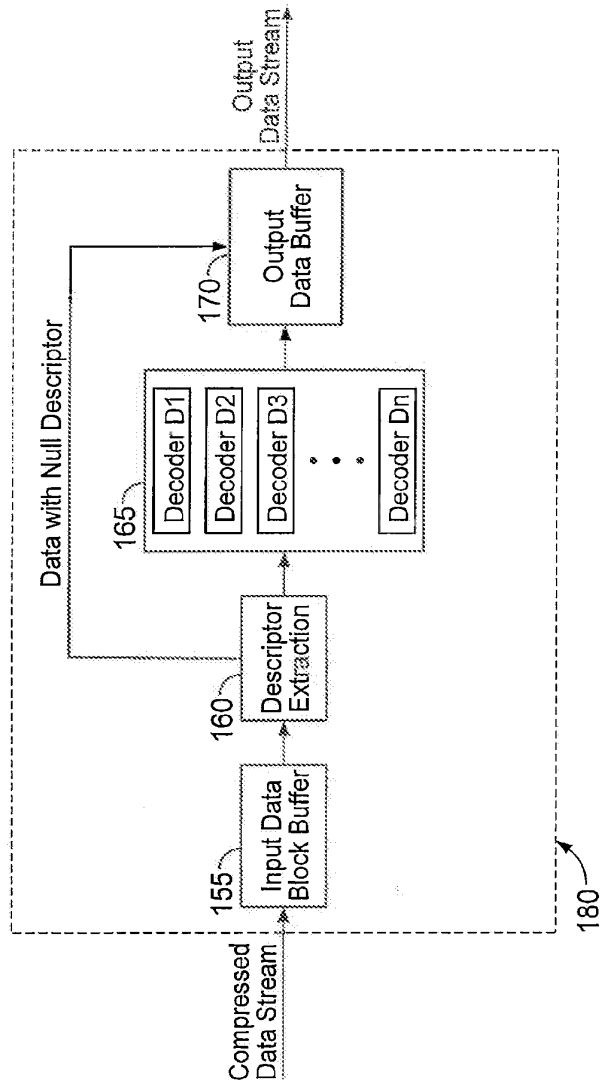

FIG. 10

DECLARATION



AS A BELOW NAMED INVENTOR, I hereby declare that:

My residence, post office address and citizenship are as stated next to my name

I believe that I am the original, first and sole (if only one name is listed below), or an original, first and joint inventor (if plural names are listed below), of the subject matter which is claimed and for which a patent is sought on the invention entitled:

TITLE: SYSTEMS AND METHODS FOR ACCELERATED LOADING OF OPERATING SYSTEMS AND APPLICATION PROGRAMS

the specification of which either is attached hereto or indicates an attorney docket no. \_\_\_\_\_, or:

[X] was filed in the U.S. Patent & Trademark Office on February 2, 2001 and assigned Serial No. 09/776,267.

[ ] and (if applicable) was amended on \_\_\_\_\_

I hereby state that I have reviewed and understand the contents of the above-identified specification, including the claims, as amended by any amendment referred to above. I acknowledge the duty to disclose information which is material to patentability and to the examination of this application in accordance with Title 37 of the Code of Federal Regulations §1.56. I hereby claim foreign priority benefits under Title 35, U.S. Code §119(a)-(d) or §365(b) of any foreign application(s) for patent or inventor's certificate, or §365(a) of any PCT international application which designated at least one country other than the United States, or §119(e) of any United States provisional application(s), listed below and have also identified below any foreign applications for patent or inventor's certificate having a filing date before that of the application on which priority is claimed:

Priority Claimed:

Yes [ ] No [ ]

(Application Number) (Country) Day/Month/Year filed

Yes [ ] No [ ]

(Application Number) (Country) (Day/Month/Year filed)

I hereby claim the benefit under Title 35, U.S. Code, §120, of any United States application(s), or §365(c) of any PCT International application designating the United States, listed below and, insofar as the subject matter of each of the claims of this application is not disclosed in the prior United States or PCT International application(s) in the manner provided by the first paragraph of Title 35, U.S. Code, §112, I acknowledge the duty to disclose information material to patentability as defined in Title 37, The Code of Federal Regulations, §1.56(a) which became available between the filing date of the prior application and the national or PCT international filing date of this application:

60/180,114 February 3, 2000 Pending (Application Serial Number) (Filing Date) (STATUS: patented, pending, abandoned)

(Application Serial Number) (Filing Date) (STATUS: patented, pending, abandoned)

I hereby appoint the following attorneys: FRANK CHAU, Reg. No. 34,136; JAMES J. BITETTO, Reg. No. 40,513, FRANK V. DeROSA, Reg. No. 43,584; and GASPARE J. RANDAZZO, Reg. No. 41,528, each of them of F. CHAU & ASSOCIATES, LLP, 1900 Hempstead Turnpike, Suite 501, East Meadow, New York 11554 to prosecute this application and to transact all business in the U.S. Patent and Trademark Office connected therewith and with any divisional, continuation, continuation-in-part, reissue or re-examination application, with full power of appointment and with full power to substitute an associate attorney or agent, and to receive all patents which may issue thereon, and request that all correspondence be addressed to:

Frank Chau, Esq.
F. CHAU & ASSOCIATES, LLP
1900 Hempstead Turnpike, Suite 501
East Meadow, New York 11554
Area Code: 516-357-0091



I HEREBY DECLARE that all statements made herein of my own knowledge are true and that all statements made on information and belief are believed to be true; and further that these statements were made with the knowledge that willful false statements and the like so made are punishable by fine or imprisonment, or both, under §1001 of Title 18 U.S. Code and that such willful false statements may jeopardize the validity of the application or any patent issued thereon.

FULL NAME OF FIRST OR SOLE INVENTOR: James J. Fallon Citizenship USA  
Inventor's signature: [Signature] Date: 4/20/01  
Residence & Post Office Address: 11 Wampus Close, Armonk  
New York 10504

FULL NAME OF SECOND INVENTOR: John Buck Citizenship USA  
Inventor's signature: [Signature] Date: 4/21/01  
Residence & Post Office Address: 362 Christopher Street; Oceanside, New York 11572

FULL NAME OF THIRD INVENTOR: Paul F. Pickel Citizenship USA  
Inventor's signature: [Signature] Date: 4/24/01  
Residence & Post Office Address: 225 Stewart Avenue, Bethpage, New York 11714

FULL NAME OF FOURTH INVENTOR: Stephen J. McElrain McELRAIN Citizenship USA  
Inventor's signature: [Signature] Date: 4/20/01  
Residence & Post Office Address: 325 East 17<sup>th</sup> Street, New York, New York 10003

FULL NAME OF FIFTH INVENTOR: \_\_\_\_\_ Citizenship \_\_\_\_\_  
Inventor's signature: \_\_\_\_\_ Date: \_\_\_\_\_  
Residence & Post Office Address: \_\_\_\_\_

FULL NAME OF SIXTH INVENTOR: \_\_\_\_\_ Citizenship \_\_\_\_\_  
Inventor's signature: \_\_\_\_\_ Date: \_\_\_\_\_  
Residence & Post Office Address: \_\_\_\_\_

FULL NAME OF SEVENTH INVENTOR: \_\_\_\_\_ Citizenship \_\_\_\_\_  
Inventor's signature: \_\_\_\_\_ Date: \_\_\_\_\_  
Residence & Post Office Address: \_\_\_\_\_

# SYSTEMS AND METHODS FOR ACCELERATED LOADING OF OPERATING SYSTEMS AND APPLICATION PROGRAMS

## CROSS-REFERENCE TO RELATED APPLICATION

[0001] This application is a continuation of United States Patent Application No. 11/551,211, filed on October 19, 2006, which is a continuation of United States Patent Application No. 09/776,267, filed on February 2, 2001, now U.S. Patent No. 7,181,608, which is based on a United States Provisional Application Serial No. 60/180,114, filed on February 3, 2000, all three of which are fully incorporated herein by reference in their entirety.

## BACKGROUND

### 1. Technical Field

[0002] The present invention relates generally to systems and methods for providing accelerated loading of operating system and application programs upon system boot or application launch and, more particularly, to data storage controllers employing lossless and/or lossy data compression and decompression to provide accelerated loading of operating systems and application programs.

### 2. Description of the Related Art

[0003] Modern computers utilize a hierarchy of memory devices. To achieve maximum performance levels, modern processors utilize onboard memory and on board cache to obtain high bandwidth access to both program and data. Limitations in process technologies currently prohibit placing a sufficient quantity of onboard memory for most applications. Thus, in order to offer sufficient memory for the operating system(s), application programs, and user data, computers often use various forms of popular off-processor high speed memory including static random access memory (SRAM), synchronous dynamic random access memory (SDRAM), synchronous burst static ram (SBSRAM). Due to the prohibitive cost of the high-speed random access memory, coupled with their power volatility, a third lower level of the hierarchy exists for non-volatile mass storage devices.

Atty. Dkt. No. 2855.004000B

[0004] Furthermore, mass storage devices offer increased capacity and fairly economical data storage. Mass storage devices (such as a "hard disk") typically store the operating system of a computer system, as well as applications and data and rapid access to such data is critical to system performance. The data storage and retrieval bandwidth of mass storage devices, however, is typically much less as compared with the bandwidth of other elements of a computing system. Indeed, over the last decade, although computer processor performance has improved by at least a factor of 50, magnetic disk storage performance has only improved by a factor of 5. Consequently, memory storage devices severely limit the performance of consumer, entertainment, office, workstation, servers, and mainframe computers for all disk and memory intensive operations.

[0005] The ubiquitous Internet combined with new multimedia applications has put tremendous emphasis on storage volumetric density, storage mass density, storewidth, and power consumption. Specifically, storage density is limited by the number of bits that are encoded in a mass storage device per unit volume. Similarly mass density is defined as storage bits per unit mass. Storewidth is the data rate at which the data may be accessed. There are various ways of categorizing storewidth in terms, several of the more prevalent metrics include sustained continuous storewidth, burst storewidth, and random access storewidth, all typically measured in megabytes/sec. Power consumption is canonically defined in terms of power consumption per bit and may be specified under a number of operating modes including active (while data is being accessed and transmitted) and standby mode. Hence one fairly obvious limitation within the current art is the need for even more volume, mass, and power efficient data storage.

[0006] Magnetic disk mass storage devices currently employed in a variety of home, business, and scientific computing applications suffer from significant seek-time access delays along with profound read/write data rate limitations. Currently the fastest available disk drives support only a sustained output data rate in the tens of megabytes per second data rate (MB/sec). This is in stark contrast to the modern Personal Computer's Peripheral Component Interconnect (PCI) Bus's low end 32 bit / 33Mhz input/output capability of 264 MB/sec and the PC's internal local bus capability of 800 MB/sec.

[0007] Another problem within the current art is that emergent high performance disk interface standards such as the Small Computer Systems Interface (SCSI-3), Fibre

Channel, AT Attachment UltraDMA/66/100, Serial Storage Architecture, and Universal Serial Bus offer only higher data transfer rates through intermediate data buffering in random access memory. These interconnect strategies do not address the fundamental problem that all modern magnetic disk storage devices for the personal computer marketplace are still limited by the same typical physical media restrictions. In practice, faster disk access data rates are only achieved by the high cost solution of simultaneously accessing multiple disk drives with a technique known within the art as data striping and redundant array of independent disks (RAID).

[0008] RAID systems often afford the user the benefit of increased data bandwidth for data storage and retrieval. By simultaneously accessing two or more disk drives, data bandwidth may be increased at a maximum rate that is linear and directly proportional to the number of disks employed. Thus another problem with modern data storage systems utilizing RAID systems is that a linear increase in data bandwidth requires a proportional number of added disk storage devices.

[0009] Another problem with most modern mass storage devices is their inherent unreliability. Many modern mass storage devices utilize rotating assemblies and other types of electromechanical components that possess failure rates one or more orders of magnitude higher than equivalent solid-state devices. RAID systems employ data redundancy distributed across multiple disks to enhance data storage and retrieval reliability. In the simplest case, data may be explicitly repeated on multiple places on a single disk drive, on multiple places on two or more independent disk drives. More complex techniques are also employed that support various trade-offs between data bandwidth and data reliability.

[0010] Standard types of RAID systems currently available include RAID Levels 0, 1, and 5. The configuration selected depends on the goals to be achieved. Specifically data reliability, data validation, data storage /retrieval bandwidth, and cost all play a role in defining the appropriate RAID data storage solution. RAID level 0 entails pure data striping across multiple disk drives. This increases data bandwidth at best linearly with the number of disk drives utilized. Data reliability and validation capability are decreased. A failure of a single drive results in a complete loss of all data. Thus another problem with RAID systems is that low cost improved bandwidth requires a significant decrease in reliability.

[0011] RAID Level 1 utilizes disk mirroring where data is duplicated on an independent disk subsystem. Validation of data amongst the two independent drives is possible if the data is simultaneously accessed on both disks and subsequently compared. This tends to decrease data bandwidth from even that of a single comparable disk drive. In systems that offer hot swap capability, the failed drive is removed and a replacement drive is inserted. The data on the failed drive is then copied in the background while the entire system continues to operate in a performance degraded but fully operational mode. Once the data rebuild is complete, normal operation resumes. Hence, another problem with RAID systems is the high cost of increased reliability and associated decrease in performance.

[0012] RAID Level 5 employs disk data striping and parity error detection to increase both data bandwidth and reliability simultaneously. A minimum of three disk drives is required for this technique. In the event of a single disk drive failure, that drive may be rebuilt from parity and other data encoded on disk remaining disk drives. In systems that offer hot swap capability, the failed drive is removed and a replacement drive is inserted. The data on the failed drive is then rebuilt in the background while the entire system continues to operate in a performance degraded but fully operational mode. Once the data rebuild is complete, normal operation resumes.

[0013] Thus another problem with redundant modern mass storage devices is the degradation of data bandwidth when a storage device fails. Additional problems with bandwidth limitations and reliability similarly occur within the art by all other forms of sequential, pseudo-random, and random access mass storage devices. These and other limitations within the current art are addressed by the present invention.

#### SUMMARY OF THE INVENTION

[0014] The present invention is directed to systems and methods for providing accelerated loading of operating system and application programs upon system boot or application launch and, more particularly, to data storage controllers employing lossless and/or lossy data compression and decompression to provide accelerated loading of operating systems and application programs.

[0015] In one aspect of the present invention, a method for providing accelerated loading of an operating system comprises the steps of: maintaining a list of boot data used for

booting a computer system; preloading the boot data upon initialization of the computer system; and servicing requests for boot data from the computer system using the preloaded boot data. The boot data may comprise program code associated with an operating system of the computer system, an application program, and a combination thereof. In a preferred embodiment, the boot data is retrieved from a boot device and stored in a cache memory device.

- [0016] In another aspect, the method for accelerated loading of an operating system comprises updating the list of boot data during the boot process. The step of updating comprises adding to the list any boot data requested by the computer system not previously stored in the list and/or removing from the list any boot data previously stored in the list and not requested by the computer system.
- [0017] In yet another aspect, the boot data is stored in a compressed format on the boot device and the preloaded boot data is decompressed prior to transmitting the preloaded boot data to the requesting system.
- [0018] In another aspect, a method for providing accelerated launching of an application program comprises the steps of maintaining a list of application data associated with an application program; preloading the application data upon launching the application program; and servicing requests for application data from a computer system using the preloaded application data.
- [0019] In yet another aspect, a boot device controller for providing accelerated loading of an operating system of a host system comprises: a digital signal processor (DSP); a programmable logic device, wherein the programmable logic device is programmed by the digital signal processor to (i) instantiate a first interface for operatively interfacing the boot device controller to a boot device and to (ii) instantiate a second interface for operatively interfacing the boot device controller to the host system; and a non-volatile memory device, for storing logic code associated with the DSP, the first interface and the second interface, wherein the logic code comprises instructions executable by the DSP for maintaining a list of boot data used for booting the host system, preloading the boot data upon initialization of the host system, and servicing requests for boot data from the host system using the preloaded boot data. The boot device controller further includes a cache memory device for storing the preloaded boot data.

- [0020] The present invention is realized due to recent improvements in processing speed, inclusive of dedicated analog and digital hardware circuits, central processing units, (and any hybrid combinations thereof), that, coupled with advanced data compression and decompression algorithms are enabling of ultra high bandwidth data compression and decompression methods that enable improved data storage and retrieval bandwidth.
- [0021] These and other aspects, features and advantages, of the present invention will become apparent from the following detailed description of preferred embodiments that is to be read in connection with the accompanying drawings.

### BRIEF DESCRIPTION OF THE DRAWINGS

- [0022] Fig. 1 is a block diagram of a data storage controller according to one embodiment of the present invention;
- [0023] Fig. 2 is a block diagram of a data storage controller according to another embodiment of the present invention;
- [0024] Fig. 3 is a block diagram of a data storage controller according to another embodiment of the present invention;
- [0025] Fig. 4 is a block diagram of a data storage controller according to another embodiment of the present invention;
- [0026] Fig. 5 is a block diagram of a data storage controller according to another embodiment of the present invention;
- [0027] Figs. 6a and 6b comprise a flow diagram of a method for initializing a data storage controller according to one aspect of the present invention;
- [0028] Figs. 7a and 7b comprise a flow diagram of a method for providing accelerated loading of an operating system and/or application programs upon system boot, according to one aspect of the present invention;
- [0029] Figs. 8a and 8b comprise a flow diagram of a method for providing accelerated loading of application programs according to one aspect of the present invention;
- [0030] Fig. 9 is a diagram of an exemplary data compression system that may be employed in a data storage controller according to the present invention; and
- [0031] Fig. 10 is a diagram of an exemplary data decompression system that may be employed in a data storage controller according to the present invention.

## DETAILED DESCRIPTION OF PREFERRED EMBODIMENTS

[0032] In the following description, it is to be understood that system elements having equivalent or similar functionality are designated with the same reference numerals in the Figures. It is to be further understood that the present invention may be implemented in various forms of hardware, software, firmware, or a combination thereof. Preferably, the present invention is implemented on a computer platform including hardware such as one or more central processing units (CPU) or digital signal processors (DSP), a random access memory (RAM), and input/output (I/O) interface(s). The computer platform may also include an operating system, microinstruction code, and dedicated processing hardware utilizing combinatorial logic or finite state machines. The various processes and functions described herein may be either part of the hardware, microinstruction code or application programs that are executed via the operating system, or any combination thereof.

[0033] It is to be further understood that, because some of the constituent system components described herein are preferably implemented as software modules, the actual system connections shown in the Figures may differ depending upon the manner in that the systems are programmed. It is to be appreciated that special purpose microprocessors, dedicated hardware, or any combination thereof may be employed to implement the present invention. Given the teachings herein, one of ordinary skill in the related art will be able to contemplate these and similar implementations or configurations of the present invention.

### I. System Architectures

[0034] The present invention is directed to data storage controllers that provide increased data storage/retrieval rates that are not otherwise achievable using conventional disk controller systems and protocols to store/retrieve data to/from mass storage devices. The concept of "accelerated" data storage and retrieval was introduced in copending U.S. Patent Application Serial No. 09/266,394, filed March 11, 1999, entitled "System and Methods For Accelerated Data Storage and Retrieval" and copending U.S. Patent Application Serial No. 09/481,243, filed January 11, 2000, entitled "System and Methods For Accelerated Data Storage and Retrieval," both of which are commonly assigned and incorporated herein by reference. In general, as described in the above-incorporated

Atty. Dkt. No. 2855.004000B



applications, "accelerated" data storage comprises receiving a digital data stream at a data transmission rate which is greater than the data storage rate of a target storage device, compressing the input stream at a compression rate that increases the effective data storage rate of the target storage device and storing the compressed data in the target storage device. For instance, assume that a mass storage device (such as a hard disk) has a data storage rate of 20 megabytes per second. If a storage controller for the mass storage device is capable of compressing an input data stream with an average compression rate of 3:1, then data can be stored in the mass storage device at a rate of 60 megabytes per second, thereby effectively increasing the storage bandwidth ("storewidth") of the mass storage device by a factor of three. Similarly, accelerated data retrieval comprises retrieving a compressed digital data stream from a target storage device at the rate equal to, e.g., the data access rate of the target storage device and then decompressing the compressed data at a rate that increases the effective data access rate of the target storage device. Advantageously, accelerated data storage/retrieval mitigates the traditional bottleneck associated with, e.g., local and network disk accesses.

[0035] Referring now to Fig. 1, a high-level block diagram illustrates a data storage controller 10 according to one embodiment of the present invention. The data storage controller 10 comprises a data compression engine 12 for compressing/decompressing data (preferably in real-time or pseudo real-time) stored/retrieved from a hard disk 11 (or any other type of mass storage device) to provide accelerated data storage/retrieval. The DCE 12 preferably employs the data compression/decompression techniques disclosed in U.S. Serial No. 09/210,491 entitled "Content Independent Data Compression Method and System," filed on December 11, 1998, which is commonly assigned and which is fully incorporated herein by reference. It is to be appreciated that the compression and decompression systems and methods disclosed in U.S. Serial No. 09/210,491 are suitable for compressing and decompressing data at rates, which provide accelerated data storage and retrieval. A detailed discussion of a preferred "content independent" data compression process will be provided below.

[0036] The data storage controller 10 further comprises a cache 13, a disk interface (or disk controller) 14 and a bus interface 15. The storage controller 10 is operatively connected to the hard disk 12 via the disk controller 14 and operatively connected to an expansion bus (or main bus) 16 of a computer system via the bus interface 15. The disk

interface 14 may employ a known disk interface standard such as UltraDMA, SCSI, Serial Storage Architecture, FibreChannel or any other interface that provides suitable disk access data rates. In addition, the storage controller 10 preferably utilizes the American National Standard for Information Systems (ANSI) AT Attachment Interface (ATA/ATAPI-4) to connect the data storage controller 10 to the hard disk 12. As is known in the art, this standard defines the connectors and cables for the physical interconnects between the data storage controller and the storage devices, along with the electrical and logical characteristics of the interconnecting signals.

[0037] Further, the bus interface 15 may employ a known standard such as the PCI (Peripheral Component Interconnect) bus interface for interfacing with a computer system. The use of industry standard interfaces and protocols is preferable, as it allows the storage controller 10 to be backwards compatible and seamlessly integrated with current systems. However in new designs the present invention may be utilize any suitable computer interface or combination thereof.

[0038] It is to be understood that although Fig. 1 illustrates a hard disk 12, the storage controller 10 may be employed with any form of memory device including all forms of sequential, pseudo-random, and random access storage devices. Storage devices as known within the current art include all forms of random access memory, magnetic and optical tape, magnetic and optical disks, along with various other forms of solid-state mass storage devices. The current invention applies to all forms and manners of memory devices including, but not limited to, storage devices utilizing magnetic, optical, and chemical techniques, or any combination thereof. In addition, the cache 13 may comprise volatile or non-volatile memory, or any combination thereof. Preferably, the cache 13 is implemented in SDRAM (static dynamic random access memory).

[0039] The system of Fig. 1 generally operates as follows. When data is read from disk by the host computer, data flows from the disk 11 through the data storage controller 10 to the host computer. Data is stored in one of several proprietary compression formats on the disk 11 (e.g., "content independent" data compression). Data blocks are pre-specified in length, comprised of single or multiple sectors, and are typically handled in fractional or whole equivalents of tracks, e.g. V2 track, whole track, multiple tracks, etc. To read disk data, a DMA transfer is setup from the disk interface 14 to the onboard cache memory 13. The disk interface 14 comprises integral DMA control to allow transfer of

data from the disk 11 directly to the onboard cache 13 without intervention by the DCE 12. It should be noted that the DCE 12 acts as a system level controller and sets-up specific registers within both the disk interface 14 and bus interface 15 to facilitate DMA transfers to and from the cache memory 13. To initiate a transfer from the disk 11 to the cache 13, the DMA transfer is setup via specifying the appropriate command (read disk), the source address (disk logical block number), amount of data to be transferred (number of disk logical blocks), and destination address within the onboard cache memory 13. Then, a disk data interrupt signal ("DISKINT#") is cleared (if previously set and not cleared) and the command is initiated by writing to the appropriate address space. Once data has been read from disk 11 and placed into onboard cache memory 13, the DISKINT# interrupt is asserted notifying the DCE 12 that requested data is now available in the cache memory 13. Data is then read by the DMA controller within the DCE 12 and placed into local memory for subsequent decompression. The decompressed data is then DMA transferred from the local memory of the DCE 12 back to the cache memory 13. Finally, data is DMA transferred via the bus interface controller 15 from the cache memory 13 to the bus 16. It is to be understood that in the read mode, the data storage controller acts as a bus master. A bus DMA transfer is then setup via specifying the appropriate command (write to host computer), the source address within the cache memory 13, the quantity of data words to be transferred (transfers are preferably in 4 byte increments), and the destination address on the host computer. When a bus 16 read or write transaction has completed, the appropriate interrupt signals (respectively referred to as PCIRDINT# and PCIWRINT#) are asserted to the DCE 12. Either of these interrupts are cleared by a corresponding interrupt service routines through a read or write to the appropriate address of the DCE 12.

**[0040]** Similarly, when data is written to the disk 11 from the host computer, data flows from the host computer through the data storage controller 10 and onto disk 11. Data is normally received from the host computer in uncompressed (raw) format and is compressed by the DCE 12 and stored on the disk 11. Data blocks from the host are pre-specified in length and are typically handled in blocks that are a fixed multiplier higher than fractional or whole equivalents of tracks, e.g. V2 track, whole track, multiple tracks, etc. This multiplier is preferably derived from the expected average compression ratio that is selected when the disk is formatted with the virtual file management system. To

read host computer data, a bus DMA transfer is setup from the host bus 16 to the onboard cache memory 13. The bus interface controller 15 comprises integral DMA control that allows large block transfers from the host computer directly to the onboard cache 13 without intervention by the DCE 12. The bus interface controller 15 acts as a host computer Bus Master when executing such transfer. Once data has been read from the host and placed into onboard cache memory 13, the data is read by the onboard DMA controller (residing on the DCE 12) and placed into local memory for subsequent compression. The compressed data is then DMA transferred from the local memory of the DCE 12 back to the cache memory 13. Finally, data is DMA transferred via the disk controller 14 from the cache 13 to the disk 11.

[0041] As discussed in greater detail below, upon host computer power-up or external user reset, the data storage controller 10 initializes the onboard interfaces 14, 5 prior to release of the external host bus 16 from reset. The processor of the host computer then requests initial data from the disk 11 to facilitate the computer's boot-up sequence. The host computer requests disk data over the Bus 16 via a command packet issued from the host computer. Command packets are preferably eight words long (in a preferred embodiment, each word comprises 32 bits). Commands are written from the host computer to the data storage controller 10 with the host computer as the Bus Master and the data storage controller 10 as the slave. The data storage controller 10 includes at least one Base Address Register (BAR) for decoding the address of a command queue of the data storage controller 10. The command queue resides within the cache 13 or within onboard memory of the DCE 12.

[0042] When a command is received from the host computer, an interrupt (referred to herein as PCICMDINT#) is generated to the DCE processor. The eight-word command is read by the DCE 12 and placed into the command queue. Because the commands occupy a very small amount of memory, the location of the command queue is at the discretion of software and the associated system level performance considerations. Commands may be moved from the bus interface 16 to the command queue by either explicit reads and writes by the DCE processor or, as explained below, by utilizing programmed DMA from an Enhanced DMA Controller (EDMA) residing on the DCE 12. This second technique may better facilitate system throughput by allowing the EDMA to automatically load

commands while the highly pipelined data compression and decompression processing in the DCE is executed fully undisturbed.

[0043] The DCE 12, disk interface 14 and bus interface 15 commonly share the cache 13. As explained in detail below, the storage controller 10 preferably provides maximum system bandwidth by allowing simultaneous data transfers between the disk 12 and cache 13, the DCE 12 and the cache 13, and the expansion bus 16 and the cache 13. This is realized by employing an integral DMA (direct memory access) protocol that allows the DCE 12, disk interface 14 and bus interface 15 to transfer data without interrupting or interfering with other ongoing processes. In particular, as explained in detail below, an integral bandwidth allocation controller (or arbitrator) is preferably employed to allow the DCE 12, disk controller 14, and bus interface 15 to access the onboard cache with a bandwidth proportional to the overall bandwidth of the respective interface or processing element. The bandwidth arbitration occurs transparently and does not introduce latency in memory accesses. Bandwidth division is preferably performed with a high degree of granularity to minimize the size of requisite onboard buffers to synchronize data from the disk interface 14 and bus interface 15.

[0044] It is to be appreciated that the implementation of a storage controller according to the present invention significantly accelerates the performance of a computer system and significantly increases hard disk data storage capacity. For instance, depending on the compression rate, for personal computers running standard Microsoft Windows® based business application software, the storage controller provides: (1) an increase of n:l in disk storage capacity (for example, assuming a compression ration of 3:1, a 20 gigabyte hard drive effectively becomes a 60 gigabyte hard drive) (2) a significant decrease in the computer boot-up time (turn-on and operating system load) and the time for loading application software and (3) User data storage and retrieval is increased by a factor of n:l.

[0045] Referring now to Fig. 2, a block diagram illustrates a data storage controller 20 according to another embodiment of the present invention. More specifically, Fig. 2 illustrates a PCB (printed circuit board) implementation of the data storage controller 10 of Fig. 1. The storage controller 20 comprises a DSP (digital signal processor) 21 (or any other micro-processor device) that implements the DCE 12 of Fig. 1. The storage controller 21 further comprises at least one programmable logic device 22 (or volatile logic device). The programmable logic device 22 preferably implements the logic

(program code) for instantiating and driving both the disk interface 14 and the bus interface 15 and for providing full DMA capability for the disk and bus interfaces 14, 15. Further, as explained in detail below, upon host computer power-up and/or assertion of a system-level "reset" (e.g., PCI Bus reset), the DSP 21 initializes and programs the programmable logic device 22 before of the completion of initialization of the host computer. This advantageously allows the data storage controller 20 to be ready to accept and process commands from the host computer (via the bus 16) and retrieve boot data from the disk (assuming the data storage controller 20 is implemented as the boot device and the hard disk stores the boot data (e.g., operating system, etc.)).

[0046] The data storage controller 20 further comprises a plurality of memory devices including a RAM (random access memory) device 23 and a ROM (read only memory) device 24 (or FLASH memory or other types of non-volatile memory). The RAM device 23 is utilized as on-board cache and is preferably implemented as SDRAM (preferably, 32 megabytes minimum). The ROM device 24 is utilized for non-volatile storage of logic code associated with the DSP 21 and configuration data used by the DSP 21 to program the programmable logic device 22. The ROM device 24 preferably comprises a one time (erasable) programmable memory (OTP-EPROM) device.

[0047] The DSP 21 is operatively connected to the memory devices 23, 24 and the programmable logic device 22 via a local bus 25. The DSP 21 is also operatively connected to the programmable logic device 22 via an independent control bus 26. The programmable logic device 22 provides data flow control between the DSP 21 and the host computer system attached to the bus 16, as well as data flow control between the DSP 21 and the storage device. A plurality of external I/O ports 27 are included for data transmission and/or loading of one programmable logic devices. Preferably, the disk interface 14 driven by the programmable logic device 22 supports a plurality of hard drives.

[0048] The storage controller 20 further comprises computer reset and power up circuitry 28 (or "boot configuration circuit") for controlling initialization (either cold or warm boots) of the host computer system and storage controller 20. A preferred boot configuration circuit and preferred computer initialization systems and protocols are described in U.S. Patent Application Serial No. \_\_\_\_\_ (Attorney Docket No. 8011-10), filed concurrently herewith (Express Mail Label No. EL679454245US), which is

commonly assigned and incorporated herein by reference. Preferably, the boot configuration circuit 28 is employed for controlling the initializing and programming the programmable logic device 22 during configuration of the host computer system (i.e., while the CPU of the host is held in reset). The boot configuration circuit 28 ensures that the programmable logic device 22 (and possibly other volatile or partially volatile logic devices) is initialized and programmed before the bus 16 (such as a PCI bus) is fully reset.

**[0049]** In particular, when power is first applied to the boot configuration circuit 28, the boot configuration circuit 28 generates a control signal to reset the local system (e.g., storage controller 20) devices such as a DSP, memory, and I/O interfaces. Once the local system is powered-up and reset, the controlling device (such as the DSP 21) will then proceed to automatically determine the system environment and configure the local system to work within that environment. By way of example, the DSP 21 of the disk storage controller 20 would sense that the data storage controller 20 is on a PCI computer bus (expansion bus) and has attached to it a hard disk on an IDE interface. The DSP 21 would then load the appropriate PCI and IDE interfaces into the programmable logic device 22 prior to completion of the host system reset. It is to be appreciated that this can be done for all computer busses and boot device interfaces including: PCI, NuBus, ISA, Fiber Channel, SCSI, Ethernet, DSL, ADSL, IDE, DMA, Ultra DMA, and SONET. Once the programmable logic device 22 is configured for its environment, the boot device controller is reset and ready to accept commands over the computer/expansion bus 16. Details of the boot process using a boot device comprising a programmable logic device will be provided below.

**[0050]** It is to be understood that the data storage controller 20 may be utilized as a controller for transmitting data (compressed or uncompressed) to and from remote locations over the DSP I/O ports 27 or system bus 16, for example. Indeed, the I/O ports 27 of the DSP 21 may be used for transmitting data (compressed or uncompressed) that is either retrieved from the disk 11 or received from the host system via the bus 16, to remote locations for processing and/or storage. Indeed, the I/O ports may be operatively connected to other data storage controllers or to a network communication channels. Likewise, the data storage controller 20 may receive data (compressed or uncompressed) over the I/O ports 27 of the DSP 21 from remote systems that are connected to the I/O

ports 27 of the DSP, for local processing by the data storage controller 20. For instance, a remote system may remotely access the data storage controller (via the I/O ports of the DSP or system bus 16) to utilize the data compression, in which case the data storage controller would transmit the compressed data back to the system that requested compression.

[0051] The DSP 21 may comprise any suitable commercially available DSP or processor. Preferably, the data storage controller 20 utilizes a DSP from Texas Instruments' 320 series, C62x family, of DSPs (such as TMS320C6211GFN-150), although any other DSP or processor comprising a similar architecture and providing similar functionalities may be employed. The preferred DSP is capable of up to 1.2 billion instructions per second. Additional features of the preferred DSP include a highly parallel eight processor single cycle instruction execution, onboard 4K byte UP Program Cache, 4K L1D Data Cache, and 64K byte Unified L2 Program/Data Cache. The preferred DSP further comprises a 32 bit External Memory Interface (EMIF) that provides for a glueless interface to the RAM 23 and the non-volatile memory 24 (ROM). The DSP further comprises two multi-channel buffered serial ports (McBSPs) and two 32 bit general purpose timers. Preferably, the storage controller disables the I/O capability of these devices and utilizes the I/O ports of the DSP as general purpose I/O for both programming the programmable logic device 22 using a strobed eight bit interface and signaling via a Light Emitting Diode (LED). Ancillary DSP features include a 16 bit Host Port Interface and full JTAG emulation capability for development support.

[0052] The programmable logic device 22 may comprise any form of volatile or non-volatile memory. Preferably, the programmable logic device 22 comprises a dynamically reprogrammable FPGA (field programmable gate array) such as the commercially available Xilinx Spartan Series XCS40XL-PQ240-5 FPGA. As discussed in detail herein, the FPGA instantiates and drives the disk and bus interfaces 14, 15.

[0053] The non-volatile memory device 24 preferably comprises a 128 Kbyte M27W101-80K one time (erasable) programmable read only memory, although other suitable non-volatile storage devices may be employed. The non-volatile memory device 24 is decoded at a designated memory space in the DSP 21. The non-volatile memory device 24 stores the logic for the DSP 21 and configuration data for the programmable logic device 22. More specifically, in a preferred embodiment, the lower 80 Kbytes of the non-



volatile memory device 24 are utilized for storing DSP program code, wherein the first 1k bytes are utilized for the DSP's boot loader. Upon reset of the DSP 21 (via boot configuration circuit 28), the first 1K of memory of the non-volatile memory device 24 is copied into an internal RAM of the DSP 21 by e.g., the DSP's Enhanced DMA Controller (EDMA). Although the boot process begins when the CPU of the host system is released from external reset, the transfer of the boot code into the DSP and the DSP's initialization of the programmable logic device actually occurs while the CPU of the host system is held in reset. After completion of the 1K block transfer, the DSP executes the boot loader code and continues thereafter with executing the remainder of the code in non-volatile memory device to program the programmable logic device 22.

[0054] More specifically, in a preferred embodiment, the upper 48K bytes of the non-volatile memory device 24 are utilized for storing configuration data associated with the programmable logic device 22. If the data storage controller 20 is employed as the primary boot storage device for the host computer, the logic for instantiating and driving the disk and bus interfaces 14, 15 should be stored on the data storage controller 20 (although such code may be stored in remotely accessible memory locations) and loaded prior to release of the host system bus 16 from "reset". For instance, revision 2.2 of the PCI Local Bus specification calls for a typical delay of 100msec from power-stable before release of PCI Reset. In practice this delay is currently 200msec although this varies amongst computer manufacturers. A detailed discussion of the power-on sequencing and boot operation of the data storage controller 20 will be provided below.

[0055] Fig. 3 illustrates another embodiment of a data storage controller 30 wherein the data storage controller 35 is embedded within the motherboard of the host computer system. This architecture provides the same functionality as the system of Fig. 2, and also adds the cost advantage of being embedded on the host motherboard. The system comprises additional RAM and ROM memory devices 23a, 24a, operatively connected to the DSP 21 via a local bus 25a.

[0056] Fig. 4 illustrates another embodiment of a data storage controller. The data storage controller 40 comprises a PCB implementation that is capable of supporting RAID levels 0,1 and 5. This architecture is similar to those of Fig. 1 and 2, except that a plurality of programmable logic devices 22, 22a are utilized. The programmable logic device 22 is dedicated to controlling the bus interface 15. The programmable logic

device 22a is dedicated to controlling a plurality of disk interfaces 14, preferably three interfaces. Each disk interface 14 can connect up to two drives. The DSP in conjunction with the programmable logic device 22a can operate at RAID level 0, 1 or 5. At RAID level 0, which is disk striping, two interfaces are required. This is also true for RAID level 1, which is disk minoring. At RAID level 5, all three interfaces are required.

[0057] Fig. 5 illustrates another embodiment of a data storage controller according to the present invention. The data storage controller 45 provides the same functionality as that of Figure 4, and has the cost advantage of being embedded within the computer system motherboard.

## II. Initializing A Programmable Logic Device

[0058] As discussed above with reference to Fig. 2, for example, the data storage controller 20 preferably employs an onboard Texas Instruments TMS320C6211 Digital Signal Processor (DSP) to program the onboard Xilinx Spartan Series XCS4OXL FPGA upon power-up or system level PCI reset. The onboard boot configuration circuit 28 ensures that from system power-up and/or the assertion of a bus reset (e.g., PCI reset), the DSP 21 is allotted a predetermined amount of time (preferably a minimum of 10msec) to boot the DSP 21 and load the programmable logic device 22. Because of a potential race condition between either the host computer power-up or assertion of PCI Bus reset and configuration of the programmable logic device 20 (which is used for controlling the boot device and accepting PCI Commands), an "Express Mode" programming mode for configuring the SpartanXL family XCS4OXL device is preferably employed. The XCS4OXL is factory set to byte-wide Express-Mode programming by setting both the MI/M0 bits of the XCS4OXL to 0x0. Further, to accommodate express mode programming of the programmable logic device 22, the DSP 21 is programmed to utilize its serial ports reconfigured as general purpose I/O. However, after the logic device 22 is programmed, the DSP 21 may then reconfigure its serial ports for use with other devices. Advantageously, using the same DSP ports for multiple purposes affords greater flexibility while minimizing hardware resources and thus reducing product cost.

[0059] The volatile nature of the logic device 22 effectively affords the ability to have an unlimited number of hardware interfaces. Any number of programs for execution by the programmable logic device 22 can be kept in an accessible memory location (EPROM, hard disk, or other storage device). Each program can contain new disk interfaces,

Atty. Dkt. No. 2855.004000B

interface modes or subsets thereof. When necessary, the DSP 21 can clear the interface currently residing in the logic device 22 and reprogram it with a new interface. This feature allows the data storage controller 20 to have compatibility with a large number of interfaces while minimizing hardware resources and thus reducing product cost.

[0060] A preferred protocol for programming the programmable logic device can be summarized in the following steps: (1) Clearing the configuration memory; (2) Initialization; (3) Configuration; and (4) Start-Up. When either of three events occur: the host computer is first powered-up or a power failure and subsequent recovery occurs (cold boot), or a front panel computer reset is initiated (warm boot), the host computer asserts RST# (reset) on the PCI Bus. As noted above, the data storage controller 20 preferably comprises a boot configuration circuit 28 that senses initial host computer power turn-on and/or assertion of a PCI Bus Reset ("PCI RST#"). It is important to note that assuming the data storage controller 20 is utilized in the computer boot-up sequence, it should be available exactly 5 clock cycles after the PCI RST# is deasserted, as per PCI Bus Specification Revision 2.2. While exact timings vary from computer to computer, the typical PCI bus reset is asserted for approximately 200msec from initial power turn-on.

[0061] In general, PCI RST# is asserted as soon as the computer's power exceeds a nominal threshold of about 1 volt (although this varies) and remains asserted for 200msec thereafter. Power failure detection of the 5volt or 3.3 volt bus typically resets the entire computer as if it is an initial power-up event (i.e., cold boot). Front panel resets (warm boots) are more troublesome and are derived from a debounced push-button switch input. Typical front panel reset times are a minimum of 20msec, although again the only governing specification limit is 1msec reset pulse width.

[0062] As discussed in detail below, it may not be necessary to reload the programmable logic device 22 each time the DSP is reset. The boot configuration circuit 20 preferably comprises a state machine output signal that is readable by the DSP 21 to ascertain the type of boot process requested. For example, with a front-panel reset (warm boot), the power remains stable on the PCI Bus, thus the programmable logic device 22 should not require reloading.

[0063] Referring now to Fig. 6, a flow diagram illustrates a method for initializing the programmable logic device 22 according to one aspect of the invention. In the following

discussion, it is assumed that the programmable logic device 22 is always reloaded, regardless of the type of boot process. Initially, in Fig. 6a, the DSP 21 is reset by asserting a DSP reset signal (step 50). Preferably, the DSP reset signal is generated by the boot circuit configuration circuit 28 (as described in the above-incorporated U.S. Serial No. \_\_\_\_\_ (Attorney Docket No. 8011-10). While the DSP reset signal is asserted (e.g., active low), the DSP is held in reset and is initialized to a prescribed state. Upon deassertion of the DSP Reset signal, the logic code for the DSP (referred to as the "boot loader") is copied from the non-volatile logic device 24 into memory residing in the DSP 21 (step 51). This allows the DSP to execute the initialization of the programmable logic device 22. In a preferred embodiment, the lower 1K bytes of EPROM memory is copied to the first 1k bytes of DSP's low memory (0x0000 0000 through 0x0000 03FF). As noted above, the memory mapping of the DSP 21 maps the CE1 memory space located at 0x9000 0000 through 0x9001 FFFF with the OTP EPROM. In a preferred embodiment using the Texas Instrument DSP TMS320c6211GFN-150, this ROM boot process is executed by the EDMA controller of the DSP. It is to be understood, however, that the EDMA controller may be instantiated in the programmable logic device (Xilinx), or shared between the DSP and programmable logic device.

[0064] After the logic is loaded in the DSP 21, the DSP 21 begins execution out of the lower 1K bytes of memory (step 52). In a preferred embodiment, the DSP 21 initializes with at least the functionality to read EPROM Memory (CE 1) space. Then, as described above, the DSP preferably configures its serial ports as general purpose I/O (step 53).

[0065] Next, the DSP 21 will initialize the programmable logic device 22 using one or more suitable control signals. (step 54). After initialization, the DSP 21 begins reading the configuration data of the programmable logic device 22 from the non-volatile memory 24 (step 55). This process begins with clearing a Data Byte Counter and then reading the first data byte beginning at a prespecified memory location in the non-volatile memory 24 (step 56). Then, the first output byte is loaded into the DSP's I/O locations with LSB at DO and MSB at D7 (step 57). Before the first byte is loaded to the logic device 22, a prespecified time delay (e.g., 5usec) is provided to ensure that the logic device 22 has been initialized (step 58). In particular, this time delay should be of a duration at least equal to the internal setup time of the programmable logic device 22 from completion of

initialization. Once this time delay has expired, the first data byte in the I/O bus 26 of the DSP 21 is latched into the programmable logic device 22 (step 59).

[0066] Next, a determination is made as to whether the Data Byte Counter is less than a prespecified value (step 60). If the Data Byte Counter is less than the prespecified value (affirmative determination in step 60), the next successive data byte for the programmable logic device 22 is read from the non-volatile memory 24 (step 61) and the Data Byte Counter is incremented (step 62).

[0067] Next, the read data byte is loaded into the I/O of the DSP (step 63). A time delay of, e.g., 20 nsec is allowed to expire before the data byte is latched to the programmable logic device to ensure that a minimum data set-up time to the programmable logic device 21 is observed (step 64) and the process is repeated (return to step 60). It is to be appreciated that steps 60-64 may be performed while the current data byte is being latched to the programmable logic device. This provides "pipeline" programming of the logic device 22 and minimizes programming duration.

[0068] When the Data Byte Counter is not less than the prespecified count value negative determination in step 60), as shown in Fig. 6b, the last data byte is read from the non-volatile memory and latched to the programmable logic device 22, and the DSP 21 will then poll a control signal generated by the programmable logic device 22 to ensure that the programming of the logic device 22 is successful (step 65). If programming is complete (affirmative determination in step 66), the process continues with the remainder of the data storage controller initialization (step 67). Otherwise, a timeout occurs (step 68) and upon expiration of the timeout, an error signal is provided and the programming process is repeated (step 69).

### III. Data Storage and Retrieval Protocols

[0069] A detailed discussion of operational modes of a data storage controller will now be provided with reference to the embodiment of Fig 2 (although it is to be understood that the following discussion is applicable to all the above-described embodiments). The data storage controller 20 utilizes a plurality of commands to implement the data storage, retrieval, and disk maintenance functions described herein. Each command preferably comprises eight thirty-two bit data words stored and transmitted in little endian format. The commands include: Read Disk Data; Write Disk Data; and Copy Disk Data, for example. For example, a preferred format for the "Read Disk Data" command is:

31	16	15	8	7	0	
Command Packet Number 0000h to FFFFh		Command Type 00h		Command Parameters (00h)		00h
Starting Block Address (Least Significant Word)						04h
Starting Block Address (Most Significant Word)						08h
Number of Blocks (Least Significant Word)						0Ch
Number of Blocks (Most Significant Word)						10h
Destination Address (Least Significant Word)						14h
Destination Address (Most Significant Word)						18h
Checksum			Reserved			1Ch

**[0070]** The host computer commands the data storage controller 20 over the PCI Bus 16, for example. Upon computer power-up or reset, the host computer issues a PCI Bus Reset with a minimum pulse width of 100msec (in accordance with PCI Bus Specification Revision 2.2). Upon completion of the PCI Bus reset, the data storage controller 20 is fully initialized and waiting for completion of the PCI configuration cycle. Upon completion of the PCI configuration cycles, the data storage controller will wait in an idle state for the first disk command.

**[0071]** During operation, the host operating system may issue a command to the data storage controller 20 to store, retrieve, or copy specific logical data blocks. Each command is transmitted over the PCI Bus 16 at the Address assigned to the Base Address Register (BAR) of the data storage controller 20.

**[0072]** The commands issued by the host system to the data storage controller and the data transmitted to and from the data storage controller are preferably communicated via a 32 bit, 33MHz, PCI Data Bus. As noted above, the PCI Interface is preferably housed within the onboard Xilinx Spartan XCS40XL-5 40,000 field programmable gate array which instantiates a PCI 32, 32 Bit, 33MHz PCI Bus Interface (as per PCI Bus Revision 2.2).

**[0073]** The PCI Bus interface operates in Slave Mode when receiving commands and as a Bus Master when reading or writing data. The source and destination for all data is specified within each command packet. When setting up data transfers, the Enhanced Direct Memory Access (EDMA) Controller of the DSP (or the Xilinx) utilizes two

Control Registers, a 16 Word Data Write to PCI Bus FIFO, a 16 Word Data Read From PCI Bus FIFO, and a PCI Data Interrupt (PCIDATINT). The 32 Bit PCI Address Register holds either the starting Source Address for data storage controller Disk Writes where data is read from the PCI Bus, or the starting Destination Address for data storage controller Disk Reads where data is written to the PCI Bus. The second control register is a PCI Count Register that specifies the direction of the data transfer along with the number of 32 bit Data words to be written to or from the PCI bus.

**[0074]** Data is written to the PCI Bus from the DSP via a 16 Word PCI Data Write FIFO located within a prespecified address range. Data writes from the DSP to anywhere within the address range place that data word in the next available location within the FIFO. Data is read from the PCI Bus to the DSP via a 16 Word PCI Data Read FIFO located within a prespecified address range and data read by the DSP from anywhere within this address range provides the next data word from the FIFO.

**[0075]** After completion of the Xilinx initialization by the DSP and subsequent negation of the PCI Bus Reset signal (RST#) by the host computer's PCI Bridge, the data storage controller is ready to accept commands from the host computer via the PCI Bus. When accepting commands it should be noted that the data storage controller is a PCI Target (Slave) Device. Commands are preferably fixed in length at exactly 8 (thirty-two bit) words long. Commands are written from the host computer to the data storage controller via the PCI Bus utilizing the data storage controller's Base Address Register 0 (BAR0). The PCI Bus Reset initially sets the Command FIFO's Counter to zero and also signals the Xilinx's PCI Bus State Controller that the Command FIFO is empty and enable to accept a command.

**[0076]** Whenever a data write occurs within the valid data range of BAR0, the data word is accepted from PCI Bus and placed in the next available memory position within the Command FIFO. When the last of the 8 thirty-two bit data words is accepted by the PCI Bus (thus completing the command, i.e. last word for the command FIFO to be full), the PCI Bus State Controller is automatically set to Target Abort (within same PCI Transaction) or Disconnect Without Data for all subsequent PCI transactions that try to writes to BAR0. This automatic setting is the responsibility of the Xilinx PCI Data Interface.

- [0077] The PCI Command FIFO State Controller then asserts the Command Available Interrupt to the DSP. The DSP services the Command Available Interrupt by reading the command data from a prespecified address range. It should be noted that the command FIFO is read sequentially from any data access that reads data within such address range. It is the responsibility of the DSP to understand that the data is read sequentially from any order of accesses within the data range and should thus be stored accordingly.
- [0078] Upon completion of the Command Available Interrupt Service Routine the DSP executes a memory read or write to desired location within the PCI Control Register Space mapped into the DSP's CE3 (Xilinx) memory space. This resets the Command FIFO Counter back to zero. Next, the DSP executes a memory read or write to location in the DSP Memory Space that clears the Command Available Interrupt. Nested interrupts are not possible since the PCI Bus State Machine is not yet able to accept any Command Data at BAR0. Once the Command Available Interrupt routine has cleared the interrupt and exited, the DSP may then enable the PCI State Machine to accept a new command by reading or writing to PCI Command Enable location within the PCI Command FIFO Control Register Space.
- [0079] A preferred architecture has been selected to enable the data storage controller to operate on one command at a time or to accept multiple prioritized commands in future implementations. Specifically, the decoupling of the Command Available Interrupt Service Routine from the PCI State Machine that accepts Commands at BAR0 enables the DSP's "operating system kernel" to accept additional commands at any time by software command. In single command operation, a command is accepted, the Command Available Interrupt Cleared, and the Command executed by the data storage controller in PCI Master Mode prior to the enabling of the PCI State machine to accept new commands.
- [0080] In a prioritized multi-command implementation, the "operating system kernel" may elect to immediately accept new commands or defer the acceptance of new commands based upon any software implemented decision criteria. In one embodiment, the O/S code might only allow a pre-specified number of commands to be queued. In another embodiment, commands might only be accepted during processor idle time or when the DSP is not executing time critical (i.e. highly pipelined) compress/decompress



routines. In yet another embodiment, various processes are enabled based upon a pre-emptive prioritized based scheduling system.

[0081] As previously stated, the data storage controller retrieves commands from the input command FIFO in 8 thirty-two bit word packets. Prior to command interpretation and execution, a command's checksum value is computed to verify the integrity of the data command and associated parameters. If the checksum fails, the host computer is notified of the command packet that failed utilizing the Command Protocol Error Handler. Once the checksum is verified the command type and associated parameters are utilized as an offset into the command "pointer" table or nay other suitable command/data structure that transfers control to the appropriate command execution routine.

[0082] Commands are executed by the data storage controller with the data storage controller acting as a PCI Master. This is in direct contrast to command acceptance where the data storage controller acts as a PCI Slave. When acting as a PCI Bus Master, the data storage controller reads or writes data to the PCI Bus utilizing a separate PCI Bus Data FIFO (distinct & apart from the Command FIFO). The PCI Data FIFO is 64 (thirty-two bit) words deep and may be utilized for either data reads or data writes from the DSP to the PCI Bus, but not both simultaneously.

[0083] For data to be written from the data storage controller to the Host Computer, the DSP must first write the output data to the PCI Bus Data FIFO. The Data FIFO is commanded to PCI Bus Data Write Mode by writing to a desired location within the Xilinx (CE3) PCI Control Register Space. Upon PCI Bus Reset the default state for the PCI Data FIFO is write mode and the PCI Data FIFO Available Interrupt is cleared. The PCI Data FIFO Available Interrupt should also be software cleared by writing to a prespecified location. Preferably, the first task for the data storage controller is for system boot-up or application code to be downloaded from disk. For reference, PCI Data Read Mode is commanded by writing to location BFF0 0104. The PCI Bus Reset initializes the Data FIFO Pointer to the first data of the 64 data words within the FIFO. However this pointer should always be explicitly initialized by a memory write to location BFF0 0108. This ensures that the first data word written to the FIFO by the DSP performing the data write anywhere in address range B000 0000 to B000 01FF is placed at the beginning of the FIFO. Each subsequent write to any location within this address range then places one thirty-two bit data word into the next available location within the

PCI Data FIFO. The FIFO accepts up to 64 thirty-two bit data words although it should be clearly understood that not all data transfers to and from the PCI Bus will consist of a full FIFO. Counting the number of thirty-two bit data words written to the PCI Data FIFO is the responsibility of the DSP Code. It is envisioned that the DSP will, in general, use 64 word DMA data transfers, thus alleviating any additional processor overhead.

[0084] When the data has been transferred from the DSP to the PCI Data FIFO, the PCI Bus Controller also needs the address of the PCI Target along with the number of data words to be transmitted. In the current data storage controller implementation, the PCI Bus Address is thirty-two bits wide, although future PCI bus implementations may utilize multiword addressing and/or significantly larger (64 bit & up) address widths. The single thirty-two bit address word is written by the DSP to memory location `aaaa+0x10` in the PCI Control Register Space.

[0085] Finally, the PCI Bus Data Write transaction is initiated by writing the PCI Data FIFO word count to a prespecified memory address. The word count value is always decimal 64 or less (`0x3F`). When the count register is written the value is automatically transferred to the PCI Controller for executing the PCI Bus Master writes.

[0086] When the PCI Bus has completed the transfer of all data words within the PCI Data FIFO the PCI Data FIFO Available Interrupt is set. The DSP PCI Data FIFO Available Interrupt handler will then check to see if additional data is waiting or expected to be written to the PCI Data Bus. If additional data is required the interrupt is cleared and the data transfer process repeats. If no additional data is required to be transferred then the interrupt is cleared and the routine must exit to a system state controller. For example, if the command is complete then master mode must be disabled and then slave mode (command mode) enabled — assuming a single command by command execution data storage controller.

[0087] For data to be read by the data storage controller from the Host Computer, the DSP must command the PCI Bus with the address and quantity of data to be received.

[0088] The PCI Data FIFO is commanded to PCI Bus Data Read Mode by writing to a desired location within the Xilinx (CE3) PCI Control Register Space. Upon PCI Bus Reset the default state for the PCI Data FIFO is Write Mode and the PCI Data FIFO Full Interrupt is cleared. The PCI Data FIFO Full Interrupt should also be cleared via software by writing to such location. The PCI Bus Reset also initializes the PCI Data FIFO Pointer

to the first data word of the available 64 data words within the FIFO. However this pointer should always be explicitly initialized by a memory write to prespecified location.

[0089] For data to be read from the PCI Bus by the data storage controller, the Xilinx PCI Bus Controller requires the address of the PCI Target along with the number of data words to be received. In the current data storage controller implementation, the PCI Bus Address is thirty-two bits wide, although future PCI bus implementations may utilize multiword addressing and/or significantly larger (64 bit & up) address widths. The single thirty-two bit address word is written by the DSP to prespecified memory location in the PCI Control Register Space.

[0090] Finally, the PCI Bus Data Read transaction is initiated by writing the PCI Data FIFO word count to prespecified memory address. The word count value is always decimal 64 or less (0x3F). When the count register is written the value is automatically transferred to the PCI Controller for executing the PCI Bus Master Read.

[0091] When the PCI Bus has received all the requested data words PCI Data FIFO Full Interrupt is set. The DSP PCI Data FIFO Full Interrupt handler will then check to see if additional data is waiting or expected to be read from the PCI Data Bus. If additional data is required the interrupt is cleared and the data receipt process repeats. If no additional data is required to be transferred, then the interrupt is cleared and the routine exits to a system state controller. For example, if the command is complete then master mode must be disabled and then slave mode (command mode) enabled — assuming a single command by command execution data storage controller.

[0092] It is clearly understood that there are other techniques for handling the PCI Data transfers. The current methodology has been selected to minimize the complexity and resource utilization of the Xilinx Gate Array. It should also be understood that the utilization of asynchronous memory reads and writes to initialize system states and synchronize events at a software level aids in both hardware and system level debug at the expense of increase software overhead. Subsequent embodiments of the gate array may automate resource intensive tasks if system level performance mandates.

#### IV. Memory Bandwidth Allocation

[0093] The onboard cache of the data storage controller is shared by the DSP, Disk Interface, and PCI Bus. The best case, maximum bandwidth for the SDRAM memory is 70 megawords per second, or equivalently, 280 megabytes per second. The 32 bit PCI

Bus interface has a best case bandwidth of 132 megabytes per second, or equivalently 33 megawords per second. In current practice, this bandwidth is only achieved in short bursts. The granularity of PCI data bursts to/from the data storage controller is governed by the PCI Bus interface data buffer depth of sixteen words (64 bytes). The time division multiplexing nature of the current PCI Data Transfer Buffering methodology cuts the sustained PCI bandwidth down to 66 megabytes/second.

[0094] Data is transferred across the ultraDMA disk interface at a maximum burst rate of 66 megabytes/second. It should be noted that the burst rate is only achieved with disks that contain onboard cache memory. Currently this is becoming more and more popular within the industry. However assuming a disk cache miss, the maximum transfer rates from current disk drives is approximately six megabytes per second. Allotting for technology improvements over time, the data storage controller has been designed for a maximum sustained disk data rate of 20 megabytes second (5 megawords/second). A design challenge is created by the need for continuous access to the SDRAM memory. Disks are physical devices and it is necessary to continuously read data from disk and place it into memory, otherwise the disk will incur a full rotational latency prior to continuing the read transaction. The maximum SDRAM access latency that can be incurred is the depth of the each of the two disk FIFO s or sixteen data. Assuming the FIFO is sixteen words deep the maximum latency time for emptying the other disk FIFO and restoring it to the disk interface is sixteen words at 5 megawords per second or  $(16 \times 3.2\text{usec}) = 1\text{usec}$ . Each EMIF clock cycle is 14.2857nsec, thus the maximum latency translates to 224 clock cycles. It should be noted that transfers across the disk interface are 16 bits wide, thus the FPGA is required to translate 32 bit memory transfers to 16 bit disk transfers, and vice-versa.

[0095] The DSP services request for its external bus from two requestors, the Enhanced Direct Memory Access (EDMA) Controller and an external shared memory device controller. The DSP can typically utilize the full 280 megabytes of bus bandwidth on an 8k through 64K byte (2k word through 16k word) burst basis. It should be noted that the DSRA does not utilize the SDRAM memory for interim processing storage, and as such only utilizes bandwidth in direct proportion to disk read and write commands.

[0096] For a single read from disk transaction data is transferred from and DMA transfer into SDRAM memory. This data is then DMA transferred by the DSP into onboard DSP

memory, processed, and re transferred back to SDRAM in decompressed format (3 words for every one word in). Finally the data is read from SDRAM by the PCI Bus Controller and placed into host computer memory. This equates to eight SDRAM accesses, one write from disk, one read by the DSP, three writes by the DSP and three by the PCI Bus. Disk write transactions similarly require eight SDRAM accesses, three from the PCI, three DSP reads, one DSP write, and one to the disk.

[0097] Neglecting overhead for setting up DMA transfers, arbitration latencies, and memory wait states for setting up SDRAM transactions, the maximum DSRA theoretical SDRAM bandwidth limit for disk reads or writes is 280/8 megabytes second or 35 megabytes second. It should be noted that the best case allocation of SDRAM bandwidth would be dynamic dependent upon the data compression and decompression ratios. Future enhancements to the data storage controller will utilize a programmable timeslice system to allocate SDRAM bandwidth, however this first embodiment will utilize a fixed allocation ratio as follows:

If all three requestors require SDRAM simultaneously:

PCI Bus Interface	3/8
DSP Accesses	4/8
UltraDMA Disk Interface	1/8

If only the PCI Bus and DSP require SDRAM:

PCI Bus Interface	4/8
DSP Accesses	4/8

If only the DSP and Disk require SDRAM:

DSP Accesses	6/8
UltraDMA Disk Interface	2/8

If only the PCI Bus and Disk require SDRAM:

PCI Bus Interface	6/8
UltraDMA Disk Interface	2/8

[0098] If only one device requires SDRAM it receives the full SDRAM bandwidth. It should be noted that different ratios may be applied based upon the anticipated or actual compression and/or decompression ratios. For example in the case of all three requestors

active the following equation applies. Assume that data storage accelerator achieves a compression ratio A:B for example 3:1. The Numerator and denominators of the various allocations are defined as follows:

PCI Bus Interface	A/K
DSP Accesses	(A+B)/K
UltraDMA Disk Interface	B/K

[0099] Where Further define a sum K equal to the sum of the numerators of the PCI Bus interface fraction, the DSP Access fraction, and the UltraDMA Disk Interfaces, i.e.  $K = 2(A+B)$ . Similarly:

If only the PCI Bus and DSP require SDRAM:

PCI Bus Interface	(A+B)/K
DSP Accesses	(A+B)/K

If only the DSP and Disk require SDRAM:

DSP Accesses	2A/K
UltraDMA Disk Interface	2B/K

If only the PCI Bus and Disk require SDRAM:

PCI Bus Interface	2A/K
UltraDMA Disk Interface	2B/K

[0100] It should be noted that the resultant ratios may all be scaled by a constant in order to most effectively utilize the bandwidths of the internal busses and external interfaces. In addition each ratio can be scale by an adjustment factor based upon the time required to complete individual cycles. For example if PCI Bus interface takes 20% longer than all other cycles, the PCI time slice should be adjusted longer accordingly.

#### V. Instant Boot Device For Operating System, Application Program and Loading

[0101] Typically, with conventional boot device controllers, after reset, the boot device controller will wait for a command over the computer bus (such as PCI). Since the boot device controller will typically be reset prior to bus reset and before the computer bus starts sending commands, this wait period is unproductive time. The initial bus commands inevitably instruct the boot device controller to retrieve data from the boot device (such as a disk) for the operating system. Since most boot devices are relatively

Atty. Dkt. No. 2855.004000B

slow compared to the speed of most computer busses, a long delay is seen by the computer user. This is evident in the time it takes for a typical computer to boot.

[0102] It is to be appreciated that a data storage controller (having an architecture as described herein) may employ a technique of data preloading to decrease the computer system boot time. Upon host system power-up or reset, the data storage controller will perform a self-diagnostic and program the programmable logic device (as discussed above) prior to completion of the host system reset (e.g., PCI bus reset) so that the logic device can accept PCI Bus commands after system reset. Further, prior to host system reset, the data storage controller can proceed to pre-load the portions of the computer operating system from the boot device (e.g., hard disk) into the on-board cache memory. The data storage controller preloads the needed sectors of data in the order in which they will be needed. Since the same portions of the operating system must be loaded upon each boot process, it is advantageous for the boot device controller to preload such portions and not wait until it is commanded to load the operating system. Preferably, the data storage controller employs a dedicated JO channel of the DSP (with or without data compression) to pre-load computer operating systems and applications.

[0103] Once the data is preloaded, when the computer system bus issues its first read commands to the data storage controller seeking operating system data, the data will already be available in the cache memory of the data storage controller. The data storage controller will then be able to instantly start transmitting the data to the system bus. Before transmission to the bus, if the was stored in compressed format on the boot device, the data will be decompressed. The process of preloading required (compressed) portions of the operating system significantly reduces the computer boot process time.

[0104] In addition to preloading operating system data, the data storage controller could also preload other data that the user would likely want to use at startup. An example of this would be a frequently used application such as a word processor and any number of document files.

[0105] There are several techniques that may be employed in accordance with the present invention that would allow the data storage controller to know what data to preload from the boot device. One technique utilizes a custom utility program that would allow the user to specify what applications/data should be preloaded.

[0106] Another technique (illustrated by the flow diagram of Figs. 7a and 7b) that may be employed comprises an automatic process that requires no input from the user. With this technique, the data storage controller maintain a list comprising the data associated with the first series of data requests received by the data storage controller by the host system after a power-on / reset. In particular, referring to Fig. 7a, during the computer boot process, the data storage controller will receive requests for the boot data (step 70). In response, the data storage controller will retrieve the requested boot data from the boot device (e.g., hard disk) in the local cache memory (step 71). For each requested data block, the data storage controller will record the requested data block number in a list (step 72). The data storage controller will record the data block number of each data block requested by the host computer during the boot process (repeat steps 70-72). When the boot process is complete (affirmative determination in step 73), the data storage controller will store the data list on the boot device (or other storage device) (step 74).

[0107] Then, upon each subsequent power-on / reset (affirmative result in step 75), the data storage controller would retrieve and read the stored list (step 76) and proceed to preload the boot data specified on the list (i.e., the data associated with the expected data requests) into the onboard cache memory (step 77). It is to be understood that the depending on the resources of the given system (e.g., memory, etc.), the preloading process may be completed prior to commencement of the boot process, or continued after the boot process begins (in which case booting and preloading are performed simultaneously).

[0108] When the boot process begins (step 78) (i.e., the storage controller is initialized and the system bus reset is deasserted), the data storage controller will receive requests for boot data (step 79). If the host computer issues a request for boot data that is preloaded in the local memory of the data storage controller (affirmative result in step 80), the request is immediately serviced using the preloaded boot data (step 81). If the host computer issues a request for boot data that is not preloaded in the local memory of the data storage controller (negative determination in step 80), the controller will retrieve the requested data from the boot device, store the data in the local memory, and then deliver the requested boot data to the computer bus (step 82). In addition, the data storage controller would update the boot data list by recording any changes in the actual data requests as compared to the expected data requests already stored in the list (step 83).



Then, upon the next boot sequence, the boot device controller would pre-load that data into the local cache memory along with the other boot data previously on the list.

[0109] Further, during the boot process, if no request is made by the host computer for a data block that was pre-loaded into the local memory of the data storage controller (affirmative result in step 84), then the boot data list will be updated by removing the non-requested data block from the list (step 85). Thereafter, upon the next boot sequence, the data storage controller will not pre-load that data into local memory.

#### VI. Quick Launch for Operating System, Application Program, and Loading

[0110] It is to be appreciated that the data storage controller (having an architecture as described herein) may employ a technique of data preloading to decrease the time to load application programs (referred to as “quick launch”). Conventionally, when a user launches an application, the file system reads the first few blocks of the file off the disk, and then the portion of the loaded software will request via the file system what additional data it needs from the disk. For example, a user may open a spreadsheet program, and the program may be configured to always load a company spreadsheet each time the program is started. In addition, the company spreadsheet may require data from other spreadsheet files.

[0111] In accordance with the present invention, the data storage controller may be configured to “remember” what data is typically loaded following the launch of the spreadsheet program, for example. The data storage controller may then proceed to preload the company spreadsheet and all the necessary data in the order in which such data is needed. Once this is accomplished, the data storage controller can service read commands using the preloaded data. Before transmission to the bus, if the preloaded data was stored in compressed format, the data will be decompressed. The process of preloading (compressed) program data significantly reduces the time for launching an application.

[0112] Preferably, a custom utility program is employed that would allow the user to specify what applications should be made ready for quick launch.

[0113] Figs. 8a and 8b comprise a flow diagram of a quick launch method according to one aspect of the present invention. With this technique, the data storage controller maintains a list comprising the data associated with launching an application. In particular, when an application is first launched, the data storage controller will receive

requests for the application data (step 90). In response, the data storage controller will retrieve the requested application data from memory (e.g., hard disk) and store it in the local cache memory (step 91). The data storage controller will record the data block number of each data block requested by the host computer during the launch process (step 92). When the launch process is complete (affirmative determination in step 93), the data storage controller will store the data list in a designated memory location (step 94).

[0114] Then, referring to Fig. 8b, upon each subsequent launch of the application (affirmative result in step 95), the data storage controller would retrieve and read the stored list (step 96) and then proceed to preload the application data specified on the list (i.e., the data associated with the expected data requests) into the onboard cache memory (step 97). During the application launch process, the data storage controller will receive requests for application data (step 98). If the host computer issues a request for application data that is pre-loaded in the local memory of the data storage controller (affirmative result in step 99), the request is immediately serviced using the preloaded data (step 100). If the host computer issues a request for application data that is not preloaded in the local memory of the data storage controller (negative result in step 99), the controller will retrieve the requested data from the hard disk memory, store the data in the local memory, and then deliver the requested application data to the computer bus (step 101). In addition, the data storage controller would update the application data list by recording any changes in the actual data requests as compared to the expected data requests already stored in the list (step 102).

[0115] Further, during the launch process, if no request is made by the host computer for a data block that was pre-loaded into the local memory of the data storage controller (affirmative result in step 103), then the application data list will be updated by removing the non-requested data block from the list (step 104). Thereafter, upon the next launch sequence for the given application, the data storage controller will not pre-load that data into local memory.

[0116] It is to be understood that the quick boot and quick launch methods described above are preferably implemented by a storage controller according to the present invention and may or may not utilize data compression/decompression by the DSP. However, it is to be understood that the quick boot and quick launch methods may be implemented by a separate device, processor, or system, or implemented in software.

## VII. Content Independent Data Compression

- [0117] It is to be understood that any conventional compression/decompression system and method (which comply with the above mentioned constraints) may be employed in the data storage controller for providing accelerated data storage and retrieval in accordance with the present invention. Preferably, the present invention employs the data compression/decompression techniques disclosed in the above-incorporated U.S. Serial No. 09/210,491.
- [0118] Referring to FIG. 9, a detailed block diagram illustrates an exemplary data compression system 110 that may be employed herein. Details of this data compression system are provided in U.S. Serial No. 09/210,491. In this embodiment, the data compression system 110 accepts data blocks from an input data stream and stores the input data block in an input buffer or cache 115. It is to be understood that the system processes the input data stream in data blocks that may range in size from individual bits through complete files or collections of multiple files. Additionally, the input data block size may be fixed or variable. A counter 120 counts or otherwise enumerates the size of input data block in any convenient units including bits, bytes, words, and double words. It should be noted that the input buffer 115 and counter 120 are not required elements of the present invention. The input data buffer 115 may be provided for buffering the input data stream in order to output an uncompressed data stream in the event that, as discussed in further detail below, every encoder fails to achieve a level of compression that exceeds an *a priori* specified minimum compression ratio threshold.
- [0119] Data compression is performed by an encoder module 125 which may comprise a set of encoders E1, E2, E3 ... En. The encoder set E1, E2, E3 ... En may include any number "n" (where n may =1) of those lossless encoding techniques currently well known within the art such as run length, Huffman, Lempel-Ziv Dictionary Compression, arithmetic coding, data compaction, and data null suppression. It is to be understood that the encoding techniques are selected based upon their ability to effectively encode different types of input data. It is to be appreciated that a full complement of encoders are preferably selected to provide a broad coverage of existing and future data types.
- [0120] The encoder module 125 successively receives as input each of the buffered input data blocks (or unbuffered input data blocks from the counter module 120). Data compression is performed by the encoder module 125 wherein each of the encoders E1 ....

En processes a given input data block and outputs a corresponding set of encoded data blocks. It is to be appreciated that the system affords a user the option to enable/disable any one or more of the encoders E1... En prior to operation. As is understood by those skilled in the art, such feature allows the user to tailor the operation of the data compression system for specific applications. It is to be further appreciated that the encoding process may be performed either in parallel or sequentially. In particular, the encoders E1 through En of encoder module 125 may operate in parallel (i.e., simultaneously processing a given input data block by utilizing task multiplexing on a single central processor, via dedicated hardware, by executing on a plurality of processor or dedicated hardware systems, or any combination thereof). In addition, encoders E1 through En may operate sequentially on a given unbuffered or buffered input data block. This process is intended to eliminate the complexity and additional processing overhead associated with multiplexing concurrent encoding techniques on a single central processor and/or dedicated hardware, set of central processors and/or dedicated hardware, or any achievable combination. It is to be further appreciated that encoders of the identical type may be applied in parallel to enhance encoding speed. For instance, encoder E1 may comprise two parallel Huffman encoders for parallel processing of an input data block.

[0121] A buffer/counter module 130 is operatively connected to the encoder module 125 for buffering and counting the size of each of the encoded data blocks output from encoder module 125. Specifically, the buffer/counter 130 comprises a plurality of buffer/counters BC1, BC2, BC3 .... BCn, each operatively associated with a corresponding one of the encoders E1...En. A compression ratio module 135, operatively connected to the output buffer/counter 130, determines the compression ratio obtained for each of the enabled encoders E1...En by taking the ratio of the size of the input data block to the size of the output data block stored in the corresponding buffer/counters BC1 BCn. In addition, the compression ratio module 135 compares each compression ratio with an *a priori*-specified compression ratio threshold limit to determine if at least one of the encoded data blocks output from the enabled encoders E1...En achieves a compression that exceeds an *a priori*-specified threshold. As is understood by those skilled in the art, the threshold limit may be specified as any value inclusive of data expansion, no data compression or expansion, or any arbitrarily desired compression limit. A description module 138, operatively coupled to the compression ratio module 135, appends a

corresponding compression type descriptor to each encoded data block which is selected for output so as to indicate the type of compression format of the encoded data block. A data compression type descriptor is defined as any recognizable data token or descriptor that indicates which data encoding technique has been applied to the data. It is to be understood that, since encoders of the identical type may be applied in parallel to enhance encoding speed (as discussed above), the data compression type descriptor identifies the corresponding encoding technique applied to the encoded data block, not necessarily the specific encoder. The encoded data block having the greatest compression ratio along with its corresponding data compression type descriptor is then output for subsequent data processing, storage, or transmittal. If there are no encoded data blocks having a compression ratio that exceeds the compression ratio threshold limit, then the original unencoded input data block is selected for output and a null data compression type descriptor is appended thereto. A null data compression type descriptor is defined as any recognizable data token or descriptor that indicates no data encoding has been applied to the input data block. Accordingly, the unencoded input data block with its corresponding null data compression type descriptor is then output for subsequent data processing, storage, or transmittal.

[0122] Again, it is to be understood that the embodiment of the data compression engine of Fig. 9 is exemplary of a preferred compression system which may be implemented in the present invention, and that other compression systems and methods known to those skilled in the art may be employed for providing accelerated data storage in accordance with the teachings herein. Indeed, in another embodiment of the compression system disclosed in the above-incorporated U.S. Serial No. 09/210,491, a timer is included to measure the time elapsed during the encoding process against an *a priori*-specified time limit. When the time limit expires, only the data output from those encoders (in the encoder module 125) that have completed the present encoding cycle are compared to determine the encoded data with the highest compression ratio. The time limit ensures that the real-time or pseudo real-time nature of the data encoding is preserved. In addition, the results from each encoder in the encoder module 125 may be buffered to allow additional encoders to be sequentially applied to the output of the previous encoder, yielding a more optimal lossless data compression ratio. Such techniques are discussed in greater detail in the above-incorporated U.S. Serial No. 09/210,491.

- [0123] Referring now to FIG. 10, a detailed block diagram illustrates an exemplary decompression system that may be employed herein or accelerated data retrieval as disclosed in the above-incorporated U.S. Serial No. 09/210,491. In this embodiment, the data compression engine 180 retrieves or otherwise accepts compressed data blocks from one or more data storage devices and inputs the data via a data storage interface. It is to be understood that the system processes the input data stream in data blocks that may range in size from individual bits through complete files or collections of multiple files. Additionally, the input data block size may be fixed or variable.
- [0124] The data decompression engine 180 comprises an input buffer 155 that receives as input an uncompressed or compressed data stream comprising one or more data blocks. The data blocks may range in size from individual bits through complete files or collections of multiple files. Additionally, the data block size may be fixed or variable. The input data buffer 55 is preferably included (not required) to provide storage of input data for various hardware implementations. A descriptor extraction module 160 receives the buffered (or unbuffered) input data block and then parses, lexically, syntactically, or otherwise analyzes the input data block using methods known by those skilled in the art to extract the data compression type descriptor associated with the data block. The data compression type descriptor may possess values corresponding to null (no encoding applied), a single applied encoding technique, or multiple encoding techniques applied in a specific or random order (in accordance with the data compression system embodiments and methods discussed above).
- [0125] A decoder module 165 includes one or more decoders D 1 ... Dn for decoding the input data block using a decoder, set of decoders, or a sequential set of decoders corresponding to the extracted compression type descriptor. The decoders D1 ... Dn may include those lossless encoding techniques currently well known within the art, including: run length, Huffman, Lempel-Ziv Dictionary Compression, arithmetic coding, data compaction, and data null suppression. Decoding techniques are selected based upon their ability to effectively decode the various different types of encoded input data generated by the data compression systems described above or originating from any other desired source.
- [0126] As with the data compression systems discussed in U.S. Application Serial No. 09/210,491, the decoder module 165 may include multiple decoders of the same type

applied in parallel so as to reduce the data decoding time. An output data buffer or cache 170 may be included for buffering the decoded data block output from the decoder module 165. The output buffer 70 then provides data to the output data stream. It is to be appreciated by those skilled in the art that the data compression system 180 may also include an input data counter and output data counter operatively coupled to the input and output, respectively, of the decoder module 165. In this manner, the compressed and corresponding decompressed data block may be counted to ensure that sufficient decompression is obtained for the input data block.

[0127] Again, it is to be understood that the embodiment of the data decompression system 180 of FIG. 10 is exemplary of a preferred decompression system and method which may be implemented in the present invention, and that other data decompression systems and methods known to those skilled in the art may be employed for providing accelerated data retrieval in accordance with the teachings herein.

[0128] Although illustrative embodiments have been described herein with reference to the accompanying drawings, it is to be understood that the present invention is not limited to those precise embodiments, and that various other changes and modifications may be affected therein by one skilled in the art without departing from the scope or spirit of the invention. All such changes and modifications are intended to be included within the scope of the invention as defined by the appended claims.