

(12) **United States Patent**
Stewart

(10) **Patent No.:** US 6,539,456 B2
 (45) **Date of Patent:** *Mar. 25, 2003

(54) **HARDWARE ACCELERATION OF BOOT-UP UTILIZING A NON-VOLATILE DISK CACHE**

(75) Inventor: **David C. Stewart**, Beaverton, OR (US)

(73) Assignee: **Intel Corporation**, Santa Clara, CA (US)

(*) Notice: This patent issued on a continued prosecution application filed under 37 CFR 1.53(d), and is subject to the twenty year patent term provisions of 35 U.S.C. 154(a)(2).

Subject to any disclaimer, the term of this patent is extended or adjusted under 35 U.S.C. 154(b) by 0 days.

(21) Appl. No.: **09/417,000**

(22) Filed: **Oct. 13, 1999**

(65) **Prior Publication Data**

US 2002/0156970 A1 Oct. 24, 2002

(51) **Int. Cl.**⁷ **G06F 12/00**; G06F 9/24

(52) **U.S. Cl.** **711/113**; 711/133; 711/144; 713/2

(58) **Field of Search** 711/113, 133, 711/144; 713/2

(56) **References Cited**

U.S. PATENT DOCUMENTS

5,307,497 A	*	4/1994	Feigenbaum et al.	713/1
6,061,788 A	*	5/2000	Reynaud et al.	713/2
6,073,232 A	*	6/2000	Kroeker et al.	713/1
6,172,936 B1	*	1/2001	Kitazaki	365/233
6,189,100 B1	*	2/2001	Barr et al.	713/182
6,226,740 B1	*	5/2001	Iga	713/2

* cited by examiner

Primary Examiner—Reginald G. Bragdon

(74) *Attorney, Agent, or Firm*—Schwegman, Lundberg, Woessner & Kluth, P.A.

(57) **ABSTRACT**

A computer system includes a nonvolatile memory positioned between a disk controller and a disk drive storing a boot program, in a computer system. Upon an initial boot sequence, the boot program is loaded into a cache in the nonvolatile memory. Subsequent boot sequences retrieve the boot program from the cache. Cache validity is maintained by monitoring cache misses, and/or by monitoring writes to the disk such that a write to a sector held in the cache results in the cache line for that sector being invalidated until such time as the cache is updated. A filter driver is provided to monitor writes to the disk and determine if a cache line is invalidated.

38 Claims, 5 Drawing Sheets

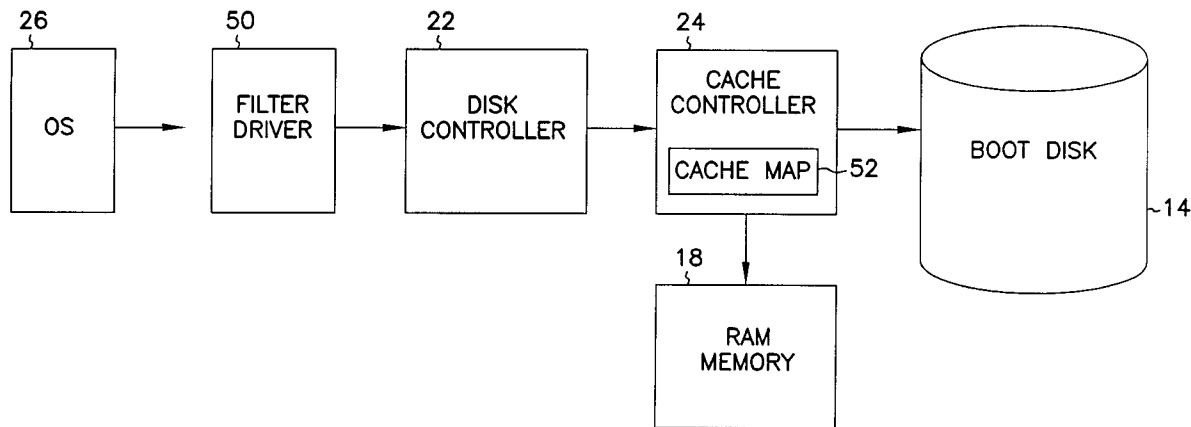

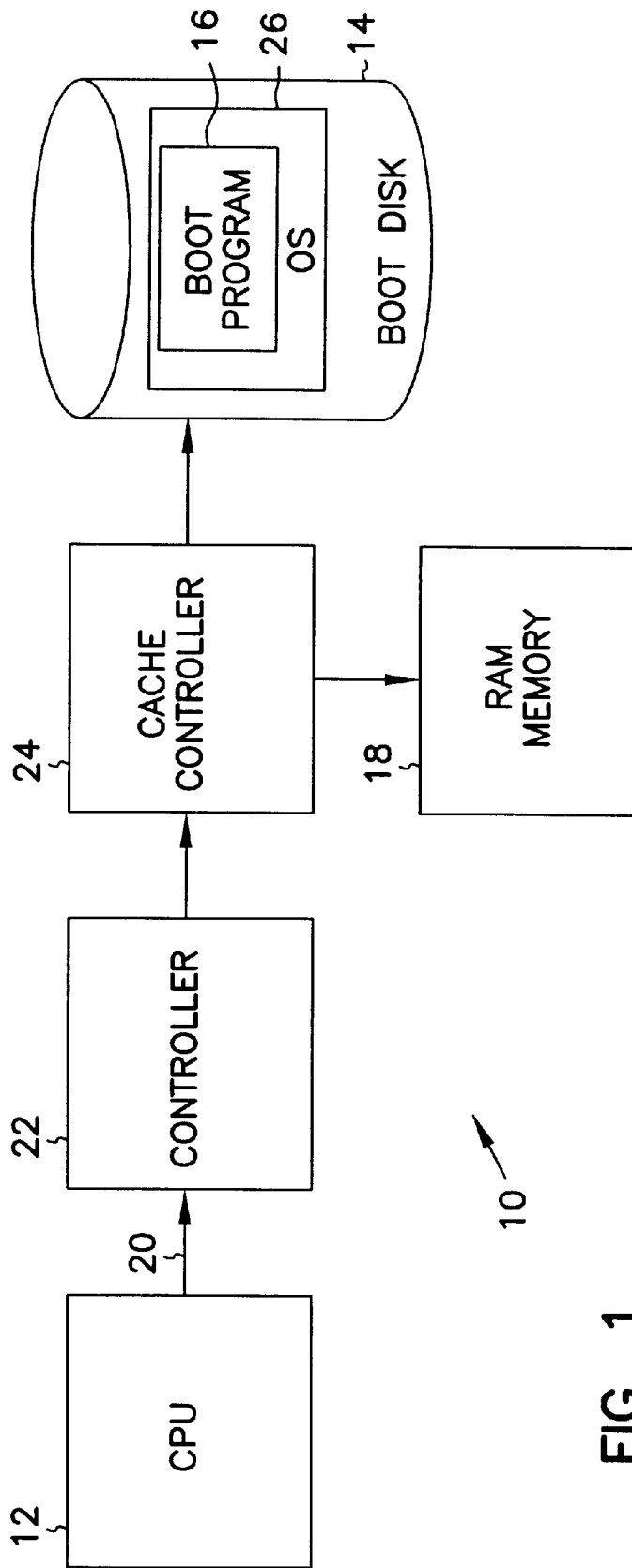
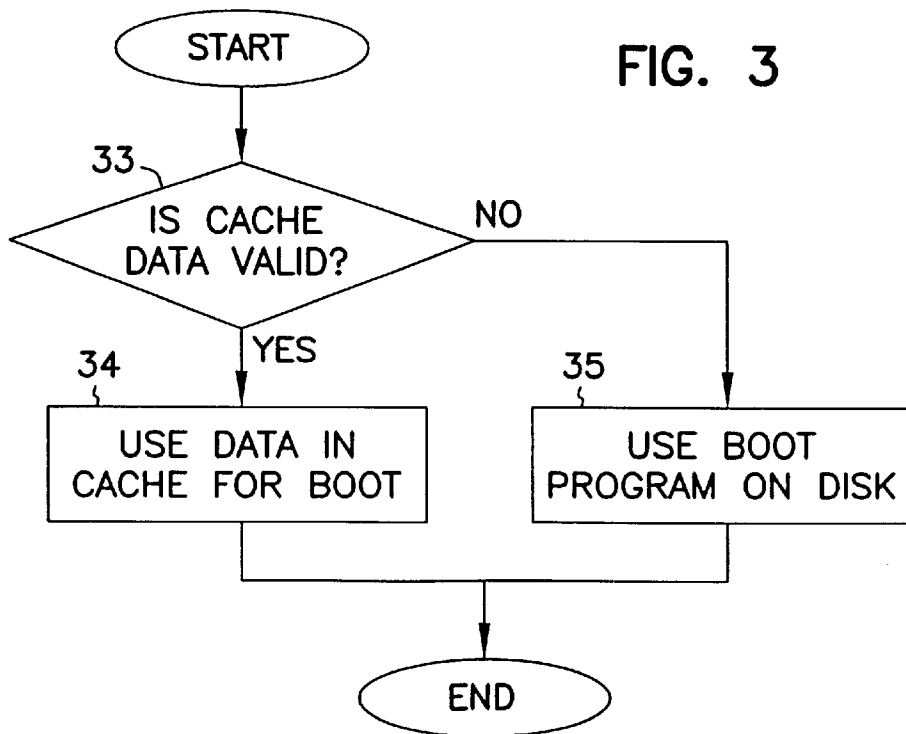
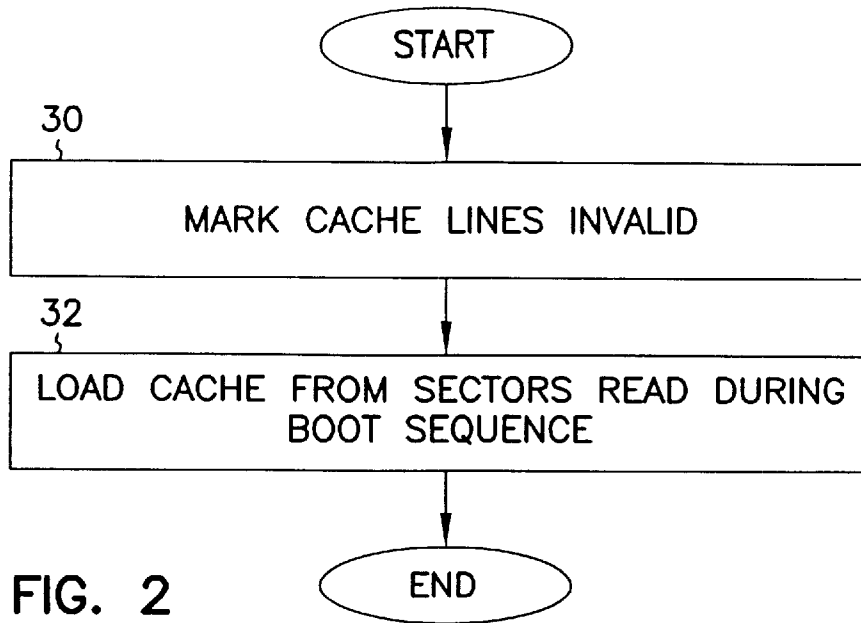

FIG. 1



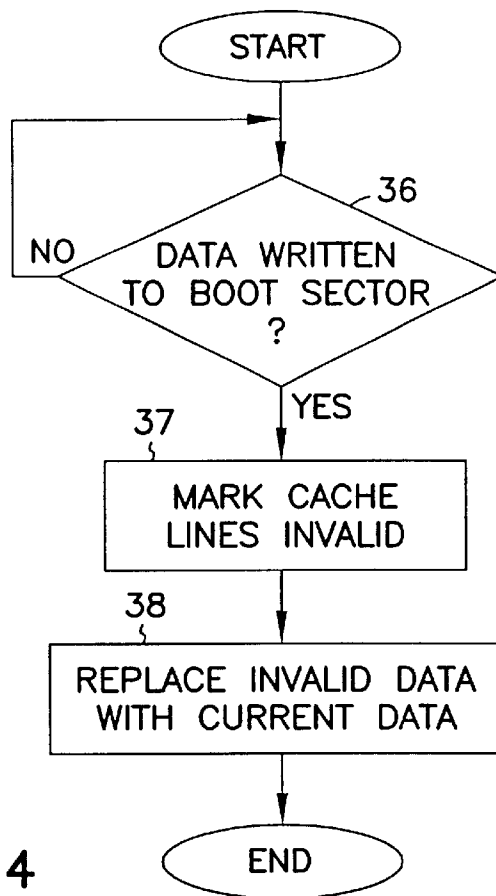

FIG. 4

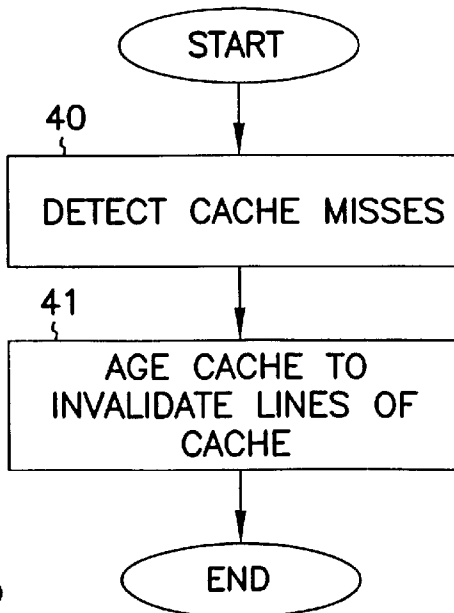

FIG. 5

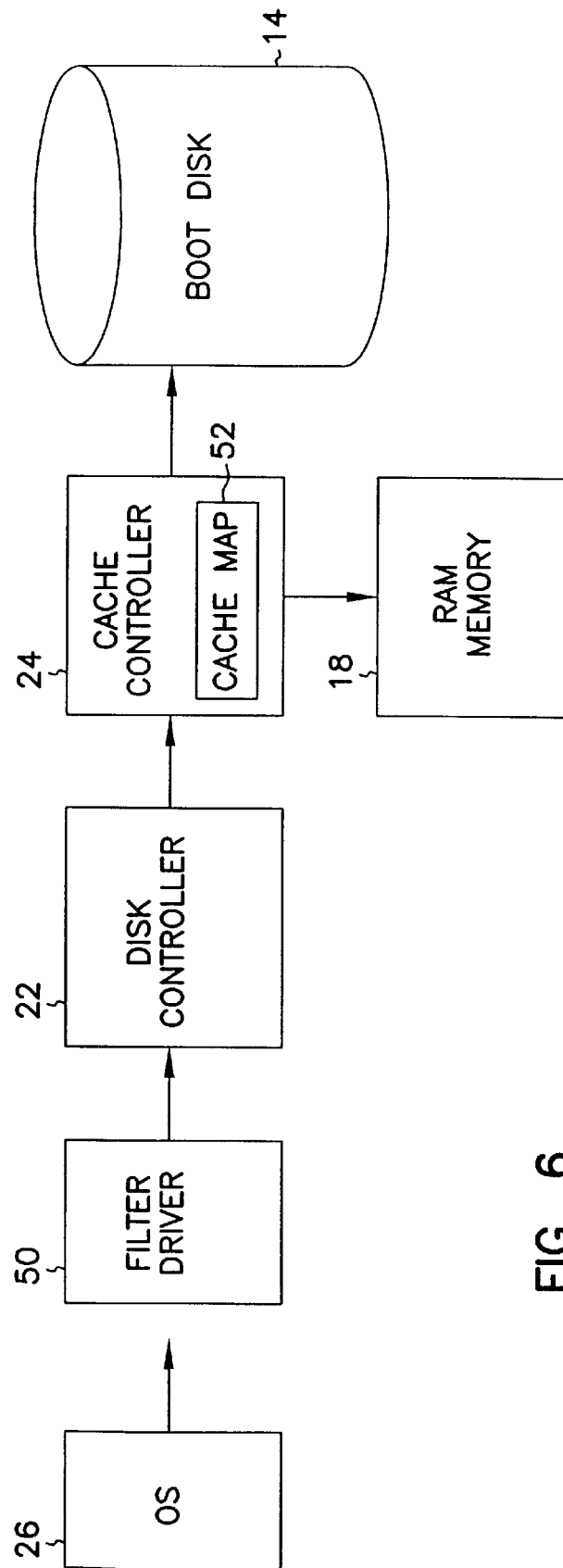

FIG. 6

Explore Litigation Insights

Docket Alarm provides insights to develop a more informed litigation strategy and the peace of mind of knowing you're on top of things.

Real-Time Litigation Alerts



Keep your litigation team up-to-date with **real-time alerts** and advanced team management tools built for the enterprise, all while greatly reducing PACER spend.

Our comprehensive service means we can handle Federal, State, and Administrative courts across the country.

Advanced Docket Research



With over 230 million records, Docket Alarm's cloud-native docket research platform finds what other services can't. Coverage includes Federal, State, plus PTAB, TTAB, ITC and NLRB decisions, all in one place.

Identify arguments that have been successful in the past with full text, pinpoint searching. Link to case law cited within any court document via Fastcase.

Analytics At Your Fingertips



Learn what happened the last time a particular judge, opposing counsel or company faced cases similar to yours.

Advanced out-of-the-box PTAB and TTAB analytics are always at your fingertips.

API

Docket Alarm offers a powerful API (application programming interface) to developers that want to integrate case filings into their apps.

LAW FIRMS

Build custom dashboards for your attorneys and clients with live data direct from the court.

Automate many repetitive legal tasks like conflict checks, document management, and marketing.

FINANCIAL INSTITUTIONS

Litigation and bankruptcy checks for companies and debtors.

E-DISCOVERY AND LEGAL VENDORS

Sync your system to PACER to automate legal marketing.