



US 20080102696A1

(19) **United States**

(12) **Patent Application Publication**
Montena

(10) **Pub. No.: US 2008/0102696 A1**

(43) **Pub. Date: May 1, 2008**

(54) **FLEXIBLE RF SEAL FOR COAX CABLE CONNECTOR**

Publication Classification

(51) **Int. Cl.**
H01R 9/05 (2006.01)

(75) **Inventor: Noah Montena, Syracuse, NY (US)**

(52) **U.S. Cl. 439/578**

(57) **ABSTRACT**

Correspondence Address:
John Mezzalingua Associates, Inc.
c/o Hiscock & Barclay, LLP
2000 HSBC Plaza, 100 Chestnut Street
Rochester, NY 14604

The present invention incorporates a flexible RF seal into the ground face of a typical connector. The seal comprises a flexible brim, a transition band, and tubular insert with an insert chamber defined within the seal. In a first embodiment the flexible brim is angled away from the insert chamber, and in a second embodiment the flexible brim is angled inward toward the insert chamber. A flange end of the seal makes a compliant contact between the port and connector faces when the nut of a connector is partially tightened, and becomes sandwiched firmly between the ground surfaces when the nut is properly tightened. The present invention allows the connector to make a uniform RF seal on a port even with a range of tightening torques.

(73) **Assignee: John Mezzalingua Associates, Inc.**

(21) **Appl. No.: 11/553,115**

(22) **Filed: Oct. 26, 2006**

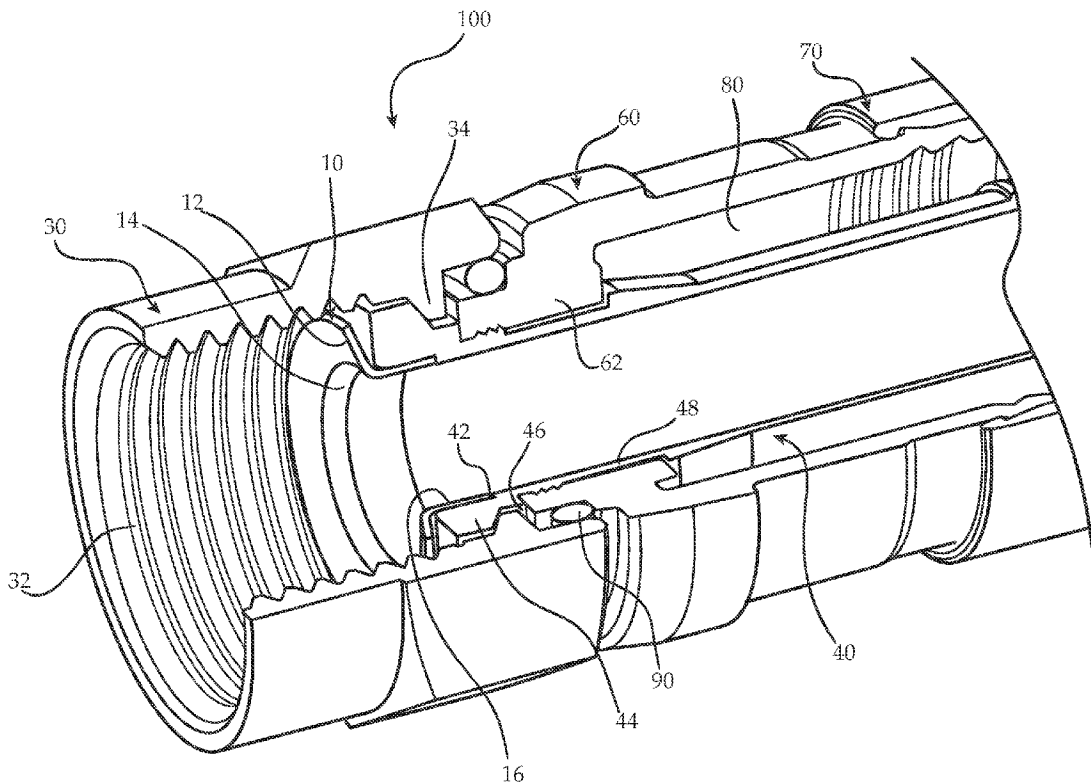

PPC Exhibit 2016

Corning v. PPC

IPR2016-01573

Fig. 1A

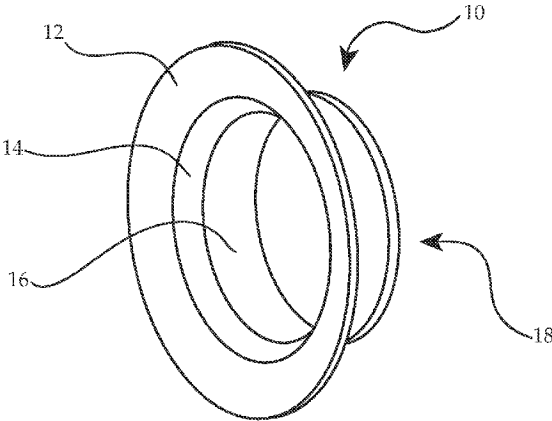
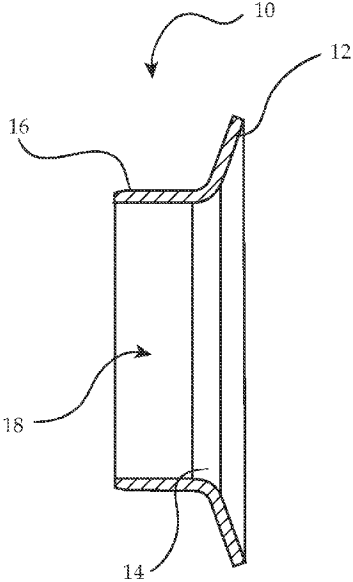

Fig. 1B

Fig. 2A

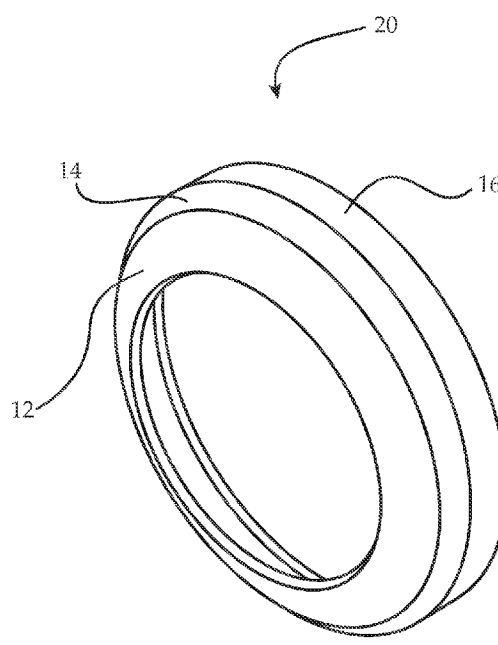
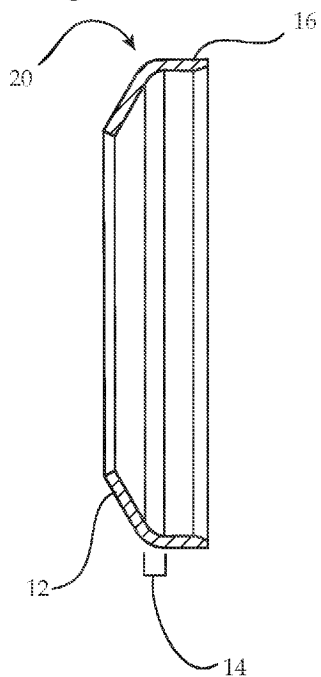

Fig. 2B

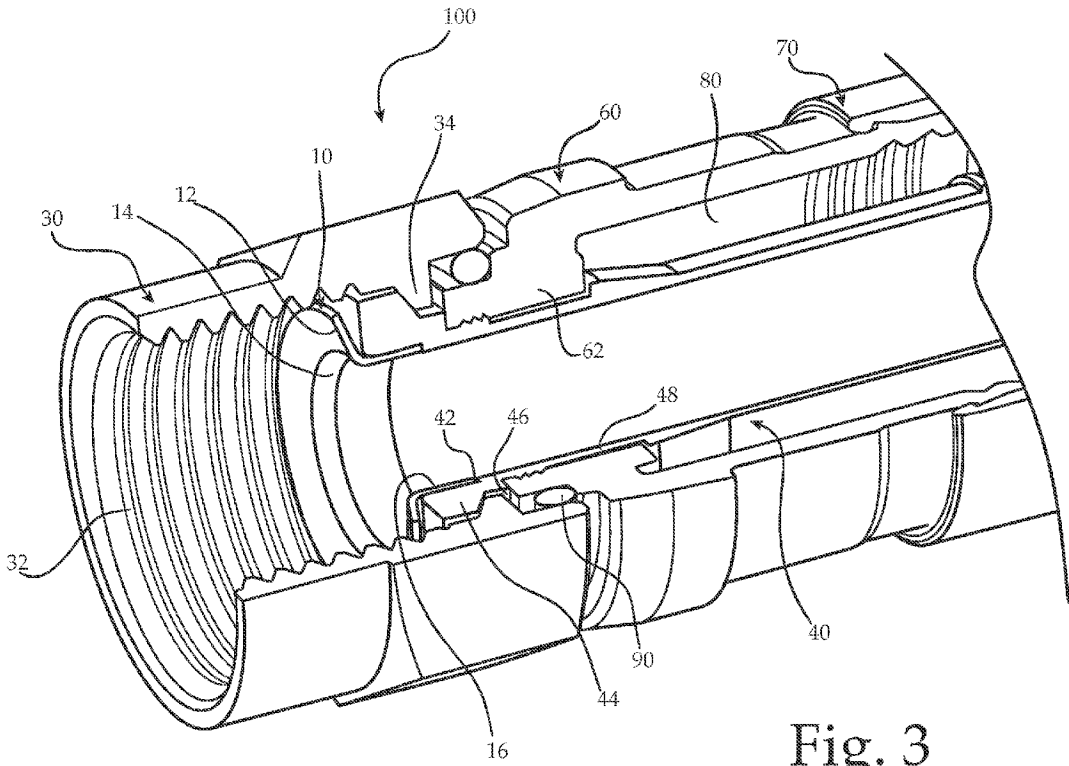

Fig. 3

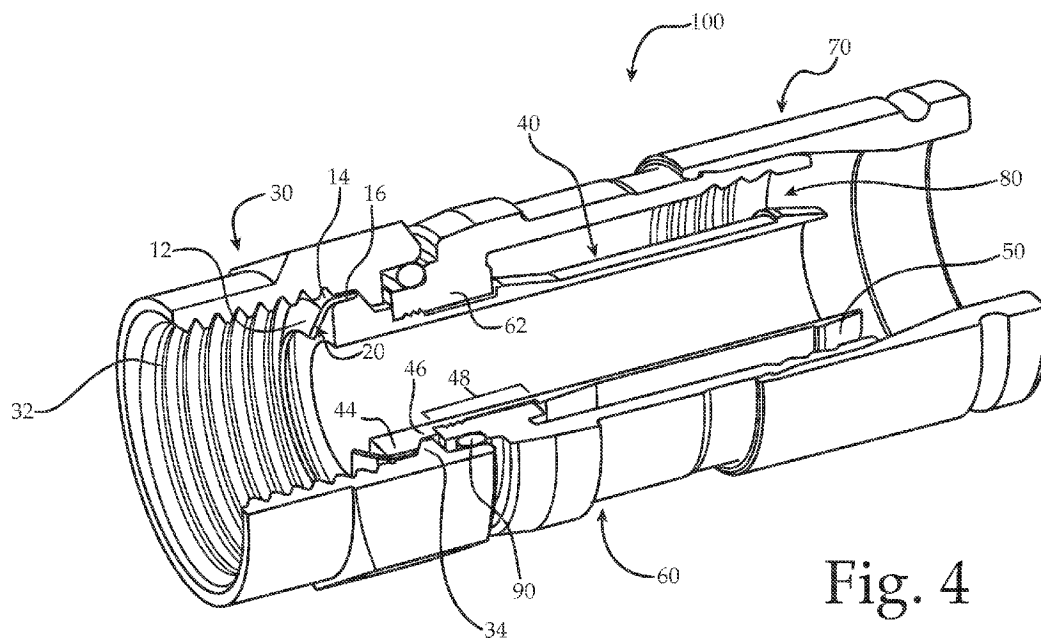

Fig. 4

Explore Litigation Insights

Docket Alarm provides insights to develop a more informed litigation strategy and the peace of mind of knowing you're on top of things.

Real-Time Litigation Alerts



Keep your litigation team up-to-date with **real-time alerts** and advanced team management tools built for the enterprise, all while greatly reducing PACER spend.

Our comprehensive service means we can handle Federal, State, and Administrative courts across the country.

Advanced Docket Research



With over 230 million records, Docket Alarm's cloud-native docket research platform finds what other services can't. Coverage includes Federal, State, plus PTAB, TTAB, ITC and NLRB decisions, all in one place.

Identify arguments that have been successful in the past with full text, pinpoint searching. Link to case law cited within any court document via Fastcase.

Analytics At Your Fingertips



Learn what happened the last time a particular judge, opposing counsel or company faced cases similar to yours.

Advanced out-of-the-box PTAB and TTAB analytics are always at your fingertips.

API

Docket Alarm offers a powerful API (application programming interface) to developers that want to integrate case filings into their apps.

LAW FIRMS

Build custom dashboards for your attorneys and clients with live data direct from the court.

Automate many repetitive legal tasks like conflict checks, document management, and marketing.

FINANCIAL INSTITUTIONS

Litigation and bankruptcy checks for companies and debtors.

E-DISCOVERY AND LEGAL VENDORS

Sync your system to PACER to automate legal marketing.