



US 20100255719A1

(19) **United States**

(12) **Patent Application Publication**
Purdy

(10) **Pub. No.: US 2010/0255719 A1**

(43) **Pub. Date: Oct. 7, 2010**

(54) **COAXIAL CABLE CONTINUITY CONNECTOR**

Publication Classification

(75) Inventor: **Eric Purdy**, Constantia, NY (US)

(51) **Int. Cl.**
H01R 9/05 (2006.01)
H01R 43/26 (2006.01)

Correspondence Address:
JOHN MEZZALINGUA ASSOCIATES, INC.
C/O SCHMEISER OLSEN & WATTS, 22 CENTURY HILL DRIVE, SUITE 302 LATHAM, NY 12110 (US)

(52) **U.S. Cl.** **439/578; 439/583**

(73) Assignee: **JOHN MEZZALINGUA ASSOCIATES, INC.**, East Syracuse, NY (US)

(57) **ABSTRACT**

(21) Appl. No.: **12/472,368**

A coaxial cable continuity connector comprising a connector body, a post engageable with connector body, wherein the post includes a flange having a tapered surface, a nut, wherein the nut includes an internal lip having a tapered surface, wherein the tapered surface of the nut oppositely corresponds to the tapered surface of the post when the nut and post are operably axially located with respect to each other when the coaxial cable continuity connector is assembled, and a continuity member disposed between and contacting the tapered surface of the post and the tapered surface of the nut, so that the continuity member endures a moment resulting from the contact forces of the opposite tapered surfaces, when the continuity connector is assembled, is provided.

(22) Filed: **May 26, 2009**

Related U.S. Application Data

(60) Provisional application No. 61/166,247, filed on Apr. 2, 2009.

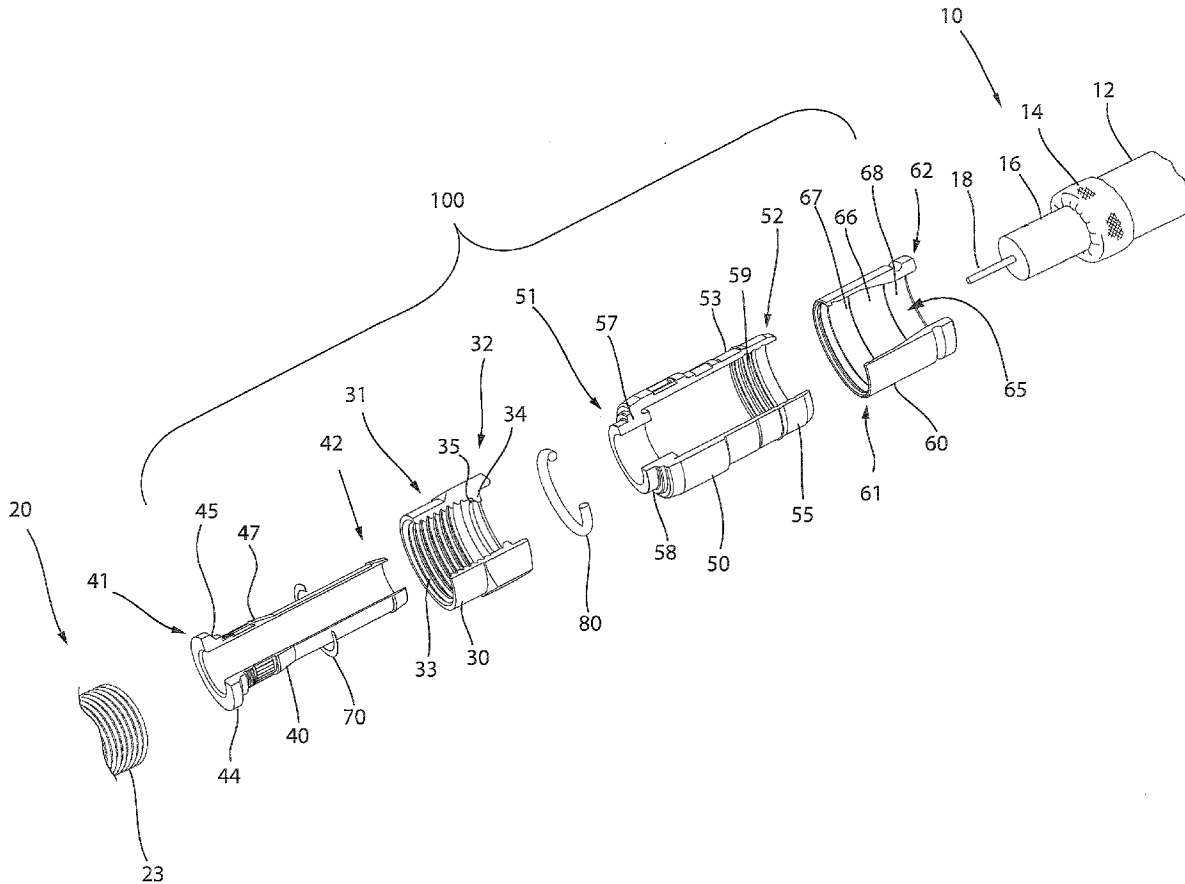

PPC Exhibit 2013
Corning v. PPC
IPR2016-01573

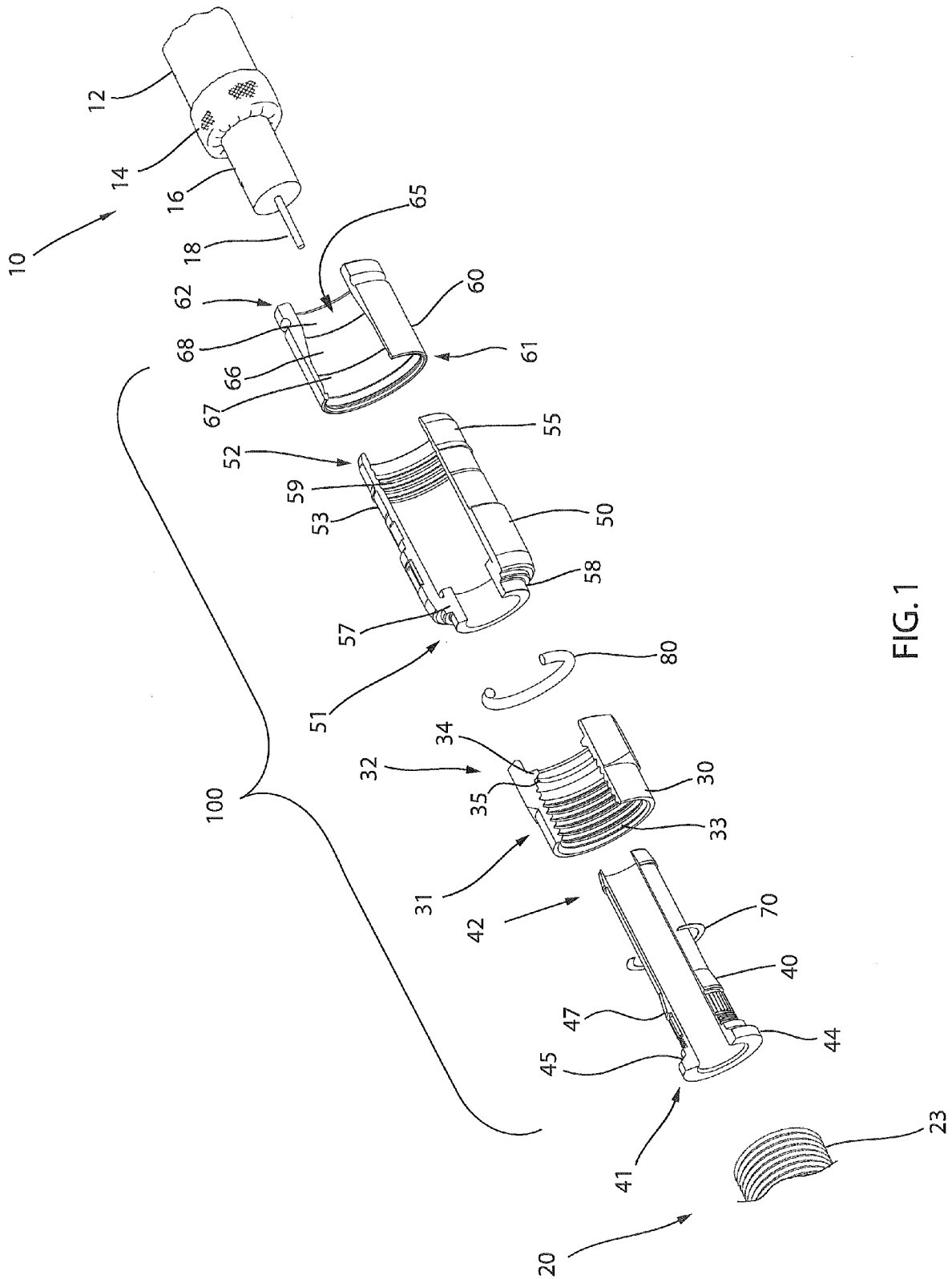

FIG. 1

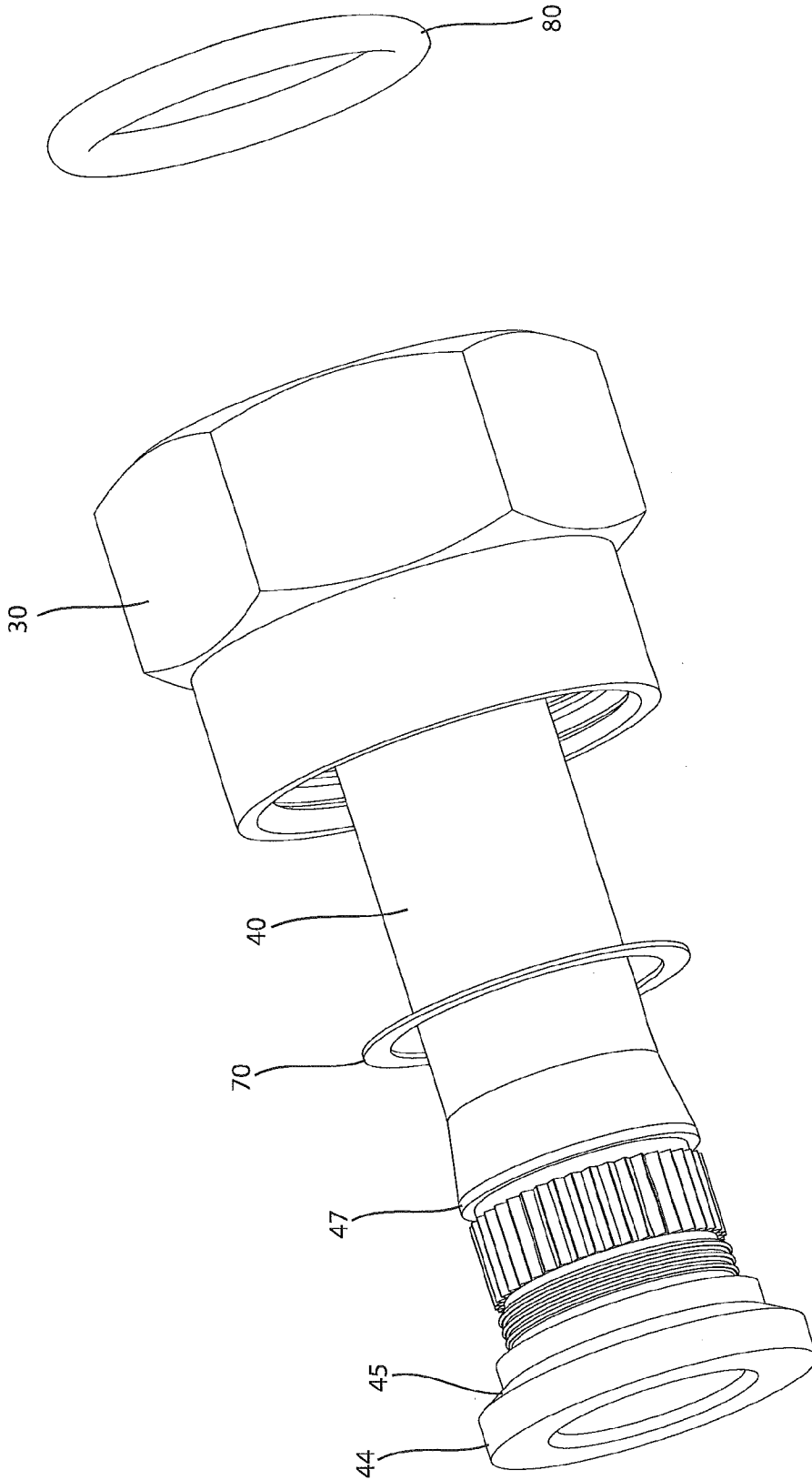

FIG. 2

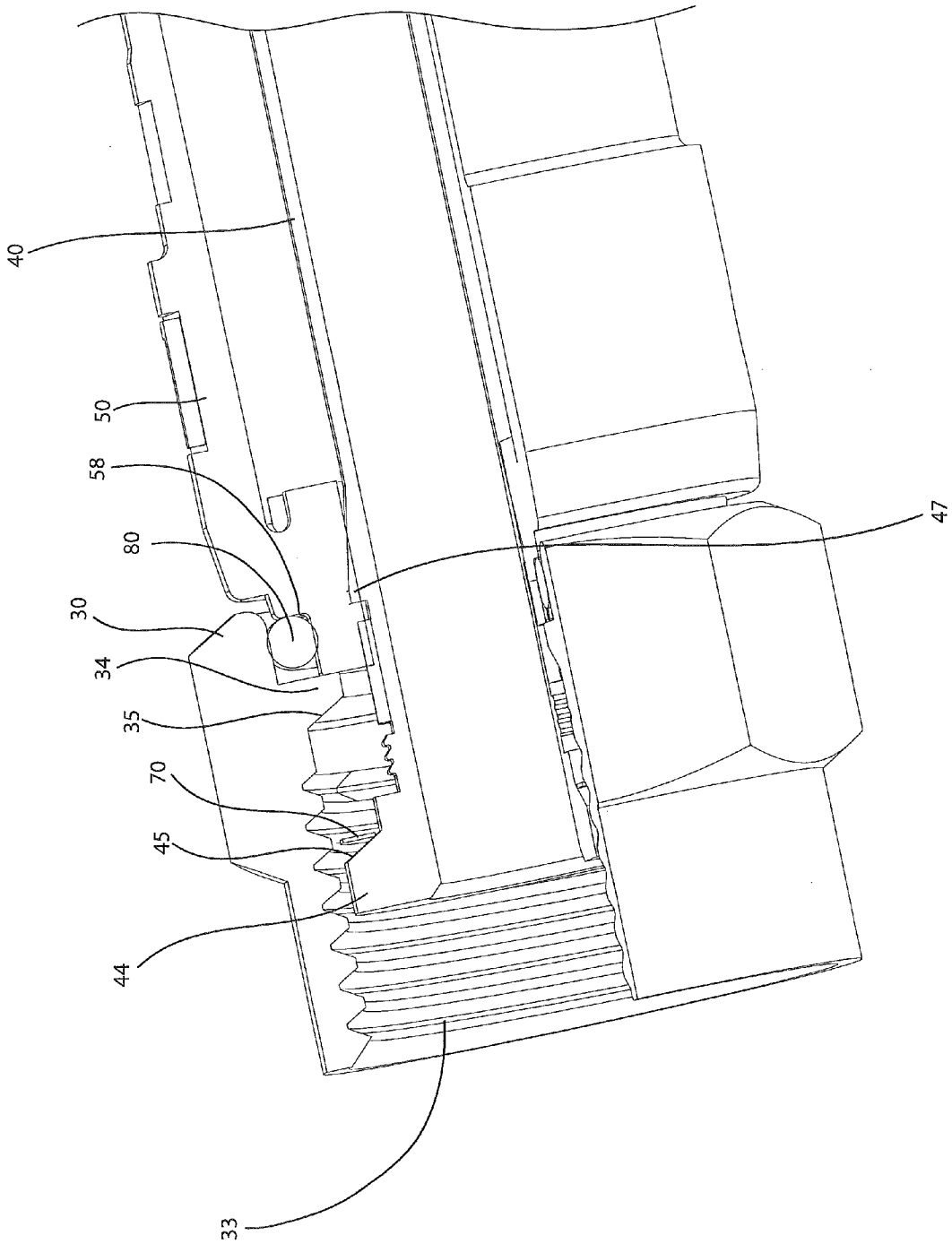

FIG. 3

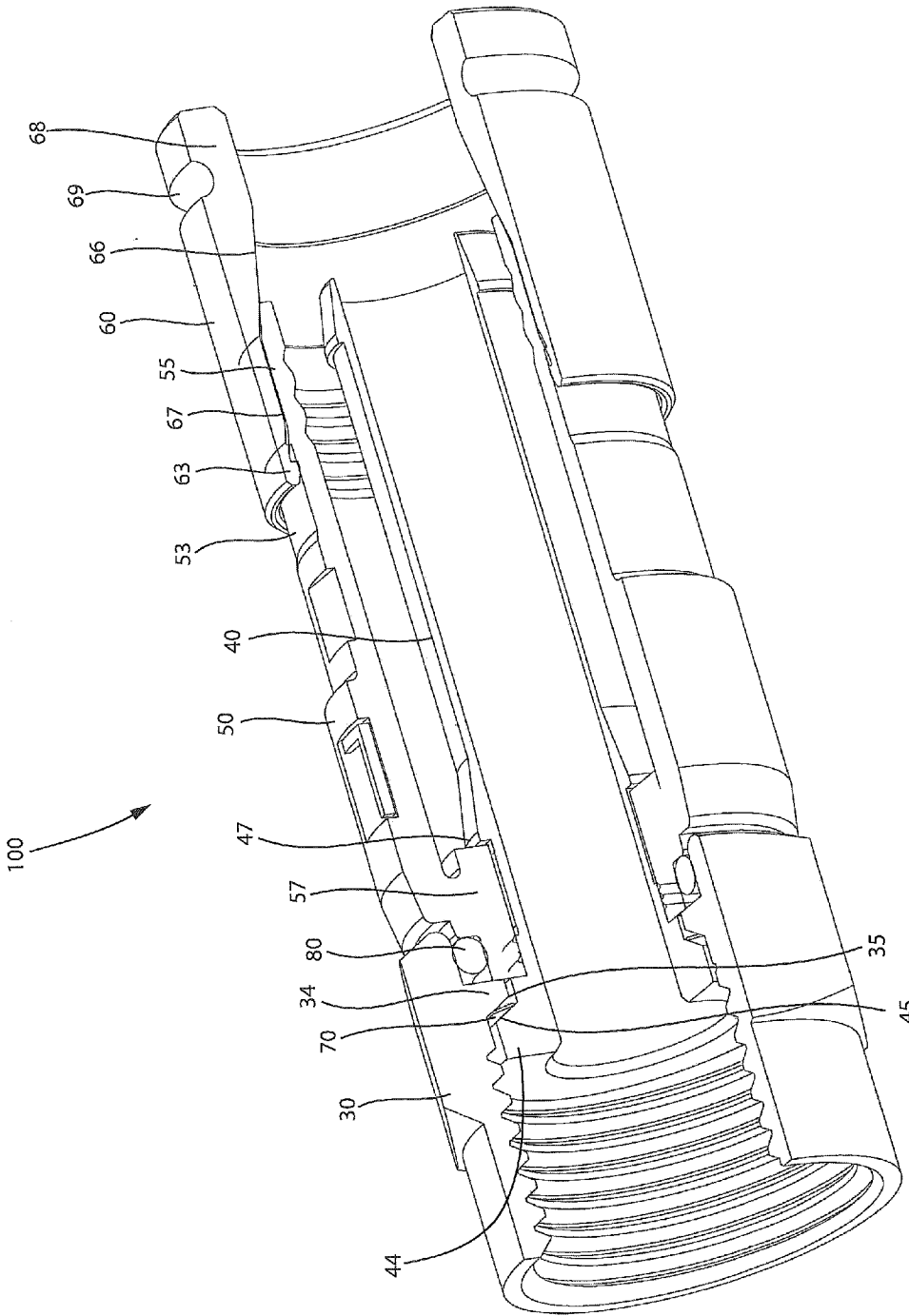

FIG. 4

Explore Litigation Insights

Docket Alarm provides insights to develop a more informed litigation strategy and the peace of mind of knowing you're on top of things.

Real-Time Litigation Alerts



Keep your litigation team up-to-date with **real-time alerts** and advanced team management tools built for the enterprise, all while greatly reducing PACER spend.

Our comprehensive service means we can handle Federal, State, and Administrative courts across the country.

Advanced Docket Research



With over 230 million records, Docket Alarm's cloud-native docket research platform finds what other services can't. Coverage includes Federal, State, plus PTAB, TTAB, ITC and NLRB decisions, all in one place.

Identify arguments that have been successful in the past with full text, pinpoint searching. Link to case law cited within any court document via Fastcase.

Analytics At Your Fingertips



Learn what happened the last time a particular judge, opposing counsel or company faced cases similar to yours.

Advanced out-of-the-box PTAB and TTAB analytics are always at your fingertips.

API

Docket Alarm offers a powerful API (application programming interface) to developers that want to integrate case filings into their apps.

LAW FIRMS

Build custom dashboards for your attorneys and clients with live data direct from the court.

Automate many repetitive legal tasks like conflict checks, document management, and marketing.

FINANCIAL INSTITUTIONS

Litigation and bankruptcy checks for companies and debtors.

E-DISCOVERY AND LEGAL VENDORS

Sync your system to PACER to automate legal marketing.