

Public Relations and Marketing role, which must be kept in mind so the wireless adaptor should be in a fairly robust and mature stage such as a "pilot series" with final form, fit and function.

1.2.3 Production

The production launch is scheduled for the summer of 2005. The wireless audio adaptor may be bundled with entertainment phones special "iRadio" edition or sold as an accessory through various distribution channels.

1.3 Scope

This document first describes the concept of the wireless audio car adapter, summarizes the various technical assumptions then proposes a road map for various market segmentations. It then highlights milestones deliverables and preliminary schedule. In appendix, are listed the specific relationship responsibilities and various term sheet details such as ownership, licensing, warranties, and technical assistance.

Key products we seek to develop through this collaboration

- 1- Initially for demonstration Q4 2004: a universal CD adaptor for a majority of OEM and aftermarket head-units forwarding on a serial bus at 9.6kbps – 19.2kbps (RS232 or TTL) all the head-unit key events along with pushing CD text information back to the head-unit. This should be based on similar products developed for iPod interface, different brand CD changer or XM / Sirius "direct connect" interface technology.
- 2- For trials Q2 2005: an integrated core reference design that could be licensed to an ODM of Motorola's choice based on an Analog Devices BlackFin technology, a similar combo DSP/ARM media processor or integrated into Zeevo BlueTooth "system on chip". This reference design will integrate audio decoder(s), Motorola's iRadio BlueTooth stack and control middleware with the partner universal CD changer adapter technology.
- 3- To be Negotiated:
 - a. small series of 100-200 wireless adaptors based on reference design to be demonstrated in Q2 2005 for limited trial.
 - b. Production agreement

1.4 Glossary

Mobile Client An iRadio enabled mobile device has its own storage and is occasionally connected to a home PC/gateway for updating stored content and sending back usage data. For the Demo and Trial, the only Mobile Client will be Motorola Entertainment phones. For later product phases Mobile Clients could also include: car decks and high-end wireless adapters, PDA, personal music player ...

**“WACA”
Wireless
Audio Car
Adapter** A device that forms the gateway between the phone and the car radio head-unit, acting as a universal adaptor for a majority of aftermarket and OEM car decks.

It will receive car radio/CD changer messages, translate them to appropriate Mobile Client commands and send the translated commands over Bluetooth to the Mobile Client.

It will receive Mobile Client commands over Bluetooth, translate them to appropriate car radio/CD changer messages to the car radio.

It will receive compressed audio over Bluetooth from the Mobile Client, decode it and output it via a lineout audio output.

In higher-end inceptions, it could broadcast audio and data over FM or store its own content directly and acts as a stand-alone renderer. Road-map allows the Bluetooth wireless link to evolve towards WiFi type of wireless protocol

A2DP A BlueTooth Advanced Audio Data profile which allows quality stereo audio to be streamed over BlueTooth rather than the limited speakerphone/or headphone profile. It uses as a standard a Sub-band perceptual codec (SBC). Alternatively, well-known codec decoders could be attached as plugins such as MP3, WMA or AAC+ to avoid codec cascading degradation.

PAN Another BlueTooth serial profile dubbed “Personal Area Network” for proximity ad-hoc networking over IP network.

SPP The basic serial profile connection for FTP exchanges over BlueTooth for point-to-point files exchange

1.5 Assumptions

- The wireless adaptor will be able to interface a majority of major aftermarket brands such as Pioneer, Alpine, Clarion, Kenwood, Sony, JVC and Panasonic
- The wireless adaptor will be able to interface a majority of major OEM brands such as GM, Ford, DaimlerChrysler, Toyota, Honda and most European makers like BMW and VW.
- The wireless adaptor will control directly the MUTE line and the proprietary bus.
- All depressed keys on the head-unit are expected to be reported. At a minimum, all presets memory keys, previous track /next track, fast forward and Rewind, source information should be relayed to the WACA
- The wireless adaptor will be able to display text on the car radio deck and will manage the timing of the displays and associated warning sounds
- The alternative use of "proprietary" custom car radio buses is legal through either legal reverse engineering and public domain information or individual agreement with the car radio makers.
- Others TBD...

2 Wireless Audio Car Adaptor options

The "WACA" concept can branch into a various family of products, which may not all end up in production, but may address different segments of the market. It starts with BlueTooth as the major wireless proximity transport then expands to the WiFi family and even branch into a tethered solution to host the transmitting phone in a recharging USB cradle. Here is a brief description of the major topologies:

2.1 Basic WACA Architecture

The WACA is a 2 way wireless gateway interface that translates audio files and commands streamed from a Motorola phone over BlueTooth into an analog or PCM audio feed to the car radio. It also receives car deck user interface commands (key push and release events) and status information so that the system operates in a closed loop where both the phone and the car deck can select which music the user wants. Finally, the WACA also send text information to the car deck through the limited CD text capabilities which are either containing audio program associated data or dialog with the user.

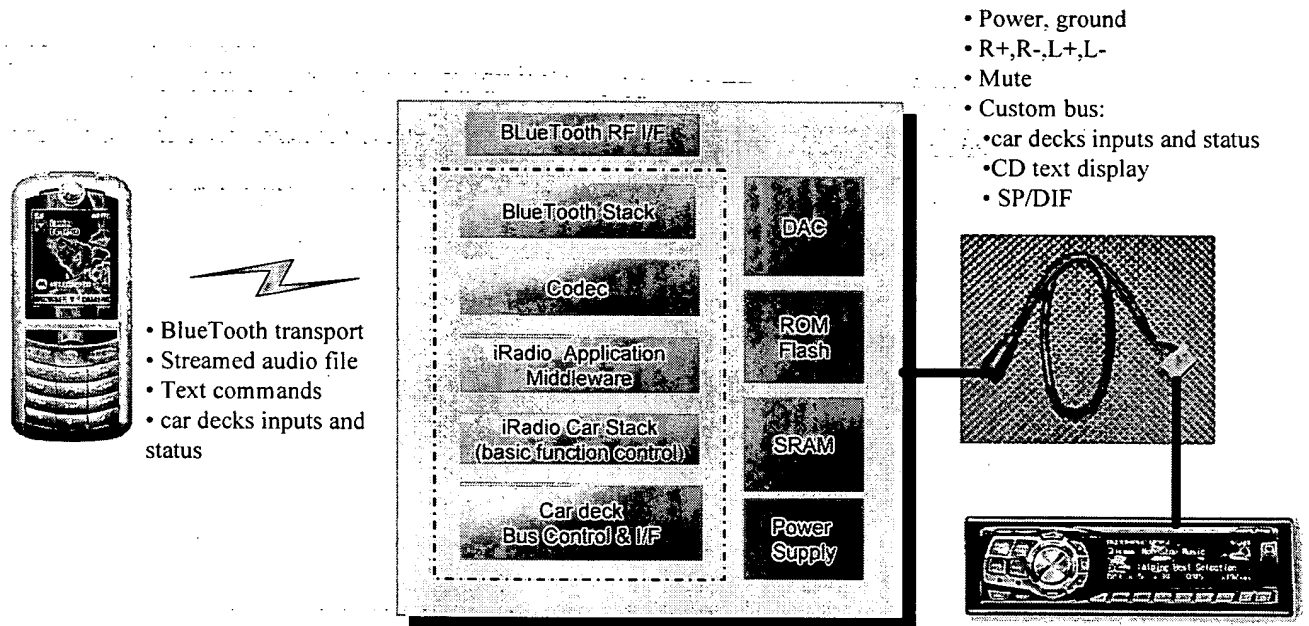

Figure 1: generic WACA Architecture

2.2 WACA#1: BlueTooth baseline thin client

The baseline will use BlueTooth as a wireless transport and the "WACA" will behave essentially as a "slave" device to the phone. The following diagram represents this:

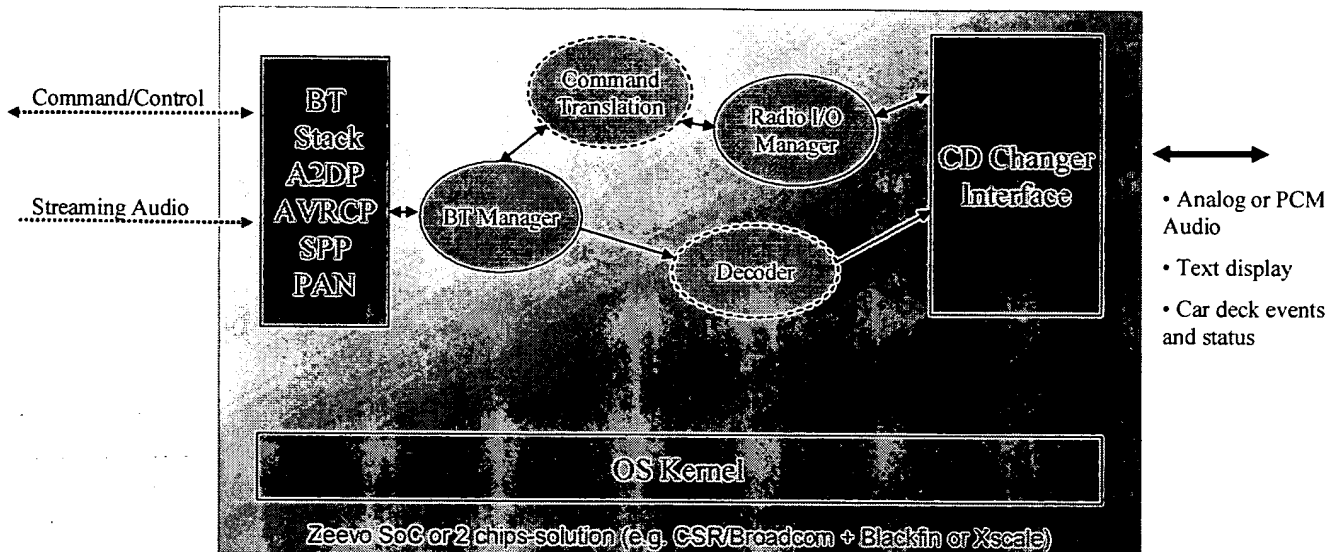

Figure 2: Baseline thin client WACA Architecture

The CD changer interface "adaptors" on the market are using some ATMEL / Cirrus 8/16bits microcontrollers which are not powerful enough to handle the BlueTooth stack and the associated audio decoding. Two controller solutions are envisioned and will dictate the road map based on price targets and flexibility of reconfiguration;

- Use an integrated "System-on-Chip" like Zeevo family of products which integrates BlueTooth stack, basic SBC decoder and ARM+DSP chips on the same die, allowing cost-effective application solutions like iRadio to be built on.
- Use a two chip solution: integrated BlueTooth baseband processor from Broadcom or CSR and multimedia embedded controller like the Analog Devices BlackFin, PowerPC or Intel Xscale

Natural evolution: With improvements in price and power consumption, WiFi / 802.11xx wireless transport may gradually replace BlueTooth in the phones and other portable media devices as ubiquitous wireless PAN transport. In such a case, a next version of the WACA thin client would replace the BlueTooth stack with a WiFi stack. WiFi/802.11xx interface may also allow direct transfer and

synchronization from the home gateway without the phone being needed if RF propagation allows it.

2.3 WACA #2: "No Install - totally wireless" thin client

For consumer mass adoption, it is likely that however simple the professional installation could be, this is still a major hurdle to clear with the consumer. A totally wireless solution would include a wireless FM broadcast to convert the audio stream and tune to one FM station at a time on the car deck. The sound quality will be sacrificed for the ease of installation. SDARS user's high percentage request has proven that the FM broadcast solution was a great enabler for mass adoption and easy listening in the car or at home.

In the case of iRadio, the two-way interaction could be improved by adding two key features:

- Use RDS to display text for audio program associated data and also interactive messages.
- Use of basic short vocabulary command based speech recognition to select channel playlists

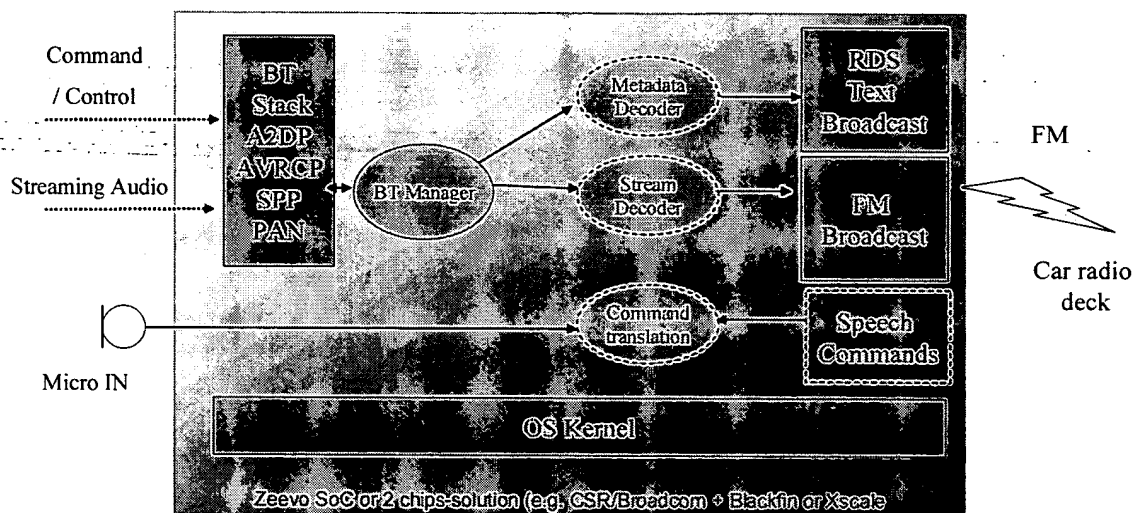

Figure 3: "Totally wireless" thin client WACA Architecture

2.4 WACA #3: Wired Audio Car Adaptor

In this architecture, the WACA is a "Master" reading content from mass storage devices connected through USB. The key advantage from this

topology is to offer a simple mass storage interface mode between phone and other MP3 media players appearing as media mass storage for the USB host, which is reading the audio tracks in sequence. This topology does not require any iRadio middleware or cellular phones iRadio enabled to work (you could plug any media player with USB and they should appear as mass storage to the WACA which would work as the master. However, adding iRadio USB manager and radio command module will bring a fuller user experience with all the advanced services for user convenience synonym of iRadio service. The USB link will be equivalent to the multiple Bluetooth connections and could multiplex audio stream and command & control data...

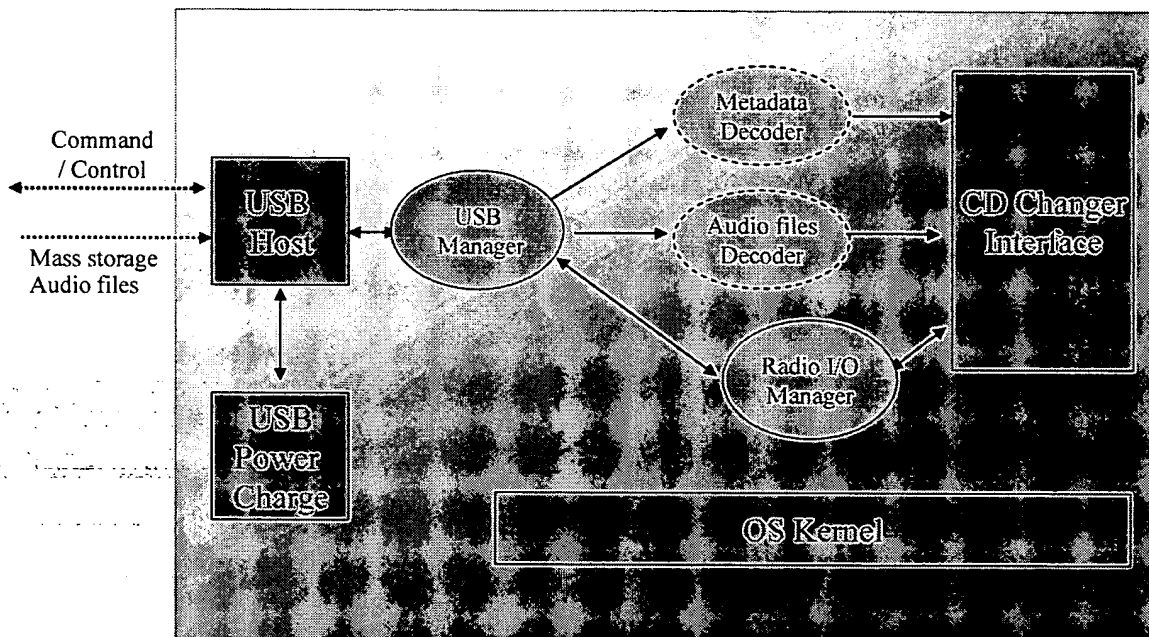

Figure 4: Wired USB thin client WACA Architecture

2.5 WACA #4: "Hands-Free" kit audio adaptor - Hybrid BlueTooth + USB cradle

This hybrid topology caters to the people who may need the flexibility to recharge their phone into the car or use the USB link with other MP3 players while having possible Hands-free phone conversation through the car radio stereo. It is also perfect for the cases where the user want to experience iRadio audio streaming without moving the phone out of his pocket.

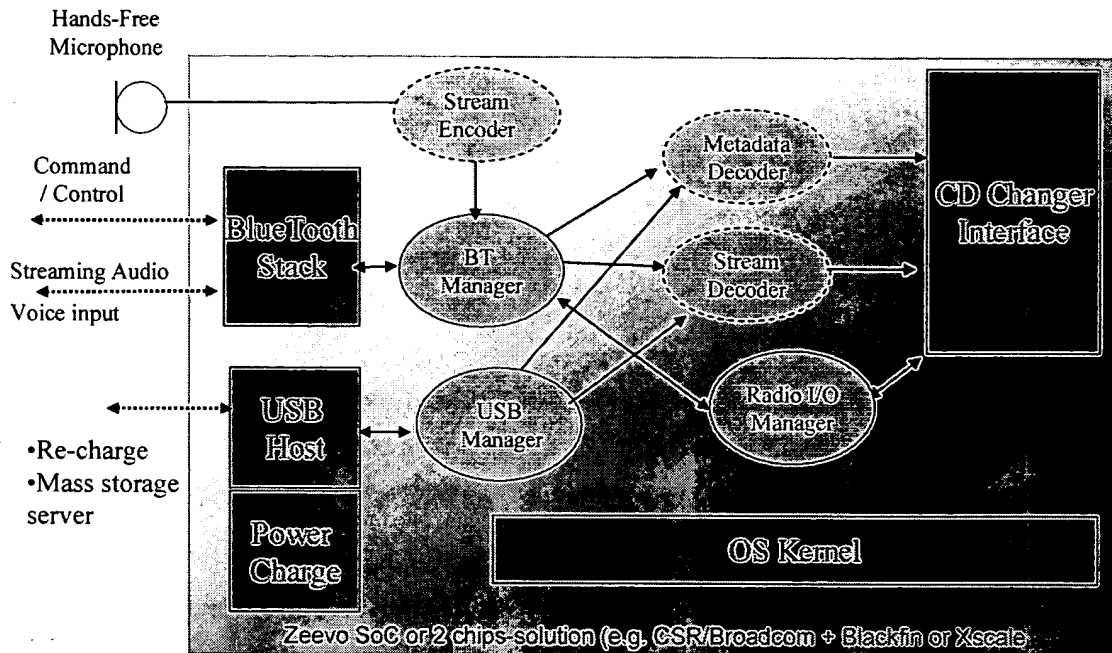

Figure 5: "Hybrid" hands-Free expandable thin client WACA Architecture

2.6 WACA #5: "Thick Client" roadmap evolutions

The WACA could evolve in a more powerful "Thick client" adaptor which would be the 'missing Link' for mass adoption of nomadic digital players into the car while waiting for BlueTooth, WiFi and hard-drives / memory cards to become ubiquitous on the car decks themselves (longer aftermarket and OEM lifecycle). It is considered "Thick" once it hosts its own memory and manages "iRadio" business rules for the content without a need for the phone. By providing more than one USB port and managing these ports, the WACA could become a successful "low cost alternative" media gateway for all the legacy car decks, that will not yet provide digital memory and wireless interfaces.

The entire iRadio middleware available in the phone can be ported into the WACA so that, in the advent of a WiFi direct link with the Home Gateway, the WACA will function as both a server and renderer roles under an UpnP A/V paradigm. The phone may not be needed in this picture unless it provides some value added services like "hot content". In such a case, the Home gateway or WiFi/WiMax hot spots on the go can transfer directly the media content updates into the car and receive usage tracking from the WACA.

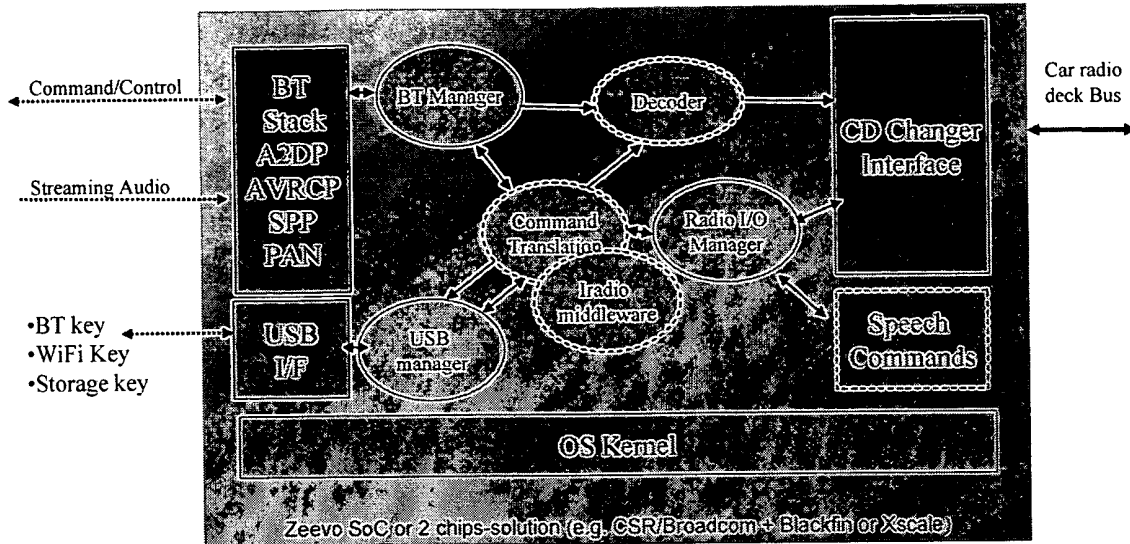

Figure 6: "High-End" expandable thin client WACA Architecture

This approach would require a more powerful controller structure than the BlueTooth Zeevo system on chip may be able to provide. The BlackFin chip series from Analog Devices has shown tremendous computing power for very cost effective price. The WACA partner will of course be influential in the decision of the core controller.

3 Timeline

3.1 iRadio timeline

- iRadio is targeted for alpha release on December 31, 2004 for CES demo
- iRadio Beta release on February 15, 2005: a beta release in this context is defined as Version 0.9:
 - Locked feature-set
 - All features implemented
 - Functionally complete
 - Operational
- Public trials of iRadio "beta" starting on April 4, 2005 for up to 200 users
- Commercial product release will commence in Q3 2005.
The Commercial product release of iRadio 1.x will assume that the product has undergone and passed rigorous QA testing for functionality, stability and data integrity.

3.2 WACA timeline

- Car deck to RS232 + Line in adaptor – one manufacturer model: no later than 11/22/04
- Car deck to RS232 + Line in adaptor – multi-manufacturers programmable model: no later than 12/1/04
- Single board BlueTooth + car adaptor prototype (alpha): 12/15/2004
- Single board BlueTooth + car adaptor (beta): 2/15/2005
- Single module BlueTooth + car adaptor (pilot) – qty 200: 4/15/2005
- Single module BlueTooth + car adaptor (production) – qty >1000/ week: 7/1/2005

4 Roles & responsibilities

4.1 Motorola:

Motorola will provide:

- Program contact
- System definition leadership
- iRadio middleware interface algorithm
- Phone interface protocol
- Integration into target phones

4.2 WACA partner

WACA partner will provide the integrality or a sub-function of the following list:

- Provides car radio adaptor interface (hardware and software)
- Provides wireless and USB interfaces (hardware & software)
- Provides hardware core reference design
- Integrates iRadio middleware with wireless and car radio adaptor
- Provide WACA kit including housing module and adaptation cable sets
- Product validation for automotive environment
- OMD high volume / low cost agreed manufacturing

1	Introduction.....	3
1.1	Overview.....	3
1.2	Phases.....	3
1.2.1	Demo.....	3
1.2.2	Trial.....	3
1.2.3	Product.....	3
1.3	Scope.....	3
1.4	Glossary.....	3
2	System Definition.....	4
2.1	Structure.....	4
2.2	Elements.....	4
2.2.1	Content Provider Interface.....	4
2.2.2	Home Configuration PC.....	5
2.2.3	Mobile Clients.....	5
2.2.4	Thin car client.....	5
2.2.5	Public WiFi Hot spot.....	5
2.2.6	Cellular data system.....	5
2.2.7	Internet.....	6
2.2.8	In-home network.....	6
2.2.9	Home remote control.....	6
2.2.10	Home renderer.....	6
2.2.11	Updating system.....	6
2.3	Actors.....	6
2.3.1	User.....	6
2.3.2	Friend.....	6
3	System Functions.....	7
3.1	Content Provider Interaction.....	7
3.1.1	Temporary Content Provider Standin.....	7
3.2	Updating.....	7
3.2.1	Discovery/Authorization.....	7
3.2.2	Opportunistic Updating.....	8
3.2.3	Mobile to mobile updates.....	8
3.2.4	Content license approaches.....	8
3.2.5	Data updated.....	8
3.2.6	Problem situations.....	Error! Bookmark not defined.
3.2.7	Cellular data opportunities.....	9
3.2.8	Hot-spot opportunities.....	9
3.3	Mobile Communications Medium.....	9
3.3.1	BlueTooth/WiFi.....	9
3.4	Thin car client (streaming from a mobile client).....	9
3.4.1	A2DP Basic.....	9
3.4.2	A2Dp Advanced.....	Error! Bookmark not defined.
3.4.3	User Interface.....	10
3.4.4	Short-term approaches.....	10
3.5	DRM/codecs.....	10
3.6	Device to Device Transitions.....	10

3.7	Configuration	10
3.7.1	Personal MP3 support	10
3.7.2	iRadio Purchased content support.....	10
3.7.3	Content not supported.....	10
3.7.4	At computer user interface.....	11
3.7.5	Remote configuration.....	11
3.7.6	Transitions.....	Error! Bookmark not defined.
3.7.7	Channels.....	11
3.8	In-home content consumption.....	11
3.8.1	Mobile unit as an in-home remote control.....	Error! Bookmark not defined.
3.8.2	UPnP	12
3.8.3	Pause/Resume	12
3.9	Mobile (Personal) operations.....	12
3.9.1	Content consumption	12
3.9.2	Storage	12
3.10	At computer content consumption.....	12
3.10.1	At home.....	12
3.10.2	Remote	12
3.11	Home Gateway.....	12
3.12	Usage tracking	12
3.13	Alarm clock.....	Error! Bookmark not defined.

1 Introduction

1.1 Overview

The core iRadio functionality is well described in the iRadio Market Requirements Document.

1.2 Phases

1.2.1 Demo

This is the CES 2005 demo. It will take place in a suite during the CES show (Jan 6–9). It will demonstrate how iRadio technology will work throughout a typical user's day, from waking up in the morning, driving to work, going to the gym and returning home. The software implementing this demo will use Bluetooth for mobile client updates. UPnP will be used for streaming content in the home.

1.2.2 Trial

A trial with several hundred users is planned over the course of the second quarter of 2005. The Trial will demonstrate seamless operation between the home and car domains. Ideally the Trial system will be a natural evolution of the Demo system. This evolution would include the implementation of missing features as well as testing and enhancements.

1.2.3 Product

The product will incorporate improvements suggested by the trial as well as improvements uncovered by testing in representative user environments. In order to be on the market with a partner in 2005, the initial product (referred to as phase 1) will probably have the same features as the demo system. More advanced features will be deferred to following phases.

1.3 Scope

This document focuses on the operation of the iRadio system for the Demo and Trial. Functionality beyond the Demo and Trial may be identified and even described, but it is not the focus of this document.

1.4 Glossary

- Mobile Client** Any iRadio enabled mobile device which is occasionally connected to either the home network or the Internet for updating stored content and providing usage data. Mobile Client can include: cell phone, car device, personal music player ...
- Playlist** An ordered set of content. By default a playlist would cause the content to be played in sequential order. There might also be a way to randomize the playlist (or playing of it) so that the original order is not apparent. On mobile client, a playlist may only be partially resident on a device.

Light-weight updating	The exchange of relatively small amounts of data which does not include bulk content
Bulk Content	Actual audio or video content which involves large amounts of data.

2 System Definition

2.1 Structure

SYSTEM DIAGRAM GOES HERE

2.2 Elements

2.2.1 Content Provider Interface

The content provider is not part of the iRadio system. This interface encompasses all communication with the content provider. At its simplest, the content provider will provide playlists (genre channels, user custom channels, and the bulk content associated with those Playlists). The iRadio Server provides user consumption and rating information. Additionally, the content provider interface handles the user's purchase of individual pieces of content. There is nothing in the system which limits the number content providers which could be supported.

2.2.2 iRadio system

The iRadio Server and the Home Gateway work together to implement the core of the iRadio system. The exact division of responsibilities between the two elements will be decided later and is often unimportant when trying to understand how the system works as a whole.

2.2.2.1 iRadio Server

This is the central content aggregation point for the iRadio system. It communicates with the content providers and passes the information on to the rest of the system. Although the Home Gateway is typically in the communications path with mobile devices, the iRadio Server can communicate directly with mobile devices via public WiFi access points or via the cellular system.

2.2.2.2 Home Gateway

The Home Gateway software runs on the user's home PC or on a dedicated in-home media server (MS1000). iRadio content is cached on the Home Gateway before it is played in the home via UPnP A/V or preemptively transferred to Mobile iRadio Clients which can connect to the Home Gateway via the home network. The Home Gateway functionality has no need for a user interface and no user interface is planned.

2.2.3 Home Configuration PC

Although the user may use the same PC for the Home Gateway as they use for configuring the iRadio, these are two different roles and are called out separately. The most extreme case for the Configuration PC being separate from the Home Gateway is when the Home gateway is a MS1000.

2.2.4 Mobile Clients

Mobile Clients are any iRadio enabled mobile devices which occasionally connect to either the home network or the Internet for updating stored content and providing usage data. For the Demo and Trial phases, cell phones are the only Mobile Client. In later phases it could be a car device can or personal music player.

2.2.4.1 Phone client

The phone is running either native or Java iRadio software which controls all iRadio functions. This software must run continuously, not just when the user is listening to content on the phone. Running in the background, the software takes care of updating the phone and the rest of the iRadio system so that content is always up-to-date. There are no specific plans to use cellular data communications for any updating, but that remains a possibility.

2.2.4.2 Car client (thick)

An iRadio in-car unit with content storage and WiFi support interacts with the iRadio system the same as any other mobile client. The in-car unit could be integrated into a radio, Telematics Control Unit or installed as an after-market unit via the CD changer interface.

2.2.5 Thin Car Client

The Thin Car Client has no memory of its own. It allows content to be streamed to it from personal device carried by someone in the car via Bluetooth or WiFi. Additionally the in-car audio control actuations are sent to the source of the stream so that the driver can easily control the content.

2.2.6 Public WiFi Hot spot

Not part of the Demo or Trial system, a public WiFi hot-spot allows mobile devices to update content directly from the iRadio Server. In early phases this updating will not include a user's personal audio files which were not purchased through the iRadio system. WiFi access points which require the user to enter encryption information will not be supported. Configuration of acceptable WiFi access points will be possible to limit connections.

2.2.7 Cellular data system

Not part of the Demo or Trial system, a mobile client capable of cellular data connections could use these connections for partial updates at minimal cost. Full updates would be cost prohibitive.

2.2.8 Internet

The Internet is used to connect the iRadio Server to the Home Gateway and in the future, directly to mobile clients via a public WiFi access point or via cellular data connection.

2.2.9 In-home network

The two responsibilities of the home network are to support the streaming of content for in-home consumption and to facilitate updating of mobile clients. These two responsibilities could be addressed by different in-home networks as long as they are both supported by the Home Gateway.

2.2.9.1 UPnP

UPnP A/V facilitates the streaming of content within a small network. This is the chosen approach for the consumption of content in the home for the Demo and Trial.

2.2.9.2 Mobile connection

In the short term, Mobile Clients will be updated over WiFi or Bluetooth, any reasonably high speed network would also work. For the Demo and Trial, Bluetooth will be the

2.2.10 Home remote control

For the Demo and Trial it is assumed that the personal mobile device will also act as the user's remote control in the home for iRadio content consumption. This will use a Bluetooth link back to the Home Gateway which will participate in the UPnP network on the remote's behalf.

2.2.11 Home renderer

This is the end point where streamed content in the home is converted to analog for presentation to the user. For UPnP there are several commercially available audio rendering devices.

2.2.12 Updating system

The updating system is the differentiating technology of the iRadio system which allows multiple devices/domains to keep in sync regarding what the user has listened to, is listening to, and is expected to listen to in the future.

2.3 Actors

2.3.1 User

This is the person who uses the iRadio system in the various domains and for various purposes.

2.3.2 Phone Friend

For scenarios and which involve receiving a phone call, this would be the person who phones the user.

3 System Functions

3.1 Content Provider Interaction

The iRadio relies on content providers for providing all the content which the user didn't already own. Content Providers would initially provide genre playlists, celebrity playlists, and content purchase. The iRadio system would provide content consumption information through this interface also. This interface would be widened as needed to cover billing and community services as needed.

The connection between the iRadio Server and the Content Provider would be over a dedicated private connection or a VPN for privacy and security. Considering the large amounts of information which may be crossing between the iRadio server and the Content Provider, they need a high capacity connection.

3.1.1 Temporary Content Provider Standin

For Demo, there will not really be a Content Provider. The content will either be faked on the iRadio server or a simple Content Provider stub could be created. The stub would use HTTP for all communications. Most of the genre playlists, celebrity playlists, and purchase interactions could be done via XML (or even SOAP). Bulk content transfers don't benefit from XML or SOAP, so those would be transferred one at a time using plain HTTP GET requests.

3.2 Updating

Updating occurs between all the major elements of the iRadio system (iRadio Server, Home Gateway and Mobile Clients) and is the main enabler of the iRadio features.

3.2.1 Discovery/Authorization

Each element of the iRadio system has a list of users which it supports. A Mobile Client will likely have only one person in the user list. The iRadio server could have millions of users. The initial handshake between to iRadio elements is used to determine whether the two elements have any users in common. If they have users in common, then the interchange proceeds to determine what information needs to be updated.

Discovery occurs amongst Mobile clients and the Home Gateway. Communications with the iRadio server is established via a known URL rather than discovery.

The following stages occur:

- **Discovery:** Receive initial inquiry or response associated with actual discovery of an iRadio enabled device
- **Authentication:** Exchange supported user's information to see if there are users in common.
- **Add to registry:** The discovered and authenticated device is placed in a registry of devices available for updating.
- **Updating:** Immediately after addition to the registry updating occurs. Updating also occurs as needed so long as the device remains in the registry.
- **Remove from registry:** When it is determined that a device in the registry can no longer be reached, then it is removed from the registry.

For devices designed to connect to the iRadio Server, in parallel with the discovery of devices in the immediate proximity, there is also an effort to form a connection to the iRadio Server.

3.2.2 Data updated

The following relatively small types of data are sent from the mobile client during updating:

- **Content Status Changes:** Playing, Stopped, Paused, Resumed, Skipped. Where appropriate, this includes play-point information.
- **Rating:** This the user's rating of the content and contains a content identifier, and both the change in rating and the new rating value.
- **Purchase Request:** This contains a content identifier.
- **Key Press:** For diagnostic purposes and user interaction studies, each key press is captured.

Each piece of data above is time stamped (UTC timezone and local offset). The Content Status Changes and Ratings are of general interest to all elements using the updating system. The Purchase Request and Key Press information is only of interest to the iRadio Server although it may be forwarded through other elements.

Updating also involves sending the following data to the mobile client:

- **Playlists/Daily Set descriptions:** These are user specific content descriptions which do not include the actual bulk content.
- **Bulk Content:** The large pieces of data which is the audio or video data.
- **User configuration/Preferences:** TBD

3.2.3 Opportunistic Updating

Because proximity network connections are transient, updating occurs whenever there is the opportunity to do so. This accommodates situations where the user rapidly changes from one domain to another and the seamless experience must be maintained.

3.2.4 Mobile to mobile updates

The current Demo and Trial plans call for each user to have only one Mobile Client so mobile to mobile updating can never occur. During the Demo and Trial, the Mobile Client will update with the Home Gateway (or possibly the iRadio Server) directly.

In situations where a user does have multiple mobile clients, most updating will occur at home directly with the Home Gateway, but there are cases where an automotive mobile client might never connect to the home network if the user lives in an apartment building. In these cases updating between mobiles is used to bridge this gap. A personal mobile client would periodically update information with the Home Gateway and the automotive mobile client. This would allow information to remain in sync.

3.2.5 Content Approaches

For the Demo and hopefully the Trial well will have considerable control over the devices in use and their capabilities. With this control we can help ensure that audio encoding, bit rate and DRM are consistent across devices. In a production system we will not be so fortunate. We must be prepared to deliver content with different audio encoding, bit rate and DRM for each device. Additionally the metadata required by devices may be different.

Given the storage resources of the Home Gateway most effective approach is to use the Home Gateway to store different versions of each piece of bulk audio content. Each version is shaped for a particular device which the user owns. The only situation where this does not perform well is

when the personal device with limited storage is used to bridge updating between the Home Gateway and a think car client (See issue 1).

3.2.6 Cellular data opportunities

Although cellular data communications are not required or planned for the Demo or Trial systems, it is an alternative for light-weight updating in the future. A cellular data connection to the iRadio Server could be used to update the relatively small amount of data which doesn't involve bulk content transfers.

3.2.7 Hotspot opportunities

In the same way that cellular data communications could provide a direct updating path to the iRadio Server, public hotspots can do the same. Network controls would be available to limit the networks which will be used.

3.2.8 Mobile Communications Medium

Any set of wireless network technologies could serve as the basis for device-to-device updating so long as it supports dynamic networks and the throughput exceeds the streaming audio data rate by several times.

3.2.8.1 Bluetooth

Bluetooth is attractive from a cost, power and wide mobile support point of view, but its throughput is marginal. For the Demo and Trial, Bluetooth's advantages outweigh its throughput disadvantage. Bluetooth has been chosen for the Demo and Trial systems.

3.2.8.2 WiFi

WiFi and other wireless IP networks have a desirable throughput but the power consumption and limited support in mobile devices has pushed this alternative out beyond the Demo and Trial phases.

3.3 Thin car client (streaming from a mobile client)

There are two approaches to supporting audio content:

- **The car device as a full mobile client:** In this case the in-car device has its own content storage and updating capability.
- **The car device as a thin renderer:** In this case the in-car device has no storage of its own and just acts as an interface device between a personal mobile client and the car audio system.

The second, thin renderer, approach has been selected for the first iRadio implementations.

3.3.1 A2DP Basic

A2DP refers to the Bluetooth profile which covers the streaming of stereo audio. As a standard, it covers the situation well with only a few weaknesses:

- The default audio encoding does not give the desired 90 dB SNR. (It is closer to 72 dB.)
- The transition from the mobile client's lossy encoding to another lossy encoding is likely to further degrade the audio quality.
- The standard is not widely implemented.

In spite of these weaknesses some form of A2DP is the chosen approach for Demo and Trial. Some of these weaknesses can be overcome by a special mobile client implementation and careful alignment with the in-car adapter. The best A2DP/adapter implementation would avoid default A2DP encoding and instead, allow the encoded content to pass directly from the mobile client to the in-car device without a second encoding. This would address the audio quality concerns.

3.3.2 User Interface

In addition to the mobile client providing audio to the car audio system through the in-car device, the in-car audio control actuations are sent to the mobile client so that the user controls all the audio from the regular car audio controls.

3.3.3 Short-term approaches

A full A2DP implementation may not be available in the Demo timeframe so an alternative serial port profile approach is being investigated. The serial port approach uses the widely implemented serial port emulation over Bluetooth to deliver the audio content.

3.4 DRM/codecs

The iRadio approach is encoder agnostic. The only requirement is that there is a way to get the audio content from the content provider into the encoding that each of our devices supports. There is an additional requirement that the encoding is compressed enough to work within the constraints of the mobile networking and mobile client storage.

For DRM, we need to have a way of applying the DRM encryption at the iRadio Server before the content is sent to the client. Ideally the content DRM encryption would be the same for all client devices and only a separate, relatively small, license file would be device specific.

3.5 Device to Device Transitions

Since the iRadio system, and the personal mobile device specifically, spans home, car and person domains, there are inevitably cases where the user moves from one domain to another while playing content. The behavior for these transitions is configurable on a case-by-case basis between automatic transitions and manual only transitions. When automatic transition is selected, the transition will occur as soon as the device (car or home) is detected. For manual operation, no transition occurs until the user explicitly chooses a new place for the audio to play from the set that are available.

3.6 Configuration

3.6.1 Personal MP3 support

3.6.2 iRadio Purchased content support

3.6.3 Content not supported

In general the iRadio system can only work with previously owned content which is not wrapped in DRM. Files that are wrapped with DRM can not be moved amongst devices.

3.6.4 At computer user interface

The primary interface at the home computer allows the user to play any of their iRadio channels, and do all the operations that are available in other domains.

Additionally, the home computer can be used to create new channels and make content assignments. Content assignments are made by dragging and dropping content on the desired channel.

3.6.5 Remote configuration

Not required for the Demo or Trial, remote configuration would allow a user's channel assignments to be done from any browser by contacting the iRadio Server directly.

3.6.6 Channels

For the Demo and Trial each user has 6 iRadio channels which they can use as-is or customize to their own tastes. A channel contains an ordered set of content which is played in sequence. There are two types of content the user can attach to an iRadio channel:

- Stations from the catalog which provide a continuous content stream. If a station is associated with an iRadio channel, then nothing else can be associated with that same channel.
- Individual pieces of content from the catalog or MP3 files from the user's personal collection. Any number of these pieces can be attached to a single iRadio channel.

3.7 In-home content consumption

In the home content is streamed from the Home Gateway to the renderer. UPnP A/V is used to setup and monitor the connection. For the Demo and Trial the personal device (E680) will be used as the in-home remote for iRadio content. The content is consumed in the home exactly how it is consumed on the go. The remote has the 6 iRadio channels and displays information about the currently playing content.

3.7.1 UPnP A/V

3.7.2 Pause/Resume

3.8 Mobile (Personal) operations

3.8.1 Content consumption

3.8.2 Storage

3.9 At computer content consumption

3.9.1 At home

3.9.2 Remote

3.10 Home Gateway

3.11 Usage tracking

4 Issues

4.1 Mobile to mobile updating problems with bulk content updating

Different DRM and encoding formats in different mobiles can prevent bulk content from being transferred between mobiles. This issue doesn't apply to light weight updating.

iRadio Concept of Operations – 1st DRAFT

Sept 9, 2004

Comments to Mark Clayton

1	Introduction.....	4
1.1	Overview.....	4
1.2	Phases.....	4
1.2.1	Demo.....	4
1.2.2	Trial.....	4
1.2.3	Product.....	4
1.3	Scope.....	4
1.4	Glossary.....	4
2	System Definition.....	5
2.1	Structure.....	5
2.2	Elements.....	5
2.2.1	Content Provider Interface.....	5
2.2.2	iRadio system.....	6
2.2.3	Home Configuration PC.....	6
2.2.4	Mobile Clients.....	6
2.2.5	Thin Car Client.....	7
2.2.6	Public WiFi Hot spot.....	7
2.2.7	Cellular data system.....	7
2.2.8	Internet.....	7
2.2.9	In-home network.....	7
2.2.10	Home remote control.....	7
2.2.11	Home renderer.....	7
2.2.12	Updating system.....	8
2.3	Actors.....	8
2.3.1	User.....	8
2.3.2	Phone Friend.....	8
3	System Functions.....	8
3.1	Content Provider Interaction.....	8
3.1.1	Temporary Content Provider Standin.....	8
3.2	Updating.....	8
3.2.1	Discovery/Authorization.....	8
3.2.2	Data updated.....	9
3.2.3	Opportunistic Updating.....	9
3.2.4	Mobile to mobile updates.....	9
3.2.5	Content Approaches.....	10
3.2.6	Cellular data opportunities.....	10
3.2.7	Hotspot opportunities.....	10
3.2.8	Mobile Communications Medium.....	10
3.3	Mobile (Personal) operations.....	11
3.3.1	User Interface.....	11
3.3.2	Storage.....	11
3.4	Thin car client (streaming from a mobile client).....	11
3.4.1	A2DP Basic.....	12
3.4.2	User Interface.....	12
3.4.3	Short-term approaches.....	12
3.5	DRM/codecs.....	12

- 3.6 Device to Device Transitions..... 12
- 3.7 Configuration..... 13
 - 3.7.1 Personal MP3 support..... 13
 - 3.7.2 iRadio Purchased content support..... 13
 - 3.7.3 Content not supported..... 13
 - 3.7.4 At computer user interface..... 13
 - 3.7.5 Remote configuration 13
 - 3.7.6 Channels..... 13
- 3.8 In-home content consumption 13
 - 3.8.1 Pause/Resume 13
- 3.9 At computer content consumption..... 14
 - 3.9.1 At Home..... 14
 - 3.9.2 Remote..... 14
- 3.10 Usage tracking 14
- 4 Issues..... 14
 - 4.1 Mobile to mobile updating problems with bulk content updating..... 14

1 Introduction

1.1 Overview

The core iRadio functionality is well described in the iRadio Market Requirements Document.

1.2 Phases

1.2.1 Demo

The CES 2005 demo will take place in a suite during the CES show (Jan 6 – 9). The current demo script demonstrates how iRadio technology works throughout a typical user's day, from waking up in the morning, driving to work, going to the gym and returning home. The software implementation for the demo will use Bluetooth for mobile client updates and UPnP will be used for streaming content in the home.

1.2.2 Trial

A trial with one or two hundred users will occur during the second quarter of 2005. The Trial will demonstrate seamless operation between the home and car domains. Ideally the Trial system will be a natural evolution of the Demo system. This evolution would include the implementation of missing features as well as testing and enhancements. In addition to securing valuable user feedback, the trial also has an important Public Relations and Marketing role which must be kept in mind.

1.2.3 Product

The product will incorporate improvements suggested by the trial as well as improvements uncovered by testing in representative user environments. In order to be on the market with a partner in 2005, the initial product (referred to as phase 1) will probably have the same features as the demo system. More advanced features will be deferred to later phases.

1.3 Scope

This document focuses on the operation of the iRadio system for the Demo and Trial. Functionality beyond the Demo and Trial may be identified and described, but it is not the focus of this document.

1.4 Glossary

Mobile Client . . . An iRadio enabled mobile device has its own storage and is occasionally connected to a for updating stored content and sending back usage data. For the Demo and Trial, the only Mobile Client will be the personal device. For later product phases Mobile Clients could include: cell phone, car device, personal music player . . .

Playlist . . . An ordered set of content which is played in sequential order. Very long

Light-weight updating

playlists (like and audio book or Internet radio station) may only be partially resident on a Mobile Client.

The relatively frequent exchange of relatively small amounts of data which does not include bulk content. It includes pause here/play there information as well as other small items.

Bulk Content

Actual audio or video content which involves large amounts of data.

2 System Definition

2.1 Structure

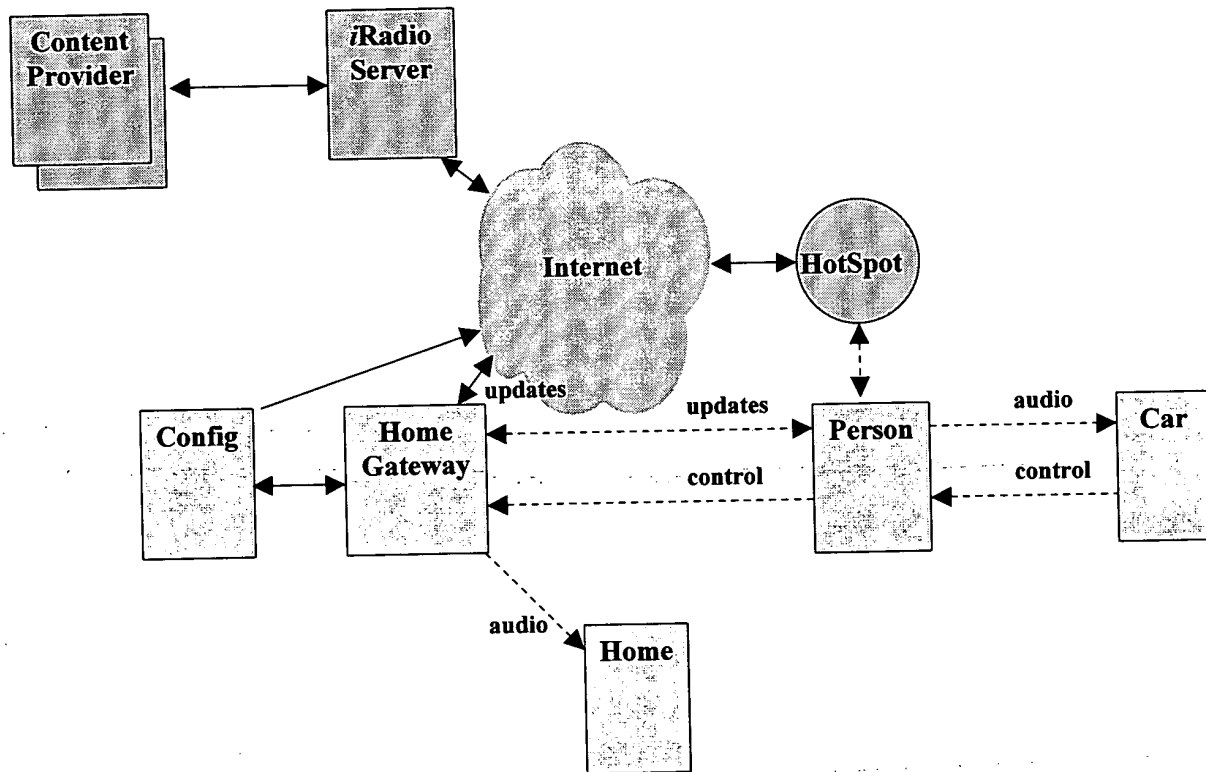

2.2 Elements

2.2.1 Content Provider Interface

The content provider is not part of the iRadio system. This interface encompasses all communication with the content provider. At its simplest, the content provider will provide playlists (genre channels, user custom channels, and the bulk content associated with those Playlists). The iRadio Server provides user consumption and rating information back the Content Provider. Additionally, the Content Provider interface handles the user's purchase of individual pieces of content.

The system allows for support of multiple content providers with individual per Content Provider user authentication data.

2.2.2 iRadio system

The iRadio Server and the Home Gateway work together to implement the core of the iRadio system. The exact division of responsibilities between the two elements will be decided later and is often unimportant when trying to understand how the system works as a whole.

2.2.2.1 iRadio Server

This is the central Content Provider aggregation point for the iRadio system. It passes the on to the rest of the system. Although the Home Gateway is typically in the communications path with mobile devices, the iRadio Server can communicate directly with mobile devices via public WiFi access points or via the cellular system if needed.

2.2.2.2 Home Gateway

The Home Gateway software runs on the user's home PC or on a dedicated in-home media server (MS1000). iRadio content is cached on the Home Gateway before it is played in the home via UPnP A/V or preemptively transferred to Mobile iRadio Clients which can connect to the Home Gateway via the home network. The Home Gateway functionality has no need for a user interface and no user interface is planned.

2.2.3 Home Configuration PC

Although the user may use the same PC for the Home Gateway as they use for configuring the iRadio, these are two different roles and are called out separately. The most extreme case for the Configuration PC being separate from the Home Gateway is when the Home gateway is a MS1000.

2.2.4 Mobile Clients

Mobile Clients are any iRadio enabled mobile devices which occasionally connect to either the home network or the Internet for updating stored content and providing usage data. For the Demo and Trial phases, cell phones are the only Mobile Client. In later phases it could be a car device can or personal music player.

2.2.4.1 Phone client

The phone is running either native or Java iRadio software which controls all iRadio functions. This software must run continuously, not just when the user is listening to content on the phone. Running in the background, the software takes care of updating the phone and the rest of the iRadio system so that content is always up-to-date. There are no specific plans to use cellular data communications for any updating, but that remains a possibility.

2.2.4.2 Car client (thick)

An iRadio in-car unit with content storage and WiFi support interacts with the iRadio system the same as any other mobile client. The in-car unit could be integrated into a radio, Telematics Control Unit or installed as an after-market unit via the CD changer interface.

2.2.5 Thin Car Client

The Thin Car Client has no memory of its own. It allows content to be streamed to it from a personal device carried by someone in the car via Bluetooth or WiFi. Additionally the in-car audio control actuations are sent to the source of the stream so that the driver can easily control the content.

2.2.6 Public WiFi Hot spot

Not part of the Demo or Trial system, a public WiFi hot-spot allows mobile devices to update content directly from the iRadio Server. In early phases this updating will not include a user's personal audio files which were not purchased through the iRadio system. WiFi access points which require the user to enter encryption information will not be supported. Configuration of acceptable WiFi access points will be possible to limit connections.

2.2.7 Cellular data system

Not part of the Demo or Trial system, a mobile client capable of cellular data connections could use these connections for partial updates at minimal cost. Full updates would be cost prohibitive.

2.2.8 Internet

The Internet is used to connect the iRadio Server to the Home Gateway and in the future, directly to mobile clients via a public WiFi access point or via cellular data connection.

2.2.9 In-home network

The two responsibilities of the home network are to support the streaming of content for in-home consumption and to facilitate updating of mobile clients. These two responsibilities could be addressed by different in-home networks as long as they are both supported by the Home Gateway.

2.2.9.1 UPnP

UPnP A/V facilitates the streaming of content within a small network. This is the chosen approach for the consumption of content in the home for the Demo and Trial.

2.2.9.2 Mobile connection

In the short term, Mobile Clients will be updated over WiFi or Bluetooth, any reasonably high speed network would also work. For the Demo and Trial, Bluetooth will be the

2.2.10 Home remote control

For the Demo and Trial it is assumed that the personal mobile device will also act as the user's remote control in the home for iRadio content consumption. This will use a Bluetooth link back to the Home Gateway which will participate in the UPnP network on the remote's behalf.

2.2.11 Home renderer

This is the end point where streamed content in the home is converted to analog for presentation to the user. For UPnP there are several commercially available audio rendering devices.

2.2.12 Updating system

The updating system is the differentiating technology of the iRadio system which allows multiple devices/domains to keep in sync regarding what the user has listened to, is listening to, and is expected to listen to in the future.

2.3 Actors

2.3.1 User

This is the person who uses the iRadio system in the various domains and for various purposes.

2.3.2 Phone Friend

For scenarios and which involve receiving a phone call, this would be the person who phones the user.

3 System Functions

3.1 Content Provider Interaction

The iRadio relies on content providers for providing all the content which the user didn't already own. Content Providers would initially provide genre playlists, celebrity playlists, and content purchase. The iRadio system would provide content consumption information through this interface also. This interface would be widened as needed to cover billing and community services as needed.

The connection between the iRadio Server and the Content Provider would be over a dedicated private connection or a VPN for privacy and security. Considering the large amounts of information which may be crossing between the iRadio server and the Content Provider, they need a high capacity connection.

3.1.1 Temporary Content Provider Standin

For Demo, there will not really be a Content Provider. The content will either be faked on the iRadio server or a simple Content Provider stub could be created. The stub would use HTTP for all communications. Most of the genre playlists, celebrity playlists, and purchase interactions could be done via XML (or even SOAP). Bulk content transfers don't benefit from XML or SOAP, so those would be transferred one at a time using plain HTTP GET requests.

3.2 Updating

Updating occurs between all the major elements of the iRadio system (iRadio Server, Home Gateway and Mobile Clients) and is the main enabler of the iRadio features.

3.2.1 Discovery/Authorization

Each element of the iRadio system has a list of users which it supports. A Mobile Client will likely have only one person in the user list. The iRadio server could have millions of users. The initial handshake between to iRadio elements is used to determine whether the two elements have any users in common. If they have users in common, then the interchange proceeds to determine what information needs to be updated.

Discovery occurs amongst Mobile clients and the Home Gateway. Communications with the iRadio server is established via a known URL rather than discovery.

The following stages occur:

- **Discovery:** Receive initial inquiry or response associated with actual discovery of an iRadio enabled device
- **Authentication:** Exchange supported user's information to see if there are users in common.
- **Add to registry:** The discovered and authenticated device is placed in a registry of devices available for updating.
- **Updating:** Immediately after addition to the registry updating occurs. Updating also occurs as needed so long as the device remains in the registry.
- **Remove from registry:** When it is determined that a device in the registry can no longer be reached, then it is removed from the registry.

For devices designed to connect to the iRadio Server, in parallel with the discovery of devices in the immediate proximity, there is also an effort to form a connection to the iRadio Server.

3.2.2 Data updated

The following relatively small types of data are sent from the mobile client during updating:

- **Content Status Changes:** Playing, Stopped, Paused, Resumed, Skipped. Where appropriate, this includes play-point information.
- **Rating:** This the user's rating of the content and contains a content identifier, and both the change in rating and the new rating value.
- **Purchase Request:** This contains a content identifier.
- **Key Press:** For diagnostic purposes and user interaction studies, each key press is captured.

Each piece of data above is time stamped (UTC timezone and local offset). The Content Status Changes and Ratings are of general interest to all elements using the updating system. The Purchase Request and Key Press information is only of interest to the iRadio Server although it may be forwarded through other elements.

Updating also involves sending the following data to the mobile client:

- **Playlists/Daily Set descriptions:** These are user specific content descriptions which do not include the actual bulk content.
- **Bulk Content:** The large pieces of data which is the audio or video data.
- **User configuration/Preferences:** TBD

3.2.3 Opportunistic Updating

Because proximity network connections are transient, updating occurs whenever there is the opportunity to do so. This accommodates situations where the user rapidly changes from one domain to another and the seamless experience must be maintained.

3.2.4 Mobile to mobile updates

The current Demo and Trial plans call for each user to have only one Mobile Client so mobile to mobile updating can never occur. During the Demo and Trial, the Mobile Client will update with the Home Gateway (or possibly the iRadio Server) directly.

In situations where a user does have multiple mobile clients, most updating will occur at home directly with the Home Gateway, but there are cases where an automotive mobile client might never connect to the home network if the user lives in an apartment building. In these cases updating between mobiles is used to bridge this gap. A personal mobile client would periodically update information with the Home Gateway and the automotive mobile client. This would allow information to remain in sync.

3.2.5 Content Approaches

For the Demo and hopefully the Trial well will have considerable control over the devices in use and their capabilities. With this control we can help ensure that audio encoding, bit rate and DRM are consistent across devices. In a production system we will not be so fortunate. We must be prepared to deliver content with different audio encoding, bit rate and DRM for each device. Additionally the metadata required by devices may be different.

Given the storage resources of the Home Gateway most effective approach is to use the Home Gateway to store different versions of each piece of bulk audio content. Each version is shaped for a particular device which the user owns. The only situation where this does not perform well is when the personal device with limited storage is used to bridge updating between the Home Gateway and a think car client (See issue 1).

3.2.6 Cellular data opportunities

Although cellular data communications are not required or planned for the Demo or Trial systems, it is an alternative for light-weight updating in the future. A cellular data connection to the iRadio Server could be used to update the relatively small amount of data which doesn't involve bulk content transfers.

3.2.7 Hotspot opportunities

In the same way that cellular data communications could provide a direct updating path to the iRadio Server, public hotspots can do the same. Network controls would be available to limit the networks which will be used.

3.2.8 Mobile Communications Medium

Any set of wireless network technologies could server as the basis for device-to-device updating so long as it supports dynamic networks and the through put exceeds the streaming audio data rate by several times.

3.2.8.1 Bluetooth

Bluetooth is attractive from a cost, power and wide mobile support point of view, but its through put is marginal. For the Demo and Trial, Bluetooth's advantages out-weights its through-put disadvantage. Bluetooth has been chosen for the Demo and Trial systems.

3.2.8.2 WiFi

WiFi and other wireless IP networks have a desirable through-put but the power consumption and limited support in mobile devices has pushed this alternative out beyond the Demo and Trial phases.

3.3 Mobile (Personal) operations

The Personal Mobile Client is a self contained music player when it is not in the house or in the car.

3.3.1 User Interface

For the Demo there will be one screen on the personal device which is used to play any preset, monitor the currently playing content and take any actions. The screen has the following major sections:

Preset buttons: the top 2/5 of the screen contains three rows of two buttons each. Pressing any preset causes the current content to be paused and the content associated with the new preset to start playing.

Content Description: The middle 2/5 of the screen contains information about the currently playing content currently playing including title, artist, album, and cover art if available.

Action buttons: the bottom 1/5 of the screen contains the progress bar and action buttons allowing the current content to be purchased.

For the Demo, the role of the personal device is inferred based on its ability to connect to the home or the car. For the product and possibly the trial, there will be a second screen which allows the role of the personal device to be explicitly controlled. For instance sitting in the back yard the personal device will probably still be connected to the Home Gateway, however assuming the role of a remote control for the home stereo system wouldn't be correct. This second screen allows the role of the personal device and the place (home, car or personal) where the content is played to be selected from an on screen list of currently available possibilities.

3.3.2 Storage

When the content is being played through the personal device, the content is always drawn from the personal device's internal storage. If the personal device is connected to the gateway or iRadio Server the content may be replenished as fast as it is consumed, but it is never directly streamed. It is assumed that there is enough storage on the personal device for a few times the normal amount of content a user would listen to. The extra capacity is used to help ensure that regardless of what iRadio channel the user listens to on a particular day, that there is sufficient content available. A minimum of eight to ten hours of storage is expected. The number of Megabytes this translates into is somewhere between 169 Megabytes and 450 Megabytes depending on the chosen encoding and desired quality. Given that 1 Gigabyte memory modules are available today for cell phones and MP3 players, the storage is available.

3.4 Thin car client (streaming from a mobile client)

There are two approaches to supporting audio content:

- **The car device as a full mobile client:** In this case the in-car device has its own content storage and updating capability.
- **The car device as a thin renderer:** In this case the in-car device has no storage of its own and just acts as an interface device between a personal mobile client and the car audio system.

The second, thin renderer, approach has been selected for the first iRadio implementations.

3.4.1 A2DP Basic

A2DP refers to the Bluetooth profile which covers the streaming of stereo audio. As a standard, it covers the situation well with only a few weaknesses:

- The default audio encoding does not give the desired 90 dB SNR. (It is closer to 72 dB.)
- The transition from the mobile client's lossy encoding to another lossy encoding is likely to further degrade the audio quality.
- The standard is not widely implemented.

In spite of these weaknesses some form of A2DP is the chosen approach for Demo and Trial. Some of these weaknesses can be overcome by a special mobile client implementation and careful alignment with the in-car adapter.

The best A2DP/adapter implementation would avoid default A2DP encoding and instead, allow the encoded content to pass directly from the mobile client to the in-car device without a second encoding. This would address the audio quality concerns.

3.4.2 User Interface

In addition to the mobile client providing audio to the car audio system through the in-car device, the in-car audio control actuations are sent to the mobile client so that the user controls all the audio from the regular car audio controls.

3.4.3 Short-term approaches

A full A2DP implementation may not be available in the Demo timeframe so an alternative serial port profile approach is being investigated. The serial port approach uses the widely implemented serial port emulation over Bluetooth to deliver the audio content.

3.5 DRM/codecs

The iRadio approach is encoder agnostic. The only requirement is that there is a way to get the audio content from the content provider into the encoding that each of our devices supports. There is an additional requirement that the encoding is compressed enough to work within the constraints of the mobile networking and mobile client storage.

For DRM, we need to have a way of applying the DRM encryption at the iRadio Server before the content is sent to the client. Ideally the content DRM encryption would be the same for all client devices and only a separate, relatively small, license file would be device specific.

3.6 Device to Device Transitions

Since the iRadio system, and the personal mobile device specifically, spans home, car and person domains, there are inevitably cases where the user moves from one domain to another while playing content. The behavior for these transitions is configurable on a case-by-case basis between automatic transitions and manual only transitions. When automatic transition is selected, the transition will occur as soon as the device (car or home) is detected. For manual operation, no transition occurs until the user explicitly chooses a new place for the audio to play from the set that are available.

3.7 Configuration

3.7.1 Personal MP3 support

3.7.2 iRadio Purchased content support

3.7.3 Content not supported

In general the iRadio system can only work with previously owned content which is not wrapped in DRM. Files that are wrapped with DRM can not be moved amongst devices.

3.7.4 At computer user interface

The primary interface at the home computer allows the user to play any of their iRadio channels, and do all the operations that are available in other domains. Additionally, the home computer can be used to create new channels and make content assignments. Content assignments are made by dragging and dropping content on the desired channel.

3.7.5 Remote configuration

Not required for the Demo or Trial, remote configuration would allow a user's channel assignments to be done from any browser by contacting the iRadio Server directly.

3.7.6 Channels

For the Demo and Trial each user has 6 iRadio channels which they can use as-is or customize to their own tastes. A channel contains an ordered set of content which is played in sequence. There are two types of content the user can attach to an iRadio channel:

- Stations from the catalog which provide a continuous content stream. If a station is associated with an iRadio channel, then nothing else can be associated with that same channel.
- Individual pieces of content from the catalog or MP3 files from the user's personal collection. Any number of these pieces can be attached to a single iRadio channel.

3.8 In-home content consumption

In the home the UPnP A/V is used to setup and monitor the streaming of content from the Home Gateway to the UPnP A/V renderer. The content will be transferred by HTTP once the connection has been established. For the Demo and Trial the personal device (E680) will be used as the in-home remote for iRadio content. From a personal device UI point of view, the content is controlled in the home exactly how it is controlled on the go. The remote has the six iRadio channels and displays information about the currently playing content.

3.8.1 Pause/Resume

The updating system allows content to resume playing from the point it was previously paused regardless of where that pause occurred. Normally UPnP A/V connections start at the beginning of a piece of content. There is no standard way to start at another point. To overcome this, the UPnP A/V controller which sets up the streaming connection will immediately seek forward to last paused point so that the resume occurs as expected.

3.9 At computer content consumption

3.9.1 At Home

Separate from the previously mentioned Home, Car and Personal playing of iRadio content, there is playing iRadio content at your home computer. This follows the same preset approach and has all the familiar iRadio controls and behaviors. This player doesn't try to replace or do the job of other content players, but instead concentrates on the iRadio experience. This may be available for Trial and must be available for Product. This will initially be available only for Microsoft Windows.

3.9.2 Remote

This feature is not required for any phase yet. It makes the user's personal iRadio experience available via a browser from any other computer on the Internet. At the home computer, the content was streamed from the content already on the home computer. In this case the content is streamed across the Internet from the iRadio server. Initial versions of this feature will not include iRadio channels which contain the user's personal content because the user's personal content is not available to the iRadio Server. In future, personal content may be streamed from the user's Home Gateway across the Internet so that all iRadio channels are available.

3.10 Usage tracking

The updating system provides an opportunity for a very thorough recording of how the iRadio is used in the field in addition to the more typical tracking of user interactions with the server. The following information can be tracked:

- User button presses
- Content status changes which result from user actions
- Update connect/disconnect information
- Update operations between devices
- Content Provider interaction
- Purchase transactions

This information is stored at the iRadio server.

4 Issues

4.1 Mobile to mobile updating problems with bulk content updating

Different DRM and encoding formats in different mobiles can prevent bulk content from being transferred between mobiles. This issue doesn't apply to light weight updating.

iRadio Concept of Operations – 2nd DRAFT

Oct 1, 2004

Revisions

Date	Author	Description
Sept 9, 2004	Mark Clayton	First draft
Sept 13, 2004	Mark Clayton	Changes as suggested by Sept 10 review meeting.
Oct 1, 2004	Mark Clayton	Changes as suggested by review meetings during the week of Sept 13. Red sections are areas needing more information.

Revisions.....	2
Revisions.....	2
1 Introduction.....	5
1.1 Overview.....	5
1.1.1 References.....	5
1.2 Phases.....	5
1.2.1 Demo.....	5
1.2.2 Trial.....	5
1.2.3 Product.....	5
1.3 Scope.....	5
1.4 Glossary.....	6
2 System Definition.....	6
2.1 Structure.....	6
2.2 Elements.....	7
2.2.1 Content Provider Interface.....	7
2.2.2 iRadio system.....	7
2.2.3 Home Personalization Application.....	8
2.2.4 Mobile Clients.....	8
2.2.5 Thin Car Client.....	8
2.2.6 Public WiFi Hot spot.....	9
2.2.7 Cellular data system.....	9
2.2.8 Internet.....	9
2.2.9 In-home network.....	9
2.2.10 Home remote control.....	9
2.2.11 Home Renderer.....	10
2.2.12 Updating system.....	10
2.3 Actors.....	10
2.3.1 User.....	10
2.3.2 Phone Friend.....	10
2.3.3 Friend, not an iRadio Customer.....	10
2.3.4 Friend, is an iRadio Customer.....	10
3 Domains.....	10
3.1 Home.....	10
3.2 Car.....	11
3.3 Person (On-the-Go).....	11
3.4 Work.....	11
4 System Functions.....	11
4.1 Content Provider Interface.....	11
4.1.1 Temporary Content Provider Standin.....	11
4.2 Updating.....	11
4.2.1 Discovery/Authorization.....	11
4.2.2 Data updated.....	12
4.2.3 Opportunistic Updating.....	12
4.2.4 Mobile to Mobile Updates.....	12
4.2.5 Content Approaches.....	13
4.2.6 Cellular data opportunities.....	13

4.2.7	Hotspot opportunities.....	13
4.2.8	Mobile Communications Medium.....	13
4.2.9	Adjustable Home Gateway Network Usage.....	14
4.3	Phone Operation.....	14
4.3.1	User Interface.....	14
4.3.2	Storage.....	14
4.3.3	Storage.....	15
	Thin car client (streaming from a mobile client).....	15
4.4	15
4.4.1	A2DP Basic.....	15
4.4.2	User Interface.....	15
4.4.3	Short-term approaches.....	15
4.5	DRM/codecs.....	15
4.6	Device to Device Transitions.....	16
4.7	Personalization.....	16
4.7.1	Personal Digital Music support.....	16
4.7.2	iRadio Purchased content support.....	16
4.7.3	Content not supported.....	16
4.7.4	At computer user interface.....	16
4.7.5	Remote Personalization.....	16
4.7.6	iRadio Channels.....	17
4.7.7	User Owned Automatic Content Selection.....	17
4.8	In-home Entertainment Unit Content Consumption.....	17
4.8.1	Pause/Resume.....	17
4.8.2	Hand-held Remote Control.....	18
4.8.3	Multiple Room Operation.....	18
4.9	At computer content consumption.....	18
4.9.1	At Home Computer.....	18
4.9.2	Remote Computer.....	18
4.10	Usage tracking.....	18
4.10.1	System Monitoring.....	18
4.11	USB.....	19
4.12	Multiple Users.....	19
4.13	Encryption.....	19
4.14	User Interface/Experience.....	19
4.14.1	Phone Interface.....	19
4.14.2	Car Interface.....	19
4.15	Subscription Termination.....	19
4.16	My Account and Billing.....	20
5	Issues.....	20
5.1	Mobile to mobile updating problems with bulk content updating.....	20
5.2	Personalization User Interface.....	Error! Bookmark not defined.
5.3	How do we browse owned content while on the go?.....	20
5.4	How do we browse owned content while home?.....	20

1 Introduction

1.1 Overview

The core iRadio functionality is well described in the iRadio Market Requirements Document.

1.1.1 References

- iRadio Marketing Requirements
- CES Demo Script

1.2 Phases

1.2.1 Demo

The CES 2005 demo will take place in a suite during the CES show (Jan 6 – 9). The current demo script demonstrates how iRadio technology works throughout a typical user's day, from waking up in the morning, driving to work, going to the gym and returning home. The software implementation for the demo will use Bluetooth for mobile client updates and UPnP will be used for streaming content in the home.

1.2.2 Trial

A trial with one or two hundred users will occur during the second quarter of 2005. The Trial will demonstrate seamless operation between the home and car domains. Ideally the Trial system will be a natural evolution of the Demo system. This evolution would include the implementation of missing features as well as testing and enhancements. In addition to securing valuable user feedback, the trial also has an important Public Relations and Marketing role which must be kept in mind.

1.2.3 Product

The product will incorporate improvements suggested by the trial as well as improvements uncovered by testing in representative user environments. In order to be on the market with a partner in 2005, the initial product (referred to as phase 1) will probably have the same features as the demo system. More advanced features will be deferred to later phases.

1.3 Scope

This document focuses on the operation of the iRadio system for the Demo and Trial. Functionality beyond the Demo and Trial may be identified and described, but it is not the focus of this document.

1.4 Glossary

Mobile Client	An iRadio enabled mobile device has its own storage and is occasionally connected to a for updating stored content and sending back usage data. For the Demo and Trial, the only Mobile Client will be the personal device. For later product phases Mobile Clients could also include: car device, PDA, personal music player ...
Playlist	An ordered set of content which is played in sequential order. Very long playlists (like and audio book or Internet radio station) may only be partially resident on a Mobile Client.
Light-weight updating	The relatively frequent exchange of relatively small amounts of data which does not include bulk content. It includes pause here/play there information as well as other small items.
Bulk Content Daily Set	Actual audio or video content which involves large amounts of data. The fresh set of custom user content which is downloaded at the beginning of the day. This content can be a mixture of owned content and content from Content Providers. The daily set is additional content which replaces content which was consumed or has become out-of-date.
Preset	One of several car radio buttons which are used in radio mode to recall previously set stations. In the iRadio mode the presets are used to access iRadio channels
Channel	This is a general term which can have many meanings depending on context. An iRadio channel refers to the portion of iRadio content which is enqueued up for sequential playing when the channel is selected or the corresponding preset is pressed.
Locked Playlist	A locked playlist allows music to be consumed like it is a webcast. There are strict consumption rules to ensure that the content is consumed as the Content Provider intended.
Station	An internet radio station. This is a continuous flow of audio content. Often a station is one of several genre specific or user personalized stations.
Webcast	Continuous content streamed across the Internet.

2 System Definition

2.1 Structure

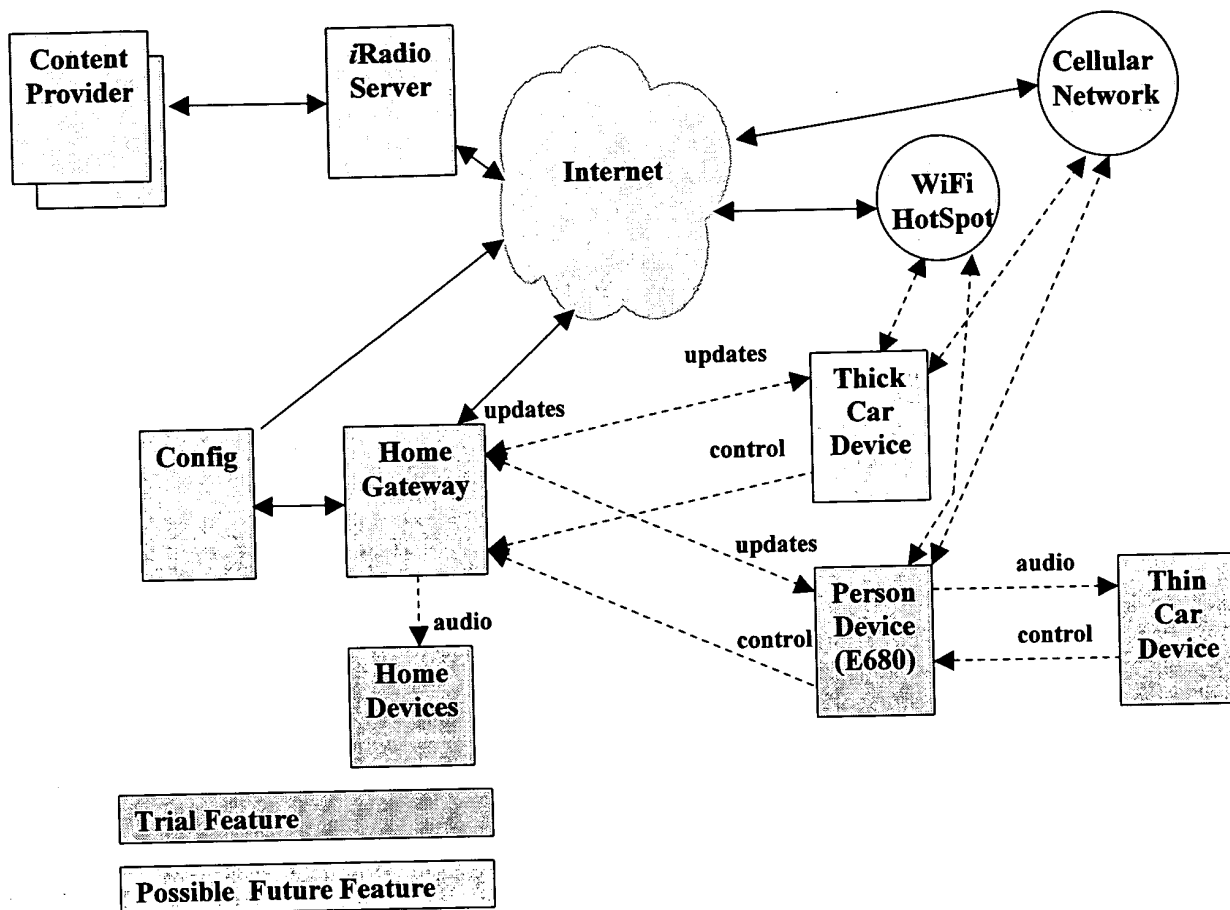

2.2 Elements

2.2.1 Content Provider Interface

The content provider is not part of the iRadio system. This interface encompasses all communication with the content provider. At its simplest, the content provider will provide playlists (genre channels, user custom channels, and the bulk content associated with those Playlists). The iRadio Server provides user consumption and rating information back the Content Provider. Additionally, the Content Provider interface handles the user's purchase of individual pieces of content.

The system allows for support of multiple content providers with individual per Content Provider user authentication data.

2.2.2 iRadio system

The iRadio Server and the Home Gateway work together to implement the core of the iRadio system. The exact division of responsibilities between the two elements will be decided later and is often unimportant when trying to understand how the system works as a whole.

2.2.2.1 iRadio Server

This is the central Content Provider aggregation point for the iRadio system. It passes the on to the rest of the system. Although the Home Gateway is typically in the communications path with mobile devices, the iRadio Server can communicate directly with mobile devices via public WiFi access points or via the cellular system if needed.

2.2.2.2 Home Gateway

The Home Gateway software runs on the user's home PC or on a dedicated in-home media server (MS1000). iRadio content is cached on the Home Gateway before it is played in the home via UPnP A/V or preemptively transferred to Mobile iRadio Clients which can connect to the Home Gateway via the home network. The Home Gateway functionality has no need for a user interface but is configured via a separate application running on the local network.

2.2.3 Home Personalization Application

Although the user may use the same PC for the Home Gateway as they use for configuring the iRadio, these are two different roles and are called out separately. The most extreme case for the Personalization Application being separate from the Home Gateway is when the Home gateway is a MS1000.

2.2.4 Mobile Clients

Mobile Clients are any iRadio enabled mobile devices which occasionally connect to either the home network or the Internet for updating stored content and providing usage data. For the Demo and Trial phases, cell phones are the only Mobile Client. In later phases it could be a car device, PDA or personal music player.

2.2.4.1 Phone Client

The iRadio phone application must run continuously, not just when the user is listening to content on the phone. Running in the background, the software takes care of updating the phone and the rest of the iRadio system so that content is always up-to-date. The application is also used for control and monitoring of iRadio content playing locally or in the home. There are no specific plans to use cellular data communications for any updating, but that remains a possibility.

2.2.4.2 Car client (thick)

An iRadio in-car unit with content storage and proximity networking (Bluetooth or WiFi) support interacts with the iRadio system the same way as any other Mobile Client. The in-car unit could be integrated into a radio, Telematics Control Unit or installed as an after-market unit via the CD changer interface.

2.2.5 Thin Car Client

The Thin Car Client has no content storage of its own and is not classed as a Mobile Client. It allows content to be streamed (via Bluetooth or WiFi) to it from a personal device carried into the vehicle. Additionally, the in-car audio control actuations are sent to the source of the audio

stream so that the user can easily control the content. The audio and control connection is made via an adapter connected to the CD changer connection on the car radio or head unit.

2.2.6 Public WiFi Hot spot

Although not part of the Demo or Trial system, a public WiFi hot-spot could allow mobile devices to update content directly from the iRadio Server. In early phases this updating would cover Content Provider content rather than a user's personal audio files which would not be available to the iRadio Server. WiFi access points which require the user to enter encryption information would not be supported. Specification of acceptable WiFi access points would allow access point connections to be limited.

2.2.7 Cellular data system

Although not part of the Demo or Trial system, a Mobile Client capable of cellular data connections could use these connections for limited updates at minimal cost. Full updates would likely be cost prohibitive. Cellular would also be ideal for loading small quantities of hot content such as weather or traffic.

2.2.8 Internet

The Internet is used to connect the iRadio Server to the Home Gateway and in the future, directly to mobile clients via a public WiFi access point or via cellular data connection.

2.2.9 In-home network

The two responsibilities of the home network are to support the streaming of content for in-home consumption and to facilitate updating of mobile clients. These two responsibilities could be addressed by different in-home networks as long as they are both supported by the Home Gateway.

2.2.9.1 UPnP

UPnP A/V facilitates the streaming of content within a small network. This is the chosen approach for the consumption of content in the home for the Demo and Trial and will use one of 802.11b, 802.11g or 802.11a. To minimize the chances of interference with the Demo, support for 802.11a might be desirable just in case there is a problem with 802.11b or 802.11g. 802.11a works on a different set of frequencies from other wireless networks.

2.2.9.2 Mobile connection

Mobile Clients will be updated over WiFi or Bluetooth, although any reasonably high speed network would also work. For the Demo and Trial, Bluetooth will be used because of its cost, power consumption and large installed base in phones.

2.2.10 Home remote control

For the Demo and Trial it is assumed that the personal mobile device will also act as the user's remote control in the home for iRadio content consumption. This will use a Bluetooth link back to the Home Gateway which will participate in the UPnP network on the remote's behalf. Although this function would be implemented along side the Mobile Client functionality, it is a separate isolated function.

Although not required for Demo or Trial, nothing in the system precludes the possibility of multiple remotes being used independently in the same home. However, if there is only one registered iRadio user in the home, the system may constrain the consumption of content so that only one renderer may be used at a time. If there are multiple registered iRadio users, then the remotes can operate independently so that different content could be streamed to different renderers.

2.2.11 Home Renderer

This is the end point where streamed content in the home is converted to analog for presentation to the user. For the chosen UPnP A/V approach, there are several commercially available audio rendering devices.

2.2.12 Updating system

The updating system is the differentiating technology of the iRadio system which allows multiple devices/domains to keep in sync regarding what the user has listened to, is listening to, and is expected to listen to in the future.

2.3 Actors

2.3.1 User

This is the person who uses the iRadio system in the various domains and for various purposes.

2.3.2 Phone Friend

For scenarios which involve receiving a phone call, this would be the person who phones the user.

2.3.3 Friend, not an iRadio Customer

This is a person who isn't an iRadio customer but may receive a transfer of music from the user via the iRadio system. This type of transfer has its own special considerations to ensure that any monies are collected and that the content is delivered in a controlled and secured manner. (This actor is part of the community scenarios and is not needed for Demo, Trial or initial Product.)

2.3.4 Friend, is an iRadio Customer

This is a person who is an iRadio customer and may receive a transfer of music from the user. (This actor is part of the community scenarios and is not needed for Demo, Trial or initial Product.)

3 Domains

3.1 Home

Describe home entertainment and at computer.

3.2 Car

3.3 Person (On-the-Go)

3.4 Work

Describe remote consumption

4 System Functions

4.1 Content Provider Interface

The iRadio relies on content providers for providing all the content which the user didn't already own. Content Providers would initially provide genre playlists, celebrity playlists, and content purchase. The iRadio system would provide content consumption information through this interface also. This interface would be widened as needed to cover billing and community services as needed.

The connection between the iRadio Server and the Content Provider would be over a dedicated private connection or a VPN for privacy and security. Considering the large amounts of information which may be crossing between the iRadio server and the Content Provider, they need a high capacity connection.

4.1.1 Temporary Content Provider Standin

For Demo, there will not really be a Content Provider. The content will either be faked on the iRadio server or a simple Content Provider stub could be created. The stub would use HTTP for all communications. Most of the genre playlists, celebrity playlists, and purchase interactions could be done via XML (or even SOAP). Bulk content transfers don't benefit from XML or SOAP, so those would be transferred one at a time using plain HTTP GET requests.

4.2 Updating

Updating occurs between all the major elements of the iRadio system (iRadio Server, Home Gateway and Mobile Clients) and is the main enabler of the iRadio features.

4.2.1 Discovery/Authorization

Each element of the iRadio system has a list of users which it supports. A Mobile Client will likely have only one person in the user list. The iRadio server could have millions of users. The initial handshake between to iRadio elements is used to determine whether the two elements have any users in common. If they have users in common, then the interchange proceeds to determine what information needs to be updated.

Discovery occurs amongst Mobile clients and the Home Gateway. Communications with the iRadio server is established via a known URL rather than discovery.

The following stages occur:

- **Discovery:** Receive initial inquiry or response associated with actual discovery of an iRadio enabled device

- **Authentication:** Exchange supported user's information to see if there are users in common.
- **Add to registry:** The discovered and authenticated device is placed in a registry of devices available for updating.
- **Updating:** Immediately after addition to the registry updating occurs. Updating also occurs as needed so long as the device remains in the registry.
- **Remove from registry:** When it is determined that a device in the registry can no longer be reached, then it is removed from the registry.

For devices designed to connect to the iRadio Server, in parallel with the discovery of devices in the immediate proximity, there is also an effort to form a connection to the iRadio Server.

Discuss how the Bluetooth associations are made -- bonding/discovery -- correct terms

4.2.2 Data updated

The following relatively small types of data are sent from the mobile client during updating:

- **Content Status Changes:** Playing, Stopped, Paused, Resumed, Skipped. Where appropriate, this includes play-point information.
- **Rating:** This the user's rating of the content and contains a content identifier, and both the change in rating and the new rating value.
- **Purchase Request:** This contains a content identifier.
- **Key Press:** For diagnostic purposes and user interaction studies, each key press is captured.

Each piece of data above is time stamped (UTC timezone and local offset). The Content Status Changes and Ratings are of general interest to all elements using the updating system. The Purchase Request and Key Press information is only of interest to the iRadio Server although it may be forwarded through other elements.

Updating also involves sending the following data to the mobile client:

- **Playlists/Daily Set descriptions:** These are user specific content descriptions which do not include the actual bulk content.
- **Bulk Content:** The large pieces of data which is the audio or video data.
- **User Personalization/Preferences:** TBD

4.2.3 Opportunistic Updating

Because proximity network connections are transient, updating occurs whenever there is the opportunity to do so. This accommodates situations where the user rapidly changes from one domain to another and the seamless experience must be maintained.

4.2.4 Mobile to Mobile Updates

The current Demo and Trial plans call for each user to have only one Mobile Client so mobile to mobile updating can never occur. During the Demo and Trial, the Mobile Client will update with the Home Gateway (or possibly the iRadio Server) directly.

In situations where a user does have multiple Mobile Clients, most updating will occur at home directly with the Home Gateway, but there are cases where an automotive Mobile Client might never connect to the home network if the user lives in an apartment building. In these cases, updating between mobiles is used to bridge the gap. A personal mobile client would

periodically update information with the Home Gateway and the automotive mobile client. This would allow information to remain in sync. If there is encoding or licensing differences between the Mobile Clients then updating will be limited to light weight updating. Ideally the licensing information would be carried in a separate small file which is platform specific. This would allow the bulk content to be common for all clients.

4.2.5 Content Approaches

For the Demo and hopefully the Trial well will have considerable control over the devices in use and their capabilities. With this control we can help ensure that audio encoding, bit rate and DRM are consistent across devices. In a production system we will not be so fortunate. We must be prepared to deliver content with different audio encoding, bit rate and DRM for each device. Additionally the metadata required by devices may be different. Given the storage resources of the Home Gateway most effective approach is to use the Home Gateway to store different versions of each piece of bulk audio content. Each version is shaped for a particular device which the user owns. The only situation where this does not perform well is when the personal device with limited storage is used to bridge updating between the Home Gateway and a think car client (See issue 1).

4.2.6 Cellular data opportunities

Although cellular data communications are not required or planned for the Demo or Trial systems, it is an alternative for light-weight updating in the future. A cellular data connection to the iRadio Server could be used to update the relatively small amount of data which doesn't involve bulk content transfers. Small amounts of hot content (weather, traffic or sports) could also be loaded so long as it was relatively small.

4.2.7 Hotspot opportunities

In the same way that cellular data communications could provide a direct updating path to the iRadio Server, public hotspots can do the same. Network controls would be available to limit the networks which will be used.

4.2.8 Mobile Communications Medium

Any set of wireless network technologies could serve as the basis for device-to-device updating so long as it supports dynamic networks and the through put exceeds the streaming audio data rate by several times.

4.2.8.1 Bluetooth

Bluetooth is attractive from a cost, power and wide mobile support point of view, but its through put is marginal. For the Demo and Trial, Bluetooth's advantages out-weigh its through-put disadvantage. Bluetooth has been chosen for the Demo and Trial systems.

4.2.8.2 WiFi

WiFi and other wireless IP networks have a desirable through-put but the power consumption and limited support in mobile devices has pushed this alternative out beyond the Demo and Trial phases.

4.2.9 Adjustable Home Gateway Network Usage

Provision will be made to ensure that the iRadio system doesn't interfere with other uses of the broadband connection into the home. This can include:

- Send data in small chunks with a delay between chunks to ensure that the link is not monopolized. The user would adjust the permitted network load on an hourly basis as part of an advanced configuration screen.
- By looking at the current network usage, the iRadio system could automatically adjust its network usage to avoid interference.

4.3 Phone Operation

The Personal Mobile Client is a self contained music player when it is not in the house or in the car.

4.3.1 User Interface

For the Demo there will be one screen on the personal device which is used to play any preset, monitor the currently playing content and take any actions. The screen has the following major sections:

Preset buttons: the top 2/5 of the screen contains three rows of two buttons each. Pressing any preset causes the current content to be paused and the content associated with the new preset to start playing.

Content Description: The middle 2/5 of the screen contains information about the currently playing content including title, artist, album, and cover art if available.

Action buttons: the bottom 1/5 of the screen contains the progress bar and action buttons allowing the current content to be purchased.

For the Demo, the role of the personal device is inferred based on its ability to connect to the home or the car. For the product and possibly the trial, there will be a second screen which allows the role of the personal device to be explicitly controlled. For instance sitting in the back yard the personal device will probably still be connected to the Home Gateway, however assuming the role of a remote control for the home stereo system wouldn't be correct. This second screen allows the role of the personal device and the place (home, car or personal) where the content is played to be selected from an on screen list of currently available possibilities.

Diagram and detailed discussion

4.3.2 Storage

When the content is being played through the personal device, the content is always drawn from the personal device's internal storage. If the personal device is connected to the gateway or iRadio Server the content may be replenished as fast as it is consumed, but it is never directly streamed. It is assumed that there is enough storage on the personal device for a few times the normal amount of content a user would listen to. The extra capacity is used to help ensure that regardless of what iRadio channel the user listens to on a particular day, that there is sufficient content available. A minimum of eight to ten hours of storage is expected. The number of Megabytes this translates into is somewhere between 169 Megabytes and 450 Megabytes depending on the chosen encoding

and desired quality. Given that 1 Gigabyte memory modules are available today for cell phones and MP3 players, the storage is available.

Insert table with memory sizes and encoding rates to give hours of listening

4.3.3 Storage

Encodings supported matrix

4.4 Thin car client (streaming from a mobile client)

4.4.1 A2DP Basic

A2DP refers to the Bluetooth profile which covers the streaming of stereo audio. As a standard, it covers the situation well with only a few weaknesses:

- The default audio encoding does not give the desired 90 dB SNR. (It is closer to 72 dB.)
- The transition from the mobile client's lossy encoding to another lossy encoding is likely to further degrade the audio quality.
- The standard is not widely implemented.

In spite of these weaknesses some form of A2DP is the chosen approach for Demo and Trial. Some of these weaknesses can be overcome by a special mobile client implementation and careful alignment with the in-car adapter.

The best A2DP/adapter implementation would avoid default A2DP encoding and instead, allow the encoded content to pass directly from the mobile client to the in-car device without a second encoding. This would address the audio quality concerns.

4.4.2 User Interface

In addition to the mobile client providing audio to the car audio system through the adapter, the in-car audio control actuations are sent to the Mobile Client. This allows the user to control all the audio from the regular car audio controls. The preferred transport for this information is the Bluetooth serial profile (SPP).

4.4.3 Short-term approaches

A full A2DP implementation may not be available in the Demo timeframe so an alternative serial port profile approach is being investigated. The serial port approach uses the widely implemented serial port emulation over Bluetooth to deliver the audio content. By avoiding the less common Bluetooth profiles, there are fewer risks and a larger set of platforms which can be supported.

4.5 DRM/codecs

The iRadio approach is encoder agnostic. The only requirement is that there is a way to get the audio content from the content provider into the encoding that each of our devices supports. There is an additional requirement that the encoding is compressed enough work within the constraints of the mobile networking and mobile client storage.

For DRM, we need to have must have a way of applying the DRM encryption at the iRadio Server before the content is sent to the client. Ideally the content DRM encryption would be the same for all client devices and only a separate, relatively small, license file would be device specific.

4.6 Device to Device Transitions

Since the iRadio system, and the personal mobile device specifically, spans home, car and person domains, there are inevitably cases where the user moves from one domain to another while playing content. The behavior for these transitions is customizable on a case-by-case basis between automatic transitions and manual only transitions. When automatic transition is selected, the transition will occur as soon as the device (car or home) is detected. For manual operation, no transition occurs until the user explicitly chooses a new place for the audio to play from the set that are available.

4.7 Personalization

Discussion of DRM and encoding issues

4.7.1 Personal Digital Music support

Personal digital music which is accessible on the Home Gateway is automatically discovered and may be made available as part of the iRadio system. Support of digital music which has a DRM wrapper or different audio encodings will only be made available if the iRadio system supports it.

4.7.2 iRadio Purchased content support

Digital content purchased via the iRadio system is available for updating using the iRadio system. Once content has been purchased, it becomes part of the user's collection and is available for updating just as is the rest of the user's collection.

4.7.3 Content not supported

In general the iRadio system can only work with previously owned content which is not wrapped in DRM. Files that are wrapped with DRM can not be moved amongst devices.

4.7.4 At computer user interface

The primary interface at the home computer allows the user to play any of their iRadio channels, and do all the operations that are available in other domains. Additionally, the home computer can be used to create new channels and make content assignments. Content assignments are made by dragging and dropping content on the desired channel.

For a variety of technical reasons it is desirable that the personalization application is browser or Java based. This gives us the best portability options in the future.

4.7.5 Remote Personalization

Not required for the Demo or Trial, remote personalization would allow a user's channel assignments to be done from any desktop browser (IE, Mozilla) by contacting the iRadio Server directly.

4.7.6 iRadio Channels

For the Demo and Trial each user has six iRadio channels which they can use as-is or customize to their own tastes. A channel contains an ordered set of content which is played in sequence. There are two types of content the user can attach to an iRadio channel:

- Stations (large or continuous blocks of DMCA compliant music content) from the Content Provider catalog which provide a continuous music content stream. If a station is associated with an iRadio channel, then nothing else can be associated with that same channel.
- Individual pieces of content from the catalog or digital music files from the user's personal collection. Any number of these pieces can be attached to a single iRadio channel, although the number may be artificially limited for a clearer user interface.

The user's personal music collection and content provider content are not mixed in the same iRadio channel.

Add a nice picture here showing content being poured into the 6 iRadio channels

4.7.7 User Owned Automatic Content Selection

Describe function

Describe approach alternatives

4.8 In-home Entertainment Unit Content Consumption

In the home the UPnP A/V is used to setup and monitor the streaming of content from the Home Gateway to the UPnP A/V renderer. The content will be transferred by HTTP once the connection has been established. For the Demo and Trial the personal device (E680) will be used as the in-home remote for iRadio content. From a personal device UI point of view, the content is controlled in the home exactly how it is controlled on the go. The remote has the six iRadio channels and displays information about the currently playing content.

Describe (with pictures) typical UPnP A/V system and entities

Show how iRadio entities correspond to these UPnP A/V entities

4.8.1 Pause/Resume

The updating system allows content to resume playing from the point it was previously paused regardless of where that pause occurred. Normally UPnP A/V connections start at the beginning of a piece of content. There is no standard way to start at another point. To overcome this, the UPnP A/V controller which sets up the streaming connection will immediately seek forward to last paused point so that the resume occurs as expected.

UPnP A/V 2.0 introduces the notion of bookmarks which would allow our pause/resume behavior to be implemented easily. The leading UPnP A/V stack providers, Mediabolic and SimpleDevices would probably track the 2.0 specification and include the bookmarking capability. It then becomes an issue of whether we want iRadio to work with older UPnP A/V devices or just selected newer ones which have 2.0 features.

4.8.2 Hand-held Remote Control

Describe how E680 works

4.8.3 Multiple Room Operation

Describe how the UI could support multiple renderers in the home. Speculate that if there is a way to determine the room the user is in, then the audio session could automatically migrate.

4.9 At computer content consumption

4.9.1 At Home Computer

Separate from the previously mentioned Home, Car and Personal playing of iRadio content, there is playing iRadio content at your home computer. This follows the same preset approach and has all the familiar iRadio controls and behaviors. This player doesn't try to replace or do the job of other content players, but instead concentrates on the iRadio experience. This may be available for Trial and must be available for Product. This will initially be available only for Microsoft Windows. Discuss implementation alternatives

4.9.2 Remote Computer

This feature is not required for any phase yet. It makes the user's personal iRadio experience available via a browser from any other computer on the Internet. At the home computer, the content was streamed from the content already on the home computer. In this case the content is streamed across the Internet from the iRadio server. Initial versions of this feature will not include iRadio channels which contain the user's personal content because the user's personal content is not available to the iRadio Server. In future, personal content may be streamed from the user's Home Gateway across the Internet so that all iRadio channels are available.

4.10 Usage tracking

The updating system provides an opportunity for a very thorough recording of how the iRadio is used in the field in addition to the more typical tracking of user interactions with the server. The following information can be tracked:

- User button presses
- Content status changes which result from user actions
- Update connect/disconnect information
- Update operations between devices (including the Home Gateway)
- Content Provider interaction
- Purchase transactions

This information is stored at the iRadio server and communicated back to the Content Provider as needed. The data is also the basis for auditing and compliance checking, including looking for simultaneous use of the system by a single user. Since the initial system is intended for use by a single person, simultaneous use should not occur.

4.10.1 System Monitoring

A separate monitoring system records and reports the overall system conditions. Flush this out with system monitoring strategy, SNMP, triggers, alarms ...

4.11 USB

USB is widely available on PCs and portable devices (including all the Mobile Clients considered for the Demo and Trial). Given Bluetooth's bandwidth limitations, USB is an attractive alternative for updating, especially bulk content loading. When connected via USB, the Mobile Client flash memory appears as a mounted disk drive. There are various ways to leverage USB:

- Update bulk content only (adding and deleting bulk content files)
- Update daily set (bulk content and playlist metadata)
- Update daily set and retrieve user activity data

Where the final item allows all update operations to be performed over USB, the first two would still rely on Bluetooth for the update of non-bulk content.

4.12 Multiple Users

Although there are no immediate plans to support multiple users on the same device, this is something which has been discussed. There are two ways to offer multiple users on a single device:

1. Multiple users under a single subscription would allow multiple sets of iRadio Channels which would avoid problems associated with sharing the just the six channels between multiple people. This approach is relatively straight forward.
2. Multiple subscriptions, with one user each could share a single device. This approach is a little more complex.

4.13 Encryption

Encryption will be needed at all levels of the system:

- During updating
- Content on any removable media
- Playlists, metadata and usage data whether on removable or non-removable storage

The system needs to be tamper proof, and ideally able to change encryption periodically under server control to help prevent tampering from becoming widespread.

4.14 User Interface/Experience

4.14.1 Phone Interface

This section to be filled out later.

4.14.2 Car Interface

This section to be filled out later.

4.15 Subscription Termination

The general consensus is that with an expired subscription, some part of the iRadio experience continues to work. The degree of continued functionality is calculated to keep the user engaged while continuously reminding them of what they are missing. Annoying commercials and a single iRadio channel of one hour have both been suggested as possibilities.

4.16 My Account and Billing

The preliminary approach for billing is to automatically bill the customer for service and purchases. A web site is provided for the user to look up any charges, impose purchase limits and control other aspects of their subscription.

5 Issues

5.1 How do we browse owned content while on the go?

In the local case, does the user have the ability to browse the owned content which iRadio preemptively cached on the device? If this is required, we need to decide how sophisticated it needs to be.

- The Preliminary answer is: we don't. Owned content is dumped in a channel and can be listened to in sequence on that channel.

5.2 How do we browse owned content while home?

In the at home case, does the user have the ability to browse their owned content from the remote control? If this is required, we need to decide how sophisticated it needs to be.

- Still open.

iRadio -- Initial Considerations

From a technical point of view, there are two basic content types:

- Channels which come from an outside provider, and
- Personal user content

Within the two basic types there are five types which the user sees:

1. Standard genre channel -- not time sensitive (type 1)
2. Custom genre/artist channel -- not time sensitive (type 1)
3. Subscription content -- time shifted (type 2)
4. Previously purchased content (type 2)
5. User owned content (type 2)

Simple System Assumptions

For the purposes of this note it is assumed that the content is presented to the user as a hierarchy. Channels are one part of the hierarchy and discrete content is another. Actions occur on the piece of content currently selected or playing. On a full screen user interface there would be some more complex operations including, searches for owned content and immediate purchase.

Channels: standard genre & custom genre/artist

These are prepackaged channels similar to that available from XM Radio or Yahoo Launch. It is provided in one form or another from the content provider and the iRadio Service Provider just makes that content available to a user's device via an in-home gateway or directly via a hotspot

Assumptions

The channel content requested by the iRadio Service Provider on behalf of the user. To reduce the amount of data sent from the Content Provider to the iRadio Service Provider it would be best if the content for a user was specified as a set of content IDs. The iRadio Service Provider would request the ID3-type metadata from the Content Provider if it didn't already have it. The content and metadata would be sent to the device (via hotspot) or in-home gateway as needed. The need could arise because the content has been consumed or expired and needs to be replenished. So long as the car is able to synchronize with the iRadio Server, the user will listen to the same content on their channels whether they are at home or in their car.

User Actions

These are actions typical of channel content:

- play
- pause/resume
- info request satisfied locally from included metadata
- info request satisfied remotely (via cellular packet data if needed)
- info request completed later via email/browser
- info sent to email at next hot-spot

- buy and download to home gateway or car at next hot-spot
- enter feedback on current track
- skip (if allowed)
- switch to another channel
- mark to buy with transaction completed later via browser (simple UI)
- buy and download to home gateway or car at next hot-spot (complex UI)
- recommend to another (complex UI)

Subscription content (time shifted)

This content might be Howard Stern, Car Talk or other radio show the user subscribes to via the iRadio Service Provider. This content can either be handled as a dedicated channel for the selected show or as purchased content. It has characteristics of both.

Like a channel, it is supplied by the Content Provider and is only played once [my assumption]. Grouping successive occurrences of the show on a single channel might be a useful organizing tool. The other channel like way to deal with this would be to gather all the subscribed content for a single day into a channel. The user could access any of the last few days channels.

Subscription content is similar to purchased tracks in that they are a single block of content which should be able to be prioritized or organized for presentation to the user like any other discrete (non-channel) block of content.

Assumptions

Subscription content is likely to have more restricted rights (number of plays and expiration) than normal purchased content. Other than these restrictions, the content can be handled the same as purchased content from an architectural point of view, even if the user interface is is unique.

User Actions

These actions could be appropriate for time-shifted content:

- play
- pause/resume
- info request satisfied locally from included metadata
- info request satisfied remotely (via cellular packet data if needed)
- info request completed later via email/browser
- enter feedback on current content
- skip (if allowed)
- pause current item and circulate it to end of current playlist
- switch to another channel
- recommend to other user

Owned content -- iRadio purchased & ripped

This is content is either pre-existing content in a format which iRadio understands (MP3) or content which was purchased via the iRadio service. Pre-existing content will have to have metadata constructed to be used in the iRadio system, but once that step is taken, it can be handled much the same as content purchased via the iRadio system.

We may want to separately consider whether we support the loading of pre-existing content from remote hotspots. If we support the remote loading, of pre-existing content then we'll be relying on the home system's ability to supply the content to a hotspot. This adds complexity and more opportunity of failure.

Assumptions

Purchased content will be available directly from the iRadio Service Provider when a device at a hotspot away from home or from the home gateway when at home. We still record play information including to help determine what content the user likes.

User Actions

These actions could be appropriate for owned content:

- play
- pause/resume
- info request satisfied locally from included metadata
- info request satisfied remotely (via cellular packet data if needed)
- info request completed later via email/browser
- enter feedback on current content
- skip
- pause current item and circulate it to end of current playlist
- switch to another channel
- recommend to other user

iRadio -- Content Provider Interfacing

There is considerable flexibility here, but this outlines a starting position ... All communication with the Content Providers is via the iRadio Service Provider. There are two general types of content to consider:

- Channels such as those provided by XM Radio or Yahoo Launch
- Content purchase

For all content interactions with the content provider, in a product grade system, the following is assumed:

All Content Provider communications are through dedicated IP connections to the content provider's data center

Dedicated connections provide security and reliable bandwidth.

The iRadio Server preemptively loads channel content from the content provider on the user's behalf. This content is made available to the user only according to rules which are agreed to by the content provider.

The iRadio has to be the single point of contact with the content provider to give a seamless experience to the user. By getting content ahead of time, we eliminate content provider latencies and have a simpler system.

The iRadio Server preemptively moves channel content to the home gateway to avoid Internet latencies when there eventually is a need to consume the content or transfer it to another device. The channel content is DRM protected or encrypted while it is on the Home Gateway.

This allows Internet latencies to be avoided when the channel content is eventually consumed or transferred to another user device.

The iRadio System, which includes everything from the iRadio Server to the user's listening device, ensures that the user only consumes content according to rules compatible with the Content Provider.

It is critical that the user never have direct access to downloaded Channel Content since that would violate the content license. Purchased content may be made available to the user under DRM control.

The iRadio System will provide content consumption and voluntary user feedback to the Content Provider.

The iRadio Server will monitor what content the user consumes and in also in the case of channel information what content expires before consumption. This data will be updated whenever the user's device is network connected. This data can be made available to the content provider as needed.

User requests for supplemental content information (lyrics, concerts ...) would also go through the iRadio Server.

This preserves the single point of contact and single face to the customer. This could be reviewed depending on business plans.

Purchases would also go through the iRadio Server.

This preserves the single point of contact and single face to the customer. This could be reviewed

depending on business plans.

Channel Data Flow

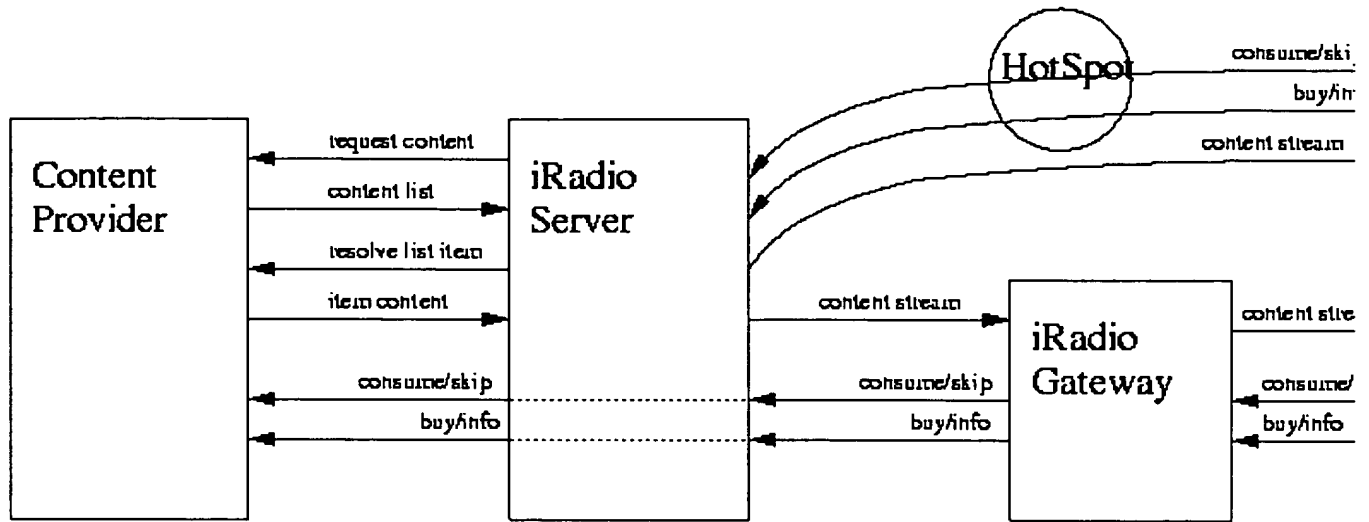

From - Thu Feb 10 10:42:49 2005
 Return-Path: <jmv@motorola.com>
 Received: from az43exm04.phx.mcd.mot.com ([144.191.86.40])
 by pooh.tcg.mcg.mot.com (8.11.6/8.9.3) with ESMTTP id i72Lclp19820
 for <CLAYTON@POOH.TCG.MCG.MOT.COM>; Mon, 2 Aug 2004 14:38:47 -0700
 Received: by az43exm04.phx.mcd.mot.com with Internet Mail Service (5.5.2657.72)
 id <M00LJZN8>; Mon, 2 Aug 2004 14:15:04 -0700
 Message-ID: <3F05200B37A1D511BE550002B3289243159F1103@az43exm04.phx.mcd.mot.com>
 From: Villevieille J-P26721 <jmv@motorola.com>
 To: Zenios Anthony-FTZ223 <anthony.zenios@motorola.com>,
 Ulmer Dave-E42721
 <david.ulmer@motorola.com>,
 Gaumond Mike-MGAUMOND
 <Mike.Gaumond@motorola.com>,
 Villevieille J-P26721 <jmv@motorola.com>
 Cc: Clayton Mark-AMC036 <AMC036@az43.mcd.mot.com>
 Subject: RE: New concept
 Date: Mon, 2 Aug 2004 14:14:59 -0700
 MIME-Version: 1.0
 X-Mailer: Internet Mail Service (5.5.2657.72)
 Content-Type: text/plain

Right on target Tony,

This is basically what the wireless car adaptor is about: a smart Airport Express th
 Nevertheless, the idea stays that it would be neat to integrate the remote control i
 Whether we can do it in time kind of depends on some of our alliances with these guy

Regards...JMV

Jean-Marc Villevieille
 Director Engineering Advanced Solutions
 Motorola
 Tempe, AZ
 (W) 602-659-8177
 (M) 480-236-3446
 jmv@motorola.com

-----Original Message-----

From: Anthony Zenios [mailto:anthony.zenios@motorola.com]
 Sent: Monday, August 02, 2004 1:44 PM
 To: Ulmer Dave; Gaumond Mike; Villevieille Jean-Marc
 Subject: New concept

Hello Everyone,

Here is another idea for our use case. It involves technology that
 Apple introduced. A couple weeks ago Apple introduced a new product
 called Airport Express. Its a small wireless router (802.11b and g). It
 plugs right in to the wall (looks like Apple's laptop chargers) but its
 a wireless base station that works seamlessly with the Airport Extreme
 and others. The new interesting feature they added is called AirTunes.
 It gives the ability to move music from your computer on itunes to an
 Airport Express base station. The base station has an audio output that
 can be used to connect to your stereo. Then the music can be played
 anywhere that you have the Airport Express. I put 3 of them in my
 apartment and works very well. I was thinking that we might be able to

make our product compatible with this. Right now, one computer can stream to one Airport Express. If we could tie our cell phones so that the wireless network in your home knows what room you are in and can move the stream from room to room. Whatever room you walk in to the music will start playing from where it left off; Or walking from your car to your home and the song picking up from where you left off in the room you are in. Also, the phone can act as a remote to change songs. Right now, you have to run back to the computer to change the song. The phone can switch songs or access playlists. So in this idea, the phone is aware of where you are in your home and is able to have your music follow you.

From - Thu Feb 10 11:25:11 2005
 Return-Path: <jmv@motorola.com>
 Received: from az43exm04.phx.mcd.mot.com ([144.191.86.40])
 by pooh.tcg.mcg.mot.com (8.11.6/8.9.3) with ESMTP id i7UKZdp14836
 for <CLAYTON@POOH.TCG.MCG.MOT.COM>; Mon, 30 Aug 2004 13:35:39 -0700
 Received: by az43exm04.phx.mcd.mot.com with Internet Mail Service (5.5.2657.72)
 id <M00M11H5>; Mon, 30 Aug 2004 13:05:29 -0700
 Message-ID: <3F05200B37A1D511BE550002B3289243159F1259@az43exm04.phx.mcd.mot.com>
 From: Villevieille J-P26721 <jmv@motorola.com>
 To: "'Jimmy Buchheim'" <jimmy@ssiameica.com>,
 Villevieille J-P26721
 <jmv@motorola.com>
 Cc: Rutledge Shawn-E50053 <shawn.rutledge@motorola.com>,
 Costello Edward-G20048 <G20048@motorola.com>,
 CLAYTON MARK-AMC036
 <Mark.Clayton@motorola.com>
 Subject: RE: Wireless Car Adapter
 Date: Mon, 30 Aug 2004 13:05:05 -0700
 Importance: high
 X-Priority: 1
 MIME-Version: 1.0
 X-Mailer: Internet Mail Service (5.5.2657.72)
 Content-Type: multipart/mixed;
 boundary="-----_=_NextPart_000_01C48ECC.A41A12C2"

This message is in MIME format. Since your mail reader does not understand this format, some or all of this message may not be legible.

-----_=_NextPart_000_01C48ECC.A41A12C2
 Content-Type: text/plain

Hi Jimmy,

Here are our quick thoughts on what could be done very quickly between us in order t

Regards...JMV

Jean-Marc Villevieille
 Director Engineering Advanced Solutions
 Motorola
 Tempe, AZ
 (W) 602-659-8177
 (M) 480-236-3446
 jmv@motorola.com

-----Original Message-----
 From: Jimmy Buchheim [mailto:jimmy@ssiameica.com]
 Sent: Monday, August 30, 2004 7:24 AM
 To: 'Villevieille J-P26721'
 Subject: RE: Wireless Car Adapter

Hi Jean,

I am back in NY after 2 weeks at XM's innovation center in FLA. Please send me the s

Best regards,

Jimmy Buchheim
www.ssiamerica.com
43C Rocklyn Ave
Lynbrook NY 11563 USA
Phone: +1 516 887 8885
Fax: + 1 516 887 8881

-----Original Message-----

From: Villevieille J-P26721 [mailto:jmv@motorola.com]
Sent: Wednesday, August 25, 2004 4:04 PM
To: 'Jimmy Buchheim'
Subject: RE: Wireless Car Adapter

Hi Jimmy,

Got stuck since I came back to Phoenix. NDA is ok so I want to start talking later

Regards...JMV

Jean-Marc Villevieille
Director Engineering Advanced Solutions
Motorola
Tempe, AZ
(W) 602-659-8177
(M) 480-236-3446
jmv@motorola.com

-----Original Message-----

From: Jimmy Buchheim [mailto:jimmy@ssiamerica.com]
Sent: Wednesday, August 18, 2004 7:41 PM
To: 'Stinson Jeff-QJS012'
Cc: 'Villevieille J-P26721'
Subject: RE: Wireless Car Adapter

Hi Jeff,

I will sign it, My name is James Buchheim, President. Company name is: Multi Techno

Best regards,

Jimmy Buchheim
www.ssiamerica.com
43C Rocklyn Ave
Lynbrook NY 11563 USA
Phone: +1 516 887 8885
Fax: + 1 516 887 8881

-----Original Message-----

From: Stinson Jeff-QJS012 [mailto:Jeff.Stinson@motorola.com]
Sent: Wednesday, August 18, 2004 8:34 PM
To: jimmy@ssiamerica.com

AABgAABAgAAAU
AAAICAAACQgAAEMIAABECAAAARQgAAfKIAABdCAAAXggAAGQIAABtCAAAbwgAAHAIAABxCAAeQgA
AH0IAACBCAAAjwgAAJQIAACYCANAwwgAAKMIACmCAAAtggAAALcIAADDCAAAzggAAM8IAADYCAA
2QgAAOgIAAD28Pbw49Pj08PTttPjw6ugmpSHenBmh3Bmh1xmXGZc9gAAAAAAAAAAAAAAAAAAAA
AAAAEHZouG65AENKHABPSgIAUUoCAASFmi6AQIAQOocAE9KAgBRsgIAABIWAgZhmGDBDShwAT0oC
AFFKAgAAGBVoZmGABZobRcIAENKHABPSgIAUUoCAAAYFWhmYZoAFmi4brkaQOocAE9KAgBRsgIA
AAoWAGZhmGDBDShgAAAoWAGOXCBDSHgAABUWAGOXCAAICIFDShgAT0oCAFFKAgAVFmhtFwgANQiB
Q0okAE9KAgBRsgIAGRZoJUAWADUIgUNKJABPSgMAUuoDAGFKJAAfFWjRTVwAFmhtFwgANQiBQ0ok
AE9KAwBRsgMAYUokAB8VaNFNXXAAWaLhuuQA1CIFDsiQAT0oDAFFKAwBhSiQAGRZougECADUIgUNK
JABPSgMAUuoDAGFKJAAKfMhtFwgAQIgAAAAFmhtFwgAQ0oYAE9KAgBRsgIAIAAGAAABCAAAAAGgA
AAMIAAAECAAABQgAAAYIAAAHCAAACAgAAAKIAABFCAAAWggAAFWIAABdCAAACAgAAHEIAABYCAA
cwGAAHQIAAB1CAAAdggAAHcIAAB4CAAeQgAAJAIAACfCAA/QAAAAAAAAAAAAAAAAAP0AAAAAAAA
AAAAAAAA9AAAAAAAAAAAAAAAAA/QAAAAAAAAAAAAAAAAAPMAAAAAAAAAAAAAAAAAAD9AAAAAAAAAAAAAAAA
/QAAAAAAAAAAAAAAAAAP0AAAAAAAAAAAAAAAAADzAAAAAAAAAAAAAAAA6gAAAAAAAAAAAAAAAAAOAAAA
AAAAAAAAAADgAAAAAAAAAAAAAAAA4AAAAAAAAAAAAAAAAOAAAAAAAAAAAAAAAAADgAAAAAAAAAAAA
AAA4AAAAAAAAAAAAAAAAOAAAAAAAAAAAAAAAAADgAAAAAAAAAAAAAAAA4AAAAAAAAAAAAAAAAAOAA
AAAAAAAAAAAAADgAAAAAAAAAAAAAAAA4AAAAAAAAAAAAAAAAOAAAAAAAAAAAAAAAAADbAAAAAAAAAA
AAAAAAAA2wAAAAAAAAAAAAAAAAAAAAAAAAAAAAAAAAAAAAEAAbnZDZIRQAACQ8AD4RwCBGE0AJehAIYITQ
AgAIdwAPhBAOXoQQDmkuG65AAoXAA3GBAFQGQASZPAAQAUppAAAAEAAAAZAAyAAPEPAABiEAAA
kBAAP39/QAA
AA
AA
AA
AA
AA
AA
AA
AA
AA
AA
AAEBAABAQOfCAAAtwgAAM8IAADZ
CAA2ggAANsIAADcCAA3QgAAN4IAADfCAA4AgAAOEIAADiCAA4wgAAOQIAAD1CAA5ggAAOcI
AADoCAAJgkAAGYJAACmCQA5wkAACcKAAD6AAAAAAAAAAAAAAAA7QAAAAAAAAAAAAAAAAO0AAAA
AAAAAAAAADJAAAAAAAAAAAAAAAA4wAAAAAAAAAAAAAAAAOMAAAAAAAAAAAAADJAAAAAAAAAAAA
AAA4wAAAAAAAAAAAAAAAAOMAAAAAAAAAAAAADJAAAAAAAAAAAA4wAAAAAAAAAAAAAAAAOMA
AAAAAAAAAAAAADJAAAAAAAAAAAAAAAA4wAAAAAAAAAAAAAAAAOMAAAAAAAAAAAAADJAAAAAAA
AAAAAAAA4wAAAAAAAAAAAAAN4AAAAAAAAAAAAADcAAAAAAAAAAAAAA1QAAAAAAAAAAAAAA
ANUAAAAAAAAAAAAAAAADOAAAAAAAAAAAAzAAAAAAAAAAAAAAAAAAAAAAAAAAAA
Bx4ADcYIAAKwBLYhAAoHHQANxggAAiAdtiEACgABHAAABA8AAyQBYSQBAAkPAA+EcAgRhNACXoRw
CGCE0AIDA8AD4SwEXGEOAJehLATYITQAmDkuG65AAEAAbnZDZIRQAAF+gIAADpCAA9wgAAPgI
AAD5CAA+ggAAcJAAIcQAAlQKaACIJAAJcQAAJAKAAUCJAAAmCQAQkKAAcJAABHCQAASAka
AGEJAABiCQAAYwkaAGQJAAB1CQAAZgkAAGkJAABqCQAahwkaAIgJAACHCQAAGkAAKMJAACkCQA
pQKAAYJAACrCQAARAKAAMgJAADJCQA4gkAAPv9ebO5sDmr8DmwM7mmubA5onA5sCa5prmwOZ4
wObAmuZh5sDmLBzoOX22ADYIgUNKGABPSgAAUeOEAFFKAABhShgAbUgABG5IAAR0SBEEQgBACAC
CIEDavYAAAAGCAEWaNF9tgBVCAFtSAAEbkgABHUIAQAgAgIbA2p7AAAABggBFmJRfbYAVQgBbUgA
BG5IAAR1CAEAKBzoOX22ADoIgU9KAABQSGQAUUoAAGFKGABtSAAEbkgABHRIEQR1CAEIAI IgQNq
AAAAAYIARzoOX22AFUIAW1IAARuSAAEdQgBAbOdagAAAAWaNF9tgBVCAFtSAAEbkgABHUIAQAv
FmjRfbYANQiBOWiBQ0oYAE9KAABQSGQAUUoAAGFKGABtSAAEbkgABHRIEQR1CAERFmjRfbYAbUgA
BG5IAAR1CAEKfMhtFwgAQ0oYAAATA2oAAAAFmhtFwgAQ0oYAFUIAQAm4gkAAOMJAADkCQA5Qka
AOYJAADnCAA7AKAA0JAAAIcGAACQoAACIKAAAJcGAAJAoAACUKAAAmCgAAJwoAACGKAAPcGAA
NQoAADYKAABQCgAAUwoAAIKAACLcGAAJwoAAJoKAACbCgAAAtQoAALYKAAC3CgAAxAoAACELAAA0
CwAAywsAACYMAABDDAAAgwAAO/h2OHB2MHY4diw4djhwaKY1JCUJiMiIyEih2UdnBncJRjXAwV
aPdcnAAWaPdcnAAABhZo91ycAAAQFmj9LKYANQiBQ0oYAFwIgQAKFmj9LKYAQ0oYAAANFmj9LKYA
NQiBQ0oYAAwVaGUJIWAWaGUJIWAAAbhZo3D9AAAAGFmh1CYsAAAYWaOVd9QAABhZoUh1IAAAGFmj9
LKYAABIWAGOXCBDSHgAT0oCAFFKAgAAGwNqAAAABZobRcIAENKGABPSgIAUUoCAFUIASACCIED
auwBAAAGCAEWaNF9tgBVCAFtSAAEbkgABHUIAQASFmjRfbYANgiBQ0oYAE9KAABQSGQAUUoAAGFK
GABtSAAEbkgABHRIEQR1CAEAEZzoOX22AGU1IAARuSAAEdQgBgNqAAAAABZoOX22AFUIAW1IAARu
SAAEdQgBACCIEDanEBAAAGCAEWaNF9tgBVCAFtSAAEbkgABHUIASQnCAAKQoAADYKAABUCgAA
mwoAAJwKAAC2CgAAAtwoAALOKAADDcGAA/QAAAAAAAAAAAAAAAAAPgAAAAAAAAAAAAAAAAADzAAAA
AAAAAA6gAAAAAAAAAAAAAAAAOAAAAAAAAAAAAAAAAAD1AAAAAAAAAAAAAAAA4AAAAAAAAAAAA
ANMAAAAAAAAAAAAAADTAA
AA
AA

LnByaW50L1BhZ2VGb3JtYXQuUE1Ib3Jpem9udGFsUmVzPC9rZXk+CgkJCQk8cmVhbD43MjwvcMvH
bd4KCQkJCTxrZXk+Y29tLmFwcGx1LnByaW50LnRpY2tldC5jbG11bnQ8L2tleT4KCQkJCTxzdhJp
bmc+Y29tLmFwcGx1LnByaW50aW5nbWfuYwDlcljwvc3RyaW5nPgoJCQkJPgtleT5jb20uYXBwbGUu
cHJpbnQudG1ja2V0LmlvZERhdGU8L2tleT4KCQkJCTxkYXR1PjIwMDQtMDgtMD1UMTc6MjI6MDRa
PC9kYXR1PgoJCQkJPgtleT5jb20uYXBwbGUucHJpbnQudG1ja2V0LnN0YXR1RmxhZzZwva2V5PgoJ
CQkJPgludGVnZXI+MDwvaW50ZwDlclj4KCQkJPc9kaWN0PgoJCTwvYXJyYXk+Cgk8L2RyY3Q+Cgk8
a2V5PmNvbS5hcHBsZS5wcm1udC5QYwDlRm9ybWFOl1BNT3JpZW50YXRpb248L2tleT4KCTxkaWN0
PgoJCTxrZXk+Y29tLmFwcGx1LnByaW50LnRpY2tldC5jcmVhdG9yPC9rZXk+CgkJPHN0cm1uz5j
b20uYXBwbGUucHJpbnRpbmdtYW5hZ2VyPC9zdHJpbnmc+CgkJPgtleT5jb20uYXBwbGUucHJpbnQu
dG1ja2V0Lml0ZW1BcnJheTwva2V5PgoJCTxhcnJheT4KCQkJPGRpY3Q+CgkJCQk8a2V5PmNvbS5h
cHBsZS5wcm1udC5QYwDlRm9ybWFOl1BNT3JpZW50YXRpb248L2tleT4KCQkJCTxpbnRlZ2VyPjE8
L2ludGVnZXI+CgkJCQk8a2V5PmNvbS5hcHBsZS5wcm1udC50aWNrZXQuY2xpZW50PC9rZXk+CgkJ
CQk8c3RyaW5nPmNvbS5hcHBsZS5wcm1udGluZ21hbmFnZXI8L3N0cm1uz4KCQkJCTxrZXk+Y29t
LmFwcGx1LnByaW50LnRpY2tldC5tb2REYXR1PC9rZXk+CgkJPc9kaWN0PgoJCTwvYXJyYXk+Cgk8
OjIyOjA0WjwvZGF0ZT4KCQkJCTxrZXk+Y29tLmFwcGx1LnByaW50LnRpY2tldC5zdGF0ZUZsYwC8
L2tleT4KCQkJCTxpbnRlZ2VyPjA8L2ludGVnZXI+CgkJPc9kaWN0PgoJCTwvYXJyYXk+Cgk8L2RyY3Q
aWN0PgoJPGtleT5jb20uYXBwbGUucHJpbnQuUGFnZUZvcmlhdC5QTVNjYXwxbmc8L2tleT4KCTxk
aWN0PgoJCTxrZXk+Y29tLmFwcGx1LnByaW50LnRpY2tldC5jcmVhdG9yPC9rZXk+CgkJPHN0cm1u
Zz5jb20uYXBwbGUucHJpbnRpbmdtYW5hZ2VyPC9zdHJpbnmc+CgkJPgtleT5jb20uYXBwbGUucHJp
bnQudG1ja2V0Lml0ZW1BcnJheTwva2V5PgoJCTxhcnJheT4KCQkJPGRpY3Q+CgkJCQk8a2V5PmNv
bS5hcHBsZS5wcm1udC5QYwDlRm9ybWFOl1BNU2NhbGluZzZwva2V5PgoJCQkJPJHJlYwW+MTwvcMvH
bd4KCQkJCTxrZXk+Y29tLmFwcGx1LnByaW50LnRpY2tldC5jbG11bnQ8L2tleT4KCQkJCTxzdhJp
bmc+Y29tLmFwcGx1LnByaW50aW5nbWfuYwDlcljwvc3RyaW5nPgoJCQkJPgtleT5jb20uYXBwbGUu
cHJpbnQudG1ja2V0LmlvZERhdGU8L2tleT4KCQkJCTxkYXR1PjIwMDQtMDgtMD1UMTc6MjI6MDRa
PC9kYXR1PgoJCQkJPgtleT5jb20uYXBwbGUucHJpbnQudG1ja2V0LnN0YXR1RmxhZzZwva2V5PgoJ
CQkJPgludGVnZXI+MDwvaW50ZwDlclj4KCQkJPc9kaWN0PgoJCTwvYXJyYXk+Cgk8L2RyY3Q+Cgk8
a2V5PmNvbS5hcHBsZS5wcm1udC5QYwDlRm9ybWFOl1BNVmVydG1jYXwSZXM8L2tleT4KCTxkaWN0
PgoJCTxrZXk+Y29tLmFwcGx1LnByaW50LnRpY2tldC5jcmVhdG9yPC9rZXk+CgkJPHN0cm1uz5j
b20uYXBwbGUucHJpbnRpbmdtYW5hZ2VyPC9zdHJpbnmc+CgkJPgtleT5jb20uYXBwbGUucHJpbnQu
dG1ja2V0Lml0ZW1BcnJheTwva2V5PgoJCTxhcnJheT4KCQkJPGRpY3Q+CgkJCQk8a2V5PmNvbS5h
cHBsZS5wcm1udC5QYwDlRm9ybWFOl1BNVmVydG1jYXwSZXM8L2tleT4KCQkJCTxyZWFS PJcyPC9y
ZWFS PgoJCQkJPgtleT5jb20uYXBwbGUucHJpbnQudG1ja2V0LmNsaWVudDwva2V5PgoJCQkJPHN0
cm1uz5jb20uYXBwbGUucHJpbnRpbmdtYW5hZ2VyPC9zdHJpbnmc+CgkJPc9kaWN0PgoJCTwvYXJyYXk
ZS5wcm1udC50aWNrZXQubW9kRGFOZTwva2V5PgoJCQkJPGRhdGU+MjAwNC0wOC0wOVQxNzoyMjow
NFo8L2RhdGU+CgkJPc9kaWN0PgoJCTwvYXJyYXk+Cgk8L2RyY3Q+CgkJPc9hcnJheT4KCTwvZG1jdD4K
CgkJPc9kaWN0PgoJCTwvYXJyYXk+Cgk8L2RyY3Q+CgkJPc9hcnJheT4KCTwvZG1jdD4K
CTxrZXk+Y29tLmFwcGx1LnByaW50L1BhZ2VGb3JtYXQuUE1WZXJ0aWNhbFNjYXwxbmc8L2tleT4K
CTxkaWN0PgoJCTxrZXk+Y29tLmFwcGx1LnByaW50LnRpY2tldC5jcmVhdG9yPC9rZXk+CgkJPHN0
cm1uz5jb20uYXBwbGUucHJpbnRpbmdtYW5hZ2VyPC9zdHJpbnmc+CgkJPgtleT5jb20uYXBwbGUu
cHJpbnQudG1ja2V0Lml0ZW1BcnJheTwva2V5PgoJCTxhcnJheT4KCQkJPGRpY3Q+CgkJPc9kaWN0
PmNvbS5hcHBsZS5wcm1udC5QYwDlRm9ybWFOl1BNVmVydG1jYXwTY2FsaW5nPc9rZXk+CgkJPc9ka
cmVhbD4xPC9yZWFS PgoJCQkJPgtleT5jb20uYXBwbGUucHJpbnQudG1ja2V0LmNsaWVudDwva2V5
PgoJCQkJPHN0cm1uz5jb20uYXBwbGUucHJpbnRpbmdtYW5hZ2VyPC9zdHJpbnmc+CgkJPc9kaWN0
PmNvbS5hcHBsZS5wcm1udC50aWNrZXQubW9kRGFOZTwva2V5PgoJCQkJPGRhdGU+MjAwNC0wOC0w
OVQxNzoyMjowNFo8L2RhdGU+CgkJPc9kaWN0PgoJCTwvYXJyYXk+Cgk8L2RyY3Q+CgkJPc9hcnJheT4K
bGFnc9rZXk+CgkJPc9kaWN0PgoJCTwvYXJyYXk+Cgk8L2RyY3Q+CgkJPc9hcnJheT4K
CTwvZG1jdD4KCTxrZXk+Y29tLmFwcGx1LnByaW50LnN1Y1RpY2tldC5wYXB1cl9pbmZvX3RpY2tld
dDwva2V5PgoJPGRpY3Q+CgkJPgtleT5jb20uYXBwbGUucHJpbnQuUGFnZUZvcmlhdC5QTVUkFkanVz
dGVkUGFnZVJlY3Q8L2tleT4KCQkJPc9kaWN0PgoJCTwvYXJyYXk+Cgk8L2RyY3Q+CgkJPc9kaWN0
LmNyZWFOb3I8L2tleT4KCQkJPHN0cm1uz5jb20uYXBwbGUucHJpbnRpbmdtYW5hZ2VyPC9zdHJp
bmc+CgkJPc9kaWN0PgoJCTwvYXJyYXk+Cgk8L2RyY3Q+CgkJPc9kaWN0PgoJCTwvYXJyYXk+Cgk8L2RyY3Q
cmF5PgoJCQkJPGRpY3Q+CgkJPc9kaWN0PgoJCTwvYXJyYXk+Cgk8L2RyY3Q+CgkJPc9kaWN0PgoJCTwvYXJyYXk
anVzdGVkUGFnZVJlY3Q8L2tleT4KCQkJPc9kaWN0PgoJCTwvYXJyYXk+Cgk8L2RyY3Q+CgkJPc9kaWN0PgoJCTwvYXJyYXk
CQkJPc9kaWN0PgoJCTwvYXJyYXk+Cgk8L2RyY3Q+CgkJPc9kaWN0PgoJCTwvYXJyYXk+Cgk8L2RyY3Q+CgkJPc9kaWN0PgoJCTwvYXJyYXk
PjU3NjwvcMvHbd4KCQkJPc9kaWN0PgoJCTwvYXJyYXk+Cgk8L2RyY3Q+CgkJPc9kaWN0PgoJCTwvYXJyYXk+Cgk8L2RyY3Q+CgkJPc9kaWN0PgoJCTwvYXJyYXk
dC5jbG11bnQ8L2tleT4KCQkJPc9kaWN0PgoJCTwvYXJyYXk+Cgk8L2RyY3Q+CgkJPc9kaWN0PgoJCTwvYXJyYXk+Cgk8L2RyY3Q+CgkJPc9kaWN0PgoJCTwvYXJyYXk
cm1uz4KCQkJPc9kaWN0PgoJCTwvYXJyYXk+Cgk8L2RyY3Q+CgkJPc9kaWN0PgoJCTwvYXJyYXk+Cgk8L2RyY3Q+CgkJPc9kaWN0PgoJCTwvYXJyYXk
CTxkYXR1PjIwMDQtMDgtMD1UMTc6MjI6MDRaPC9kYXR1PgoJCQkJPgtleT5jb20uYXBwbGUucHJpbnQudG1ja2V0LnN0YXR1RmxhZzZwva2V5PgoJCTwvYXJyYXk
aW50LnRpY2tldC5zdGF0ZUZsYwC8L2tleT4KCQkJPc9kaWN0PgoJCTwvYXJyYXk+Cgk8L2RyY3Q+CgkJPc9kaWN0PgoJCTwvYXJyYXk+Cgk8L2RyY3Q+CgkJPc9kaWN0PgoJCTwvYXJyYXk
PC9kaWN0PgoJCQk8L2FycmF5PgoJCTwvZG1jdD4KCQk8a2V5PmNvbS5hcHBsZS5wcm1udC5QYwDl

ZmFsc2UvPgoJCTxrZXk+Y29tLmFwcGx1LnByaW50LnRpY2tldC50eXB1PC9rZXk+CgkJPHN0cmlu
Zz5jb20uYXBwbGUucHJpbnQuUGFwZXJJbmcZvVG1ja2V0PC9zdHJpbmc+Cgk8L2RpY3Q+Cgk8a2V5
PmNvbS5hcHBSZS5wcm1udC50aWNrZXQuQVBjVjVmc21vbWVva2V5PgoJPHN0cmluZz4wMC4yMDwv
c3RyaW5nPgoJPGt1eT5jb20uYXBwbGUucHJpbnQudG1ja2V0LnByaXZhdGVmb2NrPC9rZXk+Cgk8
ZmFsc2UvPgoJPGt1eT5jb20uYXBwbGUucHJpbnQudG1ja2V0LnR5cGU8L2t1eT4KCTxzdhJpbmc+
Y29tLmFwcGx1LnByaW50L1BhZ2V2V2V3JtYXRUaWNRZXQ8L3N0cmluZz4KPC9kaWN0Pgo8L3BsaXN0
Pgo4Qk1NA+kAAAAAAHgAAwAAAEgASAAAAAAC3gJA/+7/7gMGA1IDZwUoA/wAAgAAAEgASAAAAAAC
2AIoAAEAAAABkAAAAAQADAwMAAAABf/8AAQABAAAAAAAAAAAAAAAAAaAgAGQGQAAAAAAAAgAAAAAAAA
AAAAAAAAAAAAAAAAAAAAAAAAAAAA4Qk1NA+0AAAAAABAAR//2AAEAAQBH//YAAQABOEJTTQQmAAAA
AAAOAAAAAAAAAAAAAD+AAAA4Qk1NBA0AAAAAAQAAAAeOEJTTQQZAAAAAAAAEAAAAHjhCSU0D8wAA
AAAAAQAAAAAAAAAAAAQA4Qk1NBAoAAAAAAEAADhCSU0nEAAAAAAACgABAAAAAAAAAAAE4Qk1NA/UA
AAAAEgAL2ZmAAEAbGZmAAyAAAAAAAEAL2ZmAAEAoZmaAAyAAAAAAAEAMgAAAAEAwGAAAAyAAAA
AAEANQAAAAEALQAAAAyAAAAAAAE4Qk1NA/gAAAAAAHAAAP////////////////////////////////////8D
6AAAAAD////////////////////////////////////+gAAAAA////////////////////////////////////wPo
AAAAAP////////////////////////////////////8D6AAAOEJTTQQAAAAAAAAACAAI4Qk1NBAIAAAAAAAyA
AAAABAE4Qk1NBAgAAAAABAAAAABAAACQAAAAkAAAAAAOEJTTQQeAAAAAAAAEAAAAADhCSU0EGgAA
AAADSwAAAAyAAAAAAAAAAAAAAAAADoAAADIAAAACwBpAFIAyQBkAGkAbwAgAEwAbwBnAG8AAAAABAAA
AAAAAAAAAAAAAAAAAAAAAAAAEAAAAAAAAAAAAAAAAAMgAAAA6AAAAAAAAAAAAAAAAAAAAAAAAAAAAAA
AAAAAAAAAAAAAAAAAAAAEAAAAEAAAAAAAAABudWxsAAAAAgAAAAZib3VuZHNPYmpjAAAAQAAAAAAAFJj
dEAAAAEAAAAAFRvcCBsb25nAAAAAAAAABMZw0bG9uZwAAAAAAAAAQnRvbWxvbmMcAAAA6AAAA
AFJnaHRsb25nAAAAyAAAAAZzbG1jZXNWbExzAAAAU9iamMAAAAABAAAAAAAFc2xpY2UAAAAASAAAA
B3NsaWN1SURsb25nAAAAAAAAAAAdncm91cE1EbG9uZwAAAAAAAAAGb3JpZ2luZW51bQAAAAxFU2xp
Y2VPCmlnaW4AAAAANYXV0b0d1bmVvYXR1ZAAAAABUeXB1ZW51bQAAAApFU2xpY2VUeXB1AAAAAE1t
ZyAAAAAGYm91bmRzT2JqYwAAAAEAAAAAAABSy3QxAAAAABAAAAABUbb3AgbG9uZwAAAAAAAAATGVm
dGxvbmMcAAAAAAAAAEJ0b21sb25nAAAAOgAAAAABSz2h0bG9uZwAAAMgAAAAADdXJsVEVYVAAAAAAEA
AAAAABudWxsVEVYVAAAAAAEAAAAAAABNc2dlVEVYVAAAAAAEAAAAAAAZhbHRUYWdURVhUAAAAAQAA
AAAAADmN1bGxvZXh0SXNIVE1MYm9vbAEAAAAIY2VsbFR1eHRURVhUAAAAAQAAAAACWhvcnpBbGln
bmVudW0AAAAAPRVNsaWN1SG9yekFsaWduAAAAAB2R1ZmF1bHQAAAAJdmVydEFsaWduZW51bQAAAA9F
U2xpY2VWZXJ0QWxpZ24AAAAHZGVMYXVsAAAAAtiZ0NvbG9yVHlwZWVudW0AAAAARRVnSaWN1QkdD
b2xvclR5cGUAAAAATm9uZQAAAA10b3BPdXRzZXRs25nAAAAAAAAAApsZWZ0T3V0c2V0bG9uZwAA
AAAAAAAMy90dG9tT3V0c2V0bG9uZwAAAAAAAAALcm1naHRPdXRzZXRs25nAAAAAA4Qk1NBEEA
AAAAAAEBADhCSU0EFAAAAAABAAAAAM4Qk1NBAwAAAAAB/8AAAAABAAAAGAAAAACUAAAGAAAA3gAAA
B+MAGAAB/9j/4AAQSkZJRgABAQEASABIAAAD/7QAMQWRvYmVfQ00AAv/uAA5BZG9iZQBkgAAAAAH/
2wCEAAwICAgJCAwJCCwRcOwLERUPDAwPFRgTExUTEExgRDAwMDAwMEQwMDAwMDAwMDAwMDAwMDAwM
DAwMDAwMDAwMDAwMDAwMDQsLDQ4NEA4OEBQODg4UFA4ODg4UEQwMDAwMEREMDAwMDAwRDAAwMDAwM
DAwMDAwMDAwMDAwMDAwMDP/AAAEIACUAgAMB1gACEQEDEQH/3QAEAAj/xAE/AAABQEBQEB
AQAAAAAAAAADAAECBAUGBwgJCgsBAAEFQAQEBQEBAAAAAAAAAAAAEAAgMEBQYHCAkKCxAAAQBBawIE
AgUHBggFAwwzAQACEQMEIRIxBUFRYRMicYeyBhSRobFCIyQVUsFiMzRygtFDBYWSU/Dh8WNzNRai
soMmRjNUZEXCo3Q2F9JV4mXys4TD03Xj80Yn1KSFtJXE1OT0pbXF1eX1VmZ2hpamtsbW5vY3R1dn
d4eXp7fh1+f3EQACAgECBAQDBAUGBwcbGTUBAAIRAYExEgRBuWfxIhMFMoGRFKGxQiPBuThwMyRi
4XKCKkNTFWNzNPE1BhaIsoMHJjXC0kSTVKMXZEVVnRl4vKzhMPTdePzRpSkhbSVxNTk9KW1xdX1
9VZmdoaWprbG1ub2JzdHV2d3h5ent8f/2gAMAwEAAhEDEQA/APVUkkL7Vjfafsnqs+07PV9GRv8A
TnZ6uz6Xp7/ZuSULSXIvdf6F1D614/WondYbdkVB111FVoue/aXM3eq2132fh/T10Po9P0vS/Rrf
yOqfZ+tYfTHs3NzqbrK3tmWuxzVvFmm307GZH0/zLGF4T1v0YiSb0qvG2TLCMOGpE2L1ceDgl+66
CSw/rd9Ybfq906nLqoZkOuvbRte8sDdzLbPU1jLXO/mvoLLP1z6303Jx6/rH0b7BjZnGrGVXc21r
S72jftGz2/zln6blfQ9W6uq70bE8QJFhhM4g0XsEkkklcpJUet59vTukZmfSxttuNS+1jHEhpLbu
9233bV106914/Vfp/VcLpzepZ+X6Jux6neilrbP5x7PVNrtRfbX/AMF6n2i39DVYiIki/GkWLrwt
6NJJJBKklx+X1nreHldXFWWMt+FkY2PiYb6mN3nMfj3Q6yvZy+jHtupq2+n+j/S3epZ+kW39XOs
Hq+DzkOG17bngNjb+isDczp5Orve/puVh2W/8N6icyK1okCadVJJNXP//Q9Te4tY5waXfoJ2t5
MfmtXI/Ur6xdAt6P9tyOoUM6nmpNvUzfY2uz1j7fT2Wu/o9FezHxNn6P0a/9L6q7BYPX/q10bJw8
znZ0vGu6kKbn02eixz3XGtwrLpb+nfv+h6u9EEAG7+ihEylEAgWa9W2rz/SsvpTos9Uyelhw+q
5riKMHp1f6Kisudv9o6g6MWh18U/aLP9j/gshdLoT0Z2Rk39W6xZXkdXymiSmh0QmXnzDxPU/
S+nv/S3Pf/P2/wDFrE+pf/UaukU9PwunPrdXXdb1ZWW12PWch5cxeql0bZzke72ZnMxnpVM/036F
dhQb/QrOQGi/a31RWSWB8fpPTc8Nc5m76G5qZAx4fSKBZuZjP3T7kxOUfSK00j6I+15H/Gls/YWJ
vnb9tZMf8VkrOzjlbq/11wfg99a7cfGqYR1U14jHmrJcNwbUL7X+rXvrGVS/e2r/AAAtXp+pkYd66
j62/Vx/1j6dVhMyRiGq9t/qGv1Z2tsr2bPVo/wBL9Len+tH1ar+sGJUx15ws3FsFuLmMbudWQRu0
3Vu2u2ss9ttf6xTj3/4FTRmAAPX91qGBMpHoeHT96t7cX64fsTqXWcfpjuk29d6rRU532eq30K6
q37X78jI9StrH+xnp/8AG/8ADY/qZv1c61ndG6X9ZsZjBKR0pjLcTEvcLTj2XC9vomxv6Oypj6ar
v0X6Kz+c/nLbFv5f1T6m7qQ6x07qwwOp20NpzrRji2u0tDG+rXj23fq+70mez1Lv5uv/AIb136R9
TDgZPUvtOac/D6tR6WZVbXtse8+obbXZNNjPa/7T1fo66a9nq1/pP0CI1Hhq7208equGXFe2+o7d

cnc37bzptR3XbUdIxIUktxBH2YyKHhr69Bv3q9mOY/Y/mqD1jmG7gufHtknhnr4csbFkJcTr1Ky
I6EOoJK1A0kEnk9izqHuve/de697917r3v3Xuve/de697917r3v3Xuve/de697917r3v3Xuve/de
697917r3v3Xuve/de697917r3v3Xuve/de697917r3v3Xuve/de6/9Hf09+691737r3TDj91bZy+
YzO3sVuDC5PO7c+0/vDh8f1KKtyeBavWV6FM1Q0081Ti5K1IXaFz1jMqoxW4U2caKVESR42EbcCQ
QDTjQ+dP10y1xBJLDHMrSpTUAQSteGoDir5V49EP+Z+z/gv8ieU+wukPkL2h0rt6oyU9FV7geXs
rZe19+YLcW3Y1XC5SsjOcoMvLksGI1WKCswSPQoRkK+n2AOa7fkvfLK/2jedzs45X+L9WNZVdcKS
NQJK8AGBH1Tqeva fdPenktfdj5v5H5c3eeKMMI6WtxNbsRS/2iKfDZaklalkINTqDA56X/wP+Kvx
9+JnQuJ2d8cWfJbI3nXy9izbvnyEmUqt7Vm4qOiSi3DJVmaWmaBsBR0dPB9uEhaCBGALMzMv5M5b
2blnZYrTZGL2sp8QuTUuWAAb0HaFFFAgK8SSST3n9yed/cznS63TnwCPd7RBaiALoFusTNqjAoDX
xGdmlVbUxFaAMXbPyTyvUXzg+LnRNdmKHKbY+Ve301cLitSy0bDMbZ3b1RtiTfy7mx1bTQxo2Cy
uBpq2jyCVbyMKr7L7cIDPqkQ02xbzY90v1Sklo0ZLeTLI2ihHqDQinlWv1l1j9f7y238zbJtbSao7
9ZAFp8DRIXLA+jDBBjzSnn0ez2Q9CjrU4+a/8xT+Y/i/5gHZfxN+Lu/6elFjvXBbd662njuveo8p
mK+Wv2Lgs9PjXzo/ttZOGXyVvZPKHmlRhYKH0gKZc2P1vlp+XrXd91tyaoS7F5ABRIK0Rh8uoF51
5v5xj5svdh207ApIqxoi4iTVFalZFPmScnpB7s/mF/zsvhvU4jdnvg2TJnNkVOYpQKWxsDqjYVft
StlniWb+CR716aodvUeMytVSxyNTCWqeQyK58cqXvGH4eXeR96Dw7VPpnC17JHLD56ZCSR64/MV6
S3HN3uVy60dxvdtqtiwH6kSBT/R1whQCRwqfyNCOtmv4gfJ7aHzD+P2xO+tm0FXhKPddPXUuY23k
Jomqu2xujBl0+J3Bgp6qFI46yGlyFKz01QEiNTRyQzGOMyGNyW3na5tm3G42+dgzIRrhWZSKg/LH
EeRqKnj1NXL292/M002u626FVkBbU5Kspoy186EYOKg0FadGY91fR11737r3XvfuVdeh/mQ9rdg
dIFCP5Adp9Wbim2nv7ae2MNUbd3FT0OLyU+LnyW8dt4WrngpM1Q5LGvM+NyU0atJC5jLh0KyKrA9
5atLe+3zbrS7j127uaipFaKx8iDxA8+gzzjf3e2cs7tFWM3h3caDS1AaVdQcEEcFLHEZ6LF/JO7
m7V74+Hua393Hv7c3Y28Z+7t9Y1s/unJTZGtixtHgdlyUmMow9oadG0stTK8dPAkcKPI7BQWYk05
4srSw31LeytliHECmiigqS2fmfmc9EntruN/uvL013uN281wblxqY1NAqUA9AKnAxnph+CXcf8zT
fPy9+Qu0v1f1vX7Z6DwVLuSTZVfXbDoNr7exGapd0Yul2pi+ud50uIoqvsVd5XbctXNU1E1TkNDR
K5mp2tTyOb9ZcrwbPt0203IbcGK6gHLEjSdRda9hDUAAA+w8Q1ytUPot1zBu9vv1mU2pQ2g1Aqgh
gFEbgAyArUkktw4jgbmfYK6kbr3v3Xuk9u7auC33tPc+yN0Uk1ftneW3s1tXcVDT5DJYmetwW4cb
U4jL0kGVw1Xj8vjJqnH1kiLUUk8FTCWDxSI4Vg5DLJbZRTxGkqMGBODQg1GDUHI4EEH36ZuIIrQC
e2nWsMiFWFSKqWIIqCCMHICCPiG9UGfGfQxp/of/wDM270w+B3G+Y+Fu60wq3po5XsrtPcOP2nt
3H9AZbN5XFS4XMbyyE3M3NHVpXVQD5Snr6iMyAxOrRxFJB3S8vNwt+V7B5F0XyIJKJGCxMoAnQoK8
B8JA9fPqKt1sNv2q7513SOJ/E215DDWSVgqiAsRpLkNwP+IMfTgOisfEv5fd+P2r/Lh6y7MXdFPj
PjrvGl6W71rszuWtP999y/MPYXZTfGCTJiaGrOVg2z1rtuCalaQuJZABMDP+wa7vs23/Scy3Vrp
1XKeJGAo7Vt3Tx6cKanY1/wYyRbBzBupvuTrK91hLOQQzEse9rtJppq8a6Y1BH8842u/cS9Tx17
37r3XvfuVde9+691/9Lf09+691X1/MH+XGV+NOzesdj9e09HXD6/JjsOk6f6ijyEkUeOwFXWxxPu
fsDIid4oaml2RiqpJ44LkzVk0C1JE1oRdy7tC7nPCz3BIsLaPkJcSB8KD/TEUr5CvDoI83cwvsl
tZwtoAd0vZRFDXgpNNUh9QgINPMkYIqOjIh3onAdC7FpduUVVPuLdmS0ZPf/YGWCTb133ueXXJW
5jM12hHeJZppBTU6hKeliOmONLct3HcJNwuDKWfjCIPhRfIAf4TxPn0c7PtU0021wqxe4bMkh+
KRvMk/4BwA4DrTK/nMFGHABu/mXR9f8Axr623hufee/6bbu5u5qPbtDuvdFJDvLFGUgr5Mxkq2Rs
nTYCirmXVeWUa4KOnuMqoBYyW+6vLON/7gLabFyVJdtocKGOXoS3nSoNTQ4+XXaX7qPuHe7V935
t75+3+1t9ps21hsWlaGImC3QqEVe0yMHFBhnbiSettPuT5E/G/8Aly/G/bDdl7sw+1trdZbA29s/
Ze0oKxZ9z7lg2pgqXA4XEbawQeozeUac0EULTLFKsRcnMwFz7zM5Y5auriHb9m2uAmKGJI650qqK
FqWPYfcmp+3rjVz9z3ajcd+5s5hvB9Ze3U1wwqNbyTSNI21RxqzUwKD5Dqv/AP14dWd4fLD5Fzj+
aH8gduVeyI6/ZlfsP4idMZFPFL1919nq1Jc3v7LUU5kr6DdW48fRrRxa2Ty01TU00bI1KyDPmK7s
dp250vtq1D0cNcSD8bjgoPAqDn7QPn1GfKFjuw/bs/PG+wmImMpawn/Q42OXI4hmGM8QTImnq9f2
A+pR60m/kh29szoT+epuzuLsOor6XZwW049pZzcVRi6CTKZCHHr1Rt21Z6XHwsstVIJalFSpva/u
cNts5tw5DhsrYazyQsBU0FfEPn1jVvO4W21e6E+43ZItorhGagqaeEowPPo0X80L+b/8eflF8adx
fGv4/wC3d+7qzfZwC2YmtuTcW2YsBjMLjts7swu7oIMHSyV9XnMpuHKZfB09IIXsXqRtYykSsxVG
KuVuTtx2rc49z3CWNEiVqKrVJLKVzGAAAK8eIGOjznf3C2jfn1m2baYZZJZmSrMukAK4ftFSxY1Q
OAFCC+XVwf8AKA+OG+fjJ8JNkbT7Lx9Xgt8b03DuPtDobYr4/DX7WXDp2FLhsJkIWSOamyibew1J
PVwsAS0tVUSQP6oz7Bv005W+6b5PNasGgRVQM0Daa1+VSQD5gA+fUhe3uz3WY8s20F6hW61dpWU
8V1UAU+h0gEg5BJH11W53p/LZ/mCZze+/d8br/mbx7Fw2U3pu+bqzE7j7k7WwFJhtL+N1k21aGs+
3qsHhtuZJMM9J95T42nroqeZm0yTWDuJrDmb15ILeCH1fxHCL4hWOM91BqI4lhWtCxFR5DoHbpyb
zbLc3V1Pzr4UbSP4QaaVR01HSD1QppSoUMAFM9RP5S3zc+TmN+Wu9vg18qOxKrtiqp6DdMey93ZX
cM09srSbq2LsplaqHH79Blr937R3Xs6lqa+CorJ55VaCJk0eeZfe+btj2ttog3/aryQglDsgaQvB
GU4KytQEADiFQdV5B5m3tN/ueVt9vDcMa2hy2shkFTR+LoyAsCSTgsep6XP8ANa/mEfIGDv7av8V/
AOF9XkcL2vu02tjt77wE1PButc9veCkyG29kbYysxKbUhhwdfT5LKZYGKeKGojCS08vQ0rKHx
Lu3Hb5eYd7Aa0XUVU/DRcMzD8WQVVeFRwJ1op575t3YbtByny2xw/cqHdfilPQqin8PaQzNggEUI
ANSL/LP+Xh/Md6B+KfZXA3aHzOr+y9nth8Q/dPV1V2j2xushyGMrtz4mGiam07oZsNuuvx2fq6aZ
pJ4KCWIeVoZH5WU92jmPlrcN2tbS12URTaj4T6I11IU1+HKgivAnyqPQMb/yjzjtOxxt/fcxma30
jxojLkwiLClNeGIYg5CkZot5nE/1W9b9ydufyi0levfj92X/AKH+3dwd9Zf+6XYv8SzoI/u7/Ccv
0/m89/uR2/S1mXp/4vtnG1td+zG2v7rSlkziCbmu5srPnC0uNxtfgs1txqSgNaiQDBoMMQfy6EPI
tnu04e39/abTe/T7g90dE1SNNDEzZUE5UFcDz9Og+/kt/Iv5Rdhfofu/p/vTvvstjDbB6X7KRcX

ujdmZz2AXd01u4OrNrjP46kyj3jnFJW1kcMjIsgHQXUgaiPannbbdqtthsbYw2+OF5J0yqgHS0cj
UNPsH5jP7b7xv13zPue37pus08cVtJhmLLqWWJdQB+RND6HoSP5k/z3+TvYPy029/Lx+DO4Z9rb
vrK3F7c3zvXBSpj9yVe7cxjP49XYTG7peKeXaW2tkbYZa3K5CgCZBJY541kRaZ45kvLPL+12+0Sc
x79HrhALKpyoUGgJX8TM2FBxwmoWc581b3d7/DyjyxMUuCQruuGLkaiob8CouWZe6tRXBBAL5C/
Ef8Amf8A8vXrSp+U20PnXvntak2VWYsv7H21NuXf2Xo6S1rs1Fj0ytZtffeW3PtrfeCosnkUjqWq
6aCeCGoaYRBBKyGO3bxytzFdDapthjiLghG0oDgVoGQKyEgYoSCRSvDoq3f1/nf1KyO+W/NEs6xk
GRdUhABNK1XLK6gnNQCAa040vs/12/LyH5sfF3ZvctXQOWJ31T1uR2T2Xh8aJBjMdv3baUb5J8Yk
0s00ONzeLyNHk6eF3kenhr1hZ5GjLth/ADHs52PdZrIMTAQGQniUatK/MEFT6kV61T1DmAcy7Hb7
iyhbKEpIBwDrStPkQQwHkGpU0r0Z6fqHqapo9/Y6p6v67qMf2tO9V2jQz7J21LR9k1M1ImPkqN/U
smMaDeM81BGsDPkVqWMKhCdIA91YvLsNbsLqTVd8B1NVPPs25zinR2dvsGW7Q2MJScl1GhaSG1P
1BTvxjurjrBJ0v07NVLWzdT9aSl15/Ze61q5N1bWeqXdHW1FBjeu9yLUNijKM/sHHU0dPhay/wBx
ioI1SmeJVAGxe3oGkXcunSy/G3wuauvHg5yw4MeNetHbduLajYQ6taNXQtduYpG3D4owKIEKjC06
Ev216W9e9+691737r3Xvfuvdf//T39PfuVda/P8APR+Knyc7Th+NPye+LdLXbj3r8V9wbpztdtLH
CCry01LnJtsV1LnMfhp1lbN1VPLgHpamLgimqpyalWjUeNmEhch7rtlq257XupCwXaqAxwMaqgny
41BOKjPHqJfdHYd6v12be9jUvc2LsxQZOdJBVfM9tCACSCkCoi29cf8ACgP5EYfg4TZxcn8u5DC5
nt2SmtJQbd2Tu3BjXtU1PI01fj9s7mxtduGYtHSyTSugMShXYAKpsZXPt9t0jPNY8x24tK8WZTSv
kWUgFLoms/drdoUjt05Quzf04IjLUAcJgXKSWWnmZ3XSifj2E7WP2nsd4+mm5ntr/fAPLlbaJQQm
CHkjDFfkC4x1KG7WX3kbr1KPCpOQNz2bkwyhIn3BZrajSdwMUFwUV6g1YpGRXj1ZF8V/5PkmP7Fp
Pkj8/e28r8vPkGLYmti6TcOmHq7ZVY9OqxSYXaFLTY/HS5GmEsKuoKsail0q6x6vV7Mt15xDWx2z
1+zFnt9KGNxt9rZNP5/PoJbD7eFLwblzXftuG7VqA39khp5LgVHA8V+XV41PT09JTUw1JBDS0tLD
FT01NTxJDT09PCixwwQQxqscUMUahVVQFVQABb2BiSSSTUnqTwAoCqAFawOsVvXW+tlvubYOze0v
5+uW6+7C29jt2bL3T3ZtHG7h251o31x2WoD1LgJzS1kaPG7wmFWWIDD1fc2WVxNa+36XFvIUnSbi
COIPiHrHDcrS2vvdas0u4RjbsXKB1PAjw1wehB/md/EbMfy2/kj0/wDN34m7dots9ZruXD0dv0tJ
JW7e2B2NiaWSKfBVdLOZJYtnd17dinCASf46kVsayQ66Qe03K+8JzNt15se7yFrrSc8C6Hz/ANMh
p+WnjnpXzty/JybvO38zbDCEstY7QKrHIB8JH8Ei1/PUKiq9Xrb8+f8Ag89/LX3184ekoY6rIUvW
dVXYjC50OKt12f2PUZCj21PiNx0eu0ORgzd05ISzpdUraSASRkxzIxAdvy9JHZNBSv8aKZaEjGpK
Fqqf6SjHoT6jquLrmyKXky65m2wVcQEgHoIsoSjDzOMan1AqMEdUX/y4P5dO3/5m21uwPld8v08u
2N75uXsHL7GpMRhty0Azs1TicRhc3UV+48/n8Xu0ajxQ/vQEx2IoKehhpY4VZXMLiADzmXmSTleW
32nZ7CGNPDDVKmmSRRQCue3LEmtfXPUYcncnw86wXe/cwbncSy+MUADDVgK1WZg1B3dqKFapoad
BF8EOuOuen/5602erOpclkdwdef9h/ILae3Mr1q+1yuRmiwvQ/alFkKeqyVFj8XSVz4/LRVFOJY
4Vv1iBu/62Wb/c3N5yHLd3iBbmSOFmAFBmWMjBJpUUPHov5Ws7Pb/c+GxsJC9pDNOikkE9sEoNSA
AaGorTy8+PQjbn3dhegP+FCNVvbuappcJtaTtWeQZzceYQ4eiXnZ3R9RtjZGenyWRQULNisNkdz0
RkqCwhojSUC6eEsqWKF9w9uxBZAtL4PacSu1MKDNSFOPOVz6WT3EW0+7TXO5MFg8f4m4ASQ6Uap
xQFhngtDnHV9f83mspF/1v8Ayalagpli9q7TjPZDEI6mSfsTzRQJTuW0zPMougUksPp7AHJ6n+
sulihqhb/jjdSp7Mv8AU7ejqFDGLPn+onRYP+E+f/ZBUU/8T12F/wc8/stTae4f/Jfx/nnT/3CR
J7S/8qs//PVJ/wAdTqt7+SZ/290+XX/iMe/P/giuqfYm54/5VTZ/+asX/VmToG+2n/K88wff80J/+
0iLpv69yFJ0X/wAKF9zT dovFh6Xdva3Y8eDzGYkip6aD/TD1rmZ+vp6aqqS8bJlPnXueLjKou16k
xmxVo/drhtf+3UQte4pClQP+FuNf7KFvy/Pqto67X7uTm+7Vknk0k8P1oz4dD89QX86fLq+X+bB2
Ns/rj4A/I+bd2SoKN95bDr+vdr0NXMi1ob3ZvEpiSRQYum8cs1ZW0nkkRWNcYqaklmYpHG8igH1
K2mueYdtEkk6JA7H0VcKn0H19pA8+pT58vLez5U3g3DgGSIXqDxZ3wAB5kfF8gCcAV6JF/wne2fn
8D8NewNzZGWmXo+e99x5HbCSatFbjsJtLzm3a/LU41FDDNm8fU0hIAbYULX4C+zz3GmjK3q3iQ1
e03Ab5EsxA/YQfz6DPtFbyxcuXc0gpHLdMV+YVEUn/egR/ter8fcf9Sr1737r3Xvfuvde9+69173
7r3Xvfuvdf/U39PfuVde9+690C/emEpk6n7Z3BhsLSNvOg6r7CO3svQ4qmn3FTZebQzS0SYqqSnk
rxUtPjPjSM3ZmtY3sS7fJr1di3lbeRxJ9LKVck11eG1KAedaU+FR/wAnW9hJzlyo19DEbf8AeVsH
LgU0GZA+ongumurNKVr1o7/ygvm30Z8G4vKx2Nu2gzm9e/t3Y/F7K616uwOBy1fld3yHIGuSliyl
LS1NFjXlZr+OVH0S6Lm4X3iF7XclbVylJzDeXgeTdpjPjjCMdR1cddKak4pWp67I/ej9pecveH/W
+5f2yeG05ItHee8u5JUWOAdnfdJBYCMVBFVr8+tuJzfaXz73f1X8St5zdf9Zbc3Zvuvav8Ak9tL
MzyemQv9oVdMs2FrdnRz7minGarIpFlnoak11TR1vdKiyo/vJwz3Pns6271u7OyQJPOSbpC1DEh
p4ZUF61K5ZDV1PaQCD1zA3blz2U2vmT3M21Octwn2yyTtMyRhnczqaSLORER4akFVktQj01qSpH
Vg7EgEgEkaKafUKd6D/E+xz1B3Xfv3XuqdcP/KZ/iX8xOL58/wCn7w+PfuI3v/oo/wBffkv/AARz
9FtFgf36/Ojx28/2f3Hn/g3plaPgbayM05u08uH1/8Ad/8AoZXxPE9WLV06PnSmrqO35C183jmv
97U/VD+F4XogWmvxP1Wuj5U6sx716W2L8ieo9+9Ldk43+J7N7BwFThMpGmhaui1LR1LWzeLlKSRK
fM7fy1PBXUcpVhHVU8BEEAgheW9Z9tvLe+tmpNG1R8/UH5EVB+R6Gu6bba7vt91tt6mq2mQqfUeY
YfnTRgfIgdVj/C/+UxV/FjaHd/Tu+PkJB3x8eu+9s1eH311LkupanZBps3PTLjI91YpDm2tuaXE
5JsKzU9QYanJpnho5lmiko4rine+bhus1jewbd9PuNu1VkeMrHHSV8NaiuRU0FWFDqPQJ5b5CbYr
fc9uut3F1tF0hDxGIpRuGpWErUOnBoKmimoKjon1P/IA3xsfdObh6U+eHY3WvWe5Kg/xTB0e1szT
bmKxWmSNcXmK/a3ZG1cFuyXwuUFRLRUaBZD/AJOQpDnJ9woJ4kN9sEct0owSw019QGRiv2VP29B4
e1FlazyjbOaZobJz1QpDU9CVkVX+0gfZ6iz13/Ip230X8keh+9OifkRufamO6srtu5Xdef3JtGg3
Pnt05PEWmm3HJic3F18TjMPQ79x889LPTy0FQuOsD3iM4KxKjuefJb/bNwsL/bkdpQQpVioUHHU

AG8AbwB0AGUAcgAAAA0AEgANxggAAuAQwCEBAgAAAGAA/k/xADIBYAMAAAAAAAAAAAAADgBCAG8A
ZAB5ACAAVAB1AHgAdAAgAEsAZQB1AHAAAAAdABMAAyQDBiQBD4Q4BBJk8AAAAABsk8ABehDgEYSQD
AAwAQIj7/09KAqBRSgIAUAAvQPEAQgFQAawAAAAAAAAAAAAAEAEwAaQBzAHQAAAAiABQAAyQDD4Sg
BRGEmP4SZPAAAAUpPAAxOsgBWCEmp5hJAMMAECI+/9PSgIAUUoCAEYA/k8BAGIBRgAMAAAAAAAA
AAAAABWQAGkAYwBOAHUAcgB1AAAADQAVAAyKqQ+EOARehDgEABAAQIj7/ONKGABPSgIAUUoCAFAA
IgbRAFIAUAAAMAQAAAAAAAAABWBDAGEAcABOAGkAbwBuAAAAFwAWAAomAAtGBwASZnWAAAAATpDwA
FKTWAQAQECIAABDShIAT0oFAFFKBQBOAP5PAQByAU4ADAAAAAAAAAAAAAAAgAVABPAEMAIABCAGEA
cwB1AAAAFAAXABJk8AAAAABsk8AANxgUAAVAZChAAQIj7/ONKGABPSgIAUUoCAHYAUEABAIIBdgAM
AAAAAAAAAAAAACwBCAG8AZAB5ACAAVAB1AHgAdAAgADIAAAA4ABgAAyQDDcYpAA1pAW4E3AhKDbgR
JhaUGgIfcCpeJ0wsujAoNQAAAAAAAAAAAAAAATpAEAYSQDDgBDSHgAaAgAdEgJBHUIAEIAUUB
AJIBQgAMAAAAAAAAAAAAACwBCAG8AZAB5ACAAVAB1AHgAdAAgADMAAAAIABkAAyQDYSQDCgBoCAB0
SAkEdQgAhgD+TwEAogGGAAwAAAAAAAAAAAAAPAEIAbAbvAGMAawAgAFEAdQvBAHQAYQB0AGkAbwBu
AAAApGAAAMkAw6E8AAPhFgFEmTcAAAAFKTwACRkDAEIDCVkBgEIDCZkBgEIDCdkBgEIDCIEAAhd
hPAAxorYBWEkAXAAQIj7/ONKGABPSgIAUUoFAFAAQOABALIBUAMAAAAANkhFAAAAEABCAG8AZAB5
ACAAVAB1AHgAdAAgAEkAbgBkAGUAbgB0AAAAcGAbAA+EOAJehNACDABDShgAT0oCAFFKAgBIABNA
AQCAEgADQEAAAIO+AAAAUAUVABPAEMAIAXAAAAAFQACAA3GCAACWAK2IQAKE6R4ABskEAAADgA1
CIE7CIFPSgIAUUoCAD4AFEABAAIAPgANAQAAAiJ4AAAAQBUE8AQwAgADIAAAAKAB0AD4TIAF6E
yAAPADoIgUNKGABPSgIAUUoCAAA6ABVAAQACADoADQEAAAIO+AAAAUAUVABPAEMAIAXAAAAAFQACAA
AA+EkAFehJABCwA2CIFPSgIAUUoCAAAyABZAAQACADIAQDEAAAAAAAAAAAAUAUVABPAEMAIAXAAAA
CgAfAA+EWAJehFgCBABDShIAMgAXQAEAAgAyAA0BAAAAAAAAAAAAAFQATwBDACAAOAAAAoAI AAP
hCADXoQgAwQAQOoSADIAGEABAAIAMgANAQAAAAAAAAABQBUE8AQwAgADYAAAAKACEAD4ToA16E
6AMEAENKEgAyAB1AAQACADIAQDEAAAAAAAAAAAAUAUVABPAEMAIAXAAAAcGAAiAA+EsARehLAEABD
ShIAMgAAQAEAAgAyAA0BAAAAAAAAAAAAAFQATwBDACAAOAAAAoAIwPhHgFXoR4BQQAQOoSADIA
G0ABAAIAMgANAQAAAAAAAAABQBUE8AQwAgADkAAAAKACQAD4RAB16EQAYEAENKEgA4AFpAAQBS
AjgADAAAAAAAAAAAAoAUABsAGEAaQBuACAAVAB1AHgAdAAAAIAJQAI AE9KBgBRSgYALgApQKIA
YQIUAAwAAAC4brkAAAAALFAAYQbnAGUAIABOAHUAbQBiAGUAcgAAAAAARgD+T0EBcgJGAAwAAAA
AAAAAAAAAE4AdQBtAGIAZQByAGUAZAAGAEwAaQBzAHQAAAAJACcACiYAC0YgAAIAE9KAABRSgAA
ZgD+TyEAsgFmAAwAADRTVwAAAAAdAFMAAdAB5AGwAZQAgAEgAZQBhAGQAAaQBuAGcAIAAYACAAKwAg
AEEAcgBpAGEAbAAgADEAMgAgAHAAdAAAAIAKAAAPADUIgUNKGABPSgIAUUoCAABSAP5PMQCSA1IA
DAAAAKMq6wAAABCAUwBOAHkAbAB1ACAAAB1AGEAZABpAG4AZwAgADMAIAArACAAMQAYACAAcAB0
AAAAAgApAAcANgiBQ0oYAABUAE1A8QCIALQADAAAAADZIRQAAABYAQgBvAGQAEQAgAFQAZQB4AHQA
IABGAGkAcgBzAHQAIABJAG4AZAB1AG4AdAAAA4AKgARhNIAFKR4AGCE0gAAAFIAUKABALICUGAM
AAAAANkhFAAAAEgBCAG8AZAB5ACAAVAB1AHgAdAAgAEkAbgBkAGUAbgB0ACAAMgAAABQAKwAPhGgB
EmTgAQEAFKR4AF6EaAEAAAG4A/k8RAMICBgAMAAAAP18LAAAAHQBTAHQAEQBsAGUAIBIAGUAYQBk
AGkAbgBnACAAMQAgACsAIABBAHIAaQBhAGwAIAAXADIAIBwAHQAAAAKACwAD4SY/16EmP4PAENK
GABPSgIAUUoCAFWIqQB+AP5PEQCCAn4ADAAAAFIdSAAAA4AUwBOAHkAbAB1ACAAAB1AGEAZABp
AG4AZwAgADEAIAArACAAQQByAGkAYQBsACAAMQAYACAAcAB0ADEAAAAAYACOAGYQABQEAABJgAj
JAAuhAAAL4QAAA8AQOoYAE9KAqBRSgIAXAiBAEgAmQABAOICSAAMAQAAwEvXAAAAABCAGEAbABs
AG8AbwBuACAAVAB1AHgAdAAAAIALgAUENKEABPSgcAUUoHAF5KBwBhShAAAAAAAAEAAAAcAAAA
AwAAAAQAAAAFAAAABgAAAAcAAAAIAAAACQAAAAoAAAAALAAAAADAAAAOAAAAOAAAAADwAAABAAAAAR
AAAAEgAAABMAAAAUAAAAFQAAABYAAAAXAAAAGAAAAABkAAAAaAAAAgWAAABwAAAAdAAAAHgAAAB8A
AAAgAAAAIQAAACIAAAAjAAAAJAAAACUAAAAmAAAAJwAAACgAAAApAAAAKgAAACsAAAAsAAAAAQAA
AJEIAAD/////AAAAAAEA/////wAAAAAAAAAAAAAAAAAAAAEAAAABAP/////8AAAAAAAAAAAAEAAAAcAAAA
AQD/////AAAAAAAAAAAAcAAAAwAAAAEA/////wAAAAAAAAAAAAwAAAAQAAAAABAP/////8AAAAAAAA
AAQAAAAFAAAAAQD/////AAAAAAAAAAAAFAAAABgAAAAEA/////wAAAAAAAAAAAABgAAAAcAAAAABAP//
//8AAAAAAAAAAAAcAAAAIAAAAQD/////AAAAAAAAAAAAIAAAACQAAAAEA/////wAAAAAAAAAAAAcQAA
AAoAAAAABAP/////8AAAAAAAAAAAAoAAAAALAAAAQD/////AAAAAAAAAAAAALAAAAADAAAAEA/////wAA
AAAAAAAAADAAAAOAAAAABAP/////8AAAAAAAAAAAAOAAAAOAAAAQD/////AAAAAAAAAAAAOAAAAADwAA
AAEA/////wAAAAAAAAAADwAAABAAAAABAP/////8AAAAAAAAAAAABAAAAARAAAAQD/////AAAAAA
AAAAAAAEgAAAAEA/////wAAAAAAAAAAAEgAAABMAAAABAP/////8AAAAAAAAAAAABMAAAAUAAAAQD/
/////AAAAAAAAAAAAAFQAAAAEA/////wAAAAAAAAAAAAAFQAAABYAAAAABAP/////8AAAAAAAAAAAABYA
AAAXAAAAQD/////AAAAAAAAAAAAAXAAAAEA/////wAAAAAAAAAAAAAGAAAAABkAAAAABAP/////8A
AAAAAAAAABkAAAAaAAAAAQD/////AAAAAAAAAAAAaAAAAgWAAAAEA/////wAAAAAAAAAAAAgWAAABwA
AAABAP///8AAAAAAAAAAABwAAAAdAAAAQD/////AAAAAAAAAAAAdAAAAHgAAAAEA/////wAAAAAA
AAAAHgAAAB8AAAAABAP///8AAAAAAAAAAAB8AAAAgAAAAQD/////AAAAAAAAAAAAgAAAAIQAAAAEA
/////wAAAAAAAAAAAAIQAAACIAAAAABAP///8AAAAAAAAAAAAIAAAAjAAAAAQD/////AAAAAAAAAAAAj
AAAAJAAAAEA/////wAAAAAAAAAAAAJAAAACUAAAAABAP///8AAAAAAAAAAAACUAAAAmAAAAAQD/////
AAAAAAAAAAAAmAAAAJwAAAAEA/////wAAAAAAAAAAAAJwAAACgAAAAABAP///8AAAAAAAAAAAAcGAAAAp
AAAAAQD/////AAAAAAAAAAAApAAAAKgAAAAEA/////wAAAAAAAAAAAAKgAAACsAAAAABAP///8AAAAA
AAAAACsAAAAsAAAAAQD/////AAAAAAAAAAAAsAAAAAQAAAAAAAAAAAAAAAAAAAAAAAAAAAAEAAAAc

AAAAAAgAJkAAAAAMAAAAAACANgIAAAEAAAQAAAAIACYAAAAGzAAAAAAAAAgDYCAAAAAAA
AAAAAAAmAAAAABswAAAAAAAAIA2AgAAAAAAAAAAAAAAAAJgAAAAbMAAAAAAACANgIAAAAAAA
AAAAACYAAAAAgzAAAAAAAAAgDYCAAAAAAAmAAAAABswAAAAAAAAIA2AgAAAAAAAA
AAAAAJgAQSAbMAAAAAAACANgIAAAAAAACAYAEeGzABAAAAAAAgDYCAAAAAAA
AAAAmAAAAABswAAAAAAAAIA2AgAAAAAAAAAAAAAAAAJgAAAAbMAAAAAAACANgIAAAAAAA
AAAYAQYgAjABAAAAKQIAACkCAAAAAAACAKAIGIAMwAAAAAAkEAAAJBAAAAAACACA
AJgAAAAbMAAAAAAACAFwQAAAAAAAgACyAAAAAGzAAAAAAAAAgBcEAAAAAAAAAAAA
mAAAAABswAAAAAAAAIAXBAAAAAACAAAAAAJgAAAAbMAAAAAAACAFwQAAAAAAACy
AAAAGzAAAAAAAAAgBcEAAAAAAAAAAAAmAAAAABswAAAAAAAAIAXBAAAAAACAAAAAAJgA
AAAbMAAAAAAACAFwQAAAAAAACyAAAAAGzAAAAAAAAAgBcEAAAAAAAAAAAAmAAA
ABswAAAAAAAAIAXBAAAAAACAAAAAAJgAAAAbMAAAAAAACAFwQAAAAAAACyAAAA
GzAAAAAAAAAgBcEAAAAAAAAAAAAmAAAAABswAAAAAAAAIAXBAAAAAACAAAAAAJgAAAAb
MAAAAAAACAFwQAAAAAAACyAAAAAGzAAAAAAAAAgBcEAAAAAAAAAAAAmAAAAABsw
AAAAAAAAIAXBAAAAAACAAAAAAJgAAAAbMAAAAAAACAFwQAAAAAAACyAAAAAGzAA
AAAAAAAAAgBcEAAAAAAAAAAAAmAAAAABswAAAAAAAAIAXBAAAAAACAAAAAAJgAAAAbMAAA
AAAAACAFwQAAAAAAACyAAAAAGzAAAAAAAAAgBcEAAAAAAAAAAAAmAAAAABswAAAA
AAAAIAXBAAAAAACAAAAAAJgAAAAbMAAAAAAACAFwQAAAAAAACyAAAAAGzAAAAAA
AAAAAgBcEAAAAAAAAAAAAmAAAAABswAAAAAAAAIAXBAAAAAACAAAAAAJgAAAAbMAAAAA
AACAFwQAAAAAAACyAAAAAGzAAAAAAAAAgBcEAAAAAAAAAAAAmAAAAABswAAAAAA
AIAAXBAAAAAACAAAAAAJgAAAAbMAAAAAAACAFwQAAAAAAACyAAAAAGzAAAAAA
gBcEAAAAAAAAAAAAmAAAAABswAAAAAAAAIAXBAAAAAACAAAAAAJgAAAAbMAAAAAAACAF
wQAAAAAAACyAAAAAGzAAAAAAAAAgBcEAAAAAAAAAAAAmAAAAABswAAAAAAAAIAXB
BAAAAAACAAAAAAJgAAAAbMAAAAAAACAFwQAAAAAAACyAAAAAGzAAAAAAAgBcE
AAAAAAAAAAAAmAAAAABswAAAAAAAAIAXBAAAAAACAAAAAAJgAAAAbMAAAAAAACAFwQA
AAAAAACyAAAAAGzAAAAAAAgBcEAAAAAAAAAAAAKAGIAMwAQAAAPoDAAD6AwAA
AAAAAACAAAAAAJgAAAAbMAAAAAAACAAAAAgAAAAAACAAAAAAAGYAAAAAGzAAAAAAAgAAAAIAA
AAAQAAAAAAAmAAAAABswAAAAAAAAIAAAACAAAAAACAAAAAAZgAAAAbMAAAAAAACAAAAAgAAA
AAAAAACAAAAAGYAAAAAGzAAAAAAAgAAAAIAAAAAQAAAAAAAmAAAAABswAAAAAAAAIAAAACAAAAA
EAAAAAAAZgAAAAbMAAAAAAACAAAAAgAAAABAAAAAAAGYQAAAEtAAAAAAAgAAAAIAAAD4
AAAAIAHmEAAAAAwAAAAAAIAAAACAAAAAACAAAAACAB5hAAAAASMAAAAAAACAAAAAgAAAAPgA
AAAAAgYQAAADAAAAAAAgAAAAIAAAAAAAIAHmEAAABEwAAAAAAIAAAACAAAAAA
AACAB5hAAAAAMAAAAAACAAAAAgAAAAFAAAAAgAeYQAAAEjAAAAAAAgAAAAIAAAAAAA
AIAHmEAAAAAwAAAAAAIAAAACAAAAAMAAAAACABwgAAAAAMAAAAAAAvKfMAQMA
AAeYAAAAADAAAAAAAgAAAAIAAAAAAAIAHmAAAAAwAAAAAAIAAAACAAAAAACAAAA
B5gAAAAAMAAAAAACAAAAAgAAAAAACAAAAAAAgAAAAIAAAAAAAIAH
mAAAAAwAAAAAAIAAAACAAAAAACAAAAACAB5gAAAAAMAAAAAACAAAAAgAAAAIAAAAAAAIAeY
AAAAADAAAAAAAgAAAAIAAAAAAAIAHmAAAAAwAAAAAAIAAAACAAAAAACAAAAACAB5gA
AAAAAMAAAAAACAAAAAgAAAAAACAAAAAAAgAeYAAAAADAAAAAAAgAAAAIAAAAAAAIAHmAAA
AAAwAAAAAAIAAAACAAAAAACAAAAACAB5gAAAAAMAAAAAACAAAAAgAAAAAACAAAA
ADAAAAAAAgAAAAIAAAAAAAIAHmAAAAAwAAAAAAIAAAACAAAAAACAAAAACAB5gAAAAA
MAAAAAAACAAAAAgAAAAAACAAAAAAAgAeYAAAAADAAAAAAAgAAAAIAAAAAAAIAHmAAAAAw
AAAAAAIAAAACAAAAAACAAAAACAB5gAAAAAMAAAAAACAAAAAgAAAAAACAAAAAgAeYAAAAADAA
AAAAAAAgAAAAIAAAAAAAIAHmAAAAAwAAAAAAIAAAACAAAAAACAAAAACAB5gAAAAAMAAA
AAAAAACAAAAAgAAAAAACAAAAAAAgAeYAAAAADAAAAAAAgAAAAIAAAAAAAIAHmAAAAAwAAA
AAAAIAAAACAAAAAACAAAAACAB5gAAAAAMAAAAAACAAAAAgAAAAAACAAAAAAAgAAAAIAA
AAAAAAIAHmAAAAAwAAAAAAIAAAACAAAAAACAAAAACAB5gAAAAAMAAAAAACAAAAAgAAA
AAAAAAIAHmAAAAAwAAAAAAIAAAACAAAAAACAAAAACAB5gAAAAAMAAAAAACAAAAAgAAA
AAAAAAAgAc80wEwLRAAAAAAABAAAAAQAAAAQAAAAFoHAAAAAEAAAAcAAAAwAAAAQAAAAF
AAAAAgAAAAcAAAAIAAAACQAAAFoAAABcAAAAxQAAAHAAAAxBAAAAcGAAAHMAAAB0AAAdQAAAHYA
AAB3AAAAeAAAAHkAAACQAAAtwAAAM8AADZAAAA2gAAANsAADcAAAA3QAAAN4AADfAAAA4AAA
AOEAAAdIAAAA4wAAAOQAAAD1AAAA5gAAAOcAAADoAAAAKQIAADYCAADDAGAAxAIAAEwDAABNAwAA
YgMAAGMDAACSCAAAmgAAAAwAAAAAAIAAAACAAAAAACAAAAACAB5oAAAAAMAAAAAACAAAA

AAC3AAAA6AAAAcGCAA2AgAAAtwIAACADAAAhAwAAyWMAAI sDAACoAwAAqQMAAOADAAAJBAAAJQQA
ACYEABQBAAAaUAUAEJFAAC3BQAAuUAAMsFAAA2BgAAOWYAAD4GAABtBgAAfwYAAJGAACoBwAA
sQcAAPEHAAD1BwAAHAaGAAcYIAAAcCAAAPggAAf8IAABhCAAAyggAAJI IAAAHAAUABwAFAAcABQAH
AAQABQAHAAUABwAFAAcABQAHAAUABwAFAAcABQAHAAUAAwAHAAUABwAFAAcABQAHAAUABwAFAAcA
BwAFAAcABQAHAAUABwACAAcAAAAAAPEHAABhCAAAyggAAJI IAAAHAAcAAgAHAP//BAAAAAARABh
AHYAZQgAFUAbAbtAGUAcgAAAAyUAUayADYANwAyADEAAAA7AID///gHdqX/w8AAAAAAAAAAAA
AAAAAAAAAQD+///ssWYphYAAAAAAAAAAAAAAAAAAAAAAEAyxkNBCZakED/D/8P/w//D/8P/w//
D/8P/w8QAOM1UwQBAAKE/w8AAAAAAAAAAAAAAAAAAAAAAQAkFy8FAQAJBP8PAAAAAAAAAAAAAAAA
AAAAAAEUnYgB7pm9hH/D/8P/w//D/8P/w//D/8P/w8BAGQUvvgBAAKE/w8AAAAAAAAAAAAAAAA
AAAAAQAwQOEI8MfGjv8P/w//D/8P/w//D/8P/w//DwAA23FCDAEACQT/DwAAAAAAAAAAAAAAAA
AAABAGYKoAwBAAKE/w8AAAAAAAAAAAAAAAAAAAAAAQBDJdQNEwAJBP8P/w//D/8P/w//D/8P/w//
DwEAKci4DyUACQT/D/8P/w//D/8P/w//D/8P/w8AAEtDeHYPAAKE/w8AAAAAAAAAAAAAAAA
AQcjfAEgCpfcqP8P/w//D/8P/w//D/8P/w//DxAAL+TIDqh9D7/D/8P/w//D/8P/w//D/8P/w8B
ACgOQYL4I+aN/w//D/8P/w//D/8P/w//D/8PEACyBJIiYF7Ghf8P/w//D/8P/w//D/8P/w//DwEA
I3THIGeACQT/DwAAAAAAAAAAAAAAAAAAAAABAGox4yUBAAKE/w8AAAAAAAAAAAAAAAAAAAAAQDw
ZnYoAHQo+v8P/w//D/8P/w//D/8P/w//DxAAAtR90LJ77Ehv/D/8P/w//D/8P/w//D/8P/w8QAF08
IiOBAAKE/w8AAAAAAAAAAAAAAAAAAAAAAQDmWCUVgl94bv8P/w//D/8P/w//D/8P/w//DxAAAt13h
NB08vh3/D/8P/w//D/8P/w//D/8P/w8QAOhQQzo01zQd/w//D/8P/w//D/8P/w//D/8P/w8PAQBMbMc7
AQAJBP8PAAAAAAAAAAAAAAAAAAAAAAEAmWFUPgEACQT/DwAAAAAAAAAAAAAAAAAAAAABAFE2Wj4B
AAKE/w8AAAAAAAAAAAAAAAAAAAAAAQD6f+Q+EwAJBP8P/w//D/8P/w//D/8P/w//DwEAsXY0PwEA
CQT/DwAAAAAAAAAAAAAAAAAAAAABAOGYXT+2u5b/w//D/8P/w//D/8P/w//D/8PEACqXvXHIpW4
KP8P/w//D/8P/w//D/8P/w//DwEAMkW2S8wm3vj/D/8P/w//D/8P/w//D/8P/w8QAHIFuk4BAAKE
/w8AAAAAAAAAAAAAAAAAAAAAQBoRV9PAQAJBP8PAAAAAAAAAAAAAAAAAAAAAAEAQ31mUWAtFJn/
D/8P/w//D/8P/w//D/8P/w8QAMNGmFOo96Ln/w8AAAAAAAAAAAAAAAAAAAAAAQC1V1hVMoL6B/8P
/w//D/8P/w//D/8P/w//DxAAAt1s7VgEACQT/DwAAAAAAAAAAAAAAAAAAAAABAKoFD1sBAAKE/w8A
AAAAAAAAAAAAAAAAAAAAAAQD6AptbnitAvv8PAAAAAAAAAAAAAAAAAAAAAAEAkTbuXUznPCQnAAAA
AAAAAAAAAAAAAAAAAAAAABANA2iF/GgrDx/w8AAAAAAAAAAAAAAAAAAAAAAQDnCLdgFEhob/8P/w//
D/8P/w//D/8P/w//DwEABlbJY2jtVt3/D/8P/w//D/8P/w//D/8P/w8BABFUqmYBAAKE/w8AAAAA
AAAAAAAAAAAAAAAAAAAAQAbXMFpAQAJBP8PAAAAAAAAAAAAAAAAAAAAAAEA1gvaaQJ1MPT/D/8P/w//
D/8P/w//D/8P/w8AAGxQjGoVAAKE/w//D/8P/w//D/8P/w//D/8PAQDMMW5rAQAJBP8PAAAAAA
AAAAAAAAAAAAAAAAAAAAEA9jqicAEACQT/DwAAAAAAAAAAAAAAAAAAAAABAIJ32XAYoHgU/w//D/8P/w//
D/8P/w//D/8PAQA0Z6xzAQAJBP8PAAAAAAAAAAAAAAAAAAAAAAEA83a9dgEACQT/DwAAAAAAAA
AAAAAAAAAAAAABABRFZncBAAKE/w8AAAAAAAAAAAAAAAAAAAAAAQDEKgv4AQAJBP8PAAAAAA
AAAAAAAAAAAAEATDokeiUACQQBAAIAAwAEAAUABgAHAAGACQAAAPg5L30BAAKE/w8AAAAAAAA
AAAAAAAAAAAAAQCKNiN/8MfGjv8P/w//D/8P/w//D/8P/w//DwAAAQAAABcAAAAAAAAAAAA
AAAAACxgAAA+ECACRhJj+FcYFAAEIBwZehAGHYSY/k9KAQBRsgEabygAAQC38AAAAAAAA
AAAAAAAAAAAAABACoAAQAAABcQAAAAAAAAAAAAAGgBAAAAAAAAAAFRgAAA+EoAURhJj+
FcYFAAGBQZehKAFYISY/k9KAQBRsgEabygAh2gAAAAAiEgAAAEat/ABAAAAF5AAAAAAAA
aEAAAAAAAAAZGAAAD4RwCBGEmP4VxgUAAXAIB16EcAhghJj+T0oGAFFKBgBeSgYabygAh2gAAAA
iEgAAAEAbwABAAAAF5AAAAAAAAAAAAaEAAAAAAAAAVGAAAD4RACxGEmP4VxgUAUAlB16EQAtg
hJj+T0oIAFFKCBvKACHaAAAAACISAAAAQCn8AEAAAAAXkAAAAAAAAAAAABoAQAAAAAABUYAAAP
hBAOeYSY/hXGBQABEA4GXoQQDmCEmP5PSgEAUuOBAG8oAIdoAAAAIhIAAABALfwQAAABeQAAAA
AAAAAAAAAGgBAAAAAAAGRgAAA+E4BARhJj+FcYFAAHgEAZehOAQYISY/k9KBgBRsgYAXkoGAG8o
AIdoAAAAIhIAAABAG8AAQAAABeQAAAAAAAAAAAAAGgBAAAAAAAFRgAAA+EsBMRhJj+FcYFAAGw
EwZehLATYISY/k9KCABRsgEabygAh2gAAAAAiEgAAAEAp/ABAAAAF5AAAAAAAAAAAAaEAAAA
AAAVGAAAD4SAFhGEmP4VxgUAAyAWB16EgBZghJj+T0oBAFFKAQbvKACHaAAAAACISAAAAQC38AEA
AAAXkAAAAAAAAAAAABoAQAAAAAABkYAAAPhFAZEYSY/hXGBQABUBkGXoRQGwCEmP5PSgEAUuOG
AF5KBgBvKACHaAAAAACISAAAAQBvAAEAAAAAXkAAAAAAAAAAAABoAQAAAAAABUYAAAPhCacEYSY
/hXGBQABIBwGXoQgHGCEmP5PSggAUUoIAG8oAIdoAAAAIhIAAABAKfwQAAABcAAAAAAAA
AAAAAAAAAAACxgAAA+EaAERhJj+FcYFAAFoAQZehGgBYISY/k9KAQBRsgEabygAAQC38AAAA
AAAAAAAAAAAAAAAsYAAAPhGgBEYSY/hXGBQABaAEGXoRoAWCEmP5PSgEAUuOBAG8o
AAEAt/ABAAAAF5AAAAAAAAAAAAAAALGAAAD4TQAhGEMPOVxgUAAAdCB16E0AJghDD9
T0oBAFFKAQbvKAABALfwAQAAABcAAAAAAAAAAAAAAACxgAAA+EaAERhJj+FcYFAAFo
AQZehGgBYISY/k9KAQBRsgEabygAAQC38AAAAAAAEAAAAAAAAAAAAAAACxgAAA+EaAERhJj+
EYQAAABXGBQABaAEGXoQAAGCEAAACAAAAALgABAAAAwABAAAAAAAAAAAAAAAAAAAAAAAGAAAD4TQ
AhGEAAVxgUAAAtgEB16E0AJghAAAAgABAC4AAQAAAAAAAAQAAAAAAAAAAAAAAABgAAA+E
oAURhAAAFcYFAAEIBwZehKAFYIQAAIAAgAuAAEAAAAEAAEAAAAAAAAAAAAAAAYAAAP
hHAIEYQAAABXGBQAB2AkGXoRwCGCEAAACAAMAKQABAAAAAAACAAAAAAAAAAAAAAAGAAA
D4RACxGEAAAVxgUAAAgMB16EQAtghAAAAwAooAQAKQABAAAAABACAAAAAAAAAAAAAA
GAAAD4QQDhGEAAAVxgUAAAGPBL6EEA5ghAAAAwAooAUAKQABAAAAAGACAAAAAAAAAAAA

AAAAGAAAD4TgEBGEAAVxgUAAUgSB16E4BBghAAAAwAoAAYAKQBAAAAABAACAAAAA
AAAAAAGAAAD4SwExGEAAVxgUAArGvB16EsBNghAAAAwAoAAcAKQBAAAAAgACAAAAA
AAAAAAGAAAD4SAFhGEAAVxgUAAegXB16EgBZghAAAAwAoAAgAKQBAAAAFwAAAAA
AAAAAAGAAAD4RoARGEmp4VxgUAAWgBB16EaAFghJj+T0oBAFFKAQBvKAABALfwQA
ABcAAAAA
bygAAQC38AEAAAABAAEAAAAAAMyAAAPhNACEYQw/RXGBQABOAIgXoTQAmCE
MP1vKAACAAALgABAAAAAABAAAAAANGAAAD4SwARGEUP4VxgUAAbABB16E
sAFghFD+bygAh2gAAAAAiEgAAEAAAAABAAAAABAwAAAAAQAQAAAAAQMFAAAAAA
wP0VxgUAAUACB16EQAJghMD9bygAh2gAAAAAiEgAAAAAAuAAEAAQAAAAAQMFAAAAAA
AAAAAADRgAAA+EOAIRhD9FcyFAAHQAgZehNACYIQw/W8oAIdoAAAAAIhIAAFAAAAAgBAC4A
AgABAAAAABAwUHAAAAAANGAAAD4RgAxGeOPwVxgUAAWADB16EYANGhKD8bygA
h2gAAAAAiEgAAAcAAAUAAEALgACAC4AAwABAAAAAABAwUHCQAAAAAANGAAAD4Tw
AxGEEPwVxgUAAfADB16E8ANGhBD8bygAh2gAAAAAiEgAAkAAAAuAAEALgACAC4AAwAuAAQAQAA
AAAAQMFBwLAAAAAADRgAAA+EGaQRhID7FcyFAAGABAZehIAEYISA+28oAIdoAAAA
AIhIAALAAALgABAC4AAgAuAAMALgAEAC4ABQABAAAAAABAwUHCQsNAAAAAANGAA
D4QQBRGE8PoVxgUAArAFB16EEAVghPD6bygAh2gAAAAAiEgAAA0AAAAuAAEALgACAC4AAwAuAAQA
hGD6bygAh2gAAAAAiEgAAA8AAAAuAAEALgACAC4AAwAuAAQALgAFAC4ABgAuAAcAAQAAAAAQMFA
BwLkDQ8RAAAAAAADRgAAA+EMAYRhND5FcyFAAEwBgZehDAGYITQ+W8oAIdoAAAAAIhIAAAR
AAAAALgABAC4AAgAuAAMALgAEAC4ABQAUAAALgAHAC4ACAABAAAAAABAAAAA
AAAAGAAAD4RoARGEmp4VxgUAAWgBB16EaAFghJj+AgAAAC4AAQAABcQAAAAAAGgBAAAA
AAAAFRgAAA+EOAURhJj+FcyFAAGBgZehKAFYISY/k9KAQBRsgEAbygAh2gAAAAAiEgAAEAT/AB
AAAAFxAAAAAaAEAAAAAZGAAAD4RwCBGEmP4VxgUAAAXIB16EcAhghJj+T0oGAFFK
BgBeSgYAbygAh2gAAAAAiEgAAEAbwABAAAAF5AAAAAaAEAAAAAVGAAAD4RACxGE
mp4VxgUAAUALB16EQAtghJj+T0oIAFFKCBvKACHAAAAACISAAAAQCn8AEAAAAAXkAAAAA
AABOQAQAAAAABUYAAAPhBAOEYSY/hXGBQABEA4GXoQQDmCEmp5PSgEAUuOBAG8oAIdoAAAAAIhI
AAABALfwQAABeQAAAAAAGgBAAAAAAGRgAAA+E4BARhJj+FcyFAAHgEAZehOQYISY
/k9KBgBRsgYAXkoGAG8oAIdoAAAAAIhIAAABAG8AAQAAABeQAAAAAAGgBAAAAA
AA+EsBMRhJj+FcyFAAGwEwZehLATYISY/k9KCABRSggAbygAh2gAAAAAiEgAAEAP/ABAAAAF5AA
AAAAAaAEAAAAAVGAAAD4SAFhGEmP4VxgUAAAYAWB16EgBZghJj+T0oBAFFKAQBvKACH
aAAAAACISAAAAQC38AEAAAAAXkAAAAAABOQAQAAAAABkYAAAPhFAZEYSY/hXGBQABUBkG
XoRQGWCEmp5PSgYAUUoGAF5KBgBvKACHAAAAACISAAAAQBvAAEAAAAAXkAAAAAABOQA
AAAAABUYAAAPhCACYSY/hXGBQABIBwGXoQgHGCEmp5PSggAUUoIAG8oAIdoAAAAAIhIAAABAKfw
AQAAAAQAQAAAAAAXgAAA+ECACRhJj+FcyFAAEIBwZehAgHYISY/m8oAAIA
AAAUAAEAAAAEAAAAAABOQAQAAAAABUYAAAPhKAFEYSY/hXGBQABOAugXoSgBWCEmp5P
SgEAUuOBAG8oAIdoAAAAAIhIAAABALfwQAABcQAAAAAAGgBAAAAAAGRgAAA+EcAgR
hJj+FcyFAAFwCAZehHAIYISY/k9KBgBRsgYAXkoGAG8oAIdoAAAAAIhIAAABAG8AAQAAABeQAAAA
AAAAAAGgBAAAAAAGRgAAA+EQAsRhJj+FcyFAAFACwZehEALYISY/k9KCABRSggAbygAh2g
AAAAAiEgAAEAP/ABAAAAF5AAAAAaAEAAAAAVGAAAD4QDhGEmP4VxgUAAAOB16E
EA5ghJj+T0oBAFFKAQBvKACHAAAAACISAAAAQC38AEAAAAAXkAAAAAABOQAQAAAAABkY
AAAPhOQeYSY/hXGBQAB4BAGXoTgEGCEmp5PSgYAUUoGAF5KBgBvKACHAAAAACISAAAAQBvAAEA
AAAXkAAAAAABOQAQAAAAABUYAAAPhLATEYSY/hXGBQABsBMGXoSWE2CEmp5PSggAUUoI
AG8oAIdoAAAAAIhIAAABAKfwQAABeQAAAAAAGgBAAAAAAGRgAAA+EGBYRhJj+FcyF
AAGAFgZehIAWYISY/k9KAQBRsgEAbygAh2gAAAAAiEgAAEAT/ABAAAAF5AAAAAaAE
AAAAAZGAAAD4RQGRGEmP4VxgUAAVAZB16EUB1ghJj+T0oGAFFKBgBeSgYAbygAh2gAAAAAiEgA
AAEAbwABAAAAF5AAAAAaAEAAAAAVGAAAD4QgHBGEmP4VxgUAAASACB16EIBxghJj+
T0oIAFFKCBvKACHAAAAACISAAAAQCn8AEAAAAAEMyAAAPhAgH
EYSY/hXGBQABCAcGXoQIB2CEmp5vKAACAAALgABAAAAFwAAAAAALGAA
D4RoARGEmp4VxgUAAWgBB16EaAFghJj+T0oBAFFKAQBvKAABALfwQAABcAAAAA
AAAAAAGcXgAAA+EAERhJj+FcyFAAFoAQZehGgBYISY/k9KAQBRsgEAbygAAQC38AEAAAAEAAA
AAAAAABOQAQAAAAABUYAAAPhKAFEYSY/hXGBQABOAugXoSgBWCEmp5PSgEAUuOBAG8oAIdo
AAAAAIhIAAABALfwQAABeQAAAAAAGgBAAAAAAGRgAAA+EcAgRhJj+FcyFAAFwCAZe
hHAIYISY/k9KBgBRsgYAXkoGAG8oAIdoAAAAAIhIAAABAG8AAQAAABeQAAAAAAGgBAAAA
AAAAFRgAAA+EQAsRhJj+FcyFAAFACwZehEALYISY/k9KCABRSggAbygAh2gAAAAAiEgAAEAP/AB
AAAAF5AAAAAaAEAAAAAVGAAAD4QDhGEmP4VxgUAAAOB16EEA5ghJj+T0oBAFFK
AQBvKACHAAAAACISAAAAQC38AEAAAAAXkAAAAAABOQAQAAAAABkYAAAPhOQeYSY/hXG
BQAB4BAGXoTgEGCEmp5PSgYAUUoGAF5KBgBvKACHAAAAACISAAAAQBvAAEAAAAAXkAAAAA
AABOQAQAAAAABUYAAAPhLATEYSY/hXGBQABsBMGXoSWE2CEmp5PSggAUUoIAG8oAIdoAAAAAIhI
AAABAKfwQAABeQAAAAAAGgBAAAAAAGRgAAA+EGBYRhJj+FcyFAAGAFgZehIAWYISY
/k9KAQBRsgEAbygAh2gAAAAAiEgAAEAT/ABAAAAF5AAAAAaAEAAAAAZGAAAD4RQ

GRGEmP4VxgUAAVAZB16EUB1ghJj+T0oGAFFKBgBeSgYAbygAh2gAAAAAiEgAAAEAbwABAAAAF5AA
AAAAAAAAAAAAAAAEAAAAAAAVGAAAD4QgHBGEmP4VxgUAAASAcB16EIBxghJj+T0oIAFFKCBvKACH
aAAAAACISAAAAQCn8AEAAAAXEAAAAAAAAAAAAABoAQAAAAAABUYAAAPhKAFEYSY/hXGBQABoAUG
XoSgBWCEmP5PSgEAUUoBAG8oAIdoAAAAAIhIAAABALfwAQAAABeQAAAAAAAAAAAAAGgBAAAAAAA
GRgAAA+EcAgRhJj+FcyFAAFwCAZehHAIYISY/k9KBgBRsGyAXkoGAG8oAIdoAAAAAIhIAAABAG8A
AQAAABeQAAAAAAAAAAAAAGgBAAAAAAAfRgAAA+EQAsRhJj+FcyFAAFwCAZehEALYISY/k9KCABR
SggAbygAh2gAAAAAiEgAAAEAp/ABAAAAF5AAAAAAAAAAAAAAAEAAAAAAAVGAAAD4QQDhGEmP4V
xgUAAAROB16EEA5ghJj+T0oBAFFKAQBvKACHaAAAAACISAAAAQC38AEAAAAAXkAAAAAAAAAAAAABo
AQAAAAAABkYAAAPhOAEYSY/hXGBQAB4BAGXoTgEGCEmP5PSgYAUUoGAF5KBgBvKACHaAAAAACI
SAAAAQBvAAEAAAAAXkAAAAAAAAAAAAABoAQAAAAAABUYAAAPhLATEYSY/hXGBQABsBMGXoSWE2CE
mP5PSggAUUoIAG8oAIdoAAAAAIhIAAABAKfwAQAAABeQAAAAAAAAAAAAAGgBAAAAAAAfRgAAA+E
gBYRhJj+FcyFAAGAFgZehIAWYISY/k9KAQBRsGEAbygAh2gAAAAAiEgAAAEAt/ABAAAAF5AAAAAA
AAAAAAAAAAAEAAAAAAAZGAAAD4RQGRGEmP4VxgUAAVAZB16EUB1ghJj+T0oGAFFKBgBeSgYAbygA
h2gAAAAAiEgAAAEAbwABAAAAF5AAAAAAAAAAAAAAAEAAAAAAAVGAAAD4QgHBGEmP4VxgUAAASAc
B16EIBxghJj+T0oIAFFKCBvKACHaAAAAACISAAAAQCn8AEAAAAXAAAAAAAAAAAAA
AAAsYAAAPhGgBEYSY/hXGBQABaAEGXoRoAWCEmP5PSgEAUUoBAG8oAAEAt/ABAAAAF5AAAAAA
AAAAAAAEAAAAAAAVGAAAD4SgBRGEmP4VxgUAAaAFB16EoAVghJj+T0oBAFFKAQBvKACHaAAAAACI
SAAAAQC38AEAAAAAXkAAAAAAAAAAAAABoAQAAAAAABUYAAAPhHAIEYSY/hXGBQABcAgGXoRwCGCE
mP5PSgYAUUoGAF5KBgBvKACHaAAAAACISAAAAQBvAAEAAAAAXkAAAAAAAAAAAAABoAQAAAAAABUY
AAAPhEALYSY/hXGBQABQAsGXoRAC2CEmP5PSggAUUoIAG8oAIdoAAAAAIhIAAABAKfwAQAAABeQ
AAAAAAAAAAAAAGgBAAAAAAAfRgAAA+EEA4RhJj+FcyFAAEQDgZehBAOYISY/k9KAQBRsGEAbygA
h2gAAAAAiEgAAAEAt/ABAAAAF5AAAAAAAAAAAAAAAEAAAAAAAZGAAAD4TgEBGEmP4VxgUAAeAQ
B16E4BBghJj+T0oGAFFKBgBeSgYAbygAh2gAAAAAiEgAAAEAbwABAAAAF5AAAAAAAAAAAAAAAEAA
AAAAAAAVGAAAD4SwExGEmP4VxgUAAAbATB16EsBNghJj+T0oIAFFKCBvKACHaAAAAACISAAAAQCn
8AEAAAAAXkAAAAAAAAAAAAABoAQAAAAAABUYAAAPhIAWEYSY/hXGBQABgBYGXoSafmCEmP5PSgEA
UUoBAG8oAIdoAAAAAIhIAAABALfwAQAAABeQAAAAAAAAAAAAAGgBAAAAAAAAGRgAAA+EUBkRhJj+
FcyFAAFQGGZehFAZYISY/k9KBgBRsGyAXkoGAG8oAIdoAAAAAIhIAAABAG8AAQAAABeQAAAAAAA
AAAAAGgBAAAAAAAfRgAAA+EIBwRhJj+FcyFAAEgHAZehCACyISY/k9KCABRSggAbygAh2gAAAA
AiEgAAAEAp/ABAAAAF5AAAAAAAAAAAAAAATGAAAD4Q4BBGEmP4VxgUAAATgEB16EOARg
hJj+T0oCAFbKAABRSgIAXkoCAG8oAAEALQABAAAAF4AAAAAAAAAAAAAAAZGAAAD4QI
BxGEmP4VxgUAAQgHB16ECAdghJj+T0oGAFFKBgBeSgYAbygAh2gAAAAAiEgAAAEAbwABAAAAF4AA
AAAAAAAAAAAAAAAVGAAAD4TYCRGEmP4VxgUAAAdgJB16E2A1ghJj+T0oIAFFKCBvKACH
aAAAAACISAAAAQCn8AEAAAAAXgAAAAAAAAAAAAAABUYAAAPhKgMEYSY/hXGBQABqAwG
XoSdGCEmP5PSgEAUUoBAG8oAIdoAAAAAIhIAAABALfwAQAAABeQAAAAAAAAAAAAA
GRgAAA+EA8RhJj+FcyFAAF4DwZehHgPYISY/k9KBgBRsGyAXkoGAG8oAIdoAAAAAIhIAAABAG8A
AQAAABeQAAAAAAAAAAAAAAAFRgAAA+ESBIRhJj+FcyFAAFIEgZehEgSYISY/k9KCABR
SggAbygAh2gAAAAAiEgAAAEAp/ABAAAAF4AAAAAAAAAAAAAAAVGAAAD4QYFRGEmP4V
xgUAAARgVB16EGBvghJj+T0oBAFFKAQBvKACHaAAAAACISAAAAQC38AEAAAAAXgAAAAAAAAAAAA
AAAAAAAAAABkYAAAPhOgXEYSY/hXGBQAB6BcGXoToF2CEmP5PSgYAUUoGAF5KBgBvKACHaAAAAACI
SAAAAQBvAAEAAAAAXgAAAAAAAAAAAAAABUYAAAPhLgaEYSY/hXGBQABuBoGXoS4GmCE
mP5PSggAUUoIAG8oAIdoAAAAAIhIAAABAKfwAQAAAAAAQAAAAAAAXgAAA+E
OAQRhJj+FcyFAAE4BAZehDgEYISY/m8oAAIAAAuAAEAAAAAXAAAAAAAAAAAAAAAsY
AAAPhGgBEYSY/hXGBQABaAEGXoRoAWCEmP5PSgEAUUoBAG8oAAEAt/ABAAAAF5AAAAAA
AAAAAAAAAALGAAAD4RoARGEmP4VxgUAAWgBB16EaAFghJj+T0oBAFFKAQBvKAABALfwAQAAABcA
AAAAAAAAAAAAAAACxgAAA+EAERhJj+FcyFAAFoAQZehGgBYISY/k9KAQBRsGEAbygA
AQC38AEAAAAABAAEAAAAAAAMyAAAPhNACEYQw/RXGBQAB0AIGXoTQAmCEMPlv
KAACAAAAALgABAAAAFwAAAAAAAAAAAAAAALGAAAD4RoARGEmP4VxgUAAWgBB16EaAFg
hJj+T0oBAFFKAQBvKAABALfwAQAAABcQAAAAAAAAAAAAANACAAAAAAEXgAAA+EOAQRhJj+FcyF
AAE4BAZehDgEYISY/k9KAQBRsGyAAUUCAF5KAQgBvKAABAC0AAQAAABeQAAAAAAANACAAAA
AAAAGRgAAA+EOAURhJj+FcyFAAGgBQZehKAFYISY/k9KBgBRsGyAXkoGAG8oAIdoAAAAAIhIAAAB
AG8AAQAAABeQAAAAAAANACAAAAAAfRgAAA+EcAgRhJj+FcyFAAFwCAZehHAIYISY/k9K
CABRSggAbygAh2gAAAAAiEgAAAEAp/ABAAAAF5AAAAAAAAAAAAAAOIAAAAAAAVGAAD4RACxGE
mP4VxgUAAUALB16EQAtghJj+T0oBAFFKAQBvKACHaAAAAACISAAAAQC38AEAAAAAXkAAAA
AADQAgAAAAAABkYAAAPhBAOEYSY/hXGBQABEA4GXoQQDmCEmP5PSgYAUUoGAF5KBgBvKACHaAAA
AACISAAAAQBvAAEAAAAAXkAAAAAAAAAAAAADQAgAAAAAABUYAAAPhOAEYSY/hXGBQAB4BAGXoTg
EGCEmP5PSggAUUoIAG8oAIdoAAAAAIhIAAABAKfwAQAAABeQAAAAAAANACAAAAAAfRgA
AA+EsBMRhJj+FcyFAAGwEwZehLATYISY/k9KAQBRsGEAbygAh2gAAAAAiEgAAAEAt/ABAAAAF5AA
AAAAAAAAAAAAOIAAAAAAAAZGAAAD4SAFhGEmP4VxgUAAAYAWB16EgBZghJj+T0oGAFFKBgBeSgYA
bygAh2gAAAAAiEgAAAEAbwABAAAAF5AAAAAAAAAAAAAAOIAAAAAAAVGAAD4RQGRGEmP4VxgUA
AVAZB16EUB1ghJj+T0oIAFFKCBvKACHaAAAAACISAAAAQCn8AEAAAAEAAEAAAAAAAAAAAAAA

AAAAAAAAAAAAAAAA0YCAAPhLATEYQAA BXGBQABGBUGXoSwE2CEAABvKACHaAAAAACISAAAAwAoAAgA
KQABAAAAwABAAAAAAAAAAAAAAAAAAAAAAAAADGAAAD4RoARGEmp4VxgUAAWgBB16EaAFghJj+bygA
AgAAAC4AAQAAABcAAAAAAAAAAAAAAAAAAAAAAAAACxgAAA+EaAERhJj+FcYFAAFoAQZehGgBYISY
/k9KAQBRsGAEbygAAQC38AEAAAAAXAAAAAAAAAAAAAAAAAAAAAAAAAsYAAAPhGgBEYSY/hXGBQAB
aEGXoRoAWCEmp5PSgEAUuOBAG8oAAEAt/ABAAAAAAAAAAAAAAAAAAAAAAAAADGAAAD4Q4
BBGEmP4VxgUAATgEB16EOARghJj+bygAAgAAAC4AAQAAABcAAAAAAAAAAAAAAAAAAAAAAAAACxgA
AA+EaAERhJj+FcYFAAFoAQZehGgBYISY/k9KAQBRsGAEbygAAQC38AEAAAAAXAAAAAAAAAAAAAAAA
AAAAAAAAAsYAAAPhGgBEYSY/hXGBQABaEGXoRoAWCEmp5PSgEAUuOBAG8oAAEAt/ABAAAAFwAA
AAAAAAAAAAAAAAAAAAAAAAAAALGAAAD4RoARGEmp4VxgUAAWgBB16EaAFghJj+T0oBAFFKAQBvKAAB
ALfwaQAAABcAAAAAAAAAAAAAAAAAAAAAAAAACxgAAA+EaAERhJj+FcYFAAFoAQZehGgBYISY/k9K
AQBRsGAEbygAAQC38AEAAAAAXAAAAAAAAAAAAAAAAAAAAAAAA0YAAAPhLBEYRQ/hXGBQABsAEG
XoSwAWCEUP5vKACHaAAAAACISAAAAQAAAAEAAAAAEDAAAAAAAAAAAAAAAAAAAAAAAA0YAAAPhEAC
EYTA/RXGBQABQAIgXoRAAmCEwP1vKACHaAAAAACISAAAAwAAAC4AAQABAAAAAABAwUAAAAAAAA
AAAAAAAAANGAAAD4TQAhGEMP0VxgUAAdACB16EOAJghDD9bygAh2gAAAAAiEgAAAUAAAUAAEA
LgACAAEAAAAAEDBQCAAAAAAAAAAAAAAAAAAAAAAAA0YAAAPhGADEYSg/BXGBQABYAMGXoRgA2CEoPxxv
KACHaAAAAACISAAAAwAAAC4AAQAAuAAIALGADAAEAAAAAEDBQCJAAAAAAAAAAAAAAAAAAAAAAAA0YAAAP
hPADEYQQ/BXGBQAB8AMGXoTWA2CEEPxxvKACHaAAAAACISAAACQAAAC4AAQAAuAAIALGADAC4ABAAB
AAAAAAAAABAwUHCQsAAAAAAAAAAAAAAAAANGAAAD4SABBGEgPsVxgUAAyAEBl6EgARghID7bygAh2gA
AAAAAiEgAAAsAAAAuAAEAALgACAC4AAwAAuAAQALgAFAAEAAAAAEDBQCJCw0AAAAAAAAAAAAAAAA0Y
AAAPhBAFEYTw+hXGBQABEAUGXoQQBWCE8PpvKACHaAAAAACISAAADQAAAC4AAQAAuAAIALGADAC4A
BAAUAAUALgAGAAEAAAAAEDBQCJCw0PAAAAAAAAAAAAAAAA0YAAAPhKAFEYRg+hXGBQABoAUGXoSg
BWCEYPPvKACHaAAAAACISAAADwAAAC4AAQAAuAAIALGADAC4ABAuAAUALgAGAC4ABwABAAAAAAB
AwUHCQsNDxEAAAAAAAAAAAAAAAAANGAAAD4QwBhGE0PkVxgUAATAGB16EMAZghND5bygAh2gAAAAAiEgA
ABEAuuAAEAALgACAC4AAwAAuAAQALgAFAC4ABgAAuAAcALgAIAEAAAAAXAAAAAAAAAAAAAAAAAAAA
AAAAAsYAAAPhGgBEYSY/hXGBQABaEGXoRoAWCEmp5PSgEAUuOBAG8oAAEAt/ABAAAAAQABAAAA
AAAAAAAAAAAAAAAAAAGAAAD4QAABGEAAVxgUAAWgBB16EAABghAAAAGAAAC4AAQAAAAAMAAQAA
AAAAAAAAAAAAAAAAAAAAABgAAA+E0AIRhAAAFcYFAAE4BAZehNACYIQAAlAAQAAuAAEAAAAAAAAEA
AAAAAAAAAAAAAAAAAAAAAYAAAPhKAFEYQAA BXGBQABCAcGXoSgBWCEAAACAAIALgABAAAAABAAB
AAAAAAAAAAAAAAAAAAAAAGAAAD4RwCBGEAAAVxgUAAdgJB16EcAhghAAAAgADACkAAQAAAAAA
AgAAAAAAAAAAAAAAAAAAAAABgAAA+EQAsRhAAAFcYFAAGoDAZehEALYIQAAMAKAAEACkAAQAA
AAQAAgAAAAAAAAAAAAAAAAAAAAABgAAA+EEA4RhAAAFcYFAAF4DwZehBAOYIQAAMAKAAAFACkA
AQAAAAIAAgAAAAAAAAAAAAAAAAAAAAABgAAA+E4BARhAAAFcYFAAFIEgZehOQYIQAAMAKAAAG
ACkAAQAAAAQAAgAAAAAAAAAAAAAAAAAAAAABgAAA+EsBMRhAAAFcYFAAEYFQZehLATYIQAAMA
KAHACkAAQAAIAAgAAAAAAAAAAAAAAAAAAAAABgAAA+EgBYRhAAAFcYFAAHoFwZehIAWYIQA
AMAKAAIACkAQgAAAEML1A0AAAAAAAAAAAAAAAAAD6f+Q+AAAAAAAAAAAAAAAAAbFCMagAAAAAAAAAA
AAAAAFJ2IACAAAAAAAAAAAAAAAAAjdMciAAAAAAAAAAAAAAAAATDOkegAAAAAAAAAAAAAAAAAP7///8A
AAAAAtPdFAwEAAACA///AAAAAAAAAAAAAAAAANGescwAAAAAAAAAAAAAAAAABRFZncAAAAAAAAAAAA
AADQNohfAAAAAAAAAAAAAAAA83a9dgAAAAAAAAAAAAAAAAF08Ii0AAAAAAAAAAAAAAAAAD4OS99AAAA
AAAAAAAAAAAAaEVfTwAAAAAAAAAAAAAAAAAIJ32XAAAAAAAAAAAAAAAAuX5MgAAAAAAAAAAAAAA
BlbJYwAAAAAAAAAAAAAAAAOhQQzoAAAAAAAAAAAAAAAAAKFy8FAAAAAAAAAAAAAAAAA+gKbWwAAAAAA
AAAAAAAAAGYKoAwAAAAAAAAAAAAAAAAADDRphTAAAAAAAAAAAAAAAAAS10SFgAAAAAAAAAAAAAAJ1h
VD4AAAAAAAAAAAAAABkFL4IAAAAAAAAAAAAAAAEVsqZgAAAAAAAAAAAAAALdbO1YAAAAAAAAAA
AAAAACxdjQ/AAAAAAAAAAAAAAAcgW6TgAAAAAAAAAAAAAAGox4yUAAAAAAAAAAAAAApNu5d
AAAAAAAAAAAAAA5wi3YAAAAAAAAAAAAAAAKpdXecAAAAAAAAAAAAAAAbXMFpAAAAAAAAAAAAAA
AAAAxCoFeAAAAAAAAAAAAAAAKoFD1sAAAAAAAAAAAAAADMMW5rAAAAAAAAAAAAAA23FCDAAA
AAAAAAAAAAAAAGYExzsAAAAAAAAAAAAAABRN1o+AAAAAAAAAAAAAA9jqicAAAAAAAAAAAAAA
ALIEkiIAAAAAAAAAAAAAAApNu5dAAAAABzx3wMBAAAA4yVTBAAAAAAAAAAAAAAACk2710AAAAA
KPhfAwEAAAAPnu5dAAAAADTx3wMBAAAAKTbuXQAAAAABA8d8DAQAAACk2710AAAAATPhfAwEAAAAP
Nu5dAAAAAFjx3wMBAAAAKTbuXQAAAAABk8d8DAQAAEN9Z1EAAAAAAAAAAAAAADmWCUvAAAAAA
AAAAAAAA03wBIAAAAAAAAAAAAAAALVXWfUAAAAAAAAAAAAAAoDkMiAAAAAAAAAAAAAAAYxkN
AAAAAAAAAAAAAAADBA4QgAAAAAAAAAAAAAAACKNiN/AAAAAAAAAAAAAAAlgvaaQAAAAAAAAAA
AAAAJAouA8AAAAAAAAAAAAAADWZnYoAAAAAAAAAAAAAAAtR90LAAAAAAAAAAAAAADJftksA
AAAAAAAAAAAAAAAC2XeE0AAAAAAAAAAAAAA6BhdPwAAAAAAAAAAAAAAAP/////////
/////////A8N8DYP///wEAAAAAXQAAAAAAAAAAAAAAeAAAAA8QAAAPhIAHEYSI
/16EgAdghIj/Q0oSAE9KAQBRsGAEbygAAQC38P/////////
/////////
/////////
/////////8BAAAAEABAAP/////////AQAAABAAAQD/////////AQAAABAAAQD/////////
AQAAABCEmp7/////////AQAAABAAAAD/////////AQAAABCEmp7/////////
/////////zsAAAAAAAAAAAAAA

AA
AA // 87AAAAAAAAABTIA
AQAJBAMACQQFAAAkEAQAJBAMACQQFAAAkEAQAJBAMACQQFAAAkEAAAAAAAAAAAAAAAAAAAAAS
AAEACQQDAAkEBQAJBAEACQQDAAkEBQAJBAEACQQDAAkEBQAJBAEAEgABAAkEAWAJBAUACQQBAAkE
AWAJBAUACQQBAAkEAWAJBAUACQQAASAAEACQQDAAkEBQAJBAEACQQDAAkEBQAJBAEACQQD
AAkEBQAJBBIAAQAJBAMACQQFAAAkEAQAJBAMACQQFAAAkEAQAJBAMACQQFAAAkEAAAASAAEACQQDAAkE
BQAJBAEACQQDAAkEBQAJBAEACQQDAAkEBQAJBBIAgCxoXAMACQQFAAAkEAQAJBAMACQQFAAAkEAQAJ
BAMACQQFAAAkEAAAAAAAAAAAAAAAAAAEGCALHTEAWAJBAUACQQBAAkEAWAJBAUACQQBAAkEAWAJBAUA
CQQAABIAGDCIGBKACQQBAkEDWAJBBKACQQBAkEDWAJBBKACQQBAkEAAAAABIAAQAJBAMACQQF
AAkEAQAJBAMACQQFAAAkEAQAJBAMACQQFAAAkEAAAASAAEACQQDAAkEBQAJBAEACQQDAAkEBQAJBAEA
CQQDAAkEBQAJBAAAEsAa0Kn
AKMGFg4BAAAAADiP/cDowYWDgEAAAAAK5UGAefb1dIAQAAAAAG1+2CJ9vV0gBAAAAADTDaQK
n29XSAAEAAAAAKMGFg4AAAAAAAAAABAGACABxrDhGjBhYOAQAAAAAAkzsOE6MGFg4BAAAAABP
XCkwn29XSAAEAAAAA9B4jJ59vV0gBAAAAAMXoIzCjBhYOAQAAAAAA9xz6MKMGFg4BAAAAAXYAC
KKMGFg4BAAAAAM4WF0rn29XSAAEAAAAAMxoiZCjBhYOAQAAAAAA9xz6MKMGFg4BAAAAABVt5zO
owYWDgEAAAAABVt5zOfb1dIAQAAAAAACzP0NKMFG4BAAAAAM+OTw3n29XSAAEAAAAAGDLWzej
BhYOAQAAAAATmm20J9vV0gBAAAAADjCuM4owYWDgEAAAAAGV1Ozyfb1dIAQAAAAAI03UPKMG
Fg4BAAAAADXLxo+owYWDgEAAAAAOcbBECfb1dIAQAAAAAYH7MQAMGFg4BAAAAACwFDxDn29X
SAAEAAAAAMVD1USjBhYOAQAAAAA6U9JRZ9vV0gBAAAAABiH11GowYWDgEAAAAADdPw0efb1dI
AQAAAAAn29XSAAAAAAAAAAAAECAAIAayN6TAAAAAAAAAAAAECAAIAAU9RTqMGFg4BAAAAACL
TWFQowYWDgEAAAAAHt4g1Cfb1dIAQAAAAA3BuFUKMGFg4BAAAAADjKnJSowYWDgEAAAAACM5
0VojBhYOAQAAAAAU38KWqMGFg4BAAAAADtEp1dowYWDgEAAAAAJgMQmCjBhYOAQAAAAAACdG
YJ9vV0gBAAAAADpdVphm29XSAAEAAAAA0uzWGfb1dIAQAAAAASWb1ZJ9vV0gBAAAAACpbjxl
owYWDgEAAAAAJtreGWfb1dIAQAAAAAE2SJZqMGFg4BAAAAADzQMppowYWDgEAAAAAGBy5Gqj
BhYOAQAAAAA1AuZa59vV0gBAAAAAMuIb5rowYWDgEAAAAADYx9WYfb1dIAQAAAAAiDBmbaMG
Fg4BAAAAABzC51tn29XSAAEAAAAANBPWm6jBhYOAQAAAAAYR0yb6MGFg4BAAAAABUSWnXowYW
DgEAAAAAH1wFXkjBhYOAQAAAAAgCbfcP9vV0gBAAAAAM0Qgx0owYWDgEAAAAALQOEXSfb1dI
AQAAAAA61pkdZ9vV0gBAAAAAD0HKV4owYWDgEAAAAAHJ7OHqfb1dIAQAAAAATzhheqMGFg4B
AAAAACVeh9n29XSAAEAAAAAGQYHH+jBhYOAQAAAAAegAAAAQAAAAIAAAA5QAAAAAAABUAAAA
ugECAN1DAwBtFwgAlFwIADwPCQC9FwoApl8LALUZDgBsWBEAH3gRAGs1EgBvSBMA4X0UACVAFgDS
ShgAVRYZAMQ06ABmMR4Aj0IKAM51JwCiMiKaFgctADQMlgDrPjAA3icyAHRFNABbszQAeHU1AHJ6
NQBiTjKazq2HAFUgPAD0WTwAlB49AEDhPQDcP0AAH1ZAADBeQAAROUIANkhFAOoDSABSBUgAAFhI
A05ySQCFEesApklMACkKUwDFNVQAc0JYABp4WAFFzFSA0U1cADIVYQDLJ2IANXdiACURYwBcFmQA
Bjx1AEsOZgCDP20Ac11yAFIDcwDwXHQAmnp5ADJwfgAD/V4IAGDKEAPZ5hwA4BYgA81yIALcsigB1
CYsAo20LAGtejqAUWo8ArFyRAGzhmgD3XJwAvFeeAPp/pAD9LKYAtEKpAH14qgB2RK4Ani6xAN8E
sgAYOLUA0X22ALhuuQALIRwADje8AM18vWBKfCUAZ0FGAISjyAARSc4AZkTPAEhyzwdNQtEALBfT
AMBL1wCnVtsA+TzCAGB33gA+Jt8AkBjjABV55wB2HugAUWjoAKMQ6wDpXewADjHtAOI87QBPf04A
0ArVAG5z8wD1XFUAAij4AKMs+gA3Fv0ADUz9AFR4/wAAAAAAtwIAAL0CAADDgAAxAIAAMwCAADd
AgAA3gIAAOYCAAD3AgAA+AIAAAADAAALwAADAMAABQDAAAfAWAAIAMAADQDAAA1AWAAPwMAAEwD
AABNAwAAVQMAAGIDAABjAwAAkggAAAAAAAAIAAAAAGEAIAAACEAQAEAgEAIAAACEAQAEAgEA
AAI BAACEAQAEAgEAIAAACEAQAEAgEAIAAACEAQAEAgEAIAAACEAQAEAgEAIAAACEAQAEAgEAIA
AgEAAJYBAAT/QAOAAQAOAgAAKATAAOjj0Q0BAAEAKATAAAAAAAAAAaAgAAQITAEWIAQAAAAAAAJE
AACQAAAQAEAAAP//AQAAAAcAVQBAGsAbgBvAHcAbgD//wEACAAAAAAAAAAAAAAAAAA//8BAAAAD/
/wAAAgD//wAAAD//wAAAgD//wAAAAJAAAArxaQAQAAAgIGAUEBQIDBI d6ACAAAACACAAAAAAA
AAD/AQAAAAAAAFQAaQBtAGUAcwAgAE4AZQB3ACAAUgBvAG0AYQBUAAAAANRaQAQIABQUBAgEHBgIF
BwAAAAAAAAAQAAAAAAAAAAAAACAAAAAFMAEQbtAGIAbwBsAAAAmyaQAQAAAgSGBAICAgICBI d6
ACAAAACACAAAAAAAAD/AQAAAAAAEEAcgBpAGEAbAAAAG0MLAEAGQIOBQCcAgYCBAQDAAAAAAAA
AAAAAAAAAAAAAQAAAAAAAAABDAG8AcABwAGUAcgBwAGwAYQB0AGUAIABHAG8AdABoAGkAYwAgAEWA
aQBnAGgAdAAAAEgAZQBShYAZQB0AGkAYwBhAAAAARzWQAYAKAgIGCQCCBqgDBL8CAKD7/MdoEAAA
AAAAAACfAAIAAAAAAE0AUwAgAE0AaQBwAGMAaBvAAAAALf8z/yAADmYdZwAAQSAQAQAAAgSFBgIC
AgMCBICCAAAAAAAAAAAAAACfAAAAAAAAAAAAEAcgBpAGEAbAAgAE4AYQByAHIAbWb3AAAApZWQ
AQAAAgcDCQICBQIEBI d6ACAAAACACAAAAAAAAD/AQAAAAAAEMAbwB1AHIAaQB1AHIAIABOAGUA
dwAADUmAAAAAILBgQDBQQEAgShEgBhAAAAAgAAAAAAAA/wEBAAAAABUAGEAaABvAG0AYQAA
ADsGkAECAUAUAAAAAAAAAAAAEAAAAAAAAAAAAAgAAAAABXAGkAbgBnAGQAaQBwAgcA
cwAAACIABAAxCiGYPDQAgAAaEAAAAAZ/KIJKPziCbAyoHmDAB1AAAAIgEAAM8GAAABAEMAAAAE
AAMQZgAAACIBAADPBgAAQBDAAAAZgAAAAAAAAhAWDwEAAAAAAAAAAAAAAAAAAAAAAAAAAAA
AA
AA

From - Thu Feb 10 14:15:13 2005
 Return-Path: <jmv@motorola.com>
 Received: from az43exm04.phx.mcd.mot.com ([144.191.86.40])
 by pooh.tcg.mcg.mot.com (8.11.6/8.9.3) with ESMTTP id i8RLoip32221
 for <CLAYTON@POOH.TCG.MCG.MOT.COM>; Mon, 27 Sep 2004 14:50:44 -0700
 Received: by az43exm04.phx.mcd.mot.com with Internet Mail Service (5.5.2657.72)
 id <TXXX45RQ>; Mon, 27 Sep 2004 14:14:06 -0700
 Message-ID: <3F05200B37A1D511BE550002B3289243159F1414@az43exm04.phx.mcd.mot.com>
 From: Villevieille J-P26721 <jmv@motorola.com>
 To: Ahmad Ahsan-G30074 <ahsan.ahmad@motorola.com>,
 Natt Amrit-AAN040
 <amritnatt@motorola.com>,
 Will Andrew-AWILL1 <Andrew.Will@motorola.com>,
 Matlock Christine-G20007 <christine.c.matlock@motorola.com>,
 Costello Edward-G20048 <ejc@motorola.com>,
 CLAYTON MARK-AMC036
 <Mark.Clayton@motorola.com>,
 Roth Matthew-p53995
 <Matthew.Roth@motorola.com>,
 Rutledge Shawn-E50053
 <shawn.rutledge@motorola.com>
 Subject: RE: When do I get content that I just bought?
 Date: Mon, 27 Sep 2004 14:14:05 -0700
 MIME-Version: 1.0
 X-Mailer: Internet Mail Service (5.5.2657.72)
 Content-Type: multipart/alternative;
 boundary="-----=_NextPart_001_01C4A4D6.EB9A60FA"

This message is in MIME format. Since your mail reader does not understand this format, some or all of this message may not be legible.

-----=_NextPart_001_01C4A4D6.EB9A60FA
 Content-Type: text/plain

Ashan,

Actually, the use case was debated before and may or may not be included in version1
 regards...JMV

Jean-Marc Villevieille
 Director Engineering Advanced Solutions
 Motorola
 Tempe, AZ
 (W) 602-659-8177
 (M) 480-236-3446
 jmv@motorola.com <mailto:jmv@motorola.com>

-----Original Message-----

From: Ahmad Ahsan-G30074
 Sent: Monday, September 27, 2004 11:57 AM
 To: Ahmad Ahsan-G30074; Natt Amrit-AAN040; Will Andrew-AWILL1; Matlock Christine-G20
 Subject: When do I get content that I just bought?

This is something we need to consider during detailed design but I thought I'd ask b
 Under the present design we were (I was) envisioning If I am listening to a song vi
 Once a user sends a request to buy content should we allow them to replay the conten

LS0tLTxCUj48Qj5Gcm9tOjwvQj4gQWhtYWQgDQogIEFoc2FuLUczMDA3NCA8Q1I+PEI+U2VudDo8
L0I+IE1vbmRheSwgU2VwdGVtYmVyIDI3LCAyMDA0IDEoXjU3IA0KICBBTtXCUj48Qj5Ubzo8L0I+
IEFobWFkIEFoc2FuLUczMDA3NDsgTmF0dCBbbXJpdC1BQU4wNDA7IFdpbGwgQW5kcmV3LUFXSUxM
MTsgDQogIE1hdGxvY2sgQ2hyaXN0aW51LUcyMDAwNzsgQ29zdGVsbG8gRWR3YXJkLUcyMDA0ODsg
VmlsbGV2aWVpbGx1IEotUDI2NzIxOyANCiAgQ0xBWVRPTiBNQVJLLUFNQzAzNjsgUm90aCBNYXR0
aGV3LXA1Mzk5NTsgUnV0bGVkZ2UgDQogIFNoYXduLUU1MDA1MzxCUj48Qj5TdWJqZWN0OjwvQj4g
V2h1biBkbyBJIGdldCBjb250ZW50IHRoYXQgSSBqdXN0IA0KICBib3VnaHQ/PEJSPjxCUj48L0ZP
TlQ+PC9ESVY+DQogIDxESVY+PEZPTlQgZmFjZT1Bcm1hbCBzaXplPTI+PFNQQU4gY2xhc3M9MzY3
MTYzNDE4LTI3MDkyMDA0P1RoaxMgaXMgc29tZXRoaw5nIA0KICB3ZSBuZWVkiHRvIGNvbnNpZGVy
IGR1cm1uZyBkZXRhaWx1ZCBkZXNpZ24gYnV0IEkqdGhvdWdodCBJJ2QgYXNrIGJlZm9yZSBjIA0K
ICBmb3JnZXQuPC9TUEFOPjwvRk9OVD48L0RJVj4NCiAgPERJVj48Rk9OVCBmYWN1PUFyaWFsIHNP
emU9Mj48U1BBTiANCiAgY2xhc3M9MzY3MTYzNDE4LTI3MDkyMDA0PjwvU1BBTj48L0ZPTlQ+Jm5i
c3A7PC9ESVY+DQogIDxESVY+PEZPTlQgZmFjZT1Bcm1hbCBzaXplPTI+PFNQQU4gY2xhc3M9MzY3
MTYzNDE4LTI3MDkyMDA0P1VuZGVyIHRoZSBwcmVzZW50IA0KICBkZXNpZ24gd2UmbmJzcDsmbmJz
cDt3ZXJlIChJHdhcykgZW52aXNpb25pbmVzSWYgSSBhbSBsaXN0ZW5pbmVzG8gYSBzb25nIHZp
YSANCiAgVjZGlVIGluIG15IGNhciBhbmQgSSB3YW50IHRvIGJleSBpdCBJIGNsaW50ICJwdXNo
IHRvIGJleSIuIEJldCBJIGNhbid0IA0KICBsaXN0ZW50IGdG8gdGh1IGNvbnR1bnQgdG8gdGh1IHRy
YWNrIGFnYWluIHVudGlsIEkqZ2V0IGhvbWUgb3IgdG8gYSBob3RzcG90IGFuZCANCiAgc3luYy4g
PC9TUEFOPjwvRk9OVD48L0RJVj4NCiAgPERJVj48Rk9OVCBmYWN1PUFyaWFsIHNPemU9Mj48U1BB
TiANCiAgY2xhc3M9MzY3MTYzNDE4LTI3MDkyMDA0PjwvU1BBTj48L0ZPTlQ+Jm5ic3A7PC9ESVY+
DQogIDxESVY+PEZPTlQgZmFjZT1Bcm1hbCBzaXplPTI+PFNQQU4gY2xhc3M9MzY3MTYzNDE4LTI3
MDkyMDA0Pk9uY2UgYSB1c2VyIHN1bmRzIA0KICBhIHJlcXVlc3QgdG8gYnV5Jm5ic3A7Y29udGVu
dCBzaG91bGQgd2UgYWxsY29udGVuZSB0byByZXBsYXkgdGh1IGNvbnR1bnQgdGhhdCANCiAgdGh1
eSBqdXN0IGJvdWdodCBpbW11ZG1hdGVseT88L1NQQU4+PC9GT05UPjwvRElWPg0KICA8RElWPjxG
T05UIGZhY2U9QXJpYWwgZ216ZT0yPjxTUEFOIA0KICBjbGFzc0zNjcxNjMOMTgtMjcwOTIwMDQ+
PC9TUEFOPjwvRk9OVD4mbmJzcDs8L0RJVj4NCiAgPERJVj48Rk9OVCBmYWN1PUFyaWFsIHNPemU9
Mj48U1BBTiANCiAgY2xhc3M9MzY3MTYzNDE4LTI3MDkyMDA0P1RoYw5rcyw8L1NQQU4+PC9GT05U
PjwvRElWPg0KICA8RElWPjxGT05UIGZhY2U9QXJpYWwgZ216ZT0yPjxTUEFOIA0KICBjbGFzc0z
NjcxNjMOMTgtMjcwOTIwMDQ+PC9TUEFOPjwvRk9OVD4mbmJzcDs8L0RJVj4NCiAgPERJVj48Rk9O
VCBmYWN1PUFyaWFsIHNPemU9Mj48U1BBTiANCiAgY2xhc3M9MzY3MTYzNDE4LTI3MDkyMDA0PkFo
c2FuPC9TUEFOPjwvRk9OVD48L0RJVj48L0JMT0NLUVVPVEU+PC9CT0RZPjwvSFRNTD4NCg==

----- _ = _NextPart_001_01C4A4D6.EB9A60FA--

From - Thu Feb 10 14:16:42 2005
Return-Path: <Michael.Pearce@Motorola.com>
Received: from az33exr03.mot.com ([10.64.251.233])
by pooh.tcg.mcg.mot.com (8.11.6/8.9.3) with ESMTTP id i8TIvWp03045
for <CLAYTON@POOH.TCG.MCG.MOT.COM>; Wed, 29 Sep 2004 11:57:32 -0700
Received: from labs.mot.com (udomsvc2.labs.mot.com [173.23.250.2])
by az33exr03.mot.com (Motorola/az33exr03) with ESMTTP id i8TIKBI032309;
Wed, 29 Sep 2004 13:20:11 -0500
Received: from udomsvc6.labs.mot.com (udomsvc6.labs.mot.com [173.23.250.6])
by labs.mot.com (MotLabs Smoke & Mirrors) with ESMTTP id i8TIKQ5j022043;
Wed, 29 Sep 2004 13:20:26 -0500 (CDT)
Received: from ames (ames.labs.mot.com [173.23.163.2])
by ims2.labs.mot.com (iPlanet Messaging Server 5.2 (built Feb 21 2002))
with ESMTTP id <0I4T0036PEY2Y8@ims2.labs.mot.com>; Wed,
29 Sep 2004 13:20:26 -0500 (CDT)
Date: Wed, 29 Sep 2004 13:20:26 -0500
From: Michael Pearce <Michael.Pearce@Motorola.com>
Subject: iRadio Streaming Media Protocol
To: "'Mark Clayton'" <mark.clayton@Motorola.com>,
Villevieille Jean Marc-P26721 <jmv@Motorola.com>,
Costello Edward-G20048 <ejc@Motorola.com>
Cc: Tzvetan Horozov <horozov@labs.mot.com>,
"'Jay Almaula'" <Jay.Almaula@Motorola.com>,
"'Venu Vasudevan'" <CVV012@Motorola.com>
Message-id: <00e801c4a650\$fe33f930\$02a317ad@labs.mot.com>
MIME-version: 1.0
X-MIMEOLE: Produced By Microsoft MimeOLE V6.00.2800.1441
X-Mailer: Microsoft Outlook, Build 10.0.6626
Content-type: text/plain; charset=us-ascii
Content-transfer-encoding: 7BIT
Importance: Normal
X-Priority: 3 (Normal)
X-MSMail-priority: Normal

Folks,

Before I get started working on the document again, I wanted to summarize the results of our meeting this morning.

- The current protocol is geared towards abstract commands only. The iRadio team feels they will have more flexibility if we can support low-level user events that are interpreted by the handset software. We'll still need the abstract commands for the in-home scenario. So, there will be three categories of messages in this area:

- + Interaction Events (key pressed/released, dials, switches)
- + Renderer Commands (pause, play, flush buffers)
- + Server Commands (goto channel, next channel, prev channel, next track, ...)

- Initialization will require the in-car adaptor to tell the handset about itself (software version) and about the head unit it's attached to (deck id).

- We'll need a power-down event from the in-car adapter to signal a graceful termination of the session.

- Push-to-buy will be special cased everywhere:

- + In the car, PTB will be interpreted based on the low-level events from the in-car adapter and recorded for later synchronization with the server.
- + On the go, PTB will be directly available on the handset UI and will be

*recorded for later synchronization with the server.

+ In the home, PTB will be directly available on the handset UI and will be sent immediately to the server as a command.

- The current ID3 message will be replaced with an abstract metadata message that can include any or all of these fields:

- + Artist
- + Title
- + Album
- + Genre
- + Channel Number
- + Channel Name
- + Track Number
- + Total Tracks
- + Channel Length
- + Track Length
- + Channel Time Remaining
- + Track Time Remaining

- Ed will be working on an interaction event format proposal that includes the necessary support for dials and switches as well as buttons while I work on other changes to the document.

If I've missed anything, let me know.

Note, I've been looking through the A2DP and AVRCP Bluetooth specs. There are a couple of interesting things I've learned:

- A2DP basically uses IETF's RTP over L2CAP (instead of over UDP/IP).
- AVRCP basically uses IEEE 1394's AV/C over L2CAP (instead of over firewire). This is a very abstract, high-level control scheme.

Mike

--

Mike Pearce
Pervasive Platforms and Architectures Lab,
Center for Applications, Content and Services Research,
Motorola Labs
email: Michael.Pearce@Motorola.com
"Stamp out extremism!"

From - Thu Feb 10 14:17:07 2005
Return-Path: <Michael.Pearce@motorola.com>
Received: from az43exm04.phx.mcd.mot.com ([144.191.86.40])
by pooh.tcg.mcg.mot.com (8.11.6/8.9.3) with ESMTTP id i8UJbtp09590
for <CLAYTON@POOH.TCG.MCG.MOT.COM>; Thu, 30 Sep 2004 12:37:55 -0700
Received: by az43exm04.phx.mcd.mot.com with Internet Mail Service (5.5.2657.72)
id <TXXXYGDW>; Thu, 30 Sep 2004 12:00:37 -0700
Received: from udomsvc6.labs.mot.com ([173.23.250.6]) by az43exm04.phx.mcd.mot.com w
id TXXXYGDQ; Thu, 30 Sep 2004 12:00:32 -0700
Received: from ames (ames.labs.mot.com [173.23.163.2])
by ims2.labs.mot.com (iPlanet Messaging Server 5.2 (built Feb 21 2002))
with ESMTTP id <0I4V00CQYBGWME@ims2.labs.mot.com> for AMC036@az43.mcd.mot.com;
Thu, 30 Sep 2004 14:00:32 -0500 (CDT)
Date: Thu, 30 Sep 2004 14:00:32 -0500
From: Michael Pearce <Michael.Pearce@motorola.com>
Subject: RE: Streaming protocol discussion.
In-reply-to:
<3F05200B37A1D511BE550002B328924316DF4E96@az43exm04.phx.mcd.mot.com>
To: "'Costello Edward-G20048'" <ejc@motorola.com>
Cc: "'Clayton Mark-AMC036'" <AMC036@az43.mcd.mot.com>
Message-id: <001b01c4a71f5c2dbdc70502a317ad@labs.mot.com>
MIME-version: 1.0
X-MIMEOLE: Produced By Microsoft MimeOLE V6.00.2800.1441
X-Mailer: Microsoft Outlook, Build 10.0.6626
Content-type: text/plain; charset=us-ascii
Importance: Normal
X-Priority: 3 (Normal)
X-MSMail-priority: Normal
Content-Transfer-Encoding: 8bit
X-MIME-Autoconverted: from quoted-printable to 8bit by pooh.tcg.mcg.mot.com id i8UJb

It sounds like the direction you're going is here is to keep stripping the WACA down until it just does two things:

- 1) Decode streamed audio for the head unit
- 2) Serve as a bi-directional conduit for UI events (from head unit) and commands (to head unit)

In theory, that will certainly work, and it has a certain elegance to it. But, this is bigger step than just using head-unit specific UI events (those are easily handled with a mapping table). My concerns (emphasis on concerns, not objections) are:

- 1) How does this approach mesh with your long-term roadmap that includes devices that have a lot more smarts on them, potentially enough to not rely on the handset at all?
- 2) Will this make it more likely or less likely to get other manufacturers to build compatible devices (since they will all be directly exposed to the details of all the head units in the world)?
- 3) From a product development process standpoint, this will mean the handset software team will have to be a lot more directly involved in understanding what the head units all look like. By defining abstract UI events and metadata formats, the protocol would serve as a stable contract that allows teams to work on implmentations of the WACA and handset software a lot more independently.

In short, we can probably handle this for CES (since there will only be one

head unit). But, long term, there may be some down sides that need to be evaluated before making this big a change.

Mike

P.S. Jean-Marc cancelled our meeting this afternoon didn't he?

> -----Original Message-----

> From: Costello Edward-G20048 [mailto:ejc@motorola.com]

> Sent: Thursday, September 30, 2004 1:37 PM

> To: PEARCE MICHAEL-AMP001

> Cc: Clayton Mark-AMC036

> Subject: Streaming protocol discussion.

>

>

> Mike,

>

> Something I was talking with Mark Clayton about is the notion
> of Metadata sent to the WACA (Wireless Audio Car Adapter).

> In our meeting yesterday, we agreed the device-specific
> smarts live in the phone. To be consistent, the metadata

> should be changed into device-specific commands to display
> text, illuminate lights, trigger audio prompts, etc on the

> head unit. I guess what I'm suggesting is the commands

> containing the metadata should be converted to simpler device
> commands and sent to the WACA at the same level we get simple

> device commands from it.

>

> Admittedly, we didn't delve too far into the ramifications
> and side effects, but wanted to broach the subject with you

> and the team.

>

> Thoughts?

>

> -----

> Ed Costello

> iRadio Client Applications

> 2900 S. Diablo Way - TCG2

> Tempe, AZ 85282

> (602) 659-7737

> ejc@motorola.com

>

> -----Original Message-----

> From: PEARCE MICHAEL-AMP001

> Sent: Thursday, September 30, 2004 11:22 AM

> To: Costello Edward-G20048

> Subject: RE: Event table for Streaming Protocol Doc.

>

>

> Yeah, this is what I was thinking (and is practically

> identical to what I put in that section as a placeholder

> yesterday afternoon!). See attached for what I have right now.

>

> I added some canonical button identifiers (table 4) -- if

> this just doesn't make any sense then we can remove it and

> leave it as "head unit specific" (tables 4, 5, and 6 would

> probably be removed in that case).

>

> I also removed the "still down" message for buttons -- I

> realized that all we need are pressed and released events,

> since "still down" messages would be synthesized based on a
> timer anyway, we can just do that in the handset (which will
> give us more flexibility over the heuristic).
>
> I also added an interpretation of the CONTROL_PARAM for dials
> that goes beyond CW/CCW boolean to include a number of clicks
> (I just interpreted CONTROL_PARAM as an 8-bit signed number).
>
> I'm going to make another pass through this with some more
> verbiage and send it out this afternoon as v0.3.
>
> Thanks,
>
> Mike
>
> > -----Original Message-----
> > From: Costello Edward-G20048 [mailto:ejc@motorola.com]
> > Sent: Thursday, September 30, 2004 1:08 PM
> > To: PEARCE MICHAEL-AMP001
> > Subject: Event table for Streaming Protocol Doc.
> >
> >
> > Mike,
> >
> > See if this matches your understanding of the lower-level events.
> >
> > Cheers,
> >
> > Ed
> > <<iRadio Streaming Media Protocol v0.1.doc>>
> >
> >

From - Thu Feb 10 14:21:56 2005
Return-Path: <ejc@motorola.com>
Received: from az43exm04.phx.mcd.mot.com ([144.191.86.40])
by pooh.tcg.mcg.mot.com (8.11.6/8.9.3) with ESMTTP id i91Huapl2218
for <CLAYTON@POOH.TCG.MCG.MOT.COM>; Fri, 1 Oct 2004 10:56:36 -0700
Received: by az43exm04.phx.mcd.mot.com with Internet Mail Service (5.5.2657.72)
id <TXXXZ24C>; Fri, 1 Oct 2004 10:19:05 -0700
Message-ID: <3F05200B37A1D511BE550002B328924316DF4EA7@az43exm04.phx.mcd.mot.com>
From: Costello Edward-G20048 <ejc@motorola.com>
To: "'tyounsi@consultant.com'" <tyounsi@consultant.com>,
PEARCE MICHAEL-AMP001 <Michael.Pearce@motorola.com>
Cc: Villevieille J-P26721 <jmv@motorola.com>,
Clayton Mark-AMC036
<AMC036@az43.mcd.mot.com>
Subject: RE: iRadio Streaming Media Protocol
Date: Fri, 1 Oct 2004 10:19:03 -0700
MIME-Version: 1.0
X-Mailer: Internet Mail Service (5.5.2657.72)
Content-Type: multipart/mixed;
boundary="-----=_NextPart_000_01C4A7DA.BA2EA628"

This message is in MIME format. Since your mail reader does not understand this format, some or all of this message may not be legible.

-----=_NextPart_000_01C4A7DA.BA2EA628
Content-Type: text/plain

Thomas,

No problem. I much prefer to have too much expert input than not enough.

To address your question: What are the spec of the WACA unit in term of CPU, MEMORY,

We're working on that now. Here's an overview of the mobile <--> WACA prototype. R

- * Programmable uProcessor (ARM-7 or ARM-9 class or equivalent?)
- * Capable of decoding MP3 and AAC+ (Min. 120 MIPS)
 - * Evaluation decoders should be made available
- * Storage for data and code (2MB Flash, 16MB SRAM or SDRAM - must have a memory cont
- * Bluetooth chipset and supported stack
 - * Might be able to use a USB<-->BT dongle if USB and SW support is available
- * Minimum 2 RS-232 ports - 115.2kBaud or higher
- * Some RTOS or uKernel (ThreadX, pSos, eCos, etc)

I'm probably omitting some things, but I hope you get the idea.

Cheers,

Ed

-----=_NextPart_000_01C4A7DA.BA2EA628
Content-Type: application/octet-stream;
name="WACA Dataflow.ZIP"
Content-Transfer-Encoding: base64
Content-Disposition: attachment;
filename="WACA Dataflow.ZIP"

base64 data omitted.



iRadio Engineering



Motorola Confidential Proprietary
Page 1





Radio™

...is the Missing Link

Trunk
Monkey
1st generation



Satisfied
iRadio
Customer



Motorola Confidential Proprietary
Page 2

intelligence everywhere™



Radio™ iRadio “Physical” Concept Architecture

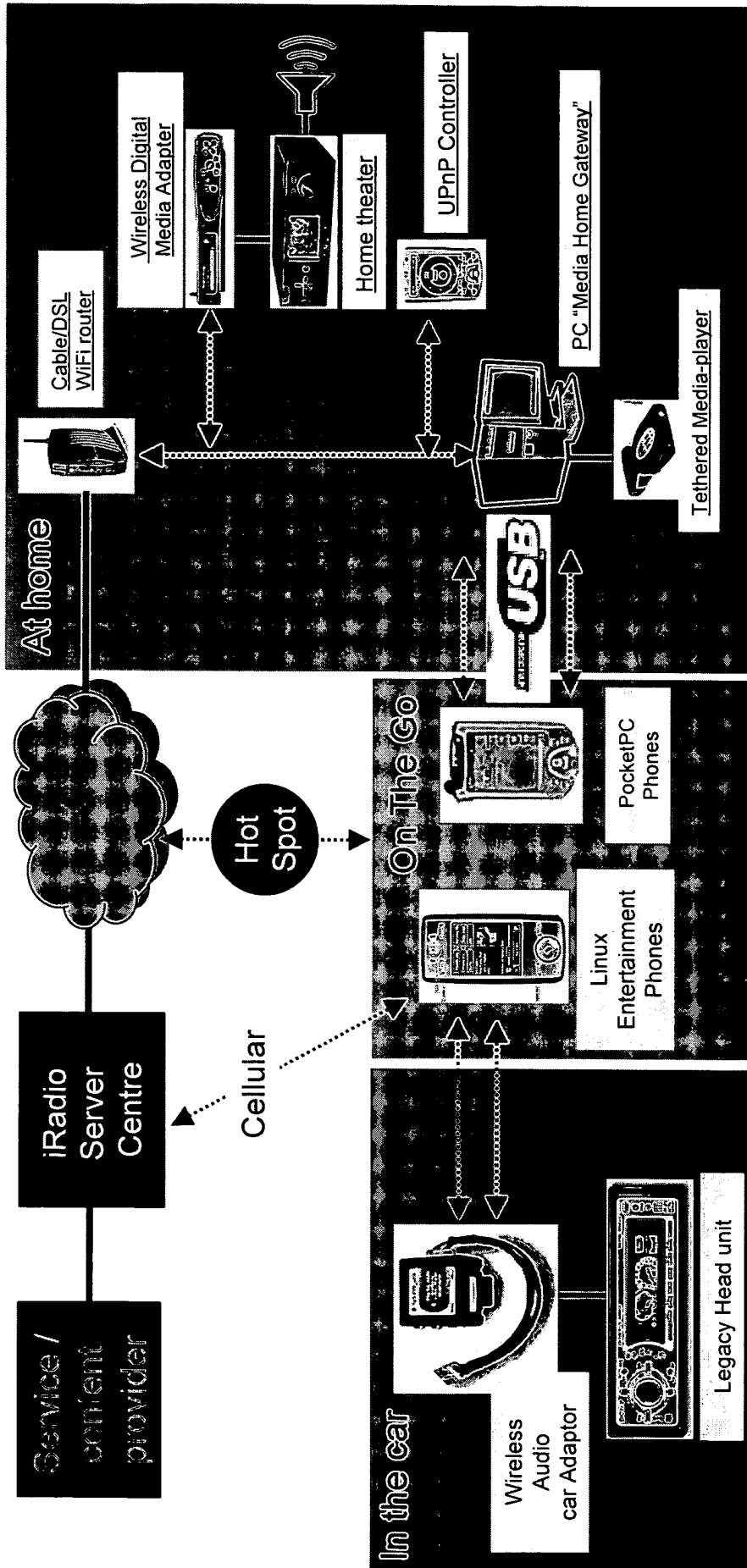

- Wireless
- Wireline
- Bluetooth
- WiFi





Radio™

Daily Set Automated Distribution...

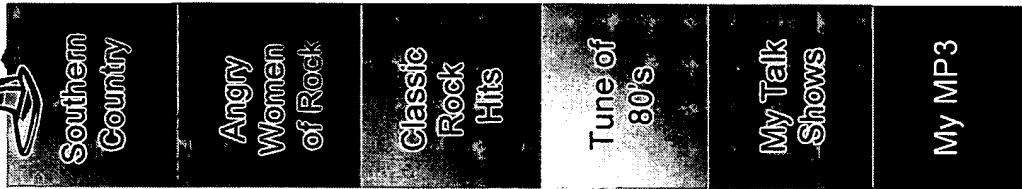

LAUNCHCAST

LIVE365.COM
radio revolution



Channel #1: Subscription Webcast

"Themed" music channel

- Sweet Home Alabama, Ramblin' Man, The Night They Old Dixie Down, Wrap it Up

Channel #2: Subscription Webcast

"Mood music" channel

- Don't Tell Me, I'm the Only One, You Oughta Know, Bitch

Channel #3: Subscription Webcast

"Genre" Music channel

- FreeBird, Can't get no Satisfaction, Smoke on the Water, Karn Evil 9

Channel #4 Subscription Webcast

"Personal" Music channel

- Burning Down The House, Sledgehammer, Girls Just Want to Have Fun, Sweet Dreams

Channel #5 Subscription Spoken

Words

- NPR-Talk of the Nation, Sporting News Flash, Cold Case Files, Weather Channel Car talk,

Stream #6: Music I own

- CD ripped collection
- Digital Music downloads

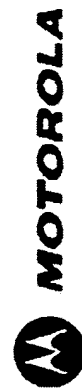
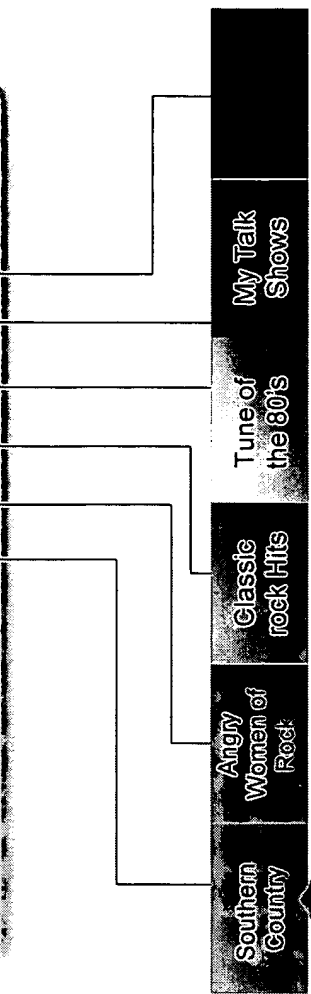
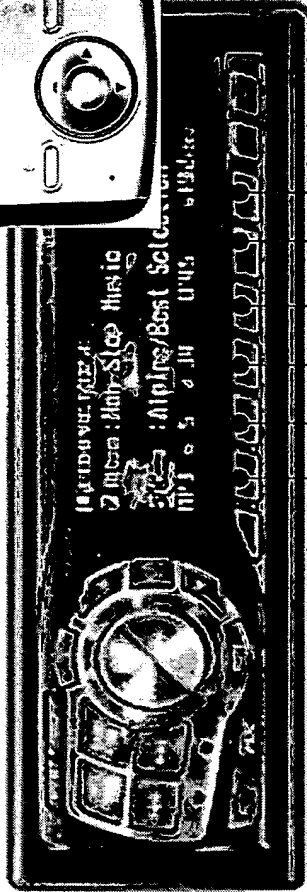
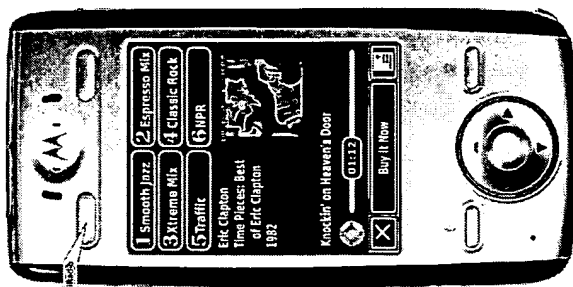

Motorola Confidential Proprietary
Page 4

intelligence everywhere™

Radio™ From @Home to On-The-Go to in the Car...

Low Cost
Wireless Audio Adaptor
Accessory

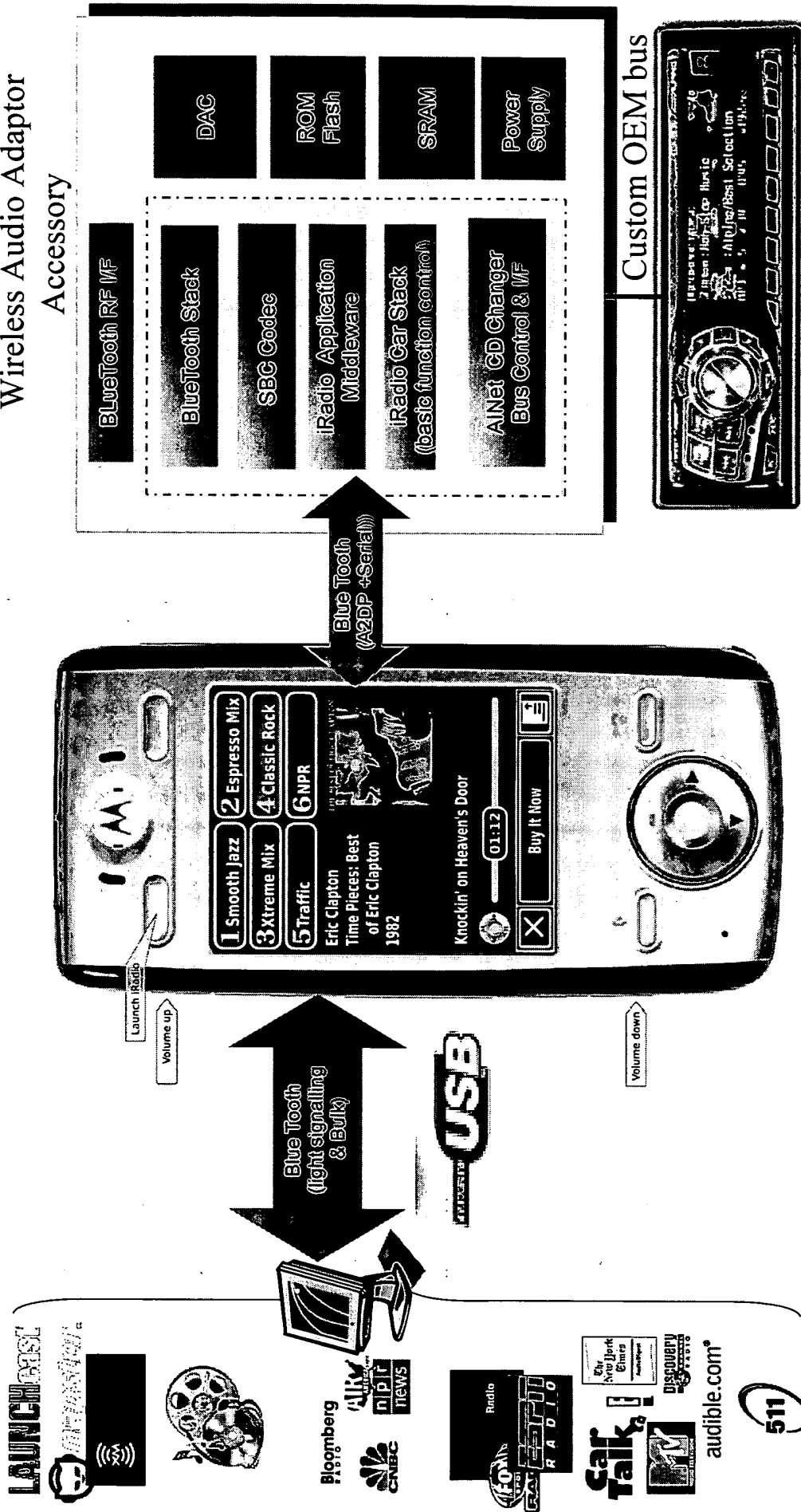

Motorola Confidential Proprietary
Page 5



intelligence everywhere™



Radio™ No new UI behavior to learn...

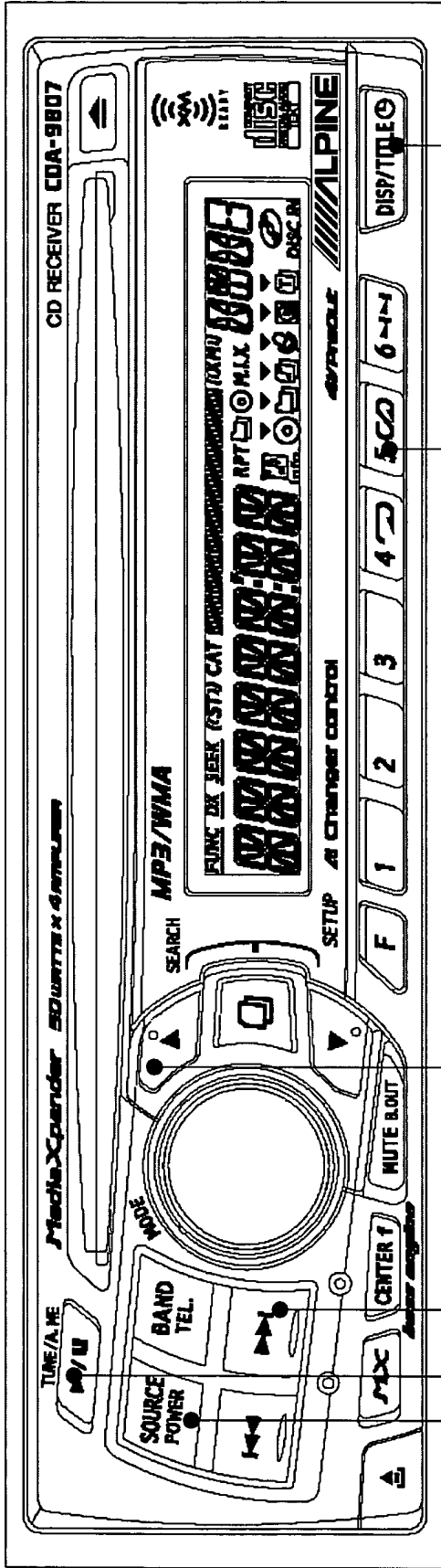

Mode CD
or CD changer

Play /
Pause iRadio

Skip &
Rewind

Optional
Sub-folder
browsing

Preset iRadio
channel

Optional Display switch
(artist, song, channel...)



Motorola Confidential Proprietary
Page 6





Radio™

iRadio Car Adaptation Road-Map

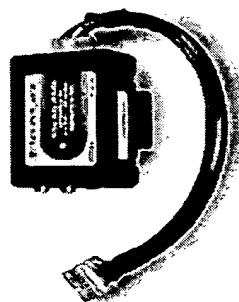

Wireless Adaptor (Legacy)

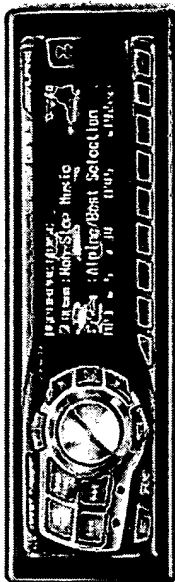
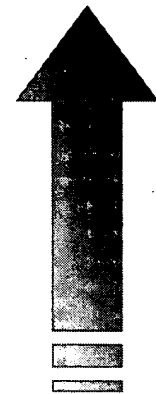

Head-Unit Integration (NextGen)

iRadio Middleware						
Blue Tooth	Wi-Fi	Media Memory Card	USB Host	FM Broadcast	Multi-Codes	Voice Commands
X						
X		X	X	X	X	
	X	X				
	X	X	X	X	X	X

Low End

High End

iRadio Middleware			
Blue Tooth	Wi-Fi	Media Memory Card	Hard Drive
X			
X		X	
	X	X	
	X		X



Motorola Confidential Proprietary
Page 7

intelligence everywhere™

Radio™ Engineering Rules of Engagement

- Mix E. Deming's Philosophy with SW Spiral Model Lifecycle:
 - 4 phases accelerated lifecycle in fast iterations
 - You can't control what you can't measure → light progress metrics
 - K.I.S.F....we need small victories one at a time...
 - Do Risk Mitigation on bigger unknowns first
- Design for testability
 - Do not forget / underestimate debugging tools (dataloggers, parsers)
 - Concurrent DFT for unit and system level
- Emphasis on shared tools & CM
 - Web portal, wiki, IM, Compass

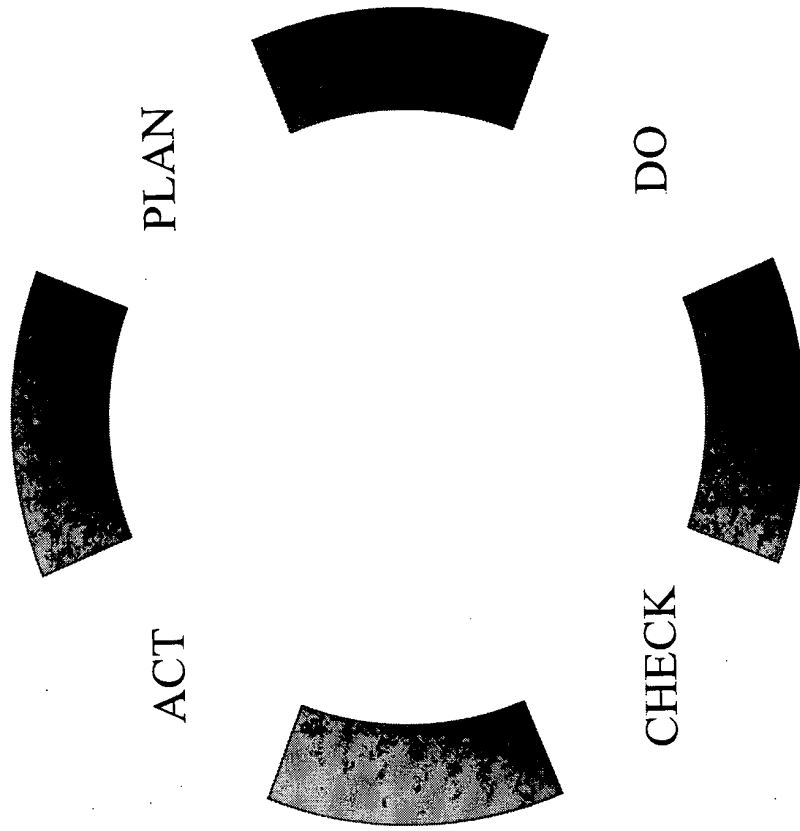

▪ ...Be curious... Experiment... Communicate... Have fun!



Radio™ Goals & Milestones

Rapid Prototyping
Oct 15 '04

CES Demo
Jan 1 '05

Limited Trial
Apr 04 '05

Market Introduction
Summer '05

• Client

- 2-boards WACA: BT+CD spoofer
- Car deck to serial CD spoofer
- Bluetooth stream from PC to WACA
- 1 phone BT to WACA BT

• Client

- Dual board WACA
- E680 & MPX BT demo
- PC client content selection
- PC BT daemon / USB host
- Pause here, play there phone & home synchro
- Push-to-Buy Simulation

• Server

- Framework
- Database Metadata schemas...

• Server

- Integration with live content AudioFeast???
- User config, profile
- User authentication
- Usage tracking
- Basic synchronization
- Administrative Mgmt

• Client

- Single board WACA pilot
- JAVA E680 & C# MPX "personal server" functions UPnP AV compliance (server, renderer, controller)
- A2DP, AVRCP, PAN, SPP
- PC client integrated UI browser+player
- Daily set synchro
- DRM
- Pause here, play there 3 domains
- Push-to-Buy

• Server

- Full content management integration AudioFeast
- DRM, automated download
- Trial level SMS
- Robust Database metadata mgmt & usage tracking

• Client

- Production WACA multi-models legacy decks
- E680 & MPX SW release middleware & application UI
- PC client content browser
- PC – phone daily synch
- Pause here, play there all domains+ all trick plays
- DRM enforcement multi-codecs

• Server

- Integration with more than 1 content provider
- Database & streaming cost optimization
- QoS monitoring
- Fully validated



MOTOROLA

Motorola Confidential Proprietary
Page 9

intelligence  everywhere™



Architecture vision / details

Mark Clayton



iRadio™ Overview

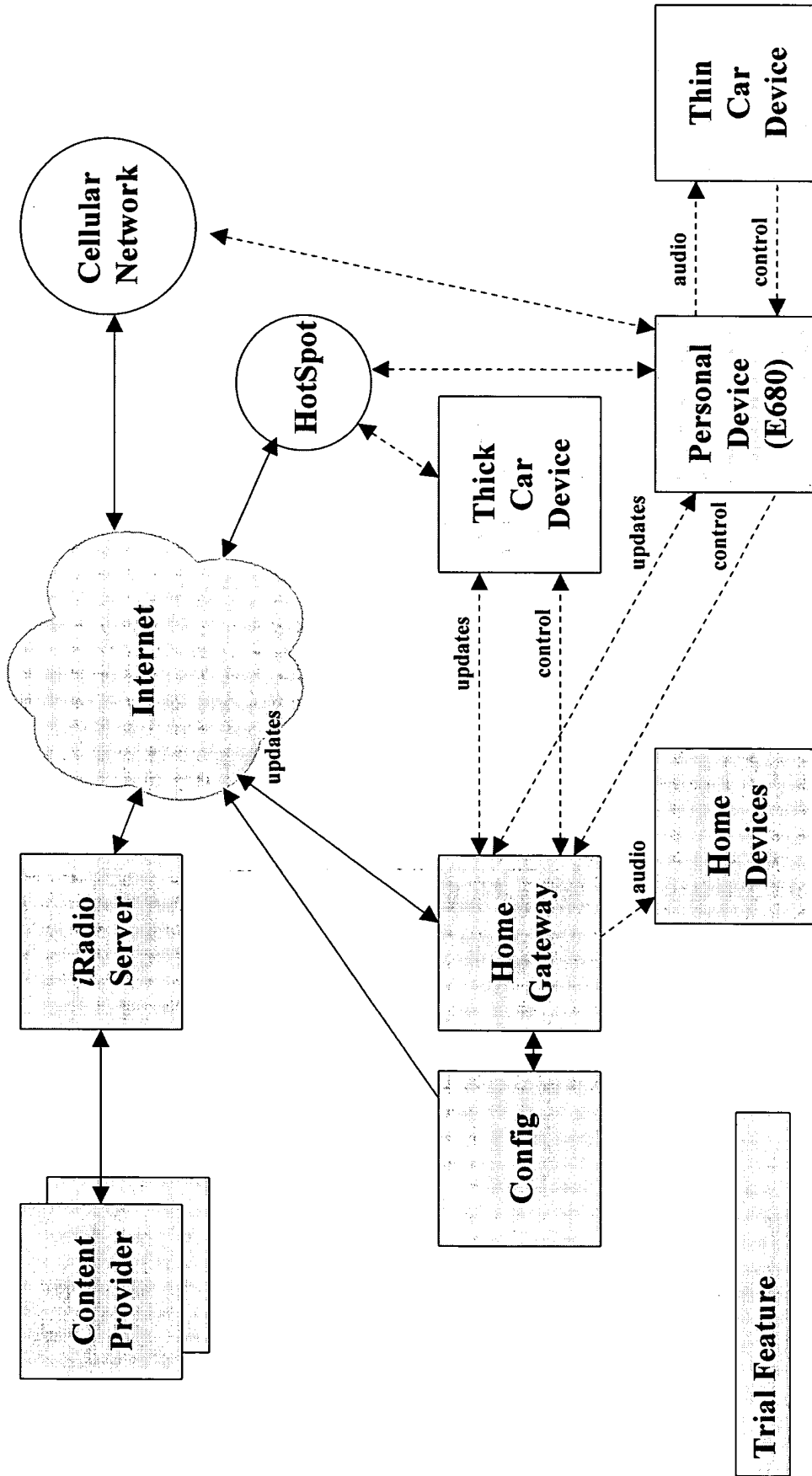

Content Providers

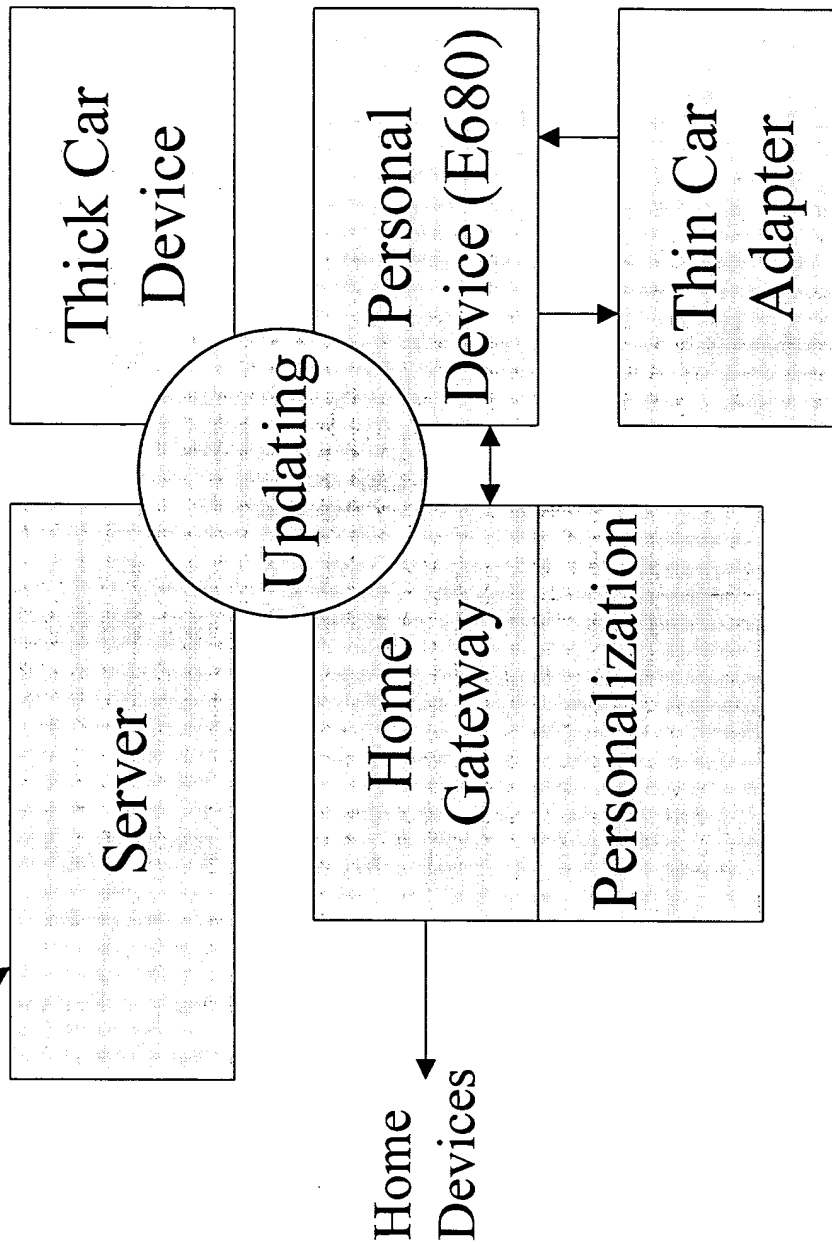

E680

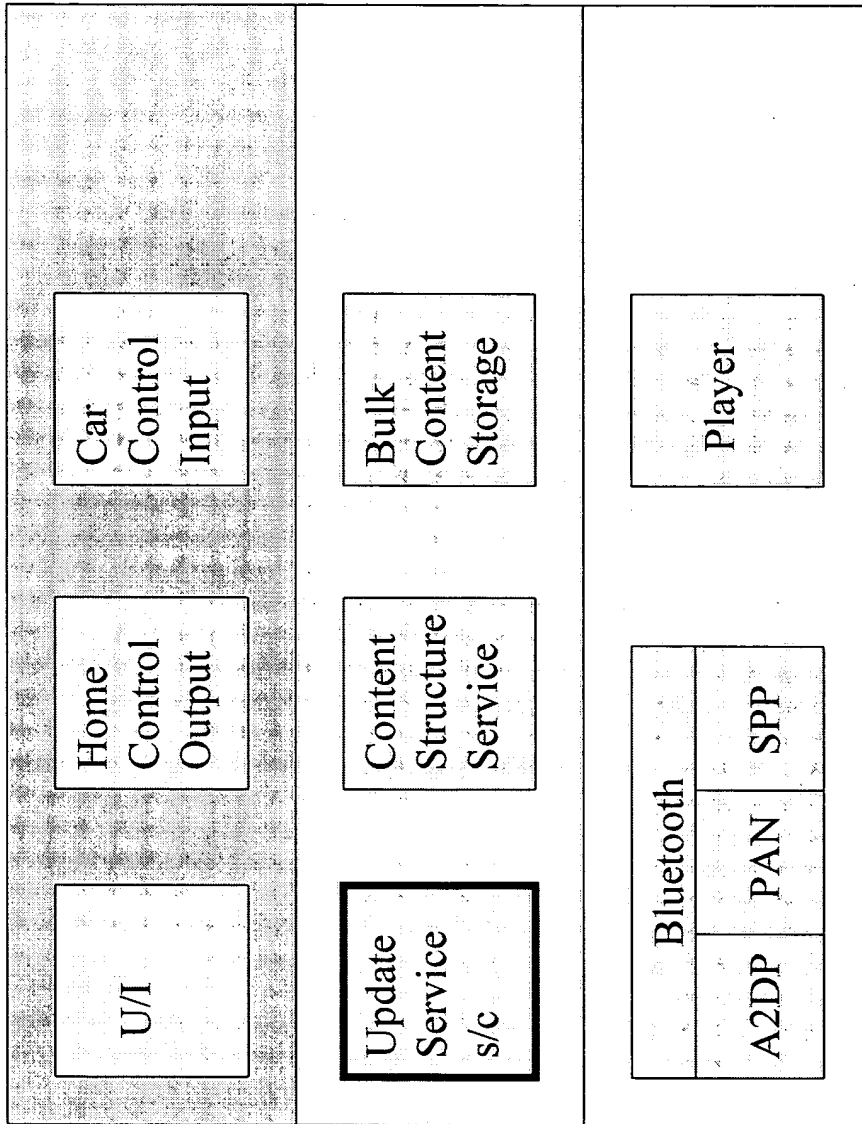



Radio™

Home Gateway

PC or MS1000

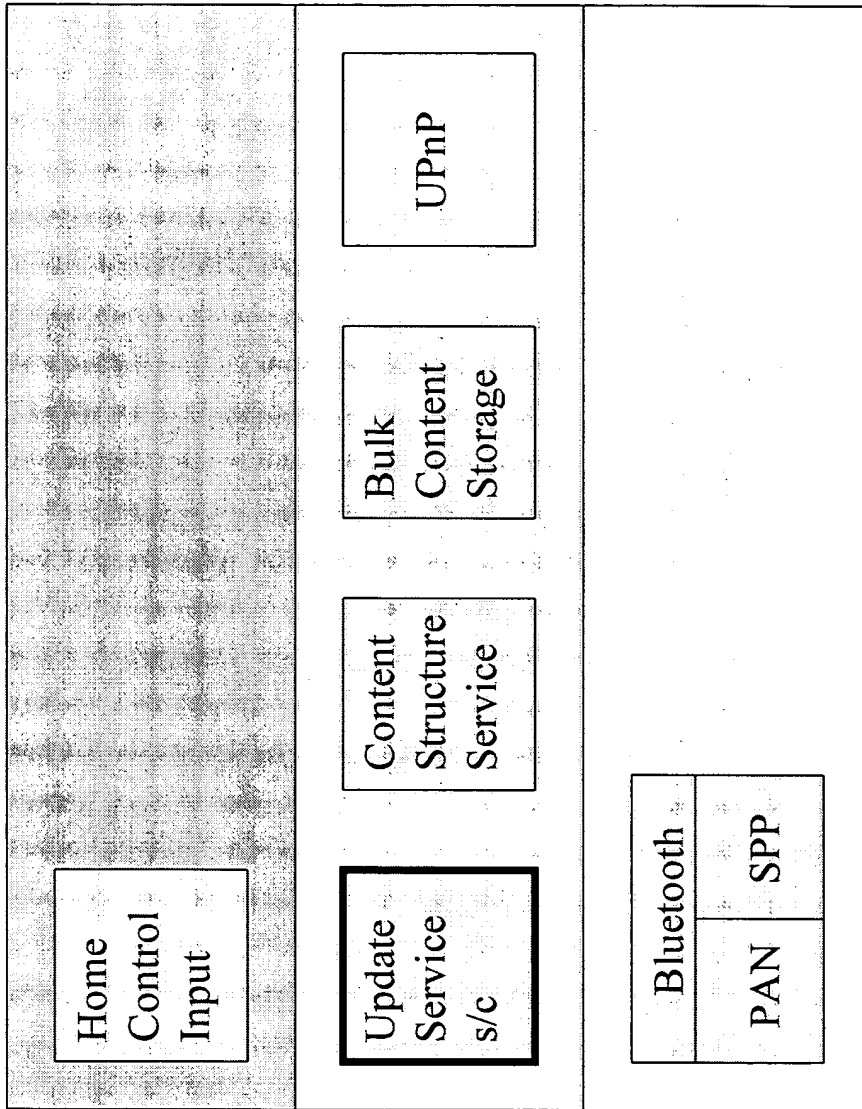

Motorola Confidential Proprietary
Page 14

intelligence  everywhere™

BT Audio Adapter

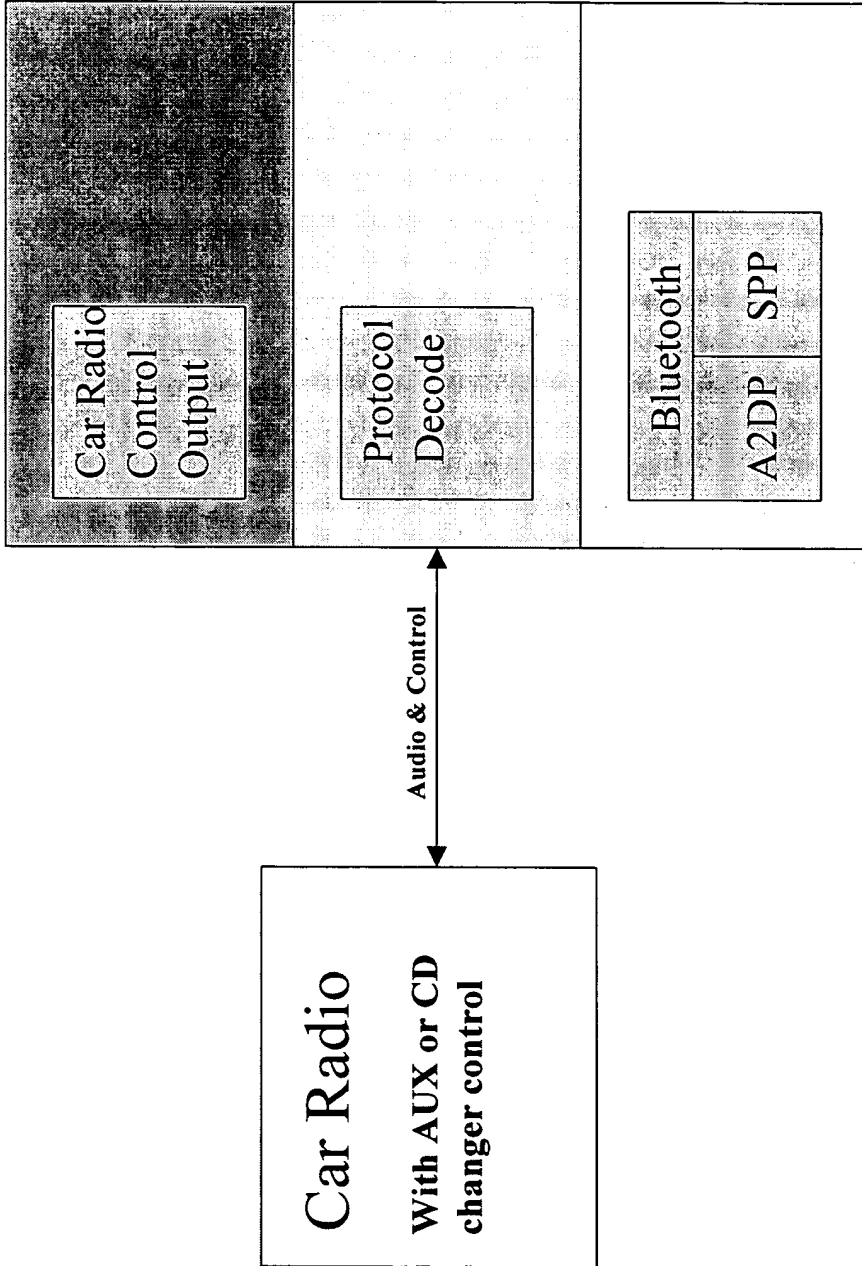

Radio™ Issues

- Licensing approaches – hopefully content is encrypted once with relatively small individual license files for each device to access the content.
- Personalization approaches – what is the user experience. Meeting scheduled for Friday to discuss.
- How do we browse owned content via the phone (local phone content and home content). Best case is we don't.





Radio™ Issues (cont.)

- How much does server bandwidth cost? iRadio will transfer LOTS of data.
- How will we work with our Content Provider(s)?





Server vision / details

- Server Team "Committee" -





Radio™

iRadio Server System Architecture - Production

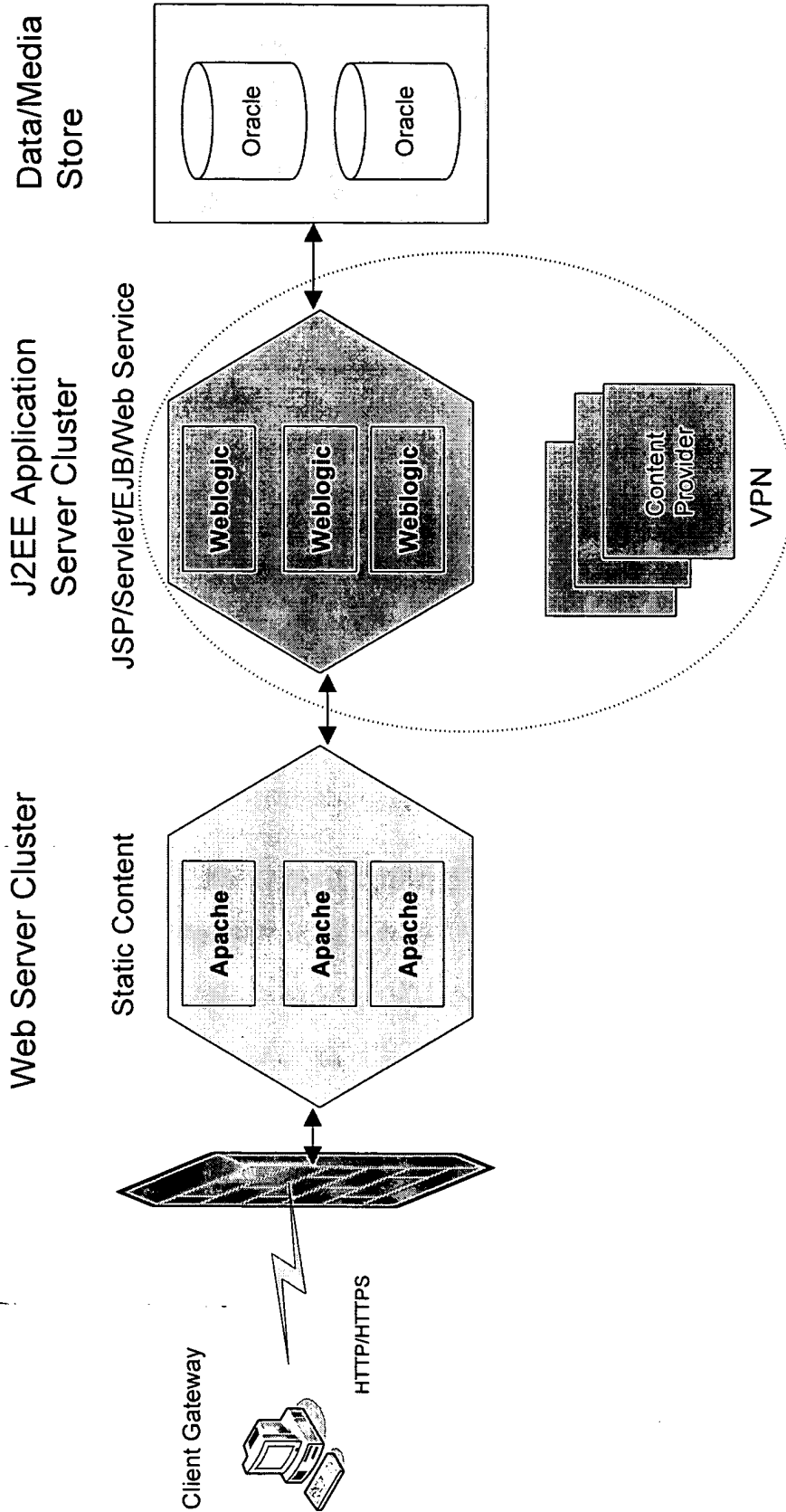



Radio™ J2EE Server Architecture

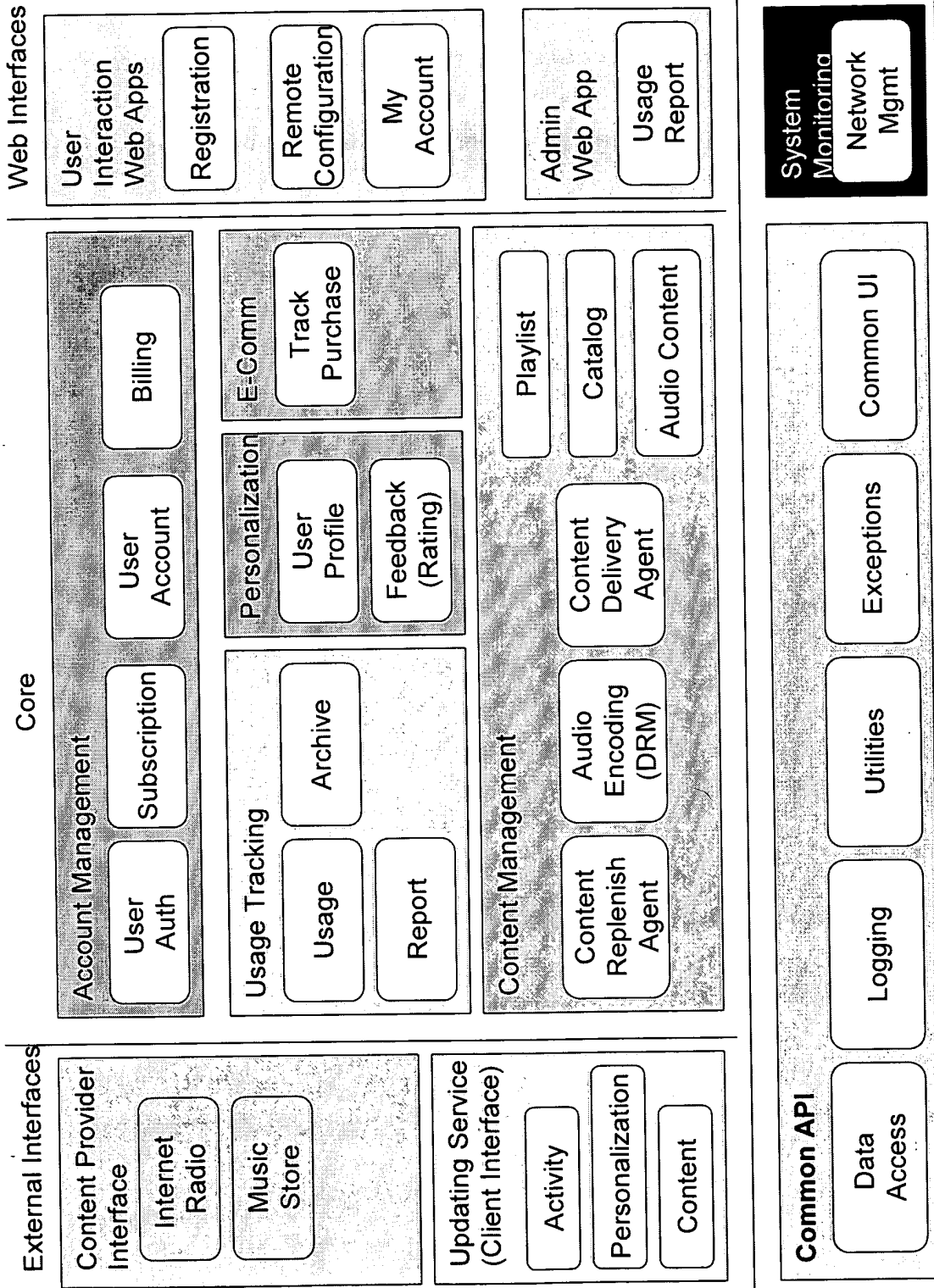



Radio™ Alpha Release

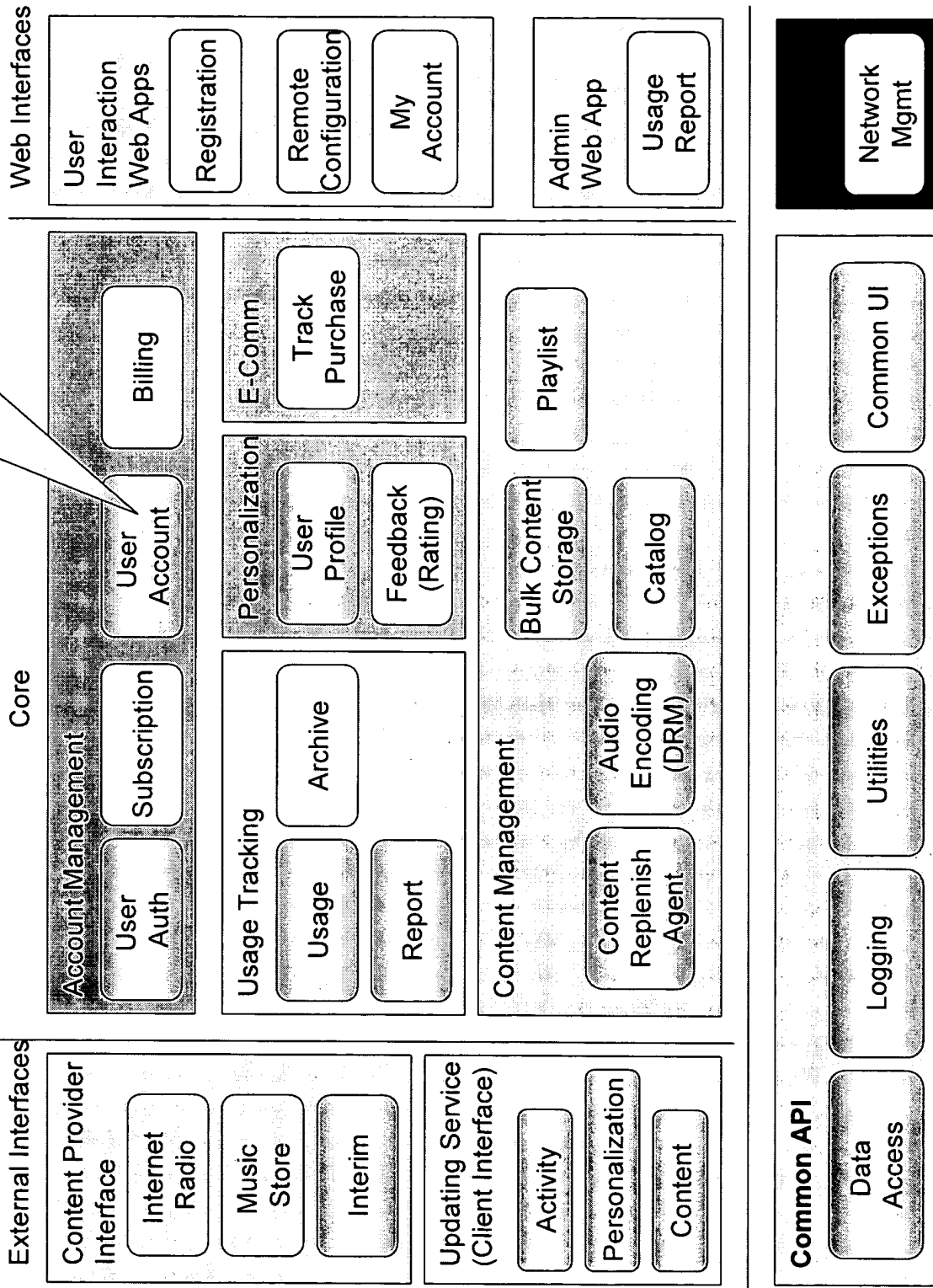



Radio™ Key Tasks for Alpha Release

Key Tasks	Owners
Domain Model	Tony/All
CM/Development Processes	Tony
Common API	All
Content Management	Amrit, Matt
Content Provider Interface	Ahsan
Updating Service (Content)	Ahsan
DRM	Matt
User Account/User Auth	Christine
Usage Tracking	Christine/Tony
Personalization	Christine/Tony
Updating Service (Activity, Personalization)	Christine/Tony
Logging	Ahsan



MOTOROLA

Motorola Confidential Proprietary
Page 22





Radio™

Client vision / details

Ed Costello & al



Motorola Confidential Proprietary
Page 23

intelligence  everywhere™



Radio™ Phone/Controller

- Acts as UPnP controller in all domains
- Collects information on user operation and consumption
- Enforces constraints on consumption
- Content updated from Home Gateway
- Streams audio to WACA
- Interprets navigation commands from WACA

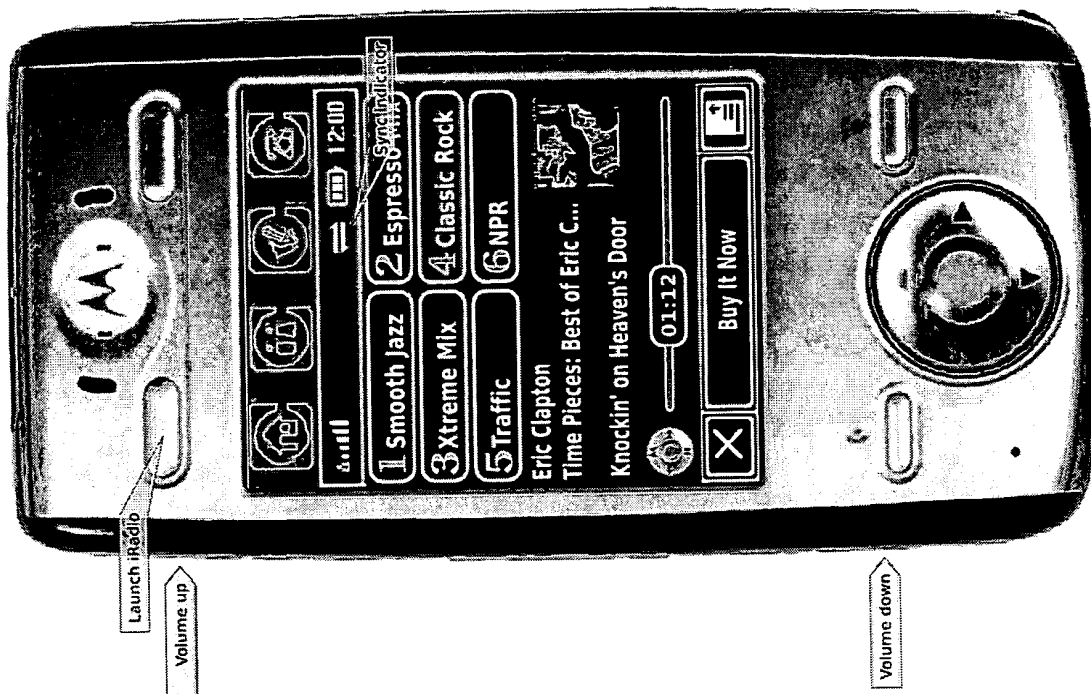



Radio™ Media Home Gateway Architecture

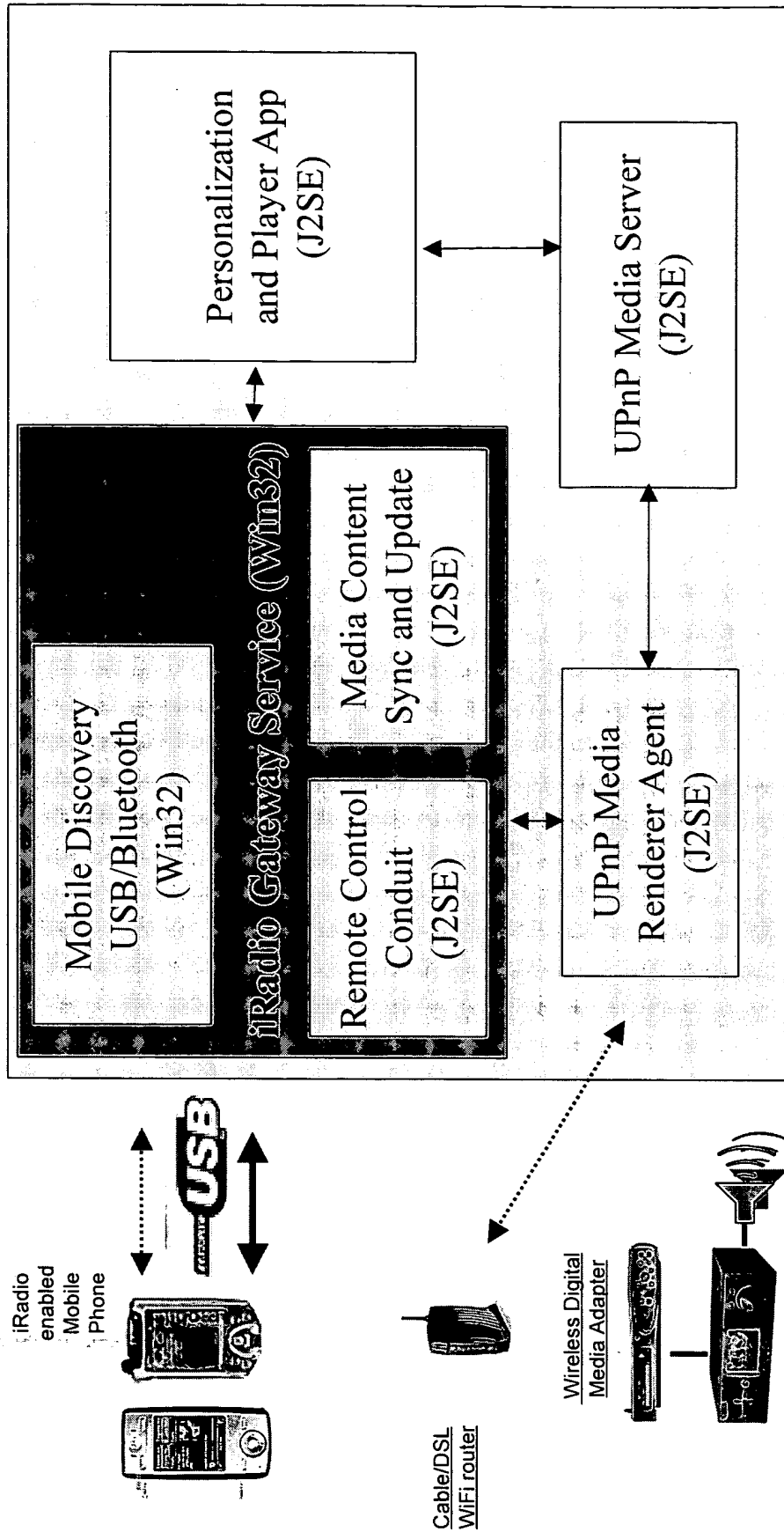



Radio™ Auto Domain

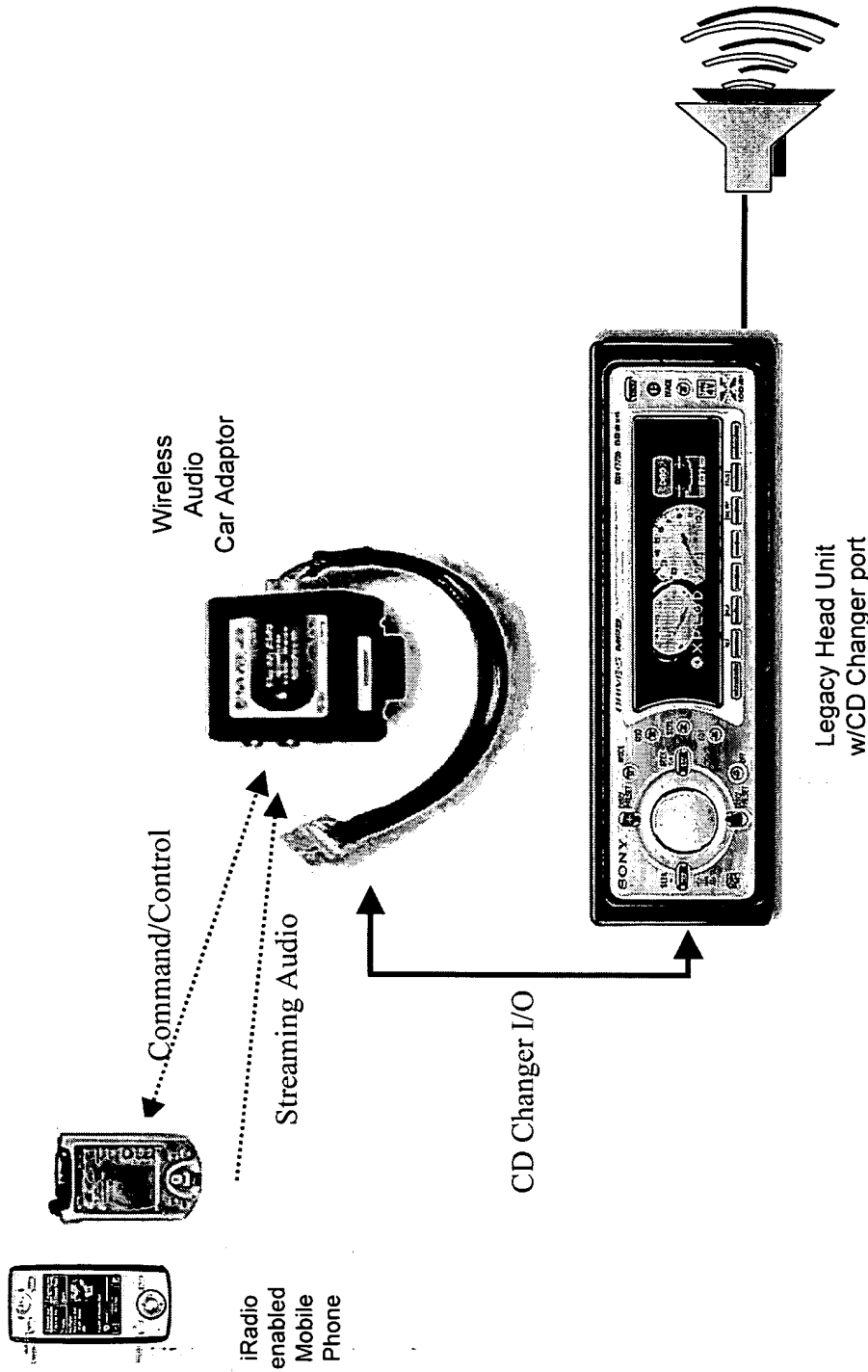

Motorola Confidential Proprietary
Page 26





Radio™ Wireless Audio Car Adapter

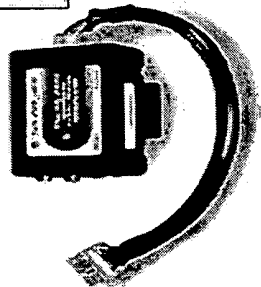
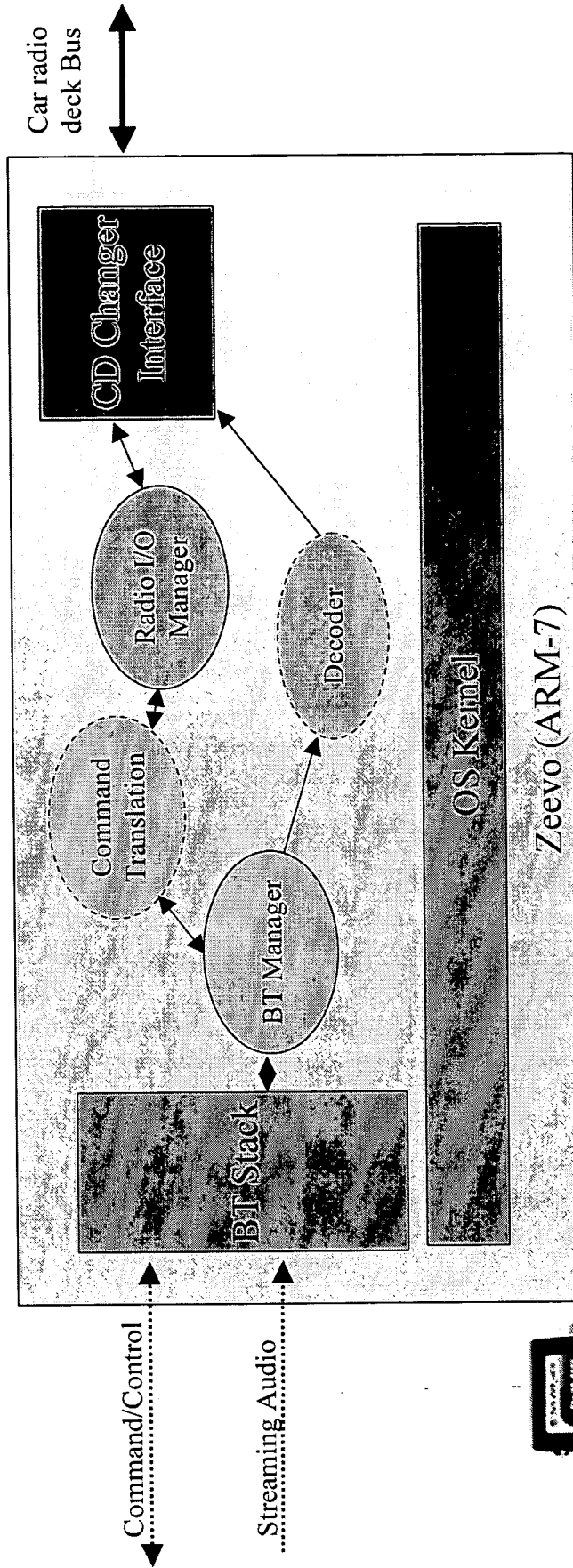



Radio™

Client Development Dependencies

- E680 Support from Beijing
 - SDK distribution
 - JSR-82 implementation (Trial & Product)
 - Allow native app loading and debug
- Collaboration/Tech transfer w/Chicago
 - UPnP AV
 - Personal Media Server project using E680
 - Extensive experience w/Zeevo
- SSI America
 - WACA Support
- Zeevo
 - HW and SDK
 - Application



MOTOROLA



Radio™ Key CES Tasks for Client

Key Tasks	Owners
Content Update – Home Gateway	Andy
Content Update – Mobile	Shawn/Thomas
Home Gateway User Interface	Andy
BT Control Mobile - Home Gateway	Andy/Shawn/Thomas
BT Device & Service Discovery	Team
BT Command/Control Mobile – WACA	Shawn/Ed/Zeevo
Mobile player app	Shawn/Thomas
Mobile audio streaming	Shawn/Thomas
WACA command translation	Ed/Zeevo/SSI
WACA audio decoding	Ed/Zeevo
WACA audio rendering	Ed/Zeevo/SSI
Buy Now simulation	Shawn/Thomas/Andy



iRadio AVRCP Interface Specification

iRadio Group
Motorola, Inc.

Revision Number	Date of revision	Author	Comments
v0.1	02/09/2005	Brian Tucker	Initial draft

Table of Content

1 Introduction

The Bluetooth AVRCP specification defines a set of functionality for a remote control device to send control commands to a audio/visual device. AVRCP does provide two way communications to and from the remote control device, but the defined set of commands is limited to standard A/V control commands such as PLAY, PAUSE and STOP. This document will define how the Motorola iRadio business group is extending the AVRCP profile to include support for iRadio specific functionality

2 Theory of Operation

By utilizing the opid_vendor_specific (0x7E) opcode id as defined by the AVRCP profile, iRadio will send Meta Data and channel control commands to and from the iRadio Wireless Audio Car Adapter (WACA). The two primary extension areas relate to Meta data transmission from the iRadio mobile device to the WACA and for channel control commands to be sent from the WACA to the mobile device. A standard Passthrough command will be used to send a vendor specific opcode (0x7E) along with the specific AVRCP extension data.

3 Messages

3.1 Message Overview

3.1.1 Message Structure

The iRadio AVRCP extension will borrow from the IMCP protocol to send and receive data to and from the mobile device and WACA. Following is the header used for all commands.

Field	Type	Length (bytes)	Value	Description
Sync	Integer	4	0xDEADB EEF	Synchronization sequence
Message Length	Integer	2	0-65535	Total length of the command
Command	Integer	1	0-255	Command for the message

3.1.2 Physical Layer

The physical layer is via the AVRCP profile.

3.1.3 Transmission Order

The transmission order is Octet 0, Octet 1, . . . , Octet n. Within each octet, the transmission order is Bit7, Bit 6, . . . Bit 1, Bit 0.

3.1.4 Byte Order

In all cases where a data element is greater than one byte, a Little Endian format will be used.

3.1.5 Checksum Calculation

The checksum is calculated by summing up all of the bytes in the message into a 16 bit counter.

3.2 Message Header

Field	Type	Length (bytes)	Value	Description
Sync	Integer	4	0xDEADB EEF	Synchronization sequence
Message Length	Integer	2	0-65535	Total length of the command
Command	Integer	1	0-255	Command for the message

3.3 Message Payload

3.3.1 Show Meta Data

This message is sent from the mobile device to the WACA. The WACA is limited in storage space, so whatever text is sent in this command is immediately displayed on the radio's graphical interface.

Field	Type	Length (bytes)	Value	Description
Sync	Integer	4	0xDEADB EEF	Synchronization sequence
Message Length	Integer	2	Variable	Total length of the command
Command	Integer	1	0	Command for the message
Data	String	Variable		Meta data to display
Checksum	Integer	2	0-65535	Sum of header and payload Message

3.3.2 iRadio Command

This message is sent from the WACA to the mobile device.

Field	Type	Length (bytes)	Value	Description
Sync	Integer	4	0xDEADB EEF	Synchronization sequence
Message Length	Integer	2	0x0003	Total length of message
Command	Integer	1	1	Command for the message
iRadio Command Type	Integer	1	0-255	Command type generated by the WACA
Checksum	Integer	2	0-65535	Sum of header and payload Message

3.3.2.1 iRadio Command Type

Command Type	Code	Comment
SCMD_GOTO_CHANNEL	0x06	Go to Channel in CMD_PARAM (zero-based)
SCMD_PURCHASE	0x07	Purchase Current Track
SCMD_GOTO_TRACK	0x08	Go to Track in CMD_PARAM (zero-based)
SCMD_GOTO_OFFSET	0x09	Go to Track offset CMD_PARAM seconds



Radio™

CES show 2005 Q&A

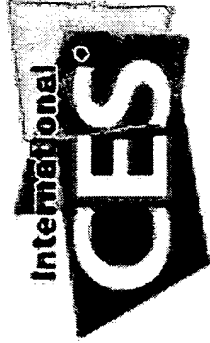

Goals and Scenarios Update

Jean-Marc Villeveille

26 July 2004

 Radio™



Motorola Confidential Proprietary
Page 1



Radio™ Topics

- **Marketing Analysis**
 - What unique/novel user scenarios (use case) problems are being addressed by iRadio?
 - What commercial problem is being addressed?
 - What are the incentives to adopt this solution?
 - What are the dependencies/unknowns and how do we plan to address them?
 - Potential Partnerships
- **Demo scenario description**
 - Overall script (multiple use cases)
 - Overall architecture
 - Wireless Audio car Adaptor





Radio™ What unique/novel user scenarios problems are being addressed by iRadio?

- **Enables the provision and access to the personalized audio content people want, when they want it and where they want it:**
 - Content you own (CDs collection, digital music purchase)
 - Content you subscribe (S-DARS, Internet Music Services...)
 - Content you receive “free-to-Air” (AM/FM, Internet...)
- **Pause here – Play there**
 - Pause playback on one device and resume on another
- **Enables user-friendly music acquisition and rights management across various platforms and services**
 - Combines power of Broadcast PUSH with intelligent Search PULL



MOTOROLA

Motorola Confidential Proprietary
Page 3

intelligence  everywhere™



Radio™ What commercial problem is being addressed?

- **For a PC-based Internet Digital Music and radio provider (Yahoo Launchcast, Napster...)**
 - Extends their “PC-centric” subscription reach to the living-room, car and “On-the-Go” phone/media players
 - Increase revenue growth through new premium service
 - Increase user’s to brand “Stickiness” through integration with other services (IMessenger, digital music store...)
- **For an S-DARS provider (XM, Sirius...)**
 - Drive Revenue Growth through enhanced service features
 - Capitalize on XM unique content (live concerts, exclusive interviews...)
 - Capture share of impulse buying revenue:
 - Turns the XM radio into a digital storefront (more than 2millions titles)
 - Integrated impulse purchasing of tracks and CD
 - Increase XM brand and service recognition leveraging Motorola footprint at home, in the car and on-the-go.



MOTOROLA

Motorola Confidential Proprietary
Page 4

intelligence  everywhere™



Radio™

What are the incentives to adopt this solution?

- **Significant potential to create new growth:**
 - By preventing “commodization” of Motorola products
 - By participating in service revenues from audio subscription models
 - By potential IPR licensing upside
- **High level of interest of key targeted service providers:**
 - Launchcast, MusicChoices, Napster, MusicNet, XM...
- **Fits broad Motorola strategic vision to provide “seamless” connected content across domains:**
 - Transversal solution across Motorola sectors’ specific products (PCS, BCS, ACES)
- **Leverages many unique Motorola assets:**
 - Home networks products, Entertainment phones and On-Star telematics TCUs, IPR, DRM strategies, “Liquid media” ...



MOTOROLA

Motorola Confidential Proprietary
Page 5

intelligence  everywhere™



Radio™ What are the dependencies/unknowns and how do we plan to address them?

- **Interfacing with key Motorola products: works with SDKs**
 - Home media gateway: MS1000 and UPnP graphical remote control, Melody Jukebox from Premise Systems (?)
 - E680 Linux/Real Audio entertainment phone: 50Meg internal + WiFi card
 - Mohawk4 TCU development platform for voice-activated Bluetooth wireless adaptor
 - Re-use parts of VIAMOTO Off-board Navigation Client-Server architecture

- **Integrating external strategic technology partners:**
 - **SIMPLE DEVICES: SimpleCenter, OMNIFI...**
 - Licensing agreement “on-going”
 - RFP for a “Poor’s man” OMNIFI wireless car adaptor
 - **Leverage / Mitigation Plan:**
 - Integrates Mediabolic software and develop stand-alone Bluetooth or WiFi wireless car adaptor





Radio™

Services Partners Assumptions

<p>Content / Services providers</p>	<p>XM / SDARS</p>	<p>INTERNET SUBSCRIPTION MUSIC LIBRARY (Napster, MusicNet)</p>	<p>INTERNET PERSONAL RADIO & MUSIC STORE (Yahoo Launcest, iTunes?)</p>
<p>Key Value proposition</p>	<ul style="list-style-type: none"> ▪ Broadcast Rich niche aggregated content ▪ Interactive back-channel ▪ Cache & autorecord XM specific events/tunes ▪ XM community IM interaction ▪ Possible Internet Radio/Music Store 	<ul style="list-style-type: none"> ▪ Unlimited library subscription ▪ Pre-canned Internet radio catalog ▪ Few music sales for out of circle users (hard CD copy) ▪ Extremely strong community / playlist referrals 	<ul style="list-style-type: none"> ▪ "personal" Content Push subscription ▪ Focused on trigger song purchase through music suggestions ▪ Some community / playlist referrals and teasers exchange (Instant Music messenger)
<p>Detailed Features</p>	<ul style="list-style-type: none"> ▪ Interactive button: <ul style="list-style-type: none"> • Live or delayed buy action • Vote, data mining, PTL ▪ Cache of XM contents <ul style="list-style-type: none"> • on live 1st hand segments • scheduled broadcasts EPG based • Scheduled events catalog based ▪ Pause and Xdomains resume ▪ "Deferred" community interactivity ▪ Possible Internet Direct play: <ul style="list-style-type: none"> • Personal radio channels referral-based engine • XM Music store 	<ul style="list-style-type: none"> ▪ Unlimited Music streaming & download: <ul style="list-style-type: none"> • Music DRM-clock based • Possible migration Talk segments • renders legacy libraries and "shady P2P content obsolete ▪ Personalized or pre-tuned channels (>100+) ▪ Personalized Play-lists ▪ Pause and Xdomains resume ▪ Community exchanges (playlists, music pointers, teasers ▪ Legal Music xfer on CDs on the top of secured clock devices 	<ul style="list-style-type: none"> ▪ Limited "personal Music" or pre-tuned channels streaming" ▪ Rating to influence referral engine ▪ Pay-per-song download / Interactive purchase ▪ Pause and Xdomains resume ▪ IM messenger music community for chat, referrals, teasers exchange



MOTOROLA

Motorola Confidential Proprietary
Page 7

Intelligence  everywhere™



Radio™ iRadio “Physical” Architecture example for XM...

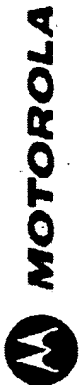
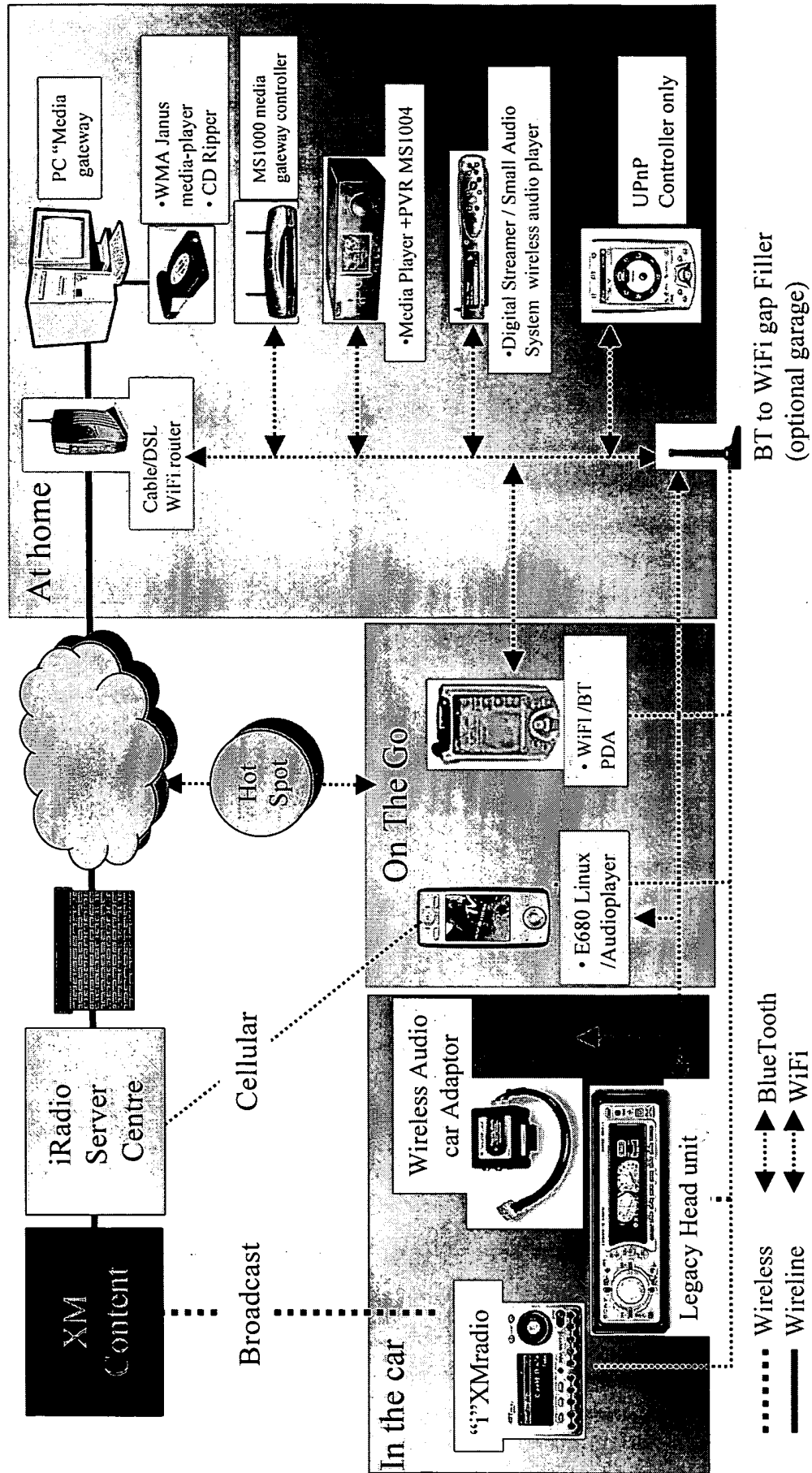



Radio™ CES example for generic service content provider...

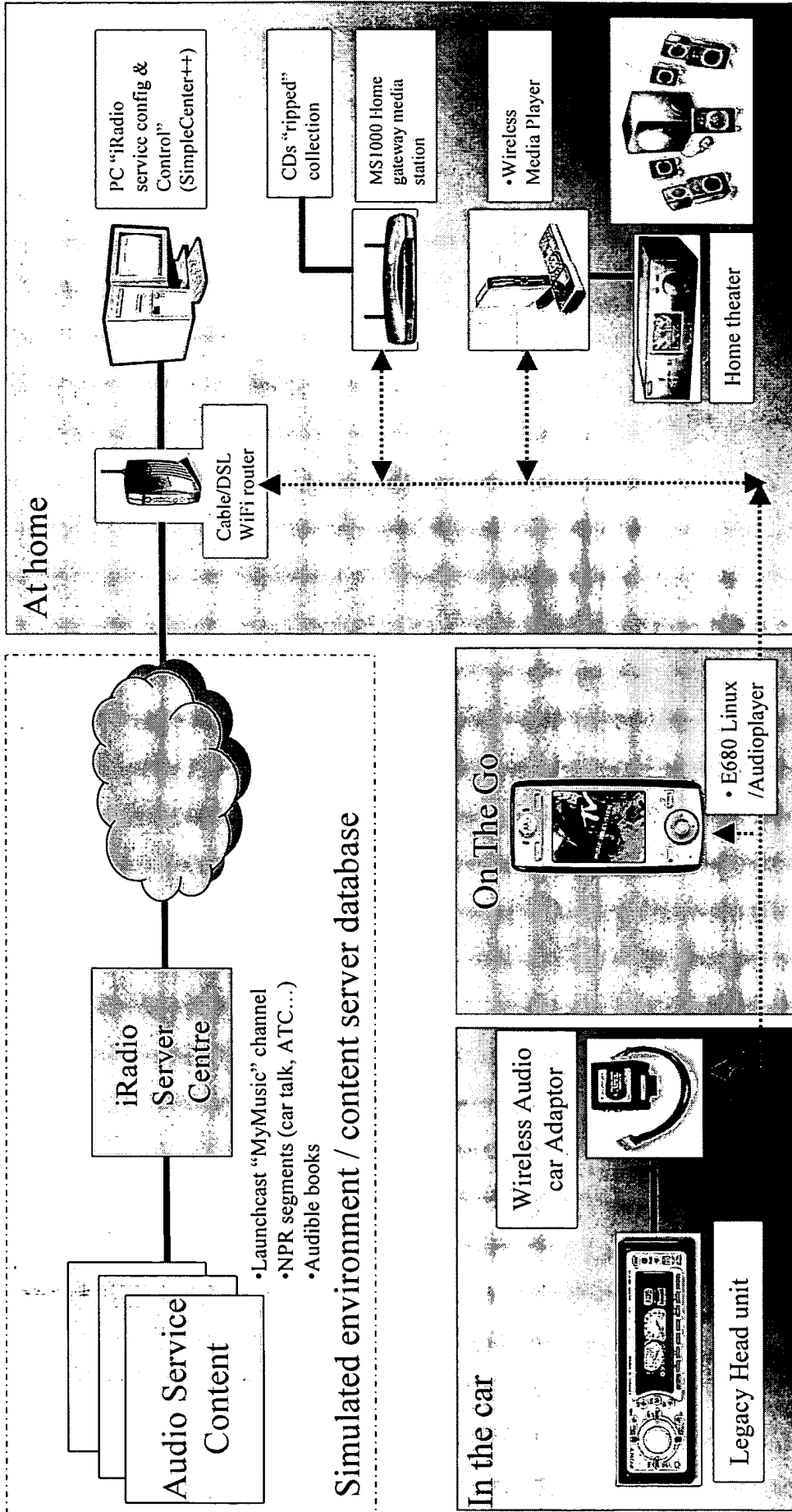

Motorola Confidential Proprietary
Page 9





Radio™ iRADIO CES Demo Script Description (preliminary)

An “Audio Day” in the life of a consumer

Key Messages

- On PC, user prepares 5-6 “Play-list” content to be automatically daily refreshed & downloaded to car and phone (preprocessing / set-up)
 - Single user interface to access “owned music”, service provider subscription library, Internet audible books and other spoken-words catalog based content
 - E.g. Itunes jukebox, Yahoo Launchcast, NPR’s Car Talk, jokes of the day, trivia, horoscope, new movies reviews, sports reports,...
 - Organize in 5 or 6 main “supersets / genres” that will be available on the car radio head-unit 5-6 preset keys with user friendly interactive bargraph to mix % of content preferences (128Meg / 4-6 hours depending codecs & content)
 - E.g. My Ripped Music, My personal music channel, My Sports, My Talk radio, My Audible book.
 - Genres could also be organized by mood: My Morning Latte, My energy boost, My relaxation, My learning channel...
- Start demo to show “domains” transitions over course of normal day:
 - Start listening to 1st program streamed on Home Theater from MSI000 NAS
 - Jump in the car – Seamless handoff to legacy car stereo
 - Use familiar CD radio controls and memory preset to browse through various prepared contents, can pause, skip forward and back. Receive live phone call – interrupts music-free on car stereo.
 - Park the car- Finish phone conversation and resume listening experience with phone earphones or external speakerphone

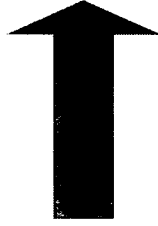

“My Audio Daily Set...”



...Follows Me:

- Home to Car
- Car to Phone



...and I can interact with it”

- End of the day: Come back in the car at then back to home...
 - Listen to a “pop tune” from subscription service and likes it: push-to-buy on radio depressing the CD start Key 2 seconds (tags the music title / artist/ CD)
 - When entering the home, request is uploaded (WiFi) from car and instantly downloaded from Music services into “My recently purchased” folder on the PC
 - Purchased Content can then be listened to right away on Home Theater
 - Also, “Tag Event” could have a “Push-to-Learn more” function that flags artist bios on PC, possible concerts in the area etc...



MOTOROLA

Motorola Confidential Proprietary
Page 10

intelligence  everywhere™



Radio™ Daily Set across domains

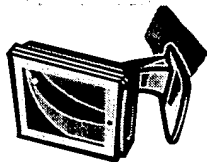

PC configuration
5 to 6 "Daily Sets" mapped to
Radio or Home receiver

- **Channel #1: My "digital music"**
 - CD ripped collection
 - Digital Music downloads
- **Channel #2: My "Yahoo" Personal Music Channel**
 - AI based suggestion
- **Channel #3: My talk show radio shows**
 - Car talk, CNBC McEnroe...
- **Channel #4: My Audible books**
- **Channel #5: My Sports radio**
 - Soccer news, stats, scores
- **Channel #6: My Lifestyles**
 - Movies reviews, Entertainment gossip, Discovery, History ...

6 presets= 6 channels
 CD commands for skip, play, pause
 Up-down arrows for possible sub-playlists
 ▲ depress 2seconds for tagging PTB

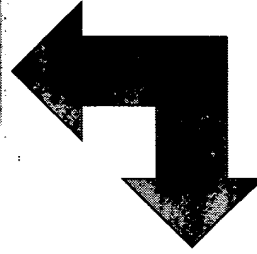
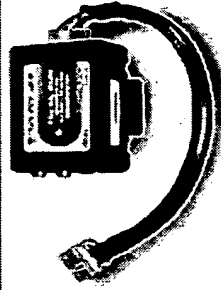
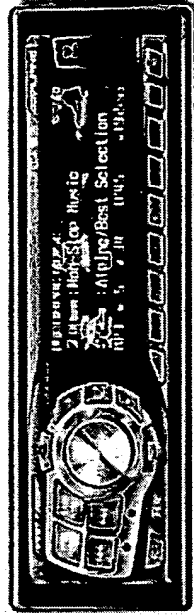
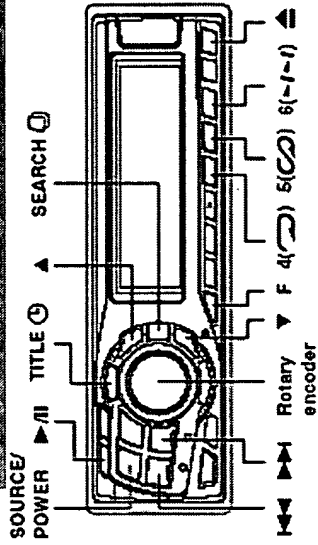

Wireless Car Audio Adaptor:

- WiFi (home, phone) or BlueTooth (phone)
- AI/Net interface CD changer spoofing, CD text spoof for ID3 tags
- 128MB storage (option)
- USB extension (option)
- Voice command (option)



MOTOROLA

Motorola Confidential Proprietary
Page 11

intelligence  everywhere™



Radio™

CES show 2005 Q&A

Answers to Reem Safadi / BCS

Jean-Marc Villeveille

25 July 2004

 Radio™



Motorola Confidential Proprietary
Page 1





Radio™ Q&A Topics from BCS

- What unique/novel user scenarios (use case) problems are being addressed by iRadio?
- What commercial problem is being addressed? What are the incentives to adopt this solution?
- What are the dependencies/unknowns and how do we plan to address them?
- What is a demo scenario description (hardware, software, and use case procedure)





Radio™ What unique/novel user scenarios problems are being addressed by iRadio?

- **Enables the provision and access to the personalized audio content people want, when they want it and where they want it:**
 - Content you own (CDs collection, digital music purchase)
 - Content you subscribe (S-DARS, Internet Music Services...)
 - Content you receive “free-to-Air” (AM/FM, Internet...)
- **Pause here – Play there**
 - Pause playback on one device and resume on another
- **Enables user-friendly music acquisition and rights management across various platforms and services**
 - Combines power of Broadcast PUSH with intelligent Search PULL



MOTOROLA

Motorola Confidential Proprietary
Page 3

intelligence  everywhere™



Radio™ What commercial problem is being addressed?

- **For a PC-based Internet Digital Music and radio provider (Yahoo Launchcast, Napster...)**
 - Extends their “PC-centric” subscription reach to the living-room, car and “On-the-Go” phone/media players
 - Increase revenue growth through new premium service
 - Increase brand “Stickiness” through integration with other services (IMessenger, digital music store...)
- **For an S-DARS provider (XM, Sirius...)**
 - Drive Revenue Growth through enhanced service features
 - Capitalize on XM unique content (live concerts, exclusive interviews...)
 - Capture share of impulse buying revenue:
 - Turns the XM radio into a digital storefront (more than 2millions titles)
 - Integrated impulse purchasing of tracks and CD
 - Increase XM brand and service recognition leveraging Motorola footprint at home, in the car and on-the-go.



MOTOROLA

Motorola Confidential Proprietary
Page 4

intelligence  everywhere™



Radio™ What are the incentives to adopt this solution?

- **Significant potential to create new growth:**
 - By preventing “commodization” of Motorola products
 - By participating in service revenues from audio subscription models
 - By potential IPR licensing upside
- **High level of interest of key targeted service providers:**
 - Launchcast, MusicChoice, Napster, MusicNet, XM...
- **Fits broad Motorola strategic vision to provide “seamless” connected content across domains:**
 - Transversal solution across Motorola sectors’ specific products (PCS, BCS, ACES)
- **Leverages many unique Motorola assets:**
 - Home networks products, Entertainment phones and On-Star telematics TCUs, IPR, DRM strategies, “Liquid media” ...



MOTOROLA

Motorola Confidential Proprietary
Page 5

intelligence  everywhere™



Radio™ What are the dependencies/unknowns and how do we plan to address them?

- **Interfacing with key Motorola products: works with SDKs**
 - Home media gateway: MS1000 and UPnP graphical remote control, Melody Jukebox from Premise Systems (?)
 - E680 Linux/Real Audio entertainment phone: 50Meg internal + WiFi card
 - Mohawk4 TCU development platform for voice-activated Bluetooth wireless adaptor
 - Re-use parts of VIAMOTO Off-board Navigation Client-Server architecture

- **Integrating external strategic technology partners:**
 - **SIMPLE DEVICES: SimpleCenter, OMNIFI...**
 - Licensing agreement “on-going”
 - RFP for a “Poor’s man” OMNIFI wireless car adaptor
 - **Leverage / Mitigation Plan:**
 - Integrates Mediabolic software and develop stand-alone Bluetooth or WiFi wireless car adaptor



MOTOROLA

Motorola Confidential Proprietary
Page 6

intelligence  everywhere™



Radio™ iRadio “Physical” Architecture example for XM...

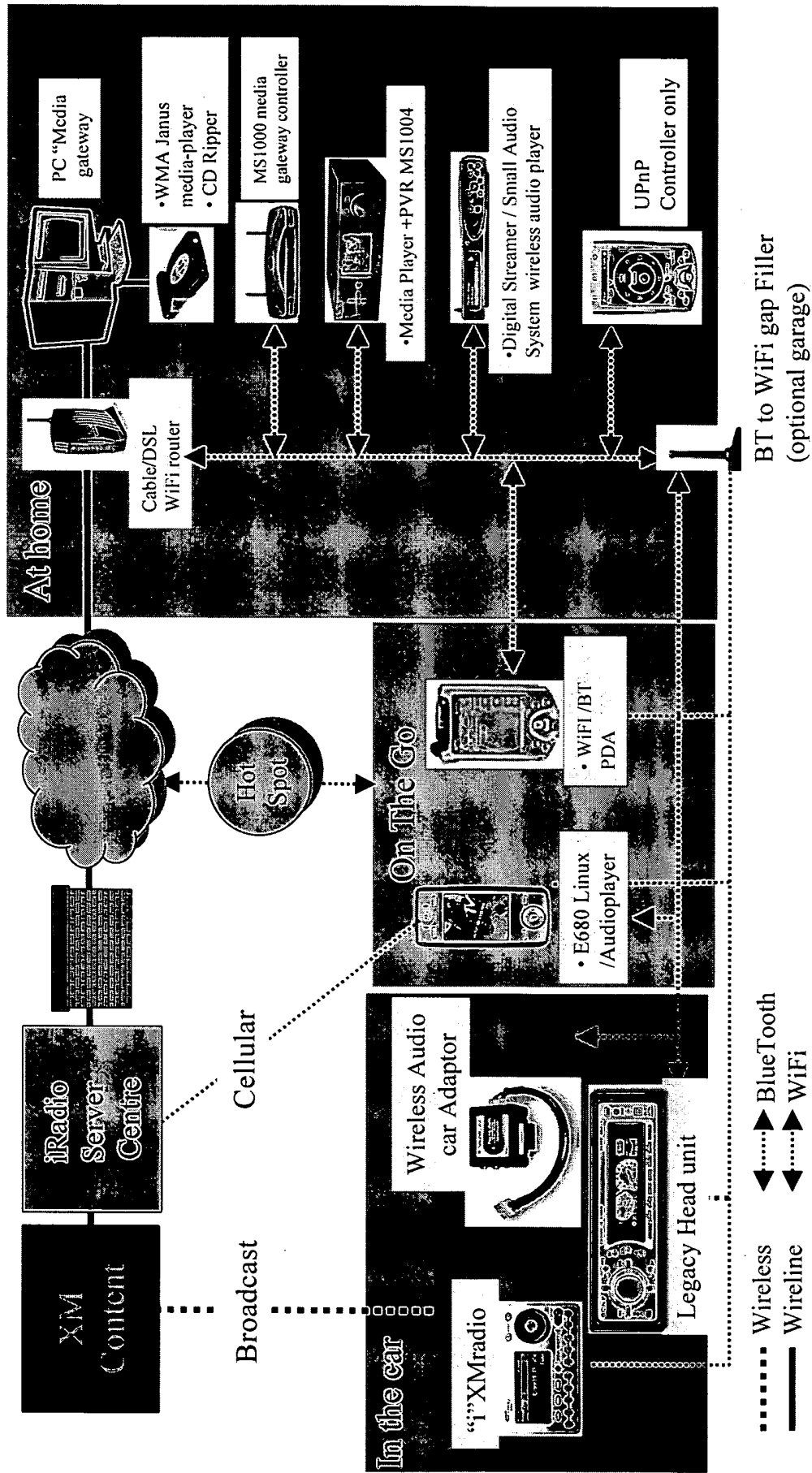



Radio™ CES example for generic service content provider...

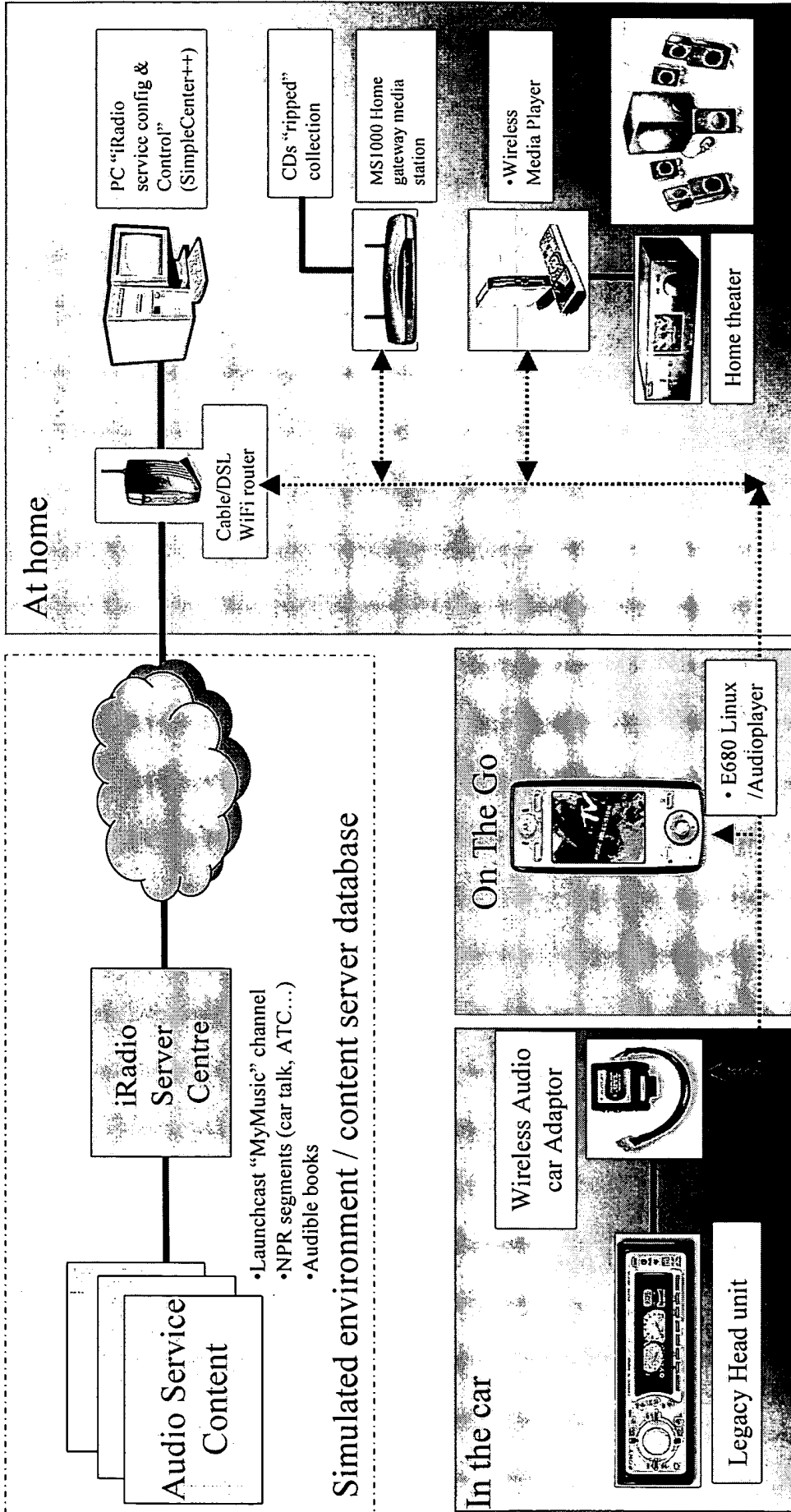

MOTOROLA

Motorola Confidential Proprietary
Page 8

intelligence  everywhere™



Radio™ iRADIO CES Demo Script Description (preliminary)

An “Audio Day” in the life of a consumer

Key Messages

- On PC, user prepares 5-6 “Play-list” content to be automatically daily refreshed & downloaded to car and phone (preprocessing / set-up)
 - Single user interface to access “owned music”, service provider subscription library, Internet audible books and other spoken-words catalog based content
 - E.g. iTunes jukebox, Yahoo Launchcast, NPR’s Car Talk, jokes of the day, trivia, horoscope, new movies reviews, sports reports,...
 - Organize in 5 or 6 main “supersets / genres” that will be available on the car radio head-unit 5-6 preset keys with user friendly interactive bargraph to mix % of content preferences (128Meg / 4-6 hours depending codecs & content)
 - E.g. My Ripped Music, My personal music channel, My Sports, My Talk radio, My Audible book.
 - Genres could also be organized by mood: My Morning Latte, My energy boost, My relaxation, My learning channel...
- Start demo to show “domains” transitions over course of normal day:
 - Start listening to 1st program streamed on Home Theater from MSI000 NAS
 - Jump in the car – Seamless handoff to legacy car stereo
 - Use familiar CD radio controls and memory preset to browse through various prepared contents, can pause, skip forward and back. Receive live phone call – interrupts music-handsfree on car stereo.
 - Park the car- Finish phone conversation and resume listening experience with phone earphones or external speakerphone



“My Audio Daily Set...”



...Follows Me:

- Home to Car
- Car to Phone



...and I can interact with it”

- End of the day: Come back in the car at then back to home...
 - Listen to a “pop tune” from subscription service and likes it: push-to-buy on radio depressing the CD start Key 2 seconds (tags the music title / artist/ CD)
 - When entering the home, request is uploaded (WiFi) from car and instantly downloaded from Music services into “My recently purchased” folder on the PC
 - Purchased Content can then be listened to right away on Home Theater
 - Also, “Tag Event” could have a “Push-to-Learn more” function that flags artist bios on PC, possible concerts in the area etc...



MOTOROLA

Motorola Confidential Proprietary
Page 9

intelligence  everywhere™



Radio™ Daily Set across domains

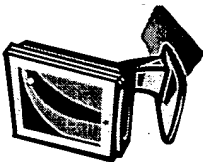

PC configuration
5 to 6 "Daily Sets" mapped to
Radio or Home receiver

- Channel #1: My "digital music"
 - CD ripped collection
 - Digital Music downloads
- Channel #2: My "Yahoo" Personal Music Channel
 - AI based suggestion
- Channel #3: My talk show radio shows
 - Car talk, CNBC McEnroe...
- Channel #4: My Audible books
- Channel #5: My Sports radio
 - Soccer news, stats, scores
- Channel #6: My Lifestyles
 - Movies reviews, Entertainment gossip, Discovery, History ...

6 presets= 6 channels
 CD commands for skip, play, pause
 Up-down arrows for possible sub-playlists
 ▲ depress 2seconds for tagging PTB

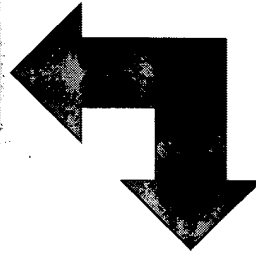
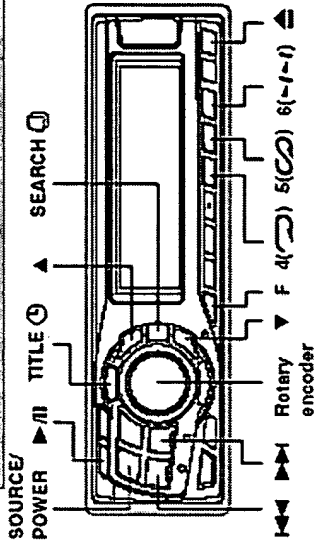

Wireless Car Audio Adaptor:

- WiFi (home, phone) or BlueTooth (phone)
- AiNet interface CD changer spoofing, CD text spoof for ID3 tags
- 128MB storage (option)
- USB extension (option)
- Voice command (option)



MOTOROLA

Motorola Confidential Proprietary
Page 10

intelligence  everywhere™



Radio™ A Day In The Life

At home

Relax...Fine Tune the experience

- Browse / tag new XM events
- Create /Update preferences daily sets: My XM.com
- e.g. XM events, talk shows, music library
- Browse XM music store

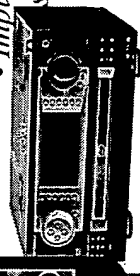
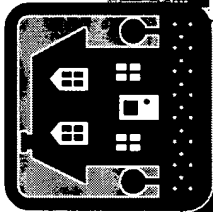

On-the-Go

- Keep listening to your XM "daily set"
- Impulse Buy
- Pause now...play later in the car ...or back home

Wake-up, get ready

- Listen to XM live broadcast or XM cache "daily sets" or a mix Music I own / recently purchased
- Impulse Buy
- Pause now...play in the car...

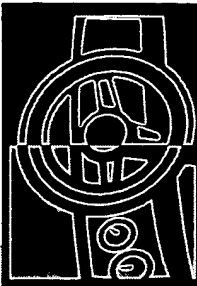

In the car

- Keep listening to XM live broadcast or your XM cache "daily set" / owned music
- Optional "off-line" tagged XM event recording
- Impulse Buy
- Pause now...play in the phone

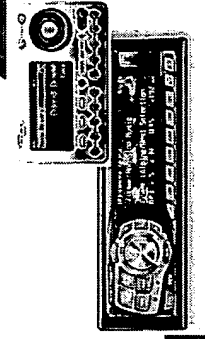

MOTOROLA

Motorola Confidential Proprietary
Page 11

intelligence  everywhere™

iRadio "Physical" Architecture example...

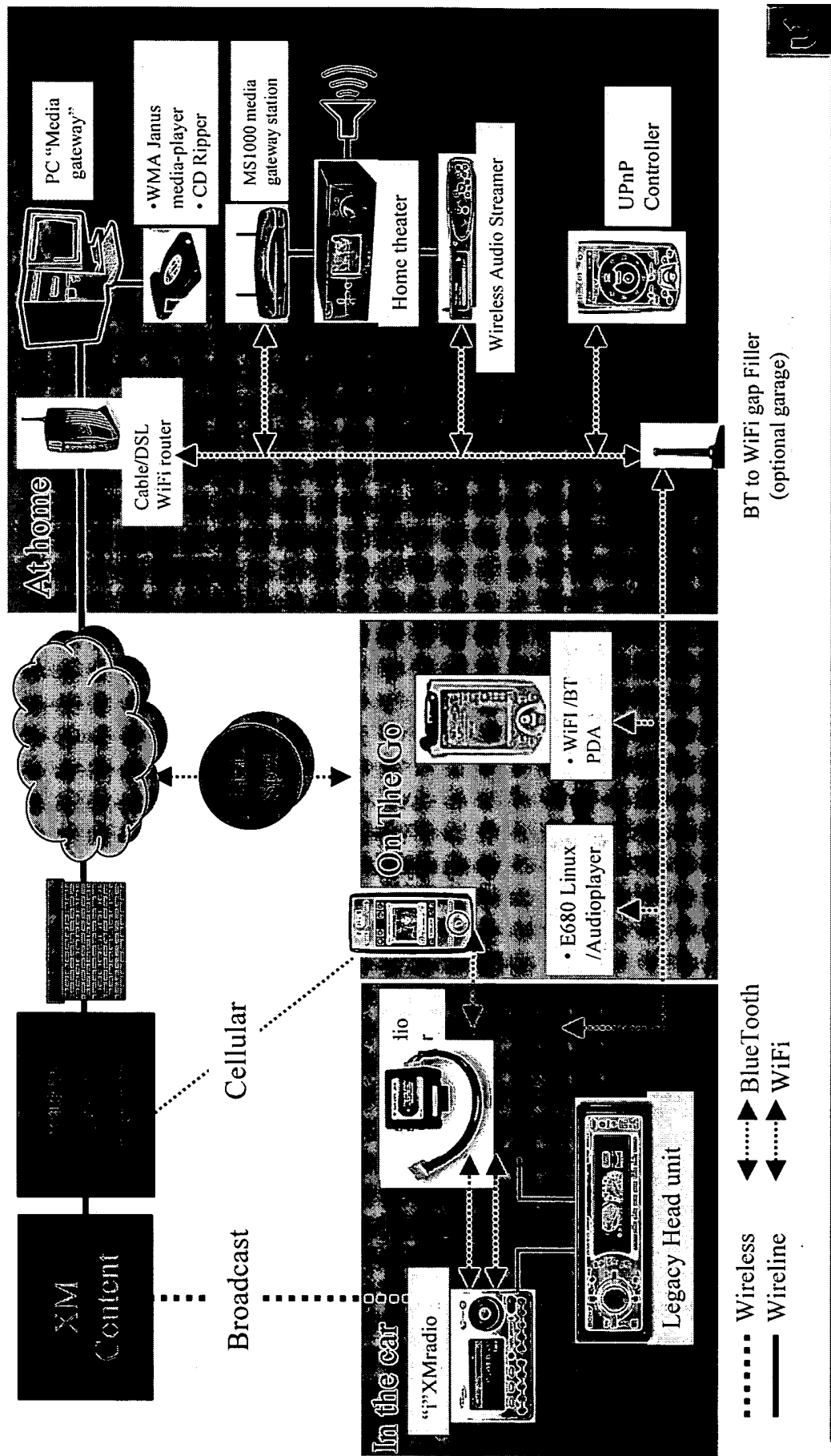

Motorola Confidential Proprietary
Page 12



Intelligence everywhere™

iRadio Server Details

User Services

- Personalization Mgmt
- Session Mgmt
- Subscription Mgmt
- Community Mgmt

Media Services

- Content Repository
- Media Storage
- Feedback Storage
- DRM Mgmt

Sync Services

- Connection Registry
- Gateway Sync Engine
- Device Sync Engine

Web UI for Personalization & Configuration & Digital Storefront

Web



Content Provider Interface/Agent

Home Gateway Interface/Agent

Device Gateway Interface/Agent

Server

Content Provider

Home Gateway

Client Devices

External

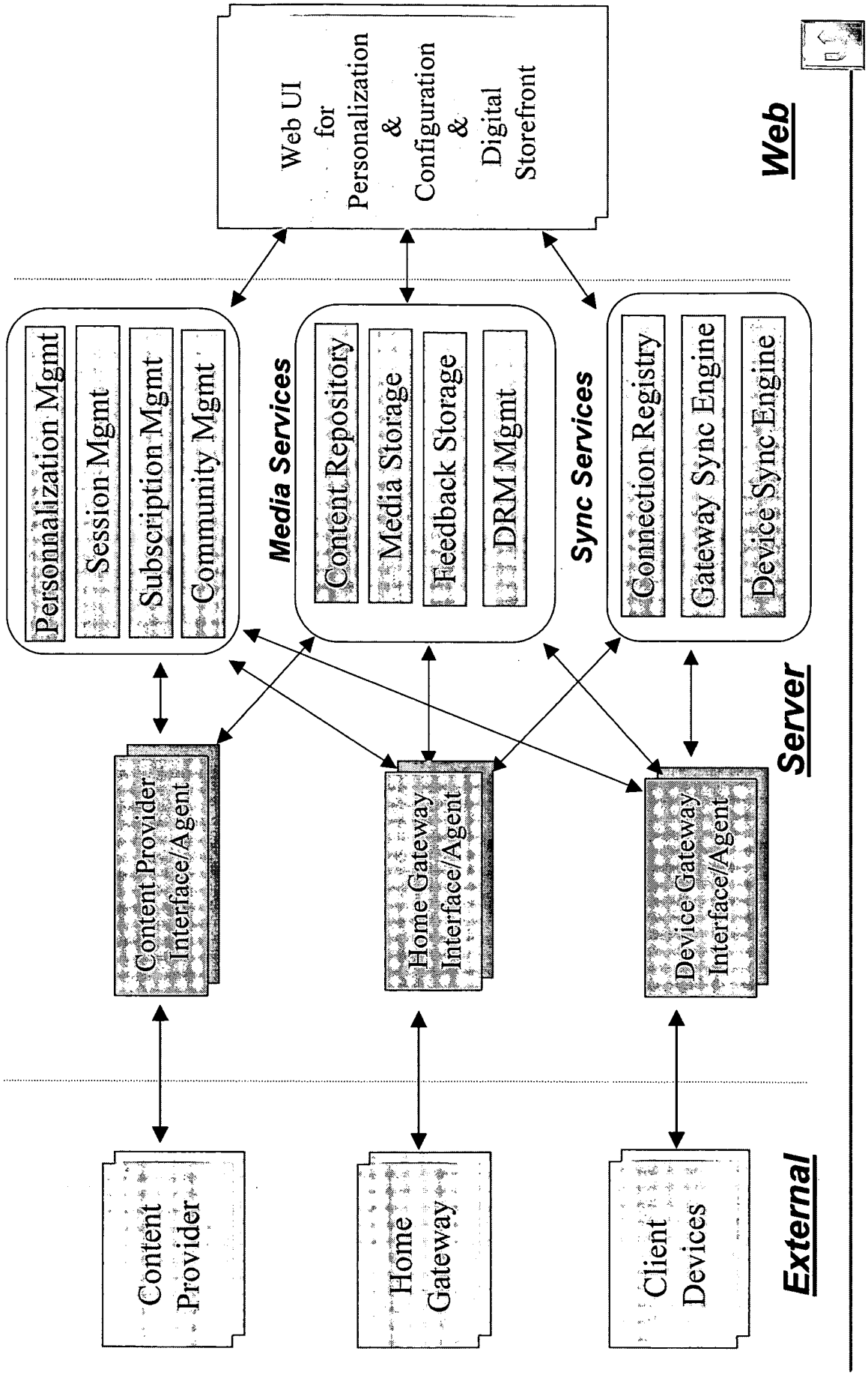

iRadio

Motorola is uniquely positioned to deliver wireless music experiences to consumers across the person, home, and car...

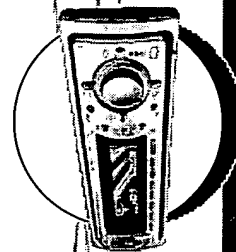
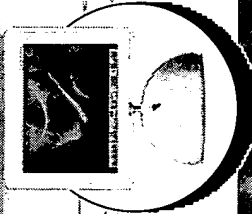
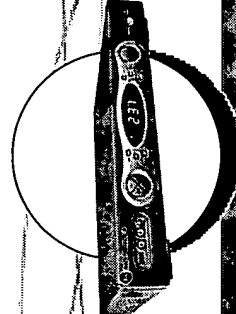
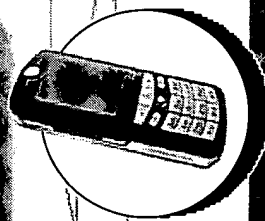
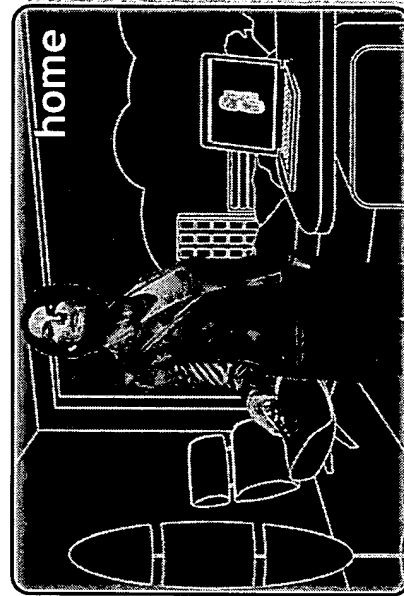
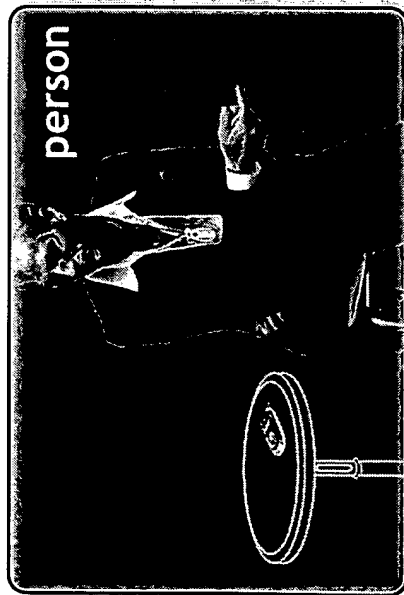

Time-Slipped & Buffered Audio Impulse Purchase Pause & Resume across domains Referral Engine

Cellular Bluetooth Hi-Speed Internet 802.11

Digital Music Store FM Broadcast Internet Radio Satellite Radio Streaming Video



MOTOROLA

intelligence  everywhere™

iRadio

- ◆ You've heard Ed Zander & Padmasree Warrior talk about iRadio. This is a space we're really excited about!
- ◆ iRadio enables your music to follow you . . . seamlessly from your home to your car & when you're on the go
- ◆ We'll create a "daily set" of your digital music collection, your favorite talk radio shows and a couple hours of your personalized radio channel
- ◆ And let you listen to it anytime, anywhere!



MOTOROLA

intelligence  everywhere™

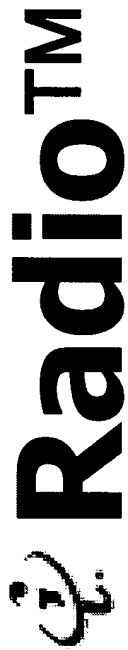

Growth Platform Update

March 8, 2004



Motorola Confidential Proprietary
Page 1



iRadio – The Original Concept

				"Where"			
				Person	Home	Car	Other
Navigation						Telematics On Steroids	
Entertainment							
Information							
Safety & Security							

Automobile Centric
Infrastructure was not Ready
Broad Vision of Services



Motorola Confidential Proprietary
Page 2

**This Page is Inserted by IFW Indexing and Scanning
Operations and is not part of the Official Record**

BEST AVAILABLE IMAGES

Defective images within this document are accurate representations of the original documents submitted by the applicant.

Defects in the images include but are not limited to the items checked:

- BLACK BORDERS
- IMAGE CUT OFF AT TOP, BOTTOM OR SIDES
- FADED TEXT OR DRAWING
- BLURRED OR ILLEGIBLE TEXT OR DRAWING
- SKEWED/SLANTED IMAGES
- COLOR OR BLACK AND WHITE PHOTOGRAPHS
- GRAY SCALE DOCUMENTS
- LINES OR MARKS ON ORIGINAL DOCUMENT
- REFERENCE(S) OR EXHIBIT(S) SUBMITTED ARE POOR QUALITY
- OTHER: _____

IMAGES ARE BEST AVAILABLE COPY.

As rescanning these documents will not correct the image problems checked, please do not report these problems to the IFW Image Problem Mailbox.

iRadio – Reincarnated

"Where"			
Person	Home	Car	Other
Navigation			
Entertainment		Tele	
Information		tics On Steroids	
Safety & Security			
Seamless Digital Audio across Person-Home-Car			

Consumer Centric – across Domains
Wireless & Content Infra Ready
Focused & Phased Approach



MOTOROLA



intelligence everywhere™

Motorola Confidential Proprietary
Page 3

Market Factors highlight a hot opportunity in digital audio services across the person-home-car

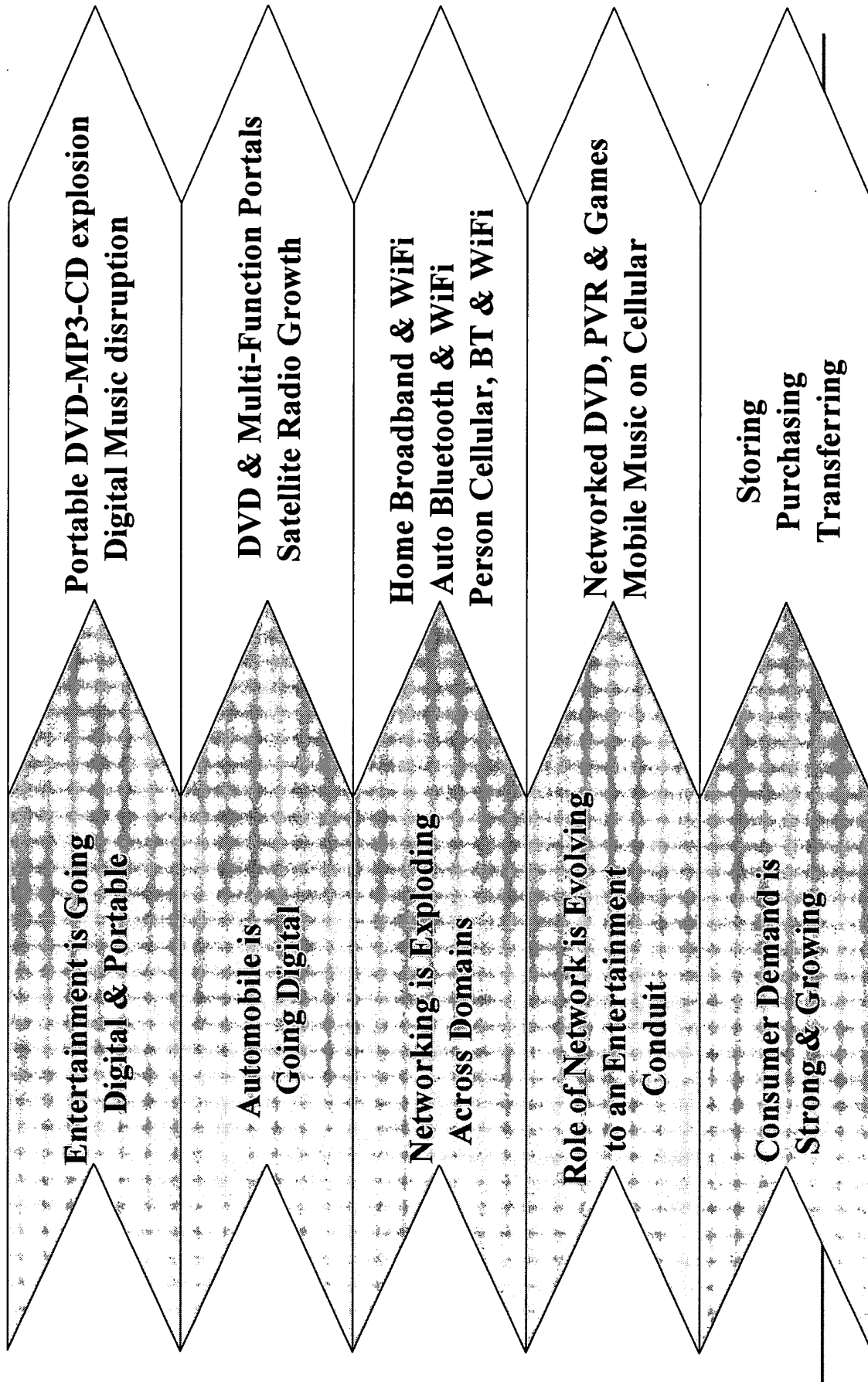

MOTOROLA

Motorola Confidential Proprietary
Page 4



intelligence everywhere

iRadio – Reinventing & Personalizing Audio!

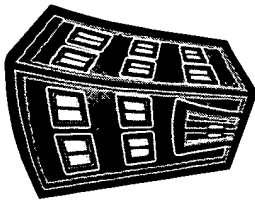

Service Provider

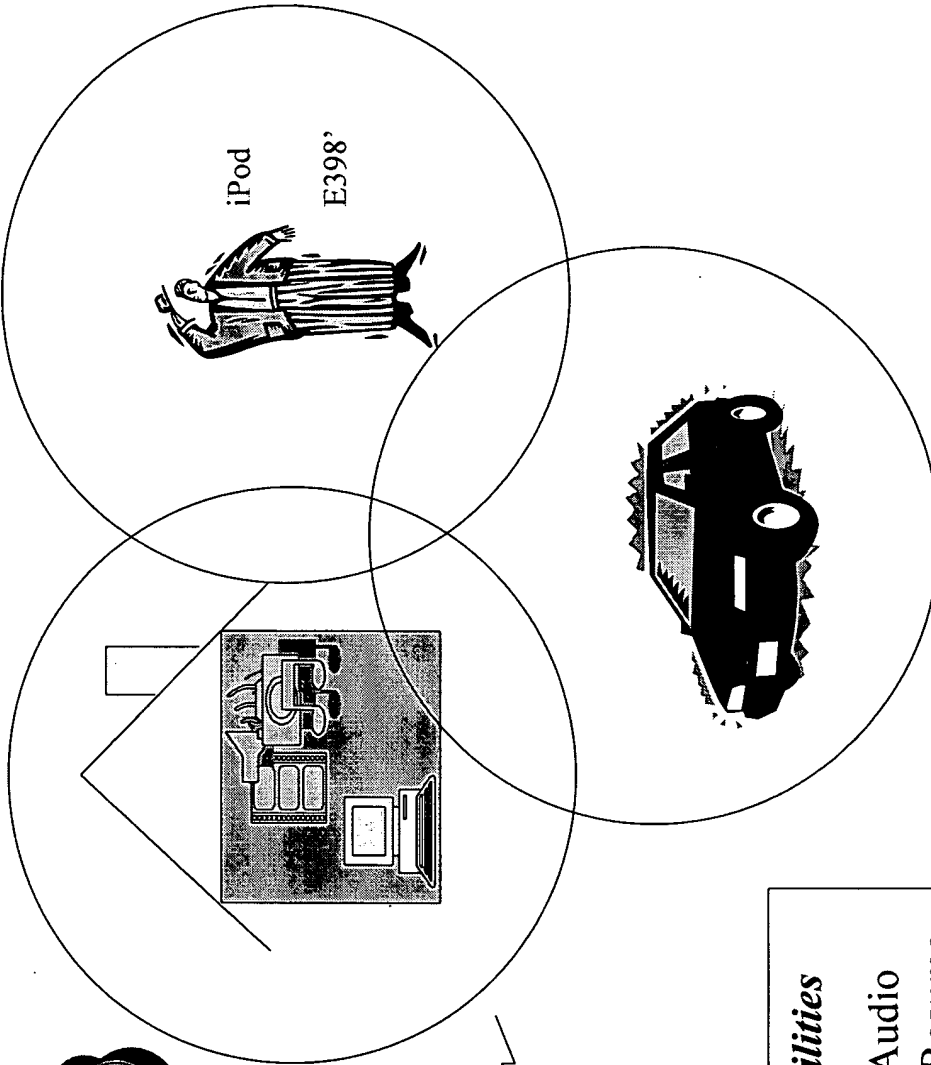

Consumer Value

- Listen to your favorite radio/TV show when & where you want to!
- Hear the 1st half in the car . . . The rest at home!
- Like what you hear? Buy it!
- Link to your community.

iRadio Capabilities

- Time Slipped Audio
- Seamless Pause-Resume
- Push-to-Buy
- Suggestion/Referral Engine



MOTOROLA



intelligence **M** everywhere™

Motorola Confidential Proprietary
Page 5

Value Chain – Where is the Strategic Control Spot?

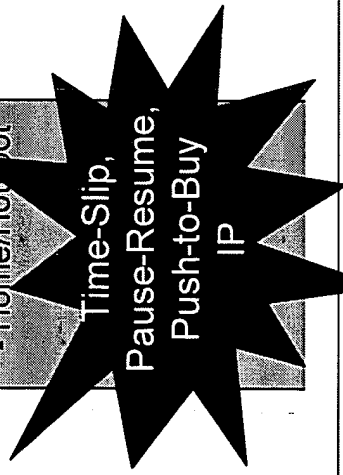
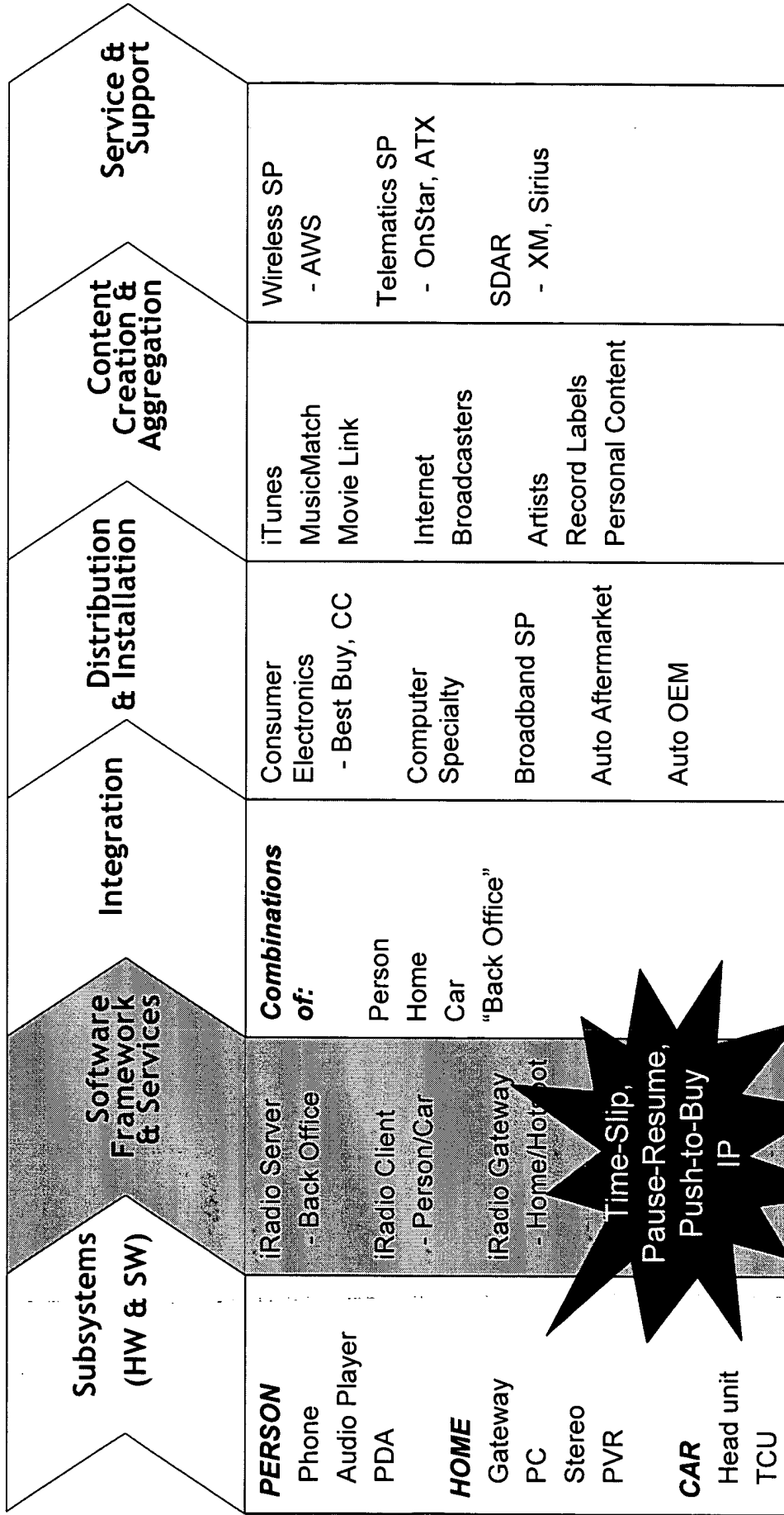

Software Framework & IP – Strategic control point to seamlessly deliver time-slipped, personalized digital audio across the person, home & car



MOTOROLA



intelligence everywhere™

Motorola Confidential Proprietary
Page 6

Competition Is Quickly Heating Up!

	Person	Home	Car	Enterprise
Consumer Electronics	Apple	X		
	Panasonic	X	X	
	Sony	X	X	
Automotive	Delphi	X	X	
	Visteon	X	X	
Computing & Networking	IBM	X		X
	Microsoft	X	X	X
	Cisco	X		X
Service	XM	X	X	
New Entrants	Gotuit	X	X	
	Simple Dev	X	X	
	Motorola	X	X	



MOTOROLA



intelligence everywhere™

Motorola Confidential Proprietary
Page 7

Why Will Motorola Win?

Motorola Brings . . .	iRadio Adds . . .
<p>Unparalleled footprint in the person, home & car</p> <ul style="list-style-type: none">➤ BCS➤ PCS➤ ACES <p>Seamless, multi-mode networking expertise</p> <ul style="list-style-type: none">➤ Cellular➤ Bluetooth➤ 802.11 <p>Strong & trusted global brand</p> <ul style="list-style-type: none">➤ Particularly in NA and China	<p>Software Architecture</p> <ul style="list-style-type: none">➤ Client➤ Server➤ Gateway <p>Intellectual Property</p> <ul style="list-style-type: none">➤ Multi-domain content synch➤ Pause-Resume➤ Push-to-Buy



MOTOROLA

Motorola Confidential Proprietary
Page 8



intelligence everywhere

iRadio Media Control Protocol

Motorola Labs

Revision History		
Working Draft v0.1	September 28, 2004	Michael Pearce
Working Draft v0.2	September 29, 2004	Michael Pearce
Working Draft v0.3	September 30, 2004	Michael Pearce
Working Draft v0.4	October 1, 2004	Michael Pearce
Working Draft v0.5	October 7, 2004	Michael Pearce
Working Draft v0.6	October 13, 2004	Michael Pearce
Working Draft v0.7	October 15, 2004	Michael Pearce
Working Draft v0.8	October 24, 2004	Michael Pearce
Working Draft v0.9	October 27, 2004	Ed Costello
<u>Working Draft v0.10</u>	<u>October 28, 2004</u>	<u>Michael Pearce</u>

Table of Contents

1	Introduction.....	1
2	Theory of Operation.....	221
2.1	Initiation.....	2
2.2	Termination.....	2
3	State Machines.....	2
3.1	Mobile Client State Machine.....	332
3.2	Peer State Machine.....	543
4	Protocol Interface.....	664
4.1	Mobile Client Interface.....	665
4.2	Peer Interface.....	775
5	Message Framing and Encoding.....	986
5.1	Framing.....	996
5.2	Control Channel.....	1097
5.3	Content Channel.....	171614
5.4	Management Channel.....	181715
6	Security Considerations.....	181715

1 Introduction

This protocol is intended to support playback of content in the distributed environment envisioned by iRadio. It supports distributed control of playback and supports optional streaming of content from a handset to a player via Bluetooth.

2 Theory of Operation

The system is envisioned to consist of three classes of devices:

1. The Mobile Client (a.k.a. handset), which contains a synchronized subset of the content. The Mobile Client also contains a playback control user interface and is capable of rendering the content locally as well as remotely controlling rendering of the content. The Mobile Client can optionally stream the content to a remote renderer.
2. The gateway, which contains the master copy of the content. The gateway also contains a playback control user interface and is capable of rendering the content locally or via remote control.
3. The WACA (Wireless Audio Car Adapter), which does not contain a copy of the content. The WACA contains a playback control user interface and is capable of rendering the content received in a stream from the Mobile Client.

Throughout this document, in contexts where either the gateway or the WACA would be playing the same role, the term “peer” is used to refer them interchangeably. However, this does not imply equivalence between these devices in the overall system architecture. Rather, it is used to in this specification to simplify the description of the protocol.

2.1 Initiation

iMCP operates over a Bluetooth serial port profile (SPP) connection. The Mobile Client is always the SPP server, while the gateway and WACA are always SPP clients. This means the gateway and WACA must be periodically scanning for the presence of the Mobile Client and, when it’s presence is detected, initiating an SPP connection to the Mobile Client. Once such a connection is established between the Mobile Client and either the gateway or the WACA, the control channel is used to exchange `MSG_SYN` and `MSG_ACKMSG_SYN_ACK` messages (which includes an indication by the peer of whether it will require streamed audio content or not). At this point, the protocol is ready to carry other control messages as well as streamed audio content (if necessary).

2.2 Termination

iMCP termination is implied by tearing down the Bluetooth SPP connection. A peer may optionally indicate termination via a `MSG_POWERDOWN` message prior to closing the Bluetooth SPP connection

3 State Machines

In the following sections, the state machines are specified using tables (one per state). In each table, only the relevant events are included. Events that occur in a state that are not specified in these tables are to be ignored for purposes of state transitions. This includes any event that occurs without a matching condition to what is specified in the table.

The Mobile Client state machine should be implemented by the handset (or other non-handset controller).

The peer state machine should be implemented by the WACA and the gateway peers.

3.1 Mobile Client State Machine

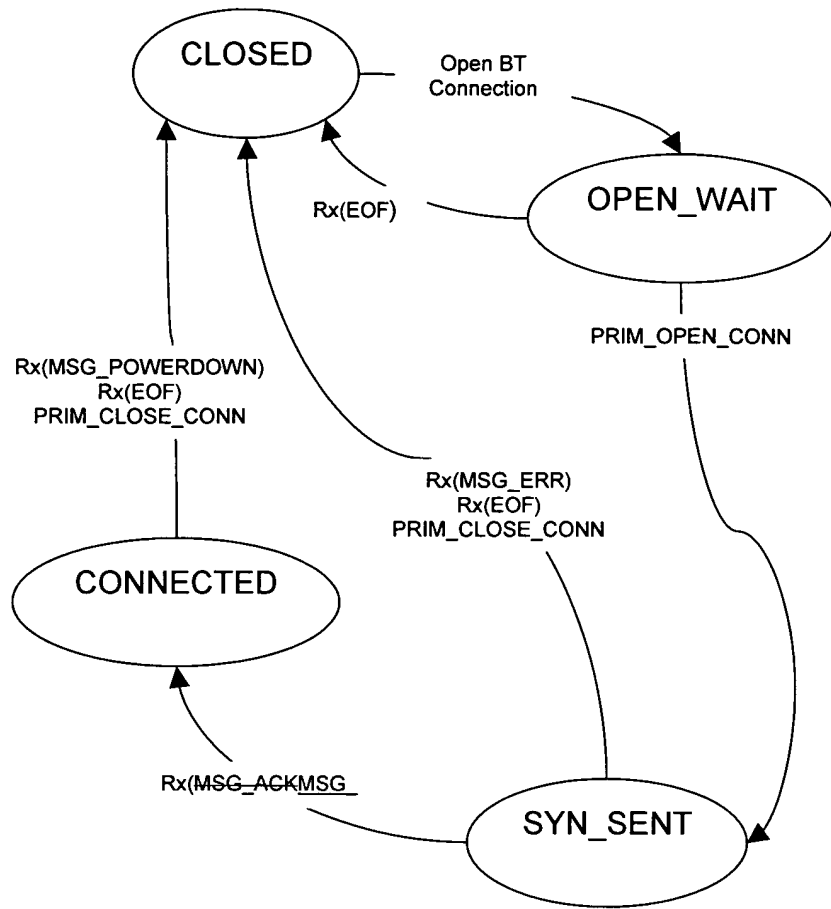

Mobile Client State Diagram

3.1.1 CLOSED State

In this state, the Bluetooth transport connection is closed. The implementation should be listening for incoming Bluetooth SPP connections.

Event	Condition	Next State	Action
New Transport Connection		OPEN_WAIT	

3.1.2 OPEN_WAIT State

In this state, the Bluetooth transport connection should be open. The state machine is waiting for the upper layer to request a connection.

Event	Condition	Next State	Action
PRIM_OPEN_CONN		SYN_SENT	Tx(MSG_SYN)

Rx(EOF)		CLOSED	Notify(CONN_FAILURE)
---------	--	--------	----------------------

3.1.3 SYN_SENT State

In this state, the state machine is awaiting a response to the MSG_SYN message.

Event	Condition	Next State	Action
Rx(MSG_ACKMSG SYN_ACK)		CONNECTED	Notify(CONN_OPEN)
Rx(MSG_ERR)		CLOSED	Notify(CONN_FAILURE)
Rx(EOF)		CLOSED	Notify(CONN_FAILURE)
PRIM_CLOSE_CONN		CLOSED	Tx(MSG_ERR)

3.1.4 CONNECTED State

In this state, the connection has been successfully opened.

Event	Condition	Next State	Action
Rx(MSG_POWERDOWN)		CLOSED	Notify(CONN_CLOSED)
Rx(EOF)		CLOSED	Notify(CONN_CLOSED)
PRIM_CLOSE_CONN		CLOSED	

3.2 Peer State Machine

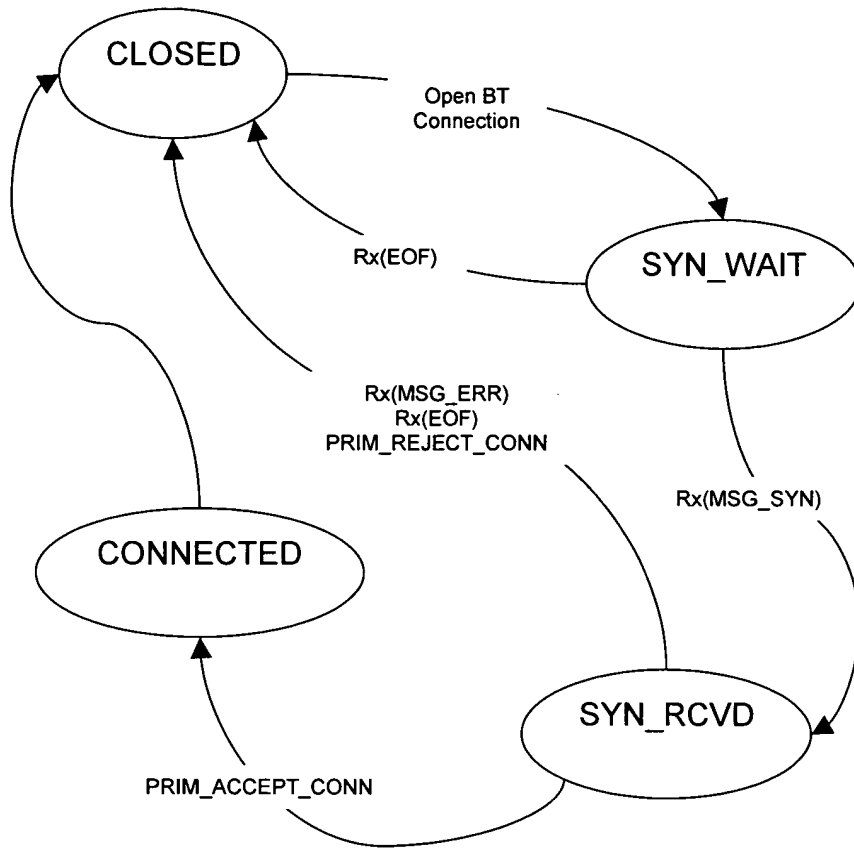

Peer State Diagram

3.2.1 CLOSED State

In this state, the Bluetooth transport connection is closed. The implementation should be periodically scanning for the presence of the Mobile Client. When the Mobile Client is detected, a new SPP connection should be initiated to the Mobile Client.

Event	Condition	Next State	Action
New Transport Connection		SYN_WAIT	

3.2.2 SYN_WAIT State

In this state, the Bluetooth transport connection should be open. The state machine is waiting for an MSG_SYN message.

Event	Condition	Next State	Action
Rx(MSG_SYN)		SYN_RCVD	Notify(CONN_REQUEST)
Rx(EOF)		CLOSED	Notify(CONN_FAILURE)

3.2.3 SYN_RCVD State

In this state, the peer has received a MSG_SYN and is waiting for the upper layer to either accept or reject the connection.

Event	Condition	Next State	Action
PRIM_ACCEPT_CONN		CONNECTED	Tx(MSG_ACKMSG_SYN_ACK)
PRIM_REJECT_CONN		CLOSED	Tx(MSG_ERR)
Rx(MSG_ERR)		CLOSED	Notify(CONN_FAILURE)
Rx(EOF)		CLOSED	Notify(CONN_FAILURE)

3.2.4 CONNECTED State

In this state, the connection has been successfully opened.

Event	Condition	Next State	Action
PRIM_POWERDOWN		CLOSED	Tx(MSG_POWERDOWN)
Rx(EOF)		CLOSED	Notify(CONN_CLOSED)

4.3.3 Protocol Interface

The primitives and notifications in the protocol interface describe only the state-changing events that drive (and are generated from) the state machines specified in section 3. Data types referenced in this section are abstract only (and should be self-explanatory).

This is not intended to be an application programming interface. It is merely intended to describe the events that are exchanged between the state machine and the upper layer. A primitive is an event received by the state machine from the upper layer, while a notification is an event delivered to the upper layer from the state machine.

4.13.3.1 Mobile Client Interface

4.1.13.3.1.1 Primitives

4.1.1.13.3.1.1.1 PRIM_OPEN_CONN

Sent to the state machine by the upper layer when the upper layer wishes to initiate the iMCP connection establishment procedures.

4.1.1.23.3.1.1.2 PRIM_CLOSE_CONN

Sent to the state machine by the upper layer when the upper layer wishes to initiate the iMCP connection close procedures.

4.1.23.3.1.2 Notifications

4.1.2.13.3.1.2.1 CONN_OPEN

Sent by the state machine to the upper layer to indicate the iMCP protocol is now open. Information included in this notification is described below.

Parameter	Type	Required	Description
iMCP_Version	Integer	Mandatory	Protocol version supported by peer
ContentAvail	Boolean	Mandatory	True: Peer has local content False: Peer needs streamed content
HardwareId	Integer	Mandatory	0: No Interaction Hardware 0x1-0xFFFFFFFF: Hardware Identifier

4.1.2.23.3.1.2.2 *CONN_FAILURE*

Sent by the state machine to the upper layer to indicate the iMCP protocol failed to open. Information included in the notification is described below.

Parameter	Type	Required	Description
ErrorCode	Integer	Mandatory	Error Code
ErrorMsg	String	Mandatory	Error Message

4.1.2.33.3.1.2.3 *CONN_CLOSED*

Sent by the state machine to the upper layer to indicate the iMCP protocol has been closed.

4.23.3.2 *Peer Interface*

4.2.13.3.2.1 *Primitives*

4.2.1.13.3.2.1.1 *PRIM_ACCEPT_CONN*

Sent by the upper layer to the state machine to indicate the upper layer wishes to accept the offered connection. Information included in this primitive is described below.

Parameter	Type	Required	Description
ContentAvail	Boolean	Mandatory	True: Peer has local content False: Peer needs streamed content
HardwareId	Integer	Mandatory	0: No Interaction Hardware 0x1-0xFFFFFFFF: Hardware Identifier

4.2.1.23.3.2.1.2 *PRIM_REJECT_CONN*

Sent by the upper layer to the state machine to indicate the upper layer does not wish to accept the offered connection. Information included in this primitive is described below.

Parameter	Type	Required	Description
-----------	------	----------	-------------

ErrorCode	Integer	Mandatory	Error Code
ErrorMsg	String	Mandatory	Error Message

4.2.1.33.3.2.1.3 PRIM_POWERDOWN

Sent by the upper layer to the state machine to indicate the upper layer is powering off and the iMCP protocol should be closed.

4.2.23.3.2.2 Notifications

4.2.2.13.3.2.2.1 CONN_REQUEST

Sent by the state machine to the upper layer to indicate a new connection has been requested. Information included in this notification is described below.

Parameter	Type	Required	Description
iMCP_Version	Integer	Mandatory	Protocol version supported by Mobile Client

4.2.2.23.3.2.2.2 CONN_FAILURE

Sent by the state machine to the upper layer to indicate the connection has failed. Information included in this notification is described below.

Parameter	Type	Required	Description
ErrorCode	Integer	Mandatory	Error Code
ErrorMsg	String	Mandatory	Error Message

4.2.2.33.3.2.2.3 CONN_CLOSED

Sent by the state machine to the upper layer to indicate the connection has been closed.

3.4 Example Message Sequences

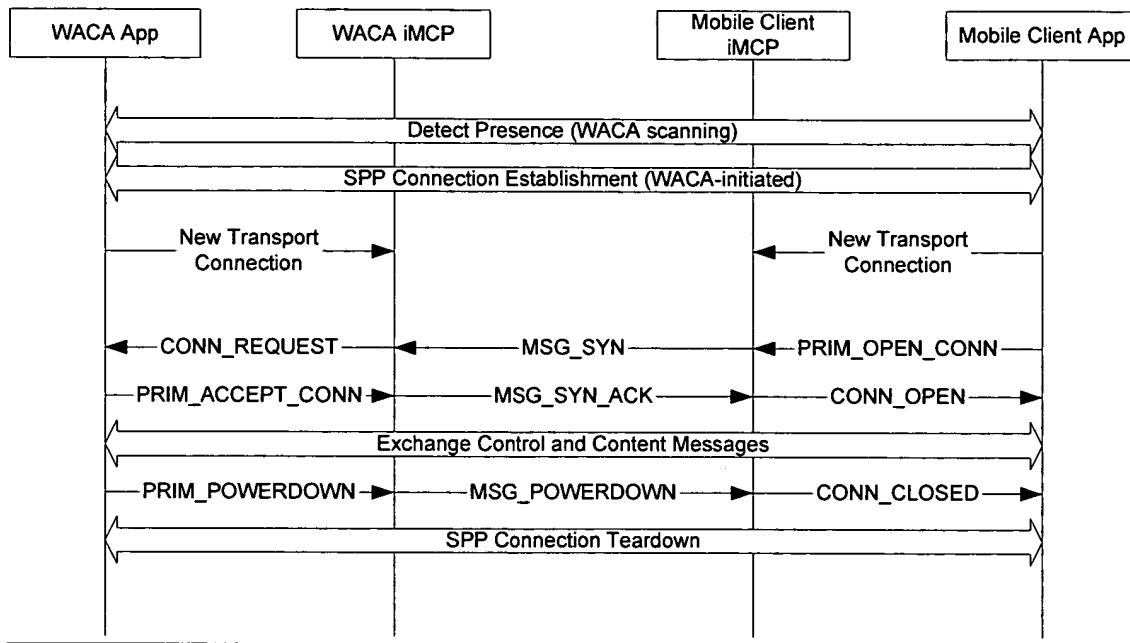

Figure 1 Normal Connection Open and Close

54 Message Framing and Encoding

Boolean data is encoded as a single byte having either a 0x00 (false) or 0x01 (true) value.

Integer data is encoded in big-endian variable length fields, depending on the maximum range of values allowed for the field in question. Integer field lengths must be 1, 2, 4, or 8 bytes long. Integers are unsigned unless otherwise indicated.

String data is encoded using a 2-byte (big-endian) length prefix followed by the specified number of bytes of UTF8-encoded character data (note: the length prefix specifies the number of bytes of character data, not the number of characters in the string). The longest string that may be transferred using this encoding is 65535 characters, assuming none of the characters requires more than one byte.

Note that this encoding scheme is compatible with the commonly used `java.io.DataInputStream` and `java.io.DataOutputStream` classes.

5.14.1 Framing

All messages begin with a 1-byte channel identifier, allowing control and content information to be multiplexed across a single byte stream.

Each message is framed using a length-prefix scheme. Immediately following the channel identifier is a 2-byte message length field. The 3 bytes of channel identification and message length information are not included in the message size, allowing a maximum enclosed message size of 65535 bytes.

Table 1 Framing Header

Field	Type	Length	Value	Description
-------	------	--------	-------	-------------

		(bytes)		
CHANNEL	Integer	1	0-1	Channel Identifier: 0: Control 1: Content
MSG_LEN	Integer	2	0-65535	Message Length

5.24.2 Control Channel

Control messages begin with a 1-byte message type field. The remainder of the message format is type-specific. The message types are enumerated below:

Table 2 Control Message Types

Message Type	Value
MSG_SYN	0x00
MSG_SYN_ACK	0x01
MSG_ERR	0x02
MSG_DISPLAY	0x03
MSG_META	0x04
MSG_CREDIT	0x05
MSG_FLUSH	0x06
MSG_POWERDOWN	0x07
MSG_RENDER_CMD	0x08
MSG_SERVER_CMD	0x09

5.2.14.2.1 MSG_SYN

This message is only sent by the Mobile Client to either the gateway or WACA peers.

Field	Type	Length (bytes)	Value	Description
CHANNEL	Integer	1	0	Control Channel
MSG_LEN	Integer	2	2	Message Length
MSG_TYPE	Integer	1	0x00	MSG_SYN
IMCP_VERSION	Integer	1	0x01	Protocol Version Number

5.2.24.2.2 MSG_ACKMSG SYN ACK

This message is only sent by the gateway or WACA peers to the Mobile Client in response to a MSG_SYN. If the peer has a local content cache (e.g., the gateway), then it

should set the FLAG_CONTENT_AVAIL to true, causing the Mobile Client to avoid sending content on the content channel as well as metadata in MSG_META messages. If the peer does not have a local content cache (e.g., the WACA), then it should set the FLAG_CONTENT_AVAIL to false, causing the Mobile Client to stream content on the content channel as well as send metadata in MSG_META messages.

The HW_ID field indicates the interaction hardware identifier. The gateway should return a zero for this field, while the WACA should return an identifier specific to the head unit it's attached to. This will enable the Mobile Client to properly interpret the interaction events for that device.

Field	Type	Length (bytes)	Value	Description
CHANNEL	Integer	1	0	Control Channel
MSG_LEN	Integer	2	3	Message Length
MSG_TYPE	Integer	1	0x01	MSG_ACK MSG_SYN_ACK
IMCP_VERSION	Integer	1	0x01	Protocol Version Number
FLAG_CONTENT_AVAIL	Boolean	1	0, 1	True: Local content available False: Need content
HW_ID	Integer	4	0x0-0xFFFFFFFF	0: No Interaction Hardware 0x1-0xFFFFFFFF: Hardware Id

5.2.34.2.3 MSG_ERR

This message may be sent by either the Mobile Client or the peers in response to MSG_SYN or MSG_EVT messages.

Field	Type	Length (bytes)	Value	Description
CHANNEL	Integer	1	0	Control Channel
MSG_LEN	Integer	2	Variable	Message Length
MSG_TYPE	Integer	1	0x02	MSG_ERR
ERR_CODE	Integer	1	0-255	Error Code
ERR_MSG	String	Variable		Error Message

Table 3 Error Codes

Error Type	Code	Description
UNKNOWN_EVENT	0x80	An unknown or invalid event message was received

5.2.44.2.4 MSG_DISPLAY

This message is sent from the Mobile Client to a content-receiving peer to indicate a request to display a short text message for a minimum amount of time.

Field	Type	Length (bytes)	Value	Description
CHANNEL	Integer	1	0	Control Channel
MSG_LEN	Integer	2	Variable	Message Length
MSG_TYPE	Integer	1	0x03	MSG_METADISPLAY
MESSAGE	String	Variable		Message to display
EXPIRES	Integer	1	0-255	0: Display until explicitly cancelled by user 1-255: Display for EXPIRES seconds (or until cancelled)

5.2.54.2.5 MSG_META

This message is sent from the Mobile Client to a content-receiving peer to indicate a change in the relevant content metadata. This message would be sent as a result of a GOTO_CHANNEL event or a transition from one track to another within a channel. Note that not all of the tag information will be sent in every META message – the Mobile Client may only include the most relevant information in a given message. For example, when a new track begins within a channel, the CHANNEL_NUM and CHANNEL_NAME tags would not be sent again since they haven’t changed.

Field	Type	Length (bytes)	Value	Description
CHANNEL	Integer	1	0	Control Channel
MSG_LEN	Integer	2	Variable	Message Length
MSG_TYPE	Integer	1	0x04	MSG_META
NUM_TAGS	Integer	1	1-255	Number of metadata tags that follow
Repeat the following NUM_TAGS times:				
TAG_ID	Integer	1	0-255	Tag Identifier
TAG_LENGTH	Integer	2	0-65535	Tag Length (bytes that follow)
TAG_DATA		Variable		Tag Data

Table 4 Tag Identifiers

Tag	Id	Comment
ARTIST	0x00	Artist Name
TITLE	0x01	Track Title
ALBUM	0x02	Album Title
GENRE	0x03	Genre
CHANNEL_NUM	0x04	Channel Number
CHANNEL_NAME	0x05	Channel Name
TRACK	0x06	Track Number
NUM_TRACKS	0x07	Number of Tracks in Channel
CHANNEL_LEN	0x08	Length of Channel
TRACK_LEN	0x09	Length of Track
CHANNEL_REMAIN	0x0A	Channel Time Remaining
TRACK_REMAIN	0x0B	Track Time Remaining

5.2.5.14.2.5.1 Artist Tag

Field	Type	Length (bytes)	Value	Description
ARTIST	String	Variable		Artist Name

5.2.5.24.2.5.2 Track Title Tag

Field	Type	Length (bytes)	Value	Description
TITLE	String	Variable		Track Title

5.2.5.34.2.5.3 Album Tag

Field	Type	Length (bytes)	Value	Description
ALBUM	String	Variable		Album Title

5.2.5.44.2.5.4 Genre Tag

Field	Type	Length (bytes)	Value	Description

GENRE	String	Variable		Genre
-------	--------	----------	--	-------

5.2.5.54.2.5.5 Channel Number Tag

Field	Type	Length (bytes)	Value	Description
CHANNEL_NUM	Integer	1	0-255	Channel Number

5.2.5.64.2.5.6 Channel Name Tag

Field	Type	Length (bytes)	Value	Description
CHANNEL_NAME	String	Variable		Channel Name

5.2.5.74.2.5.7 Track Number Tag

Field	Type	Length (bytes)	Value	Description
TRACK	Integer	1	0-255	Track Number

5.2.5.84.2.5.8 Total Tracks Tag

Field	Type	Length (bytes)	Value	Description
NUM_TRACKS	Integer	1	0-255	Number of Tracks in Channel

5.2.5.94.2.5.9 Channel Length Tag

Field	Type	Length (bytes)	Value	Description
CHANNEL_LEN	Integer	2	0-65535	Length of Channel (in seconds)

5.2.5.104.2.5.10 Track Length Tag

Field	Type	Length (bytes)	Value	Description
TRACK_LEN	Integer	2	0-65535	Length of Track (in seconds)

5.2.5.114.2.5.11 Channel Time Remaining Tag

Field	Type	Length (bytes)	Value	Description
-------	------	-------------------	-------	-------------

CHANNEL_REMAIN	Integer	2	0-65535	Channel Time remaining (in seconds)
----------------	---------	---	---------	-------------------------------------

5.2.5.124.2.5.12 Track Time Remaining Tag

Field	Type	Length (bytes)	Value	Description
TRACK_REMAIN	Integer	2	0-65535	Track Time remaining (in seconds)

5.2.64.2.6 MSG_CREDIT

This message is sent from a content-receiving peer to the Mobile Client to control the flow of content. The CREDIT field indicates the number of bytes of new content should be transmitted to the receiver before waiting for another CREDIT message.

New content bytes need not be delivered in a single message matching the value in the CREDIT field. They may be delivered in several content messages as long as no more than CREDIT bytes of new content are delivered prior to receiving a new MSG_CREDIT message (this may be necessary, for example, if the tail of one track contains fewer bytes than the advertised credit; in this case, two content messages would be sent, one with the tail of the current track, and another with the head of the next track in the channel).

New MSG_CREDIT messages may be transmitted before all of the content fulfilling the previous MSG_CREDIT message has been delivered. This pipelining may be necessary to minimize buffering in the receiver.

Field	Type	Length (bytes)	Value	Description
CHANNEL	Integer	1	0	Control Channel
MSG_LEN	Integer	2	3	Message Length
MSG_TYPE	Integer	1	0x05	MSG_CREDIT
CREDIT	Integer	2	0-65535	Content Credit

5.2.74.2.7 MSG_FLUSH

This message is sent from the Mobile Client to a content-receiving peer to cause the peer's content buffers to be flushed. This message would be sent as a result of a discontinuity in the playback due to, for example, a GOTO_CHANNEL event.

Field	Type	Length (bytes)	Value	Description
CHANNEL	Integer	1	0	Control Channel
MSG_LEN	Integer	2	1	Message Length
MSG_TYPE	Integer	1	0x06	MSG_FLUSH

5.2.84.2.8 MSG_POWERDOWN

This message is sent from the WACA to indicate it is powering down and the session should be terminated.

Field	Type	Length (bytes)	Value	Description
CHANNEL	Integer	1	0	Control Channel
MSG_LEN	Integer	2	1	Message Length
MSG_TYPE	Integer	1	0x07	MSG_POWERDOWN

5.2.94.2.9 MSG_RENDER_CMD

This message is sent from the Mobile Client to either the WACA or the gateway peer to control playback. It may also be sent from the WACA to the Mobile Client to indicate a local change in playback state (as a result of the user interaction), in which case it is informative only and will not result in a corresponding MSG_RENDER_CMD from the Mobile Client to the WACA.

Field	Type	Length (bytes)	Value	Description
CHANNEL	Integer	1	0	Control Channel
MSG_LEN	Integer	2	2	Message Length
MSG_TYPE	Integer	1	0x08	MSG_RENDER_CMD
RCMD_TYPE	Integer	1	0-255	Command Type

Table 5 Render Command Types

Command Type	Code	Comment
RCMD_PLAY	0x00	Begin Playback
RCMD_PAUSE	0x01	Pause Playback

5.2.104.2.10 MSG_SERVER_CMD

This message is sent from the Mobile Client to the gateway peer or from the WACA to the Mobile Client to control content selection.

Field	Type	Length (bytes)	Value	Description
CHANNEL	Integer	1	0	Control Channel
MSG_LEN	Integer	2	3	Message Length
MSG_TYPE	Integer	1	0x09	MSG_SERVER_CMD

SCMD_TYPE	Integer	1	0-255	Command Type
CMD_PARAM	Integer	1	0-255	Command Parameter

Table 6 Render Command Types

Command Type	Code	Comment
SCMD_FF	0x00	Fast Forward
SCMD_REW	0x01	Rewind
SCMD_NEXT_TRACK	0x02	Next Track
SCMD_PREV_TRACK	0x03	Previous Track
SCMD_NEXT_CHANNEL	0x04	Next Channel
SCMD_PREV_CHANNEL	0x05	Previous Channel
SCMD_GOTO_CHANNEL	0x06	Go to Channel in CMD_PARAM
SCMD_PURCHASE	0x07	Purchase Current Track

5.34.3 Content Channel

Blocks of encoded audio content are sent in messages across the content channel from the Mobile Client to the peer if the peer indicated a need for content during the control channel establishment (see Section 4.2.24.2.25.2.2). The size and pacing of content messages is determined by the receiving peer, which sends MSG_CREDIT messages on the control channel to the Mobile Client indicating how many more bytes of content it wishes to receive (see Section 4.2.64.2.65.2.6). There is no correlation between content channel message boundaries and MPEG frames.

Field	Type	Length (bytes)	Value	Description
CHANNEL	Integer	1	1	Control Channel
MSG_LEN	Integer	2	Variable	Message Length
CODEC_TYPE	Integer	1	0-255	Codec Identifier
CONTENT	Bytes	Variable		Audio Content

Table 7 Codec Identifiers

Codec	Id	Comment
WAV	0x00	Microsoft WAV File Format
SBC	0x01	Sub Band Codec
MP3	0x02	MPEG Layer 3 Audio
MP3_PRO	0x03	MP3 Pro

AAC	0x04	Advanced Audio Codec
AAC_PLUS	0x05	AAC w/SBR
WMA	0x06	Windows Media Audio
OGG_VORBIS	0x07	Ogg Vorbis Audio

5.44.4 Management Channel

Need to capture the management channel requirement and protocol. Fundamentally, the Mobile Client is able to send firmware or other operationally-relevant information (e.g., model-specific translation tables) to the WACA. The WACA should be capable of updating this information by re-flashing itself or otherwise remembering it. The Management Channel will be used to update the WACA when new car radio models are introduced with new user event commands or new features.

65 Security Considerations

Since this protocol is intended to run over Bluetooth, this specification relies on the Bluetooth authentication and encryption facilities for security.

iRadio Media Control Protocol

Motorola Labs

Revision History		
Working Draft v0.1	September 28, 2004	Michael Pearce
Working Draft v0.2	September 29, 2004	Michael Pearce
Working Draft v0.3	September 30, 2004	Michael Pearce
Working Draft v0.4	October 1, 2004	Michael Pearce
Working Draft v0.5	October 7, 2004	Michael Pearce
Working Draft v0.6	October 13, 2004	Michael Pearce
Working Draft v0.7	October 15, 2004	Michael Pearce
Working Draft v0.8	October 24, 2004	Michael Pearce
Working Draft v0.9	October 27, 2004	Ed Costello
Working Draft v0.10	October 28, 2004	Michael Pearce
Working Draft v0.11	November 2, 2004	Michael Pearce
Working Draft v0.12	November 19, 2004	Michael Pearce
Working Draft v0.13	December 2, 2004	Michael Pearce
<u>Working Draft v0.14</u>	<u>December 16, 2004</u>	<u>Michael Pearce</u>

Table of Contents

1	Introduction.....	2
2	Theory of Operation.....	2
2.1	Initiation.....	2
2.2	Termination.....	<u>23</u>
3	State Machines.....	<u>23</u>
3.1	Mobile Client State Machine.....	<u>34</u>
3.2	Peer State Machine	<u>56</u>
3.3	Protocol Interface.....	<u>67</u>
3.4	Example Message Sequences	<u>910</u>
4	Message Framing and Encoding.....	<u>910</u>
4.1	Framing.....	<u>910</u>
4.2	Control Channel.....	<u>1011</u>
4.3	Content Channel.....	<u>1819</u>
4.4	Harmonization.....	<u>1920</u>
4.5	Management Channel	<u>1920</u>
5	Security Considerations.....	<u>2021</u>

1 Introduction

This protocol is intended to support playback of content in the distributed environment envisioned by iRadio. It supports distributed control of playback and supports optional streaming of content from a handset to a player via Bluetooth.

2 Theory of Operation

The system is envisioned to consist of three classes of devices:

1. The Mobile Client (a.k.a. handset), which contains a synchronized subset of the content. The Mobile Client also contains a playback control user interface and is capable of rendering the content locally as well as remotely controlling rendering of the content. The Mobile Client can optionally stream the content to a remote renderer.
2. The gateway, which contains the master copy of the content. The gateway also contains a playback control user interface and is capable of rendering the content locally or via remote control.
3. The WACA (Wireless Audio Car Adapter), which does not contain a copy of the content. The WACA contains a playback control user interface and is capable of rendering the content received in a stream from the Mobile Client.

Throughout this document, in contexts where either the gateway or the WACA would be playing the same role, the term “peer” is used to refer them interchangeably. However, this does not imply equivalence between these devices in the overall system architecture. Rather, it is used to in this specification to simplify the description of the protocol.

2.1 Initiation

iMCP operates over a Bluetooth serial port profile (SPP) connection. The Mobile Client is always the SPP server, while the gateway and WACA are always SPP clients. This means the gateway and WACA must be periodically scanning for the presence of the Mobile Client and, when it’s presence is detected, initiating an SPP connection to the Mobile Client. Once such a connection is established between the Mobile Client and either the gateway or the WACA, the control channel is used to exchange MSG_SYN and MSG_SYN_ACK messages (which includes an indication by the peer of whether it will require streamed audio content or not). At this point, the protocol is ready to carry other control messages as well as streamed audio content (if necessary).

2.2 Termination

iMCP termination is implied by tearing down the Bluetooth SPP connection. A peer may optionally indicate termination via a MSG_POWERDOWN message prior to closing the Bluetooth SPP connection

3 State Machines

In the following sections, the state machines are specified using tables (one per state). In each table, only the relevant events are included. Events that occur in a state that are not

specified in these tables are to be ignored for purposes of state transitions. This includes any event that occurs without a matching condition to what is specified in the table.

The Mobile Client state machine should be implemented by the handset (or other non-handset controller).

The peer state machine should be implemented by the WACA and the gateway peers.

3.1 Mobile Client State Machine

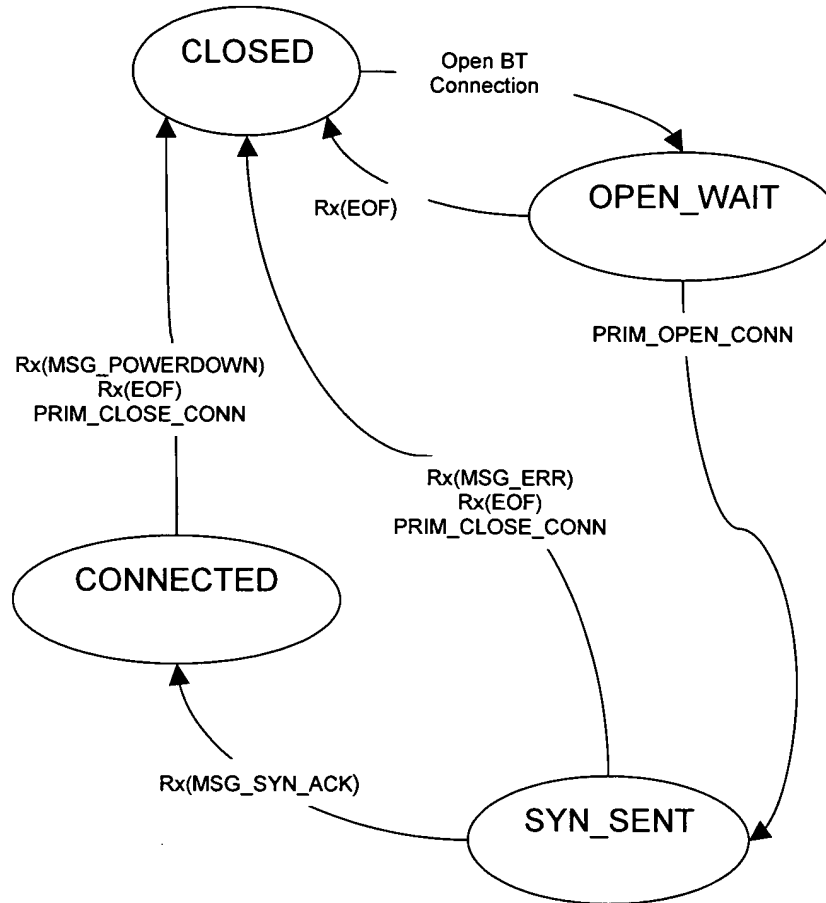

Mobile Client State Diagram

3.1.1 CLOSED State

In this state, the Bluetooth transport connection is closed. The implementation should be listening for incoming Bluetooth SPP connections.

Event	Condition	Next State	Action
New Transport Connection		OPEN_WAIT	

3.1.2 OPEN_WAIT State

In this state, the Bluetooth transport connection should be open. The state machine is waiting for the upper layer to request a connection.

Event	Condition	Next State	Action
PRIM_OPEN_CONN		SYN_SENT	Tx(MSG_SYN)
Rx(EOF)		CLOSED	Notify(CONN_FAILURE)

3.1.3 SYN_SENT State

In this state, the state machine is awaiting a response to the MSG_SYN message.

Event	Condition	Next State	Action
Rx(MSG_SYN_ACK)		CONNECTED	Notify(CONN_OPEN)
Rx(MSG_ERR)		CLOSED	Notify(CONN_FAILURE)
Rx(EOF)		CLOSED	Notify(CONN_FAILURE)
PRIM_CLOSE_CONN		CLOSED	Tx(MSG_ERR)

3.1.4 CONNECTED State

In this state, the connection has been successfully opened.

Event	Condition	Next State	Action
Rx(MSG_POWERDOWN)		CLOSED	Notify(CONN_CLOSED)
Rx(EOF)		CLOSED	Notify(CONN_CLOSED)
PRIM_CLOSE_CONN		CLOSED	

3.2 Peer State Machine

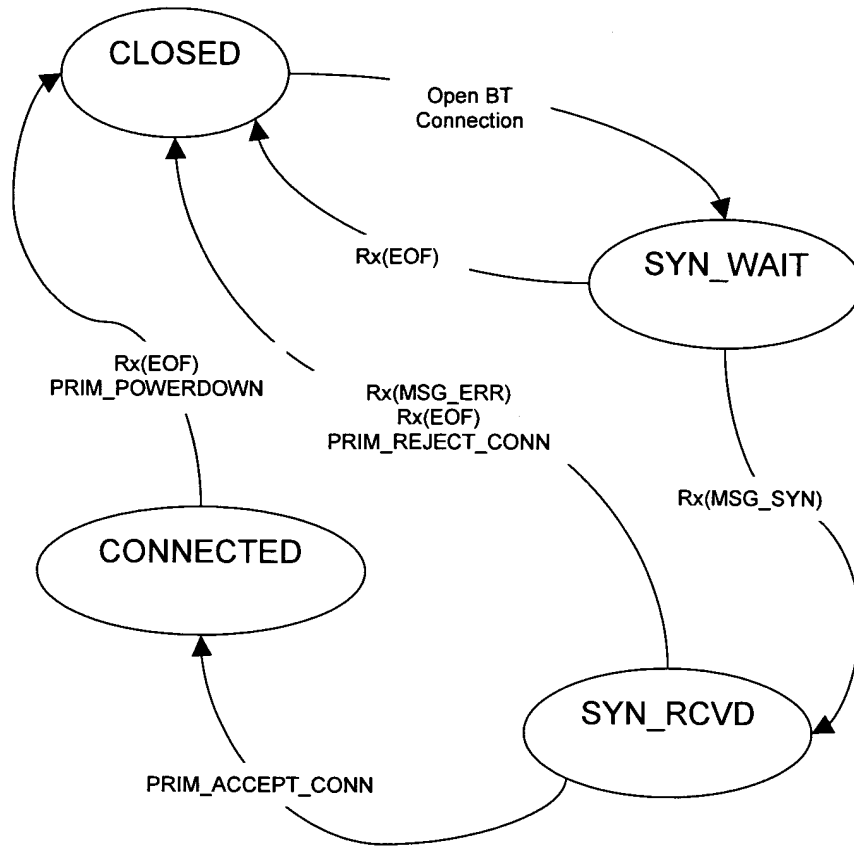

Peer State Diagram

3.2.1 CLOSED State

In this state, the Bluetooth transport connection is closed. The implementation should be periodically scanning for the presence of the Mobile Client. When the Mobile Client is detected, a new SPP connection should be initiated to the Mobile Client.

Event	Condition	Next State	Action
New Transport Connection		SYN_WAIT	

3.2.2 SYN_WAIT State

In this state, the Bluetooth transport connection should be open. The state machine is waiting for an MSG_SYN message.

Event	Condition	Next State	Action
Rx(MSG_SYN)		SYN_RCVD	Notify(CONN_REQUEST)
Rx(EOF)		CLOSED	Notify(CONN_FAILURE)

3.2.3 SYN_RCVD State

In this state, the peer has received a MSG_SYN and is waiting for the upper layer to either accept or reject the connection.

Event	Condition	Next State	Action
PRIM_ACCEPT_CONN		CONNECTED	Tx(MSG_SYN_ACK)
PRIM_REJECT_CONN		CLOSED	Tx(MSG_ERR)
Rx(MSG_ERR)		CLOSED	Notify(CONN_FAILURE)
Rx(EOF)		CLOSED	Notify(CONN_FAILURE)

3.2.4 CONNECTED State

In this state, the connection has been successfully opened.

Event	Condition	Next State	Action
PRIM_POWERDOWN		CLOSED	Tx(MSG_POWERDOWN)
Rx(EOF)		CLOSED	Notify(CONN_CLOSED)

3.3 Protocol Interface

The primitives and notifications in the protocol interface describe only the state-changing events that drive (and are generated from) the state machines specified in section 3. Data types referenced in this section are abstract only (and should be self-explanatory).

This is not intended to be an application programming interface. It is merely intended to describe the events that are exchanged between the state machine and the upper layer. A primitive is an event received by the state machine from the upper layer, while a notification is an event delivered to the upper layer from the state machine.

3.3.1 Mobile Client Interface

3.3.1.1 Primitives

3.3.1.1.1 PRIM_OPEN_CONN

Sent to the state machine by the upper layer when the upper layer wishes to initiate the iMCP connection establishment procedures.

3.3.1.1.2 PRIM_CLOSE_CONN

Sent to the state machine by the upper layer when the upper layer wishes to initiate the iMCP connection close procedures.

3.3.1.2 Notifications

3.3.1.2.1 CONN_OPEN

Sent by the state machine to the upper layer to indicate the iMCP protocol is now open. Information included in this notification is described below.

Parameter	Type	Required	Description
iMCP_Version	Integer	Mandatory	Protocol version supported by peer
ContentAvail	Boolean	Mandatory	True: Peer has local content False: Peer needs streamed content
HardwareId	Integer	Mandatory	0: No Interaction Hardware 0x1-0xFFFFFFFF: Hardware Identifier

3.3.1.2.2 *CONN_FAILURE*

Sent by the state machine to the upper layer to indicate the iMCP protocol failed to open. Information included in the notification is described below.

Parameter	Type	Required	Description
ErrorCode	Integer	Mandatory	Error Code
ErrorMsg	String	Mandatory	Error Message

3.3.1.2.3 *CONN_CLOSED*

Sent by the state machine to the upper layer to indicate the iMCP protocol has been closed.

3.3.2 Peer Interface

3.3.2.1 Primitives

3.3.2.1.1 *PRIM_ACCEPT_CONN*

Sent by the upper layer to the state machine to indicate the upper layer wishes to accept the offered connection. Information included in this primitive is described below.

Parameter	Type	Required	Description
ContentAvail	Boolean	Mandatory	True: Peer has local content False: Peer needs streamed content
HardwareId	Integer	Mandatory	0: No Interaction Hardware 0x1-0xFFFFFFFF: Hardware Identifier

3.3.2.1.2 *PRIM_REJECT_CONN*

Sent by the upper layer to the state machine to indicate the upper layer does not wish to accept the offered connection. Information included in this primitive is described below.

Parameter	Type	Required	Description
-----------	------	----------	-------------

ErrorCode	Integer	Mandatory	Error Code
ErrorMsg	String	Mandatory	Error Message

3.3.2.1.3 PRIM_POWERDOWN

Sent by the upper layer to the state machine to indicate the upper layer is powering off and the iMCP protocol should be closed.

3.3.2.2 Notifications

3.3.2.2.1 CONN_REQUEST

Sent by the state machine to the upper layer to indicate a new connection has been requested. Information included in this notification is described below.

Parameter	Type	Required	Description
iMCP_Version	Integer	Mandatory	Protocol version supported by Mobile Client

3.3.2.2.2 CONN_FAILURE

Sent by the state machine to the upper layer to indicate the connection has failed. Information included in this notification is described below.

Parameter	Type	Required	Description
ErrorCode	Integer	Mandatory	Error Code
ErrorMsg	String	Mandatory	Error Message

3.3.2.2.3 CONN_CLOSED

Sent by the state machine to the upper layer to indicate the connection has been closed.

3.4 Example Message Sequences

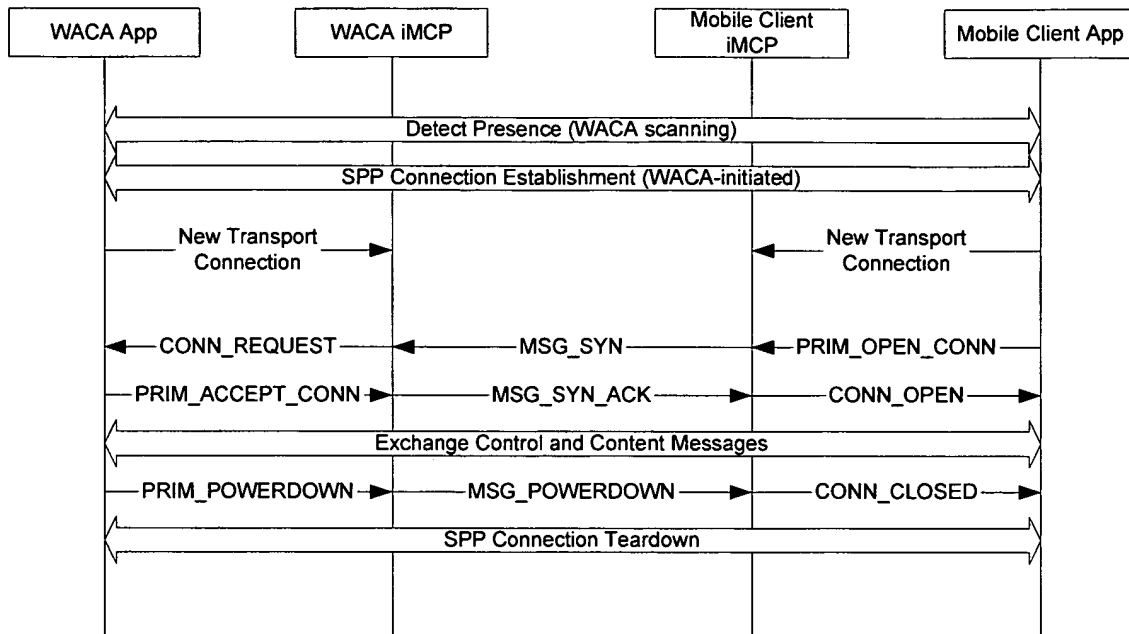

Figure 1 Normal Connection Open and Close

4 Message Framing and Encoding

Boolean data is encoded as a single byte having either a 0x00 (false) or 0x01 (true) value.

Integer data is encoded in big-endian variable length fields, depending on the maximum range of values allowed for the field in question. Integer field lengths must be 1, 2, 4, or 8 bytes long. Integers are unsigned unless otherwise indicated.

String data is encoded using a 2-byte (big-endian) length prefix followed by the specified number of bytes of UTF8-encoded character data (note: the length prefix specifies the number of bytes of character data, not the number of characters in the string). The longest string that may be transferred using this encoding is 65535 characters, assuming none of the characters requires more than one byte.

Note that this encoding scheme is compatible with the commonly used `java.io.DataInputStream` and `java.io.DataOutputStream` classes.

4.1 Framing

All messages begin with a 4-byte synchronization sequence¹ (0xDEADBEEF) followed by a 1-byte channel identifier, allowing control and content information to be multiplexed across a single byte stream.

Each message is framed using a length-prefix scheme. Immediately following the channel identifier is a 2-byte message length field. The 7 bytes of synchronization, channel

¹ The synchronization sequence is present in every message, but is only included in table 1 in this document.

identification and message length information are not included in the message size, allowing a maximum enclosed message size of 65535 bytes.

Table 1 Framing Header

Field	Type	Length (bytes)	Value	Description
SYNC	Integer	4	0xDEADBEEF	Synchronization Sequence
CHANNEL	Integer	1	0-1	Channel Identifier: 0: Control 1: Content 2: Harmonization 255: Management
MSG_LEN	Integer	2	0-65535	Message Length

4.2 Control Channel

Control messages begin with a 1-byte message type field. The remainder of the message format is type-specific. The message types are enumerated below:

Table 2 Control Message Types

Message Type	Value
MSG_SYN	0x00
MSG_SYN_ACK	0x01
MSG_ERR	0x02
MSG_DISPLAY	0x03
MSG_META	0x04
MSG_CREDIT	0x05
MSG_FLUSH	0x06
MSG_POWERDOWN	0x07
MSG_RENDER_CMD	0x08
MSG_SERVER_CMD	0x09
MSG_ECHO	0x0A

4.2.1 MSG_SYN

This message is only sent by the Mobile Client to either the gateway or WACA peers.

Field	Type	Length	Value	Description
-------	------	--------	-------	-------------

		(bytes)		
CHANNEL	Integer	1	0	Control Channel
MSG_LEN	Integer	2	2	Message Length
MSG_TYPE	Integer	1	0x00	MSG_SYN
IMCP_VERSION	Integer	1	0x01	Protocol Version Number

4.2.2 MSG_SYN_ACK

This message is only sent by the gateway or WACA peers to the Mobile Client in response to a MSG_SYN. If the peer has a local content cache (e.g., the gateway), then it should set the FLAG_CONTENT_AVAIL to true, causing the Mobile Client to avoid sending content on the content channel as well as metadata in MSG_META messages. If the peer does not have a local content cache (e.g., the WACA), then it should set the FLAG_CONTENT_AVAIL to false, causing the Mobile Client to stream content on the content channel as well as send metadata in MSG_META messages.

The HW_ID field indicates the interaction hardware identifier. The gateway should return a zero for this field, while the WACA should return an identifier specific to the head unit it's attached to. This will enable the Mobile Client to properly interpret the interaction events for that device.

Field	Type	Length (bytes)	Value	Description
CHANNEL	Integer	1	0	Control Channel
MSG_LEN	Integer	2	7	Message Length
MSG_TYPE	Integer	1	0x01	MSG_SYN_ACK
IMCP_VERSION	Integer	1	0x01	Protocol Version Number
FLAG_CONTENT_AVAIL	Boolean	1	0, 1	True: Local content available False: Need content
HW_ID	Integer	4	0x0-0xFFFFFFFF	0: No Interaction Hardware 0x1-0xFFFFFFFF: Hardware Id

4.2.3 MSG_ERR

This message may be sent by either the Mobile Client or the peers in response to MSG_SYN or MSG_EVT messages.

Field	Type	Length	Value	Description
-------	------	--------	-------	-------------

		(bytes)		
CHANNEL	Integer	1	0	Control Channel
MSG_LEN	Integer	2	Variable	Message Length
MSG_TYPE	Integer	1	0x02	MSG_ERR
ERR_CODE	Integer	1	0-255	Error Code
ERR_MSG	String	Variable		Error Message

Table 3 Error Codes

Error Type	Code	Description
UNKNOWN_EVENT	0x80	An unknown or invalid event message was received

4.2.4 MSG_DISPLAY

This message is sent from the Mobile Client to a content-receiving peer to indicate a request to display a short text message for a minimum amount of time.

Field	Type	Length (bytes)	Value	Description
CHANNEL	Integer	1	0	Control Channel
MSG_LEN	Integer	2	Variable	Message Length
MSG_TYPE	Integer	1	0x03	MSG_DISPLAY
MESSAGE	String	Variable		Message to display
EXPIRES	Integer	1	0-255	0: Display until explicitly cancelled by user 1-255: Display for EXPIRES seconds (or until cancelled)

4.2.5 MSG_META

This message is sent from the Mobile Client to a content-receiving peer to indicate a change in the relevant content metadata, and will be inserted immediately prior to the content message to which it applies. This message would be sent as a result of a GOTO_CHANNEL event or a transition from one track to another within a channel. Note that not all of the tag information will be sent in every META message – the Mobile Client may only include the most relevant information in a given message. For example, when a new track begins within a channel, the CHANNEL_NUM and CHANNEL_NAME tags would not be sent again since they haven't changed.

This message will also be sent from the WACA and Gateway to the Mobile Client to indicate when the playback process actually makes the metadata relevant. In the WACA case, this is necessary due to the buffering on the WACA, while in the Gateway case, the Mobile Client has no other way to determine exactly when track playback begins.

Field	Type	Length (bytes)	Value	Description
CHANNEL	Integer	1	0	Control Channel
MSG_LEN	Integer	2	Variable	Message Length
MSG_TYPE	Integer	1	0x04	MSG_META
NUM_TAGS	Integer	1	1-255	Number of metadata tags that follow
Repeat the following NUM_TAGS times:				
TAG_ID	Integer	1	0-255	Tag Identifier
TAG_LENGTH	Integer	2	0-65535	Tag Length (bytes that follow)
TAG_DATA		Variable		Tag Data

Table 4 Tag Identifiers

Tag	Id	Comment
ARTIST	0x00	Artist Name
TITLE	0x01	Track Title
ALBUM	0x02	Album Title
GENRE	0x03	Genre
CHANNEL_NUM	0x04	Channel Number
CHANNEL_NAME	0x05	Channel Name
TRACK	0x06	Track Number
NUM_TRACKS	0x07	Number of Tracks in Channel
CHANNEL_LEN	0x08	Length of Channel
TRACK_LEN	0x09	Length of Track
CHANNEL_REMAIN	0x0A	Channel Time Remaining
TRACK_REMAIN	0x0B	Track Time Remaining

4.2.5.1 Artist Tag

Field	Type	Length (bytes)	Value	Description
ARTIST	String	Variable		Artist Name

4.2.5.2 Track Title Tag

Field	Type	Length	Value	Description
-------	------	--------	-------	-------------

		(bytes)		
TITLE	String	Variable		Track Title

4.2.5.3 Album Tag

Field	Type	Length (bytes)	Value	Description
ALBUM	String	Variable		Album Title

4.2.5.4 Genre Tag

Field	Type	Length (bytes)	Value	Description
GENRE	String	Variable		Genre

4.2.5.5 Channel Number Tag

Field	Type	Length (bytes)	Value	Description
CHANNEL_NUM	Integer	1	0-255	Channel Number

4.2.5.6 Channel Name Tag

Field	Type	Length (bytes)	Value	Description
CHANNEL_NAME	String	Variable		Channel Name

4.2.5.7 Track Number Tag

Field	Type	Length (bytes)	Value	Description
TRACK	Integer	1	0-255	Track Number

4.2.5.8 Total Tracks Tag

Field	Type	Length (bytes)	Value	Description
NUM_TRACKS	Integer	1	0-255	Number of Tracks in Channel

4.2.5.9 Channel Length Tag

Field	Type	Length	Value	Description
-------	------	--------	-------	-------------

		(bytes)		
CHANNEL_LEN	Integer	2	0-65535	Length of Channel (in seconds)

4.2.5.10 Track Length Tag

Field	Type	Length (bytes)	Value	Description
TRACK_LEN	Integer	2	0-65535	Length of Track (in seconds)

4.2.5.11 Channel Time Remaining Tag

Field	Type	Length (bytes)	Value	Description
CHANNEL_REMAIN	Integer	2	0-65535	Channel Time remaining (in seconds)

4.2.5.12 Track Time Remaining Tag

Field	Type	Length (bytes)	Value	Description
TRACK_REMAIN	Integer	2	0-65535	Track Time remaining (in seconds)

4.2.6 MSG_CREDIT

This message is sent from a content-receiving peer to the Mobile Client to control the flow of content. The CREDIT field indicates the number of bytes of new content should be transmitted to the receiver before waiting for another CREDIT message.

New content bytes need not be delivered in a single message matching the value in the CREDIT field. They may be delivered in several content messages as long as no more than CREDIT bytes of new content are delivered prior to receiving a new MSG_CREDIT message (this may be necessary, for example, if the tail of one track contains fewer bytes than the advertised credit; in this case, two content messages would be sent, one with the tail of the current track, and another with the head of the next track in the channel).

New MSG_CREDIT messages may be transmitted before all of the content fulfilling the previous MSG_CREDIT message has been delivered. This pipelining may be necessary to minimize buffering in the receiver.

Field	Type	Length (bytes)	Value	Description
CHANNEL	Integer	1	0	Control Channel
MSG_LEN	Integer	2	3	Message Length
MSG_TYPE	Integer	1	0x05	MSG_CREDIT

CREDIT	Integer	2	0-65535	Content Credit
--------	---------	---	---------	----------------

4.2.7 MSG_FLUSH

This message is sent from the Mobile Client to a content-receiving peer to cause the peer's content buffers to be flushed. This message would be sent as a result of a discontinuity in the playback due to, for example, a GOTO_CHANNEL event. This message resets any accumulated credit to zero. As a result, the content-receiving peer should immediately send a new MSG_CREDIT message indicating a new credit value.

Field	Type	Length (bytes)	Value	Description
CHANNEL	Integer	1	0	Control Channel
MSG_LEN	Integer	2	1	Message Length
MSG_TYPE	Integer	1	0x06	MSG_FLUSH

4.2.8 MSG_POWERDOWN

This message is sent from the WACA to indicate it is powering down and the session should be terminated.

Field	Type	Length (bytes)	Value	Description
CHANNEL	Integer	1	0	Control Channel
MSG_LEN	Integer	2	1	Message Length
MSG_TYPE	Integer	1	0x07	MSG_POWERDOWN

4.2.9 MSG_RENDER_CMD

This message is sent from the Mobile Client to either the WACA or the gateway peer to control playback. It may also be sent from the WACA to the Mobile Client to indicate a local change in playback state (as a result of the user interaction), in which case it is informative only and will not result in a corresponding MSG_RENDER_CMD from the Mobile Client to the WACA.

Field	Type	Length (bytes)	Value	Description
CHANNEL	Integer	1	0	Control Channel
MSG_LEN	Integer	2	2	Message Length
MSG_TYPE	Integer	1	0x08	MSG_RENDER_CMD
RCMD_TYPE	Integer	1	0-255	Command Type

Table 5 Render Command Types

Command Type	Code	Comment
RCMD_PLAY	0x00	Begin Playback
RCMD_PAUSE	0x01	Pause Playback

4.2.10 MSG_SERVER_CMD

This message is sent from the Mobile Client to the gateway peer or from the WACA to the Mobile Client to control content selection.

Field	Type	Length (bytes)	Value	Description
CHANNEL	Integer	1	0	Control Channel
MSG_LEN	Integer	2	3	Message Length
MSG_TYPE	Integer	1	0x09	MSG_SERVER_CMD
SCMD_TYPE	Integer	1	0-255	Command Type
CMD_PARAM	Integer	1	0-255	Command Parameter

Table 6 Render-Server Command Types

Command Type	Code	Comment
SCMD_FFWD	0x00	Skip Forward CMD_PARAM tenths of a second
SCMD_REW	0x01	Skip Backwards CMD_PARAM tenths of a second
SCMD_NEXT_TRACK	0x02	Next Track
SCMD_PREV_TRACK	0x03	Previous Track
SCMD_NEXT_CHANNEL	0x04	Next Channel
SCMD_PREV_CHANNEL	0x05	Previous Channel
SCMD_GOTO_CHANNEL	0x06	Go to Channel in CMD_PARAM (zero-based)
SCMD_PURCHASE	0x07	Purchase Current Track
SCMD_GOTO_TRACK	0x08	Go to Track in CMD_PARAM (zero-based)
SCMD_GOTO_OFFSET	0x09	Go to Track offset CMD_PARAM seconds

The expected operation of the SCMD_FFWD and SCMD_REW messages is as follows: the CMD_PARAM field indicates a skip forward or backward in tenths of a second. A single SCMD_FFWD or SCMD_REW command can therefore indicate up to 25.5 seconds of skip. For typical user interfaces that use the >> and << buttons held down as FFWD/REW, this means the user interface will need to show the user a clock running forward or backward while the button is held down. If the user accumulates more than

25.5 seconds of skip, a SCMD_FFW or SCMD_REW will need to be sent. When the user releases the button, another message will need to be sent with the remainder.

The SCMD_GOTO_CHANNEL command uses zero-based channel indexing for the CMD_PARAM field. This allows up to 256 channels numbered zero through 255.

The SCMD_GOTO_TRACK command uses zero-based track indexing for the CMD_PARAM field. This allows up to 256 tracks numbered zero through 255.

The SCMD_GOTO_OFFSET command CMD_PARAM field indicates an absolute track offset at which playback should continue. Interpreting the CMD_PARAM field in seconds allows this command to indicate an offset up to 255 seconds (4 minutes 15 seconds) into the track.

Many of the server commands imply a discontinuity in the audio stream. If the mobile client is streaming audio content to a peer, the discontinuity will be handled by sending a MSG_FLUSH (see Section 4.2.7).

4.2.11 MSG ECHO

This message is sent from either the Mobile Client or one of the peers (gateway or WACA). MSG_ECHO with FLAG_REQ_RESP == 0 is an echo request, while FLAG_REQ_RESP == 1 is an echo response. On reception of an echo request, an echo response must be sent immediately. The echo response ECHO_DATA field must exactly match the ECHO_DATA field of the original echo request message (in order to correlate a response with a particular request). If a response to an echo request is not received in some implementation-defined interval, the sender may determine the connection is no longer usable and disconnect.

<u>Field</u>	<u>Type</u>	<u>Length</u> (bytes)	<u>Value</u>	<u>Description</u>
<u>CHANNEL</u>	<u>Integer</u>	<u>1</u>	<u>0</u>	<u>Control Channel</u>
<u>MSG_LEN</u>	<u>Integer</u>	<u>2</u>	<u>5</u>	<u>Message Length</u>
<u>MSG_TYPE</u>	<u>Integer</u>	<u>1</u>	<u>0x0A</u>	<u>MSG_ECHO</u>
<u>FLAG_REQ_RESP</u>	<u>Integer</u>	<u>1</u>	<u>0-1</u>	<u>Request/Response Flag</u> <u>0: Echo Request</u> <u>1: Echo Response</u>
<u>ECHO_DATA</u>	<u>Integer</u>	<u>4</u>	<u>Any</u>	<u>Response Correlation</u>

4.3 Content Channel

Blocks of encoded audio content are sent in messages across the content channel from the Mobile Client to the peer if the peer indicated a need for content during the control channel establishment (see Section **Error! Reference source not found.**4.2.2). The size and pacing of content messages is determined by the receiving peer, which sends MSG_CREDIT messages on the control channel to the Mobile Client indicating how

many more bytes of content it wishes to receive (see Section 4.2.6). There is no correlation between content channel message boundaries and MPEG frames.

Field	Type	Length (bytes)	Value	Description
CHANNEL	Integer	1	1	Control Channel
MSG_LEN	Integer	2	Variable	Message Length
CODEC_TYPE	Integer	1	0-255	Codec Identifier
CONTENT	Bytes	Variable		Audio Content

Table 7 Codec Identifiers

Codec	Id	Comment
WAV	0x00	Microsoft WAV File Format
SBC	0x01	Sub Band Codec
MP3	0x02	MPEG Layer 3 Audio
MP3_PRO	0x03	MP3 Pro
AAC	0x04	Advanced Audio Codec
AAC_PLUS	0x05	AAC w/SBR
WMA	0x06	Windows Media Audio
OGG_VORBIS	0x07	Ogg Vorbis Audio

4.4 Harmonization

The iRadio Harmonization Protocol (iHP) messages may be carried in iMCP channel 2 when the Mobile Client is connected to the Gateway. iHP is not supported between the Mobile Client and WACA. All Mandatory and Optional iHP fields must be included in iHP messages.

At this time, only the Playpoints message (iradio.plp, type 0x0011) is supported. Immediately following transition to the CONNECTED state, the Mobile Client will transmit its current Playpoint information to the Gateway in a channel 2 iMCP frame. The Gateway should immediately respond with a harmonized Playpoint message which the Mobile Client will use to replace its current Playpoint information.

4.5 Management Channel

Need to capture the management channel requirement and protocol. Fundamentally, the Mobile Client is able to send firmware or other operationally-relevant information (e.g., model-specific translation tables) to the WACA. The WACA should be capable of updating this information by re-flashing itself or otherwise remembering it. The Management Channel will be used to update the WACA when new car radio models are introduced with new user event commands or new features.

5 Security Considerations

Since this protocol is intended to run over Bluetooth, this specification relies on the Bluetooth authentication and encryption facilities for security.



Overview



Where is Motorola in *your* life?

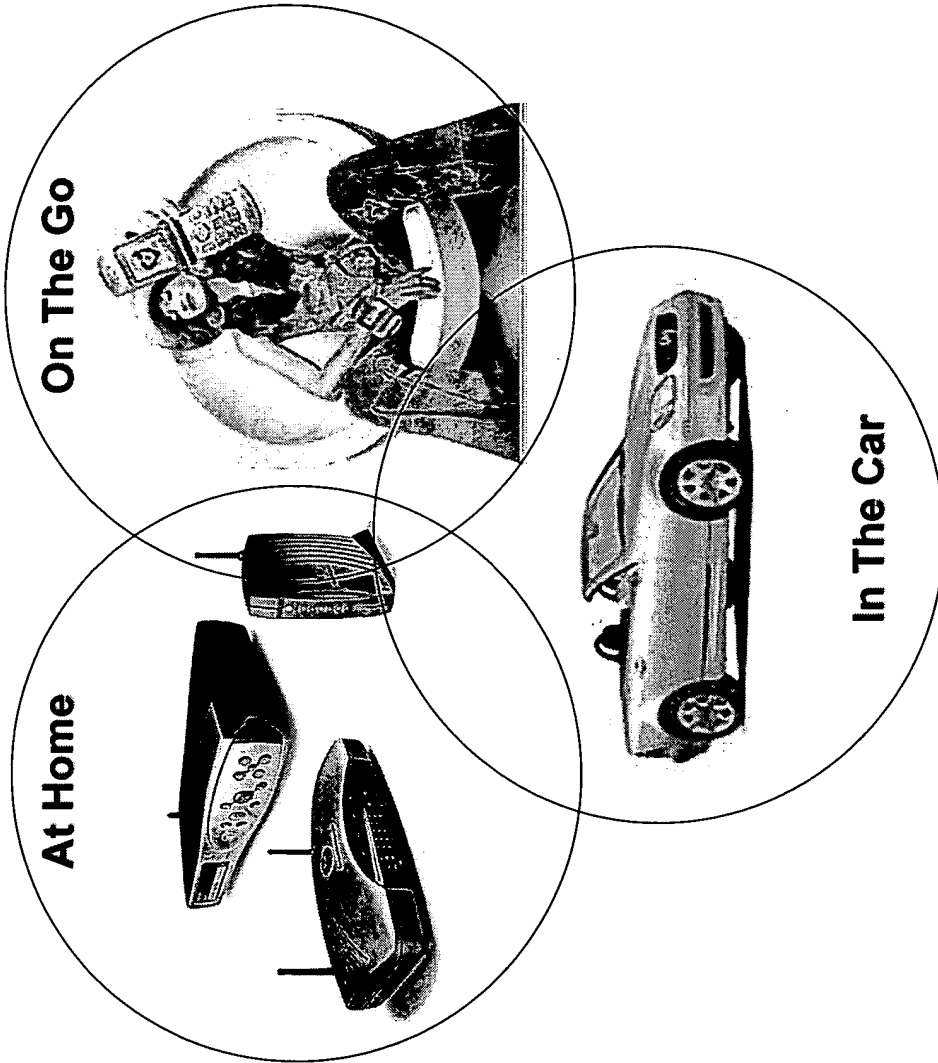

And where do you listen to music?

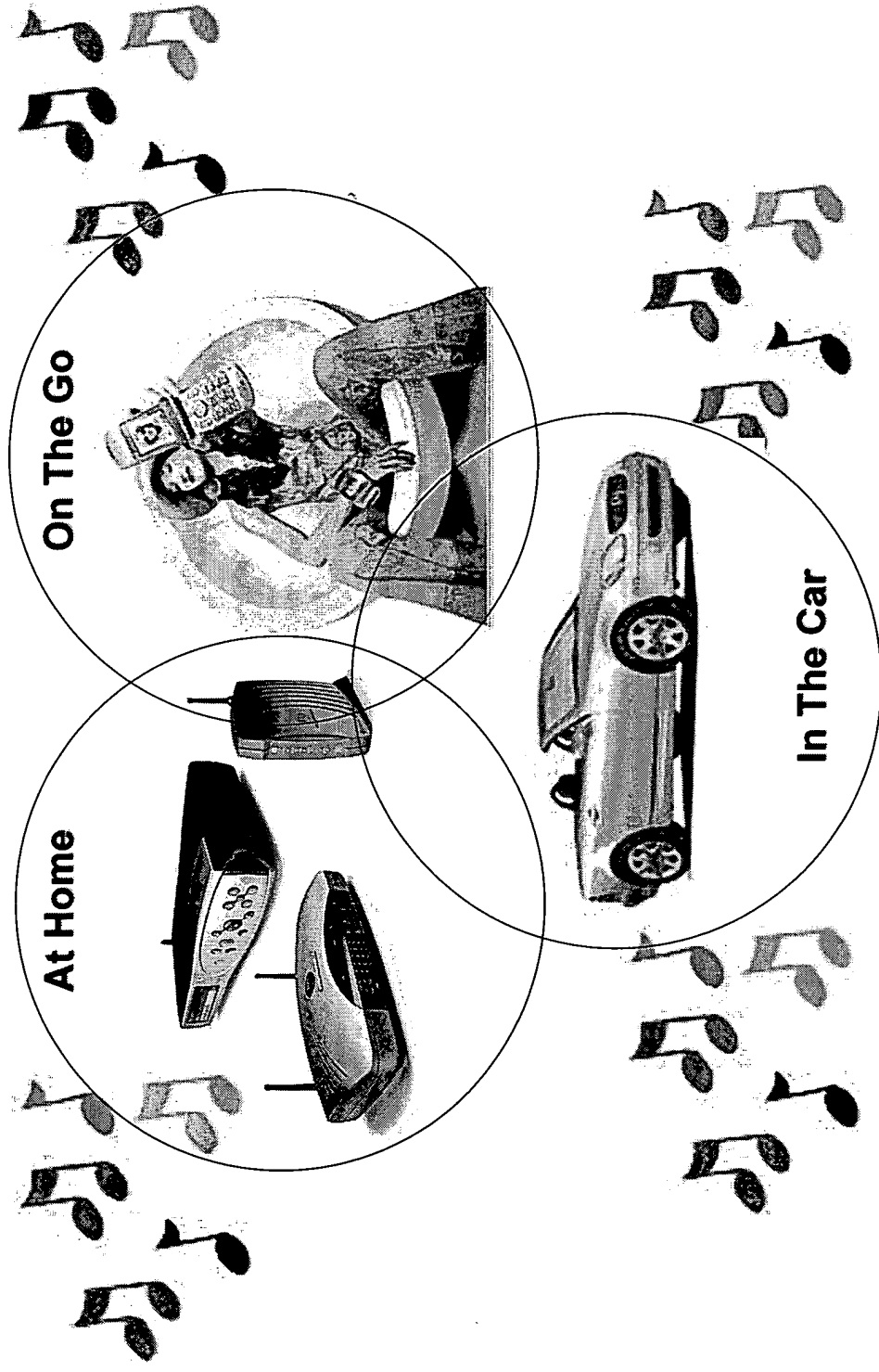

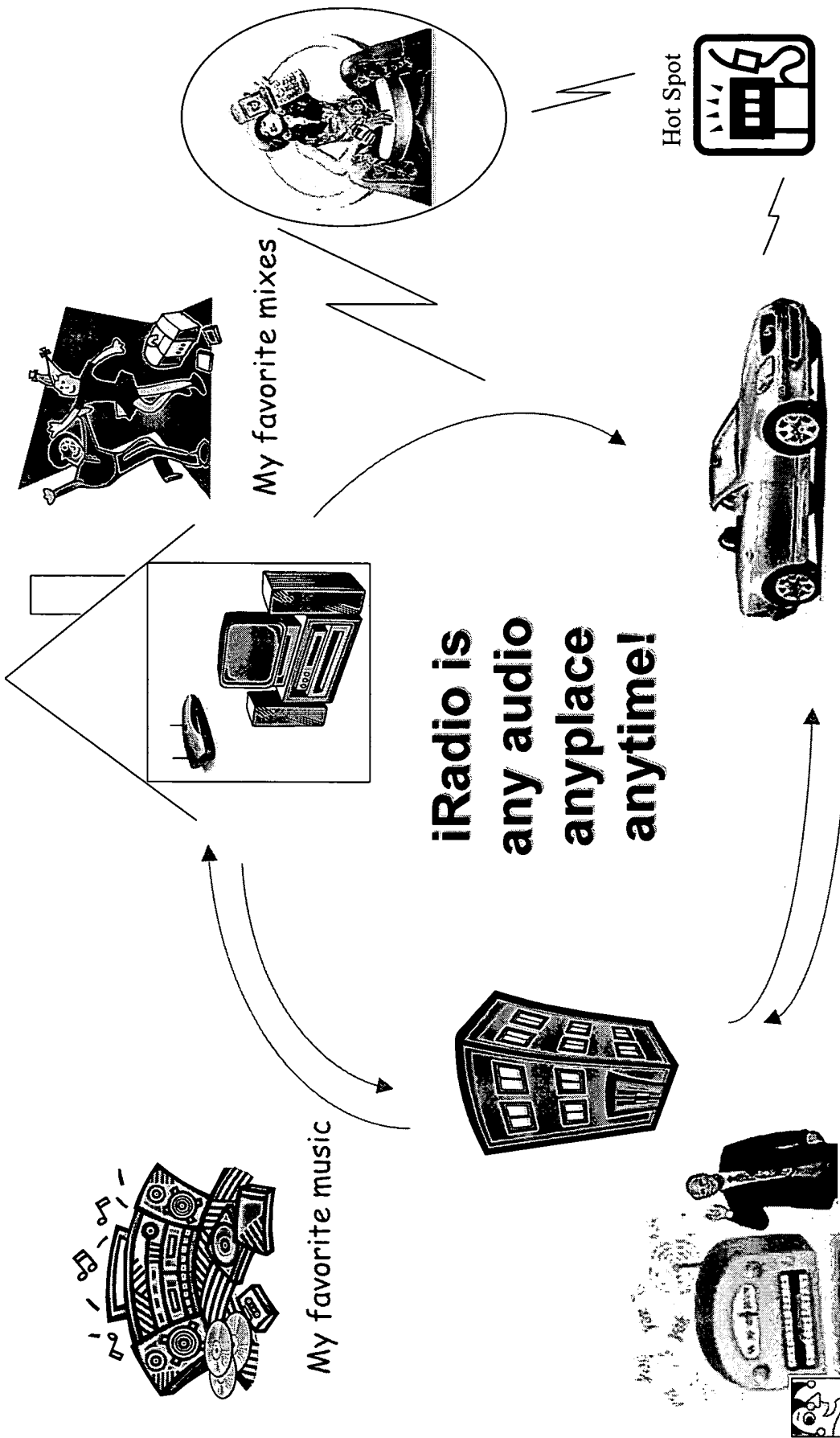

intelligence  everywhere™

 **MOTOROLA**

Access to the content you want . . .

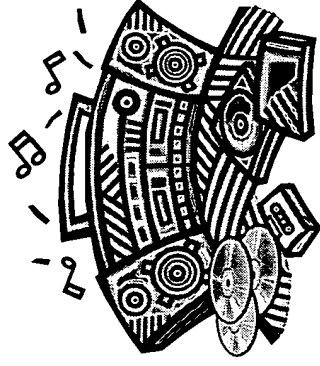

- ◆ **Content you own:**
 - Home music collection
 - Downloaded purchases
- ◆ **Content you “rent”:**
 - Satellite radio broadcasts
 - Online subscriptions to music services
 - Online memberships to personality talk shows
 - Custom radio channels
- ◆ **Content you receive:**
 - Broadcast radio
 - DAB & Analog



MOTOROLA

intelligence  everywhere™

Where you want it . . .

- ◆ **Home entertainment system**
- ◆ **Home PC network**
- ◆ **Car stereo**
- ◆ **Portable digital music device**
- ◆ **Cellular handset**
- ◆ **Laptop on the road**
- ◆ **And whatever comes next!**



intelligence  everywhere™

Whenever you want it!

- ◆ **Schedule your favorite programs to playback when you want to hear them**
- ◆ **Synchronize your playlists across domains and devices**
- ◆ **Access your home collection while driving your car or exercising at the gym**

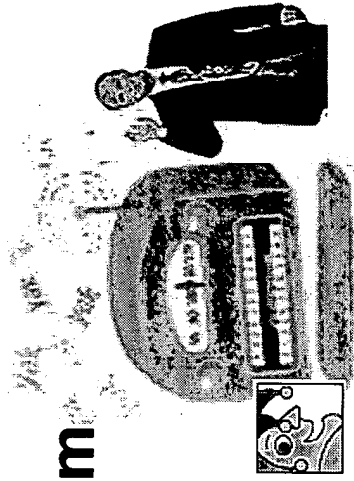

Key iRadio Capabilities

- ◆ **Time-shifted programming**
 - “Server-in-the-sky” records and stores favorite programs to play back when and where requested
- ◆ **Pause here – Play there**
 - Pause playback on one device and resume on another
- ◆ **Buffered broadcasts**
 - Pause, rewind, & repeat music, news, talk, weather and sports
- ◆ **Push-to-Buy**
 - Buy the track or CD of the songs you’re listening to



MOTOROLA



Benefits to content owners & distributors

- ◆ **Converts radio play to subscription pay**
 - Added value of convenience & personalization drives demand for service
 - Sparks transition from ad-based business to music sales & subscription-based business
- ◆ **Extends purchase points beyond the PC**
 - Into home, car, phone and portable devices
- ◆ **Eases transition to secure distribution**
 - Transparent move to a full end-to-end DRM system



MOTOROLA



Benefits to consumers

- ◆ **Seamless mobility**
 - Cures music schizophrenia
 - Multiple playlists, codecs, libraries, devices, and protocols
- ◆ **Unprecedented access to catalogs and choices**
 - Wherever you are, whenever you want it
 - All available content is *actually* available

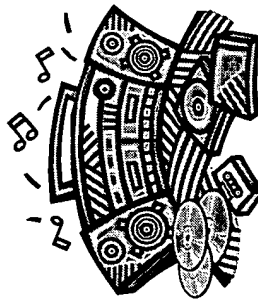

anytime

My favorite music



anywhere

My favorite mixes

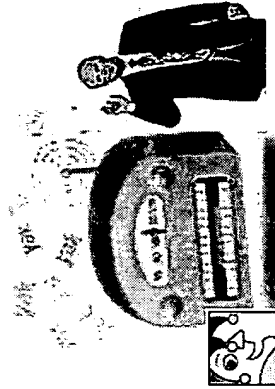

My favorite programs



MOTOROLA

intelligence  everywhere™

iRadio Car Radio Interface Serial Protocol

iRadio Group
Motorola, Inc.

Revision Number	Date of revision	Author	Comments
X0.1	12/1/2004	Brian Tucker	Initial draft
X0.2	12/1/2004	JMV	Formating

Table of Content

1 INTRODUCTION.....4

2 THEORY OF OPERATION..... 4

3 MESSAGES.....5

3.1 MESSAGE OVERVIEW 5

 3.1.1 *Message Structure* 5

 3.1.2 *Physical Layer*..... 5

 3.1.3 *Transmission Order*..... 5

3.2 MESSAGE HEADER 6

3.3 MESSAGE PAYLOAD 6

 3.3.1 *Key Press*..... 6

 3.3.1.1 Valid Key Codes 6

 3.3.2 *Key Release*..... 7

 3.3.3 *Radio Power Change* 7

 3.3.4 *Source Change* 8

 3.3.5 *Radio Type*..... 8

 3.3.5.1 Valid Car Radio Types..... 8

 3.3.6 *METADATA Text*..... 9

 3.3.6.1 METADATA Types 9

1 Introduction

This iRadio Car radio Interface Serial Protocol (iCRISP) is intended to unify the interface between the Wireless Audio Car Adapter (WACA) and the Car Radio Serial Interface. The primary purpose of this protocol is to notify the WACA of key presses and releases on the car radio and provide a mechanism for the WACA to display METADATA text on the car radio interface.

2 Theory of Operation

The system will consist of two primary functionalities:

1. The WACA needs to be aware of key presses and key release on the car radio head unit. Each possible key will be assigned a value that will provide a universal set of key codes across all car radio makes and models. The Car Radio Serial Interface will send a message to the WACA for each key press and key release.
2. The WACA needs to provide information to the user via the user interface of the car radio. This protocol will provide a consistent interface for sending audio METADATA text and general informational messages to the car radio for display

3 Messages

3.1 Message Overview

3.1.1 Message Structure

iCRISP messages will be consistent for all messages sent to and from the WACA and Car Radio Serial Interface. Each message will consist of a 4 bytes header followed by the message payload followed by a two byte checksum of the Header and payload message.

Field	Type	Length (bytes)	Value	Description
Header	Integer	4	See next paragraph	Indicates the start of an iCRISP message. Includes start header and message length
Payload Message	Integer	variable	See rest of document	Commands or car radio events codes
Checksum	Integer	2 (MSB,LSB)	0-xFFFF	Sum of Header and payload Message <i>(no complement to 1?)</i>

3.1.2 Physical Layer

The physical layer is an USART. The protocol is one start bit, eight data bits, and one stop bit. The baud rate is 9600.

3.1.3 Transmission Order

The transmission order is Octet 0, Octet 1, . . . , Octet n. Within each octet, the transmission order is Bit7, Bit 6, . . . Bit 1, Bit 0.

3.2 Message Header

Field	Type	Length (bytes)	Value	Description
Start Header (MSB,LSB?)	Integer	2	0xA55A	Indicates the start of an iCRISP message.
Message Length (MSB,LSB?)	Integer	2	0-65535	Length of message payload. This does not include the 4 byte header of 2 byte checksum.

3.3 Message Payload

3.3.1 Key Press

This message is sent from the Car Radio Serial Interface to the WACA when a key on the car radio is pressed.

Field	Type	Length (bytes)	Value	Description
Start Header	Integer	2	0xA55A	Indicates the start of an iCRISP message.
Message Length	Integer	2	0-65535	Length of message payload. This does not include the 4 byte header of 2 byte checksum.
Command	Integer	1	0x10	Key press command
Key Pressed	Integer	1	0-255	Key code of key that was pressed. See included chart for valid key codes
Checksum	Integer	2	0-65535	ADD 00 to n-2 Octet

3.3.1.1 Valid Key Codes

Here are the valid key codes that the Car Radio Serial Interface can send to the WACA.

Key Description	Code
Channel 1	0x41
Channel 2	0x42
Channel 3	0x43
Channel 4	0x44
Channel 5	0x45
Channel 6	0x46
Channel Band	0x50
Right	0x51
Left	0x52

Up	0x53
Down	0x54
Text Display Change	0x55
Previous Track	0x10
Next Track	0x11
Disc Up	0x12
Disc Down	0x13
Repeat	0x14
Shuffle	0x15
Fast Forward	0x16
Reverse	0x17

3.3.2 Key Release

This message is sent from the Car Radio Serial Interface to the WACA when a key on the car radio is released.

Field	Type	Length (bytes)	Value	Description
Start Header	Integer	2	0xA55A	Indicates the start of an iCRISP message.
Message Length	Integer	2	0-65535	Length of message payload. This does not include the 4 byte header of 2 byte checksum.
Command	Integer	1	0x13	Key release command
Key Released	Integer	1	0-255	Key code of key that was pressed. See included chart for valid key codes
Checksum	Integer	2	0-65535	ADD 00 to n-2 Octet

3.3.3 Radio Power Change

This message is sent from the Car Radio Serial Interface to the WACA when the car radio is turned on or off.

Field	Type	Length (bytes)	Value	Description
Start Header	Integer	2	0xA55A	Indicates the start of an iCRISP message.
Message Length	Integer	2	0-65535	Length of message payload. This does not include the 4 byte header of 2 byte checksum.
Command	Integer	1	0x11	Radio power command
On/Off	Integer	1	0x00, 0x01	0x00 = Radio OFF 0x01 = Radio ON
Checksum	Integer	2	0-65535	ADD 00 to n-2 Octet

3.3.4 Source Change

This message is sent from the Car Radio Serial Interface to the WACA when the user selects/deselects the iRadio source.

Field	Type	Length (bytes)	Value	Description
Start Header	Integer	2	0xA55A	Indicates the start of an iCRISP message..
Message Length	Integer	2	0-65535	Length of message payload. This does not include the 4 byte header of 2 byte checksum.
Command	Integer	1	0x12	Source select command
Select/Deselect	Integer	1	0x00, 0x01	0x00 = iRadio deselected 0x01 = iRadio selected
Checksum	Integer	2	0-65535	ADD 00 to n-2 Octet

3.3.5 Radio Type

This message is sent from the Car Radio Serial Interface to the WACA after the WACA has asked for the type of car radio that is connected to the Car Radio Serial Interface.

Field	Type	Length (bytes)	Value	Description
Start Header	Integer	2	0xA55A	Indicates the start of an iCRISP message.
Message Length	Integer	2	0-65535	Length of message payload. This does not include the 4 byte header of 2 byte checksum.
Command	Integer	1	0x14	Radio type command
Type	Integer	1	0-255	Type of radio that is connected to the Car Radio Serial Interface.
Checksum	Integer	2	0-65535	ADD 00 to n-2 Octet

3.3.5.1 Valid Car Radio Types

Here are the valid car radio types

Key Description	Code	Supported Radios (Tested)
Sony 1	0x00	XR-CA350X
Pioneer 1	0x01	DEH-P4600MP

3.3.6 METADATA Text

This message is sent from the WACA to the Car Radio Serial Interface to send METADATA text to the car radio.

Field	Type	Length (bytes)	Value	Description
Start Header	Integer	2	0xA55A	Indicates the start of an iCRISP message.
Message Length	Integer	2	0-65535	Length of message payload. This does not include the 4 byte header of 2 byte checksum.
Command	Integer	1	0x20	METADATA text command
METADATA Type	Integer	1	0-255	Type of METADATA being sent to the car radio. See the include chart for valid types.
METADATA text	String	Variable		METADATA text
Checksum	Integer	2	0-65535	ADD 00 to n-2 Octet

3.3.6.1 METADATA Types

Here are the valid METADATA text types

METADATA Type	Code
Artist Name	0x00
Song Title	0x01
Time Remaining	0x02

**Copyright Questions
iRadio**

iRadio™

iRadio Business Case
Supporting Research
Alan Lopez
15 April 2004



MOTOROLA

AL, March 2004

Motorola Confidential Proprietary

MOTOROLA and the Stylized M Logo are registered in the US Patent & Trademark Office. All other product or service names are the property of their respective owners. © Motorola, Inc. 2003.



intelligence everywhere™

iRadio - Assumptions

Content Sources

- Internet Services
- ex. Yahoo Launchcast
- Cable Service
- ex. MusicChoice
- Satellite Radio
- ex. XM/Sirius
- Digital FM
- ex. Ibiqity

Services

- Time-slip, seamless
pause/resume
- Partner with broadcaster (ex. XM)
- Push-to-buy
- Partner with seller (ex. iTunes)
- Daily Set:
- Partner with content aggregator
(ex. MusicChoice, Launchcast)
- Share in revenue from add-on
services

Content Types

- Time-Slip and Pause/Resume
- Store digital broadcast content
- Play later, play/resume on other device
- Stored as time segments, not tracks
- Daily Set
- Set of tracks received from service
- Tailored to user's preferences/feedback
- Purchased Tracks
- MP3, MPEG, etc. purchased by user
- Promotional Tracks
- Trail period tracks, or
- 30sec snippets, or
- Trail tracks recorded at lower quality
- Other information requested by user
- Recorded commercials

Hardware & Clients

- Home: PC or set top box with SW
- Car: in-dash head-unit with SW
- Person: client SW on phone
- Server: central server, server SW

Content Use

- For personal use only
- No redistribution in any form
- If necessary, limited plays or
expiration time
- Files of all categories will be
copied between devices as
needed for seamless experience

Digital Rights Management

- Store time-slip, pause/resume
and daily set in secure format
- Prevent content copies from
leaving single user's device set
- Allow copies of content between
single user's devices for
seamless experience



MOTOROLA

AL, April 2004

Motorola Confidential Proprietary

MOTOROLA and the Stylized M Logo are registered in the US Patent & Trademark Office. All other product or service names are the property of their respective owners. © Motorola, Inc. 2003.



intelligence everywhere™

Slide 2

iRadio – Capabilities

Time-Slip, Pause/Resume

"Virtual TIVO for radio"

Store digital non-interactive broadcast content to hard-drive

Play/resume on *any device*

Purchased Tracks

Play purchased tracks on *any device*

Typical MP3 player capabilities + *seamless pers/home/car experience*

Push-to-Buy

Central Service

- Seamless Time-Slip, Pause/Resume

- Daily Set (batch or streaming)

- Push-to-X

Existing service provider + add-on

Daily Set

Receive custom-tailored set of tracks from central service

Play daily set from *any device*

Capture user ratings for later upload

Enable push-to-buy, push-for-more and recommend-to-friend

Promotional Tracks

Receive and store promotional information and/or snippets requested by user (push-for-more)

Record tracks as snippets, at lower quality or with expire feature

Enable push-to-buy for promo tracks - download to device-of-choice

Record commercials for later use as requested by user



MOTOROLA

AL, April 2004

Motorola Confidential Proprietary

MOTOROLA and the Stylized M Logo are registered in the US Patent & Trademark Office. All other product or service names are the property of their respective owners. © Motorola, Inc. 2003.



intelligence **everywhere™**

Slide 3

iRadio - Personal Content Repository

- Common structure across devices
- easy synchronization and pause/resume
- Consistent meta-data
- Holds all user data
- Secure data format

Enables seamless experience

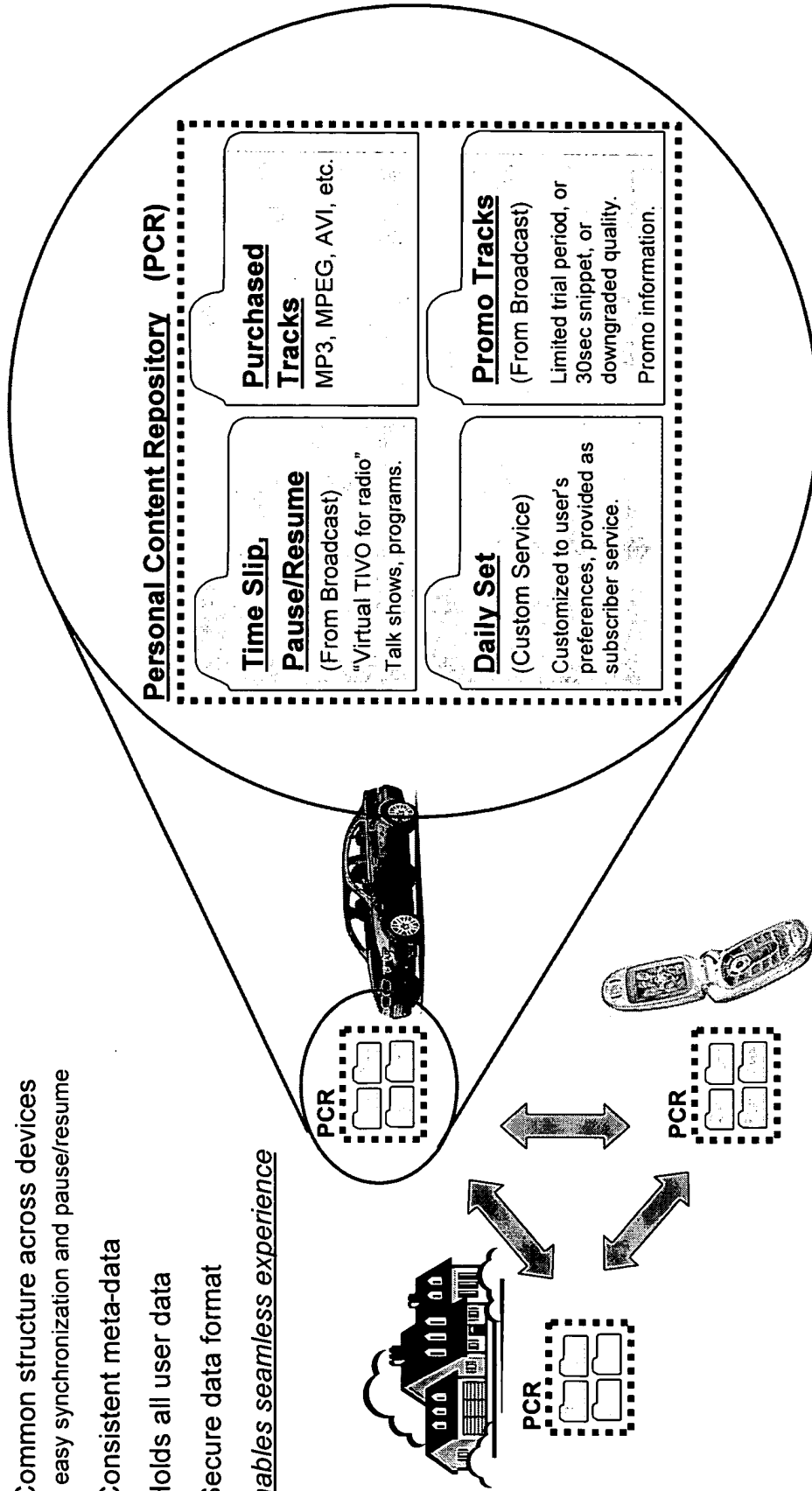

Slide 4



MOTOROLA

AL, April 2004
 Motorola Confidential Proprietary
 MOTOROLA and the Stylized M Logo are registered in the US Patent & Trademark Office. All other product or service names are the property of their respective owners. © Motorola, Inc. 2003.

intelligence  **everywhere™**

Possible Content Sources

- Aggregator provides batch or stream of custom-tailored content via Cable or Internet (interactive)
 - ex. MusicChoice, YahooLaunchcast subscriber service
- Digital Satellite Radio received by car or home
 - ex. XM/Sirius add-on subscriber service
- Digital FM received by car or home
 - free digital broadcast

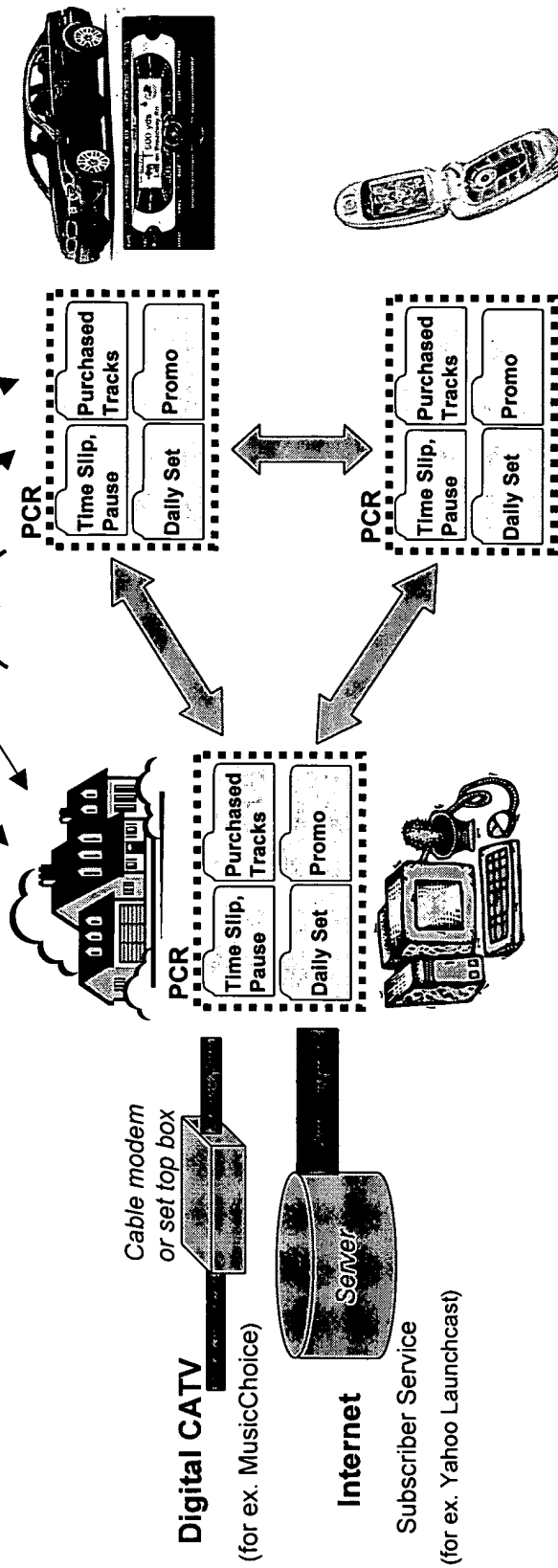

Slide 5



AL, April 2004
 Motorola Confidential Proprietary
 MOTOROLA and the Stylized M Logo are registered in the US Patent & Trademark Office. All other product or service names are the property of their respective owners. © Motorola, Inc. 2003.



Content Use

Time slip and pause/resume

- requires copy of content to destination device

Daily Set

- synchronize to any device
- Enables Push-to-Buy**

Promotional Tracks

- synchronize to any device
- Enables Push-to-Buy**

Purchased Tracks

- MP3-like functionality
 - synchronize across devices
- Seamless experience**

Strictly personal use

No redistribution in any form

Content

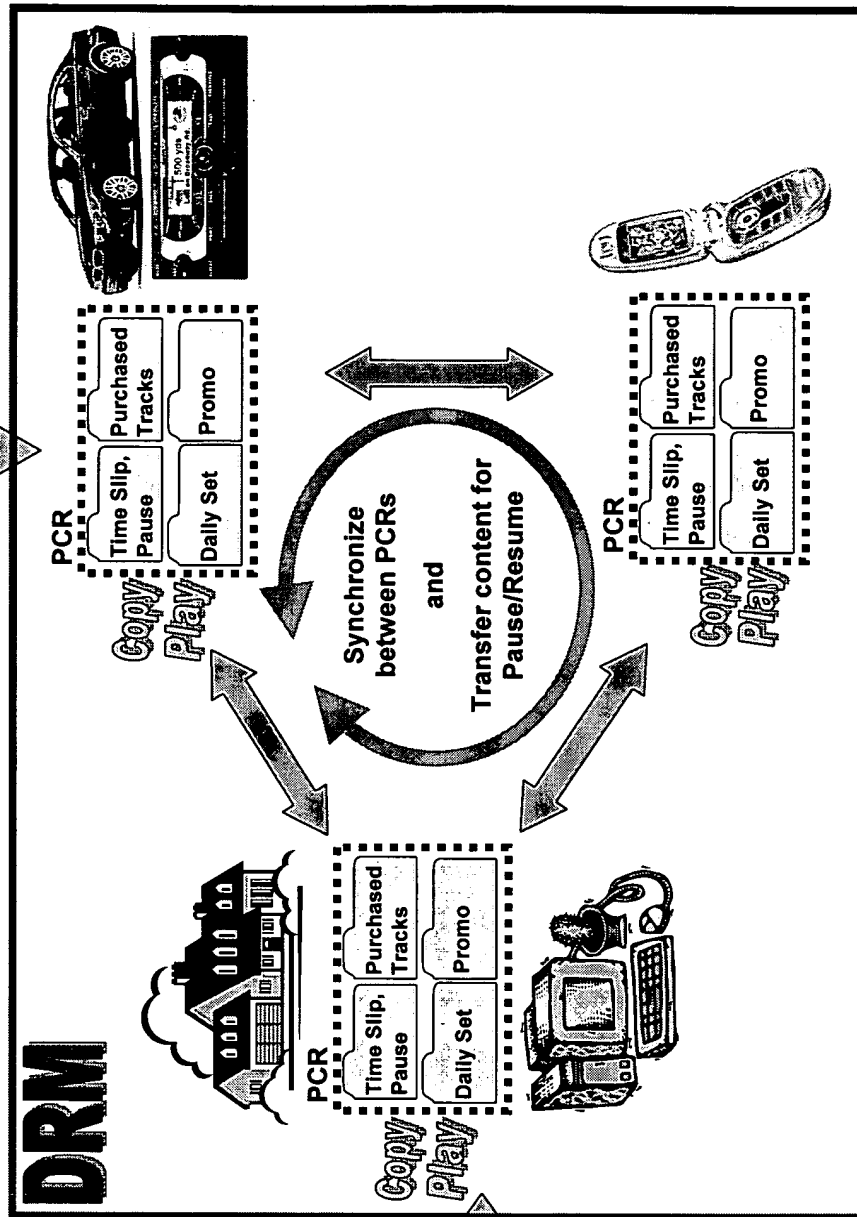

MOTOROLA

AL, April 2004
 Motorola Confidential Proprietary
 MOTOROLA and the Stylized M Logo are registered in the US Patent & Trademark Office. All other product or service names are the property of their respective owners. © Motorola, Inc. 2003.

intelligence  *everywhere™*

Questions - Time-Slip, Pause/Resume - Broadcast

For each content source:

-Digital Satellite Radio
(subscription service)

-Digital FM

1. Is an additional license needed to perform seamless time-slip and pause/resume?
2. If so, would either the content providers or copyright owners be likely to negotiate a license?
3. What is the risk of infringement litigation and how can it be reduced?

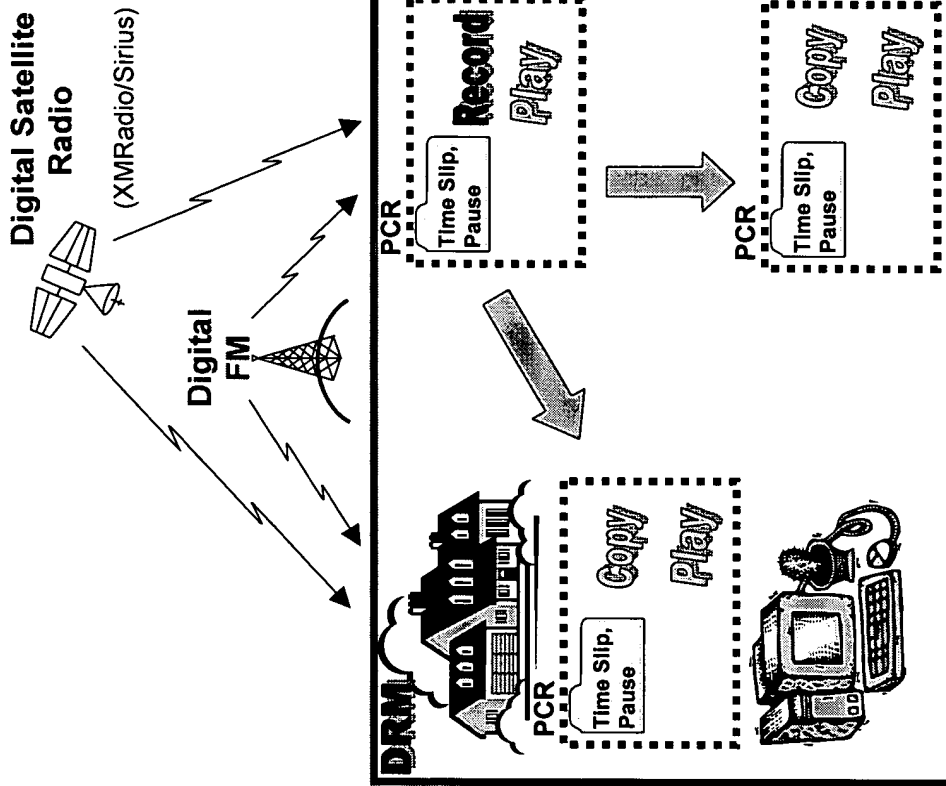

Slide 7



AL, April 2004

Motorola Confidential Proprietary

MOTOROLA and the Stylized M Logo are registered in the US Patent & Trademark Office. All other product or service names are the property of their respective owners. © Motorola, Inc. 2003.



Questions - Time-Slip, Pause/Resume - Internet/Cable Stream

For each content source:

- Cable content service
(ex. *MusicChoice*)
- Internet interactive service
(ex. *YahooLaunchcast*)

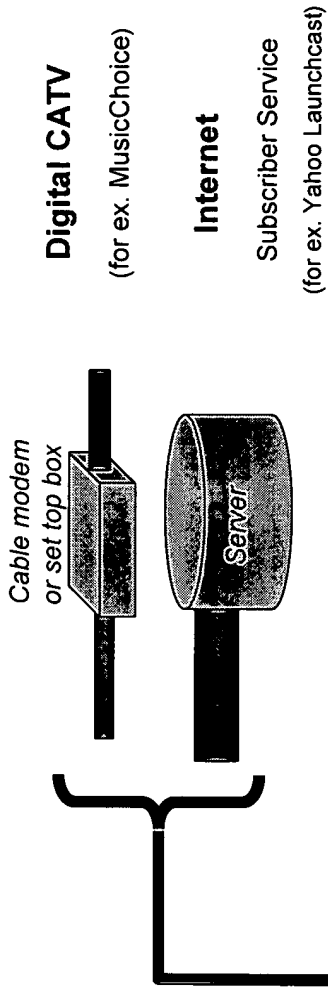

1. Is an additional license needed to perform seamless time-slip and pause/resume?
2. If so, would either the content providers or copyright owners be likely to negotiate a license?
3. What is the risk of infringement litigation and how can it be reduced?

Slide 8



AL, April 2004

Motorola Confidential Proprietary

MOTOROLA and the Stylized M Logo are registered in the US Patent & Trademark Office. All other product or service names are the property of their respective owners. © Motorola, Inc. 2003.



Questions - Daily Set

For each content source:

- Cable content service
(ex. MusicChoice)
- Internet interactive service
(ex. YahooLaunchcast)

1. Is an additional license needed to perform seamless time-slip and pause/resume?
2. If so, would either the content providers or copyright owners be likely to negotiate a license?
3. What is the risk of infringement litigation and how can it be reduced?
4. Does push-to-buy, push-for-more and/or recommend track/artist/album-to-friend require a transactional patent license?

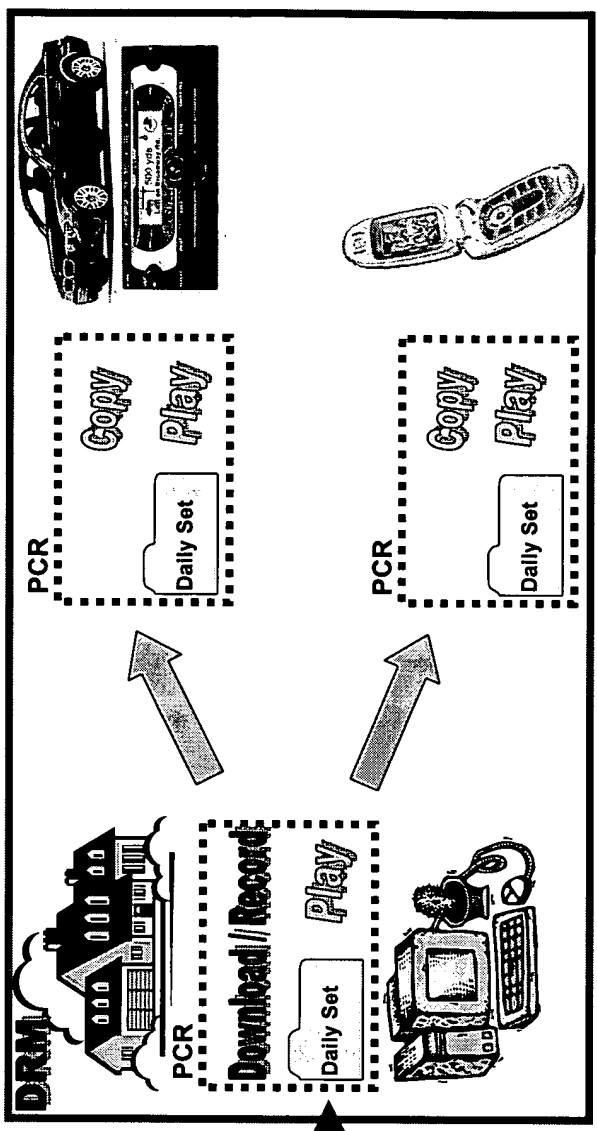
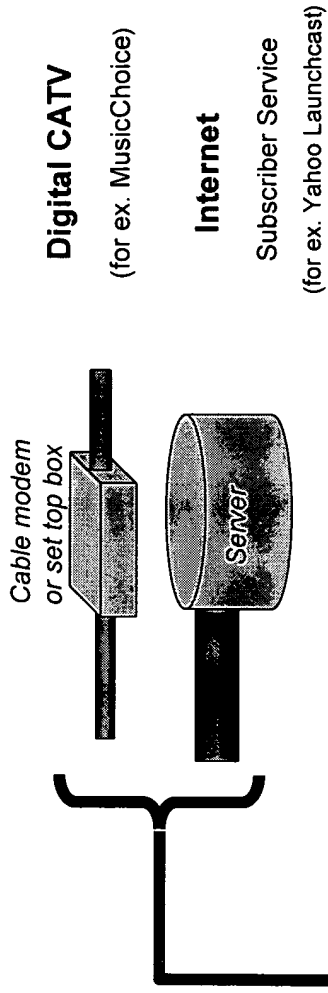

Slide 9



AL, April 2004
 Motorola Confidential Proprietary
 MOTOROLA and the Stylized M Logo are registered in the US Patent & Trademark Office. All other product or service names are the property of their respective owners. © Motorola, Inc. 2003.

intelligence  everywhere™

Questions – Promotional Tracks

For each content source:

-Digital Satellite Radio
(*subscription service*)

-Digital FM

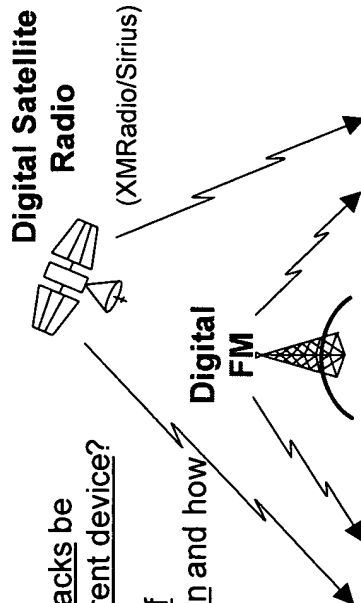

5. Can purchased tracks be downloaded to different device?

6. What is the risk of infringement litigation and how can it be reduced?

1. Is a license needed to

- a) Record track at lower quality (Analog FM or worse)?
- b) Record 30 second snippet?
- c) Record track which expires after certain period?
- d) Export track from daily set to promotional tracks in one of the above formats?

2. If so, would either the content providers or copyright owners be likely to negotiate a license?

3. Is a license needed to provide push-to-buy service for promotional tracks?

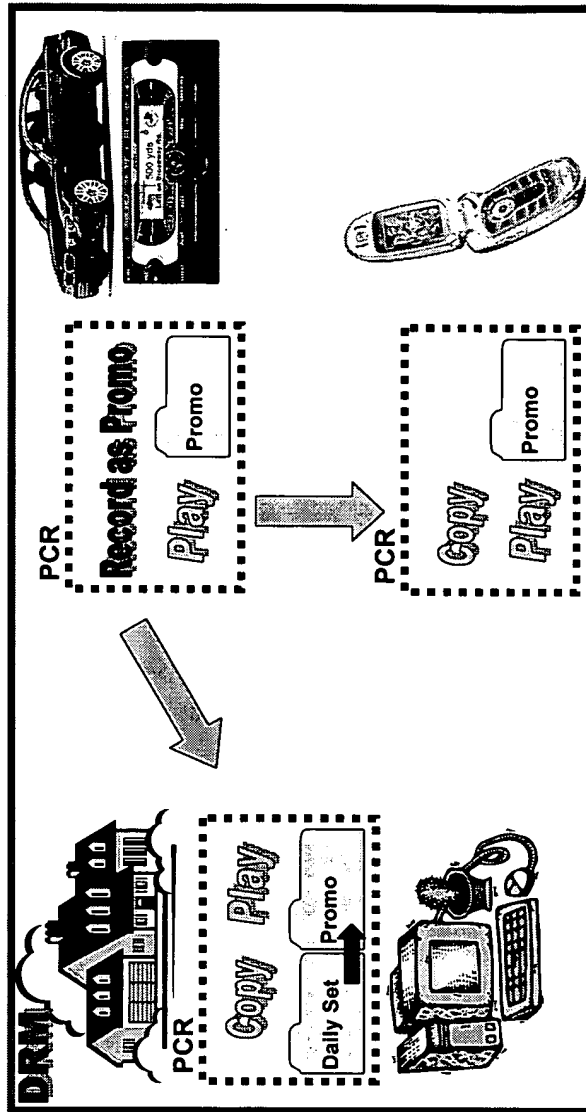

MOTOROLA

AL, April 2004
Motorola Confidential Proprietary
MOTOROLA and the Stylized M Logo are registered in the US Patent & Trademark Office. All other product or service names are the property of their respective owners. © Motorola, Inc. 2003.

intelligence  everywhere™

Questions – Purchased Tracks

For content which was purchased:

1. Is a additional license needed to copy tracks to other devices for play?
2. If so, would either the content providers or copyright owners be likely to negotiate a license? (ex. iTunes)?
3. What is the risk of infringement litigation and how can it be reduced?

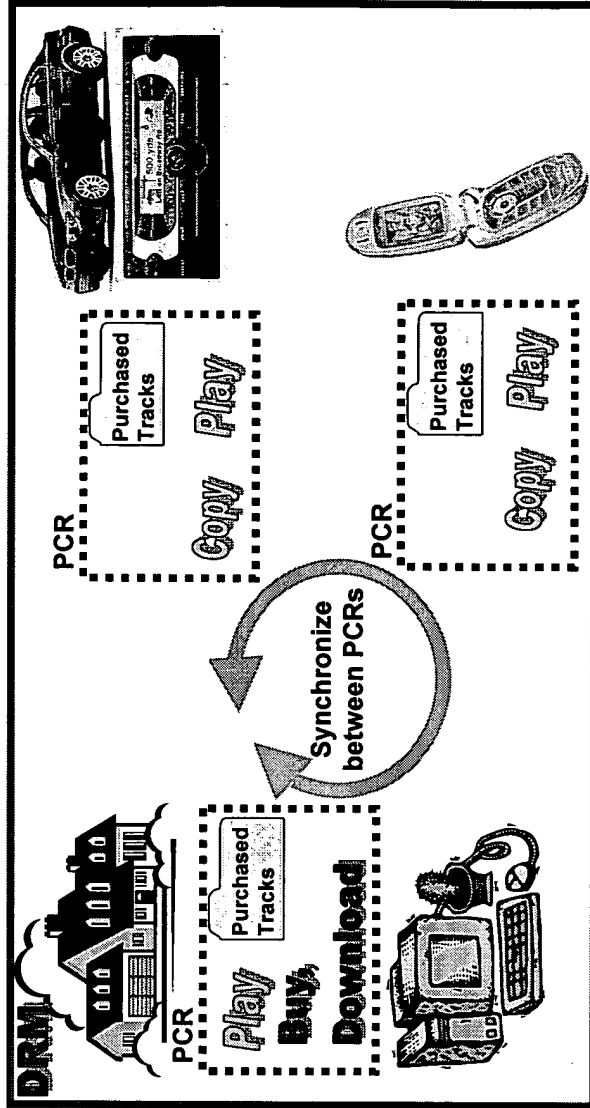

Slide 11



AL, April 2004

Motorola Confidential Proprietary
MOTOROLA and the Stylized M Logo are registered in the US Patent & Trademark Office. All other product or service names are the property of their respective owners. © Motorola, Inc. 2003.





iRadio Team Session

9/22/04

 Radio™



Motorola Confidential Proprietary
Page 1





History & Vision

Consumer Perspective

Partners & Business Model

Solution Summary & Status



Motorola Confidential Proprietary
Page 2





Radio™

iRadio Phase I Approach

Second 45 days

First 45 days

External
Customer
Consumer
Competition
Technology



Set Targets

	"Where"			
	Person	Home	Car	Other
Navigation				
Entertainment				
Seamless Digital Audio across Person-Home-Car				
Information				
Safety & Security				



Internal
Competencies
Resources
Goal

Solution Definition & Business Model

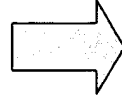

Business Case & Eco-System

Seed Funding Request



MOTOROLA

Motorola Confidential Proprietary
Page 3

intelligence everywhere™



Radio™

Entertainment is shifting to digital delivery mechanisms & portable devices

Number of Years to 1 Million Comparative Products and Services

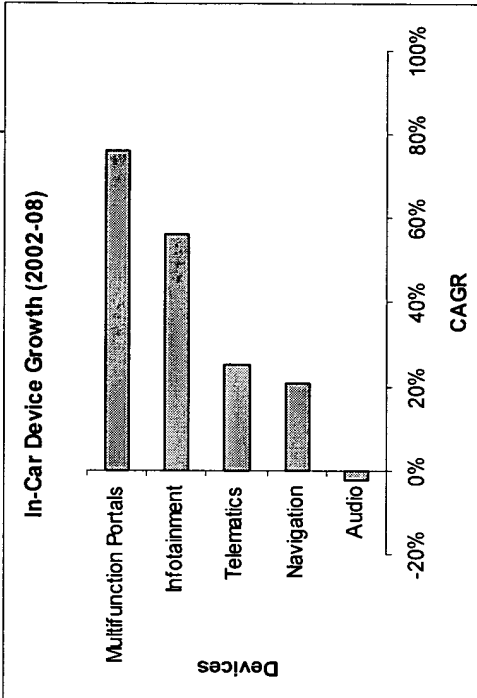
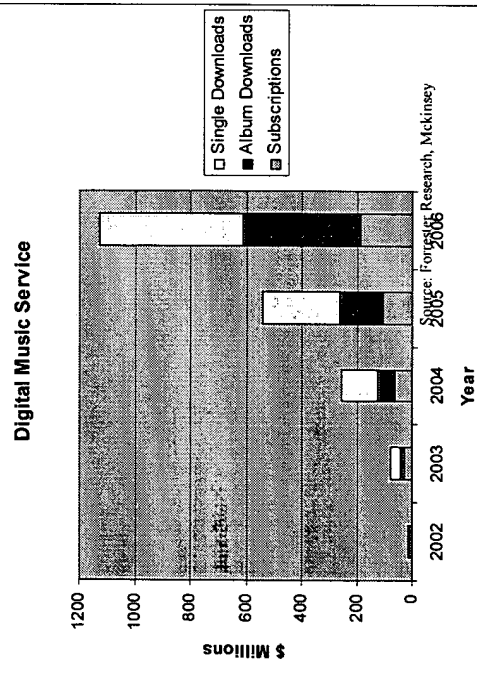
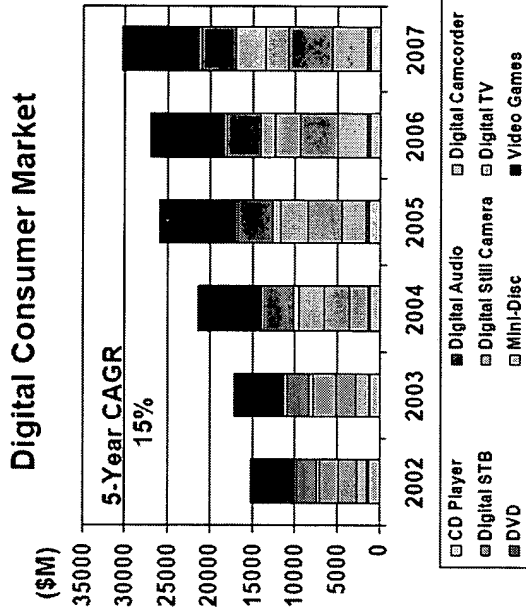
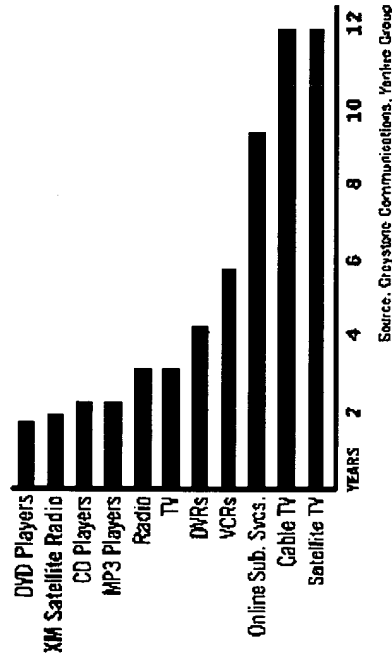

MOTOROLA

Motorola Confidential Proprietary Page 4

intelligence everywhere™

Two Distinct Market Entry Strategies

Option 1: Sustain Broadcast Radio by offering customers a premium service that allows them to purchase songs they hear, create customized playlists and listen to precisely what they want, when they want

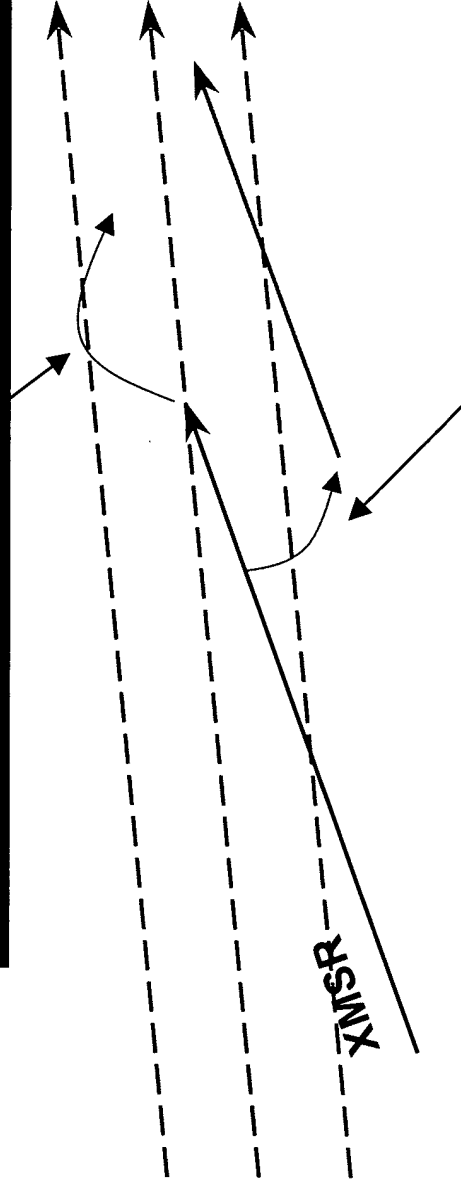

Option 2: Disrupt Broadcast Radio by offering a distinct business model, with less total choice but lower prices, greater flexibility and more customization. Partner with alternate content provider (e.g., Yahoo!Launch) to provide content

Time





Radio™

History & Vision



Consumer Perspective

Partners & Business Model

Solution Summary & Status



MOTOROLA

Motorola Confidential Proprietary
Page 6



Consumers' Perspective - An opportunity to serve the 97%



Satellite subscribers love their service!

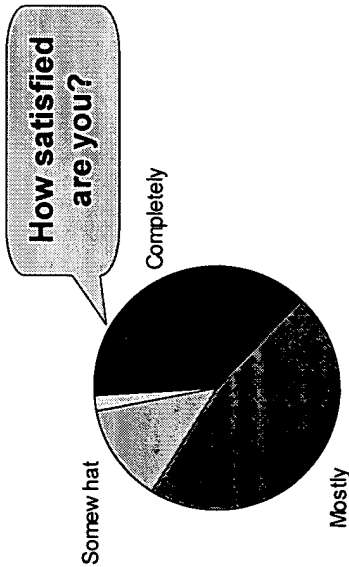

Importance to Satellite Users

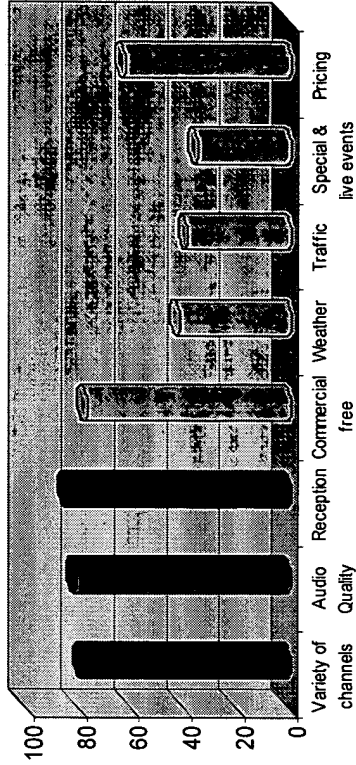

But non-subscribers shun cost & hassle...and desire satellite benefits

Objections of Non-Users

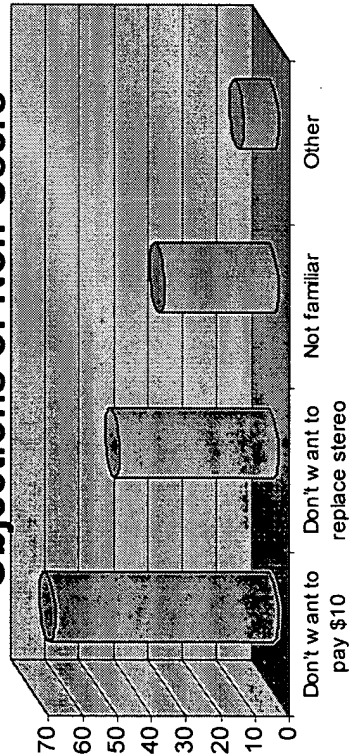

Problems non-users want to solve

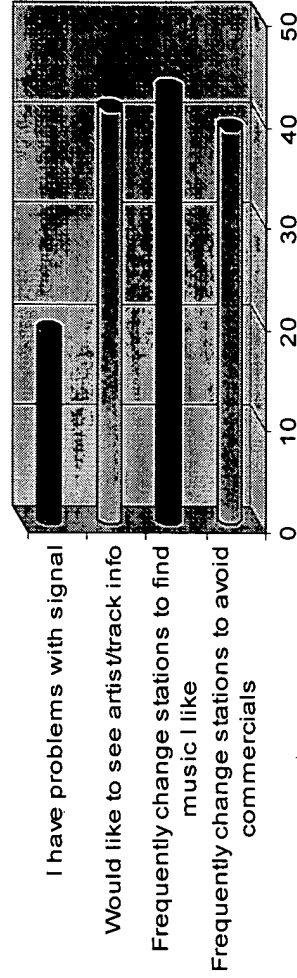

Source: eBrain/iRadio consumer research, Aug. 04



Motorola Confidential Proprietary
Page 7





Radio™

What do consumers want?

- **I want *my* content... “The best of both worlds”!**
 - Includes my home music collection (66%)
 - A wide variety of audio content that better matches my moods and tastes (65%)

- **Where I listen to music**
 - In my car (89%)
 - On my home stereo (71%)
 - On my PC (48%)

- **And with the ability to:**
 - Skip commercials (70%)
 - Pause, resume, rewind (61%)
 - Add song I’m hearing to my home collection (53%)

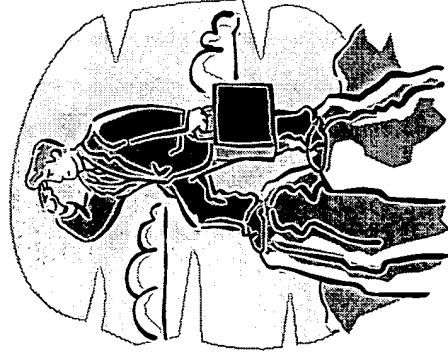

Source: eBrain/iRadio consumer research, Aug. 04



MOTOROLA

Motorola Confidential Proprietary
Page 8

intelligence  everywhere™



Radio™

And a high willingness to pay!

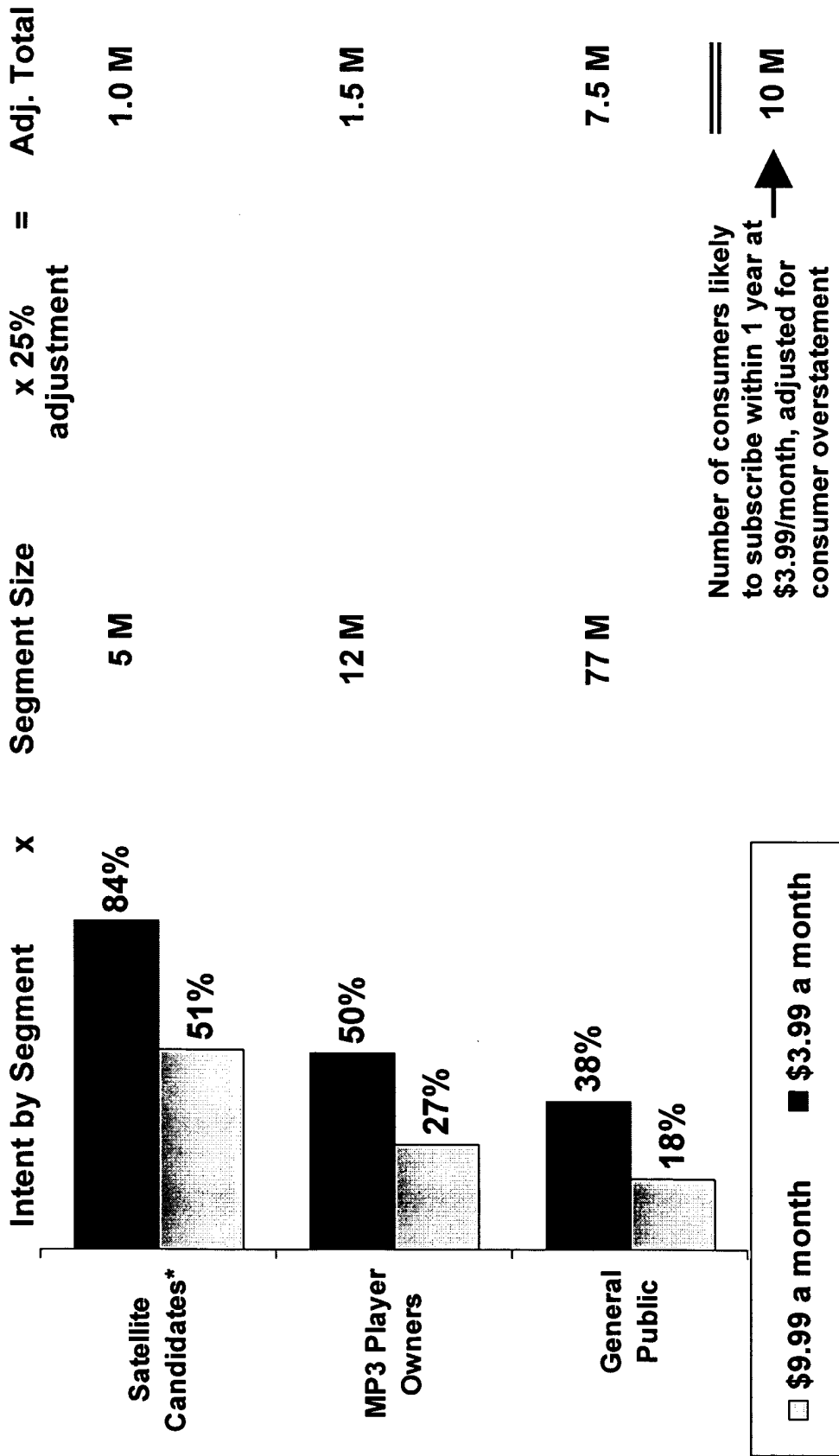

* Hi interest, Heavy commute, Hi income

Source: eBrain/iRadio consumer research, Aug. 04



MOTOROLA

Motorola Confidential Proprietary
Page 9

intelligence everywhere™



Radio™

Conservative Estimates for Initial Offering Reveal \$500M Business Readily Achievable

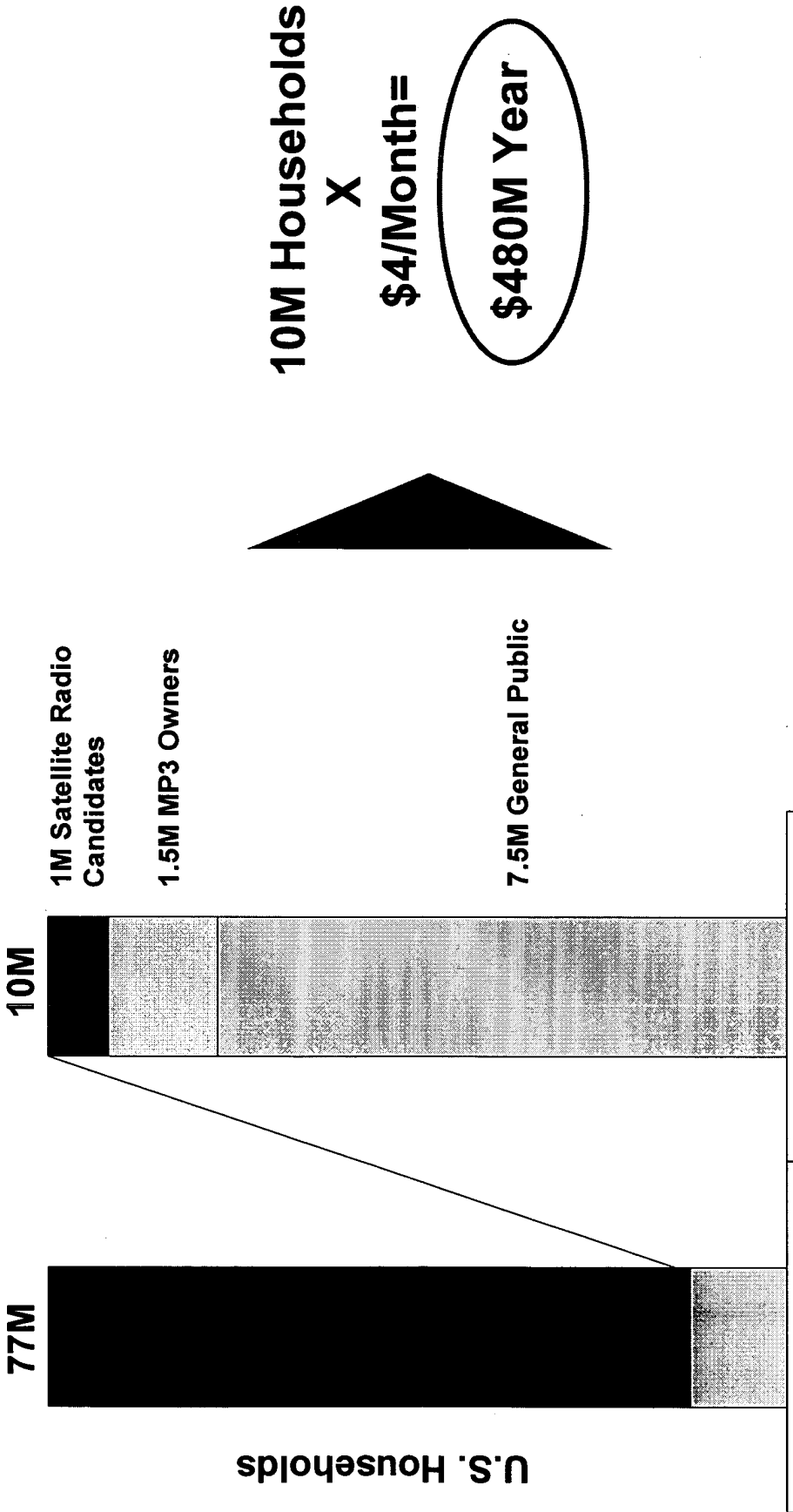

Total Market **Target**

Source: eBrain/iRadio consumer research, Aug. 04



MOTOROLA

Motorola Confidential Proprietary
Page 10

Intelligence  everywhere™

Radio™ **AudioFeast Will Be Our Initial Content Partner** **JEFF**

	Web Caster				Wholesaler	Digital TV
	LAUNCHCAST musicmatch before for music lovers	AOL.COM	AudioFeast	LIVE 365.COM radio revolution		
Interest/ Solution Fit	●	●	●	●	●	●
Content Variety	●	●	●	●	●	
•Music •Talk	● ○	● ○	● ●	● ○	● ○	● ○
Licensing	○	●	●	●		●
Business Model	●	●	●	●	●	○
Customer Reach/ Brand	●	●	○	●	○	●

• Customer Reach
• Lose Control

• Not Go to Market
• Strategic Control

● ● ○ ○

Good Poor



Motorola Confidential Proprietary
Page 11





Radio™

History & Vision

Consumer Perspective

Partners & Business Model

Solution Summary & Status

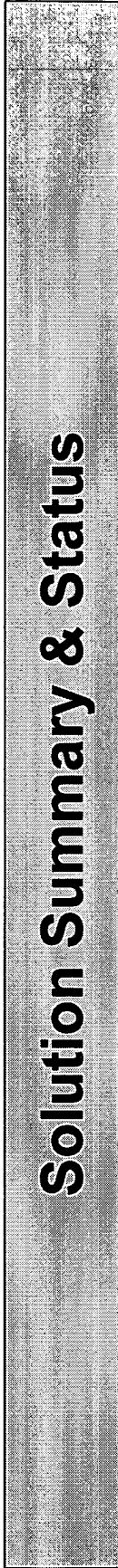

MOTOROLA

Motorola Confidential Proprietary
Page 12





Seamless Digital Audio . . . At home, in the car & on the go

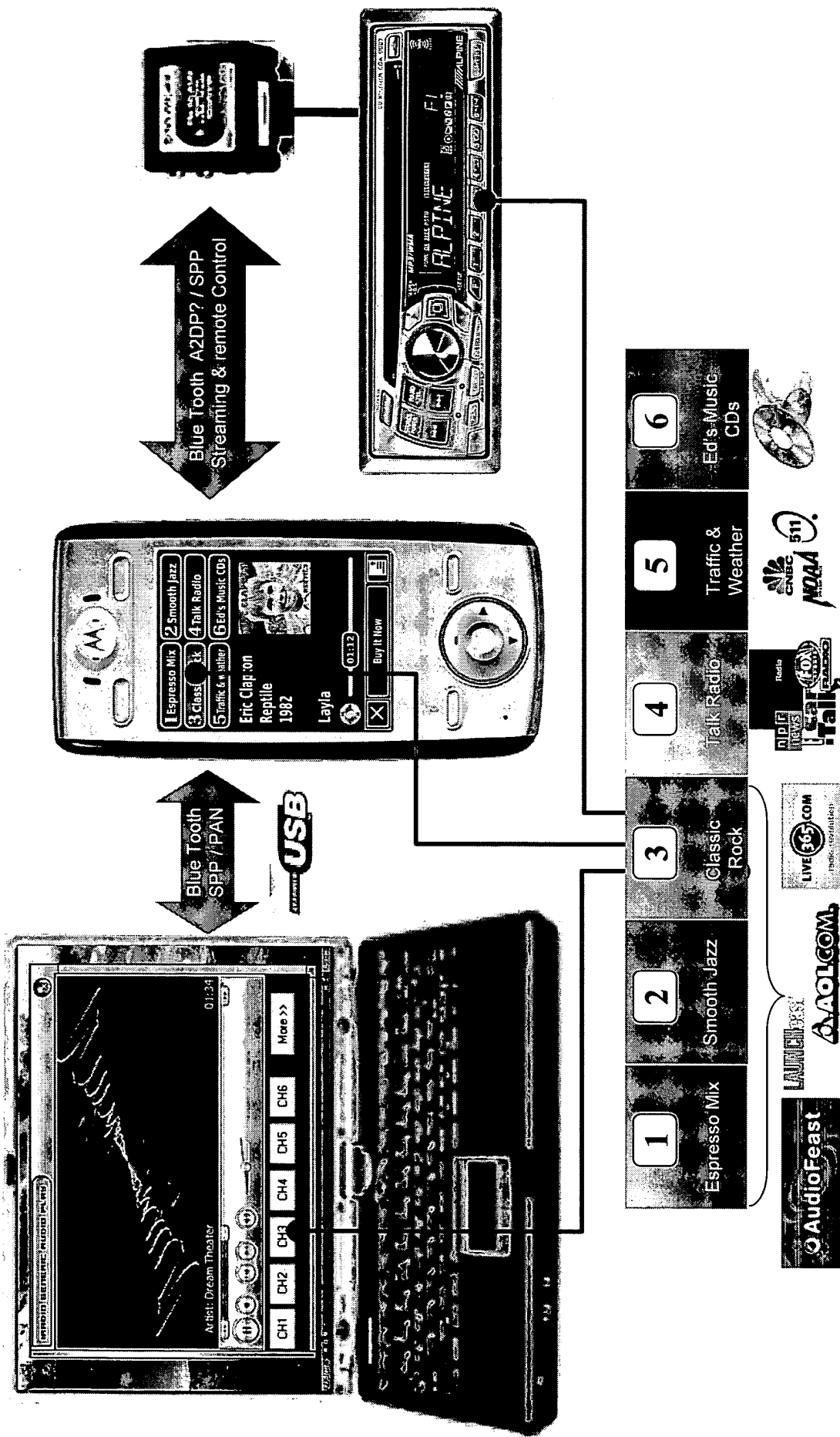

Motorola Confidential Proprietary
Page 13



Intelligence everywhere™



Radio™ Phone/Controller

- **ROLE:**
 - Acts as UPnP controller in all domains
 - Collects information on user operation and consumption
 - Enforces constraints on consumption
 - Content updated from Home Gateway
 - Streams audio to WACA
 - Interprets navigation commands from WACA

▪ User Interface

- Emulating iPod joystick behavior
- Limited display pages:
 - Artist/song
 - Art Cover menus
 - Extended Menu (preferences, vote...)
- Direct PTB on screen or 2 sec activation center select key

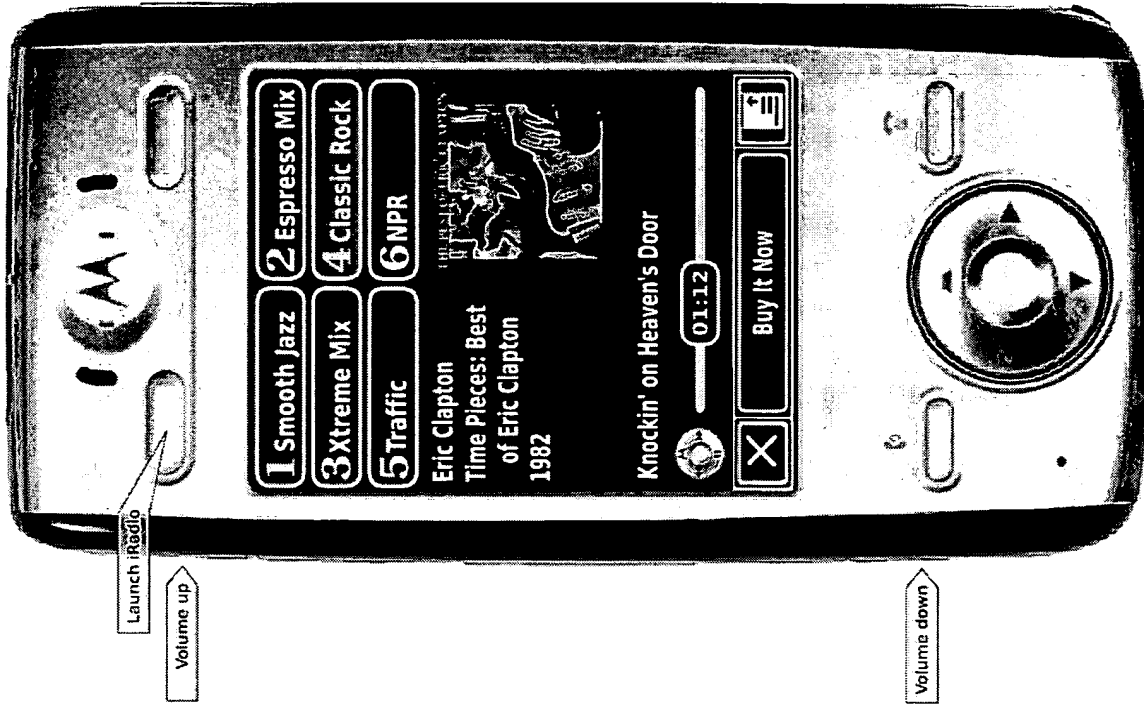
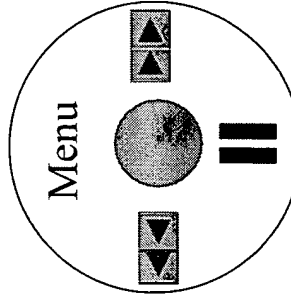

Radio™ Overview

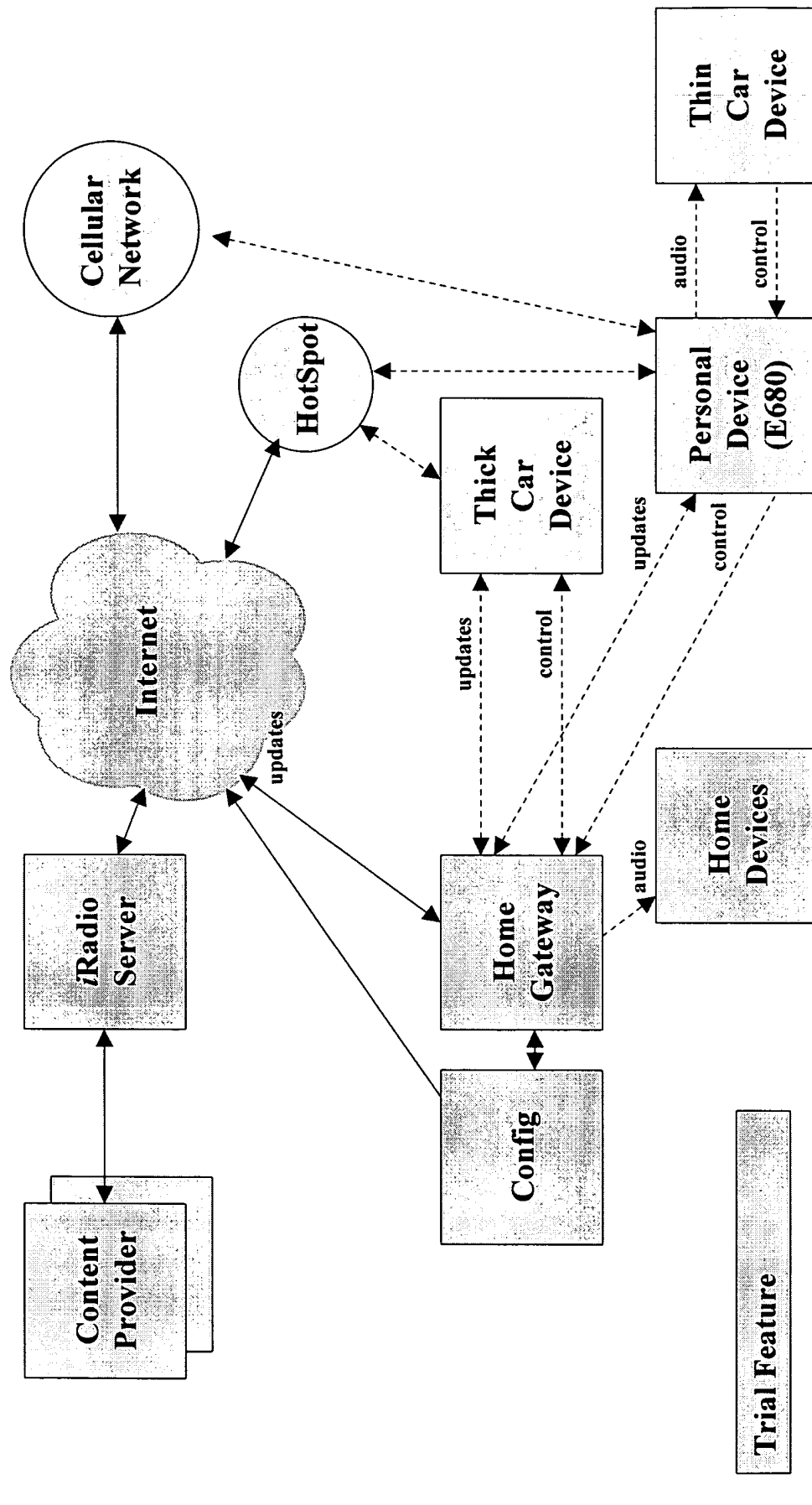

Motorola Confidential Proprietary
Page 15

intelligence  everywhere™

 **MOTOROLA**

Trial Feature
Possible Future Feature

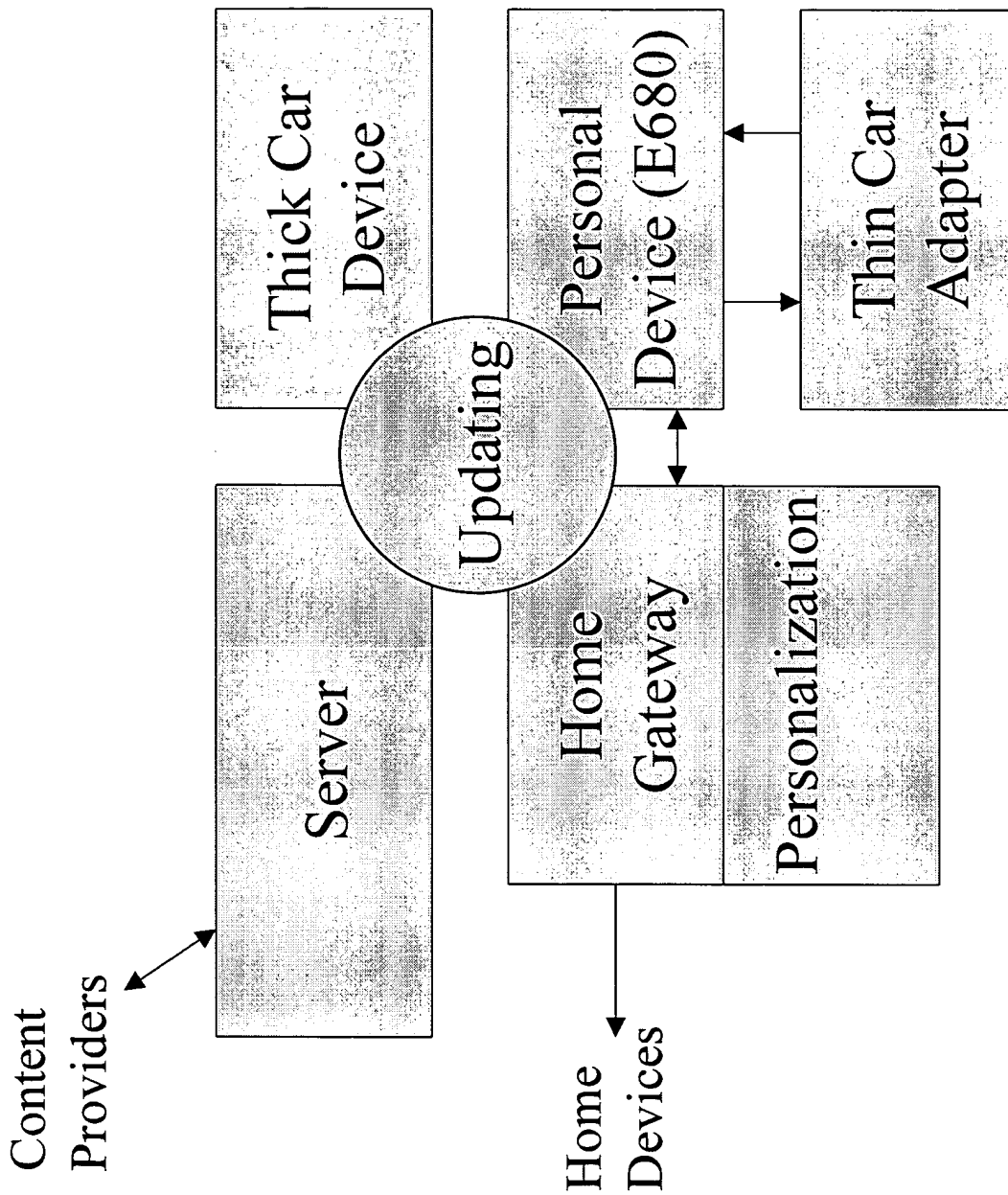

E680

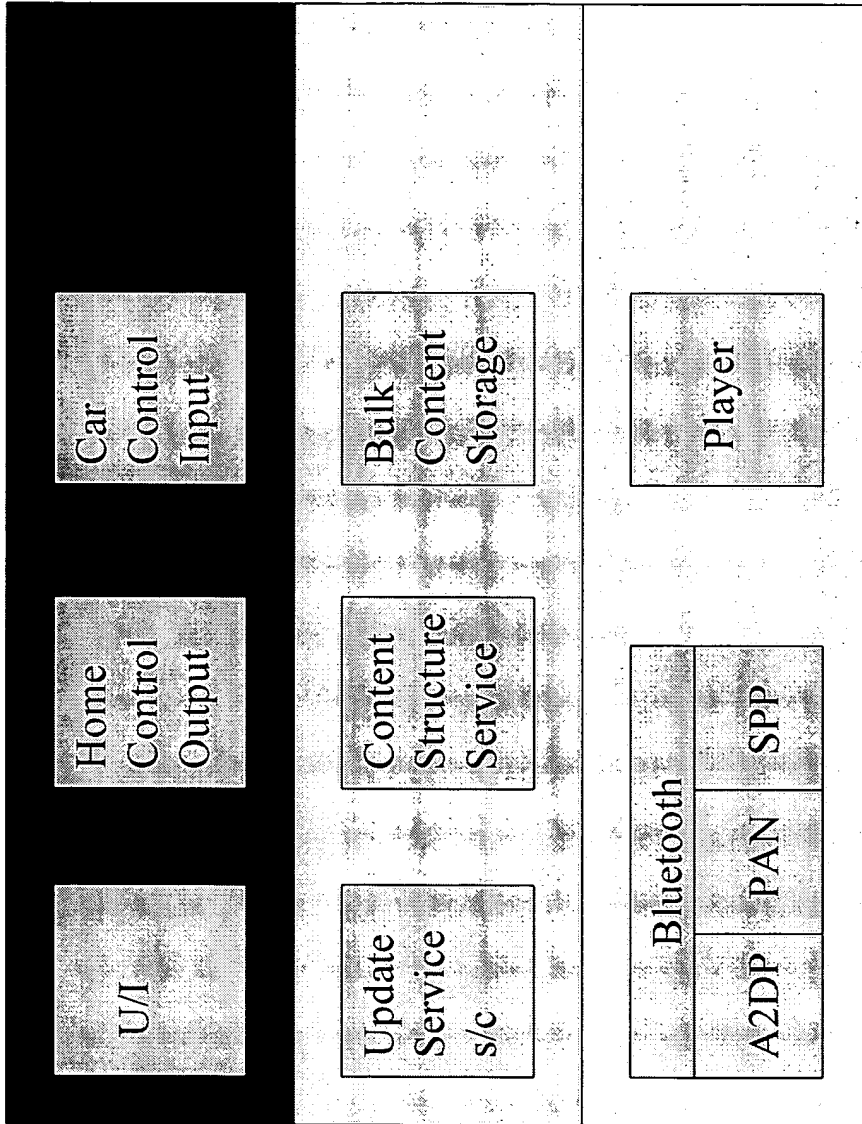



Radio™

Home Gateway

PC or MS1000

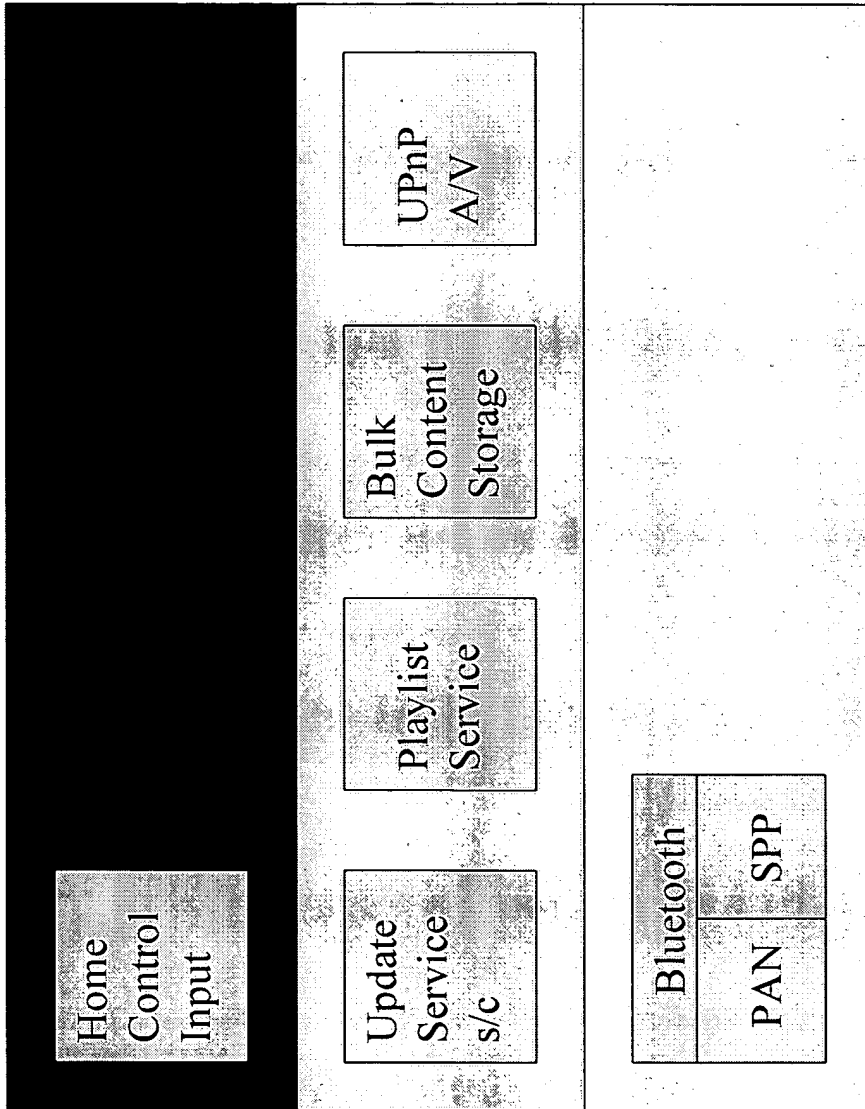

MOTOROLA

Motorola Confidential Proprietary
Page 18

intelligence  everywhere™

BT Audio Adapter

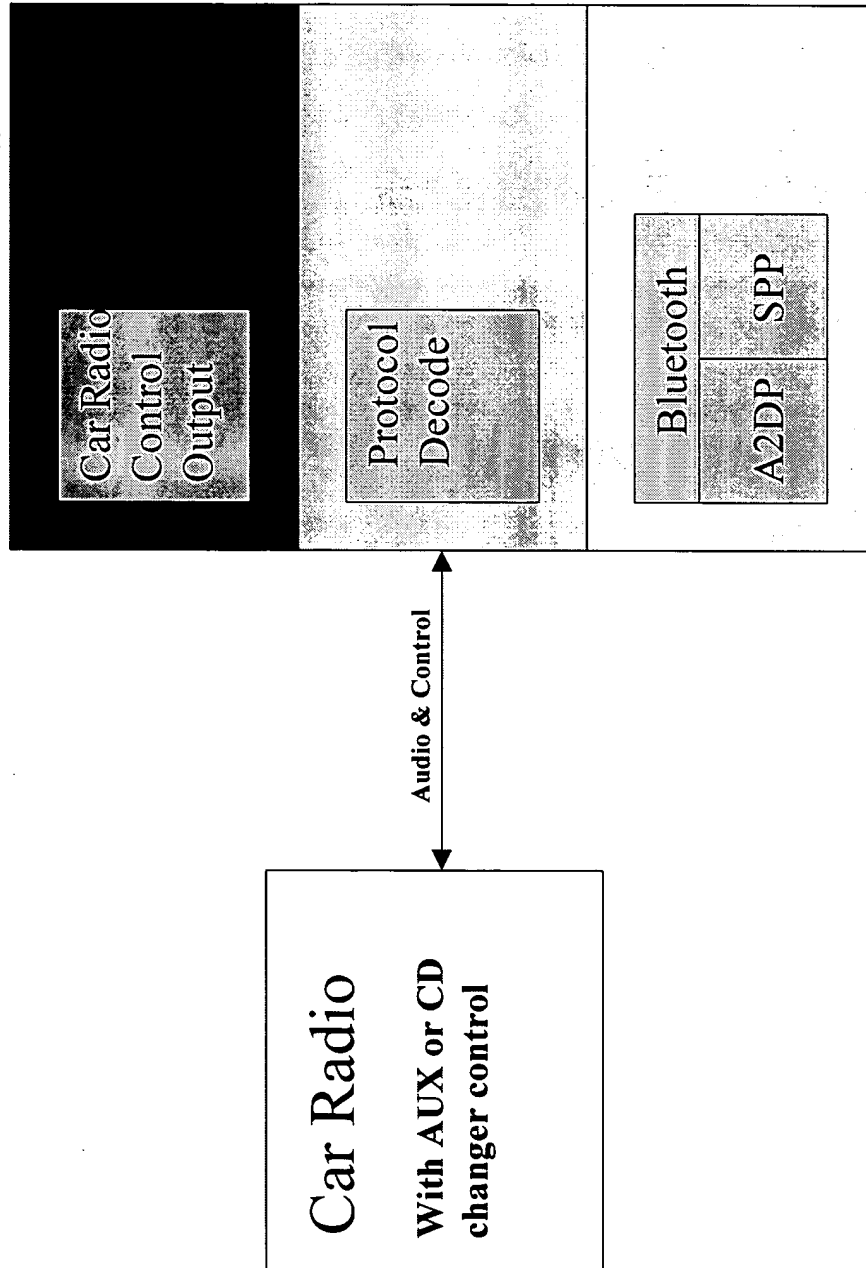



Radio™ Goals & Milestones

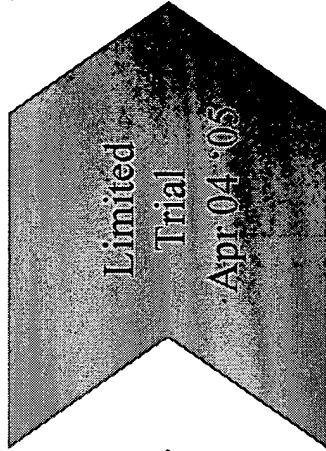
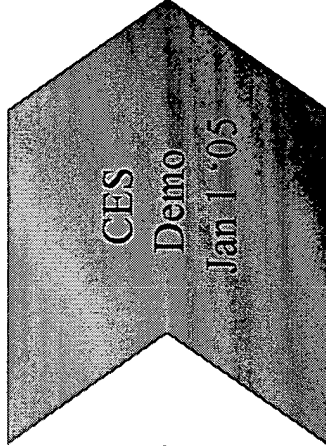
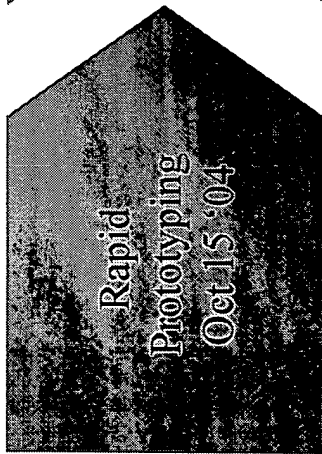

• Client

- 2-boards WACA: BT+CD spoofer
- Car deck to serial CD spoofer
- Bluetooth stream from PC to WACA
- 1 phone BT to WACA BT

• Client

- Dual board WACA
- E680 & MPX BT demo
- PC client content selection
- PC BT daemon / USB host
- Pause here, play there phone & home synchro
- Push-to-Buy Simulation

• Client

- Single board WACA pilot
- JAVA E680 & C# MPX "personal server" functions UPnP AV compliance (server, renderer, controller)
- A2DP, AVRCP, PAN, SPP
- PC client integrated UI browser+player
- Daily set synchro
- DRM

• Client

- Pause here, play there all domains+ all trick plays
- DRM enforcement multi-codecs

• Client

- Production WACA multi-models legacy decks
- E680 & MPX SW release middleware & application UI
- PC client content browser
- PC – phone daily synch
- Pause here, play there all domains+ all trick plays
- DRM enforcement multi-codecs

• Server

- Framework
- Database Metadata schemas...

• Server

- Integration with live content AudioFeast???
- User config, profile
- User authentication
- Usage tracking
- Basic synchronization
- Administrative Mgmt

• Server

- Full content management integration AudioFeast
- DRM, automated download
- Trial level SMS
- Robust Database metadata mgmt & usage tracking

• Server

- Integration with more than 1 content provider
- Database & streaming cost optimization
- QoS monitoring
- Fully validated



MOTOROLA

Motorola Confidential Proprietary
Page 20

intelligence  everywhere™



**iRadio UART High level
protocol for Wireless Audio
Adaptor
Requirement Document**

Draft Revision XA

Motorola, Inc.
iRadio
JM Villeveille
Director of Engineering
8/30/2004

1 AN INTRODUCTION TO THIS DOCUMENT ERROR! BOOKMARK NOT DEFINED.
1.1 WHAT IT IS ERROR! BOOKMARK NOT DEFINED.

1 Introduction

1.1 Transport Frame Structure:

Please use whichever is fastest to implement: XM –like CBM or iPOD TBD

E.g. SDARS CBM transport:

OCTET	FIELD
octet 0	start header MSB
octet 1	start header LSB
octet 2	length MSB
octet 3	length LSB
iRadio Bus Message	
octet n-1	checksum MSB
octet n	checksum LSB

Start header: 2 bytes – 00A5h / 005ah

Length: 2 bytes – 0000h-FFFFh

iRadio message:

- Transaction code = 1 byte
- Message body

Checksum: 2 bytes (XOR 00 to n-2 Octet)

1.2 iRadio Bus Message structure

1.2.1 Messages from the Head-Unit

What we need:

User_interface control type: e.g Button, dial, switch

User_interface control number #ID

User_interface control action

Optional for later:

Head-Unit Status (audio source, ...)

Head-Unit profile (display capability, ...)

Power_ON handshake – Devices discovery

Specific controls buttons/ switches - asap

PRESETS keys 1-6

SOURCE: Audio Source (AM, FM, CD, XM...)

STOP / PLAY/ PAUSE

FORWARD (hold & Momentary)

REWIND (hold & Momentary)

SEEK/SCAN

ENTER / SELECT (if different from the play)

INFO

Examples of codes needed:

UI_CONTROL_BUTTON

UI_CONTROL_DIAL

UI_CONTROL_SWITCH

UI_ACTION_DOWN

UI_ACTION_HOLD

UI_ACTION_UP

UI_ACTION_ON

UI_ACTION_OFF

UI_ACTION_CLOCKWISE

UI_ACTION_COUNTERCLOCKWISE

1.2.2 Messages to the HeadUnit

What we need:

Read /Write on remote Head-Unit Display informations associated with the track or text prompts...

Optional:

Power_ON handshake – Devices discovery

Get status

Get Profile

iRadio -- Experimentation

Last updated: June 16

Introduction

We have an initial outline of what the iRadio system might consist of, but given the huge number of business and product uncertainties it is not clear what the system will eventually be. This page focuses on refining the outline by doing a very simple trial implementation. There are the following high-level goals for this implementation:

- Have something to demonstrate the iRadio idea
- Refine ideas by squarely facing implementation details
- Allow future experimentation which user interfaces

Even if this plan is overtaken or modified by events, there is still much which will be learned.

Proposed Implementation

The minimum system involves the following ingredients/entities:

Content

The nature and quality of the content will be driven by demo requirements. For experimentation and proving the idea, it doesn't matter what format the content has. Initially I would rip some of my personal CDs to relatively small WAV or MP3 files. Other alternatives are:

- Purchase popular CDs for the the office
- Purchase music which is specifically royalty free (this is available on the net)
- Use MIDI files of songs which are out of copyright (this is available on the net)

Content Provider

This would be a Linux laptop which would would have the content and a few channels/playlists which would be constructed by hand. It would contain servlets which would allow the content to be retrieved from the iRadio Server. Being a laptop, it could more easily be moved for connection to the external Internet.

iRadio Server

This would be a Linux laptop (could be the same laptop as the Content Provider) which would cache the content and hold the user configuration data. It would contain the following very simple service and agent implementations:

- content storage service
- channel/playlist storage service
- User configuration service
- General Preferences/Profile service
- Authorized user service
- Usage Tracking/logging service
- Content fetching agent

There would also be servlet which would be called by the mobile devices to update provide feedback and get updated content.

Wireless Communications

For this proposal Bluetooth is the suggested mobile communications approach. For demos and in-office experimentation Bluetooth (class 2, PAN, DUN or SPP) has the following advantages over 802.11:

- Limited range
- Less interference and interoperation problems with the building's existing wireless LAN which is 802.11 based.
- Phone mobile clients are likely already have some type of Bluetooth support

The only disadvantage is limited throughput. (For DUN or SPP, very limited throughput.)

Mobile Device

The mobile device could be a another laptop or more impressively, a cell phone. It would contain software to login to the iRadio Server, provide feedback and get updated content and configuration information. The user would have a simple set of channels which would allow the playing of channels.

What's Included

- Getting content from a content provider
- Caching content in the iRadio Server
- Updating content in the Mobile Device
- Capturing feedback from the Mobile Device
- Pause/Resume between different Mobile Devices

What's Not Included

- No DRM
- No communications security
- No high quality audio unless we use 802.11
- No video
- No UPnP A/V
- No community stuff
- No push to buy (is an optional enhancement)
- No recording or program guides
- No expiration of content
- No or limited network failure recovery

Development Tasks

None of the tasks should be longer than 2 intense days if done as a highest priority. Done in the background (at home) each could take a week. There is significant reuse of services between the three entities.

Content Provider

Some of the services which will be required for the iRadio Server and/or the Mobile Client are convenient building blocks for the content provider. The content provider could be developed without using these building blocks, but it will be easier to use them. Therefore, the content provider development looks larger because it includes development of these services.

1. Design and implement preferences/profile service (reused elsewhere)
2. Design, document and write stubs for HTTP login and channel protocol
3. Design and implement channel building tool
4. Design and implement channel storage service (reused elsewhere)
5. Design and implement media storage service (reused elsewhere)
6. Design and implement the channel servlets

7. Design and implement user authentication service (reused elsewhere)

Optional

8. Design and document HTTP purchase protocol
9. Design and implement the purchase servlet(s)

iRadio Server

1. Design and implement channel content replenishment agent
2. Design and implement mobile update servlet(s)
3. Design and implement user configuration service

4. Design and implement feedback queuing service

Optional

5. Design and implement trivial owned content storage service (reused elsewhere)
6. Design and implement owned content acquisition agent

Mobile Device

1. Design and implement content player on top of platform
2. Design and implement configuration driven UI
3. Design and implement updating agent

4. Design and implement server connection discovery

Optional

5. Design and implement owned content browser

Other Tasks

1. Get a few phones with Bluetooth support:
 - o J2ME or BREW network access over Bluetooth using PAN
 - o J2ME or BREW network access over Bluetooth using SSP
 - o J2ME with serial port access and Bluetooth SSP dongle

iRadio -- Experimentation

Last updated: July 13

Introduction

We have an broad initial outline of what the *iRadio* system might consist of, but given the huge number of business and product uncertainties it is not clear what the system will eventually be. This page focuses on refining the outline by doing a very simple trial implementation. There are the following high-level goals for this implementation:

- Refine ideas by squarely facing implementation details
- Have something to demonstrate the *iRadio* idea
- Allow future experimentation with user interfaces

There are obviously some conflicts between the above goals and the time available. Polish will be sacrificed for time where ever possible.

Even if this plan is overtaken or modified by events, there is still much that will be learned.

Proposed Implementation

The minimum system involves the following ingredients/entities:

Content

The nature and quality of the content will be driven by demo requirements. For experimentation and proving the idea, it doesn't matter what format the content has. Initially I would use MIDI files or rip some of my personal CDs to relatively small WAV or MP3 files. Other longer-term alternatives are:

- Purchase popular CDs for the the office
- Purchase music which is specifically royalty free (this is available on the net)
- Get some type of agreement with a real content provider

Content Provider

This would be a Linux laptop which would would have the content and a few channels/playlists which would be constructed by hand. It would contain servlets which would allow the content to be retrieved from the *iRadio* Server. Being a laptop, it could more easily be moved for connection to the external Internet.

iRadio Server

This would be a Linux laptop (could be the same laptop as the Content Provider) which would cache the content and hold the user configuration data. It would contain the following very simple service and agent implementations:

- content storage service
- playlist storage service
- channel (U/I Config) storage service
- User configuration service
- General Preferences/Profile service

- User Authentication service
- Usage Tracking/logging service
- Content fetching agent
- Mobile client interface servlet(s)

Wireless Communications

For this proposal Bluetooth is the suggested mobile communications approach. For demos and in-office experimentation Bluetooth (class 2, PAN, DUN or SPP) has the following advantages over 802.11:

- Limited range
- Less interference and potential interoperation problems with the building's existing wireless LAN which is 802.11 based.
- Phone mobile clients more likely to already have some type of Bluetooth support

The only disadvantage -- a big one -- is limited throughput. (DUN and SPP, have very limited throughput.)

Mobile Device

The mobile device could be a another laptop (allowing WiFi) or more impressively, a cell phone. It would contain software to login to the *iRadio* Server, provide feedback and get updated content and configuration information. The user would have a simple set of channels which would allow the playing of channels.

What's Included

- Getting content from a content provider
- Caching content in the *iRadio* Server
- Updating content in the Mobile Device
- Capturing feedback from the Mobile Device
- Pause here - Play there between different Mobile Devices

What's Not Included

- No DRM
- No communications security
- No high quality audio unless we use 802.11
- No video
- No UPnP A/V
- No community stuff
- No push to buy (is an optional enhancement)
- No recording or program guides
- No expiration of content
- No or limited network failure recovery

Development Tasks

None of the tasks should be longer than 2 intense days if done as a highest priority. Done in the background (at home) each could take a week or more. There is significant reuse of services between the three entities.

Content Provider

Some of the services which will be required for the iRadio Server and/or the Mobile Client are convenient building blocks for the content provider. The content provider could be developed without using these building blocks, but it will be easier to use them. Therefore, the content provider development looks larger because it includes development of these services.

1. Design and implement preferences/profile service (reused elsewhere)
2. Design, document and write stubs for HTTP login and channel protocol
3. Design and implement playlist/content stream building tool
4. Design and implement playlist storage service (reused elsewhere)
5. Design and implement media storage service (reused elsewhere)
6. Design and implement the playlist/content stream servlets

Optional

7. Design and implement user authentication service (reused elsewhere)
8. Design and document HTTP purchase protocol
9. Design and implement the purchase servlet(s)

iRadio Server

This reuses several of the Content Provider services, so only the new development is listed below.

1. Design and implement playlist/content replenishment agent
2. Design and implement mobile update servlet(s)
3. Design and implement user configuration service

4. Design and implement feedback queuing service

Optional

5. Design and implement trivial owned content storage service (reused elsewhere)
6. Design and implement owned content acquisition agent

Mobile Device

This reuses several of the Content Provider and iRadio Server services, so only the new development is listed below.

1. Design and implement content player on top of platform
2. Design and implement configuration driven UI
3. Design and implement updating agent

4. Design and implement server connection discovery

Optional

5. Design and implement owned content browser

Other Tasks

1. Get a few phones with Bluetooth support:
 - o J2ME or BREW network access over Bluetooth using PAN
 - o J2ME or BREW network access over Bluetooth using SSP
 - o J2ME with serial port access and Bluetooth SSP dongle

Risks/Unknowns

Wireless networking

There is no specific task associated with getting the wireless networking working. If WiFi is used, then this should be trivial if it is transparent on the mobile device. If Bluetooth is used then there will probably be work on the server and client to make it work.

Language/Platform

For a J2ME client, there is substantial opportunity for code reuse. For other platforms, there will need to be some additional development.

iRadio -- Initial Approach

The initial iRadio system will concentrate on seamless delivery of content for home and vehicle. Although "person" is not included in this initial system, the behavior of a personal device is largely identical to the vehicle case. This initial set of functionality is targeted as in place internally by the end of 2004 and available for trials in 1Q05.

Requirements

These are not formal requirements, but more like points we need to agree upon. The points are half user expectations, half implementation and half requirements. :-)

Service Assumptions

- User listens to audio channels (like Yahoo launch & XM) with supporting images, text and links available.
- The service provider will have access to feedback and disposition (listened, skipped, timed-out) concerning the content.

Home

- User can play audio on their sound system via a hand-held remote
- UPnP A/V (with extensions) will be used for all in-home audio
- UPnP A/V extensions are required for feedback
- The MS-1000 is the prime candidate for content storage in the home
- For rich interfaces (TV screen?), user can link to more information or purchase the audio (single/album).

Car

- The user could view data associated with the playing content.
- If the network is available, the user could access extended data associated with the song. Not sure who we need for this, maybe GraceNote. I could see concert schedule/tickets, lyrics ... We need something better than Yahoo which just does a search.
- The user selects a channel and it starts playing from where it left off when last played in any domain. Do we have some limited ability for the user to restart the song if it is starting in the middle? It would need to be limited because it could be abused to repeat a song an arbitrary number of times.
- For limited interfaces, user could purchase immediately if a plan is set up ahead of time. Ideally the just purchased track would be immediately available (plucked out of the channel stream) on the device for selection and playing.
- For limited interfaces, user can press a button to mark an intent to buy which sends an email. The actual purchase is done later via a browser.
- Ability to search and play owned content on the device. This would have the same pause capability.
- Do we want a limited rewind/replay capability just in case the user misses something the first time. (This would be more for talk radio.)

Initial *i*Radio Architecture

Mark Clayton

System Components

The system is composed of the following physical components:

- Content Provider
- iRadio Server
- Home Gateway
- Mobile Devices
- Home Device

Content Provider Subsystems

- *i*Radio interface
 - Supplier interface (server) – supplying content
 - Feedback interface (server) – getting feedback

iRadio Server Subsystems

- Content Provider interface
 - Supplier interface (client) – getting content
 - Feedback interface (client) – providing feedback
- Content Repository – user’s enqueued content
- Media Storage service – bulk media storage
- Content fetching Agent
- DRM encoder
- User/device authentication/subscription services
- User preferences service
- Device sync agent
- Home Gateway sync agent
- Web preferences/configuration interface

Home Gateway Subsystems

- Content Repository -- user's enqueued content
- Device sync agent
- iRadio server sync agent
- User/device authentication – lightweight
- UPnP A/V services for home device support

Mobile Device Subsystems

- Sync agent
- Client authentication
- Content repository – lightweight version
- Media streamer – device independent
- DRM decoder
- Platform media player
- Platform UI

Home Device Subsystems

- UPnP A/V renderer implementation
- UPnP A/V controller implementation
- DRM decoder

Architectural Issues

- Need to setup the master/slave relationships and other details for the for the various synchronizations.
- Do we use UPnP (SimpleDevices stuff) for synchronization? – this would require using a special tunnel for UPnP to work at a HotSpot.

iRadio Server Details

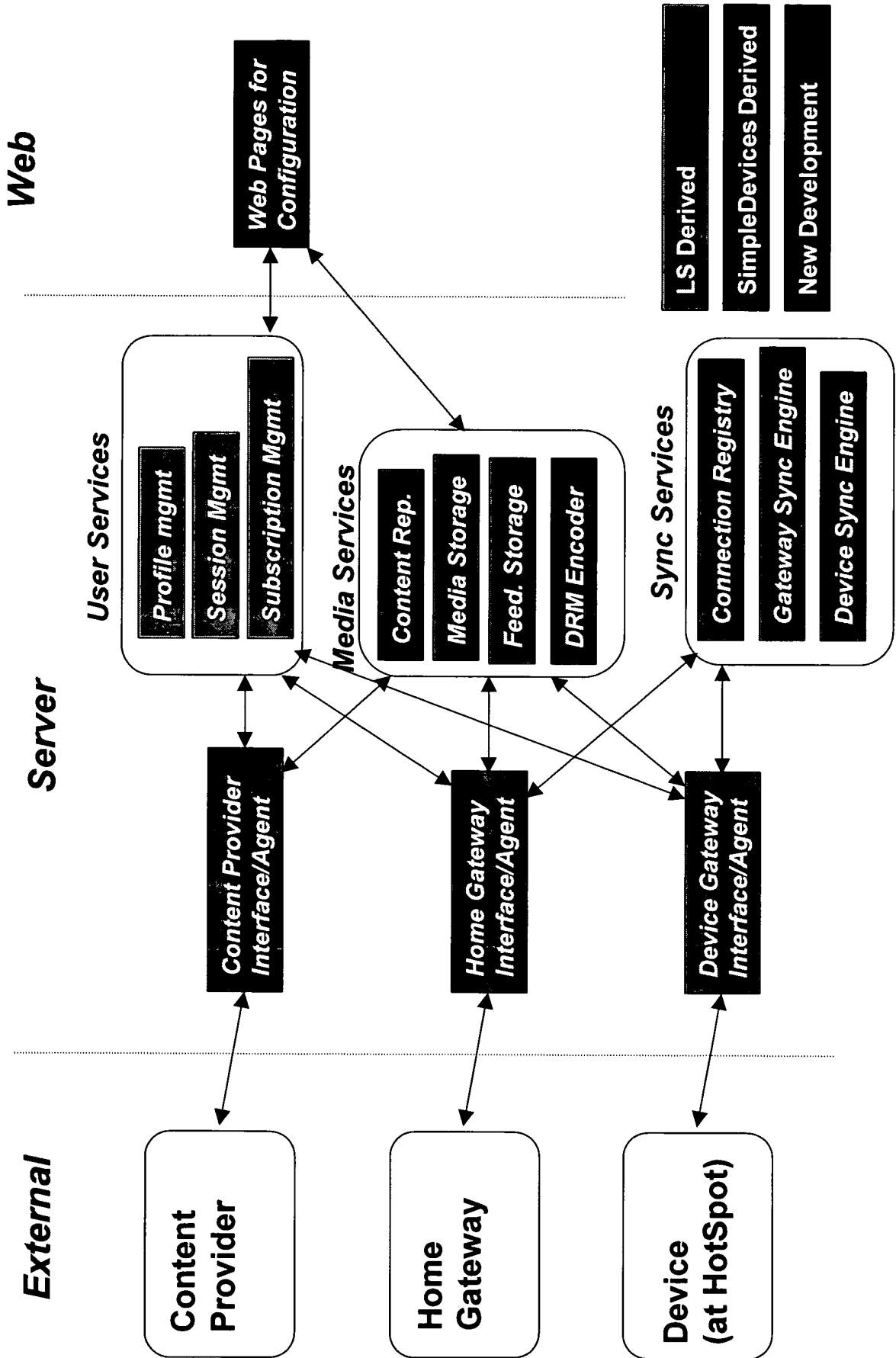

Home Gateway Details

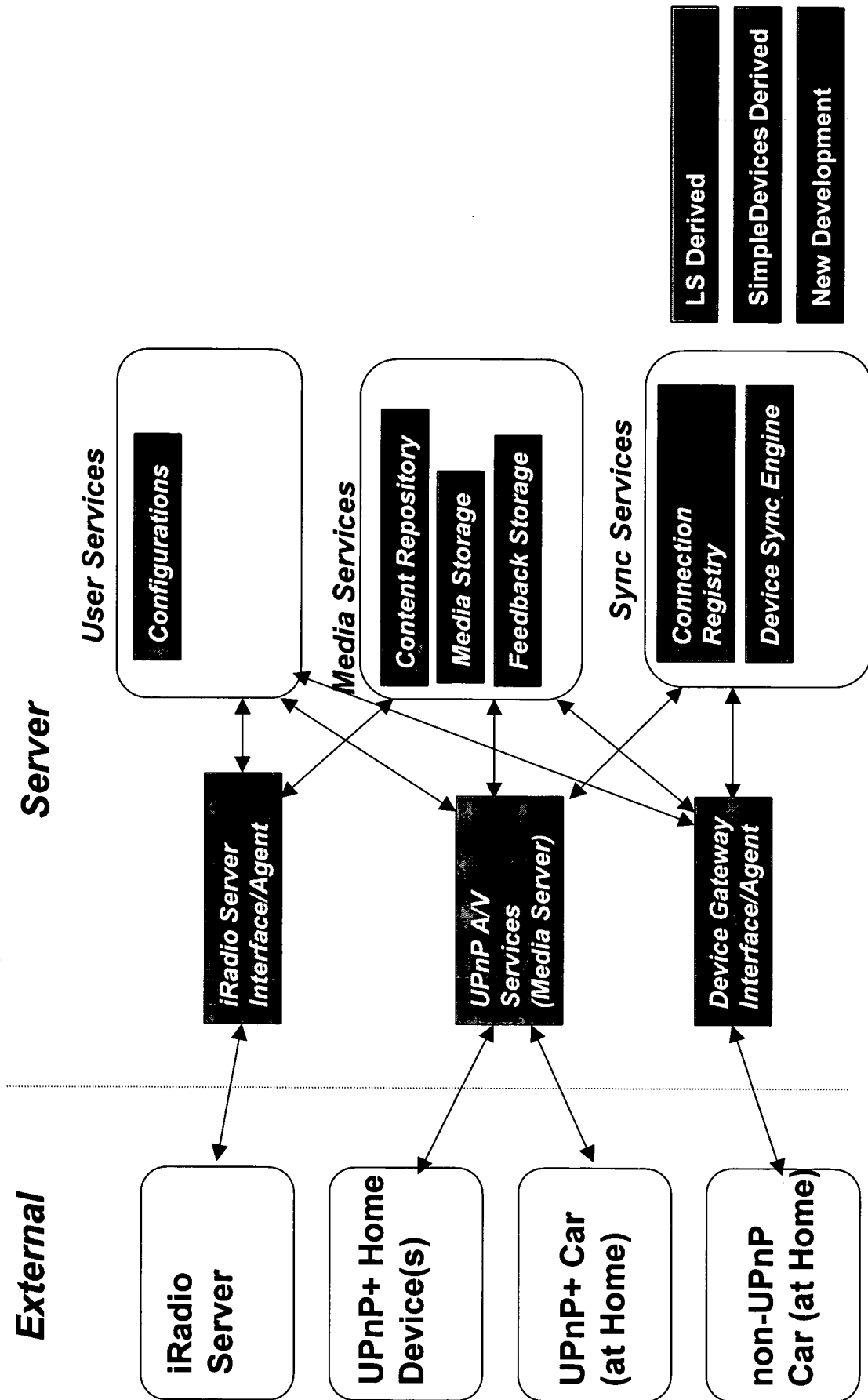

non-UPnP Car Details

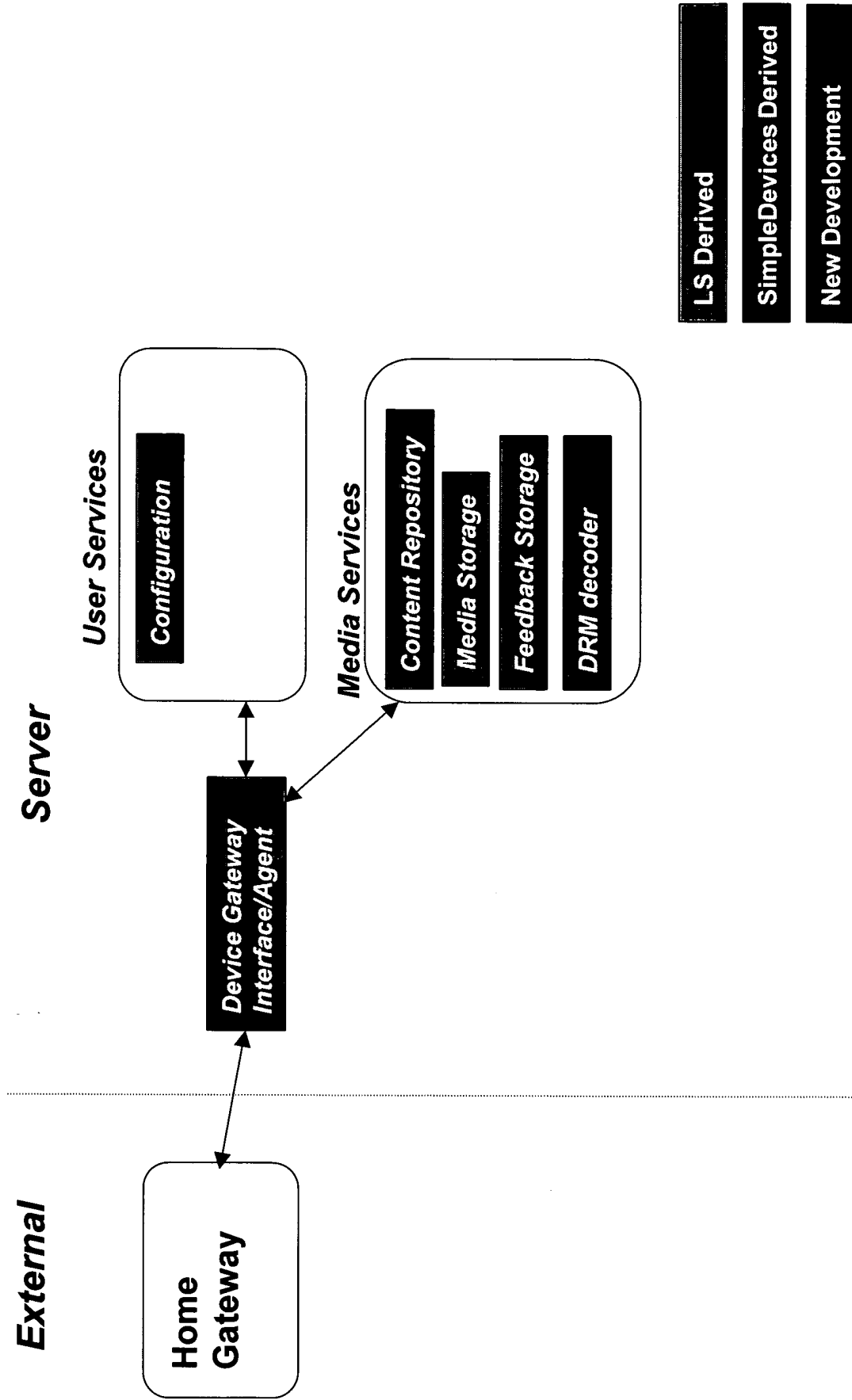

iRadio 2004

This note is a companion to the May 20 "Initial iRadio System" slides.

For 2004, the iRadio system will concentrate on seamless access to of content from home and vehicle. The content consists of genre based audio channels and playlists composed of content the user has previously purchased. The audio content is preemptively recorded on the user's mobile devices so that it is available when needed. The consumption and pause information is promptly communicated to the iRadio server (when possible) so that devices is other domains can continue seamlessly. The user is also able instant buy the currently playing audio.

At home, the audio is streamed from the user's local Home Gateway.

The mobile devices communicate via 802.11 or other high speed wireless protocol. Communications occurs via a wireless access point connected to a home broadband connection or at other public access points away from home. There is no need for the iRadio devices to have cellular access or a broadcast receiver.

This initial set of functionality is targeted to be in place internally by the end of 2004 and available for trials in 1Q05.

Extensions already considered for the future include:

- broader range of content sources including video
- community services would allow content suggestions and playlists to be made between users
- Import existing MP3 or other content

System Operations

These points are half user expectations, half implementation and half requirements. :-)

Service Assumptions

- The user has access to the following audio content:
 - Genre audio channels (similar to CM Radio or Yahoo Launch)
 - Playlists composed of the content the user has purchased
 - Subset of user purchased content which is on the device
- Audio is accompanied by supporting text and images
- Audio is seamless between home and car. (Pause resume across devices in different domains.)
- A service provider will have access to feedback and disposition (listened, skipped, timed-out) concerning the content they supply.
- Instant buy.
- The iRadio system extends from the Content Providers to the point at which the user listens to the content. Digital content itself is never exposed outside this system as individual pieces of content. This gives us more flexibility in the user of DRM/Encryption.
- There are multiple entities in the system, some of which are behind firewalls which constrain communications. If we assume that user content can only be consumed at one point at a time, then state changes to be synchronized across the user's devices are only being introduced at one point

at a time. The picture is much more complex if a user's content is allowed to be consumed concurrently at multiple points.

- It would be very convenient if all the initially supported devices had the same DRM system. (Assuming we are using DRM on individual pieces of content rather than Encrypting the whole content store.)
- Regardless of the encryption method chosen, there needs to be rights management on the pieces of content once they reach the user.
- There are many caches in the system. There is provision for cached content to expire. The Service Provider is notified of this.

Home Experience

- User can play audio on their sound system.
- For rich interfaces (TV screen?), user can link to more information or purchase the audio (single/album).

Car

- The user could view data associated with the playing content.
- The user selects a channel and it starts playing from where it left off when last played in any domain. (Does content licensing allow some limited ability for the user to restart the song if it is starting in the middle? It would need to be limited because it could be abused to repeat a song an arbitrary number of times.)
- For limited interfaces, user could purchase immediately if a plan is set up ahead of time. (Ideally the just purchased track would be immediately available (plucked out of the channel stream) on the device for selection and playing.)
- Ability to search and play owned content on the device. This would have the same pause capability.
- Do we want a limited rewind/replay capability just in case the user misses something the first time. (This would be more for talk radio.)
- For limited interfaces, user can press a button to mark an intent to buy which sends an email. The actual purchase is done later via a browser.
- If the network is available, the user could access extended data associated with the song. (Not sure who we need for this, maybe GraceNote.) I could see concert schedule/tickets, lyrics ... (We need something better than Yahoo for lyrics. They just does a search for lyrics.)

System Implementation

Various early implementation thoughts ...

Content Providers

Content providers (as the name implies) supply all the content we deliver to our customers. The following content will be needed:

- Genre channels (either customized or fixed).
- Ability to purchase any content the user hears on the channels.

These two type of content will probably require different content providers with us being the

middleman. We will need a unambiguous way to identify content regardless of which content provider it came from. Hopefully there is some industry standard which all providers support.

We will always be the initiator of communications with the Content Provider. Every request for content will be for a uniquely identified user. For each piece of content a Content Provider specifies for a user, the disposition of the content will eventually be reported back (skip, rating, timed-out, etc.).

iRadio Server

- All communications with our customers is directly or indirectly through the iRadio Server. (The user never communicates directly with the Content Provider.)
- Synchronization engine for HotSpot connections
- Assuming that UPnP is the basis for synchronization, then the iRadio Server must provide for for tunneling (or other mechanism) to allow UPnP to work between subnets.
- iRadio web site allows for user configuration of the iRadio service
- Supports preemptive caching of content on the Home Gateway.
- Caches channel content for all users
- For more efficient interaction with the content provider, it would be best if the iRadio Server cached individual pieces of content as separate entities. This would vastly reduce the number of times identical content was transferred from the content provider.
- With the iRadio Server caching the actual content, the content provider can specify channel content as a list of content id which refer to the actual content.
- We need a way to map and handle internally content ids from different content providers.
- For trials, a VPN to the Content Provider(s) should be sufficient. For commercial operations we will want to have redundant dedicated and secure connections to the Content Providers.
- The iRadio Server makes the following requests to the Content Provider:
 - user session creation
 - request channel content to be played (returned as ids)
 - request actual content for a specified id

HotSpot

- This is assumed to be a commercial 802.11 access point.
- It is also assumed that firewalls will largely require that connections be initiated by the device rather than the iRadio Server.
- Caching of content at HotSpots is unlikely to be worthwhile until a large number of devices exist. A HotSpot can not predict which user content will be needed ahead of time, so caching would need to be very extensive to be useful.

Home Gateway

- This is an embedded device with no user interface required.
- Top candidates for the Gateway are the MS-1000 or a PC which is always on.
- A reliable broadband connection is assumed to exist between the Home Gateway and the iRadio Server so that they are always in sync.
- Local (at home) synchronization engine for devices within range of the home wireless network.
- Preemptively caches user content so that it is ready to be copied to mobile devices or streamed to home devices.
- We may need to cache multiple copies of the content to support different device DRM or encodings. (Especially in the early stages when we have to make do with existing systems.)

- To avoid Internet latencies, the Home Gateway should be able to function independent of the *i*Radio Server for hours at a time.
- Communications with the *i*Radio Server should be secure.
- The Home Gateway initiates communications with the *i*Radio Server to help avoid firewall issues.

Mobile Devices

- In-vehicle devices are the current focus.
- Play stored content.
- Download content as needed when connected to the Home network or a foreign network which can reach the *i*Radio Server.
- SimpleDevices has a solution for the automated loading of media using UPnP A/V
- We'll probably want to keep tabs on the trade-offs of using UPnP A/V for synchronization versus a specifically developed solution since we may need that other solution when we move to other devices (phones).
- A modified OmniFi is the early leading candidate for the actual mobile device. (SimpleDevices did the original software for it.)
- If the OmniFi (or other existing device) were used, extensions would be required for consumption feedback including pause information.
- The mobile device will have to initiate the connection to the *i*Radio Server on foreign networks to help avoid firewall issues.
- Instant buy copies content to owned area on the device for immediate replay and actual purchase transaction completes when the device next contacts the *i*Radio Server.
- The Mobile Device doesn't need cellular access.
- All network communications should be secure.

Home Device

- UPnP A/V (with extensions) will be used for all in-home audio
- UPnP A/V extensions are required for consumption feedback including pause information.
- No device has been chosen yet.

Web Browser

- Any web browser.
- Required Plug-ins would depend on the interface implementation.
- This effort would be more complex if the user can listen to content as part of a browser session.

Disruptive Business and Technical Issues

Huge Library Subscription Model

Some music services avoid the whole ownership issue and offer a subscription which gives you access to huge amounts of audio so long as your subscription is current. This would place a different emphasis on the type of applications we provide to the user but overall should not require significant changes.

Huge amounts of mobile storage

This would make our job easier. Although it may be harder to demonstrate the value of our system.

Initial *i*Radio System

Mark Clayton

May 20, 2004

Minimal iRadio Functionality

- Channels (like launch.yahoo.com or XM Radio)
- Seamless media consumption between home & car
- Pause/resume works between home & car
- Everything is subject to change depending on business deals

User Interface – Mobile

- Ability to listen to any of the channels configured for that device
- Possible ability to provide feedback for the currently playing content (skip, rating ...)
- Instant purchase and repeat of content
- Future –ability to mark a piece of content for further attention/purchase later (via email?)

User Interface – Home

- Primarily determined by UPnP A/V controller/renderer
- Ability to select and stream any channels configured for home (probably at higher quality than mobile devices)
- Actual capabilities determined by selected device(s)
- Allow search and playing of purchased content

User Interface – Browser

- Allows a user to manage their preferences (channels available) for each device
- Updated preferences are stored on the iRadio Server and Home Gateway
- U/I details TDB
- Ability to consume content from Browser –TBD
- Future – ability to review marked content (including purchase)

System Overview Picture

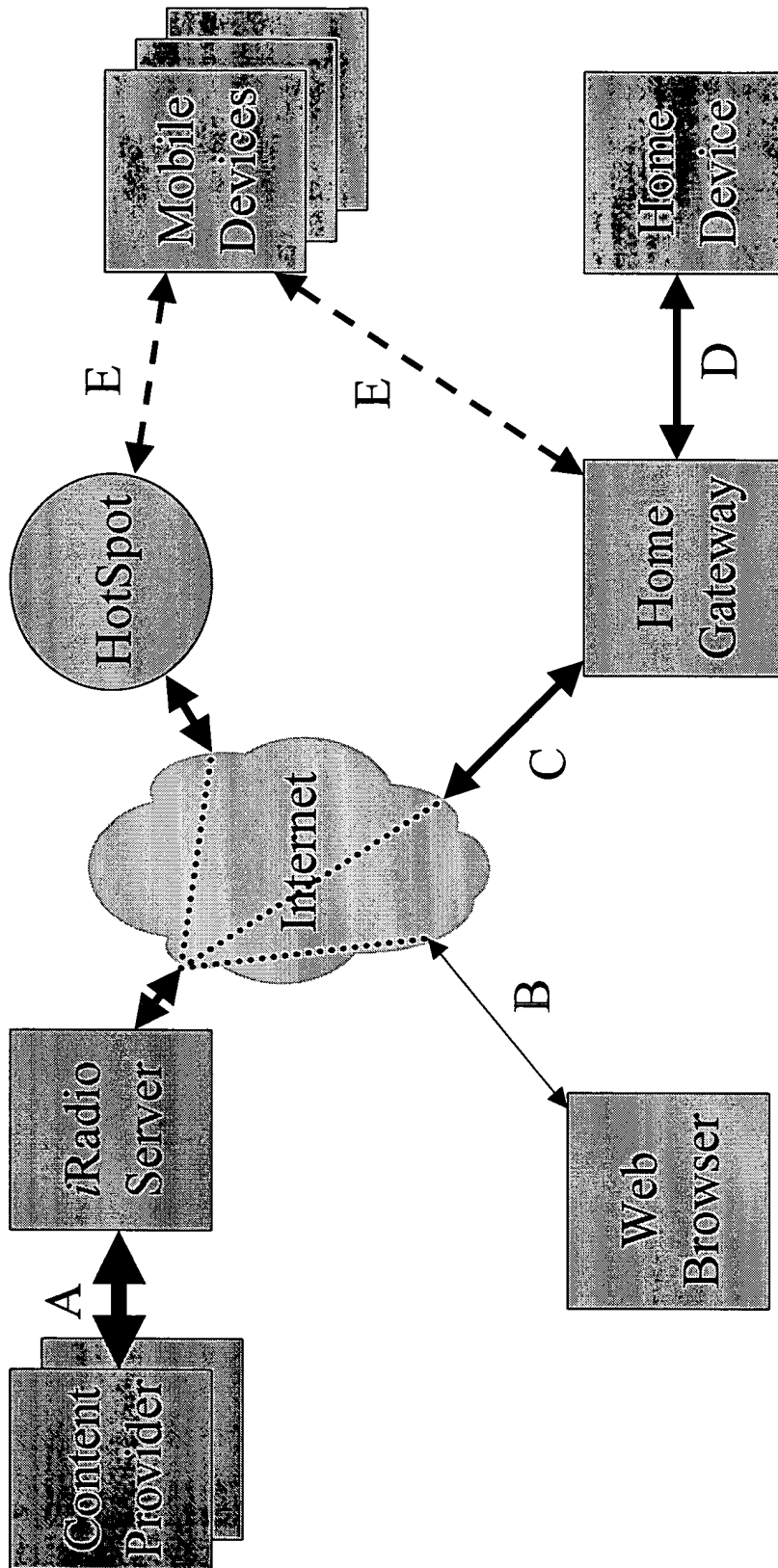

System Components

Content Providers – Supplier of audio content

iRadio Server – Our aggregation point and remote sync engine

HotSpot – Any public Internet hot spot

Home Gateway – Local content cache and local sync engine

Home Device – Home streaming player

Mobile Device – Mobile storage player with sync capability

Content Providers

- Supplies all content
- Organizes content into channels
- Provides metadata associated with content
- Receives user consumption feedback
- Maintains royalty agreements with
copyright owners

iRadio Server

- Single point of contact with the Content Provider
- *iRadio* content aggregation point
- Central synchronization master
- Synchronization engine for public hot spots
- *iRadio* configuration web site
- Cache of user channel content

HotSpot

- Any public hot spot – nothing special
- Acts as a pipe back to the iRadio Server
- Allows synchronization of device content away from home

Home Gateway

- Local preemptive caching of user channels so that Internet latency is eliminated
- Local synchronization engine
- Always in sync with iRadio Server
- Streaming server for home consumption of content (via UPnP)
- Could be MA-1000 or PC (always on)

Mobile Devices

- Vehicle or personal devices
- Play stored content anytime, anywhere
- Synchronize consumption and feedback information when connected to a network
- Load new content as needed when connected to a network

Home Device

- Streams information from the Home Gateway
- Fundamentally different from Mobile Devices because it doesn't store content.
- Streaming via UPnP with extensions.

Web Browser

- Allows user to configure their preferences on the *iRadio Server*
- Likely via the user's home PC

Component Connections

- A** – Preemptive fetching of user channel content and consumption feedback
- B** – Interactive configuration of preferences
- C** – Preemptive fetching of user channel content and consuming feedback
- D** – UPnP+ streaming of channel content
- E** – Synchronization of new content and consumption feedback

Connection A

Content Provider – *i*Radio Server

- *i*Radio Server requests x minutes of user y channel z content
- Content Provider responds with a list of content items and associated metadata
- *i*Radio Server provides consumption feedback to the Content Provider on a per user/channel/item basis
- High capacity connection
- Should consider having the *i*Radio Server cache content items to avoid redundant transfers

Connection B

iRadio Server – Web Browser

- User channel and device preference information is managed via a Browser
- Handled via standard HTTP/HTML/JavaScript as required for the desired user experience
- Typical web browsing connection capacity

Connection C

*i*Radio Server – Home Gateway

- Synchronization:
 - *i*Radio Server sends new channel pause/consumption information (due to hot spot sync)
 - Home Gateway sends new channel pause/consumption information (due to local sync or streaming)
 - *i*Radio Server sends new channel content and associated metadata to the Home Gateway
- Relatively high capacity connection preferred to facilitate content loading

Connection D

Home Gateway – Home Device

- UPnP A/V protocol with extensions for pause, consumption and device management
- Moderate capacity connection for content streaming – probably wireless

Connection E

Home Gateway/iRadio Server – Mobile Devices

- **Synchronization:**
 - Sync Engine sends new channel pause/consumption information (due to update from iRadio Server)
 - Mobile Device sends new channel pause/consumption information (due to pause or consumption)
 - Sync Engine sends new channel content and associated metadata to the Mobile Device
- **Relatively high capacity connection preferred to facilitate content loading – wireless assumed**
- **No upload of content from Mobile Devices**

Beyond the Initial System

- No significant communication paths change
- Complexity and breadth of transferred information will increase
- Integration of purchased/pre-owned content will prompt more sophisticated interfaces
- Integration of commercial video shouldn't introduce significant changes

Updating Approach

Created: Sept 16, 2004

Introduction

The iRadio allows the customer to personalize the content they want and then consume it seamlessly as they pass through their various domains (home, car and personal). As they listen to their audio content at various times of the day, they continue listening from the same point they previously stopped, so they miss nothing. Fresh up-to-date content is automatically loaded onto the phone when the phone is part of the home network.

Updating is the key behind iRadio's seamless experience across domains. It works in the background allowing all the user's iRadio audio channels to be kept up-to-date.

Updating has two aspects:

Content loading

This is the loading of the audio content. Even with lossy compression, this is over 14 Megabytes per hour of content (assuming 32 Kbps). Loading this amount of data requires a relatively high bandwidth connection (USB, WiFi, or better) to get the job done quickly. With Bluetooth connections peaking at 700 Kbps, it will take several minutes to load each hour of audio content when BT is used.

For economic reasons, the data connection for content loading (especially the bulk content) must be free or covered by a flat rate rather than a per Megabyte rate.

Light weight updating

This is the playpoint and assorted usage tracking information which is collected by the client and sent to the Home Gateway and other Mobile Clients.

Terms

Client

For the purposes of this note, the word client will refer to any client of the updating system which includes the iRadio Server, Home Gateway and any Mobile clients.

Bridging

This is when one Mobile Client updates another so that the other may never actually connect directly with the Home Gateway.

Bulk Content

The actual audio content which is the bulk of the content which needs to be moved. This is distinct from all the other information which is updated.

Synchronization

This word is used interchangeably with "updating". It refers to the exchange of specific information between updating clients. Some aspects of this exchange meet the normal definition

of synchronization while others do not.

Scope

The updating system is used to keep the *iRadio* Server, Home Gateway and Mobile Clients in close synchronization. It does not interact with the Content Provider even though some of the updated information will eventually be sent there.

Assumptions

- Communications may end prematurely. but any data received on an updating communications channel is assumed to be correct.
- The communications channel is assumed to be secure. Otherwise security will have to be introduced as an updating requirement.
- Although the system will probably support multiple users in the future, we are largely assuming a single user per device for this note.
- *iRadio*/Home Gateway bandwidth issues are not addressed as part of this note.
- User preference information will reuse the audio updating system to be updated on clients.
- USB will only be used for download of Bulk content and possibly playlists.
- Wireless updating will make leverage bulk content already on the client rather than downloading it again. This will allow USB downloaded to be "found" and used without any special coordination.

Goals

1. Bulk content can be loaded over USB or network updating
2. Consumption and usage data is sent from clients
3. Updating works with HTTP port 80 (to traverse firewalls)
4. Updating works with a single two-way serial channel
5. Updating works with multiple two-way serial channels
6. Tolerates sudden disconnects
7. Mobile Clients discover connections which cover matching user(s)
8. Clients can act as update bridges
9. *iRadio* Server or Home Gateway can be the master copy depending on the data
10. No use intervention to resolve updating issues
11. Support multiple Mobile Clients per person
12. Playpoints are updated between clients
13. Content is updated between clients
14. Updating approach is platform agnostic

Data

For a typical Mobile Client, the following data is sent:

Content Status Changes

Any change in the playing/paused/consumed state of an audio track is captured on the client and updated to other devices. This usage information information is needed on the *iRadio* Server for reporting user content consumption to the content provider.

Rating

Relative changes to the rating of a piece of content are captured on the client and updated to other devices. If this is implemented at all in Phase 1, this information could be used by the Home Gateway for a user's personal content and by the *iRadio* Server for Content Provider. It could also be used by other clients to update the rating information for the content they hold.

Purchase Request

Purchase requests are captured on the client and updated to other devices. This is of critical interest to the *iRadio* Server. Other update clients could use this information to update metadata on the content or move the content into the owned category.

Key Press

Each UI actuation is captured here whether or not any action resulted. This usage tracking information is intended for later analysis on the *iRadio* Server.

Other Events

This contains other events of interest to the updating clients.

A typical Mobile Client receives:

***iRadio* Channel Additions**

If an *iRadio* Channel has been partly consumed, updating can add additional items to the channel. This includes adding items to the channel description.

Content updates

This is the bulk content associated with the *iRadio* channel additions which contains the actual audio content.

Above are the typical cases for a Mobile Client in a system with only a single Mobile Client. The *iRadio* Server and Home Gateway tend to reverse the flow of content. For systems with more than one Mobile Client, each type of updating information will flow in both directions.

Approach

Updating occurs in the following phases:

0. Discovery or establish session

Initial connection to setup communication.

1. Playpoint updating for all *iRadio* Channels

Playpoint information is exchanged and each client uses the most recent playpoint information.

2. Light weight content updating

Usage tracking and other event data is exchanged. Also exchanged is acknowledgement information.

3. iRadio Channel updating

If channel content has been consumed, this phase allows new content to be added to an iRadio Channel.

Most of these phases have their own sub-phases.

Discovery or Establish Session

Mobile Clients which are intermittently connected use discovery to learn when other updating clients for the same user are in the vicinity. Bluetooth and WiFi both have mechanisms (or at least the primitives) which allow other devices in the vicinity to be discovered. Once an updating client has been discovered, a conversation can occur which includes a challenge/response to determine whether they have any users in common. With matching users, the updating process proceeds.

Connections to the iRadio server are a little different. They don't involve discovery or use a conversational approach. HTTP (or HTTPS) is used used for communication to ensure that firewalls can be traversed. The first exchange establishes a session id which is used for the remainder of the communications. Initially, the only iRadio Server communications which occurs is with the Home Gateway. In the future, cellular and hotspot communication could allow Mobile Clients to also connect to the iRadio Server. These direct Mobile Client connections to the iRadio Server also use HTTP/HTTPS.

Playpoint Updating for All iRadio Channels

Playpoint information includes channel description, channel item, and the actual playpoint time index. For each channel, this information is exchanged and the following process is followed:

```

if my channel_description_id and other channel_description_id match
  if my channel_item is not as advanced other channel_item
    if my cached content for the channel includes other channel_item
      adopt the other playpoint and channel item as current
      mark the intervening content as consumed
    else
      do nothing, there is no overlap (reload in phase 3)
  else if my channel_item is the same as other channel_item
    if my playpoint is not as advanced as the other channel_playpoint
      adopt the other playpoint
    else
      do nothing
  else
    do nothing
else
  do nothing

```

Light Weight Content Updating

In the simplest Mobile Client case, the Home Gateway would indicate indicate what content it needed from the Mobile client and what content had already reached the iRadio Server. With this information

the Mobile Client can erase the information which the iRadio Server already has and would start supplying the information requested by the Home Gateway. This is the degenerate case of the more complex system which is needed for multiple Mobile Clients. The more complex system involves client information being shared between all Mobile Clients assuming this maximizes the chances of information reaching its destination.

Each information record has a record number which is constantly increasing. Each updating client has their own independent sequence of record numbers. (A 32 bit integer is more than adequate to hold the sequence number.)

At the start of light weight updating, the clients exchange the request information and confirmed receipt information which are all expressed in terms of record sequence numbers. This information is used to determine what gets transferred. The request information is the starting sequence number for each client the other client would like to receive. Data for multiple clients is requested and transferred to account for bridging situations.

The confirmed receipt information is a matrix which shows for each client information updating stream, what the last confirmed sequence number is for each other client. This information is used to update the current client's matrix. Information which has been updated to all clients (or the iRadio Server in the case of some information) can be erased from the local client..

Information records are sent oldest first so that there are no sequence number gaps.

iRadio Channel Updating

In this last phase the iRadio Channel information between the two clients is compared and the client and the content updating priorities are established.

The channel description ids are compared between the two clients. When descriptions ids don't match, the more recent description is used to update the channel information of the other client. When description ids match, an assessment is made of what content can be transferred. The channels requiring the most content to be transferred are updated first on the assumption they are the more heavily listened to.

The bulk content is updated before the iRadio Channel playlists are updated. This bulk/playlist updating order is a natural fit for USB updating of the bulk content.

Issues

USB operation is still sketchy

USB operation still needs more work. For instance, the USB host will need to erase content and load new content. The USB host will need to understand the content naming and placement scheme.

Locked Playlists still sketchy

For content provider music, we are required to make it accessible just as it would be in a stream. Having the content exposed, on removable memory cards makes this difficult. An enforcement mechanism hasn't been identified.

Network Bandwidth is an issue

This note outlines a common updating system which could use multiple transports to address all iRadio updating situations including iRadio Server to Home Gateway updating. Although this is still technically viable and probably handy for early development, business issues will probably push use to adopt some type of secure peer-to-peer approach to address bulk content loading.

Revisions

Date	Author	Description
Sept 29, 2004	Mark Clayton	Initial draft for limited distribution (including Motorola Labs)
Oct 6, 2004	Mark Clayton	Minor updates

iRadio WACA (Wireless Audio Car Adapter) Use Cases

Revision Number	Date of revision	Author	Comments
0.1	12/2/2004	Mark Clayton	Initial draft

Table of Contents

INTRODUCTION	4
IHOLLYWOOD SHOW	4
CES DEMO	4
TRIAL	5
USE CASES	5
COLD START TO AUDIO STREAMING.....	5
SWITCHING IRADIO CHANNELS FROM CAR RADIO.....	5
SWITCHING IRADIO CHANNELS FROM STREAMER.....	6
PLAYING NEXT TRACK IN IRADIO CHANNEL.....	7
PAUSE AND RESUME OF STREAMING CONTENT.....	7
PURCHASE CURRENT CONTENT	8
NOT DISCOVERABLE BY OTHER BLUETOOTH DEVICES	8

Introduction

Use cases describe the functionality which is required at a particular point in time. The iRadio project has the following timing requirements:

Dec 8, 2004	iHollywood show
Jan 6, 2005	CES Demo
Apr 4, 2005	Trial start
Sep 30, 2005	Product launch

This note covers the first two items in the list with a testing focus rather than software development.

iHollywood Show

Hollywood has the following high-level WACA requirements:

- fits in the Hummer
- supports Pioneer car radio
- supports BT receipt and display of metadata
- supports BT streaming of MP3 audio (at least 96 Kbps)
- supports BT switching of MP3 audio streams

The following WACA use cases exist for this show:

- Cold start to audio streaming
- Switching iRadio channels from streamer
- Playing next track in iRadio channel
- Pause and resume of streaming content
- Not discoverable by other Bluetooth devices

CES Demo

The CES functionality is based on the 0.4 Demo Script for CES.

The CES demo has the following high-level WACA requirements:

- fits in the CES kiosk
- supports Pioneer car radio
- supports BT transmission of car radio presets
- supports BT transmission of pause, resume, and purchase
- supports BT receipt and display of metadata
- supports BT streaming of MP3 audio (at least 96 Kbps)
- supports BT switching of MP3 audio streams
- supports BT echo of metadata back to streamer

The following WACA use cases must be supported for the demo:

- Cold start to audio streaming
- Switching iRadio channels from car radio
- Switching iRadio channels from streamer
- Playing next track in iRadio channel
- Pause and resume of streaming content
- Purchase current content
- Not discoverable by other Bluetooth devices

Trial

The Trial will add use cases associated with installation and tighter metadata presentation.

Use Cases

All use cases are from the perspective of the WACA as the system.

Cold start to audio streaming

This use case describes the process of the streaming device and WACA coming together and content being played.

Actors: Streamer (E680), Car radio

Pre-Conditions:

- Bluetooth binding/association has already occurred
- Streamer already has content
- WACA is already connected to the car radio
- Car radio is already powered and in iRadio mode

Flow of Events:

1. WACA uses iMCP to connect to streamer
2. Streamer sends initial car radio text over iMCP
3. Car radio displays initial text on car radio
4. Streamer sends metadata for song
5. Metadata is displayed on car radio display
6. Streamer sends MP3 audio data as a stream
7. iRadio channel audio is playing from car radio

Post-Conditions:

- Audio content is playing from car radio
- Associated metadata is displayed on car radio

Switching iRadio channels from car radio

This use case describes the process of changing from one iRadio channel to another via the preset buttons on the car radio. This same series of steps occurs then a track is skipped within a channel.

Actors: Streamer (E680), Car radio

Pre-Conditions:

- Bluetooth binding/association has already occurred
- Streamer already has content and is streaming an iRadio channel
- WACA is powered and already connected to the car radio which is in iRadio mode

Flow of Events:

1. Car radio sends preset press notification to WACA
2. WACA notifies streamer via iMCP connection of button press
3. Streamer commands WACA to stop and flush current content
4. Streamer sends metadata for song on new channel
5. Metadata is displayed on car radio display
6. Streamer sends MP3 audio data as a stream
7. iRadio channel audio is playing from car radio

Post-Conditions:

- Audio content for new channel is playing from car radio
- Associated metadata is displayed on car radio

Switching iRadio channels from streamer

This use case describes the process of changing from one iRadio channel to another without using the car radio interface. This same series of steps occurs then a track is skipped within a channel without using the car radio interface. Since the car radio interface isn't used to initiate the change in audio flow, presumably some user interface associated directly with the streamer is used.

Actors: Streamer (E680), Car radio

Pre-Conditions:

- Bluetooth binding/association has already occurred
- Streamer already has content and is streaming an iRadio channel
- WACA is powered and already connected to the car radio which is in iRadio mode

Flow of Events:

1. Streamer commands WACA to stop and flush current content
2. Streamer sends metadata for song on new channel
3. Metadata is displayed on car radio display
4. Streamer sends MP3 audio data as a stream
5. iRadio channel audio is playing from car radio

Post-Conditions:

- Audio content for new channel is playing from car radio
- Associated metadata is displayed on car radio

Playing next track in iRadio channel

This use case describes the process associated with one track naturally ending and a new one starting.

Actors: Streamer (E680), Car radio

Pre-Conditions:

- Bluetooth binding/association has already occurred
- Streamer already has content and is streaming an iRadio channel
- WACA is powered and already connected to the car radio which is in iRadio mode

Flow of Events:

1. Streamer streams last bit of previous track to WACA
2. Streamer sends metadata for song on new channel
3. Last bit of previous track plays on car radio
4. Metadata is displayed on car radio display
5. Streamer sends MP3 audio data as a stream
6. iRadio channel audio is playing from car radio

Post-Conditions:

- Audio content for new channel is playing from car radio
- Associated metadata is displayed on car radio

Pause and resume of streaming content

This use case describes the process associated with pausing the current track and resuming it a short time later. This use case assumes that the pause and resume were initiated from the streamer interface rather than the car radio interface. The only difference is the button information received by the WACA from the car radio and the additional iMCP button notifications.

Actors: Streamer (E680), Car radio

Pre-Conditions:

- Bluetooth binding/association has already occurred
- Streamer already has content and is streaming an iRadio channel
- WACA is powered and already connected to the car radio which is in iRadio mode

Flow of Events:

1. Streamer sends a pause command to WACA via iMCP
2. WACA stops sending audio information to the car radio
3. Time passes with the car radio being silent
4. Streamer sends resume command to the WACA via iMCP
5. WACA resumes sending audio information to the car radio

Post-Conditions:

- Audio content is playing from car radio
- Associated metadata is displayed on car radio

Purchase current content

This use case describes the process associated with purchasing the current audio track.

Actors: Streamer (E680), Car radio

Pre-Conditions:

- Bluetooth binding/association has already occurred
- Streamer already has content and is streaming an iRadio channel
- WACA is powered and already connected to the car radio which is in iRadio mode

Flow of Events:

1. Car radio sends button press notification to WACA which corresponds to purchase
2. WACA notifies streamer via iMCP connection of button press
3. Streamer sends a "Purchased" text display command to WACA via iMCP with a TBD (5?) second timeout
4. car radio displays the "Purchased" text for TBD (5?) seconds

Post-Conditions:

- Audio content is playing from car radio
- Associated metadata is displayed on car radio

Issues:

- What type of feedback does the user get if the track can not be purchased or is already owned?

Not discoverable by other Bluetooth devices

This use case describes the process associated with ignoring other Bluetooth devices in the vicinity, including other streamers which the WACA doesn't already have a relationship with.

Actors: Streamer (E680), Car radio, a 3rd Bluetooth device

Pre-Conditions:

- Bluetooth binding/association has already occurred with associated streamer
- WACA is powered and already connected to the carradio which is in iRadio mode
- A second Bluetooth device (not associated with the WACA) is present

Flow of Events:

1. A Bluetooth SDP scan by a device (with is not the associated streamer)
2. WACA does not respond and WACA doesn't show up in the list of close Bluetooth devices

Post-Conditions:

- No change to WACA
- WACA is not in list of discovered devices



Disclosure BCS03802 (29148)

ID: BCS03802 (29148)
Title: Wireless audio adapter for car radios
Innovators: [Mark Clayton](#), [Mike Gaumont](#), [Dave Ulmer](#), [Jmv Villevieille](#)
Status: [REDACTED]
Submitted Date: [REDACTED]
Review Date: [REDACTED]
Originating Sector: [IESS](#)
Owning Sector: [BCS](#)
Patent Committee: [BCS - iRadio](#)
Business Unit: [IESS-Other](#)
Organization: IESS, iRADIO, OTHER
Department: JD128
Location: AZ43
Submit Country: USA
Previous Docket Number(s): IS01963TC

Workflow

Role	Name	Action
First Innovator	Mark Clayton	Verification Complete 10/7/2004
Co-Innovator	Mike Gaumont	Verification Complete 10/11/2004
Co-Innovator	Dave Ulmer	Verification Complete 10/7/2004
Co-Innovator	Jmv Villevieille	Verification Complete 10/25/2004
Witness	Blake Bullock	Acknowledgement Complete 10/27/2004, Notebook Not Signed
Witness	Tom Miller	Acknowledgement Complete 10/25/2004, Notebook Not Signed
Manager	Michael Bordelon	Acknowledgement Complete 12/6/2004
Technical Reviewer	Bob D'Avello	Review Complete 2/2/2005

Reviewer Information

Role	Name	Action
Technical Reviewer	Bob D'Avello	

Documents

Document Name	Description	Document Type	Uploaded By	Uploaded Date	Size
device_disclosure.ppt	Device connection diagram	Disclosure Details	Mark Clayton	6 Oct 2004	19 Kb

Questions

Name of Innovation or Engineering Development?

Wireless audio adapter for car radios

What is the problem(s) to be resolved by or need(s) for your idea?

Portable music players which are used in a car or other vehicle don't have any convenient way to integrate with the average person's car audio system and controls.

What patents or publications describe your idea and why don't they resolve the problem(s) or fulfill the need(s)?

There is at least one specific case there Apple's iPod player can use the audio system and controls in a BMW via a special cable, but this isn't wireless and hardly addresses the average car owner. Other solutions like FM rebroadcast of content don't leverage the in-car audio controls and have degraded audio quality.

What is the idea you are disclosing? Please provide a written description summarizing the idea. Please define all acronyms and other terms of art used.

This patent is for a device which allows a suitably enabled portable audio player to wirelessly integrate with the audio system in the vehicle via the existing car radio. The device would plug into the CD changer or AUX connection on the back of the radio. This gives the device access to the car audio system and controls. The device then uses Bluetooth, 802.11 or another proximity network to interact with the portable player. The player would send audio to the device (possibly encoded) which would be sent to the car audio system after conversion if required. The device would send any audio control requests from the in-car audio controls to the personal audio device so that the audio can be controlled by the in-car controls. Status and radio identification information would also be sent to the portable music player. For car radios which have the ability to display text, this adapter device would allow this text to be displayed if the portable audio device supplied information about the audio content. The in-car device would support a discovery protocol which would allow the portable audio device to dynamically discover this adapter device.

For a Bluetooth transport, there are standard stereo audio profiles which can be leveraged.

This would allow the adapter to work with a large variety of portable devices even if the device didn't implement the control and status communications.

Because of the wireless interface to existing car radios and the ability to use the regular in-car media controls, this is more than just another headset or car kit.

How does this idea resolve the problem(s) or fulfill the need(s) in a new way?

It allows audio from a portable audio device to be played and controlled in the car in a natural and intuitive way for the majority of cars being sold today.

How or where will this idea be used (e.g. what process or product will it be applied to)?

This will be used as part of the iRadio project to stream audio from a hand-held audio player (E680) within the car.

Please enter one or more key words that may be used to identify your disclosure.

iRadio audio car streaming control

Do you plan to disclose your idea outside of Motorola (e.g. conference, publication, customer meeting, product offering, etc.)?

[REDACTED]

Is your idea known or has it been disclosed outside of Motorola without a duty of confidence (e.g., non-disclosure agreement, joint development agreement, etc.)?

NO

Has a product incorporating your idea been sold, offered for sale, placed in production, qualification, sampled, described in any publication (including Motorola promotional literature), marketed, shipped to anyone outside of Motorola (customer or distributor), or placed into inventory?

NO

What is the earliest verifiable date that you communicated your idea to an individual that is NOT an innovator (e.g., the date a non-innovator witness signed your engineering notebook)?

Was your idea created or developed through work performed with a consortium, alliance, government contract, university, or joint venture?
NO

Please specify the Export Control Classification Number(s) (ECCN) to which this disclosure pertains
Unknown

Standards

None Selected

Key Technologies

IESS - Wireless communications (Primary)
IESS - User interfaces

Innovators

Richard M Clayton (Mark)

The address and personal information for this innovator should be treated as confidential.

Commerce ID:	10002604	Core ID:	AMC036
Phone:	602/659-8110	Fax:	
Email:	Mark.Clayton@motorola.com	Location:	AZ43
Department:	JD128	Manager:	Jmv Villevieille
Mail Drop:	TCG2	Business Unit:	IESS-Other
Sector:	IESS		
SSN:	054805444	Citizenship:	Canada
Residential Address:	13418 S 41ST ST PHOENIX, AZ 85044 USA	Mailing Address:	13418 S 41ST ST PHOENIX, AZ 85044 USA

Michael T Gaumond (Mike)

The address and personal information for this innovator should be treated as confidential.

Commerce ID:	10115459	Core ID:	MGAUMOND
Phone:	602-659-8053	Fax:	602-659-8176
Email:	Mike.Gaumond@motorola.com	Location:	AZ43
Department:	OR918	Manager:	Michael Bordelon
Mail Drop:	2 NC	Business Unit:	PCS-CXPS/Other
Sector:	PCS		
SSN:	389743609	Citizenship:	USA
Residential Address:	10943 East Greenway Scottsdale, AZ 85255 USA	Mailing Address:	10943 East Greenway Scottsdale, AZ 85255 USA

David E Ulmer (Dave)

The address and personal information for this innovator should be treated as confidential.

Commerce ID:	12050680	Core ID:	E42721
Phone:	602/659-8161	Fax:	
Email:	david.ulmer@motorola.com	Location:	AZ43
Department:	JD128	Manager:	Mike Gaumond
Mail Drop:	TCG2	Business Unit:	IESS-Other
Sector:	IESS		
SSN:	568236001	Citizenship:	USA

Residential Address:	4647 E. Francisco Dr #123 Phoenix, AZ 85044 USA	Mailing Address:	4647 E. Francisco Dr #123 Phoenix, AZ 85044 USA
-----------------------------	--	-------------------------	--

Jean Marc A Villeveille (Jmv)

The address and personal information for this innovator should be treated as confidential.

Commerce ID:	10023319	Core ID:	P26721
Phone:	602/659-8177	Fax:	
Email:	jmv@motorola.com	Location:	AZ43
Department:	JD128	Manager:	<u>Mike Gaumont</u>
Mail Drop:	TCG2	Business Unit:	IESS-Other
Sector:	IESS		
SSN:	316988916	Citizenship:	France
Residential Address:	2615 East Amberwood Phoenix, AZ 85048 USA	Mailing Address:	2615 East Amberwood Phoenix, AZ 85048 USA

ver 2

Attorney-Client Privileged Upon Completion

Send any comments to: [eIntelligence Contacts](#)
Last Updated: 8 July 2004

[Privacy Practices](#)

© Copyright 2000-2004 Motorola, Inc. All Rights Reserved.
Motorola Confidential Proprietary

**This Page is Inserted by IFW Indexing and Scanning
Operations and is not part of the Official Record**

BEST AVAILABLE IMAGES

Defective images within this document are accurate representations of the original documents submitted by the applicant.

Defects in the images include but are not limited to the items checked:

- BLACK BORDERS
- IMAGE CUT OFF AT TOP, BOTTOM OR SIDES
- FADED TEXT OR DRAWING
- BLURRED OR ILLEGIBLE TEXT OR DRAWING
- SKEWED/SLANTED IMAGES
- COLOR OR BLACK AND WHITE PHOTOGRAPHS
- GRAY SCALE DOCUMENTS
- LINES OR MARKS ON ORIGINAL DOCUMENT
- REFERENCE(S) OR EXHIBIT(S) SUBMITTED ARE POOR QUALITY
- OTHER: _____

IMAGES ARE BEST AVAILABLE COPY.

As rescanning these documents will not correct the image problems checked, please do not report these problems to the IFW Image Problem Mailbox.

PATENT APPLICATION SERIAL NO. _____

U.S. DEPARTMENT OF COMMERCE
PATENT AND TRADEMARK OFFICE
FEE RECORD SHEET

02/16/2005 EABUBAK1 00000030 502117 60651963

01 FC:1005 200.00 DA

PTO-1556
(5/87)

*U.S. Government Printing Office: 2002 — 489-267/60033

PATENT APPLICATION SERIAL NO. _____

U.S. DEPARTMENT OF COMMERCE
PATENT AND TRADEMARK OFFICE
FEE RECORD SHEET

03/18/2005 AGDITOM 00000004 502117 60651963

01 FC:1085 3000.00 DA

02/16/2005 EABUBAK1 00000030 502117 60651963

01 FC:1005 200.00 DA

PTO-1556
(5/87)

*U.S. Government Printing Office: 2002 — 489-267/80033

BEST AVAILABLE COPY