

Source: [Command Searching](#) > [News, All \(English, Full Text\)](#) Terms: [6233389](#) or [6,233,389](#) ([Edit Search](#) | [Suggest Terms for My Search](#)) Select for FOCUS™ or Delivery

*United States: Federal Circuit Clarifies the Scope of the Privilege Waiver When Relying on Opinion of Counsel Mondaq Business Briefing May 22, 2006*

Copyright 2006 Mondaq Ltd.  
All Rights Reserved  
Mondaq Business Briefing

May 22, 2006

**LENGTH:** 973 words

**HEADLINE:** United States: Federal Circuit Clarifies the Scope of the Privilege Waiver When Relying on Opinion of Counsel

**BYLINE:** By Blair Jacobs and Katherine R. Lahnstein

**BODY:**

In a decision handed down on May 1, 2006, the Federal Circuit addressed the breadth of waiver that attaches to attorney-client privilege and work-product immunity when a litigant relies on an opinion of counsel as a defense to willfulness. In re EchoStar Communications, 2006 U.S. App. LEXIS 11162 (Fed. Cir. 2006). The Federal Circuit opinion addressed the split among the district courts on this issue and sought to clarify this oft-litigated and potentially perilous area of patent law.

TiVo sued EchoStar for allegedly infringing its U.S. Patent No. **6,233,389**. As is typically the case, TiVo also alleged willful infringement. In opposing this allegation of willful infringement, EchoStar asserted reliance on advice of counsel, based on an opinion "formed by in-house counsel and conveyed to EchoStar executives." *Id.* at \*8. This in-house opinion was created before the action was filed. After the action was filed, EchoStar obtained a second opinion from its outside counsel, Merchant & Gould. EchoStar opted not to rely on that opinion and, accordingly, Merchant & Gould never transmitted it to EchoStar.

Tivo sought production of privileged documents relating to the opinions. EchoStar resisted the disclosure of any privileged materials other than the opinions of counsel. In fact, EchoStar first argued that because the opinion it relied upon was an "internal investigation involving in-house engineers and in-house counsel" it was legally distinct, and not subject to the same waiver as "legal opinions commissioned at a later date from outside lawyers." *Id.* The Federal Circuit found this to be a meritless argument, holding that an opinion from in-house counsel was no different from an opinion of outside counsel.

EchoStar next argued that the district court's compulsion order cast too wide a net by including within the waiver's scope documents never communicated by Merchant & Gould (the attorney) to EchoStar (the client). The district court had held that by relying on advice of counsel, EchoStar waived attorney-client privilege and attorney work-product immunity



relating to advice of any counsel regarding infringement. Also, the district court held that the scope of the waiver included communications made either before or after the filing of the complaint and any work-product, whether or not such product was communicated to EchoStar.

The Federal Circuit focused its analysis primarily on the scope of waiver issue. The Federal Circuit speculated that the underlying cause of the district court casting such a wide net was, at least in part, a circuit split on the treatment of work-product documents, particularly work-product that is never communicated to the client. *Id.* at \*10.

The Court explained that work-product immunity "can protect documents and tangible things prepared in anticipation of litigation that are both non-privileged and relevant." *Id.* at \*15. From a policy perspective, work-product immunity is intended to protect the thoughts and strategies of an attorney, thereby promoting a fair and efficient adversarial process. *Id.* Thus, while work-product can be waived, such waiver must be balanced against the important objective of promoting counsel to record their thoughts and advice. The waiver therefore extends to work-product concerning the same subject matter as the disclosed work-product, and only factual or non-opinion work-product can be waived. *Id.* (citation omitted.)

The Court went on to provide some fairly clear guidance on the scope of work-product waiver. The Court first recognized three categories of work-product relevant to the advice-of-counsel defense:

- (1) documents that embody a communication between the attorney and client concerning the subject matter of the case, such as a traditional opinion letter;
- (2) documents analyzing the law, facts, trial strategy, and so forth that reflect the attorney's mental impressions but were not given to the client; and
- (3) documents that discuss a communication between attorney and client concerning the subject matter of the case but are not themselves communications to or from the client.

*Id.* at \*19.

With respect to the first category, the Court reiterated "that when a party relies on the advice-of-counsel as a defense to willful infringement the party waives its attorney-client privilege for all communications between the attorney and client [relating to the same subject matter], including any documentary communications such as opinion letters and memoranda." *Id.*

As to the second category, the Court clarified that these communications were not waived because they do not provide insight into the infringer's state of mind. "It is what the alleged infringer knew or believed, and by contradistinction not what other items counsel may have prepared but did not communicate to the client, that informs the court of an infringer's willfulness." *Id.* at \*22.

Finally, the Court noted that the third category fell somewhere in between, and it would be a question of the contents of the document in each instance. Nevertheless, the Court was clear that documents could be waived where the content of the documents had been communicated to the client.

The Federal Circuit's ruling will hopefully lend guidance to what has been a particularly murky area of the law. One point is clear: if you do not want counsel's work-product brought front and center in a case involving willfulness allegations, such work-product should not be disclosed or discussed with the client in any manner.

2006 Sutherland Asbill & Brennan LLP. All Rights Reserved.

This article is for informational purposes and is not intended to constitute legal advice.

Sutherland Asbill & Brennan  
1275 Pennsylvania Avenue, NW  
Washington, DC  
20004-2415  
UNITED STATES  
E-mail:  
[info@sablaw.com](mailto:info@sablaw.com)  
URL:  
[www.sablaw.com](http://www.sablaw.com)

(c) Mondaq Ltd, 2006 - Tel. +44 (0)20 8544 8300 - <http://www.mondaq.com>

**LOAD-DATE:** May 23, 2006

Source: [Command Searching > News, All \(English, Full Text\)](#)   
Terms: **6233389** or **6,233,389** ([Edit Search](#) | [Suggest Terms for My Search](#))  
View: Full  
Date/Time: Wednesday, October 31, 2007 - 10:03 AM EDT

[My Lexis™](#) | [Search](#) | [Research Tasks](#) | [Get a Document](#) | [Shepard's®](#) | [Alerts](#)  
[History](#) | [Delivery Manager](#) | [Switch Client](#) | [Preferences](#) | [Sign Off](#) | [Help](#)



**LexisNexis®**

[About LexisNexis](#) | [Terms & Conditions](#) | [Contact Us](#)  
Copyright © 2007 LexisNexis, a division of Reed Elsevier Inc. All rights reserved.



Source: [Command Searching > News, All \(English, Full Text\)](#) Terms: **6233389** or **6,233,389** ([Edit Search](#) | [Suggest Terms for My Search](#)) Select for FOCUS™ or Delivery*SATELLITE WEEK April 03, 2006 Monday*Copyright 2006 Warren Publishing, Inc.  
All Rights Reserved  
SATELLITE WEEK

April 03, 2006 Monday

**SECTION:** SATELLITE TV**LENGTH:** 213 words**BODY:**

A set of jurors in Tex. will learn more than they ever wanted to know about PVR gear, as EchoStar and TiVo debate whether EchoStar stole TiVo's "time warp" patent in an infringement case that opened last week in Marshall.

The case hinges on whether EchoStar's DVR uses TiVo technology. TiVo wants unspecified but large damages, pegged at \$100 million by analysts. An EchoStar motion to transfer the TiVo case to federal court in Cal. was denied. News reports said the federal courts in Marshall and other east Tex. cities are known for fast work on patent cases. An EchoStar spokeswoman had no comment on the lawyers' opening statements. EchoStar said in a March 10-K SEC filing it "intends to vigorously defend this case." But if Dish Network loses the time-warp fight, it may face substantial damages -- triple what jurors fix as lost TiVo revenue -- "and/or an injunction that could require us to materially modify certain user-friendly features that we currently offer consumers," the EchoStar filing warned. The TiVo suit alleges infringement of U.S. Patent **6,233,389** for pausing live TV. An EchoStar suit against TiVo and Humax U.S.A. alleges infringement of 4 U.S. patents on PVR technology. An EchoStar spokeswoman said she didn't know what the 4 countersuit patents protect.

**LOAD-DATE:** March 31, 2006Source: [Command Searching > News, All \(English, Full Text\)](#) Terms: **6233389** or **6,233,389** ([Edit Search](#) | [Suggest Terms for My Search](#))

View: Full

Date/Time: Wednesday, October 31, 2007 - 10:03 AM EDT





Source: [Command Searching > News, All \(English, Full Text\)](#) Terms: **6233389** or **6,233,389** ([Edit Search](#) | [Suggest Terms for My Search](#)) Select for FOCUS™ or Delivery*CONSUMER ELECTRONICS DAILY March 30, 2006 Thursday*

Copyright 2006 Warren Publishing, Inc.

All Rights Reserved

CONSUMER ELECTRONICS DAILY

March 30, 2006 Thursday

**SECTION:** COURTS**LENGTH:** 226 words**BODY:**

A jury in Tex. will learn more than jurors ever wanted to know about DVR gear, as EchoStar and TiVo argue as to whether EchoStar stole TiVo's "time warp" patent, in an infringement case that opened Wed.

in Marshall, Tex. The case hinges on whether EchoStar's DVR uses TiVo technology. TiVo wants heavy but undisclosed damages, pegged at \$100 million by analysts. An EchoStar motion to transfer the TiVo case to federal court in Cal. was denied. News reports said the federal courts in Marshall and other east Tex. cities are known for fast work on patent cases. An EchoStar spokeswoman had no comment on the day's opening remarks by lawyers for both sides. EchoStar said in a March 10K filing it "intends to vigorously defend this case." But should Dish Network lose the time warp fight, it may face substantial damages -- perhaps 3 times what jurors fix as lost TiVo revenue, the EchoStar filing warned. Damages could include "treble damages and/or an injunction that could require us to materially modify certain user-friendly features that we currently offer consumers," Dish said. The TiVo suit alleges infringement of U.S. Patent No. **6,233,389** for pausing live TV. An EchoStar suit against TiVo and Humax U.S.A. alleges infringement of 4 U.S. patents on DVR technology. An EchoStar spokeswoman said she didn't know what the 4 countersuit patents protect.

**LOAD-DATE:** March 29, 2006Source: [Command Searching > News, All \(English, Full Text\)](#) Terms: **6233389** or **6,233,389** ([Edit Search](#) | [Suggest Terms for My Search](#))

View: Full

Date/Time: Wednesday, October 31, 2007 - 10:03 AM EDT





[About LexisNexis](#) | [Terms & Conditions](#) | [Contact Us](#)  
Copyright © 2007 LexisNexis, a division of Reed Elsevier Inc. All rights reserved.

Source: [Command Searching > News, All \(English, Full Text\)](#) Terms: [6233389](#) or [6,233,389](#) ([Edit Search](#) | [Suggest Terms for My Search](#)) Select for FOCUS™ or Delivery*COMMUNICATIONS DAILY March 30, 2006 Thursday*

Copyright 2006 Warren Publishing, Inc.

All Rights Reserved

COMMUNICATIONS DAILY

March 30, 2006 Thursday

**SECTION:** SATELLITE**LENGTH:** 226 words**BODY:**

A jury in Tex. will learn more than jurors ever wanted to know about DVR gear, as EchoStar and TiVo argue as to whether EchoStar stole TiVo's "time warp" patent, in an infringement case that opened Wed.

in Marshall, Tex. The case hinges on whether EchoStar's DVR uses TiVo technology. TiVo wants heavy but undisclosed damages, pegged at \$100 million by analysts. An EchoStar motion to transfer the TiVo case to federal court in Cal. was denied. News reports said the federal courts in Marshall and other east Tex. cities are known for fast work on patent cases. An EchoStar spokeswoman had no comment on the day's opening remarks by lawyers for both sides. EchoStar said in a March 10K filing it "intends to vigorously defend this case." But should Dish Network lose the time warp fight, it may face substantial damages -- perhaps 3 times what jurors fix as lost TiVo revenue, the EchoStar filing warned. Damages could include "treble damages and/or an injunction that could require us to materially modify certain user-friendly features that we currently offer consumers," Dish said. The TiVo suit alleges infringement of U.S. Patent No. **6,233,389** for pausing live TV. An EchoStar suit against TiVo and Humax U.S.A. alleges infringement of 4 U.S. patents on DVR technology. An EchoStar spokeswoman said she didn't know what the 4 countersuit patents protect.

**LOAD-DATE:** March 29, 2006Source: [Command Searching > News, All \(English, Full Text\)](#) Terms: [6233389](#) or [6,233,389](#) ([Edit Search](#) | [Suggest Terms for My Search](#))

View: Full

Date/Time: Wednesday, October 31, 2007 - 10:03 AM EDT





[About LexisNexis](#) | [Terms & Conditions](#) | [Contact Us](#)  
Copyright © 2007 LexisNexis, a division of Reed Elsevier Inc. All rights reserved.

Source: [Command Searching](#) > **News, All (English, Full Text)** Terms: **6233389** or **6,233,389** ([Edit Search](#) | [Suggest Terms for My Search](#)) Select for FOCUS™ or Delivery

*TiVo Joins the Collection of Nation's Most Influential Inventions; United States Patent and Trademark Office Museum Honors Ideas That Improve Lives PR Newswire US July 20, 2005  
Wednesday 12:00 PM GMT*

Copyright 2005 PR Newswire Association LLC.  
All Rights Reserved.  
PR Newswire US

July 20, 2005 Wednesday 12:00 PM GMT

**LENGTH:** 583 words

**HEADLINE:** TiVo Joins the Collection of Nation's Most Influential Inventions;  
United States Patent and Trademark Office Museum Honors Ideas That Improve Lives

**DATELINE:** ALVISO, Calif. July 20

**BODY:**

ALVISO, Calif., July 20 /PRNewswire-FirstCall/ -- Joining the esteemed ranks of inventions such as the toothbrush, seat belt, computer and alarm clock, several TiVo inventions are featured in a new year-long exhibit at the United States Patent and Trademark Office (USPTO) Museum in Alexandria, Va., beginning July 13.

Designed to celebrate the nation's most influential inventions, "The Invention Machine: A Day in My Life" exhibit features everyday inventions that impact and improve people's daily lives, including the TiVo(R) digital video recorder (DVR) and the TiVo Service. The digital lifestyle that was launched by TiVo's creation has brought choice and control to the lives of millions of Americans.

"It is an honor for TiVo, and for me personally, to be placed in the US Patent and Trademark Office Museum," said James Barton, Senior Vice President of Research and Development, Chief Technology Officer, and co-founder of TiVo Inc. "It isn't every day that an invention is embraced by millions of people. To be featured in such a terrific showcase is a great day for TiVo."

Depicted in a three-dimensional virtual diorama, the TiVo display showcases a living room decorated with TiVo trademarked logos and icons on everything from rugs to wall decor. Set to upbeat music, a video loop displayed on a TV on the "living room" wall highlights the benefits of TiVo's Time Warp patent (U.S. Patent No. **6,233,389**), which covers TiVo's proprietary technology for efficiently storing and playing back TV shows. The video loop also highlights other patented aspects of TiVo's DVR and service, including novel ways of controlling live TV, TiVo's intuitive user interface and TiVo's award-winning remote control.

The USPTO Museum was designed and built by experts at Invent Now, a non-profit



organization formed to recognize and encourage invention and creativity and curators of the National Inventor's Hall of Fame. "Our goal with the USPTO Museum was to create a fun, thought-provoking, and memorable experience. The TiVo exhibit is sure to be a favorite among guests," said Mitch Scott, Senior Designer for Invent Now. "We are showing visitors of all ages how imagination can be made real."

Ranging from interactive activities and touch-screen technology to artifacts and videos, the USPTO Museum provides a high-impact educational experience and is immediately visible to all those passing through the atrium of the United States Patent and Trademark Office. The new exhibit opened to the public on Wednesday, July 13, 2005. More information is available at <http://www.uspto.gov/>.

#### About TiVo Inc.

Founded in 1997, TiVo (NASDAQ:TIVO), a pioneer in home entertainment, created a brand new category of products with the development of the first digital video recorder (DVR). Today, the company continues to revolutionize the way consumers watch and access home entertainment by making TiVo the focal point of the digital living room, a center for sharing and experiencing television, music, photos and other content. TiVo connects consumers to the digital entertainment they want, where and when they want it. The company is based in Alviso, Calif.

NOTE: TiVo is a registered trademark of TiVo Inc. or its subsidiaries in the United States and other jurisdictions.

CONTACT: Krista Wierzbicki of TiVo Inc., +1-408-519-9438, or [kwierzbicki@tivo.com](mailto:kwierzbicki@tivo.com); or Delia Spears of Weber Shandwick, +1-952-346-6303, or [dspears@webershandwick.com](mailto:dspears@webershandwick.com), for TiVo Inc.

Web site: <http://www.tivo.com/>

SOURCE TiVo Inc.

URL: <http://www.prnewswire.com>

NOTES: NOTE TO EDITORS: TiVo exhibit photos available upon request.

LOAD-DATE: July 21, 2005

Source: [Command Searching > News, All \(English, Full Text\)](#) 

Terms: **6233389** or **6,233,389** ([Edit Search](#) | [Suggest Terms for My Search](#))

View: Full

Date/Time: Wednesday, October 31, 2007 - 10:04 AM EDT

[My Lexis™](#) | [Search](#) | [Research Tasks](#) | [Get a Document](#) | [Shepard's®](#) | [Alerts](#)  
[History](#) | [Delivery Manager](#) | [Switch Client](#) | [Preferences](#) | [Sign Off](#) | [Help](#)



**LexisNexis®**

[About LexisNexis](#) | [Terms & Conditions](#) | [Contact Us](#)

Copyright © 2007 LexisNexis, a division of Reed Elsevier Inc. All rights reserved.

Source: [Command Searching](#) > **News, All (English, Full Text)** Terms: **6233389** or **6,233,389** ([Edit Search](#) | [Suggest Terms for My Search](#)) Select for FOCUS™ or Delivery

*TiVo Patent Suit Advances on Federal Court Denial of Echostar Motions PR Newswire US  
March 9, 2005 Wednesday*

Copyright 2005 PR Newswire Association LLC.  
All Rights Reserved.  
PR Newswire US

March 9, 2005 Wednesday

**LENGTH:** 691 words

**HEADLINE:** TiVo Patent Suit Advances on Federal Court Denial of Echostar Motions

**DATELINE:** ALVISO, Calif. March 9

**BODY:**

ALVISO, Calif., March 9 /PRNewswire-FirstCall/ -- TiVo Inc. (NASDAQ:TIVO), the creator of and a leader in television services for digital video recorders (DVRs), today announced that the federal district court for the Eastern District of Texas, Marshall Division has denied motions to dismiss and transfer TiVo's patent infringement case against Echostar Communications Corporation (ECC) and affiliated companies. In that case, TiVo has alleged that ECC and certain subsidiaries are violating a key TiVo patent (U.S. Patent No. **6,233,389** issued to TiVo in May 2001, known as the "Time Warp" patent). The defendants had sought to transfer the case out of Texas, and two of the defendants argued that they were not subject to jurisdiction in Texas. The Court denied both motions.

Key TiVo inventions protected by this patent include a method for recording one program while playing back another; watching a show as it is recording; and a storage format that supports advanced capabilities -- such as pausing live television, fast-forwarding, rewinding, instant replays, and slow motion.

As a result of the Court's rulings, the case will move forward in TiVo's chosen forum of the Eastern District of Texas, where the Court has scheduled jury selection to begin on October 4, 2005. TiVo is being represented by law firms Irell & Manella LLP (led by trial attorney Morgan Chu) and McKool Smith, P.C. (led by trial attorney Sam Baxter).

About TiVo Inc.

Founded in 1997, TiVo Inc., a pioneer in home entertainment, created a brand new category of products with the development of the first digital video recorder (DVR). Today, the Company continues to revolutionize the way consumers watch and access home entertainment by making TiVo the focal point of the digital living room, a center for sharing and experiencing television, music, photos and other content. TiVo connects consumers to the digital entertainment they want, where and when they want it. The Company is based in



Alviso, Calif.

This release contains certain forward-looking statements within the meaning of the Private Securities Litigation Reform Act of 1995. These statements relate to, among other things, TiVo's intellectual property litigation, patents, or other factors that may affect future earnings or financial results. Forward-looking statements generally can be identified by the use of forward-looking terminology such as, "believe," "expect," "may," "will," "intend," "estimate," "continue," or similar expressions or the negative of those terms or expressions. Such statements involve risks and uncertainties, which could cause actual results to vary materially from those expressed in or indicated by the forward-looking statements. Factors that may cause actual results to differ materially include delays in development, competitive service offerings and lack of market acceptance, as well as the "Factors That May Affect Future Operating Results." More information on potential factors that could affect the Company's financial results is included from time to time in the Company's public reports filed with the Securities and Exchange Commission, including the Company's Annual Report on Form 10-K for the fiscal year ended January 31, 2004, as amended, and the Quarterly Reports on Form 10-Q for the periods ended April 30, 2004, July 31, 2004, and October 31, 2004, filed with the Securities and Exchange Commission. We caution you not to place undue reliance on forward-looking statements, which reflect an analysis only and speak only as of the date hereof. TiVo disclaims any obligation to update these forward-looking statements.

NOTE: TiVo and the TiVo logo are registered trademarks of TiVo Inc. in the United States and other jurisdictions. All rights reserved. All other company or product names mentioned may be trademarks or registered trademarks of the respective companies with which they are affiliated.

CONTACT: Amanda Sanyal of SutherlandGold Comm., +1-866-262-7373, ext. 106, or [amanda@sutherlandgold.com](mailto:amanda@sutherlandgold.com), for TiVo Inc; or Ed Lockwood of TiVo Inc. Investor Relations, +1-408-519-9345, or [ir@tivo.com](mailto:ir@tivo.com)

Web site: <http://www.tivo.com/>

SOURCE TiVo Inc.

URL: <http://www.prnewswire.com>

LOAD-DATE: March 10, 2005

Source: [Command Searching > News, All \(English, Full Text\)](#) 

Terms: **6233389** or **6,233,389** ([Edit Search](#) | [Suggest Terms for My Search](#))

View: Full

Date/Time: Wednesday, October 31, 2007 - 10:04 AM EDT

[My Lexis™](#) | [Search](#) | [Research Tasks](#) | [Get a Document](#) | [Shepard's®](#) | [Alerts](#)  
[History](#) | [Delivery Manager](#) | [Switch Client](#) | [Preferences](#) | [Sign Off](#) | [Help](#)



**LexisNexis®** [About LexisNexis](#) | [Terms & Conditions](#) | [Contact Us](#)  
Copyright © 2007 LexisNexis, a division of Reed Elsevier Inc. All rights reserved.

Source: [Command Searching > News, All \(English, Full Text\)](#) Terms: **6233389** or **6,233,389** ([Edit Search](#) | [Suggest Terms for My Search](#)) Select for FOCUS™ or Delivery*TiVo slaps EchoStar with DVR suit CED February 1, 2004*

Copyright 2004 Reed Business Information US, a division of Reed Elsevier Inc.

All Rights Reserved  
THE PREMIER MEDIUM OF BUSINESS AND TECHNOLOGY**CED**  
CED

February 1, 2004

**SECTION:** Departments; Upfront; Pg. 14**LENGTH:** 157 words**HEADLINE:** TiVo slaps EchoStar with DVR suit**BYLINE:** Staff**BODY:**

EchoStar beat TiVo in the race to reach 1 million DVR subscribers, but TiVo beat the DBS provider in the courts, slapping EchoStar with a patent infringement suit last month.

TiVo, in a suit filed in Texas, alleged that EchoStar has infringed on TiVo's "Time Warp" patent. That patent, No. **6,233,389**, includes a method for some key DVR functions, including the recording of one program while playing back another, watching a program as it is recording, and a storage format that supports trick-play (pause, fast-forward, rewind, etc.) functions. TiVo said it filed the patent in July 1998.

TiVo surpassed the 1 million subscriber milestone in November 2003, just behind EchoStar, which reached that milestone in September.

EchoStar CEO Charlie Ergen told reporters at last month's Consumer Electronics Show that he was "confident we do not infringe on [TiVo's] patent. We do not think TiVo has a particularly strong case."

**LOAD-DATE:** February 03, 2004Source: [Command Searching > News, All \(English, Full Text\)](#) Terms: **6233389** or **6,233,389** ([Edit Search](#) | [Suggest Terms for My Search](#))

View: Full

Date/Time: Wednesday, October 31, 2007 - 10:04 AM EDT

[My Lexis™](#) | [Search](#) | [Research Tasks](#) | [Get a Document](#) | [Shepard's®](#) | [Alerts](#)  
[History](#) | [Delivery Manager](#) | [Switch Client](#) | [Preferences](#) | [Sign Off](#) | [Help](#)



**LexisNexis®**

[About LexisNexis](#) | [Terms & Conditions](#) | [Contact Us](#)  
Copyright © 2007 LexisNexis, a division of Reed Elsevier Inc. All rights reserved.



Source: [Command Searching](#) > **News, All (English, Full Text)** [i]

Terms: **6233389** or **6,233,389** ([Edit Search](#) | [Suggest Terms for My Search](#))

☑ Select for FOCUS™ or Delivery

*TIVO: Files Complaint Against EchoStar Comm.- Patent Knobias.com January 23, 2004 Friday*

Copyright 2004 Comtex News Network, Inc.

All Rights Reserved

Copyright 2004 Knobias.com, LLC, All rights reserved



Knobias.com

This content is provided to LexisNexis by Comtex News Network, Inc.

January 23, 2004 Friday

**LENGTH:** 460 words

**HEADLINE:** TIVO: Files Complaint Against EchoStar Comm.- Patent

**DATELINE:** Ridgeland, MS

**BODY:**

TiVo Incorporated (NASDAQ NM : TIVO) filed an 8-K on 1/23, in which the Company reported that on 1/5, it filed a complaint against EchoStar Communications Corporation in the U.S. District Court for the Eastern District of Texas alleging willful and deliberate infringement of U.S. Patent No. **6,233,389**, entitled "Multimedia Time Warping System." On January 15, 2004, the Company amended its complaint to add EchoStar DBS Corporation, EchoStar Technologies Corporation, and Echosphere Limited Liability Corporation as additional defendants.

The Company alleges that it is the owner of this patent, and further alleges that the defendants have willfully and deliberately infringed this patent by making, selling, offering to sell and/or selling digital video recording devices, digital video recording device software and/or personal television services in the United States.

**Tribune Media Services, Inc. Agreement**

On January 12, 2004 the Company executed a new Television Listings Data Agreement with Tribune Media Services, Inc. the current sole supplier of program guide data for the TiVo service. This agreement supersedes its existing television listing agreement with Tribune, which was originally executed in 1998. Pursuant to the new agreement, the Company will license program guide data for the TiVo service in exchange for monthly fees. In the event that the Company request format changes or require additional services, Tribune may increase its fees depending on the change in service requested. Pursuant to the new

agreement, Tribune and the Company will indemnify each other against claims and damages by third parties for breach of the agreement, or personal injury, property damage or infringement of intellectual property claims arising from the agreement or the Tribune data. The new agreement will become effective on March 1, 2004, will have an initial term of three years and will automatically renew for up to two additional terms of one year each unless we notify Tribune of our desire to terminate the agreement at least 90 days before the end of the then-current term.

#### Acquisition of Strangeberry Inc.

On January 12, 2004 the Company acquired Strangeberry Inc., a small Palo Alto based technology company specializing in using home network and broadband technologies to create new entertainment experiences on television. Strangeberry has created technology, based on industry standards and including a collection of protocols and tools, designed to enable the development of new broadband-based content delivery services. In exchange for all of the issued and outstanding capital stock of Strangeberry, the Company issued shares of TiVo common stock to the stockholders of Strangeberry in a private placement.

**LOAD-DATE:** January 24, 2004

Source: [Command Searching](#) > [News, All \(English, Full Text\)](#)   
Terms: [6233389](#) or [6,233,389](#) ([Edit Search](#) | [Suggest Terms for My Search](#))  
View: Full  
Date/Time: Wednesday, October 31, 2007 - 10:04 AM EDT

[My Lexis™](#) | [Search](#) | [Research Tasks](#) | [Get a Document](#) | [Shepard's®](#) | [Alerts](#)  
[History](#) | [Delivery Manager](#) | [Switch Client](#) | [Preferences](#) | [Sign Off](#) | [Help](#)



**LexisNexis®**

[About LexisNexis](#) | [Terms & Conditions](#) | [Contact Us](#)  
Copyright © 2007 LexisNexis, a division of Reed Elsevier Inc. All rights reserved.



Source: [Command Searching](#) > [News, All \(English, Full Text\)](#) Terms: [6233389](#) or [6,233,389](#) ([Edit Search](#) | [Suggest Terms for My Search](#)) Select for FOCUS™ or Delivery*Tech Lawsuit Tracker: Jan. 6, 2004 Daily Deal/The Deal January 7, 2004 Wednesday*Copyright 2004 The Deal, L.L.C.  
Daily Deal/The Deal

January 7, 2004 Wednesday

**SECTION:** TECH LAWSUIT**LENGTH:** 678 words**HEADLINE:** Tech Lawsuit Tracker: Jan. 6, 2004**BYLINE:** by Paul Bonanos and Gerald Magpily**HIGHLIGHT:**

Metrologic wins a patent lawsuit against Symbol.

**BODY:**

The new year brought resolution for two warring factions and a new battle for others.

Metrologic Instruments Inc. rang in 2004 by declaring victory in a lawsuit against Symbol Technologies Inc., apparently ending one aspect of the 11-year legal dispute between the two makers of bar-code scanners and wireless devices.

By refusing to overturn an earlier summary judgment, the U.S. Court of Appeals for the Second Circuit essentially named Metrologic the winner in the case. The suit is one of several involving the two companies, including a more recent patent infringement action filed in June 2003.

The federal court rejected Symbol's appeal, citing a lack of jurisdiction. Symbol had claimed that Metrologic violated the terms of a licensing agreement between the two, but the U.S. District Court for the Eastern District of New York sided with Metrologic in a decision handed down in March 2003.

Metrologic first filed suit against Symbol in 1992, claiming that the Holtsville, N.Y.-based company violated its patent on circuitry for a bar-code reader. The suit was settled with an injunction in 1993, and by 1996, the two companies had developed a licensing agreement.

But over the past two years, relations between the companies have soured again. First, Metrologic disputed which products fell under the licensing agreement and withheld its payment for fourth-quarter 2001. Then, in June 2003, Metrologic filed a suit in the U.S. District Court in New Jersey alleging that two Symbol products violate its patents for point-of-sale bar-code scanners, used in retail environments.

Separately, Symbol prevailed in a recent patent infringement case against Proxim Corp., in which the U.S. District Court in Delaware determined that the Sunnyvale, Calif.-based



wireless networking company violated two Symbol patents and will have to pay royalties to Symbol.

For Symbol, the development wasn't even the biggest news of the week. The Holtsville, N.Y.-based company, which develops wireless local-area networking switches as well as bar-code scanners, said chief executive and acting chairman Richard Bravman had stepped down from his positions. Former Cisco Systems Inc. executive William Nuti was promoted from president and chief operating officer to CEO, and took a seat on Symbol's board of directors.

Blackwood, N.J.-based Metrologic has retained Morgan, Lewis & Bockius LLP of New York as outside counsel. Symbol did not respond to queries regarding its legal assistance.

#### Protecting its turf

Digital video recorder maker TiVo Inc. began the new year by launching a lawsuit against satellite TV provider EchoStar Communications Corp.

San Jose, Calif.-based TiVo, which achieved a milestone in November when its customer base broke the 1 million mark, is scrambling to protect its technology and expand its customer base in an effort to reach profitability.

TiVo filed a patent lawsuit Jan. 5 against EchoStar in the Federal District Court in Texas. It alleges that EchoStar violated its U.S. Patent **6,233,389**, also known as its "time warp patent." The company said the patent allows for "a method for recording one program while playing back another, watching a program as it is recording, and a storage format that supports advanced TrickPlay capabilities." (For example, pausing live television broadcast, fast-forwarding, rewinding, instant replays and slow motion).

TiVo originally filed the patent with the U.S. Patent and Trademark Office in July 1998 and received the rights to the patent in May 2001.

"We take great pride in the fact that TiVo has created and developed the technology that revolutionizes the way people watch television," said Mike Ramsay, CEO of TiVo. "We've invested in building a comprehensive patent portfolio to protect our intellectual property and as the DVR category grows, we will be aggressive in protecting those assets."

EchoStar sells set-top boxes that include similar technology, but unlike its rival DirecTV, it does not pay TiVo a royalty.

**LOAD-DATE:** January 7, 2004

Source: [Command Searching](#) > [News, All \(English, Full Text\)](#) 

Terms: [6233389](#) or [6,233,389](#) ([Edit Search](#) | [Suggest Terms for My Search](#))

View: [Full](#)

Date/Time: Wednesday, October 31, 2007 - 10:05 AM EDT

[My Lexis™](#) | [Search](#) | [Research Tasks](#) | [Get a Document](#) | [Shepard's®](#) | [Alerts](#)  
[History](#) | [Delivery Manager](#) | [Switch Client](#) | [Preferences](#) | [Sign Off](#) | [Help](#)



**LexisNexis®**

[About LexisNexis](#) | [Terms & Conditions](#) | [Contact Us](#)

Copyright © 2007 LexisNexis, a division of Reed Elsevier Inc. All rights reserved.

Source: [Command Searching > News, All \(English, Full Text\)](#) 

Terms: [6233389](#) or [6,233,389](#) ([Edit Search](#) | [Suggest Terms for My Search](#))

 Select for FOCUS™ or Delivery

*TIVO Files Patent Infringement Suit Against DISH Knobias.com January 6, 2004 Tuesday*

Copyright 2004 Comtex News Network, Inc.

All Rights Reserved

Copyright 2004 Knobias.com, LLC, All rights reserved.



Knobias.com

This content is provided to LexisNexis by Comtex News Network, Inc.

January 6, 2004 Tuesday

**LENGTH:** 84 words

**HEADLINE:** TIVO Files Patent Infringement Suit Against DISH

**DATELINE:** Ridgeland, MS

**BODY:**

TiVo Inc. (TIVO) filed a patent infringement suit against EchoStar Communications Corporation (DISH) in federal district court in Texas alleging the satellite television service provider is violating claims of US Patent No. **6,233,389** issued to TIVO in May 2001. Key TIVO inventions protected by the Time Warp patent include a method for recording one program while playing back another, watching a program as it is recording, and a storage format that supports advanced TrickPlay(TM) capabilities.

**LOAD-DATE:** January 7, 2004

Source: [Command Searching > News, All \(English, Full Text\)](#) 

Terms: [6233389](#) or [6,233,389](#) ([Edit Search](#) | [Suggest Terms for My Search](#))

View: Full

Date/Time: Wednesday, October 31, 2007 - 10:05 AM EDT



**LexisNexis®**

[About LexisNexis](#) | [Terms & Conditions](#) | [Contact Us](#)

Copyright © 2007 LexisNexis, a division of Reed Elsevier Inc. All rights reserved.



Source: [Command Searching](#) > **News, All (English, Full Text)** Terms: **6233389** or **6,233,389** ([Edit Search](#) | [Suggest Terms for My Search](#)) Select for FOCUS™ or Delivery*TiVo Files Patent Infringement Suit Against EchoStar PR Newswire January 5, 2004 Monday*Copyright 2004 PR Newswire Association, Inc.  
PR Newswire

January 5, 2004 Monday

**SECTION:** FINANCIAL NEWS**DISTRIBUTION:** TO BUSINESS, ENTERTAINMENT AND TECHNOLOGY EDITORS**LENGTH:** 750 words**HEADLINE:** TiVo Files Patent Infringement Suit Against EchoStar**DATELINE:** SAN JOSE, Calif. Jan. 5**BODY:**

TiVo Inc. (Nasdaq: TIVO) today filed a patent infringement suit against EchoStar Communications Corporation in federal district court in Texas alleging the satellite television service provider is violating claims of U.S. Patent No. **6,233,389** issued to TiVo in May 2001, known as the "Time Warp" patent. Key TiVo inventions protected by the Time Warp patent include a method for recording one program while playing back another, watching a program as it is recording, and a storage format that supports advanced TrickPlay(TM) capabilities (i.e. pausing live television broadcast, fast-forwarding, rewinding, instant replays, and slow motion).

"We take great pride in the fact that TiVo has created and developed the technology that revolutionizes the way people watch television," said Mike Ramsay, CEO of TiVo. "We've invested in building a comprehensive patent portfolio to protect our intellectual property and as the DVR category grows, we will be aggressive in protecting those assets."

"Our plan has been to leverage our intellectual property to support our drive for market share growth. The success of our licensing business clearly demonstrates the value the industry has placed on TiVo's technology. It's important that we protect our IP for TiVo and our licensees," continued Ramsay.

TiVo filed the patent involved in this litigation with the U.S. Patent and Trademark Office in July 1998.

As disclosed in its most recent annual report, TiVo has been awarded 49 patents and has over 100 patent applications pending. These patents and patent applications protect its original DVR software and hardware design, as well as additional features that enhance the TiVo service and enable networked home entertainment.



## About TiVo

Founded in 1997 with the mission to dramatically improve consumers' television viewing experiences, TiVo is the creator of television services for digital video recorders (DVRs). TiVo's leadership has defined and inspired the entire category, earning the company patents for pioneering inventions associated with DVR software and hardware design. TiVo was the first to deliver on the promise of consumer choice and control over TV viewing, building a loyal and passionate subscriber base with over 97% of customers surveyed recommending TiVo to a friend. This enthusiasm has contributed to overwhelming growth over the past year, and the total subscriber base exceeds 1 million. TiVo is headquartered in San Jose, CA. Additional information can be found at [www.tivo.com](http://www.tivo.com).

This release contains certain forward-looking statements within the meaning of the Private Securities Litigation Reform Act of 1995. These statements relate to, among other things, TiVo's business, services, business development, strategy, customers or other factors that may affect future earnings or financial results. Forward-looking statements generally can be identified by the use of forward-looking terminology such as, "believe," "expect," "may," "will," "intend," "estimate," "continue," or similar expressions or the negative of those terms or expressions. Such statements involve risks and uncertainties, which could cause actual results to vary materially from those expressed in or indicated by the forward-looking statements. Factors that may cause actual results to differ materially include the risk that a court may not find infringement, or determine the patent to be invalid or unenforceable, and the cost of litigation, as well as the "Factors That May Affect Future Operating Results" and other risks detailed in our Annual Report on Form 10-K for the fiscal year ended January 31, 2003, and our Quarterly Report on Form 10-Q for the quarter ended October 31, 2003, filed with the Securities and Exchange Commission. We caution you not to place undue reliance on forward-looking statements, which reflect an analysis only and speak only as of the date hereof. TiVo disclaims any obligation to update these forward-looking statements.

NOTE: TiVo is a registered trademark of TiVo Inc. in the United States and other jurisdictions. TrickPlay is a trademark of TiVo Inc. in the United States and other jurisdictions. All rights reserved. All other company or product names mentioned may be trademarks or registered trademarks of the respective companies with which they are associated.

SOURCE TiVo Inc.

CONTACT: Lesley Gold of SutherlandGold Comm., +1-866-262-7373, ext. 102, or [Lesley@SutherlandGold.com](mailto:Lesley@SutherlandGold.com); or Ed Lockwood of TiVo Inc. Investor Relations, +1-408-519-9345, or [ir@tivo.com](mailto:ir@tivo.com)

URL: <http://www.prnewswire.com>

LOAD-DATE: January 6, 2004

Source: [Command Searching > News, All \(English, Full Text\)](#) 

Terms: **6233389** or **6,233,389** ([Edit Search](#) | [Suggest Terms for My Search](#))

View: Full

Date/Time: Wednesday, October 31, 2007 - 10:05 AM EDT





[About LexisNexis](#) | [Terms & Conditions](#) | [Contact Us](#)  
Copyright © 2007 LexisNexis, a division of Reed Elsevier Inc. All rights reserved.

Source: [Command Searching > News, All \(English, Full Text\)](#) Terms: **6233389** or **6,233,389** ([Edit Search](#) | [Suggest Terms for My Search](#)) Select for FOCUS™ or Delivery*Individual Income Tax Returns, 2000. Statistics of Income. SOI Bulletin September 22, 2002*

Copyright 2002 Gale Group, Inc.

ASAP

Copyright 2002 U.S. Government Printing Office  
Statistics of Income. SOI Bulletin

September 22, 2002

**SECTION:** No. 2, Vol. 22; Pg. 7; ISSN: 0730-0743**IAC-ACC-NO:** 104836854**LENGTH:** 77476 words**HEADLINE:** Individual Income Tax Returns, 2000.**BYLINE:** Campbell, David; Parisi, Michael**BODY:**

... 4,000	1,975,427	* 7,231	* 4,309	
\$ 4,000 under \$ 5,000	2,976,113	28,610	18,008	
\$ 5,000 under \$ 6,000	3,832,338	17,785	7,594	
\$ 6,000 under \$ 7,000	4,654,746	32,775	23,579	
\$ 7,000 under \$ 8,000	<b>6,233,389</b>	33,350	13,321	
\$ 8,000 under \$ 9,000	6,366,153	28,038	11,189	
\$ 9,000 under \$ 10,000	8,171,358	58,195	45,349	
\$ 10,000 under \$ 11,000	6,926,068	53,362	39,284	
\$ 11,000 under \$ 12,000	7,178,202	57,467	...	

Source: [Command Searching > News, All \(English, Full Text\)](#) Terms: **6233389** or **6,233,389** ([Edit Search](#) | [Suggest Terms for My Search](#))

View: KWIC ± 25

Date/Time: Wednesday, October 31, 2007 - 10:06 AM EDT



[My Lexis™](#) | [Search](#) | [Research Tasks](#) | [Get a Document](#) | [Shepard's®](#) | [Alerts](#)  
[History](#) | [Delivery Manager](#) | [Switch Client](#) | [Preferences](#) | [Sign Off](#) | [Help](#)



**LexisNexis®**

[About LexisNexis](#) | [Terms & Conditions](#) | [Contact Us](#)  
Copyright © 2007 LexisNexis, a division of Reed Elsevier Inc. All rights reserved.

Source: [Command Searching > News, All \(English, Full Text\)](#)   
Terms: **6233389** or **6,233,389** ([Edit Search](#) | [Suggest Terms for My Search](#))

 Select for FOCUS™ or Delivery

*Intellectual Property Today April, 2002*

Copyright 2002 Omega Communications, Inc.  
Intellectual Property Today

April, 2002

**SECTION:** REC EXPRESS TM; Recently Filed Patent Cases; Pg. 26

**LENGTH:** 1232 words

**BODY:**

01-3995 -- Filed:011024  
02 MICRO INTERNATIONAL LTD.  
vs.  
MONOLITHIC POWER SYSTEMS INC.  
6,259,615-363/98

02-70 -- Filed:020108  
ALLENTOWN CAGING & EQUIPMENT CO.  
vs.  
ANCARE CORP.  
5,894,816-119/417

01-981 -- Filed:011210  
AMERICAN PHYTOTHERAPY RESEARCH  
LABORATORY  
vs.  
SCIENTIFICALLY ADVANCED NUTRITION  
4,525,359-514/653; 4,588,724-514/250

01-960 -- Filed:011220  
ANATOMIC RESEARCH INC.  
vs.  
ADIDAS AMERICA INC.,  
ADIDAS SALES INC., ET AL  
6,115,941-36/25R; 6,163,982-36/25R

02-122 -- Filed:020130  
ANDY WOLF INC.  
vs.  
JAYSPOURT INTERNATIONAL INC.  
6,290,249-280/609

02-23 -- Filed:020109  
ANTONIO CAMPAGNOLI



vs.  
SCHROEDER & TREMAYNE INC.  
5,144,744-29/446

01-2657 -- Filed:011217  
ATWELL G. WEST

vs.  
KIDS II INC.  
5,067,925-446/397

01-3835 -- Filed:011221  
BEADS BY THE DOZEN INC.

vs.  
MARDI GRAS IMPORTS INC.

02-559 -- Filed:020123  
BEROL CORP. & SANFORD

vs.  
BIC CORP. & BIC USA  
6,312,180-401/130

01-1903 -- Filed:011214  
BLACKHAWK INDUSTRIES INC.

vs.  
JOHN W. CARVER & EAGLE INDUSTRIES INC.  
5,265,365-42/74

01-761 -- Filed:011126  
BRADFORD CO.

vs.  
STONE CONTAINER CORP.  
4,966,280-206/721

01-5494 -- Filed:011128  
BRADLEY PHARMACEUTICALS INC.

vs.  
ALBERT FLEISCHNER  
5,919,470-424/401

01-618 -- Filed:011113  
C&P SERVICES OF MONROE INC.

vs.  
EROSION CONTROL SERVICES INC., ET AL  
6,294,095-210/747

02-94 -- Filed:020204  
CERTCO INC.

vs.  
PAYPAL INC.  
6,026,150-379/90.01

01-9245 -- Filed:011203  
CHARLES HOBERMAN

vs.  
DESPLENTER NOVELTY CONCESSION  
4,942,700-52/81.2; 5,024,031-52/81.2

02-54 -- Filed:020118  
CODE ZEBRA

vs.  
MICROSOFT  
6,239,813-345/440

02-10 -- Filed:020108  
DAIMLERCHRYSLER AG

vs.  
GENERAL MOTORS CORP., ET AL  
4,454,390-200/6A

01-1909 -- Filed:011219  
DARREL LEWIS

vs.  
NRG MANUFACTURING INC. & NATIONAL OIL WELL INC.  
5,427,353-251/203

02-543 -- Filed:020201  
DOOR-MASTER CORP.

vs.  
YORKTOWNE INC.  
338,718-D25/48

02-64 -- Filed:020125  
DSM DESOTECH

vs.  
VANTICO INC.  
4,942,060-427/553; 6,174,156-425/174.4; 6,340,297-425/174.4

02-6074 -- Filed:020211  
EASTMAN KODAK

vs.  
SUN MICROSYSTEMS INC.  
5,206,951-709/315

01-10601 -- Filed:011121  
ELYSSE COSMETICS LTD.

vs.  
TACTIA INTERNATIONAL INC.  
6,318,378-132/212

02-60059 -- Filed:020119  
ESKIMO ICE CORP. & WILLIAM GRAYSON

vs.  
T.K. ALLEY INC., THOMAS ALLEY, NAUTIC-KOLD INC. & BRUCE E. ANTOGNONI  
4,922,724-62/135

01-2416 -- Filed:011219  
GRAVES SPRAY SUPPLY INC.

vs.  
GLAS-CRAFT INC. & POLYGARD INC.  
6,322,008-239/543

01-847 -- Filed:011026



HELIUS  
vs.  
HUGHES ELECTRONICS  
6,205,473-709/217

01-5379 -- Filed:011119  
ICON HEALTH & FITNESS  
vs.  
SPORT CRAFT LTD.  
5,672,140-482/54

01-807 -- Filed:011206  
INTELLECTUAL DEVELOPMENT  
vs.  
CHARTER COMMUNICATIONS INC.  
4,135,202-725/148

01-4986 -- Filed:011219  
JUMPSPORT INC.  
vs.  
JUMPING INC., ET AL  
6,053,845-482/35; 6,261,207-482/27

01-7821 -- Filed:011130  
KING OF FANS INC.  
vs.  
ANGELO BROTHERS CO.  
5,947,436-248/345

02-172 -- Filed:020125  
LARRY G. JUNKER  
vs.  
JAMES R. EDDINGS, GALT MEDICAL CORP. & XENTEK MEDICAL INC.  
450,839-D24/130

02-123 -- Filed:020130  
LEVITON MANUFACTURING CO.  
vs.  
MORRIS PRODUCTS INC.  
4,595,894-335/18

02-6 -- Filed:020123  
LIFETIME PRODUCTS INC.  
vs.  
CORRELL INC.  
5,536,552-428/98

02-8 -- Filed:020104  
LOEGERING MANUFACTURING INC.  
vs.  
GROUSER PRODUCTS INC. & RONALD J. HOFFART  
5,951,124-305/111

01-7208 -- Filed:011231  
M.A.B. SUPERFIT INC.  
vs.

KV INC.  
5,136,858-63/15.7

01-1901 -- Filed:011214  
MARVIN FABRIKANT & PATRICIA FABRIKANT  
vs.  
W. C. BRADLEY CO. & HOME DEPOT USA INC.  
5,740,724-99/426; 5,970,856-99/426

02-132 -- Filed:020118  
MAURICE MITCHELL  
vs.  
SAMSUNG ELECTRONICS CO.  
4,875,154-712/38

02-153 -- Filed:020124  
MAURICE MITCHELL  
vs.  
SAMSUNG ELECTRONICS CO.  
6,240,143-375/295; 6,157,611-370/208; 6,314,107-370/441

02-70 -- Filed:020125  
MITYLITE  
vs.  
MIDWEST FOLDING PRODUCTS  
5,271,338-108/161

01-187 -- Filed:011219  
MONSANTO CO.  
vs.  
JON SCOTT BRYANT  
5,633,435-800/288; 5,352,605-435/418

01-1963 -- Filed:011214  
MONSANTO CO.  
vs.  
KENNETH P. WILLIS & CARL WILLIS + SONS INC.  
5,633,435-800/288; 5,352,605-435/418

01-8284 -- Filed:011212  
NATIONAL MOULDING  
vs.  
NEWELL RUBBERMAID  
5,438,737-24/630

02-21 -- Filed:020116  
NICK L. FRENCH, ET AL  
vs.  
MIKE DURKEE DBA DURKEE ENTERPRISES  
6,336,416-112/103

01-726 -- Filed:011106  
NIPPON CARBON CO.  
vs.  
NUCOR CORP.  
4,941,149-373/96



02-136 -- Filed:020122

OAKLEY INC.

vs.

RIVIERA TRADING INC.

415,188-D16/326; 420,036-D16/326

01-2879 -- Filed:011026

PARADYNE CORP.

vs.

GAO RESEARCH INC.

5,103,227-341/61; 5,251,236-375/298

02-15 -- Filed:020108

PAUL KOSCH SR. & PAUL J. KOSCH

vs.

SPECTRA PRODUCTS CORP. & KSDM DBA MEGAWALL

4,961,295-52/36.5

01-9966 -- Filed:011228

PHILLIP S. JACKSON

vs.

ALASKA AIRLINES INC., ET AL

4,596,900-379/102.02

01-4554 -- Filed:011129

PLIANT CORP.

vs.

ISO POLY FILMS INC.

5,985,391-428/36.6

01-140 -- Filed:011128

POSITECH INTERNATIONAL INC.

vs.

DRAKE AIR INC. & PACIFIC OIL COOLER SERVICE INC.

6,301,780-29/890.031

02-118 -- Filed:020122

PROTEIN TECHNOLOGIES INC.

vs.

SOLBAR HAZOR LTD. & SOLBAR PLANT EXTRACTS

5,990,291-536/8; 6,323,018-435/200

01-2059 -- Filed:011108

RAYZIST PHOTOMASK INC.

vs.

THE CHROMALINE CORP.

6,235,449-430/273.1

01-5820 -- Filed:011213

REGENESIS LLC

vs.

RAPID BRAND INC., ET AL

4,856,541-132/110

01-2211 -- Filed:011121

REN JUDKINS  
vs.  
NEWELL WINDOW FURNISHING INC.  
5,692,550-160/84.05

02-137 -- Filed:020122  
RICHARD D. POLLAK  
vs.  
CHARLES E. LAWRENCE  
5,888,918-501/86

01-454 -- Filed:011206  
RICHARD HELINSKI  
vs.  
ROYDEN SANDERS ET AL  
5,136,515-700/119

01-1905 -- Filed:011206  
ROTO-DIE COMPANY DBA ROTOMETRICS  
vs.  
ATLAS DIE INC.  
6,311,601-83/863

02-288 -- Filed:020116  
SEMITOOL INC.  
vs.  
TOKYO ELECTRON AMERICA INC., ET AL  
5,784,797-34/58

01-6594 -- Filed:011221  
SIMPLIFIED IMPLANT SYSTEMS, ET AL  
vs.  
INSTITUT STRAUMANN AG, ET AL  
6,068,478-433/172

01-2069 -- Filed:011108  
SYMBOL TECHNOLOGIES INC.  
vs.  
SYMAGERY MICROSYSTEMS INC.  
6,123,261-235/462.01

01-727 -- Filed:011106  
TAKEDA CHEMICAL  
vs.  
AMERICAN HOME PRODUCTS  
5,433,959-424/475; 5,639,478-424/475

01-74775 -- Filed:011217  
TELEFLEX CORP.  
vs.  
KSR INTERNATIONAL INC.  
6,237,565-123/399

01-60230 -- Filed:011031  
TELEFLEX INC.  
vs.



PILOT INDUSTRIES INC.  
35,527-174/47

02-365 -- Filed:020123  
TIVO INC.

vs.  
SONICBLUE INC., ET AL  
**6,233,389**-386/46

01-11657 -- Filed:011221  
TRISH MCEVOY LTD.

vs.  
NEW KINGDOM INC., ET AL  
408,130-D3/205

01-4676 -- Filed:011203  
TUMBLEWEED COMMUNICATIONS CORP.

vs.  
AMERICAN GREETINGS CORP.  
6,192,407-709/229; 5,790,790-709/206

01-2183 -- Filed:011127  
TURN KEY TECH LCC

vs.  
SONY CORP. & SONY ELECTRONICS INC.  
5,045,268-264/246

02-129 -- Filed:020118  
UNITHER PHARMA INC.

vs.  
REAL HEALTH LABS.  
5,217,997-515/565; 6,117,872-514/249

02-490 -- Filed:020122  
V-FORMATION INC.

vs.  
K-2 CORP.  
6,045,143-280/11.231; 5,803,466-280/7.13; 5,873,584-280/11.221

01-159 -- Filed:011214  
WHITE PINE DBA BUNDLE ME CO.

vs.  
TOYS R US DBA BABIES R US  
6,012,189-5/655

01-4231 -- Filed:011114  
ZONE LABS INC.

vs.  
SYGATE TECHNOLOGIES INC.  
5,987,611-713/201

**LOAD-DATE:** April 19, 2002

Source: [Command Searching](#) > News, All (English, Full Text) 

Terms: **6233389** or **6,233,389** ([Edit Search](#) | [Suggest Terms for My Search](#))  
View: Full  
Date/Time: Wednesday, October 31, 2007 - 10:06 AM EDT

[My Lexis™](#) | [Search](#) | [Research Tasks](#) | [Get a Document](#) | [Shepard's®](#) | [Alerts](#)  
[History](#) | [Delivery Manager](#) | [Switch Client](#) | [Preferences](#) | [Sign Off](#) | [Help](#)



**LexisNexis®**

[About LexisNexis](#) | [Terms & Conditions](#) | [Contact Us](#)  
Copyright © 2007 LexisNexis, a division of Reed Elsevier Inc. All rights reserved.

Source: [Command Searching](#) > **News, All (English, Full Text)** Terms: **6233389** or **6,233,389** ([Edit Search](#) | [Suggest Terms for My Search](#)) Select for FOCUS™ or Delivery

*Do Patents Really Make a Difference to Stock Price? n1;(TiVo Stock's Patent-Induced Roller Coaster Ride)n1 Craig P. Opperman, Chief Intellectual Property Officer, MIH Group Limited; U.S. and South African patent attorney; and former partner at Cooley Godward LLP. E-mail: [opperman@opentv.com](mailto:opperman@opentv.com). The views represented here are those of the author and not those of the MIH Group or any of its portfolio companies. Intellectual Property Today February, 2002*

Copyright 2002 Omega Communications, Inc.  
Intellectual Property Today

February, 2002

**SECTION:** FEATURES; Pg. 8

**LENGTH:** 1444 words

**HEADLINE:** Do Patents Really Make a Difference to Stock Price? n1;  
(TiVo Stock's Patent-Induced Roller Coaster Ride)

n1 Craig P. Opperman, Chief Intellectual Property Officer, MIH Group Limited; U.S. and South African patent attorney; and former partner at Cooley Godward LLP. E-mail: [opperman@opentv.com](mailto:opperman@opentv.com). The views represented here are those of the author and not those of the MIH Group or any of its portfolio companies.

**BYLINE:** BY CRAIG P. OPPERMAN

**BODY:**

In today's volatile technology markets, stock price -- or company valuation -- is a most watched corporate viability indicator. It is a company's badge of success, or failure, and its currency for attracting valuable employees and strategic partners. Many factors impact stock price, each of which concerns senior management, but intellectual property and patents are ones that usually do not spring to mind. Yet, as TiVo can attest, patent issues can make significant differences to a company's stock price.

If there is any lesson from TiVo, it is that the Market is sophisticated about and pays attention to patents and, when appropriate, will reward or punish a company on patent events alone.

**WHO IS TIVO?**

TiVo Inc (Nasdaq: TIVO; [www.tivo.com](http://www.tivo.com)) was once, and by some measures still is, a darling of technology watchers. It markets a "sexy" new technology-based product called a Digital Video Recorders or DVR. DVR devices are like VCRs, but record programs onto a computer hard disk instead of videotape. This allows a viewer to appear to be able to "pause," "rewind," instant replay, and slow-motion live or recorded TV. TiVo's software also lets users record programs for later viewing. It went public in Q3 in 1999 and, like with many other



high tech companies saw its stock rise dizzyingly (to over \$ 70) and plummet precipitously, to as low as \$ 2.75 per share.

A technology hype and stock price extreme aside, there is another very interesting story behind TiVo. It is a classic poster child for how competitive patent events can really impact a company, particularly its stock price. TiVo's stock price has, as analyzed below, been subjected to a patent-induced roller coaster ride.

#### TIVO'S STOCK-PRICE ROLLER-COASTER RIDE

##### *Round I: "Down it goes" as Gemstar sues TiVo*

TiVo's first patent-induced stock price experience came in January 2000 when Gemstar and its StarSight Telecast subsidiary sued against TiVo. The suit alleged that the interactive program guide used in TiVo's DVR infringed Gemstar/StarSight patent rights. n2

n2 <http://www.adec.edu/user/skyreport/2000/sky01-20.html>

Although the existence of another Gemstar patent suit is fairly unremarkable, the impact on TiVo's stock price is very interesting. In 10 days, from a January 18 closing price of \$ 54.88, TiVo's stock plummeted \$ 24.38 to close at \$ 30.50. This startling 44% drop was a \$ 130 million loss in shareholder equity n3 and, as is shown in Graph 1 n4 below, is more than the \$ 15.00 per share drop (from \$ 32.88 to \$ 17.88) that TiVo suffered in April 2000 when "Internet bubble" burst.

n3 Based on the 5.5 offered during its IPO.

n4 The numbers for all stock related graphs were obtained from Yahoo.com.

##### *Round II: "Up it rockets" as TiVo announces a fundamental patent*

After the Gemstar litigation, patent issues did not feature for TiVo for just over a year. Then, on May 24, 2001, TiVo announced it had received U.S. patent **6,233,389**, which it characterized as covering "many of the key inventions associated with personal video recording software and hardware design". n5

n5 [http://www.tivo.com/flash.asp?page=tivoinc\\_index](http://www.tivo.com/flash.asp?page=tivoinc_index)

The Market's response, as shown in Graph 2 below, was extremely positive. TiVo's stock price shot up by 127% (from \$ 4.94 to \$ 11.21) in two days on trading volumes that increased nearly 4,400%. Even after normalizing a few days later, trading volumes were still up 10 times what they were before the patent announcement. To add to this, a day after the announcement, two analysts, Thomas Weissel and Deutsche Banc Alex Brown upgraded TiVo to "Buy" and "Market Perform" respectively.

All in all, therefore, this was a good "patent round" for TiVo stock.

##### *Round III: "No effect" when Gotuit files a patent suit against TiVo in October 2001*

TiVo's next patent adventure came in October 2001, when Pause Technology (Gotuit) sued



TiVo for patent infringement. According to Pause, the 1995 patent it was asserting against TiVo covers "live pause," and the ability to replay portions of a program while it is being recorded as well as fast-forwarding through recorded segments.

Contrary to what may be expected, TiVo's stock price did not decline at all. In fact it did the opposite and maintained a steady increase for the month of October, from \$ 3.35 to \$ 5.50! This response (or lack thereof) is, however, not at all surprising and is exactly in line with what one should expect from the Market.

The Market is sophisticated enough to discern between competitive and non-competitive patent events, i.e., patent events driven by or at a company's direct competitors and which could impact its market share. Competitive patent events impact stock prices, while non-competitive events do not.

The Gemstar litigation was a competitive event. Gemstar wishes to prevent TiVo from using specific program guide based functionality and, if Gemstar succeeds, the Market seems to believe this may be damaging to TiVo's competitive position. Hence the stock price came down. Similarly, when TiVo announced its patent, the Market read this as giving TiVo a competitive advantage. Hence the stock price went up.

But, Gotuit is different. Its ultimate goal does not seem to be to exclude TiVo from part of the DVR market. Rather, Gotuit is in the business of licensing its patent and its lawsuit against TiVo is aimed at furthering that business goal. Thus, TiVo's maximum exposure is paying licensing fees to Gotuit, and not market share and the Gotuit litigation is not a "competitive" patent event at all. The Market is sophisticated enough to take this into account and, accordingly, did not punish TiVo's stock price.

#### *Round IV: The SONICblue (Replay) competitive patent roller coaster*

This Market sophistication is reflected in the TiVo vs. SONICblue patent duel in late 2001.

On December 3, 2001, SONICblue, a TiVo rival DVR technology company, announced n6 that it had received a fundamental patent for DVR technology. SONICblue described the patent, number 6,324,338, as "a key patent . . . describing fundamental properties for implementing a DVR," with chairman and CEO, Ken Potashner, predicting that "[this] patent and other forthcoming ReplayTV patents will establish SONICblue as the leading provider of Digital Video Recording technology."

n6 [http://biz.yahoo.com/bw/011203/30087\\_1.html](http://biz.yahoo.com/bw/011203/30087_1.html)

SONICblue is a TiVo competitor and, as such, its announcement of an important patent is clearly a "competitive" patent issue for TiVo. Not surprisingly, the Market responded. As shown in Graph 3 n7 above, TiVo's stock price dropped by about 10% in the first few hours of trading after the announcement.

n7 Graph courtesy of Yahoo.com

TiVo was not to be outdone, however. The following week, as trading opened on December 11, 2001, TiVo announced n8 it had received two important patents, resulting in an almost instantaneous jump of over 17% in TiVo's stock price and a 500% increase in trading volume of stock jumped. CBSmarketWatch.com characterized n9 this as "TiVo [being] buoyed after winning patents."



n8 [http://biz.yahoo.com/prnews/011211/sftu081\\_l.html](http://biz.yahoo.com/prnews/011211/sftu081_l.html)

n9 <http://www.marketwatch.com/news/yhoo/story.asp?source=blq/yhoo&siteid=yhoo&dist=yhoo&guid=%7B6A6D3249%2D32F4%2D4667%2DAC59%2DCF9D4B40297E%7D>

But, as Graph 4 n10 below illustrates, these stock price gains evaporated almost immediately when SONICBlue's indicated n11 on December 12 that it planned to file a patent infringement lawsuit against TiVo. By the December 14 end-of-week, TiVo's stock price had dropped nearly 11% to \$ 4.69, only slightly above its \$ 4.48 price on the eve of TiVo's patent announcement.

n10 Graph courtesy of Yahoo.com

n11 [http://biz.yahoo.com/bw/011212/120001\\_l.html](http://biz.yahoo.com/bw/011212/120001_l.html)

#### CONCLUSION

There is only one conclusion to be drawn from these responses. The Market is sophisticated and pays attention to competitive patent events. TiVo has seen a 44% drop; a 127% rise; and a 10% drop followed by a 17% rise and an 11% fall in its stock price -- just because of competitive patent issues. Yes, the Market does care and patents do make a difference in a company's perceived valuation.

Without wishing to belabor the obvious, if the market cares about competitive patent issues, so too should corporate executives. Patents can and do effect corporate valuations, real and perceived. As ABN AMRO analysts Spencer Wang put it on November 8, 2001: "We are maintaining our Hold rating on TiVo in light of ongoing concerns over future financing needs, competition, and patent risk." (Emphasis added.)

**GRAPHIC:** Graph 1, TiVo's closing stock price from Jan 18 to April 28, 2000; Graph 2, TiVo's closing stock price and trading volumes from May 21 to June 1, 2001; Graph 3, TiVo's stock price Nov 28 to Dec 4, 2001; Graph 4, TiVo's stock price for the week of December 10, 2001

**LOAD-DATE:** February 14, 2002

Source: [Command Searching > News, All \(English, Full Text\)](#) 

Terms: **6233389** or **6,233,389** ([Edit Search](#) | [Suggest Terms for My Search](#))

View: Full

Date/Time: Wednesday, October 31, 2007 - 10:06 AM EDT

[My Lexis™](#) | [Search](#) | [Research Tasks](#) | [Get a Document](#) | [Shepard's®](#) | [Alerts](#)  
[History](#) | [Delivery Manager](#) | [Switch Client](#) | [Preferences](#) | [Sign Off](#) | [Help](#)



**LexisNexis®**

[About LexisNexis](#) | [Terms & Conditions](#) | [Contact Us](#)

Copyright © 2007 LexisNexis, a division of Reed Elsevier Inc. All rights reserved.



Source: [Command Searching > News, All \(English, Full Text\)](#) Terms: [6233389](#) or [6,233,389](#) ([Edit Search](#) | [Suggest Terms for My Search](#)) Select for FOCUS™ or Delivery

*PATENTS ISSUED; TiVo Awarded Two New Patents Covering Core DVR Functions and Home Networking Capabilities Intellectual Property Today January, 2002*

Copyright 2002 Omega Communications, Inc.  
Intellectual Property Today

January, 2002

**SECTION:** TECHNO BYTES TM; Pg. 10

**LENGTH:** 273 words

**HEADLINE:** PATENTS ISSUED;

TiVo Awarded Two New Patents Covering Core DVR Functions and Home Networking Capabilities

**SOURCE:** Latest Patents Expand TiVo's Intellectual Property Portfolio to Cover Pause, Rewind, Instant Replay and Slow Motion of Live TV

**DATELINE:** San Jose, CA

**BODY:**

TiVo (Nasdaq: TIVO) the creator and leader of television services for digital video recording, announced it has been granted additional patents for its technology and service. The first patent protects the functions that are the core of digital recording devices. The second patent covers inventions that enable simple and reliable networking of multiple streaming media devices in the home. The TrickPlay™ patent issued by the United States Patent office as number 6,327,418, describes a method of controlling streaming media in a digital device. In today's implementation of a TiVo DVR, the TrickPlay patent covers the functions that enable TiVo subscribers to pause live TV as well as rewind, fast forward, play, play faster, play slower, and play in reverse television signals cached by the DVR. Storing, editing and manipulation of video are also among the 64 claims supported by the TrickPlay patent. The Home Networking patent issued as USPTO number 6,310,886 describes a simple and reliable method for connecting TiVo DVRs and other streaming media devices to a network in the home. This technology allows TiVo to extend the ease of use of its current product and service to digital entertainment that can be enjoyed throughout the home. Combined with TiVo's landmark Time Warp patent [USPTO No. **6,233,389**] which enables the simultaneous recording and playback of multiple streams as well as efficient and low-cost processing, synchronization, and storage of multimedia streams, the TrickPlay patent ensures that TiVo's patent portfolio covers the key functions that are essential to operate the TiVo DVR.

**LOAD-DATE:** January 10, 2002

Source: [Command Searching > News, All \(English, Full Text\)](#) Terms: [6233389](#) or [6,233,389](#) ([Edit Search](#) | [Suggest Terms for My Search](#))

View: Full

Date/Time: Wednesday, October 31, 2007 - 10:06 AM EDT

[My Lexis™](#) | [Search](#) | [Research Tasks](#) | [Get a Document](#) | [Shepard's®](#) | [Alerts](#)  
[History](#) | [Delivery Manager](#) | [Switch Client](#) | [Preferences](#) | [Sign Off](#) | [Help](#)



**LexisNexis®**

[About LexisNexis](#) | [Terms & Conditions](#) | [Contact Us](#)  
Copyright © 2007 LexisNexis, a division of Reed Elsevier Inc. All rights reserved.

Source: [Command Searching > News, All \(English, Full Text\)](#) Terms: **6233389** or **6,233,389** ([Edit Search](#) | [Suggest Terms for My Search](#)) Select for FOCUS™ or Delivery*AUDIO WEEK December 17, 2001, Monday*Copyright 2001 Warren Publishing, Inc.  
AUDIO WEEK

December 17, 2001, Monday

**SECTION:** AUDIO NOTES**LENGTH:** 156 words**BODY:**

TiVo has been granted additional U.S. patents for its personal video recorder (PVR) technology and service, San Jose company said. One patent covers functions of digital recording devices while 2nd applies to networking of multiple streaming media devices in home. TiVo said TrickPlay patent (6,327,418) describes method of controlling streaming media in digital device, such as ability to pause live TV and perform other disc transport functions. Storing, editing and manipulating video also are among 64 claims in patent. Company earlier this year received patent (**6,233,389**) for Time Warp technology that enables simultaneous recording and playback. Other new patent (6,310,886) is for home networking that permits TiVo PVR and other streaming media devices to be linked in home -- application that TiVo said will proliferate in future. Company is now embroiled in PVR patent dispute with Replay TV owner SonicBlue.

**LOAD-DATE:** December 17, 2001Source: [Command Searching > News, All \(English, Full Text\)](#) Terms: **6233389** or **6,233,389** ([Edit Search](#) | [Suggest Terms for My Search](#))

View: Full

Date/Time: Wednesday, October 31, 2007 - 10:07 AM EDT





Source: [Command Searching > News, All \(English, Full Text\)](#) Terms: **6233389** or **6,233,389** ([Edit Search](#) | [Suggest Terms for My Search](#)) Select for FOCUS™ or Delivery*Consumer Electronics December 17, 2001, Monday*Copyright 2001 Warren Publishing, Inc.  
Consumer Electronics

December 17, 2001, Monday

**SECTION:** NOTEBOOK**LENGTH:** 156 words**BODY:**

TiVo has been granted additional U.S. patents for its personal video recorder (PVR) technology and service, San Jose company said. One patent covers functions of digital recording devices while 2nd applies to networking of multiple streaming media devices in home. TiVo said TrickPlay patent (6,327,418) describes method of controlling streaming media in digital device, such as ability to pause live TV and perform other disc transport functions. Storing, editing and manipulating video also are among 64 claims in patent. Company earlier this year received patent (**6,233,389**) for Time Warp technology that enables simultaneous recording and playback. Other new patent (6,310,886) is for home networking that permits TiVo PVR and other streaming media devices to be linked in home -- application that TiVo said will proliferate in future. Company is now embroiled in PVR patent dispute with Replay TV owner SonicBlue.

**LOAD-DATE:** December 17, 2001Source: [Command Searching > News, All \(English, Full Text\)](#) Terms: **6233389** or **6,233,389** ([Edit Search](#) | [Suggest Terms for My Search](#))

View: Full

Date/Time: Wednesday, October 31, 2007 - 10:07 AM EDT



Source: [Command Searching](#) > [News, All \(English, Full Text\)](#) Terms: [6233389](#) or [6,233,389](#) ([Edit Search](#) | [Suggest Terms for My Search](#)) Select for FOCUS™ or Delivery*Sonicblue on the War Path Online Reporter December 17, 2001*Copyright 2001 Gale Group, Inc.  
Business and Industry  
Online Reporter

December 17, 2001

**SECTION:** No. 277**RDS-ACC-NO:** 3177616**LENGTH:** 504 words**HEADLINE:** Sonicblue on the War Path**BYLINE:** Curtis Lee Fulton**HIGHLIGHT:**

Sonicblue, which makes ReplayTV personal video recorder, file patent infringement suit against rival Tivo

**BODY:**

Sonicblue, makers of the ReplayTV personal video recorder (PVR), has filed a patent infringement suit against rival Tivo in federal court, demanding that Tivo halt production of its PVR widget and pay damages.

Tivo says it will continue to ship.

The company also leaked an internal memo to the Wall Street Journal in which Tivo CEO Mike Ramsey told Sonicblue chief exec Ken Potashner that he was interested in working out a deal for Sonicblue to build Tivo hardware while Tivo focused on service. The exchange was dated late July, a period when Sonicblue was in the midst of acquiring ReplayTV.

PVRs record incoming broadcast and cable signals onto an internal hard drive that lets users select what programs to record from an on-screen menu that's automatically updated.

At issue is Sonicblue patent 6,324,338, a broad claim on implementing a PVR. It describes how the ReplayTV programming menu is presented to the user as well as how users choose programs and how the shows are recorded. But Tivo has been awarded 13 PVR-related patents of its own, which when cobbled together cover roughly the same ground as Sonicblue's 50-item whopper.

The two companies got to market at roughly the same time. Patents can be ruled inert by prior art.

Tivo beat Sonicblue to the punch on two patents that detail methods described in the



ReplayTV patent. Tivo's patent 6,327,418 was filed five months before the ReplayTV patent, which describes non-linear access to recorded programs. Another Tivo patent, **6,233,389**, which describes a "Multimedia Time Warping System," was filed four months before Sonicblue's. The Time Warp system describes basic PVR principles including the storage format and the various input and output video signals the device supports.

The day before Sonicblue filed suit, the company said it planned to "initiate discussions with Tivo to obtain a licensing agreement for Sonicblue's ReplayTV technology." Neither company is talking to anybody, but evidently Tivo either refused to talk or consider licensing Sonicblue IP and the lawsuit was filed. Sonicblue was obviously anticipating Tivo's response it had the paperwork ready to sue the next day.

Because Tivo has some patents to wield over Sonicblue, the two companies will probably end up cross-licensing their patents to each other. Both companies say that they expect IP licensing to be a significant part of their future revenues, and cross-licensing patents could create an IP base broad enough for both to cash in on PVR newcomers.

Tivo says it never planned to go the court route. "We're disappointed," it said, "that Sonicblue is opting to use litigation to build visibility for its company, as opposed to constructively working with others in the industry...."

The situation hints Sonicblue rejected a cross-license. Tivo's patents give it enough ammunition for a countersuit, which is more than likely to happen if a cross-license agreement doesn't happen. Copyright 2001 G2 Intelligence, Inc. Copyright 2001 G2 Intelligence, Inc. 464

**TYPE:** Newsletter; Fulltext

**JOURNAL-CODE:** ONLIREPO

**LOAD-DATE:** January 27, 2005

Source: [Command Searching > News, All \(English, Full Text\)](#) 

Terms: **6233389** or **6,233,389** ([Edit Search](#) | [Suggest Terms for My Search](#))

View: Full

Date/Time: Wednesday, October 31, 2007 - 10:07 AM EDT

[My Lexis™](#) | [Search](#) | [Research Tasks](#) | [Get a Document](#) | [Shepard's®](#) | [Alerts](#)  
[History](#) | [Delivery Manager](#) | [Switch Client](#) | [Preferences](#) | [Sign Off](#) | [Help](#)



**LexisNexis®**

[About LexisNexis](#) | [Terms & Conditions](#) | [Contact Us](#)

Copyright © 2007 LexisNexis, a division of Reed Elsevier Inc. All rights reserved.



Source: [Command Searching > News, All \(English, Full Text\)](#) Terms: **6233389** or **6,233,389** ([Edit Search](#) | [Suggest Terms for My Search](#)) Select for FOCUS™ or Delivery*Sonicblue on the War Path. The Online Reporter December 17, 2001*

Copyright 2001 Gale Group, Inc.

ASAP

Copyright 2001 G2 Computer Intelligence  
The Online Reporter

December 17, 2001

**SECTION:** Pg. NA ; ISSN: 1364-7113**IAC-ACC-NO:** 80809943**LENGTH:** 496 words**HEADLINE:** Sonicblue on the War Path.**BYLINE:** Fulton, Curtis Lee**BODY:**

Sonicblue, makers of the ReplayTV personal video recorder (PVR), has filed a patent infringement suit against rival Tivo in federal court, demanding that Tivo halt production of its PVR widget and pay damages.

Tivo says it will continue to ship.

The company also leaked an internal memo to the Wall Street Journal in which Tivo CEO Mike Ramsey told Sonicblue chief exec Ken Potashner that he was interested in working out a deal for Sonicblue to build Tivo hardware while Tivo focused on service. The exchange was dated late July, a period when Sonicblue was in the midst of acquiring ReplayTV.

PVRs record incoming broadcast and cable signals onto an internal hard drive that lets users select what programs to record from an on-screen menu that's automatically updated.

At issue is Sonicblue patent 6,324,338, a broad claim on implementing a PVR. It describes how the ReplayTV programming menu is presented to the user as well as how users choose programs and how the shows are recorded. But Tivo has been awarded 13 PVR-related patents of its own, which when cobbled together cover roughly the same ground as Sonicblue's 50-item whopper.

The two companies got to market at roughly the same time. Patents can be ruled inert by prior art.

Tivo beat Sonicblue to the punch on two patents that detail methods described in the ReplayTV patent. Tivo's patent 6,327,418 was filed five months before the ReplayTV patent, which describes non-linear access to recorded programs. Another Tivo patent, **6,233,389**, which describes a "Multimedia Time Warping System," was filed four months before

Sonicblue's. The Time Warp system describes basic PVR principles including the storage format and the various input and output video signals the device supports.

The day before Sonicblue filed suit, the company said it planned to "initiate discussions with Tivo to obtain a licensing agreement for Sonicblue's ReplayTV technology." Neither company is talking to anybody, but evidently Tivo either refused to talk or consider licensing Sonicblue IP and the lawsuit was filed. Sonicblue was obviously anticipating Tivo's response; it had the paperwork ready to sue the next day.

Because Tivo has some patents to wield over Sonicblue, the two companies will probably end up cross-licensing their patents to each other. Both companies say that they expect IP licensing to be a significant part of their future revenues, and cross-licensing patents could create an IP base broad enough for both to cash in on PVR newcomers.

Tivo says it never planned to go the court route. "We're disappointed," it said, "that Sonicblue is opting to use litigation to build visibility for its company, as opposed to constructively working with others in the industry...."

The situation hints Sonicblue rejected a cross-license. Tivo's patents give it enough ammunition for a countersuit, which is more than likely to happen if a cross-license agreement doesn't happen.

**IAC-CREATE-DATE:** September 26, 2003

**LOAD-DATE:** October 02, 2003

Source: [Command Searching](#) > [News, All \(English, Full Text\)](#) 

Terms: **6233389** or **6,233,389** ([Edit Search](#) | [Suggest Terms for My Search](#))

View: Full

Date/Time: Wednesday, October 31, 2007 - 10:07 AM EDT

[My Lexis™](#) | [Search](#) | [Research Tasks](#) | [Get a Document](#) | [Shepard's®](#) | [Alerts](#)  
[History](#) | [Delivery Manager](#) | [Switch Client](#) | [Preferences](#) | [Sign Off](#) | [Help](#)



**LexisNexis®**

[About LexisNexis](#) | [Terms & Conditions](#) | [Contact Us](#)

Copyright © 2007 LexisNexis, a division of Reed Elsevier Inc. All rights reserved.



Source: [Command Searching > News, All \(English, Full Text\)](#) Terms: **6233389** or **6,233,389** ([Edit Search](#) | [Suggest Terms for My Search](#)) Select for FOCUS™ or Delivery

*TiVo Awarded Two New Patents Covering Core DVR Functions and Home Networking Capabilities; Latest Patents Expand TiVo's Intellectual Property Portfolio to Cover Pause, Rewind, Instant Replay and Slow Motion of Live TV PR Newswire December 11, 2001, Tuesday*

Copyright 2001 PR Newswire Association, Inc.  
PR Newswire

December 11, 2001, Tuesday

**SECTION:** FINANCIAL NEWS

**DISTRIBUTION:** TO BUSINESS, TECHNOLOGY AND RADIO-TELEVISION EDITORS

**LENGTH:** 978 words

**HEADLINE:** TiVo Awarded Two New Patents Covering Core DVR Functions and Home Networking Capabilities;  
Latest Patents Expand TiVo's Intellectual Property Portfolio to Cover Pause, Rewind, Instant Replay and Slow Motion of Live TV

**DATELINE:** SAN JOSE, Calif., Dec. 11

**BODY:**

TiVo (Nasdaq: TIVO) the creator and leader of television services for digital video recording, today announced it has been granted additional patents for its technology and service. The first patent protects the functions that are the core of digital recording devices. The second patent covers inventions that enable simple and reliable networking of multiple streaming media devices in the home.

The TrickPlay(TM) patent issued by the United States Patent office as number 6,327,418, describes a method of controlling streaming media in a digital device. In today's implementation of a TiVo DVR, the TrickPlay patent covers the functions that enable TiVo subscribers to pause live TV as well as rewind, fast forward, play, play faster, play slower, and play in reverse television signals cached by the DVR. Storing, editing and manipulation of video are also among the 64 claims supported by the TrickPlay patent.

Combined with TiVo's landmark Time Warp patent [USPTO No. **6,233,389**] which enables the simultaneous recording and playback of multiple streams as well as efficient and low-cost processing, synchronization, and storage of multimedia streams, the TrickPlay patent ensures that TiVo's patent portfolio covers the key functions that are essential to operate the TiVo DVR.

"The ability to pause live TV is one of the most desirable DVR functions. The combination of TiVo's TimeWarp patent issued earlier this year and the TrickPlay patent we are announcing today protects all the basic inventions that make TiVo the revolutionary product our customers enjoy today and insures it will be the product of the future," said Jim Barton, Chief Technology Officer for TiVo. "These patents further bolster our licensing business and protect current and future licensees using TiVo technology."

The Home Networking patent issued as USPTO number 6,310,886 describes a simple and



reliable method for connecting TiVo DVRs and other streaming media devices to a network in the home. This technology allows TiVo to extend the ease of use of its current product and service to digital entertainment that can be enjoyed throughout the home.

"Our foundation technology for DVRs is just the beginning, and we continue to extend that technology looking forward to the networked multimedia home of the future," continued Barton. "Televisions, radios, telephones and the PC are some of the products that could access media on an easy to use home network. We look forward to not only the continued proliferation of TiVo DVR's but to the future of home entertainment."

#### About TiVo Inc.

Founded in 1997 with the mission to dramatically improve consumers' television viewing experiences, TiVo is the creator of and undisputed leader in television services for digital video recorders (DVR). TiVo's leadership has defined and inspired the entire category, earning the company patents for pioneering inventions associated with DVR software and hardware design. TiVo was the first to deliver on the promise of consumer choice and control over TV viewing, building a loyal and passionate subscriber base with over 97% of customers recommending TiVo to a friend. This enthusiasm has contributed to an overwhelming 300% growth over the past year, bringing the total subscriber base to exceed 280,000.

Today, the TiVo Service is available in the United States on the Philips Personal TV Recorder(TM) and the Sony Digital Network Recorder (TM) and DIRECTV Receivers with TiVo in nearly 3500 consumer electronics retail and online outlets and in the UK under the Thomson Scenium brand. TiVo is headquartered in San Jose, CA. Revenues for fiscal year ended December 31, 2000 were \$3.6 million. Additional information can be found at <http://www.tivo.com>.

This release contains forward-looking statements. You can identify forward-looking statements by use of forward-looking terminology such as "believes," "anticipates," "expects," "plans," "may," "will," "intends" or the negative of these words and phrases or similar words or phrases. You can also identify forward-looking statements by discussions of strategy, plans or intentions. Such forward-looking statements have known and unknown risks, uncertainties and other factors that may cause our actual results, performance or achievements to be materially different from any results, performance or achievements expressed or implied by such forward-looking statements. Actual results could differ materially from those set forth in such forward-looking statements. Factors that may cause actual results to differ materially include delays in development, competitive service offerings and lack of market acceptance, as well as the "Factors That May Affect Future Operating Results" and other risks detailed in our Annual Report on Form 10-K for the period ended December 31, 2000, the Transition Report on Form 10-K for the period ended January 31, 2001, and the Quarterly Report on Form 10-Q for the period ended July 31, 2001, filed with the Securities and Exchange Commission. We caution you not to place undue reliance on forward-looking statements, which reflect an analysis only and speak only as of the date hereof.

NOTE: TiVo is a registered trademark of TiVo, Inc. in the United States and other jurisdictions. All other company or product names mentioned may be trademarks or registered trademarks of the respective companies with which they are associated.

MAKE YOUR OPINION COUNT - Click Here  
<http://tbutton.prnewswire.com/prn/11690X58077737>

SOURCE TiVo, Inc.

CONTACT: Rebecca Baer of TiVo Inc., +1-408-519-9225, or [rebecca@tivo.com](mailto:rebecca@tivo.com); or Teresa Brewer of Blanc and Otus, +1-415-856-5225, or [tbrewer@blancandotus.com](mailto:tbrewer@blancandotus.com), for TiVo

URL: <http://www.prnewswire.com>

**LOAD-DATE:** December 12, 2001

Source: [Command Searching > News, All \(English, Full Text\)](#) 

Terms: **6233389** or **6,233,389** ([Edit Search](#) | [Suggest Terms for My Search](#))

View: Full

Date/Time: Wednesday, October 31, 2007 - 10:07 AM EDT

[My Lexis™](#) | [Search](#) | [Research Tasks](#) | [Get a Document](#) | [Shepard's®](#) | [Alerts](#)  
[History](#) | [Delivery Manager](#) | [Switch Client](#) | [Preferences](#) | [Sign Off](#) | [Help](#)



**LexisNexis®**

[About LexisNexis](#) | [Terms & Conditions](#) | [Contact Us](#)

[Copyright ©](#) 2007 LexisNexis, a division of Reed Elsevier Inc. All rights reserved.



Source: [Command Searching > News, All \(English, Full Text\)](#) Terms: **6233389** or **6,233,389** ([Edit Search](#) | [Suggest Terms for My Search](#)) Select for FOCUS™ or Delivery

*PAUSE SUES TIVO AS PVR PATENT FIGHT ESCALATES Consumer Electronics October 8, 2001,  
Monday*

Copyright 2001 Warren Publishing, Inc.  
Consumer Electronics

October 8, 2001, Monday

**SECTION:** THIS WEEK'S NEWS

**LENGTH:** 432 words

**HEADLINE:** PAUSE SUES TIVO AS PVR PATENT FIGHT ESCALATES

**BODY:**

Pause Technology's filing of patent infringement suit against TiVo is most recent volley in what is likely to be continuing battle for rights to various aspects of personal video recorder (PVR) technology.

Boston-based Pause filed suit in U.S. Dist. Court there alleging that TiVo had violated patent issued in 1995 and reaffirmed in 2000 that covered technology that enabled viewers to pause live TV, fast forward programs and replay parts of programs while they were being recorded. But Pause patent claims could expand beyond TiVo. Motorola has signed licensing agreement with Pause for its digital cable set-top boxes that are expected to be based on ReplayTV's PVR platform. Pause has had discussions with ReplayTV and others, spokesman said: "We're essentially talking to everybody in the industry." ReplayTV officials weren't available for comment.

Inventors of Pause technology are listed as James Logan, Windham, N.H., and Daniel Goessling, Wayland, Mass. Pause suit puts chink in TiVo patent portfolio. TiVo earlier this year received broad patent covering PVR technology (TVD May 28 p13). Patent, (U.S. **6,233,389**) filed in July 1998 and granted May 15, covers simultaneous playback and recording of TV programs, feature that TiVo only recently has begun to implement via DirecTV/PVR product that contains 2 tuners. Patent has 56 claims including methods of processing various multimedia streams such as audio and video at low cost and storage format that allows user to pause and scan through live TV broadcast.

TiVo spokeswoman said company was "surprised and disappointed" that Pause filed suit, but said "we stand by our prior claim to this company that we don't infringe." Pause spokesman said company contacted TiVo twice, starting in spring, on its patent before filing suit. TiVo also has been target of other patent infringement suits, including one filed by Gemstar-TV Guide International in 2000, largely because it so far has been only company to have generated significant business using PVR technology. Company has attracted more than 200,000 subscribers since starting service in 2000. ReplayTV, which made run at selling PVRs via own Web site and under Panasonic's Showstopper brand, underwent major restructuring last fall to shift focus to licensing of technology and since has sold company to Sonicblue.



PVR technology situation could become sticky, with possibility of patents' being reexamined. Others with patents include Gemstar (U.S. 5,701,383, granted Dec. 23, 1997) and Matsushita (U.S. 5,999,691, granted Dec. 7, 1999).

**LOAD-DATE:** October 8, 2001

Source: [Command Searching > News, All \(English, Full Text\)](#) 

Terms: **6233389** or **6,233,389** ([Edit Search](#) | [Suggest Terms for My Search](#))

View: Full

Date/Time: Wednesday, October 31, 2007 - 10:08 AM EDT

[My Lexis™](#) | [Search](#) | [Research Tasks](#) | [Get a Document](#) | [Shepard's®](#) | [Alerts](#)  
[History](#) | [Delivery Manager](#) | [Switch Client](#) | [Preferences](#) | [Sign Off](#) | [Help](#)



**LexisNexis®**

[About LexisNexis](#) | [Terms & Conditions](#) | [Contact Us](#)

Copyright © 2007 LexisNexis, a division of Reed Elsevier Inc. All rights reserved.

Source: [Command Searching > News, All \(English, Full Text\)](#) Terms: **6233389** or **6,233,389** ([Edit Search](#) | [Suggest Terms for My Search](#)) Select for FOCUS™ or Delivery*IN BRIEF Broadcasting & Cable June 04, 2001*

Copyright 2001 Cahners Business Information, a division of Reed Elsevier Inc.

All Rights Reserved

**BROADCASTING & CABLE**

Broadcasting &amp; Cable

June 04, 2001

**SECTION:** Interactive Media; IN BRIEF; Pg. 50**LENGTH:** 178 words**HEADLINE:** IN BRIEF**BYLINE:** Staff**BODY:**

ABCNews.com to host Webby Awards

Staff

ABCNews.com will host the live Webcast of the 5th Annual Webby Awards to be held on Wednesday, July 18, at the San Francisco War Memorial Opera House. The Webcast will kick off with the Webby preshow, which will be hosted by Sam Donaldson, host of [SamDonaldson@ABCNews.com](mailto:SamDonaldson@ABCNews.com), who will also present an award.

The Webby Awards recognize specific Web sites and individual achievement in creativity and technology on the World Wide Web.

TiVo gets patent

Staff

TiVo Inc. has received patent No. **6,233,389** for its "Multimedia Timewarping System." Applied for in July 1998, the patent covers many of the key innovations, such as program search by title and viewer profiling, in personal video recording software and hardware.

FOXSports.com, Ivast Partner on MPEG-4

Staff

A provider of MPEG-4 content-delivery software, IFAST Inc. is working with FoxSports.com to bring new, interactive features and functionality to sports fans visiting the Web site over broadband from PCs and other access devices.

**LOAD-DATE:** June 06, 2001



Source: [Command Searching > News, All \(English, Full Text\)](#) 

Terms: **6233389** or **6,233,389** ([Edit Search](#) | [Suggest Terms for My Search](#))

View: Full

Date/Time: Wednesday, October 31, 2007 - 10:08 AM EDT

[My Lexis™](#) | [Search](#) | [Research Tasks](#) | [Get a Document](#) | [Shepard's®](#) | [Alerts](#)  
[History](#) | [Delivery Manager](#) | [Switch Client](#) | [Preferences](#) | [Sign Off](#) | [Help](#)



**LexisNexis®**

[About LexisNexis](#) | [Terms & Conditions](#) | [Contact Us](#)

Copyright © 2007 LexisNexis, a division of Reed Elsevier Inc. All rights reserved.

Source: [Command Searching](#) > News, All (English, Full Text) Terms: 6233389 or 6,233,389 ([Edit Search](#) | [Suggest Terms for My Search](#)) Select for FOCUS™ or Delivery*PVR Patent Raises Concerns Multichannel News June 04, 2001*

Copyright 2001 Cahners Business Information, a division of Reed Elsevier Inc.

All Rights Reserved

**Multichannel**<sup>NEWS</sup>

Multichannel News

June 04, 2001

**SECTION:** Top Stories; Pg. 5**LENGTH:** 1036 words**HEADLINE:** PVR Patent Raises Concerns**BYLINE:** By STEVE DONOHUE and JEFF BAUMGARTNER**BODY:**

The personal video-recording patent obtained by TiVo Inc. could set off legal battles in a nascent but rapidly growing sector, industry observers said.

Cable operators interested in PVR capabilities are keeping an eye out, but don't yet seem overly worried about TiVo following the example of litigious electronic program guide maker Gemstar-TV Guide International Inc.

On May 15, TiVo said the U.S. Patent and Trademark Office had granted it a patent for several elements that cover PVR software and hardware design. That patent (No. **6,233,389**) is for a "Multimedia Timewarping System" TiVo originally filed in 1998.

The patent covers a time-shifting method for recording one program while playing back another or watching a program as it is being recorded; a method for processing and synchronizing several streams in a digital signal, such as video, audio and closed-captioning; and "Trickplay" capabilities that allow viewers to pause a live TV show or fast-forward and rewind digitally recorded video.

The USPTO also issued TiVo a patent for methods designed to imbed data within a TV signal to survive analog-to-digital and digital-to-analog conversions, as well as hardware and software features related to its partnership with DirecTV Inc., which markets a satellite receiver with an on-board PVR.

TiVo also has applied for a patent covering the "end-to-end" features and functions of the company's PVR service.

TiVo's pause patent could come in handy, considering last month's news that PVR technology firm Gotuit Media Corp. won a contract to become the exclusive marketing agent for Pause Technology LLC, which holds a patent that also enables viewers to pause live TV programs.



A run on PVR patents caused some to question whether TiVo might aspire to Gemstar's example of demanding royalties for its interactive and electronic program guide patents.

Comments TiVo chief technical officer Jim Barton made in a recent Los Angeles Times story added fuel to that fire. Barton told the Times that Microsoft Corp.'s UltimateTV service and technology could possibly be infringing on TiVo's intellectual property.

TiVo officials said Barton wasn't available for comment. But in a press release, Barton said, "From the inception of the company, we have placed great emphasis on developing and protecting our intellectual properties, including patents, copyrights, trademarks and trade secrets."

Still, industry observers believe it's much too early for a Gemstar-like party to emerge in the PVR arena.

In the PVR space, "you won't see a Gemstar patent that brings competitors to their knees," said Sean Badding, vice president of business development at The Carmel Group. "It's more of a marketing move than a technology advancement.

"You can argue that there's a patent war coming, but it's still wide open and these patents will continue to come out and improvements will be made to their existing technology," he said.

"I don't believe that [TiVo's] service is unique enough based on what they've patented," added Adi Kishore, an analyst with the Yankee Group. "There are ways for others to work around those patents," he said, noting that there's a "hair's breadth difference" between some PVR patents.

Kishore said, though, he "will be very surprised if we don't see a whole bunch of lawyers being kept very busy over the next couple of years."

Meanwhile, cable operators didn't believe PVR patent disputes would have much impact on their current business plans with respect to the technology.

Cox Communications Inc., which owns about 240,000 shares in TiVo, isn't concerned about running into any intellectual property obstacles involving the TiVo patents if the company deploys set-tops containing PVR technology, according to Dallas Clement, the MSO's senior vice president of strategy and development.

Clement said it would be up to the company's hardware vendors, such as Scientific-Atlanta Inc., to license the patents from TiVo. He said he doesn't believe Cox itself would be required to license the technology.

"TiVo ought to work with other companies that will try to sell an integrated box to us, but it doesn't really have an impact on an MSO who is providing the service," Clement said.

Cox conducted a trial on its Las Vegas system that required use of a second set-top, Clement said. But based on feedback from subscribers, the MSO will look for a one-box solution when it deploys a PVR service, he added.

Charter Communications Inc. has been covering its PVR bases with a multitude of partners, including Motorola Broadband Communications Sector, which has an arrangement with PVR-software firms SonicBlue and Gotuit.

TiVo's patents aren't "the silver bullet that will kill the werewolf," predicted Charter vice

president of corporate development Jim Henderson. What those patents could do for TiVo is strengthen its plan to license its intellectual property and open up another revenue stream, he added. Henderson said Charter has had discussions with TiVo.

Badden agreed that MSOs shouldn't be too concerned about PVR patents and potential lawsuits. "Those issues will work themselves out. The true issue is, what does this mean for the PVR businesses in general, which can't move ahead without support from the MSOs."

It's still not clear how some other technology companies pursuing PVR services may be affected by the TiVo patents, as most refused to discuss the TiVo patent.

A representative for Microsoft Corp.'s UltimateTV service released a prepared statement that said the company doesn't comment "on the specific patents its competitors receive. However, Microsoft has an extensive portfolio of patents of its own that protects its products."

While Microsoft has been assigned more than 1,000 U.S. patents, a search of the U.S. Patent and Trademark Office database found no Microsoft patents involving PVR technology, or for technology that records one program while playing back or watching another show.

Motorola Broadband Communications Sector, which is working with Gotuit and SonicBlue, "takes patents very seriously," a spokeswoman said. "We study it carefully, and if we think it's appropriate, we'll take a license"

**LOAD-DATE:** June 06, 2001

Source: [Command Searching > News, All \(English, Full Text\)](#) 

Terms: **6233389** or **6,233,389** ([Edit Search](#) | [Suggest Terms for My Search](#))

View: Full

Date/Time: Wednesday, October 31, 2007 - 10:08 AM EDT

[My Lexis™](#) | [Search](#) | [Research Tasks](#) | [Get a Document](#) | [Shepard's®](#) | [Alerts](#)  
[History](#) | [Delivery Manager](#) | [Switch Client](#) | [Preferences](#) | [Sign Off](#) | [Help](#)



[About LexisNexis](#) | [Terms & Conditions](#) | [Contact Us](#)  
Copyright © 2007 LexisNexis, a division of Reed Elsevier Inc. All rights reserved.



Source: [Command Searching](#) > [News, All \(English, Full Text\)](#) Terms: **6233389** or **6,233,389** ([Edit Search](#) | [Suggest Terms for My Search](#)) Select for FOCUS™ or Delivery*PVR Patent Raises Concerns Multichannel News June 04, 2001*

Copyright 2001 Cahners Business Information, a division of Reed Elsevier Inc.

All Rights Reserved

**Multichannel**<sup>NEWS</sup>

Multichannel News

June 04, 2001

**SECTION:** Top Stories; Pg. 5**LENGTH:** 1036 words**HEADLINE:** PVR Patent Raises Concerns**BYLINE:** By STEVE DONOHUE and JEFF BAUMGARTNER**BODY:**

The personal video-recording patent obtained by TiVo Inc. could set off legal battles in a nascent but rapidly growing sector, industry observers said.

Cable operators interested in PVR capabilities are keeping an eye out, but don't yet seem overly worried about TiVo following the example of litigious electronic program guide maker Gemstar-TV Guide International Inc.

On May 15, TiVo said the U.S. Patent and Trademark Office had granted it a patent for several elements that cover PVR software and hardware design. That patent (No. **6,233,389**) is for a "Multimedia Timewarping System" TiVo originally filed in 1998.

The patent covers a time-shifting method for recording one program while playing back another or watching a program as it is being recorded; a method for processing and synchronizing several streams in a digital signal, such as video, audio and closed-captioning; and "Trickplay" capabilities that allow viewers to pause a live TV show or fast-forward and rewind digitally recorded video.

The USPTO also issued TiVo a patent for methods designed to imbed data within a TV signal to survive analog-to-digital and digital-to-analog conversions, as well as hardware and software features related to its partnership with DirecTV Inc., which markets a satellite receiver with an on-board PVR.

TiVo also has applied for a patent covering the "end-to-end" features and functions of the company's PVR service.

TiVo's pause patent could come in handy, considering last month's news that PVR technology firm Gotuit Media Corp. won a contract to become the exclusive marketing agent for Pause Technology LLC, which holds a patent that also enables viewers to pause live TV programs.



A run on PVR patents caused some to question whether TiVo might aspire to Gemstar's example of demanding royalties for its interactive and electronic program guide patents.

Comments TiVo chief technical officer Jim Barton made in a recent Los Angeles Times story added fuel to that fire. Barton told the Times that Microsoft Corp.'s UltimateTV service and technology could possibly be infringing on TiVo's intellectual property.

TiVo officials said Barton wasn't available for comment. But in a press release, Barton said, "From the inception of the company, we have placed great emphasis on developing and protecting our intellectual properties, including patents, copyrights, trademarks and trade secrets."

Still, industry observers believe it's much too early for a Gemstar-like party to emerge in the PVR arena.

In the PVR space, "you won't see a Gemstar patent that brings competitors to their knees," said Sean Badding, vice president of business development at The Carmel Group. "It's more of a marketing move than a technology advancement.

"You can argue that there's a patent war coming, but it's still wide open and these patents will continue to come out and improvements will be made to their existing technology," he said.

"I don't believe that [TiVo's] service is unique enough based on what they've patented," added Adi Kishore, an analyst with the Yankee Group. "There are ways for others to work around those patents," he said, noting that there's a "hair's breadth difference" between some PVR patents.

Kishore said, though, he "will be very surprised if we don't see a whole bunch of lawyers being kept very busy over the next couple of years."

Meanwhile, cable operators didn't believe PVR patent disputes would have much impact on their current business plans with respect to the technology.

Cox Communications Inc., which owns about 240,000 shares in TiVo, isn't concerned about running into any intellectual property obstacles involving the TiVo patents if the company deploys set-tops containing PVR technology, according to Dallas Clement, the MSO's senior vice president of strategy and development.

Clement said it would be up to the company's hardware vendors, such as Scientific-Atlanta Inc., to license the patents from TiVo. He said he doesn't believe Cox itself would be required to license the technology.

"TiVo ought to work with other companies that will try to sell an integrated box to us, but it doesn't really have an impact on an MSO who is providing the service," Clement said.

Cox conducted a trial on its Las Vegas system that required use of a second set-top, Clement said. But based on feedback from subscribers, the MSO will look for a one-box solution when it deploys a PVR service, he added.

Charter Communications Inc. has been covering its PVR bases with a multitude of partners, including Motorola Broadband Communications Sector, which has an arrangement with PVR-software firms SonicBlue and Gotuit.

TiVo's patents aren't "the silver bullet that will kill the werewolf," predicted Charter vice



president of corporate development Jim Henderson. What those patents could do for TiVo is strengthen its plan to license its intellectual property and open up another revenue stream, he added. Henderson said Charter has had discussions with TiVo.

Badden agreed that MSOs shouldn't be too concerned about PVR patents and potential lawsuits. "Those issues will work themselves out. The true issue is, what does this mean for the PVR businesses in general, which can't move ahead without support from the MSOs."

It's still not clear how some other technology companies pursuing PVR services may be affected by the TiVo patents, as most refused to discuss the TiVo patent.

A representative for Microsoft Corp.'s UltimateTV service released a prepared statement that said the company doesn't comment "on the specific patents its competitors receive. However, Microsoft has an extensive portfolio of patents of its own that protects its products."

While Microsoft has been assigned more than 1,000 U.S. patents, a search of the U.S. Patent and Trademark Office database found no Microsoft patents involving PVR technology, or for technology that records one program while playing back or watching another show.

Motorola Broadband Communications Sector, which is working with Gotuit and SonicBlue, "takes patents very seriously," a spokeswoman said. "We study it carefully, and if we think it's appropriate, we'll take a license"

**LOAD-DATE:** June 08, 2001

Source: [Command Searching > News, All \(English, Full Text\)](#) 

Terms: **6233389** or **6,233,389** ([Edit Search](#) | [Suggest Terms for My Search](#))

View: Full

Date/Time: Wednesday, October 31, 2007 - 10:08 AM EDT

[My Lexis™](#) | [Search](#) | [Research Tasks](#) | [Get a Document](#) | [Shepard's®](#) | [Alerts](#)  
[History](#) | [Delivery Manager](#) | [Switch Client](#) | [Preferences](#) | [Sign Off](#) | [Help](#)



**LexisNexis®**

[About LexisNexis](#) | [Terms & Conditions](#) | [Contact Us](#)

Copyright © 2007 LexisNexis, a division of Reed Elsevier Inc. All rights reserved.

Source: [Command Searching > News, All \(English, Full Text\)](#) Terms: **6233389** or **6,233,389** ([Edit Search](#)) [Suggest Terms for My Search](#) Select for FOCUS™ or Delivery*PVR pioneer receives key US patent; Tivo; Brief Article Screen Digest June 1, 2001*

Copyright 2001 Gale Group, Inc.  
All Rights Reserved  
IAC (SM) Newsletter Database (TM)  
Copyright 2001 Screen Digest Limited  
Screen Digest

June 1, 2001

**ACC-NO:** 75445445**LENGTH:** 209 words**HEADLINE:** PVR pioneer receives key US patent;  
Tivo;  
Brief Article**BODY:**

Prospects for loss-making US personal video recorder (PVR ) pioneer Tivo have improved slightly following acceptance of its July 1998 'Multimedia time warping system' patent by US Patent and Trademark Office. Patent number **6,233,389** covers several key technology areas for the both process and apparatus required to:

\* view a television broadcast programme with the option of instantly reviewing previous scenes that is commonly referred to as time-shifting;

\* store selected television broadcast programmes whilst user is simultaneously watching another programme.

Challenges facing Tivo (USA; +1/408 747 5080; [www.tivo.com](http://www.tivo.com)) include its decision to remain in the consumer hardware business in the face of increasing losses--Tivo lost \$ 49.1m in the first three months 2001 on revenues of \$ 3.2m. Competitor ReplayTV dropped this strategy to focus on licensing software instead (see 2000/363b3), and Microsoft's UltimateTV and the WebTV inventor (see 2001/140a2) have recently entered the fray.

\* Possibly most significant long-term factor is competition from set-top box manufacturers that will enable TV operators to introduce many PVR-like functions plus other interactive features such as electronic programme guides (EPGs) without having to partner TIVO.

**LOAD-DATE:** July 3, 2001Source: [Command Searching > News, All \(English, Full Text\)](#) Terms: **6233389** or **6,233,389** ([Edit Search](#)) [Suggest Terms for My Search](#)



View: Full  
Date/Time: Wednesday, October 31, 2007 - 10:09 AM EDT

[My Lexis™](#) | [Search](#) | [Research Tasks](#) | [Get a Document](#) | [Shepard's®](#) | [Alerts](#)  
[History](#) | [Delivery Manager](#) | [Switch Client](#) | [Preferences](#) | [Sign Off](#) | [Help](#)



**LexisNexis®**

[About LexisNexis](#) | [Terms & Conditions](#) | [Contact Us](#)  
Copyright © 2007 LexisNexis, a division of Reed Elsevier Inc. All rights reserved.

Source: [Command Searching](#) > **News, All (English, Full Text)** Terms: **6233389** or **6,233,389** ([Edit Search](#) | [Suggest Terms for My Search](#)) Select for FOCUS™ or Delivery

*TIVO OBTAINS PATENT FOR PVR STOCK SOARS 72 PERCENT ON NEWS San Jose Mercury News (California) May 25, 2001 Friday MORNING FINAL EDITION*

Copyright 2001 San Jose Mercury News  
All Rights Reserved  
San Jose Mercury News (California)

May 25, 2001 Friday MORNING FINAL EDITION

**SECTION:** BUSINESS; Pg. 4C

**LENGTH:** 497 words

**HEADLINE:** TIVO OBTAINS PATENT FOR PVR STOCK SOARS 72 PERCENT ON NEWS

**BYLINE:** MERCURY NEWS STAFF AND WIRE REPORTS

**BODY:**

TiVo, one of three companies pioneering the market for personal video recorders, said Thursday that it has received a wide-ranging patent covering its technology.

PVRs use a hard disk instead of videotape to store television programs, and models currently available for about \$400 can hold 30 hours of recorded shows.

Although San Jose-based TiVo's two main competitors -- ReplayTV and the WebTV Networks division of Microsoft, both based in Mountain View -- said they haven't had time to analyze the impact, it doesn't appear the patent is so broad it would immediately cause TiVo to make infringement claims.

Boost for licensing

However, the patent does bolster TiVo's goal of licensing its software to electronics manufacturers for PVR-enabled cable-television set-top boxes, satellite-TV receivers and future applications such as video-game systems that would also record TV programs.

Investors were clearly excited by the news, pushing TiVo up 72 percent, or \$3.56 a share Thursday, to close at \$8.50 -- although TiVo remains far below its 52-week high of \$37.50 reached in June 2000.

The stock rose even more in after-hours trading to above \$9 a share.

TiVo also reported a loss Thursday for the quarter ended April 30 of \$50.2 million, or \$1.20 a share, compared with a loss of \$23.4 million, or 66 cents a share, a year ago. Revenue for the quarter was \$3.2 million, up from \$499,000 last year.

The U.S. Patent Office issued patent number **6,233,389** to TiVo for a Multimedia Timewarping System, based on an application filed in July 1998. The patent covers TiVo's



method for implementing the key features that separate PVRs from videocassette recorders.

#### Live pause

The most important of these features is "live pause," which allows a PVR to begin recording a program at the push of a remote-control button while freezing the action on screen. The viewer then can resume watching the program at any time, with the PVR playing back the delayed program while continuing to record the incoming live signal.

This capability also allows a PVR to play a previously recorded program while recording a new program for later viewing.

TiVo has previously received patents covering other parts of its PVR design.

Rebecca Baer, a TiVo spokeswoman, said the company didn't know if ReplayTV, WebTV or others were potentially infringing on TiVo's new patent and said chasing after other companies with infringement claims "is not part of our business strategy."

Steve Shannon, vice president of marketing for ReplayTV, said his company also filed for several patents at about the same time as TiVo and still expects many of them will be granted. Ultimately, Shannon said, he expects the first entrants in the PVR field will work out patent-sharing or cross-licensing agreements. Companies subsequently seeking to enter the business then would pay royalties if they decide not to create their own unique PVR technology.

**LOAD-DATE:** December 2, 2001

Source: [Command Searching](#) > [News, All \(English, Full Text\)](#) 

Terms: [6233389](#) or [6,233,389](#) ([Edit Search](#) | [Suggest Terms for My Search](#))

View: Full

Date/Time: Wednesday, October 31, 2007 - 10:09 AM EDT

[My Lexis™](#) | [Search](#) | [Research Tasks](#) | [Get a Document](#) | [Shepard's®](#) | [Alerts](#)  
[History](#) | [Delivery Manager](#) | [Switch Client](#) | [Preferences](#) | [Sign Off](#) | [Help](#)



**LexisNexis®**

[About LexisNexis](#) | [Terms & Conditions](#) | [Contact Us](#)

Copyright © 2007 LexisNexis, a division of Reed Elsevier Inc. All rights reserved.

Source: [Command Searching > News, All \(English, Full Text\)](#) 

Terms: [6233389](#) or [6,233,389](#) ([Edit Search](#) | [Suggest Terms for My Search](#))

 Select for FOCUS™ or Delivery

*TiVo Granted Patent on Personal Video Recording Software and Hardware Design; Significant Patent Grants TiVo License for Key Personal Video Recording Technologies PR Newswire May 24, 2001, Thursday*

Copyright 2001 PR Newswire Association, Inc.  
PR Newswire

May 24, 2001, Thursday

**SECTION:** FINANCIAL NEWS

**DISTRIBUTION:** TO BUSINESS, TECHNOLOGY AND RADIO-TELEVISION EDITORS

**LENGTH:** 1025 words

**HEADLINE:** TiVo Granted Patent on Personal Video Recording Software and Hardware Design;  
Significant Patent Grants TiVo License for Key Personal Video Recording Technologies

**DATELINE:** SAN JOSE, Calif., May 24

**BODY:**

TiVo Inc. (Nasdaq: TIVO), the creator of and leader in personal television, today announced the United States Patent and Trademark Office (USPTO) has issued to TiVo a patent that covers many of the key inventions associated with personal video recording software and hardware design.

TiVo was formed on a foundation of significant technology developments and engineering that is unique in the landscape of technology art and sets TiVo apart from its competitors. As the first to market with the product and service now commonly referred to as a Personal Video Recorder or Digital Video Recorder, TiVo has defined the category and built a brand whose qualities exemplify the market overall. The TiVo brand is backed by significant inventions that were filed with the patent office long before consumers recognized the technology and its benefits. The USPTO issued patent number **6,233,389** to TiVo for a "Multimedia Timewarping System," originally filed in July of 1998.

"We are pleased that TiVo is receiving formal recognition for the invention of unique and novel technologies -- underpinning the making of Personal Video Recording devices. We realize that delivering a compelling and easy to use product and service to the market demands a new level of technological aptitude," said Jim Barton, Chief Technology Officer for TiVo. "TiVo's aptitude in this regard will become increasingly apparent as our patent portfolio grows over time. From the inception of the company, we have placed great emphasis on developing and protecting our intellectual properties including patents, copyrights, trademarks and trade secrets."

This patent discloses all aspects of the design and construction of the TiVo Receiver/Recorder. Key inventions in the patent include:

- a method for recording one program while playing back another or watching a program as it is recording, often referred to as



- time-shifting the program;
- a method for efficient and low-cost processing and synchronizing of the various multimedia streams in a television signal such as video, audio and closed-captioning, and
- a storage format that easily supports advanced Trickplay capabilities. Trickplay includes pausing the live TV broadcast, fast-forwarding, rewinding, instant replays and slow motion.

This is one of many patents filed by TiVo. In addition to the patent above, TiVo has been issued patent 6,215,526, which describes a method for embedding data within a television signal in such a way that it survives analog-to-digital and digital-to-analog conversion during the transmission process. TiVo owns design patents for its award winning remote control and the design for the integrated DIRECTV Receiver with TiVo. These patents are issued as Remote Control design patents: D424,061, D431,552, Remote Control housing design patents: D424,577, D435,403 and DIRECTV Receiver with TiVo bezel design patent: D434,043. TiVo also has pending applications that cover the end-to-end features and functions of the TiVo Service.

The patents have also been examined and approved under the terms of the Patent Convention Treaty (PCT), which provides for nominal acceptance of the patent in countries that are signatories to the treaty, which includes most countries in the world. TiVo is currently filing for acceptance in key countries around the world.

#### About TiVo, Inc.

TiVo is the creator of and leader in personal television. Founded in 1997 with the mission to dramatically improve consumers' television viewing experiences, TiVo developed a technology that serves as a platform for delivering a variety of home entertainment services. TiVo's Personal TV Service(TM) simplifies the way we watch and enjoy television by digitally recording television shows, without videotape, so you can watch what you want, when you want to watch it. TiVo was the first to deliver on the promise of consumer choice and control over TV viewing, building a loyal and passionate subscriber base. TiVo's leadership is grounded in its ability to forge critical partnerships, working together with the giants of the media, technology, consumer electronics, and television industries. Industry support of TiVo is reflected in its partner roster that includes, AOL, BSkyB, DIRECTV, Philips, SONY, Thomson and the leading cable and network television companies. Today, the TiVo Service is available in the United States on the Philips Personal TV Recorder(TM) and the Sony Digital Network Recorder (TM) in nearly 3500 consumer electronics retail and online outlets and in the UK under the Thomson Scenium brand. TiVo is headquartered in San Jose, CA. Additional information can be found at <http://www.tivo.com>.

This release may contain forward-looking statements regarding TiVo's business, customers or other factors that may affect future earnings or financial results. Such statements involve risks and uncertainties, which could cause actual results to vary materially from those, expressed in or indicated by the forward-looking statements. Factors that may cause actual results to differ materially include delays in development, competitive service offerings and lack of market acceptance. These risks and uncertainties are more fully described in the TiVo Annual Report on Form 10-K for the period ended December 31, 1999 and Form 10-Q for the quarter ended September 30, 2000 filed with the Securities and Exchange Commission.

NOTE: TiVo is a registered trademark of TiVo, Inc. in the United States and other jurisdictions. All other company or product names mentioned may be trademarks or registered trademarks of the respective companies with which they are associated.

MAKE YOUR OPINION COUNT - Click Here  
<http://tbutton.prnewswire.com/prn/11690X31292497>

SOURCE TiVo, Inc.

CONTACT: Rebecca Baer of TiVo Inc., 408-519-9225, or [rebecca@tivo.com](mailto:rebecca@tivo.com); or Teresa Brewer of Blanc and Otus, 408-519-9420, or [tbrewer@blancandotus.com](mailto:tbrewer@blancandotus.com), for TiVo Inc.

URL: <http://www.prnewswire.com>

**LOAD-DATE:** May 25, 2001

Source: [Command Searching > News, All \(English, Full Text\)](#) 

Terms: **6233389** or **6,233,389** ([Edit Search](#) | [Suggest Terms for My Search](#))

View: Full

Date/Time: Wednesday, October 31, 2007 - 10:09 AM EDT

[My Lexis™](#) | [Search](#) | [Research Tasks](#) | [Get a Document](#) | [Shepard's®](#) | [Alerts](#)  
[History](#) | [Delivery Manager](#) | [Switch Client](#) | [Preferences](#) | [Sign Off](#) | [Help](#)



**LexisNexis®**

[About LexisNexis](#) | [Terms & Conditions](#) | [Contact Us](#)

Copyright © 2007 LexisNexis, a division of Reed Elsevier Inc. All rights reserved.



Source: [Command Searching](#) > **News, All (English, Full Text)** 

Terms: **6233389** or **6,233,389** ([Edit Search](#) | [Suggest Terms for My Search](#))

Select for FOCUS™ or Delivery

*WORLD TRADE CENTER NETWORK - TRADE LEADS Journal of Commerce February 22, 1989, Wednesday*

Copyright 1989 The Journal of Commerce, Inc.  
Journal of Commerce

February 22, 1989, Wednesday

**SECTION:** EXPORTS, Pg. 8B

**LENGTH:** 2837 words

**HEADLINE:** WORLD TRADE CENTER NETWORK - TRADE LEADS

**BYLINE:** World Trade Center NETWORK

**BODY:**

HOW TO USE:

These trade leads are supplied through the World Trade Center NETWORK, a service of the World Trade Centers Association. Where possible, direct contacts are given. However, where none is provided, please contact the nearest World Trade Center or World Trade Center Association headquarters (tel: 212 466-8284; telex: 285472 WTN Y UR) and cite the file number given at the end of each tem.

OFFERS TO BUY

Plywood, soda ash

M/S. Peacock Int'l Ltd. Telex: 11717 PECACO. Fax: 886-2-7510442.

No. 108820 Filed 1989-02-16

Reebok shoes/export

Orion International Inc. Fax: (312) 246-0657. Tel: (312) 246-0026. Telex: 362802 ORIONINTL.

No. 108773 Filed 1989-02-14

Plastic, PVC products

Inpass-Trading, Marseille, France. Tel: (33) 91226559. Fax: (33) 91914114.

No. 108914 Filed 1989-02-21

X-mas ornaments

Grand Bahama Corp. Tel: (617) 524-3160. Fax: (617) 524-8042.

No. 108772 Filed 1989-02-14

Fish meal

Eastern Trust Industrial and Commercial Development Ent Ltd, Macau. Tel: 561181. Fax: 594038.

No. 108842 Filed 1989-02-17

Film for tape industry

Sanmin Trading Co., Taipei, Taiwan. Tel: (02) 7710116-8. Fax: 886-2-7517236.

No. 108896 Filed 1989-02-20

Shoes

Min Shen Enterprise Co., Taipei, Taiwan. Fax: 886-2-3813140. Telex: 22608 MINSHEN.

No. 108924 Filed 1989-02-21

TTL/CMOS items

Mr. E.K. Chang, En'sco Co., Taiwan. Fax: 886-2-7139646. Telex: 19252 ENSCOLTD.

No. 108785 Filed 1989-02-15

Boeing 747

Curtiss International. Fax: (216) 464-7609. Tel: (216) 292-8128.

No. 108865 Filed 1989-02-17

Iron or steel moulds

ICR SA, Geneva, Switzerland. Fax: 4122/43 08 70. Tel: 4122/43 53 71.

No. 108900 Filed 1989-02-20

Gold

A. Vaz P. de Carvalho. Telex: 53894 VAZPEC P. Tel: 075 62161.

No. 108897 Filed 1989-02-20

1989 automobiles

Shiuh Hao Trading Co., Taiwan. Tel: 886-7-7236180/7236107. Telex: 72124 SUPER.

No. 108787 Filed 1989-02-15

Cellulose acetate tow



M/S Peacock Int'l Ltd. Telex: 11717 PECACO. Fax: 886-2-7510442.

No. 108844 Filed 1989-02-17

8" color monitor

En'sco Co., Taiwan. Fax: 886-2-7139646. Telex: 19252 ENSCOLTD.

No. 108826 Filed 1989-02-16

Joint venture aluminum can  
manufacturing plant

A.A. Laquis Ltd. Tel: (809) 623-7325. Telex: 22572 LAQUIS WG.

No. 108830 Filed 1989-02-16

Coffee bean, 1,000 tons monthly

Pathfinder International Co., Taiwan. Tel: 886-2-3216731. Telex: 27161 BNGCOLTD

No. 108797 Filed 1989-02-15

Multifunction impact dot  
matrix printer

Reseumatique SA, France. Tel: (33) 32 30 23 46. Telex: 770693.

No. 108822 Filed 1989-02-16

Paper (5,000 tons) for printing

Guilpap Co., Nantes, France. Fax: 33 40 44 60 90. Tel: 33 40 35 20 25.

No. 108901 Filed 1989-02-20

Cane sugar

Allied Industries. Tel: (714) 947-8002. Fax: (714) 635-1210.

No. 108786 Filed 1989-02-15

Titanium dioxide

Yetgin Trading Co. GmbH, D-4300 Essen 1. Tel: +49-201-81 26 187. Fax: +49-201-81 26 199.

No. 108852 Filed 1989-02-17

F12/22 (5 containers)

Argonaut International, Waukesha, Wis. Fax: (414) 549-6837.

No. 108860 Filed 1989-02-17

Non-sterile examination gloves

A.A. Laquis Ltd., Port-of-Spain, Trinidad. Fax: (809) 623-4850. Tel: (809) 623-7325.

No. 108856 Filed 1989-02-17

Professional audio/video equipment

Mayfor International Corp., Taiwan. Fax: 886-2-7556832.

No. 108819 Filed 1989-02-16

Bearing/live centers

Zhu Zhi-ming, Nanjing Xinsheng Factory, Nanjing, China. Tel: 633118. Cable: 0348.

No. 108879 Filed 1989-02-18

Porcelain bath, basin, floor tile, etc.

Gu Lou Multiple Developing Co. of Cities and Towns, Nanjing, China. Tel: 306729/306063.

No. 108878 Filed 1989-02-18

Consumer goods

(health and beauty care)

Win-Bear Enterprise Ltd., Taipei, Taiwan. Fax: 886-2-7002932.

No. 108894 Filed 1989-02-20

Wool yarn

Elisabeth Siverling, Waukesha, Wis. Fax: (414) 549-6837. Tel: (414) 549-6858.

No. 108886 Filed 1989-02-19

Automatic dishwashing

machine detergent

Geng Yiu International Co., Taiwan. Telex: 29330 PIMCO. Tel: (02) 7058628, 7083178.

No. 108825 Filed 1989-02-16

TV sets, VCR, videotapes

Yetgin Trading Co. GmbH, D-4300 Essen 1. Tel: +49-201-81 26 187. Fax: +49-201-81 26 199.

No. 108851 Filed 1989-02-17

Auto parts



Argonaut International, Waukesha, Wis. Fax: (414) 549-6837. Tel: (414) 549-6858.

No. 108861 Filed 1989-02-17

OFFERS TO SELL

Urea, sulfur, broomstrick,

plywood, sugar

Eagle International Enterprises. Tel: (415) 340-8744. Telex: 4996186 JENNIKE.

No. 108812 Filed 1989-02-15

Inflatables for sales promotion

Boon Liew Corp., Taiwan. Telex: 20146 BLCORPT. Tel: (02) 5027676

No. 108792 Filed 1989-02-15

Laser system for use

in ophthalmology surgery

Mattom Co., Denver. Telex: 650 3586781 MCIUW. Fax: (303) 832-3018.

No. 108905 Filed 1989-02-20

Adirondack style wooden chairs

Tel: (716) 654-7777. Fax: (716) 482-1919.

No. 108775 Filed 1989-02-14

Ultrasound measuring equip.,

sphygmo-oscillometers

Amics International Inc. Tel: (804) 379-1354. Fax: (804) 379-3520

No. 108774 Filed 1989-02-14

Video movies

North American Sales Corp., Rockville, Md. Tel: (301) 975-9435. Fax: (301) 975-9429.

No. 108903 Filed 1989-02-20

Military boots (26,000 pairs)

Basil P.B. Giletto. Fax: (215) 732-6695. Tel: (215) 732-6527.

No. 108916 Filed 1989-02-21

Trade show exhibits, booths, stands

Derse Co. Tel: (414) 257-2000. Fax: (414) 257-1145.

No. 108782 Filed 1989-02-14

Water cooling type diesel engine

Taiyo Sangyo Co., Fukuoka, Japan. Fax: 093-621-6422. Tel: 093-621-6421.

No. 108888 Filed 1989-02-19

Syrian lentils

World Trade Centre Cairo. Fax: (202) 391-6233. Telex: 22612 WTCCAI UN.

No. 108887 Filed 1989-02-19

Discount travel

IBT Discount Travel. Tel: (714) 986-4182. Fax: (714) 986-1555.

No. 108913 Filed 1989-02-20

High-tech rotary-winged aircraft

World Trade Centre Toronto. Fax: (416) 226-2365.

No. 108912 Filed 1989-02-20

Stainless steel flatware,

steam table accessories

Bob Wallace. Tel: (512) 637-0555. Fax: (512) 637-0558

No. 108789 Filed 1989-02-15

Bib aprons, overstock of bed linen

Bob Wallace. Tel: (512) 637-0555. Fax: (512) 637-0558.

No. 108788 Filed 1989-02-15

Construction tools

Branche International Inc. Tel: (503) 626-6086. Fax: (503) 626-9433.

No. 108835 Filed 1989-02-16

Soundless alarm clock,

message clock

Prophone Co., Taiwan. Tel: 886-2-6233189, 886-2-**6233389**. Fax: 886-2-6235559.

No. 108892 Filed 1989-02-20



Batteries: general purpose AA, C, D

Asia Now Ltd., New York. Tel: (212) 410-6511. Fax: (212) 439-9109.

No. 108838 Filed 1989-02-16

Polypropylene polyethylene

M.A. Bagby Export Management Co. Tel: (213) 871-1315.

No. 108843 Filed 1989-02-17

Surgeon's sterile latex gloves

International Trading Ventures Inc. Tel: (212) 737-7310. Telex: 405632 ITV- INTL UD

No. 108778 Filed 1989-02-14

Fresh frozen horse mackerel 100 m/t Sunriseco Ind. Co., Taiwan. Tel: 886-7-8717635.  
Telex: 71503 SRCIDTS

No. 108821 Filed 1989-02-16

Sugar, tennis balls

Astros Import & Export. Tel: (305) 226-1747. Fax: (305) 223-5302.

No. 108891 Filed 1989-02-20

Razor blades, French

champagne, caviar

Yetgin Trading Co. GmbH, Essen, West Germany. Tel: +49 201 8126187. Fax: +49 201 8126199.

No. 108899 Filed 1989-02-20

Jeans

A. Vaz P. de Carvalho. Telex: 53894 VAZPEC P. Tel: 075 62161.

No. 108898 Filed 1989-02-20

Used medical equipment

Fax: (212) 933-6821.

No. 108870 Filed 1989-02-17

Cosmetics, skincare products

Owens-Stephens & Co. Intl. Tel: (415) 877-1559. Telex: 401785 OS UD

No. 108834 Filed 1989-02-16

Eau de toilette

Panda Trading of France. Telex: 136 707. Fax: 20 32 15 20.

No. 108864 Filed 1989-02-17

PVC floor tiles/carpets

Kaiser International Inc., One World Trade Centre, NY. Tel: (212) 466-6000. Fax: (212) 466-0074.

No. 108915 Filed 1989-02-21

Collection of 3,000 plush pets

Hubert Co., France. Telex: 722 266 F. Or Chamber of Commerce and Industry, France. Tel: (33) 41 88 23 11. Fax: 41 87 76 77.

No. 108799 Filed 1989-02-15

Synthetic fiber and yarn

Pathfinder International Co., Taiwan. Tel: 886-2-3216731. Telex: 27161 BNGCOLTD

No. 108796 Filed 1989-02-15

Fire truck, new, high aerial ladder

Frank K. Huber, Huber and Associates Inc. Tel: (414) 782-5945. Fax: (414) 274-3846.

No. 108779 Filed 1989-02-14

Shopping center

Tri-Star International Inc. Tel: (305) 893-2400. Fax: (305) 893-6105.

No. 108800 Filed 1989-02-15

Modular telephone accessories

Chien Chen Enterprises Co., Taiwan. Tel: 886-2-9150444, 9116850. Fax: 886-2-9175413.

No. 108793 Filed 1989-02-15

Raw quartz, antracite,

gems, minerals

De Brit's S.O.M., Colombia. Tel: 2183601, 2183701, 2183561. Telex: 45666 CEMCO CO.

No. 108804 Filed 1989-02-15

White flour

International Export Trading Co., Des Moines, Iowa. Tel: (515) 246-6013. Fax: (515) 246-6014.



No. 108884 Filed 1989-02-18

452-room luxury hotel

Tri-Star International Inc. Tel: (305) 893-2400. Fax: (305) 893-6105.

No. 108801 Filed 1989-02-15

Glass bottles

Lien Hoe Trading Co., Taiwan. Fax: 886-2-5361519. Tel: 886-2-5621166.

No. 108918 Filed 1989-02-21

Golf club head

Miss Fan Lih-jing, Taiwan. Tel: (07) 7416217. Fax: (07) 7467683.

No. 108795 Filed 1989-02-15

720,000 mt bulk urea

Burton Schwartz, Granfield Supply. Tel: (203) 334-5979. Fax: (203) 334-6702.

No. 108769 Filed 1989-02-14

Spring and winter wheat

American International Trading Group. Tel: (816) 333-5550. Fax: (816) 361-5096.

No. 108917 Filed 1989-02-21

Engines, transmissions, trucks, trailers Tel: (415) 877-1559. Fax: (415) 877-4471. Telex: 401785 OS UD.

No. 108833 Filed 1989-02-16

World sugar, US#2 yellow corn

Fax: (213) 578-7388. Telex: 493-1220 TUNEX-UI.

No. 108776 Filed 1989-02-14

Steam generator

James Kuklinski, Delphi International. Tel: (202) 466-7951. Fax: (202) 466-4113.

No. 108783 Filed 1989-02-14

Fla. waterfront shopping center

Tri-Star International Inc. Tel: (305) 893-2400. Fax: (305) 893-6105.

No. 108780 Filed 1989-02-14

Soviet Far East northern art

World Class Products Ltd. Tel: (503) 223-8970. Fax: (503) 464-2299.

No. 108906 Filed 1989-02-20

IBM 3101 MOD 834 monitors

Marvin Scroggins. Fax: 827-6115. Telex: 214098 UWBS UR.

No. 108817 Filed 1989-02-15

Computer: 101 key keyboard

Bill Dorsey. Tel: (619) 453-8445. Fax: (619) 558-3088.

No. 108873 Filed 1989-02-17

10,000 mt EC butter

Granfield Supply. Tel: (203) 334-5979. Fax: (203) 334-6702.

No. 108770 Filed 1989-02-14

Stone crab claws, seafood

Alkar International. Tel: (713) 999-5575. Fax: (713) 999-5574.

No. 108771 Filed 1989-02-14

Closed-circuit TV system

for home/business

Summa Industries. Tel: (801) 466-4019. Fax: (801) 467-2200.

No. 108920 Filed 1989-02-21

Golf shirts, dress shoes

Sanghwan Enterprise Co., Taiwan. Tel: 7251985. Fax: 886-2-9060328.

No. 108919 Filed 1989-02-21

Ascending conveyor and plastic roller Marino Enterprise Co., Taiwan. Tel: 07-7256652. Fax: 07-7256884.

No. 108840 Filed 1989-02-17

Used hospital/medical equipment

Aits Holding Co., Alaska. Fax: (907) 258-5520. Tel: (907) 258-5525.

No. 108875 Filed 1989-02-18

Latex exam gloves



Jasa International Corp. Tel: (714) 870-5277, 541-3005. Fax: (714) 680-0858, 835-9078.

No. 108784 Filed 1989-02-14

Reproductions of antique

Chinese pottery

Elliot & Azedo, Macau (via Hong Kong). Tel: 853-307668. Fax: 853-563398.

No. 108848 Filed 1989-02-17

Optical cases, spectacles,

clock/watch

Syzo International Inc., Taiwan. Telex: 27357 FWINSOME. Fax: 886-2-7620624.

No. 108847 Filed 1989-02-17

Software for IBM/PC

Thai S.L. Co., Thailand. Tel: 284-3210, 284-0210, 284-1700. Fax: 294-2263.

No. 108850 Filed 1989-02-17

27 mhz 286 plasma laptop computer

Confident Computer Co., Taiwan. Tel: 886-2-7173560 (4 lines). Fax: 886-2-7173564.

No. 108902 Filed 1989-02-20

Wyse 286/530 monitors

Fax: (612) 827-6115. Telex: 214098 UWBS UR.

No. 108816 Filed 1989-02-15

Cardboard

STE Recopa, France. Tel: 99.64.65.20. Fax: 99.64.80.40.

No. 108827 Filed 1989-02-16

No. 2 yellow corn, American

Delcor Industries. Tel: (512) 732-2000. Fax: (512) 525-0595.

No. 108863 Filed 1989-02-17

Badges, pins

Alvin Lee Jewelry, Inc., Taiwan. Tel: 2-712-5142. Fax: 2-713-9267.

No. 108882 Filed 1989-02-18

Structural square tubing

United Trade International. Fax: 27+11+545389. Telex: 4-25594 SA (U.T.I.)

No. 108855 Filed 1989-02-17

Sparkling wine

Ideal Business Services Ltd., West Germany. Fax: 49-201-265187.

No. 108802 Filed 1989-02-15

Toilet paper and paper towels

Young & Associates Ltd. Fax: (312) 991-9002.

No. 108832 Filed 1989-02-16

Ground enamel

Bioinvest Engineering, Bulgaria. Telex: 23162. Fax: 707295.

No. 108858 Filed 1989-02-17

Liquid carbon dioxide

Chimcomplect Eng., Bulgaria. Telex: 22785. Fax: 003592/867-3026.

No. 108857 Filed 1989-02-17

Commercial gear pump

motor products

Stephen Oehleyu. Fax: 2711 545389 or 2711 4 65 2746. Telex: 4-25594 S.A. (UTI) POST.

No. 108854 Filed 1989-02-17

Wheaten flour

Yetgin Trading Co. GmbH, Gildehof D-4300 Essen 1. Tel: +49-201-81 26 187. Fax: +49-201-81 26 199.

No. 108853 Filed 1989-02-17

Ultra compact head-phone stereo

Area Service Inc., Japan. Tel: (03) 366-9691. Fax: (03) 366-9650.

No. 108890 Filed 1989-02-20

Soybean oil

Jayro Corp. Fax: (914) 472-9744. Tel: (914) 725-1128



No. 108813 Filed 1989-02-15

Car burglar alarm and sensors

Howenia Enterprise Co., Taiwan. Fax: 886-2-7174407. Tel: (02) 7131517-8.

No. 108846 Filed 1989-02-17

Konica fax 100

Tel: (619) 453-8445. Fax: (619) 558-3088.

No. 108839 Filed 1989-02-17

Tartaric acid

Visatradars, France. Fax: 33 1 69 21 07 88.

No. 108926 Filed 1989-02-21

Oil refining barge

Hector M. Rodriguez. Tel: (512) 826-3422. Fax: (512) 820-3939.

No. 108781 Filed 1989-02-14

Industrial compressors/  
motors/pumps/generators

Bob Wallace. Tel: (512) 637-0555. Fax: (512) 637-0558.

No. 108921 Filed 1989-02-21

Telephone switching equipment

N.T.I. Tel: (717) 822-6677. Fax: (202) 785-4188.

No. 108815 Filed 1989-02-15

Distrs to foundries for sealant

Dean International. Fax: (414) 258-7067. Tel: (414) 250-0600.

No. 108872 Filed 1989-02-17

Exercise equipment/toning tables

Sleek Images. Tel: (513) 294-1777. Fax: (513) 294-5668.

No. 108871 Filed 1989-02-17

Distributors for cigarettes,

latex and sugar

Mr. N.A. Hernandez. Fax: (305) 620-4393. Tel: (305) 624-7734.

No. 108790 Filed 1989-02-15

Latex exam gloves

Sun Valley International. Tel: (602) 254 9452. Fax: (602) 258 4681.

No. 108910 Filed 1989-02-20

Ship for voyage or charter

Van Esch World Trade. Fax: (213) 658-7675. Tel: (213) 658-7747.

No. 108814 Filed 1989-02-15

Aerobic leather jump rope

Tel: (619) 558-3011. Fax: (619) 558-3029.

No. 108841 Filed 1989-02-17

Frozen banana passion fruit pulp

N. Franco y Cia S. en C., Colombia. Tel: 2184190-2184469.

No. 108805 Filed 1989-02-15

Charmglow LP gas grills/export

Young & Associates Ltd. Fax: (312) 991-9002.

No. 108831 Filed 1989-02-16

Pipe bending machine

Ming Jen International Enterprise Co., Taiwan. Telex: 22617 MINGJCO. Fax: 886-2-5015233.

No. 108791 Filed 1989-02-15

T-shirts, sweaters

Intra-Pac Enterprise. Tel: (415) 668-9433. Fax: (415) 668-9436.

No. 108923 Filed 1989-02-21

Pigskin for leather industry

Tsao Hou Co., Taiwan. Tel: 886-07-7319063/7319070. Fax: 886-07-7311783.

No. 108922 Filed 1989-02-21

Imitation jewelry

Tayford Enterprise Co., Taiwan. Tel: (02) 9463229, 9463234, 9425566. Fax: 886-2-9441463.



No. 108893 Filed 1989-02-20

Xerox 455 machines

Spartan Corp. Fax: (301) 621-8296. Tel: (301) 621-8290.

No. 108908 Filed 1989-02-20

Laser discs, blank video tapes

North American Sales Corp. Tel: (301) 975-9435. Fax: (301) 975-9429.

No. 108907 Filed 1989-02-20

Wood working machines

Boarke Machine Co., Taiwan. Tel: (045) 221792, 263738. Fax: (045) 337047. No. 108895  
Filed 1989-02-20

Computers

Bill Dorsey. Tel: (619) 453-8445. Fax: (619) 558-3088.

No. 108874 Filed 1989-02-17

Wire forming parts and components

Aye-Star Co., Taiwan. Tel: (02) 7005120, 7085221. Fax: 886-2-7008675.

No. 108881 Filed 1989-02-18

Collector prints

Alaskan Artifacts, Anchorage, Alaska 99511. Fax: (907) 561-1541. Tel: (907) 561-1615.

No. 108876 Filed 1989-02-18

Fertilizer

Global Marketing Ltd. Fax: (312) 803-8656.

No. 108807 Filed 1989-02-15

Sunglasses

Select Trade, Downsview, Ontario, Canada M3K1S2. Tel: 416-631-0781. Fax: 416-631-0213.

No. 108904 Filed 1989-02-20

Imitation pearls

Beauty Kingdom International Co., Taiwan. Tel: 02-7132790 (rep). Fax: 886-2-7127254.

No. 108824 Filed 1989-02-16

Cotton denim T-shirts

Pacific Fibers Inc. Tel: 602 254 9452. Fax: 602 258 4681.

No. 108911 Filed 1989-02-20

Door bell, automatic emergency lightMain Fain Trading Co., Taiwan. Telex: 12681 MFAIN.  
Fax: 886-2-3627573.

No. 108794 Filed 1989-02-15

**EDITOR-NOTE:**

WORLD TRADE CENTER NETWORK - Trade Leads. Briefs

**LOAD-DATE:** December 19, 1996

Source: [Command Searching](#) > [News, All \(English, Full Text\)](#) 

Terms: **6233389** or **6,233,389** ([Edit Search](#) | [Suggest Terms for My Search](#))

View: Full

Date/Time: Wednesday, October 31, 2007 - 10:09 AM EDT

[My Lexis™](#) | [Search](#) | [Research Tasks](#) | [Get a Document](#) | [Shepard's®](#) | [Alerts](#)  
[History](#) | [Delivery Manager](#) | [Switch Client](#) | [Preferences](#) | [Sign Off](#) | [Help](#)



**LexisNexis®**

[About LexisNexis](#) | [Terms & Conditions](#) | [Contact Us](#)

Copyright © 2007 LexisNexis, a division of Reed Elsevier Inc. All rights reserved.



Source: [Command Searching](#) > **News, All (English, Full Text)**   
Terms: **6233389** or **6,233,389** ([Edit Search](#) | [Suggest Terms for My Search](#))

Select for FOCUS™ or Delivery

*WORLD TRADE CENTER NETWORK - TRADE LEADS Journal of Commerce February 1, 1989,  
Wednesday*

Copyright 1989 The Journal of Commerce, Inc.  
Journal of Commerce

February 1, 1989, Wednesday

**SECTION:** EXPORTS, Pg. 4B

**LENGTH:** 2771 words

**HEADLINE:** WORLD TRADE CENTER NETWORK - TRADE LEADS

**BYLINE:** World Trade Center NETWORK

**BODY:**  
HOW TO USE:

These trade leads are supplied through the World Trade Center NETWORK, a service of the World Trade Centers Association. Where possible, direct contacts are given. However, where none is provided, please contact the nearest World Trade Center or World Trade Center Association headquarters (tel: 212 466-8284; telex: 285472 WTN YR) and cite the file number given at the end of each tem.

**OFFERS TO BUY**

Nintendo software games

North American Sales Corp., Rockville, Md. Tel: (301) 975-9435. Fax: (301) 975-9429.

No. 108416 Filed 1989-01-26

Portland cement

Spring Come Industrial Co., Taipei, Taiwan. Fax: 886-2-7853080. Telex: 17016 SPRCOME.

No. 108455 Filed 1989-01-28

Lobster, black tiger

Hyogo-Pref., Japan. Tel: 0794 (32) 1200. Fax: 0794 (32) 3476.

No. 108462 Filed 1989-01-30

Auto belt factory, brake shoes

A. Nassif Trading Co., Los Angeles. Fax: (818) 569-7470. Tel: (818) 848-9419.

No. 108364 Filed 1989-01-24

Salt block manufacturing plant

Banacom Corp., Southbridge, Mass. Telex: 9102900434 BANACOM UQ. Fax: (508) 764-7207.

No. 108459 Filed 1989-01-28

Used H-P computer equipment

Fax: (619) 558-3088.

No. 108449 Filed 1989-01-27

Fax machines, computers

Harold Glatt. Tel: (305) 726-1353. Fax: (305) 721-4386.

No. 108487 Filed 1989-01-30

Sports equipment

Harold Glatt. Tel: (305) 726-1353. Fax: (305) 721-4386.

No. 108486 Filed 1989-01-30

Machinery for bowling alleys,

table TV games, gym exercise

Meisei Trading Co., Osaka, Japan. Telex: 5277456 SEPYOL J. Fax: 06-976-4732.

No. 108427 Filed 1989-01-27

Wool boiling machinery

Impex Industries, Gothenburg, Sweden. Tel: +46 31 811835. Telex: 21163 IMPEX S.

No. 108379 Filed 1989-01-25

Food

Hong Ya Food Co., Taipei Hsien, Taiwan. Fax: 886-2-9448877. Tel: 886-2-9434660.

No. 108468 Filed 1989-01-30

Kitchen accommodations,

carpet for large hotel

Meisei Trading Co., Osaka, Japan. Telex: 5277456 SEPYOL J. Fax: 06-976-4732.

No. 108428 Filed 1989-01-27

Plastics scrap (surplus or reject)

Lion Rock Holdings Ltd., Vancouver. Fax: (604) 662-7934. Telex: 04-54654 VCR.

No. 108370 Filed 1989-01-24

Log homes

Joseph Russo, Xport Port Authority Trading Co., One World Trade Center. Tel: (212) 466-8306. Fax: (212) 432-0297. Telex: 427346 NYANDNJ.

No. 108507 Filed 1989-01-31

Safety shoes

Rennes Chamber of Commerce, France. Tel: 99.33.66.50. Telex: 730091. Fax: 99.33.24.28.

No. 108430 Filed 1989-01-27

Crude oil, diesel

Blazepoint Ltd. Fax: 44 51 709 4. Telex: 627617 BLAZE G. Tel: 44 51 709 4485.

No. 108504 Filed 1989-01-31

Used EMD and Alco

marine engine blocks

Kelly Steele. Tel: (504) 340-4393. Fax: (504) 340-4397.

No. 108488 Filed 1989-01-30

Caprolactam

Trans-Atlantic Trading Ltd. Fax: (914) 332-1175. Telex: 4974205 TAT UI.

No. 108368 Filed 1989-01-24

Large aircraft

Sharp & Associates Inc., Lexington, Ky. Tel: (606) 269-9663. Fax: (606) 269-9664.

No. 108365 Filed 1989-01-24

Color TV

Ch. Liegler Kg, Vienna, Austria. Fax: 432226048075.

No. 108506 Filed 1989-01-31

Hunting and fishing equipment

UTM-Produkter AB, Sweden. Tel: +46 278 46390. Fax: +46 278 46395.

No. 108399 Filed 1989-01-26



Beauty goods

Sunrise Ind. Co., Kaohsiung, Taiwan. Tel: 886 7 8717635-8. Telex: 71503 SRCIDTS.

No. 108426 Filed 1989-01-27

Telecommunication products

Societe Commerciale Euro-Taiwanaise, Taipei, Taiwan. Tel: 886-2-5413253/4. Fax: 886-2-5367575.

No. 108398 Filed 1989-01-26

Air compressor for refrigerator,

urea, cement

M/S Peacock International Ltd. Fax: 886-2-7510442. Telex: 11717.

No. 108394 Filed 1989-01-26

OEM toners for copiers

and laser printers

IMX International Inc., Skokie, Ill. Fax: (312) 675-1242. Tel: (312) 675-1234.

No. 108406 Filed 1989-01-26

Urea, almonds

United Enterprises. Telex: 06526129. Fax: (416) 475-1556.

No. 108423 Filed 1989-01-27

Barley

Blazepoint Ltd. Fax: 44 51 709 4886. Telex: 627617. Tel: 44 51 709 4485.

No. 108502 Filed 1989-01-31

T/C ball for ball point pen

Bensia Co., Bangkok, Thailand. Tel: (662) 538-2588. Fax: (662) 538-6687. Telex: 22336 BENSIA.

No. 108497 Filed 1989-01-31

Polyurethane foam, scrap

Tim Kennedy or Cliff Carlson. Tel: (417) 887-1907. Fax: (417) 887-2305.

No. 108414 Filed 1989-01-26

OFFERS TO SELL

Video movies

North American Sales Corp., Rockville, Md. Tel: (301) 975-9435. Fax: (301) 975-9429.

No. 108420 Filed 1989-01-26

Disposable medical supplies

Mann Chi Trading Co., Taiwan. Fax: 7-2718300. Telex: 73202 MANCHI. Tel: 7-2718819,2812700.

No. 108500 Filed 1989-01-31

600 mt apricot pulp concentrate,

computer/fax paper

S-B Group International Inc., Miami. Tel: (305) 854-4415. Fax: (305) 446-8444. Telex: 6503640870 MCI UW.

No. 108367 Filed 1989-01-24

Radon test kits

J.C. Brantley International Traders. Fax: (515) 246-6008. Tel: (515) 246-6182.

No. 108366 Filed 1989-01-24

Barber chairs

Bob Dolch, San Antonio, Texas. Tel: (512) 341-5159.

No. 108372 Filed 1989-01-25

Seafood

Camelot International Export Inc., Nova Scotia. Tel: (902) 428-7233. Fax: (902) 423-0658.

No. 108434 Filed 1989-01-27

Ionization smoke detectors

National Alarm, Los Angeles. Tel: (213) 487-3015. Fax: (412) 963-9106.

No. 108395 Filed 1989-01-26

Fine art photography cards

Western Wonder Art Photos, Lakeside, Ore. Tel: (503) 759-3936.

No. 108417 Filed 1989-01-26

Fishing vessels

Jean Michel Delaboudiniere, World Trade Center Nantes. Telex: 710 586. Fax: 33 40 44 60

90.

No. 108478 Filed 1989-01-30

Mufflers

Jun Gin Co., Taipei Taiwan. Telex: 34314. Fax: 2 2532348.

No. 108501 Filed 1989-01-31

Disposable wooden chopsticks

Intra-Pac Enterprise. Fax: (415) 668-9433. Tel: (415) 668-9436.

No. 108412 Filed 1989-01-26

Textile wax roll for

cotton, wool, polyester

Tailent Chen/Talent Point Co., Taiwan. Tel: 886-2-9469666. Telex: 27267 CSQUILT.

No. 108383 Filed 1989-01-25

3m diskettes - 5.25 and 3.5 inch

M. Scroggins. Tel or fax: (612) 827-6115. Telex: 214098 UWBS UR.

No. 108382 Filed 1989-01-25

Raw metals, silicon gel

Metalinco, Singapore. Tel: 65-4663851. Fax: 65-4663718. Telex: RS 24200 TM2744.

No. 108373 Filed 1989-01-25

Woodcarvings

Vazquez Lopez Inc. Tel: (512) 662-6935.

No. 108458 Filed 1989-01-28

Solvents, reagents

Tailent Chen/Talent Point Co., Taiwan. Tel: 886-2-9469666. Telex: 27267 CSQUIT.

No. 108384 Filed 1989-01-25

IBM PC-compatible products

Ms. Bennie S. Wynn. Tel: (212) 870-4188.

No. 108437 Filed 1989-01-27

Golf clubs



Lanzarotta World Trade, Port Hueneme, Calif. Tel: (805) 984-0608. Fax: (805) 988-1862.

No. 108436 Filed 1989-01-27

Used trucks, parts

Benne Trading Co., NY. Tel: (718) 392-5615. Fax: (718) 729-7085. Telex: 4930510 BEN UI.

No. 108489 Filed 1989-01-30

Cotton and related fibers

Care Tech Products. Tel: (214) 404-8050. Fax: (214) 404-0973.

No. 108473 Filed 1989-01-30

Color diskettes

Summa Industries, Salt Lake City. Tel: (801) 466-4019. Telex: 7101113204.

No. 108376 Filed 1989-01-25

Golf balls, equipment

Fax: (714) 964-9848.

No. 108448 Filed 1989-01-27

Patient transfer device

Tel: (503) 626-6086. Fax: (503) 626-9433.

No. 108446 Filed 1989-01-27

Debarked logs

Overseas Trading Co., Kent, Conn. Fax: (203) 927-3978.

No. 108451 Filed 1989-01-28

Tubular braided rug, oval rug

M/S Peacock Int'l Ltd., Taiwan. Telex: 11717 PECACO. Fax: 886-2-7510442.

No. 108403 Filed 1989-01-26

Salt-to-fresh water desalting

equipment for boats

Japan General Supplies Corp., Kobe, Japan. Fax: 81-78-222-6123. Telex: J78882 JAGENSCO.

No. 108496 Filed 1989-01-31

Christmas decorations

Firman International Co., Taiwan. Fax: 886-2-7043675. Telex: 051-265037 IPSA.

No. 108400 Filed 1989-01-26

Bimetal thermometers

and pressure gauges

Yuen Mai Industrial Co., Taiwan. Fax: 886-2-7324373. Telex: 14882 YMAIC.

No. 108397 Filed 1989-01-26

Portland cement, fishmeal

Care Tech Products. Tel: (214) 404-8050. Fax: (214) 404-0973.

No. 108475 Filed 1989-01-30

Exotic reptile skins

Care Tech Products. Tel: (214) 404-8050. Fax: (214) 404-0973.

No. 108472 Filed 1989-01-30

Shower toilet seat

Aizia Enterprise Co., Taiwan. Telex: 31219 KUOBROS. Fax: 886-2-9651166.

No. 108380 Filed 1989-01-25

Soundless (vibrating) alarm

clock, message clock

Prophone Co., Taiwan. Tel: 886-2-6233189, 886-2-**6233389**. Fax: 886-2-6235559.

No. 108424 Filed 1989-01-27

Sulfur, urea

Care Tech Products. Tel: (214) 404-8050. Fax: (214) 404-0973.

No. 108466 Filed 1989-01-30

Thai rice, canned tuna

Care Tech Products. Tel: (214) 404-8050. Fax: (214) 404-0973.

No. 108465 Filed 1989-01-30

Exotic wood

International Diversified Associates. Tel: (604) 872-5132. Fax: (604) 874-7232.

No. 108463 Filed 1989-01-30

Water filter/purifier systems

Page International, Placentia, Calif. Tel: (714) 524-8567. Telex: 213889 PAGE UR.

No. 108438 Filed 1989-01-27

Costa Rican coffee/candies/jam;

Canadian liquor

Lion Rock Holdings Ltd, Vancouver. Fax: (604) 662-7934. Telex: 04-54654 VCR.

No. 108391 Filed 1989-01-25

Sterile surgeon's gloves

Miller Products Co., North Bergen, N.J. Tel: (201) 662-2010. Fax: (201) 662-0912.

No. 108388 Filed 1989-01-25

VHS movies

North American Sales Corp., Rockville, Md. Tel: (301) 975-9435. Telex: 401453 (NASC UD).

No. 108421 Filed 1989-01-26

Latex gloves

IBC Cargo Inc., Windsor Locks, Conn. Tel: (203) 627-5522.

No. 108493 Filed 1989-01-30

Sterile surgical latex gloves

International Trading Ventures Inc. Tel: (212) 737-7310. Telex: 405632 ITV INTL UD.

No. 108490 Filed 1989-01-30

British soap

IBC Cargo Inc., Windsor Locks, Conn. Tel: (203) 627-5522.

No. 108491 Filed 1989-01-30

IV sets

Cosmic International, Houston. Tel: (713) 868-9569. Fax: (713) 868-1649.

No. 108494 Filed 1989-01-30

Refrigeration/air conditioning tools

Golden Scorpio International Co., Taiwan. Tel: 886-4-2926023. Fax: 886-4-2950723.

No. 108464 Filed 1989-01-30



Vinyl gloves

Miller Products Co., North Bergen, N.J. Tel: (201) 662-2010. Fax: (201) 662-0912.

No. 108387 Filed 1989-01-25

Small arms ammunition

Wayne Clingman, Waukesha, Wis. Fax: (414) 549-1095.

No. 108374 Filed 1989-01-25

Digital electronics equipment

International Diversified. Tel: (604) 253-3987. Fax: 604 874-7232.

No. 108419 Filed 1989-01-26

HDPE bags/black garbage bags

Hannah Int. Co., Bangkok, Thailand. Fax: (662) 5389668. Tel: (662) 5389766.

No. 108498 Filed 1989-01-3 1

Zinc scrap

Bob Dolch, San Antonio, Texas. Tel: (512) 341-5159.

No. 108371 Filed 1989-01-25

High-speed ferry

Mr. Demencius. Tel: (504) 469-9119. Telex: 984170. Fax: 504 469-9919.

No. 108432 Filed 1989-01-27

Tung oil floor finish

Tom Lavery Overseas Trading Co., Kent, Conn. Fax: (203) 927-3978.

No. 108452 Filed 1989-01-28

Micro-capsule for making

carbonless paper

Talent Chen/Talent Point Co., Taiwan. Tel: 886-2-9469666. Telex: 27267 CSQUILT.

No. 108385 Filed 1989-01-25

Pure maple syrup

Advanced International Marketing, Oshawa, Ontario. Fax: (416) 487-3981.

No. 108443 Filed 1989-01-27

1987 Cadillac touring sedan

Mr. Van Camp. Tel: (606) 276-4709. Fax: (606) 276-4509.

No. 108442 Filed 1989-01-27

Designer umbrellas

Saint Dynasty Enterprise Ltd., Taiwan. Telex: 29330 PIMCO. Fax: 02- 7070227.

No. 108378 Filed 1989-01-25

VDT filter

Taiwan. Tel: (02) 551-3692. Fax:(02)536-3696. Telex: 28902 RCSTEC.

No. 108401 Filed 1989-01-26

Floppy diskettes

The Digital Trading Co., Columbus, Ohio. Tel: (614) 263-3797. Fax: (614) 263-3606.

No. 108415 Filed 1989-01-26

Canned tuna

Murraymark Industries Inc. Fax: (416) 673-9494. Tel: (416) 622-2696.

No. 108413 Filed 1989-01-26

Leather products

Pt. Astra Export Co., Indonesia. Tel: 62-021-354474, 356831-34. Telex: 46049 ACECOM IA.

No. 108474 Filed 1989-01-30

Culinary product (pot and pan pad)

Grenoco HB, Gothenburg, Sweden. Tel: +46 31 163506. Fax: +46 31 166261.

No. 108381 Filed 1989-01-25

Seafood processing plant

Dick Demencius. Tel: (504) 469-9119. Telex: 984170. Fax: (504) 469-9919.

No. 108481 Filed 1989-01-30

Fishing basket, brassware, lamp

Rice Fragrance Ent. Corp., Taiwan. Fax: 886-2-776-1549. Telex: 20246 DANIEL.

No. 108505 Filed 1989-01-31

Bamboo and wooden chopsticks

Yuang Hua Enterprise Co., Taipei, Taiwan. Tel: (02)5067281. Telex: 27823 YUANGHUA.

No. 108471 Filed 1989-01-30

Quartz wall clocks

Pt. Mirado Abadi Corp., Indonesia. Fax: 62-031-513088. Telex: 34365 IA.

No. 108469 Filed 1989-01-30

Long grain polished #2 white rice

Figueroa International Inc. Fax: (504) 468-8785. Tel: (504) 469-4210.

No. 108450 Filed 1989-01-28

Fax thermal paper in jumbo rolls

Japan General Supplies Corp., Kobe, Japan. Fax: 81-78-222-6123.

No. 108377 Filed 1989-01-25

Live trees, tree seedlings,

cut flowers, orchid, bonsai

Ko Long Industrial Co., Taiwan. Telex: 07-73456 KOLONG. Fax: 07-3124697. Tel: 07-3126063.

No. 108454 Filed 1989-01-28

Ascending conveyor, plastic roller

Marino Enterprise Co., Taiwan. Tel: 07-7256652. Telex: 71738 ENG-DENG. Fax: 07-7256884.

No. 108453 Filed 1989-01-28

Fashion costume jewelry

Starrylite Fashions Co., Taiwan. Telex: 25500 GICOLTD. Fax: 886-2-5428749.

No. 108499 Filed 1989-01-31

Yttrium oxide 99.99 percent

Mica Schober. Tel: (614) 431-9944. Fax: (614) 885-3881. Telex: 9102509944 MICA INTL UQ.

No. 108407 Filed 1989-01-26

Hospital/medical equipment

Aits Holding Co., Anchorage, Alaska. Fax: (907) 258-5520. Telex: 403291 AITS INVEST.

No. 108440 Filed 1989-01-27



Canadian mineral water

Kevin Wifison. Tel: (604) 941-0671. Fax: (604) 464-1935.

No. 108439 Filed 1989-01-27

North American cars and parts

Camelot International, c/o World Trade Centre Halifax. Tel: (902) 428-7233. Fax: (902) 423-0658.

No. 108435 Filed 1989-01-27

Ancient Egyptian art

Momtaz Louka. Tel: (713) 893-3062. Fax: (713) 875-5940.

No. 108359 Filed 1989-01-24

Aluminum sheet and plate

D. Wells. Tel: (902) 876-7861. Fax: (902) 876-8455.

No. 108411 Filed 1989-01-26

Rosewood and teak furnishings

Dynasty Imports, Nova Scotia. Tel: (902) 542-4464. Fax: (902) 679-2688.

No. 108409 Filed 1989-01-26

Cement in bags

Mica Schober. Tel: (614) 431-9944. Fax: (614) 885-3881. Telex: 9102509944 MICA INTL UQ.

No. 108408 Filed 1989-01-26

Steel bars and billets, steel rebar

Kreher Steel Co. Tel: (312) 345-8180. Fax: (312) 345-8293. Telex: 654808.

No. 108444 Filed 1989-01-27

OTHERS

Sponsor company needed to deal

with Royal Family of Saudi Arabia

Multinational Enterprises Network. Fax: (202) 362-3037.

No. 108457 Filed 1989-01-28

West African lumber trade fair

Rolling Investments Ltd., Quincy Mass. Tel: (617) 328-7881. Telex: 951131 HQBSN.

No. 108456 Filed 1989-01-28

Horse industry

publication subscription

The Horse Digest Magazine, Berea, Ky. Tel: (606) 986-4644. Fax: (606) 986-1770.

No. 108445 Filed 1989-01-27

Hazardous material conference

Canadian Exhibition Management Inc., Edmonton. Tel: (403) 469-2400. Fax: (403) 469-1398.

No. 108390 Filed 1989-01-25

Customs broker, international freight

forwarder, distribution and warehousing

Columbia Shipping Inc. (West), Los Angeles. Fax: (213) 649-0484. Telex: 295309 CSIW UR.

No. 108375 Filed 1989-01-25

Agents for Korea

Contact: Jin Sung Corp., Seoul, Korea. Tel: (02)-774-5007. Fax: (02)- 774-5008.

No. 108477 Filed 1989-01-30

Computerized translation

(French to English)

Tel: (215) 891-1983. Fax: (215) 891-7870.

No. 108460 Filed 1989-01-29

Swiss banking facilities

Nisma SA, Geneva, Switzerland. Tel: 20 30 90. Telex: 42 12 71. Fax: 20 00 06.

No. 108405 Filed 1989-01-26

Distribution of electrical

products in France

Mr. Schwartz, World Trade Center Strasbourg (France). Telex: ITAST 890 673F. Tel: (33) 88 32 48 90. Fax: (33) 88 75 51 23.

No. 108404 Filed 1989-01-26

Agents for Switzerland

Mica Schober. Tel: (614) 431-9944. Fax: (614) 885-3881. Telex: 9102509944 MICA INTL UQ.

No. 108447 Filed 1989-01-27

Large ship for private club

Dick Demencius. Tel: (504) 469-9119. Telex: 984170. Fax: (504) 469-9919.

No. 108484 Filed 1989-01-30

Marine transportation

Dick Demencius. Tel: (504) 469-9119. Telex: 984170. Fax: (504) 469-9919.

No. 108483 Filed 1989-01-30

Shoe retail stores

Mr. Gerard Nicole, Lac d'Annecy, France. Tel: 50.45.37.44. Telex: 385 417.

No. 108470 Filed 1989-01-30

Building system technology

Depon International. Fax: (907) 373-7377. Telex: 981074 WTCA AHG UD.

No. 108441 Filed 1989-01-27

**EDITOR-NOTE:**

WORLD TRADE CENTER NETWORK - Trade Leads. Briefs

**LOAD-DATE:** December 19, 1996

Source: [Command Searching](#) > [News, All \(English, Full Text\)](#) 

Terms: **6233389** or **6,233,389** ([Edit Search](#) | [Suggest Terms for My Search](#))

View: Full

Date/Time: Wednesday, October 31, 2007 - 10:10 AM EDT

[My Lexis™](#) | [Search](#) | [Research Tasks](#) | [Get a Document](#) | [Shepard's®](#) | [Alerts](#)  
[History](#) | [Delivery Manager](#) | [Switch Client](#) | [Preferences](#) | [Sign Off](#) | [Help](#)



**LexisNexis®**

[About LexisNexis](#) | [Terms & Conditions](#) | [Contact Us](#)

Copyright © 2007 LexisNexis, a division of Reed Elsevier Inc. All rights reserved.





UNITED STATES PATENT AND TRADEMARK OFFICE

UNITED STATES DEPARTMENT OF COMMERCE  
United States Patent and Trademark Office  
Address: COMMISSIONER FOR PATENTS  
P.O. Box 1450  
Alexandria, Virginia 22313-1450  
www.uspto.gov

APPLICATION NO.	FILING DATE	FIRST NAMED INVENTOR	ATTORNEY DOCKET NO.	CONFIRMATION NO.
90/007,750	10/17/2005	6233389	2513.001REX0	4653

26111                      7590                      11/01/2007

STERNE, KESSLER, GOLDSTEIN & FOX P.L.L.C.  
1100 NEW YORK AVENUE, N.W.  
WASHINGTON, DC 20005

EXAMINER

ART UNIT                      PAPER NUMBER

DATE MAILED: 11/01/2007

Please find below and/or attached an Office communication concerning this application or proceeding.



UNITED STATES PATENT AND TRADEMARK OFFICE

Commissioner for Patents  
United States Patent and Trademark Office  
P.O. Box 1450  
Alexandria, VA 22313-1450  
[www.uspto.gov](http://www.uspto.gov)

THIRD PARTY REQUESTER'S CORRESPONDENCE ADDRESS

11/1/07

DAVID L. FEHRMAN  
MORRISON & FOERSTER, LLP  
555 W. FIFTH STREET, SUITE 3500  
LOS ANGELES, CA 90013

***EX PARTE* REEXAMINATION COMMUNICATION TRANSMITTAL FORM**

REEXAMINATION CONTROL NO 90/007750  
PATENT NO. 6,233,389  
ART UNIT 3992

Enclosed is a copy of the latest communication from the United States Patent and Trademark Office in the above identified ex parte reexamination proceeding (37 CFR 1.550(f)).

Where this copy is supplied after the reply by requester, 37 CFR 1.535, or the time for filing a reply has passed, no submission on behalf of the ex parte reexamination requester will be acknowledged or considered (37 CFR 1.550(g)).



UNITED STATES PATENT AND TRADEMARK OFFICE

Commissioner for Patents  
United States Patent and Trademark Office  
P.O. Box 1450  
Alexandria, VA 22313-1450  
[www.uspto.gov](http://www.uspto.gov)

STERNE, KESSLER, GOLDSTEIN  
& FOX P.L.L.C.  
1100 NEW YORK AVENUE, N.W.  
WASHINGTON DC 20005

(For Patent Owner)

MAILED

NOV 01 2007

CENTRAL REEXAMINATION UNIT

(For Third Party Requester)

David L Fehrman  
MORRISON & FOERSTER, LLP  
555 W. Fifth Street, Suite 3500  
Los Angeles, CA 90013

DECISION GRANTING  
PETITION FOR EXTENSION  
OF TIME  
[37 CFR 1.550(c)]

*In re: Barton et alia*  
*Ex Parte* Reexamination Proceeding  
Control No. 90/007,750  
Filed: October 17, 2005  
For: US Patent No. 6,233,389

This is a decision on the October 29, 2007, "Petition for Extension of Time Under 37 CFR 1.550 (c)," requesting that the time for responding to the Office action mailed July 30, 2007, be further extended by one week (seven days).

The petition is before the Director of the Central Reexamination Unit for consideration.

The petition is granted for the reasons set forth below.



### Decision

The Patent Owner requests a further extension of time in which to file a response to the Office action mailed July 30, 2007, which set a two month date for filing a response thereto. The Office action is a non-final Office action. The petition for extension of time was timely filed on October 29, 2007, together with the on-line payment authorization for the \$200.00 petition fee required by 37 CFR 1.515(c).

37 CFR 1.550 (c ) states:

(c) The time for taking any action by a patent owner in an ex parte reexamination proceeding will be extended only for sufficient cause and for a reasonable time specified. Any request for such extension must be filed on or before the day on which action by the patent owner is due, but in no case will the mere filing of a request effect any extension. Any request for such extension must be accompanied by the petition fee set forth in § 1.17(g). See § 1.304(a) for extensions of time for filing a notice of appeal to the U.S. Court of Appeals for the Federal Circuit or for commencing a civil action.

Addressing the requirement of 37 CFR 1.550 (c ) to make a showing of “sufficient cause” to grant an extension of time request, MPEP 2265 states, in pertinent part:

Evaluation of whether sufficient cause has been shown for an extension must be made in the context of providing the patent owner with a fair opportunity to present an argument against any attack on the patent, and the requirement of the statute (35 U.S.C. 305) that the proceedings be conducted with special dispatch. ...

Any request for an extension of time in a reexamination proceeding must fully state the reasons therefor. ...

### Analysis and Findings

On balance, the Patent Owner’s showing of “sufficient cause” is met by reasoning regarding the extensive time required to adequately respond to the outstanding Office action. The patent owner has submitted an after final amendment and requested an extension of seven days to determine whether a further response is required to place the claims in a determination of patentability or confirmed.

The petition request is **granted**.

**Conclusion**

1. The patent owner's petition for a further extension of one-week (seven days) time in which to file a response to the Office action dated July 30, 2007 is **granted**.
2. The Patent Owner's response is due **November 6, 2007**.
3. Response may be submitted as follows:

By Mail to: Mail Stop *Ex Parte* Reexam  
Central Reexamination Unit  
Commissioner for Patents  
United States Patent & Trademark Office  
P. O. Box 1450  
Alexandria, VA 22313-1450

By Fax to: (571) 273-9900  
Central Reexamination Unit

By Hand: Customer Service Window  
Randolph Building  
401 Dulany Street  
Alexandria, VA 22314

4. Telephone inquiries with regard to this decision should be directed to Mark Reinhart, Supervisory Patent Examiner in the Central Reexamination Unit, Art Unit 3992, at (571) 272-1611

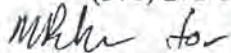

MARK J. REINHART  
SPRE-AU 3992  
CENTRAL REEXAMINATION UNIT

Lissi Mojica Marquis,  
Director,  
Central Reexamination Unit  
3999



<b>Issue Classification</b> 	Application/Control No.	Applicant(s)/Patent under Reexamination	
	90/007,750	6233389	
	Examiner	Art Unit	
	Ovidio Escalante	3992	

ISSUE CLASSIFICATION											
ORIGINAL					CROSS REFERENCE(S)						
CLASS		SUBCLASS			CLASS	SUBCLASS (ONE SUBCLASS PER BLOCK)					
386		46			386	68	E5.043	E5.07			
INTERNATIONAL CLASSIFICATION					348	E5.007	E5.108				
H	0	4	N	5/91							
				/							
				/							
				/							
				/							

None (Assistant Examiner) (Date)	<i>Ovidio Escalante</i> (Primary Examiner) (Date)	Total Claims Allowed: 61
<i>James R. Matthew</i> 11-7-07 (Legal Instruments Examiner) (Date)	11/1/07 (Date)	O.G. Print Claim(s) 1
		O.G. Print Fig. 1

<input checked="" type="checkbox"/> Claims renumbered in the same order as presented by applicant		<input type="checkbox"/> CPA		<input type="checkbox"/> T.D.		<input type="checkbox"/> R.1.47	
Final	Original	Final	Original	Final	Original	Final	Original
1	1	31	31	61	61		121
2	2	32	32		62		122
3	3	33	33		63		123
4	4	34	34		64		124
5	5	35	35		65		125
6	6	36	36		66		126
7	7	37	37		67		127
8	8	38	38		68		128
9	9	39	39		69		129
10	10	40	40		70		130
11	11	41	41		71		131
12	12	42	42		72		132
13	13	43	43		73		133
14	14	44	44		74		134
15	15	45	45		75		135
16	16	46	46		76		136
17	17	47	47		77		137
18	18	48	48		78		138
19	19	49	49		79		139
20	20	50	50		80		140
21	21	51	51		81		141
22	22	52	52		82		142
23	23	53	53		83		143
24	24	54	54		84		144
25	25	55	55		85		145
26	26	56	56		86		146
27	27	57	57		87		147
28	28	58	58		88		148
29	29	59	59		89		149
30	30	60	60		90		150
							151
							152
							153
							154
							155
							156
							157
							158
							159
							160
							161
							162
							163
							164
							165
							166
							167
							168
							169
							170
							171
							172
							173
							174
							175
							176
							177
							178
							179
							180
							181
							182
							183
							184
							185
							186
							187
							188
							189
							190
							191
							192
							193
							194
							195
							196
							197
							198
							199
							200
							201
							202
							203
							204
							205
							206
							207
							208
							209
							210



<b>Index of Claims</b>  	<b>Application/Control No.</b>  90007750	<b>Applicant(s)/Patent Under Reexamination</b>  6233389
	<b>Examiner</b>  Escalante, Ovidio	<b>Art Unit</b>  3992

✓	<b>Rejected</b>	-	<b>Cancelled</b>	N	<b>Non-Elected</b>	A	<b>Appeal</b>
=	<b>Allowed</b>	÷	<b>Restricted</b>	I	<b>Interference</b>	O	<b>Objected</b>

Claims renumbered in the same order as presented by applicant
  CPA
  T.D.
  R.1.47

CLAIM			DATE						
Final	Original	11/01/2007							
1	1	=							
2	2	=							
3	3	=							
4	4	=							
5	5	=							
6	6	=							
7	7	=							
8	8	=							
9	9	=							
10	10	=							
11	11	=							
12	12	=							
13	13	=							
14	14	=							
15	15	=							
16	16	=							
17	17	=							
18	18	=							
19	19	=							
20	20	=							
21	21	=							
22	22	=							
23	23	=							
24	24	=							
25	25	=							
26	26	=							
27	27	=							
28	28	=							
29	29	=							
30	30	=							
31	31	=							
32	32	=							
33	33	=							
34	34	=							
35	35	=							
36	36	=							

<b>Index of Claims</b> 	<b>Application/Control No.</b> 90007750	<b>Applicant(s)/Patent Under Reexamination</b> 6233389
	<b>Examiner</b> Escalante, Ovidio	<b>Art Unit</b> 3992

✓	<b>Rejected</b>	-	<b>Cancelled</b>	N	<b>Non-Elected</b>	A	<b>Appeal</b>
=	<b>Allowed</b>	÷	<b>Restricted</b>	I	<b>Interference</b>	O	<b>Objected</b>

Claims renumbered in the same order as presented by applicant
  CPA
  T.D.
  R.1.47

CLAIM		DATE									
Final	Original	11/01/2007									
37	37	=									
38	38	=									
39	39	=									
40	40	=									
41	41	=									
42	42	=									
43	43	=									
44	44	=									
45	45	=									
46	46	=									
47	47	=									
48	48	=									
49	49	=									
50	50	=									
51	51	=									
52	52	=									
53	53	=									
54	54	=									
55	55	=									
56	56	=									
57	57	=									
58	58	=									
59	59	=									
60	60	=									
61	61	=									









Welcome United States Patent and Trademark Office

Search Results

BROWSE

SEARCH

IEEE XPLORE GUIDE

SUPP

Results for "(((mpeg and (parse or parsing or parses) and (dvr or recorder))<in>metadata)) <and> (pyr..."



Your search matched 0 of 1690033 documents.

A maximum of 100 results are displayed, 25 to a page, sorted by Relevance in Descending order.



Modify Search

(((mpeg and (parse or parsing or parses) and (dvr or recorder))<in>metadata)) <and> Search

Check to search only within this results set

Display Format:  Citation  Citation & Abstract

» Search Options

[View Session History](#)

[New Search](#)

» Key

- IEEE JNL IEEE Journal or Magazine
- IET JNL IET Journal or Magazine
- IEEE CNF IEEE Conference Proceeding
- IET CNF IET Conference Proceeding
- IEEE STD IEEE Standard

IEEE/IET

Books

Educational Courses

Applicatio

IEEE/IET journals, transactions, letters, magazines, conference proceedings, and standard

[view selected items](#)

[Select All](#) [Deselect All](#)

No results were found.

Please edit your search criteria and try again. Refer to the Help pages if you need assistance revisin





Home | Login | Logout | Access Information | Alerts | Purchase History | Cart |

Welcome United States Patent and Trademark Office

Search Results

BROWSE

SEARCH

IEEE XPLORE GUIDE

SUPI

Results for "(((mpeg and (parses or parse or parsing) and (audio and video))<in>metadata)) <and> (pyr..."  
Your search matched 3 of 1690033 documents.  
A maximum of 100 results are displayed, 25 to a page, sorted by Relevance in Descending order.

e-mail



Modify Search

(((mpeg and (parses or parse or parsing) and (audio and video))<in>metadata)) <and> Search

Check to search only within this results set

Display Format: Citation Citation & Abstract

» Search Options

View Session History

New Search

IEEE/IET

Books

Educational Courses

Application

IEEE/IET journals, transactions, letters, magazines, conference proceedings, and standard

» Key

- IEEE JNL IEEE Journal or Magazine
- IET JNL IET Journal or Magazine
- IEEE CNF IEEE Conference Proceeding
- IET CNF IET Conference Proceeding
- IEEE STD IEEE Standard

view selected items

Select All Deselect All

- 1. **A syntactic framework for bitstream-level representation of audio-visual objects**  
Fang, Y.; Eleftheriadis, A.;  
Image Processing, 1996. Proceedings., International Conference on  
Volume 1, 16-19 Sept. 1996 Page(s):421 - 424 vol.2  
Digital Object Identifier 10.1109/ICIP.1996.560864  
AbstractPlus | Full Text: PDF(340 KB) IEEE CNF  
Rights and Permissions
- 2. **Joint audio-video processing of MPEG encoded sequences**  
Boccignone, G.; De Santo, M.; Percannella, G.;  
Multimedia Computing and Systems, 1999. IEEE International Conference on  
Volume 2, 7-11 June 1999 Page(s):225 - 229 vol.2  
Digital Object Identifier 10.1109/MMCS.1999.778288  
AbstractPlus | Full Text: PDF(416 KB) IEEE CNF  
Rights and Permissions
- 3. **MD<sup>2</sup>L: content description of multimedia documents for efficient process and search**  
Hu, M.J.; Ye Jian;  
Research and Technology Advances in Digital Libraries, 1999. ADL '99. Proceedings. II  
19-21 May 1999 Page(s):200 - 213  
Digital Object Identifier 10.1109/ADL.1999.777715  
AbstractPlus | Full Text: PDF(188 KB) IEEE CNF  
Rights and Permissions



Help Contact Us Privacy &

© Copyright 2007 IEEE -



Home | Login | Logout | Access Information | Alerts | Purchase History | Cart |

Welcome United States Patent and Trademark Office

Search Results

BROWSE

SEARCH

IEEE XPLORE GUIDE

SUPP

Results for "(((mpeg and (parses or parse or parsing) and (tv or television))<in>metadata)) <and> (py..."

e-mail

Your search matched 1 of 1690033 documents.

A maximum of 100 results are displayed, 25 to a page, sorted by Relevance in Descending order.



Modify Search

Check to search only within this results set

Display Format:  Citation  Citation & Abstract

» Search Options

[View Session History](#)

[New Search](#)

» Key

- IEEE JNL IEEE Journal or Magazine
- IET JNL IET Journal or Magazine
- IEEE CNF IEEE Conference Proceeding
- IET CNF IET Conference Proceeding
- IEEE STD IEEE Standard

IEEE/IET

Books

Educational Courses

Applicatio

IEEE/IET journals, transactions, letters, magazines, conference proceedings, and standard

[Select All](#) [Deselect All](#)

- 1. **Implementation of MPEG transport demultiplexer with a RISC-based microcontrol**  
 Fujii, Y.; Nakase, J.; Matsuno, K.; Gunji, H.;  
[Consumer Electronics, IEEE Transactions on](#)  
 Volume 42, Issue 3, Aug. 1996 Page(s):431 - 438  
 Digital Object Identifier 10.1109/30.536140  
[AbstractPlus](#) | Full Text: [PDF\(596 KB\)](#) IEEE JNL  
[Rights and Permissions](#)



[Help](#) [Contact Us](#) [Privacy &](#)

© Copyright 2007 IEEE -





Home | Login | Logout | Access Information | Alerts | Purchase History | Cart |

Welcome United States Patent and Trademark Office

Search Results

BROWSE

SEARCH

IEEE XPLORE GUIDE

SUPI

Results for "(((mpeg and (parses or parse or parsing))<in>metadata)) <and> (pyr >= 1950 <and>..."  
 Your search matched 14 of 1690033 documents.  
 A maximum of 100 results are displayed, 25 to a page, sorted by Relevance in Descending order.

e-mail



» Search Options

[View Session History](#)

[New Search](#)

» Key

- IEEE JNL IEEE Journal or Magazine
- IET JNL IET Journal or Magazine
- IEEE CNF IEEE Conference Proceeding
- IET CNF IET Conference Proceeding
- IEEE STD IEEE Standard

Modify Search

Check to search only within this results set

Display Format:  Citation  Citation & Abstract

IEEE/IET

Books

Educational Courses

Application

*Interactive online content developed from IEEE conference tutorials.*

[Select All](#) [Deselect All](#)

- 1. **A syntactic framework for bitstream-level representation of audio-visual objects**  
 Fang, Y.; Eleftheriadis, A.;  
[Image Processing, 1996. Proceedings., International Conference on](#)  
 Volume 1, 16-19 Sept. 1996 Page(s):421 - 424 vol.2  
 Digital Object Identifier 10.1109/ICIP.1996.560864  
[AbstractPlus](#) | Full Text: [PDF\(340 KB\)](#) IEEE CNF  
[Rights and Permissions](#)
- 2. **A fast algorithm for video parsing using MPEG compressed sequences**  
 Shen, K.; Delp, E.J.;  
[Image Processing, 1995. Proceedings., International Conference on](#)  
 Volume 2, 23-26 Oct. 1995 Page(s):252 - 255 vol.2  
 Digital Object Identifier 10.1109/ICIP.1995.537462  
[AbstractPlus](#) | Full Text: [PDF\(336 KB\)](#) IEEE CNF  
[Rights and Permissions](#)
- 3. **MD<sup>2</sup>L: content description of multimedia documents for efficient process and search**  
 Hu, M.J.; Ye Jian;  
[Research and Technology Advances in Digital Libraries, 1999. ADL '99. Proceedings. II](#)  
 19-21 May 1999 Page(s):200 - 213  
 Digital Object Identifier 10.1109/ADL.1999.777715  
[AbstractPlus](#) | Full Text: [PDF\(188 KB\)](#) IEEE CNF  
[Rights and Permissions](#)
- 4. **A multi-threading MPEG processor with variable issue modes**  
 Woo-Seung Yang; Hansoo Kim; Myoung-Cheol Shin; In-Cheol Park; Chong-Min Kyung  
[VLSI and CAD, 1999. ICVC '99. 6th International Conference on](#)  
 26-27 Oct. 1999 Page(s):545 - 548  
 Digital Object Identifier 10.1109/ICVC.1999.820996  
[AbstractPlus](#) | Full Text: [PDF\(228 KB\)](#) IEEE CNF  
[Rights and Permissions](#)
- 5. **MPEG-2 video decoding on the TMS320C6X DSP architecture**  
 Sriram, S.; Ching-Yu Hung;

Signals, Systems & Computers, 1998. Conference Record of the Thirty-Second Asilom:  
Volume 2, 1-4 Nov. 1998 Page(s):1735 - 1739 vol.2  
Digital Object Identifier 10.1109/ACSSC.1998.751622

[AbstractPlus](#) | Full Text: [PDF\(456 KB\)](#) IEEE CNF  
[Rights and Permissions](#)

6. **WebClip: a WWW video editing/browsing system**  
Meng, H.J.; Di Zhong; Shih-Fu Chang;  
Multimedia Signal Processing, 1997., IEEE First Workshop on  
23-25 June 1997 Page(s):553 - 557  
Digital Object Identifier 10.1109/MMSP.1997.602692  
[AbstractPlus](#) | Full Text: [PDF\(240 KB\)](#) IEEE CNF  
[Rights and Permissions](#)
7. **Implementation of MPEG transport demultiplexer with a RISC-based microcontrol**  
Fujii, Y.; Nakase, J.; Matsuno, K.; Gunji, H.;  
Consumer Electronics, IEEE Transactions on  
Volume 42, Issue 3, Aug. 1996 Page(s):431 - 438  
Digital Object Identifier 10.1109/30.536140  
[AbstractPlus](#) | Full Text: [PDF\(596 KB\)](#) IEEE JNL  
[Rights and Permissions](#)
8. **Joint audio-video processing of MPEG encoded sequences**  
Boccignone, G.; De Santo, M.; Percannella, G.;  
Multimedia Computing and Systems, 1999. IEEE International Conference on  
Volume 2, 7-11 June 1999 Page(s):225 - 229 vol.2  
Digital Object Identifier 10.1109/MMCS.1999.778288  
[AbstractPlus](#) | Full Text: [PDF\(416 KB\)](#) IEEE CNF  
[Rights and Permissions](#)
9. **Wipe scene change detector for use with video compression algorithms and MPE**  
Alattar, A.M.;  
Consumer Electronics, IEEE Transactions on  
Volume 44, Issue 1, Feb. 1998 Page(s):43 - 51  
Digital Object Identifier 10.1109/30.663729  
[AbstractPlus](#) | Full Text: [PDF\(660 KB\)](#) IEEE JNL  
[Rights and Permissions](#)
10. **Embedding visible video watermarks in the compressed domain**  
Jianhao Meng; Shih-Fu Chang;  
Image Processing, 1998. ICIP 98. Proceedings. 1998 International Conference on  
Volume 1, 4-7 Oct. 1998 Page(s):474 - 477 vol.1  
Digital Object Identifier 10.1109/ICIP.1998.723534  
[AbstractPlus](#) | Full Text: [PDF\(456 KB\)](#) IEEE CNF  
[Rights and Permissions](#)
11. **Integrated shot boundary detection using object-based technique**  
Wei Jyh Heng; Ngan, K.N.;  
Image Processing, 1999. ICIP 99. Proceedings. 1999 International Conference on  
Volume 3, 24-28 Oct. 1999 Page(s):289 - 293 vol.3  
Digital Object Identifier 10.1109/ICIP.1999.817119  
[AbstractPlus](#) | Full Text: [PDF\(591 KB\)](#) IEEE CNF  
[Rights and Permissions](#)
12. **Video segmentation of MPEG compressed data**  
Koprinska, I.; Carrato, S.;  
Electronics, Circuits and Systems, 1998 IEEE International Conference on  
Volume 2, 7-10 Sept. 1998 Page(s):243 - 246 vol.2  
Digital Object Identifier 10.1109/ICECS.1998.814872



[AbstractPlus](#) | Full Text: [PDF\(440 KB\)](#) [IEEE CNF](#)  
[Rights and Permissions](#)

13. **A cell loss padding technique for the transport of MPEG-2 transport stream over**  
Shuaib, K.; Saadawi, T.; Lee, M.; Gringeri, S.; Basch, B.;  
[Intelligent Information Systems, 1997. IIS '97. Proceedings](#)  
8-10 Dec. 1997 Page(s):450 - 454  
Digital Object Identifier 10.1109/IIS.1997.645334  
[AbstractPlus](#) | Full Text: [PDF\(556 KB\)](#) [IEEE CNF](#)  
[Rights and Permissions](#)

14. **Extracting story units from long programs for video browsing and navigation**  
Minerva Yeung; Boon-Lock Yeo; Bede Liu;  
[Multimedia Computing and Systems, 1996., Proceedings of the Third IEEE International](#)  
17-23 June 1996 Page(s):296 - 305  
Digital Object Identifier 10.1109/MMCS.1996.534991  
[AbstractPlus](#) | Full Text: [PDF\(1756 KB\)](#) [IEEE CNF](#)  
[Rights and Permissions](#)



[Help](#) [Contact Us](#) [Privacy & :  
© Copyright 2007 IEEE -](#)



# ProQuest

[Return to the USPTO NPL Page](#) | [Help](#)

- 
- 
- 
- 
- 

Interface language:  
English

Databases selected: Multiple databases...

## Results

2 documents found for: (MPEG and (parse or parses or parsing)) AND PDN (<7/30/1998)

[» Refine Search](#) | [Set Up Alert](#)

Mark all   Sort results by:

- 1. **Effective MPEG asset management with intelligent content analysis**  
David Keightley. *Advanced Imaging*. Melville: Feb 1998. Vol. 13, Iss. 2; p. 27 (4 pages)  
[Abstract](#) | [Text+Graphics](#) | [Full Text - PDF \(1 MB\)](#)
- 2. **MICROSOFT SUPPORT TO BOOST STORAGE MARKET Operating System Upgrades Will Ease Device Installation**  
*Optical Memory News*. San Francisco: Jan 13, 1998. p. 1  
[Abstract](#) | [Full text](#)

1-2 of 2

Want to be notified of new results for this search? [Set Up Alert](#)

Results per page:

## Basic Search

Tools: [Search Tips](#) [Browse Topics](#) [1 Recent Searches](#)

MPEG and (parse or parses or parsing)

Database:  [Select multiple databases](#)

Date range:   [About](#)

- Limit results to:  Full text documents only  Scholarly journals, including peer-reviewed [About](#)

[More Search Options](#)

Copyright © 2007 ProQuest LLC. All rights reserved.



# ProQuest

[Return to the USPTO NPL Page](#) | [Help](#)

- [Basic](#)
- [Advanced](#)
- [Topics](#)
- [Publications](#)
- [My Research  
0 marked items](#)

Interface language:  
[English](#)

Databases selected: Multiple databases...

No documents found for: *(MPEG and (parse or parses or parsing) and (video and audio)) AND PDN(<7/30/1998)*

**Refine your search** below using the following tips:

- Check your spelling.
- Reduce the number of terms included in your search.
- Broaden your search by selecting other [databases](#), removing limits, or searching "Citations and document text" (if avail).
- Use "AND" to connect two words that don't need to be searched as a phrase.
- Connect similar terms with the "OR" operator (e.g. military OR pentagon). See [Search Tips](#) for more hints.

Or try the following:

[Suggested Topics](#) [About](#)

[< Previous](#) |

[Audio equipment AND Video](#)

[Audio recordings AND Video](#)

## Basic Search

Tools: [Search Tips](#) [Browse Topics](#) [2 Recent Searches](#)

MPEG and (parse or parses or parsing) and (video and audio)

Database:   [Select multiple databases](#)

Date range:   [About](#)

Limit results to:  Full text documents only

Scholarly journals, including peer-reviewed  [About](#)

[More Search Options](#)

Copyright © 2007 ProQuest LLC. All rights reserved.



# ProQuest

[Return to the USPTO NPL Page](#) | [Help](#)

Basic

Advanced

Topics

Publications

My Research  
0 marked items

Interface language:

English

Databases selected: Multiple databases...

No documents found for: *(MPEG and (TV or television) and (parses or parsing)) AND PDN(<7/30/1998)*

**Refine your search** below using the following tips:

- Check your spelling.
- Reduce the number of terms included in your search.
- Broaden your search by selecting other [databases](#), removing limits, or searching "Citations and document text" (if avail).
- Use "AND" to connect two words that don't need to be searched as a phrase.
- Connect similar terms with the "OR" operator (e.g. military OR pentagon). See [Search Tips](#) for more hints.

Or try the following:

[Suggested Topics](#) [About](#)

[< Previous](#) |

[Television AND Cable TV](#)

[Television AND NBC-TV \(company/org\)](#)

[Television AND Court TV \(company/org\)](#)

[Television AND WABC-TV \(company/org\)](#)

[Television AND ABC-TV \(company/org\)](#)

[Television AND CBS-TV \(company/org\)](#)

## Basic Search

Tools: [Search Tips](#) [Browse Topics](#) [1 Recent Searches](#)

MPEG and (TV or television) and (parses or parsing)

Search

Clear

Database: Multiple databases...

[Select multiple databases](#)

Date range: Before this date...

07/30/1998

[About](#)

Limit results to:  Full text documents only

Scholarly journals, including peer-reviewed [About](#)

[More Search Options](#)

Copyright © 2007 ProQuest LLC. All rights reserved.







UNITED STATES PATENT AND TRADEMARK OFFICE

UNITED STATES DEPARTMENT OF COMMERCE  
 United States Patent and Trademark Office  
 Address: COMMISSIONER FOR PATENTS  
 P.O. Box 1450  
 Alexandria, Virginia 22313-1450  
 www.uspto.gov

BIB DATA SHEET

CONFIRMATION NO. 4653

SERIAL NUMBER	FILING or 371(c) DATE	CLASS	GROUP ART UNIT	ATTORNEY DOCKET NO.	
90/007,750	10/17/2005	386	3992	2513.001REX0	
<b>APPLICANTS</b> 6233389, Residence Not Provided; TIVO Inc.(Owner), Sunnyvale, CA; David L. Fehrman(3rd. Pty. Req.), Los Angeles, CA; David L. Fehrman, Los Angeles, CA;					
<b>** CONTINUING DATA *****</b> This application is a REX of 09/126,071 07/30/1998 PAT 6,233,389					
<b>** FOREIGN APPLICATIONS *****</b>					
<b>** IF REQUIRED, FOREIGN FILING LICENSE GRANTED **</b>					
Foreign Priority claimed <input type="checkbox"/> Yes <input checked="" type="checkbox"/> No 35 USC 119(a-d) conditions met <input type="checkbox"/> Yes <input checked="" type="checkbox"/> No Verified and Acknowledged <u>Ovidio Escalante /</u> <small>Examiner's Signature</small>	<input type="checkbox"/> Met after Allowance <small>Initials</small>	<b>STATE OR COUNTRY</b>	<b>SHEETS DRAWINGS</b>	<b>TOTAL CLAIMS</b> 61	<b>INDEPENDENT CLAIMS</b> 4
<b>ADDRESS</b> STERNE, KESSLER, GOLDSTEIN & FOX P.L.L.C. 1100 NEW YORK AVENUE, N.W. WASHINGTON, DC 20005 UNITED STATES					
<b>TITLE</b> MULTIMEDIA TIME WARPING SYSTEM					
<b>FILING FEE RECEIVED</b> 2520	FEES: Authority has been given in Paper No. _____ to charge/credit DEPOSIT ACCOUNT No. _____ for following:		<input type="checkbox"/> All Fees <input type="checkbox"/> 1.16 Fees (Filing) <input type="checkbox"/> 1.17 Fees (Processing Ext. of time) <input type="checkbox"/> 1.18 Fees (Issue) <input type="checkbox"/> Other _____ <input type="checkbox"/> Credit		





UNITED STATES PATENT AND TRADEMARK OFFICE

UNITED STATES DEPARTMENT OF COMMERCE  
United States Patent and Trademark Office  
Address: COMMISSIONER FOR PATENTS  
P.O. Box 1450  
Alexandria, Virginia 22313-1450  
www.uspto.gov

APPLICATION NO.	FILING DATE	FIRST NAMED INVENTOR	ATTORNEY DOCKET NO.	CONFIRMATION NO.
90/007,750	10/17/2005	6233389	2513.001REX0	4653
26111	7590	11/28/2007	EXAMINER	
STERNE, KESSLER, GOLDSTEIN & FOX P.L.L.C. 1100 NEW YORK AVENUE, N.W. WASHINGTON, DC 20005			ART UNIT      PAPER NUMBER	

DATE MAILED: 11/28/2007

Please find below and/or attached an Office communication concerning this application or proceeding.





UNITED STATES PATENT AND TRADEMARK OFFICE

Commissioner for Patents  
United States Patent and Trademark Office  
P.O. Box 1450  
Alexandria, VA 22313-1450  
[www.uspto.gov](http://www.uspto.gov)

THIRD PARTY REQUESTER'S CORRESPONDENCE ADDRESS

DAVID L. FEHRMAN  
MORRISON & FOERSTER, LLP  
555 W. FIFTH STREET, SUITE 3500  
LOS ANGELES, CA 90013

**EX PARTE REEXAMINATION COMMUNICATION TRANSMITTAL FORM**

REEXAMINATION CONTROL NO 90/007750  
PATENT NO. 6,233,389  
ART UNIT 3992

Enclosed is a copy of the latest communication from the United States Patent and Trademark Office in the above identified ex parte reexamination proceeding (37 CFR 1.550(f)).

Where this copy is supplied after the reply by requester, 37 CFR 1.535, or the time for filing a reply has passed, no submission on behalf of the ex parte reexamination requester will be acknowledged or considered (37 CFR 1.550(g)).

**Notice of Intent to Issue  
Ex Parte Reexamination Certificate**

<b>Control No.</b> 90/007,750	<b>Patent Under Reexamination</b> 6233389	
<b>Examiner</b> Ovidio Escalante	<b>Art Unit</b> 3992	

-- The MAILING DATE of this communication appears on the cover sheet with the correspondence address --

1.  Prosecution on the merits is (or remains) closed in this *ex parte* reexamination proceeding. This proceeding is subject to reopening at the initiative of the Office or upon petition. Cf. 37 CFR 1.313(a). A Certificate will be issued in view of
  - (a)  Patent owner's communication(s) filed: 29 October 2007.
  - (b)  Patent owner's late response filed: \_\_\_\_\_.
  - (c)  Patent owner's failure to file an appropriate response to the Office action mailed: \_\_\_\_\_.
  - (d)  Patent owner's failure to timely file an Appeal Brief (37 CFR 41.31).
  - (e)  Other: \_\_\_\_\_.

Status of *Ex Parte* Reexamination:

  - (f) Change in the Specification:  Yes  No
  - (g) Change in the Drawing(s):  Yes  No
  - (h) Status of the Claim(s):
    - (1) Patent claim(s) confirmed: 1-61.
    - (2) Patent claim(s) amended (including dependent on amended claim(s)): \_\_\_\_\_.
    - (3) Patent claim(s) cancelled: \_\_\_\_\_.
    - (4) Newly presented claim(s) patentable: \_\_\_\_\_.
    - (5) Newly presented cancelled claims: \_\_\_\_\_.
2.  Note the attached statement of reasons for patentability and/or confirmation. Any comments considered necessary by patent owner regarding reasons for patentability and/or confirmation must be submitted promptly to avoid processing delays. Such submission(s) should be labeled: "Comments On Statement of Reasons for Patentability and/or Confirmation."
3.  Note attached NOTICE OF REFERENCES CITED (PTO-892).
4.  Note attached LIST OF REFERENCES CITED (PTO/SB/08).
5.  The drawing correction request filed on \_\_\_\_\_ is:  approved  disapproved.
6.  Acknowledgment is made of the priority claim under 35 U.S.C. § 119(a)-(d) or (f).
  - a)  All b)  Some\* c)  None of the certified copies have
    - been received.
    - not been received.
    - been filed in Application No. \_\_\_\_\_.
    - been filed in reexamination Control No. \_\_\_\_\_.
    - been received by the International Bureau in PCT Application No. \_\_\_\_\_.

\* Certified copies not received: \_\_\_\_\_.
7.  Note attached Examiner's Amendment.
8.  Note attached Interview Summary (PTO-474).
9.  Other: \_\_\_\_\_.

Ovidio Escalante  
CRU Examiner  
Art Unit: 3992

cc: Requester (if third party requester)  
U.S. Patent and Trademark Office  
PTOL-469 (Rev.08-06)

Notice of Intent to Issue Ex Parte Reexamination Certificate

Part of Paper No 20071029

**DETAILED ACTION**

1. This action is in response to the Patent Owner's response filed on October 29, 2007.  
Claims 1-61 are pending in the present *ex parte* reexamination proceeding.

*Status of the Claims*

2. Original claims 1-61 are confirmed.

**STATEMENT OF REASONS FOR PATENTABILITY AND/OR CONFIRMATION**

The following is an examiner's statement of reasons for patentability and/or confirmation of the claims found patentable in this reexamination proceeding:

*Regarding claims 1 and 32:*

*U.S. Patent 6,788,882 to Geer et al.*

The claim requires *inter alia* providing "...at least one Input Section, wherein said Input Section converts said specific program to an Moving Pictures Expert Group (MPEG) formatted stream for internal transfer and manipulation; providing a Media Switch, wherein said Media Switch parses said MPEG stream, said MPEG stream is separated into its video and audio components; storing said video and output components on a storage device...wherein said Output Section extracts said video and audio components from said storage device..."

The Geer Patent discloses the use of a computerized content search feature that automatically catalogs audio content digitally. According to Geer, the process utilizes the audio portion of the broadcast signal. As described in col. 4, lines 10-15, Geer describes the broadcast



Art Unit: 3992

signal to be in the form of (1) NTSC analog TV, (2) PAL/SECAM analog TV, (3) digital TV, (4) analog HDTV and (5) HDTV. Geer also discloses in col. 6, lines 14-25 that the broadcast signal can be received in compressed form such as MPEG II.

With the uncompressed broadcast signal, Geer performs content-based analysis prior to compression to MPEG II. After the analysis is performed, the analyzed data component will be stored as compressed MPEG II form and subsequently outputted after being decompressed. Since the claims require, converting the broadcast signal to MPEG format, then parsing the MPEG stream into its video and audio components and then storing said video and output components, then it is clear that Geer fails to disclose of the above steps when receiving an uncompressed broadcast signal since Geer does not disclose an uncompressed signal being converted to MPEG and then subsequently being parsed into its audio and video components prior to having the audio and video components stored.

However, the Examiner notes that Geer discloses that the content analysis is performed to a broadcast signal and since MPEG II is one of the possible broadcast signals then, as known in the art, the MPEG II stream will inherently be decompressed prior to being analyzed and stored. Geer discloses of parsing the MPEG II stream to extract the audio component and performing a content analysis on the audio component.

Geer also separately discloses that for stored MPEG II compressed video, the output is first sent to the decompression device such as a MPEG decoder when the stream is going to be outputted to the television set.

The Examiner acknowledges that Geer does not specifically disclose of decompressing the received MPEG II stream for analysis but argued that it is inherent that Geer performs this

because "it is impossible to analyze the audio portion of a MPEG data stream without decompressing it first". The Examiner also previously noted that decompression requires a demultiplexer for parsing and separating at least the audio component from the stream so that it can be decompressed.

Thus, the Examiner noted that Geer discloses either through inherency or obviousness of parsing the MPEG stream into at least its audio component (video is parsed based on disclosure of Cobbley). The Examiner also noted that Geer further discloses of storing the received MPEG II stream and outputting the MPEG stream as TV signals after going through a decoder.

Geer fails to disclose after parsing the MPEG stream and obtaining the audio component, that the same audio component (which resulted from the parsing) is stored and that the **same audio component that was obtained from the parsing is sent to a decoder for converting it to a TV signal.**

As stated by the Patent Owner in the response received on October 29, 2007:

"[I]ndependent claims 1 and 32 require the system to accept "TV broadcast signals" and tune "to a specific program." The system also "converts said specific program to an ... MPEG formatted stream for internal transfer and manipulation." The system "parses said MPEG stream, said MPEG stream is separated into its video and audio components." This is the first mention of "video and audio components." These same video and audio components are stored on a storage device and also extracted for playback. In other words, the "MPEG stream is separated into its video and audio components," and both the storing and extracting must be of these same "said video and audio components." These "said video and audio components" are



**also assembled into an MPEG stream which is sent to a decoder for conversion into TV output signals,**" (underlining and bolding inserted by Examiner).

Thus, it is clear that the audio and video components which resulted from the parsed MPEG stream is the same audio and video components which are stored and are subsequently the same audio and video components that are sent to the decoder for conversion to TV signals.

While Geer discloses the storing at least the audio component of the stored audio stream and that it was well known to decompress MPEG streams prior to being outputted, there is no disclosure or reason for the audio component to be compressed back to compressed MPEG form in order to be decompressed again for output in view of at least the disclosure of Geer.

The Patent Owner argued that the content-based analysis in Geer, if performed, must be performed either in Geer's input - prior to compression - or in Geer's output - after decompression by the decoder for output of the decompresses signal to the television. The Patent Owner further states that after the content-based analysis, Geer stores the indexed text of the uncompressed audio and thus does not teach or even suggest a *compressed (MPEG) stream* that is separated into its video and audio components and storing these same compressed *MPEG video and audio components* as required.

The Examiner agrees that for uncompressed input the content analysis is performed before compression, thus the claims are confirmed over this disclosure. However, the Examiner disagrees that compressed inputs (such as MPEG II) is performed prior to being outputted. The Examiner notes that this step in Geer is performed prior to any consideration of the MPEG stream being "outputted" since the audio component must be stored after the analyzing step thus prior to the outputting step. Nonetheless, as stated above, Geer fails to disclose at least providing



Art Unit: 3992

a Media Switch, wherein said Media Switch parses said MPEG stream, said MPEG stream is separated into its video and audio component; storing *said* video and audio components on a storage device; providing at least one Output Section, wherein said Output Section extracts *said* video and audio components from said storage device," since there is no disclosure in Geer of having the audio and video components which resulted from the parsing of the MPEG stream being stored and having that same audio and video components being decoded and converted to TV output signals.

Thus, the Examiner will not maintain the rejection under Geer for the above reasons and confirms the claims as originally filed.

***U.S. Patent 5,614,940 to Cobbley et al.***

As stated in the office action mailed on May 25, 2006 "[w]hat is missing from the Cobbley et al. showing, with respect to the claimed subject matter, is any teaching or suggestion of the "parsing" an MPEG data stream by a "Media Switch," wherein the MPEG data stream is "separated" into "its" audio and video components [i.e., as recited in the context of the independent claims 1 and 32]. That is, even when deriving the index information locally (e.g., @ 112), it seems that the content-based analysis would be performed on the received TV programming, e.g., in digital format, prior to MPEG compression [note lines 16-23 of column 6]. That is, it seems unlikely that one would receive a digital TV signal, compress the digital TV signal into an MPEG data stream, and then decompress the MPEG data stream back into its digital format for analysis (e.g., "parsing"). It would make more sense to perform the analysis/"parsing" of the TV signal prior to MPEG compression thereby avoiding the need for,

Art Unit: 3992

and expense of, an MPEG decoder. In any event, motivation for such an implementation/ modification of the Cobbley et al. system appears to be absent from the record.

***Regarding claims 3-5,15-18 and 20-25:***

The claims are confirmed based upon its dependency on confirmed independent claim 1.

***Regarding claims 34-36,46-49 and 51-55:***

The claims are confirmed based upon its dependency on confirmed independent claim 32.

***As set forth in the final rejection:***

***Regarding claim 2:***

The prior art of record does not show or suggest an "Input Section" as set forth in claim 1 wherein said input section directs the MPEG stream to the destination indicated by control commands, as recited in claim 2.

***Regarding claim 6:***

The prior art of record does not show or suggest a "Media Switch" as set forth in claim 1 wherein said Media Switch calculates and associates a time stamp to the audio and video components as is recited in claim 6.

***Regarding claim 7:***

The prior art of record does not show or suggest a "Media Switch" as set forth in claim 1 wherein said Media Switch logically associates received time stamp values with the audio and video components as is recited in claim 7.

***Regarding claim 8:***

Art Unit: 3992

The prior art of record does not show or suggest the "posting" of an event in a circular event file indicative of the location of a video component in a circular video buffer as set forth in claim 8.

***Regarding claim 9:***

The prior art of record does not show or suggest the "posting" of an event in a circular event file indicative of the location of a audio component in a circular video buffer as set forth in claim 9.

***Regarding claims 10 and 11:***

Claims 10 and 11 depend from claims 8 and 9 and avoid the art of record at least for the reasons expressed above for those claims.

***Regarding claim 12:***

The prior art of record does not show or suggest a method as recited in claim 1 in which the rate of the decoder system clock is increased for fast playback as is recited in claim 12.

***Regarding claim 13:***

The prior art of record does not show or suggest a method as recited in claim 1 in which the rate of the decoder system clock is decreased for slow playback as is recited in claim 13.

***Regarding claim 14:***

The prior art of record does not show or suggest a method as recited in claim 1 in which audio cues and on-screen displays are combined with the TV output signals as is recited in claim 14.



Art Unit: 3992

***Regarding claim 19:***

The prior art of record does not show or suggest a method as recited in claim 1 in the Media switch shares and address bus with the CPU.

***Regarding claim 26:***

The prior art of record does not show or suggest a method as recited in claim 24 in the user set time schedules the times during which stored programming is provided to an external recording device.

***Regarding claim 27:***

The prior art of record does not show or suggest a method as recited in claim 24 in a tile page is set to the external recording device.

***Regarding claim 28:***

The prior art of record does not show or suggest a method as recited in claim 24 in which the program is sped up to fit within the limited time available on the recording medium.

***Regarding claim 29:***

The prior art of record does not show or suggest a method as recited in claim 24 in which frames of the programming are dropped to permit it to fit within the limited time available on the recording medium.

***Regarding claim 30:***

The prior art of record does not show or suggest a method as recited in claim 24 in which the output of the recording device is provided back to the input section.

***Regarding claim 33:***

The prior art of record does not show or suggest an "Input Section" as set forth in claim 32 wherein said input section directs the MPEG stream to the destination indicated by control commands, as recited in claim 33.

***Regarding claim 37:***

The prior art of record does not show or suggest a "Media Switch" as set forth in claim 32 wherein said Media Switch itself calculates and associates a time stamp to the audio and video components as is recited in claim 37. The Examiner notes that the time stamps are associated with the files in Geer et al., however, not by the "media switch" (e.g. note lines 21-31 of col. 13).

***Regarding claim 38:***

The prior art of record does not show or suggest a "Media Switch" as set forth in claim 32 wherein said Media Switch itself logically associates received time stamp values with the audio and video components as is recited in claim 38. The Examiner notes that the time stamps are associated with the files in Geer et al., however, not by the "media switch" (e.g. note lines 21-31 of col. 13).

***Regarding claim 39:***

The prior art of record does not show or suggest the "posting" of an event in a circular event file indicative of the location of a video component in a circular video buffer as set forth in claim 39.

***Regarding claim 40:***

Art Unit: 3992

The prior art of record does not show or suggest the "posting" of an event in a circular event file indicative of the location of a audio component in a circular video buffer as set forth in claim 40.

***Regarding claims 41 and 42:***

Claims 41 and 42 depend from claims 39 and 40 and avoid the art of record at least for the reasons expressed above for those claims.

***Regarding claim 43:***

The prior art of record does not show or suggest an apparatus as recited in claim 32 in which the rate of the decoder system clock is increased for fast playback as is recited in claim 43.

***Regarding claim 44:***

The prior art of record does not show or suggest an apparatus as recited in claim 32 in which the rate of the decoder system clock is decreased for slow playback as is recited in claim 44.

***Regarding claim 45:***

The prior art of record does not show or suggest a method as recited in claim 32 in which audio cues and on-screen displays are combined with the TV output signals as is recited in claim 45.

***Regarding claim 50:***

The prior art of record does not show or suggest a method as recited in claim 32 in the media switch shares and address bus with the CPU.

***Regarding claim 56:***



The prior art of record does not show or suggest a method as recited in claim 54 in the user set time schedules the times during which stored programming is provided to an external recording device.

***Regarding claim 57:***

The prior art of record does not show or suggest a method as recited in claim 54 in a tile page is set to the external recording device.

***Regarding claim 58:***

The prior art of record does not show or suggest a method as recited in claim 54 in which the program is sped up to fit within the limited time available on the recording medium.

***Regarding claim 59:***

The prior art of record does not show or suggest a method as recited in claim 54 in which frames of the programming are dropped to permit it to fit within the limited time available on the recording medium.

***Regarding claim 60:***

The prior art of record does not show or suggest a method as recited in claim 54 in which the output of the recording device is provided back to the input section.

***Regarding claims 31 and 61:***

The prior art of record does not show or suggest an object-based method/apparatus that is recited in claims 31 and 61.

Art Unit: 3992

Any comments considered necessary by PATENT OWNER regarding the above statement must be submitted promptly to avoid processing delays. Such submission by the patent owner should be labeled: "Comments on Statement of Reasons for Patentability and/or Confirmation" and will be placed in the reexamination file.

### *Conclusion*

#### **NOTICE RE PATENT OWNER'S CORRESPONDENCE ADDRESS**

Effective May 16, 2007, 37 CFR 1.33(c) has been revised to provide that:

The patent owner's correspondence address for all communications in an *ex parte* reexamination or an *inter partes* reexamination is designated as the correspondence address of the patent.

*Revisions and Technical Corrections Affecting Requirements for Ex Parte and Inter Partes Reexamination, 72 FR 18892 (April 16, 2007)(Final Rule)*

**The correspondence address for any pending reexamination proceeding not having the same correspondence address as that of the patent is, by way of this revision to 37 CFR 1.33(c), automatically changed to that of the patent file as of the effective date.**

This change is effective for any reexamination proceeding which is pending before the Office as of May 16, 2007, including the present reexamination proceeding, and to any reexamination proceeding which is filed after that date.

Parties are to take this change into account when filing papers, and direct communications accordingly.

In the event the patent owner's correspondence address listed in the papers (record) for the present proceeding is different from the correspondence address of the patent, it is strongly encouraged that the patent owner affirmatively file a Notification of Change of Correspondence Address in the reexamination proceeding and/or the patent (depending on which address patent owner desires), to conform the address of the proceeding with that of the patent and to clarify the record as to which address should be used for correspondence.

Telephone Numbers for reexamination inquiries:

Reexamination and Amendment Practice  
Central Reexam Unit (CRU)

(571) 272-7703  
(571) 272-7705



Art Unit: 3992

Reexamination Facsimile Transmission No. (571) 273-9900

3. The patent owner is reminded of the continuing responsibility under 37 CFR 1.565(a), to apprise the Office of any litigation activity, or other prior or concurrent proceeding, involving Patent No. 6,233,389 throughout the course of this reexamination proceeding. See MPEP §§ 2207, 2282 and 2286.

4. Extensions of time under 37 CFR 1.136(a) will not be permitted in these proceedings because the provisions of 37 CFR 1.136 apply only to "an applicant" and not to parties in a reexamination proceeding. Additionally, 35 U.S.C. 305 requires that reexamination proceedings "will be conducted with special dispatch" (37 CFR 1.550(a)). Extension of time in *ex parte* reexamination proceedings are provided for in 37 CFR 1.550(c).

5. All correspondence related to this *ex parte* reexamination proceeding should be directed as follows:

**Please MAIL any communications to:**

Attn: Mail Stop *Ex Parte* Reexam  
Central Reexamination Unit  
Commissioner for Patents  
P.O. Box 1450  
Alexandria, Virginia 22313-1450

**Please FAX any communication to:**

(571) 273-9900  
Central Reexamination Unit

**Please HAND-DELIVER any communications to:**

Customer Service Window  
Attn: Central Reexamination Unit  
Randolph Building, Lobby Level  
401 Dulany Street  
Alexandria, VA 22314



Art Unit: 3992

6. Any inquiry by the patent owner concerning this communication or earlier communications from the Legal Advisor or Examiner, or as to the status of this proceeding, should be directed to the Central Reexamination Unit at telephone number (571) 272-7705.

*Ovidio Escalante*

Ovidio Escalante  
Primary Examiner  
Central Reexamination Unit - Art Unit 3992  
(571) 272-7537

Conferee:

*D. Harvey*  
David Harvey

Conferee:

Mark Reinhart

*Mark Reinhart*

MARK J. REINHART  
SPRE-AU 3992  
CENTRAL REEXAMINATION UNIT



Robert Greene Sterne  
 Jorge A. Goldstein  
 David K.S. Cornwell  
 Robert W. Esmond  
 Tracy-Gene G. Durkin  
 Michele A. Cimbala  
 Michael B. Ray  
 Robert E. Sokohl  
 Eric K. Steffe  
 Michael Q. Lee  
 John M. Covert  
 Robert C. Milonig  
 Donald J. Featherstone  
 Timothy J. Shea, Jr.  
 Michael V. Messinger  
 Judith U. Kim  
 Jeffrey T. Helvey  
 Eldora L. Ellison

Donald R. Banowitz  
 Peter A. Jackman  
 Brian J. Del Buono  
 Mark Fox Evans  
 Vincent L. Capuano  
 Elizabeth J. Haanes  
 Michael D. Specht  
 Kevin W. McCabe  
 Glenn J. Perry  
 Edward W. Yee  
 Grant E. Reed  
 Virgil Lee Beasston  
 Theodore A. Wood  
 Joseph S. Ostroff  
 Jason D. Eisenberg  
 Tracy L. Muller  
 Jon E. Wright  
 LuAnne M. DeSantis

Ann E. Summerfield  
 Helene C. Carlson  
 Cynthia M. Bouchez  
 Timothy A. Doyle  
 Gaby L. Longworth  
 Lori A. Gordon  
 Laura A. Vogel  
 Bashir M.S. Ali  
 Shannon A. Carroll  
 Anbar F. Khal  
 Michelle K. Holoubek  
 Marsha A. Rose  
 Scott A. Schaller  
 Lei Zhou  
 W. Blake Coblentz  
 James J. Pohl  
 John T. Haran  
 Mark W. Rygiel

Michael R. Malek\*  
 Carla Ji-Eun Kim  
 Doyle A. Siever\*  
 Ulrike Winkler Jenks  
 Paul A. Calvo  
 Robert A. Schwartzman  
 C. Matthew Rozier\*  
 Shameek Ghose  
 Randall K. Baldwin  
 Daniel J. Nevrivy  
 Registered Patent Agents\*  
 Karen R. Markowicz  
 Matthew J. Dowd  
 Mita Mukherjee  
 Scott M. Woodhouse  
 Peter A. Socarras  
 Jeffrey K. Mills

Danielle L. Letting  
 Lori Brandes  
 Steven C. Oppenheimer  
 Aaron S. Lukas  
 Gaurav Asthana  
 Robert E. Bakin  
 Salvador M. Bezos

Of Counsel  
 Edward J. Kessler  
 Kenneth C. Bass III  
 Marvin C. Guthrie  
 Christopher P. Wrist

\*Admitted only in Maryland  
 \*Admitted only in Virginia  
 \*Practice Limited to  
 Federal Agencies

December 17, 2007

WRITER'S DIRECT NUMBER:  
 (202) 772-8550  
 INTERNET ADDRESS:  
 EKESSLER@SKGF.COM

Commissioner for Patents  
 PO Box 1450  
 Alexandria, VA 22313-1450

Re: Reexamination of U.S. Patent No. 6,233,389  
 Reexam Control No. 90/007,750; Filed: October 17, 2005  
 For: **Multimedia Time Warping System**  
 Inventors: BARTON *et al.*  
 Our Ref: 2513.001REX0

Sir:

Transmitted herewith for appropriate action are the following documents:

1. Petition under 37 C.F.R. § 1.182;
2. Certification of Service of Petition under 37 C.F.R. § 1.182;
3. Supplemental Information Disclosure Statement;
4. Certification of Service of Information Disclosure Statement; and
5. Online Credit Card Payment Authorization for \$400.00 to cover petition fee.

The above-listed documents are filed electronically through EFS-Web.

Fee payment is provided through online credit card payment. The U.S. Patent and Trademark Office is hereby authorized to charge any fee deficiency, or credit any overpayment, to our Deposit Account No. 19-0036.

Respectfully submitted,  
 STERNE, KESSLER, GOLDSTEIN & FOX P.L.L.C.

Edward J. Kessler  
 Attorney for Patent Owner  
 Registration No. 25,688

EJK/LAG/mlb  
 Enclosures  
 759667\_1.DOC

IN THE UNITED STATES PATENT AND TRADEMARK OFFICE

In re reexam of: U.S. Patent 6,233,389  
(Barton)

Reexam Control No.: 90/007,750

Filed: October 17, 2005

For: **Multimedia Time Warping System**

Confirmation No.: 4653

Art Unit: 3992

Examiner: Ovidio Escalante

Atty. Docket No.: 2513.001REX0

**Petition Under 37 C.F.R. § 1.182**

Attn: Central Reexamination Unit  
Commissioner for Patents  
P.O. Box 1450  
Alexandria, VA 22313-1450

*Mail Stop: Ex Parte Reexam*

Dear Sir:

TiVo (the owner of the subject patent) respectfully petitions under 37 C.F.R. § 1.182 to submit an Information Disclosure Statement to bring certain newly discovered references to the attention of the Examiner.

Accompanying this Petition are:

- (a) Information Disclosure Statement,
- (b) PTO-1449 listing the references to be considered, and
- (c) The petition fee under 37 C.F.R. § 1.17(f) is provided in our accompanying PTO-2038 Credit Card Payment Form.

On October 19, 2007, the Patent and Trademark Office mailed an Office Action in Application No. 10/081,776, which is a division of a continuation of the patent that is the subject of the above-captioned re-examination proceeding (hereafter the "'389 patent"). The Office Action cited one reference, U.S. Patent No. 6,353,461.

On or about December 3, 2007, a representative of TiVo discovered a recently issued patent, U.S. Patent No. 7,272,298, issued September 18, 2007. The '298 patent



is related to the subject matter of the '389 patent in that it describes a system and method for time-shifted viewing of broadcast television programs.

This Petition is requested to permit TiVo to submit the '461 and '298 patents for the Examiner's review and consideration. TiVo wishes to have the '461 and '298 patents considered by the Examiner to avoid any appearance of impropriety and to ensure that all potentially material art known to TiVo has been considered in this re-examination proceeding.

For the above reason, TiVo specifically requests that this Petition be granted and that the accompanying Information Disclosure Statement be entered and considered by the Examiner.

Respectfully submitted,

STERNE, KESSLER, GOLDSTEIN & FOX P.L.L.C.

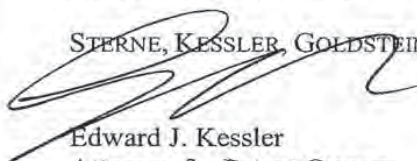

Edward J. Kessler  
Attorney for Patent Owner  
Registration No. 25,688

Date: 17 Dec, 2007

1100 New York Avenue, N.W.  
Washington, D.C. 20005-3934  
(202) 371-2600

758284\_1.DOC

**Patent Under Reexamination:** 6,233,389  
**Reexamination Control No.:** 90/007,750  
**Examiner:** Ovidio Esclanate  
**Art Unit:** 3992

Commissioner for Patents  
P.O. Box 1450  
Alexandria, VA 22313-1450

Sir:

**CERTIFICATION OF SERVICE OF PETITION UNDER 37 C.F.R. §1.182**

In compliance with 37 C.F.R. § 1.550(f), the undersigned, on behalf of the patent owner, hereby certifies that a copy of this paper has been served on the third-party requester by first class mail on December 14, 2007. The name and address of the party served is as follows:

David L. Fehrman  
Morrison & Foerster, LLP  
555 W. Fifth Street, Suite 3500  
Los Angeles, CA 90013

Respectfully submitted,

STERNE, KESSLER, GOLDSTEIN & FOX P.L.L.C.

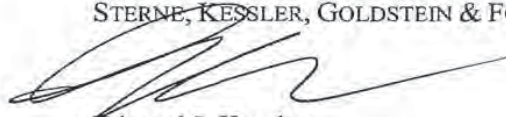

Edward J. Kessler  
Attorney for Patent Owner  
Registration No. 25,688

Date: December 17, 2007

1100 New York Avenue, N.W.  
Washington, D.C. 20005-3934  
(202) 371-2600

758284\_1.DOC

IN THE UNITED STATES PATENT AND TRADEMARK OFFICE

In re reexam of: U.S. Patent 6,233,389  
(Barton)

Reexam Control No.: 90/007,750

Filed: October 17, 2005

For: **Multimedia Time Warping System**

Confirmation No.: 4653

Art Unit: 3992

Examiner: Ovidio Escalante

Atty. Docket No.: 2513.001REX0

**Supplemental Information Disclosure Statement**

Commissioner for Patents  
Washington, D.C. 20231

Sir:

Listed on accompanying Form PTO-1449 are documents that may be considered material to the examination of this re-examination, in compliance with the duty of disclosure requirements of 37 C.F.R. §§ 1.56, 1.97 and 1.98.

Applicants have listed publication dates on the attached PTO-1449 based on information presently available to the undersigned. However, the listed publication dates should not be construed as an admission that the information was actually published on the date indicated.

Applicants reserve the right to establish the patentability of the claimed invention over any of the information provided herewith, and/or to prove that this information may not be prior art, and/or to prove that this information may not be enabling for the teachings purportedly offered.

Applicants provide the following comments regarding the documents:

Document US1 was cited by an Examiner in co-pending U.S. Patent Application Serial No. 10/081,776, which is a division of a continuation of the patent that is the subject of the above-captioned re-examination proceeding.



Document US2 was discovered by a representative of the patent owner on or about December 3, 2007.

This statement should not be construed as a representation that information more material to the examination of the present patent application does not exist. The Examiner is specifically requested not to rely solely on the material submitted herewith.

This Information Disclosure Statement is being filed after the mailing date of a Notice of Intent to Issue Reexamination Certificate in the subject re-examination proceeding. A separate Petition, requesting consideration of this Information Disclosure Statement, is concurrently submitted herewith, along with Credit Card payment in the amount of \$400.00 in payment of the fee under 37 C.F.R. § 1.17(f).

Concise explanations of the relevance of the cited documents US1 and US2 appear below:

According to the Abstract of Disclosure, Document US1 appears to describe a video assist control system and method for use in film/video production. The system and method provide a link between production and post-production by storing and managing recorded media and production information. Multiple video and audio signals may be selectively received and simultaneously digitally recorded and stored, along with time code information, with near instantaneous playback capability for multiple current and past recordings. Database functionality is incorporated to provide for entry and storage of information associated with each recording. The database provides searching capabilities to locate and retrieve past recordings, based on stored information, for playback review, editing and assembly of recordings or portions thereof. Editing functionality is provided including identification of action points, cut points for segmentation within recordings, and selection of active channels for selected segments upon playback so as to provide for sequential playback

of assembled video portions from multiple recordings. Compositing functionality is further incorporated to allow playback of pre-existing material in superimposition with new material being recorded, thus allowing near real-time viewing of special effects.

According to the Abstract of Disclosure, Document US2 appears to describe a system and method for time-shifted viewing of broadcast television programs. Simultaneous recording and playback are provided by using buffer storage as the source and destination of compressed or uncompressed digital video/audio programs. Full VCR-like control is provided for all playback within the buffer storage. Playback and control of recorded programs may be initiated by the user at any time after initiation of the broadcast program with simultaneous continuous recording of the ongoing live broadcast. Larger archival storage and removable is also provided for storing and building a library of programs. Viewer playback control data may be stored as part of the program or used as edit points prior to archival. Options are provided for features such as continuous automatic recording in a circular buffer fashion, program archival, editing, Internet interfaces, multiple-channel recording and more. More specifically, a circular buffer and device configuration via a user interface over the Internet are required.

Neither Document US1 or US2 teaches or suggests the invention of the '389 patent. In particular, neither document teaches or suggests a Media Switch, as required by independent claims 1 and 32 of the '389 patent. Independent claims 1 and 32 require the system to accept "TV broadcast signals" and tune "to a specific program." The system also "converts said specific program to an ... MPEG formatted stream for internal transfer and manipulation." The system "parses said MPEG stream, said MPEG stream is separated into its video and audio components." This is the first mention of "video and audio components." These same video and audio components are stored on a storage device and also extracted for



playback. In other words, the "MPEG stream is separated into its video and audio components," and both the storing and extracting must be of these same "said video and audio components." These "said video and audio components" are also assembled into an MPEG stream which is sent to a decoder for conversion into TV output signals.

Neither cited document teaches or suggests a Media Switch, particularly one having the characteristics recited in claims 1 and 32.

In accordance with 37 C.F.R. § 1.98(a)(2), no copies of U.S. patents and patent application publications cited on the attached IDS Forms are submitted.

It is respectfully requested that the Examiner initial and return a copy of the enclosed PTO-1449, and indicate in the official file wrapper of this re-examination that the documents have been considered.

The U.S. Patent and Trademark Office is hereby authorized to charge any fee deficiency, or credit any overpayment, to our Deposit Account No. 19-0036.

Respectfully submitted,

STERNE, KESSLER, GOLDSTEIN & FOX P.L.L.C.



Edward J. Kessler  
Attorney for Applicants  
Registration No. 25,688

Date: 17 Dec. 2007

1100 New York Avenue, N.W.  
Suite 600  
Washington, D.C. 20005-3934  
(202) 371-2600  
759633\_2.DOC



Substitute for form 1449A/PTO				<b>Complete if Known</b>	
<b>SUPPLEMENTAL INFORMATION DISCLOSURE STATEMENT BY APPLICANT</b> <i>(Use as many sheets as necessary)</i>				Control Number	90/007,750
				Filing Date	October 17, 2005
				First Named Inventor	BARTON
				Art Unit	3992
				Examiner Name	Ovidio Escalante
Sheet	1	of	1	Attorney Docket Number	2513.001REX0

U.S. PATENT DOCUMENTS					
Examiner Initials*	Cite No. <sup>1</sup>	Document Number	Publication Date MM-DD-YYYY	Name of Patentee or Applicant of Cited Document	Pages, Columns, Lines, Where Relevant Passages or Relevant Figures Appear
		Number-Kind Code <sup>2</sup> (if known)			
	US1	6,353,461	03-05-2002	SHORE, et al.	
	US2	7,272,298	09-18-2007	LANG, et al	
	US3				
	US4				
	US5				
	US6				
	US7				
	US8				
	US9				
	US10				
	US11				
	US12				
	US13				
	US14				
	US15				
	US16				
	US17				
	US18				
	US19				
	US20				

FOREIGN PATENT DOCUMENTS						
Examiner Initials*	Cite No. <sup>1</sup>	Foreign Patent Document	Publication Date MM-DD-YYYY	Name of Patentee or Applicant of Cited Document	Pages, Columns, Lines, Where Relevant Passages or Relevant Figures Appear	T <sup>6</sup>
		Country Code <sup>3</sup> Number <sup>4</sup> Kind Code <sup>5</sup> (if known)				
	FP1					
	FP2					
	FP3					
	FP4					
	FP5					
	FP6					
	FP7					
	FP8					
	FP9					

595325\_1.DOC

Examiner Signature	Date Considered
--------------------	-----------------

\*EXAMINER: Initial if reference considered, whether or not citation is in conformance with MPEP 609. Draw line through citation if not in conformance and not considered. Include copy of this form with next communication to applicant. <sup>1</sup> Applicant's unique citation designation number (optional). <sup>2</sup> See Kinds Codes of USPTO Patent Documents at [www.uspto.gov](http://www.uspto.gov) or MPEP 901.04. <sup>3</sup> Enter Office that issued the document, by the two-letter code (WIPO Standard ST.3). <sup>4</sup> For Japanese patent documents, the indication of the year of the reign of the Emperor must precede the serial number of the patent document. <sup>5</sup> Kind of document by the appropriate symbols as indicated on the document under WIPO Standard ST.16 if possible. <sup>6</sup> Applicant is to place a check mark here if English language Translation is attached.

This collection of information is required by 37 CFR 1.97 and 1.98. The information is required to obtain or retain a benefit by the public which is to file (and by the USPTO to process) an application. Confidentiality is governed by 35 U.S.C. 122 and 37 CFR 1.14. This collection is estimated to take 2 hours to complete, including gathering, preparing, and submitting the completed application form to the USPTO. Time will vary depending upon the individual case. Any comments on the amount of time you require to complete this form and/or suggestions for reducing this burden, should be sent to the Chief Information Officer, U.S. Patent and Trademark Office, P.O. Box 1450, Alexandria, VA 22313-1450. DO NOT SEND FEES OR COMPLETED FORMS TO THIS ADDRESS. SEND TO: Commissioner for Patents, P.O. Box 1450, Alexandria, VA 22313-1450.

If you need assistance in completing the form, call 1-800-PTO-9199 (1-800-786-9199) and select option 2.

**Patent Under Reexamination:** 6,233,389  
**Reexamination Control No.:** 90/007,750  
**Examiner:** Ovidio Escalante  
**Art Unit:** 3992

Commissioner for Patents  
P.O. Box 1450  
Alexandria, VA 22313-1450

Sir:

**CERTIFICATION OF SERVICE OF INFORMATION DISCLOSURE  
STATEMENT**

In compliance with 37 C.F.R. § 1.550(f), the undersigned, on behalf of the patent owner, hereby certifies that a copy of this paper has been served on the third-party requester by first class mail on December 17, 2007. The name and address of the party served is as follows:

David L. Fehrman  
Morrison & Foerster, LLP  
555 W. Fifth Street, Suite 3500  
Los Angeles, CA 90013

Respectfully submitted,

STERNE, KESSLER, GOLDSTEIN & FOX P.L.L.C.

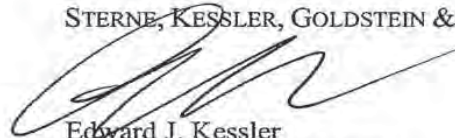

Edward J. Kessler  
Attorney for Patent Owner  
Registration No. 25,688

Date: December 17, 2007

1100 New York Avenue, N.W.  
Washington, D.C. 20005-3934  
(202) 371-2600

759633\_2.DOC

## Electronic Patent Application Fee Transmittal

<b>Application Number:</b>	90007750			
<b>Filing Date:</b>	17-Oct-2005			
<b>Title of Invention:</b>	MULTIMEDIA TIME WARPING SYSTEM			
<b>First Named Inventor/Applicant Name:</b>	6233389			
<b>Filer:</b>	Lori Ann Gordon/Kim Perry			
<b>Attorney Docket Number:</b>	2513.001REX0			
Filed as Large Entity				
<b>ex parte reexam Filing Fees</b>				
<b>Description</b>	<b>Fee Code</b>	<b>Quantity</b>	<b>Amount</b>	<b>Sub-Total in USD(\$)</b>
<b>Basic Filing:</b>				
<b>Pages:</b>				
<b>Claims:</b>				
<b>Miscellaneous-Filing:</b>				
<b>Petition:</b>				
Petition fee- 37 CFR 1.17(f) (Group I)	1462	1	400	400
<b>Patent-Appeals-and-Interference:</b>				
Post-Allowance-and-Post-Issuance:				
<b>Extension-of-Time:</b>				



Description	Fee Code	Quantity	Amount	Sub-Total in USD(\$)
Miscellaneous:				
<b>Total in USD (\$)</b>				<b>400</b>

## Electronic Acknowledgement Receipt

<b>EFS ID:</b>	2602708
<b>Application Number:</b>	90007750
<b>International Application Number:</b>	
<b>Confirmation Number:</b>	4653
<b>Title of Invention:</b>	MULTIMEDIA TIME WARPING SYSTEM
<b>First Named Inventor/Applicant Name:</b>	6233389
<b>Customer Number:</b>	26111
<b>Filer:</b>	Lori Ann Gordon/Kim Perry
<b>Filer Authorized By:</b>	Lori Ann Gordon
<b>Attorney Docket Number:</b>	2513.001REX0
<b>Receipt Date:</b>	17-DEC-2007
<b>Filing Date:</b>	17-OCT-2005
<b>Time Stamp:</b>	18:56:16
<b>Application Type:</b>	Reexam (Patent Owner)

### Payment information:

Submitted with Payment	yes
Payment Type	Credit Card
Payment was successfully received in RAM	\$400
RAM confirmation Number	3848
Deposit Account	
Authorized User	

### File Listing:

Document Number	Document Description	File Name	File Size(Bytes) /Message Digest	Multi Part /.zip	Pages (if appl.)
-----------------	----------------------	-----------	----------------------------------	------------------	------------------

1		2513001REX0.pdf	366135	yes	10
			a8338c4f64e3b9a91044de3039048745 14194c33		
<b>Multipart Description/PDF files in .zip description</b>					
		<b>Document Description</b>	<b>Start</b>	<b>End</b>	
		Reexam Miscellaneous Incoming Letter	1	1	
		Receipt of Petition in a Reexam	2	3	
		Reexam Certificate of Service	4	4	
		Reexam - Info Disclosure Statement Filed by 3rd Party	5	9	
		Reexam Certificate of Service	10	10	
<b>Warnings:</b>					
<b>Information:</b>					
2	Fee Worksheet (PTO-06)	fee-info.pdf	8149	no	2
			efd20db1170c03d13d23f578293288539 f19e392e		
<b>Warnings:</b>					
<b>Information:</b>					
<b>Total Files Size (in bytes):</b>			374284		
<p>This Acknowledgement Receipt evidences receipt on the noted date by the USPTO of the indicated documents, characterized by the applicant, and including page counts, where applicable. It serves as evidence of receipt similar to a Post Card, as described in MPEP 503.</p> <p><b><u>New Applications Under 35 U.S.C. 111</u></b>  If a new application is being filed and the application includes the necessary components for a filing date (see 37 CFR 1.53(b)-(d) and MPEP 506), a Filing Receipt (37 CFR 1.54) will be issued in due course and the date shown on this Acknowledgement Receipt will establish the filing date of the application.</p> <p><b><u>National Stage of an International Application under 35 U.S.C. 371</u></b>  If a timely submission to enter the national stage of an international application is compliant with the conditions of 35 U.S.C. 371 and other applicable requirements a Form PCT/DO/EO/903 indicating acceptance of the application as a national stage submission under 35 U.S.C. 371 will be issued in addition to the Filing Receipt, in due course.</p> <p><b><u>New International Application Filed with the USPTO as a Receiving Office</u></b>  If a new international application is being filed and the international application includes the necessary components for an international filing date (see PCT Article 11 and MPEP 1810), a Notification of the International Application Number and of the International Filing Date (Form PCT/RO/105) will be issued in due course, subject to prescriptions concerning national security, and the date shown on this Acknowledgement Receipt will establish the international filing date of the application.</p>					





Edward J. Kessler  
STERNE, KESSLER, GOLDSTEIN & FOX, PLLC  
1100 New York Avenue NW  
Washington, DC 20005-3934

(For Patent Owner)

MAILED

FEB 07 2008

David L. Fehrman  
Morrison & Foerster, LLP  
555 W. Fifth Street, Suite 3500  
Los Angeles, CA 90013

(For Third Party Requester)

CENTRAL REEXAMINATION UNIT

In re James Barton et al.  
Reexamination Proceeding  
Control No.: 90/007,750  
Filed: October 17, 2005  
For: U.S. Patent No.: 6,233,389

:  
:  
: **DECISION**  
: **ON PETITION**  
: **UNDER 37 CFR 1.182**

This is a decision on the December 17, 2007 patent owner petition under 37 CFR 1.182 to enter, and to have the examiner consider, an information disclosure statement (IDS) filed after the termination of the prosecution in this reexamination proceeding.

The petition is before the Office of Patent Legal Administration for decision.

The petition is dismissed for the reasons set forth below.

**Thus, the IDS filed December 17, 2007, has not been entered for consideration by the examiner.**

**BACKGROUND**

1. Patent number 6,233,389 issued on May 15, 2001.
2. A request for reexamination, assigned control No. 90/007,750 (the '7750 proceeding), was filed on October 17, 2005 by a third party requester.
3. On December 15, 2005 the Office issued an order granting the '7750 reexamination request.
4. The '7750 proceeding progressed to the point where a Notice of Intent to Issue a Reexamination Certificate (NIRC) issued on November 28, 2007.
5. On December 17, 2007, the instant petition was submitted with an IDS, which the patent owner requests the Office to consider. The IDS submitted two references, designated US1 and US2.
6. The reexamination proceeding is being processed toward publication of the reexamination certificate.



## RELEVANT LAW AND PROCEDURE

### 35 U.S.C. 305 Conduct of reexamination proceedings.

... All reexamination proceedings under this section, including any appeal to the Board of Patent Appeals and Interferences, will be conducted with **special dispatch** within the Office. (Emphasis added.)

### MPEP 2256

....Once the NIRC has been mailed, the reexamination proceeding must proceed to publication of the Reexamination Certificate as soon as possible. Thus, when the patent owner provides a submission of patents and printed publications, or other information described in 37 CFR 1.98(a), after the NIRC has been mailed, the submission must be accompanied by **(A) a factual accounting providing a sufficient explanation of why the information submitted could not have been submitted earlier, and (B) an explanation of the relevance of the information submitted with respect to the claimed invention in the reexamination proceeding.** This is provided via a petition under 37 CFR 1.182 (with petition fee) for entry and consideration of the information submitted after NIRC. The requirement in item (B) above is for the purpose of facilitating the Office's compliance with the statutory requirement for "special dispatch," when the requirement in item (A) above is satisfied to provide a basis for interrupting the proceeding after the NIRC.

Once the reexamination has entered the Reexamination Certificate publication process, pulling the proceeding from that process provides an even greater measure of delay. 37 CFR 1.313 states for an application (emphasis added):

"(c) Once the issue fee has been paid, the application will not be withdrawn from issue upon petition by the applicant for any reason except:

(1) Unpatentability of one or more claims, which petition must be accompanied by an unequivocal statement that one or more claims are unpatentable, an amendment to such claim or claims, and an explanation as to how the amendment causes such claim or claims to be patentable;"

The publication process for an application occurs after the payment of the issue fee (there is no issue fee in reexamination); and thus 37 CFR 1.313(c) applies during the publication cycle for an application. Based on the statutory requirement for "special dispatch," the requirements for withdrawal of a reexamination proceeding from its publication cycle are at least as burdensome as those set forth in 37 CFR 1.313(b) and (c). Accordingly, where a submission of patents and printed publications, or other information described in 37 CFR 1.98(a), is made while a proceeding is in its publication cycle, the patent owner must provide an unequivocal statement as to why the art submitted makes at least one claim unpatentable, an amendment to such claim or claims, and an explanation as to how the amendment causes such claim or claims to be patentable. This is in addition to the above-discussed (A) a factual accounting providing a sufficient explanation of why the information submitted could not have been submitted earlier. The submission of patents and printed publications must be accompanied by a petition under 37 CFR 1.182 (with petition fee) for withdrawal of the reexamination proceeding from the publication process for entry and consideration of the information submitted by patent owner. A grantable petition must provide the requisite showing discussed in this paragraph. (Emphasis added)

## DECISION

In a reexamination proceeding, there is no withdrawal under 37 CFR 1.313 of the proceeding from the publication process for consideration of an Information Disclosure Statement (IDS), because 37 CFR 1.313(a) applies to applications, and not to reexamination proceedings.

Accordingly, in this instance, the petition for withdrawal of the present proceeding from the publication process, for consideration of the accompanying IDS papers, has been appropriately filed under 37 CFR 1.182.

While there is no regulatory provision for withdrawal of a reexamination proceeding from the publication process for consideration of an IDS, the policy for withdrawal from the publication process, after the NIRC has been mailed but before the proceeding has actually entered the printing cycle, is explicitly set forth in MPEP 2256 as follows:

...Once the NIRC has been mailed, the reexamination proceeding must proceed to publication of the Reexamination Certificate as soon as possible. Thus, when the patent owner provides a submission of patents and printed publications, or other information described in 37 CFR 1.98(a), after the NIRC has been mailed, the submission must be accompanied by **(A) a factual accounting providing a sufficient explanation of why the information submitted could not have been submitted earlier, and (B) an explanation of the relevance of the information submitted with respect to the claimed invention in the reexamination**



**proceeding.** This is provided via a petition under 37 CFR 1.182 (with petition fee) for entry and consideration of the information submitted after NIRC. The requirement in item (B) above is for the purpose of facilitating the Office's compliance with the statutory requirement for "special dispatch," when the requirement in item (A) above is satisfied to provide a basis for interrupting the proceeding after the NIRC.

In the present instance, the submission fails to satisfy item (A) in regard to one of the two references submitted (US1), because there is no factual accounting to explain why the information submitted could not be submitted earlier in the reexamination proceeding. The instant petition was filed very late in the reexamination proceeding, and while an attempt to satisfy the guidance of MPEP 2256 was made, it is partially insufficient and the Office cannot enter an IDS in part. In regards to reference US1, the patent owner states they were put on actual notice of the reference in an Office action in a related case on October 19, 2007, approximately six weeks prior to the Office's issuance of a NIRC in the '7750 reexamination proceeding. The patent owner presents no factual accounting as to why the information was not submitted during the six weeks prior to issuance of the NIRC. In regards to reference US2, the patent owner states they were not put on actual notice as to the existence of the reference until December 3, 2007, approximately five days after issuance of the NIRC in the '7750 proceeding. This factual accounting is a sufficient explanation as to why the reference could not be submitted earlier. In regards to both references US1 and US2, patent owner states that the relevance of the references with respect to the claimed invention in the reexamination proceeding, namely that both references disclose all the claimed elements of independent claims 1 and 32 but without a media switch, both in general and particularly a media switch possessing the characteristics as set forth in the independent claims. As patent owner has not fully satisfied the requirements of item (A) with regard to reference US1 in the IDS submitted at this late stage of reexamination the present petition does not meet the requirements necessary for consideration of an IDS after a NIRC has been mailed.

For *ex parte* reexamination, 35 U.S.C. 305 provides that all *ex parte* reexamination proceedings "will be conducted with special dispatch within the Office." A review of the record shows that the examiner terminated prosecution on the merits by issuing a NIRC on November 28, 2007, and the proceeding is being prepared to enter the final stages of the publication process. The proceeding is clearly not scheduled to come up for further action on the merits. In order to provide the requested relief, the present proceeding would need to be withdrawn from the publication process, thus significantly regressing the processing of the proceeding. This would run contrary to the statutory requirement of 35 U.S.C. 305 that "[a]ll reexamination proceedings under this section...will be conducted with special dispatch within the Office." The statutory mandate of special dispatch is based upon the public interest in providing certainty and finality as to the question of patentability raised by a request for reexamination. In view of the submission of the IDS information after termination of the prosecution in this reexamination proceeding, and the failure to provide the requisite discussion of the submitted art citations, the present reexamination proceeding will not be reopened at this late date to consider the proffered IDS papers. Accordingly the petition is dismissed as to the request for consideration of the IDS papers.

If, however, the patent owner in fact believes that any reference submitted raises a substantial question of patentability as to at least one claim of the patent *different* than raised in this proceeding, the patent owner can always file a new request for reexamination for consideration of such reference(s).



The IDS submitted by patent owner will be placed in the file, and will remain of record. However, since prosecution has been terminated for this reexamination proceeding, the IDS will not be considered by the examiner.

#### CONCLUSION

1. The petition is dismissed as to the request for consideration of the IDS filed on December 17, 2007.
2. The IDS papers have not been considered by the examiner. A copy of the IDS submission will, however, be placed in the electronic image file wrapper (IFW) for the proceeding.
3. The present proceeding will continue in the publication process, toward issuance of a reexamination certificate.
4. Telephone inquiries related to this decision should be directed to Joseph F. Weiss, Jr., Legal Advisor, at (571) 272-7759.

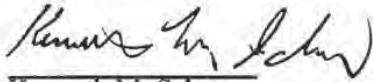

Kenneth M. Schor  
Senior Legal Advisor  
Office of Patent Legal Administration



UNITED STATES PATENT AND TRADEMARK OFFICE

UNITED STATES DEPARTMENT OF COMMERCE  
United States Patent and Trademark Office  
Address: COMMISSIONER FOR PATENTS  
P.O. Box 1450  
Alexandria, Virginia 22313-1450  
www.uspto.gov

APPLICATION NO.	FILING DATE	FIRST NAMED INVENTOR	ATTORNEY DOCKET NO.	CONFIRMATION NO.
90/007,750	10/17/2005	6233389	2513.001REX0	4653

26111 7590 09/05/2008

STERNE, KESSLER, GOLDSTEIN & FOX P.L.L.C.  
1100 NEW YORK AVENUE, N.W.  
WASHINGTON, DC 20005

EXAMINER

ART UNIT PAPER NUMBER

DATE MAILED: 09/05/2008

Please find below and/or attached an Office communication concerning this application or proceeding.



UNITED STATES PATENT AND TRADEMARK OFFICE

Commissioner for Patents  
United States Patent and Trademark Office  
P.O. Box 1450  
Alexandria, VA 22313-1450  
[www.uspto.gov](http://www.uspto.gov)

**DO NOT USE IN PALM PRINTER**

(THIRD PARTY REQUESTER'S CORRESPONDENCE ADDRESS)

David L. Fehrman  
Morrison & Foerster, LLP  
555 W. Fifth Street, Suite 3500  
Los Angeles, CA 90013

**MAILED**

**SEP 05 2008**

CENTRAL REEXAMINATION UNIT

**EX PARTE REEXAMINATION COMMUNICATION TRANSMITTAL FORM**

REEXAMINATION CONTROL NO. 90/007,750.

PATENT NO. 6233389.

ART UNIT 3992.

Enclosed is a copy of the latest communication from the United States Patent and Trademark Office in the above identified *ex parte* reexamination proceeding (37 CFR 1.550(f)).

Where this copy is supplied after the reply by requester, 37 CFR 1.535, or the time for filing a reply has passed, no submission on behalf of the *ex parte* reexamination requester will be acknowledged or considered (37 CFR 1.550(g)).





UNITED STATES DEPARTMENT OF COMMERCE

U.S. Patent and Trademark Office

Address: COMMISSIONER FOR PATENTS  
P.O. Box 1450  
Alexandria, Virginia 22313-1450

APPLICATION NO./ CONTROL NO.	FILING DATE	FIRST NAMED INVENTOR / PATENT IN REEXAMINATION	ATTORNEY DOCKET NO.
90007750	10/17/05	6233389	2513.001REX0

STERNE, KESSLER, GOLDSTEIN & FOX P.L.L.C.  
1100 NEW YORK AVENUE, N.W.  
WASHINGTON, DC 20005

EXAMINER

OVIDIO ESCALANTE

ART UNIT	PAPER
----------	-------

3992                      20080904

DATE MAILED:

Please find below and/or attached an Office communication concerning this application or proceeding.

Commissioner for Patents

Upon review of the record it appears that a few IDS documents may not have been sent to the Patent Owner and Third Party Requester. The Examiner attaches hereto the IDS submitted on May 25, 2006 (one page was not fully initialed), the IDS submitted on April 25, 2006 and the IDS submitted on April 25, 2007. All compliant IDS documents have been previously considered.

ESK

*Ovidio Escalante*

M.B.

Under the Paperwork Reduction Act of 1995, no persons are required to respond to a collection of information unless it contains a valid OMB control number.

Substitute for form 1449A/PTO				<b>Complete if Known</b>	
<b>SUPPLEMENTAL INFORMATION DISCLOSURE STATEMENT BY APPLICANT</b> <i>(Use as many sheets as necessary)</i>				Reexam Control Number	90/007,750
				Filing Date	October 17, 2005
				First Named Inventor	James M. BARTON
				Art Unit	3992
				Examiner Name	Harvey, David E.
Sheet	1	of	1	Attorney Docket Number	2513.001REX0

U.S. PATENT DOCUMENTS					
Examiner Initials*	Cite No. <sup>1</sup>	Document Number	Publication Date	Name of Patentee or Applicant of Cited Document	Pages, Columns, Lines, Where Relevant Passages or Relevant Figures Appear
		Number-Kind Code <sup>2</sup> (if known)	MM-DD-YYYY		
OE	US1	5,121,476	06-09-1992	Yee	
OE	US2	5,227,876	07-13-1993	Cucchi <i>et al.</i>	
OE	US3	5,600,364	02-04-1997	Hendricks <i>et al.</i>	
OE	US4	5,648,824	07-15-1997	Dunn <i>et al.</i>	
OC	US5	6,229,532	05-08-2001	Fujii	
OE	US6	6,243,741	06-05-2001	Utsumi	
OE	US7	6,400,407	06-04-2002	Zigmond <i>et al.</i>	
OE	US8	6,698,020	02-24-2004	Zigmond <i>et al.</i>	
OE	US9	7,055,166	05-30-2006	Logan <i>et al.</i>	
	US10				
	US11				
	US12				
	US13				
	US14				
	US15				
	US16				
	US17				
	US18				
	US19				
	US20				

FOREIGN PATENT DOCUMENTS						
Examiner Initials*	Cite No. <sup>1</sup>	Foreign Patent Document	Publication Date	Name of Patentee or Applicant of Cited Document	Pages, Columns, Lines, Where Relevant Passages or Relevant Figures Appear	T <sup>6</sup>
		Country Code <sup>3</sup> Number <sup>4</sup> Kind Code <sup>5</sup> (if known)	MM-DD-YYYY			
OE	FP1	DE 44 34 034 A1	03-28-1996	Deutsche Thomson-Brandt GmbH		
	FP2					
	FP3					
	FP4					
	FP5					
	FP6					
	FP7					
	FP8					
	FP9					

667804\_1.DOC

Examiner Signature	<i>Ovidio E. Realonte</i>	Date Considered	9/2/08
--------------------	---------------------------	-----------------	--------

\*EXAMINER: Initial if reference considered, whether or not citation is in conformance with MPEP 609. Draw line through citation if not in conformance and not considered. Include copy of this form with next communication to applicant. <sup>1</sup> Applicant's unique citation designation number (optional). <sup>2</sup> See Kinds Codes of USPTO Patent Documents at www.uspto.gov or MPEP 901.04. <sup>3</sup> Enter Office that issued the document, by the two-letter code (WIPO Standard ST.3). <sup>4</sup> For Japanese patent documents, the indication of the year of the reign of the Emperor must precede the serial number of the patent document. <sup>5</sup> Kind of document by the appropriate symbols as indicated on the document under WIPO Standard ST.16 if possible. <sup>6</sup> Applicant is to place a check mark here if English language Translation is attached.

This collection of information is required by 37 CFR 1.97 and 1.98. The information is required to obtain or retain a benefit by the public which is to file (and by the USPTO to process) an application. Confidentiality is governed by 35 U.S.C. 122 and 37 CFR 1.14. This collection is estimated to take 2 hours to complete, including gathering, preparing, and submitting the completed application form to the USPTO. Time will vary depending upon the individual case. Any comments on the amount of time you require to complete this form and/or suggestions for reducing this burden, should be sent to the Chief Information Officer, U.S. Patent and Trademark Office, P.O. Box 1450, Alexandria, VA 22313-1450. DO NOT SEND FEES OR COMPLETED FORMS TO THIS ADDRESS. SEND TO: Commissioner for Patents, P.O. Box 1450, Alexandria, VA 22313-1450.

If you need assistance in completing the form, call 1-800-PTO-9199 (1-800-786-9199) and select option 2.

Copied from 90006724 on 09/13/2007



Under the Paperwork Reduction Act of 1995, no persons are required to respond to a collection of information unless it contains a valid OMB control number.

Substitute for form 1449/PTO  <b>SUPPLEMENTAL INFORMATION DISCLOSURE STATEMENT BY APPLICANT</b> <i>(Use as many sheets as necessary)</i>				<b>Complete if Known</b>		
				Reexam Control Number	90/007,750	
				Filing Date	October 17, 2005	
				First Named Inventor	James M. BARTON	
				Art Unit	3992	
Examiner Name	Harvey, David E.					
Sheet	1	of	1	Attorney Docket Number	2513.001REX0	

NON PATENT LITERATURE DOCUMENTS			
Examiner Initials*	Cite No. <sup>1</sup>	Include name of the author (in CAPITAL LETTERS), title of the article (when appropriate), title of the item (book, magazine, journal, serial, symposium, catalog, etc.), date, page(s), volume issue number(s), publisher, city and/or country where published	T <sup>2</sup>
OE	NPL1	Office Action from European Patent Office for foreign application no. 06019602.9 dated January 10, 2007, including attachments (26 pages).	
OE	NPL2	European Search Report for foreign application no. 06019602.9 dated November 6, 2006 (5 pages).	
	NPL3		
	NPL4		
	NPL5		
	NPL6		
	NPL7		
	NPL8		
	NPL9		
	NPL10		

667801\_1.DOC

Examiner Signature	<i>Ovidio Escalante</i>	Date Considered	9/2/08
--------------------	-------------------------	-----------------	--------

\*EXAMINER: Initial if reference considered, whether or not citation is in conformance with MPEP 809. Draw line through citation if not in conformance and not considered. Include copy of this form with next communication to applicant.

<sup>1</sup> Applicant's unique citation designation number (optional). <sup>2</sup> Applicant is to place a check mark here if English language Translation is attached.

This collection of information is required by 37 CFR 1.98. The information is required to obtain or retain a benefit by the public which is to file (and by the USPTO to process) an application. Confidentiality is governed by 35 U.S.C. 122 and 37 CFR 1.14. This collection is estimated to take 2 hours to complete, including gathering, preparing, and submitting the completed application form to the USPTO. Time will vary depending upon the individual case. Any comments on the amount of time you require to complete this form and/or suggestions for reducing this burden, should be sent to the Chief Information Officer, U.S. Patent and Trademark Office, P.O. Box 1450, Alexandria, VA 22313-1450. DO NOT SEND FEES OR COMPLETED FORMS TO THIS ADDRESS. SEND TO: Commissioner for Patents, P.O. Box 1450, Alexandria, VA 22313-1450.

*(If you need assistance in completing the form, call 1-800-PTO-9199 (1-800-786-9199) and select option 2.)*

Copied from 90006724 on 09/13/2007



**INFORMATION DISCLOSURE CITATION  
IN AN APPLICATION**



(PTO-1449)

ATTY. DOCKET NO.  
60097-0357

APPLICATION NO.  
90/007,750

APPLICANT:  
James M. Barton, et al.

FILING DATE:  
October 17, 2005

GROUP:  
NYA

**U.S. PATENT DOCUMENTS**

Exam. Initial*	Cite No. <sup>1</sup>	U.S. Patent Document		Name of Patentee or Applicant of Cited Document	Date of Publication of Cited Document MM-DD-YYYY	Pages, Columns, Lines, Where Relevant Passages or Relevant Figures Appear
		Number	Kind Code <sup>2</sup> (If known)			

**FOREIGN PATENT DOCUMENTS**

Exam. Initial*	Cite No. <sup>1</sup>	Foreign Patent Document			Name of Patentee or Applicant of Cited Document	Date of Publication of Cited Document MM-DD-YYYY	Pages, Columns, Lines, Where Relevant Passages or Relevant Figures Appear	T <sup>6</sup>
		Office <sup>3</sup>	Number <sup>4</sup>	Kind Code <sup>5</sup> (If known)				

**OTHER ART – NO PATENT LITERATURE DOCUMENTS**

Examiner Initials*	Cite No. <sup>1</sup>	Include name of the author (in CAPITAL LETTERS), title of the article (when appropriate), title of the item (book, magazine, journal, serial, symposium, catalog, etc.), date, page(s), volume-issue number(s), publisher, city and/or country where published	Translation <sup>2</sup>
OE		TiVo Inc. vs. Echostar Communications Corp, et al., Case No. 2:04-CV-1-DF, "Verdict Form", filed April 13, 2006 in U.S. District Court, Eastern District of Texas, Marshall Division (8 pgs).	

Examiner Signature	<i>Orlando Escalante</i>	Date Considered	9/2/08
--------------------	--------------------------	-----------------	--------

\*EXAMINER: Initial if reference considered, whether or not citation is in conformance with MPEP 609; Draw line through citation if not in conformance and not considered. Include copy of this form with next communication to applicant.

<sup>1</sup>Unique citation designation number. <sup>2</sup>See attached Kinds of U.S. Patent Documents. <sup>3</sup>Enter Office that issued the document, by the two-letter code (WIPO Standard S.3). <sup>4</sup>For Japanese patent documents, the indication of the year of reign of the Emperor must precede the serial number of the patent document. <sup>5</sup>Kind of document by the appropriate symbols as indicated on the document under WIPO Standard ST.16 if possible. <sup>6</sup>Applicant is to place a check mark here if English language Translation is attached.

Burden Hour Statement: This form is estimated to take 2.0 hours to complete. Time will vary depending upon the needs of the individual case. Any comments on the amount of time you are required to complete this form should be sent to the Chief Information Officer, Patent and Trademark Office, Washington, DC 20231. DO NOT SEND FEES OR COMPLETED FORMS TO THIS ADDRESS. SEND TO: Assistant Commissioner for Patents, Washington, DC 20231.



Substitute for Form 1449A/PTO (Modified) (use as many sheets as necessary)		Attorney Docket No.: 60097-0357	Application Number: 90/007,750
		First Named Inventor: James M. Barton, et al	
		Filing Date: October 17, 2005	
<b>OTHER ART - NO PATENT LITERATURE DOCUMENTS</b>			
Examiner Initials*	Cite No <sup>1</sup>	Include name of the author (in CAPITAL LETTERS), title of the article (when appropriate), title of the item (book, magazine, journal, serial, symposium, catalog, etc.), date, page(s), volume-issue number(s), publisher, city and/or country where published	Translation <sup>2</sup>
OE		Winston Hodge, et al., "Chapter 7, True Video on Demand vs. Near Video on Demand", delivered at National Cable Television Conference, May 24, 1994 (pps. 103-120).	
OE		Cyril U. Orji, et al., "Design and Configuration Rationales for Digital Video Storage and Delivery Systems", Multimedia Tools and Applications, 9, 275-302 (1992), © 1992 Kluwer Academic Publishers, Boston (pps. 275-302).	
OE		SCSI Specification, 0663 and 0663 Enhanced Disk Drive, Release 4.0, (247 pgs).	
OE		R. Johnston, et al., "A Digital Television Sequence Store", IBEE, (pps. 594-600) © 1978.	
OE		M. Hausdorfer, "Symposium Record Broadcast Sessions", HDTV Production: Today and Tomorrow, June 17, 1989, (7 pgs).	
OE		S. Berson, "Computer Science Department Technical Report", Staggered Striping in Multimedia Information System, December 1993, April 29, 1994, (24 pgs).	
OE		S. Berson, et al., "Design of a Scalable Multimedia Storage Manager", (pps. 1-30).	
OE		Conner Filepro Performance Series, CFP1060E/CFP1060S/CFP1060W, "Intelligent Disk Drive Product Manual", Rev. A, May 1994, © 1994, Conner Peripherals, Inc., (79 pgs).	
OE		Hugh M. Sierra, "An Introduction to Direct Access Storage Devices", © 1990 by Academic Press, Inc., (269 pgs).	
		<del>J. Freeman, et al., "Systems Aspects of COBE Science Data Compression", Cosmology Data Analysis Center, (pps. 85-97).</del>	
OE		Douglas T. Anderson, "The Hard Disk Technical Guide", Tenth Revision S-D., February 1994, © 1990, 1991, 1992, 1993, 1994 by Micro House International Inc., (70 pgs).	
		<del>Official Action from EPO for foreign application no. 99 909 867.6 2002 dated 27 December 2005 (5 pgs) attached.</del>	

Examiner Signature		Date Considered	4/2006
--------------------	---	-----------------	--------

\*EXAMINER: Initial if reference considered, whether or not citation is in conformance with MPEP 609; Draw line through citation if not in conformance and not considered. Include copy of this form with next communication to applicant.

Ovidio E. Realonte

9/2/2008





US006233389C1

(12) EX PARTE REEXAMINATION CERTIFICATE (6516th)  
United States Patent  
Barton et al.

(10) Number: US 6,233,389 C1  
(45) Certificate Issued: Nov. 11, 2008

(54) MULTIMEDIA TIME WARPING SYSTEM

(75) Inventors: **James M. Barton**, Los Gatos, CA (US); **Roderick James McInnis**, Milpitas, CA (US); **Alan S. Moskowitz**, San Francisco, CA (US); **Andrew Martin Goodman**, Menlo Park, CA (US); **Ching Tong Chow**, Fremont, CA (US); **Jean Swey Kao**, Cupertino, CA (US)

(73) Assignee: **TiVo, Inc.**, Sunnyvale, CA (US)

**Reexamination Request:**  
No. 90/007,750, Oct. 17, 2005

**Reexamination Certificate for:**  
Patent No.: **6,233,389**  
Issued: **May 15, 2001**  
Appl. No.: **09/126,071**  
Filed: **Jul. 30, 1998**

(51) **Int. Cl.**  
**H04N 5/91** (2006.01)

(52) **U.S. Cl.** ..... **386/46; 386/68; 386/E5.043; 386/E5.07; 348/E5.007; 348/E5.108**

(58) **Field of Classification Search** ..... **386/46, 386/E5.007, E5.108, 86, E5.043, E5.07**  
See application file for complete search history.

(56) **References Cited**

**U.S. PATENT DOCUMENTS**

3,682,363 A 8/1972 Hull  
3,942,190 A 3/1976 Detweiler  
4,141,039 A 2/1979 Yamamoto

(Continued)

**FOREIGN PATENT DOCUMENTS**

DE 44 34 034 A1 3/1996

(Continued)

**OTHER PUBLICATIONS**

Ramanathan et al, "Toward personalized multimedia dial-up services", Computer Networks and ISDN Systems Jul. 26, 1994, No. 10, Amsterdam, NL.\*

(Continued)

*Primary Examiner*—Ovidio Escalante

(57) **ABSTRACT**

A multimedia time warping system. The invention allows the user to store selected television broadcast programs while the user is simultaneously watching or reviewing another program. A preferred embodiment of the invention accepts television (TV) input streams in a multitude of forms, for example, National Television Standards Committee (NTSC) or PAL broadcast, and digital forms such as Digital Satellite (DSS), Digital Broadcast Services (DBS), or Advanced Television Standards Committee (ATSC). The TV streams are converted to an Moving Pictures Experts Group (MPEG) formatted stream for internal transfer and manipulation and are parsed and separated it into video and audio components. The components are stored in temporary buffers. Events are recorded that indicate the type of component that has been found, where it is located, and when it occurred. The program logic is notified that an event has occurred and the data is extracted from the buffers. The parser and event buffer decouple the CPU from having to parse the MPEG stream and from the real time nature of the data streams which allows for slower CPU and bus speeds and translate to lower system costs. The video and audio components are stored on a storage device and when the program is requested for display, the video and audio components are extracted from the storage device and reassembled into an MPEG stream which is sent to a decoder. The decoder converts the MPEG stream into TV output signals and delivers the TV output signals to a TV receiver. User control commands are accepted and sent through the system. These commands affect the flow of said MPEG stream and allow the user to view stored programs with at least the following functions: reverse, fast forward, play, pause, index, fast/slow reverse play, and fast/slow play.

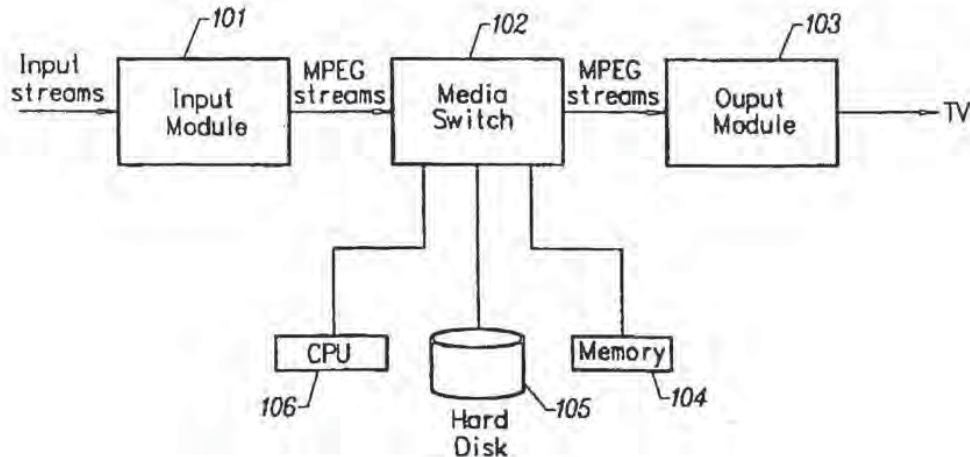



U.S. PATENT DOCUMENTS					
4,224,481 A	9/1980	Russell	5,233,423 A	8/1993	Jernigan et al.
4,258,418 A	3/1981	Heath	5,233,603 A	8/1993	Tekeuchi et al.
4,313,135 A	1/1982	Cooper	5,237,648 A	8/1993	Mills et al.
4,347,527 A	8/1982	Lainez	5,241,428 A	8/1993	Goldwasser et al.
4,388,659 A	6/1983	Lemke	5,245,430 A	9/1993	Nishimura
4,408,309 A	10/1983	Kiesling et al.	5,247,347 A	9/1993	Litteral et al.
4,423,480 A	12/1983	Bauer et al.	5,251,009 A	10/1993	Bruno
4,439,785 A	3/1984	Leonard	5,253,275 A	10/1993	Yurt et al.
4,506,348 A	3/1985	Miller et al.	5,283,659 A	2/1994	Akiyama et al.
4,506,358 A	3/1985	Montgomery	5,285,272 A	2/1994	Bradley et al.
4,602,297 A	7/1986	Reese	5,287,182 A	2/1994	Haskell et al.
4,633,331 A	12/1986	McGrady et al.	5,311,423 A	5/1994	Clark
4,665,431 A	5/1987	Cooper	5,317,603 A	5/1994	Osterweil
4,688,106 A	8/1987	Keller et al.	5,317,604 A	5/1994	Osterweil
4,689,022 A	8/1987	Peers et al.	5,329,307 A	* 7/1994	Takemura et al. .... 347/151
4,706,121 A	11/1987	Young	5,329,320 A	7/1994	Yifrach
4,723,181 A	2/1988	Hickok	5,357,276 A	10/1994	Banker et al.
4,752,834 A	6/1988	Koombes	5,361,261 A	11/1994	Edem et al.
4,755,889 A	7/1988	Schwartz	5,371,551 A	12/1994	Logan et al.
4,760,442 A	7/1988	O'Connell et al.	5,412,416 A	5/1995	Nemirofsky
4,761,684 A	8/1988	Clark et al.	5,414,455 A	5/1995	Hooper et al.
4,789,961 A	12/1988	Tindall	5,428,731 A	6/1995	Powers
4,805,217 A	2/1989	Morihiro et al.	5,438,423 A	8/1995	Lynch et al.
4,816,905 A	3/1989	Tweedy et al.	5,440,334 A	8/1995	Walters et al.
4,821,121 A	4/1989	Beaulier	5,442,390 A	8/1995	Hooper et al.
4,833,710 A	5/1989	Hirashima	5,452,006 A	* 9/1995	Auld ..... 375/240.26
4,876,670 A	10/1989	Nakabayashi et al.	5,477,263 A	12/1995	O'Callaghan
4,891,715 A	1/1990	Levy	5,481,542 A	1/1996	Logston et al.
4,897,867 A	1/1990	Foster et al.	5,488,409 A	1/1996	Yuen et al.
4,920,533 A	4/1990	Dufresne et al.	5,506,615 A	4/1996	Awaji
4,924,387 A	5/1990	Jeppesen	5,508,940 A	4/1996	Rossmere et al.
4,939,594 A	7/1990	Moxon et al.	5,513,011 A	4/1996	Matsumoto
4,947,244 A	8/1990	Fenwick et al.	5,513,306 A	4/1996	Mills et al.
4,949,169 A	8/1990	Lumelsky et al.	5,519,684 A	5/1996	Iizuka et al.
4,949,187 A	8/1990	Cohen	5,521,630 A	5/1996	Chen et al.
4,963,866 A	10/1990	Duncan	5,528,281 A	6/1996	Grady et al.
4,963,995 A	10/1990	Lang	5,528,282 A	6/1996	Voeten et al.
4,972,396 A	11/1990	Rafner	5,537,157 A	* 7/1996	Washino et al. .... 348/722
4,979,050 A	12/1990	Westland et al.	5,550,594 A	8/1996	Cooper et al.
RE33,535 E	2/1991	Cooper	5,550,982 A	8/1996	Long et al.
4,991,033 A	2/1991	Takeshita	5,555,463 A	9/1996	Staron
5,001,568 A	3/1991	Efron et al.	5,559,999 A	9/1996	Maturi
5,014,125 A	5/1991	Pocock et al.	5,563,714 A	* 10/1996	Inoue et al. .... 386/66
5,018,186 A	5/1991	Kimura et al.	5,572,261 A	11/1996	Cooper
5,019,900 A	5/1991	Clark et al.	5,577,190 A	11/1996	Peters
5,021,893 A	6/1991	Scheffler	5,581,479 A	12/1996	McLaughlin et al.
5,027,241 A	6/1991	Hatch et al.	5,583,561 A	12/1996	Baker et al.
5,027,400 A	6/1991	Baji et al.	5,583,652 A	12/1996	Ware
5,047,857 A	9/1991	Duffield et al.	5,586,264 A	12/1996	Belknap et al.
5,057,932 A	10/1991	Lang	5,600,364 A	2/1997	Hendricks et al.
5,063,453 A	11/1991	Yoshimura et al.	5,603,058 A	2/1997	Belknap et al.
5,089,885 A	2/1992	Clark	5,604,544 A	2/1997	Bertram
5,093,718 A	3/1992	Hoarty et al.	5,612,749 A	3/1997	Bacher et al.
5,109,281 A	4/1992	Koberi et al.	5,614,940 A	3/1997	Cobbly et al.
5,118,105 A	6/1992	Brim et al.	5,615,401 A	3/1997	Harscoet et al.
5,121,476 A	6/1992	Yee	5,619,247 A	4/1997	Russo
5,126,852 A	6/1992	Nishino et al.	5,619,337 A	* 4/1997	Naipally ..... 386/83
5,126,982 A	6/1992	Yifrach	5,625,464 A	4/1997	Compoint et al.
5,130,792 A	7/1992	Tindell et al.	5,629,732 A	5/1997	Moskowitz et al.
5,132,992 A	7/1992	Yurt	5,635,984 A	6/1997	Lee
5,134,499 A	7/1992	Sata et al.	5,642,171 A	* 6/1997	Baumgartner et al. .... 348/515
5,142,532 A	8/1992	Adams	5,648,824 A	7/1997	Dunn et al.
5,153,726 A	10/1992	Billing	5,659,539 A	8/1997	Porter
5,168,353 A	12/1992	Walker et al.	5,664,044 A	9/1997	Ware
5,172,413 A	12/1992	Bradley et al.	5,668,948 A	9/1997	Belknap et al.
5,202,761 A	4/1993	Cooper	5,675,388 A	10/1997	Cooper
5,208,665 A	5/1993	McCalley et al.	5,696,866 A	12/1997	Iggulden et al.
5,214,768 A	5/1993	Martin et al.	5,696,868 A	12/1997	Kim et al.
5,226,141 A	7/1993	Esbensen	5,701,383 A	12/1997	Russo
5,227,876 A	7/1993	Cucchi et al.	5,706,388 A	1/1998	Isaka
			5,712,976 A	1/1998	Falcon, Jr. et al.



5,715,356 A 2/1998 Hirayama et al.  
 5,719,982 A 2/1998 Kawamura et al.  
 5,721,815 A 2/1998 Ottesen et al.  
 5,721,878 A 2/1998 Ottesen et al.  
 5,724,474 A 3/1998 Oguro et al.  
 5,729,741 A \* 3/1998 Liaguno et al. .... 707/104.1  
 5,751,282 A 5/1998 Girard et al.  
 5,751,338 A 5/1998 Ludwig et al.  
 5,751,371 A 5/1998 Shintani  
 5,751,883 A 5/1998 Ottesen et al.  
 5,754,254 A 5/1998 Kobayashi et al.  
 5,761,166 A 6/1998 Sedimayr et al.  
 5,761,417 A 6/1998 Henley et al.  
 5,771,334 A 6/1998 Yamauchi et al.  
 5,774,170 A 6/1998 Hite et al.  
 5,774,186 A 6/1998 Brodsky et al.  
 5,778,137 A 7/1998 Nielsen et al.  
 5,787,225 A 7/1998 Honjo  
 5,805,763 A 9/1998 Lawler et al.  
 5,805,821 A 9/1998 Saxena et al.  
 5,808,607 A 9/1998 Brady et al.  
 5,815,689 A 9/1998 Shaw  
 5,822,493 A 10/1998 Uehara et al.  
 5,852,705 A 12/1998 Hanko et al.  
 5,864,682 A 1/1999 Porter et al.  
 5,870,553 A 2/1999 Shaw et al.  
 5,889,915 A 3/1999 Hewton  
 5,892,884 A 4/1999 Sugiyama et al.  
 5,899,578 A 5/1999 Yanagihara et al.  
 5,920,572 A 7/1999 Washington et al.  
 5,920,842 A 7/1999 Cooper et al.  
 5,930,444 A 7/1999 Camhi et al.  
 5,949,948 A 9/1999 Krause et al.  
 5,949,954 A 9/1999 Young et al.  
 5,956,716 A 9/1999 Kenner et al.  
 5,963,202 A 10/1999 Polish  
 5,973,679 A 10/1999 Abbott et al.  
 5,991,496 A 11/1999 Kojitma  
 5,995,709 A 11/1999 Tsuge  
 5,999,691 A 12/1999 Takagi  
 6,002,832 A 12/1999 Yoneda  
 6,005,562 A 12/1999 Shiga et al.  
 6,005,564 A 12/1999 Ahmad  
 6,018,612 A 1/2000 Thomason et al.  
 6,028,599 A 2/2000 Yuen et al.  
 RE36,801 E 8/2000 Logan et al.  
 6,112,226 A 8/2000 Weaver et al.  
 6,138,147 A 10/2000 Weaver et al.  
 6,141,385 A 10/2000 Yamaji et al.  
 6,151,059 A 11/2000 Schein et al.  
 6,154,771 A 11/2000 Rangan et al.  
 6,163,644 A 12/2000 Owashi et al.  
 6,167,083 A 12/2000 Sporer  
 6,169,843 B1 1/2001 Lenihan et al.  
 6,192,189 B1 2/2001 Fujinami et al.  
 6,198,877 B1 3/2001 Kawamura et al.  
 6,226,447 B1 5/2001 Sasaki  
 6,229,532 B1 5/2001 Fujii  
 6,233,389 B1 5/2001 Barton et al.  
 6,243,741 B1 6/2001 Utsumi  
 6,249,641 B1 6/2001 Yokota  
 6,253,375 B1 6/2001 Gordon et al.  
 6,256,704 B1 7/2001 Hlava et al.  
 6,272,672 B1 8/2001 Conway  
 6,278,837 B1 8/2001 Yasukohchi et al.  
 6,285,824 B1 9/2001 Yanagihara et al.  
 6,292,618 B1 9/2001 Ohara et al.  
 6,292,619 B1 9/2001 Fujita et al.  
 6,301,711 B1 10/2001 Nusbickel  
 6,304,714 B1 10/2001 Krause et al.  
 6,330,675 B1 12/2001 Wisner et al.

6,341,195 B1 1/2002 Mankovitz et al.  
 6,400,407 B1 6/2002 Zigmond et al.  
 6,424,791 B1 7/2002 Saib  
 6,445,738 B1 9/2002 Zdepski  
 6,445,872 B1 9/2002 Sano et al.  
 6,498,894 B2 12/2002 Ito et al.  
 6,504,990 B1 1/2003 Abecassis  
 6,516,467 B1 \* 2/2003 Schindler et al. .... 725/153  
 6,529,685 B2 3/2003 Ottesen et al.  
 6,542,695 B1 4/2003 Akiba et al.  
 6,553,178 B2 4/2003 Abecassis  
 6,698,020 B1 2/2004 Zigmond et al.  
 6,754,254 B2 6/2004 Sendonaris  
 6,788,882 B1 9/2004 Geer et al.  
 7,055,166 B1 5/2006 Logan et al.  
 2005/0025469 A1 2/2005 Geer et al.  
 2005/0132418 A1 6/2005 Barton et al.  
 2005/0226604 A1 10/2005 Kawamura et al.

FOREIGN PATENT DOCUMENTS

EP 0594241 A1 10/1993  
 EP 0594241 B1 4/1994  
 EP 0726574 B1 8/1996  
 EP 0726574 A2 8/1996  
 EP 0785675 A2 1/1997  
 EP 0817483 A2 1/1998  
 GB 2222742 A 8/1989  
 GB 2320637 \* 6/1998  
 WO 91/03112 A1 8/1990  
 WO 92/04573 6/1992  
 WO 92/22983 A2 12/1992  
 WO 2000/76130 A1 5/2000

OTHER PUBLICATIONS

Fujii et al., "Implementation of MPEG Transport Demultiplexer with a RISC-Based Microcontroller," IEEE, 1996.\*  
 Neil McManes, "QuickTime ready for prime time", MacWEEK, vol. 5, No. 42, Dec. 13, 1991.  
 Chris Ruemmler, et al., "UNIX disk access patterns", Hewlett-Packard Laboratories, Winter USENIX, San Diego, CA, Jan. 25-29, 1993.  
 J.M. Harker, et al., "A Quarter Century of Disk File Innovation," IBM J. Res. Develop., vol. 25, No. 5, Sep. 1981.  
 Andrew David Hospodor, "The Effect of Prefetch in SCSI Disk Drive Cache Buffers," Doctoral Thesis, Santa Clara University, May 2, 1994.  
 D. J. Woodham, "A Solid State 'Action Replay' Recorder," International TV Symposium and Technical Exhibition, Montreux, Switzerland, Jun. 17-22, 1989.  
 English Language Abstract of Japanese Patent Publication No. JP 04-088772, data supplied by delphion, 1 page (Mar. 23, 1992—Date of Publication).  
 English Language Abstract of Japanese Patent Publication No. JP 06-233234, data supplied by delphion, 1 page (Aug. 19, 1994—Date of Publication).  
 English Language Abstract of Japanese Patent Publication No. JP 06-245157, data supplied by delphion, 1 page (Sep. 2, 1994—Date of Publication).  
 English Language Abstract of Japanese Patent Publication No. JP 07-111629, data supplied by delphion, 1 page (Apr. 25, 1995—Date of Publication).  
 English Language Abstract of Japanese Patent Publication No. JP 07-131754, data supplied by delphion, 1 page (May 19, 1995—Date of Publication).  
 English Language Abstract of Japanese Patent Publication No. JP 07-250305, data supplied by delphion, 1 page (Sep. 26, 1995—Date of Publication).



- English Language Abstract of Japanese Patent Publication No. JP 07-264529, data supplied by delphion, 1 page (Oct. 13, 1995—Date of Publication).
- English Language Abstract of Japanese Patent Publication No. JP 09-233415, data supplied by delphion, 2 pages (Sep. 5, 1997—Date of Publication).
- I. Freedman, et al. "Systems Aspects of COBE Science Data Compression", pp. 85-97.
- K. Shen et al., *A Fast Algorithm for Video Parsing Using MPEG Compressed Sequences*, IEEE, pp. 252-255 (0-8185-7310-9/626/1995).
- S. Smollar et al.; *Content-based Video Indexing and Retrieval*, IEEE, Summer 1994, pp. 62-72.
- J. Meng et al., *CVEPS—A Compressed Video Editing and Parsing System*, ACM Multimedia '96, Boston MA, pp. 43-53 (ACM 0-89791-671-1/96/1).
- Zhang, HongJiang, "Video Parsing, Retrieval and Browsing: An Integrated and Content-Based Solution," ACM Multimedia 95, Electronic Proceedings, Nov. 5-9, 1995, 16 pages.
- Inside Macintosh "QuickTime", Apple Technology Library by Apple Computer, Inc., © 1993 (published by Addison-Wesley Publishing Company) 719 pgs.
- Inside Macintosh "Files", Apple Technology Library by Apple Computer, Inc., © 1992 (published by Addison-Wesley Publishing Company) 532 pgs.
- Inside Macintosh "Memory", Apple Technology Library by Apple Computer, Inc., © 1992 (published by Addison-Wesley Publishing Company) 303 pgs.
- Inside Macintosh "QuickTime Components", Apple Technology Library by Apple Computer, Inc., © 1993 (published by Addison-Wesley Publishing Company) 828 pgs.
- Inside Macintosh "Overview", Apple Technology Library by Apple Computer, Inc., © 1992 (published by Addison-Wesley Publishing Company) 251 pgs.
- Quantum Q500 Series High Capacity 5¼" Fixed Disk Drive, Quantum Corporation, © 1983 (2 pgs).
- Quantum 2000 Series Low-Cost 8" Fixed Disk Drives, "New DC Motor Option", Quantum Corporation (2 pgs).
- Quantum Q2080 Low-Cost, 85 Megabyte Fixed Disk Drive, "85 Mb capacity/40ms average access time", Quantum Corporation, © 1982 (2 pgs).
- OEM Interface Specifications for DSAA-3xxx, 3.5-Inch Hard Disk Drive with ATA Interface, IBM Corporation, © 1994 (65 pgs).
- International Standard ISO/IEC 11172-2:1993(E), (Part 2: Video), Downloaded Jun. 15, 2005 (136 pgs).
- International Standard ISO/IEC 11171-3:1993/Cor.1:1996(E), (Part 3: Audio), Downloaded Jun. 15, 2005 (159 pgs).
- Hewlett Packard® MPEGscope User's Guide, Hewlett Packard Company © 1997-2000 (282 pgs).
- DiviCom, MP100 User Guide, DiviCom, Inc., © 1996 (97 pgs).
- Hewlett Packard® MPEGscope Startup Guide, Hewlett Packard Company © 1997-2000 (39 pgs).
- MediaStream by Media4, "Desktop Satellite Multimedia", "The MediaStream Receiver Card", "MediaStream Uplink System", by Media4, Inc. (2 pgs).
- Jim Stratigos et al., Media4 Press Release "Announces Reseller Agreement with AlphaStar Television Networks", Microsoft® and Windows® 95 (3 pgs).
- Jim Stratigos et al., Media4 Press Release "Announces Multimedia Satellite Network for Personal Computers", Microsoft® and Windows® 95 (3 pgs).
- Media Stream, "Satellite Receiver" Installation and Users Guide for Windows 95, Media4, Inc., © 1996 (33 pgs).
- International Standard ISO/IEC 13818-1:2000(E) "Information Technology—Generic Coding of Moving Pictures and Associated Audio Information: Systems", © ISO/IEC 2000, Downloaded Jun. 30, 2005 (173 pgs).
- International Standard ISO/IEC 13818-1:2000/Amd.2:2004(E) "Information Technology—Generic Coding of Moving Pictures and Associated Audio Information: Systems", Amendment 2: Support of IPMP on MPEG-2 Systems, © ISO/IEC 2004, Downloaded Jun. 30, 2005 (13 pgs).
- International Standard ISO/IEC 13818-2:2000(E) "Information Technology—Generic Coding of Moving Pictures and Associated Audio Information: Video", © ISO/IEC 2000, Downloaded Jun. 30, 2005 (219 pgs).
- International Standard ISO/IEC 13818-3:1998(E) "Information Technology—Generic Coding of Moving Pictures and Associated Audio Information: Audio", © ISO/IEC 1998 (125 pgs).
- Guide to VAX/VMS File Applications., Software Version VAX/VMS Version 4.0, Sep. 1984 (19 pgs).
- Harrick M. Vin, et al., *Designing A Multiuser HDTV Storage Server*, IEEE Journal, vol. 11, No. 1, Jan. 1993 (pp. 153-164).
- Quantum Fireball 640/1280S Product Manual, Quantum®, Copyright © 1995 by Quantum Corporation (190 pgs).
- Winston Hodge, et al., "Chapter 7, True Video on Demand vs. Near Video on Demand", delivered at National Cable Television Conference, May 24, 1994 (pp. 103-120).
- Cyril U. Orji, et al., "Design and Configuration Rationales for Digital Video Storage and Delivery Systems", Multimedia Tools and Applications, 9, 275-302 (1992), © 1992 Kluwer Academic Publishers, Boston (pp. 275-302).
- SCSI Specification, 0663 and 0663 Enhanced Disk Drive, Release 4.0, (247 pgs).
- R. Johnston, et al., "A Digital Television Sequence Store", IEEE, (pp. 594-600) © 1978.
- M. Hausdorfer, "Symposium Record Broadcast Sessions", HDTV Production: Today and Tomorrow, Jun. 17, 1989, (7 pgs).
- S. Berson, "Computer Science Department Technical Report", Staggered Striping in Multimedia Information System, December 1993, Apr. 29, 1994, (24 pgs).
- S. Berson, et al., "Design of a Scalable Multimedia Storage Manager", (pp. 1-30).
- Conner Filepro Performance Series, CFP1060E/CFP1060S/CFP1060W, "Intelligent Disk Drive Product Manual", Rev. A, May 1984, © 1994, Conner Peripherals, Inc., (79 pgs).
- Hugh M. Sierra, "An Introduction to Direct Access Storage Devices", © 1990, by Academic Press, Inc., (269 pgs).
- Douglas T. Anderson, "The Hard Disk Technical Guide", Tenth Revision S-D., Feb. 1994, © 1990, 1991, 1992, 1993, 1994 by Micro House International Inc., (70 pgs).
- Astarte DVDirector™, Beta Testing Program.
- International Standard ISO/IEC 11172 (MPEG-1 Standard, Part 1: Systems).



K. Shen et al., *A fast algorithm for video parsing using MPEG compressed sequences*, IEEE, pp. 252-255 (0-8185-7310-9/959/1995).

S. Smollar et al., *Content-based video indexing and retrieval*, IEEE, Summer 1994, pp. 62-72.

H. Zhang et al, *Video parsing, retrieval and browsing: an integrated and content-based solution*, ACM Multimedia 95-Electronic Proceedings (Nov. 5-9, 1995, San Francisco, CA).

*Tivo Inc. vs. Echostar Communications Corp, et al.*, Case No. 2:04-CV-1-DF, "Verdict Form", filed Apr. 13, 2006 in U.S. District Court, Eastern District of Texas, Marshall Division (8 pgs).

Office Action from European Patent Office for foreign application No. 06019602.9 dated Jan. 10, 2007, including attachments (26 pages).

European Search Report for foreign application No. 06019602.9 dated Nov. 6, 2006 (5 pages).

\* cited by examiner

US 6,233,389 C1

**1**  
**EX PARTE**  
**REEXAMINATION CERTIFICATE**  
**ISSUED UNDER 35 U.S.C. 307**

NO AMENDMENTS HAVE BEEN MADE TO  
THE PATENT

**2**  
AS A RESULT OF REEXAMINATION, IT HAS BEEN  
DETERMINED THAT:

5 The patentability of claims 1-61 is confirmed.

\* \* \* \* \*