

- [54] METHOD AND APPARATUS FOR SCRAMBLING AND UNSCRAMBLING COMMUNICATION SIGNALS
- [75] Inventors: **Albert F. Hartung**, Woodland Hills; **Frank W. Lehan**, Santa Barbara; **Charles T. Barooshian**, Pacific Palisades; **Edward J. Zacharski**, Malibu, all of Calif.
- [73] Assignee: **System Development Corporation**, Santa Monica, Calif.
- [22] Filed: **Aug. 15, 1973**
- [21] Appl. No.: **388,439**
- [52] U.S. Cl. **178/5.1; 178/DIG. 13; 178/22; 325/34**
- [51] Int. Cl.² **H04N 1/44**
- [58] Field of Search **178/5.1, DIG. 13, 22; 325/34**

Primary Examiner—Maynard R. Wilbur
 Assistant Examiner—S. C. Buczinski
 Attorney, Agent, or Firm—Fulwider, Patton, Rieber Lee & Utecht

[57] **ABSTRACT**
 Method and apparatus for scrambling and unscrambling television video and audio signals in a subscription television system in which program selections of subscribers are known at a central transmitting site, and control signals encoded into vertical blanking intervals of the video signals are addressed to receivers authorized to receive unscrambled transmissions, to selectively control unscrambling at those receivers. In an unscrambler at each subscriber's receiver, the control signals are decoded, and, if addressed to the particular subscriber's receiver, operate to enable or disable the unscrambler, or to frequently vary its mode of operation, thereby greatly increasing the security of the system and deterring viewing of scrambled transmissions. Video scrambling and unscrambling are effected by inversion of selected horizontal lines of a transmitted television picture, and possible modes of scrambling and unscrambling include inversion of alternate groups of equal numbers of lines, inversion or non-inversion selected on a line-by-line basis, with an appropriate control signal being transmitted with each line, and inversion or non-inversion in a preselected sequence, as determined by synchronized logic at the receivers and the transmitting site.

[56] **References Cited**
UNITED STATES PATENTS

| | | | |
|-----------|---------|---------------------|---------|
| 3,106,604 | 10/1963 | Shanahan..... | 178/5.1 |
| 3,184,537 | 5/1965 | Court et al..... | 178/5.1 |
| 3,527,877 | 9/1970 | Walker..... | 178/5.1 |
| 3,538,243 | 11/1970 | Shanahan et al..... | 178/5.1 |
| 3,732,355 | 5/1973 | Harna et al..... | 178/5.1 |
| 3,757,225 | 9/1973 | Ulicki..... | 178/5.1 |
| 3,777,053 | 12/1973 | Wittig et al..... | 178/5.1 |
| 3,789,131 | 1/1974 | Harney..... | 178/5.1 |
| 3,790,700 | 2/1974 | Callais et al..... | 178/5.1 |
| 3,801,732 | 4/1974 | Reeves..... | 178/5.1 |

52 Claims, 16 Drawing Figures

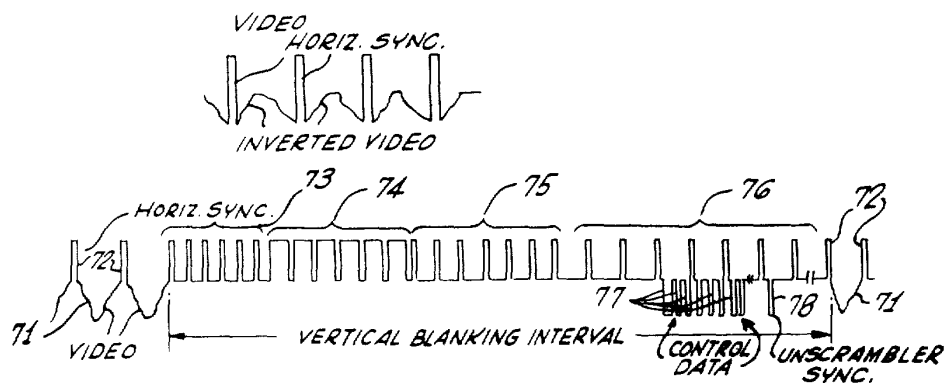

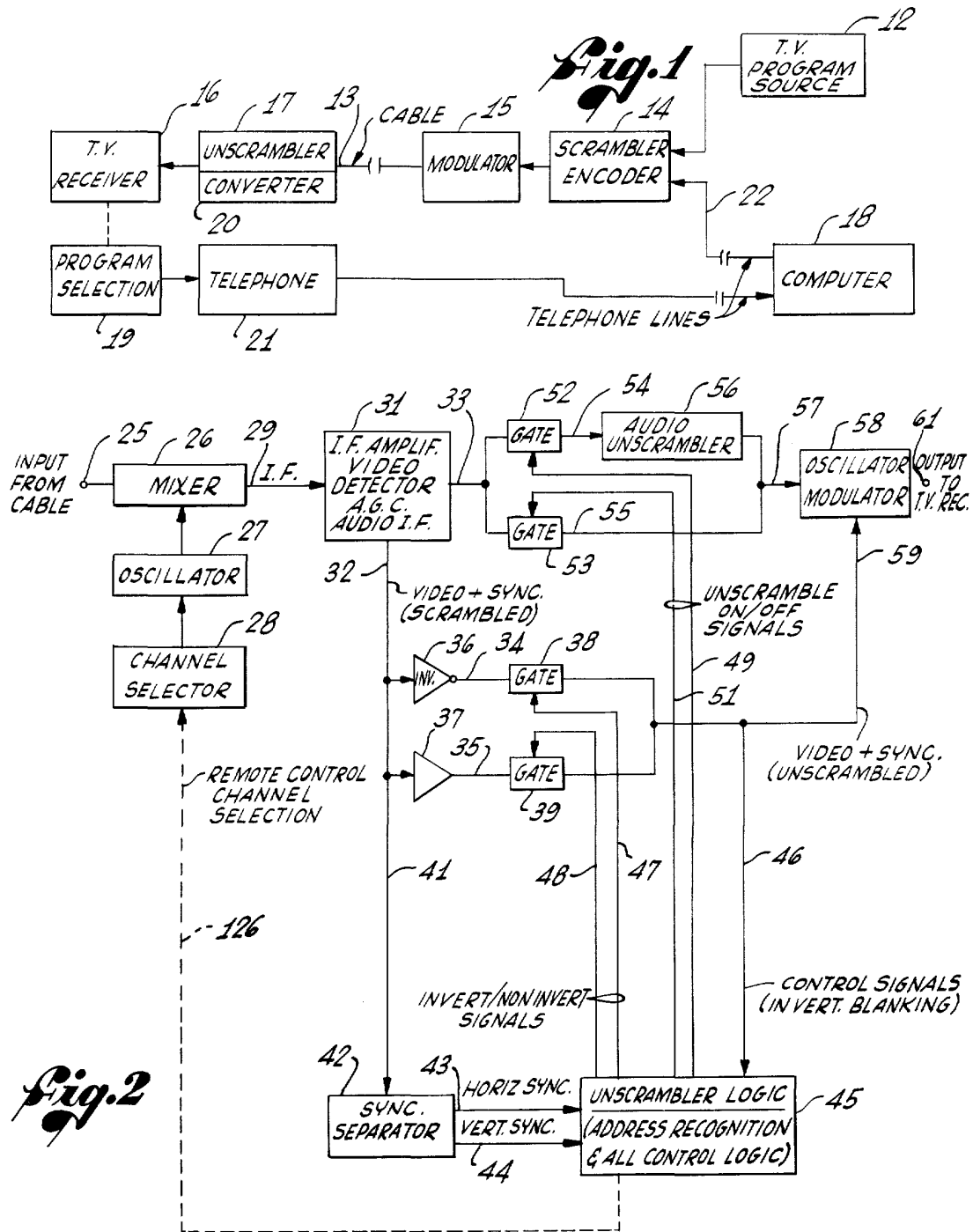

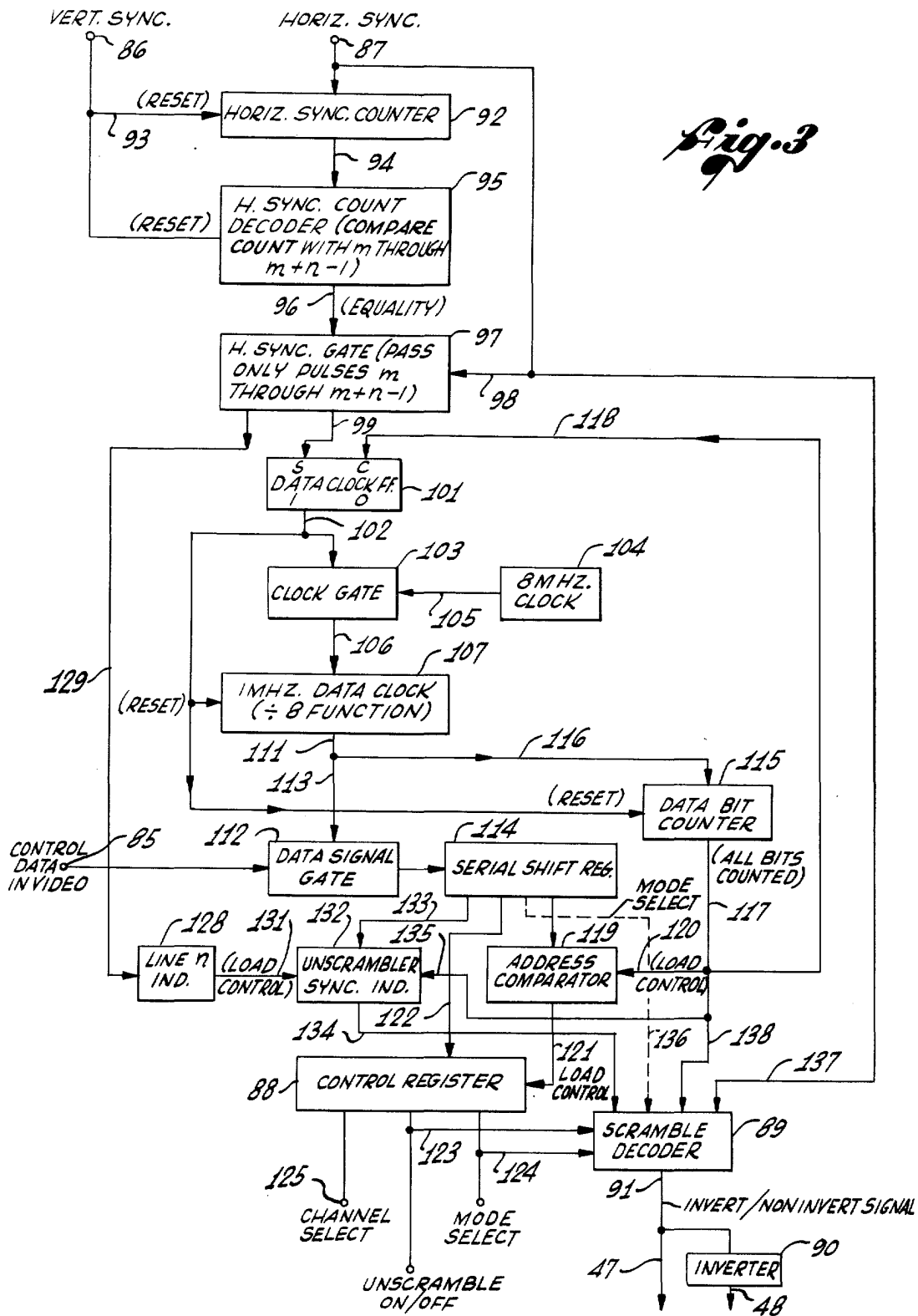
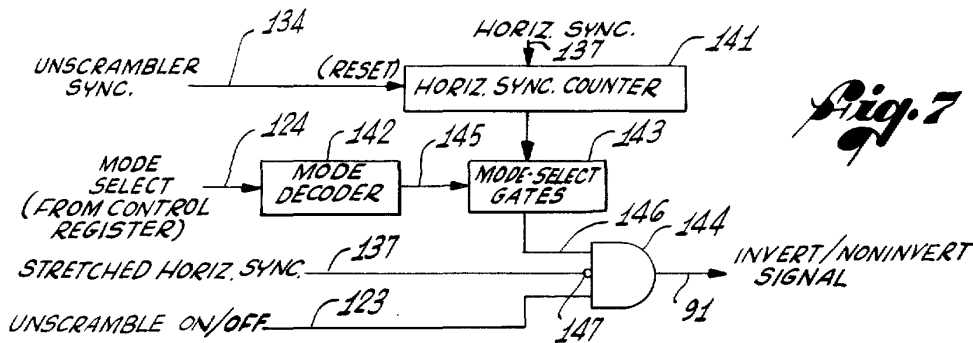
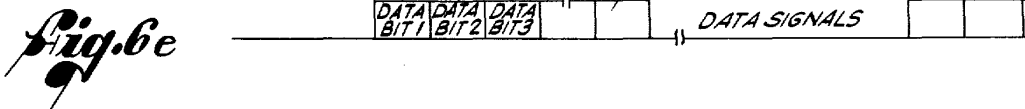
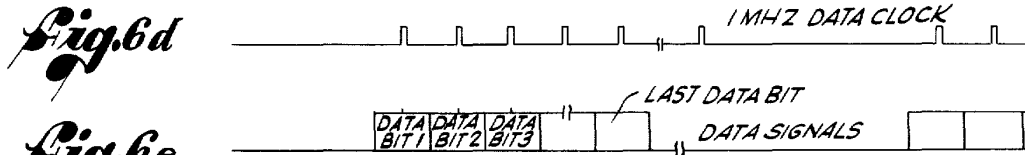
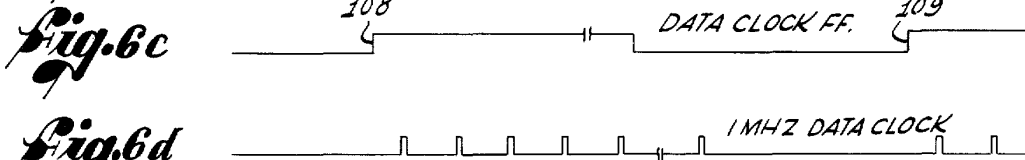
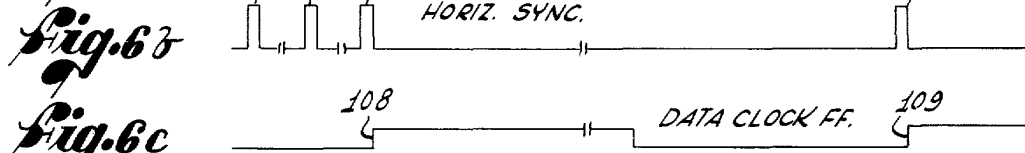
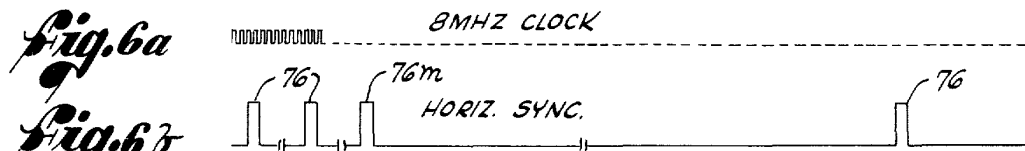
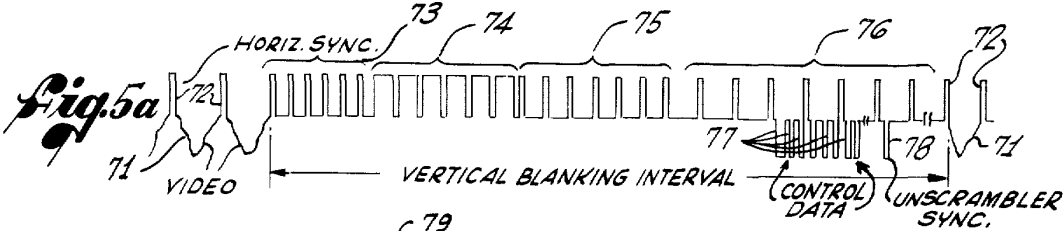
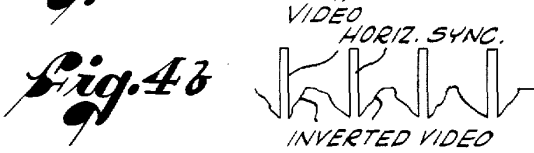
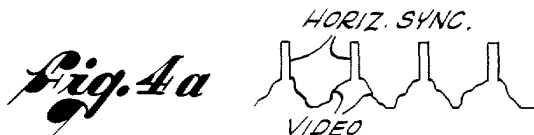
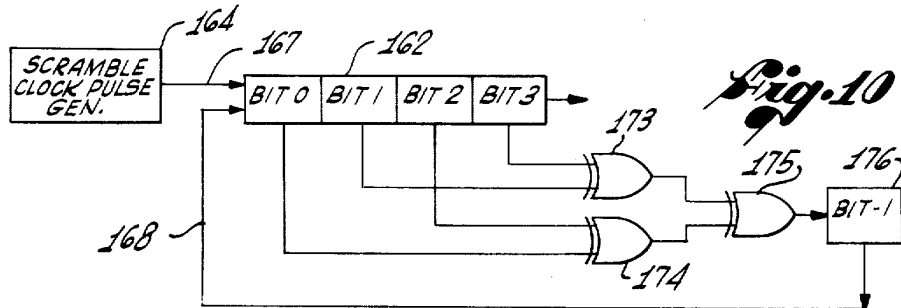
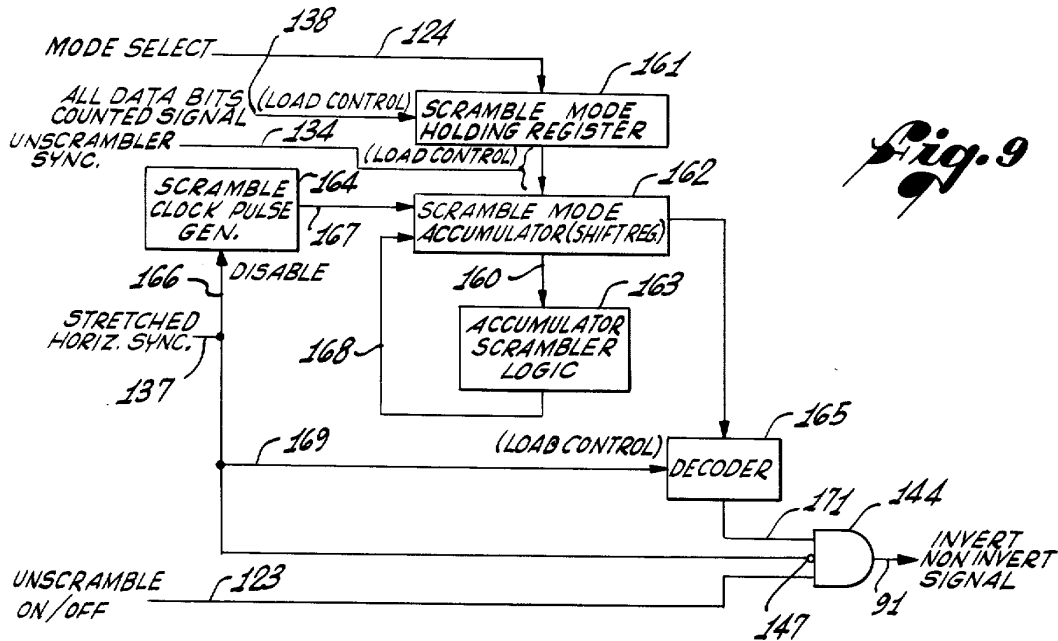
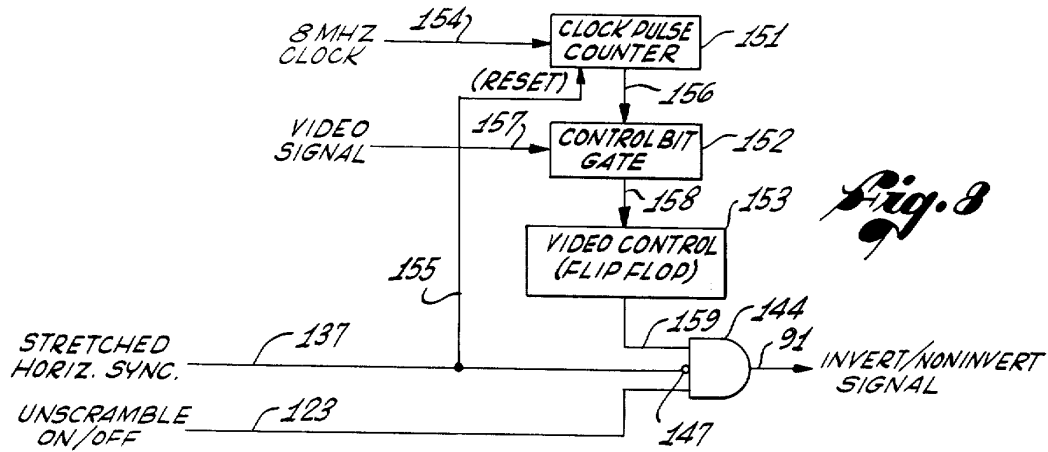

Fig. 3





Explore Litigation Insights

Docket Alarm provides insights to develop a more informed litigation strategy and the peace of mind of knowing you're on top of things.

Real-Time Litigation Alerts



Keep your litigation team up-to-date with **real-time alerts** and advanced team management tools built for the enterprise, all while greatly reducing PACER spend.

Our comprehensive service means we can handle Federal, State, and Administrative courts across the country.

Advanced Docket Research



With over 230 million records, Docket Alarm's cloud-native docket research platform finds what other services can't. Coverage includes Federal, State, plus PTAB, TTAB, ITC and NLRB decisions, all in one place.

Identify arguments that have been successful in the past with full text, pinpoint searching. Link to case law cited within any court document via Fastcase.

Analytics At Your Fingertips



Learn what happened the last time a particular judge, opposing counsel or company faced cases similar to yours.

Advanced out-of-the-box PTAB and TTAB analytics are always at your fingertips.

API

Docket Alarm offers a powerful API (application programming interface) to developers that want to integrate case filings into their apps.

LAW FIRMS

Build custom dashboards for your attorneys and clients with live data direct from the court.

Automate many repetitive legal tasks like conflict checks, document management, and marketing.

FINANCIAL INSTITUTIONS

Litigation and bankruptcy checks for companies and debtors.

E-DISCOVERY AND LEGAL VENDORS

Sync your system to PACER to automate legal marketing.