



US005598254A

United States Patent [19]

[11] Patent Number: **5,598,254**

Ikesue et al.

[45] Date of Patent: **Jan. 28, 1997**

[54] **CARTRIDGE FOR REPLENISHING TWO-INGREDIENT DEVELOPER TO AN IMAGE FORMING APPARATUS AND A REPLENISHING DEVICE USING THE SAME**

[75] Inventors: **Masumi Ikesue**, Tokyo; **Tsukuru Kai**, Fujisawa; **Hidetoshi Yano**, Yokohama; **Nobuto Yokokawa**, Gotenba, all of Japan

[73] Assignee: **Ricoh Company, Ltd.**, Tokyo, Japan

[21] Appl. No.: **521,324**

[22] Filed: **Aug. 30, 1995**

[30] Foreign Application Priority Data

Aug. 31, 1994	[JP]	Japan	6-207632
Oct. 20, 1994	[JP]	Japan	6-255629
Nov. 4, 1994	[JP]	Japan	6-271312
Nov. 4, 1994	[JP]	Japan	6-271314
Jul. 6, 1995	[JP]	Japan	7-171157

[51] Int. Cl.⁶ **G03G 15/06**

[52] U.S. Cl. **399/262; 222/129; 222/DIG. 1; 399/358**

[58] Field of Search **355/260, 245, 355/298, 246; 222/129, 43, 94, DIG. 1, 325; 118/653**

[56] References Cited

U.S. PATENT DOCUMENTS

3,443,726	5/1969	Muller et al.	222/129 X
4,611,730	9/1986	Ikesue et al.	222/DIG. 1 X
4,641,945	2/1987	Ikesue et al.	222/DIG. 1 X

4,696,255	9/1987	Yano et al.	118/653
4,700,659	10/1987	Hirakura et al.	355/253 X
4,744,493	5/1988	Ikesue et al.	222/DIG. 1 X
4,760,422	7/1988	Seimiya et al.	118/653 X
4,878,603	11/1989	Ikesue et al.	222/DIG. 1 X
4,930,438	6/1990	Demizu et al.	118/653 X
5,109,254	4/1992	Oka et al.	222/DIG. 1 X
5,280,324	1/1994	Ono et al.	355/260
5,416,568	5/1995	Yoshiki et al.	355/245 X
5,450,178	9/1995	Kawashima et al.	355/260
5,502,552	3/1996	Ikesue et al.	355/245 X
5,508,794	4/1996	Ikesue et al.	355/260

FOREIGN PATENT DOCUMENTS

2-244174	9/1990	Japan .
6-43755	2/1994	Japan .
6-258943	9/1994	Japan .

Primary Examiner—Shuk Yin Lee
Attorney, Agent, or Firm—Oblon, Spivak, McClelland, Maier & Neustadt, P.C.

[57] ABSTRACT

A cartridge for replenishing a two-ingredient developer to an image forming apparatus, and a developer replenishing device using it are disclosed. The cartridge is made up of two containers each storing a content of particular kind. One of the containers has an annular portion and a bore formed at the center by the annular portion. The other container has a cylindrical configuration and coaxially mates with the above container to form a single unit. Coaxial openings are respectively formed in the containers. Spiral grooves inclined in opposite directions to each other are respectively formed on the inner peripheries of the containers.

8 Claims, 18 Drawing Sheets

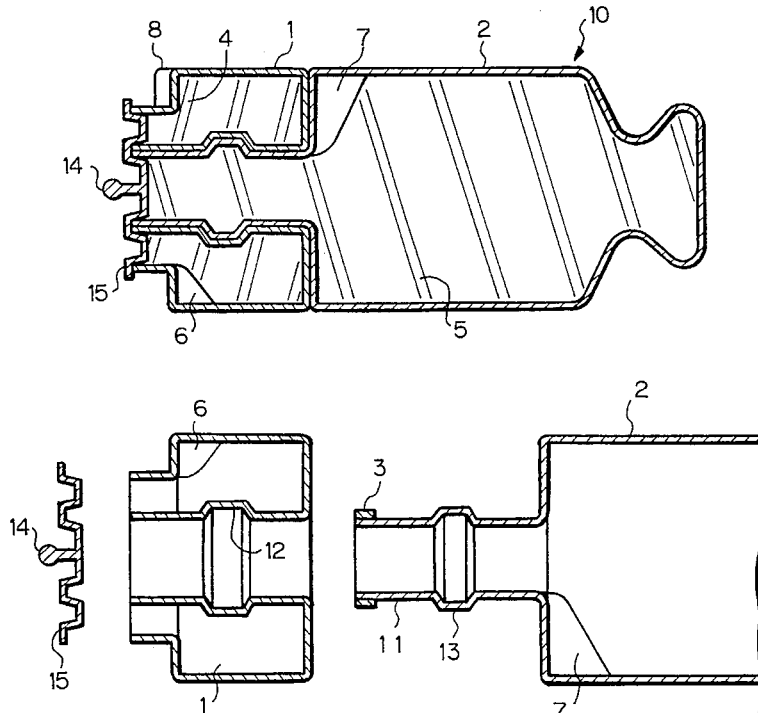

GPI EXHIBIT 1007

Fig. 1

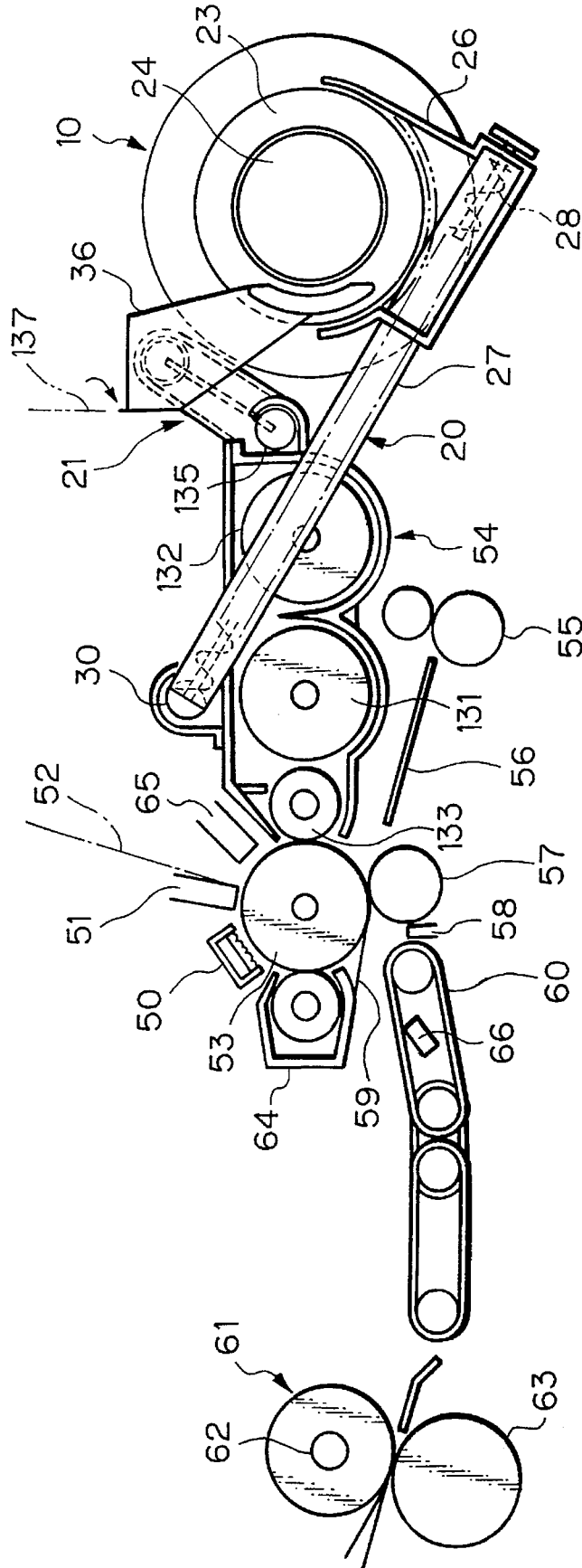

Fig. 2A

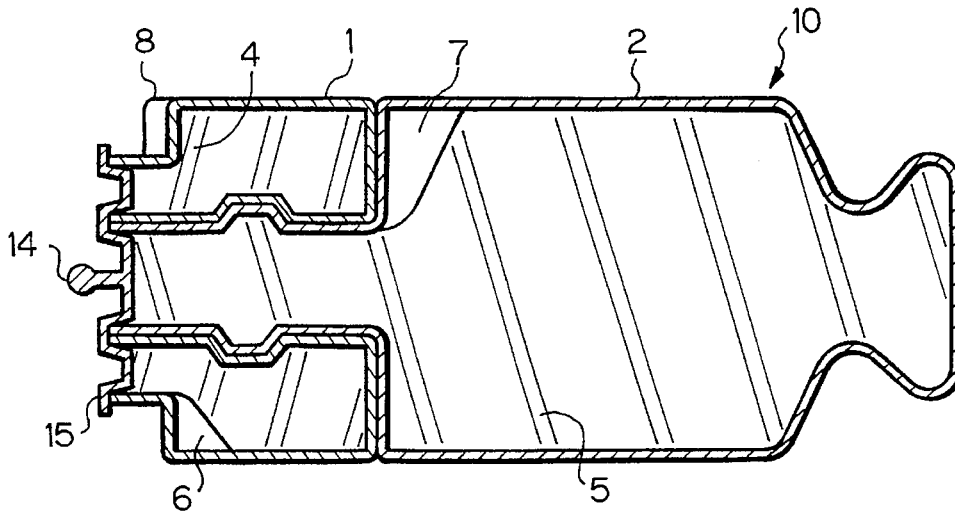

Fig. 2B

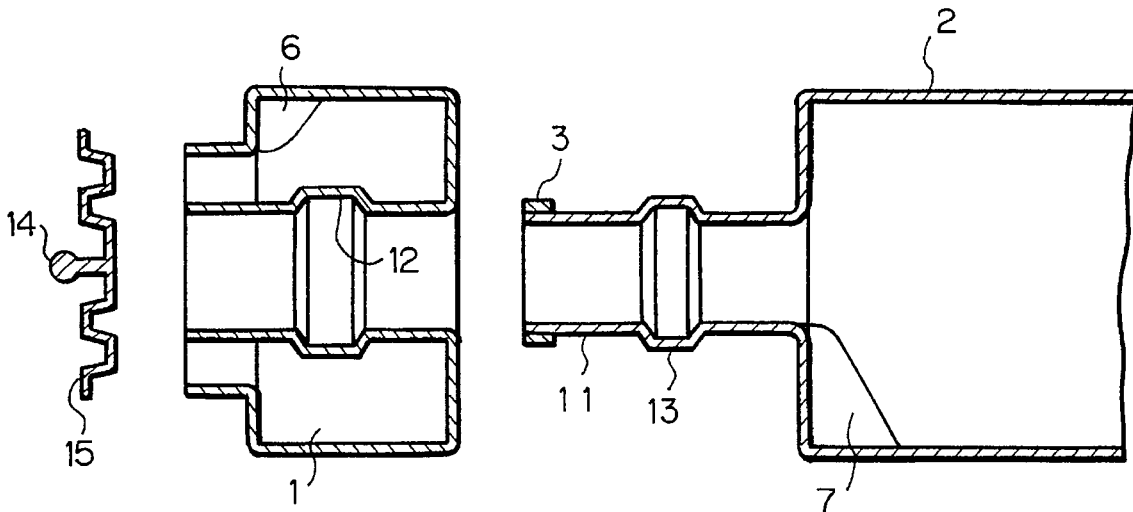

Fig. 2C

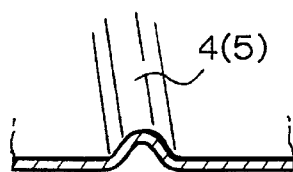

Fig. 3A

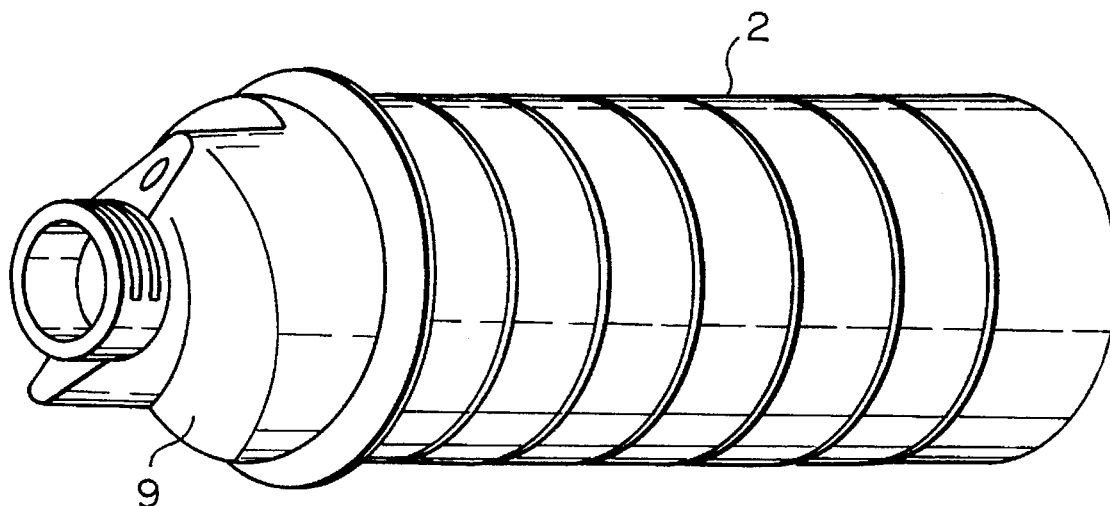

Fig. 3B

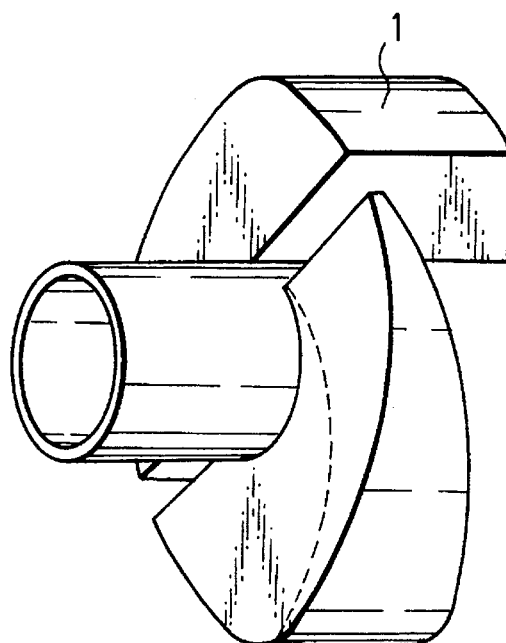

Fig. 4A

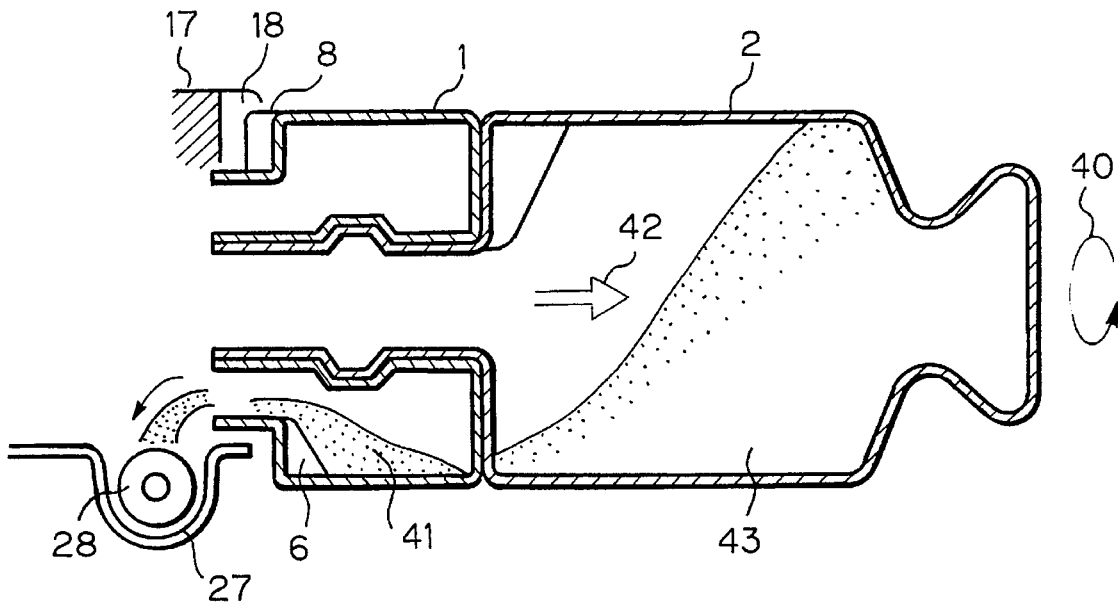
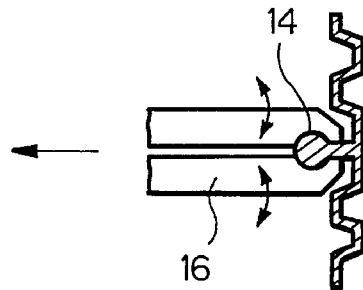

Fig. 4B



Explore Litigation Insights

Docket Alarm provides insights to develop a more informed litigation strategy and the peace of mind of knowing you're on top of things.

Real-Time Litigation Alerts



Keep your litigation team up-to-date with **real-time alerts** and advanced team management tools built for the enterprise, all while greatly reducing PACER spend.

Our comprehensive service means we can handle Federal, State, and Administrative courts across the country.

Advanced Docket Research



With over 230 million records, Docket Alarm's cloud-native docket research platform finds what other services can't. Coverage includes Federal, State, plus PTAB, TTAB, ITC and NLRB decisions, all in one place.

Identify arguments that have been successful in the past with full text, pinpoint searching. Link to case law cited within any court document via Fastcase.

Analytics At Your Fingertips



Learn what happened the last time a particular judge, opposing counsel or company faced cases similar to yours.

Advanced out-of-the-box PTAB and TTAB analytics are always at your fingertips.

API

Docket Alarm offers a powerful API (application programming interface) to developers that want to integrate case filings into their apps.

LAW FIRMS

Build custom dashboards for your attorneys and clients with live data direct from the court.

Automate many repetitive legal tasks like conflict checks, document management, and marketing.

FINANCIAL INSTITUTIONS

Litigation and bankruptcy checks for companies and debtors.

E-DISCOVERY AND LEGAL VENDORS

Sync your system to PACER to automate legal marketing.