



US 20070058595A1

(19) **United States**

(12) **Patent Application Publication**

**Classon et al.**

(10) **Pub. No.: US 2007/0058595 A1**

(43) **Pub. Date: Mar. 15, 2007**

(54) **METHOD AND APPARATUS FOR REDUCING ROUND TRIP LATENCY AND OVERHEAD WITHIN A COMMUNICATION SYSTEM**

(21) Appl. No.: 11/276,981

(22) Filed: Mar. 20, 2006

**Related U.S. Application Data**

(75) Inventors: **Brian K. Classon**, Palatine, IL (US); **Kevin L. Baum**, Rolling Meadows, IL (US); **Amitava Ghosh**, Buffalo Grove, IL (US); **Robert T. Love**, Barrington, IL (US); **Vijay Nangia**, Algonquin, IL (US); **Kenneth A. Stewart**, Grayslake, IL (US)

(60) Provisional application No. 60/666,494, filed on Mar. 30, 2005.

**Publication Classification**

(51) **Int. Cl.**  
*H04B 7/212* (2006.01)

(52) **U.S. Cl.** ..... 370/337; 709/236

Correspondence Address:  
**MOTOROLA, INC.**  
1303 EAST ALGONQUIN ROAD  
IL01/3RD  
SCHAUMBURG, IL 60196

(57) **ABSTRACT**

During operation radio frames are divided into a plurality of subframes. Data is transmitted over the radio frames within a plurality of subframes, and having a frame duration selected from two or more possible frame durations.

(73) Assignee: **MOTOROLA, INC.**, Schaumburg, IL (US)

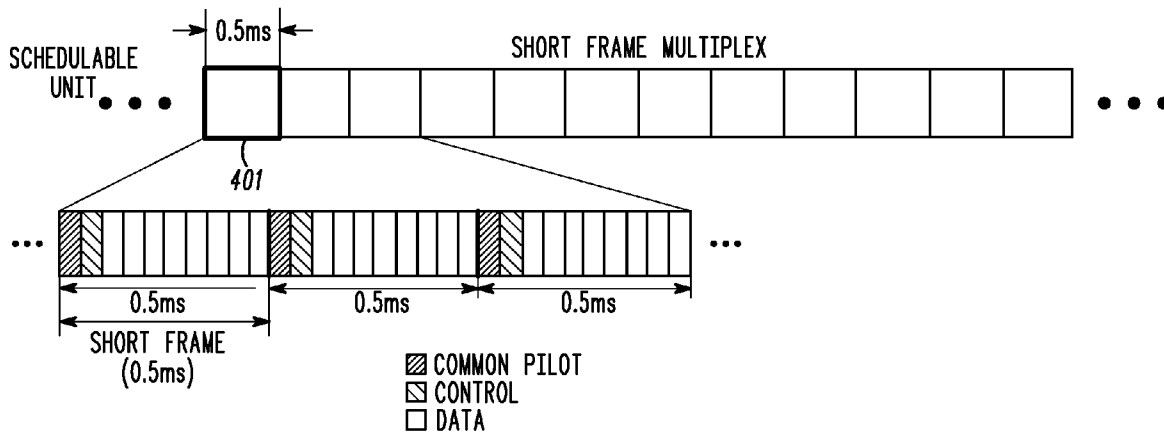

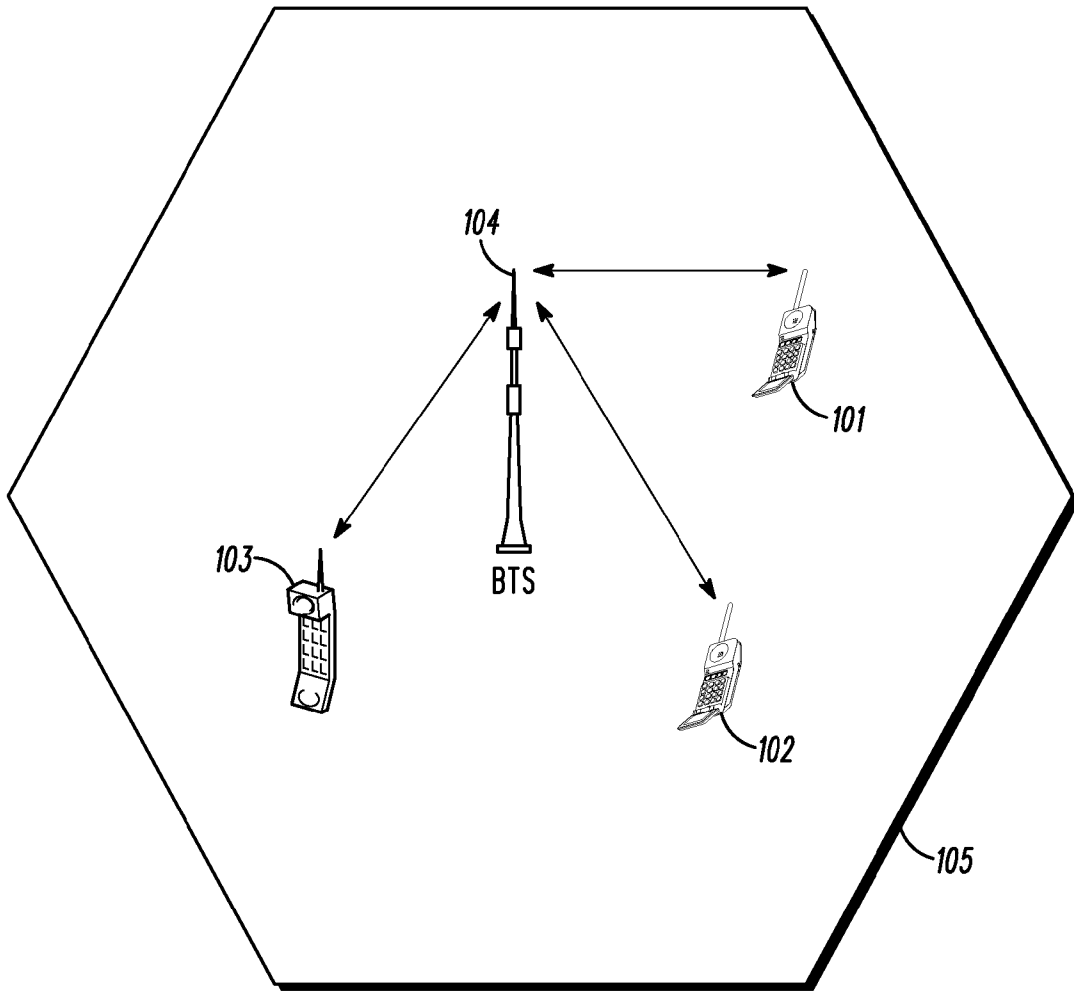

**FIG. 1**

100

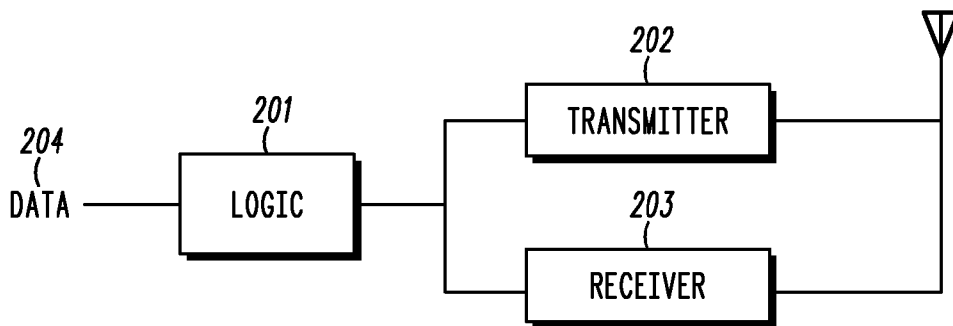

**FIG. 2**

200

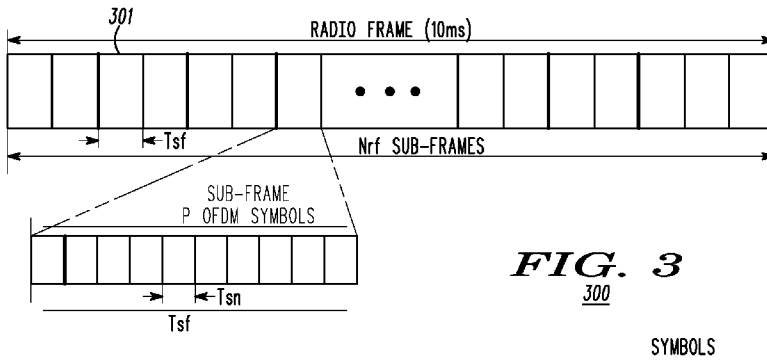

**FIG. 3**  
**300**

SYMBOLS

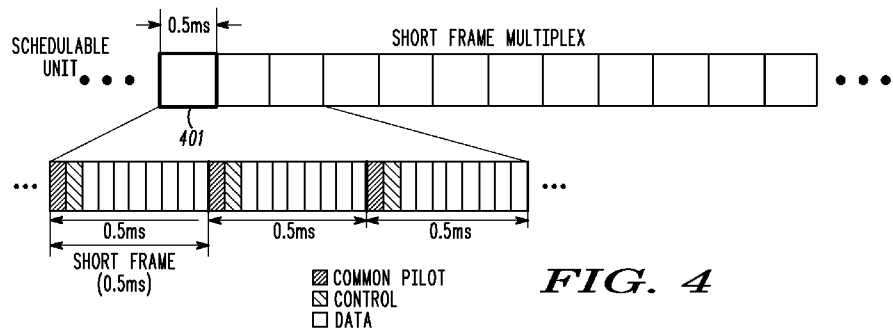

**FIG. 4**

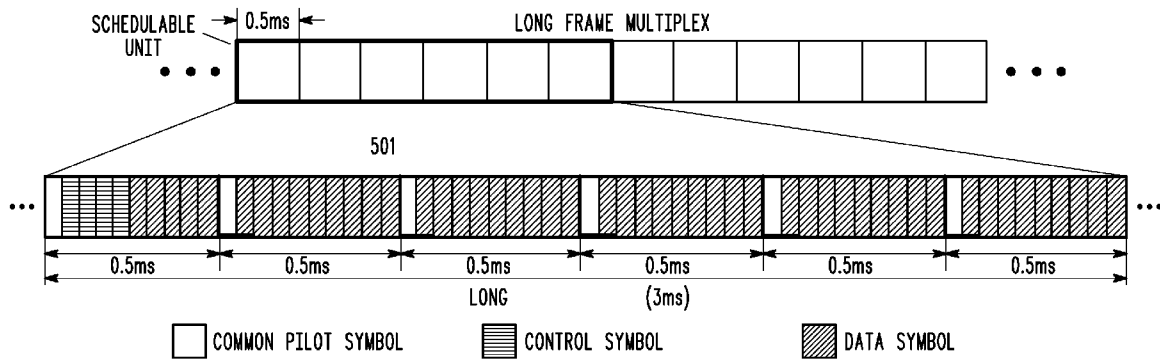
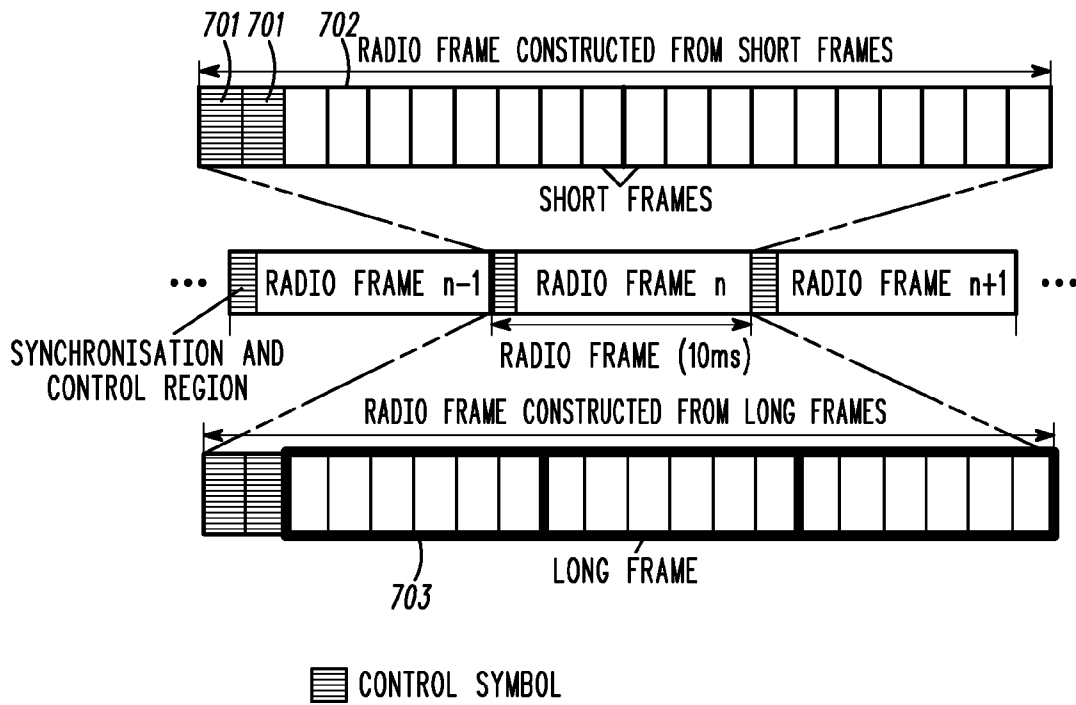

FIG. 5

PARAMETER	LONG FRAME CONFIGURATION												
	10	10	10	10	10	10	10	10	10	10	10	10	10
RADIO FRAME DURATION (ms)	10	10	10	10	10	10	10	10	10	10	10	10	10
SUBFRAMES / RADIO FRAME	20	20	20	18	18	18	16	16	16	15	15	15	15
SUBFRAME DURATION (ms)	0.5	0.5	0.5	0.55556	0.55556	0.55556	0.625	0.625	0.625	0.66667	0.66667	0.66667	0.66667
SUBFRAMES / LONG FRAME	3	4	6	4	5	6	3	4	5	3	4	5	5
LONG FRAME DURATION (ms)	1.5	2	3	2.22222	2.77778	3.33333	1.875	2.5	3.125	2	2.66667	3.33333	3.33333
OVERHEAD SUBFRAMES	2	2	2	2	2	2	2	2	2	2	2	2	2
MAX LONG / RADIO FRAME	6	4	3	4	3	2	4	3	2	4	3	2	2
MIN SHORT RADIO FRAME	0	2	0	0	1	4	2	2	4	1	1	3	3

FIG. 6 EXEMPLARY LONG FRAME CONFIGURATIONS vs. SUBFRAME DURATION



**FIG. 7**

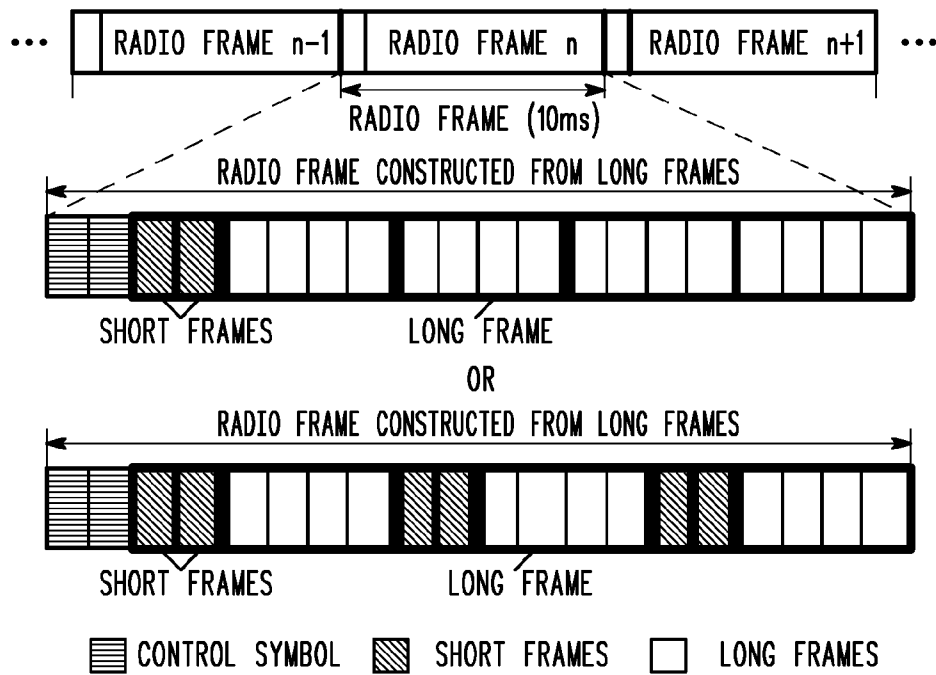

**FIG. 8**

# Explore Litigation Insights

Docket Alarm provides insights to develop a more informed litigation strategy and the peace of mind of knowing you're on top of things.

## Real-Time Litigation Alerts



Keep your litigation team up-to-date with **real-time alerts** and advanced team management tools built for the enterprise, all while greatly reducing PACER spend.

Our comprehensive service means we can handle Federal, State, and Administrative courts across the country.

## Advanced Docket Research



With over 230 million records, Docket Alarm's cloud-native docket research platform finds what other services can't. Coverage includes Federal, State, plus PTAB, TTAB, ITC and NLRB decisions, all in one place.

Identify arguments that have been successful in the past with full text, pinpoint searching. Link to case law cited within any court document via Fastcase.

## Analytics At Your Fingertips



Learn what happened the last time a particular judge, opposing counsel or company faced cases similar to yours.

Advanced out-of-the-box PTAB and TTAB analytics are always at your fingertips.

## API

Docket Alarm offers a powerful API (application programming interface) to developers that want to integrate case filings into their apps.

## LAW FIRMS

Build custom dashboards for your attorneys and clients with live data direct from the court.

Automate many repetitive legal tasks like conflict checks, document management, and marketing.

## FINANCIAL INSTITUTIONS

Litigation and bankruptcy checks for companies and debtors.

## E-DISCOVERY AND LEGAL VENDORS

Sync your system to PACER to automate legal marketing.