

DECLARATION OF DAVID L. RINGLE

I, David Ringle, am over twenty-one (21) years of age. I have never been convicted of a felony, and I am fully competent to make this declaration. I declare the following to be true to the best of my knowledge, information and belief:

1. I am the Director of IEEE Standards Association Governance for the Institute of Electrical and Electronics Engineers, Inc. (“IEEE”).
2. IEEE is a neutral third party in this dispute.
3. Neither I nor IEEE itself is being compensated for this declaration.
4. Among my responsibilities as Director of IEEE-SA Governance I act as a custodian of certain records for IEEE.
5. I make this declaration based on my personal knowledge, information contained in the business records of IEEE, or confirmation with other responsible IEEE personnel with such knowledge.
6. As part of its ordinary course of business IEEE publishes and makes available technical articles and standards. These publications are made available for public download through the IEEE digital library, IEEE Xplore.
7. It is the regular practice of IEEE to publish articles and other writings including article abstracts and make them available to the public through IEEE Xplore. IEEE maintains copies of publications in the ordinary course of its regularly conducted activities.
8. The document below, along with its abstract, has been attached as Exhibit A to this declaration:

A.	IEEE Std 802.16-2004 IEEE Standard for Local and Metropolitan Area Networks Part 16: Air Interface for Fixed Broadband Wireless Access Systems
----	------------------------------------------------------------------------------------------------------------------------------------------------
9. I obtained a copy of Exhibit A through IEEE Xplore, where it is maintained in the ordinary course of IEEE’s business. Exhibit A is a true and correct copy of the Exhibit as it existed on or about March 25, 2016.
10. Exhibit A states the date of its publication.

11. IEEE Std 802.16-2004 IEEE Standard for Local and Metropolitan Area Networks Part 16: Air Interface for Fixed Broadband Wireless Access Systems was published on October 1, 2004. This document is currently available for public download from the IEEE digital library, IEEE Xplore.

12. I hereby declare that all statements made herein of my own knowledge are true and that all statements made on information and belief are believed to be true, and further that these statements were made with the knowledge that willful false statements and the like are punishable by fine or imprisonment, or both, under 18 U.S.C. § 1001.

I declare under penalty of perjury that the foregoing statements are true and correct.

Executed on: 25 March 2016



BROWSE ▾ MY SETTINGS ▾ GET HELP ▾ WHAT CAN I ACCESS? SUBSCRIBE

Search

Basic Search Author Search Publication Search

Advanced Search Other Search Options ▾

Browse Standards > IEEE Std 802.16-2004 (Revisio ... ?

802.16-2004 - IEEE Standard for Local and Metropolitan Area Networks Part 16: Air Interface for Fixed Broadband Wireless Access Systems

Full Text
Sign-In or Purchase

Abstract	Referenced Items	Versions	Standards Dictionary Terms	Cited By	Keywords	Metrics	Similar
-----------------	------------------	----------	----------------------------	----------	----------	---------	---------

- Download Citations
- Email
- Print
- Request Permissions
- Export

-
-
-

This standard specifies the air interface of fixed broadband wireless access (BWA) systems supporting multimedia services. The medium access control layer (MAC) supports a primarily point-to-multipoint architecture, with an optional mesh topology. The MAC is structured to support multiple physical layer (PHY) specifications, each suited to a particular operational environment. For operational frequencies from 10-66 GHz, the PHY is based on single-carrier modulation. For frequencies below 11 GHz, where propagation without a direct line of sight must be accommodated, three alternatives are provided, using OFDM, OFDMA, and single-carrier modulation. This standard revises and consolidates IEEE Std 802.16-2001, IEEE Std 802.16aTM-2003, and IEEE Std 802.16cTM-2002.

Date of Publication :
2004

Status :
Inactive

Page(s):
0_1 - 857

E-ISBN :
0-7381-4069-4

Print ISBN:
0-7381-4070-8

DOI:
[10.1109/IEEESTD.2004.226664](https://doi.org/10.1109/IEEESTD.2004.226664)

ICS Code:
[35.100.10](#) ; [35.100.20](#) ; [35.110](#)

Persistent Link:
<http://ieeexplore.ieee.org/servlet/opac?punumber=9349>
[More »](#)

Year :
2004

Sponsored by :
IEEE Computer Society

Date of Current Version :
Mon Nov 01 00:00:00 EST 2004

Issue Date :
2004

[Personal Sign In](#) | [Create Account](#)

IEEE Account

- » [Change Username/Password](#)
- » [Update Address](#)

Purchase Details

- » [Payment Options](#)
- » [Order History](#)
- » [View Purchased Documents](#)

Profile Information

- » [Communications Preferences](#)
- » [Profession and Education](#)
- » [Technical Interests](#)

Need Help?

- » **US & Canada:** +1 800 678 4333
- » **Worldwide:** +1 732 981 0060
- » [Contact & Support](#)

[About IEEE Xplore](#) | [Contact Us](#) | [Help](#) | [Terms of Use](#) | [Nondiscrimination Policy](#) | [Sitemap](#) | [Privacy & Opting Out of Cookies](#)

A not-for-profit organization, IEEE is the world's largest professional association for the advancement of technology.
© Copyright 2016 IEEE - All rights reserved. Use of this web site signifies your agreement to the terms and conditions.



802.16™

**IEEE Standard for
Local and metropolitan area networks**

Part 16: Air Interface for Fixed Broadband Wireless Access Systems

**IEEE Computer Society
and the
IEEE Microwave Theory and Techniques Society**

Sponsored by the
LAN/MAN Standards Committee



3 Park Avenue, New York, NY 10016-5997, USA

1 October 2004
Print: SH95246
PDF: SS95246

Authorized licensed use limited to: IEEE Publications Operations Staff. Downloaded on March 24,2016 at 14:47:03 UTC from IEEE Xplore. Restrictions apply.

**IEEE Standard for
Local and metropolitan area networks**

**Part 16: Air Interface for Fixed
Broadband Wireless Access Systems**

Sponsor
LAN/MAN Standards Committee
of the
IEEE Computer Society

and the
IEEE Microwave Theory and Techniques Society

Approved 24 June 2004
IEEE-SA Standards Board



Grateful acknowledgment is made to Cable Television Laboratories for the permission to use the following source material:

Radio Frequency Interface Specification (version 1.1), part of Data-Over-Cable Service Interface Specifications, © Copyright 1999, Cable Television Laboratories.

Baseline Privacy Plus Interface Specification, © Copyright 1999, Cable Television Laboratories.

Abstract: This standard specifies the air interface of fixed broadband wireless access (BWA) systems supporting multimedia services. The medium access control layer (MAC) supports a primarily point-to-multipoint architecture, with an optional mesh topology. The MAC is structured to support multiple physical layer (PHY) specifications, each suited to a particular operational environment. For operational frequencies from 10–66 GHz, the PHY is based on single-carrier modulation. For frequencies below 11 GHz, where propagation without a direct line of sight must be accommodated, three alternatives are provided, using OFDM, OFDMA, and single-carrier modulation. This standard revises and consolidates IEEE Std 802.16-2001, IEEE Std 802.16a™-2003, and IEEE Std 802.16c™-2002.

Keywords: fixed broadband wireless access network, metropolitan area network, microwave, millimeter wave, WirelessMAN® standards

The Institute of Electrical and Electronics Engineers, Inc.
3 Park Avenue, New York, NY 10016-5997, USA

Copyright © 2004 by the Institute of Electrical and Electronics Engineers, Inc.
All rights reserved. Published 1 October 2004. Printed in the United States of America.

IEEE, 802, and WirelessMAN are registered trademarks in the U.S. Patent & Trademark Office, owned by the Institute of Electrical and Electronics Engineers, Incorporated.

WirelessMAN-OFDM, WirelessMAN-OFDMA, WirelessMAN-SC, and WirelessMAN-SCa, are trademarks owned by the Institute of Electrical and Electronics Engineers, Incorporated.

Print: ISBN 0-7381-4069-4 SH95246
PDF: ISBN 0-7381-4070-8 SS95246

No part of this publication may be reproduced in any form, in an electronic retrieval system or otherwise, without the prior written permission of the publisher.

IEEE Standards documents are developed within the IEEE Societies and the Standards Coordinating Committees of the IEEE Standards Association (IEEE-SA) Standards Board. The IEEE develops its standards through a consensus development process, approved by the American National Standards Institute, which brings together volunteers representing varied viewpoints and interests to achieve the final product. Volunteers are not necessarily members of the Institute and serve without compensation. While the IEEE administers the process and establishes rules to promote fairness in the consensus development process, the IEEE does not independently evaluate, test, or verify the accuracy of any of the information contained in its standards.

Use of an IEEE Standard is wholly voluntary. The IEEE disclaims liability for any personal injury, property or other damage, of any nature whatsoever, whether special, indirect, consequential, or compensatory, directly or indirectly resulting from the publication, use of, or reliance upon this, or any other IEEE Standard document.

The IEEE does not warrant or represent the accuracy or content of the material contained herein, and expressly disclaims any express or implied warranty, including any implied warranty of merchantability or fitness for a specific purpose, or that the use of the material contained herein is free from patent infringement. IEEE Standards documents are supplied “**AS IS.**”

The existence of an IEEE Standard does not imply that there are no other ways to produce, test, measure, purchase, market, or provide other goods and services related to the scope of the IEEE Standard. Furthermore, the viewpoint expressed at the time a standard is approved and issued is subject to change brought about through developments in the state of the art and comments received from users of the standard. Every IEEE Standard is subjected to review at least every five years for revision or reaffirmation. When a document is more than five years old and has not been reaffirmed, it is reasonable to conclude that its contents, although still of some value, do not wholly reflect the present state of the art. Users are cautioned to check to determine that they have the latest edition of any IEEE Standard.

In publishing and making this document available, the IEEE is not suggesting or rendering professional or other services for, or on behalf of, any person or entity. Nor is the IEEE undertaking to perform any duty owed by any other person or entity to another. Any person utilizing this, and any other IEEE Standards document, should rely upon the advice of a competent professional in determining the exercise of reasonable care in any given circumstances.

Interpretations: Occasionally questions may arise regarding the meaning of portions of standards as they relate to specific applications. When the need for interpretations is brought to the attention of IEEE, the Institute will initiate action to prepare appropriate responses. Since IEEE Standards represent a consensus of concerned interests, it is important to ensure that any interpretation has also received the concurrence of a balance of interests. For this reason, IEEE and the members of its societies and Standards Coordinating Committees are not able to provide an instant response to interpretation requests except in those cases where the matter has previously received formal consideration. At lectures, symposia, seminars, or educational courses, an individual presenting information on IEEE standards shall make it clear that his or her views should be considered the personal views of that individual rather than the formal position, explanation, or interpretation of the IEEE.

Comments for revision of IEEE Standards are welcome from any interested party, regardless of membership affiliation with IEEE. Suggestions for changes in documents should be in the form of a proposed change of text, together with appropriate supporting comments. Comments on standards and requests for interpretations should be addressed to:

Secretary, IEEE-SA Standards Board
445 Hoes Lane
P.O. Box 1331
Piscataway, NJ 08855-1331USA

NOTE—Attention is called to the possibility that implementation of this standard may require use of subject matter covered by patent rights. By publication of this standard, no position is taken with respect to the existence or validity of any patent rights in connection therewith. The IEEE shall not be responsible for identifying patents for which a license may be required by an IEEE standard or for conducting inquiries into the legal validity or scope of those patents that are brought to its attention.

Authorization to photocopy portions of any individual standard for internal or personal use is granted by the Institute of Electrical and Electronics Engineers, Inc., provided that the appropriate fee is paid to Copyright Clearance Center. To arrange for payment of licensing fee, please contact Copyright Clearance Center, Customer Service, 222 Rosewood Drive, Danvers, MA 01923 USA; +1 978 750 8400. Permission to photocopy portions of any individual standard for educational classroom use can also be obtained through the Copyright Clearance Center.

Introduction

(This introduction is not part of IEEE Std 802.16-2004, IEEE Standard for Local and metropolitan area networks—Part 16: Air Interface for Fixed Broadband Wireless Access Systems.)

This standard specifies the air interface of fixed broadband wireless access (BWA) systems supporting multimedia services. The medium access control layer (MAC) supports a primarily point-to-multipoint architecture, with an optional mesh topology. The MAC is structured to support multiple physical layer (PHY) specifications, each suited to a particular operational environment. For operational frequencies from 10–66 GHz, the WirelessMAN-SC PHY, based on single-carrier modulation, is specified. For frequencies below 11 GHz, where propagation without a direct line of sight must be accommodated, three alternatives are provided: WirelessMAN-OFDM (using orthogonal frequency-division multiplexing), WirelessMAN-OFDMA (using orthogonal frequency-division multiple access), and WirelessMAN-SCa (using single-carrier modulation). This standard revises and consolidates IEEE Standards 802.16-2001, 802.16a-2003, and 802.16c-2002.

Conformance test methodology

The multipart conformance test documents for IEEE Standard 802.16 by “IEEE Standard 802.16/ConformanceXX”. For example, the first part of the conformance specification for IEEE 802.16 is designated “IEEE Standard 802.16/Conformance01.”

Patents

Attention is called to the possibility that implementation of this standard may require use of subject matter covered by patent rights. By publication of this standard, no position is taken with respect to the existence or validity of any patent rights in connection therewith. The IEEE shall not be responsible for identifying patents or patent applications for which a license may be required to implement an IEEE standard or for conducting inquiries into the legal validity or scope of those patents that are brought to its attention. A patent holder or patent applicant has filed a statement of assurance that it will grant licenses under these rights without compensation or under reasonable rates and nondiscriminatory, reasonable terms and conditions to applicants desiring to obtain such licenses. The IEEE makes no representation as to the reasonableness of rates, terms, and conditions of the license agreements offered by patent holders or patent applicants. Further information may be obtained from the IEEE Standards Department.

Notice to users

Errata

Errata, if any, for this and all other standards can be accessed at the following URL: <http://standards.ieee.org/reading/ieee/updates/errata/index.html>. Users are encouraged to check this URL for errata periodically.

Interpretations

Current interpretations can be accessed at the following URL: <http://standards.ieee.org/reading/ieee/interp/index.html>.

Participants

This document was developed by the IEEE 802.16 Working Group on Broadband Wireless Access, which develops the WirelessMAN[®] Standard for Wireless Metropolitan Area Networks.

IEEE 802.16 Working Group Officers

Roger B. Marks, *Chair*
Kenneth Stanwood, *Vice Chair*
Dean Chang, *Secretary*

Primary development was carried out by the Working Group's Task Group d:

TGd Officers

Gordon Antonello, *Chair*
Itzik Kitroser, *Chief Technical Editor*
Robert Nelson, *Assistant Editor*
Brian Eidson, *SCa PHY Editorial Contributor*
Nico van Waes, *Former Chief Technical Editor*

The following members of the IEEE 802.16 Working Group on Broadband Wireless Access participated in the Working Group Letter Ballot in which the draft of this standard was prepared and finalized for IEEE Ballot:

Aditya Agrawal
Gordon Antonello
Reza Arefi
Eli Avivi
Dean Chang
Naftali Chayat
Rémi Chayer
Brian Eidson
Carl Eklund
Marc Engels
Avraham Freedman
G. Jack Garrison
Marianna Goldhammer
Zion Hadad
David Johnston
Panyuh Joo
Tal Kaitz

Phil Kelly
Ofer Kelman
Brian Kiernan
Itzik Kitroser
Changhoi Koo
Jonathan Labs
Yigal Leiba
Barry Lewis
Lingjie Li
John Liebetreu
Lars Lindh
Hui-Ling Lou
Heinz Lycklama
Roger B. Marks
Russell McKown
Andrew Middleton

Ronald Murias
Robert Nelson
Kamlesh Rath
Gene Robinson
Yossi Segal
Radu Selea
James Simkins
Kenneth Stanwood
Carl Stevenson
Shawn Taylor
Rainer Ullmann
Nico van Waes
Eyal Verbin
Arthur Wang
Lei Wang
Stanley Wang
Vladimir Yanover

The following members of the IEEE Balloting Committee voted on this standard. Balloters may have voted for approval, disapproval, or abstention.

John Adams	Tal Kaitz	Subbu Ponnuswamy
Gordon Antonello	Stuart Kerry	Vikram Punj
Eladio Arvelo	Brian Kiernan	Klaus Rapf
John Barnett	Itzik Kitroser	Durga Satapathy
Dean Chang	Jonathan Labs	Yossi Segal
Naftali Chayat	Yigal Leiba	Neil Shipp
Aik Chindapol	Jan-Ray Liao	Gil Shultz
Todor Cooklev	Randolph Little	Yoram Solomon
Guru Dutt Dhingra	Gregory Luri	Kenneth Stanwood
Thomas Dineen	Roger B. Marks	Carl Stevenson
Sourav Dutta	Kevin Marquess	Shawn Taylor
Brian Eidson	John McKown	Scott Valcourt
Avraham Freedman	Russell McKown	Nico van Waes
Theodore Georgantas	Ingolf Meier	Stanley Wang
Andrew Germano	Steve Methley	Cor van de Water
Mariana Goldhamer	George Miao	Hung-yu Wei
Zion Hadad	Yinghua Min	Vladimir Yanover
Andreas Hutter	Robert R Nelson	Huanchun Ye
Raj Jain	Michael Newman	Oren Yuen
Tony Jeffree	Charles Ngethe	Surong Zeng
David Johnston	Roger Pandanda	

When the IEEE-SA Standards Board approved this standard on 24 June 2004, it had the following membership:

Don Wright, *Chair*
Steve M. Mills, *Vice Chair*
Judith Gorman, *Secretary*

Chuck Adams	Raymond Hapeman	Daleep C. Mohla
H. Stephen Berger	Richard J. Holleman	Paul Nikolich
Mark D. Bowman	Richard H. Hulet	T. W. Olsen
Joseph A. Bruder	Lowell G. Johnson	Ronald C. Petersen
Bob Davis	Joseph L. Koepfinger*	Gary S. Robinson
Roberto de Boisson	Hermann Koch	Frank Stone
Julian Forster*	Thomas J. McGean	Malcolm V. Thaden
Arnold M. Greenspan		Doug Topping
Mark S. Halpin		Joe D. Watson

*Member Emeritus

Also included are the following nonvoting IEEE-SA Standards Board liaisons:

Satish K. Aggarwal, *NRC Representative*
Richard DeBlasio, *DOE Representative*
Alan Cookson, *NIST Representative*

Michelle D. Turner
IEEE Standards Project Editor

CONTENTS

1.	Overview.....	1
1.1	Scope.....	1
1.2	Purpose.....	1
1.3	Frequency bands	1
1.3.1	10–66 GHz licensed bands	1
1.3.2	Frequencies below 11 GHz.....	2
1.3.3	License-exempt frequencies below 11 GHz (primarily 5–6 GHz).....	2
1.3.4	Air interface nomenclature and PHY compliance	2
1.4	Reference model	3
2.	References.....	5
3.	Definitions	7
4.	Abbreviations and acronyms	13
5.	Service-specific CS	17
5.1	ATM CS.....	17
5.1.1	CS service definition.....	17
5.1.2	Data/Control plane.....	17
5.1.2.1	PDU formats	17
5.1.2.2	Classification	18
5.1.2.3	PHS	18
5.1.2.4	Signaling procedure.....	19
5.2	Packet CS	20
5.2.1	MAC SDU format.....	21
5.2.2	Classification	21
5.2.3	PHS	23
5.2.3.1	PHS operation	23
5.2.3.2	PHS signaling	26
5.2.4	IEEE Std 802.3/Ethernet-specific part.....	27
5.2.4.1	IEEE Std 802.3/Ethernet CS PDU format	27
5.2.4.2	IEEE Std 802.3/Ethernet CS classifiers.....	27
5.2.5	IEEE Std 802.1Q-1998 virtual local area network (VLAN) specific part.....	28
5.2.5.1	IEEE Std 802.1Q-1998 VLAN CS PDU format.....	28
5.2.5.2	IEEE Std 802.1Q-1998 CS classifiers	28
5.2.6	IP specific part	28
5.2.6.1	IP CS PDU format	28
5.2.6.2	IP classifiers.....	29
6.	MAC common part sublayer.....	31
6.1	PMP	31
6.2	Mesh.....	32
6.3	Data/Control plane.....	33
6.3.1	Addressing and connections	33
6.3.1.1	PMP	33
6.3.1.2	Mesh.....	34
6.3.2	MAC PDU formats	35

6.3.2.1	MAC header formats	35
6.3.2.2	MAC subheaders and special payloads	39
6.3.2.3	MAC Management messages	42
6.3.3	Construction and transmission of MAC PDUs.....	121
6.3.3.1	Conventions	121
6.3.3.2	Concatenation	123
6.3.3.3	Fragmentation	123
6.3.3.4	Packing.....	124
6.3.3.5	CRC calculation	127
6.3.3.6	Encryption of MAC PDUs.....	127
6.3.3.7	Padding	128
6.3.4	ARQ mechanism.....	128
6.3.4.1	ARQ Block Usage	128
6.3.4.2	ARQ Feedback IE format	130
6.3.4.3	ARQ parameters	132
6.3.4.4	ARQ procedures	132
6.3.4.5	ARQ-enabled connection setup and negotiation	133
6.3.4.6	ARQ operation.....	133
6.3.5	Scheduling services.....	138
6.3.5.1	Outbound transmission scheduling	139
6.3.5.2	Uplink request/grant scheduling	139
6.3.6	Bandwidth allocation and request mechanisms	141
6.3.6.1	Requests	141
6.3.6.2	Grants.....	142
6.3.6.3	Polling	142
6.3.6.4	Contention-based focused Bandwidth Requests for WirelessMAN-OFDM	147
6.3.6.5	Contention-based CDMA Bandwidth Requests for WirelessMAN-OFDMA	147
6.3.6.6	Optional Mesh topology support	148
6.3.7	MAC support of PHY	151
6.3.7.1	FDD	151
6.3.7.2	TDD	152
6.3.7.3	DL-MAP	152
6.3.7.4	UL-MAP	152
6.3.7.5	Map relevance and synchronization	154
6.3.7.6	Optional MAC AAS Support of WirelessMAN-SCa, OFDM, and OFDMA	162
6.3.8	Contention resolution.....	165
6.3.8.1	Transmission opportunities.....	167
6.3.9	Network entry and initialization	167
6.3.9.1	Scanning and synchronization to the downlink	169
6.3.9.2	Obtain downlink parameters.....	169
6.3.9.3	Obtain uplink parameters.....	171
6.3.9.4	Message flows during scanning and uplink parameter acquisition	173
6.3.9.5	Initial ranging and automatic adjustments	174
6.3.9.6	Ranging parameter adjustment	178
6.3.9.7	Negotiate basic capabilities	182
6.3.9.8	SS authorization and key exchange	184
6.3.9.9	Registration.....	184
6.3.9.10	Establish IP connectivity	187
6.3.9.11	Establish time of day.....	187
6.3.9.12	Transfer operational parameters	188
6.3.9.13	Establish provisioned connections.....	190

6.3.9.14	Network Entry and synchronization in Mesh mode	190
6.3.10	Ranging	199
6.3.10.1	Downlink burst profile management	199
6.3.10.2	Uplink periodic ranging	202
6.3.10.3	OFDMA-based ranging	204
6.3.11	Update of channel descriptors.....	213
6.3.12	Assigning SSs to multicast groups.....	215
6.3.13	Establishment of multicast connections.....	218
6.3.14	QoS	218
6.3.14.1	Theory of operation	218
6.3.14.2	Service flows.....	219
6.3.14.3	Object model.....	221
6.3.14.4	Service classes	222
6.3.14.5	Authorization	222
6.3.14.6	Types of service flows	223
6.3.14.7	Service Flow Creation	224
6.3.14.8	Dynamic service flow modification and deletion	226
6.3.14.9	Service flow management.....	226
6.3.15	DFS for license-exempt operation	263
6.3.15.1	Introduction.....	263
6.3.15.2	Testing channels for primary users	263
6.3.15.3	Discontinuing operations after detecting primary users	264
6.3.15.4	Detecting primary users	264
6.3.15.5	Scheduling for channel testing.....	264
6.3.15.6	Requesting and reporting of measurements.....	264
6.3.15.7	Selecting and advertising a new channel	265
6.3.16	MAC Management message tunneling in Mesh Mode	265
6.3.17	MAC support for H-ARQ	266
6.3.17.1	Subpacket generation.....	268
6.3.17.2	DL/UL ACK/NAK signaling.....	268
6.3.17.3	H-ARQ parameter signaling	268
6.3.17.4	CQICH Operations	268
7.	Security sublayer.....	271
7.1	Architecture	271
7.1.1	Packet data encryption	271
7.1.2	Key management protocol	271
7.1.3	Security Associations.....	272
7.1.4	Mapping of connections to SAs.....	273
7.1.5	Cryptographic Suite	273
7.2	PKM protocol	273
7.2.1	SS authorization and AK exchange overview	273
7.2.2	TEK exchange overview.....	274
7.2.2.1	TEK exchange overview for PMP topology.....	274
7.2.2.2	TEK exchange overview for Mesh Mode.....	275
7.2.3	Security capabilities selection.....	275
7.2.4	Authorization state machine	276
7.2.4.1	States.....	278
7.2.4.2	Messages.....	278
7.2.4.3	Events.....	279
7.2.4.4	Parameters.....	280
7.2.4.5	Actions	280
7.2.5	TEK state machine.....	282
7.2.5.1	States	284

7.2.5.2	Messages	285
7.2.5.3	Events	285
7.2.5.4	Parameters	286
7.2.5.5	Actions	286
7.3	Dynamic SA creation and mapping	288
7.3.1	Dynamic SA creation	288
7.3.2	Dynamic mapping of SA	288
7.4	Key usage	289
7.4.1	BS key usage	289
7.4.1.1	AK key lifetime	289
7.4.1.2	AK transition period on BS side	289
7.4.1.3	BS usage of AK	291
7.4.1.4	TEK lifetime	291
7.4.1.5	BS usage of TEK	292
7.4.1.6	Node re-authorization in Mesh Mode during normal operation	292
7.4.2	SS key usage	292
7.4.2.1	SS reauthorization	292
7.4.2.2	SS usage of AK	294
7.4.2.3	SS usage of TEK	294
7.4.2.4	TEK usage in Mesh Mode	294
7.4.2.5	Node usage of the Operator Shared Secret in Mesh Nodes	295
7.5	Cryptographic methods	295
7.5.1	Data Encryption methods	295
7.5.1.1	Data encryption with DES in CBC mode	295
7.5.1.2	Data encryption with AES in CCM mode	295
7.5.2	Encryption of TEK	298
7.5.2.1	Encryption of TEK with 3-DES	299
7.5.2.2	Encryption of TEK with RSA	299
7.5.2.3	Encryption of TEK-128 with AES	299
7.5.3	Calculation of HMAC-Digests	299
7.5.4	Derivation of TEKs, KEKs, and message authentication keys	300
7.5.4.1	DES Keys	300
7.5.4.2	3-DES KEKs	300
7.5.4.3	HMAC authentication keys	300
7.5.5	Public-key encryption of AK	301
7.5.6	Digital signatures	301
7.6	Certificate profile	301
7.6.1	Certificate format	301
7.6.1.1	tbsCertificate.validity.notBefore and tbsCertificate.validity.notAfter	302
7.6.1.2	tbsCertificate.serialNumber	302
7.6.1.3	tbsCertificate.signature and signatureAlgorithm	302
7.6.1.4	tbsCertificate.issuer and tbsCertificate.subject	302
7.6.1.5	tbsCertificate.subjectPublicKeyInfo	304
7.6.1.6	tbsCertificate.issuerUniqueID and tbsCertificate.subjectUniqueID	304
7.6.1.7	tbsCertificate.extensions	304
7.6.1.8	signatureValue	304
7.6.2	SS certificate storage and management in the SS	304
7.6.3	Certificate processing and management in the BS	305
8.	PHY	307
8.1	WirelessMAN-SC PHY specification	307
8.1.1	Overview	307
8.1.2	Framing	307

8.1.2.1	Supported frame durations.....	307
8.1.3	Duplexing techniques and PHY Type parameter encodings	307
8.1.3.1	FDD operation	308
8.1.3.2	TDD operation	309
8.1.4	Downlink PHY	309
8.1.4.1	Downlink subframe.....	310
8.1.4.2	Downlink burst allocation.....	316
8.1.4.3	Downlink Transmission Convergence sublayer	317
8.1.4.4	Downlink PMD sublayer	319
8.1.5	Uplink PHY	334
8.1.5.1	Uplink subframe	334
8.1.5.2	Uplink Transmission Convergence sublayer	339
8.1.5.3	Uplink PMD sublayer	339
8.1.6	Baud rates and channel bandwidths.....	343
8.1.7	Radio subsystem control.....	343
8.1.7.1	Synchronization technique.....	343
8.1.7.2	Frequency control	343
8.1.7.3	Power control.....	344
8.1.8	Minimum performance	344
8.1.8.1	Propagation conditions	346
8.1.8.2	Transmitter characteristics.....	348
8.1.9	Channel quality measurements	350
8.1.9.1	Introduction.....	350
8.1.9.2	RSSI mean and standard deviation	351
8.1.9.3	CINR mean and standard deviation.....	352
8.2	WirelessMAN-SCa PHY	355
8.2.1	Transmit processing.....	355
8.2.1.1	Source Bit Randomization	356
8.2.1.2	FEC	356
8.2.1.3	Modulations and constellation mapping	370
8.2.1.4	Burst set framing.....	378
8.2.1.5	Duplex framing	391
8.2.1.6	Support for AAS	396
8.2.1.7	Frame Control Header burst profile.....	401
8.2.1.8	Compressed FCH maps	402
8.2.1.9	MAP message fields and IEs	404
8.2.1.10	Burst profile formats.....	416
8.2.1.11	AAS-FBCK-REQ/RSP message bodies	418
8.2.1.12	Baseband Pulse Shaping	420
8.2.1.13	Quadrature modulation	420
8.2.1.14	Power control.....	420
8.2.2	Channel quality measurements	421
8.2.2.1	Introduction.....	421
8.2.2.2	RSSI mean and standard deviation	421
8.2.2.3	CINR mean and standard deviation.....	422
8.2.3	System requirements.....	423
8.2.3.1	Channel frequency accuracy	423
8.2.3.2	Symbol rate.....	424
8.2.3.3	Symbol timing jitter.....	424
8.2.3.4	Transmitter minimum SNR and EVM.....	424
8.2.3.5	Transmitter power level control.....	424
8.2.3.6	Ramp-up/down requirements.....	424
8.2.3.7	Spurious emissions during burst on/off transients.....	424
8.2.3.8	Out of band spurious emissions	424

	8.2.3.9	Receiver sensitivity	424
	8.2.3.10	Receiver maximum input signal	425
	8.2.3.11	Receiver adjacent channel interference	425
8.3	WirelessMAN-OFDM PHY		427
	8.3.1	Introduction.....	427
	8.3.1.1	OFDM symbol description	427
	8.3.2	OFDM symbol parameters and transmitted signal	428
	8.3.2.1	Primitive parameter definitions	428
	8.3.2.2	Derived parameter definitions	428
	8.3.2.3	Transmitted signal.....	429
	8.3.2.4	Parameters of transmitted signal.....	429
	8.3.3	Channel coding	430
	8.3.3.1	Randomization	430
	8.3.3.2	FEC	432
	8.3.3.3	Interleaving	440
	8.3.3.4	Modulation.....	441
	8.3.3.5	Example OFDM uplink RS-CC encoding	444
	8.3.3.6	Preamble structure and modulation	446
	8.3.4	Transmission convergence (TC) sublayer	449
	8.3.5	Frame structure	449
	8.3.5.1	PMP	449
	8.3.5.2	PMP-AAS Zone.....	453
	8.3.5.3	Mesh.....	459
	8.3.5.4	Frame duration codes.....	460
	8.3.5.5	Burst Profile format	460
	8.3.6	Map message fields and IEs.....	461
	8.3.6.1	DL-MAP PHY synchronization field	461
	8.3.6.2	DL-MAP IE format.....	461
	8.3.6.3	UL-MAP IE format.....	466
	8.3.6.4	AAS-FBCK-REQ/RSP message bodies	472
	8.3.6.5	AAS-BEAM-REQ/RSP message	474
	8.3.7	Control mechanisms	476
	8.3.7.1	Synchronization	476
	8.3.7.2	Ranging	477
	8.3.7.3	Bandwidth requesting	479
	8.3.7.4	Power control.....	483
	8.3.8	Transmit diversity: Space-Time Coding (optional).....	484
	8.3.8.1	Multiple input single output channel estimation and synchronization	484
	8.3.8.2	STC encoding	485
	8.3.8.3	STC decoding	485
	8.3.9	Channel quality measurements	486
	8.3.9.1	Introduction.....	486
	8.3.9.2	RSSI mean and standard deviation	486
	8.3.9.3	CINR mean and standard deviation	488
	8.3.10	Transmitter requirements	489
	8.3.10.1	Transmit power level control.....	489
	8.3.10.2	Transmitter channel bandwidth and RF carrier frequencies	490
	8.3.11	Receiver requirements	491
	8.3.11.1	Receiver sensitivity.....	491
	8.3.11.2	Receiver adjacent and alternate channel rejection	492
	8.3.11.3	Receiver maximum input signal	493
	8.3.11.4	Receiver maximum tolerable signal	493
	8.3.11.5	Receiver image rejection	493
	8.3.12	Frequency and timing requirements	493

8.4	WirelessMAN-OFDMA PHY	493
8.4.1	Introduction.....	493
8.4.2	OFDMA symbol description, symbol parameters and transmitted signal.....	494
8.4.2.1	Time domain description	494
8.4.2.2	Frequency domain description.....	494
8.4.2.3	Primitive parameters	495
8.4.2.4	Derived parameters	495
8.4.2.5	Transmitted signal.....	495
8.4.3	OFDMA basic terms definition	496
8.4.3.1	Slot and Data Region	496
8.4.3.2	Segment	496
8.4.3.3	Permutation Zone.....	496
8.4.3.4	OFDMA data mapping	497
8.4.4	Frame structure	499
8.4.4.1	Duplexing modes	499
8.4.4.2	PMP frame structure	499
8.4.4.3	DL Frame Prefix	501
8.4.4.4	Allocation of subchannels for FCH, and logical subchannel numbering	502
8.4.4.5	Uplink transmission allocations.....	505
8.4.4.6	Optional Diversity-Map Scan	505
8.4.4.7	Optional Direct Signaling Method.....	509
8.4.5	Map message fields and IEs.....	520
8.4.5.1	DL-MAP PHY Synchronization Field.....	520
8.4.5.2	Frame duration codes.....	520
8.4.5.3	DL-MAP IE format.....	521
8.4.5.4	UL-MAP IE format.....	531
8.4.5.5	Burst profile format	547
8.4.5.6	Compressed maps	547
8.4.5.7	AAS-FBCK-REQ/RSP message bodies	550
8.4.6	OFDMA subcarrier allocations.....	551
8.4.6.1	Downlink	552
8.4.6.2	Uplink	568
8.4.6.3	Optional permutations for AAS and AMC subchannels	574
8.4.7	OFDMA ranging.....	576
8.4.7.1	Initial-ranging transmissions.....	576
8.4.7.2	Periodic-ranging and bandwidth-request transmissions	577
8.4.7.3	Ranging codes.....	578
8.4.8	Transmit diversity (optional)	579
8.4.8.1	Transmit diversity using two antennas	579
8.4.8.2	Transmit diversity for four antennas.....	585
8.4.9	Channel coding	587
8.4.9.1	Randomization	588
8.4.9.2	Encoding	589
8.4.9.3	Interleaving	615
8.4.9.4	Modulation.....	616
8.4.10	Control mechanisms	620
8.4.10.1	Synchronization	620
8.4.10.2	Ranging.....	620
8.4.10.3	Power control.....	620
8.4.11	Channel quality measurements	622
8.4.11.1	Introduction.....	622
8.4.11.2	RSSI mean and standard deviation	622
8.4.11.3	CINR mean and standard deviation.....	624
8.4.12	Transmitter requirements	625

8.4.12.1	Transmit power level control	625
8.4.12.2	Transmitter spectral flatness	625
8.4.12.3	Transmitter constellation error and test method	625
8.4.13	Receiver requirements	627
8.4.13.1	Receiver sensitivity	627
8.4.13.2	Receiver adjacent and alternate channel rejection	628
8.4.13.3	Receiver maximum input signal	629
8.4.13.4	Receiver maximum tolerable signal	629
8.4.14	Frequency control requirements	629
8.4.14.1	Center frequency and symbol clock frequency tolerance	629
8.5	WirelessHUMAN specific components.....	629
8.5.1	Channelization	629
8.5.2	Transmit spectral mask	631
9.	Configuration	633
9.1	SS IP addressing	633
9.1.1	DHCP fields used by the SS	633
9.2	SS Configuration file	634
9.2.1	SS binary configuration file format	634
9.2.2	Configuration file settings	634
9.2.3	Configuration file creation.....	635
9.2.3.1	SS MIC calculation.....	636
10.	Parameters and constants	637
10.1	Global values	637
10.2	PKM parameter values.....	640
10.3	PHY-specific values	641
10.3.1	WirelessMAN-SC parameter and constant definitions.....	641
10.3.1.1	PS	641
10.3.1.2	Symbol rate	641
10.3.1.3	Uplink center frequency.....	642
10.3.1.4	Downlink center frequency.....	642
10.3.1.5	Tolerated poll jitter	642
10.3.1.6	Allocation Start Time.....	642
10.3.1.7	Timing Adjust Units	642
10.3.2	WirelessMAN-SCa parameters and constant definitions	642
10.3.2.1	Uplink Allocation Start Time	642
10.3.2.2	PS	642
10.3.2.3	Timing adjust units	642
10.3.3	WirelessMAN-OFDM parameters and constant definitions	642
10.3.3.1	Uplink Allocation Start Time	642
10.3.3.2	PS	642
10.3.3.3	Timing adjust units	643
10.3.4	WirelessMAN-OFDMA parameters and constant definitions.....	643
10.3.4.1	Uplink Allocation Start Time	643
10.3.4.2	PS	643
10.3.4.3	Timing adjust units	643
10.4	Well-known addresses and identifiers	643
11.	TLV encodings	645
11.1	Common encodings	646

11.1.1	Current transmit power	646
11.1.2	HMAC tuple	646
11.1.3	MAC version encoding	647
11.1.4	Service flow descriptors.....	647
11.1.5	Vendor ID encoding.....	647
11.1.6	Vendor-specific information.....	648
11.2	Configuration file encodings	649
11.2.1	SS MIC configuration setting	649
11.2.2	Software upgrade descriptors.....	649
11.2.2.1	Vendor ID	649
11.2.2.2	Hardware ID	649
11.2.2.3	Software version	650
11.2.2.4	Upgrade filename.....	650
11.2.3	Software upgrade TFTP server	650
11.2.4	TFTP Server Timestamp.....	650
11.2.5	Authorization Node.....	651
11.2.6	Registration Node	651
11.2.7	Provisioning Node	651
11.3	UCD management message encodings.....	651
11.3.1	UCD channel encodings	651
11.3.1.1	Uplink burst profile encodings	655
11.4	DCD management message encodings.....	659
11.4.1	DCD channel encodings	659
11.4.2	Downlink burst profile encodings.....	660
11.5	RNG-REQ management message encodings	664
11.6	RNG-RSP management message encodings	665
11.7	REG-REQ/RSP management message encodings.....	667
11.7.1	ARQ Parameters	667
11.7.2	SS management support.....	667
11.7.3	IP management mode.....	667
11.7.4	IP version	668
11.7.5	Secondary Management CID.....	668
11.7.6	Number of uplink CID supported	668
11.7.7	Convergence Sublayer Capabilities	668
11.7.7.1	Classification/PHS options and SDU encapsulation support	668
11.7.7.2	Maximum number of classifiers	669
11.7.7.3	PHS support	669
11.7.8	SS capabilities encodings.....	669
11.7.8.1	ARQ Support	669
11.7.8.2	DSx flow control.....	669
11.7.8.3	MAC CRC support	670
11.7.8.4	MCA flow control.....	670
11.7.8.5	Multicast polling group CID support.....	670
11.7.8.6	PKM flow control	670
11.7.8.7	Authorization Policy Support	670
11.7.8.8	Maximum number of supported security associations	671
11.8	SBC-REQ/RSP management message encodings	671
11.8.1	Bandwidth Allocation Support	671
11.8.2	Capabilities for Construction and Transmission of MAC PDUs	671
11.8.3	Physical Parameters Supported.....	671
11.8.3.1	Subscriber transition gaps	671
11.8.3.2	Maximum transmit power.....	672
11.8.3.3	Current transmit power	672
11.8.3.4	WirelessMAN-SC specific parameters	672

11.8.3.5	WirelessMAN-SCa specific parameters	674
11.8.3.6	WirelessMAN-OFDM specific parameters	678
11.8.3.7	WirelessMAN-OFDMA specific parameters	680
11.9	PKM-REQ/RSP management message encodings	681
11.9.1	Display string	683
11.9.2	AUTH-Key	683
11.9.3	TEK.....	683
11.9.4	Key lifetime	684
11.9.5	Key-Sequence-Number.....	684
11.9.6	HMAC-Digest.....	684
11.9.7	SAID	684
11.9.8	TEK parameters	685
11.9.9	CBC-IV	685
11.9.10	Error code.....	685
11.9.11	CA certificate	686
11.9.12	SS certificate	687
11.9.13	Security capabilities	687
11.9.14	Cryptographic suite.....	688
11.9.15	Cryptographic-Suite-List	689
11.9.16	Version.....	689
11.9.17	SA-Descriptor	690
11.9.18	SA type.....	690
11.9.19	PKM configuration settings	691
11.9.19.1	Authorize wait timeout	691
11.9.19.2	Reauthorize wait timeout	691
11.9.19.3	Authorization grace time.....	691
11.9.19.4	Operational wait timeout.....	691
11.9.19.5	Rekey wait timeout	692
11.9.19.6	TEK grace time	692
11.9.19.7	Authorize reject wait timeout.....	692
11.10	MCA-REQ management message encodings	692
11.11	REP-REQ management message encodings	693
11.12	REP-RSP management message encodings	694
11.13	Service Flow management encodings.....	694
11.13.1	SFID	697
11.13.2	CID	697
11.13.3	Service Class Name.....	697
11.13.4	QoS parameter set type	698
11.13.5	Traffic priority	699
11.13.6	Maximum sustained traffic rate.....	699
11.13.7	Maximum traffic burst	699
11.13.8	Minimum reserved traffic rate.....	700
11.13.9	Minimum tolerable traffic rate	700
11.13.10	Vendor-specific QoS parameters	701
11.13.11	Service flow scheduling type	701
11.13.12	Request/transmission policy.....	701
11.13.13	Tolerated jitter	702
11.13.14	Maximum latency.....	702
11.13.15	Fixed-length versus variable-length SDU indicator.....	703
11.13.16	SDU size.....	703
11.13.17	Target SAID	703
11.13.18	ARQ TLVs for ARQ-enabled connections	703
11.13.18.1	ARQ Enable	703
11.13.18.2	ARQ_WINDOW_SIZE	704

11.13.18.3	ARQ_RETRY_TIMEOUT	704
11.13.18.4	ARQ_BLOCK_LIFETIME.....	705
11.13.18.5	ARQ_SYNC_LOSS_TIMEOUT	705
11.13.18.6	ARQ_DELIVER_IN_ORDER	705
11.13.18.7	ARQ_RX_PURGE_TIMEOUT.....	705
11.13.18.8	ARQ_BLOCK_SIZE	706
11.13.19	CS specific service flow encodings.....	706
11.13.19.1	CS specification	706
11.13.19.2	CS parameter encoding rules	707
11.13.19.3	Packet CS encodings for configuration and MAC messaging.....	707
11.13.19.4	ATM CS Encodings for Configuration and MAC Messaging	718
12.	System profiles	721
12.1	WirelessMAN-SC (10–66 GHz) system profiles	721
12.1.1	WirelessMAN-SC MAC system profiles	721
12.1.1.1	Basic ATM MAC system profile.....	721
12.1.1.2	Basic Packet MAC system profile	722
12.1.1.3	Conventions for MAC Management messages for profiles profM1 and profM2	722
12.1.1.4	MAC Management message Parameter Transmission Order.....	722
12.1.1.5	Message parameters specific to profM1	728
12.1.1.6	Message parameters specific to profM2	729
12.1.2	WirelessMAN-SC PHY Profiles	730
12.1.2.1	WirelessMAN-SC 25 MHz Channel PHY Profile	730
12.1.2.2	WirelessMAN-SC 28 MHz Channel PHY Profile	735
12.1.2.3	Conventions for MAC Management messages for profiles profP1 and profP2.....	741
12.1.2.4	UCD and DCD parameter transmission order for profP1 and profP2.....	741
12.1.2.5	Initial Ranging IE usage for profP1 and profP2	742
12.2	WirelessMAN-SCa and WirelessHUMAN(-SCa) system profiles	742
12.2.1	WirelessMAN-SCa MAC System Profiles	742
12.2.1.1	Basic ATM MAC System Profile.....	742
12.2.1.2	Basic Packet MAC System Profile	742
12.2.1.3	Conventions for MAC Management Messages for profiles profM4 and profM5	743
12.2.2	WirelessMAN-SCa Power class profiles.....	743
12.2.3	WirelessMAN-SCa Physical Layer (PHY) Profiles	744
12.2.3.1	Common features of PHY profiles	747
12.2.3.2	Specific PHY profiles	749
12.2.4	WirelessMAN-SCa RF profiles	750
12.2.4.1	RF profiles for 3.5 MHz channelization	750
12.2.4.2	RF profiles for 7 MHz channelization	750
12.2.4.3	RF profiles for 10 MHz channelization	751
12.2.4.4	RF profiles for 20 MHz channelization	752
12.3	WirelessMAN-OFDM and WirelessHUMAN(-OFDM) System Profiles.....	752
12.3.1	WirelessMAN-OFDM and WirelessHUMAN(-OFDM) MAC Profiles	753
12.3.1.1	ProfM3_PMP: Basic Packet PMP MAC System Profile.....	754
12.3.1.2	ProfM3_Mesh: Basic Packet Mesh MAC System Profile.....	756
12.3.2	WirelessMAN-OFDM and WirelessHUMAN(-OFDM) Physical Layer Profiles	758
12.3.2.1	ProfP3_1.75: WirelessMAN-OFDM PHY profile for 1.75MHz channelization	760
12.3.2.2	ProfP3_3.5: WirelessMAN-OFDM PHY profile for 3.5 MHz channelization	760
12.3.2.3	ProfP3_7: WirelessMAN-OFDM PHY profile for 7 MHz channelization .	761

12.3.2.4	ProfP3_3: WirelessMAN-OFDM PHY profile for 3 MHz channelization .	762
12.3.2.5	ProfP3_5.5: WirelessMAN-OFDM PHY profile for 5.5 MHz channelization	763
12.3.2.6	profP3_10: WirelessHUMAN(-OFDM) PHY profile for 10 MHz channelization	764
12.3.3	WirelessMAN-OFDM RF profiles	765
12.3.3.1	RF profiles for 10 MHz channelization	765
12.4	WirelessMAN-OFDMA and WirelessHUMAN(-OFDMA) system profiles.....	766
12.4.1	WirelessMAN-OFDMA Power class profiles	766
12.4.2	WirelessMAN-OFDMA and WirelessHUMAN(-OFDMA) MAC Profiles	767
12.4.2.1	Basic Packet PMP MAC Profile	767
12.4.3	WirelessMAN-OFDMA and WirelessHUMAN(-OFDMA) System PHY Profiles....	768
12.4.3.1	Common Features of PHY Profiles	768
12.4.3.2	WirelessMAN-OFDMA 1.25 MHz channel basic PHY Profile.....	770
12.4.3.3	WirelessMAN-OFDMA 3.5 MHz channel basic PHY Profile.....	771
12.4.3.4	WirelessMAN-OFDMA 7 MHz channel basic PHY Profile.....	772
12.4.3.5	WirelessMAN-OFDMA 8.75 MHz channel basic PHY Profile.....	773
12.4.3.6	WirelessMAN-OFDMA 14 MHz channel basic PHY Profile.....	774
12.4.3.7	WirelessMAN-OFDMA 17.5 MHz channel basic PHY Profile.....	775
12.4.3.8	WirelessMAN-OFDMA 28 MHz channel basic PHY Profile.....	776
12.4.3.9	WirelessHUMAN(-OFDMA) 10 MHz channel basic PHY Profile	777
12.4.3.10	WirelessHUMAN(-OFDMA) 20 MHz channel basic PHY Profile	778
12.4.4	WirelessMAN-OFDMA RF profiles	778
Annex A (informative) Bibliography		781
Annex B (informative) Supporting material for frequencies below 11 GHz.....		785
Annex C (informative) Example MAC common part sublayer service definition.....		841

List of Figures

Figure 1—IEEE Std 802.16 protocol layering, showing SAPs	3
Figure 2—PDU and SDU in a protocol stack.....	10
Figure 3—ATM CS PDU format.....	18
Figure 4—CS PDU format for VP-switched ATM connections	19
Figure 5—CS PDU format for VC-switched ATM connections.....	19
Figure 6—MAC SDU format	21
Figure 7—Classification and CID mapping (BS to SS)	22
Figure 8—Classification and CID mapping (SS to BS)	22
Figure 9—PHS operation.....	25
Figure 10—PHS with masking	26
Figure 11—PHS signaling example	27
Figure 12—IEEE 802.3/Ethernet CS PDU format without header suppression	27
Figure 13—IEEE 802.3/Ethernet CS PDU format with header suppression	27
Figure 14—IEEE 802.1Q VLAN CS PDU format without header suppression	28
Figure 15—IEEE 802.1Q VLAN CS PDU format with header suppression	28
Figure 16—IP CS PDU format without header suppression	29
Figure 17—IP CS PDU format with header suppression	29
Figure 18—MAC PDU formats.....	35
Figure 19—Generic MAC header format.....	36
Figure 20—Bandwidth request header format.....	38
Figure 20—Bandwidth Request Header Format	38
Figure 21—MAC Management message format.....	43
Figure 22—Reduced CID Decoding.....	106
Figure 23—Subchannel allocation modes of Compact DL-MAP_IE for Band AMC	112
Figure 24—Construction of a MAC PDU	122
Figure 25—MAC PDU concatenation showing example CIDs	123
Figure 26—Packing fixed-length MAC SDUs into a single MAC PDU	124
Figure 27—Packing variable-length MAC SDUs into a single MAC PDU.....	125
Figure 28—Packing with fragmentation.....	125
Figure 29—Example MAC PDU with extended Fragmentation subheaders	126
Figure 30—Example MAC PDU with ARQ Packing subheader	126
Figure 31—MAC PDU encryption.....	127
Figure 32—Block usage examples for ARQ with and without rearrangement.....	129
Figure 33—ARQ transmit block states.....	134
Figure 34—ARQ Reset message dialog—transmitter initiated.....	135
Figure 35—ARQ Reset message dialog—receiver initiated	136
Figure 36—ARQ block reception.....	137
Figure 37—SS Request/Grant flow chart	143
Figure 38—Unicast polling	144
Figure 39—Multicast and broadcast polling	146
Figure 40—PM bit usage.....	147
Figure 41—MSH-CSCF schedule example.....	149
Figure 42—MSH-CSCH flow usage example.....	150
Figure 43—MSH-CSCH schedule validity	151
Figure 44—Example of Burst FDD bandwidth allocation	152
Figure 45—TDD frame structure.	153
Figure 46—Maximum time relevance of DL-MAP and UL-MAP(TDD)	155
Figure 47—Minimum time relevance of DL-MAP and UL-MAP (TDD).....	155
Figure 48—Maximum time relevance of DL-MAP and UL-MAP (FDD)	155
Figure 49—Minimum time relevance of DL-MAP and UL-MAP (FDD).....	156
Figure 50—Time relevance example of MSH-DSCH in distributed scheduling	158

Figure 51—Time relevance example of MSH-CSCH in centralized scheduling	158
Figure 52—AAS Zone, FDD.....	163
Figure 53—AAS Zone, TDD.....	164
Figure 54—Example of Request IE containing multiple transmission opportunities	167
Figure 55—SS Initialization overview	168
Figure 56—Obtaining downlink synchronization	170
Figure 57—Maintaining downlink synchronization.....	171
Figure 58—Obtaining uplink parameters	172
Figure 59—Maintain uplink parameters.....	173
Figure 60—Initial Ranging—SS (part 1).....	178
Figure 61—Initial Ranging—SS (part 2).....	179
Figure 62—Initial Ranging—BS	180
Figure 63—Initial Ranging, Polled Phase—BS	181
Figure 64—Initial ranging—BS response to undecodable message	182
Figure 65—Negotiate Basic Capabilities—SS	182
Figure 66—Wait for SBC-RSP—SS	183
Figure 67—Negotiate Basic Capabilities—BS.....	183
Figure 68—Registration—SS	184
Figure 69—Wait for REG-RSP—SS.....	185
Figure 70—Registration—BS.....	186
Figure 71—Wait for TFTP-CPLT—BS	189
Figure 72—Wait for TFTP-RSP—SS	189
Figure 73—Mesh network synchronization and entry—New node—I.....	192
Figure 74—Mesh network synchronization and entry—New node—II.....	193
Figure 75—Mesh network synchronization and entry—Sponsor node.....	194
Figure 76—Registration—Candidate node	196
Figure 77—Wait for registration response—Candidate node	196
Figure 78—Registration—Registration node	197
Figure 79—Transition to a more robust burst profile.....	200
Figure 80—Transition to a less robust burst profile.....	201
Figure 81—Burst profile threshold usage.....	201
Figure 82—Periodic Ranging receiver processing—BS	203
Figure 83—Periodic Ranging opportunity allocation—BS.....	203
Figure 84—Periodic Ranging—SS.....	204
Figure 85—CDMA Initial Ranging—SS (part 1).....	207
Figure 86—CDMA Initial Ranging—SS (part 2).....	208
Figure 87—CDMA Initial Ranging—BS	209
Figure 88—Periodic CDMA ranging—BS.....	210
Figure 89—Periodic ranging—Received ranging code—BS	211
Figure 90—Periodic CDMA ranging—SS	212
Figure 91—Multicast polling assignment—SS	216
Figure 92—Multicast polling assignment—BS.....	217
Figure 93—Provisioned authorization model “envelopes”	220
Figure 94—Dynamic authorization model “envelopes”.....	220
Figure 95—Theory of Operation Object Model	221
Figure 96—DSA message flow—SS-initiated	225
Figure 97—DSA message flow—BS-initiated.....	226
Figure 98—Dynamic service flow overview	227
Figure 99—Dynamic Service Flow state transition diagram.....	230
Figure 100—DSA—Locally Initiated Transaction state transition diagram	231
Figure 101—DSA—Remotely Initiated Transaction state transition diagram.....	232
Figure 102—DSC—Locally Initiated Transaction state transition diagram	233
Figure 103—DSC—Remotely Initiated Transaction state transition diagram.....	234
Figure 104—DSD—Locally Initiated Transaction state transition diagram	235

Figure 105—DSD—Remotely Initiated Transaction state transition diagram.....	236
Figure 106—DSA—Locally Initiated Transaction Begin state flow diagram	239
Figure 107—DSA—Locally Initiated Transaction DSA-RSP Pending state flow diagram	240
Figure 108—DSA—Locally Initiated Transaction Holding state flow diagram.....	241
Figure 109—DSA—Locally Initiated Transaction Retries Exhausted state flow diagram.....	242
Figure 110—DSA—Locally Initiated Transaction Deleting Service Flow state flow diagram.....	243
Figure 111—DSA—Remotely Initiated Transaction Begin state flow diagram	244
Figure 112—DSA—Remotely Initiated Transaction DSA-ACK Pending state flow diagram.....	245
Figure 113—DSA—Remotely Initiated Transaction Holding Down state flow diagram.....	246
Figure 114—DSA—Remotely Initiated Transaction Deleting Service state flow diagram.....	246
Figure 115—DSC—Locally Initiated Transaction Begin state flow diagram	250
Figure 116—DSC—Locally Initiated Transaction DSC-RSP Pending state flow diagram.....	251
Figure 117—DSC—Locally Initiated Transaction Holding Down state flow diagram	252
Figure 118—DSC—Locally Initiated Transaction Retries Exhausted state flow diagram	253
Figure 119—DSC—Locally Initiated Transaction Deleting Service Flow state flow diagram	254
Figure 120—DSC—Remotely Initiated Transaction Begin state flow diagram	255
Figure 121—DSC—Remotely Initiated Transaction DSC-ACK Pending state flow diagram	256
Figure 122—DSC—Remotely Initiated Transaction Holding Down state flow diagram.....	257
Figure 123—DSC—Remotely Initiated Transaction Deleting Service Flow state flow diagram.....	257
Figure 124—DSD—Locally Initiated Transaction Begin state flow diagram	259
Figure 125—DSD—Locally Initiated Transaction DSD-RSP Pending state flow diagram	260
Figure 126—DSD—Locally Initiated Transaction Holding Down state flow diagram.....	261
Figure 127—DSD—Remotely Initiated Transaction Begin state flow diagram.....	262
Figure 128—DSD—Remotely Initiated Transaction Holding Down state flow diagram.....	263
Figure 129—MAC over UDP/IP tunneling	266
Figure 130—Construction of H-ARQ encoder packet	267
Figure 131—Authorization state machine flow diagram	277
Figure 132—TEK state machine flow diagram	283
Figure 133—AK management in BS and SS.....	290
Figure 134—TEK management in BS and SS.....	293
Figure 135—TEK management in BS and SS.....	296
Figure 136—Initial CCM Block B_0	297
Figure 137—Construction of A_i	298
Figure 138—Example of FDD bandwidth allocation	308
Figure 139—TDD frame structure	309
Figure 140—TDD downlink subframe structure.....	310
Figure 141—FDD downlink subframe structure	311
Figure 142—DL-MAP usage with shortened FEC blocks—TDM case	317
Figure 144—Format of the downlink Transmission Convergence sublayer PDU.....	317
Figure 143—DL-MAP usage with shortened FEC blocks—TDMA case	318
Figure 145—Conceptual block diagram of the downlink PMD sublayer	319
Figure 146—Randomizer logic diagram	320
Figure 147—Inner code for Code Type 2 in the downlink.....	323
Figure 148—Two-dimensional product code matrix.....	324
Figure 149—Example encoder for a (16,11) extended Hamming Code	325
Figure 150—Structure of shortened 2 D block.....	327
Figure 151—QPSK constellation	329
Figure 152—16-QAM constellation (gray-coded)	330
Figure 153—64-QAM constellation (gray-coded)	331
Figure 154—Uplink subframe structure	335
Figure 155—Conceptual block diagram of the uplink PHY	340
Figure 156—Structure of shortened 2 D block.....	341
Figure 157—Illustration of EVM	350
Figure 158—Transmit processing	356

Figure 159—Randomizer for energy dispersal.....	356
Figure 160—Concatenated FEC encoder blocks.....	357
Figure 161—Binary rate 1/2 convolutional encoder	359
Figure 162—Pragmatic TCM encoder for rate 1/2 16-QAM	362
Figure 163—Pragmatic TCM encoder for rate 3/4 16-QAM	362
Figure 164—Pragmatic TCM encoder for rate 2/3 64-QAM	363
Figure 165—Pragmatic TCM encoder for rate 5/6 64-QAM	363
Figure 166—Optional pragmatic TCM encoder for rate 3/4 256-QAM	364
Figure 167—Optional pragmatic TCM encoder for rate 7/8 256-QAM	364
Figure 168—BTC and shortened BTC structures.....	365
Figure 169—CTC encoder.....	368
Figure 170— BPSK Constellation maps	371
Figure 171—Gray maps for QPSK and 16-QAM constellations	371
Figure 172—Gray map for 64-QAM constellation	372
Figure 173—Gray map for 256-QAM constellation	373
Figure 174—Pragmatic maps for 16-QAM and 64-QAM constellations.....	374
Figure 175—Pragmatic map for 256-QAM constellation	375
Figure 176—Spread BPSK processing.....	376
Figure 177—Spreading PN sequence generator	377
Figure 178—Fundamental framing elements in a standard format burst set.....	380
Figure 179—Burst set preamble composition	380
Figure 180—Pilot Word patterning within a burst set.....	382
Figure 181—Paired blocks used in STC transmit diversity combining	383
Figure 182—STC dual blocks without UWs.....	384
Figure 183—STC dual blocks with UWs	385
Figure 184—STC burst set preamble	386
Figure 185—Base frame	387
Figure 186—Base frame partitioning and padding.....	387
Figure 187—Forming an appended block	387
Figure 188—Forming a repeat segment	388
Figure 189—Forming a burst set segment from repeat segments	388
Figure 190—Forming of subchannel burst set from segments	389
Figure 191—Segment alignment for overlapping burst sets on different subchannels	390
Figure 192—Example of FDD frame format	392
Figure 193—Example of TDD frame format	395
Figure 194—MAC frame contents with AAS elements	397
Figure 195—OFDM symbol time structure.....	427
Figure 196—OFDM frequency description.....	428
Figure 197—PRBS for data randomization.....	431
Figure 198—OFDM randomizer downlink initialization vector for burst #2...N	431
Figure 199—OFDM randomizer uplink initialization vector	431
Figure 200—Convolutional encoder of rate 1/2	433
Figure 201—BTC and shortened BTC structure	436
Figure 202—CTC encoder.....	438
Figure 203—BPSK, QPSK, 16-QAM, and 64-QAM constellations	442
Figure 204—PRBS for pilot modulation	443
Figure 205—Downlink and network entry preamble structure	447
Figure 206—P _{EVEN} time domain structure	448
Figure 207—Example of OFDM frame structure with TDD	450
Figure 208—Example of OFDM frame structure with FDD	451
Figure 209—Structure of AAS Zone	454
Figure 210—Mesh frame structure.....	459
Figure 211—Illustration of STC.....	485
Figure 212—STC usage with OFDM	486

Figure 213—OFDMA symbol time structure.....	494
Figure 214—OFDMA frequency description (3 channel schematic example)	495
Figure 215—Example of the data region which defines the OFDMA allocation	496
Figure 216—Example of mapping OFDMA slots to subchannels and symbols in the downlink (in PUSC mode).....	498
Figure 217—Example of mapping OFDMA slots to subchannels and symbols in the uplink.....	499
Figure 218—Time plan - one TDD time frame (with only mandatory zone)	500
Figure 219—Illustration of OFDMA frame with multiple zones	501
Figure 220—FCH subchannel allocation for all 3 segments	503
Figure 221—Example of DL renumbering the allocated subchannels for segment 1 in PUSC.....	504
Figure 222—Example of UL renumbering the allocated subchannels for segment 1 in PUSC.....	505
Figure 223—Example of allocation for AAS_DL_Scan IE	506
Figure 224—AAS Diversity Map Frame Structure	507
Figure 225—Frame Layout in the AAS Region	511
Figure 226—Downlink BW Allocation/Access channel	512
Figure 227—Reverse link AAS subframe structure showing RLT signaling	514
Figure 228—Forward link subframe structure showing FLI and FLT signaling	515
Figure 229—PHY control signal sequence diagrams	516
Figure 230—Mapping order of FAST-FEEDBACK messages to the FAST-FEEDBACK region	539
Figure 231—Mapping of MIMO coefficients to fast MIMO feedback payload bits	542
Figure 232—Downlink transmission basic structure.....	552
Figure 233—Downlink basic structure	553
Figure 234—Cluster structure	564
Figure 235—Downlink symbol structure for segment 0 on symbol number 1 using FUSC.....	566
Figure 236—Description of an uplink tile	569
Figure 237—Description of an uplink tile	572
Figure 238—Bin structure	575
Figure 239—Initial-ranging transmission for OFDMA.....	576
Figure 240—Initial-ranging transmission for OFDMA, using two consecutive initial ranging codes	577
Figure 241—Periodic-ranging or bandwidth-request transmission for OFDMA using one code.....	577
Figure 242—Periodic-ranging or bandwidth-request transmission for OFDMA using three consecutive codes	578
Figure 243—PRBS for ranging code generation	578
Figure 244—Illustration of STC.....	579
Figure 245—Cluster structure	581
Figure 246—STC usage with PUSC	581
Figure 247—STC usage with FUSC	582
Figure 248— Example of using FHDC in PUSC	583
Figure 249—UL STC tile	584
Figure 250—Illustration of Transmit diversity using four antennas	585
Figure 251—Cluster structure	586
Figure 252—Channel coding process for regular and repetition coding transmission.....	588
Figure 253—PRBS for data randomization.....	588
Figure 254—Creation of OFDMA randomizer initialization vector	589
Figure 255—Convolutional encoder of rate 1/2	590
Figure 256—BTC and shortened BTC structure	593
Figure 257—CTC encoder.....	595
Figure 258—Block diagram of subpacket generation	600
Figure 259—Block diagram of the interleaving scheme	600
Figure 260—PRBS of the randomization	604
Figure 261—Initialization construction for the PRBS of the randomizer	604
Figure 262—PRBS for pilot modulation	616
Figure 263—QPSK, 16-QAM, and 64-QAM constellations.....	617
Figure 264—Channelization, 20 MHz.....	630

Figure 265—Transmit spectral mask (see Table 341)	631
Figure 266—Configuration file structure	634
Figure 267—Create TLV entries for parameters required by the SS	635
Figure 268—Add SS MIC	635
Figure 269—Add end of data marker and pad	635
Figure B.1—WirelessHUMAN Mesh deployment model	788
Figure B.2—Mesh interference code sample	798
Figure B.3—Immediate neighborhood scenario.....	800
Figure B.4—Example network scenario.....	803
Figure B.5—Reuse of 1 configuration, 3 sectors per cell.....	814
Figure B.6—Reuse of 1 configuration, 3 sectors per cell.....	815
Figure C.1—Use of primitives to request service of MAC and generate response.....	842
Figure C.2—MAC SAP event and MAC event sequence for connection creation stimulated by CS	850
Figure C.3—MAC SAP event and MAC event sequence for connection change stimulated by CS	851
Figure C.4—MAC SAP event and MAC event sequence for connection deletion stimulated by CS	851

List of Tables

Table 1—Air interface nomenclature	2
Table 2—ATM CS PDU header.....	17
Table 3—Mesh CID construction.....	34
Table 4—MAC header format.....	35
Table 5—Generic MAC header fields	37
Table 6—Type encodings.....	37
Table 7—Bandwidth request header fields.....	38
Table 8—Fragmentation subheader format	39
Table 9—Grant Management subheader format.....	40
Table 10—Grant Management subheader fields	40
Table 11—Packing subheader format.....	41
Table 12—Mesh subheader format.....	42
Table 13—FAST-FEEDBACK allocation subheader format	42
Table 14—MAC Management messages	43
Table 15—DCD message format.....	45
Table 16—DL-MAP message format	46
Table 17—UCD message format.....	47
Table 18—UL-MAP message format	48
Table 19—RNG-REQ message format	49
Table 20—RNG-RSP message format	50
Table 21—REG-REQ message format.....	51
Table 22—REG-RSP message format.....	53
Table 23—PKM MAC messages	54
Table 24—PKM request (PKM-REQ) message format	54
Table 25—PKM response (PKM-RSP) message format.....	54
Table 26—PKM message codes	55
Table 27—SA Add attributes	56
Table 28—Auth Request attributes.....	57
Table 29—Auth Reply attributes	57
Table 30—Auth Reject attributes	58
Table 31—Key Request attributes	58
Table 32—Key Request attributes for Mesh Mode.....	58
Table 33—Key Reply attributes	59
Table 34—Key Reject attributes.....	60
Table 35—Authorization Invalid attributes	60
Table 36—TEK Invalid attributes	61
Table 37—Auth Info attributes.....	61
Table 38—DSA-REQ message format.....	62
Table 39—DSA-RSP message format.....	63
Table 40—DSA-ACK message format	64
Table 41—DSC-REQ message format.....	65
Table 42—DSC-RSP message format	66
Table 43—DSC-ACK message format.....	67
Table 44—DSD-REQ message format.....	68
Table 45—DSD-RSP message format.....	69
Table 46—MCA-REQ message format.....	70
Table 47—MCA-RSP message format.....	70
Table 48—DBPC-REQ message format	71
Table 49—DBPC-RSP message format	72
Table 50—RES-CMD message format	72
Table 51—SS SBC-REQ message format.....	73

Table 52—SS SBC-RSP message format.....	73
Table 53—CLK-CMP message format	74
Table 54—DREG-CMD message format.....	75
Table 55—Action Codes and actions	75
Table 56—DSX-RVD message format	76
Table 57—TFTP-CPLT message format.....	76
Table 58—Config File TFTP-RSP message format	77
Table 59—ARQ Feedback message format	77
Table 60—ARQ Discard message format	78
Table 61—ARQ Reset message format.....	79
Table 62—Channel measurements Report Request (REP-REQ) message format.....	79
Table 63—Channel measurement Report Response (REP-RSP) message format.....	80
Table 64—Fast power control message format	80
Table 65—MSH-NCFG message format	81
Table 66—Nbr Physical IE.....	84
Table 67—Nbr Logical IE	84
Table 68—MSH-NCFG embedded data.....	85
Table 69—Network Descriptor IE.....	86
Table 70—MSH-NCFG Channel IE (license-exempt).....	87
Table 71—MSH-NCFG Channel IE (licensed).....	87
Table 72—Network Entry Open IE.....	88
Table 73—Network Entry Reject IE	88
Table 74—Neighbor Link Establishment IE	89
Table 75—MSH-NENT message format	89
Table 76—MSH-NENT Request IE	90
Table 77—MSH-DSCH message format	91
Table 78—MSH-DSCH Scheduling IE.....	93
Table 79—MSH-DSCH Request IE	93
Table 80—MSH-DSCH Availability IE.....	94
Table 81—MSH-DSCH Grants IE	95
Table 82—MSH-CSCH message format.....	97
Table 83—MSH-CSCF message format	98
Table 84—AAS Feedback Request (AAS-FBCK-REQ) message format	100
Table 85—AAS Feedback Response (AAS-FBCK-RSP) message format.....	100
Table 86—AAS_Beam_Select message format	100
Table 87—DREG-REQ message format	101
Table 88—H-ARQ MAP message format.....	102
Table 89—Compact_DL-MAP IE types	103
Table 90—Compact_UL-MAP IE types	103
Table 91—Format configuration IE	104
Table 92—Field length for Band AMC MAP_IE	105
Table 93—RCID_IE format	106
Table 94—H-ARQ_Control IE format	107
Table 95—H-ARQ_Control IE format	108
Table 96—H-ARQ Compact_DL-MAP IE format for normal subchannel.....	109
Table 97—H-ARQ Compact_DL-MAP IE format for band AMC.....	110
Table 98—H-ARQ Compact_DL-MAP IE format for safety	112
Table 99—H-ARQ Compact_DL-MAP IE format for DIUC subchannel.....	113
Table 100—H-ARQ Compact_DL-MAP IE format for H-ARQ BITMAP	114
Table 101—H-ARQ Compact_DL-MAP IE format for extension	115
Table 102—H-ARQ Compact_UL-MAP IE format for normal subchannel.....	115
Table 103—H-ARQ Compact_UL-MAP IE format for band AMC	116
Table 104—H-ARQ Compact_UL-MAP IE format for safety	118
Table 105—H-ARQ Compact_UL-MAP IE format for UIUC subchannel	118

Table 106—H-ARQ Compact_UL-MAP IE format for H-ARQ Region allocation	119
Table 107—H-ARQ Compact_UL-MAP IE format for CQI Region allocation.....	120
Table 108—H-ARQ Compact_UL-MAP IE format for extension	121
Table 109—Fragmentation rules	123
Table 110—ARQ Feedback Payload format	127
Table 111—ARQ Feedback IE.....	130
Table 112—Scheduling services and usage rules	139
Table 113—Sample UL-MAP with multicast and broadcast IE for SC and SCa	145
Table 114—Message flows during scanning and uplink parameter acquisition	173
Table 115—Ranging and automatic adjustments procedure	176
Table 116—Establishing IP connectivity	187
Table 117—Establishing time of day	188
Table 118—Transfer of Operational Parameters.....	188
Table 119—Successful network entry message exchange	195
Table 120—Establishing link connectivity.....	198
Table 121—CDMA initial Ranging and automatic adjustments procedure.....	206
Table 122—CDMA periodic Ranging and automatic adjustments procedure	212
Table 123—UCD update	214
Table 124—DCD update	215
Table 125—DSA initiated from SS	236
Table 126—DSA initiated from BS.....	237
Table 127—SS-initiated DSC.....	248
Table 128—BS-initiated DSC	249
Table 129—DSD-initiated from SS.....	258
Table 130—DSD-initiated from BS	258
Table 132—Tunnel subheader Format	266
Table 131—MAC Management messages tunneled over UDP during network entry.....	266
Table 133—Authorization FSM state transition matrix	277
Table 134—TEK FSM state transition matrix.....	284
Table 135—Basic fields of an X.509 Version 3 certificate	301
Table 136—Frame durations and frame duration codes.....	308
Table 137—PHY Type parameter encoding	308
Table 138—Downlink burst preambles.....	311
Table 139—Frame start preamble	312
Table 140—Downlink TDMA burst preamble.....	312
Table 141—SC DL-MAP_IE	313
Table 142—SC PHY synchronization field.....	314
Table 143—Mapping of burst profile to DIUC	315
Table 144—SC Downlink_Burst_Profile format	316
Table 145—SC DIUC allocation	319
Table 146—FEC Code Types.....	320
Table 147—Parameters of the inner codes for the BCC	323
Table 148—SC Hamming code generator polynomials	324
Table 150—Encoded block	326
Table 149—Original data for encoding	326
Table 151—Required block codes for the BTC option for the downlink channel	327
Table 152—Parameters for burst profile (DIUC=0).....	328
Table 153—QPSK bits to symbol mapping	330
Table 154—16-QAM bits to symbol mapping	331
Table 155—64-QAM bits to symbol mapping	332
Table 156—16-symbol uplink preamble sequence	335
Table 158—SC UL-MAP_IE format.....	336
Table 157—32-symbol uplink preamble sequence	336
Table 159—SC UIUC values	337

Table 160—SC UL-MAP extended IE format	337
Table 161—SC Power Control IE format.....	338
Table 162—SC Uplink_Burst_Profile format	339
Table 163—Required block codes for the BTC option for the uplink channel.....	342
Table 164—Baud rates and channel sizes for a roll-off factor of 0.25.....	343
Table 165—Minimum BS transmitter performance.....	344
Table 166—Minimum SS transmitter performance	345
Table 167—Minimum SS receiver performance.....	346
Table 168—Propagation models	347
Table 169—Downlink spectrum mask at 28MHz channel.....	348
Table 170—Uplink spectrum mask at 28MHz channel.....	349
Table 171—Downlink and uplink NFD mask	349
Table 172—EVM values vs. modulation scheme	350
Table 173—Operating parameters for block interleaver	358
Table 174—Puncture patterns and serialization for convolution code.....	359
Table 175—Supported modulations and inner (TCM) code rates.....	360
Table 176—Flushing bit requirements for inner code termination	360
Table 177—BTC component codes.....	365
Table 178—(n-1,k) Hamming code generator polynomials	366
Table 179—BTC code banks.....	367
Table 180—Circulation state lookup table (Sc)	369
Table 181—Circulation state lookup table (Sc)	370
Table 182—Modulations supported	370
Table 183—Unity average power normalization factors.....	376
Table 184—Spreading PN sequence generator seeds.....	378
Table 185—Unique Word lengths, types, and support.....	379
Table 186—Multiplexing arrangement for block STC processing	383
Table 187—Channel settings for FCH burst	401
Table 188—Burst profile settings for FCH burst	402
Table 189—SCa compressed DL-MAP format.....	403
Table 190—SCa compressed UL-MAP format.....	404
Table 191—SCa PHY synchronization field.....	404
Table 192—SCa DL-MAP IE format	405
Table 193—SCa DIUCs	406
Table 194—SCa DL-MAP extended IE format	407
Table 195—SCa Channel measurement extended IE format	407
Table 196—SCa FCH burst profile change extended IE format	408
Table 197—SCa AAS DL extended IE format	408
Table 198—SCa burst set delimiter extended IE format	409
Table 199—SCa AAS DL preamble index extended IE format.....	410
Table 200—SCa concurrent transmission extended IE format	411
Table 201—SCa UL-MAP IE format	412
Table 202—SCa UL-MAP IEs	413
Table 203—SCa UL-MAP extended IE format	414
Table 204—SCa power control extended IE format	414
Table 205—SCa AAS UL extended IE format	415
Table 206—SCa AAS UL preamble index extended IE format.....	415
Table 207—SCa concurrent transmission extended IE format	416
Table 208—SCa Downlink_Burst_Profile format	417
Table 209—SCa Uplink_Burst_Profile format	417
Table 210—SCa AAS Feedback Request message body	418
Table 211—SCa AAS Feedback Request message body	419
Table 212—Minimum adjacent and alternate adjacent channel interference performance	425
Table 213—OFDM symbol parameters	429

Table 214—The inner convolutional code with puncturing configuration	433
Table 216—BTC component codes.....	434
Table 215—Mandatory channel coding per modulation	434
Table 217—OFDM Hamming code generator polynomials	435
Table 218—Optional BTC channel coding per modulation.....	436
Table 219—Optional BTC channel coding with subchannelization	437
Table 220—Optional CTC channel coding per modulation.....	438
Table 222—CTC puncturing (Sc).....	440
Table 221—Circulation state lookup table (Sc)	440
Table 223—Block sizes of the Bit Interleaver.....	441
Table 224—OFDM Rate ID encodings	443
Table 225—OFDM downlink frame prefix format	452
Table 226—AAS_DLFP Structure	454
Table 227—AAS_DLFP_DL IE format.....	455
Table 228—AAS_DLFP_UL IE format.....	456
Table 229—AAS_COMP_UL IE format	456
Table 230—UIUC Usage in AAS Zone	457
Table 231—AAS NW Entry Response IE format	458
Table 232—OFDM frame duration (TF ms) codes	460
Table 233—OFDM Downlink_Burst_Profile format.....	460
Table 234—OFDM Uplink_Burst_Profile format	461
Table 235—OFDM PHY synchronization field.....	461
Table 236—OFDM DL-MAP IE.....	461
Table 237—OFDM DIUC values.....	463
Table 238—DL-MAP extended IE format	463
Table 239—OFDM Channel measurement IE format.....	464
Table 240—OFDM AAS DL IE format	464
Table 242—OFDM DL-MAP Concurrent transmission IE format.....	465
Table 241—OFDM STC IE format	465
Table 244—OFDM DL-MAP dummy IE format.....	466
Table 243—OFDM DL-MAP Physical Modifier IE format	466
Table 245—OFDM UL-MAP IE format	467
Table 246—OFDM UIUC values	468
Table 247—OFDM focused contention IE format	468
Table 248—Subchannelized network entry IE format	469
Table 249—OFDM UL-MAP extended IE format.....	470
Table 250—OFDM power control IE format	470
Table 251—OFDM AAS UL IE format	471
Table 252—OFDM UL-MAP Physical Modifier IE format	471
Table 253—OFDM UL-MAP dummy IE format.....	472
Table 254—OFDM AAS Feedback Request message body	472
Table 255—OFDM AAS Feedback Response message body.....	473
Table 256—AAS Beam request message format	474
Table 257—AAS Beam response message format.....	475
Table 258—AAS Beam report IE format	476
Table 259—OFDM AAS_NW_ENTRY_REQ format	478
Table 260—OFDM SBCH_AAS_NW_ENTRY_REQ format.....	479
Table 261—OFDM Contention codes	481
Table 262—OFDM Contention channels	481
Table 263—OFDM Spectral flatness	489
Table 264—Allowed relative constellation error versus data rate.....	489
Table 265—Example of channelization for licensed bands	491
Table 266—Receiver SNR assumptions.....	491
Table 267—Adjacent and nonadjacent channel rejection	493

Table 268—OFDMA downlink Frame Prefix format	501
Table 269—AAS-DLFP Structure, Diversity-Map Scan	508
Table 270—Structure of AAS_COMP_DL_IE ()	509
Table 271—AAS-DLFP2 Structure, Directed Signaling	512
Table 272—Bandwidth Granularity with AAS and AMC subchannels.....	517
Table 273—OFDMA PHY Synchronization Field	520
Table 274—OFDMA frame duration (TF ms) codes	520
Table 275—OFDMA DL-MAP_IE format	521
Table 276—OFDMA DIUC values	522
Table 277—DL-MAP extended IE format	523
Table 278—OFDMA downlink AAS IE	523
Table 279—OFDMA downlink TD_ZONE IE format	524
Table 280—OFDMA channel measurement IE	525
Table 281—OFDMA Data location in another BS IE.....	525
Table 282—OFDMA downlink CID Switch IE format	526
Table 283—MIMO DL basic IE format	527
Table 284—MIMO DL enhanced IE format	528
Table 285—H-ARQ MAP pointer IE format	529
Table 286—OFDMA DL-MAP Physical Modifier IE format	530
Table 287—OFDMA UL-MAP IE format	532
Table 288—OFDMA UIUC values	533
Table 289—PAPR reduction and safety zone allocation IE format	534
Table 290—CDMA Allocation IE format	534
Table 291—OFDMA UL-MAP extended IE format.....	535
Table 292—OFDMA Power Control IE.....	536
Table 293—OFDMA uplink AAS IE	536
Table 294—OFDMA uplink ZONE IE format.....	537
Table 295—Mini-subchannel allocation IE format	537
Table 296—FAST_FEEDBACK channel subcarrier modulation.....	539
Table 297—FAST_FEEDBACK subcarrier modulation in each vector.....	540
Table 298—Encoding of payload bits for FAST-FEEDBACK slot.....	542
Table 299—MIMO UL basic IE format	543
Table 300—CQICH alloc IE format.....	544
Table 301—Orthogonal Modulation for ACK channel.....	545
Table 302—OFDMA UL-MAP Physical Modifier IE format	546
Table 303—OFDMA Downlink_Burst_Profile TLV format	547
Table 304—OFDMA Uplink_burst_profile TLV format.....	547
Table 305—Compressed DL-MAP message format	548
Table 306—Compressed UL-MAP message format	549
Table 307—OFDMA AAS Feedback Request message body	550
Table 308—OFDMA AAS Feedback Response message body.....	551
Table 309—Preamble modulation series per segment	553
Table 310—OFDMA downlink carrier allocations—PUSC	563
Table 311—OFDMA downlink carrier allocations	565
Table 312—OFDMA optional FUSC downlink subcarrier allocation	567
Table 313—OFDMA uplink subcarrier allocations	568
Table 314—Subchannel partitioning into mini-subchannels.....	571
Table 315—OFDMA uplink subcarrier allocations	572
Table 316—OFDMA AAS subcarrier allocations.....	575
Table 317—Subchannel concatenation rule	589
Table 318—Encoding Subchannel concatenation for different allocations and modulations.....	590
Table 319—The inner convolutional code with puncturing configuration	591
Table 320—Useful data payload for a subchannel.....	591
Table 321—OFDMA Hamming code generator polynomials	592

Table 322—Useful data payload for a subchannel.....	593
Table 323—Optional channel coding per modulation.....	593
Table 324—Subchannel concatenation rule for CTC.....	596
Table 325—Encoding subchannel concatenation for different rates in CTC.....	596
Table 326—Optimal CTC channel coding per modulation.....	597
Table 327—Optimal CTC channel coding per modulation when supporting H-ARQ.....	598
Table 328—Circulation state lookup table (Sc).....	599
Table 329—Parameters for the subblock interleavers.....	601
Table 330—Parameters for the subblock interleavers when supporting H-ARQ.....	602
Table 331—Transmission format and modulation level for DL.....	606
Table 332—N _{EP} encoding.....	610
Table 333—Transmission format and modulation level for UL.....	611
Table 334—Normalized C/N per modulation.....	621
Table 335—Spectral flatness.....	625
Table 336—Allowed relative constellation error versus data rate.....	625
Table 337—Receiver minimum input level sensitivity (dBm).....	627
Table 338—Receiver SNR and Eb/N0 assumptions.....	627
Table 339—Adjacent and nonadjacent channel rejection.....	629
Table 340—Channelizations.....	630
Table 341—Transmit spectral mask parameters.....	631
Table 342—Parameters and constants.....	637
Table 343—Operational ranges for privacy configuration settings.....	641
Table 344—Values for privacy configuration setting for protocol testing.....	641
Table 345—CIDs.....	643
Table 346—Type values for common TLV encodings.....	646
Table 347—HMAC Tuple definition.....	646
Table 348—HMAC Tuple value field.....	647
Table 349—UCD common channel encodings.....	651
Table 350—UCD PHY-specific channel encodings — WirelessMAN-SC.....	652
Table 351—UCD PHY-specific channel encodings — WirelessMAN-SCa.....	653
Table 352—UCD PHY-specific channel encodings — WirelessMAN-OFDM.....	653
Table 353—UCD PHY-specific channel encodings — WirelessMAN-OFDMA.....	654
Table 354—UCD burst profile encodings—WirelessMAN-SC.....	655
Table 355—UCD burst profile encodings—WirelessMAN-SCa.....	656
Table 356—UCD burst profile encodings—WirelessMAN-OFDM.....	657
Table 357—UCD burst profile encodings—WirelessMAN-OFDMA.....	658
Table 358—DCD channel encoding.....	659
Table 359—DCD PHY-common burst profile encodings.....	660
Table 360—DCD burst profile encodings—WirelessMAN-SC.....	660
Table 361—DCD burst profile encodings—WirelessMAN-SCa.....	661
Table 362—DCD burst profile encodings—WirelessMAN-OFDM.....	663
Table 363—DCD burst profile encodings—WirelessMAN-OFDMA.....	663
Table 364—RNG-REQ message encodings.....	664
Table 365—SCa-specific RNG-REQ message encodings.....	664
Table 366—SCa-specific RNG-RSP message encodings.....	665
Table 367—RNG-RSP message encodings.....	665
Table 368—OFDM-specific RNG-RSP message encodings.....	666
Table 369—OFDMA-specific RNG-RSP message encodings.....	666
Table 370—PKM attribute types.....	682
Table 371—Attribute value data types.....	683
Table 372—TEK-parameters subattributes.....	685
Table 373—Error-code attribute code values.....	686
Table 374—Security-capabilities subattributes.....	687
Table 375—Data encryption algorithm identifiers.....	688

Table 376—Data authentication algorithm identifiers	688
Table 377—TEK encryption algorithm identifiers.....	688
Table 378—Allowed cryptographic suites	689
Table 379—Version attribute values	689
Table 380—SA-Descriptor subattributes.....	690
Table 381—SA-type attribute values	690
Table 382—Multicast assignment request message encodings.....	692
Table 383—Service flow encodings.....	695
Table 384—CC values.....	696
Table 385—Values used in Dynamic Service messages	698
Table 386—Profile definitions	721
Table 387—SS Minimum Performance requirements for profP1	731
Table 388—BS Tx minimum performance requirements for profP1	733
Table 389—BS Rx minimum performance for profP1	734
Table 390—SS Minimum performance for profP2	736
Table 391—BS Tx minimum performance for profP2.....	738
Table 392—BS Rx minimum performance for profP2	739
Table 393—Power classes	743
Table 394—SS minimum Tx performance requirements	744
Table 395—SS minimum Rx performance requirements.....	744
Table 396—BS minimum Tx performance requirements	745
Table 397—BS minimum Rx performance requirements	746
Table 398—Profile definitions	752
Table 399—Power classes profiles.....	753
Table 400—Sample system profile.....	753
Table 401—Optional feature requirements profM3_PMP	754
Table 402—Optional feature requirements profM3_mesh.....	756
Table 403—Optional PHY feature requirements	758
Table 404—Minimum Performance basic requirements.....	759
Table 405—Minimum Performance requirements for profP3_1.75	760
Table 406—Minimum Performance requirements for profP3_3.5	761
Table 407—Minimum Performance requirements for profP3_7	762
Table 408—Minimum Performance requirements for profP3_3	763
Table 409—Minimum Performance requirements for profP3_5.5	764
Table 410—Minimum Performance requirements for profP3_10	765
Table 411—Profile definitions	766
Table 412—Power classes	767
Table 413—Minimum performance requirements for all profiles	769
Table 414—Minimum performance requirements for OFDMA_ProfP1	770
Table 415—Minimum Performance requirements for OFDMA_ProfP2	771
Table 416—Minimum Performance requirements for OFDMA_ProfP3	772
Table 417—Minimum Performance requirements for OFDMA_ProfP4	773
Table 418—Minimum Performance requirements for OFDMA_ProfP5	774
Table 419—Minimum Performance requirements for OFDMA_ProfP6	775
Table 420—Minimum Performance requirements for OFDMA_ProfP7	776
Table 421—Minimum Performance requirements for OFDMA_ProfP8	777
Table 422—Minimum Performance requirements for OFDMA_ProfP9	778
Table 423—License bands RF Profiles List	779
Table B.1—Frequency bands and channel allocation	785
Table B.2—Single U-NII BWA to synthetic aperture radar 4 (SAR-4) Interference	787
Table B.3—Tx activity parameters.....	788
Table B.4—Antenna parameters.....	789
Table B.5—Relevant radio parameters.....	789
Table B.6—Altimeter satellite characteristics	790

Table B.7—Typical space borne imaging radar characteristics	790
Table B.8—Typical space borne imaging radar characteristics	792
Table B.9—RLAN Parameters I.....	793
Table B.10—RLAN parameters II.....	793
Table B.11—RTTT RSU parameters	794
Table B.12—RTTT OBU Parameters (–35× to +35×).....	794
Table B.13—Relevant radar parameters.....	795
Table B.14—Single U-NII BWA to SAR-4 interference	795
Table B.15—WirelessHUMAN Mesh devices in the SAR footprint.....	799
Table B.16—Tolerable Mesh nodes for FSS operation.....	800
Table B.17—Link attenuations and ranges.....	803
Table B.18— Tx Power, conducted and EIRP (regulatory limited).....	804
Table B.19—Received Signal Levels (dBm)	804
Table B.20—Sustainable modulation during interference	805
Table B.21—Needed separation distance Mesh to RSU and OBU	805
Table B.22—Minimum separation distance of radar to Mesh.....	806
Table B.23—Minimum separation distance of Mesh to radar.....	807
Table B.24—WirelessMAN-SCa raw bit rates (Mb/s) for 0.25 roll-off.....	808
Table B.25—WirelessMAN-SCa raw bit rates (Mb/s) for 0.15 roll-off.....	808
Table B.26—OFDM channelization parameters for licensed bands	810
Table B.27—OFDMA channelization parameters for licensed bands	811
Table B.28—OFDM/OFDMA channelization parameters for license-exempt bands.....	812
Table B.29—OFDM/OFDMA raw bitrates (Mb/s).....	812

**IEEE Standard for
Local and metropolitan area networks**

Part 16: Air Interface for Fixed Broadband Wireless Access Systems

1. Overview

1.1 Scope

This revised standard specifies the air interface, including the medium access control layer and multiple physical layer specifications, of fixed BWA systems supporting multiple services. It consolidates IEEE Std 802.16TM, IEEE Std 802.16aTM, and IEEE Std 802.16cTM, retaining all modes and major features without adding modes. Content is added or revised to improve performance, ease deployment, or replace incorrect, ambiguous, or incomplete material, including system profiles.

1.2 Purpose

This standard enables rapid worldwide deployment of innovative, cost-effective, and interoperable multi-vendor BWA products, facilitates competition in broadband access by providing alternatives to wireline broadband access, encourages worldwide spectrum allocation, and accelerates the commercialization of BWA systems.

1.3 Frequency bands

The applications depend on the spectrum to be used. The primary bands of interest are as follows:

1.3.1 10–66 GHz licensed bands

The 10–66 GHz bands provide a physical environment where, due to the short wavelength, line-of-sight (LOS) is required and multipath is negligible. In the 10–66 GHz band, channel bandwidths of 25 MHz or 28 MHz are typical. With raw data rates in excess of 120 Mb/s, this environment is well suited for PMP access serving applications from small office/home office (SOHO) through medium to large office applications.

The single-carrier modulation air interface specified herein for 10–66 GHz shall be known as the “WirelessMAN-SC[®]” air interface.

1.3.2 Frequencies below 11 GHz

Frequencies below 11 GHz provide a physical environment where, due to the longer wavelength, LOS is not necessary and multipath may be significant. The ability to support near-LOS and non-LOS (NLOS) scenarios requires additional PHY functionality, such as the support of advanced power management techniques, interference mitigation/coexistence, and multiple antennas.

Additional MAC features such as mesh topology and automatic repeat request (ARQ) are introduced.

1.3.3 License-exempt frequencies below 11 GHz (primarily 5–6 GHz)

The physical environment for the license-exempt bands below 11 GHz is similar to that of the licensed bands in the same frequency range, as described in 1.3.2. However, the license-exempt nature introduces additional interference and co-existence issues, whereas regulatory constraints limit the allowed radiated power. In addition to the features described in 1.3.2, the PHY and MAC introduce mechanisms such as dynamic frequency selection (DFS) to detect and avoid interference.

1.3.4 Air interface nomenclature and PHY compliance

Table 1 summarizes the nomenclature for the various air interface specifications in this standard.

Table 1—Air interface nomenclature

Designation	Applicability	PHY	Additional MAC requirements	Options	Duplexing alternative
WirelessMAN-SC™	10–66 GHz	8.1			TDD FDD
WirelessMAN-SCa™	Below 11 GHz licensed bands	8.2		AAS (6.3.7.6) ARQ (6.3.4) STC (8.2.1.4.3)	TDD FDD
WirelessMAN-OFDM™	Below 11 GHz licensed bands	8.3		AAS (6.3.7.6) ARQ (6.3.4) Mesh (6.3.6.6) STC (8.3.8)	TDD FDD
WirelessMAN-OFDMA	Below 11 GHz licensed bands	8.4		AAS (6.3.7.6) ARQ (6.3.4) STC (8.4.8)	TDD FDD
WirelessHUMAN™	Below 11 GHz license-exempt bands	[8.2, 8.3, or 8.4] and 8.5	DFS (6.3.15)	AAS (6.3.7.6) ARQ (6.3.4) Mesh (6.3.6.6) (with 8.3 only) STC (8.2.1.4.3/8.3.8/8.4.8)	TDD

All implementations of this standard shall comply with the requirements of Clause 6 and Clause 7.

Implementations of this standard for any applicable frequencies between 10 GHz and 66 GHz shall comply with the WirelessMAN-SC PHY as described in 8.1.

Implementations of this standard for licensed frequencies below 11 GHz (such as those listed in B.1) shall either comply with the WirelessMAN-SCa PHY as described in 8.2, the WirelessMAN-OFDM PHY as described in 8.3, the WirelessMAN-OFDMA PHY as described in 8.4, or the WirelessMAN-SC PHY as described in 8.1 for licensed frequencies above 10 GHz.

Implementations of this standard for license-exempt frequencies below 11 GHz (such as those listed in B.1) shall comply with the WirelessMAN-SCa PHY as described in 8.2, the WirelessMAN-OFDM PHY as described in 8.3, or the WirelessMAN-OFDMA PHY as described in 8.4. They shall further comply with the DFS protocols (6.3.15) and with 8.5.

1.4 Reference model

Figure 1 illustrates the reference model and scope of this standard.

The MAC comprises three sublayers. The Service-Specific Convergence Sublayer (CS) provides any transformation or mapping of external network data, received through the CS service access point (SAP), into MAC SDUs received by the MAC Common Part Sublayer (CPS) through the MAC SAP. This includes classifying external network service data units (SDUs) and associating them to the proper MAC service flow identifier (SFID) and connection identifier (CID). It may also include such functions as payload header suppression (PHS). Multiple CS specifications are provided for interfacing with various protocols. The internal format of the CS payload is unique to the CS, and the MAC CPS is not required to understand the format of or parse any information from the CS payload.

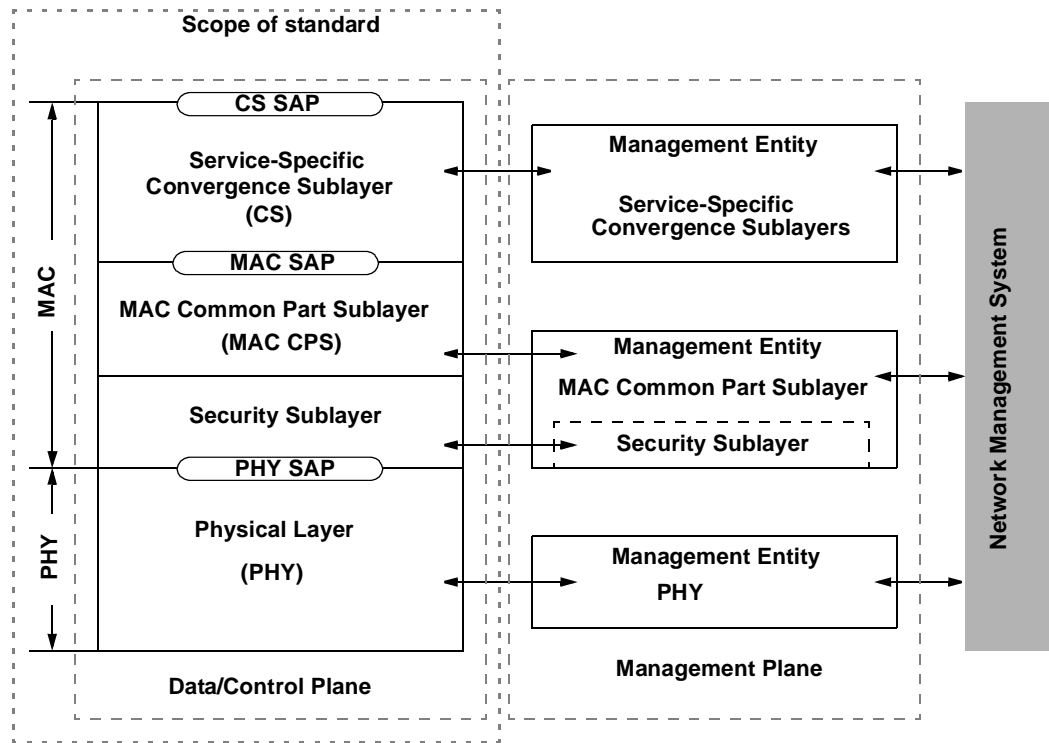

Figure 1—IEEE Std 802.16 protocol layering, showing SAPs

The MAC CPS provides the core MAC functionality of system access, bandwidth allocation, connection establishment, and connection maintenance. It receives data from the various CSs, through the MAC SAP, classified to particular MAC connections. An example of MAC CPS service definition is given in Annex C. Quality of Service (QoS) is applied to the transmission and scheduling of data over the PHY.

The MAC also contains a separate security sublayer providing authentication, secure key exchange, and encryption.

Data, PHY control, and statistics are transferred between the MAC CPS and the PHY via the PHY SAP (which is implementation specific).

The PHY definition includes multiple specifications, each appropriate to a particular frequency range and application. The various PHY specifications supported are discussed in Clause 8.

2. References

This standard shall be used in conjunction with the following publications. When the following specifications are superseded by an approved revision, the revision shall apply.

ATM Forum Specification af-uni-0010.002, ATM User-Network Interface Specification, Version 3.1, September 1994.¹

ATM Forum Specification af-sig-0061.000, ATM User-Network Interface (UNI) Signalling Specification, Version 4.0, July 1996.

ETSI EN 301 213-3, Fixed Radio Systems; Point-to-multipoint equipment; Point-to-multipoint digital radio systems in frequency bands in the range 24,25 GHz to 29,5 GHz using different access methods; Part 3: Time Division Multiple Access (TDMA) methods, Version 1.3.1, September 2001.²

FIPS 46-3, Data Encryption Standard (DES), October, 1999.³

FIPS 74, Guidelines for Implementing and Using the NBS Data Encryption Standard, April 1981.

FIPS 81, DES Modes of Operation, December 1980.

FIPS 180-1, Secure Hash Standard (SHS), April 1995.

FIPS 186-2, Digital Signature Standard (DSS), January 2000.

IEEE Std 802[®]-2001, IEEE Standards for Local and Metropolitan Area Networks: Overview and Architecture.^{4, 5}

IEEE Std 802.1D[™]-2004, IEEE Standard for Local and metropolitan Area Networks: Media Access Control (MAC) Bridges.⁶

IEEE Std 802.1Q, 2003 Edition, IEEE Standards for Local and Metropolitan Area Networks: Virtual Bridged Local Area Networks.

IEEE Std 802.2[™]-1998 (ISO/IEC 8802-2: 1998), Information technology—Telecommunications and information exchange between systems—Local and metropolitan area networks—Specific requirements—Part 2: Logical Link Control.

IEEE Std 802.3[™]-2002, IEEE Standard for Information technology—Telecommunications and information exchange between systems—Local and metropolitan area networks—Specific requirements—Part 3: Carrier sense multiple access with collision detection (CSMA/CD) access method and physical layer specifications.

IEEE Std 802.16.2[™]-2004, IEEE Recommended Practice for Local and metropolitan area networks—Coexistence of Fixed Broadband Wireless Access Systems.

¹ATM Forum publications are available from the ATM Forum at <http://www.atmforum.com/>.

²ETSI publications are available from the European Telecommunications Standards Institute at <http://www.etsi.org/>.

³FIPS publications are available from the National Technical Information Service (NTIS), U. S. Dept. of Commerce, 5285 Port Royal Road, Springfield, VA 22161 (<http://www.ntis.gov/>).

⁴IEEE and 802 are registered trademarks in the U.S. Patent & Trademark Office, owned by the Institute of Electrical and Electronics Engineers, Incorporated.

⁵IEEE publications are available from the Institute of Electrical and Electronics Engineers, Inc., 445 Hoes Lane, P.O. Box 1331, Piscataway, NJ 08855-1331, USA (<http://standards.ieee.org/>).

⁶IEEE standards referred to in Clause 2 are trademarks owned by the Institute of Electrical and Electronics Engineers, Incorporated.

IETF RFC 791, “Internet Protocol,” J. Postel, September 1981.⁷

IETF RFC 868, “Time Protocol,” J. Postel, K. Harrenstien, May 1983.

IETF RFC 1042, “A Standard for the Transmission of IP Datagrams over IEEE 802 Networks,” J. Postel, J. Reynolds, February 1988.

IETF RFC 1123, “Requirements for Internet Hosts—Application and Support,” R. Braden, October 1989.

IETF RFC 1157, “A Simple Network Management Protocol (SNMP),” M. Schoffstall, M. Fedor, J. Davin, and J. Case, May 1990.

IETF RFC 2104, “HMAC: Keyed-Hashing for Message Authentication,” H. Krawczyk, M. Bellare, R. Canetti, February 1997.

IETF RFC 2131, “Dynamic Host Configuration Protocol,” R. Droms, March 1997.

IETF RFC 2132, “DHCP Options and BOOTP Vendor Extensions,” S. Alexander, and R. Droms, March 1997.

IETF RFC 2349, “TFTP Timeout Interval and Transfer Size Options,” G. Malkin and A. Harkin, May 1998.

IETF RFC 2459, “Internet X.509 Public Key Infrastructure Certificate and CRL Profile,” R. Housley, W. Ford, W. Polk, D. Solo, January 1999.

IETF RFC 2460, “Internet Protocol, Version 6 (IPv6) Specification,” S. Deering, R. Hinden, December 1998.

IETF RFC 2474, “Definition of the Differentiated Services Field (DS Field) in the IPv4 and IPv6 Headers,” K. Nichols, S. Blake, F. Baker, D. Black, December 1998.

Internet Assigned Numbers Authority (IANA), “Protocol Numbers,” <<http://www.iana.org/assignments/protocol-numbers>>, June 2001.

ISO/IEC 8825, Information technology—Open Systems Interconnection—Specification of the Basic Encoding Rules for Abstract Syntax Notation One (ASN.1), May 1999.⁸

ITU-T Recommendation X.690, Information Technology—ASN.1 Encoding Rules: Specification of Basic Encoding Rules (BER), Canonical Encoding Rules (CER), and Distinguished Encoding Rules (DER), December 1997.⁹

PKCS #1 v2.0, RSA Cryptography Standard, RSA Laboratories, October 1998 <<http://www.rsasecurity.com/rsalabs/pkcs/pkcs-1>>.

⁷IETF publications are available from the Internet Engineering Task Force at <http://www.ietf.org/>.

⁸ISO/IEC publications are available from the ISO Central Secretariat, Case Postale 56, 1 rue de Varembe, CH-1211, Geneva 20, Switzerland/Suisse or the IEC Sales Department, Case Postale 131, 3, rue de Varembe, CH-1211, Geneva 20, Switzerland/Suisse. They are also available in the United States from the Sales Department, American National Standards Institute, 11 West 42nd Street, 13th floor, New York, NY 10036, USA.

⁹ITU-T publications are available from the International Telecommunications Union, Place des Nations, CH-1211, Geneva 20, Switzerland/Suisse (<http://www.itu.int/>).

3. Definitions

For the purposes of this standard, the following terms and definitions apply. *The Authoritative Dictionary of IEEE Standards Terms*, Seventh Edition [B23],¹⁰ should be referenced for terms not defined in this clause.

3.1 adaptive antenna system (AAS): A system adaptively exploiting more than one antenna to improve the coverage and the system capacity.

3.2 adaptive modulation: A system's ability to communicate with another system using multiple burst profiles and a system's ability to subsequently communicate with multiple systems using different burst profiles.

3.3 automatic repeat request (ARQ) block: A distinct unit of data that is carried on an ARQ-enabled connection. Such a unit is assigned a sequence number, and is managed as a distinct entity by the ARQ state machines. Block size is a parameter negotiated during connection establishment.

3.4 bandwidth stealing: The use, by a subscriber station (SS), of a portion of the bandwidth allocated in response to a Bandwidth Request for a connection to send another Bandwidth Request rather than sending data.

3.5 base station (BS): A generalized equipment set providing connectivity, management, and control of the subscriber station (SS).

3.6 basic connection: Connection that is established during subscriber station (SS) initial ranging and used to transport delay-intolerant medium access control (MAC) management messages.

3.7 broadband: Having instantaneous bandwidths greater than around 1 MHz and supporting data rates greater than about 1.5 Mb/s.

3.8 broadband wireless access (BWA): Wireless access in which the connection(s) capabilities are broadband.

3.9 burst profile: Set of parameters that describe the uplink or downlink transmission properties associated with an interval usage code. Each profile contains parameters such as modulation type, forward error correction (FEC) type, preamble length, guard times, etc. *See also: interval usage code.*

3.10 channel identifier (ChID): An identifier used to distinguish between multiple uplink channels, all of which are associated with the same downlink channel.

3.11 concatenation: The act of combining multiple medium access control (MAC) protocol data units (PDUs) into a single PHY SDU.

3.12 connection: A unidirectional mapping between base station (BS) and subscriber station (SS) medium access control (MAC) peers for the purpose of transporting a service flow's traffic. Connections are identified by a connection identifier (CID). All traffic is carried on a connection, even for service flows that implement connectionless protocols, such as Internet Protocol (IP). *See also: connection identifier.*

3.13 connection identifier (CID): A 16-bit value that identifies a connection to equivalent peers in the MAC of the base station (BS) and subscriber station (SS). It maps to a service flow identifier (SFID), which defines the Quality of Service (QoS) parameters of the service flow associated with that connection. Security associations (SAs) also exist between keying material and CIDs. *See also: service flow identifier.*

¹⁰The numbers in brackets correspond to those of the bibliography in Annex A.

3.14 DC subcarrier: In an orthogonal frequency division multiplexing (OFDM) or orthogonal frequency division multiple access (OFDMA) signal, the subcarrier whose frequency would be equal to the RF center frequency of the station.

3.15 directed mesh (DM): The realization of a physical mesh using substantially directional antennas. *See also: mesh.*

3.16 downlink: The direction from the base station (BS) to the subscriber station (SS).

3.17 downlink burst transition gap (DLBTG): Gap included on the trailing edge of each allocated downlink burst so that ramp down can occur and delay spread can clear receivers.

3.18 downlink channel descriptor (DCD): A MAC message that describes the PHY characteristics of a downlink channel.

3.19 downlink interval usage code (DIUC): An interval usage code specific to a downlink. *See also: interval usage code.*

3.20 downlink map (DL-MAP): A MAC message that defines burst start times for both time division multiplex and time division multiple access (TDMA) by a subscriber station (SS) on the downlink.

3.21 dynamic frequency selection (DFS): The ability of a system to switch to different physical RF channels between transmit and receive activity based on channel measurement criteria.

3.22 dynamic service: The set of messages and protocols that allow the base station (BS) and subscriber station (SS) to add, modify, or delete the characteristics of a service flow.

3.23 fixed wireless access: Wireless access application in which the location of the base station (BS) and subscriber station (SS) are fixed in location during operation.

3.24 frame: A structured data sequence of fixed duration used by some PHY specifications. A frame may contain both an uplink subframe and a downlink subframe.

3.25 frequency division duplex (FDD): A duplex scheme in which uplink and downlink transmissions use different frequencies but are typically simultaneous.

3.26 frequency offset index: An index number identifying a particular subcarrier in an orthogonal frequency division multiplexing (OFDM) or orthogonal frequency division multiple access (OFDMA) signal, which is related to its subcarrier index. Frequency offset indices may be positive or negative.

3.27 initial ranging connection identifier: A well-known CID that is used by a subscriber station (SS) during the initial ranging process. This CID is defined as constant value within the protocol since an SS has no addressing information available until the initial ranging process is complete.

3.28 interval usage code: A code identifying a particular burst profile that can be used by a downlink or uplink transmission interval.

3.29 mesh (MSH): Network architecture, wherein systems are capable of forwarding traffic from and to multiple other systems.

3.30 minislots: A unit of uplink bandwidth allocation equivalent to n physical slots (PSs), where $n = 2^m$ and m is an integer ranging from 0 through 7.

3.31 multicast polling group: A group of zero or more subscriber stations (SSs) that are assigned a multicast address for the purposes of polling.

3.32 node: A term associated with a mesh network station. A node, due to the nature of mesh, may behave as a BS, SS, or both, and will generate and forward data to other nodes.

3.33 packing: The act of combining multiple service data units (SDUs) from a higher layer into a single medium access control protocol data unit (PDU).

3.34 payload header suppression (PHS): The process of suppressing the repetitive portion of payload headers at the sender and restoring the headers at the receiver.

3.35 payload header suppression field (PHSF): A string of bytes representing the header portion of a protocol data unit (PDU) in which one or more bytes are to be suppressed (i.e., a snapshot of the uncompressed PDU header inclusive of suppressed and unsuppressed bytes).

3.36 payload header suppression index (PHSI): An 8-bit mask that indicates which bytes in the Payload Header Suppression Field (PHSF) to suppress and which bytes to not suppress.

3.37 payload header suppression size (PHSS): The length of the suppressed field in bytes. This value is equivalent to the number of bytes in the Payload Header Suppression Field (PHSF) and also the number of valid bits in the Payload Header Suppression Mask (PHSM).

3.38 payload header suppression valid (PHSV): A flag that tells the sending entity to verify all bytes that are to be suppressed.

3.39 physical slot (PS): A unit of time, dependent on the PHY specification, for allocating bandwidth

3.40 point to point (PtP): A mode of operation whereby a link exists between two network entities.

3.41 primary management connection: A connection that is established during initial subscriber station (SS) ranging and used to transport delay-tolerant medium access control (MAC) management messages.

3.42 privacy key management (PKM) protocol: A client/server model between the base station (BS) and subscriber station (SS) that is used to secure distribution of keying material.

3.43 protocol data unit (PDU): The data unit exchanged between peer entities of the same protocol layer. On the downward direction, it is the data unit generated for the next lower layer. On the upward direction, it is the data unit received from the previous lower layer (see Figure 2).

3.44 RF center frequency: The center of the frequency band in which a base station (BS) or SS is intended to transmit.

3.45 receive/transmit transition gap (RTG): A gap between the uplink burst and the subsequent downlink burst in a time division duplex (TDD) transceiver. This gap allows time for the base station (BS) to switch from receive to transmit mode and SSs to switch from transmit to receive mode. During this gap, the BS and SS are not transmitting modulated data but simply allowing the BS transmitter carrier to ramp up, the transmit/receive (Tx/Rx) antenna switch to actuate, and the SS receiver sections to activate. Not applicable for FDD systems.

3.46 secondary management connection: A connection that may be established during subscriber station (SS) registration that is used to transport standards-based (SNMP, DHCP, etc.) messages.

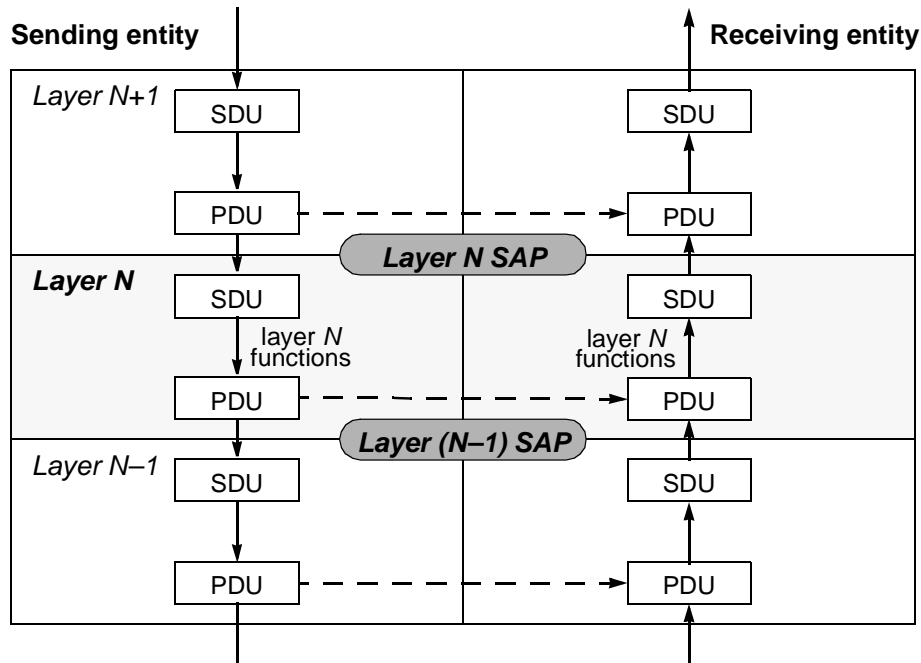

Figure 2—PDU and SDU in a protocol stack

3.47 security association (SA): The set of security information a base station (BS) and one or more of its client subscriber stations (SSs) share in order to support secure communications. This shared information includes traffic encryption keys (TEKs) and cipher block chaining (CBC) initialization vectors.

3.48 security association identifier (SAID): An identifier shared between the base station (BS) and subscriber station that uniquely identifies a security association (SA).

3.49 service access point (SAP): The point in a protocol stack where the services of a lower layer are available to its next higher layer.

3.50 service data unit (SDU): The data unit exchanged between two adjacent protocol layers. On the downward direction, it is the data unit received from the previous higher layer. On the upward direction, it is the data unit sent to the next higher layer (see Figure 2).

3.51 service flow (SF): A unidirectional flow of medium access control (MAC) service data units (SDUs) on a connection that is provided a particular Quality of Service (QoS).

3.52 service flow identifier (SFID): A 32-bit quantity that uniquely identifies a service flow to both the subscriber station and base station (BS).

3.53 SS Rx/Tx gap (SSRTG): The SSRTG is the minimum receive to transmit turnaround gap. SSRTG is measured from the time of the last sample of the received burst to the first sample of the transmitted burst, at the antenna port of the SS.

3.54 SS Tx/Rx gap (SSTTG): The SSTTG is the minimum transmit to receive turnaround gap. SSTTG is measured from the time of the last sample of the transmitted burst to the first sample of the received burst, at the antenna port of the SS.

3.55 subcarrier index: An index number identifying a particular used subcarrier in an orthogonal frequency division multiplexing (OFDM) or orthogonal frequency division multiple access (OFDMA) signal. Subcarrier indices are greater than or equal to zero.

3.56 subscriber station (SS): A generalized equipment set providing connectivity between subscriber equipment and a base station (BS).

3.57 time division duplex (TDD): A duplex scheme where uplink and downlink transmissions occur at different times but may share the same frequency.

3.58 time division multiple access (TDMA) burst: A contiguous portion of the uplink or downlink using PHY parameters, determined by the Downlink Interval Usage Code (DIUC) or Uplink Interval Usage Code (UIUC), that remain constant for the duration of the burst. TDMA bursts are separated by preambles and are separated by gaps in transmission if subsequent bursts are from different transmitters.

3.59 time division multiplexing (TDM) burst: A contiguous portion of a TDM data stream using PHY parameters, determined by the Downlink Interval Usage Code (DIUC), that remain constant for the duration of the burst. TDM bursts are not separated by gaps or preambles.

3.60 transport connection: A connection used to transport user data.

3.61 transport connection identifier: A unique identifier taken from the CID address space that uniquely identifies the transport connection.

3.62 turbo decoding: Iterative decoding, using soft inputs and soft outputs.

3.63 transmit/receive transition gap (TTG): A gap between the downlink burst and the subsequent uplink burst in a time division duplex (TDD) transceiver. This gap allows time for the base station (BS) to switch from transmit to receive mode and Ss to switch from receive to transmit mode. During this gap, the BS and SS are not transmitting modulated data but simply allowing the BS transmitter carrier to ramp down, the transmit/receive (Tx/Rx) antenna switch to actuate, and the BS receiver section to activate. Not applicable for FDD systems.

3.64 type/length/value (TLV): A formatting scheme that adds a tag to each transmitted parameter containing the parameter type (and implicitly its encoding rules) and the length of the encoded parameter.

3.65 uplink: The direction from a subscriber station to the base station (BS).

3.66 uplink channel descriptor (UCD): A medium access control message that describes the PHY characteristics of an uplink.

3.67 uplink interval usage code (UIUC): An interval usage code specific to an uplink.

3.68 uplink map (UL-MAP): A set of information that defines the entire access for a scheduling interval.

3.69 user data: PDUs of any protocol above a Service Specific Convergence Sublayer received over the CS SAP.

3.70 wireless access: End-user radio connection(s) to core networks.

4. Abbreviations and acronyms

3-DES	triple data encryption standard
AAS	adaptive antenna system
AGC	automatic gain control
AK	authorization key
ARQ	automatic repeat request
ATDD	adaptive time division duplexing
ATM	asynchronous transfer mode
BCC	block convolutional code
BE	best effort
BER	bit error rate
BPSK	binary phase shift keying
BR	bandwidth request
BS	base station
BSN	block sequence number
BTC	block turbo code
BW	bandwidth
BWA	broadband wireless access
C/I	carrier-to-interference ratio
C/N	carrier-to-noise ratio
CA	certification authority
CBC	cipher block chaining
CC	confirmation code
CCI	co-channel interference
CCS	common channel signaling
CCV	clock comparison value
CDMA	code division multiple access
CEPT	european conference of postal and telecommunications administrations
ChID	channel identifier
CID	connection identifier
CINR	carrier-to-interference-and-noise ratio
CIR	channel impulse response
CLP	cell loss priority
CP	cyclic prefix
CPS	common part sublayer
CRC	cyclic redundancy check
CS	convergence sublayer
CSCF	centralized scheduling configuration
CSCH	centralized scheduling
DAMA	demand assigned multiple access
DARS	digital audio radio satellite
DCD	downlink channel descriptor
DES	data encryption standard
DFS	dynamic frequency selection
DHCP	dynamic host configuration protocol
DIUC	downlink interval usage code
DL	downlink
DM	directed mesh
DSA	dynamic service addition
DSC	dynamic service change
DSCH	distributed scheduling
DSCP	differentiated services codepoint
DSD	dynamic service deletion

DSx	dynamic service addition, change, or deletion
EC	encryption control
ECB	electronic code book
EDE	encrypt-decrypt-encrypt
EESS	earth exploratory satellite system
EIRP	effective isotropic radiated power
EKS	encryption key sequence
EVM	error vector magnitude
FC	fragmentation control
FCH	frame control header
FDD	frequency division duplex or duplexing
FEC	forward error correction
FFT	fast fourier transform
FPC	fast power control
FSH	fragmentation subheader
FSN	fragment sequence number
FSS	fixed satellite service
GF	galois field
GPS	global positioning system
GS	guard symbol
HCS	header check sequence
HEC	header error check
H-FDD	half-duplex frequency division duplex
HMAC	hashed message authentication code
HT	header type
HUMAN	high-speed unlicensed metropolitan area network
I	inphase
IANA	internet assigned numbers authority
IE	information element
IFFT	inverse fast fourier transform
IP	internet protocol
ITU	international telecommunications union
IWF	interworking function
KEK	key encryption key
LAN	local area network
LFSR	linear feedback shift register
LLC	logical link control
LOS	line-of-sight
LSB	least significant bit
MAC	medium access control layer
MAN	metropolitan area network
MBd	megabaud
MBd/s	megabaud per second
Mb/s	megabit per second
MDS	multipoint distribution service
MIB	management information base
MIC	message integrity check
MMDS	multichannel multipoint distribution service
MPEG	moving pictures experts group
MSB	most significant bit
MSH	mesh
NCFG	network configuration
NENT	network entry
NLOS	non-line-of-sight

NNI	network-to-network interface (or network node interface)
nrtPS	non-real-time polling service
OFDM	orthogonal frequency division multiplexing
OFDMA	orthogonal frequency division multiple access
OID	object identifier
PBR	piggyback request
PDU	protocol data unit
PHS	payload header suppression
PHSF	payload header suppression field
PHSI	payload header suppression index
PHSM	payload header suppression mask
PHSS	payload header suppression size
PHSV	payload header suppression valid
PHY	physical layer
PKM	privacy key management
PM	poll-me bit
PMD	physical medium dependent
PMP	point-to-multipoint
PPP	point-to-point protocol
PRBS	pseudo-random binary sequence
PS	physical slot
PSH	packing subheader
PTI	payload type indicator
PtP	point to point
PVC	permanent virtual circuit
Q	quadrature
QAM	quadrature amplitude modulation
QoS	quality of service
QPSK	quadrature phase-shift keying
REQ	request
RLAN	radio local access network
RNG	ranging
RS	Reed–Solomon
RSP	response
RSS	receive signal strength
RSSI	receive signal strength indicator
RTG	receive/transmit transition gap
rtps	real-time polling service
Rx	receiver
RxDS	receiver delay spread clearing interval
SA	security association
SAID	security association identifier
SAP	service access point
SAR	synthetic aperture radar
SC	single carrier
SCTE	society of cable telecommunications engineers
SDU	service data unit
SF	service flow
SFID	service flow identifier
SHA	secure hash algorithm
SI	slip indicator
SNMP	simple network management protocol
SNR	signal-to-noise ratio
SS	subscriber station

SSTG	subscriber station transition gap
STC	space time coding
SVC	switched virtual circuit
TC	transmission convergence sublayer
TCM	trellis coded modulation
TCP	transmission control protocol
TDD	time division duplex or duplexing
TDM	time division multiplexing
TDMA	time division multiple access
TEK	traffic encryption key
TFTP	trivial file transfer protocol
TLV	type/length/value
TTG	transmit/receive transition gap
Tx	transmitter
UCD	uplink channel descriptor
UDP	user datagram protocol
UGS	unsolicited grant service
UIUC	uplink interval usage code
UL	uplink
UNI	user-to-network interface or user-network interface
U-NII	unlicensed national information infrastructure
UTC	universal coordinated time
UW	unique word
VC	virtual channel
VCI	virtual channel identifier
VLAN	virtual local area network
VP	virtual path
VPI	virtual path identifier
WirelessMAN	Wireless Metropolitan Area Networks
WirelessHUMAN	Wireless High-speed Unlicensed Metropolitan Area Networks
XOR	exclusive-or

5. Service-specific CS

The service-specific CS resides on top of the MAC CPS and utilizes, via the MAC SAP, the services provided by the MAC CPS (see Figure 1). The CS performs the following functions:

- Accepting higher-layer protocol data units (PDUs) from the higher layer
- Performing classification of higher-layer PDUs
- Processing (if required) the higher-layer PDUs based on the classification
- Delivering CS PDUs to the appropriate MAC SAP
- Receiving CS PDUs from the peer entity

Currently, two CS specifications are provided: the asynchronous transfer mode (ATM) CS and the packet CS. Other CSs may be specified in the future.

5.1 ATM CS

The ATM CS is a logical interface that associates different ATM services with the MAC CPS SAP. The ATM CS accepts ATM cells from the ATM layer, performs *classification* and, if provisioned, *PHS*, and delivers CS PDUs to the appropriate MAC SAP.

5.1.1 CS service definition

The ATM CS is specifically defined to support the convergence of PDUs generated by the ATM layer protocol of an ATM network. Since ATM cell streams are generated according to the ATM standards, no ATM CS service primitive is required.

5.1.2 Data/Control plane

5.1.2.1 PDU formats

The ATM CS PDU shall consist of an ATM CS PDU Header, defined in Table 2, and the ATM CS PDU payload. The ATM CS PDU payload shall be equal to the ATM cell payload. The ATM CS PDU is illustrated in Figure 3.

Table 2—ATM CS PDU header

Syntax	Size	Notes
ATM_CS_PDU_Header () {		
if (no PHS) {		
ATM_Header	40 bits	The full ATM cell header
}		
else if (VP-switched) {		
PTI	3 bits	From the ATM cell header
CLP	1 bit	From the ATM cell header
<i>reserved</i>	4 bits	Shall be set to zero
VCI	16 bits	From the ATM cell header
}		
else (VC-switched) {		
PTI	3 bits	From the ATM cell header

Table 2—ATM CS PDU header (continued)

Syntax	Size	Notes
CLP	1 bit	From the ATM cell header
<i>reserved</i>	4 bits	Shall be set to zero
}		
}		

**Figure 3—ATM CS PDU format****5.1.2.2 Classification**

An ATM connection, which is uniquely identified by a pair of values of virtual path identifier (VPI) and virtual channel identifier (VCI), is either Virtual Path (VP) switched or Virtual Channel (VC) switched. In VP-switched mode, all VCIs within one single incoming VPI are automatically mapped to that of an outgoing VPI. In VC-switched mode, input VPI/VCI values are individually mapped to output VPI/VCI values. Thus, when performing PHS, the ATM CS differentiates these two types of connections and performs the suppression accordingly.

A classifier is a set of matching criteria applied to each ATM cell entering the ATM CS. It consists of some ATM cell matching criteria, such as VPI and VCI, and a reference to a CID. If an ATM cell matches the specified matching criteria, it is delivered to the MAC SAP for delivery on the connection identified by the CID.

5.1.2.2.1 VP-switched mode

For VP-switched mode, the VPI field, 12 bits for a network-to-network interface (NNI) and 8 bits for a user-to-network interface (UNI), is mapped to the 16-bit CID for the MAC connection on which it is transported. Since the QoS and category of service parameters for the connection are set at connection establishment, this mapping of VPI to CID guarantees the correct handling of the traffic by the MAC.

5.1.2.2.2 VC-switched mode

For VC-switched mode, the VPI and VCI fields, 28 bits total for an NNI and 24 bits total for a UNI, are mapped to the 16-bit CID for the MAC connection on which it is transported. Since the QoS and category of service parameters for the connection are set at connection establishment, this mapping of VPI and VCI to CID guarantees the correct handling of the traffic by the MAC. Note that the full range of VPI/VCI combinations (up to 2^{28} for NNI and 2^{24} for UNI) cannot be simultaneously supported in this mode.

5.1.2.3 PHS

In PHS, a repetitive portion of the payload headers of the CS SDUs is suppressed by the sending entity and restored by the receiving entity. On the downlink, the sending entity is the ATM CS on the BS and the receiving entity is the ATM CS on the SS. On the uplink, the sending entity is the ATM CS on the SS, and the receiving entity is the ATM CS on the BS. To further save bandwidth, multiple ATM cells (with or without PHS) that share the same CID may be packed and carried by a single MAC CPS PDU. Note that

when PHS is turned off, no part of any ATM cell header including Header Error Check (HEC) field shall be suppressed. This provides an option for protecting the integrity of the cell header. Whether or not PHS is applied to an ATM connection is signaled in the Dynamic Service Addition (DSA) Request (DSA-REQ) message at the connection's creation. Similarly, the VPI (for VP-switched connections) or the VPI/VCI (for VC-switched connections) is also signaled in the classifier settings of the DSA-REQ message at connection creation.

5.1.2.3.1 PHS for VP-switched ATM connections

In VP-switched mode, the VPI is mapped to a CID. This allows the disposal of the remainder of the ATM cell header except for the VCI, Payload Type Indicator (PTI), and Cell Loss Priority (CLP) fields. These fields shall be encapsulated in the CS PDU header.

Figure 4 shows a CS PDU containing a single VP-switched ATM cell with the cell header suppressed and the format of the ATM CS PDU Header for VP-switched ATM connections.

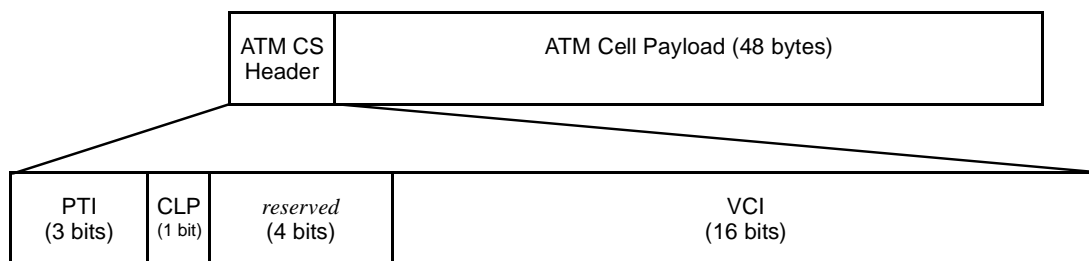

Figure 4—CS PDU format for VP-switched ATM connections

5.1.2.3.2 PHS for VC-switched ATM connections

In VC-switched mode, the VPI/VCI combination is mapped to a CID. This allows the disposal of the remainder of the ATM cell header except for the PTI and CLP fields. These fields shall be encapsulated in the CS PDU Header.

Figure 5 shows a CS PDU containing a single VC-switched ATM cell with the cell header suppressed and the format of the ATM CS PDU header for VC-switched ATM connections.

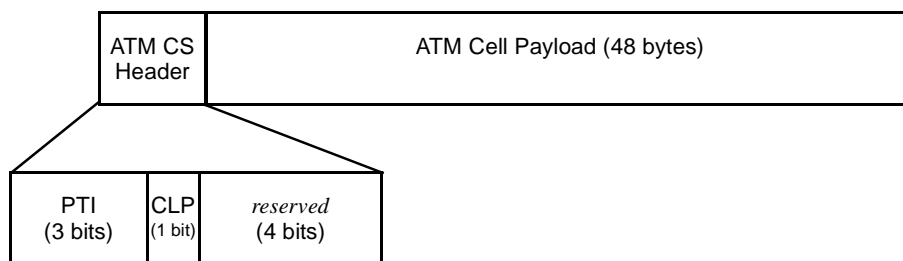

Figure 5—CS PDU format for VC-switched ATM connections

5.1.2.4 Signaling procedure

ATM interfaces support three types of connections, switched virtual circuit (SVC), permanent virtual circuit (PVC), and soft PVC. SVCs are established and terminated dynamically on demand by the use of signaling.

The word “permanent” signifies that the circuit is established administratively. Although both PVC and soft PVC are established administratively, PVCs are established by provisioning process, and soft PVCs are established by the use of signaling.

ATM networks use common channel signaling (CCS), where signaling messages are carried over a connection completely independent of user connections and where one signaling channel can carry signaling messages for a number of user connections. Per nonassociated signaling (ATM as-sig-0061.000), by default, the signaling channel on VPI = 0 controls all VPs on the same physical interface. In other words, except when the optional proxy signaling capability (Annex 2 of ATM as-sig-0061.000) or when the optional Virtual UNI capability (Annex 8 of ATM as-sig-0061.000) is used, the signaling channel is identified by VPI = 0 and VCI = 5. Note that this specification does not support associated signaling (ATM af-uni-0010.002), where VCI = 5 of each VP is used as the signaling channel for all VCs on the same VP. In addition, this specification does not support either proxy signaling or virtual UNI.

To establish an SVC, it is the responsibility of the calling party to initiate the signaling procedure by issuing the appropriate signaling messages. Either end can establish or release the SVC. Details on how to use these signaling messages are available in ATM as-sig-0061.000. It shall be the responsibility of the implementation of the BS to map ATM signaling messages to corresponding MAC CPS service primitives.

To establish a soft PVC, the network management system provisions one end of the soft PVC with the address identifying the egress ATM interface of the ATM network. The calling end has the responsibility for establishing and releasing the connection. It is also the responsibility of the calling party (if necessary) to reestablish the connection in case of switching system or link failure. It shall be the responsibility of the implementation of the BS to map ATM signaling messages to corresponding MAC CPS service primitives.

On the downlink direction, the signaling starts at an “end user” of the ATM backhaul network that implements an ATM UNI and terminates at the BS that shall implement either an ATM UNI or an ATM NNI. The signaling may be mapped by an interworking function (IWF) and extended to some user network on the SS-side. On the uplink direction, the signaling starts at the ATM interface of the BS and ends at the ATM UNI of an “end user.” In addition, the signaling may be originated by an “end user” of some user network and mapped by the IWF. Note that mapping of data units carried by the air link shall be limited to only cell-level convergence (5.1.2.2). If required by a user network, other levels of mappings (e.g., the convergence of, say, an Ethernet packet to ATM cells) shall be handled by the user network’s IWF exclusively.

During the provisioning process, each SS joining the IEEE Std 802.16 system shall request a dedicated CID as the signaling connection corresponding to the CCS connection used by ATM networks. Any CID provisioned for this purpose shall not be dynamically changed or terminated. Each IEEE Std 802.16 system shall provision a set of CIDs for this purpose.

5.2 Packet CS

The packet CS resides on top of the IEEE Std 802.16 MAC CPS. The CS performs the following functions, utilizing the services of the MAC:

- a) Classification of the higher-layer protocol PDU into the appropriate connection
- b) Suppression of payload header information (optional)
- c) Delivery of the resulting CS PDU to the MAC SAP associated with the service flow for transport to the peer MAC SAP
- d) Receipt of the CS PDU from the peer MAC SAP
- e) Rebuilding of any suppressed payload header information (optional)

The sending CS is responsible for delivering the MAC SDU to the MAC SAP. The MAC is responsible for delivery of the MAC SDU to peer MAC SAP in accordance with the QoS, fragmentation, concatenation, and other transport functions associated with a particular connection's service flow characteristics. The receiving CS is responsible for accepting the MAC SDU from the peer MAC SAP and delivering it to a higher-layer entity.

The packet CS is used for transport for all packet-based protocols such as Internet Protocol (IP), Point-to-Point Protocol (PPP), and IEEE Std 802.3 (Ethernet).

5.2.1 MAC SDU format

Once classified and associated with a specific MAC connection, higher-layer PDUs shall be encapsulated in the MAC SDU format as illustrated in Figure 6. The 8-bit Payload Header Suppression Index (PHSI) field shall be present when a Payload Header Suppression (PHS) rule has been defined for the associated connection.

Payload Header Suppression is described in 5.2.3.

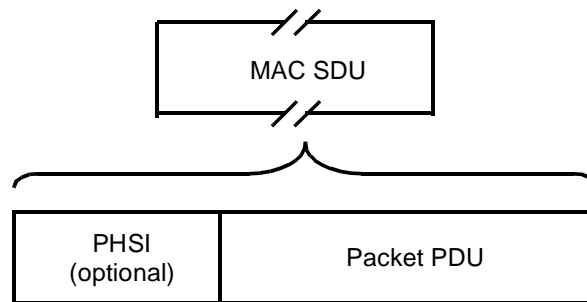

Figure 6—MAC SDU format

5.2.2 Classification

Classification is the process by which a MAC SDU is mapped onto a particular connection for transmission between MAC peers. The mapping process associates a MAC SDU with a connection, which also creates an association with the service flow characteristics of that connection. This process facilitates the delivery of MAC SDUs with the appropriate QoS constraints.

A classifier is a set of matching criteria applied to each packet entering the IEEE Std 802.16 network. It consists of some protocol-specific packet matching criteria (destination IP address, for example), a classifier priority, and a reference to a CID. If a packet matches the specified packet matching criteria, it is then delivered to the SAP for delivery on the connection defined by the CID. Implementation of each specific classification capability (as, for example, IPv4 based classification) is optional. The service flow characteristics of the connection provide the QoS for that packet.

Several classifiers may each refer to the same service flow. The classifier priority is used for ordering the application of classifiers to packets. Explicit ordering is necessary because the patterns used by classifiers may overlap. The priority need not be unique, but care shall be taken within a classifier priority to prevent ambiguity in classification. Downlink classifiers are applied by the BS to packets it is transmitting and uplink classifiers are applied at the SS. Figure 7 and Figure 8 illustrate the mappings discussed in the previous paragraph.

It is possible for a packet to fail to match the set of defined classifiers. In this case, the CS shall discard the packet.

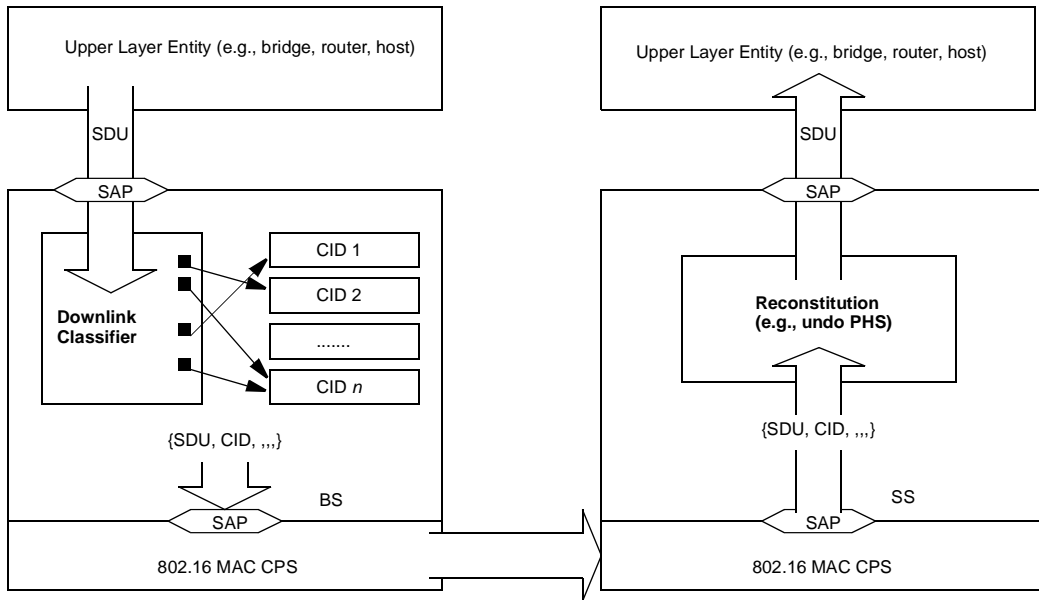

Figure 7—Classification and CID mapping (BS to SS)

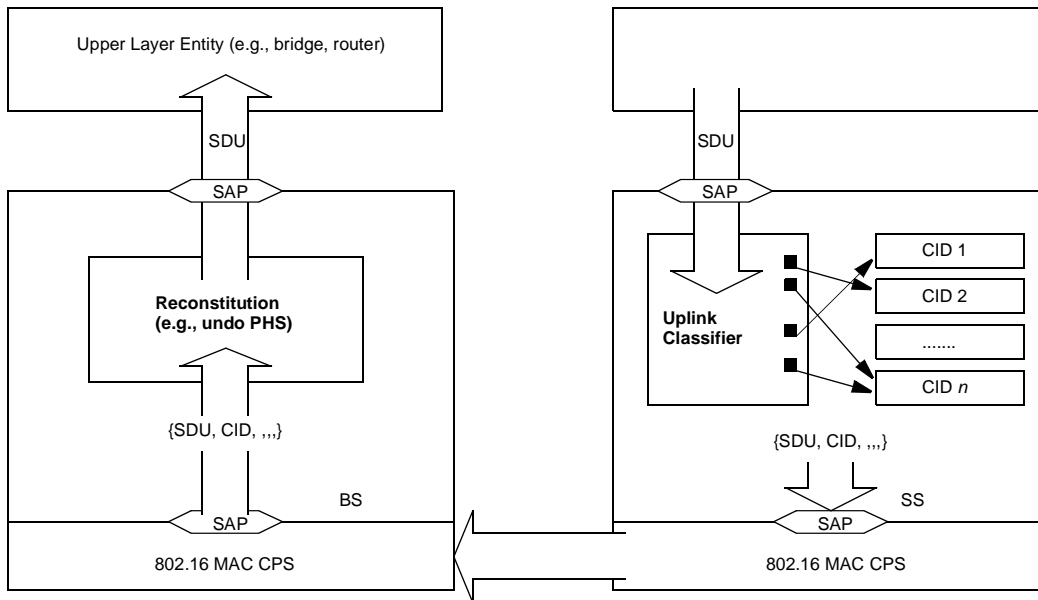

Figure 8—Classification and CID mapping (SS to BS)

5.2.3 PHS

In PHS, a repetitive portion of the payload headers of the higher layer is suppressed in the MAC SDU by the sending entity and restored by the receiving entity. Implementation of PHS capability is optional. On the uplink, the sending entity is the SS and the receiving entity is the BS. On the downlink, the sending entity is the BS and the receiving entity is the SS. If PHS is enabled at MAC connection, each MAC SDU is prefixed with a PHSI, which references the Payload Header Suppression Field (PHSF).

The sending entity uses classifiers to map packets into a service flow. The classifier uniquely maps packets to its associated PHS Rule. The receiving entity uses the CID and the PHSI to restore the PHSF. Once a PHSF has been assigned to a PHSI, it shall not be changed. To change the value of a PHSF on a service flow, a new PHS rule shall be defined, the old rule is removed from the service flow, and the new rule is added. When a classifier is deleted, any associated PHS rule shall also be deleted.

PHS has a Payload Header Suppression Valid (PHSV) option to verify or not verify the payload header before suppressing it. PHS has also a Payload Header Suppression Mask (PHSM) option to allow select bytes not to be suppressed. The PHSM facilitates suppression of header fields that remain static within a higher-layer session (e.g. IP addresses), while enabling transmission of fields that change from packet to packet (e.g. IP Total Length).

The BS shall assign all PHSI values just as it assigns all CID values. Either the sending or the receiving entity shall specify the PHSF and the Payload Header Suppression Size (PHSS). This provision allows for preconfigured headers or for higher level signaling protocols outside the scope of this standard to establish cache entries.

It is the responsibility of the higher-layer service entity to generate a PHS Rule that uniquely identifies the suppressed header within the service flow. It is also the responsibility of the higher-layer service entity to guarantee that the byte strings that are being suppressed are constant from packet to packet for the duration of the active service flow.

5.2.3.1 PHS operation

SS and BS implementations are free to implement PHS in any manner as long as the protocol specified in this subclause is followed. Figure 9 illustrates the following procedure.

A packet is submitted to the packet CS. The SS applies its list of Classifier rules. A match of the rule shall result in an Uplink Service Flow, CID, and a PHS Rule. The PHS Rule provides PHSF, PHSI, PHSM, PHSS, and PHSV. If PHSV is set or not present, the SS shall compare the bytes in the packet header with the bytes in the PHSF that are to be suppressed as indicated by the PHSM. If they match, the SS shall suppress all the bytes in the Uplink PHSF except the bytes masked by PHSM. The SS shall then prefix the PDU with the PHSI and present the entire MAC SDU to the MAC SAP for transport on the uplink.

When the MAC PDU is received by the BS from the air interface, the BS MAC layer shall determine the associated CID by examination of the generic MAC header. The BS MAC layer sends the PDU to the MAC SAP associated with that CID. The receiving packet CS uses the CID and the PHSI to look up PHSF, PHSM, and PHSS. The BS reassembles the packet and then proceeds with normal packet processing. The reassembled packet contains bytes from the PHSF. If verification was enabled, then the PHSF bytes equal the original header bytes. If verification was not enabled, then there is no guarantee that the PHSF bytes match the original header bytes.

A similar operation occurs on the downlink. The BS applies its list of Classifiers. A match of the Classifier shall result in a Downlink Service Flow and a PHS Rule. The PHS Rule provides PHSF, PHSI, PHSM, PHSS, and PHSV. If PHSV is set or not present, the BS shall verify the Downlink Suppression Field in the packet with the PHSF. If they match, the BS shall suppress all the bytes in the Downlink Suppression Field except the bytes masked by PHSM. The BS shall then prefix the PDU with the PHSI and present the entire MAC SDU to the MAC SAP for transport on the downlink.

The SS shall receive the packet based upon the CID Address filtering within the MAC. The SS receives the PDU and then sends it to the CS. The CS then uses the PHSI and CID to lookup PHSF, PHSM, and PHSS. The SS reassembles the packet and then proceeds with normal packet processing.

Figure 10 demonstrates packet suppression and restoration when using PHS masking. Masking allows only bytes that do not change to be suppressed. Note that the PHSF and PHSS span the entire suppression field, included suppressed and unsuppressed bytes.

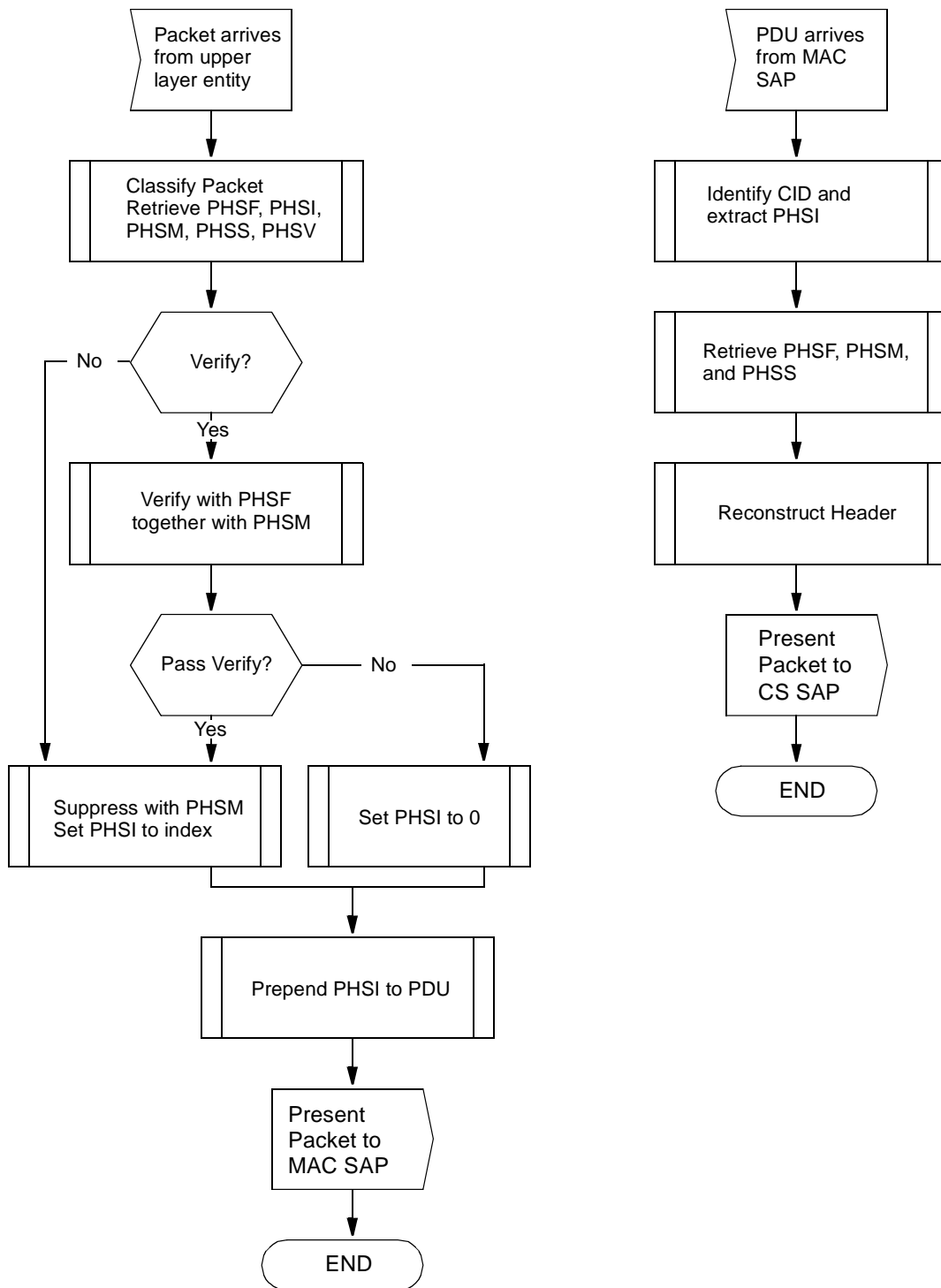

Figure 9—PHS operation

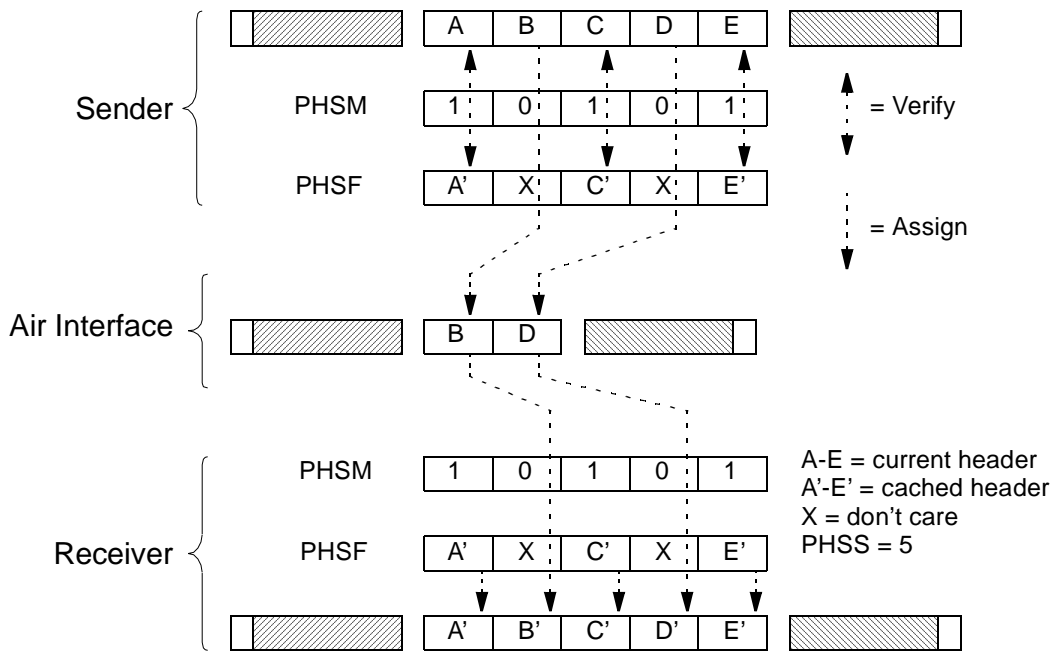

Figure 10—PHS with masking

5.2.3.2 PHS signaling

PHS requires the creation of the following three objects:

- Service flow
- Classifier
- PHS rule

These three objects may be created either simultaneously or in separate message flows.

PHS Rules are created with DSA or Dynamic Service Change (DSC) messages. The BS shall define the PHSI when the PHS Rule is created. PHS rules are deleted with the DSC or Dynamic Service Deletion (DSD) messages. The SS or BS may define the PHSS and PHSF. To change the value of a PHSF on a service flow, a new PHS rule shall be defined, the old rule is removed from the service flow, and the new rule is added.

Figure 11 shows the two ways to signal the creation of a PHS rule.

It is possible to partially specify a PHS rule (in particular the size of the rule) at the time a service flow is created. As an example, it is likely that when a service flow is first provisioned, the header fields to be suppressed will be known. The values of some of the fields [for example: IP addresses, User Datagram Protocol (UDP) port numbers, etc.] may be unknown and would be provided in a subsequent DSC as part of the activation of the service flow (using the “Set PHS Rule” DSC Action). If the PHS rule is being defined in more than one step, each step, whether it is a DSA or DSC message, shall contain both the SFID (or reference) and a PHS index to uniquely identify the PHS rule that is being defined.

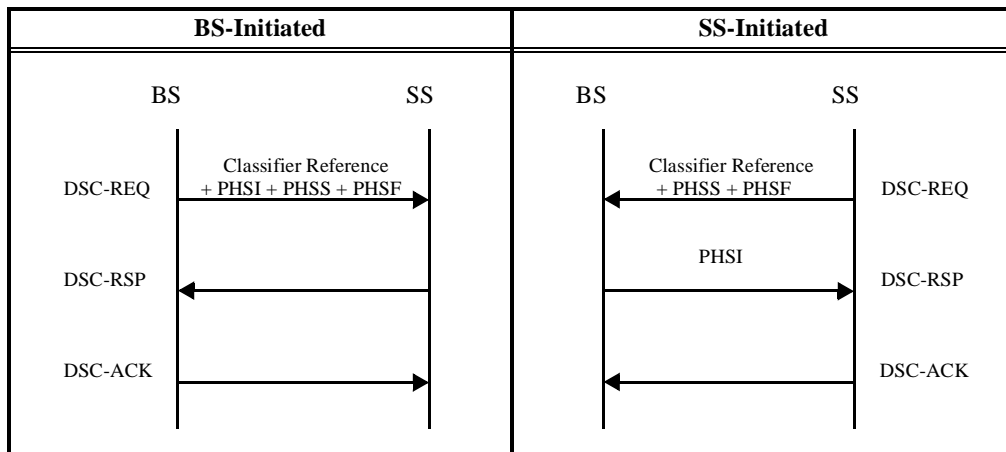

Figure 11—PHS signaling example

5.2.4 IEEE Std 802.3/Ethernet-specific part

5.2.4.1 IEEE Std 802.3/Ethernet CS PDU format

The IEEE Std 802.3/Ethernet PDUs are mapped to MAC SDUs according to Figure 12 (when header suppression is enabled at the connection, but not applied to the CS PDU) or Figure 13 (with header suppression).

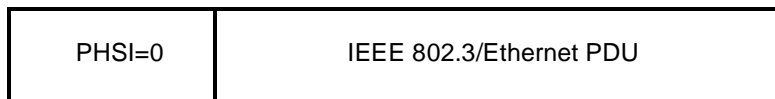

Figure 12—IEEE 802.3/Ethernet CS PDU format without header suppression

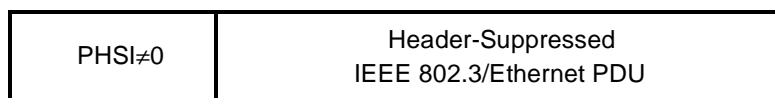

Figure 13—IEEE 802.3/Ethernet CS PDU format with header suppression

5.2.4.2 IEEE Std 802.3/Ethernet CS classifiers

The following parameters are relevant for IEEE Std 802.3/Ethernet CS classifiers:

Logical link control (LLC) classification parameters—zero or more of the LLC classification parameters (destination MAC address, source MAC address, Ethertype/SAP).

For IP over IEEE 802.3/Ethernet, IP headers may be included in classification. In this case, the IP classification parameters (11.13.19.3.4.2–11.13.19.3.4.7) are allowed.

5.2.5 IEEE Std 802.1Q-1998 virtual local area network (VLAN) specific part

This CS shall be employed when IEEE Std 802.1Q-1998 tagged VLAN frames are to be carried over the IEEE Std 802.16 network.

5.2.5.1 IEEE Std 802.1Q-1998 VLAN CS PDU format

The format of the IEEE Std 802.1Q-1998 VLAN CS PDU shall be as shown in Figure 14 (when header suppression is enabled at the connection, but not applied to the CS PDU) or Figure 15 (with header suppression).

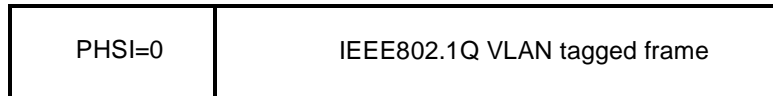

Figure 14—IEEE 802.1Q VLAN CS PDU format without header suppression

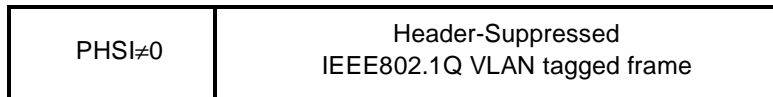

Figure 15—IEEE 802.1Q VLAN CS PDU format with header suppression

5.2.5.2 IEEE Std 802.1Q-1998 CS classifiers

The following parameters are relevant for IEEE Std 802.1Q-1998 CS classifiers:

LC classification parameters—zero or more of the LLC classification parameters (Destination MAC address, source MAC address, Ethertype/SAP).

IEEE Std 802.1D-1998 Parameters—zero or more of the IEEE classification parameters (IEEE Std 802.1D-1998 Priority Range, IEEE Std 802.1Q-1998 VLAN ID).

For IP over IEEE Std 802.1Q-1998 VLAN, IP headers may be included in classification. In this case, the IP classification parameters (11.13.19.3.4.2—11.13.19.3.4.7) are allowed.

5.2.6 IP specific part

This subclause applies when IP (IETF RFC 791, IETF RFC 2460) is carried over the IEEE Std 802.16 network.

5.2.6.1 IP CS PDU format

The format of the IP CS PDU shall be as shown in Figure 16 (when header suppression is enabled at the connection, but not applied to the CS PDU) or Figure 17 (with header suppression).



Figure 16—IP CS PDU format without header suppression

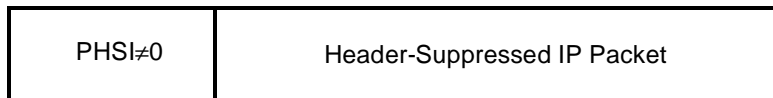

Figure 17—IP CS PDU format with header suppression

5.2.6.2 IP classifiers

IP classifiers operate on the fields of the IP header and the transport protocol. The parameters (11.13.19.3.4.2–11.13.19.3.4.7) may be used in IP classifiers.

6. MAC common part sublayer

A network that utilizes a shared medium shall provide an efficient sharing mechanism. Two-way PMP and Mesh topology wireless networks are examples for sharing wireless media. Here, the medium is the space through which the radio waves propagate.

Though the MAC specification invokes IP protocols, they are required only as a standard basis for element management rather than MAC operation, since, in all practicality, element management is necessary in this type of network.

6.1 PMP

The downlink, from the BS to the user, operates on a PMP basis. The IEEE Std 802.16 wireless link operates with a central BS and a sectorized antenna that is capable of handling multiple independent sectors simultaneously. Within a given frequency channel and antenna sector, all stations receive the same transmission, or parts thereof. The BS is the only transmitter operating in this direction, so it transmits without having to coordinate with other stations, except for the overall time division duplexing (TDD) that may divide time into uplink and downlink transmission periods. The downlink is generally broadcast. In cases where the DL-MAP does not explicitly indicate that a portion of the downlink subframe is for a specific SS, all SSs capable of listening to that portion of the downlink subframe shall listen. The SSs check the CIDs in the received PDUs and retain only those PDUs addressed to them.

Subscriber stations share the uplink to the BS on a demand basis. Depending on the class of service utilized, the SS may be issued continuing rights to transmit, or the right to transmit may be granted by the BS after receipt of a request from the user.

In addition to individually addressed messages, messages may also be sent on multicast connections (control messages and video distribution are examples of multicast applications) as well as broadcast to all stations.

Within each sector, users adhere to a transmission protocol that controls contention between users and enables the service to be tailored to the delay and bandwidth requirements of each user application. This is accomplished through four different types of uplink scheduling mechanisms. These are implemented using unsolicited bandwidth grants, polling, and contention procedures. Mechanisms are defined in the protocol to allow vendors to optimize system performance by using different combinations of these bandwidth allocation techniques while maintaining consistent interoperability definitions. For example, contention may be used to avoid the individual polling of SSs that have been inactive for a long period of time.

The use of polling simplifies the access operation and guarantees that applications receive service on a deterministic basis if it is required. In general, data applications are delay tolerant, but real-time applications like voice and video require service on a more uniform basis and sometimes on a very tightly-controlled schedule.

The MAC is connection-oriented. For the purposes of mapping to services on SSs and associating varying levels of QoS, all data communications are in the context of a connection. Service flows may be provisioned when an SS is installed in the system. Shortly after SS registration, connections are associated with these service flows (one connection per service flow) to provide a reference against which to request bandwidth. Additionally, new connections may be established when a customer's service needs change. A connection defines both the mapping between peer convergence processes that utilize the MAC and a service flow. The service flow defines the QoS parameters for the PDUs that are exchanged on the connection.

The concept of a service flow on a connection is central to the operation of the MAC protocol. Service flows provide a mechanism for uplink and downlink QoS management. In particular, they are integral to the bandwidth allocation process. An SS requests uplink bandwidth on a per connection basis (implicitly identifying the service flow). Bandwidth is granted by the BS to an SS as an aggregate of grants in response to per connection requests from the SS.

Connections, once established, may require active maintenance. The maintenance requirements vary depending upon the type of service connected. For example, unchannelized T1 services require virtually no connection maintenance since they have a constant bandwidth allocated every frame. Channelized T1 services require some maintenance due to the dynamic (but relatively slowly changing) bandwidth requirements if compressed, coupled with the requirement that full bandwidth be available on demand. IP services may require a substantial amount of ongoing maintenance due to their bursty nature and due to the high possibility of fragmentation. As with connection establishment, modifiable connections may require maintenance due to stimulus from either the SS or the network side of the connection.

Finally, connections may be terminated. This generally occurs only when a customer's service contract changes. The termination of a connection is stimulated by the BS or SS.

All three of these connection management functions are supported through the use of static configuration and dynamic addition, modification, and deletion of connections.

6.2 Mesh

The main difference between the PMP and optional Mesh modes is that in the PMP mode, traffic only occurs between the BS and SSs, while in the Mesh mode traffic can be routed through other SSs and can occur directly between SSs. Depending on the transmission protocol algorithm used, this can be done on the basis of equality using distributed scheduling, or on the basis of superiority of the Mesh BS, which effectively results in centralized scheduling, or on a combination of both.

Within a Mesh network, a system that has a direct connection to backhaul services outside the Mesh network, is termed a Mesh BS. All the other systems of a Mesh network are termed Mesh SS. In general, the systems of a Mesh network are termed nodes. Within Mesh context, uplink and downlink are defined as traffic in the direction of the Mesh BS and traffic away from the Mesh BS, respectively.

The other three important terms of Mesh systems are neighbor, neighborhood and extended neighborhood. The stations with which a node has direct links are called neighbors. Neighbors of a node shall form a neighborhood. A node's neighbors are considered to be "one hop" away from the node. An extended neighborhood contains, additionally, all the neighbors of the neighborhood.

In a Mesh system not even the Mesh BS can transmit without having to coordinate with other nodes. Using distributed scheduling, all the nodes including the Mesh BS shall coordinate their transmissions in their two-hop neighborhood and shall broadcast their schedules (available resources, requests and grants) to all their neighbors. Optionally the schedule may also be established by directed uncoordinated requests and grants between two nodes. Nodes shall ensure that the resulting transmissions do not cause collisions with the data and control traffic scheduled by any other node in the two-hop neighborhood. There is no difference in the mechanism used in determining the schedule for downlink and uplink.

Using centralized scheduling, resources are granted in a more centralized manner. The Mesh BS shall gather resource requests from all the Mesh SSs within a certain hop range. It shall determine the amount of granted resources for each link in the network both in downlink and uplink, and communicates these grants to all the Mesh SSs within the hop range. The grant messages do not contain the actual schedule, but each node shall compute it by using the predetermined algorithm with given parameters.

All the communications are in the context of a link, which is established between two nodes. One link shall be used for all the data transmissions between the two nodes. QoS is provisioned over links on a message-by-message basis. No service or QoS parameters are associated with a link, but each unicast message has service parameters in the header. Traffic classification and flow regulation are performed at the ingress node by upper-layer classification/regulation protocol. The service parameters associated with each message shall be communicated together with the message content via the MAC SAP.

Mesh systems typically use omnidirectional or 360° steerable antennas, but can also be co-located using sector antennas. At the edge of the coverage area of the Mesh network, where only a connection to a single point is needed, even highly directional antennas can be used.

6.3 Data/Control plane

6.3.1 Addressing and connections

6.3.1.1 PMP

Each SS shall have a 48-bit universal MAC address, as defined in IEEE Std 802[®]-2001. This address uniquely defines the SS from within the set of all possible vendors and equipment types. It is used during the initial ranging process to establish the appropriate connections for an SS. It is also used as part of the authentication process by which the BS and SS each verify the identity of the other.

Connections are identified by a 16-bit CID. At SS initialization, two pairs of management connections (uplink and downlink) shall be established between the SS and the BS and a third pair of management connections may be optionally generated. The three pairs of connections reflect the fact that there are inherently three different levels of QoS for management traffic between an SS and the BS. The basic connection is used by the BS MAC and SS MAC to exchange short, time-urgent MAC management messages. The primary management connection is used by the BS MAC and SS MAC to exchange longer, more delay-tolerant MAC management messages. Table 14 specifies which MAC Management messages are transferred on which of these two connections. Finally, the Secondary Management Connection is used by the BS and SS to transfer delay tolerant, standards-based [Dynamic Host Configuration Protocol (DHCP), Trivial File Transfer Protocol (TFTP), SNMP, etc.] messages. These messages are carried in IP datagrams, as specified in 5.2.6. Messages carried on the Secondary Management Connection may be packed and/or fragmented. For the SCA, OFDM, and OFDMA PHY layers, management messages shall have CRC. Use of the secondary management connection is required only for managed SS.

The CIDs for these connections shall be assigned in the RNG-RSP and REG-RSP messages. The message dialogs provide three CID values. The same CID value is assigned to both members (uplink and downlink) of each connection pair.

For bearer services, the BS initiates the set-up of connections based upon the provisioning information distributed to the BS. The registration of an SS, or the modification of the services contracted at an SS, stimulates the higher layers of the BS to initiate the setup of the connections.

The CID can be considered a connection identifier even for nominally connectionless traffic like IP, since it serves as a pointer to destination and context information. The use of a 16-bit CID permits a total of 64K connections within each downlink and uplink channel.

Requests for transmission are based on these CIDs, since the allowable bandwidth may differ for different connections, even within the same service type. For example, an SS unit serving multiple tenants in an office building would make requests on behalf of all of them, though the contractual service limits and other connection parameters may be different for each of them.

Many higher-layer sessions may operate over the same wireless CID. For example, many users within a company may be communicating with Transmission Control Protocol (TCP)/IP to different destinations, but since they all operate within the same overall service parameters, all of their traffic is pooled for request/grant purposes. Since the original local area network (LAN) source and destination addresses are encapsulated in the payload portion of the transmission, there is no problem in identifying different user sessions.

The type of service and other current parameters of a service are implicit in the CID; they may be accessed by a lookup indexed by the CID.

6.3.1.2 Mesh

Each node shall have a 48-bit universal MAC address, as defined in IEEE Std 802-2001. The address uniquely defines the node from within the set of all possible vendors and equipment types. This address is used during the network entry process and as part of the authorization process by which the candidate node and the network verify the identity of each other.

When authorized to the network the candidate node shall receive a 16-bit node identifier (Node ID) upon a request to the Mesh BS. Node ID is the basis for identifying nodes during normal operation. The Node ID is transferred in the Mesh subheader, which follows the generic MAC header, in both unicast and broadcast messages.

For addressing nodes in the local neighborhood, 8-bit link identifiers (Link IDs) shall be used. Each node shall assign an ID for each link it has established to its neighbors. The Link IDs are communicated during the Link Establishment process as neighboring nodes establish new links. The Link ID is transmitted as part of the CID in the generic MAC header in unicast messages. The Link IDs shall be used in distributed scheduling to identify resource requests and grants. Since these messages are broadcast, the receiver nodes can determine the schedule using the transmitter's Node ID in the Mesh subheader, and the Link ID in the payload of the MSH-DSCH (Mesh Mode Schedule with Distributed Scheduling) message.

The Connection ID in Mesh mode is specified as shown in Table 3 to convey broadcast/unicast, service parameters, and the link identification.

Table 3—Mesh CID construction

Syntax	Size	Notes
CID {		
if (Xmt Link ID == 0xFF) {		
Logical Network ID	8 bits	0x00: All-net Broadcast
} else {		
Type	2 bits	0x0: MAC Management 0x1: IP 0x2-0x3: <i>Reserved</i>
Reliability	1 bit	0x0: No retransmissions 0x1: Up to 4 retransmissions
Priority/Class	3 bits	
Drop Precedence	2 bits	
}		
Xmt Link ID	8 bits	0xFF: MAC management broadcast
}		

Priority/Class

Priority field indicates message class.

Drop Precedence

Messages with larger Drop Precedence shall have higher dropping likelihood during congestion.

Xmt Link ID

The Link ID is assigned by the transmitter node to the link to the receiver node.

6.3.2 MAC PDU formats

MAC PDUs shall be of the form illustrated in Figure 18. Each PDU shall begin with a fixed-length generic MAC header. The header may be followed by the Payload of the MAC PDU. If present, the Payload shall consist of zero or more subheaders and zero or more MAC SDUs and/or fragments thereof. The payload information may vary in length, so that a MAC PDU may represent a variable number of bytes. This allows the MAC to tunnel various higher-layer traffic types without knowledge of the formats or bit patterns of those messages.

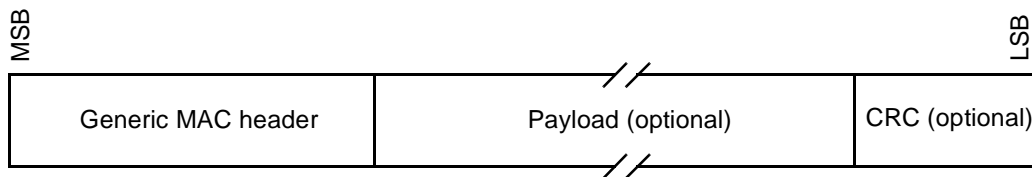

Figure 18—MAC PDU formats

A MAC PDU may contain a CRC, as described in 6.3.3.5. Implementation of CRC capability is mandatory for SCa, OFDM and OFDMA PHY layers.

6.3.2.1 MAC header formats

Two MAC header formats are defined. The first is the generic MAC header that begins each MAC PDU containing either MAC management messages or CS data. The second is the bandwidth request header used to request additional bandwidth. The single-bit Header Type (HT) field distinguishes the generic MAC header and bandwidth request header formats. The HT field shall be set to zero for the Generic Header and to one for a bandwidth request header.

The MAC header formats are defined in Table 4.

Table 4—MAC header format

Syntax	Size	Notes
MAC Header() {		
HT	1 bit	0 = Generic MAC header 1 = Bandwidth request header
EC	1 bit	If HT = 1, EC = 0
if (HT == 0) {		
Type	6 bits	
<i>reserved</i>	1 bit	Shall be set to zero
CI	1 bit	

Table 4—MAC header format (continued)

Syntax	Size	Notes
EKS	2 bits	
<i>reserved</i>	1 bit	Shall be set to zero
LEN	11 bits	
}		
else {		
Type	3 bits	
BR	19 bits	
}		
CID	16 bits	
HCS	8 bits	
}		

6.3.2.1.1 Generic MAC header

The generic MAC header is illustrated in Figure 19.

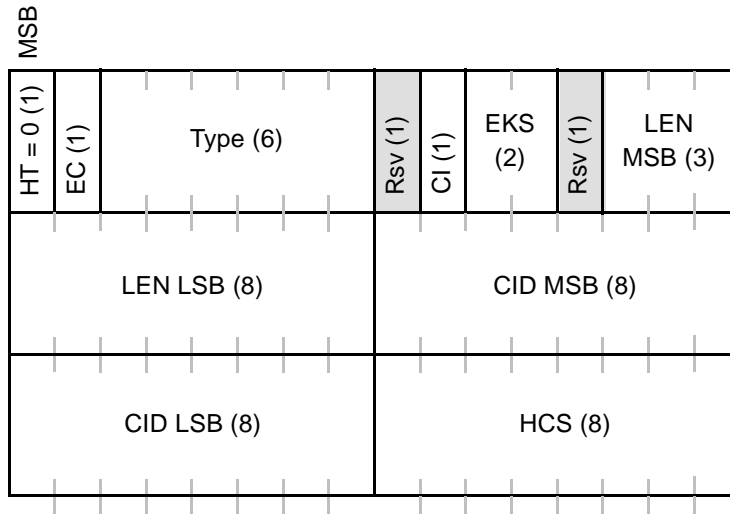

Figure 19—Generic MAC header format

The fields of the generic MAC header are defined in Table 5. Every header is encoded, starting with the HT and encryption control (EC) fields. The coding of these fields is such that the first byte of a MAC header shall never have the value of 0xFF, where “X” means “don’t care.” This prevents false detection on the stuff byte used in the Transmission Convergence sublayer.

Table 5—Generic MAC header fields

Name	Length (bits)	Description
CI	1	CRC Indicator 1 = CRC is included in the PDU by appending it to the PDU Payload after encryption, if any 0 = No CRC is included
CID	16	Connection identifier
EC	1	Encryption Control 0 = Payload is not encrypted 1 = Payload is encrypted
EKS	2	Encryption Key Sequence The index of the Traffic Encryption Key (TEK) and Initialization Vector used to encrypt the payload. This field is only meaningful if the EC field is set to 1.
HCS	8	Header Check Sequence An 8-bit field used to detect errors in the header. The transmitter shall calculate the HCS value for the first five bytes of the cell header, and insert the result into the HCS field (the last byte of the MAC header). It shall be the remainder of the division (Modulo 2) by the generator polynomial $g(D = D^8 + D^2 + D + 1)$ of the polynomial D^8 multiplied by the content of the header excluding the HCS field. (Example: [HT EC Type]=0x80, BR=0xAAAA, CID=0x0F0F; HCS should then be set to 0xD5).
HT	1	Header Type. Shall be set to zero.
LEN	11	Length. The length in bytes of the MAC PDU including the MAC header and the CRC if present.
Type	6	This field indicates the subheaders and special payload types present in the message payload.

The definition of the Type field is indicated in Table 6.

Table 6—Type encodings

Type bit	Value
#5 most significant bit (MSB)	Mesh subheader 1 = present, 0 = absent
#4	ARQ Feedback Payload 1 = present, 0 = absent
#3	Extended Type Indicates whether the present Packing or Fragmentation Subheaders, is Extended 1 = Extended 0 = not Extended. Applicable to connections where ARQ is not enabled
#2	Fragmentation subheader 1 = present, 0 = absent
#1	Packing subheader 1 = present, 0 = absent
#0 least significant bit (LSB)	Downlink: FAST-FEEDBACK Allocation subheader Uplink: Grant Management subheader 1 = present, 0 = absent

6.3.2.1.2 Bandwidth request header

The Bandwidth Request PDU shall consist of bandwidth request header alone and shall not contain a payload. The bandwidth request header is illustrated in Figure 20.

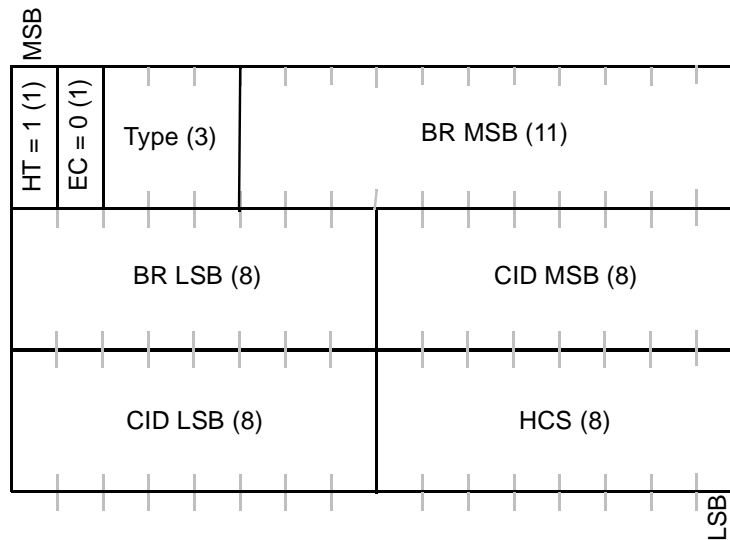

Figure 20—Bandwidth request header format

The Bandwidth Request shall have the following properties:

- The length of the header shall always be 6 bytes.
- The EC field shall be set to 0, indicating no encryption.
- The CID shall indicate the connection for which uplink bandwidth is requested.
- The Bandwidth Request (BR) field shall indicate the number of bytes requested.
- The allowed types for bandwidth requests are “000” for incremental and “001” for aggregate.

An SS receiving a bandwidth request header on the downlink shall discard the PDU.

The fields of the bandwidth request header are defined in Table 7. Every header is encoded, starting with the HT and EC fields. The coding of these fields is such that the first byte of a MAC header shall never have the value of 0xFF. This prevents false detection of the stuff byte.

Table 7—Bandwidth request header fields

Name	Length (bits)	Description
BR	19	Bandwidth Request The number of bytes of uplink bandwidth requested by the SS. The bandwidth request is for the CID. The request shall not include any PHY overhead.
CID	16	Connection identifier
EC	1	Always set to zero
HCS	8	Header Check Sequence Same usage as HCS entry in Table 5
HT	1	Header Type = 1
Type	3	Indicates the type of bandwidth request header

6.3.2.2 MAC subheaders and special payloads

Five types of subheaders may be present. The per-PDU subheaders (i.e., Mesh, Fragmentation, FAST-FEEDBACK_Allocation, and Grant Management) may be inserted in MAC PDUs immediately following the Generic MAC header. If both the Fragmentation subheader and Grant Management subheader are indicated, the Grant Management subheader shall come first. If the Mesh subheader is indicated, it shall precede all other subheaders. The FAST-FEEDBACK Allocation subheader shall always appear as the last per-PDU subheader.

The only per-SDU subheader is the Packing subheader. It may be inserted before each MAC SDU if so indicated by the Type field. The Packing and Fragmentation subheaders are mutually exclusive and shall not both be present within the same MAC PDU.

When present, per-PDU subheaders shall always precede the first per-SDU subheader.

6.3.2.2.1 Fragmentation subheader

The Fragmentation subheader is shown in Table 8.

Table 8—Fragmentation subheader format

Syntax	Size	Notes
Fragmentation Subheader() {		
FC	2 bits	Indicates the fragmentation state of the payload: 00 = no fragmentation 01 = last fragment 10 = first fragment 11 = continuing (middle) fragment
if (ARQ-enabled Connection)		
BSN	11 bits	Sequence number of first block in the current SDU fragment.
else {		
if (Type bit Extended Type)		See Table 6
FSN	11 bits	Sequence number of the current SDU fragment. This field increments by one (modulo 2048) for each fragment, including unfragmented SDUs.
else		
FSN	3 bits	Sequence number of the current SDU fragment. This field increments by one (modulo 8) for each fragment, including unfragmented SDUs.
}		
<i>reserved</i>	3 bits	Shall be set to zero
}		

6.3.2.2.2 Grant Management subheader

The Grant Management subheader is two bytes in length and is used by the SS to convey bandwidth management needs to the BS. This subheader is encoded differently based upon the type of uplink scheduling service for the connection (as given by the CID). The use of this subheader is defined in 6.3.6. The Grant Management subheader is shown in Table 9. Its fields are defined in Table 10. The capability of Grant Management subheader at both BS and SS is optional.

Table 9—Grant Management subheader format

Syntax	Size	Notes
Grant Management Subheader() {		
if (scheduling service type == UGS) {		
SI	1 bit	
PM	1 bit	
<i>reserved</i>	14 bits	Shall be set to zero
}		
else {		
PiggyBack Request	16 bits	
}		
}		

Table 10—Grant Management subheader fields

Name	Length (bits)	Description
PBR	16	PiggyBack Request The number of bytes of uplink bandwidth requested by the SS. The bandwidth request is for the CID. The request shall not include any PHY overhead. The request shall be incremental.
PM	1	Poll-Me 0 = No action 1 = Used by the SS to request a bandwidth poll.
SI	1	Slip Indicator 0 = No action 1 = Used by the SS to indicate a slip of uplink grants relative to the uplink queue depth.

6.3.2.2.3 Packing subheader

When Packing (see 6.3.3.4) is used, the MAC may pack multiple SDUs into a single MAC PDU. When packing variable-length MAC SDUs, the MAC precedes each one with a Packing subheader. The Packing subheader is defined in Table 11.

Table 11—Packing subheader format

Syntax	Size	Notes
Packing Subheader() {		
FC	2 bits	Indicates the fragmentation state of the payload: 00 = no fragmentation 01 = last fragment 10 = first fragment 11 = continuing (middle) fragment
if (ARQ-enabled Connection)		
BSN	11 bits	Sequence number of first block in the current SDU fragment.
else {		
if (Type bit Extended Type)		See Table 6.
FSN	11 bits	Sequence number of the current SDU fragment. This field increments by one (modulo 2048) for each fragment, including unfragmented SDUs.
else		
FSN	3 bits	Sequence number of the current SDU fragment. This field increments by one (modulo 8) for each fragment, including unfragmented SDUs.
}		
Length	11 bits	
}		

6.3.2.2.4 ARQ feedback

If the ARQ Feedback Payload bit in the MAC Type field (see Table 6) is set, the ARQ Feedback Payload shall be transported. If packing is used, it shall be transported as the first packed payload. See 6.3.3.4.3.

6.3.2.2.5 Mesh subheader

The Mesh subheader is specified in Table 12. When using Mesh mode, the Mesh subheader always follows the generic MAC header as specified in 6.3.2.2.

Table 12—Mesh subheader format

Syntax	Size	Notes
Mesh Subheader {		
Xmt Node Id	16 bits	
}		

6.3.2.2.6 FAST-FEEDBACK allocation subheader

The format of the FAST-FEEDBACK allocation subheader is specified in Table 13. The FAST-FEEDBACK allocation subheader, when used, shall always be the last per-PDU subheader as specified in 6.3.2.2. The support of the FAST-FEEDBACK allocation subheader is PHY specification specific.

Table 13—FAST-FEEDBACK allocation subheader format

Syntax	Size	Notes
FAST-FEEDBACK allocation Subheader {		
Allocation offset	6 bits	
Feedback type	2 bits	00 – Fast DL measurement 01 – Fast MIMO feedback, antenna #0 10 – Fast MIMO feedback, antenna #1 11 – MIMO mode and permutation mode feedback
}		

Allocation offset

Defines the offset, in units of slots, from the beginning of the FAST-FEEDBACK uplink bandwidth allocation (8.4.5.4.9), of the slot in which the SS servicing the CID appearing in the MAC generic header, must send an FAST-FEEDBACK feedback message for the connection associated with the CID value. Range of values 0 to 63. The allocation applies to the UL subframe of the next frame.

6.3.2.3 MAC Management messages

A set of MAC Management messages are defined. These messages shall be carried in the Payload of the MAC PDU. All MAC Management messages begin with a Management Message Type field and may contain additional fields. MAC Management messages on the Basic, Broadcast, and Initial Ranging connections shall neither be fragmented nor packed. MAC Management messages on the Primary Management Connection may be packed and/or fragmented. For the SCa, OFDM, and OFDMA PHY layers, management messages carried on the Initial Ranging, Broadcast, Basic, and Primary Management connections shall have CRC usage enabled. The format of the Management message is given in Figure 21. The encoding of the Management Message Type field is given in Table 14. MAC management messages

shall not be carried on Transport Connections. MAC management messages that have a Type value specified in Table 14 as “*reserved*,” or those not containing all required parameters or containing erroneously encoded parameters, shall be silently discarded.

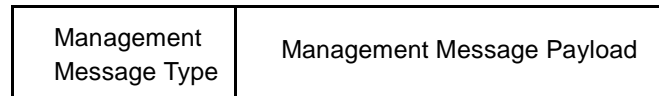

Figure 21—MAC Management message format

Table 14—MAC Management messages

Type	Message name	Message description	Connection
0	UCD	Uplink Channel Descriptor	Broadcast
1	DCD	Downlink Channel Descriptor	Broadcast
2	DL-MAP	Downlink Access Definition	Broadcast
3	UL-MAP	Uplink Access Definition	Broadcast
4	RNG-REQ	Ranging Request	Initial Ranging or Basic
5	RNG-RSP	Ranging Response	Initial Ranging or Basic
6	REG-REQ	Registration Request	Primary Management
7	REG-RSP	Registration Response	Primary Management
8		<i>reserved</i>	
9	PKM-REQ	Privacy Key Management Request	Primary Management
10	PKM-RSP	Privacy Key Management Response	Primary Management
11	DSA-REQ	Dynamic Service Addition Request	Primary Management
12	DSA-RSP	Dynamic Service Addition Response	Primary Management
13	DSA-ACK	Dynamic Service Addition Acknowledge	Primary Management
14	DSC-REQ	Dynamic Service Change Request	Primary Management
15	DSC-RSP	Dynamic Service Change Response	Primary Management
16	DSC-ACK	Dynamic Service Change Acknowledge	Primary Management
17	DSD-REQ	Dynamic Service Deletion Request	Primary Management
18	DSD-RSP	Dynamic Service Deletion Response	Primary Management
19		<i>reserved</i>	
20		<i>reserved</i>	
21	MCA-REQ	Multicast Assignment Request	Primary Management
22	MCA-RSP	Multicast Assignment Response	Primary Management
23	DBPC-REQ	Downlink Burst Profile Change Request	Basic
24	DBPC-RSP	Downlink Burst Profile Change Response	Basic
25	RES-CMD	Reset Command	Basic

Table 14—MAC Management messages (continued)

Type	Message name	Message description	Connection
26	SBC-REQ	SS Basic Capability Request	Basic
27	SBC-RSP	SS Basic Capability Response	Basic
28	CLK-CMP	SS network clock comparison	Broadcast
29	DREG-CMD	De/Re-register Command	Basic
30	DSX-RVD	DSx Received Message	Primary Management
31	TFTP-CPLT	Config File TFTP Complete Message	Primary Management
32	TFTP-RSP	Config File TFTP Complete Response	Primary Management
33	ARQ-Feedback	Standalone ARQ Feedback	Basic
34	ARQ-Discard	ARQ Discard message	Basic
35	ARQ-Reset	ARQ Reset message	Basic
36	REP-REQ	Channel measurement Report Request	Basic
37	REP-RSP	Channel measurement Report Response	Basic
38	FPC	Fast Power Control	Broadcast
39	MSH-NCFG	Mesh Network Configuration	Broadcast
40	MSH-NENT	Mesh Network Entry	Basic
41	MSH-DSCH	Mesh Distributed Schedule	Broadcast
42	MSH-CSCH	Mesh Centralized Schedule	Broadcast
43	MSH-CSCF	Mesh Centralized Schedule Configuration	Broadcast
44	AAS-FBCK-REQ	AAS Feedback Request	Basic
45	AAS-FBCK-RSP	AAS Feedback Response	Basic
46	AAS_Beam_Select	AAS Beam Select message	Basic
47	AAS_BEAM_REQ	AAS Beam Request message	Basic
48	AAS_BEAM_RSP	AAS Beam Response message	Basic
49	DREG-REQ	SS De-registration message	Basic
50–255		<i>reserved</i>	

During the adaptive antenna system (AAS) portion of the frame, DL-MAP, UL-MAP, DCD, UCD, and CLK-CMP messages may be sent using the basic CID.

6.3.2.3.1 Downlink Channel Descriptor (DCD) message

A DCD shall be transmitted by the BS at a periodic interval (Table 342) to define the characteristics of a downlink physical channel.

Table 15—DCD message format

Syntax	Size	Notes
DCD_Message_Format() {		
Management Message Type = 1	8 bits	
Downlink channel ID	8 bits	
Configuration Change Count	8 bits	
TLV Encoded information for the overall channel	<i>variable</i>	TLV specific
Begin PHY Specific Section {		See applicable PHY section
for ($i = 1; i \leq n; i++$) {		For each downlink burst profile 1 to n
Downlink_Burst_Profile		PHY specific
}		
}		
}		

A BS shall generate DCDs in the format shown in Table 15, including all of the following parameters:

Configuration Change Count

Incremented by one (modulo 256) by the BS whenever any of the values of this channel descriptor change. If the value of this count in a subsequent DCD remains the same, the SS can quickly decide that the remaining fields have not changed and may be able to disregard the remainder of the message.

Downlink Channel ID

The identifier of the downlink channel to which this message refers. This identifier is arbitrarily chosen by the BS and is unique only within the MAC domain. This acts as a local identifier for transactions such as ranging.

The following WirelessMAN-OFDM PHY-specific parameter shall be included in the DCD message:

Frame Duration Code Frame Number

The message parameters following the Configuration Change Count shall be encoded in a TLV form (see 11.4). All channel encodings (see 11.4.1) shall appear first before the Downlink_Burst_Profile encodings.

The Downlink_Burst_Profile is a compound TLV encoding that defines, and associates with a particular Downlink Interval Usage Code (DIUC), the PHY characteristics that shall be used with that DIUC. Within each Downlink_Burst_Profile shall be an unordered list of PHY attributes, encoded as TLV values (see 11.4.2). Each interval is assigned a DIUC by the DL-MAP message. A Downlink_Burst_Profile shall be included for each DIUC to be used in the DL-MAP unless the PHY's Downlink_Burst_Profile is explicitly known.

Downlink_Burst_Profile contents are defined separately for each PHY specification in Clause 8.

6.3.2.3.2 Downlink map (DL-MAP) message

The DL-MAP message defines the access to the downlink information. If the length of the DL-MAP message is a non-integral number of bytes, the LEN field in the MAC header is rounded up to the next integral number of bytes. The message shall be padded to match this length, but the SS shall disregard the four pad bits.

A BS shall generate DL-MAP messages in the format shown in Table 16, including all of the following parameters:

PHY Synchronization

The PHY synchronization field is dependent on the PHY specification used. The encoding of this field is given in each PHY specification separately.

DCD Count

Matches the value of the configuration change count of the DCD, which describes the downlink burst profiles that apply to this map.

Base Station ID

The Base Station ID is a 48-bit long field identifying the BS. The Base Station ID shall be programmable. The most significant 24 bits shall be used as the operator ID. This is a network management hook that can be combined with the Downlink Channel ID of the DCD message for handling edge-of-sector and edge-of-cell situations.

The encoding of the remaining portions of the DL-MAP message is PHY-specification dependent and may be absent. Refer to the appropriate PHY specification.

Table 16—DL-MAP message format

Syntax	Size	Notes
DL-MAP_Message_Format() {		
Management Message Type = 2	8 bits	
PHY Synchronization Field	<i>variable</i>	See appropriate PHY specification.
DCD Count	8 bits	
Base Station ID	48 bits	
Begin PHY Specific Section {		See applicable PHY section.
for ($i = 1; i \leq n; i++$) {		For each DL-MAP element 1 to n .
DL-MAP_IE()	<i>variable</i>	See corresponding PHY specification.
}		
}		
if !(byte boundary) {		
Padding Nibble	4 bits	Padding to reach byte boundary.
}		
}		

6.3.2.3.3 Uplink Channel Descriptor (UCD) message

A UCD shall be transmitted by the BS at a periodic interval (Table 342) to define the characteristics of an uplink physical channel.

A BS shall generate UCDs in the format shown in Table 17, including all of the following parameters:

Configuration Change Count

Incremented by one (modulo 256) by the BS whenever any of the values of this channel descriptor change. If the value of this count in a subsequent UCD remains the same, the SS can quickly decide that the remaining fields have not changed and may be able to disregard the remainder of the message. This value is also referenced from the UL-MAP messages.

Ranging Backoff Start

Initial backoff window size for initial ranging contention, expressed as a power of 2. Values of n range 0–15 (the highest order bits shall be unused and set to 0).

Ranging Backoff End

Final backoff window size for initial ranging contention, expressed as a power of 2. Values of n range 0–15 (the highest order bits shall be unused and set to 0).

Request Backoff Start

Initial backoff window size for contention BW requests, expressed as a power of 2. Values of n range 0–15 (the highest order bits shall be unused and set to 0).

Request Backoff End

Final backoff window size for contention BW requests, expressed as a power of 2. Values of n range 0–15 (the highest order bits shall be unused and set to 0).

Table 17—UCD message format

Syntax	Size	Notes
UCD_Message_Format() {		
Management Message Type = 0	8 bits	
Configuration Change Count	8 bits	
Ranging Backoff Start	8 bits	
Ranging Backoff End	8 bits	
Request Backoff Start	8 bits	
Request Backoff End	8 bits	
TLV Encoded information for the overall channel	<i>variable</i>	TLV specific.
Begin PHY Specific Section {		See applicable PHY section.
for ($i = 1; i \leq n; i++$) {		For each uplink burst profile 1 to n .
Uplink_Burst_Profile	<i>variable</i>	PHY specific.
}		
}		
}		

To provide for flexibility, the remaining message parameters shall be encoded in a TLV form (see 11.3). All Channel encodings (see 11.3.1) shall appear first before the Uplink_Burst_Profile encodings.

The Uplink_Burst_Profile is a compound TLV encoding that defines, and associates with a particular UIUC, the PHY characteristics that shall be used with that UIUC. Within each Uplink_Burst_Profile shall be an unordered list of PHY attributes, encoded as TLV values (see 11.3.1.1 for an example applicable to the 10–66 GHz PHY specification). Each interval is assigned a UIUC by the UL-MAP message. An Uplink_Burst_Profile shall be included for each UIUC to be used in the UL-MAP.

Uplink_Burst_Profile contents are defined separately for each PHY specification in Clause 8.

6.3.2.3.4 Uplink map (UL-MAP) message

The UL-MAP message allocates access to the uplink channel. The UL-MAP message shall be as shown in Table 18.

Table 18—UL-MAP message format

Syntax	Size	Notes
UL-MAP_Message_Format() {		
Management Message Type = 3	8 bits	
Uplink Channel ID	8 bits	
UCD Count	8 bits	
Allocation Start Time	32 bits	
Begin PHY Specific Section {		See applicable PHY section.
for ($i = 1; i \leq n; i++$) {		For each UL-MAP element 1 to n .
UL-MAP_IE()	<i>variable</i>	See corresponding PHY specification.
}		
}		
if !(byte boundary) {		
Padding Nibble	4 bits	Padding to reach byte boundary.
}		
}		

The BS shall generate the UL-MAP with the following parameters:

Uplink Channel ID

The identifier of the uplink channel to which this message refers.

UCD Count

Matches the value of the Configuration Change Count of the UCD, which describes the uplink burst profiles that apply to this map.

Allocation Start Time

Effective start time of the uplink allocation defined by the UL-MAP (units are PHY-specific, see 10.3).

Map IEs

The contents of a UL-MAP IE is PHY-specification dependent.

IEs define uplink bandwidth allocations. Each UL-MAP message shall contain at least one IE that marks the end of the last allocated burst. Ordering of IEs carried by the UL-MAP is PHY-specific.

The CID represents the assignment of the IE to either a unicast, multicast, or broadcast address. When specifically addressed to allocate a bandwidth grant, the CID shall be the Basic CID of the SS. A UIUC shall be used to define the type of uplink access and the uplink burst profile associated with that access. An Uplink_Burst_Profile shall be included in the UCD for each UIUC to be used in the UL-MAP.

6.3.2.3.5 Ranging request (RNG-REQ) message

An RNG-REQ shall be transmitted by the SS at initialization and periodically to determine network delay and to request power and/or downlink burst profile change. The format of the RNG-REQ message is shown in Table 19. The RNG-REQ message may be sent in Initial Ranging and data grant intervals.

Table 19—RNG-REQ message format

Syntax	Size	Notes
RNG-REQ_Message_Format() {		
Management Message Type = 4	8 bits	
Downlink Channel ID	8 bits	
TLV Encoded Information	<i>variable</i>	TLV specific
}		

The CID field in the MAC header shall assume the following values when sent in an Initial Ranging interval:

- Initial ranging CID if the SS is attempting to join the network.
- Initial ranging CID if the SS has not yet registered and is changing downlink (or both downlink and uplink) channels.
- In all other cases, the Basic CID is used as soon as one is assigned in the RNG-RSP message.

If sent in a data grant interval, the CID is always equal to the Basic CID.

An SS shall generate RNG-REQ messages in the format shown in Table 19, including the following parameter:

Downlink Channel ID

The identifier of the downlink channel on which the SS received the UCD describing the uplink on which this ranging request message is to be transmitted. This is an 8-bit field.

All other parameters are coded as TLV tuples as defined in 11.5.

The following parameters shall be included in the RNG-REQ message when the SS is attempting to join the network:

Requested Downlink Burst Profile
SS MAC Address

The following parameters shall be included in the RNG-REQ message when transmitted during initial ranging on the SS's Basic connection:

MAC Version (11.1.3)

The following parameters may be included in the RNG-REQ message after the SS has received an RNG-RSP addressed to the SS:

Requested Downlink Burst Profile
Ranging Anomalies

The following parameter may be included in the RNG-REQ message:

AAS broadcast capability

6.3.2.3.6 Ranging response (RNG-RSP) message

An RNG-RSP shall be transmitted by the BS in response to a received RNG-REQ. In addition, it may also be transmitted asynchronously to send corrections based on measurements that have been made on other received data or MAC messages. As a result, the SS shall be prepared to receive an RNG-RSP at any time, not just following an RNG-REQ transmission.

To provide for flexibility, the message parameters following the Uplink Channel ID shall be encoded in a TLV form.

A BS shall generate RNG-RSPs in the form shown in Table 20, including all of the following parameters:

Uplink Channel ID

The identifier of the uplink channel on which the BS received the RNG-REQ to which this response refers. This is an 8-bit quantity.

All other parameters are coded as TLV tuples, as defined in 11.6.

Table 20—RNG-RSP message format

Syntax	Size	Notes
RNG-RSP_Message_Format() {		
Management Message Type = 5	8 bits	
Uplink Channel ID	8 bits	
TLV Encoded Information	<i>variable</i>	TLV specific
}		

The following parameters shall be included in the RNG-RSP message:

Ranging Status

The following parameters may be included in the RNG-RSP message:

Timing Adjust Information

If this field is not included, no adjustment shall be made

Power Adjust Information

If this field is not included, no adjustment shall be made

Downlink Frequency Override

Uplink Channel ID Override

Downlink Operational Burst Profile

Basic CID

A required parameter if the RNG-RSP message is being sent on the Initial Ranging CID in response to a RNG-REQ message that was sent on the Initial Ranging CID.

Primary Management CID

A required parameter if the RNG-RSP message is being sent on the Initial Ranging CID in response to a RNG-REQ message that was sent on the Initial Ranging CID.

SS MAC Address (48-bit)

A required parameter when the CID in the MAC header is the Initial Ranging CID.

Frequency Adjust Information

AAS broadcast permission

The following WirelessMAN-SCa or WirelessMAN-OFDM PHY-specific parameters may also be included in the RNG-RSP message:

Frame Number

Frame number in which the corresponding RNG-REQ message or subchannelized initial ranging indication (for OFDM) was received. When Frame Number is included, SS MAC Address shall not appear in the same message.

Initial Ranging Opportunity Number

Initial Ranging opportunity within the frame in which the corresponding RNG-REQ message or subchannelized initial ranging indication (for OFDM) was received. If not provided, and Frame Number is included in the message, Initial Ranging Opportunity is assumed to be one.

The following WirelessMAN-OFDM PHY-specific parameter may also be included in the RNG-RSP message:

Ranging Subchannel

The OFDM ranging subchannel index that was used to transmit the initial ranging message.

The following WirelessMAN-OFDMA PHY specific parameters shall be included in the RNG-RSP message when an initial ranging message based on code division multiple access (CDMA) is received, in which case the RNG-RSP shall use the initial ranging CID.

Ranging code attributes

Indicates the OFDMA time symbols reference, subchannel reference, and frame number used to transmit the ranging code, and the ranging code index that was sent by the SS.

6.3.2.3.7 Registration request (REG-REQ) message

An REG-REQ shall be transmitted by an SS at initialization. An SS shall generate REG-REQs in the form shown in Table 21.

Table 21—REG-REQ message format

Syntax	Size	Notes
REG-REQ_Message_Format() {		
Management Message Type = 6	8 bits	
TLV Encoded Information	<i>variable</i>	TLV Specific
}		

An SS shall generate REG-REQs including the following parameters:

Primary Management CID (*in the generic MAC header*)

The CID in the generic MAC header is the Primary Management CID for this SS, as assigned in the RNG-RSP message.

All other parameters are coded as TLV tuples.

The REG-REQ shall contain the following TLVs:

Hashed Message Authentication Code (HMAC) Tuple

Shall be final attribute in the message's TLV attribute list (11.1.2).

In Mesh Mode, message digest is calculated using HMAC_KEY_U.

For PMP operation, the REG-REQ shall contain the following TLVs:

Uplink CID Support (11.7.6)

SS management support (11.7.2)

IP management mode (11.7.3)

In Mesh Mode, the REG-REQ shall contain the following TLVs:

SS MAC Address

MAC Version (11.1.3)

The MAC version implemented in the Candidate Node.

The REG-REQ may contain the following TLVs:

IP Version (11.7.4)

SS Capabilities Encodings (11.7.8)

Vendor ID Encoding (11.1.5)

Vendor-specific information (11.1.6)

Convergence Sublayer Capabilities (11.7.7)

ARQ Parameters (11.7.1)

ARQ and fragmentation parameters desired by the SS for establishing the secondary management connection. When the TLV is not supplied, the SS is indicating its desire to not support ARQ on the connection. For purposes of the parameter negotiation dialog, the parameters supplied in this message are equivalent to those supplied in the DSA-REQ message.

6.3.2.3.8 Registration response (REG-RSP) message

A REG-RSP shall be transmitted by the BS in response to received REG-REQ.

To provide for flexibility, the message parameters following the response field shall be encoded in a TLV format.

A BS shall generate REG-RSPs in the form shown in Table 22, including both of the following parameters:

CID (*in the generic MAC header*)

The CID in the generic MAC header is the Primary Management CID for this SS.

Response

A 1 byte quantity with one of the two values:

0 = OK

1 = Message authentication failure

Table 22—REG-RSP message format

Syntax	Size	Notes
REG-RSP_Message_Format() {		
Management Message Type = 7	8 bits	
Response	8 bits	
TLV Encoded Information	<i>variable</i>	TLV specific
}		

The REG-RSP shall contain the following TLVs:

SS management support (11.7.2)

Response to REG-REQ indicating the mode of SS management operation.

Secondary Management CID (11.7.5)

Present only if the SS has indicated in the REG-REQ that it is a managed SS.

HMAC Tuple (11.1.2)

The HMAC Tuple attribute shall be the final attribute in the message's TLV attribute list. In Mesh Mode, message digest is calculated using HMAC_KEY_D.

In Mesh Mode, the REG-RSP shall contain the following TLVs:

Node ID

MAC Version (11.1.3)

MAC Version used in the network

The REG-RSP may contain the following TLVs:

SS Capabilities Encodings (11.7.8)

Response to the capabilities of the requester provided in the REG-REQ. Included in the response if the request included capabilities information. The response indicates whether or not the capabilities may be used. If a capability is not recognized, the response indicates that this capability shall not be used by the requester. Capabilities returned in the REG-RSP shall not be set to require greater capability of the requester than is indicated in the REG-REQ.

IP Version (11.7.4)

Vendor ID Encoding (of the responder; 11.1.5)

Vendor-specific information (11.1.6)

Included if the REG-REQ contained the Vendor ID Encoding of the requestor.

ARQ Parameters (11.7.1)

ARQ and fragmentation parameters specified by the BS to complete ARQ parameter negotiation for the secondary management connection. This information is only included in the message if ARQ Parameters were supplied by the SS in the original REG-REQ message. For purposes of the parameter negotiation dialog, the parameters supplied in this message are equivalent to those supplied in the DSA-RSP message.

IP management mode (11.7.3)

Response to REG-REQ indication of whether or not the requester wishes to accept IP-based traffic on the Secondary Management Connection, once the initialization process has completed.

6.3.2.3.9 Privacy key management (PKM) messages (PKM-REQ/PKM-RSP)

PKM employs two MAC message types: PKM Request (PKM-REQ) and PKM Response (PKM-RSP), as described in Table 23.

Table 23—PKM MAC messages

Type Value	Message name	Message description
9	PKM-REQ	Privacy Key Management Request [SS -> BS]
10	PKM-RSP	Privacy Key Management Response [BS -> SS]

These MAC management message types distinguish between PKM requests (SS-to-BS) and PKM responses (BS-to-SS). Each message encapsulates one PKM message in the Management Message Payload.

PKM protocol messages transmitted from the SS to the BS shall use the form shown in Table 24. They are transmitted on the SSs Primary Management Connection.

Table 24—PKM request (PKM-REQ) message format

Syntax	Size	Notes
PKM-REQ_Message_Format() {		
Management Message Type = 9	8 bits	
Code	8 bits	
PKM Identifier	8 bits	
TLV Encoded Attributes	<i>variable</i>	TLV specific
}		

PKM protocol messages transmitted from the BS to the SS shall use the form shown in Table 25. They are transmitted on the SSs Primary Management Connection.

Table 25—PKM response (PKM-RSP) message format

Syntax	Size	Notes
PKM-RSP_Message_Format() {		
Management Message Type = 10	8 bits	
Code	8 bits	
PKM Identifier	8 bits	
TLV Encoded Attributes	<i>variable</i>	TLV specific
}		

The parameters shall be as follows:

Code

The Code is one byte and identifies the type of PKM packet. When a packet is received with an invalid Code, it shall be silently discarded. The code values are defined in Table 26.

PKM Identifier

The Identifier field is one byte. An SS uses the identifier to match a BS response to the SS's requests.

The SS shall increment (modulo 256) the Identifier field whenever it issues a new PKM message. A "new" message is an Authorization Request or Key Request that is not a retransmission being sent in response to a Timeout event. For retransmissions, the Identifier field shall remain unchanged.

The Identifier field in Authentication Information messages, which are informative and do not effect any response messaging, shall be set to zero. The Identifier field in a BS's PKM-RSP message shall match the Identifier field of the PKM-REQ message the BS is responding to. The Identifier field in TEK Invalid messages, which are not sent in response to PKM-REQs, shall be set to zero. The Identifier field in unsolicited Authorization Invalid messages shall be set to zero.

On reception of a PKM-RSP message, the SS associates the message with a particular state machine (the Authorization state machine in the case of Authorization Replies, Authorization Rejects, and Authorization Invalids; a particular TEK state machine in the case of Key Replies, Key Rejects, and TEK Invalids).

An SS shall keep track of the identifier of its latest, pending Authorization Request. The SS shall discard Authorization Reply and Authorization Reject messages with Identifier fields not matching that of the pending Authorization Request.

An SS shall keep track of the identifiers of its latest, pending Key Request for each SA. The SS shall discard Key Reply and Key Reject messages with Identifier fields not matching those of the pending Key Request messages.

Attributes

PKM attributes carry the specific authentication, authorization, and key management data exchanged between client and server. Each PKM packet type has its own set of required and optional attributes. Unless explicitly stated, there are no requirements on the ordering of attributes within a PKM message. The end of the list of attributes is indicated by the LEN field of the MAC PDU header.

Table 26—PKM message codes

Code	PKM message type	MAC Management message name
0-2	<i>reserved</i>	—
3	SA Add	PKM-RSP
4	Auth Request	PKM-REQ
5	Auth Reply	PKM-RSP
6	Auth Reject	PKM-RSP

Table 26—PKM message codes (continued)

Code	PKM message type	MAC Management message name
7	Key Request	PKM-REQ
8	Key Reply	PKM-RSP
9	Key Reject	PKM-RSP
10	Auth Invalid	PKM-RSP
11	TEK Invalid	PKM-RSP
12	Auth Info	PKM-REQ
13–255	<i>reserved</i>	—

Formats for each of the PKM messages are described in the following subclauses. The descriptions list the PKM attributes contained within each PKM message type. The attributes themselves are described in 11.9. Unknown attributes shall be ignored on receipt and skipped over while scanning for recognized attributes.

The BS shall silently discard all requests that do not contain ALL required attributes. The SS shall silently discard all responses that do not contain ALL required attributes.

6.3.2.3.9.1 SA Add message

This message is sent by the BS to the SS to establish one or more additional SAs.

Code: 3

Attributes are shown in Table 27.

Table 27—SA Add attributes

Attribute	Contents
Key-Sequence-Number	Authorization key (AK) sequence number.
(one or more) SA-Descriptor(s)	Each compound SA-Descriptor attribute specifies an SA identifier (SAID) and additional properties of the SA.
HMAC-Digest	Keyed secure hash algorithm (SHA) message.

The HMAC-Digest attribute shall be the final attribute in the message's attribute list.

6.3.2.3.9.2 Authorization Request (Auth Request) message

Code: 4

Attributes are shown in Table 28.

Table 28—Auth Request attributes

Attribute	Contents
SS-Certificate	Contains the SS's X.509 user certificate.
Security-Capabilities	Describes requesting SS's security capabilities.
SAID	SS's primary SAID equal to the Basic CID.

The SS-certificate attribute contains an X.509 SS certificate (see 7.6) issued by the SS's manufacturer. The SS's X.509 certificate is a public-key certificate that binds the SS's identifying information to its RSA public key in a verifiable manner. The X.509 certificate is digitally signed by the SS's manufacturer, and that signature can be verified by a BS that knows the manufacturer's public key. The manufacturer's public key is placed in an X.509 certification authority (CA) certificate, which in turn is signed by a higher-level CA.

The Security-Capabilities attribute is a compound attribute describing the requesting SS's security capabilities. This includes the data encryption and data authentication algorithms the SS supports.

An SAID attribute contains a Privacy SAID. In this case, the provided SAID is the SS's Basic CID, which is equal to the Basic CID assigned to the SS during initial ranging.

6.3.2.3.9.3 Authorization Reply (Auth Reply) message

Sent by the BS to a client SS in response to an Authorization Request, the Authorization Reply message contains an AK, the key's lifetime, the key's sequence number, and a list of SA-Descriptors identifying the Primary and Static SAs that the requesting SS is authorized to access and their particular properties (e.g., type, cryptographic suite). The AK shall be encrypted with the SS's public key. The SA-Descriptor list shall include a descriptor for the Basic CID reported to the BS in the corresponding Auth Request. The SA-Descriptor list may include descriptors of Static SAIDs that the SS is authorized to access.

The Auth Reply may also contain PKM configuration settings that override the default timer values.

Code: 5

Attributes are shown in Table 29.

Table 29—Auth Reply attributes

Attribute	Contents
AUTH-Key	Authorization (AUTH) Key, encrypted with the target client SS's public key.
Key-Lifetime	AK's active lifetime.
Key-Sequence-Number	AK sequence number.
(one or more) SA-Descriptor(s)	Each compound SA-Descriptor attribute specifies an SAID and additional properties of the SA.
PKM Configuration settings (optional)	PKM timer values.
Operator Shared Secret	Mesh Mode Only. Key known to all.
Key-Sequence-Number	Mesh Mode Only. Sequence number of the Operator Shared Secret.
Key-Lifetime	Mesh Mode Only. Lifetime of the Operator Shared Secret.

6.3.2.3.9.4 Authorization Reject (Auth Reject) message

The BS responds to an SS's authorization request with an Authorization Reject message if the BS rejects the SS's authorization request.

Code: 6

Attributes are shown in Table 30.

Table 30—Auth Reject attributes

Attribute	Contents
Error-Code	Error code identifying reason for rejection of authorization request.
Display-String (optional)	Display String providing reason for rejection of authorization request.

The Error-Code and Display-String attributes describe to the requesting SS the reason for the authorization failure.

6.3.2.3.9.5 Key Request message

Code: 7

For PMP operations, attributes are shown in Table 31.

Table 31—Key Request attributes

Attribute	Contents
Key-Sequence-Number	AK sequence number.
SAID	Security association identifier.
HMAC-Digest	Keyed SHA message digest.

When operating in Mesh Mode, the attributes of the Key Request message shall be those of Table 32.

Table 32—Key Request attributes for Mesh Mode

Attribute	Contents
SS Certificate	X.509 Certificate of the Node.
SAID	SA identifier.
HMAC-Digest	HMAC using HMAC_KEY_S.

The HMAC-Digest attribute shall be the final attribute in the message's attribute list.

Inclusion of the keyed digest allows the BS to authenticate the Key Request message. The HMAC-Digest's authentication key is derived from the AK or Operator Shared Secret.

6.3.2.3.9.6 Key Reply message

Code: 8

Attributes are shown in Table 33.

Table 33—Key Reply attributes

Attribute	Contents
Key-Sequence-Number	AK sequence number.
SAID	Security Association ID.
TEK-Parameters	“Older” generation of key parameters relevant to SAID.
TEK-Parameters	“Newer” generation of key parameters relevant to SAID.
HMAC-Digest	Keyed SHA message digest.

The TEK-Parameters attribute is a compound attribute containing all of the keying material corresponding to a particular generation of an SAID's TEK. This would include the TEK, the TEK's remaining key lifetime, its key sequence number, and the cipher block chaining (CBC) initialization vector. The TEK is encrypted. See 11.9.8 for details.

At all times the BS maintains two sets of active generations of keying material per SAID. (A set of keying material includes a TEK and its corresponding CBC initialization vector.) One set corresponds to the “older” generation of keying material, the second set corresponds to the “newer” generation of keying material. The newer generation has a key sequence number one greater than (modulo 4) that of the older generation. Subclause 7.4.1 specifies BS requirements for maintaining and using an SAID's two active generations of keying material.

The BS distributes to a client SS both generations of active keying material. Thus, the Key Reply message contains two TEK-Parameters attributes, each containing the keying material for one of the SAID's two active sets of keying material.

The HMAC-Digest attribute shall be the final attribute in the message's attribute list.

Inclusion of the keyed digest allows the receiving client to authenticate the Key Reply message and ensure SS and BS have synchronized AKs. The HMAC-Digest's authentication key is derived from the AK. See 7.5 for details.

6.3.2.3.9.7 Key Reject message

Receipt of a Key Reject indicates the receiving client SS is no longer authorized for a particular SAID.

Code: 9

Attributes are shown in Table 34.

Table 34—Key Reject attributes

Attribute	Contents
Key-Sequence-Number	AK sequence number.
SAID	Security Association ID.
Error-Code	Error code identifying reason for rejection of Key Request.
Display-String (optional)	Display string containing reason for Key Reject.
HMAC-Digest	Keyed SHA message digest.

The HMAC-Digest attribute shall be the final attribute in the message's attribute list.

Inclusion of the keyed digest allows the receiving client to authenticate the Key Reject message and ensure SS and BS have synchronized AKs. The HMAC-Digest's authentication key is derived from the AK. See 7.5 for details.

6.3.2.3.9.8 Authorization Invalid message

The BS may send an Authorization Invalid message to a client SS as:

- a) An unsolicited indication, or
- b) A response to a message received from that SS.

In either case, the Authorization Invalid message instructs the receiving SS to reauthorize with its BS.

The BS sends an Authorization Invalid in response to a Key Request if (1) the BS does not recognize the SS as being authorized (i.e., no valid AK associated with the requesting SS) or (2) verification of the Key Request's keyed message digest (in HMAC-Digest attribute) failed, indicating a loss of AK synchronization between SS and BS.

Code: 10

Attributes are shown in Table 35.

Table 35—Authorization Invalid attributes

Attribute	Contents
Error-Code	Error code identifying reason for Authorization Invalid.
Display-String (optional)	Display String describing failure condition.

6.3.2.3.9.9 TEK Invalid message

The BS sends a TEK Invalid message to a client SS if the BS determines that the SS encrypted an uplink PDU with an invalid TEK (i.e., an SAID's TEK key sequence number), contained within the received packet's MAC Header, is out of the BS's range of known, valid sequence numbers for that SAID.

Code: 11

Attributes are shown in Table 36.

Table 36—TEK Invalid attributes

Attribute	Contents
Key-Sequence-Number	AK sequence number.
SAID	Security Association ID.
Error-Code	Error code identifying reason for TEK Invalid message.
Display-String (optional)	Display string containing vendor-defined information.
HMAC-Digest	Keyed SHA message digest.

The HMAC-Digest attribute shall be the final attribute in the message's attribute list.

Inclusion of the keyed digest allows the receiving client to authenticate the TEK Invalid message and ensure SS and BS have synchronized AKs. The HMAC-Digest's authentication key is derived from the AK. See 7.5 for details.

6.3.2.3.9.10 Authentication Information (Auth Info) message

The Auth Info message contains a single CA-Certificate attribute, containing an X.509 CA certificate for the manufacturer of the SS. The SS's X.509 user certificate shall have been issued by the CA identified by the X.509 CA certificate.

Auth Info messages are strictly informative; while the SS shall transmit Auth Info messages as indicated by the Authentication state model (7.2.4), the BS may ignore them.

Code: 12

Attributes are shown in Table 37.

Table 37—Auth Info attributes

Attribute	Contents
CA-Certificate	Certificate of manufacturer CA that issued SS certificate.

The CA-certificate attribute contains an X.509 CA certificate for the CA that issued the SS's X.509 user certificate. The external CA issues these CA certificates to SS manufacturers.

6.3.2.3.10 DSA-REQ message

A DSA-REQ is sent by an SS or BS to create a new service flow.

Table 38—DSA-REQ message format

Syntax	Size	Notes
DSA-REQ_Message_Format() {		
Management Message Type = 11	8 bits	
Transaction ID	16 bits	
TLV Encoded Information	<i>variable</i>	TLV specific
}		

An SS or BS shall generate DSA-REQ messages in the form shown in Table 38, including the following parameters:

CID (*in the generic MAC header*)

SS's Primary Management CID.

Transaction ID

Unique identifier for this transaction assigned by the sender.

All other parameters are coded as TLV tuples.

A DSA-REQ message shall not contain parameters for more than one service flow.

The DSA-REQ message shall contain the following:

Service Flow Parameters (see 11.13)

Specification of the service flow's traffic characteristics and scheduling requirements.

Convergence Sublayer Parameter Encodings (see 11.13.19)

Specification of the service flow's CS specific parameters

HMAC Tuple (see 11.1.2)

The HMAC Tuple attribute contains a keyed message digest (to authenticate the sender). The HMAC Tuple attribute shall be the final attribute in the DSx message's attribute list.

6.3.2.3.10.1 SS-Initiated DSA

Service Flow ID shall not be present in the DSA message; at the BS the service flow within the DSA-REQ shall be assigned a unique Service Flow ID, which will be sent back in the DSA-RSP message. SS-initiated DSA-REQs may use the Service Class Name in place of some, or all, of the QoS Parameters.

6.3.2.3.10.2 BS-Initiated DSA

BS-initiated DSA-REQ may also include a CID. CIDs are unique within the MAC domain.

BS-initiated DSA-REQs for named Service Classes shall include the QoS Parameter Set associated with that Service Class. BS-initiated DSA-REQs shall also include the SA-Descriptor for the service flow.

6.3.2.3.11 DSA-RSP message

A DSA-RSP shall be generated in response to a received DSA-REQ. The format of a DSA-RSP shall be as shown in Table 39.

Table 39—DSA-RSP message format

Syntax	Size	Notes
DSA-RSP_Message_Format() {		
Management Message Type = 12	8 bits	
Transaction ID	16 bits	
Confirmation Code	8 bits	
TLV Encoded Information	<i>variable</i>	TLV specific
}		

Parameters shall be as follows:

CID (*in the generic MAC header*)

SS's Primary Management CID.

Transaction ID

Transaction ID from corresponding DSA-REQ.

Confirmation Code (see 11.13)

The appropriate Confirmation Code (CC) for the entire corresponding DSA-REQ.

All other parameters are coded as TLV tuples.

If the transaction is successful, the DSA-RSP may contain the following:

Service Flow Parameters (see 11.13)

The complete specification of the service flow shall be included in the DSA-RSP if it includes a newly assigned CID or an expanded Service Class Name or to point to specific parameter that caused rejection of connection creation (only in the case CC = "reject-notsupported-parameter-value" or "reject-not-supported-parameter").

CS Parameter Encodings (see 11.13.19)

Specification of the service flow's CS specific parameters.

If the transaction is unsuccessful, the DSA-RSP shall include:

Service Flow Error Set (see 11.13)

A Service Flow Error Set and identifying service flow reference/SFID shall be included for every failed service flow in the corresponding DSA-REQ message. Every Service Flow Error Set shall include every specific failed QoS Parameter of the corresponding service flow (see 11.13). This parameter shall be omitted if the entire DSA-REQ is successful.

Whether successful or unsuccessful, the message shall include the following:

HMAC Tuple (see 11.1.2)

The HMAC Tuple attribute contains a keyed message digest (to authenticate the sender). The HMAC Tuple attribute shall be the final attribute in the DSx message's attribute list.

6.3.2.3.11.1 SS-Initiated DSA

The BS's DSA-RSP for service flows that are successfully added shall contain an SFID. The DSA-RSP for successfully Admitted or Active uplink QoS Parameter Sets shall also contain a CID.

The BS's DSA-RSP shall also include the SA-Descriptor for the service flow. If the corresponding DSA-REQ uses the Service Class Name (see 11.13.3) to request service addition, a DSA-RSP shall contain the QoS Parameter Set associated with the named Service Class. If the Service Class Name is used in conjunction with other QoS Parameters in the DSA-REQ, the BS shall accept or reject the DSA-REQ using the explicit QoS Parameters in the DSA-REQ. If these service flow encodings conflict with the Service Class attributes, the BS shall use the DSA-REQ values as overrides for those of the Service Class.

If the transaction is unsuccessful, the BS shall use the original service flow reference to identify the failed parameters in the DSA-RSP.

6.3.2.3.11.2 BS-Initiated DSA

If the transaction is unsuccessful, the SS shall use the SFID to identify the failed parameters in the DSA-RSP.

6.3.2.3.12 DSA-ACK message

A DSA-ACK shall be generated in response to a received DSA-RSP. The format of a DSA-ACK shall be as shown in Table 40.

Table 40—DSA-ACK message format

Syntax	Size	Notes
DSA-ACK_Message_Format() {		
Management Message Type = 13	8 bits	
Transaction ID	16 bits	
Confirmation Code	8 bits	
TLV Encoded Information	<i>variable</i>	TLV specific
}		

Parameters shall be as follows:

CID (*in the generic MAC header*)

SS's Primary Management CID.

Transaction ID

Transaction ID from corresponding DSA-RSP.

Confirmation Code (see 11.13)

The appropriate CC for the entire corresponding DSA-RSP.

All other parameters are coded TLV tuples.

Service Flow Error Set (see 11.13)

The Service Flow Error Set of the DSA-ACK message encodes specifics of any failed service flows in the DSA-RSP message. A Service Flow Error Set and identifying service flow reference shall be included for every failed QoS Parameter of every failed service flow in the corresponding DSA-REQ message (see 11.13). This parameter shall be omitted if the entire DSA-REQ is successful.

HMAC Tuple (see 11.1.2)

The HMAC Tuple attribute contains a keyed message digest (to authenticate the sender). The HMAC Tuple attribute shall be the final attribute in the DSx message's attribute list.

6.3.2.3.13 DSC Request (DSC-REQ) message

A DSC-REQ is sent by an SS or BS to dynamically change the parameters of an existing service flow.

An SS or BS shall generate DSC-REQ messages in the form shown in Table 41, including the following parameters:

CID (in the generic MAC header)

SS's Primary Management CID.

Transaction ID

Unique identifier for this transaction assigned by the sender.

All other parameters are coded as TLV tuples.

Table 41—DSC-REQ message format

Syntax	Size	Notes
DSC-REQ_Message_Format() {		
Management Message Type = 14	8 bits	
Transaction ID	16 bits	
TLV Encoded Information	<i>variable</i>	TLV specific
}		

A DSC-REQ message shall not carry parameters for more than one service flow.

A DSC-REQ shall contain the following:

Service Flow Parameters (see 11.13)

Specifies the service flow's new traffic characteristics and scheduling requirements. The Admitted and Active QoS Parameter Sets currently in use by the service flow. If the DSC message is successful and it contains service flow parameters, but does not contain replacement sets for both Admitted and Active QoS Parameter Sets, the omitted set(s) shall be set to null. The service flow parameters shall contain a SFID.

HMAC Tuple (see 11.1.2)

The HMAC Tuple attribute contains a keyed message digest (to authenticate the sender). The HMAC Tuple attribute shall be the final attribute in the DSx message's attribute list.

6.3.2.3.14 DSC Response (DSC-RSP) message

A DSC-RSP shall be generated in response to a received DSC-REQ. The format of a DSC-RSP shall be as shown in Table 42.

Table 42—DSC-RSP message format

Syntax	Size	Notes
DSC-RSP_Message_Format() {		
Management Message Type = 15	8 bits	
Transaction ID	16 bits	
Confirmation Code	8 bits	
TLV Encoded Information	<i>variable</i>	TLV Specific
}		

Parameters shall be as follows:

CID (*in the generic MAC header*)

SS's Primary Management CID.

Transaction ID

Transaction ID from corresponding DSC-REQ.

Confirmation Code (see 11.13)

The appropriate CC for the corresponding DSC-REQ.

All other parameters are coded as TLV tuples.

If the transaction is successful, the DSC-RSP may contain the following:

Service Flow Parameters (see 11.13)

The complete specification of the service flow shall be included in the DSC-RSP only if it includes a newly assigned CID or an expanded Service Class Name. If a Service Flow Parameter Set contained an uplink Admitted QoS Parameter Set and this service flow does not have an associated CID, the DSC-RSP shall include a CID. If a Service Flow Parameter Set contained a Service Class Name and an Admitted QoS Parameter Set, the DSC-RSP shall include the QoS Parameter Set corresponding to the named Service Class. If specific QoS Parameters were also included in the Classed service flow request, these QoS Parameters shall be included in the DSC-RSP instead of any QoS Parameters of the same type of the named Service Class.

CS Parameter Encodings (see 11.13.19)

Specification of the service flow's CS specific parameters.

If the transaction is unsuccessful, the DSC-RSP shall contain the following:

Service Flow Error Set (see 11.13)

A Service Flow Error Set and identifying CID shall be included for every failed service flow in the corresponding DSC-REQ message. Every Service Flow Error Set shall include every specific failed QoS Parameter of the corresponding service flow (see 11.13). This parameter shall be omitted if the entire DSC-REQ is successful.

Whether successful or unsuccessful, the message shall include the following:

HMAC Tuple (see 11.1.2)

The HMAC Tuple attribute contains a keyed message digest (to authenticate the sender). The HMAC Tuple attribute shall be the final attribute in the DSx message's attribute list).

6.3.2.3.15 DSC Acknowledge (DSC-ACK) message

A DSC-ACK shall be generated in response to a received DSC-RSP. The format of a DSC-ACK shall be as shown in Table 43.

Table 43—DSC-ACK message format

Syntax	Size	Notes
DSC-ACK_Message_Format() {		
Management Message Type = 16	8 bits	
Transaction ID	16 bits	
Confirmation Code	8 bits	
TLV Encoded Information	<i>variable</i>	TLV specific
}		

Parameters shall be as follows:

CID (*in the generic MAC header*)

SS's Primary Management CID.

Transaction ID

Transaction ID from the corresponding DSC-REQ.

Confirmation Code (see 11.13)

The appropriate CC for the entire corresponding DSC-RSP.

All other parameters are coded TLV tuples.

Service Flow Error Set (see 11.13)

The Service Flow Error Set of the DSC-ACK message encodes specifics of any failed service flows in the DSC-RSP message. A Service Flow Error Set and identifying SFID shall be included for every failed QoS Parameter of each failed service flow in the corresponding DSC-RSP message (see 11.13). This parameter shall be omitted if the entire DSC-RSP is successful.

HMAC Tuple (see 11.1.2)

The HMAC Tuple attribute contains a keyed message digest (to authenticate the sender). The HMAC Tuple attribute shall be the final attribute in the DSx message's attribute list.

6.3.2.3.16 DSD-REQ message

A DSD-REQ is sent by an SS or BS to delete an existing service flow. The format of a DSD-REQ shall be as shown in Table 44.

Table 44—DSD-REQ message format

Syntax	Size	Notes
DSD-REQ_Message_Format() {		
Management Message Type = 17	8 bits	
Transaction ID	16 bits	
Service Flow ID	32 bits	
TLV Encoded Information	<i>variable</i>	TLV specific
}		

Parameters shall be as follows:

CID (*in the generic MAC header*)

SS's Primary Management CID.

Service Flow ID

The SFID to be deleted.

Transaction ID

Unique identifier for this transaction assigned by the sender.

All other parameters are coded as TLV tuples.

HMAC Tuple (see 11.1.2)

The HMAC Tuple attribute contains a keyed message digest (to authenticate the sender). The HMAC Tuple attribute shall be the final attribute in the DSx message's attribute list.

6.3.2.3.17 DSD-RSP message

A DSD-RSP shall be generated in response to a received DSD-REQ. The format of a DSD-RSP shall be as shown in Table 45.

Table 45—DSD-RSP message format

Syntax	Size	Notes
DSD-RSP_Message_Format() {		
Management Message Type = 18	8 bits	
Transaction ID	16 bits	
Confirmation Code	8 bits	
Service Flow ID	32 bits	
TLV Encoded Information	<i>variable</i>	TLV specific
}		

Parameters shall be as follows:

CID (*in the generic MAC header*)

SS's Primary Management CID.

Service Flow ID

SFID from the DSD-REQ to which this response refers.

Transaction ID

Transaction ID from the corresponding DSD-REQ.

Confirmation Code (see 11.13)

The appropriate CC for the corresponding DSD-REQ.

All other parameters are coded as TLV tuples.

HMAC Tuple (see 11.1.2)

The HMAC Tuple attribute contains a keyed message digest (to authenticate the sender). The HMAC Tuple attribute shall be the final attribute in the DSx message's attribute list.

6.3.2.3.18 Multicast Polling Assignment Request (MCA-REQ) message

The MCA-REQ message is sent to an SS to assign it to or remove it from a multicast polling group. The format of the message is shown in Table 46.

Table 46—MCA-REQ message format

Syntax	Size	Notes
MCA-REQ_Message_Format() {		
Management Message Type = 21	8 bits	
Transaction ID	16 bits	
TLV Encoded Information	<i>variable</i>	TLV specific
}		

Parameters shall be as follows:

CID (*in the generic MAC header*)

SS's Primary Management CID.

Transaction ID

Unique identifier for this transaction assigned by the sender.

All other parameters are coded as TLV tuples.

Multicast CID (see 11.10)

Assignment (see 11.10)

6.3.2.3.19 Multicast Polling Assignment Response (MCA-RSP) message

The MCA-RSP is sent by the SS in response to a MCA-REQ. The message format shall be as shown in Table 47.

Table 47—MCA-RSP message format

Syntax	Size	Notes
MCA-RSP_Message_Format() {		
Management Message Type = 22	8 bits	
Transaction ID	16 bits	
Confirmation Code	8 bits	
}		

Parameters shall be as follows:

CID (*in the generic MAC header*)

SS's Primary Management CID.

Transaction ID

Unique identifier for this transaction assigned by the sender.

Confirmation Code

Zero indicates the request was successful. Non-zero indicates failure.

6.3.2.3.20 Downlink Burst Profile Change Request (DBPC-REQ) message

The DBPC-REQ message is sent by the SS to the BS on the SS's Basic CID to request a change of the downlink burst profile used by the BS to transport data to the SS. Note that a change of downlink burst profile may also be requested by means of a RNG-REQ message as defined in 6.3.2.3.5.

The DBPC-REQ message shall be sent at the current operational Data Grant Burst Type for the SS. If the SS detects fading on the downlink, the SS uses this message to request transition to a more robust Data Grant Burst Type. The message format shall be as shown in Table 48.

Table 48—DBPC-REQ message format

Syntax	Size	Notes
DBPC-REQ_Message_Format() {		
Management Message Type = 23	8 bits	
<i>reserved</i>	4 bits	Shall be set to zero
DIUC	4 bits	
Configuration Change Count	8 bits	
}		

Parameters shall be as follows:

DIUC

Data grant DIUC values. (PHY specific: SC—Table 145, SCa—Table 193, OFDM—Table 237, OFDMA—Table 276)

Configuration Change Count

Value of Configuration Change Count provided in DCD defining the burst profile associated with DIUC.

6.3.2.3.21 Downlink Burst Profile Change Response (DBPC-RSP) message

The DBPC-RSP message shall be transmitted by the BS on the SS's Basic CID in response to a DBPC-REQ message from the SS. If the DIUC parameter is the same as requested in the DBPC-REQ message, then the request was accepted. Otherwise, if the request is rejected, the DIUC parameter shall be the previous DIUC at which the SS was receiving downlink data. The message format shall be as shown in Table 49.

Table 49—DBPC-RSP message format

Syntax	Size	Notes
DBPC-RSP_Message_Format() {		
Management Message Type = 24	8 bits	
<i>reserved</i>	4 bits	Shall be set to zero
DIUC	4 bits	
Configuration Change Count	8 bits	
}		

Parameters shall be as follows:

DIUC

Data grant DIUC values. (PHY specific: SC—Table 145, SCa—Table 193, OFDM—Table 237, OFDMA—Table 276)

Configuration Change Count

Value of Configuration Change Count provided in DCD defining the burst profile associated with DIUC.

6.3.2.3.22 Reset Command (RES-CMD) message

The RES-CMD message shall be transmitted by the BS on an SS's Basic CID to force the SS to reset itself, reinitialize its MAC, and repeat initial system access. This message may be used if an SS is unresponsive to the BS or if the BS detects continued abnormalities in the uplink transmission from the SS.

The MAC Management Message Type for this message is given in Table 14. The RES-CMD message format is shown in Table 50.

Table 50—RES-CMD message format

Syntax	Size	Notes
RES-CMD_Message_Format() {		
Management Message Type = 25	8 bits	
TLV encoded information	<i>variable</i>	
}		

The RES-CMD shall include the following parameters encoded as TLV tuples:

HMAC Tuple (see 11.1.2)

The HMAC Tuple shall be the last attribute in the message.

6.3.2.3.23 SS Basic Capability Request (SBC-REQ) message

The SS SBC-REQ shall be transmitted by the SS during initialization. An SS shall generate SBC-REQ messages in the form shown in Table 51.

Table 51—SS SBC-REQ message format

Syntax	Size	Notes
SBC-REQ_Message_Format() {		
Management Message Type = 26	8 bits	
TLV Encoded Information	<i>variable</i>	TLV specific
}		

An SS shall generate SS SBC-REQs including the following parameter:

Basic CID (*in the MAC Header*)

The CID in the MAC Header is the Basic CID for this SS, as assigned in the RNG-RSP message.

All other parameters are coded as TLV tuples.

Basic Capability Requests contain those SS Capabilities Encodings (11.7.8) that are necessary for effective communication with the SS during the remainder of the initialization protocols. Only the following parameters shall be included in the Basic Capabilities Request:

Physical Parameters Supported (see 11.8.3)

Bandwidth Allocation Support (see 11.8.1)

6.3.2.3.24 SS Basic Capability Response (SBC-RSP) message

The SS SBC-RSP shall be transmitted by the BS in response to a received SBC-REQ.

To provide flexibility, the message parameters following the Response field shall be encoded in a TLV format.

Table 52—SS SBC-RSP message format

Syntax	Size	Notes
SBC-RSP_Message_Format() {		
Management Message Type = 27	8 bits	
TLV Encoded Attributes	<i>variable</i>	TLV specific
}		

A BS shall generate SS SBC-RSPs in the form shown in Table 52, including both of the following parameters:

CID (*in the MAC Header*)

The CID in the MAC Header is the Basic CID for this SS, as appears in the RNG-REQ message.

The following parameters shall be included in the SBC-RSP if found in the SS SBC-REQ:

Physical Parameters Supported (see 11.8.3)

Bandwidth Allocation Support (see 11.8.1)

The BS response to the subset of SS capabilities present in the SBC-REQ message. The BS responds to the SS capabilities to indicate whether they may be used. If the BS does not recognize an SS capability, it may return this as “off” in the SBC-RSP.

Only capabilities set to “on” in the SBC-REQ may be set “on” in the SBC-RSP, as this is the handshake indicating that they have been successfully negotiated.

6.3.2.3.25 Clock Comparison (CLK-CMP) message

In network systems with service flows carrying information that requires the SSs to reconstruct their network clock signals (e.g., DS1 and DS3), CLK-CMP messages shall be periodically broadcast by the BS. When these services are not supported by the SS, the implementation of the CLK-CMP message at the SS shall be optional. If provisioned to do so, the BS shall take a clock difference measurement at every periodic interval (within the tolerance of the 10MHz reference defined in the definition of the Clock Comparison Value) defined in Table 342 and generate and transmit one CLK-CMP message according to the format shown in Table 53.

Table 53—CLK-CMP message format

Syntax	Size	Notes
CLK-CMP_Message_Format() {		
Management Message Type = 28	8 bits	
Clock Count n	8 bits	
for ($i = 1; i \leq n; i++$) {		For each clock signal 1 through n
Clock ID [i]	8 bits	
Sequence Number [i]	8 bits	
Comparison Value [i]	8 bits	
}		
}		

CLK-CMP messages shall include the following parameters where Clock ID, Sequence Number, and Clock Comparison Value (CCV) shall be repeated for each clock signal:

Clock Count

This 8-bit value shall be the number of CCVs included in the CLK-CMP message.

Clock ID

This 8-bit value shall be the unique identifier for each clock signal from which the CCVs are generated by the BS.

Sequence Number

This 8-bit value shall be incremented by one (modulo the field size, 256) by the BS whenever a new CLK-CMP message is generated. This parameter is used to detect packet losses.

Clock Comparison Value

This 8-bit value shall be the difference (modulo the field size, 256) between the following two reference clock signals: (1) a 10 MHz reference clock locked to the symbol clock of the airlink [such as a global positioning satellite (GPS) reference used to generate the symbol clock], and (2) an 8.192 MHz reference clock locked to the network clock.

6.3.2.3.26 De/Re-register Command (DREG-CMD) message

The DREG-CMD message shall be transmitted by the BS on an SS's Basic CID to force the SS to change its access state. The BS may transmit the DREG-CMD unsolicited or in response to an SS DREG-REQ message. Upon receiving a DREG-CMD, the SS shall take the action indicated by the action code.

The MAC Management Message Type for this message is given in Table 14. The format of the message is shown in Table 54.

Table 54—DREG-CMD message format

Syntax	Size	Notes
DREG-CMD_Message_Format() {		
Management Message Type = 29	8 bits	
Action Code	8 bits	
TLV encoded parameters	<i>variable</i>	
}		

The Action Code values and the corresponding actions are specified in Table 55.

Table 55—Action Codes and actions

Action Code	Action
0x00	SS shall leave the current channel and attempt to access another channel.
0x01	SS shall listen to the current channel but shall not transmit until an RES-CMD message or DREG_CMD with an Action Code that allows transmission is received.
0x02	SS shall listen to the current channel but only transmit on the Basic, Primary Management, and Secondary Management Connections.
0x03	SS shall return to normal operation and may transmit on any of its active connections.
0x04	SS shall terminate current Normal Operations with the BS; the BS shall transmit this action code only in response to any SS DREG-REQ message.
0x05-0xFF	<i>reserved</i>

The DREG-CMD shall include the following parameters encoded as TLV tuples:

HMAC Tuple (see 11.1.2)

The HMAC Tuple shall be the last attribute in the message.

6.3.2.3.27 DSx Received (DSX-RVD) message

The DSX-RVD message shall be generated by the BS in response to an SS-initiated DSx-REQ to inform the SS that the BS has received the DSx-REQ message in a more timely manner than provided by the DSx-RSP message, which shall be transmitted only after the DSx-REQ is authenticated. The format of the DSX-RVD shall be as shown in Table 56.

Table 56—DSX-RVD message format

Syntax	Size	Notes
DSX-RVD_Message_Format() {		
Management Message Type = 30	8 bits	
Transaction ID	16 bits	
Confirmation Code	8 bits	
}		

Parameters shall be as follows:

CID (*in the generic MAC header*)

SS's Primary Management CID.

Transaction ID

Transaction ID from corresponding DSx-REQ.

Confirmation Code (see 11.13)

The appropriate CC indicating the integrity of the corresponding DSx-REQ.

6.3.2.3.28 Config File TFTP Complete (TFTP-CPLT) message

The Config File TFTP-CPLT message shall be generated by the SS when it has successfully retrieved its configuration file from the provisioning server (see 6.3.9.12). If the SS does not need a config file it shall send the TFTP-CPLT message to the BS anyway, to indicate that it has completed secondary management connection initialization and is ready to accept services. The format of the TFTP-CPLT shall be as shown in Table 57.

Table 57—TFTP-CPLT message format

Syntax	Size	Notes
TFTP-CPLT_Message_Format() {		
Management Message Type = 31	8 bits	
TLV encoded information	<i>variable</i>	
}		

Parameters shall be as follows:

CID (*in the generic MAC header*)
SS's Primary Management CID.

The TFTP-CPLT shall include the following parameters encoded as TLV tuples:

HMAC Tuple (see 11.1.2)
The HMAC Tuple shall be the last attribute in the message.

6.3.2.3.29 Config File TFTP Complete Response (TFTP-RSP) message

The Config File TFTP-RSP message shall be generated by the BS in response to a TFTP-CPLT message from the SS (see 6.3.9.12). The format of the TFTP-RSP shall be as shown in Table 58.

Table 58—Config File TFTP-RSP message format

Syntax	Size	Notes
TFTP-RSP_Message_Format() {		
Management Message Type = 32	8 bits	
Response	8 bits	
}		

Parameters shall be as follows:

CID (*in the generic MAC header*)
SS's Primary Management CID.

Response

A 1 byte quantity with one of the two values:

0 = OK

1 = Message authentication failure

6.3.2.3.30 ARQ Feedback message

A system supporting ARQ shall be able to receive and process the ARQ Feedback message.

The ARQ Feedback message, as shown in Table 59, can be used to signal any combination of different ARQ ACKs (cumulative, selective, selective with cumulative). The message shall be sent on the appropriate basic management connection.

Table 59—ARQ Feedback message format

Syntax	Size	Notes
ARQ_Feedback_Message_Format() {		

Table 59—ARQ Feedback message format (continued)

Syntax	Size	Notes
Management Message Type =33	8 bits	
ARQ_Feedback_Payload	<i>variable</i>	See 6.3.3.4.3.
}		

ARQ_Feedback_Payload field shall be either sent using this ARQ Feedback message or by packing (“piggy-backing”) the ARQ_Feedback_Payload as described in 6.3.3.4.3.

6.3.2.3.31 ARQ Discard message

This message is applicable to ARQ-enabled connections only.

The transmitter sends this message when it wants to skip a certain number of ARQ blocks. The ARQ Discard message shall be sent as a MAC management message on the basic management connection of the appropriate direction. Table 60 shows the format of the Discard message.

Table 60—ARQ Discard message format

Syntax	Size	Notes
ARQ_Discard_Message_Format() {		
Management Message Type = 34	8 bits	
Connection ID	16 bits	CID to which this message refers.
<i>reserved</i>	5 bits	Shall be set to zero.
BSN	11 bits	Sequence number of the last block in the transmission window that the transmitter wants to discard.
}		

6.3.2.3.32 ARQ Reset message

This message is applicable to ARQ-enabled connections only.

The transmitter or the receiver may send this message. The message is used in a dialog to reset the parent connection’s ARQ transmitter and receiver state machines. The ARQ Reset message shall be sent as a MAC management message on the basic management connection of the appropriate direction. Table 61 shows the format of the Reset message.

Table 61—ARQ Reset message format

Syntax	Size	Notes
ARQ_Reset_Message_Format() {		
Management Message Type = 35	8 bits	
Connection ID	16 bits	CID for which this message refers to.
Type	2 bits	00 = Original message from Initiator 01 = Acknowledgment from Responder 10 = Confirmation from Initiator 11 = <i>Reserved</i>
<i>reserved</i>	6 bits	Shall be set to zero.
}		

6.3.2.3.33 Channel measurement Report Request/Response (REP-REQ/RSP)

If the BS, operating in bands below 11 GHz or a DM-configured BS operating at any frequency, requires RSSI and CINR channel measurement reports, it shall send the channel measurements Report Request message. In license-exempt bands, it shall additionally be used to request the results of the DFS measurements the BS has previously scheduled. Table 62 shows the REP-REQ message.

Table 62—Channel measurements Report Request (REP-REQ) message format

Syntax	Size	Notes
Report_Request_Message_Format() {		
Management Message Type = 36	8 bits	
Report Request TLVs	<i>variable</i>	
}		

The REP-REQ message shall contain the following TLV encoded parameters:

Report Request

The channel measurement Report Response message shall be used by the SS to respond to the channel measurements listed in the received Report Requests. In license-exempt bands, the SS shall also send a REP-RSP in an unsolicited fashion upon detecting a Primary User on the channel it is operating in. The SS may also send a REP-RSP containing channel measurement reports, in an unsolicited fashion, or when non-primary user interference is detected above a threshold value. Table 63 shows the REP-RSP message.

Table 63—Channel measurement Report Response (REP-RSP) message format

Syntax	Size	Notes
Report_Response_Message_Format {		
Management Message Type = 37	8 bits	
Report Response TLVs	<i>variable</i>	
}		

The REP-RSP shall contain the following TLV encoded parameters:

Report

Compound TLV that shall contain the measurement Report in accordance with the Report Request (see 11.11).

6.3.2.3.34 Fast Power Control (FPC) message

Power control shall be effected by the use of periodic ranging. In addition, the BS may adjust the power levels of multiple subscribers simultaneously with the Fast Power Control (FPC) message. SSs shall apply the indicated change within the “SS downlink management message processing time.” FPC shall be sent on the broadcast CID. This message shall only apply to SCa, OFDM, and OFDMA PHY specifications. See Table 64.

Table 64—Fast power control message format

Syntax	Size	Notes
Fast_Power_Control message format () {		
Management message type = 38	8 bits	
Number of stations	8 bits	
for (i=0;i<Number of stations;i++) {		
Basic CID	16 bits	
Power adjust	8 bits	
}		
}		

Number of stations

Number of CID and Power Adjust tuples contained in this message.

Basic CID

Basic connection identifier associated with the SS.

Power Adjust

Signed integer, which expresses the change in power level (in multiples of 0.25 dB) that the SS shall apply to its current transmission power.

6.3.2.3.35 MSH-NCFG message

MSH-NCFG messages provide a basic level of communication between nodes in different nearby networks whether from the same or different equipment vendors or wireless operators. All the nodes (BS and SS) in the Mesh network shall transmit MSH-NCFGs as described in 6.3.7.5.5.

All the nodes shall generate MSH-NCFGs in the format shown in Table 65, including all of the following parameters:

Table 65—MSH-NCFG message format

Syntax	Size	Notes
MSH-NCFG_Message_Format() {		
Management Message Type = 39	8 bits	
NumNbrEntries	5 bits	
NumBSEntries	2 bits	
Embedded Packet Flag	1 bit	0 = Not present, 1= present
Xmt Power	4 bits	
Xmt Antenna	3 bits	
NetEntry MAC Address Flag	1 bit	0= Not present, 1= present
Network base channel	4 bits	
<i>reserved</i>	4 bits	Shall be set to zero
NetConfig Count	4 bits	
Timestamp Frame Number Network Control Slot Number in frame Synchronization Hop Count	12 bits 4 bits 8 bits	See 8.2.3.2
NetConfig schedule info Next Xmt Mx Xmt Holdoff Exponent	3 bits 5 bits	
if (NetEntry MAC Address Flag) NetEntry MAC Address	48 bits	
for (i=0; i< NumBSEntries; ++i) {		
BS Node ID	16 bits	
Number of hops	3 bits	
Xmt energy/bit	5 bits	
}		
for (i=0; i< NumNbrEntries; ++i) {		
Nbr Node ID	16 bits	
MSH-Nbr_Physical_IE()	16 bits	See Table 66
if (Logical Link Info Present Flag) MSH-Nbr_Logical_IE()	16 bits	See Table 66 See Table 67

Table 65—MSH-NCFG message format (continued)

Syntax	Size	Notes
}		
if (Embedded Packet Flag) MSH-NCFG_embedded_data()	<i>variable</i>	See Table 68
}		

NumNbrEntries

Number of neighbors reported on in the message. The number of neighbors reported on may be a fraction of the whole set of neighbors known to this node. A node can report on subsequent subsets of neighbors in its subsequent MSH-NCFG transmissions.

The following procedure is used to select the list neighbors of which only the Physical IE is reported:

- i) All neighbor entries with the “Reported Flag” set to TRUE are excluded as defined below in this subclause.
- ii) The remaining neighbor entries are ordered by the Next Xmt Time and those with the Next Xmt Time the furthest in the future are reported in this MSH-NCFG packet. (In general, learning of nodes with Next Xmt Times furthest into the future is more valuable than learning of nodes with Next Xmt Times approaching soon, since the neighbors will have more time to use this ineligibility information before it is stale.)

The “Reported Flag” for all neighbors in either of the above neighbor lists is set to TRUE upon transmission of this MSH-NCFG packet. It is set to FALSE as described in 6.3.7.5.5.8.

N270umBSEntries

Number of Mesh BS neighbors reported on in this message.

Xmt Power

In 2 dBm steps, starting from 8 dBm. (i.e., 1111 indicates 38 dBm).

Xmt Antenna

The logical antenna used for transmission of this message. This allows for support for up to eight antenna directions.

Network base channel

The base channel being used in this node’s network, which is the logical number of the physical channel (see 8.5.1), shall be used to broadcast schedule control information. A subset of the possible physical channel numbers is mapped to logical channels in the Network Descriptor.

Netconfig count

Counter of MSH-NCFG packets transmitted by this node. Used by neighbors to detect missed transmissions. Incremented by 1 for every MSH-NCFG transmission by this node.

Frame Number

A modulo 2^{12} number, which shall be increased by one for every frame.

Network Control Slot Number in frame

See 8.3.5.3.

Synchronization hop count

This counter is used to determine superiority between nodes when synchronizing the network. Nodes can be assigned as master time keepers, which are synchronized externally (for example using GPS). These nodes transmit a Synchronization hop count of 0. Nodes shall synchronize to nodes with lower synchronization hop count, or if counts are the same, to the node with the lower Node ID.

Netconfig schedule info

See **Xmt Holdoff Exponent** and **Next Xmt Mx**.

Xmt Holdoff Exponent

The **Xmt Holdoff Time** is the number of MSH-NCFG transmit opportunities after **Next Xmt Time** (there are $\text{MSH-CTRL-LEN} - 1$ opportunities per network control subframe, see 8.3.5.3), that this node is not eligible not transmit MSH-NCFG packets (see 6.3.7.5.5.6).

$$\text{Xmt Holdoff Time} = 2^{(\text{Xmt Holdoff Exponent} + 4)} \quad (1)$$

Next Xmt Mx

Next Xmt Time is the next MSH-NCFG eligibility interval for this neighbor and computed as the range:

$$2^{\text{Xmt Holdoff Exponent}} \cdot \text{Next Xmt Mx} < \text{Next Xmt Time} \leq 2^{\text{Xmt Holdoff Exponent}} \cdot (\text{Next Xmt Mx} + 1) \quad (2)$$

For example, if **Next Xmt Mx** = 3 and **Xmt Holdoff Exponent** = 4, then the node shall be considered eligible for its next MSH-NCFG transmission between 49 and 64 (due to the granularity) transmission opportunities away and ineligible before that time.

If the **Next Xmt Mx** field is set to 0x1F (all ones), then the neighbor should be considered to be eligible to transmit from the time indicated by this value and every MSH-NCFG opportunity thereafter (i.e., treat **Xmt Holdoff Time** = 0).

NetEntry MAC Address

Indicates presence or sponsorship of new node. See Mesh Network Entry (MSH-NENT) message in 6.3.2.3.36 and Mesh network entry in 6.3.7.5.5.4.

BS node ID

Node ID of the Mesh BS node reported on.

Number of hops

Number of hops between the reporting node and the reported Mesh BS node.

Xmt energy/bit factor

Indication of energy/bit needed to reach Mesh BS through this node. **Xmt energy/bit** is computed as in Equation (3).

$$E_i = \min_{j \in N_i} [E_{j \rightarrow i} + E_j] \quad mW \cdot \mu s \quad (3)$$

where

N is the set of neighbors reporting the Mesh BS and $E_{i \rightarrow j} = P_{\text{Tx}}/R_{i \rightarrow j}$,

P_{Tx} is the transmission power in mW from node i to node j ,

$R_{i \rightarrow j}$ is the data rate in Mb/s from node i to node j . E_j is the **Xmt energy/bit** reported by neighbor j .

The reported **Xmt energy/bit factor** is the computed **Xmt energy/bit** divided by $2^{(\text{XmtEnergyUnitExponent} - 4)}$.

XmtEnergyUnitExponent is a 4-bit field reported in the Network Descriptor.

Nbr node ID

Node ID of the neighbor node reported on.

6.3.2.3.35.1 Nbr Physical IE**Table 66—Nbr Physical IE**

Syntax	Size	Notes
MSH-Nbr_Physical_IE() {		
Logical Link Info Present	1 bit	0 = Not present, 1 = present
Logical Link Requested	1 bit	0 = No, 1 = Yes
Logical Link Accepted	1 bit	0 = No, 1 = Yes
Hops to Neighbor	1 bit	0 = 1 hop (direct neighbor), 1 = 2 hops
Estimated propagation delay	4 bits	in μ s
Nbr Next Xmt Mx	5 bits	
Nbr Xmt Holdoff Exponent	3 bits	
}		

6.3.2.3.35.2 Nbr Logical IE**Table 67—Nbr Logical IE**

Syntax	Size	Notes
MSH-Nbr_Logical_IE() {		
Rev Link Quality	3 bit	
Nbr burst Profile	4 bit	Burst profile Nbr shall use in next transmission to this node
Excess Traffic Demand	1 bit	0 = No, 1 = Yes
Nbr Xmt Power	4 bits	
Nbr Xmt Antenna	3 bits	
Short Preamble flag	1 bit	0 = Don't use, 1 = Use Requested/Use Confirmed
}		

Rev Link Quality

Measure of the receive link reliability, indicating the reliability of MSH-NCFG size packets using the indicated burst profile. This is an estimated measure.

The reliability is indicated in Equation (4):

$$\text{Reliability} = 100 \cdot (1 - 10^{-(\text{Rev Link Quality}+1)/4}) \% \quad (4)$$

Nbr burst profile

Indicates the burst profile the indicated node should use when sending data bursts to the reporting node.

Excess traffic demand

May be used to indicate to the neighbor that the current schedule is insufficient to transfer pending traffic.

Nbr Xmt Power

The suggested transmit power for this neighbor to use for this link in 2 dBm steps, starting from 8 dBm. (i.e., 1111 indicates 38 dBm).

Short Preamble flag

A node may optionally set this bit to notify the neighbor to use the short preamble (see 8.3.3.6) for transmissions in the data portion of the frame. Capability to transmit the short preamble is mandatory. Capability to receive the short preamble is optional.

6.3.2.3.35.3 MSH-NCFG embedded data**Table 68—MSH-NCFG embedded data**

Syntax	Size	Notes
MSH-NCFG_embedded_data() {		
Extended embedded_data	1 bit	Indicates whether this embedded IE is followed by another one. 0 = No, 1 = Yes
<i>reserved</i>	3 bits	Shall be set to zero
Type	4 bits	
Length	8 bits	Length of embedded_IE in bytes, exclusive this header
Embedded_data_IE()	<i>variable</i>	Type dependent
}		

Type

The following types are defined:

- 0x0: *Reserved*
- 0x1: Network Descriptor
- 0x2: Network Entry Open
- 0x3: Network Entry Reject
- 0x4: Network Entry Ack (Embedded_data_IE() == NULL)
- 0x5: Neighbor Link Establishment Protocol

The Network Descriptor shall contain the parameters listed in Table 69:

Table 69—Network Descriptor IE

Syntax	Size	Notes
MSH-NCFG_embedded_data_IE() {		
Frame Length Code	4 bits	4 LSB of Frame Duration Code. See Table 232.
MSH-CTRL-LEN	4 bits	Control subframe length (see 8.3.5.3).
MSH-DSCH-NUM	4 bits	Number of DSCH opportunities in schedule control subframe (see 8.3.5.3).
MSH-CSCH-DATA-FRACTION	4 bits	
Scheduling Frames	4 bits	Defines how many frames have a schedule control subframe between two frames with network control subframes (see 8.3.5.3) in multiples of four frames. 0 = 0 frames, 1 = 4 frames etc.
Num_Burst_Profiles	4 bits	Number of burst profile definitions. If not set to zero, shall total all defined burst profiles.
Operator ID	16 bits	
XmtEnergyUnitsExponent	4 bits	
Channels	4 bits	Number of logical channels. A value of 0 indicates the channel information is not carried in this message.
MinCSForwardingDelay	7 bits	Number of OFDM symbols delay inserted between receiving and forwarding control packets.
ExtendedNeighborhoodType	1 bit	0 = 2-hop neighborhood 1 = 3-hop neighborhood
if (Channels) MSH-NCFG_Channel_IE()	<i>variable</i>	
for (i=0;i < Num_Burst_Profiles;i++) {		
FEC Code Type	8 bits	See Table 362.
Mandatory Exit Threshold	8 bits	See Table 362.
Mandatory Entry Threshold	8 bits	See Table 362.
}		
}		

MSH-CSCH-DATA-FRACTION

Maximum percentage (value $\times 6.67$) of minislots in the data-subframe allocated to centralized scheduling. The number of minislots is rounded to the nearest whole number of minislots and allocated starting from the beginning of the data subframe. The remainder of the data subframe, as well as any minislots not occupied by the current centralized schedule, may be used for distributed scheduling.

ExtendedNeighborhoodType

If value 0, then only nodes with **Hops to Neighbor** = 0 (see 6.3.2.3.35.1) are reported; if value 1, then also nodes with **Hops to Neighbor** = 1 are reported.

MinCSForwardingDelay

The minimum delay in OFDM symbols that shall be inserted between the end of reception and the start of transmission of a centralized scheduling message (i.e., MSH-CSCH and MSH-CSCF) by any node. See Table 70 and Table 71.

Table 70—MSH-NCFG Channel IE (license-exempt)

Syntax	Size	Notes
MSH-NCFG_Channel_IE() {		For license-exempt channels.
for (i=0; i< Channels; ++i)		
Physical Channel code	8 bits	Physical channel (see 8.5.1) the logical channel <i>i</i> is mapped to. Ordered with channels with same regulatory rules successive.
Channel reuse	3 bits	Minimum number of hops of separation between links, before a channel can be reused by the centralized scheduling algorithm. Range is 1 hop to 7 hops, 0 for no reuse.
Peak/Average flag	1 bit	Regulatory limits are peak or average.
<i>reserved</i>	2 bits	Shall be set to zero.
NumChannelMaps	2 bits	
for (i=0; i< NumChannelMaps; ++i) {		
Number of Channels	8 bits	Nodes in channel map to which rules apply.
Max. xmt power at antenna port	6 bits	Regulatory limit in dBm.
Max. EIRP	6 bits	Regulatory limit in dBm.
}		
}		

Table 71—MSH-NCFG Channel IE (licensed)

Syntax	Size	Notes
MSH-NCFG_Channel_IE() {		For licensed channels.
for (i=0; i< Channels; ++i) {		
Physical Channel center frequency	24 bits	Positive integer in kHz.
Physical Channel width	8 bits	Positive integer in 100 kHz.
}		

Table 71—MSH-NCFG Channel IE (licensed) (continued)

Syntax	Size	Notes
Channel Reuse	3 bits	Minimum number of hops of separation between links, before a channel can be reused by the centralized scheduling algorithm. Range is 1 hop to 7 hops, 0 for no reuse.
<i>reserved</i>	5 bits	Shall be set to zero.
}		

The Network Entry Open, which is used to respond to MSH-NENT request messages, shall contain the parameters listed in Table 72:

Table 72—Network Entry Open IE

Syntax	Size	Notes
MSH-CNFG_embedded_data_IE() {		
Minislot Start	8 bits	Schedule start for upper layer network entry.
Minislot Range	8 bits	Schedule range for upper layer network entry.
Frame number	12 bits	Frame number this schedule becomes valid.
Channel	4 bits	Logical channel for new node to Xmt in above Minislot Range.
Schedule validity	12 bits	Validity of Schedule in frames.
Channel	4 bits	Logical Rcv channel for new node.
Estimated Propagation Delay	4 bits	Measured in μ s.
<i>reserved</i>	4 bits	Shall be set to zero.
}		

The Network Entry Reject, which is used to reject MSH-NENT requests, shall contain the parameters listed in Table 73:

Table 73—Network Entry Reject IE

Syntax	Size	Notes
MSH-NCFG_embedded_data_IE() {		
Rejection Code	8 bits	
Rejection Reason	160 bits	ASCII string
}		

Rejection Code

- 0x0: Operator Authentication Value Invalid
- 0x1: Excess Propagation delay
- 0x2: Select new sponsor

Neighbor Link Establishment IE is given in Table 74.

Table 74—Neighbor Link Establishment IE

Syntax	Size	Notes
MSH-NCFG_embedded_data_IE() {		
Action Code	2 bits	0x0 Challenge 0x1 Challenge response 0x2 Accept 0x3 Reject
<i>reserved</i>	6 bits	Shall be set to zero.
if (Action Code == 0x0 or 0x1)		
Nbr Authentication value	32 bits	
if (Action Code == 0x1 or 0x2)		
Link ID	8 bits	Transmitting node's link ID for this link.
}		

Nbr Authentication value

HMAC{AK | frame number | own Node ID, Node ID of other node} where the AK is a secret key (obtained from Operator).

6.3.2.3.36 MSH-NENT message

MSH-NENT messages provide the means for a new node to gain synchronization and initial network entry into a Mesh network.

When a MSH-NENT message is sent, the Mesh subheader is set to 0x0000 until the node has been assigned a node ID. In the Mesh CID, the Network ID is set the sponsor's network code or to 0x0000 if not known and the Link ID is set to 0xFF (Broadcast). See Table 75.

Table 75—MSH-NENT message format

Syntax	Size	Notes
MSH-NENT_Message_Format() {		
Management Message Type = 40	8 bits	
Type	3 bits	0x0 <i>Reserved</i> 0x1 NetEntryAck 0x2 NetEntryRequest 0x3 NetEntryClose

Table 75—MSH-NENT message format (continued)

Syntax	Size	Notes
Xmt counter for this Type	3 bits	For NetEntryAck, this is the Type being acknowledged.
<i>reserved</i>	2 bits	Shall be set to zero.
Sponsor Node ID	16 bits	
Xmt Power	4 bits	
Xmt Antenna	3 bits	
<i>reserved</i>	1 bit	Shall be set to zero.
if (Type == 0x2)		
MSH-NENT_Request_IE()	<i>variable</i>	
}		

Sponsor Node ID

ID of the node sought to assist the requesting node in entering the network.

Xmt Power

In 2 dBm steps, starting from 8 dBm. (i.e., 0xF indicates 38 dBm).

Xmt Antenna

The logical antenna used for transmission of this message. This allows for support for up to eight antenna directions.

The MSH-NENT_request_IE is given in Table 76.

Table 76—MSH-NENT Request IE

Syntax	Size	Notes
MSH-NENT_Request_IE() {		
MAC Address	48 bits	
OpConfInfo	64 bits	
Operator Authentication Value	32 bits	
Node serial Number	32 bits	
}		

MAC Address

MAC Address of the new node sending the request.

OpConfInfo

Operator Configuration Information (obtained from Operator).

Operator Authentication Value

HMAC{MAC Address | Node Serial Number | AK }

where the AK is a secret key (obtained from Operator).

6.3.2.3.37 MSH-DSCH message

MSH-DSCH messages shall be transmitted in Mesh mode when using distributed scheduling. In coordinated distributed scheduling, all the nodes shall transmit a MSH-DSCH at a regular interval to inform all the neighbors of the schedule of the transmitting station. This transmission time is determined by the same algorithm used for MSH-NCFG messages (see 6.3.7.5.5.6). In both coordinated and uncoordinated scheduling, MSH-DSCH messages shall be used to convey resource requests and grants to the neighbors. Further, the MSH-DSCH messages shall be used to convey information about free resources that the neighbors can issue grants in. This message shall not be fragmented. The MSH-DSCH message format is given in Table 77.

Table 77—MSH-DSCH message format

Syntax	Size	Notes
MSH-DSCH_Message_Format() {		
Management Message Type =41	8 bits	
Coordination Flag	1 bit	
Grant/Request Flag	1 bit	
Sequence counter	6 bits	
No. Requests	4 bits	
No. Availabilities	4 bits	
No. Grants	6 bits	
<i>reserved</i>	2 bits	Shall be set to zero.
if (Coordination Flag == 0)		
MSH-DSCH_Scheduling_IE()	<i>variable</i>	
for (i=0; i<No_Requests; ++i)		
MSH-DSCH_Request_IE()	16 bits	
for (i=0; i<No_Availabilities; ++i)		
MSH-DSCH_Availability_IE()	32 bits	
for (i=0; i<No_Grants; ++i)		
MSH-DSCH_Grant_IE()	40 bits	
}		

Coordination Flag

0 = Coordinated

1 = Uncoordinated

Coordinated MSH-DSCH transmissions take place in the control subframe (see 8.3.5.3).

Uncoordinated MSH-DSCH transmissions take place in the data subframe (see 8.3.5.3). Both the

cases require a threeway handshake (Request, Grant, and Grant confirmation) to establish a valid schedule. Uncoordinated scheduling may only take place in minislots that cause no interference with the coordinated schedule.

Grant/Request Flag

0 = Request message

1 = Grant message (also used as Grant confirmation)

The Request Type indicates that a new Request is made of one or more other nodes. The **No. Requests** shall be nonzero in this case. The message may also contain Availabilities and Grants.

The Grant Type indicates that one or more Grants are given or confirmed. The **No. Grants** shall be nonzero in this case. The message may also contain Availabilities and Requests. Requests in this type of message indicate pending demand to the indicated node(s), but do not solicit a Grant from this node.

This flag is always set to 0 for coordinated distributed scheduling.

Sequence Counter

Sequentially increased counter for solicit messages in uncoordinated scheduling (used as multiple solicits might be outstanding). In coordinated scheduling, it allows nodes to detect missed scheduling messages.

Independent counters are used for the coordinated and uncoordinated messages.

No. Requests

Number of Request IEs in the message.

No. Availabilities

Number of Availability IEs in the message. The Availability IEs are used to indicate free minislot ranges that neighbors could issue Grants in.

No. Grants

Number of Grant IEs in the message.

6.3.2.3.37.1 MSH-DSCH Scheduling IE

The Coordinated distributed scheduling information carried in the MSH-DSCH message shall be used to distribute information needed to determine transmission timing of the MSH-DSCH messages with coordinated distributed scheduling. Each node shall report the two related parameters both of its own and all its neighbors. The scheduling information shall include all of the following parameters:

Next Xmt Mx

Next Xmt Time is the next MSH-DSCH eligibility interval for this node and computed as the range:

$$2^{\text{Xmt Holdoff Exponent}} \cdot \text{Next Xmt Mx} < \text{Next Xmt Time} \leq 2^{\text{Xmt Holdoff Exponent}} \cdot (\text{Next Xmt Mx} + 1) \quad (5)$$

For example, if **Next Xmt Mx** = 3 and **Xmt Holdoff Exponent** = 4, then the node shall be considered eligible for its next MSH-DSCH transmission between 49 and 64 (due to the granularity) transmission opportunities away and ineligible before that time.

If the **Next Xmt Mx** field is set to 0x1F (all ones), then the neighbor should be considered to be eligible to transmit from the time indicated by this value and every MSH-DSCH opportunity thereafter (i.e., treat **Xmt Holdoff Time** = 0).

Neighbor Next Xmt Mx

Advertises the **Next Xmt Mx** as reported by this neighbor.

Xmt Holdoff Exponent

The **Xmt Holdoff Time** is the number of MSH-DSCH transmit opportunities after **Next Xmt Time** (there are MSH-CTRL-LEN –1 opportunities per network control subframe, see 8.3.5.3) that this node is not eligible to transmit MSH-DSCH packets (see 6.3.7.5.5.6).

$$\text{Xmt Holdoff Time} = 2^{(\text{Xmt Holdoff Exponent} + 4)} \quad (6)$$

Neighbor Xmt Holdoff Exponent

Advertises the **Xmt Holdoff Exponent** as reported by this neighbor.

No. SchedEntries

Number of Neighbor MSH-DSCH Scheduling Entries in the message. See Table 78.

Neighbor Node ID

The Node ID of the neighbor being reported on.

Table 78—MSH-DSCH Scheduling IE

Syntax	Size	Notes
MSH-DSCH_Scheduling_IE() {		
Next Xmt Mx	5 bits	
Xmt holdoff exponent	3 bits	
No. SchedEntries	8 bits	
for (i=0; i< No_SchedEntries; ++i) {		
Neighbor Node ID	16 bits	
Neighbor Next Xmt Mx	5 bits	
Neighbor Xmt holdoff exponent	3 bits	
}		
}		

6.3.2.3.37.2 MSH-DSCH Request IE

The Requests carried in the MSH-DSCH message shall convey resource requests on per link basis. The Requests shall include all of the parameters listed in Table 79:

Table 79—MSH-DSCH Request IE

Syntax	Size	Notes
MSH-DSCH_Request_IE() {		
Link ID	8 bits	
Demand Level	8 bits	
Demand Persistence	3 bits	
<i>reserved</i>	1 bit	Shall be set to zero.
}		

Link ID

The ID assigned by the transmitting node to the link to this neighbor that this request involves.

Demand Level

Demand in minislots (assuming the current burst profile).

Demand Persistence

Persistency field for demands. Number of frames wherein the demand exists.

- 0 = cancel reservation
- 1 = single frame
- 2 = 2 frames
- 3 = 4 frames
- 4 = 8 frames
- 5 = 32 frames
- 6 = 128 frames
- 7 = Good until cancelled or reduced

6.3.2.3.37.3 MSH-DSCH Availabilities IE

The Availabilities carried in the MSH-DSCH message shall be used to indicate free minislot ranges that neighbors could issue Grants in. The Availabilities shall include all of the parameters listed in Table 80:

Table 80—MSH-DSCH Availability IE

Syntax	Size	Notes
MSH-DSCH_Availability_IE() {		
Start Frame number	8 bits	8 LSB of Frame number.
Minislot start	8 bits	
Minislot range	7 bits	
Direction	2 bits	
Persistence	3 bits	
Channel	4 bits	
}		

Start Frame number

Availability start:

Indicates lowest 8 bits of frame number in which the availability starts.

Minislot start

The start position of the availability within a frame (minislots as time unit, see 8.3.5.3 for definition).

Minislot range

The number of minislots free for grants

Direction

- 0 = Minislot range is unavailable.
- 1 = Available for transmission in this minislot range.
- 2 = Available for reception in this minislot range.
- 3 = Available for either transmission or reception

Persistence

Persistency field for Availabilities. Number of frames over which the Availability is valid.

- 0 = cancel availability
- 1 = single frame
- 2 = 2 frames
- 3 = 4 frames
- 4 = 8 frames
- 5 = 32 frames
- 6 = 128 frames
- 7 = Good until cancelled or reduced

Channel

Logical channel number, which is the logical number of the physical channel. A subset of the possible physical channel numbers is mapped to logical channels in the Network Descriptor.

6.3.2.3.37.4 MSH-DSCH Grants IE

The Grants carried in the MSH-DSCH message shall convey information about a granted minislot range selected from the range reported as available. Grants shall be used both to grant and confirm a grant. The Grants shall include all of the parameters listed in Table 81:

Table 81—MSH-DSCH Grants IE

Syntax	Size	Notes
MSH-DSCH_Grants_IE() {		
Link ID	8 bits	
Start Frame number	8 bits	8 LSB of Start Frame number.
Minislot start	8 bits	
Minislot range	8 bits	
Direction	1 bit	
Persistence	3 bits	
Channel	4 bits	
}		

Link ID

The ID assigned by the transmitting node to the neighbor that this grant involves.

Start Frame number

Schedule start:

Indicates lowest 8 bits of frame number in which the schedule is granted.

Minislot start

The start position of the reservation within a frame (minislots as time unit, see 8.3.5.3 for definition).

Minislot range

The number of minislots reserved.

Direction

0= From requester (i.e., to granter)

1= To requester (i.e., from granter)

Persistence

Persistency field for grants. Number of frames over which the grant is allocated.

0 = cancel reservation

- 1 = single frame
- 2 = 2 frames
- 3 = 4 frames
- 4 = 8 frames
- 5 = 32 frames
- 6 = 128 frames
- 7 = Good until cancelled or reduced

Channel

Logical channel number, which is the logical number of the physical channel. A subset of the possible physical channel numbers is mapped to logical channels in the Network Descriptor.

6.3.2.3.38 Mesh centralized scheduling (MSH-CSCH) message

A MSH-CSCH message shall be created by a Mesh BS when using centralized scheduling. The BS shall broadcast the MSH-CSCH message to all its neighbors, and all the nodes with hop count lower than $HR_{\text{threshold}}$ shall forward the MSH-CSCH message to their neighbors that have a higher hop count. In all these cases, the **Grant/Request Flag** = 0. $HR_{\text{threshold}}$ is a configuration value that need only be known to the Mesh BS, as it can be derived by the other nodes from the MSH-CSCF message.

Nodes can use MSH-CSCH messages to request bandwidth from the Mesh BS setting the **Grant/Request Flag** = 1. Each node reports the individual traffic demand requests of each “child” node in its subtree from the BS. The nodes in the subtree are those in the current scheduling tree to and from the Mesh BS, known to all nodes in the network, and ordered by node ID.

The BS shall generate MSH-CSCHs in the format shown in Table 82, including all of the following parameters:

Configuration sequence number

Indicates the configuration that shall be used to interpret this packet. It refers to the configuration number in the MSH-CSCF packet.

Grant/Request Flag

- 0 = Grant (transmitted in downlink)
- 1 = Request (transmitted in uplink)

Configuration Flag

Indicates which centralized scheduling control message type (CSCH or CSCF) will be transmitted next by the Mesh BS. This bit may be set to aid the nodes in computing the validity of the schedule indicated in the current message (see 6.3.6.6.2).

Flow Scale Exponent

Determines scale of the granted bandwidth. Its value typically depends on the number of nodes in the network, the achievable PHY bit rate, the traffic demand, and the provided service.

For the downlink, this gives the absolute values of flow granted, so the total minislot range allowed for centralized scheduling need not be used if not needed, with the remainder set aside for distributed scheduling.

For uplink, the lowest exponent possible is used at each hop, with quantization of forwarded requests rounded up (e.g., avoids reducing any requests to zero).

Num_Link_updates

Link updates are inserted by the Mesh BS if the number of link tree changes does not warrant a MSH-CSCF broadcast. The Mesh BS shall repeat the a link update in every MSH-CSCH either until the update becomes invalid, or until the change is reflected in a MSH-CSCF message.

NumFlowEntries

Number of 8-bit assignment fields followed, ordered according to appearance in MSH-CSCF. This number shall match the number of entries in the most recent MSH-CSCF message.

UplinkFlow

Base of the granted/requested bandwidth as bits/s for the uplink traffic of the node in the BS's scheduling tree. The allocation is the same as for **DownlinkFlow**.

DownlinkFlow

Parameter used, as shown in Equation (7), to compute the granted/requested bandwidth as bits/s for the downlink traffic of the node in the BS's scheduling tree. The flow indicates only traffic that initiates or terminates in the node itself (i.e., forwarded traffic is not included), except for traffic forwarded from/to nodes not part of the MSH-CSCF tree. The actual granted/requested bandwidth shall be calculated as

$$\begin{aligned} BW_{\text{traffic to BS}} &= \text{UplinkFlow} \cdot 2^{\text{Flowscale Exponent}+14} && \text{bits/s} \\ BW_{\text{traffic from BS}} &= \text{DownlinkFlow} \cdot 2^{\text{Flowscale Exponent}+14} && \text{bits/s} \end{aligned} \quad (7)$$

The assignments in the list are ordered according to the order in the MSH-CSCF message (see 6.3.2.3.39).

Frame schedule flag

If this flag is set, the allocation of flows shall occur over two frames, rather than one.

Sponsor Node Request

Three parameters (Sponsor Node, and Downlink Burst Profile, and Uplink Burst Profile) shall be set to 0, except by nodes that wish to reserve an allocation for the "upper MAC initialization" as specified in 6.3.9.14.3. A node may only set these values if all its children report these values as 0. The Mesh BS shall in response provide a grant to Node Index 0x00, which shall be reserved for this purpose.

Table 82—MSH-CSCH message format

Syntax	Size	Notes
MSH-CSCH_Message_Format() {		
Management Message Type = 42	8 bits	
Configuration sequence number	3 bits	Last MSH-CSCF sequence number.
Grant / Request Flag	1 bit	0 = Grant, 1 = Request.
Frame schedule Flag	1 bit	
Configuration Flag	1 bit	0 = Next schedule control message is MSH-CSCH. 1 = Next schedule control message is MSH-CSCF.
<i>reserved</i>	2 bits	Shall be set to zero.
NumFlowEntries	8 bits	
for (i=0; i< NumFlowEntries; ++i) {		
UplinkFlow	4 bits	
if (Grant / Request Flag == 0) DownlinkFlow	4 bits	
}		

Table 82—MSH-CSCH message format (continued)

Syntax	Size	Notes
Flow Scale Exponent	4 bits	
Padding Nibble	4 bits	
if (Grant/Request Flag = =0) {		
No_link_updates	4 bits	
for (i=0; i< No_link_updates; ++i) {		
Node Index self	8 bits	Index in MSH-CSCF list.
Node Index parent	8 bit	Index in MSH-CSCF list.
Uplink Burst Profile	4 bit	
Downlink Burst Profile	4 bit	
}		
} else {		Sponsor Node Request.
Sponsor Node	8 bits	Index in node tree.
Downlink Burst Profile	4 bits	
Uplink Burst Profile	4 bits	
}		
}		

6.3.2.3.39 Mesh centralized scheduling Configuration (MSH-CSCF) message

A MSH-CSCF message shall be broadcast in Mesh mode when using centralized scheduling. The Mesh BS shall broadcast the MSH-CSCF message to all its neighbors, and all nodes shall forward (rebroadcast) the message according to its index number specified in the message. The BS shall generate MSH-CSCFs in the format shown in Table 83.

Table 83—MSH-CSCF message format

Syntax	Size	Notes
MSH-CSCF_Message_Format() {		
Management Message Type = 43	8 bits	
Configuration sequence number	4 bits	
NumberOfChannels	4 bits	
for (i=0; i< NumberOfChannels; ++i) {		
Channel index	4 bits	
}		
Padding Nibble	0 or 4 bits	Pad till byte boundary.

Table 83—MSH-CSCF message format (continued)

Syntax	Size	Nodes
NumberOfNodes	8 bits	
for (i=0; i< NumberOfNodes; ++i) {		
NodeID	16 bits	Node index for this node is <i>i</i> .
NumOfChildren	8 bits	
for (j=0; j< NumberOfChildren; ++j) {		
Child Index	8 bits	Index of j^{th} child node.
Uplink Burst Profile	4 bits	Burst profile from j^{th} child node.
Downlink Burst Profile	4 bits	Burst profile to j^{th} child node.
}		
}		
}		

Configuration sequence number

Number of the configuration. With each new configuration message, the number is incremented by 1.

NumberOfChannels

Number of channels available for centralized scheduling.

Channel Index

The logical index of the Physical channel, as reported in MSH-NCFG:NetworkDescriptor.

NumberOfNodes

Number of nodes in scheduling tree.

Each entry of the scheduling tree shall include all of the following parameters:

Node ID

Unique node identifier assigned to node.

NumberOfChildren

Number of child nodes for this node. A child node is a neighbor with a hop count, which is one higher than this nodes hop count.

ChildIndex

NumberOfChildren index in this table of child node.

Uplink/Downlink Burst Profile

Burst profile of link from/to child node.

6.3.2.3.40 AAS Channel Feedback Request/Response (AAS-FBCK-REQ/RSP)

The AAS Channel Feedback Request message shall be used by a system supporting AAS. This message serves to request channel measurement that will help in adjusting the direction of the adaptive array. See Table 84.

Table 84—AAS Feedback Request (AAS-FBCK-REQ) message format

Syntax	Size	Nodes
AAS-FBCK-REQ_Message_Format() {		
Management Message Type = 44	8 bits	
Message body	<i>variable</i>	See 8.2, 8.3, or 8.4.
}		

The AAS Channel Feedback Response message shall be sent as a response to the AAS-FBCK-REQ message after the indicated measurement period has expired. See Table 85.

Table 85—AAS Feedback Response (AAS-FBCK-RSP) message format

Syntax	Size	Nodes
AAS-FBCK-RSP_Message_Format() {		
Management Message Type = 45	8 bits	
Message body	<i>variable</i>	See 8.2, 8.3, or 8.4.
}		

6.3.2.3.41 AAS Beam Select message

The AAS Beam Select message may be used by a system supporting AAS. This message may be sent by the SS in an unsolicited manner, to inform the BS about the preferred beam for the AAS SS sending this message. The AAS Beam Select message shall be sent on the basic CID.

Table 86—AAS_Beam_Select message format

Syntax	Size	Notes
AAS_Beam_Select message format() {		
Management message type = 46	8 bits	
AAS beam index	6 bits	
<i>reserved</i>	2 bits	Shall be set to zero.
}		

AAS beam index

This index shall correspond to the direction the AAS beam is pointing at during the AAS_DL_Scan_IE() preferred by the SS (see 8.4.4.6).

6.3.2.3.42 SS De-registration Request (DREG-REQ) message

An SS may send a DREG-REQ message to a BS in order to notify the BS of SS de-registration from Normal Operation service from the BS. The MAC Management Message Type for this message is given in Table 14. The format of the message is shown in Table 87.

Table 87—DREG-REQ message format

Syntax	Size	Notes
DREG-REQ message format() {		
Management message type = 49	8 bits	
De-registration_Request_Code	8 bits	0x00 = SS de-registration request from BS and network 0x01-0xFF = <i>Reserved</i>
TLV encoded parameters	<i>variable</i>	
}		

An SS shall generate SS DREG-REQs including the following parameters:

De-registration_Request_Code

Request code identifying the type of de-registration request:
0x00 = SS de-registration request for de-registration from BS
0x01 – 0xFF = reserved

The DREG-REQ shall include the following parameters encoded as TLV tuples:

HMAC Tuple (see 11.1.2)

The HMAC Tuple shall be the last attribute in the message.

6.3.2.3.43 H-ARQ MAP message

This subclause describes the H-ARQ MAP message, which is designed for H-ARQ enabled SS. This IE shall only be used by a BS supporting H-ARQ, for SS supporting H-ARQ.

6.3.2.3.43.1 H-ARQ MAP message format

The H-ARQ MAP message format is presented in Table 88. This message includes Compact DL/UL-MAP_IE and defines the access information for the downlink and uplink burst of H-ARQ enabled SS. This message shall be sent without a generic MAC header.

BS may broadcast multiple H-ARQ MAP messages using multiple burst after the MAP message. Each H-ARQ MAP message should have a different modulation and coding rate. If the frame contains DCD or UCD message following the MAP message, the H-ARQ MAP should follow DCD or UCD message.

The DL-MAP_IEs in the MAP message describe the location and coding and modulation schemes of the bursts. The order of DLMAP_IEs in the MAP message and the bursts for H-ARQ MAP messages is determined by the coding and modulation scheme of the burst. The burst for H-ARQ MAP message with lower rate coding and modulation should be placed before other bursts for H-ARQ MAP message.

The presence of the H-ARQ MAP message format is indicated by the contents of the three most significant bits of the first data byte of a burst. These bytes overlay the HT and EC bits of a generic MAC header. When these bits are both set to 1 (an invalid combination for a standard header) and followed by 1 bits of 1, the Compact DL-MAP format is present.

Table 88—H-ARQ MAP message format

Syntax	Size	Notes
H-ARQ_MAP message format() {		
H-ARQ MAP Indicator = 111	3 bits	Set to 0b111.
H-ARQ_UL-MAP appended	1 bit	
CRC appended	1 bit	
Map message length	9 bits	Length of H-ARQ MAP in bytes.
DL IE count	6 bits	Number of DL IE in the burst.
for (i=0; i < DL IE count; i++){		
Compact DL-MAP IE()	variable	
}		
If (Compact_UL-MAP appended ==1){		
while (map data remains) {		
Compact DL-MAP IE()	variable	
}		
}		
if !(byte boundary) {		
Padding nibble	4 bits	
}		
}		

H-ARQ MAP Indicator

The value of 0b111 means this message is a H-ARQ MAP Message.

Compact UL-MAP appended

A value of 1 indicates a compact UL-MAP is appended to the current compact DL-MAP data structure.

CRC appended

A value of one indicates a CRC-32 value is appended to the end of the H-ARQ MAP data. The CRC is computed across all bytes of the H-ARQ MAP starting with the byte containing the H-ARQ MAP indicator through the last byte of the map as specified by the Map message length field. The

CRC calculation is the same as that used for standard MAC messages. A value of zero indicates that no CRC is appended.

MAP message length

This value specifies the length of the H-ARQ MAP message beginning with the byte containing the H-ARQ MAP indicator and ending with the last byte of the H-ARQ MAP message. The length includes the computed 32-bit CRC value if the CRC appended indicator is on.

DL IE count

This field holds the number of IE entries in the following list of DL-MAP IEs.

Table 89 and Table 90 represent the types of compact DL/UL MAP IE.

Table 89—Compact_DL-MAP IE types

Compact DL-MAP Type	Description
0	Normal subchannel
1	Band AMC
2	Safety
3	DIUC
4	Format_Configuration_IE
5	H-ARQ_ACK_BITMAP_IE
6	<i>reserved</i>
7	Extension

Table 90—Compact_UL-MAP IE types

Compact UL-MAP Type	Description
0	Normal subchannel
1	Band AMC
2	Safety
3	UIUC
4	H-ARQ_Region_IE
5	CQI_Region_IE
6	<i>reserved</i>
7	Extension

6.3.2.3.43.2 Format Configuration

Table 91 represents the format of Format_Configuration_IE that configures CID type, safety pattern, maximum logical bands, and frame structure. The format should be set to default value at the start of each frame.

Table 91—Format configuration IE

Syntax	Size	Notes
Compact_DL-MAP_IE() {		
DL-MAP Type = 4	3 bits	Format_Configuration_IE
New Format Indication	1 bit	0 = Use the format configured by the latest Format_Configuration_IE 1 = New format
if (New Format Indication == 1) {		
CID Type	2 bits	00 = Normal CID 01 = RCID11 (default) 10 = RCID7 11 = RCID3
Safety Pattern	10 bits	
Subchannel type for Band AMC	2 bits	See Band AMC specification (8.4.6.3). 00 = Default type (default) 01 = 1x6 type 10 = 2x3 type 11 = 3x2 type
Max Logical Bands	2 bits	0 = 3 bands, 1 = 6 bands, 2 = 12 bands (default) 3 = 24 bands
No. Symbols for Broadcast	4 bits	No. Symbol, (default = 0)
No. Symbols for DL Band AMC	4 bits	No. Symbol, (default = 0)
No. Symbols for UL Band AMC	4 bits	No. Symbol, (default = 0)
}		
}		

New Format Indication

If this value set to 0, the format should be configured by the latest Format Configuration_IE in the previous frames. Otherwise, all parameters in Format Configuration IE should be configured. The configured parameters are valid for the following Compact_DL/UL_MAP_IE. At the start of each frame all parameters are set to default values.

CID Type

This value specifies CID type used in the Compact_DL/UL_MAP_IE.

Safety Pattern

If this value is less than 16, the number of safety bins is 12 and the indices of allocated bins for safety are $16m+x$, where x is the value of Safety Pattern and $m = 0 \dots 11$. If this value is not less than 16, the number of safety bins is 24 and the indices of allocated bins for safety are $16m+x'$ and $16m+(x'+8)$, where $x' = x - 16$ and $m = 0 \dots 11$.

Subchannel Type for Band AMC

This value specifies the subchannel type for Band AMC subchannel. See related PHY specification.

No. Symbols for Broadcast

This specifies the number of symbols allocated for Broadcast subchannel.

No. Symbols for DL Band AMC

This specifies the number of symbols allocated for DL Band AMC subchannel. The other DL symbols excluding the symbols for Broadcast and DL Band are allocated for the DL Normal subchannel.

No. Symbols for UL Band AMC

This specifies the number of symbols allocated for UL Band AMC subchannel. The other UL symbols excluding the symbols for UL Band are allocated for the UL Normal subchannel.

Max Logical Bands

This value specifies the maximum number of logical bands for Band AMC. The size of 3 fields (No. Selected Bands, Band BITMAP and Band Index) in the DL/UL-MAP_IE for Bands AMC depends on this value. Table 92 represents the fields in the DL/UL-MAP_IE and specific values.

Table 92—Field length for Band AMC MAP_IE

Logical Bands	24 Bands	12 Bands	6 Bands	3 Bands
Max Logical Bands	11	10	01	00
Nb-Band (# of bits for No. Selected Bands)	4 bits	4 bits	4 bits	0 bits
Nb-BITMAP (# of bits for Band BITMAP)	24 bits	12 bits	8 bits	4 bits
Nb-Index (# of bits for Band Index)	8 bits	4 bits	4 bits	0 bits

6.3.2.3.43.3 Reduced CID

Figure 93 presents the format of reduced CID. BS may use reduced CID instead of basic CID or multicast CID to reduce the size of HARQ MAP message. The type of reduced CID is determined by BS considering the range of basic CIDs of SS connected with the BS and specified by the RCID_Type field of the Format Configuration IE.

The reduced CID is composed of 1 bit of prefix and n-bits of LSB of CID of SS. The prefix is set to 1 for the broadcast CID or multicast CID and set to 0 for basic CID. The reduced CID cannot be used instead of transport CID, primary management CID, or secondary management CID.

Figure 22 shows the decoding of reduced CID when the RCID_Type is set to 3.

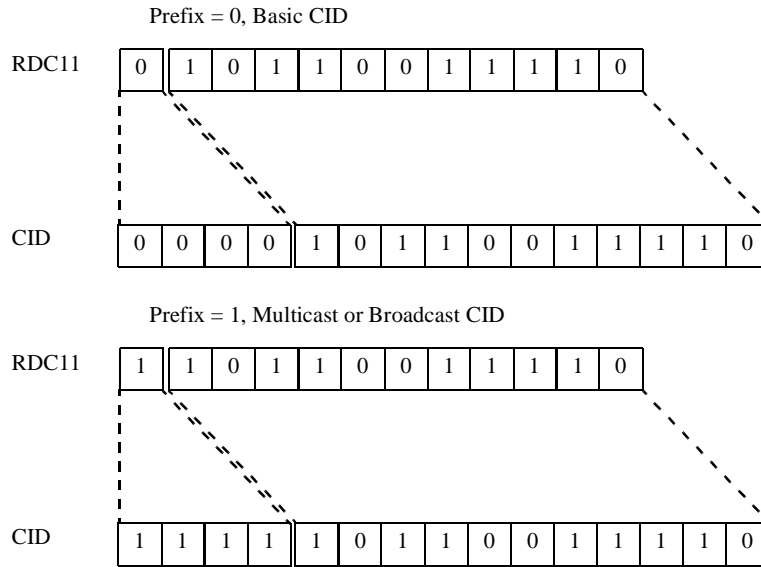

Figure 22—Reduced CID Decoding

Table 93—RCID_IE format

Syntax	Size	Notes
RCID_IE () {		
if (RCID_Type == 0) {		RCID_Type is specified in Format_Configuration IE
CID	16 bits	Normal CID
} else {		
Prefix	1 bit	For multicast, AAS, Padding and broadcast burst temporary disable RCID
if (Prefix == 1){		
RCID 11	11 bits	11 LSB of Multicast, AAS or Broadcast CID
} else {		
if (RCID_Type == 1) {		
RCID 11	11 bits	11 LSB of Basic CID
} else if (RCID_Type == 2) {		
RCID 7	7 bits	7 LSB of Basic CID
} else if (RCID_Type == 3) {		

Table 93—RCID_IE format (continued)

Syntax	Size	Notes
RCID 3	3 bits	3 LSB of Basic CID
}		
}		
}		
}		

CID

Normal 16 bits CID.

Prefix

A value of 1 indicates that 11 bits RCID for broadcast and multicast follows the prefix. Otherwise, the n-bits RCID for basic CID follows the prefix. The value of n is determined by the RCID_Type field in Format_Configuration_IE.

RCID n

n-bits LSB of CID.

6.3.2.3.43.4 H-ARQ control IE

The format of H-ARQ_Control_IE, which includes encoding/decoding information for H-ARQ enabled DL/UL bursts, is presented in Table 94. This IE shall be located in the compact DL/UL MAP_IE.

Table 94—H-ARQ_Control IE format

Syntax	Size	Notes
H-ARQ_Control_IE ()		
Prefix	1 bit	0 = Temporary disable H-ARQ 1 = enable H-ARQ
if (Prefix == 1) {		
AI_SN	1 bit	H-ARQ ID Seq. No
SPID	2 bits	Subpacket ID
ACID	4 bits	H-ARQ CH ID
} else {		
<i>reserved</i>	3 bits	Shall be set to zero
}		
}		

Prefix

Indicates whether H-ARQ is enabled or not.

AI_SN

Defines ARQ Identifier Sequence Number. This is toggled between “0” and “1” on successfully transmitting each encoder packet with the same ARQ channel.

SPID

Defines SubPacket ID, which is used to identify the four subpackets generated from an encoder packet.

ACID

Defines H-ARQ Channel ID, which is used to identify H-ARQ channels. Each connection can have multiple HARQ channels, each of which may have an encoder packet transaction pending.

6.3.2.3.43.5 CQICH Control IE

The format of CQICH Control IE is presented in Table 95.

Table 95—H-ARQ_Control IE format

Syntax	Size	Notes
CQICH_Control_IE () {		
CQICH indicator	1 bit	If the indicator is set to 1, the CQICH_Control IE follows.
if (CQICH indicator == 1) {		
Allocation Index	6 bits	Index to the channel in a frame the CQI report should be transmitted by the SS.
Period (p)	2 bits	A CQI feedback is transmitted on the CQI channels indexed by the (CQI Channel Index) by the SS in every 2^p frames.
Frame offset	3 bits	The MSS starts reporting at the frame of which the number has the same 3 LSB as the specified frame offset. If the current frame is specified, the MSS should start reporting in 8 frames
Duration (d)	4 bits	A CQI feedback is transmitted on the CQI channels indexed by the (CQI Channel Index) by the SS for $2^{(d-1)}$ frames. If d is 0b0000, the CQICH is de-allocated. If d is 0b1111, the MSS should report until the BS command for the MSS to stop.
} else {		
<i>reserved</i>	3 bits	Shall be set to zero
}		
}		

Allocation Index

Indicates its position from the start of the CQICH region.

Period

Informs the SS of the period of CQI reports.

Frame offset

Informs the SS of when to start. The SS starts reporting at the frame of which the number has the same 3 LSB as the specified frame offset. If the current frame is specified, the SS should start reporting in 8 frames.

Duration

Indicates when the SS should stop reporting unless the CQICH allocation is refreshed beforehand. If duration $d = 0b0000$, the BS is intended to de-allocate the CQICH. If $d = 0b1111$, the CQICH is allocated indefinitely and the SS should report until the BS commands the SS to stop, which happens it receives another MAP_IE with $d = 0b0000$.

6.3.2.3.43.6 Compact DL-MAP IE**6.3.2.3.43.6.1 Compact DL-MAP IE for normal subchannel**

The format of Compact DL-MAP IE for normal subchannel is presented in Table 96.

Table 96—H-ARQ Compact_DL-MAP IE format for normal subchannel

Syntax	Size	Notes
Compact_DL-MAP_IE () {		
DL-MAP Type =0	3 bits	
UL-MAP append	1 bit	
RCID_IE	<i>variable</i>	
N_{EP} code	4 bits	Code of encoder packet bits (see 8.4.9.2.3.5)
N_{SCH} code	4 bits	Code of allocated subchannels (see 8.4.9.2.3.5)
H-ARQ_Control_IE	<i>variable</i>	
CQICH_Control_IE	<i>variable</i>	
if (UL-MAP append) {		
N_{EP} code for UL	4 bits	
N_{SCH} code for UL	4 bits	
H-ARQ_Control_IE for UL	<i>variable</i>	
}		
}		

DL-MAP Type

This value specifies the type of the compact DL-MAP IE. A value of 0 indicates the Normal Subchannel.

UL-MAP append

A value of 1 indicates the uplink access information is appended to the end of the DL-MAP IE.

RCID_IE

Represent the assignment of the IE.

 N_{EP} code, N_{SCH} code

The combination of N_{EP} code and N_{SCH} code indicates the number of allocated subchannels and scheme of coding and modulation for the DL burst.

N_{EP} code for UL, N_{SCH} code for UL

The combination of N_{EP} code and N_{SCH} code indicates the number of allocated subchannels and scheme of coding and modulation for the UL burst.

6.3.2.3.43.6.2 Compact DL-MAP IE for Band AMC Subchannel

The format of Compact DL-MAP IE for Band AMC Subchannel is presented in Table 97.

Table 97—H-ARQ Compact_DL-MAP IE format for band AMC

Syntax	Size	Notes
Compact_DL-MAP_IE () {		
DL-MAP Type =1	3 bits	
<i>reserved</i>	1 bit	Shall be set to zero
RCID_IE	<i>variable</i>	
N_{EP} code	4 bits	Code of encoder packet bits (see 8.4.9.2.3.5)
N_{SCH} code	4 bits	Code of allocated subchannels (see 8.4.9.2.3.5)
Nband	Nb-Band bits	Number of bands, 0 = use BITMAP instead
if (Nband == 0) {		
Band BITMAP	Nb-BITMAP bits	n -th LSB is 1 if n -th band is selected
} else {		
for ($i=0; i < Nband; i++$)		
Band Index	Nb-Index bits	Band selection.
}		
Allocation Mode	2 bits	Indicates the subchannel allocation mode. 00 = same number of subchannels for the selected bands 01 = different number of subchannels for the selected bands 10 = total number of subchannels for the selected bands determined by N_{SCH} code and N_{EP} code 11 = reserved
<i>reserved</i>	2 bits	Shall be set to zero
if (Allocation Mode == 00){		
No. Subchannels	8 bits	
} else if (Allocation Mode == 01){		
for ($i=0; i < \text{band count}; i++$)		If Nband is 0, band count is the number of "1" in Band BITMAP. Otherwise band count is Nband.
No. Subchannels	8 bits	
}		

Table 97—H-ARQ Compact_DL-MAP IE format for band AMC (continued)

Syntax	Size	Notes
H-ARQ_Control_IE	<i>variable</i>	
CQICH_Control_IE	<i>variable</i>	
}		

DL-MAP Type

This value specifies the type of the compact DL-MAP IE. A value of 1 indicates the Band AMC Subchannel.

RCID_IE

Represents the assignment of the IE.

 N_{EP} code, N_{SCH} code

The combination of N_{EP} code and N_{SCH} code indicates the number of allocated subchannels and scheme of coding and modulation for the DL burst.

Nband

Indicates the number of bands selected for the burst. If this value is set to 0, the Band BITMAP is used to indicate the number and the position of selected bands instead. The number of the maximum logical bands determines the length of this field.

Band BITMAP

This BITMAP is valid when Nband is 0. The n -th LSB of the Band BITMAP is set to 1 when the n -th logical band is selected for the burst. If the number of the maximum logical bands is 12 then the length of the Band BITMAP is 12 bits. The band count is set to the number of “1”s in the Band BITMAP. The number of the maximum logical bands determines the length of this field.

Band Index

This value indexes the selected band offset and is valid when Nband is larger than 0. The number of the maximum logical bands determines the length of this field.

Allocation Mode

This value indicates the subchannel allocation mode in the selected bands. The value is set to binary 00 when the same numbers of subchannels are allocated in the selected bands by the “No. Subchannels” field. The value is set to 01 when different numbers of subchannels are allocated in each selected bands by the following fields “No. Subchannels.” The value is set to 10 when the total number of subchannels allocated in the selected bands is defined by N_{SCH} code and N_{EP} code. The subchannels fill from the bands with lowest index. The allocation mode variant is shown in Figure 23.

No. Subchannels

This value indicates the number of subchannels allocated for this burst.

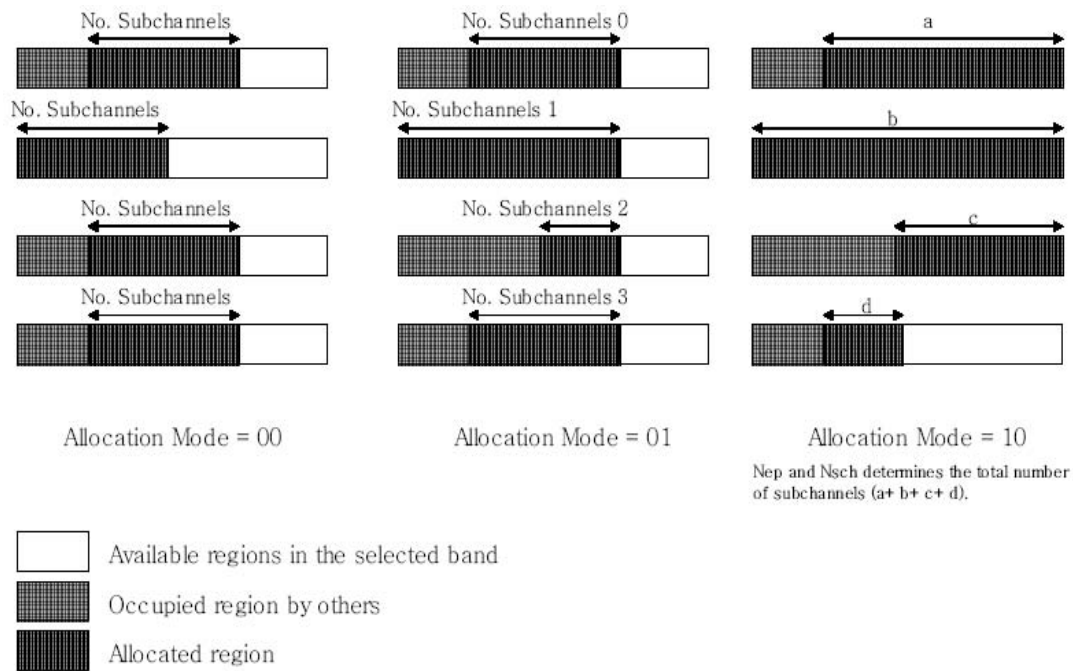

Figure 23—Subchannel allocation modes of Compact DL-MAP_IE for Band AMC

6.3.2.3.43.6.3 Compact DL-MAP IE for safety subchannel

The format of Compact DL-MAP IE for safety subchannel is presented in Table 98.

Table 98—H-ARQ Compact_DL-MAP IE format for safety

Syntax	Size	Notes
Compact_DL-MAP_IE () {		
DL-MAP Type =2	3 bits	
UL-MAP append	1 bit	
RCID_IE	<i>variable</i>	
N_{EP} code	4 bits	Code of encoder packet bits (see 8.4.9.2.3.5)
N_{SCH} code	4 bits	Code of allocated subchannels (see 8.4.9.2.3.5)
BIN offset	8 bits	
H-ARQ_Control_IE	<i>variable</i>	
CQICH_Control_IE	<i>variable</i>	
if (UL-MAP append) {		
N_{EP} code for UL	4 bits	Code of encoder packet bits (see 8.4.9.2.3.5)

Table 98—H-ARQ Compact_DL-MAP IE format for safety (continued)

Syntax	Size	Notes
N_{SCH} code for UL	4 bits	Code of allocated subchannels (see 8.4.9.2.3.5)
BIN offset for UL	8 bits	
H-ARQ_Control_IE for UL	<i>variable</i>	
}		
}		

DL-MAP Type

This value specifies the type of the compact DL-MAP IE. A value of 2 indicates the Safety Subchannel.

RCID_IE

Represent the assignment of the IE.

 N_{EP} code, N_{SCH} code

The combination of N_{EP} code and N_{SCH} code indicates the number of allocated subchannels and scheme of coding and modulation for the DL burst.

BIN Offset

The offset of the BIN allocated for this DL burst. See appropriate specification.

 N_{EP} code for UL, N_{SCH} code for UL

The combination of N_{EP} code and N_{SCH} code indicates the number of allocated subchannels and scheme of coding and modulation for the UL burst.

BIN Offset for UL

The offset of the BIN allocated for this UL burst. See appropriate specification.

6.3.2.3.43.6.4 Compact DL-MAP IE for DIUC subchannel

The format of Compact DL-MAP IE for DIUC subchannel is presented in Table 99.

Table 99—H-ARQ Compact_DL-MAP IE format for DIUC subchannel

Syntax	Size	Notes
Compact_DL-MAP_IE () {		
DL-MAP Type =3	3 bits	
<i>reserved</i>	1 bit	Shall be set to zero
DIUC	4 bits	
RCID_IE	<i>variable</i>	
No. Subchannels	8 bits	The number of subchannels allocated by the IE
}		

DL-MAP Type

This value specifies the type of the compact DL-MAP IE. A value of 3 indicates the DIUC type.

DIUC

This value indicates the usage of this burst.

RCID_IE

Represent the assignment of the IE.

No. Subchannels

This value indicates the number of subchannels allocated by the IE.

6.3.2.3.43.6.5 Compact DL-MAP IE for H-ARQ ACK BITMAP

The H-ARQ_ACK_Bitmap information for the H-ARQ enabled UL bursts is delivered through the Compact_DL-MAP_IE as shown in Table 100. The bit position in the bitmap is determined by the order of the H-ARQ enabled UL bursts in the UL-MAP. The frame offset between the UL burst and the H-ARQ-ACK-BITMAP is specified by “H-ARQ_ACK_Delay_for UL Burst” field in the DCD message.

For example, when an SS transmits a H-ARQ enabled burst at i -th frame and the burst is j -th H-ARQ enabled burst in the MAP, the SS should receive H-ARQ ACK at j -th bit of the BITMAP, which is sent by the BS at $i+(\text{frame offset})$ -th frame.

Table 100—H-ARQ Compact_DL-MAP IE format for H-ARQ BITMAP

Syntax	Size	Notes
Compact_DL-MAP_IE () {		
DL-MAP Type =5	3 bits	
<i>reserved</i>	1 bit	Shall be set to zero
BITMAP Length	4 bits	Length in bytes
BITMAP	<i>variable</i>	
}		

DL-MAP Type

Defines the type of Compact DL-MAP. If the type value is 5, the Compact DL-MAP is for H-ARQ-ACK-BITMAP.

BITMAP Length

Specifies the length of the following BITMAP field.

BITMAP

Includes H-ARQ ACK information for H-ARQ enabled UL bursts. The size of BITMAP should be equal or larger than the number of H-ARQ enabled UL-bursts.

6.3.2.3.43.6 Compact DL-MAP IE for extension

The format of Compact DL-MAP IE for extension is presented in Table 101.

Table 101—H-ARQ Compact_DL-MAP IE format for extension

Syntax	Size	Notes
Compact_DL-MAP_IE () {		
DL-MAP Type =7	3 bits	
DL-MAP subtype	5 bits	Extension subtype
Length	4 bits	Length of the IE in bytes
Payload	<i>variable</i>	Subtype dependent payload
}		

DL-MAP Type

This value specifies the type of the compact DL-MAP IE. A value of 7 indicates the extension type.

DL-MAP Subtype

This value specifies the subtype of the compact DL-MAP IE.

Length

This indicates the length of this IE in bytes. If an SS cannot recognize the DL-MAP Subtype, it skips the IE.

Payload

The payload depends on the value of DL-MAP Subtype. The length of payload is Length – 1 bytes.

6.3.2.3.43.7 UL-MAP IE

6.3.2.3.43.7.1 Compact UL-MAP IE for normal subchannel

The format of Compact UL-MAP IE for normal subchannel is presented in Table 102.

Table 102—H-ARQ Compact_UL-MAP IE format for normal subchannel

Syntax	Size	Notes
Compact_UL-MAP_IE () {		
UL-MAP Type =0	3 bits	
<i>reserved</i>	1 bit	Shall be set to zero
RCID_IE	<i>variable</i>	
N_{EP} code	4 bits	Code of encoder packet bits (see 8.4.9.2.3.5)
N_{SCH} code	4 bits	Code of allocated subchannels (see 8.4.9.2.3.5)
H-ARQ_Control_IE	<i>variable</i>	
}		

UL-MAP Type

This value specifies the type of the compact UL-MAP IE. A value of 0 indicates the Normal Subchannel.

RCID_IE

Represent the assignment of the IE.

 N_{EP} code, N_{SCH} code

The combination of N_{EP} code and N_{SCH} code indicates the number of allocated subchannels and scheme of coding and modulation for the UL burst.

6.3.2.3.43.7.2 Compact UL-MAP IE for Band AMC Subchannel

The format of Compact UL-MAP IE for Band AMC Subchannel is presented in Table 103.

Table 103—H-ARQ Compact_UL-MAP IE format for band AMC

Syntax	Size	Notes
Compact_UL-MAP_IE () {		
UL-MAP Type =band	3 bits	
<i>reserved</i>	1 bit	Shall be set to zero
RCID_IE	<i>variable</i>	
N_{EP} code	4 bits	Code of encoder packet bits (see 8.4.9.2.3.5)
N_{SCH} code	4 bits	Code of allocated subchannels (see 8.4.9.2.3.5)
Nband	Nb-Band bits	Indicates the number of selected bands. 0 = BITMAP indicates the number and offset of selected bands
if (Nband == 0) {		
Band BITMAP	Nb-BITMAP bits	n-th LSB is 1 if n-th band is selected
} else {		
for (i=0;i< Nband; i++)		
Band Index	Nb-Index bits	Band selection.
}		
Allocation Mode	2 bits	Indicates the subchannel allocation mode. 00 = same number of subchannels for the selected bands 01 = different number of subchannels for the selected bands 10 = total number of subchannels for the selected bands determined by N_{SCH} code 11 = reserved
<i>reserved</i>	2 bits	Shall be set to zero
if (Allocation Mode == 00){		
No. Subchannels	8 bits	
} else if (Allocation Mode == 1){		

Table 103—H-ARQ Compact_UL-MAP IE format for band AMC (continued)

Syntax	Size	Notes
for ($i=0; i < \text{band count}; i++$)		If Nband is 0, band count is the number of “1” in Band BITMAP. Otherwise band count is Nband.
No. Subchannels	8 bits	
}		
H-ARQ_Control_IE	<i>variable</i>	
}		

UL-MAP Type

This value specifies the type of the compact UL-MAP IE. A value of 1 indicates the Band AMC Subchannel.

RCID_IE

Represent the assignment of the IE.

 N_{EP} code, N_{SCH} code

The combination of N_{EP} code and N_{SCH} code indicates the number of allocated subchannels and scheme of coding and modulation for the UL burst.

Nband

Indicates the number of bands selected for the burst. If this value is set to 0, the Band BITMAP is used to indicate the number and the position of selected bands instead. The number of the maximum logical bands determines the length of this field.

Band BITMAP

This BITMAP is valid when Nband is 0. The n-th LSB of the Band BITMAP is set to 1 when the n-th logical band is selected for the burst. If the number of the maximum logical bands is 12, then the length of the Band BITMAP is 12 bits. The band count is set to the number of “1”s in the Band BITMAP. The number of the maximum logical bands determines the length of this field.

Band Index

This value indexes the selected band offset and is valid when Nband is larger than 0. The number of the maximum logical bands determines the length of this field.

Allocation Mode

This value indicates the subchannel allocation mode in the selected bands. The value is set to binary 00 when the same numbers of subchannels are allocated in the selected bands by the following field “No. Subchannels.” The value is set to 01 when different numbers of subchannels are allocated in each selected bands by the following fields “No. Subchannels.” The value is set to 10 when the total number of subchannels allocated in the selected bands is defined by N_{SCH} code and N_{EP} code. The subchannels fill from the bands with lowest index. The allocation mode variant is shown in Figure 23.

No. Subchannels

This value indicates the number of subchannels allocated for this burst.

6.3.2.3.43.7.3 Compact UL-MAP IE for safety subchannel

The format of Compact UL-MAP IE for safety subchannel is presented in Table 98.

Table 104—H-ARQ Compact_UL-MAP IE format for safety

Syntax	Size	Notes
Compact_UL-MAP_IE () {		
UL-MAP Type =2	3 bits	
<i>reserved</i>	1 bit	Shall be set to zero
RCID_IE	<i>variable</i>	
<i>N_{EP} code</i>	4 bits	Code of encoder packet bits (see 8.4.9.2.3.5)
<i>N_{SCH} code</i>	4 bits	Code of allocated subchannels (see 8.4.9.2.3.5)
BIN offset	8 bits	
H-ARQ_Control_IE	<i>variable</i>	
}		

UL-MAP Type

This value specifies the type of the compact UL-MAP IE. A value of 2 indicates the Safety Subchannel.

RCID_IE

Represents the assignment of the IE.

N_{EP} code, N_{SCH} code

The combination of *N_{EP} code* and *N_{SCH} code* indicates the number of allocated subchannels and scheme of coding and modulation for the UL burst.

BIN Offset

The offset of the BIN allocated for this UL burst.

6.3.2.3.43.7.4 Compact UL-MAP IE for UIUC subchannel

The format of Compact UL-MAP IE for UIUC subchannel is presented in Table 105.

Table 105—H-ARQ Compact_UL-MAP IE format for UIUC subchannel

Syntax	Size	Notes
Compact_UL-MAP_IE () {		
UL-MAP Type =4	3 bits	
<i>reserved</i>	1 bit	Shall be set to zero
UIUC	4 bits	

Table 105—H-ARQ Compact_UL-MAP IE format for UIUC subchannel (continued)

Syntax	Size	Notes
RCID_IE	<i>variable</i>	
No. Subchannels	8 bits	The number of subchannels allocated by the IE
}		

UL-MAP Type

This value specifies the type of the compact UL-MAP IE. A value of 3 indicates the UIUC type.

UIUC

This value indicates the usage of this burst.

RCID_IE

Represents the assignment of the IE.

No. Subchannels

This value indicates the number of subchannels allocated by the IE.

6.3.2.3.43.7.5 Compact UL-MAP IE for H-ARQ Region allocation

The H-ARQ ACK region information is delivered through the Compact_UL-MAP_IE as shown in Table 106. SS sends ACK information for H-ARQ enabled DL bursts in the H-ARQ region specified by the IE.

The subchannels in the H-ARQ region are divided into two half-subchannels. The first half-subchannel is composed of first, third, and fifth tiles, and the second half-subchannel is composed of second, fourth, and sixth tiles. In the H-ARQ Region, the $2n$ -th half-subchannel is the first half-subchannel and the $(2n+1)$ -th half-subchannel is the second half-subchannel of the n -th subchannel.

The H-ARQ enabled SS that receives H-ARQ DL burst at i -th frame should transmit ACK signal through the half-subchannel in the H-ARQ region at $(i+j)$ -th frame. The frame offset " j " is defined by the "H-ARQ ACK Delay for DL Burst" field in the UCD message. The half-subchannel offset in the H-ARQ Region is determined by the order of H-ARQ enabled DL burst in the H-ARQ MAP. For example, when an SS receives a H-ARQ enabled burst at i -th frame and the burst is n -th H-ARQ enabled burst in the H-ARQ MAP, the SS should transmit H-ARQ ACK at n -th half-subchannel in H-ARQ Region that is allocated by the BS at the $(i+j)$ -th frame.

Table 106—H-ARQ Compact_UL-MAP IE format for H-ARQ Region allocation

Syntax	Size	Notes
Compact_UL-MAP_IE () {		
UL-MAP Type =4	3 bits	
H-ARQ Region Change Indication	1 bit	0: no region change 1: region changed
if (H-ARQ Region Change Indication == 1) {		
OFDMA Symbol offset	8 bits	
Subchannel offset	8 bits	
No. OFDMA Symbols	8 bits	

Table 106—H-ARQ Compact_UL-MAP IE format for H-ARQ Region allocation (continued)

Syntax	Size	Notes
No. Subchannels	8 bits	
}		
}		

UL-MAP Type

Defines the type of Compact UL-MAP. If the type value is 4, the Compact UL-MAP is for H-ARQ Region allocation.

H-ARQ Region Change Indication

Indicates whether the region for H-ARQ ACK is changed or not.

OFDMA Symbol offset**Subchannel offset****No. OFDMA Symbols****No. Subchannels**

Specify the start symbol offset, the start subchannel offset, the number of allocated symbols, and the number of subchannels for the H-ARQ acknowledgement region respectively.

6.3.2.3.43.7.6 Compact UL-MAP IE for CQICH Region allocation

The CQI region information is delivered through the Compact_UL-MAP_IE as shown in Table 107. SS sends CQI report in CQI region.

Table 107—H-ARQ Compact_UL-MAP IE format for CQI Region allocation

Syntax	Size	Notes
Compact_UL-MAP_IE () {		
UL-MAP Type =5	3 bits	
CQI Region Change Indication	1 bit	0: no region change 1: region changed
if (CQI Region Change Indication == 1) {		
OFDMA Symbol offset	8 bits	
Subchannel offset	8 bits	
No. OFDMA Symbols	8 bits	
No. Subchannels	8 bits	
}		
}		

UL-MAP Type

Defines the type of Compact UL-MAP. If the type value is 5, the Compact UL-MAP is for CQI Region allocation.

CQI Region Change Indication

Indicates whether the region for CQI is changed or not.

OFDMA Symbol offset**Subchannel offset****No. OFDMA Symbols****No. Subchannels**

Specify the start symbol offset, the start subchannel offset, the number of allocated symbols, and the number of subchannels for the CQI report region respectively.

6.3.2.3.43.7 Compact UL-MAP IE for extension

The format of Compact UL-MAP IE for extension is presented in Table 108.

Table 108—H-ARQ Compact_UL-MAP IE format for extension

Syntax	Size	Notes
Compact_UL-MAP_IE () {		
UL-MAP Type =7	3 bits	
UL-MAP subtype	5 bits	Extension subtype
Length	4 bits	Length of the IE in bytes
Payload	<i>variable</i>	Subtype dependent payload
}		

UL-MAP Type

Specifies the type of the compact UL-MAP IE. A value of 7 indicates the extension type.

UL-MAP Subtype

Specifies the subtype of the compact UL-MAP IE.

Length

Indicates the length of this IE in bytes. If an SS cannot recognize the UL-MAP Subtype, it skips the IE.

Payload

The payload depends on the value of UL-MAP Subtype. The length of payload is Length – 1 bytes.

6.3.3 Construction and transmission of MAC PDUs

The construction of a MAC PDU is illustrated in Figure 24.

6.3.3.1 Conventions

Data shall be transmitted in accordance with the following rules:

- Fields of MAC messages are transmitted in the same order as they appear in the corresponding tables in this standard.
- Fields of MAC messages and fields of TLVs, which are specified in this standard as binary numbers (including CRC and HCS), are transmitted as a sequence of their binary digits, starting from MSB. Bit masks (for example, in ARQ) are considered numerical fields. For signed numbers MSB is

allocated for the sign. Length field in the “definite form” of ITU-T X.690 is also considered a numerical field.

- c) Fields specified as SDUs or SDU fragments (for example, MAC PDU payloads) are transmitted in the same order of bytes as received from upper layers.
- d) Fields specified as strings are transmitted in the order of symbols in the string.

In cases c) and d), bits within a byte are transmitted in the order “MSB first.”

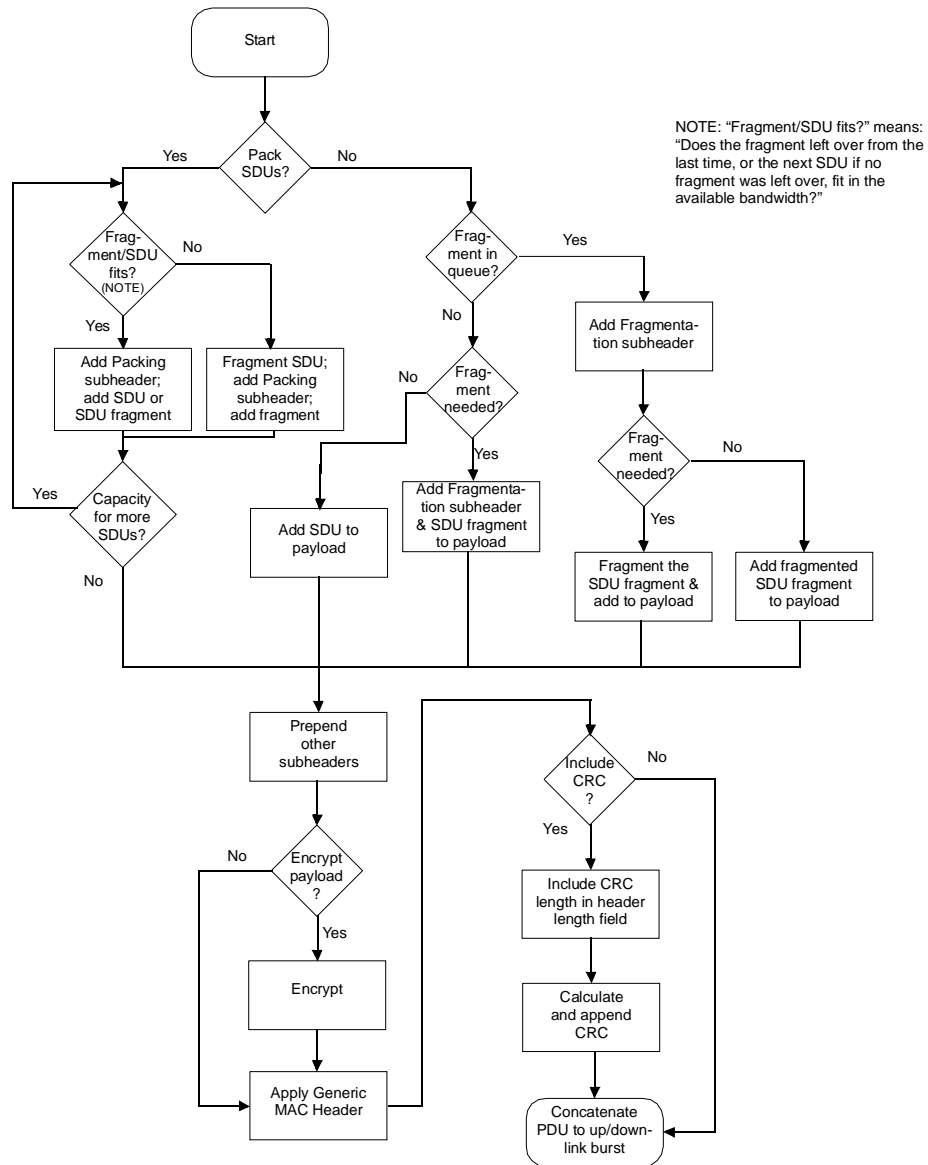

Figure 24—Construction of a MAC PDU

6.3.3.2 Concatenation

Multiple MAC PDUs may be concatenated into a single transmission in either the uplink or downlink directions. Figure 25 illustrates this concept for an uplink burst transmission. Since each MAC PDU is identified by a unique CID, the receiving MAC entity is able to present the MAC SDU (after reassembling the MAC SDU from one or more received MAC PDUs) to the correct instance of the MAC SAP. MAC Management messages, user data, and bandwidth request MAC PDUs may be concatenated into the same transmission.

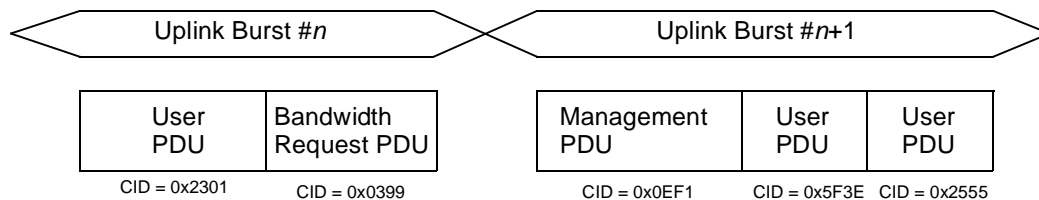

Figure 25—MAC PDU concatenation showing example CIDs

6.3.3.3 Fragmentation

Fragmentation is the process by which a MAC SDU is divided into one or more MAC PDUs. This process is undertaken to allow efficient use of available bandwidth relative to the QoS requirements of a connection's service flow. Capabilities of fragmentation and reassembly are mandatory.

The authority to fragment traffic on a connection is defined when the connection is created by the MAC SAP. Fragmentation may be initiated by a BS for downlink connections and by an SS for uplink connections.

Fragments are tagged with their position in their parent SDU in accordance with Table 109.

Table 109—Fragmentation rules

Fragment	Fragmentation control (FC)
First Fragment	10
Continuing Fragment	11
Last Fragment	01
Unfragmented	00

6.3.3.3.1 Non-ARQ Connections

For non-ARQ connections, fragments are transmitted once and in sequence. The sequence number assigned to each fragment allows the receiver to recreate the original payload and to detect the loss of any intermediate packets. A connection may be in only one fragmentation state at any given time.

Upon loss, the receiver shall discard all MAC PDUs on the connection until a new first fragment is detected or a non-fragmented MAC PDU is detected.

6.3.3.3.2 ARQ-Enabled Connections

For ARQ-enabled connections, fragments are formed for each transmission by concatenating sets of ARQ blocks with adjacent sequence numbers (see 6.3.4.2). The BSN value carried in the fragmentation subheader is the BSN for the first ARQ block appearing in the segment.

6.3.3.4 Packing

If packing is turned on for a connection, the MAC may pack multiple MAC SDUs into a single MAC PDU. Packing makes use of the connection attribute indicating whether the connection carries fixed-length or variable-length packets. The transmitting side has full discretion whether or not to pack a group of MAC SDUs in a single MAC PDU. The capability of unpacking is mandatory.

The construction of PDUs varies for ARQ and non-ARQ connections with respect to packing and fragmentation syntax. The packing and fragmentation mechanisms for both the ARQ and non-ARQ connections are specified in 6.3.3.4.1 through 6.3.3.4.3.

6.3.3.4.1 Packing for non-ARQ connections

6.3.3.4.1.1 Packing fixed-length MAC SDUs

For connections that do not use ARQ and are indicated by the fixed-length versus variable-length SDU indicator (11.13.15), to carry fixed-length MAC SDUs, the packing procedure described in this subclause may be used. For all other non-ARQ connections, the variable length packing algorithm described in 6.3.3.4.1.2 shall be used.

For packing with fixed-length blocks, the Request/Transmission Policy (11.13.12) shall be set to allow packing and prohibit fragmentation, and the SDU size (11.13.16) shall be included in DSA-REQ message when establishing the connection. The length field of the MAC header implicitly indicates the number of MAC SDUs packed into a single MAC PDU. If the MAC SDU size is n bytes, the receiving side can unpack simply by knowing that the length field in the MAC header will be $n \times k + j$, where k is the number of MAC SDUs packed into the MAC PDU and j is the size of the MAC header and any prepended MAC subheaders. A MAC PDU containing a packed sequence of fixed-length MAC SDUs would be constructed as in Figure 26. Note that there is no added overhead due to packing in the fixed-length MAC SDU case, and a single MAC SDU is simply a packed sequence of length l .

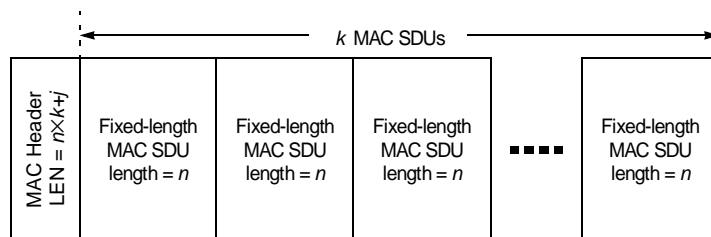

Figure 26—Packing fixed-length MAC SDUs into a single MAC PDU

6.3.3.4.1.2 Packing variable-length MAC SDUs

When packing variable-length SDU connections, such as 802.3/Ethernet, the $n \times k + j$ relationship between the MAC header's length field and the higher-layer MAC SDUs no longer holds. This necessitates indication of where one MAC SDU ends and another begins. In the variable-length MAC SDU case, the MAC attaches a Packing subheader to each MAC SDU. This subheader is described in 6.3.2.2.3.

A MAC PDU containing a packed sequence of variable-length MAC SDUs is constructed as shown in Figure 27. If more than one MAC SDU is packed into the MAC PDU, the type field in the MAC header indicates the presence of Packing subheaders (PSHs). Note that unfragmented MAC SDUs and MAC SDU fragments may both be present in the same MAC PDU (see Figure 28).

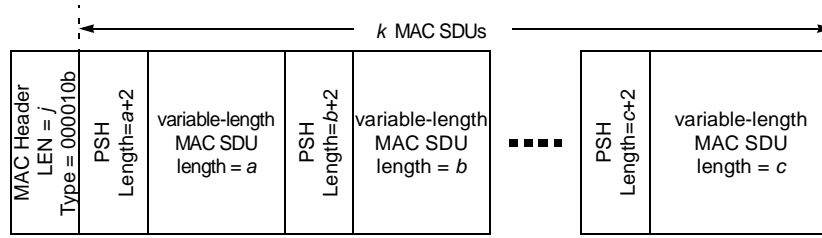

Figure 27—Packing variable-length MAC SDUs into a single MAC PDU

Simultaneous fragmentation and packing allows efficient use of the airlink, but requires guidelines to be followed so it is clear which MAC SDU is currently in a state of fragmentation. To accomplish this, when a Packing subheader is present, the fragmentation information for individual MAC SDUs or MAC SDU fragments is contained in the corresponding Packing subheader. If no PSH is present, the fragmentation information for individual MAC SDU fragments is contained in the corresponding Fragmentation subheader (FSH). This is shown in Figure 28.

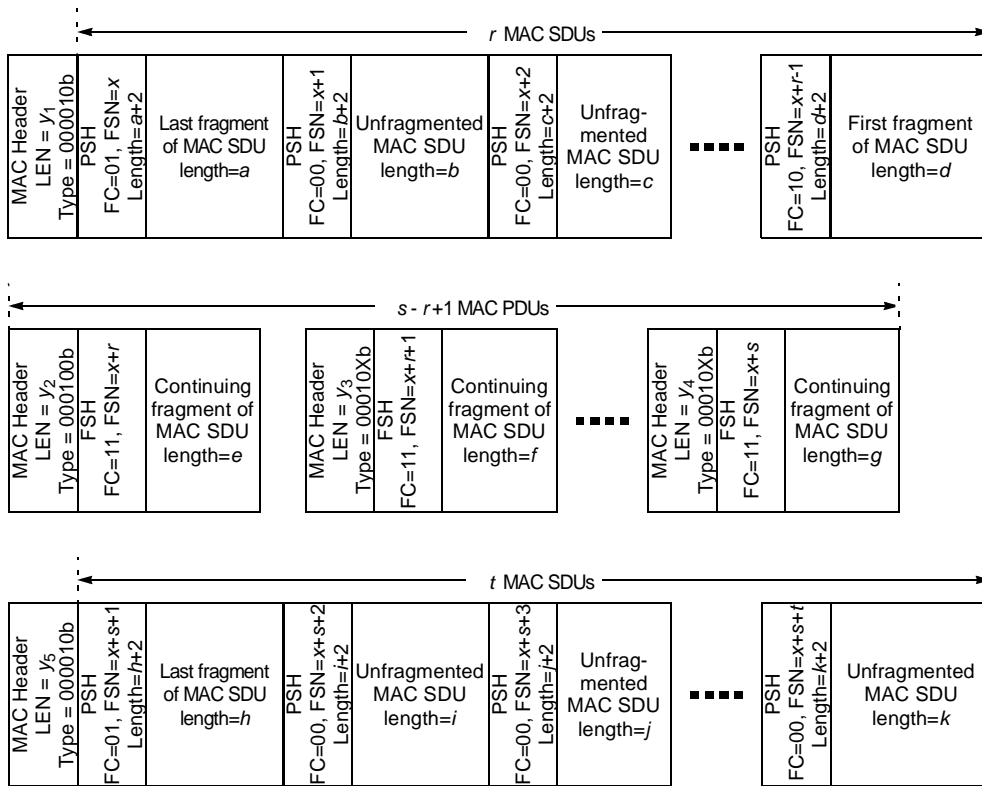

Figure 28—Packing with fragmentation

Note that while it is legal to have continuation fragments packed with other fragments, the circumstances for creating continuation fragments would preclude this from happening.

6.3.3.4.2 Packing for ARQ-enabled connections

The use of Packing subheaders for ARQ-enabled connections is similar to that for non-ARQ connections as described in 6.3.3.4.1.2, except that ARQ-enabled connections shall set the Extended Type bit (see Table 6) in the generic MAC header to 1. If packing is turned on for a connection, the MAC may pack multiple MAC SDUs into a single MAC PDU. The transmitting side has full discretion whether or not to pack a group of MAC SDUs and/or fragments in a single MAC PDU.

The packing of variable-length MAC SDUs for the ARQ-enabled connections is similar to that of non-ARQ connections, when fragmentation is enabled. The BSN of the Packing subheader shall be used by the ARQ protocol to identify and retransmit lost fragments.

For ARQ-enabled connections, when the type field indicates Packing subheaders are in use, fragmentation information for each individual MAC SDU or MAC SDU fragment is contained in the associated Packing subheader. When the type field indicates that packing is not in use, fragmentation information for the MAC PDU's single payload (MAC SDU or MAC SDU fragment) is contained in the fragmentation header appearing in the message. Figure 29 illustrates the use of Fragmentation subheader without packing.

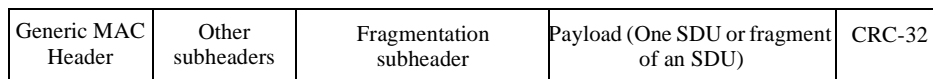

Figure 29—Example MAC PDU with extended Fragmentation subheaders

Figure 30 illustrates the structure of a MAC PDU with ARQ Packing subheaders. Each of the packed MAC SDU or MAC SDU fragments or ARQ feedback payload requires its own Packing subheader and some of them may be transmissions while others are retransmissions.

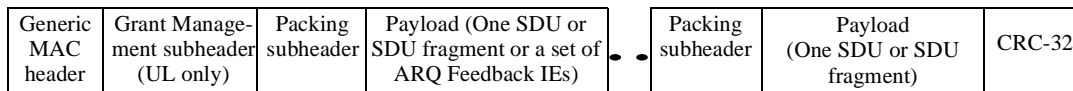

Figure 30—Example MAC PDU with ARQ Packing subheader

A MAC SDU may be partitioned into multiple fragments that are then packed into the same MAC PDU for the first transmission. MAC PDUs may have fragments from the same or different SDUs, including a mix of first transmissions and retransmissions. The 11-bit BSN and 2-bit FC fields uniquely identify each fragment or non-fragmented SDU.

6.3.3.4.3 Packing ARQ Feedback IEs

An ARQ Feedback Payload (see Table 110) consists of one or more ARQ Feedback IEs (see 6.3.4.2). The ARQ Feedback Payload may be sent on an ARQ or non-ARQ connection; however, policies based on implementation and/or QoS constraints may restrict the use of certain connections for transporting ARQ Feedback

Payload. The ARQ Feedback Payload is treated like any other payload (SDU or fragments) from the packing perspective, except that only one ARQ Feedback Payload shall be present within a single MAC PDU.

Table 110—ARQ Feedback Payload format

Syntax	Size	Notes
ARQ_Feedback_Payload_Format() {		
do		
ARQ_Feedback_IE(last)	<i>variable</i>	Insert as many as desired, until last==TRUE. See 6.3.4.2.
until (last)		
}		

The presence of an ARQ Feedback Payload in a MAC PDU is indicated by the value of the ARQ Feedback Payload bit in the Type field (see Table 6) in the generic MAC header. When present, the first packed payload shall be the ARQ Feedback Payload. The Packing subheader preceding the ARQ Feedback Payload indicates the total length of the payload including the Packing subheader and all ARQ Feedback IEs within the payload. The FSN/BSN field of the Packing subheader shall be ignored for the ARQ Feedback Payload and the FC bits shall be set to 00.

6.3.3.5 CRC calculation

A service flow may require that a CRC be added to each MAC PDU carrying data for that service flow (11.13.12). In this case, for each MAC PDU with HT=0, a CRC (as defined in IEEE Std 802.3), shall be appended to the payload of the MAC PDU; i.e., request MAC PDUs are unprotected. The CRC shall cover the generic MAC header and the Payload of the MAC PDU. The CRC shall be calculated after encryption; i.e., the CRC protects the Generic Header and the ciphered Payload.

6.3.3.6 Encryption of MAC PDUs

When transmitting a MAC PDU on a connection that is mapped to an SA, the sender shall perform encryption and data authentication of the MAC PDU payload as specified by that SA. When receiving a MAC PDU on a connection mapped to an SA, the receiver shall perform decryption and data authentication of the MAC PDU payload, as specified by that SA.

The generic MAC header shall not be encrypted. The Header contains all the Encryption information [EC Field, encryption key sequence (EKS) Field, and CID] needed to decrypt a Payload at the receiving station. This is illustrated in Figure 31.

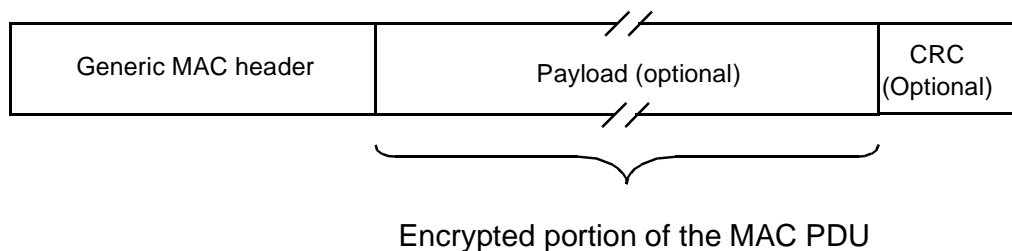

Figure 31—MAC PDU encryption

Two bits of a MAC Header contain a key sequence number. Note that the keying material associated with an SA has a limited lifetime, and the BS periodically refreshes an SA's keying material. The BS manages a 2-bit key sequence number independently for each SA and distributes this key sequence number along with the SA's keying material to the client SS. The BS increments the key sequence number with each new generation of keying material. The MAC Header includes this sequence number to identify the specific generation of that SA keying material being used to encrypt the attached payload. Being a 2-bit quantity, the sequence number wraps around to 0 when it reaches 3.

Comparing a received MAC PDU's key sequence number with what it believes to be the "current" key sequence number, the SS or the BS can easily recognize a loss of key synchronization with its peer. An SS shall maintain the two most recent generations of keying material for each SA. Keeping on hand the two most recent key generations is necessary for maintaining uninterrupted service during an SA's key transition.

Encryption of the payload is indicated by the EC bit field. A value of 1 indicates the payload is encrypted and the EKS field contains meaningful data. A value of 0 indicates the payload is not encrypted. Any unencrypted MAC PDU received on a connection mapped to an SA requiring encryption shall be discarded.

6.3.3.7 Padding

Allocated space within a data burst that is unused shall be initialized to a known state. This may be accomplished by setting each unused byte to the stuff byte value (0xFF). If the size of the unused region is at least the size of a MAC header, the region may also be initialized by formatting the unused space as an MAC PDU. When doing so, the MAC header CID field shall be set to the value of the Padding CID (see Table 345), the CI, EC, HT, and Type fields shall be set to zero, the length field shall be set to the number of unused bytes (including the size of the MAC header created for the padding MAC PDU) in the data burst, and the HCS shall be computed in the normal way.

6.3.4 ARQ mechanism

ARQ shall not be used with the PHY specification defined in 8.1.

The ARQ mechanism is a part of the MAC, which is optional for implementation. When implemented, ARQ may be enabled on a per-connection basis. The per-connection ARQ shall be specified and negotiated during connection creation. A connection cannot have a mixture of ARQ and non-ARQ traffic. Similar to other properties of the MAC protocol the scope of a specific instance of ARQ is limited to one unidirectional connection.

For ARQ-enabled connections, enabling of fragmentation is optional. When fragmentation is enabled, the transmitter may partition each SDU into fragments for separate transmission based on the value of the ARQ_BLOCK_SIZE parameter. When fragmentation is not enabled, the connection shall be managed as if fragmentation was enabled. In this case, regardless of the negotiated block size, each fragment formed for transmission shall contain all the blocks of data associated with the parent SDU.

The ARQ feedback information can be sent as a standalone MAC management message on the appropriate basic management connection, or piggybacked on an existing connection. ARQ feedback cannot be fragmented. The implementation of ARQ is optional.

6.3.4.1 ARQ Block Usage

A MAC SDU is logically partitioned into blocks whose length is specified by the connection TLV parameter ARQ_BLOCK_SIZE. When the length of the SDU is not an integer multiple of the connection's block size, the final block of the SDU is formed using the SDU bytes remaining after the final full block has been determined.

Once an SDU is partitioned into a set of blocks, that partitioning remains in effect until all blocks of the SDU are successfully delivered to the receiver, or the SDU is discarded by the transmitter state machine.

Sets of blocks selected for transmission or retransmission are encapsulated into a PDU. A PDU may contain blocks that are transmitted for the first time as well as those being retransmitted. Fragmentation shall occur only on ARQ block boundaries. If a PDU is not packed, all the blocks in that PDU must have contiguous block numbers. When a PDU is packed, the sequence of blocks immediately between MAC subheaders and the sequence of blocks after the last packing subheader must have contiguous block numbers.

If ARQ is enabled at the connection, Fragmentation and Packing subheaders contain a BSN, which is the sequence number of the first ARQ block in the sequence of blocks following the subheader. It is a matter of transmitter policy whether or not a set of blocks once transmitted as a single PDU should be retransmitted also as a single PDU. Figure 32 illustrates the use of blocks for ARQ transmissions and retransmissions; two options for retransmission are presented—with and without rearrangements of blocks.

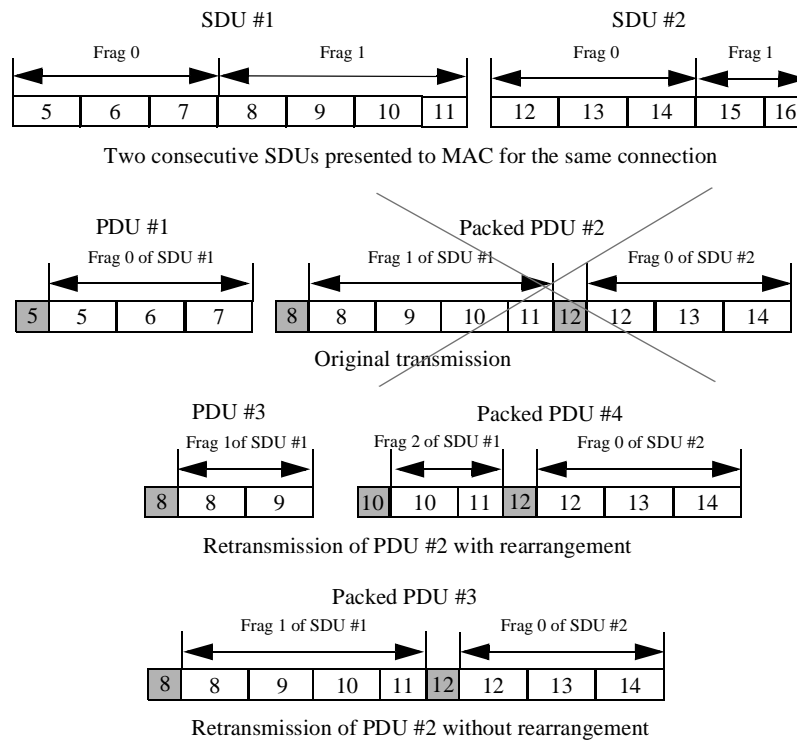

Figure 32—Block usage examples for ARQ with and without rearrangement

6.3.4.2 ARQ Feedback IE format

Table 111 defines the ARQ Feedback IE used by the receiver to signal positive or negative acknowledgments. A set of IEs of this format may be transported either as a packed payload (“piggybacked”) within a packed MAC PDU or as a payload of a standalone MAC PDU.

Table 111—ARQ Feedback IE

Syntax	Size	Notes
ARQ_feedback_IE (LAST) {	<i>variable</i>	
CID	16 bits	The ID of the connection being referenced
LAST	1 bit	0 = More ARQ feedback IE in the list 1 = Last ARQ feedback IE in the list
ACK Type	2 bits	0x0 = Selective ACK entry 0x1 = Cumulative ACK entry 0x2 = Cumulative with Selective ACK entry 0x3 = Cumulative ACK with Block Sequence Ack entry
BSN	11 bits	
Number of ACK Maps	2 bits	If ACK Type == 01, the field is reserved and set to 00. Otherwise the field indicates the number of ACK maps: 0x0 = 1, 0x1 = 2, 0x2 = 3, 0x3 = 4
if (ACK Type != 01) {		
for (<i>i</i> =0; <i>i</i> < Number of ACK Maps + 1; ++ <i>i</i>) {		
if (ACK Type != 3) {		
Selective ACK Map	16 bits	
}		
else {		Start of Block Sequence ACK Map definition (16 bits)
Sequence Format	1 bit	Number of block sequences associated with descriptor 0: 2 block sequences 1: 3 block sequences
if (Sequence Format = 0) {		
Sequence ACK Map	2 bits	
Sequence 1 Length	6 bits	
Sequence 2 Length	6 bits	
<i>Reserved</i>	1 bit	
}		
else {		
Sequence ACK Map	3 bits	
Sequence 1 Length	4 bits	
Sequence 2 Length	4 bits	

Table 111—ARQ Feedback IE (continued)

Syntax	Size	Notes
Sequence 3 Length	4 bits	
}		
}		End of Block Sequence ACK Map definition
}		
}		
}		

BSN

If (ACK Type == 0x0): BSN value corresponds to the most significant bit of the first 16-bit ARQ ACK map.

If (ACK Type == 0x1): BSN value indicates that its corresponding block and all blocks with lesser (see 6.3.4.6.1) values within the transmission window have been successfully received.

If (ACK Type == 0x2): Combines the functionality of types 0x0 and 0x1.

If (ACK Type == 0x3): Combines the functionality of type 0x1 with the ability to acknowledge reception of ARQ blocks in terms of block sequences. A block sequence is defined as a set of ARQ blocks with consecutive BSN values. With this option, members of block sequences are identified and associated with the same reception status indication.

Selective ACK Map

Each bit set to one indicates the corresponding ARQ block has been received without errors. The bit corresponding to the BSN value in the IE, is the most significant bit of the first map entry. The bits for succeeding block numbers are assigned left-to-right (MSB to LSB) within the map entry. If the ACK Type is 0x2, then the most significant bit of the first map entry shall be set to one and the IE shall be interpreted as a cumulative ACK for the BSN value in the IE. The rest of the bitmap shall be interpreted similar to ACK Type 0x0.

Sequence ACK Map

Each bit set to one indicates the corresponding block sequence has been received without error. The MSB of the field corresponds to the first sequence length field in the descriptor. The bits for succeeding length fields are assigned left-to-right within the map entry.

Since the block sequence described by the first descriptor of the first map entry of the IE corresponds to the sequence of blocks immediately after the Cumulative ACK, the ACK map bit for this sequence shall be zero indicating this sequence has not yet been received.

Sequence Length

This value indicates the number of blocks that are members of the associated sequence.

The BSN of the first block of the block sequence described by the first descriptor of the first IE map entry is the value of the Cumulative ACK plus one. The BSN of the first block of each block sequence is determined by adding the BSN of the first block of the previous block sequence to the length of that sequence. Within a map entry, Sequence Map/Length ordering follows the rule

specified in the definition of Sequence ACK Map. Across map entries, ordering moves from the first map entry ($i = 0$) to the last map entry ($i = \mathbf{Number\ of\ ACK\ Maps}$).

6.3.4.3 ARQ parameters

6.3.4.3.1 ARQ_BSN_MODULUS

ARQ_BSN_MODULUS is equal to the number of unique BSN values, i.e., 2^{11} .

6.3.4.3.2 ARQ_WINDOW_SIZE

ARQ_WINDOW_SIZE is the maximum number of unacknowledged ARQ blocks at any given time. An ARQ block is unacknowledged if it has been transmitted but no acknowledgment has been received.

ARQ_WINDOW_SIZE shall be less than or equal to half of the *ARQ_BSN_MODULUS*.

6.3.4.3.3 ARQ_BLOCK_LIFETIME

ARQ_BLOCK_LIFETIME is the maximum time interval an ARQ block shall be managed by the transmitter ARQ state machine, once initial transmission of the block has occurred. If transmission (or subsequent retransmission) of the block is not acknowledged by the receiver before the time limit is reached, the block is discarded.

6.3.4.3.4 ARQ_RETRY_TIMEOUT

ARQ_RETRY_TIMEOUT is the minimum time interval a transmitter shall wait before retransmission of an unacknowledged block for retransmission. The interval begins when the ARQ block was last transmitted.

6.3.4.3.5 ARQ_SYNC_LOSS_TIMEOUT

ARQ_SYNC_LOSS_TIMEOUT is the maximum time interval *ARQ_TX_WINDOW_START* or *ARQ_RX_WINDOW_START* shall be allowed to remain at the same value before declaring a loss of synchronization of the sender and receiver state machines when data transfer is known to be active. The ARQ receiver and transmitter state machines manage independent timers. Each has its own criteria for determining when data transfer is “active” (see 6.3.4.6.2 and 6.3.4.6.3).

6.3.4.3.6 ARQ_RX_PURGE_TIMEOUT

ARQ_RX_PURGE_TIMEOUT is the time interval the receiver shall wait after successful reception of a block that does not result in advancement of *ARQ_RX_WINDOW_START*, before advancing *ARQ_RX_WINDOW_START* (see 6.3.4.6.3).

6.3.4.3.7 ARQ_BLOCK_SIZE

ARQ_BLOCK_SIZE is the length used for partitioning an SDU into a sequence of ARQ blocks prior to transmission (see 6.3.4.1)

6.3.4.4 ARQ procedures

6.3.4.4.1 ARQ state machine variables

All ARQ state machine variables are set to 0 at connection creation or by an ARQ reset operation.

6.3.4.4.1.1 Transmitter variables

ARQ_TX_WINDOW_START: All BSN up to (*ARQ_TX_WINDOW_START* - 1) have been acknowledged.

ARQ_TX_NEXT_BSN: BSN of the next block to send. This value shall reside in the interval *ARQ_TX_WINDOW_START* to (*ARQ_TX_WINDOW_START* + *ARQ_WINDOW_SIZE*), inclusive.

6.3.4.4.1.2 Receiver variables

ARQ_RX_WINDOW_START: All BSN up to (*ARQ_RX_WINDOW_START* - 1) have been correctly received.

ARQ_RX_HIGHEST_BSN: BSN of the highest block received, plus one. This value shall reside in the interval *ARQ_RX_WINDOW_START* to (*ARQ_RX_WINDOW_START* + *ARQ_WINDOW_SIZE*), inclusive.

6.3.4.5 ARQ-enabled connection setup and negotiation

Connections are set up and defined dynamically through the DSA/DSC class of messages. CRC-32 shall be used for error detection of PDUs for all ARQ-enabled connections. All the ARQ parameters (see 6.3.4.3) shall be set when an ARQ-enabled connection is set up. The transmitter and receiver variables (defined in 6.3.4.4.1) shall be reset on connection setup.

6.3.4.6 ARQ operation

6.3.4.6.1 Sequence number comparison

Transmitter and receiver state machine operations include comparing BSNs and taking actions based on which is larger or smaller. In this context, it is not possible to compare the numeric sequence number values directly to make this determination. Instead, the comparison shall be made by normalizing the values relative to the appropriate state machine base value and the maximum value of sequence numbers, *ARQ_BSN_MODULUS*, and then comparing the normalized values. Normalization is accomplished by using Equation (8).

$$\text{bsn}' = (\text{bsn} - \text{BSN_base}) \bmod \text{ARQ_BSN_MODULUS} \quad (8)$$

The base values for the receiver and transmitter state machines are *ARQ_TX_WINDOW_START* and *ARQ_RX_WINDOW_START*, respectively.

6.3.4.6.2 Transmitter state machine

An ARQ block may be in one of the following four states—not-sent, outstanding, discarded, and waiting-for-retransmission. Any ARQ block begins as not-sent. After it is sent it becomes outstanding for a period of time termed *ACK_RETRY_TIMEOUT*. While a block is in outstanding state, it is either acknowledged and discarded, or transitions to waiting-for-retransmission after *ACK_RETRY_TIMEOUT* or NACK. An ARQ block can become waiting-for-retransmission before the *ACK_RETRY_TIMEOUT* period expires if it is negatively acknowledged. An ARQ block may also change from waiting-for-retransmission to discarded when an ACK message for it is received or after a timeout *ARQ_BLOCK_LIFETIME*.

For a given connection the transmitter shall first handle (transmit or discard) blocks in “waiting-for-retransmission” state and only then blocks in “non-sent” state. Blocks in “outstanding” or “discarded” state shall not be transmitted. When blocks are retransmitted, the block with the lowest BSN shall be retransmitted first.

The ARQ transmit block state sequence is shown in Figure 33.

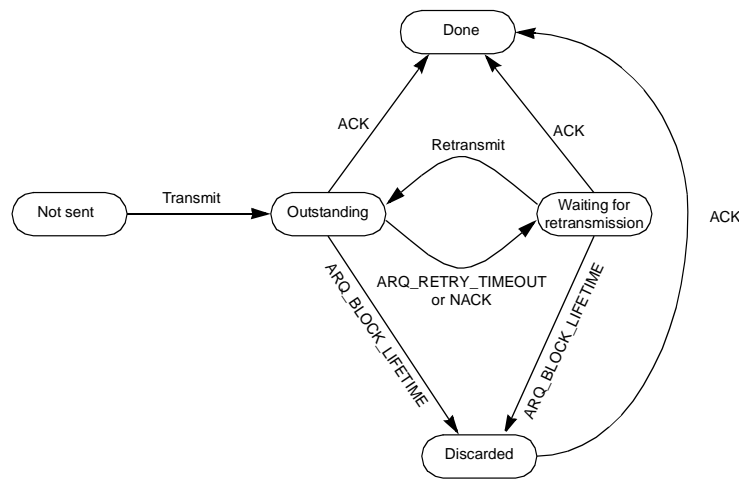

Figure 33—ARQ transmit block states

MAC PDU formation continues with a connection's "not-sent" MAC SDUs. The transmitter builds each MAC PDU using the rules for fragmentation and packing as long as the number of blocks to be sent plus the number of block already transmitted and awaiting retransmission does not exceed the limit imposed by *ARQ_WINDOW_SIZE*. As each "not-sent" block is formed and included in a MAC PDU, it is assigned the current value of *ARQ_TX_NEXT_BSN*, which is then incremented.

When an acknowledgment is received, the transmitter shall check the validity of the BSN. A valid BSN is one in the interval *ARQ_TX_WINDOW_START* to *ARQ_TX_NEXT_BSN* - 1 (inclusive). If BSN is not valid, the transmitter shall ignore the acknowledgment.

When a cumulative acknowledgment with a valid BSN is received, the transmitter shall consider all blocks in the interval *ARQ_TX_WINDOW_START* to BSN (inclusive) as acknowledged and set *ARQ_TX_WINDOW_START* to BSN + 1.

When a selective acknowledgment is received, the transmitter shall consider as acknowledged all blocks so indicated by the entries in the bitmap for valid BSN values. As the bitmap entries are processed in increasing BSN order, *ARQ_TX_WINDOW_START* shall be incremented each time the BSN of an acknowledged block is equal to the value of *ARQ_TX_WINDOW_START*.

When *ARQ_TX_WINDOW_START* has been advanced by either of the above methods and acknowledgment of reception has already been received for the block with the BSN value now assigned to *ARQ_TX_WINDOW_START*, the value of *ARQ_TX_WINDOW_START* shall be incremented until an BSN value is reached for which no acknowledgment has been received.

A bitmap entry not indicating acknowledgement shall be considered a NACK for the corresponding blocks.

When a cumulative with selective acknowledgment and a valid BSN is received, the transmitter performs the actions described above for cumulative acknowledgment, followed by those for a selective acknowledgment.

All timers associated with acknowledged blocks shall be cancelled.

A Discard message shall be sent following violation of *ARQ_BLOCK_LIFETIME*. The message may be sent immediately or may be delayed up to *ARQ_RX_PURGE_TIMEOUT* + *ARQ_RETRY_TIMEOUT*. Following the first transmission, subsequent discard orders shall be sent to the receiver at intervals of *ARQ_RETRY_TIMEOUT* until an acknowledgment to the discarded BSN has been received. Discard orders for adjacent BSN values may be accumulated in a single Discard message.

The actions to be taken by the transmitter state machine when it wants to initiate a reset of the receiver ARQ state machine are provided in Figure 34. The actions to be taken by the transmitter state machine when an ARQ Reset message is received are also provided in Figure 34.

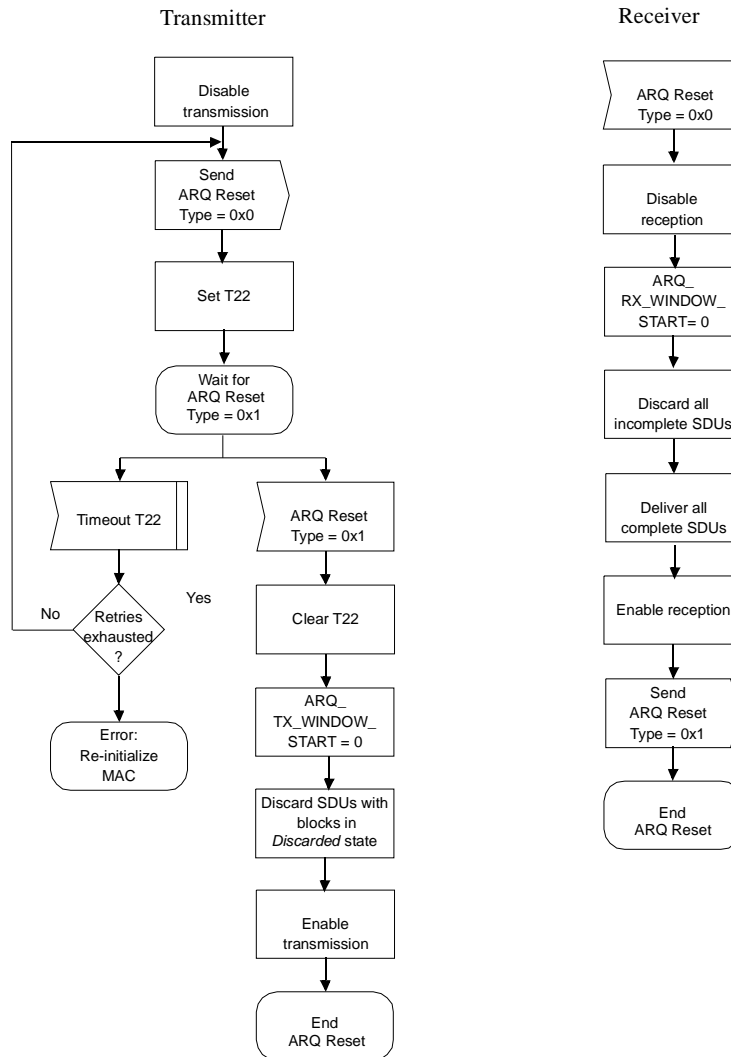

Figure 34—ARQ Reset message dialog—transmitter initiated

Synchronization of the ARQ state machines is governed by a timer managed by the transmitter state machine. Each time *ARQ_TX_WINDOW_START* is updated, the timer is set to zero. When the timer exceeds the value of *ARQ_SYNC_LOSS_TIMEOUT*, the transmitter state machine shall initiate a reset of the connection's state machines as described in Figure 35.

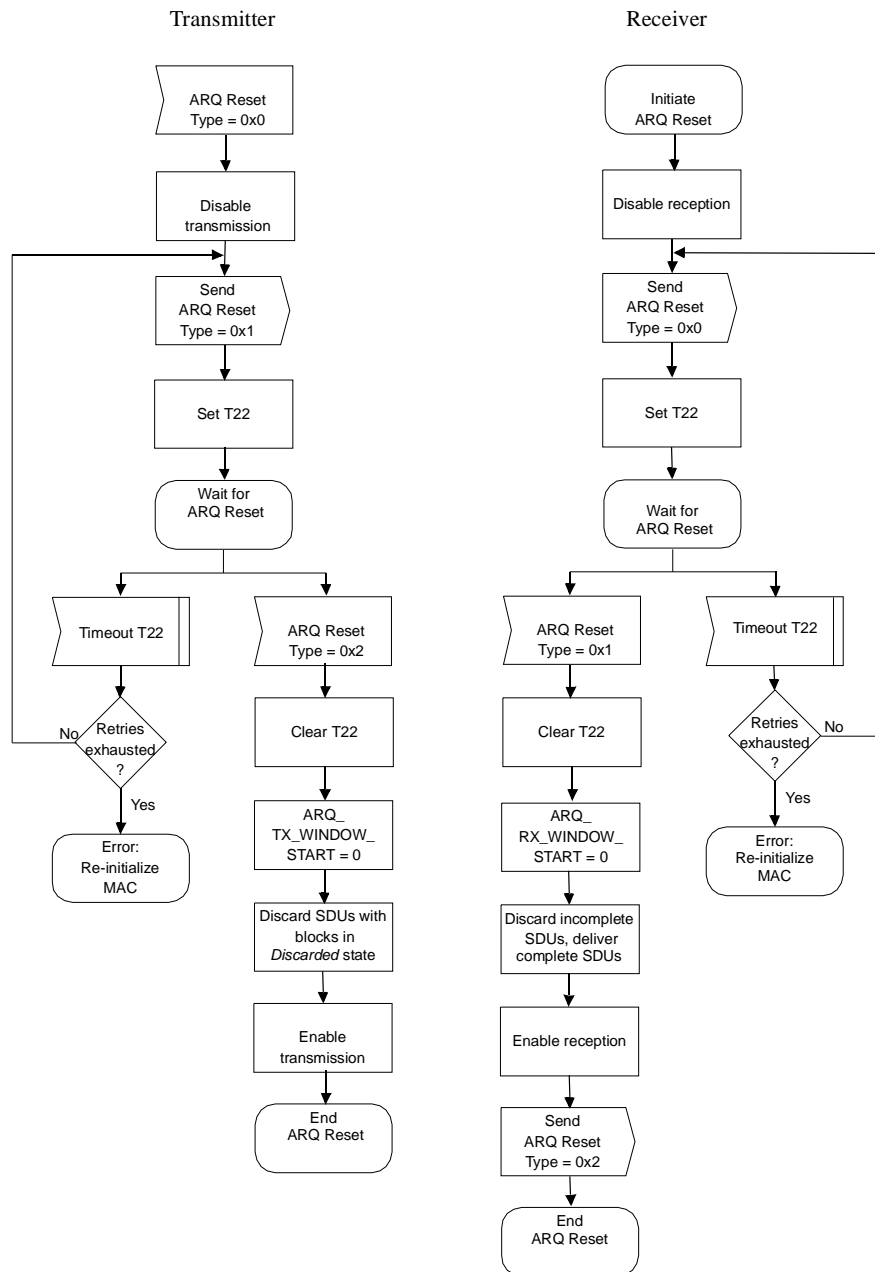

Figure 35—ARQ Reset message dialog—receiver initiated

A Discard message may be sent to the receiver when the transmitter wants to skip ARQ blocks up to the BSN value specified in the Discard message. Upon receipt of the message, the receiver updates its state information to indicate the specified blocks were received and forwards the information to the transmitter through an ARQ Feedback IE at the appropriate time.

6.3.4.6.3 Receiver state machine

When a PDU is received, its integrity is determined based on the CRC-32 checksum. If a PDU passes the checksum, it is unpacked and de-fragmented, if necessary. The receiver maintains a sliding-window defined by *ARQ_RX_WINDOW_START* state variable and the *ARQ_WINDOW_SIZE* parameter. When an ARQ block with a number that falls in the range defined by the sliding window is received, the receiver shall accept it. ARQ block numbers outside the sliding window shall be rejected as out of order. The receiver should discard duplicate ARQ blocks (i.e., ARQ blocks that were already received correctly) within the window.

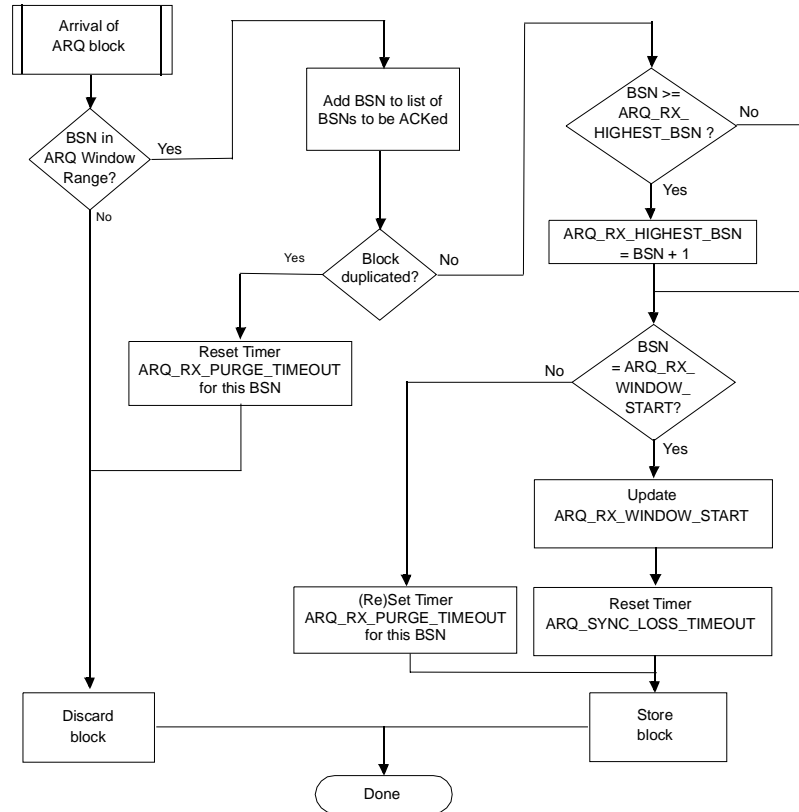

Figure 36—ARQ block reception

The sliding window is maintained such that the *ARQ_RX_WINDOW_START* variable always points to the lowest numbered ARQ block that has not been received or has been received with errors. When an ARQ block with a number corresponding to the *ARQ_RX_WINDOW_START* is received, the window is advanced (i.e., *ARQ_RX_WINDOW_START* is incremented modulo *ARQ_BSN_MODULUS*) such that the *ARQ_RX_WINDOW_START* variable points to the next lowest numbered ARQ block that has not been received or has been received with errors. The timer associated with *ARQ_SYNC_LOSS_TIMEOUT* shall be reset.

As each block is received, a timer is started for that block. When the value of the timer for a block exceeds *ARQ_RX_PURGE_TIMEOUT*, the timeout condition is marked. When the timeout condition is marked, *ARQ_RX_WINDOW_START* is advanced to the BSN of the next block not yet received after the marked block. Timers for delivered blocks remain active and are monitored for timeout until the BSN values are outside the receive window.

When *ARQ_RX_WINDOW_START* is advanced, any BSN values corresponding to blocks that have not yet been received residing in the interval between the previous and current *ARQ_RX_WINDOW_START* value shall be marked as received and the receiver shall send an ARQ Feedback IE to the transmitter with the updated information. Any blocks belonging to complete SDUs shall be delivered. Blocks from partial SDUs shall be discarded.

When a discard message is received from the transmitter, the receiver shall discard the specified blocks, advance *ARQ_RX_WINDOW_START* to the BSN of the first block not yet received after the BSN provided in the Discard message, and mark all not received blocks in the interval from the previous to new *ARQ_RX_WINDOW_START* values as received for ARQ feedback IE reporting.

For each ARQ block received, an acknowledgment shall be sent to the transmitter. Acknowledgment for blocks outside the sliding window shall be cumulative. Acknowledgments for blocks within the sliding window may be either for specific ARQ blocks (i.e., contain information on the acknowledged ARQ block numbers), or cumulative (i.e., contain the highest ARQ block number below which all ARQ blocks have been received correctly) or a combination of both (i.e., cumulative with selective). Acknowledgments shall be sent in the order of the ARQ block numbers they acknowledge. The frequency of acknowledgment generation is not specified here and is implementation dependent.

A MAC SDU is ready to be handed to the upper layers when all of the ARQ blocks of the MAC SDU have been correctly received within the time-out values defined.

When *ARQ_DELIVER_IN_ORDER* is enabled, a MAC SDU is handed to the upper layers as soon as all the ARQ blocks of the MAC SDU have been correctly received within the defined time-out values and all blocks with sequence numbers smaller than those of the completed message have either been discarded due to time-out violation or delivered to the upper layers.

When *ARQ_DELIVER_IN_ORDER* is not enabled, MAC SDUs are handed to the upper layers as soon as all blocks of the MAC SDU have been successfully received within the defined time-out values.

The actions to be taken by the receiver state machine when an ARQ Reset message is received are provided in Figure 34. The actions to be taken by the receiver state machine when it wants to initiate a reset of the transmitter ARQ state machine are provided in Figure 35.

Synchronization of the ARQ state machines is governed by a timer managed by the receiver state machine. Each time *ARQ_RX_WINDOW_START* is updated, the timer is set to zero. When the timer exceeds the value of *ARQ_SYNC_LOSS_TIMEOUT* the receiver state machine shall initiate a reset of the connection's state machines as described in Figure 35.

6.3.5 Scheduling services

Scheduling services represent the data handling mechanisms supported by the MAC scheduler for data transport on a connection. Each connection is associated with a single data service. Each data service is associated with a set of QoS parameters that quantify aspects of its behavior. These parameters are managed using the DSA and DSC message dialogs. Four services (11.13.11) are supported: Unsolicited Grant Service (UGS), Real-time Polling Service (rtPS), Non-real-time Polling Service (nrtPS), and Best Effort (BE). The following text provides a brief description of each of the supported scheduling services, including the mandatory QoS parameters that shall be included in the service flow definition when the scheduling service is enabled for a service flow. A detailed description of each QoS parameter is provided in 11.13.

The UGS is designed to support real-time data streams consisting of fixed-size data packets issued at periodic intervals, such as T1/E1 and Voice over IP without silence suppression. The mandatory QoS service flow parameters for this scheduling service are Maximum Sustained Traffic Rate (11.13.6), Maximum Latency (11.13.14), Tolerated Jitter (11.13.13), and Request/Transmission Policy (11.13.12). If present, the

Minimum Reserved Traffic Rate parameter (11.13.8) shall have the same value as the Maximum Sustained Traffic Rate parameter.

The rtPS is designed to support real-time data streams consisting of variable-sized data packets that are issued at periodic intervals, such as moving pictures experts group (MPEG) video. The mandatory QoS service flow parameters for this scheduling service are Minimum Reserved Traffic Rate (11.13.8), Maximum Sustained Traffic Rate (11.13.6), Maximum Latency (11.13.14), and Request/Transmission Policy (11.13.12).

The nrtPS is designed to support delay-tolerant data streams consisting of variable-sized data packets for which a minimum data rate is required, such as FTP. The mandatory QoS service flow parameters for this scheduling service are Minimum Reserved Traffic Rate (11.13.8), Maximum Sustained Traffic Rate (11.13.6), Traffic Priority (11.13.5), and Request/Transmission Policy (11.13.12).

The BE service is designed to support data streams for which no minimum service level is required and therefore may be handled on a space-available basis. The mandatory QoS service flow parameters for this scheduling service are Maximum Sustained Traffic Rate (11.13.6), Traffic Priority (11.13.5), and Request/Transmission Policy (11.13.12).

6.3.5.1 Outbound transmission scheduling

Outbound transmission scheduling selects the data for transmission in a particular frame/bandwidth allocation and is performed by the BS for downlink, and SS for uplink. In addition to whatever other factors the scheduler may deem pertinent, the following items are taken into account for each active service flow:

- The scheduling service specified for the service flow.
- The values assigned to the service flow's QoS parameters.
- The availability of data for transmission.
- The capacity of the granted bandwidth.

6.3.5.2 Uplink request/grant scheduling

Uplink request/grant scheduling is performed by the BS with the intent of providing each subordinate SS with bandwidth for uplink transmissions or opportunities to request bandwidth. By specifying a scheduling service and its associated QoS parameters, the BS scheduler can anticipate the throughput and latency needs of the uplink traffic and provide polls and/or grants at the appropriate times.

Table 112 summarizes the scheduling services and the poll/grant options available for each. The following subclauses define service flow scheduling services for uplink operations.

Table 112—Scheduling services and usage rules

Scheduling type	PiggyBack Request	Bandwidth stealing	Polling
UGS	Not allowed	Not allowed	PM bit is used to request a unicast poll for bandwidth needs of non-UGS connections.
rtPS	Allowed	Allowed	Scheduling only allows unicast polling.
nrtPS	Allowed	Allowed	Scheduling may restrict a service flow to unicast polling via the transmission/request policy; otherwise all forms of polling are allowed.
BE	Allowed	Allowed	All forms of polling allowed.

6.3.5.2.1 UGS

The UGS is designed to support real-time service flows that generate fixed-size data packets on a periodic basis, such as T1/E1 and Voice over IP without silence suppression. The service offers fixed-size grants on a real-time periodic basis, which eliminate the overhead and latency of SS requests and assure that grants are available to meet the flow's real-time needs. The BS shall provide Data Grant Burst IEs to the SS at periodic intervals based upon the Maximum Sustained Traffic Rate of the service flow. The size of these grants shall be sufficient to hold the fixed-length data associated with the service flow (with associated generic MAC header and Grant management subheader) but may be larger at the discretion of the BS scheduler. In order for this service to work correctly, the Request/Transmission Policy (see 11.13.12) setting shall be such that the SS is prohibited from using any contention request opportunities for this connection. The key service IEs are the Maximum Sustained Traffic, Maximum Latency, the Tolerated Jitter, and the Request/Transmission Policy. If present, the Minimum Reserved Traffic Rate parameter shall have the same value as the Maximum Sustained Traffic Rate parameter.

The Grant Management subheader (6.3.2.2.2) is used to pass status information from the SS to the BS regarding the state of the UGS service flow. The most significant bit of the Grant Management field is the Slip Indicator (SI) bit. The SS shall set this flag once it detects that this service flow has exceeded its transmit queue depth. Once the SS detects that the service flow's transmit queue is back within limits, it shall clear the SI flag. The flag allows the BS to provide for long term compensation for conditions, such as lost maps or clock rate mismatches, by issuing additional grants. The poll-me (PM) bit (6.3.6.3.3) may be used to request to be polled for a different, non-UGS connection.

The BS shall not allocate more bandwidth than the Maximum Sustained Traffic Rate parameter of the Active QoS Parameter Set, excluding the case when the SI bit of the Grant Management field is set. In this case, the BS may grant up to 1% additional bandwidth for clock rate mismatch compensation.

6.3.5.2.2 rtPS

The rtPS is designed to support real-time service flows that generate variable size data packets on a periodic basis, such as moving pictures experts group (MPEG) video. The service offers real-time, periodic, unicast request opportunities, which meet the flow's real-time needs and allow the SS to specify the size of the desired grant. This service requires more request overhead than UGS, but supports variable grant sizes for optimum data transport efficiency.

The BS shall provide periodic unicast request opportunities. In order for this service to work correctly, the Request/Transmission Policy setting (see 11.13.12) shall be such that the SS is prohibited from using any contention request opportunities for that connection. The BS may issue unicast request opportunities as prescribed by this service even if prior requests are currently unfulfilled. This results in the SS using only unicast request opportunities in order to obtain uplink transmission opportunities (the SS could still use unsolicited Data Grant Burst Types for uplink transmission as well). All other bits of the Request/Transmission Policy are irrelevant to the fundamental operation of this scheduling service and should be set according to network policy. The key service IEs are the Maximum Sustained Traffic Rate, the Minimum Reserved Traffic Rate, the Maximum Latency and the Request/Transmission Policy.

6.3.5.2.3 nrtPS

The nrtPS offers unicast polls on a regular basis, which assures that the service flow receives request opportunities even during network congestion. The BS typically polls nrtPS CIDs on an interval on the order of one second or less.

The BS shall provide timely unicast request opportunities. In order for this service to work correctly, the Request/Transmission Policy setting (see 11.13.12) shall be set such that the SS is allowed to use contention request opportunities. This results in the SS using contention request opportunities as well as unicast request

opportunities and unsolicited Data Grant Burst Types. All other bits of the Request/Transmission Policy are irrelevant to the fundamental operation of this scheduling service and should be set according to network policy.

6.3.5.2.4 BE service

The intent of the BE service is to provide efficient service for best effort traffic. In order for this service to work correctly, the Request/Transmission Policy setting shall be set such that the SS is allowed to use contention request opportunities. This results in the SS using contention request opportunities as well as unicast request opportunities and unsolicited Data Grant Burst Types. All other bits of the Request/Transmission Policy are irrelevant to the fundamental operation of this scheduling service and should be set according to network policy.

6.3.6 Bandwidth allocation and request mechanisms

Note that during network entry and initialization every SS is assigned up to three dedicated CIDs for the purpose of sending and receiving control messages. These connection pairs are used to allow differentiated levels of QoS to be applied to the different connections carrying MAC management traffic. Increasing (or decreasing) bandwidth requirements is necessary for all services except incompressible constant bit rate UGS connections. The needs of incompressible UGS connections do not change between connection establishment and termination. The requirements of compressible UGS connections, such as channelized T1, may increase or decrease depending on traffic. Demand Assigned Multiple Access (DAMA) services are given resources on a demand assignment basis, as the need arises.

When an SS needs to ask for bandwidth on a connection with BE scheduling service, it sends a message to the BS containing the immediate requirements of the DAMA connection. QoS for the connection was established at connection establishment and is looked up by the BS.

There are numerous methods by which the SS can get the bandwidth request message to the BS. The methods are listed in 6.3.6.1 through 6.3.6.6.

6.3.6.1 Requests

Requests refer to the mechanism that SSs use to indicate to the BS that they need uplink bandwidth allocation. A Request may come as a stand-alone bandwidth request header or it may come as a PiggyBack Request (see 6.3.2.2.2). The capability of Piggyback Request is optional.

Because the uplink burst profile can change dynamically, all requests for bandwidth shall be made in terms of the number of bytes needed to carry the MAC header and payload, but not the PHY overhead. The Bandwidth Request message may be transmitted during any uplink allocation, except during any initial ranging interval.

Bandwidth Requests may be incremental or aggregate. When the BS receives an incremental Bandwidth Request, it shall add the quantity of bandwidth requested to its current perception of the bandwidth needs of the connection. When the BS receives an aggregate Bandwidth Request, it shall replace its perception of the bandwidth needs of the connection with the quantity of bandwidth requested. The Type field in the bandwidth request header indicates whether the request is incremental or aggregate. Since Piggybacked Bandwidth Requests do not have a type field, Piggybacked Bandwidth Requests shall always be incremental. The self-correcting nature of the request/grant protocol requires that SSs shall periodically use aggregate Bandwidth Requests. The period may be a function of the QoS of a service and of the link quality. Due to the possibility of collisions, Bandwidth Requests transmitted in broadcast or multicast Request IEs should be aggregate requests.

Additional bandwidth request mechanisms include the focused bandwidth requests (see 6.3.6.4) and CDMA bandwidth requests (see 6.3.6.5).

6.3.6.2 Grants

For an SS, bandwidth requests reference individual connections while each bandwidth grant is addressed to the SS's Basic CID, not to individual CIDs. Since it is nondeterministic which request is being honored, when the SS receives a shorter transmission opportunity than expected (scheduler decision, request message lost, etc.), no explicit reason is given. In all cases, based on the latest information received from the BS and the status of the request, the SS may decide to perform backoff and request again or to discard the SDU.

An SS may use Request IEs that are broadcast, directed at a multicast polling group it is a member of, or directed at its Basic CID. In all cases, the Request IE burst profile is used, even if the BS is capable of receiving the SS with a more efficient burst profile. To take advantage of a more efficient burst profile, the SS should transmit in an interval defined by a Data Grant IE directed at its Basic CID. Because of this, unicast polling of an SS would normally be done by allocating a Data Grant IE directed at its Basic CID. Also note that, in a Data Grant IE directed at its Basic CID, the SS may make bandwidth requests for any of its connections.

The procedure followed by SSs is shown in Figure 37.

6.3.6.3 Polling

Polling is the process by which the BS allocates to the SSs bandwidth specifically for the purpose of making bandwidth requests. These allocations may be to individual SSs or to groups of SSs. Allocations to groups of connections and/or SSs actually define bandwidth request contention IEs. The allocations are not in the form of an explicit message, but are contained as a series of IEs within the UL-MAP.

Note that polling is done on SS basis. Bandwidth is always requested on a CID basis and bandwidth is allocated on an SS basis.

6.3.6.3.1 Unicast

When an SS is polled individually, no explicit message is transmitted to poll the SS. Rather, the SS is allocated, in the UL-MAP, bandwidth sufficient to respond with a Bandwidth (BW) Request. If the SS does not need bandwidth, the allocation is padded in accordance with 6.3.3.7. SSs that have an active UGS connection of sufficient bandwidth shall not be polled individually unless they set the PM bit in the header of a packet on the UGS connection. This saves bandwidth over polling all SSs individually. Note that unicast polling would normally be done on a per-SS basis by allocating a Data Grant IE directed at its Basic CID.

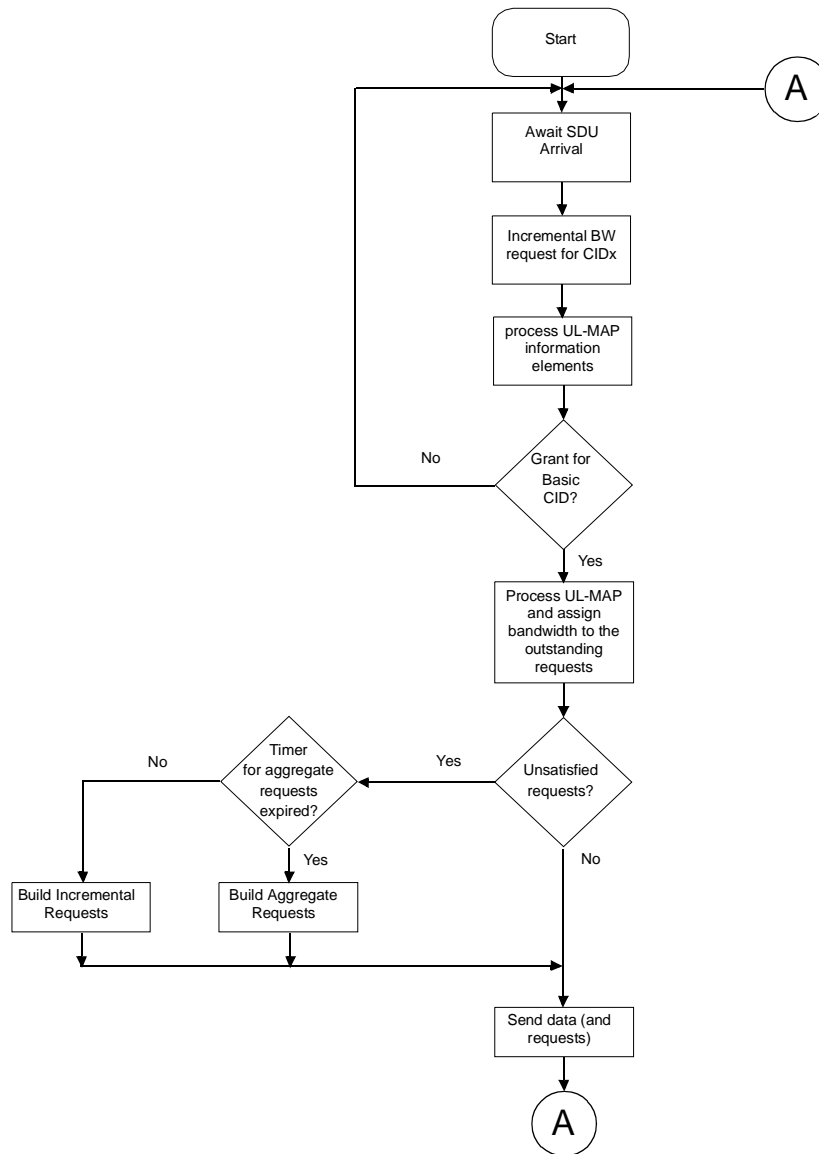

NOTE—The SS local scheduler decides which connections get the granted bandwidth.

Figure 37—SS Request/Grant flow chart

The information exchange sequence for individual polling is shown in Figure 38.

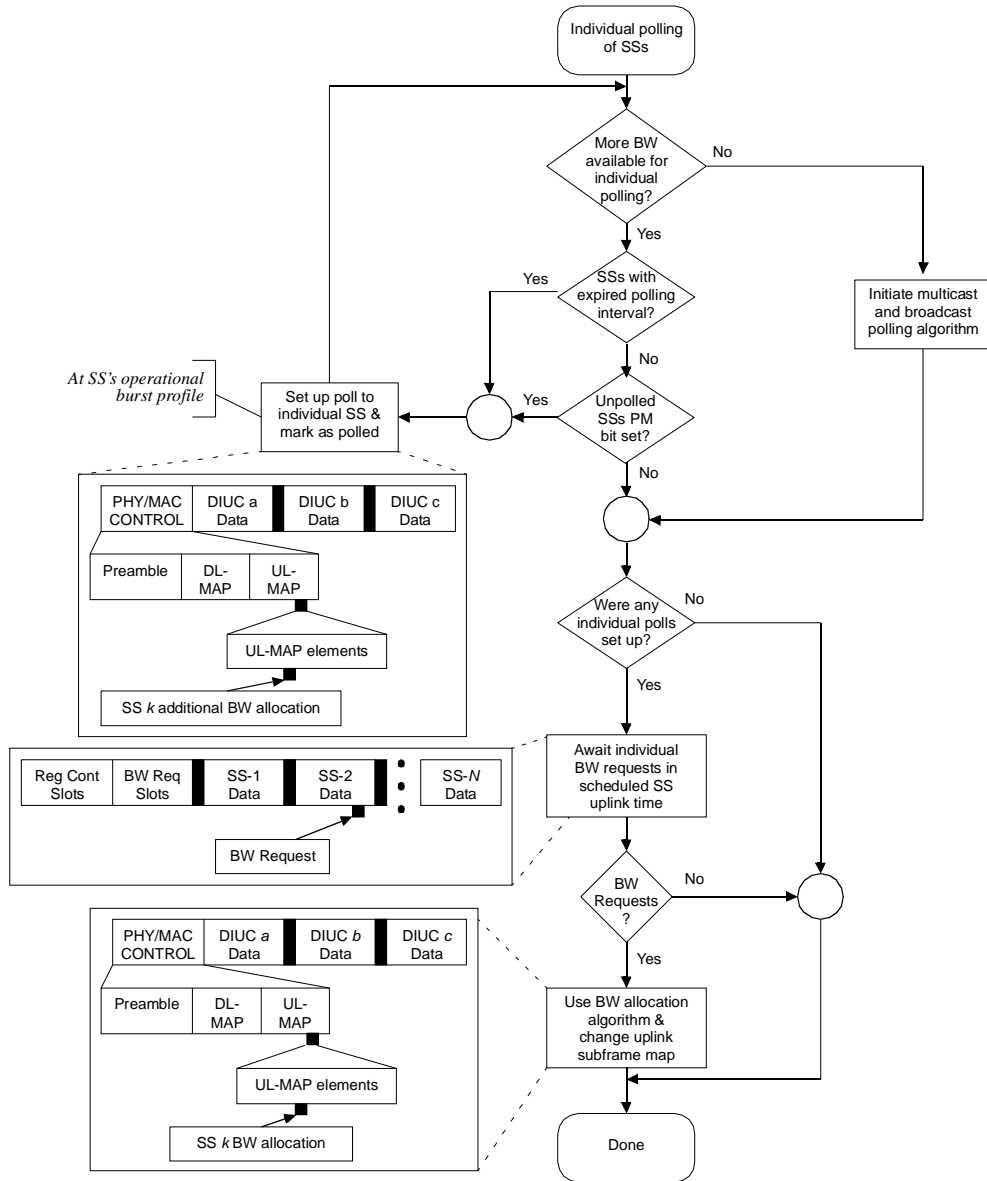

Figure 38—Unicast polling

6.3.6.3.2 Multicast and broadcast

If insufficient bandwidth is available to individually poll many inactive SSs, some SSs may be polled in multicast groups or a broadcast poll may be issued. Certain CIDs are reserved for multicast groups and for broadcast messages, as described in Table 345. As with individual polling, the poll is not an explicit message, but bandwidth allocated in the UL-MAP. The difference is that, rather than associating allocated bandwidth with an SS's Basic CID, the allocation is to a multicast or broadcast CID. An example is provided in Table 113.

The information exchange sequence for multicast and broadcast polling is shown in Figure 39.

When the poll is directed at a multicast or broadcast CID, an SS belonging to the polled group may request bandwidth during any request interval allocated to that CID in the UL-MAP by a Request IE. In order to reduce the likelihood of collision with multicast and broadcast polling, only SS's needing bandwidth reply; they shall apply the contention resolution algorithm as defined in 6.3.8 to select the slot in which to transmit the initial bandwidth request. Zero-length bandwidth (BW) requests shall not be used in multicast or broadcast Request Intervals.

The SS shall assume that the transmission has been unsuccessful if no grant has been received in the number of subsequent UL-MAP messages specified by the parameter Contention-based reservation timeout (see 11.3.1). Note that, with a frame-based PHY with UL-MAPs occurring at predetermined instants, erroneous UL-MAPs may be counted towards this number. If the rerequest is made in a multicast or broadcast opportunity, the SS continues to run the contention resolution algorithm in 6.3.8. Note that the SS is not restricted to issuing the rerequest in a multicast or broadcast Request Interval.

Table 113—Sample UL-MAP with multicast and broadcast IE for SC and SCa

Interval description	UL-MAP IE fields		
	CID (16 bits)	UIUC (4 bits)	Offset (12 bits)
Initial Ranging	0000	2	0
Multicast group 0xFFC5 Bandwidth Request	0xFFC5	1	405
Multicast group 0xFFDA Bandwidth Request	0xFFDA	1	605
Broadcast Bandwidth Request	0xFFFF	1	805
SS 5 Uplink Grant	0x007B	4	961
SS 21 Uplink Grant	0x01C9	7	1136
*	*	*	*
*	*	*	*
*	*	*	*

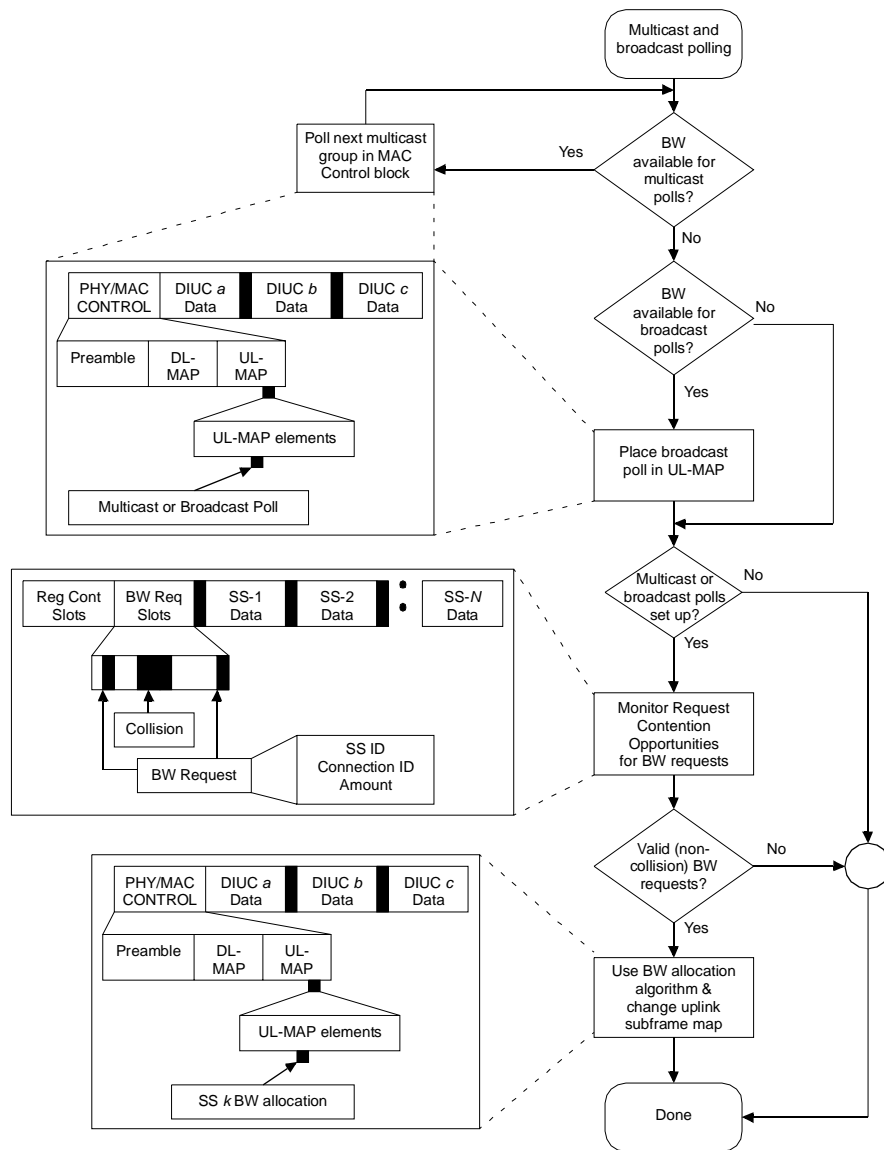

Figure 39—Multicast and broadcast polling

6.3.6.3.3 PM bit

SSs with currently active UGS connections may set the PM bit [bit PM in the Grant Management subheader (6.3.2.2.2)] in a MAC packet of the UGS connection to indicate to the BS that they need to be polled to request bandwidth for non-UGS connections. To reduce the bandwidth requirements of individual polling, SSs with active UGS connections need be individually polled only if the PM bit is set (or if the interval of the UGS is too long to satisfy the QoS of the SS’s other connections). Once the BS detects this request for polling, the process for individual polling is used to satisfy the request. The procedure by which an SS stimulates the BS to poll it is shown in Figure 40. To minimize the risk of the BS missing the PM bit, the SS may set the bit in all UGS MAC Grant Management subheaders in the uplink scheduling interval.

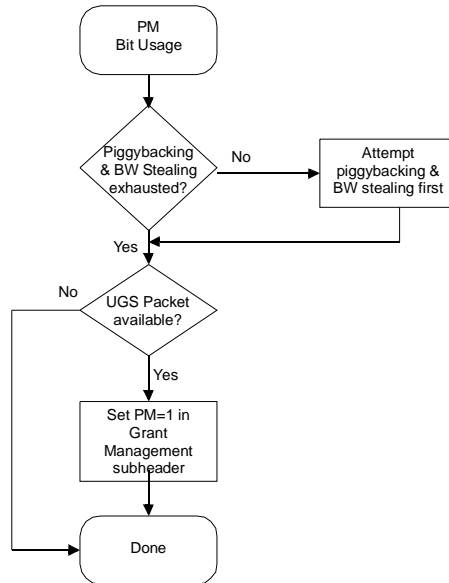

Figure 40—PM bit usage

6.3.6.4 Contention-based focused Bandwidth Requests for WirelessMAN-OFDM

The WirelessMAN-OFDM PHY supports two contention-based Bandwidth Request mechanisms. The mandatory mechanism allows the SS to send the bandwidth request header as specified in 6.3.6.1 during a REQ Region-Full. Alternatively, the SS may send a Focused Contention Transmission during a REQ Region-Focused. This transmission consists of a Contention Code modulated on a Contention Channel consisting of four carriers. The selection of the Contention Code is done with equal probability among the eight possible codes. The selection of the Contention Channel is done with equal probability among the time/frequency transmit opportunities applicable to the SS. Upon detection, the BS shall provide an uplink allocation for the SS to transmit a Bandwidth Request MAC PDU and optionally additional data, but instead of indicating a Basic CID, the broadcast CID shall be sent in combination with an OFDM Focused_Contention_IE, which specifies the Contention Channel, Contention Code, and Transmit Opportunity that were used by the SS. This allows an SS to determine whether it has been given an allocation by matching these parameters with the parameters it used. See also 8.3.7.3.3.

6.3.6.5 Contention-based CDMA Bandwidth Requests for WirelessMAN-OFDMA

The WirelessMAN-OFDMA PHY supports two mandatory contention-based Bandwidth Request mechanisms: the SS shall either send the bandwidth request header as specified in 6.3.6.1, or use the CDMA-based mechanism as specified in the following paragraphs of this subclause.

As specified in 6.3.10.3, the OFDMA-based PHY specifies a Ranging Subchannel and a subset of Ranging codes that shall be used for contention-based Bandwidth Requests. The SS, upon needing to request bandwidth, shall select, with equal probability, a Ranging Code from the code subset allocated to Bandwidth Requests. This Ranging Code shall be modulated onto the Ranging Subchannel and transmitted during the appropriate uplink allocation.

Upon detection, the BS shall provide (an implementation dependent) uplink allocation for the SS, but instead of indicating a Basic CID, the broadcast CID shall be sent in combination with a CDMA_Allocation_IE, which specifies the transmit region and Ranging Code that were used by the SS. This allows an SS to determine whether it has been given an allocation by matching these parameters with

the parameters it used. The SS shall use the allocation to transmit a Bandwidth Request MAC PDU and/or data. The SS may only omit the Bandwidth Request PDU when the BS indicated so in the CDMA_Allocation_IE (see Table 290).

If the BS does not issue the uplink allocation described above, or the Bandwidth Request MAC PDU does not result in a subsequent allocation of any bandwidth, the SS shall assume that the Ranging Code transmission resulted in a collision and follow the contention resolution as specified in 6.3.8.

6.3.6.6 Optional Mesh topology support

The WirelessHUMAN system provides optional support for Mesh topology. Unlike the PMP mode, there are no clearly separate downlink and uplink subframes in the Mesh mode. Each station is able to create direct communication links to a number of other stations in the network instead of communicating only with a BS. However, in typical installations, there will still be certain nodes that provide the BS function of connecting the Mesh network to the backhaul links. In fact, when using Mesh centralized scheduling (described below), these BS nodes perform much of the same basic functions as do the BS in PMP mode. Thus, the key difference is that in Mesh mode all the SSs may have a direct links with other SSs. Further, there is no need to have direct link from an SS to the BS of the Mesh network. This connection can be provided via other SSs. Communication in all these links shall be controlled by a centralized algorithm (either by the BS or “decentralized” by all nodes periodically), scheduled in a distributed manner within each node’s extended neighborhood, or scheduled using a combination of these.

6.3.6.6.1 Distributed scheduling

The stations that have direct links are called neighbors and shall form a neighborhood. A node’s neighbors are considered to be “one hop” away from the node. A two-hop extended neighborhood contains, additionally, all the neighbors of the neighborhood. In the coordinated distributed scheduling mode, all the stations (BS and SSs) shall coordinate their transmissions in their extended two-hop neighborhood.

The coordinated distributed scheduling mode uses some or the entire control portion of each frame to regularly transmit its own schedule and proposed schedule changes on a PMP basis to all its neighbors. Within a given channel all neighbor stations receive the same schedule transmissions. All the stations in a network shall use this same channel to transmit schedule information in a format of specific resource requests and grants.

Coordinated distributed scheduling ensures that transmissions are scheduled in a manner that does not rely on the operation of a BS, and that are not necessarily directed to or from the BS.

Within the constraints of the coordinated schedules (distributed or centralized), uncoordinated distributed scheduling can be used for fast, ad-hoc setup of schedules on a link-by-link basis. Uncoordinated distributed schedules are established by directed requests and grants between two nodes, and shall be scheduled to ensure that the resulting data transmissions (and the request and grant packets themselves) do not cause collisions with the data and control traffic scheduled by the coordinated distributed nor the centralized scheduling methods.

Both the coordinated and uncoordinated distributed scheduling employ a three-way handshake.

- MSH-DSCH: Request is made along with MSH-DSCH:Avalabilities, which indicate potential slots for replies and actual schedule.
- MSH-DSCH: Grant is sent in response indicating a subset of the suggested availabilities that fits, if possible, the request. The neighbors of this node not involved in this schedule shall assume the transmission takes place as granted.

- MSH-DSCH:Grant is sent by the original requester containing a copy of the grant from the other party, to confirm the schedule to the other party. The neighbors of this node not involved in this schedule shall assume the transmission takes place as granted.

The differences between coordinated and uncoordinated distributed scheduling are as follows: In the coordinated case, the MSH-DSCH messages are scheduled in the control subframe in a collision free manner; whereas, in the uncoordinated case, MSH-DSCH messages may collide. Nodes responding to a Request should, in the uncoordinated case, wait a sufficient number of minislots of the indicated Availabilities before responding with a grant, such that nodes listed earlier in the Request have an opportunity to respond. The Grant confirmation is sent in the minislots immediately following the first successful reception of an associated Grant packet.

6.3.6.6.2 Centralized scheduling

The schedule using centralized scheduling is determined in more of a centralized manner than in the distributed scheduling mode.

The network connections and topology are the same as in the distributed scheduling mode described in 6.3.6.6.1, but the scheduled transmissions for the SSs shall be defined by the BS. The BS determines the flow assignments from the resource requests from the SSs. Subsequently, the SSs determine the actual schedule from these flow assignments by using a common algorithm that divides the frame proportionally to the assignments. Thus, the BS acts just like the BS in a PMP network except that not all of the SSs have to be directly connected to the BS, and the assignments determined by the BS extends to those SSs not directly connected to the BS. The SS resource requests and the BS assignments are both transmitted during the control portion of the frame.

Centralized scheduling ensures that transmissions are coordinated to ensure collision-free scheduling over the links in the routing tree to and from the BS, typically in a more optimal manner than the distributed scheduling method for traffic streams (or collections of traffic streams that share links), which persist over a duration that is greater than the cycle time to relay the new resource requests and distribute the updated schedule.

A simple example of the use of the centralized scheduling flow-mechanism in MSH-CSCF is provided in Figure 42. The requested flows for the network are shown in Figure 41. For simplicity of notation, the data rate is assumed to be the burst profile number.

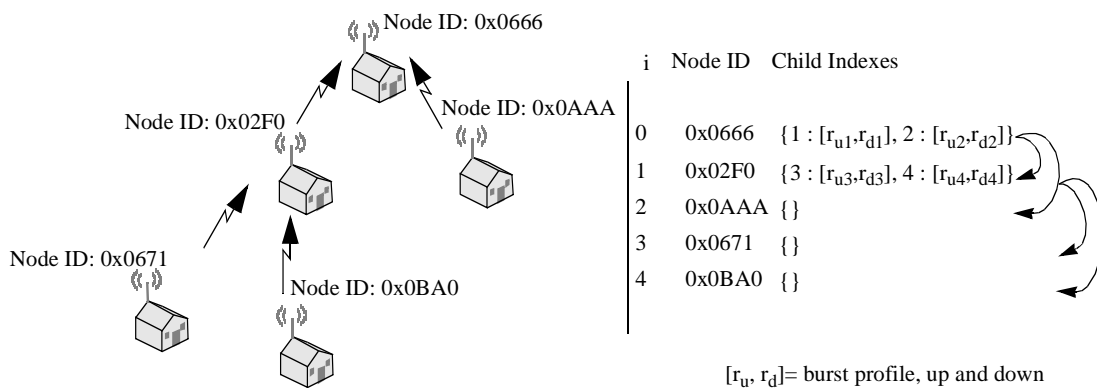

Figure 41—MSH-CSCF schedule example

The link fractions shown in Figure 42 are multiplied with ($2^{\text{FlowScale Exponent}+14}$) and with the frame duration, then rounded up to the nearest duration of a whole number of minislots required to transmit this fraction (including preamble).

Each node shall ensure that the duration of all resulting minislot allocations per channel does not exceed the available minislot space (in one or two frames depending on the **Frame schedule flag**) by reducing all allocations proportionally. Each node shall then recursively round down the number of minislots of the allocation with the smallest decimal fraction and add another minislot to the allocation with the largest decimal fraction. Before transmitting the schedule, the Mesh BS shall ensure that this computation does not result in nonzero allocations smaller than required to transmit a preamble and one data symbol.

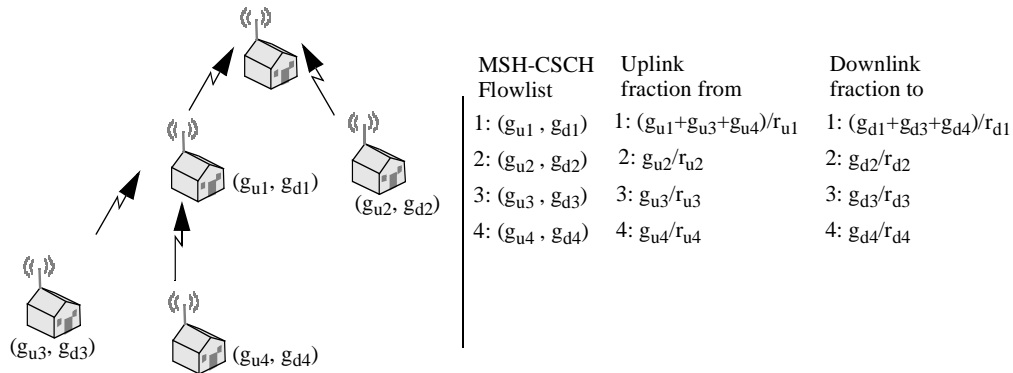

Figure 42—MSH-CSCH flow usage example

The number of frames during which the CSCH schedule is valid is limited by the number of frames it takes to aggregate and distribute the next schedule.

Each node uses the newly received schedule to compute the following:

- The time the node shall transmit this schedule (if eligible) for nodes further down the transmission tree.
- The frame where the last node in the transmission tree will be receiving this schedule.
- The original transmission time by the Mesh BS of this schedule.

To compute this, the node uses the routing tree from the last MSH-CSCF messages as modified by the link updates of the last MSH-CSCH message (which dictates the size of MSH-CSCH messages) and the following steps:

- Step 1) The Mesh BS transmits first in a new frame.
- Step 2) Then, the eligible children of the Mesh BS (i.e., nodes with a hop count equals 1), ordered by their appearance in the routing tree, transmit.
- Step 3) Then, the eligible children of the nodes from Step 2) (i.e., nodes with a hop count that equals 2), also ordered by their appearance in the routing tree, transmit.
- Step 4) The process continue until all eligible nodes in the routing tree have transmitted.

Nodes shall fragment their message if it does not fit entirely before the end of the control subframe and at least the preamble and one data symbol fit. All nodes are eligible to transmit the grant schedule, except those that have no children. If a node's order requires it to transmit immediately after receiving, a delay of **MinCSForwardingDelay** μ s is inserted.

Each node shall also compute the timing of the uplink requests. Uplink requests start in the last frame where a node received the previous schedule. All nodes are eligible to transmit requests, except the Mesh BS. The request transmission order is reverse in hopcount (i.e., largest hopcount first), but retains the transmission order as listed in the routing tree for nodes with the same hopcount.

The time between the first frame in which a node sends the request schedule and the last frame where a node receives the new grant schedule marks the validity of the previous grant schedule. This validity time overrides the **Frame schedule flag** two frame usage at the end of the validity time. Note that MSH-CSCF messages may be sent after the last request is received and before the grant schedule is transmitted by the Mesh BS.

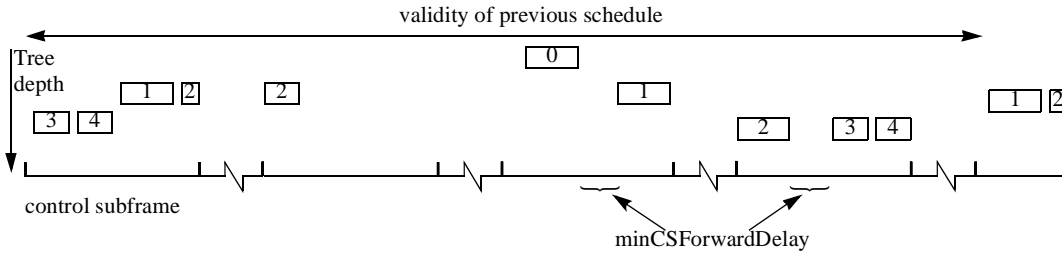

Figure 43—MSH-CSCH schedule validity

6.3.7 MAC support of PHY

Several duplexing techniques are supported by the MAC protocol. The choice of duplexing technique may affect certain PHY parameters as well as impact the features that can be supported.

6.3.7.1 FDD

In an FDD system, the uplink and downlink channels are located on separate frequencies and the downlink data can be transmitted in bursts. A fixed duration frame is used for both uplink and downlink transmissions. This facilitates the use of different modulation types. It also allows simultaneous use of both full-duplex SSs (which can transmit and receive simultaneously) and optionally half-duplex SSs (which cannot). If half-duplex SSs are used, the bandwidth controller shall not allocate uplink bandwidth for a half-duplex SS at the same time that it is expected to receive data on the downlink channel, including allowance for the propagation delay, SS transmit/receive transition gap (SSTTG) and SS receive/transmit transition gap (SSRTG).

Figure 44 describes the basics of the FDD mode of operation. The fact that the uplink and downlink channels utilize a fixed duration frame simplifies the bandwidth allocation algorithms. A full-duplex SS is capable of continuously listening to the downlink channel, while a half-duplex SS can listen to the downlink channel only when it is not transmitting in the uplink channel.

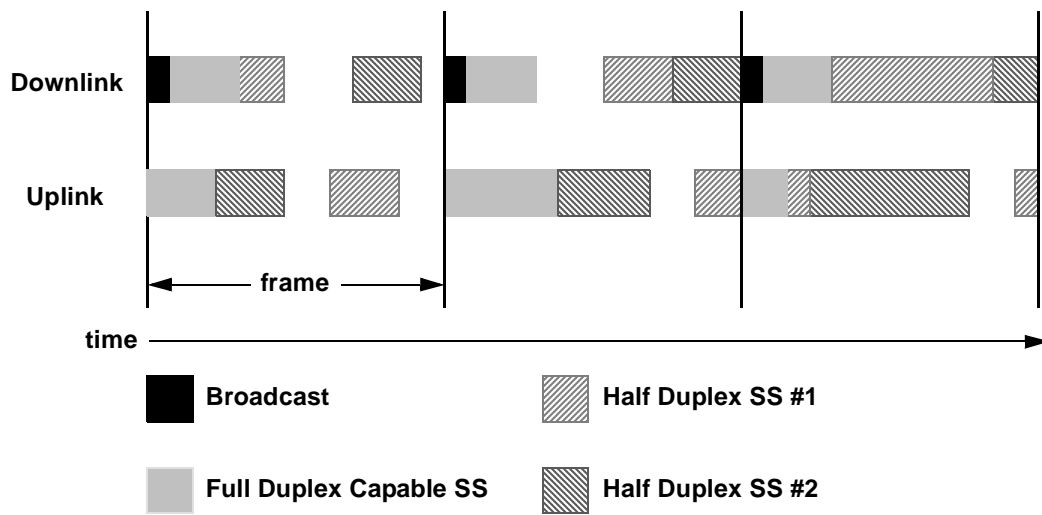

6.3.7.2 TDD

In the case of TDD, the uplink and downlink transmissions occur at different times and usually share the same frequency. A TDD frame (see Figure 45) has a fixed duration and contains one downlink and one uplink subframe. The frame is divided into an integer number of PSs, which help to partition the bandwidth easily. The TDD framing is adaptive in that the bandwidth allocated to the downlink versus the uplink can vary. The split between uplink and downlink is a system parameter and is controlled at higher layers within the system.

6.3.7.3 DL-MAP

The DL-MAP message defines the usage of the downlink intervals for a burst mode PHY.

6.3.7.4 UL-MAP

The UL-MAP defines the uplink usage in terms of the offset of the burst relative to the Allocation Start Time (units PHY-specific).

6.3.7.4.1 Uplink timing

Uplink timing is referenced from the beginning of the downlink subframe. The Allocation Start Time in the UL-MAP is referenced from the start of the downlink subframe and may be such that the UL-MAP references some point in the current or a future frame (see 6.3.7.5). The SS shall always adjust its concept of uplink timing based upon the Timing Adjustments sent in the RNG-RSP messages.

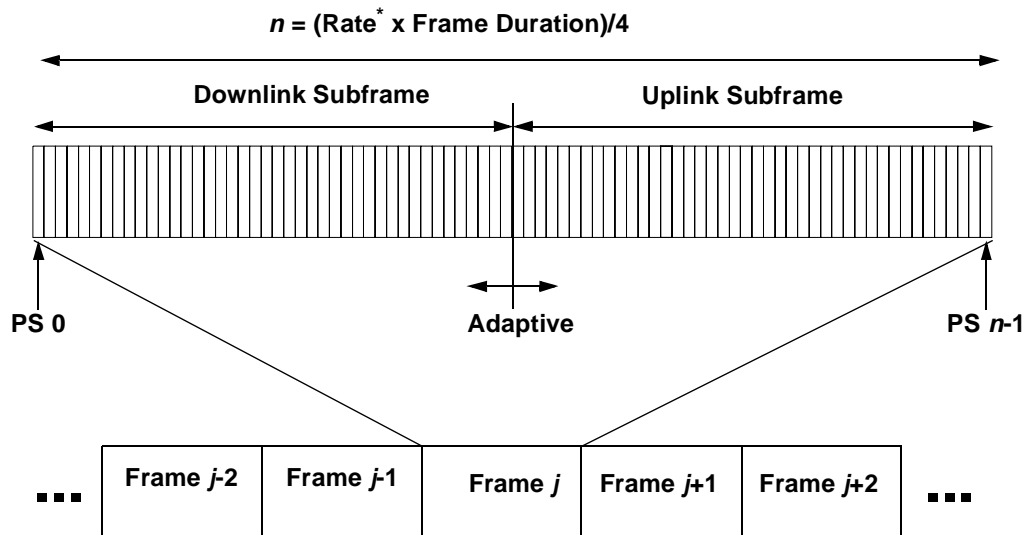

[*] for SC, SCa, the Rate is the Symbol Rate; for OFDM, OFDMA, the Rate is the nominal sampling frequency (F_s).

Figure 45—TDD frame structure.

6.3.7.4.2 Uplink allocations

For the SC and SCa PHY layers, the uplink bandwidth allocation map (UL-MAP) uses units of minislots. The size of the minislot is specified as a function of PSs and is carried in the UCD for each uplink channel.

For the OFDM and OFDMA PHY layers, the uplink bandwidth allocation map (UL-MAP) uses units of symbols and subchannels.

6.3.7.4.3 Uplink interval definition

All of the IEs defined in 6.3.7.4.3.1 through 6.3.7.4.3.5 shall be supported by conformant SSs. Conformant BS may use any of these IEs when creating a UL-MAP message.

6.3.7.4.3.1 Request IE

Via the Request IE, the BS specifies an uplink interval in which requests may be made for bandwidth for uplink data transmission. The character of this IE changes depending on the type of CID used in the IE. If broadcast or multicast, this is an invitation for SSs to contend for requests. If unicast, this is an invitation for a particular SS to request bandwidth. Unicasts may be used as part of a QoS scheduling scheme that is vendor dependent. For any uplink allocation, the SS may optionally decide to use the allocation for data or requests (or requests piggybacked in data). PDUs transmitted in this interval shall use the bandwidth request header format (see 6.3.2).

For bandwidth request contention opportunities, the BS shall allocate a grant that is an integer multiple of the value of “Bandwidth request opportunity size,” which shall be published in each UCD transmission.

6.3.7.4.3.2 Initial Ranging IE

Via the Initial Ranging IE, the BS specifies an interval in which new stations may join the network. An interval, equivalent to the maximum round-trip propagation delay plus the transmission time of the RNG-REQ message, shall be provided in some UL-MAPs to allow new stations to perform initial ranging. Packets transmitted in this interval shall use the RNG-REQ MAC Management message format (see 6.3.2.3.5).

For ranging contention opportunities, the BS shall allocate a grant that is an integer multiple of the value of “Ranging request opportunity size,” which shall be published in each UCD transmission.

6.3.7.4.3.3 Data Grant Burst Type IEs

The Data Grant Burst Type IEs provide an opportunity for an SS to transmit one or more uplink PDUs. These IEs are issued either in response to a request from a station, or because of an administrative policy, such as unicast polling, providing some amount of bandwidth to a particular station.

The number of Data Grant Types available is PHY specific. Each Data Grant Burst Type description is defined in the UCD message.

6.3.7.4.3.4 End of map IE

An end of map IE terminates all actual allocations in the IE list. It is used to determine the length of the last interval.

6.3.7.4.3.5 Gap IE

The Gap IE indicates pauses in uplink transmissions. An SS shall not transmit during a Gap IE.

6.3.7.5 Map relevance and synchronization

Timing information in the DL-MAP and UL-MAP is relative. The following time instants are used as a reference for timing information:

- DL-MAP: The start of the first symbol (including the preamble if present) of the frame in which the message was transmitted.
- UL-MAP: The start of the first symbol (including the preamble if present) of the frame in which the message was transmitted plus the value of the Allocation Start Time.

Information in the DL-MAP pertains to the current frame (the frame in which the message was received). Information carried in the UL-MAP pertains to a time interval starting at the Allocation Start Time measured from the beginning of the current frame and ending after the last specified allocation. This timing holds for both the TDD and FDD variants of operation. The TDD variant is shown in Figure 46 and Figure 47. The FDD variant is shown in Figure 48 and Figure 49.

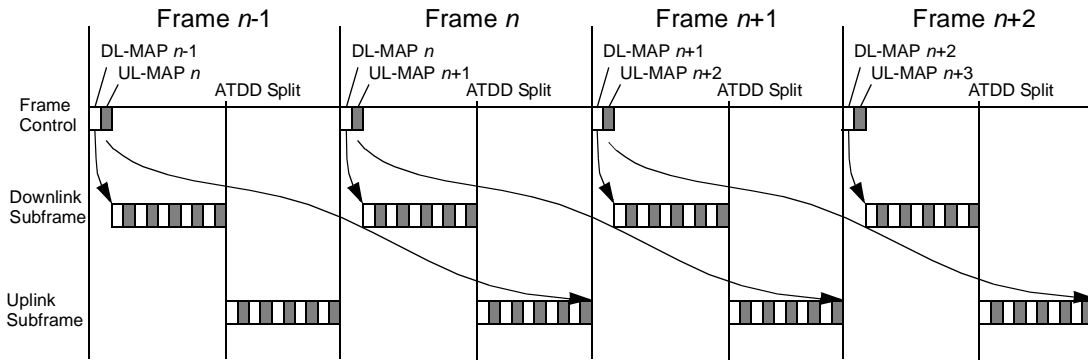

Figure 46—Maximum time relevance of DL-MAP and UL-MAP(TDD)

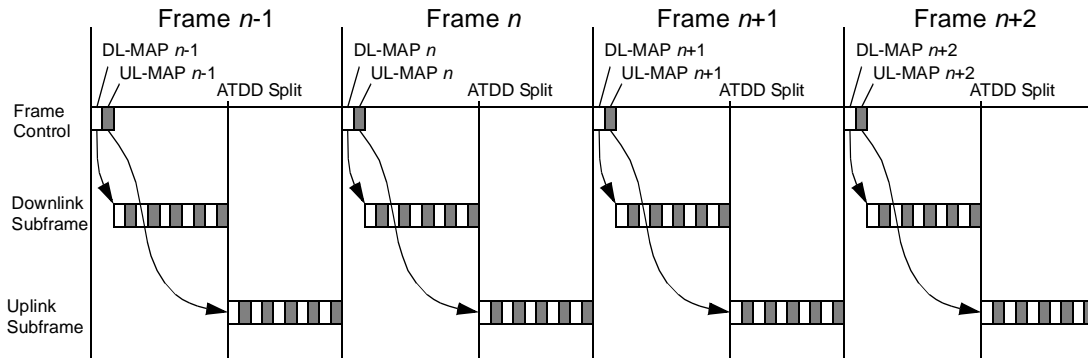

Figure 47—Minimum time relevance of DL-MAP and UL-MAP (TDD)

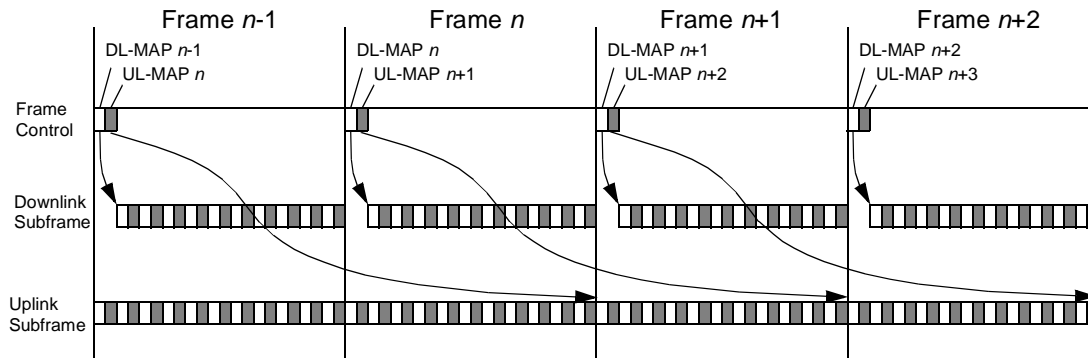

Figure 48—Maximum time relevance of DL-MAP and UL-MAP (FDD)

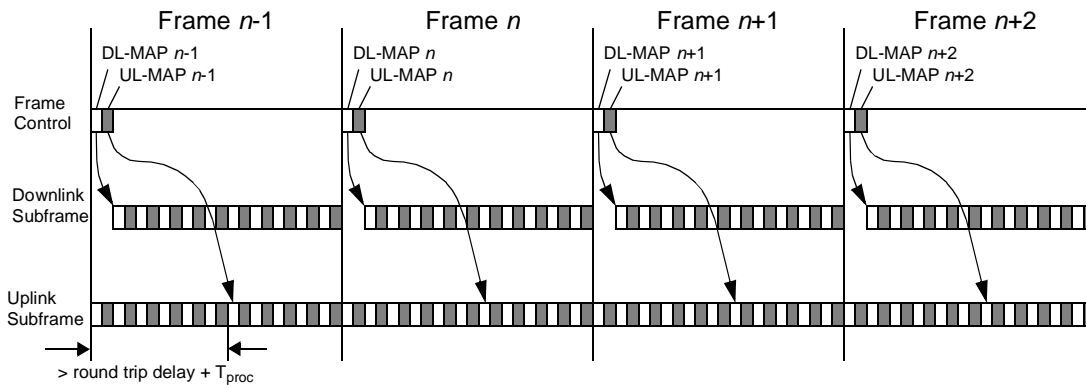

Figure 49—Minimum time relevance of DL-MAP and UL-MAP (FDD)

6.3.7.5.1 WirelessMAN-SC PHY

Allocation Start Time shall be subject to the following limitations: For FDD, the minimum Allocation Start Time value shall be the round trip delay + T_{proc} , and the maximum Allocation Start Time value is T_f (i.e., the beginning of the next frame). For TDD, the Allocation Start Time value shall be either the ATDD split or the ATDD split + T_f . The allocation shall be within a single frame.

6.3.7.5.2 WirelessMAN-SCa PHY

The first burst appearing in the downlink portion of a frame shall be the frame control header. The FCH shall contain one DL-MAP message, one UL-MAP message for each associated uplink channel, and optionally, a DCD message and a UCD message for each associated uplink channel. The order of appearance of the messages in an FCH burst shall be DL-MAP, UL-MAP, DCD, and UCD.

The first burst description appearing in a DL-MAP shall specify the start of the burst immediately following the FCH.

Each UL-MAP shall describe the content of the uplink portion of a single frame.

Allocation Start Time shall be subject to the following limitations:

- Minimum value: Allocation Start Time $\geq T_f$
- Maximum value: Allocation Start Time $< 2 \times T_f$

6.3.7.5.3 WirelessMAN-OFDM PHY

Allocation Start Time shall be subject to the following limitations:

- For FDD, the minimum Allocation Start Time value shall be the round trip delay + T_{proc} , and the maximum Allocation Start Time value is T_f (i.e., the beginning of the next frame).
- For TDD, the Allocation Start Time value shall be either the ATDD split, or the ATDD split + T_f ; and the allocation shall be within a single frame.

6.3.7.5.4 WirelessMAN-OFDMA PHY

Allocation Start Time shall be subject to the following limitations:

- Minimum value: Allocation Start Time $\geq T_f$
- Maximum value: Allocation Start Time $< 2 \times T_f$

6.3.7.5.5 Optional Mesh mode

Only TDD is supported in Mesh mode. Contrary to the basic PMP mode, there are no clearly separate downlink and uplink subframes in the Mesh mode. Stations shall transmit to each other either in scheduled channels or in random access channels as in PMP mode. The frame structure is described in 8.3.5.3.

6.3.7.5.5.1 Physical neighborhood list

All the basic functions like scheduling and network synchronization are based on the neighbor information that all the nodes in the Mesh network shall maintain. Each node (BS and SS) maintains a physical neighborhood list with each entry containing the following fields:

MAC Address

48-bit MAC address of the neighbor.

Hop Count

Indicates distance in hops of this neighbor from the present node. If a packet has been successfully received from this neighbor it is considered to be 1 hop away.

Node Identifier

16-bit number used to identify this node in a more efficient way in MSH-NCFG messages.

Xmt Holdoff Time

The minimum number of MSH-NCFG transmit opportunities that no MSH-NCFG message transmission is expected from this node after **Next Xmt Time** (see 6.3.2.3.35 for detailed definition).

Next Xmt Time

The MSH-NCFG transmit opportunity(ies) when the next MSH-NCFG from this node is expected (see 6.3.2.3.35 for detailed definition).

Reported Flag

Set to TRUE if this **Next Xmt Time** has been reported by this node in a MSH-NCFG packet. Else set to FALSE.

Synchronization hop count

This counter is used to determine superiority between nodes when synchronizing the network. Nodes can be assigned as master time keepers, which are synchronized externally (for example, using GPS). These nodes transmit Synchronization hop count of 0. Nodes shall synchronize to nodes with lower synchronization hop count, or if counts are the same, to the node with the lower Node ID.

6.3.7.5.5.2 Schedule relevance with distributed scheduling

When using coordinated distributed scheduling all the stations in a network shall use the same channel to transmit schedule information in a format of specific resource requests and grants in MSH-DSCH messages. A station shall indicate its own schedule by transmitting a MSH-DSCH regularly. The MSH-DSCH messages shall be transmitted during the control portion of the frame. Relevance of the MSH-DSCH is variable and entirely up to the station. An example case is given in Figure 50, in which **Schedule Frames** = 0x2 (8 frames) has been assumed.

MSH-DSCH messages are transmitted regularly throughout the whole Mesh network to distribute nodes' schedules and (together with network configuration packets) provide network synchronization information.

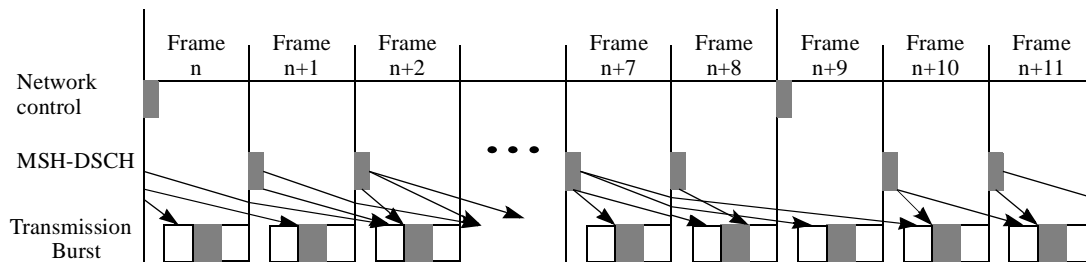

Figure 50—Time relevance example of MSH-DSCH in distributed scheduling

An SS that has a direct link to the BS shall synchronize to the BS while an SS that is at least two hops from the BS shall synchronize to its neighbor SSs that are closer to the BS.

The control portion of every [**Schedule Frames** + 1] frames (see MSH-NCFG:Network Descriptor, 6.3.2.3.35.3) is reserved for communication of MSH-NCFG and MSH-NENT packets.

6.3.7.5.5.3 Schedule relevance with centralized scheduling

When using centralized scheduling the BS shall act as a centralized scheduler for the SSs. Using centralized scheduling, the BS shall provide schedule configuration (MSH-CSCF) and assignments (MSH-CSCH) to all SSs.

The validity of a MSH-CSCH schedule is computed by each node as specified in 6.3.6.6.2. The BS determines the assignments from the resource requests received from the SSs. Intermediate SSs are responsible for forwarding these requests for SSs (listed in the current routing tree as specified by the last MSH-CSCF modified by the last MSH-CSCH update) that are further from the BS (i.e., more hops from the BS) as needed. All the SSs shall listen and compute the schedule. Further, they shall forward the MSH-CSCH message to their neighbors that are further away from the BS.

Additionally, as with distributed scheduling, the control portion of every [**Schedule Frames** + 1] frames (see MSH-NCFG:Network Descriptor, 6.3.2.3.35.3) is reserved for communication of MSH-NCFG and MSH-NENT packets.

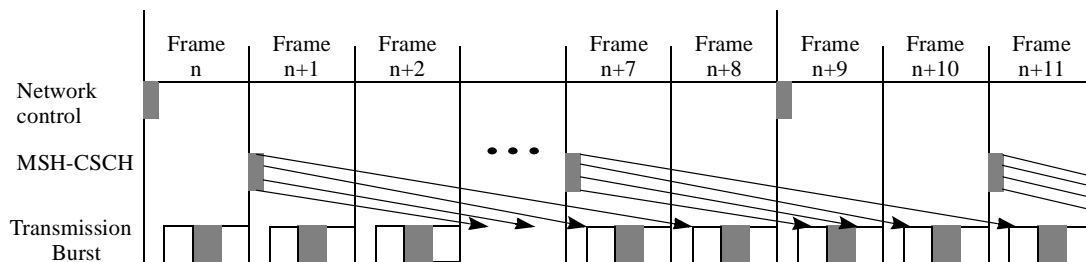

Figure 51—Time relevance example of MSH-CSCH in centralized scheduling

6.3.7.5.5.4 Mesh network synchronization

Network configuration (MSH-NCFG) and network entry (MSH-NENT) packets provide a basic level of communication between nodes in different nearby networks whether from the same or different equipment vendors or wireless operators. These packets are used to synchronize both centralized and distributed control Mesh networks.

This communication is used to support basic configuration activities such as: synchronization between nearby networks used (i.e., for multiple, co-located BSs to synchronize their uplink and downlink transmission periods), communication and coordination of channel usage by nearby networks, and discovery and basic network entry of new nodes.

MSH-NCFG, MSH-NENT, and MSH-DSCH can assist a node in synchronizing to the start of frames. For these messages, the control subframe, which initiates each frame, is divided into transmit opportunities (see 8.3.5.3). The first transmit opportunity in a network control subframe may only contain MSH-NENT messages, while the remainder **MSH-CTRL-LEN-1** may only contain MSH-NCFG messages. In scheduling control subframes, the **MSH-DSCH-NUM** transmit opportunities assigned for MSH-DSCH messages come last in the control subframe. The MSH-NCFG messages also contain the number of its transmit opportunity, which allows nodes to easily calculate the start time of the frame.

6.3.7.5.5.5 MSH-NCFG/MSH-NENT transmission timing

MSH-NCFG and MSH-NENT packets are scheduled for transmission during control subframes. To ensure that all nearby nodes receive these transmissions, the channel used is cycled through the available channels in the band, with the channel selection being based on the Frame number. So, for frame number i , the channel is determined by the array lookup shown in Equation (9).

$$\text{NetConfigChannel} = \text{Logical channel list}[(\text{Frame Number} / (\text{Scheduling Frames} \cdot 4 + 1)) \% \text{Channels}] \quad (9)$$

where the Logical channel List, **Channels**, and **Scheduling Frames** are derived from the MSH-NCFG:Network Descriptor (see 6.3.2.3.35.3). The location within frames, burst profile etc. of MSH-NCFG and MSH-NENT packets are described in 8.3.5.3.

6.3.7.5.5.6 Scheduling next MSH-NCFG transmission

During the current **Xmt Time** of a node (i.e., the time slot when a node transmits its MSH-NCFG packet), the node uses the following procedure to determine its **Next Xmt Time**:

Order its physical neighbor table by the **Next Xmt Time**.

For each entry of the neighbor table, add the node's **Next Xmt Time** to the node's **Xmt Holdoff Time** to arrive at the node's **Earliest Subsequent Xmt Time**.

Set **TempXmtTime** equal to this node's advertised **Xmt Holdoff Time** added to the current **Xmt Time**.

Set *success* equal to false.

While *success* equals false **do**:

Determine the eligible competing nodes, which is the set of all nodes in the physical-neighbor list with a **Next Xmt Time** eligibility interval that includes **TempXmtTime** or with an **Earliest Subsequent Xmt Time** equal to or smaller than **TempXmtTime**.

Hold a *Mesh Election* among this set of eligible competing nodes and the local node using **TempXmtTime** and the list of the Node IDs of all eligible competing nodes as the input: *MeshElection (TempXmtTime, MyNodeID, CompetingNodeIDsList [])*

If (this node does not win *Mesh election*)

Set **TempXmtTime** equal to next MSH-NCFG opportunity.

Else:

Set *success* equal to true.

Set the node's **Next Xmt Time** equal to **TempXmtTime**.

The *Mesh Election* procedure determines whether the local node is the winner for a specific **TempXmtTime** among all the competing nodes. It returns TRUE, if the local node wins, or otherwise FALSE. The algorithm works as follows:

```

boolean MeshElection (uint32 XmtTime,uint16 MyNodeID,uint16 NodeIDList [ ] ) {
    uint32 nbr_smear_val,smear_val1,smear_val2;
    smear_val1 =inline_smear(MyNodeID ^ XmtTime );
    smear_val2 =inline_smear(MyNodeID +XmtTime );
    For each Node ID nbrsNodeID in NodeIDList Do {
        nbr_smear_val =inline_smear(nbrsNodeID ^ XmtTime );
        if(nbr_smear_val >smear_val1 ) {
            return FALSE;//This node loses.
        }
        else if(nbr_smear_val ==smear_val1 ) {
            //1st tie-breaker.
            nbr_smear_val =inline_smear(nbrsNodeID +XmtTime );
            if(nbr_smear_val >smear_val2 ) {
                return FALSE;//This node loses.
            }
            else if(nbr_smear_val ==smear_val2 ) {
                //If we still collide at this point Break the tie based on MacAdr
                if ((XmtTime is even &&(nbrsNodeID >MyNodeID))||
                    (XmtTime is odd &&(nbrsNodeID <MyNodeID ))) {
                    return FALSE;//This node loses.
                }
            }
        }
    }
    //This node won over this competing node
} //End for all competing nodes
//This node is winner,it won over all competing nodes.
return TRUE;
}

// Convert a uniform 16-bit value to an uncorrelated uniform 16-bit hash value, uses mixing.

uint32 inline_smear(uint16 val) {
    val +=(val <<12);
    val ^=(val >>22);
    val +=(val <<4);
    val ^=(val >>9);
    val +=(val <<10);
    val ^=(val >>2);
    val +=(val <<7);
    val ^=(val >>12);
    return(val);
}

```

6.3.7.5.5.7 Scheduling MSH-NENT messages

The NetEntry scheduling protocol provides the upper-layer protocol an unreliable mechanism to access the NetEntry slot(s), so that new nodes, which are not yet fully-functional members of the network, can communicate with the fully-functional members of the network.

In the NetEntry slots, new nodes shall transmit MSH-NENT messages using the following two step procedure:

- 1) The initial MSH-NENT packet with request IE is sent in a random, contention-based fashion in a free network entry transmission slot immediately following MSH-NENT transmission opportunity after the targeted sponsor sends a MSH-NCFG. with sponsored MAC address 0x000000000000
- 2) After the sponsor advertises the new nodes MAC Address in a MSH-NCFG message, the new node may send a MSH-NENT immediately following MSH-NENT transmission opportunity.

A new node uses the algorithm specified by the following C-like pseudocode to access NetEntry transmission slots:

```

/*Variable Definitions */
Pkt *MSH-NENT_MsgQ =NULL;//MSH-NENT Message queue
uint SponsorsState =UNAVAILABLE;//SponsorsState and OthersState record the NetEntry
uint OthersState =BUSY;
// Address in the MSH-NCFG packet form the sponsor or other nodes,
// which can be used to determine the availability of the next NetEntry transmission opportunity
//SponsorsState can be UNAVAILABLE,AVAILABLE and POLLING.
//OthersState can be AVAILABLE and BUSY.
uint OthersMaxMacAdr =0xFFFFFFFF;
uint OthersMinMacAdr =0x00000000;

void RecvOutgoingMSH-NENT_Msg (Pkt *MSH-NENT_Msg) {
    MSH-NENT_MsgQ->enqueue (MSH-NENT_Msg);
}

void RecvIncomingMSH-NCFG_Msg (Pkt *MSH-NCFG_Msg) {
    if (MSH-NCFG_Msg->sourceMacAdr ==sponsorsMacAdr) {
        switch (MSH-NCFG_Msg->NetEntryAddress)
        {
            case 0x000000000000:SponsorsState =AVAILABLE; break;
            case myMacAdr: SponsorsState =POLLING; break;
            default: break;
        }
    } else {
        switch (MSH-NCFG_Msg->NetEntryAddress)
        {
            case 0x000000000000:break;
            default:OthersState =BUSY;
                if (OthersMaxMacAdr <MSH-NCFG_Msg->NetEntryAddress)
                    OtherMaxMacAdr=MSH-NCFG_Msg->NetEntryAddress;
                if (OthersMinMacAdr >MSH-NCFG_Msg->NetEntryAddress)
                    OtherMinMacAdr =MSH-NCFG_Msg->NetEntryAddress;
        }
    }
}

void NetworkControlSubframeStart () {
    boolean xmt =FALSE;
    if (MSH-NENT_MsgQ->qLength()) {
        if (SponsorsState ==AVAILABLE) {

```

```

        if (OthersState !=BUSY) {
            xmt =TRUE;
        }
    }
    else if (SponsorsState ==POLLING) {
        if (OthersState !=BUSY) {
            xmt =TRUE;
        }
        else
        {
            if (((mayMacAdr >OthersMaxMacAdr)&&(even superframe))||
                ((mayMacAdr <OthersMinMacAdr)&&(odd superframe))) {
                xmt =TRUE;
            }
        }
    }
}
if (xmt) {
    Pkt*MSH-NENT_Msg =MSH-NENT_MsgQ->getHead();
    MSH-NENT_MsgQ->dequeue(MSH-NENT_Msg);
    SendOutPkt (MSH-NENT_Msg,nextNetEntryslot);
}
SponsorsState =UNAVAILABLE;
OthersState =AVAILABLE;
OthersMaxMacAdr =0x000000000000;
OthersMinMacAdr =0xFFFFFFFFFFFF;
}

```

6.3.7.5.5.8 MSH-NCFG Reception Procedure

When a MSH-NCFG packet is received from a neighbor, the following is performed:

The hop count field in the Physical Neighborhood List (see 6.3.7.5.5.1) for the neighbor itself is set to 1. The hop count field for other nodes listed in the MSH-NCFG message is set to **Hops to Neighbor +2** (see Table 66) unless they are already listed with a lower hop count.

The **Next Xmt Time** and **Xmt Holdoff Time** of the transmitting node and all reported nodes are updated.

The “Reported Flag” for each entry in the Physical Neighbor Table that was modified is set to FALSE.

6.3.7.6 Optional MAC AAS Support of WirelessMAN-SCa, OFDM, and OFDMA

6.3.7.6.1 AAS MAC services

AAS (see [B4], [B36], [B37], and [B3] for generic literature), through the use of more than one antenna element, can improve range and system capacity by adapting the antenna pattern and concentrating its radiation to each individual subscriber. The spectral efficiency can be increased linearly with the number of antenna elements. This is achieved by steering beams to multiple users simultaneously so as to realize an inter-cell frequency reuse of one and an in-cell reuse factor proportional to the number of antenna elements. An additional benefit is the signal-to-noise ratio (SNR) gain realized by coherently combining multiple signals, and the ability to direct this gain to particular users. Another possible benefit is the reduction in interference achieved by steering nulls in the direction of co-channel interferers. Combining the benefits of increasing the SNR of certain subscribers and steering nulls to others, enables bursts to be concurrently transmitted to spatially separated SSs. For the uplink direction the same principle can be applied in a

reciprocal fashion. A concurrent transmission of bursts does not necessarily increase the system’s range but may enhance system capacity.

Support mechanisms for AAS are specified, which allow a system to deliver the benefits of adaptive arrays while maintaining compatibility for non-AAS SSs.

The design of the AAS option provides a mechanism to migrate from a non-AAS system to an AAS enabled system in which the initial replacement of the non-AAS capable BS by an AAS capable BS should cause the only service interruption to (non-AAS) SSs.

This is achieved by dedicating part of the frame to non-AAS traffic and part to AAS traffic. The allocation is performed dynamically by the BS. Non-AAS SSs shall ignore AAS traffic, which they can identify based on the DL-MAP/UL-MAP messages.

The AAS part of the DL frame begins with an AAS specific Preamble, see Figure 52 and Figure 53.

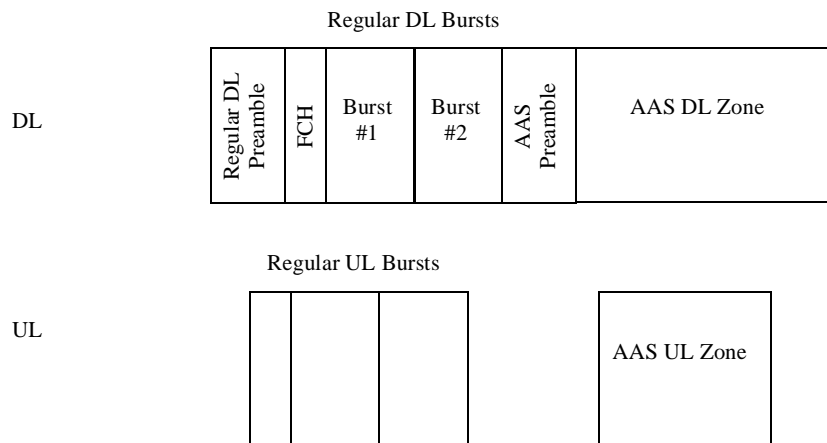

Figure 52—AAS Zone, FDD

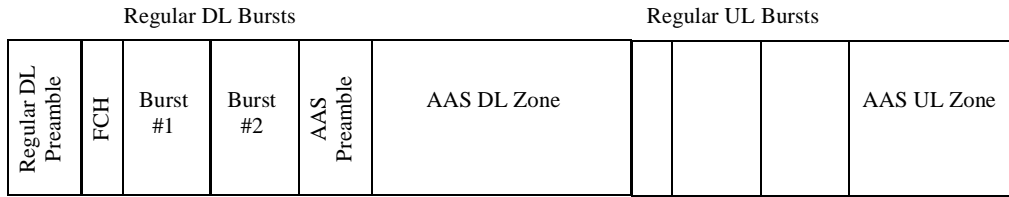

Figure 53—AAS Zone, TDD

For bandwidth request/allocation, AAS enabled SSs may use dedicated private DL-MAP/UL-MAP messages as well as tools specific for AAS (see specific PHY sections), which can be used to facilitate avoidance of collisions with non-AAS traffic.

Special considerations apply to those parts of the frame that are not scheduled, e.g., initial-ranging and Bandwidth-request, as discussed in 6.3.7.6.3 and 6.3.7.6.6.

6.3.7.6.2 MAC control functions

The control of the AAS part of the frame may be done by unicasting private management messages to individual SSs. These messages shall be the same as the broadcast management messages, except that the basic CID assigned to the SS is used instead of the Broadcast CID.

If AAS enabled SSs can decode the broadcast DL-MAP and DCD messages, the BS may specify concurrent bursts by means of the extended concurrent transmission IE format as described in 8.2.1.9.2.7, 8.2.1.9.3.5, and 8.3.6.2.6.

6.3.7.6.3 AAS downlink synchronization

When the SS first attempts to synchronize to the downlink transmission, the BS is unaware of its presence, and therefore is not aiming the adaptive array at its direction. Nevertheless, the frame start preamble is a repetitive well-known pattern, and SS may utilize the inherent processing gain associated with it in order to synchronize timing and frequency parameters with the BS. The BS may further employ active scanning or diversity methods to speed up and enhance the process of downlink synchronization. These methods are PHY-specific, and described in the respective PHY section.

6.3.7.6.4 Alerting the BS about presence of a new SS in an AAS system

In a non-AAS system, after synchronizing to the downlink, an SS attempts to obtain the downlink parameters by decoding the DL-MAP and DCD messages. In an AAS system, an SS may be able to obtain the downlink parameters if it receives the broadcast channel with enough energy so it can decode the DL-MAP and DCD messages. If this is the case, the SS can continue with the network entry process just like the non-AAS case, and the BS will get the chance to tune the adaptive array to it during the ranging process.

Alternatively, an AAS SS may use the following procedure to alert the BS to its presence, so the BS can adapt its antenna array to the SS position.

An AAS BS may reserve a fixed, pre-defined part of the frame as initial-ranging contention slots for this alert procedure. The number of contention slots and their location in the frame is PHY specific (see 8.2.1.9.3, 8.3.7.2, 8.4.4.2, respectively). These contention slots shall be called AAS-alert-slots.

When an AAS SS has synchronized to the downlink, yet is unable to obtain the downlink parameters because it cannot decode the DL-MAP and DCD messages, it shall attempt initial ranging on the AAS-alert-slots. Unlike usual initial ranging, the SS shall use all available contention slots, in order to allow the BS adaptive array enough time and processing gain to shape the beam for it. After such an attempt the SS shall wait for a transmission containing DL-MAP and DCD messages from the BS, and shall continue the network entry process like a non-AAS SS.

If the DL-MAP and DCD messages fail to arrive, the SS shall use an exponential backoff algorithm for selecting the next frame in which to attempt alerting the BS to its presence. The algorithm shall be the same as that used for initial ranging by non-AAS stations (see 6.3.8).

6.3.7.6.5 FDD/TDD support

Adaptive Arrays use channel state information in the PHY at both downlink and uplink. When channel state of the downlink is required at the BS, there are two ways to obtain it:

- By relying on reciprocity, thus using the uplink channel state estimation as the downlink channel state.
- By using feedback, thus transmitting the estimated channel state from the SS to BS.

The first method is simpler and is well suited for TDD systems. The second method is more suitable for FDD systems, where reciprocity does not apply (due to the large frequency separation between uplink and downlink channels). The second method may also be used for TDD systems.

Channel state information is obtained by using two MAC control messages: AAS-FBCK-REQ and AAS-FBCK-RSP (see 6.3.2.3.40). The request instructs the SS to measure, the results of which shall be returned in the response after the measurement period has ended. The BS shall provide an uplink allocation to enable the SS to transmit this response. Using FDD, the BS shall issue AAS-FBCK-REQ messages. Using TDD, the BS may issue AAS-FBCK messages.

6.3.7.6.6 Requesting bandwidth

AAS subscribers might not be able to request bandwidth using the usual contention mechanism. This happens because the adaptive array may not have a beam directed at the SS when it is requesting bandwidth, and the Bandwidth Request will be lost. In order to avoid this situation, an AAS SS is directed by the BS as to whether or not it may use broadcast allocations for requesting bandwidth. The BS may change its direction dynamically using the AAS broadcast permission TLV, which is carried by the RNG-RSP message. The SS shall signify by using the AAS broadcast capability TLV in the RNG_REQ message whether or not it can receive the broadcast messages.

When an SS is directed not to use the broadcast CID to request bandwidth, it is the responsibility of the BS to provide a polling mechanism to learn about the SS bandwidth requirements.

6.3.8 Contention resolution

The BS controls assignments on the uplink channel through the UL-MAP messages and determines which minislots are subject to collisions. Collisions may occur during Initial Ranging and Request intervals defined by their respective IEs. The potential occurrence of collisions in Request Intervals is dependent on the CID in the respective IE. This subclause describes uplink transmission and contention resolution. For

simplicity, it refers to the decisions an SS makes. Since an SS can have multiple uplink service flows (each with its own CID), it makes these decisions on a per CID or per service QoS basis.

The mandatory method of contention resolution that shall be supported is based on a truncated binary exponential backoff, with the initial backoff window and the maximum backoff window controlled by the BS. The values are specified as part of the UCD message and represent a power-of-two value. For example, a value of 4 indicates a window between 0 and 15; a value of 10 indicates a window between 0 and 1023.

When an SS has information to send and wants to enter the contention resolution process, it sets its internal backoff window equal to the Request (or Ranging for initial ranging) Backoff Start defined in the UCD message referenced by the UCD Count in the UL-MAP message currently in effect.¹¹

The SS shall randomly select a number within its backoff window. This random value indicates the number of contention transmission opportunities that the SS shall defer before transmitting. An SS shall consider only contention transmission opportunities for which this transmission would have been eligible. These are defined by Request IEs (or Initial Ranging IEs for initial ranging) in the UL-MAP messages. Note that each IE may consist of multiple contention transmission opportunities.

Using bandwidth requests as an example, consider an SS whose initial backoff window is 0 to 15 and assume it randomly selects the number 11. The SS must defer a total of 11 contention transmission opportunities. If the first available Request IE is for 6 requests, the SS does not use this and has 5 more opportunities to defer. If the next Request IE is for 2 requests, the SS has 3 more to defer. If the third Request IE is for 8 requests, the SS transmits on the fourth opportunity, after deferring for 3 more opportunities.

After a contention transmission, the SS waits for a Data Grant Burst Type IE in a subsequent map (or waits for a RNG-RSP message for initial ranging). Once received, the contention resolution is complete.

The SS shall consider the contention transmission lost if no data grant has been given within T16 (or no response within T3 for initial ranging). The SS shall now increase its backoff window by a factor of two, as long as it is less than the maximum backoff window. The SS shall randomly select a number within its new backoff window and repeat the deferring process described above.

This retry process continues until the maximum number (i.e., Request Retries for bandwidth requests and Contention Ranging Retries for initial ranging) of retries has been reached. At this time, for bandwidth requests, the PDU shall be discarded. For initial ranging, proper actions are specified in 6.3.9.5. Note that the maximum number of retries is independent of the initial and maximum backoff windows that are defined by the BS.

For bandwidth requests, if the SS receives a unicast Request IE or Data Grant Burst Type IE at any time while deferring for this CID, it shall stop the contention resolution process and use the explicit transmission opportunity.

The BS has much flexibility in controlling the contention resolution. At one extreme, the BS may choose to set up the Request (or Ranging) Backoff Start and Request (or Ranging) Backoff End to emulate an Ethernet-style backoff with its associated simplicity and distributed nature as well as its fairness and efficiency issues. This would be done by setting Request (or Ranging) Backoff Start = 0 and Request (or Ranging) Backoff End = 10 in the UCD message. At the other end, the BS may make the Request (or Ranging) Backoff Start and Request (or Ranging) Backoff End identical and frequently update these values in the UCD message so that all SS are using the same, and hopefully optimal, backoff window.

¹¹The map currently in effect is the map whose allocation start time has occurred but which includes IEs that have not occurred.

6.3.8.1 Transmission opportunities

A transmission opportunity is defined as an allocation provided in a UL-MAP or part thereof intended for a group of SSs authorized to transmit bandwidth requests or Initial Ranging requests. This group may include either all SSs having an intention to join the cell or all registered SSs or a multicast polling group. The number of transmission opportunities associated with a particular IE in a map is dependent on the total size of the allocation as well as the size of an individual transmission.

The size of an individual transmission opportunity for each type of contention IE shall be published in each transmitted UCD message. The BS shall always allocate bandwidth for contention IEs in integer multiples of these published values.

As an example, consider contention-based bandwidth requests for a WirelessMAN-SC system where the PHY protocol has a frame duration of 1 ms, 4 symbols for each PS, 2 PSs for each minislot, an uplink preamble of 16 symbols (i.e., 2 minislots), and an SS transition gap (SSTG) of 24 symbols (i.e., 3 minislots). Thus, assuming quadrature phase-shift keying (QPSK) modulation, each transmission opportunity requires 8 minislots: 3 for the SSTG, 2 for the preamble, and 3 for the bandwidth request message. This payload requirement would be specified as a value of 16 assigned to the UCD TLV “Bandwidth request opportunity size”.

If the BS schedules a Request IE of, for example, 24 minislots, there will be three transmission opportunities within this IE. Details of the three transmission opportunities are shown in Figure 54.

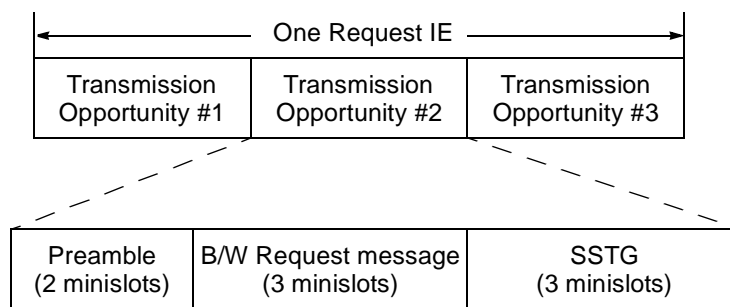

Figure 54—Example of Request IE containing multiple transmission opportunities

6.3.9 Network entry and initialization

Systems shall support the applicable procedures for entering and registering a new SS or a new node to the network. All network entry procedures described hereunder through and including 6.3.9.13 apply only to PMP operation. The network entry procedure for Mesh operation is described in 6.3.9.14.

The procedure for initialization of an SS shall be as shown in Figure 55. This figure shows the overall flow between the stages of initialization in an SS. This shows no error paths and is shown simply to provide an overview of the process. The more detailed finite state machine representations of the individual sections (including error paths) are shown in the subsequent figures. Timeout values are defined in 10.1.

The procedure can be divided into the following phases:

- a) Scan for downlink channel and establish synchronization with the BS
- b) Obtain transmit parameters (from UCD message)
- c) Perform ranging

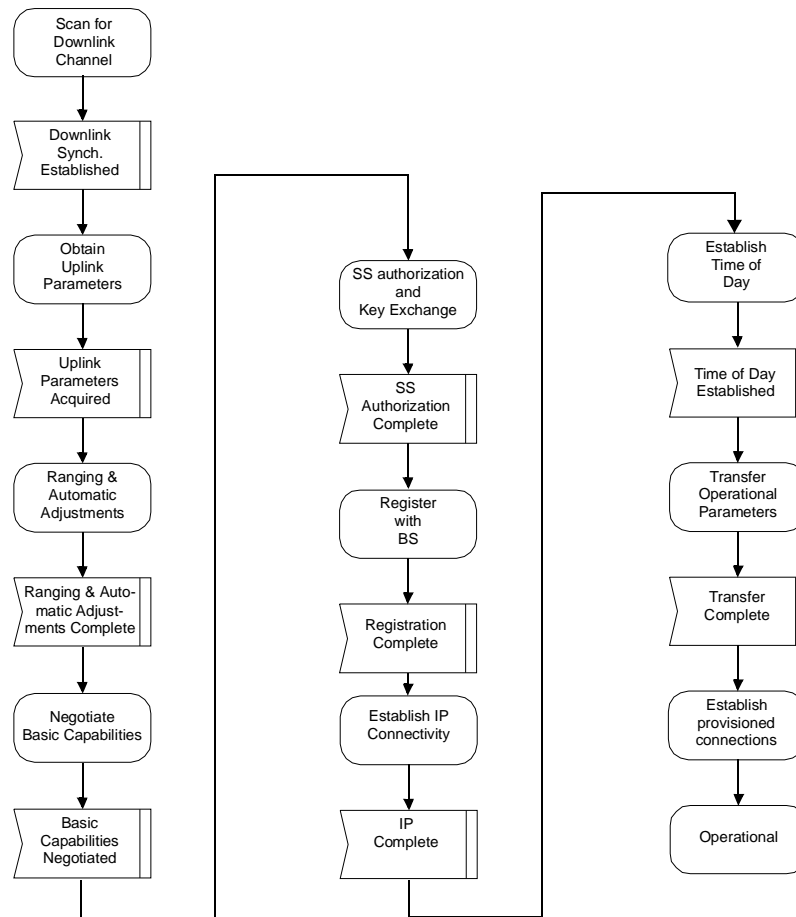

Figure 55—SS Initialization overview

- d) Negotiate basic capabilities
- e) Authorize SS and perform key exchange
- f) Perform registration
- g) Establish IP connectivity
- h) Establish time of day
- i) Transfer operational parameters
- j) Set up connections

Implementation of phases g), h), and i) at the SS is optional. These phases shall only be performed if the SS has indicated in the REG-REQ message that it is a managed SS.

Each SS contains the following information when shipped from the manufacturer:

- a) A 48-bit universal MAC address (per IEEE Std 802-2001) assigned during the manufacturing process. This is used to identify the SS to the various provisioning servers during initialization.
- b) Security information as defined in Clause 7 (e.g., X.509 certificate) used to authenticate the SS to the security server and authenticate the responses from the security and provisioning servers.

6.3.9.1 Scanning and synchronization to the downlink

On initialization or after signal loss, the SS shall acquire a downlink channel. The SS shall have nonvolatile storage in which the last operational parameters are stored and shall first try to reacquire this downlink channel. If this fails, it shall begin to continuously scan the possible channels of the downlink frequency band of operation until it finds a valid downlink signal.

Once the PHY has achieved synchronization, as given by a PHY Indication, the MAC shall attempt to acquire the channel control parameters for the downlink and then the uplink.

6.3.9.2 Obtain downlink parameters

The MAC shall search for the DL-MAP MAC management messages. The SS achieves MAC synchronization once it has received at least one DL-MAP message. An SS MAC remains in synchronization as long as it continues to successfully receive the DL-MAP and DCD messages for its Channel. If the Lost DL-MAP Interval (Table 342) has elapsed without a valid DL-MAP message or the T1 interval (Table 342) has elapsed without a valid DCD message, an SS shall try to reestablish synchronization. The process of acquiring synchronization is illustrated in Figure 56. The process of maintaining synchronization is illustrated in Figure 57.

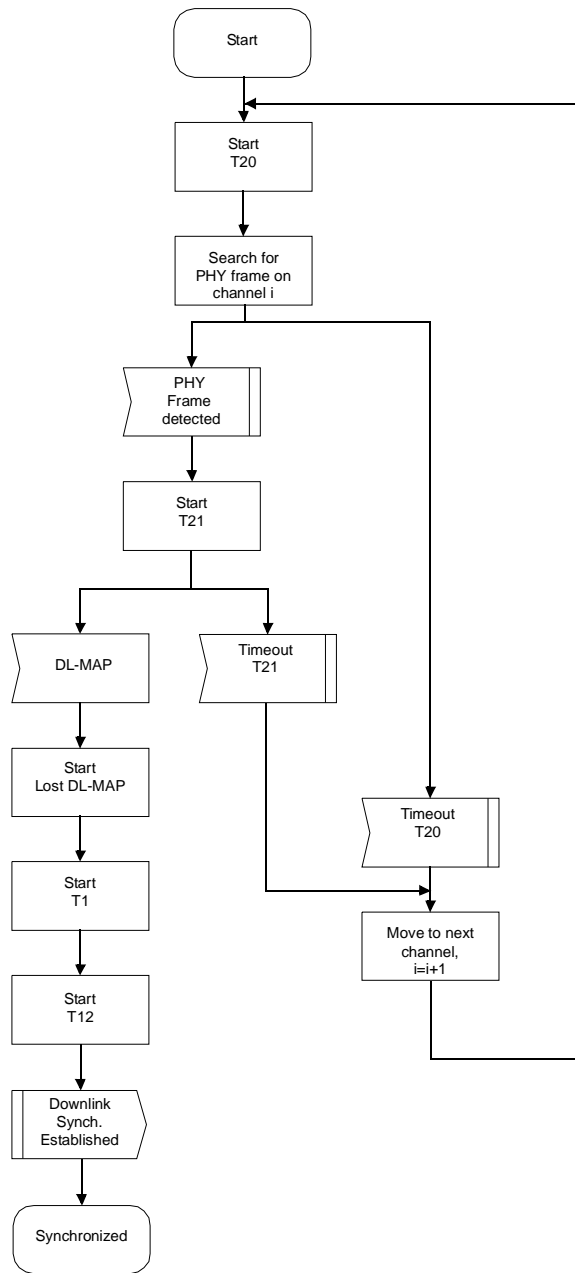

Figure 56—Obtaining downlink synchronization

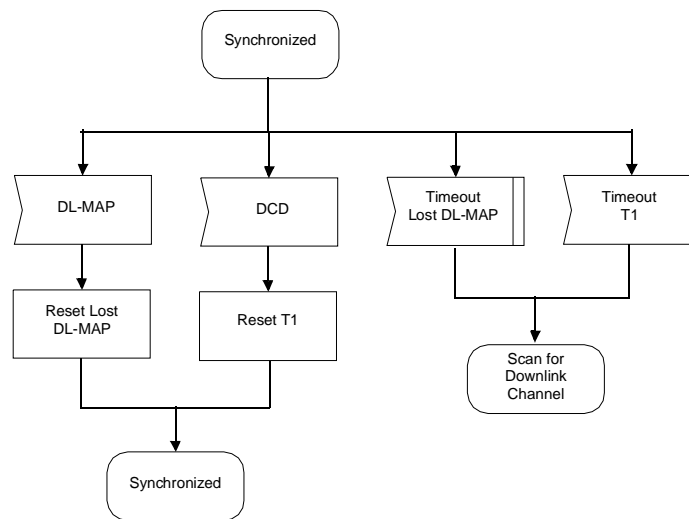

Figure 57—Maintaining downlink synchronization

6.3.9.3 Obtain uplink parameters

After synchronization, the SS shall wait for a UCD message from the BS in order to retrieve a set of transmission parameters for a possible uplink channel. These messages are transmitted periodically from the BS for all available uplink channels and are addressed to the MAC broadcast address.

If no uplink channel can be found after a suitable timeout period, then the SS shall continue scanning to find another downlink channel. The process of obtaining uplink parameters is illustrated in Figure 58.

The SS shall determine from the channel description parameters whether it may use the uplink channel. If the channel is not suitable, then the SS shall continue scanning to find another downlink channel. If the channel is suitable, the SS shall extract the parameters for this uplink from the UCD. It then shall wait for the next DL-MAP message and extract the time synchronization from this message. Then, the SS shall wait for a bandwidth allocation map for the selected channel. It may begin transmitting uplink in accordance with the MAC operation and the bandwidth allocation mechanism.

The SS shall perform initial ranging at least once, per Figure 60 and Figure 61. If initial ranging is not successful, the procedure is restarted from scanning to find another downlink channel.

The SS MAC is considered to have valid uplink parameters as long as it continues to successfully receive the UL-MAP and UCD messages. If at least one of these messages is not received within the time intervals specified in Table 342, the SS shall not use the uplink. This is illustrated in Figure 59.

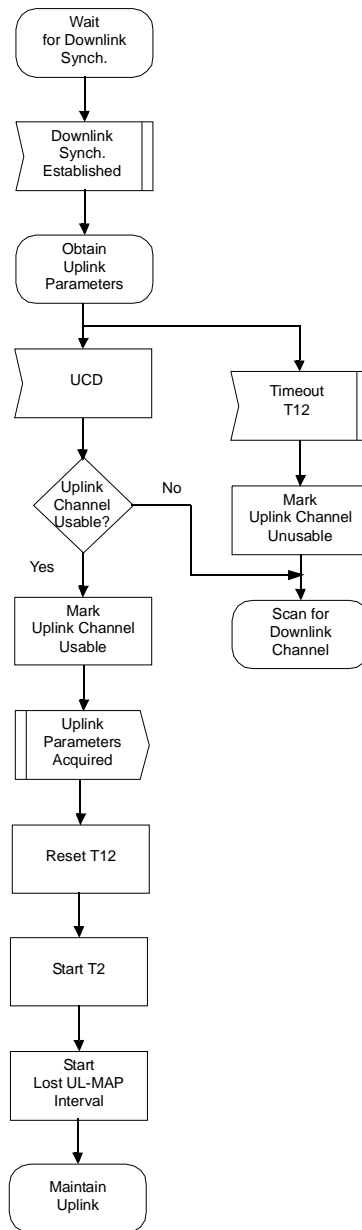

Figure 58—Obtaining uplink parameters

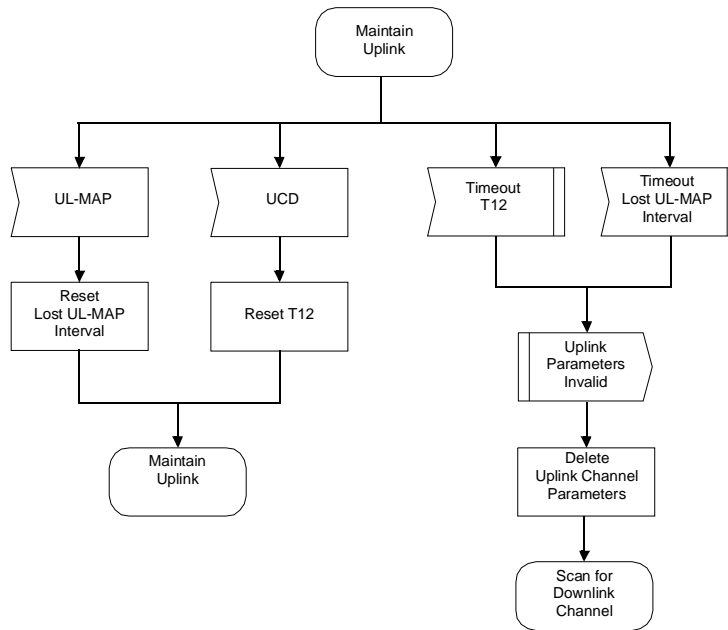

Figure 59—Maintain uplink parameters

6.3.9.4 Message flows during scanning and uplink parameter acquisition

The BS shall generate UCD and DCD messages on the downlink at periodic intervals within the ranges defined in Table 342. The BS may generate UL-MAP and DL-MAP at intervals as specified in a particular PHY specification. These messages are addressed to all SSs. Refer to Table 114.

Table 114—Message flows during scanning and uplink parameter acquisition

BS	SS
clock time to send DL-MAP	-----DL-MAP----->
clock time to send UCD and DCD	-----UCD and DCD----->
clock time to send DL-MAP	-----DL-MAP----->
	Example of a UCD and DCD
	cycle prior to SS power-on
clock time to send DL-MAP	-----DL-MAP----->
clock time to send DL-MAP	-----DL-MAP----->
clock time to send DL-MAP	-----DL-MAP----->

Table 114—Message flows during scanning and uplink parameter acquisition (continued)

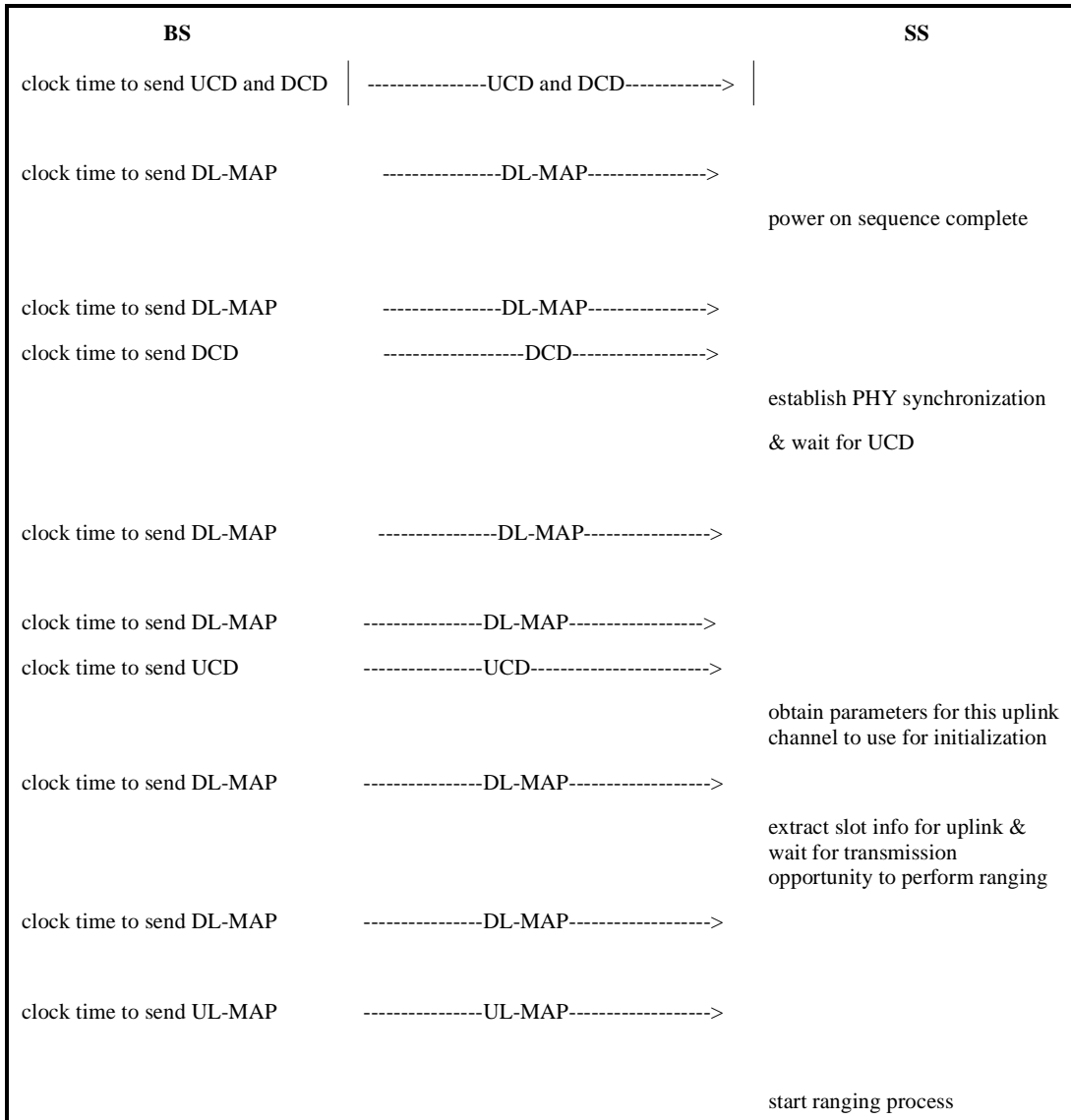

6.3.9.5 Initial ranging and automatic adjustments

Ranging is the process of acquiring the correct timing offset and power adjustments such that the SS's transmissions are aligned to a symbol that marks the beginning of a minislot boundary in SC and Sca PHY, or aligned with the BS receive frame for OFDM and OFDMA PHY, and received within the appropriate reception thresholds. The timing delays through the PHY shall be relatively constant. Any variation in the PHY delays shall be accounted for in the guard time of the uplink PHY overhead.

6.3.9.5.1 Contention based Initial ranging and automatic adjustments

First, an SS shall synchronize to the downlink and learn the uplink channel characteristics through the UCD MAC management message. At this point, the SS shall scan the UL-MAP message to find an Initial Ranging Interval. The BS shall allocate an Initial Ranging Interval consisting of one or more transmission

opportunities. For SC, SCa, and OFDM PHY, the size of each transmission opportunity shall be as specified by the UCD TLV, Ranging request opportunity size.

For SC, SCa, and OFDM PHY, the SS shall put together a RNG-REQ message to be sent in an Initial Ranging Interval. The CID field shall be set to the non initialized SS value (zero). For the OFDMA PHY, the initial ranging process shall begin by sending initial-ranging CDMA codes on the UL allocation dedicated for that purpose (for more details see 6.3.10.3), instead of RNG-REQ messages sent on contention slots.

Ranging adjusts each SS's timing offset such that it appears to be co-located with the BS. The SS shall set its initial timing offset to the amount of internal fixed delay equivalent to collocating the SS next to the BS. This amount includes delays introduced through a particular implementation and shall include the downlink PHY interleaving latency, if any.

When the Initial Ranging transmission opportunity occurs, the SS shall send the RNG-REQ message (or a CDMA code in case of the OFDMA PHY). Thus, the SS sends the message as if it were colocated with the BS.

The SS shall calculate the maximum transmit signal strength for initial ranging, $P_{TX_IR_MAX}$, from Equation (10).

$$P_{TX_IR_MAX} = EIR \times P_{IR,max} + BS_EIRP - RSS \quad (10)$$

where the $EIR \times P_{IR,max}$ and BS_EIRP are obtained from the DCD, and RSS is the measured RSSI, by the SS, as described in the respective PHY.

In the case that the receive and transmit gain of the SS antennae are substantially different, the SS shall use Equation (11).

$$P_{TX_IR_MAX} = EIR \times P_{IR,max} + BS_EIRP - RSS + (G_{Rx_SS} - G_{Tx_SS}) \quad (11)$$

where

G_{Rx_SS} is the SS receive antenna gain,
 G_{Tx_SS} is the SS transmit antenna gain.

In the case that the $EIR \times P_{IR,max}$ and/or BS_EIRP are/is not known, the SS shall start from the minimum transmit power level defined by the BS

NOTE—The $EIR \times P_{IR,max}$ is the maximum equivalent isotropic received power, which is computed for a simple single-antenna receiver as $RSS_{IR,max} - GANT_BS_Rx$, where the $RSS_{IR,max}$ is the received signal strength at antenna output and $GANT_BS_Rx$ is the receive antenna gain. The BS_EIRP is the equivalent isotropic radiated power of the base station, which is computed for a simple single-antenna transmitter as $P_{Tx} + GANT_BS_Tx$, where P_{Tx} is the transmit power and $GANT_BS_Tx$ is the transmit antenna gain.

For SC, SCa, and OFDM PHY, the SS shall send the RNG-REQ at a power level below $P_{TX_IR_MAX}$, measured at the antenna connector. If the SS does not receive a response, the SS shall resend the RNG-REQ at the next appropriate Initial Ranging transmission opportunity at one step higher power level. If the SS receives a response containing the frame number in which the RNG-REQ was transmitted, it shall consider the transmission attempt unsuccessful but implement the corrections specified in the RNG-RSP and issue another RNG-REQ message after the appropriate backoff delay. If the SS receives a response containing its MAC Address, it shall consider the RNG-RSP reception successful.

When a WirelessMAN-SCa or WirelessMAN-OFDM BS detects a transmission in the ranging slot that it is unable to decode, it may respond by transmitting a RNG-RSP that includes transmission parameters, but

identifies the frame number and frame opportunity when the transmission was received instead of the MAC Address of the transmitting SS.

For OFDMA, the SS shall send a CDMA code at a power level below $P_{TX_IR_MAX}$, measured at the antenna connector. If the SS does not receive a response, the SS shall send a new CDMA code at the next appropriate Initial Ranging transmission opportunity at one step higher power level. If the SS receives a RNG-RSP message containing the parameters of the code it has transmitted and status continue, it shall consider the transmission attempt unsuccessful but implement the corrections specified in the RNG-RSP and issue another CDMA code after the appropriate backoff delay. If the SS receives an UL-MAP containing a CDMA allocation IE with the parameters of the code it has transmitted, it shall consider the RNG-RSP reception successful, and proceed to send a unicast RNG-REQ on the allocated BW. More details on this procedure can be found in 6.3.10.3.

Once the BS has successfully received the RNG-REQ message, it shall return a RNG-RSP message using the initial ranging CID. Within the RNG-RSP message shall be the Basic and Primary Management CIDs assigned to this SS. The message shall also contain information on RF power level adjustment and offset frequency adjustment as well as any timing offset corrections. At this point the BS shall start using invited Initial Ranging Intervals addressed to the SS's Basic CID to complete the ranging process, unless the status of the RNG-RSP message is success, in which case the initial ranging procedure shall end.

If the status of the RNG-RSP message is continue, the SS shall wait for an individual Initial Ranging interval assigned to its Basic CID. Using this interval, the SS shall transmit another RNG-REQ message using the Basic CID along with any power level and timing offset corrections.

The BS shall return another RNG-RSP message to the SS with any additional fine tuning required. The ranging request/response steps shall be repeated until the response contains a Ranging Successful notification or the BS aborts ranging. Once successfully ranged (RNG-REQ is within tolerance of the BS), the SS shall join normal data traffic in the uplink. In particular, state machines and the applicability of retry counts and timer values for the ranging process are defined in Table 342.

NOTE—The burst profile to use for any uplink transmission is defined by the Uplink Interval Usage Code (UIUC). Each UIUC is mapped to a burst profile in the UCD message.

For SC, SCa, and OFDM PHY, the message sequence chart (Table 115) and flow charts (Figure 60, Figure 61, Figure 62, and Figure 63) on the following pages define the ranging and adjustment process that shall be followed by compliant SSs and BSs. For OFDMA PHY, these details can be found in 6.3.10.3.

Table 115—Ranging and automatic adjustments procedure

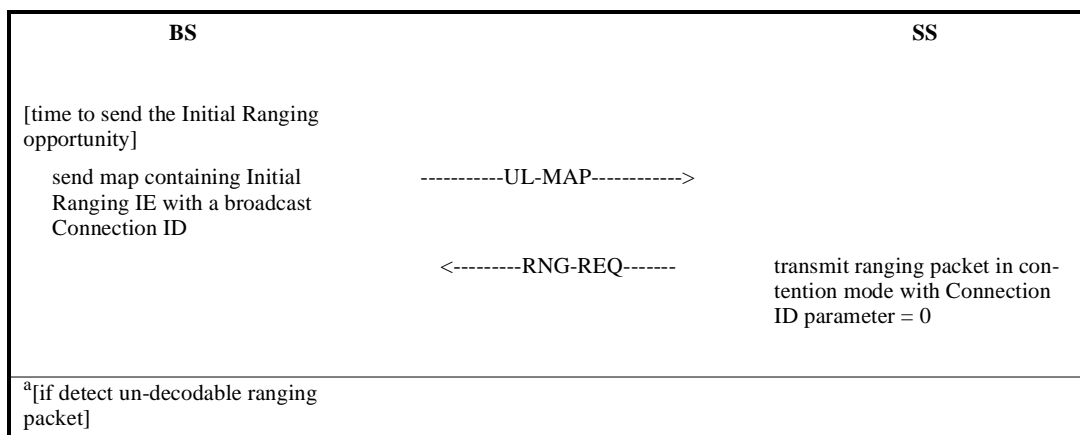

Table 115—Ranging and automatic adjustments procedure (continued)

BS		SS
^a send ranging response, including Frame Number, Frame Opportunity, CID=0	-----RNG-RSP ^a ----->	^a [recognize frame number/opportunity when packet was sent] Adjust parameters, prepare to transmit another RNG-REQ at next opportunity
[else receive decodable ranging packet]		
allocate Basic and Primary Management Connection ID		
send ranging response	-----RNG-RSP----->	
add Basic Connection ID to poll list		[recognize own MAC Address] store Basic Connection ID and adjust other parameters
[time to send the next map]		
send map with Initial Ranging IE to SS using Basic CID	-----UL-MAP----->	[recognize own Basic Connection ID in map]
	<-----RNG-REQ-----	reply to Initial Ranging opportunity poll
send ranging response	-----RNG-RSP----->	adjust local parameters
send periodic transmit opportunity to broadcast address	-----UL-MAP----->	

^aWirelessMAN-SCa and WirelessMAN-OFDM PHY only.

NOTES

1—The BS shall allow the SS sufficient time to have processed the previous RNG-RSP (i.e., to modify the transmitter parameters) before sending the SS a specific ranging opportunity. This is defined as SS Ranging Response Processing Time in Table 342.

2—For multichannel support, the SS shall attempt initial ranging on every suitable uplink channel before moving to the next available downlink channel.

On receiving a RNG-RSP instruction to move to a new downlink frequency and/or uplink channel ID, the SS shall consider any previously assigned Basic, Primary Management, and Secondary Management CIDs to be deassigned, and shall obtain new Basic, Primary Management, and Secondary Management CIDs via initial ranging and registration.

It is possible that the RNG-RSP may be lost after transmission by the BS. The SS shall recover by timing out and reissuing its Initial RNG-REQ. Since the SS is uniquely identified by the source MAC address in the Ranging Request, the BS may immediately reuse the Basic, Primary Management, and Secondary Management CIDs previously assigned. If the BS assigns new Basic, Primary Management, and Secondary Management CIDs, it shall make some provision for aging out the old CIDs that went unused.

6.3.9.6 Ranging parameter adjustment

Adjustment of local parameters (e.g., transmit power) in an SS as a result of the receipt (or non receipt) of a RNG-RSP is considered to be implementation-dependent with the following restrictions:

- a) All parameters shall be within the approved range at all times.
- b) Power adjustment shall start from the initial value selected with the algorithm described in 6.3.9.5 unless a valid power setting is available from nonvolatile storage, in which case this value may be used as the starting point.
- c) Power adjustment shall be capable of being reduced or increased by the specified amount in response to RNG-RSP messages.
- d) If, during initialization, power is increased to the maximum value (without a response from the BS) it shall wrap back to the minimum

On receiving a RNG-RSP, the SS shall not transmit until the RF signal has been adjusted in accordance with the RNG-RSP and has stabilized.

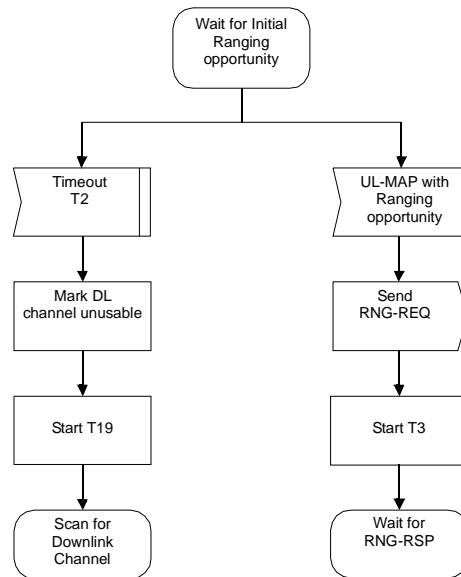

Figure 60—Initial Ranging—SS (part 1)

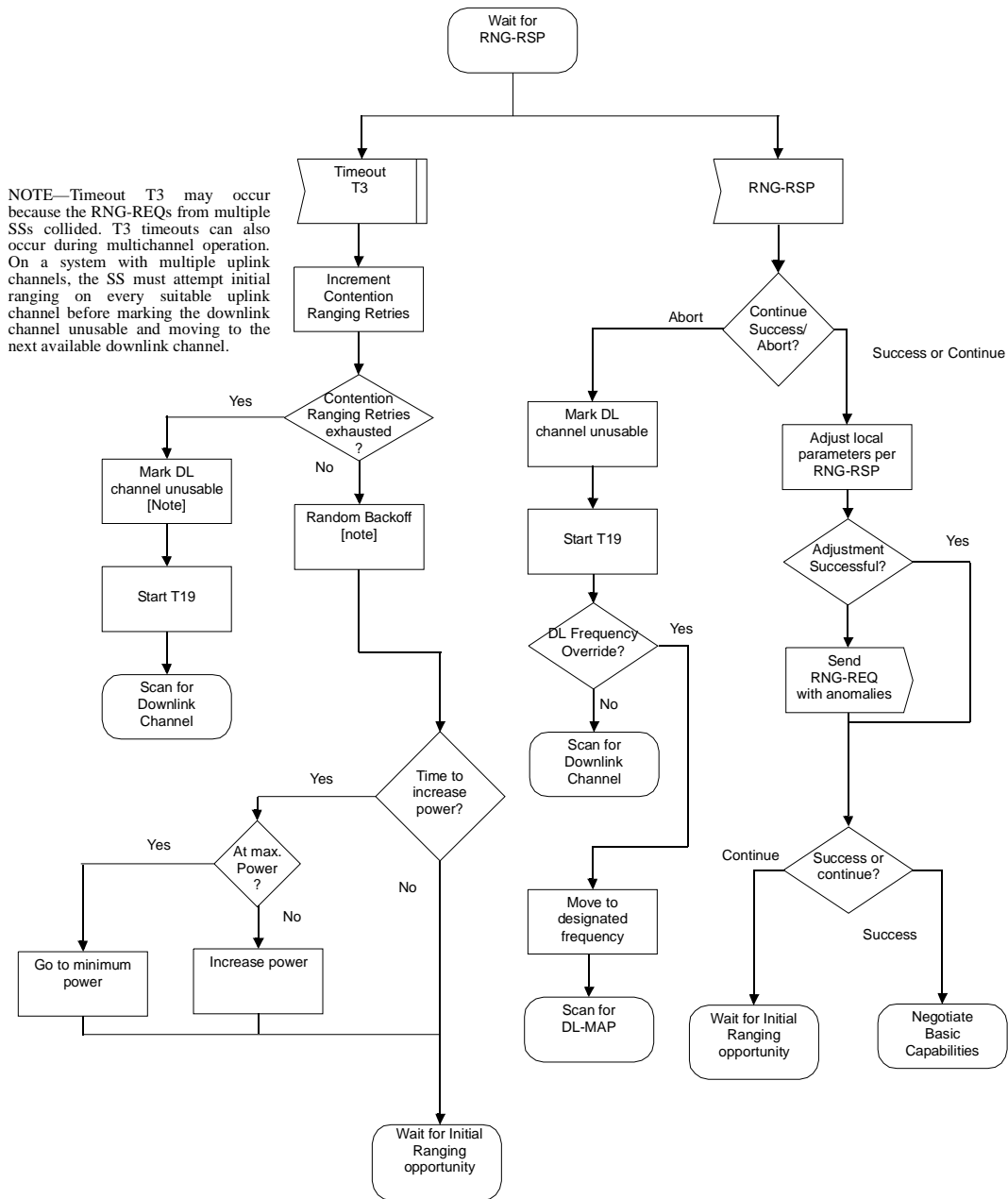

Figure 61—Initial Ranging—SS (part 2)

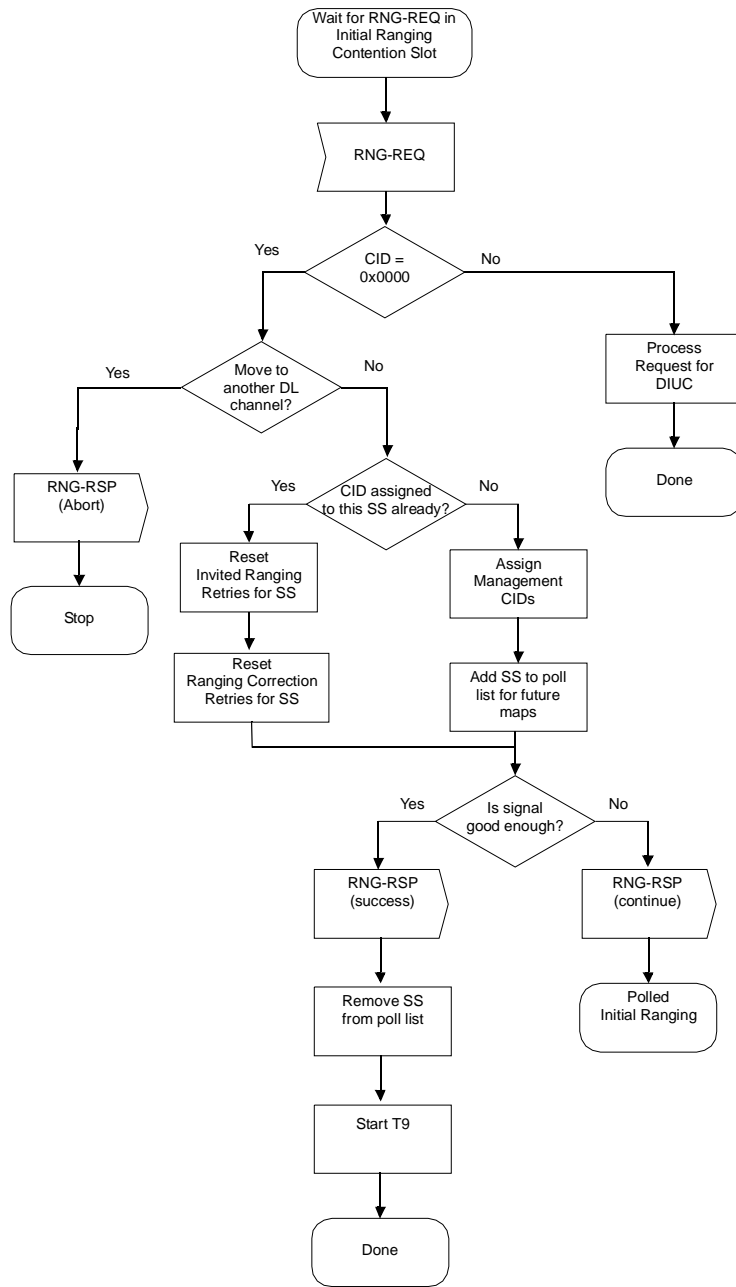
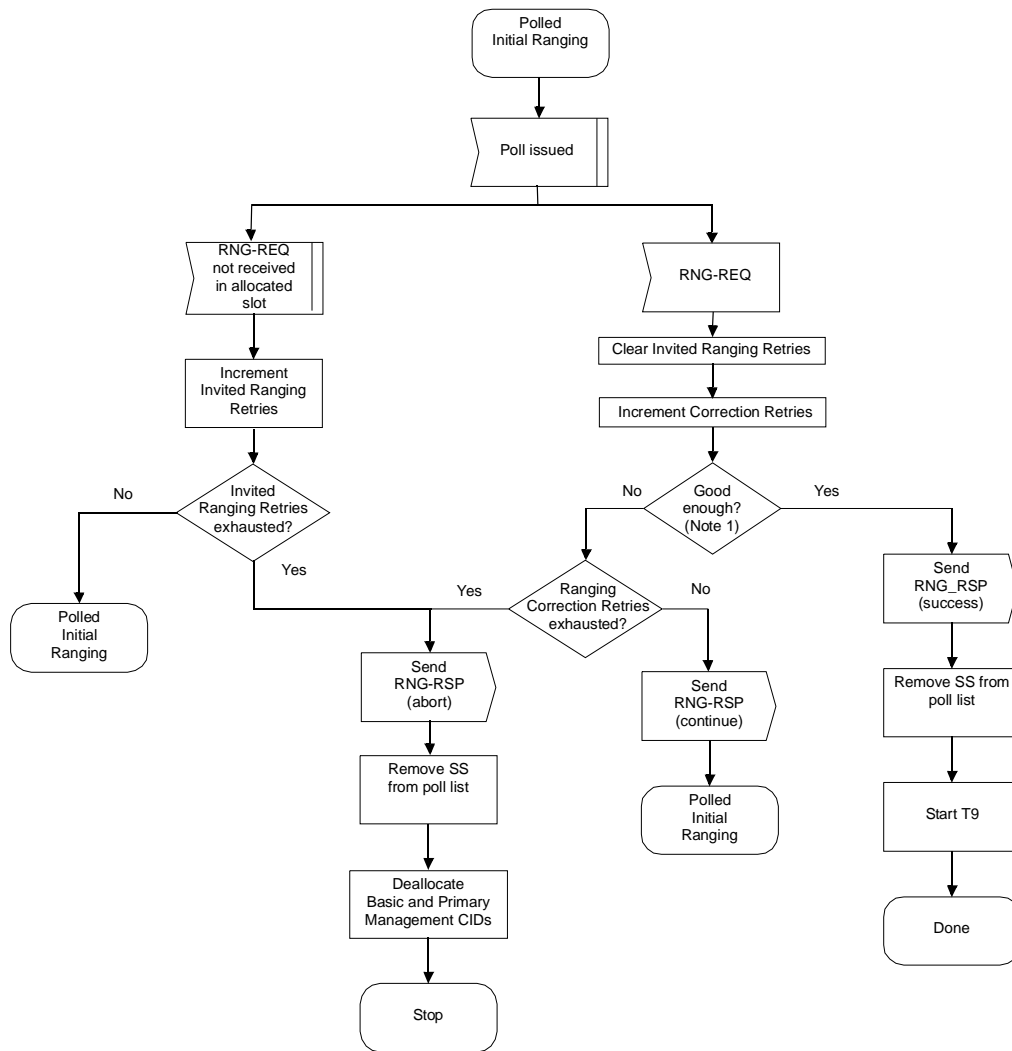

Figure 62—Initial Ranging—BS



NOTE—Means ranging is within the tolerable limits of the BS.

Figure 63—Initial Ranging, Polled Phase-BS

For systems operating below 11 GHz, the BS may in addition respond to undecodable messages in an Initial Ranging slot as shown in Figure 64.

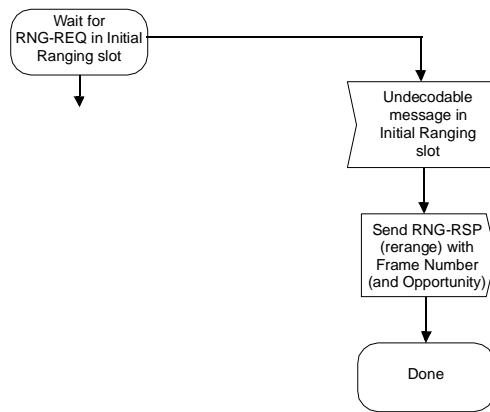

Figure 64—Initial ranging—BS response to undecodable message

6.3.9.7 Negotiate basic capabilities

Immediately after completion of ranging, the SS informs the BS of its basic capabilities by transmitting an SBC-REQ message with its capabilities set to “on” (see Figure 65). The BS responds with an SBC-RSP message with the intersection of the SS’s and the BS’s capabilities set to “on” (see Figure 66 and Figure 67, respectively).

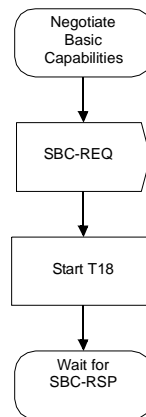

Figure 65—Negotiate Basic Capabilities—SS

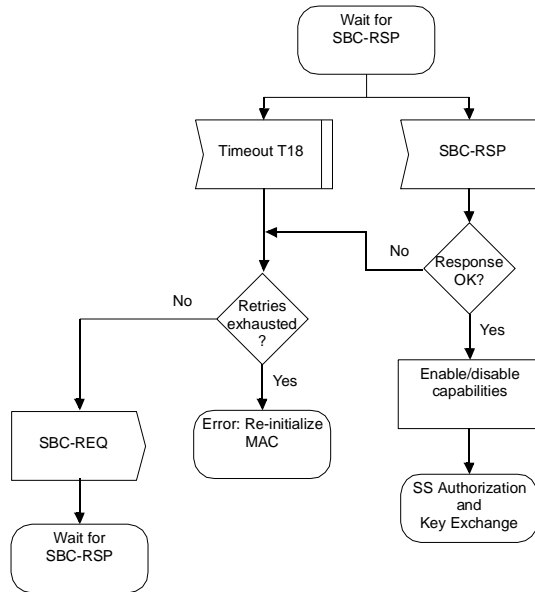

Figure 66—Wait for SBC-RSP—SS

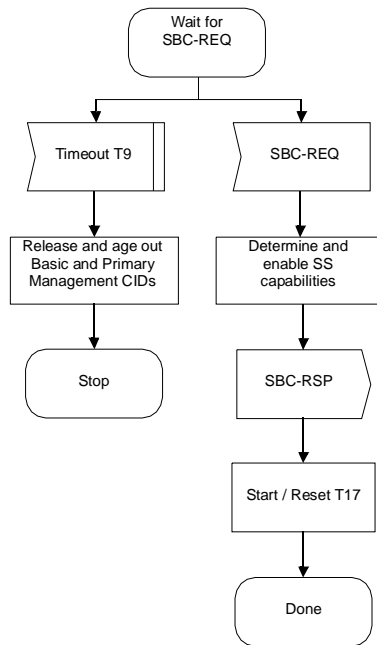

Figure 67—Negotiate Basic Capabilities—BS

6.3.9.8 SS authorization and key exchange

The BS and SS shall perform authorization and key exchange as described in 7.2.

6.3.9.9 Registration

Registration is the process by which the SS is allowed entry into the network and a managed SS receives its Secondary Management CID and thus becomes manageable. To register with a BS, the SS shall send a REG-REQ message to the BS. The BS shall respond with a REG-RSP message. For an SS that has indicated being a managed SS in the REG-REQ message, the REG-RSP message shall include the Secondary Management CID.

Figure 68 shows the procedure that shall be followed by the SS.

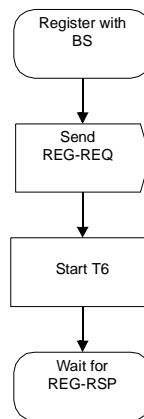

Figure 68—Registration—SS

Once the SS has sent a REG-REQ to the BS, it shall wait for a REG-RSP to authorize it to forward traffic to the network. Figure 69 shows the waiting procedure that shall be followed by the SS.

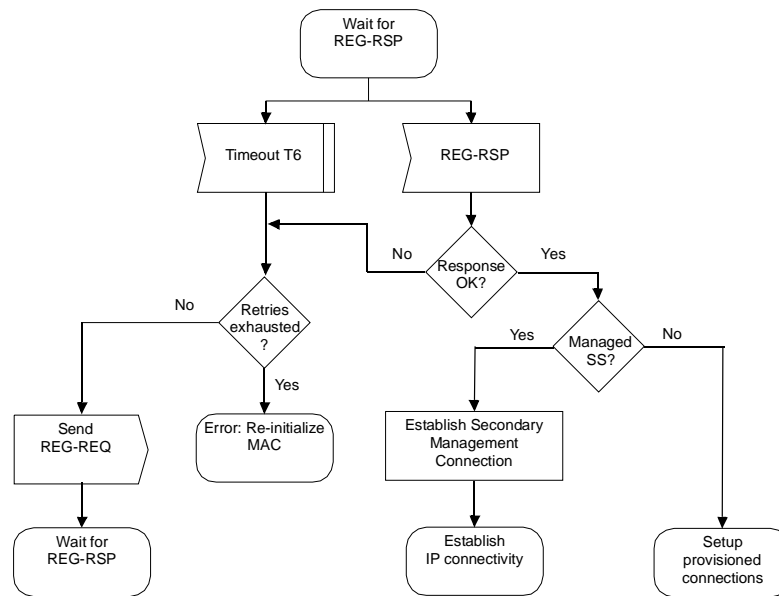

Figure 69—Wait for REG-RSP—SS

The BS shall perform the operations shown in Figure 70.

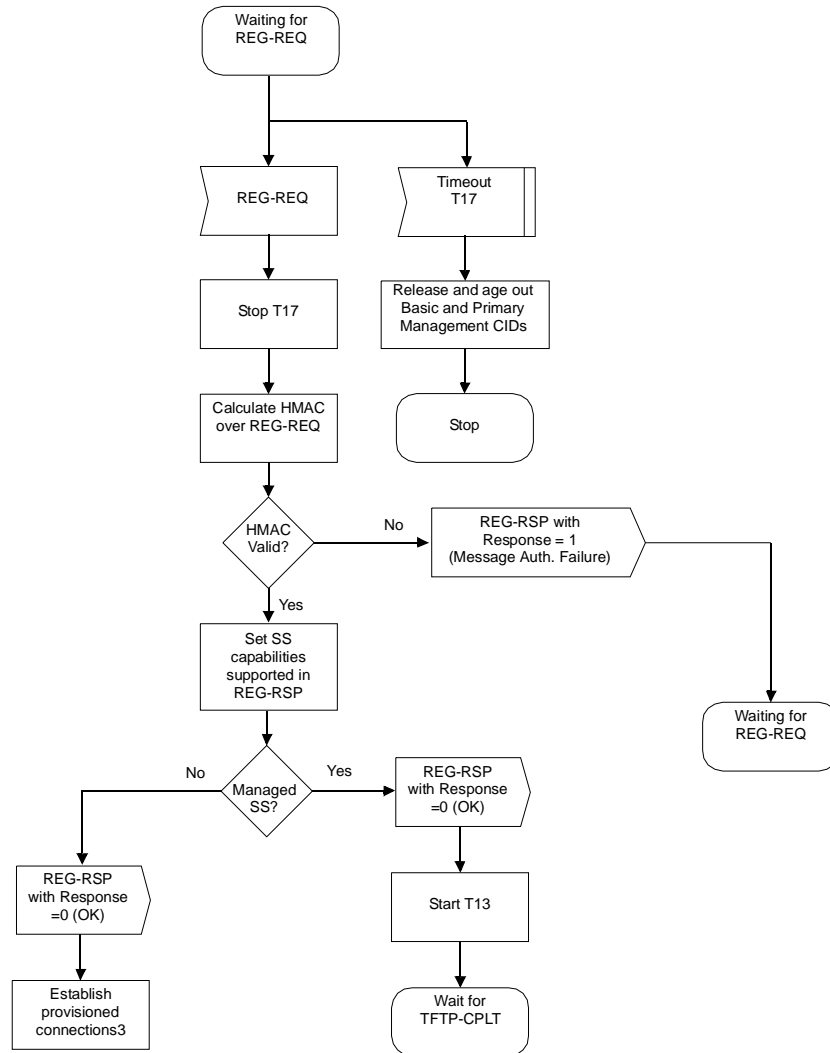

Figure 70—Registration—BS

For managed SS, upon sending a REG-RSP, the BS shall wait for a TFTP-CPLT. If timer T13 (defined in Table 342) expires, the BS shall both deassign the management CIDs from that SS and make some provision for aging out those CIDs (see Figure 71 and Figure 72).

6.3.9.9.1 IP version negotiation

The SS may include the IP Version (11.7.4) parameter in the REG-REQ to indicate which versions of IP it supports on the Secondary Management Connection. When present in the REG-REQ, the BS shall include the IP Version parameter (11.7.4) in the REG-RSP to command the SS to use the indicated version of IP on the Secondary Management Connection. The BS shall command the use of exactly one of the IP versions supported by the SS.

The omission of the IP Version parameter in the REG-REQ shall be interpreted as IPv4 support only. Consequently, omission of the IP Version parameter in the REG-RSP shall be interpreted as a command to use IPv4 on the Secondary Management Connection.

6.3.9.10 Establish IP connectivity

At this point, the SS shall invoke DHCP mechanisms (IETF RFC 2131) in order to obtain an IP address and any other parameters needed to establish IP connectivity. If the SS has a configuration file, the DHCP response shall contain the name of a file that contains further configuration parameters. Establishment of IP connectivity shall be performed on the SS's Secondary Management Connection (see Table 116).

Table 116—Establishing IP connectivity

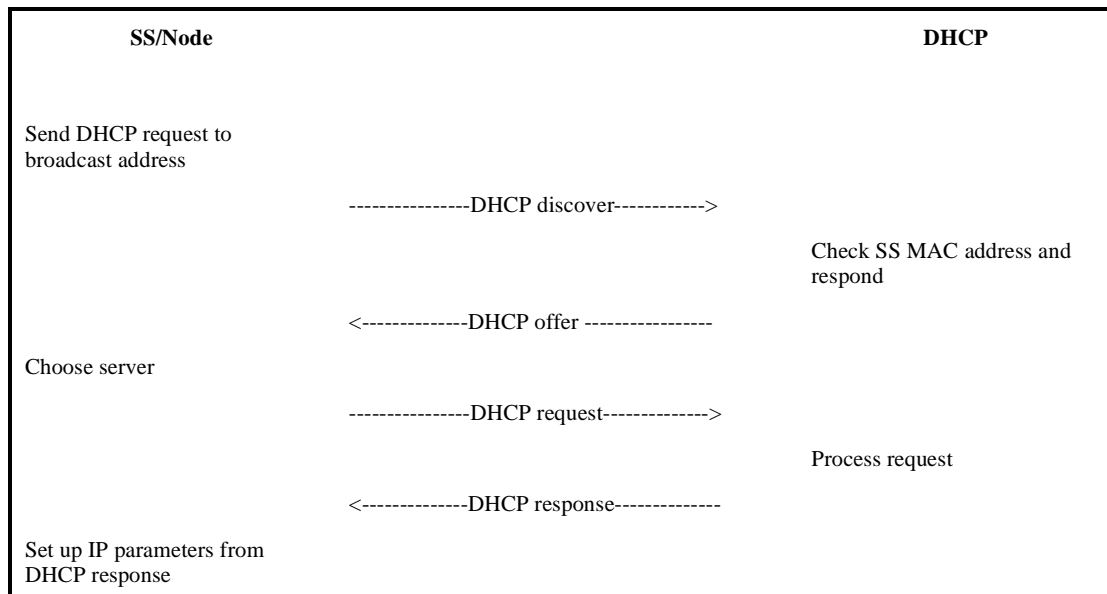

6.3.9.11 Establish time of day

The SS and BS need to have the current date and time. This is required for time-stamping logged events for retrieval by the management system. This need not be authenticated and need be accurate only to the nearest second.

The protocol by which the time of day shall be retrieved is defined in IETF RFC 868. Refer to Table 117. The request and response shall be transferred using UDP. The time retrieved from the server [universal coordinated time (UTC)] shall be combined with the time offset received from the DHCP response to create the current local time. Establishment of time of day shall be performed on the SS's Secondary Management Connection.

Table 117—Establishing time of day

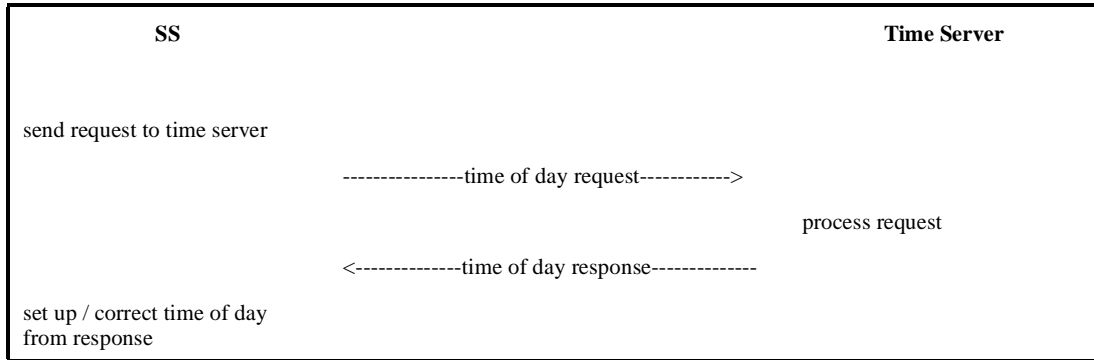

Successfully acquiring the Time of Day is not mandatory for a successful registration, but is necessary for ongoing operation. The specific timeout for Time of Day Requests is implementation dependent. However, the SS shall not exceed more than three Time of Day requests in any five-minute period.

6.3.9.12 Transfer operational parameters

After DHCP is successful, the SS shall download the SS Configuration File (9.2) using TFTP on the SS’s Secondary Management Connection, as shown in Table 118 if specified in the DHCP response. The TFTP Configuration File server is specified by the “siaddr” field of the DHCP response. The SS shall use an adaptive timeout for TFTP based on binary exponential backoff (IETF RFC 1123, IETF RFC 2349).

Table 118—Transfer of Operational Parameters

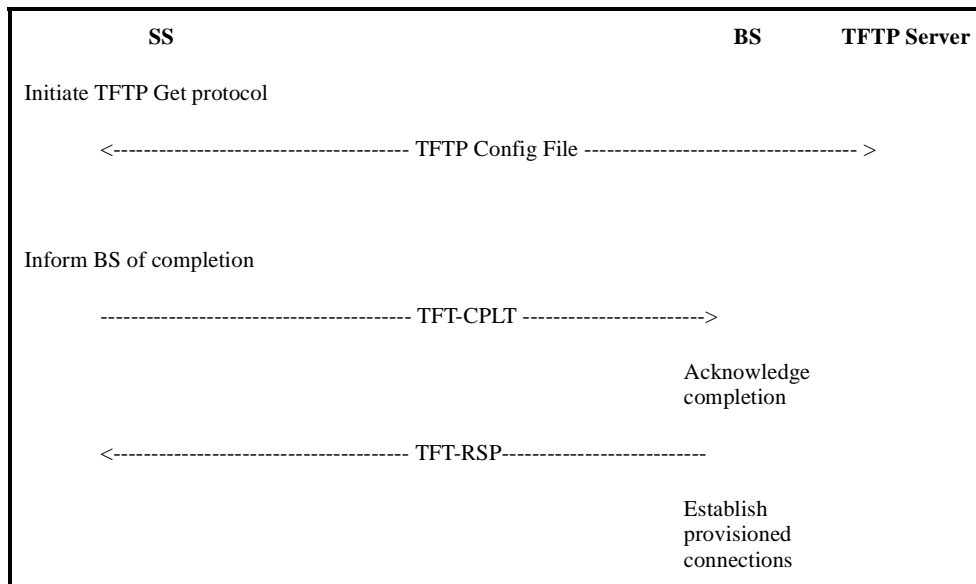

The parameter fields required in the DHCP response and the format and content of the configuration file shall be as defined in 9.2. Note that these fields are the minimum required for interoperability.

When the configuration file download has completed successfully, the SS shall notify the BS by transmitting a TFTP-CPLT message on the SS's primary management connection. Transmissions shall continue periodically until a TFTP-RSP message is received with "OK" response from the BS (see Figure 71 and Figure 72) or the SS terminates retransmission due to retry exhaustion.

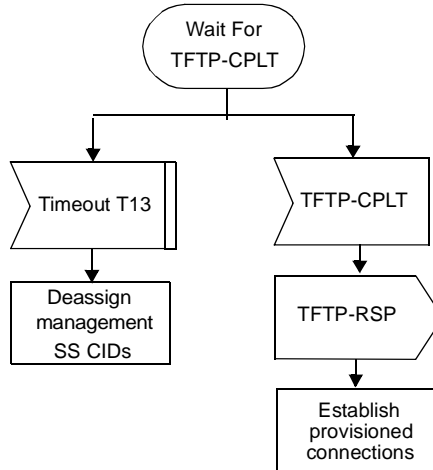

Figure 71—Wait for TFTP-CPLT—BS

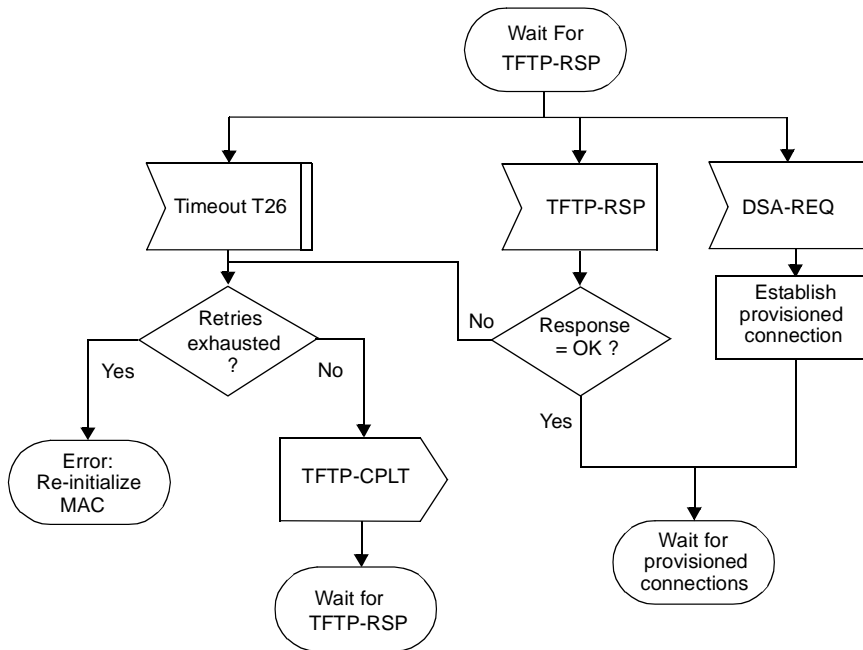

Figure 72—Wait for TFTP-RSP—SS

6.3.9.13 Establish provisioned connections

After the transfer of operational parameters (for managed SS) or after registration (for unmanaged SS), the BS shall send DSA-REQ messages to the SS to set up connections for preprovisioned service flows belonging to the SS. The SS responds with DSA-RSP messages. This is described further in 6.3.14.7.1.

6.3.9.14 Network Entry and synchronization in Mesh mode

Node initialization and network entry procedures in Mesh mode are in some aspects different from those in PMP mode. A new node entering the Mesh network obeys the following procedures. The whole entry process to the stage when the node can start scheduled transmissions can be divided into the following phases:

- a) Scan for active network and establish coarse synchronization with the network
- b) Obtain network parameters (from MSH-NCFG messages)
- c) Open Sponsor Channel
- d) Node authorization
- e) Perform registration
- f) Establish IP connectivity
- g) Establish time of day
- h) Transfer operational parameters

The entry process is depicted in Figure 56, Figure 74, and Figure 75.

Each node contains the following information when shipped from the manufacturer:

- A 48-bit universal MAC address (per IEEE Std 802) assigned during the manufacturing process. This is used to identify the node to the various provisioning servers during initialization and whenever performing authentication with a neighbor node.

6.3.9.14.1 Scanning and coarse synchronization to the network

On initialization or after signal loss, the node shall search for MSH-NCFG messages to acquire coarse synchronization with the network. Upon receiving a MSH-NCFG message the node acquires the network time from the **Timestamp** field of the message. The node may have nonvolatile storage in which all the last operational parameters are stored and shall first try to re-acquire coarse synchronization with the network. If this fails, it shall begin to continuously scan the possible channels of the frequency band of operation until a valid network is found.

Once the PHY has achieved synchronization, the MAC shall attempt to acquire network parameters. At the same time the node shall build a physical neighbor list.

6.3.9.14.2 Obtaining network parameters

A node shall remain in synchronization as long as it receives MSH-NCFG messages. A node shall accumulate MSH-NCFG messages at least until it receives a MSH-NCFG message from the same node twice and until it has received a MSH-NCFG:Network Descriptor with an operator ID matching (one of) its own if it has any. In parallel, the new node shall build a physical neighbor list (see 6.3.7.5.5.1) from the acquired information.

From the established physical neighbor list, the new node shall select a potential Sponsoring Node out of all nodes having the Logical Network ID of the node for which it found a suitable Operator ID. The new node shall then synchronize its time to the potential sponsor assuming 0 propagation delay after which it shall

send a MSH-NENT:NetEntryRequest including the Node ID of the potential sponsor. To determine a suitable transmission time, the node shall adhere to 6.3.7.5.5.7.

Until the node has obtained an unique Node ID (see 6.3.9.14.5), it shall use temporary Node ID (0x0000) as Transmitter's Node ID in all transmissions.

Once the Candidate Node has selected a Sponsoring Node, it shall use the Sponsoring Node to negotiate basic capabilities and to perform authorization. For that purpose the Candidate Node shall first request the Sponsoring Node to open Sponsor Channel for more effective message exchange.

6.3.9.14.3 Open Sponsor Channel

Once the new node has selected one of its neighbors as the candidate Sponsoring Node it becomes a Candidate Node. To get further in the initialization procedure, the Candidate Node shall request the candidate Sponsoring Node to establish a temporary schedule that could be used for further message delivery during the Candidate Node initialization. The temporary schedule requested is termed Sponsor Channel.

The process is initiated by the Candidate Node, which transmits a MSH-NENT:NetEntryRequest message (a MSH-NENT message with Type set to 0x2) to the Sponsoring Node.

Upon reception of the MSH-NENT:NetEntryRequest message with the Sponsor Node ID equal to Node ID of its own, the candidate Sponsoring Node shall assess the request and either opens the Sponsor Channel or rejects the request. The response is given in a MSH-NCFG message with an Embedded Data as defined in 6.3.2.3.35.3. If the candidate Sponsoring Node does not advertise the Candidate Node's MAC address in the sponsor's next MSH-NCFG transmission, then the procedure is repeated MSH_SPONSOR_ATTEMPTS times using a random backoff between attempts. If these attempts all fail, then a different Candidate Sponsoring Node is selected and the procedure repeated (including re-initializing coarse network synchronization). If the selected candidate Sponsoring Node does advertise the Candidate Node's MAC address, it shall continue to advertise this MAC address in all its MSH-NCFG messages until the sponsorship is terminated.

Once the Candidate Node has received a positive response (a NetEntryOpen message) in from the candidate Sponsoring Node in the MSH-NCFG message, it shall acknowledge the response by transmitting a MSH-NENT:NetEntryAck message (a MSH-NENT message with Type set to 0x1) to the Sponsoring Node at the first following network entry transmission opportunity (see 8.3.5.3). Before that the Candidate Node shall perform fine time synchronization. It makes a correction to its transmission timing by the **Estimated propagation delay** indicated in the embedded MSH-NCFG:NetEntryOpen message.

If the Sponsoring Node accepts the request and opens a Sponsor Channel, the channel is ready for use immediately after the transmission of the acknowledgment message. At the same time, the candidate Sponsoring Node becomes the Sponsoring Node.

If the candidate Sponsoring Node embeds a MSH-NCFG:NetEntryReject, the new node shall perform the following action based on the rejection code:

- 0x0: Operator Authentication Value Invalid
The Candidate Node shall select a new candidate Sponsoring Node with a different operator ID.
- 0x1: Excess Propagation delay
The Candidate Node shall repeat its MSH-NENT:NetEntryRequest in the following network entry transmission opportunity to the same candidate Sponsoring Node.
- 0x2: Select new sponsor
The Candidate Node shall select a new candidate Sponsoring Node.

If the candidate Sponsoring Node embedded neither MSH-NCFG:NetEntryOpen nor MSH-NCFG:NetEntryReject, the Candidate Node shall wait (with timeout time T23), for the next MSH-NCFG with NetEntryOpen from the candidate Sponsoring Node and resend the MSH-NENT:NetEntryRequest on timeout.

The Candidate Node and the Sponsoring Node use the schedule indicated in the NetEntryOpen message to perform message exchanges described in 6.3.9.14.4 through 6.3.9.14.9. After this is completed, the Candidate Node shall terminate the entry process by sending a MSH-NENT:NetEntryClose message to the Sponsoring Node in the network entry transmission immediately following a MSH-NCFG transmission from the Sponsoring Node, which shall Ack termination with MSH-NCFG:NetEntryAck.

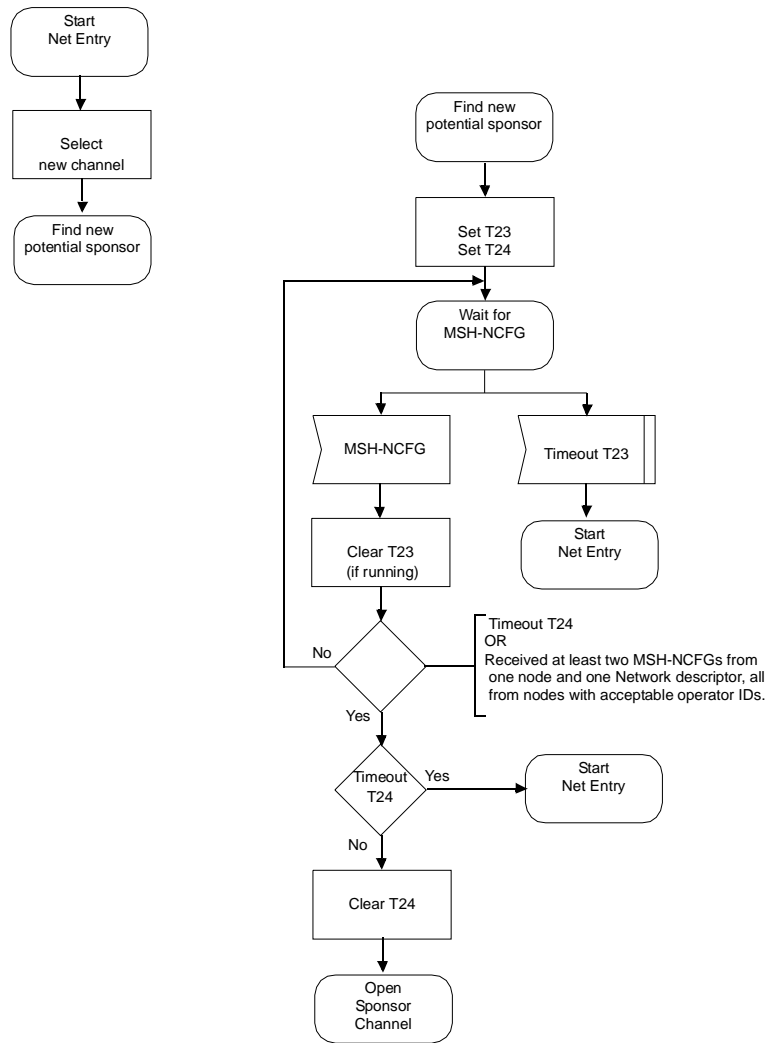

Figure 73—Mesh network synchronization and entry—New node—I

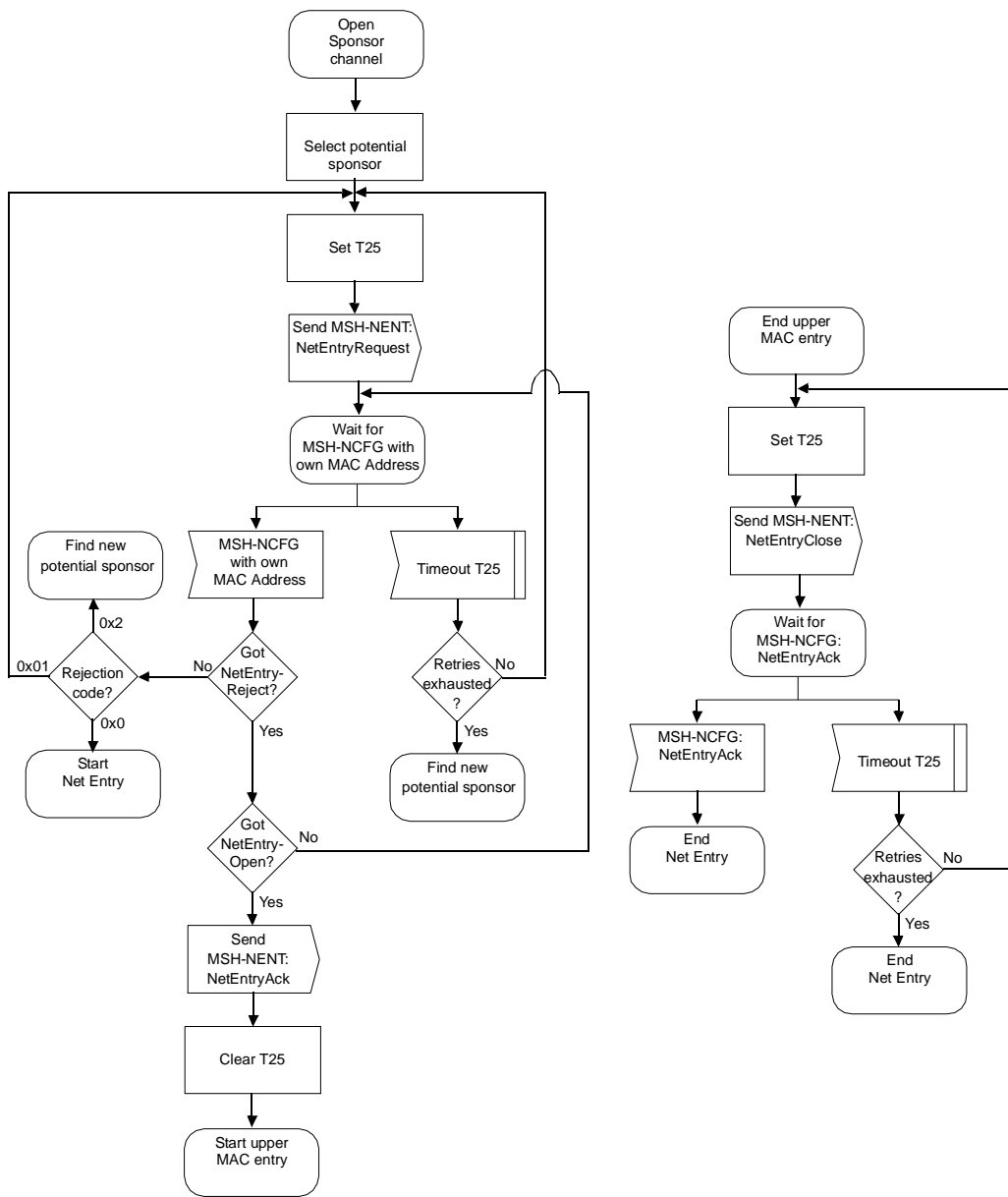

Figure 74—Mesh network synchronization and entry—New node—II

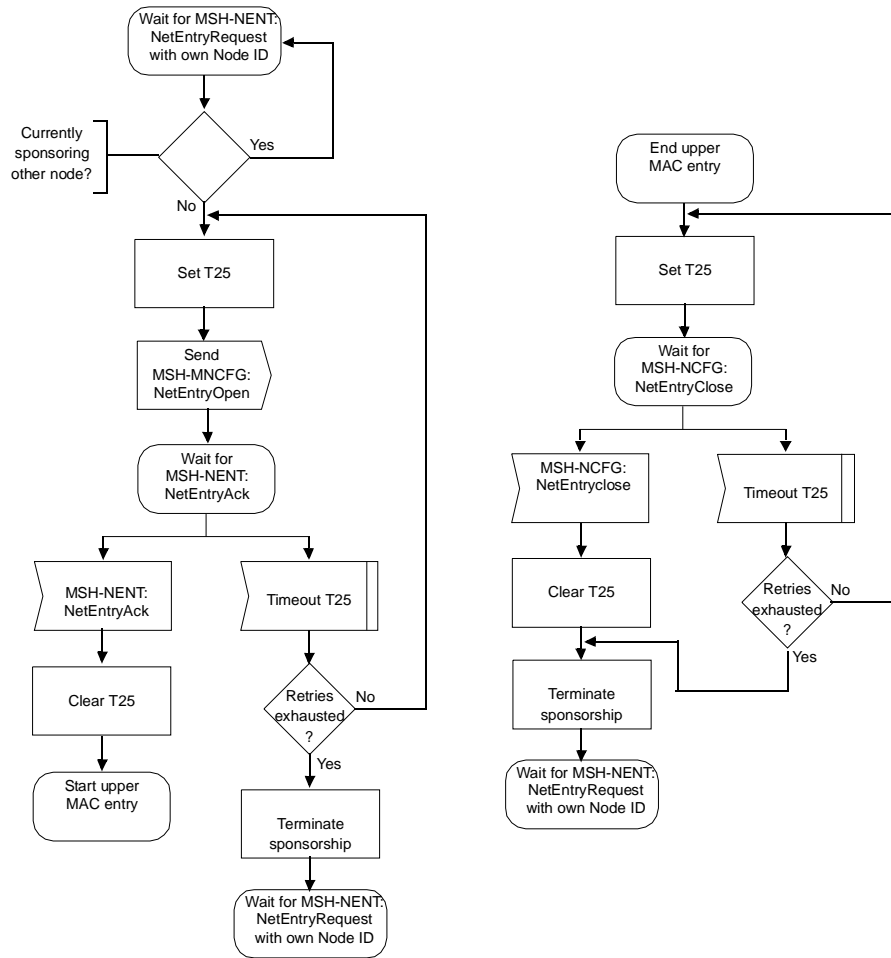
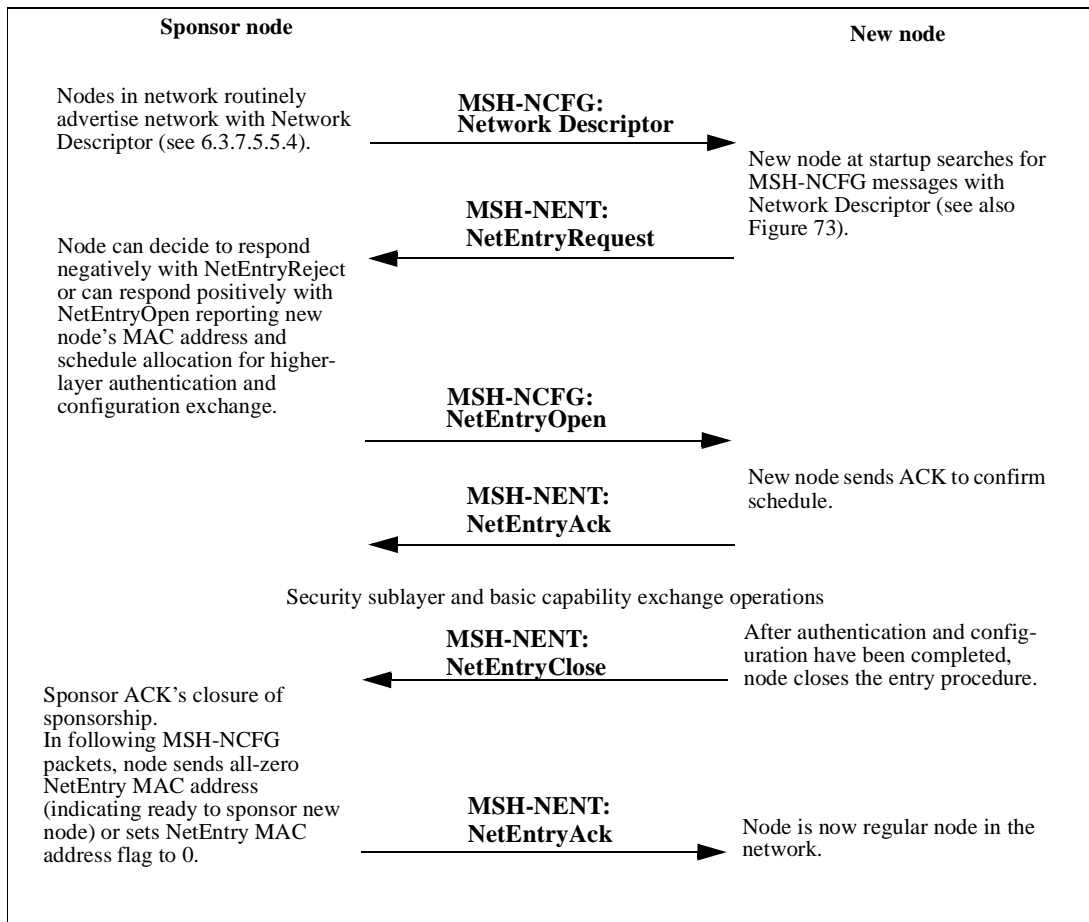

Figure 75—Mesh network synchronization and entry—Sponsor node

Table 119 displays the message transfer sequence during a successful network entry without repetitions or timeouts.

Table 119—Successful network entry message exchange



6.3.9.14.4 Negotiate basic capabilities

In Mesh mode, the basic capabilities shall be negotiated as described in 6.3.9.7 after a logical link has been established between two nodes. The node that requested the logical link (see 6.3.1.2) shall act as the SS and initiate the SBC-REQ.

6.3.9.14.5 Node authorization

The new node shall perform authorization as described in 7.2. The new node shall act as the SS. The sponsor node upon reception of the Auth Info and Auth Request shall tunnel the messages as described in 6.3.16 to the Authorization Node. The Authorization Node, acting as the BS, shall verify the SS Certificate of the new node and determine whether the new node is authorized to join the Network. Upon receiving tunneled PKM-RSP MAC messages from the Authorization Node the Sponsor shall forward the messages to the new node.

6.3.9.14.6 Node registration

Registration is the process where a node is assigned its Node ID. The sponsoring node upon reception of the REG-REQ shall tunnel the message as described in 6.3.16 to the Registration Node. Upon receiving

tunneled REG-RSP MAC messages from the Registration Node the Sponsor shall forward the messages to the new node. The new node shall follow the procedure in Figure 76 and Figure 77. The Registration Node shall follow the procedure in Figure 70.

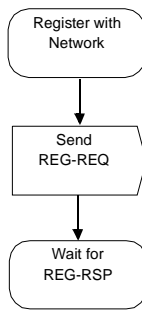

Figure 76—Registration—Candidate node

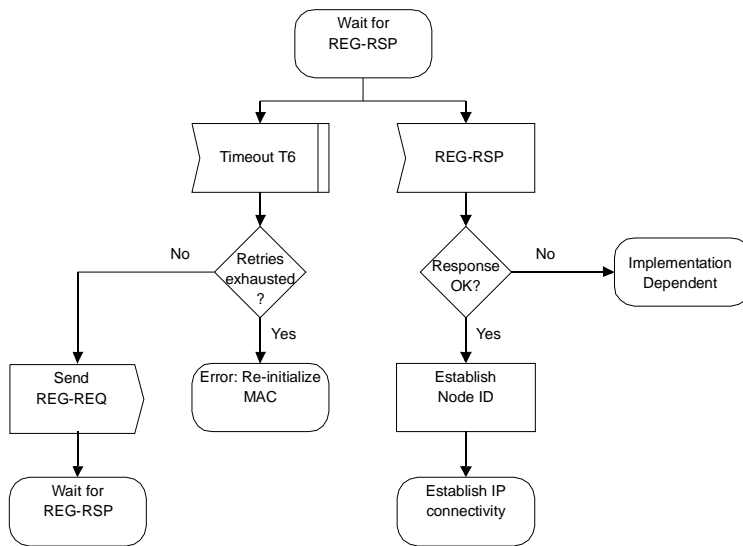

Figure 77—Wait for registration response—Candidate node

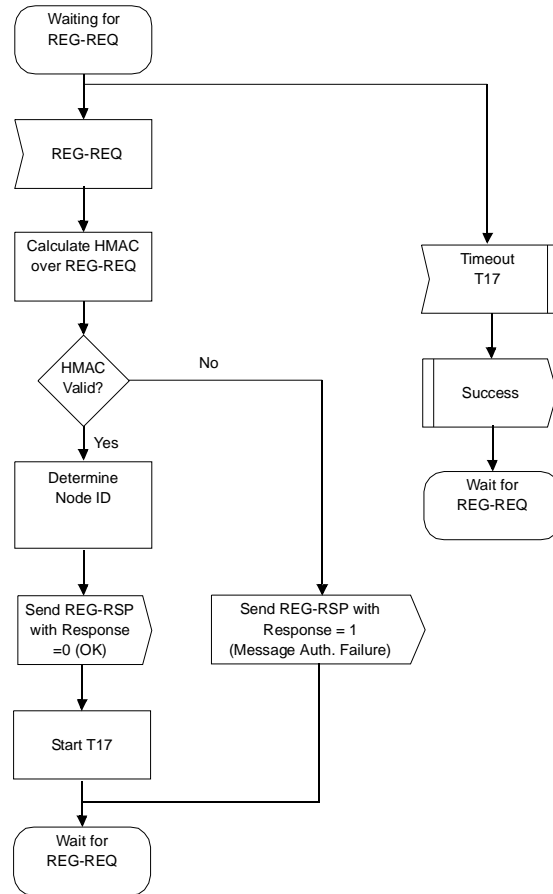

Figure 78—Registration—Registration node

6.3.9.14.7 Establish IP connectivity

The Node shall acquire an IP address using DHCP. The procedure is shown in Table 116 and takes place over the Sponsor Channel.

6.3.9.14.8 Establish time of day

The Nodes in a Mesh network shall retrieve the time of day using the protocol defined in IETF RFC 868. The messages shall be carried over UDP in the Sponsor Channel.

6.3.9.14.9 Transfer operational parameters

After successfully acquiring an IP address via DHCP, the Node shall download a parameter file using TFTP. The procedure is described in 6.3.9.12. The Node shall use the Sponsor Channel for this purpose instead of the Secondary Management connection.

6.3.9.14.10 Setup provisioned traffic parameters

Using Mesh, QoS is provisioned on a packet-by-packet basis using the Mesh CID. Hence, the connection-based QoS provisioning using the DSx messages defined in 6.3.14 are not used. A Mesh node obtains its AuthorizedQoSParamSet during the transfer of operational parameters.

6.3.9.14.11 Establishing links to neighbors

After entering the network, a node can establish links with nodes other than its sponsor by following the secure process as defined in Table 120. This process uses the MSH-NCFG:Neighbor Link Establishment IE.

- a) Node A sends a challenge (action code = 0x0) containing:
 - HMAC{Operator Shared Secret, frame number, Node ID of node A, Node ID of node B}
 - where the Operator Shared Secret is a private key obtained from the provider (which is also used to enter the network) and the frame number is the last known frame number in which Node B sent a MSH-NCFG message.
- b) Node B, upon reception, computes the same value (it may also attempt some earlier frame numbers where it sent MSH-NCFG messages, in case node A missed the last of its MSH-NCFGs) in item a) and compares. If the values do not match, a rejection (action code = 0x3) is returned. If a match is achieved, Node B sends, implicitly accepting the link, a challenge response (action code=0x1) containing:
 - HMAC{Operator Shared Secret, frame number, Node ID of node B, Node ID of node A}
 - where the frame number is the frame number in which Node A sent the MSH-NCFG message with challenge. It also randomly selects and includes an unused link ID, which shall from this point forward indicate the link from node B to node A.
- c) Node A, upon reception, computes the same value in item b) and compares. If the values do not match, a rejection (action code = 0x3) is returned. If a match is achieved, Node A sends an Accept. It also randomly selects and includes an unused link ID, which shall from this point forward indicate the link from node A to node B.

Table 120—Establishing link connectivity

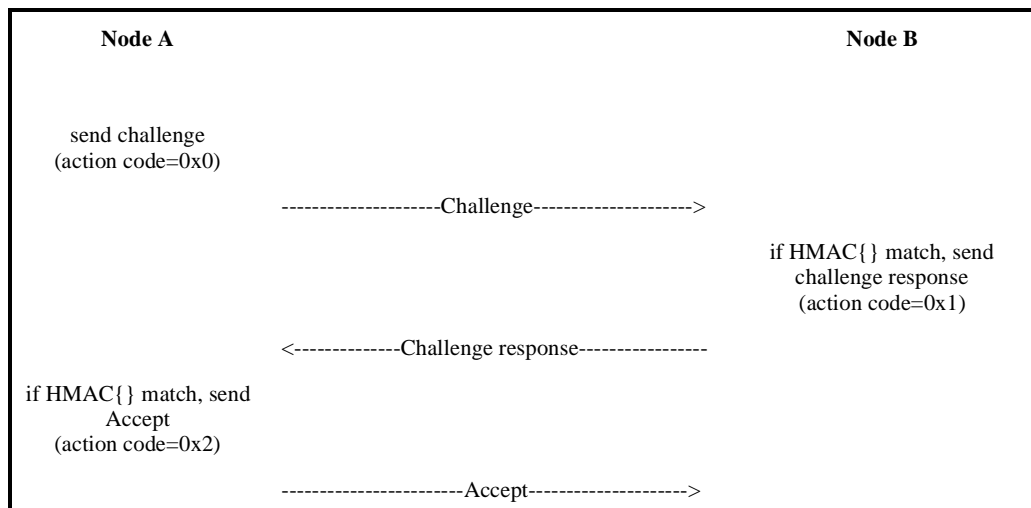

6.3.10 Ranging

Ranging is a collection of processes by which the SS and BS maintain the quality of the RF communication link between them. Distinct processes are used for managing uplink and downlink. Also some PHY modes support ranging mechanisms unique to their capabilities.

6.3.10.1 Downlink burst profile management

The downlink burst profile is determined by the BS according to the quality of the signal that is received by each SS. To reduce the volume of uplink traffic, the SS monitors the CINR and compares the average value against the allowed range of operation. This region is bounded by threshold levels. If the received CINR goes outside of the allowed operating region, the SS requests a change to a new burst profile using one of two methods. If the SS has been granted uplink bandwidth (a data grant allocation to the SS's Basic CID), the SS shall send a DBPC-REQ message in that allocation. The BS responds with a DBPC-RSP message. If a grant is not available and the SS requires a more robust burst profile on the downlink, the SS shall send a RNG-REQ message in an Initial Ranging interval. With either method, the message is sent using the Basic CID of the SS. The coordination of message transmit and receipt relative to actual change of modulation is different depending upon whether an SS is transitioning to a more or less robust burst profile. Figure 79 shows the case where an SS is transitioning to a more robust type. Figure 80 shows transition to a less robust burst profile.

The SS applies an algorithm to determine its optimal burst profile in accordance with the threshold parameters established in the DCD message in accordance with Figure 81.

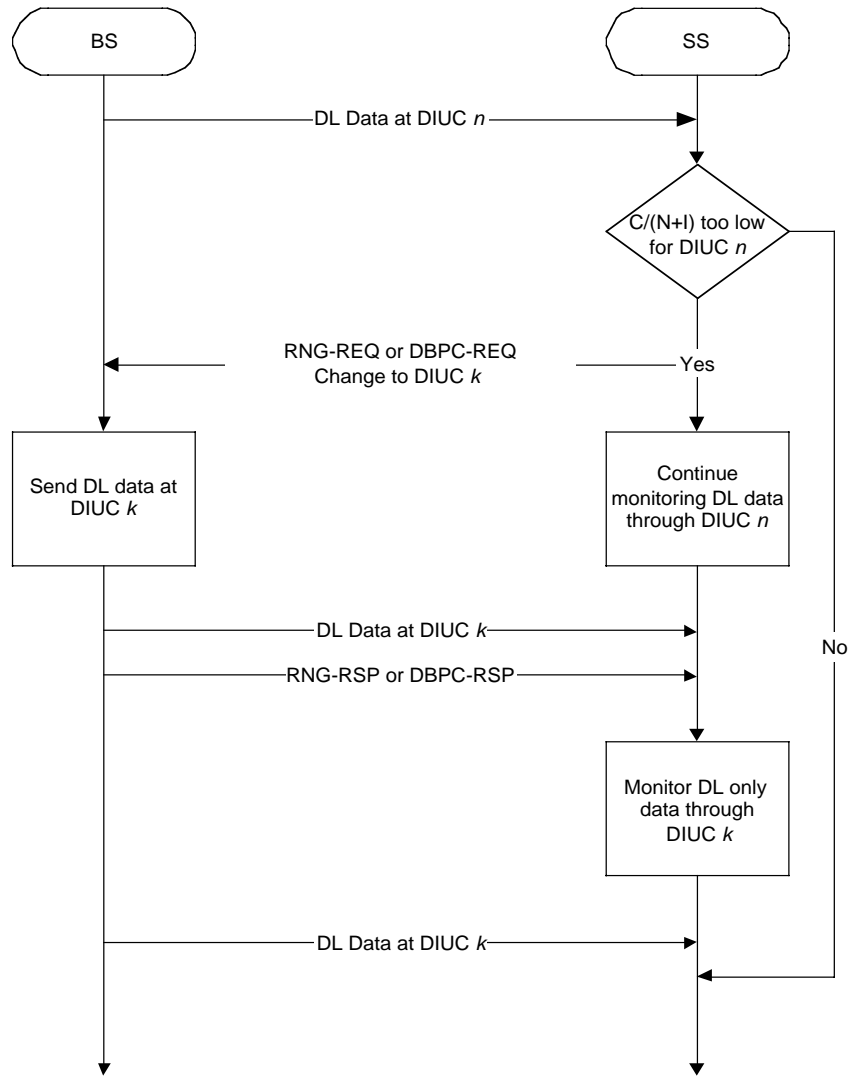

Figure 79—Transition to a more robust burst profile

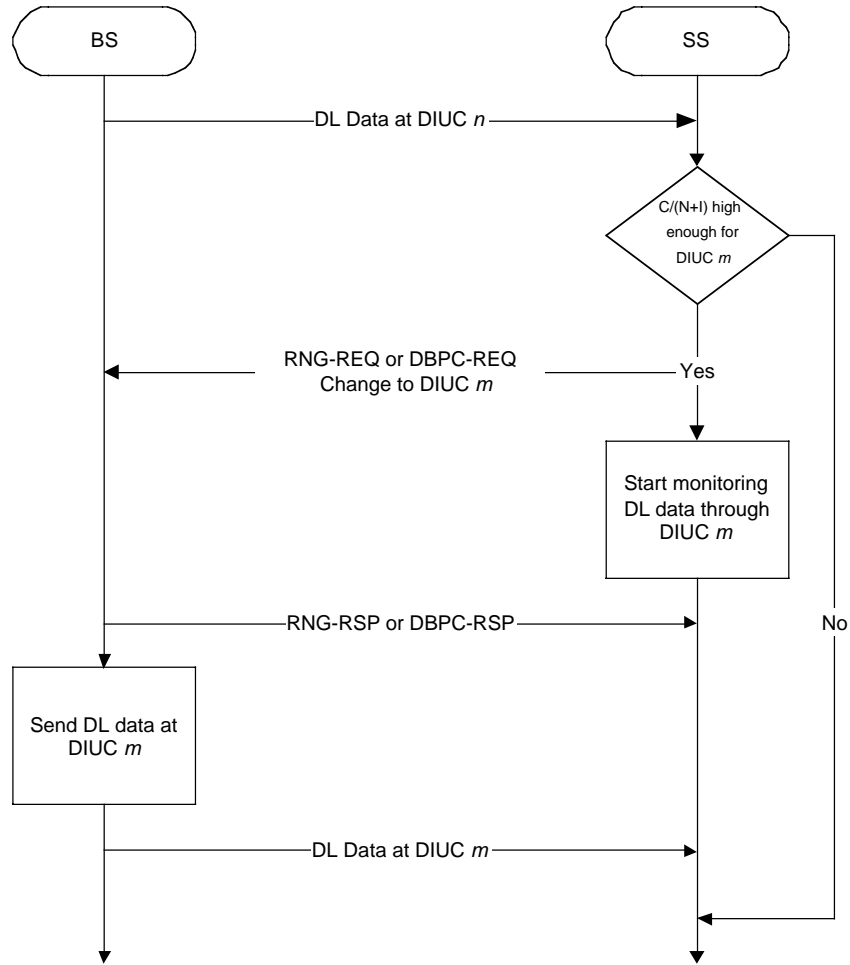

Figure 80—Transition to a less robust burst profile

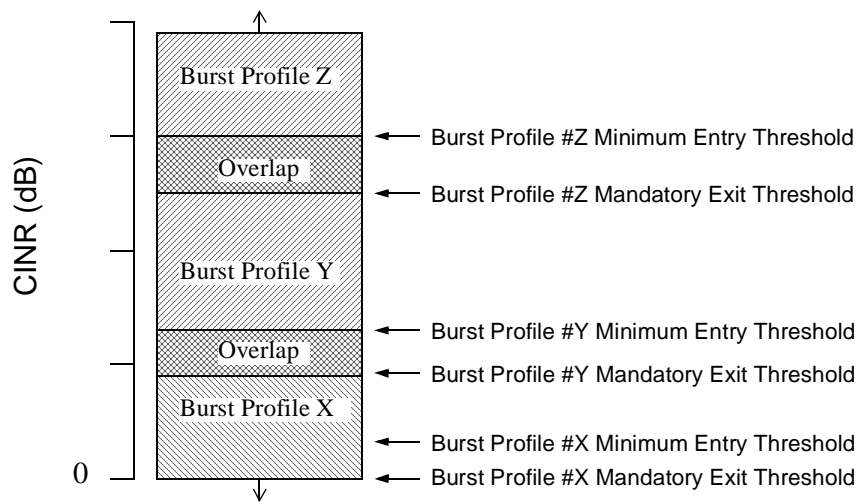

Figure 81—Burst profile threshold usage

6.3.10.2 Uplink periodic ranging

Uplink ranging consists of two procedures—initial ranging and periodic ranging. Initial ranging (see 6.3.9.5) allows an SS joining the network to acquire correct transmission parameters, such as time offset and Tx power level, so that the SS can communicate with the BS. Following initial ranging, periodic ranging allows the SS to adjust transmission parameters so that the SS can maintain uplink communications with the BS.

The following summarizes the general algorithm for periodic ranging available to all PHY layers. Diagrams of the SS and BS processes are provided in Figure 82, Figure 83, and Figure 84. CDMA-based ranging for OFDMA systems is described in 6.3.10.3.

- 1) For each SS, the BS shall maintain a T27 timer. At each expiration of the timer, the BS shall grant bandwidth to the SS for an uplink transmission. The timer is restarted each time a unicast grant is made to the SS. As a result, as long as the SS remains active, the BS does not specifically grant bandwidth to the SS for a ranging opportunity.
- 2) Each SS shall maintain a T4 timer. The expiration of this timer indicates to the SS that it has not been given the opportunity to transmit to the BS for an extended period of time. Operating on the assumption that its uplink transmission parameters are no longer usable, the SS initiates a restart of its MAC operations
- 3) For each unicast uplink burst grant, the BS determines whether or not a transmitted signal is present. If no signal is detected in a specified number of successive grants, the BS shall terminate link management for the associated SS.
- 4) For each unicast uplink burst grant in which a signal is detected, the BS makes a determination as to the quality of the signal. If the signal is within acceptable limits and the data carried in the burst includes the RNG-REQ message, the RNG-RSP message shall be issued with a status of *success*. If the signal is not within acceptable limits, the RNG-RSP message shall be issued that includes the appropriate correction data and a status of *continue*. If a sufficient number of correction messages are issued without the SS signal quality becoming acceptable, the BS shall send the RNG-RSP message with a status of *abort*, and terminate link management of the SS.
- 5) The SS shall process each RNG-RSP message it receives, implementing any PHY corrections that are specified (when the status is *continue*) or initiating a restart of MAC activities (when the status is *abort*).
- 6) The SS shall respond to each uplink bandwidth grant addressed to it. When the status of the last RNG-RSP message received is *continue*, the RNG-REQ message shall be included in the transmitted burst. When the status of the last RNG-RSP message received is *success*, the SS shall use the grant to service its pending uplink data queues. If no data is pending, the SS shall respond to the grant by transmitting a block of padded data.

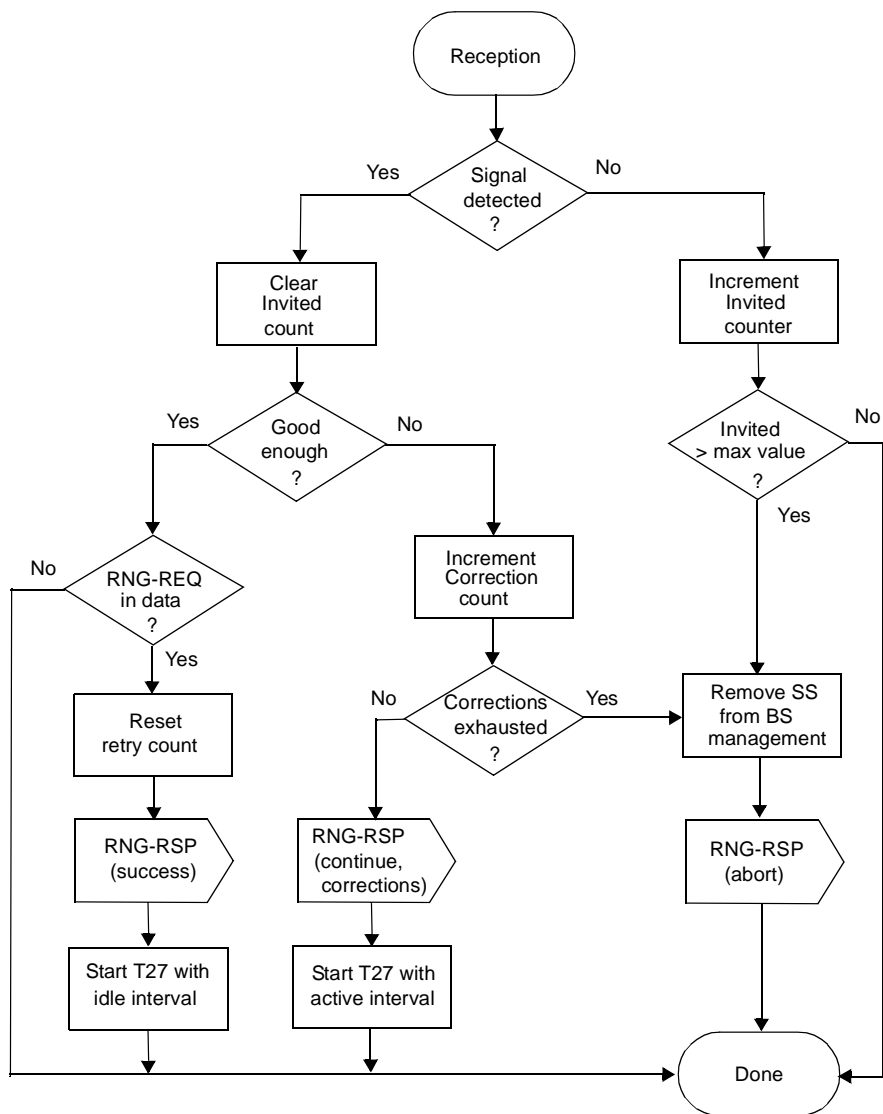

Figure 82—Periodic Ranging receiver processing—BS

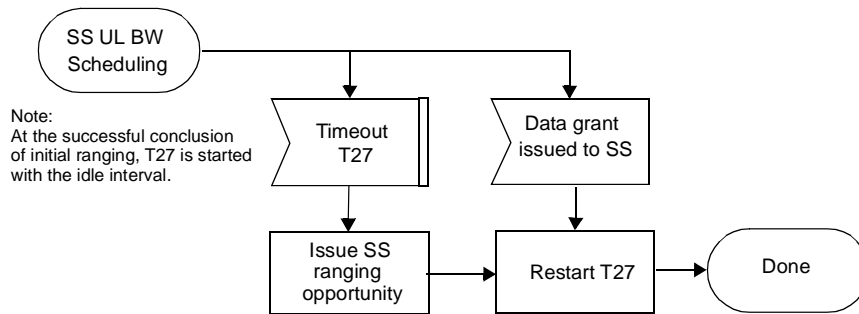

Figure 83—Periodic Ranging opportunity allocation—BS

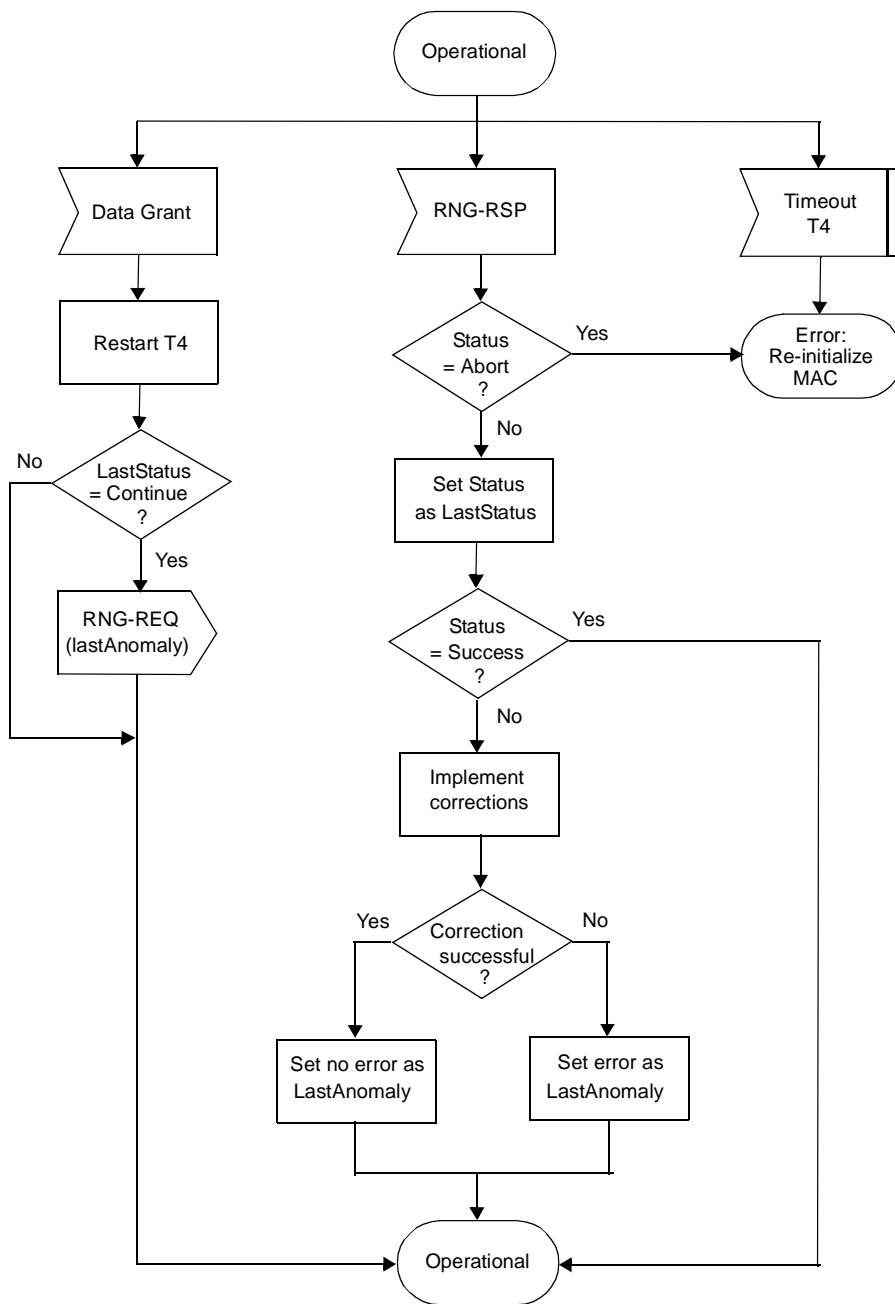

Figure 84—Periodic Ranging—SS

6.3.10.3 OFDMA-based ranging

The WirelessMAN-OFDMA PHY specifies a Ranging Subchannel and a set of special pseudonoise Ranging Codes. Subsets of codes shall be allocated in the UCD Channel Encoding for Initial Ranging, Periodic Ranging and Bandwidth Requests, such that the BS can determine the purpose of the received code by the subset to which the code belongs. An example of Ranging Channel in OFDMA frame structure is specified in Figure 218.

SSs that wish to perform one of the aforementioned operations shall select, with equal probability, one of the codes of the appropriate subset, modulate it onto the Ranging Subchannel, and subsequently transmit in ranging slot selected with equal probability from the available ranging slots on the UL subframe. Details on the modulation and Ranging Codes are specified in 8.4.7.

6.3.10.3.1 Contention based initial ranging and automatic adjustments

A SS that wishes to perform initial ranging shall take the following steps:

- The SS, after acquiring downlink synchronization and uplink transmission parameters, shall choose randomly a Ranging Slot (with the use of a binary truncated exponent algorithm to avoid possible re-collisions) at the time to perform the ranging, then it chooses randomly a Ranging Code (from the Initial Ranging domain) and sends it to the BS (as a CDMA code).
- The BS cannot tell which SS sent the CDMA ranging request; therefore, upon successfully receiving a CDMA Ranging Code, the BS broadcasts a Ranging Response message that advertises the received Ranging Code as well as the ranging slot (OFDMA symbol number, subchannel, etc.) where the CDMA Ranging code has been identified. This information is used by the SS that sent the CDMA ranging code to identify the Ranging Response message that corresponds to its ranging request. The Ranging Response message contains all the needed adjustment (e.g., time, power, and possibly frequency corrections) and a status notification.
- When the BS receives an initial-ranging CDMA code that results in sending an RNG-RSP message with success status, the BS shall provide BW allocation for the SS using the CDMA_Allocation_IE to send an RNG-REQ message.
- Upon receiving a Ranging Response message with continue status, the SS shall continue the ranging process as done on the first entry with ranging codes randomly chosen from the Periodic Ranging domain.
- Using the OFDMA ranging mechanism, the periodic ranging timer is controlled by the SS, not the BS.

Adjustment of local parameters (e.g., transmit power) in an SS as a result of the receipt (or nonreceipt) of a RNG-RSP is considered to be implementation-dependent with the following restrictions:

- a) All parameters shall be within the approved range at all times.
- b) Power adjustment shall start from the initial value selected with the algorithm described in 6.3.9.5 unless a valid power setting is available from nonvolatile storage, in which case this value may be used as the starting point.
- c) Power adjustment shall be capable of being reduced or increased by the specified amount in response to RNG-RSP messages.
- d) If, during initialization, power is increased to the maximum value (without a response from the BS) it shall wrap back to the minimum.

On receiving an RNG-RSP, the SS shall not transmit until the RF signal has been adjusted in accordance with the RNG-RSP and has stabilized.

The message sequence chart (Table 121) and flow charts (Figure 85, Figure 86, and Figure 87) on the following pages define the ranging and adjustment process that shall be followed by compliant SSs and BSs.

Table 121—CDMA initial Ranging and automatic adjustments procedure

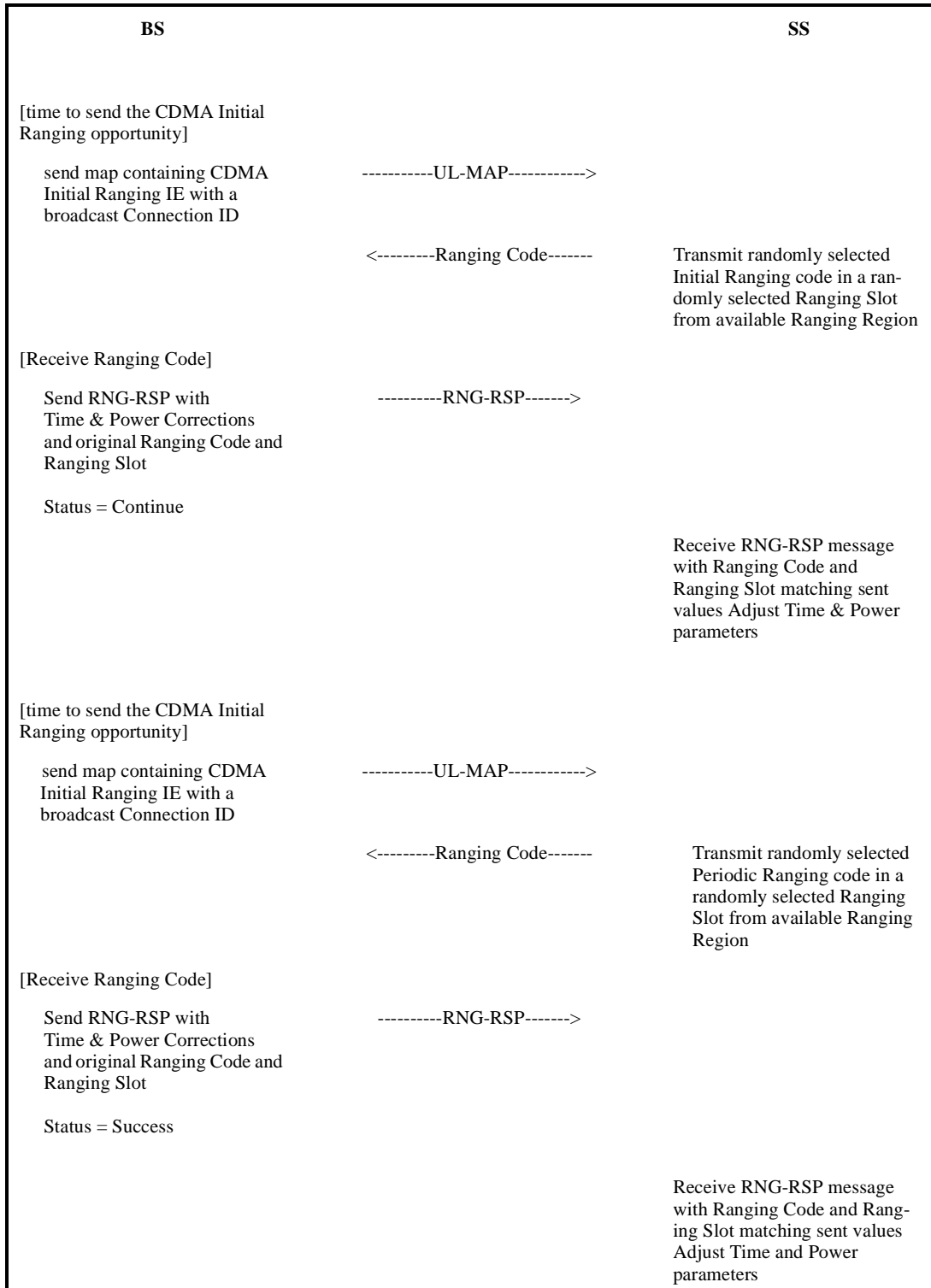

Table 121—CDMA initial Ranging and automatic adjustments procedure (continued)

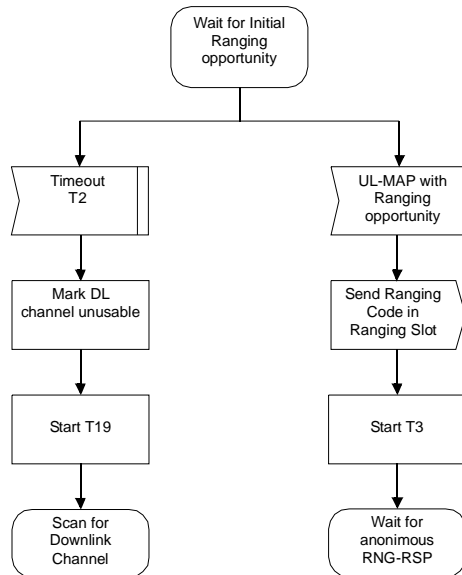
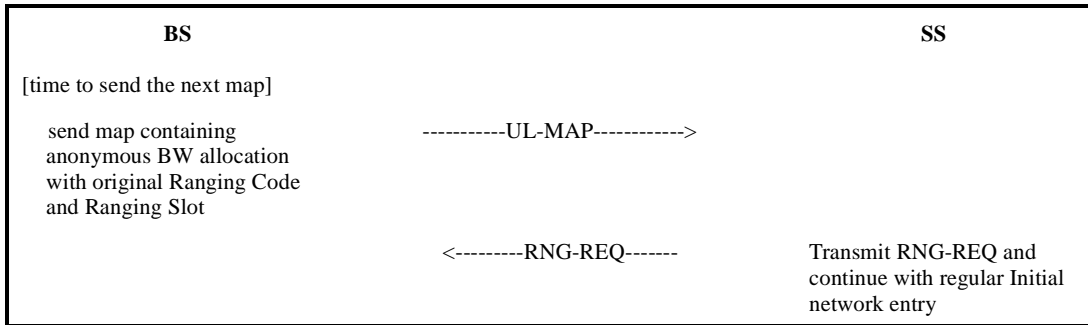

Figure 85—CDMA Initial Ranging—SS (part 1)

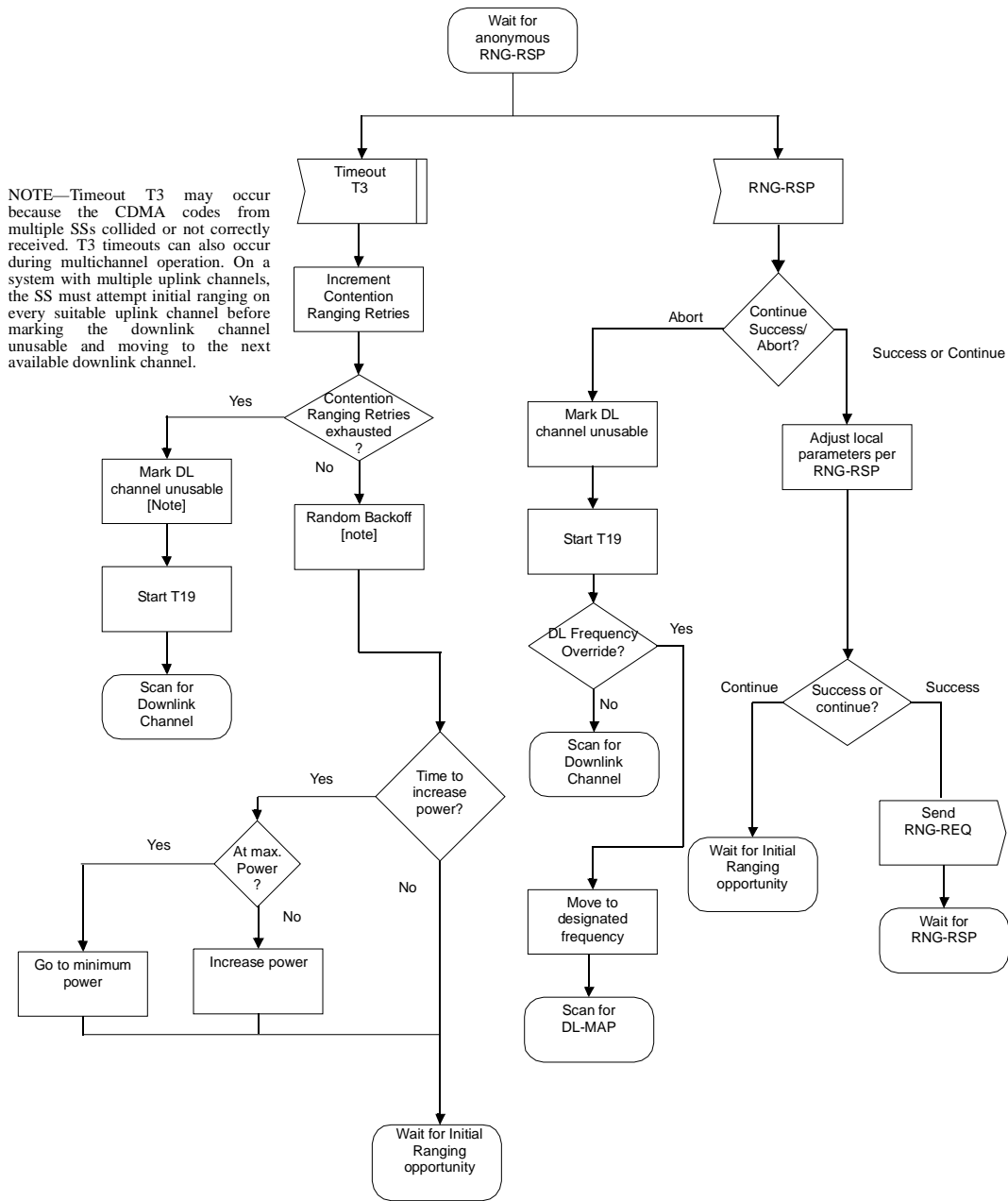
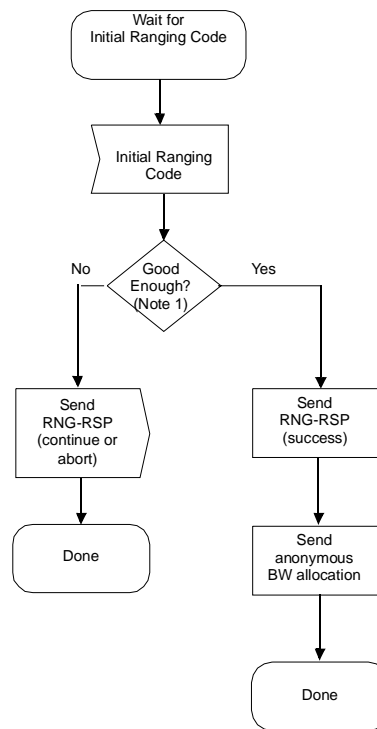

Figure 86—CDMA Initial Ranging—SS (part 2)



NOTE —Means ranging is within the tolerable limits of the BS.

Figure 87—CDMA Initial Ranging—BS

6.3.10.3.2 Periodic ranging and automatic adjustments

An SS that wishes to perform periodic ranging shall take the following steps:

- The SS, shall choose randomly a Ranging Slot (with the use of a binary truncated exponent algorithm to avoid possible re-collisions) at the time to perform the ranging, then it chooses randomly a Ranging Code (from the Periodic Ranging domain) and sends it to the BS (as a CDMA code).
- The BS cannot tell which SS sent the CDMA ranging request; therefore, upon successfully receiving a CDMA Ranging Code, the BS broadcasts a Ranging Response message that advertises the received Ranging Code as well as the ranging slot (OFDMA symbol number, subchannel, etc.) where the CDMA Ranging code has been identified. This information is used by the SS that sent the CDMA ranging code to identify the Ranging Response message that corresponds to its ranging request. The Ranging Response message contains all the needed adjustment (e.g., time, power, and possibly frequency corrections) and a status notification.
- Upon receiving a Ranging Response message with continue status, the SS shall continue the ranging process with further ranging codes randomly chosen from the Periodic Ranging domain.
- Using the OFDMA ranging mechanism, the periodic ranging timer is controlled by the SS, not the BS.
- The BS may send an unsolicited RNG-RSP as a response to a CDMA-based bandwidth-request or any other data transmission from the SS.

When the SS receives an unsolicited RNG-RSP message, it shall reset the periodic ranging timer and adjust the parameters (timing and power, etc.) as notified in the RNG-RSP message.

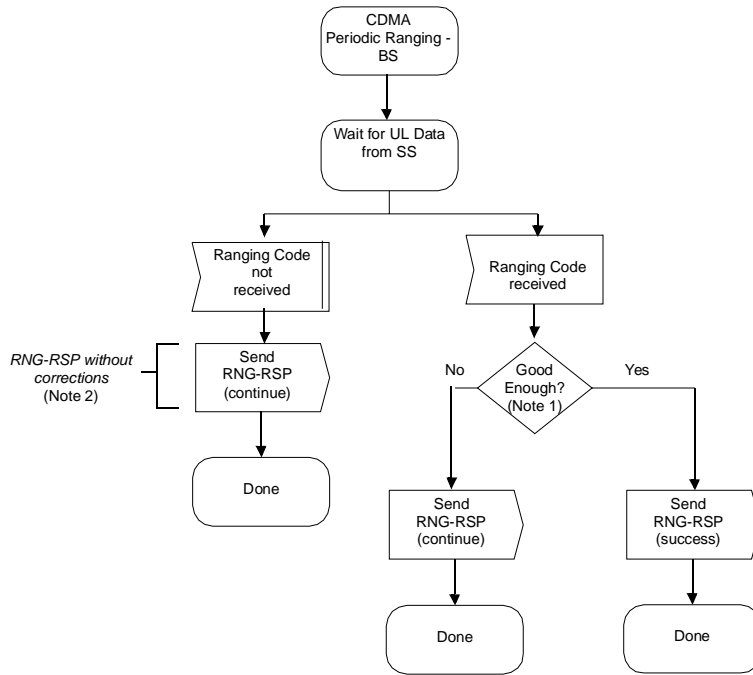

NOTES

1—Means ranging is within the tolerable limits of the BS.

2—In this case, the RNG-RSP message is sent in order to initiate the SS to send ranging code.

Figure 88—Periodic CDMA ranging—BS

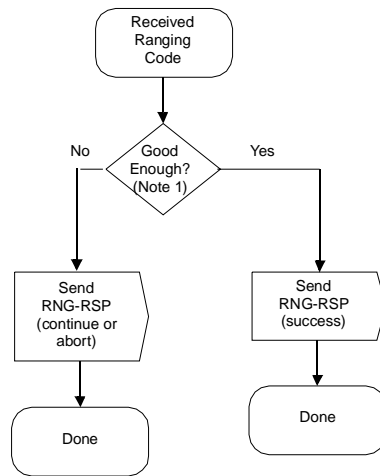

NOTE —Means ranging is within the tolerable limits of the BS.

Figure 89—Periodic ranging—Received ranging code—BS

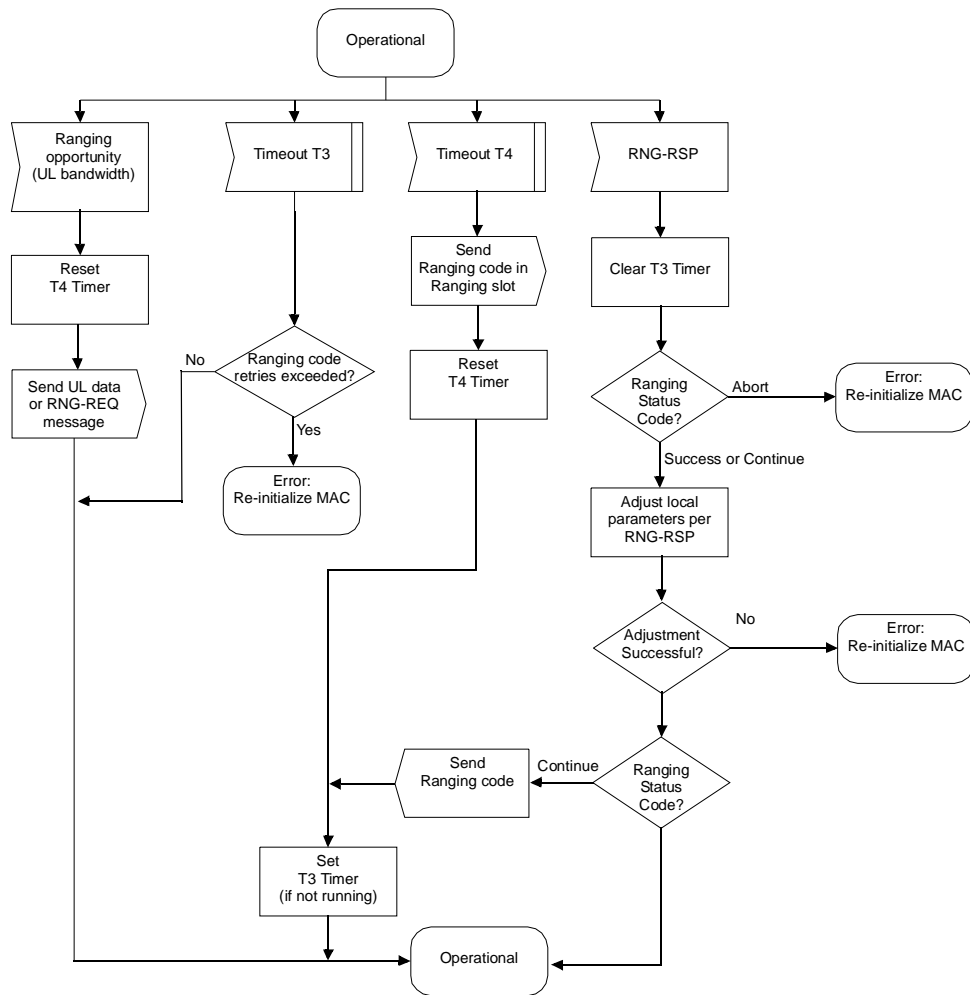
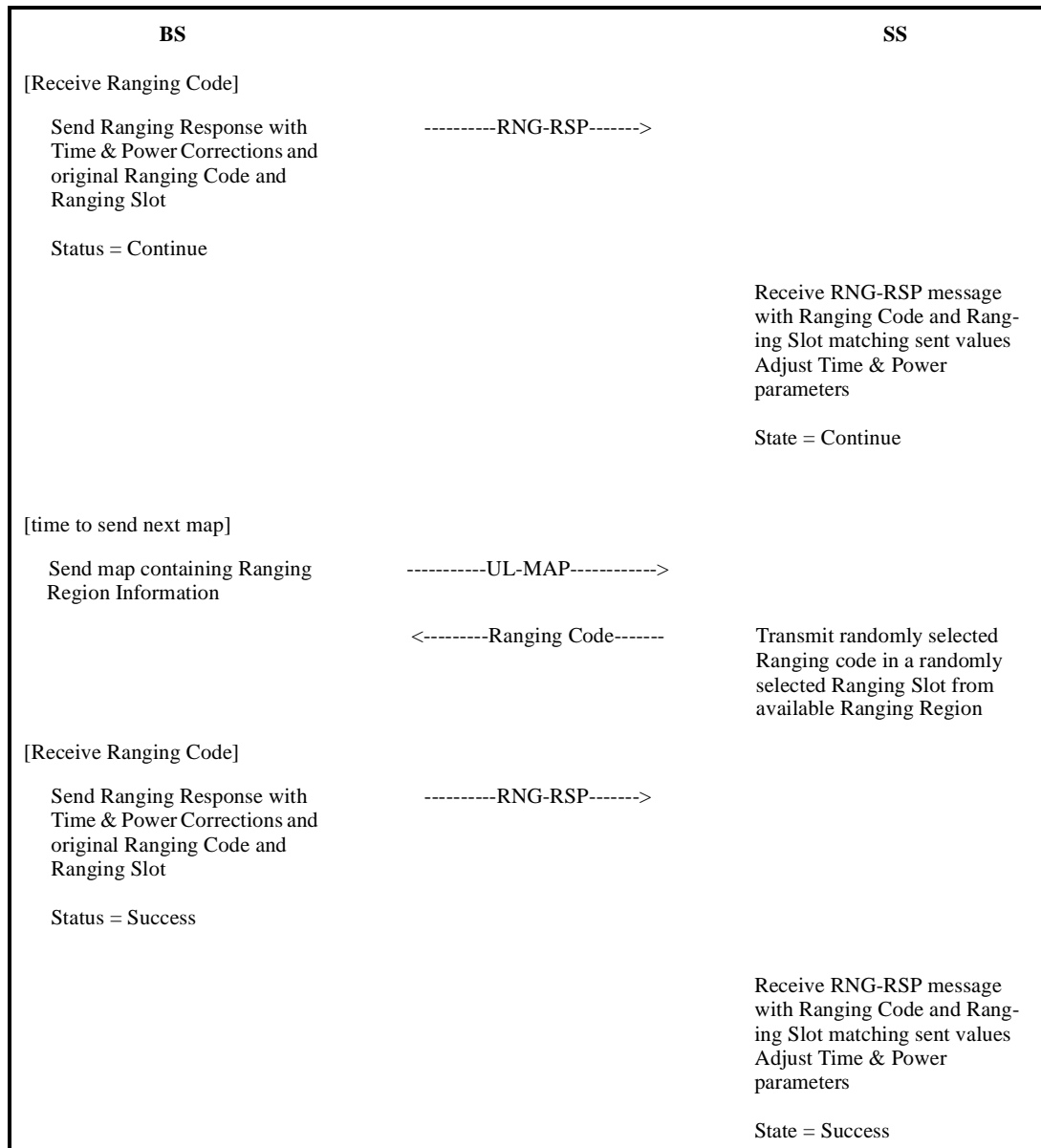

Figure 90—Periodic CDMA ranging—SS

Table 122 describes the ranging adjustment process.

Table 122—CDMA periodic Ranging and automatic adjustments procedure

BS	SS
[time to send next map]	
Send map containing Ranging Region Information	-----UL-MAP----->
	<-----Ranging Code-----
	Transmit randomly selected Ranging code in a randomly selected Ranging Slot from available Ranging Region

Table 122—CDMA periodic Ranging and automatic adjustments procedure (continued)

6.3.11 Update of channel descriptors

The channel descriptors (i.e., the UCD and DCD messages) are transmitted at regular intervals by the BS. Each descriptor contains the Configuration Change Count, which shall remain unchanged as long as the channel descriptor remains unchanged. All UL-MAP and DL-MAP messages allocating transmissions and receptions using burst profiles defined in a channel descriptor with a given Configuration Change Count value shall have a UCD/DCD Count value equal to the Configuration Change Count of the corresponding channel descriptor.

The procedure to transition from one generation of the channel descriptors (and, as a consequence, the set of burst profiles) to the next is shown in Table 123 and Table 124, for the uplink and downlink, respectively.

The Configuration Change Count shall be incremented by 1 modulo 256 for every new generation of channel descriptor. After issuing a DL-MAP or UL-MAP message with the Configuration Change Count equal to that of the new generation, the old channel descriptor ceases to exist and the BS shall not issue UL-MAP and DL-MAP messages referring to it. When transitioning from one generation to the next, the BS shall schedule the transmissions of the UCD and DCD messages in such a way that each terminal has the possibility to hear it at least once.

Table 123—UCD update

BS		SS
send UL-MAP with UCD Count = i	-----UL-MAP----->	descriptor with UCD Count = i previously stored in SS
	<-----data-----	Transmit using burst profiles defined in UCD with Configuration Change Count = i
[change of channel descriptor com- manded]		
send UL-MAP with UCD Count = i	-----UL-MAP----->	descriptor with Configuration Change Count = i still stored in SS
send UCD message with Configura- tion Change Count = $(i+1 \text{ MOD } 256)$	-----UCD----->	store new descriptor with Configuration Change Count = $(i+1 \text{ MOD } 256)$
	<-----data-----	Transmit using burst profiles defined in UCD with Configuration Change Count = i
send UL-MAP with UCD Count = i	-----UL-MAP----->	descriptor with Configuration Change Count = i still stored in SS
Retransmit UCD message with Configuration Change Count = $(i+1 \text{ MOD } 256)$ [UCD transition interval start]	-----UCD----->	store new descriptor with Configuration Change Count = $(i+1 \text{ MOD } 256)$
	<-----data-----	Transmit using burst profiles defined in UCD with Configuration Change Count = i
send UL-MAP with UCD Count = i	-----UL-MAP----->	descriptor with UCD Count = i previously stored in SS
	<-----data-----	Transmit using burst profiles defined in UCD with Configuration Change Count = i
[UCD transition interval expired]		
send UL-MAP with UCD Count = $(i+1 \text{ MOD } 256)$	-----UL-MAP----->	delete descriptor with Configuration Change Count = i
	<-----data-----	Transmit using burst profiles defined in UCD with Configuration Change Count = $(i+1 \text{ MOD } 256)$

Table 124—DCD update

BS		SS
send DL-MAP with DCD Count = i	-----DL-MAP----->	descriptor with Configuration Change Count = i previously stored in SS
Transmit using burst profiles defined in DCD with Configuration Change Count = i	-----data----->	Receive using burst profiles defined in DCD with Configuration Change Count = i
[change of channel descriptor commanded]		
send DL-MAP with DCD Count = i	-----DL-MAP----->	descriptor with Configuration Change Count = i still stored in SS
send DCD message with Configuration Change Count = $(i+1 \text{ MOD } 256)$	-----DCD----->	store new descriptor with Configuration Change Count = $(i+1 \text{ MOD } 256)$
Transmit using burst profiles defined in DCD with Configuration Change Count = i	-----data----->	Receive using burst profiles defined in DCD with Configuration Change Count = i
send DL-MAP with DCD Count = i	-----DL-MAP----->	descriptor with Configuration Change Count = i still stored in SS
Retransmit DCD message with Configuration Change Count = $(i+1 \text{ MOD } 256)$ [DCD transition interval start]	-----DCD----->	store new descriptor with Configuration Change Count = $(i+1 \text{ MOD } 256)$
Transmit using burst profiles defined in DCD with Configuration Change Count = i	-----data----->	Receive using burst profiles defined in DCD with Configuration Change Count = i
[DCD transition interval expired]		
send DL-MAP with Configuration Change Count = $(i+1 \text{ MOD } 256)$	-----DL-MAP----->	delete descriptor with Configuration Change Count = i
Transmit using burst profiles defined in DCD with Configuration Change Count = $i+1$	-----data----->	Receive using burst profiles defined in DCD with Configuration Change Count = $(i+1 \text{ MOD } 256)$

6.3.12 Assigning SSs to multicast groups

The BS may add an SS to a Multicast polling group by sending an MCA-REQ message with the Join command. Upon receiving an MCA-REQ message, the SS shall respond by sending an MCA-RSP message. The protocol is shown in Figure 91 and Figure 92.

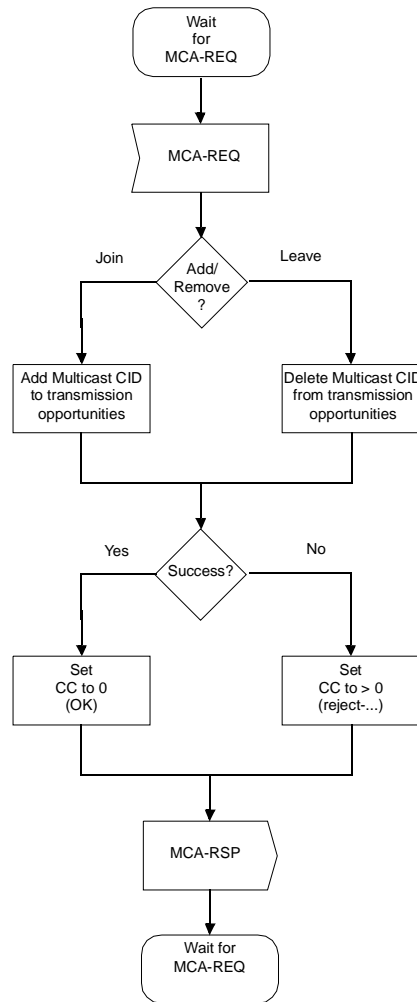

Figure 91—Multicast polling assignment—SS

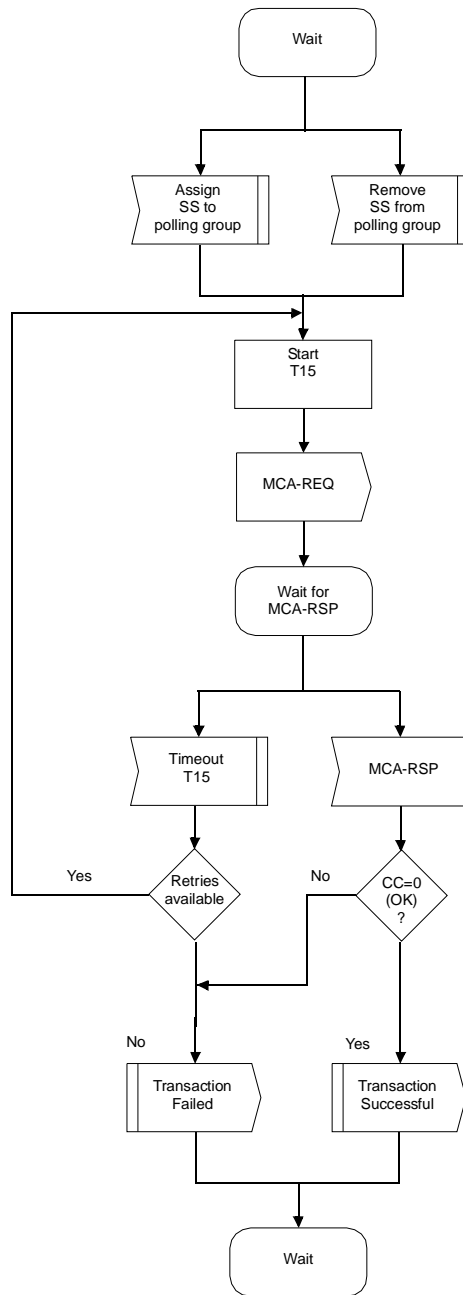

Figure 92—Multicast polling assignment—BS

6.3.13 Establishment of multicast connections

The BS may establish a downlink multicast service by creating a connection with each SS to be associated with the service. Any available traffic CID value may be used for the service (i.e., there are no dedicated CIDs for multicast transport connections). To ensure proper multicast operation, the CID used for the service is the same for all SSs on the same channel that participate in the connection. The SSs need not be aware that the connection is a multicast connection. The data transmitted on the connection with the given CID shall be received and processed by the MAC of each involved SS. Thus, each multicast SDU is transmitted only once per BS channel. Since a multicast connection is associated with a service flow, it is associated with the QoS and traffic parameters for that service flow.

ARQ is not applicable to multicast connections.

If a downlink multicast connection is to be encrypted, each SS participating in the connection shall have an additional security association (SA), allowing that connection to be encrypted using keys that are independent of those used for other encrypted transmissions between the SSs and the BS.

6.3.14 QoS

This standard defines several QoS related concepts. These include the following:

- a) Service Flow QoS Scheduling
- b) Dynamic Service Establishment
- c) Two-phase Activation Model

6.3.14.1 Theory of operation

The various protocol mechanisms described in this document may be used to support QoS for both uplink and downlink traffic through the SS and the BS. This subclause provides an overview of the QoS protocol mechanisms and their part in providing end-to-end QoS.

The requirements for QoS include the following:

- a) A configuration and registration function for preconfiguring SS-based QoS service flows and traffic parameters.
- b) A signaling function for dynamically establishing QoS-enabled service flows and traffic parameters.
- c) Utilization of MAC scheduling and QoS traffic parameters for uplink service flows.
- d) Utilization of QoS traffic parameters for downlink service flows.
- e) Grouping of service flow properties into named Service Classes, so upper-layer entities and external applications (at both the SS and BS) may request service flows with desired QoS parameters in a globally consistent way.

The principal mechanism for providing QoS is to associate packets traversing the MAC interface into a service flow as identified by the CID. A service flow is a unidirectional flow of packets that is provided a particular QoS. The SS and BS provide this QoS according to the QoS Parameter Set defined for the service flow.

The primary purpose of the QoS features defined here is to define transmission ordering and scheduling on the air interface. However, these features often need to work in conjunction with mechanisms beyond the air interface in order to provide end-to-end QoS or to police the behavior of SSs.

Service flows exist in both the uplink and downlink direction and may exist without actually being activated to carry traffic. All service flows have a 32-bit SFID; admitted and active service flows also have a 16-bit CID.

6.3.14.2 Service flows

A service flow is a MAC transport service that provides unidirectional transport of packets either to uplink packets transmitted by the SS or to downlink packets transmitted by the BS.¹² A service flow is characterized by a set of *QoS Parameters* such as latency, jitter, and throughput assurances. In order to standardize operation between the SS and BS, these attributes include details of how the SS requests uplink bandwidth allocations and the expected behavior of the BS uplink scheduler.

A service flow is partially characterized by the following attributes:¹³

- a) *Service Flow ID*: An SFID is assigned to each existing service flow. The SFID serves as the principal identifier for the service flow in the network. A service flow has at least an SFID and an associated direction.
- b) *CID*: Mapping to an SFID that exists only when the connection has an admitted or active service flow.
- c) *ProvisionedQoSParamSet*: A QoS parameter set provisioned via means outside of the scope of this standard, such as the network management system.
- d) *AdmittedQoSParamSet*: Defines a set of QoS parameters for which the BS (and possibly the SS) are reserving resources. The principal resource to be reserved is bandwidth, but this also includes any other memory or time-based resource required to subsequently activate the flow.
- e) *ActiveQoSParamSet*: Defines a set of QoS parameters defining the service actually being provided to the service flow. Only an Active service flow may forward packets.
- f) *Authorization Module*: A logical function within the BS that approves or denies every change to QoS Parameters and Classifiers associated with a service flow. As such, it defines an “envelope” that limits the possible values of the AdmittedQoSParamSet and ActiveQoSParamSet.

The relationship between the QoS Parameter Sets is as shown in Figure 93 and Figure 94. The ActiveQoSParamSet is always a subset¹⁴ of the AdmittedQoSParamSet, which is always a subset of the authorized “envelope.” In the dynamic authorization model, this envelope is determined by the Authorization Module (labeled as the AuthorizedQoSParamSet). In the provisioned authorization model, this envelope is determined by the ProvisionedQoSParamSet. It is useful to think of three types of service flows:

- 1) *Provisioned*: This type of service flow is known via provisioning by, for example, the network management system. Its AdmittedQoSParamSet and ActiveQoSParamSet are both null.

¹²A service flow, as defined here, has no direct relationship to the concept of a “flow” as defined by the IETF Integrated Services (IntServ) Working Group (IETF RFC 2212). An IntServ flow is a collection of packets sharing transport-layer endpoints. Multiple IntServ flows can be served by a single service flow.

¹³Some attributes are derived from the above attribute list. The Service Class Name is an attribute of the ProvisionedQoSParamSet. The activation state of the service flow is determined by the ActiveQoSParamSet. If the ActiveQoSParamSet is null, then the service flow is inactive.

¹⁴To say that QoS Parameter Set A is a subset of QoS Parameter Set B the following shall be true for all QoS Parameters in A and B:
 if (a smaller QoS parameter value indicates less resources, e.g., Maximum Traffic Rate)
 A is a subset of B if the parameter in A is less than or equal to the same parameter in B
 if (a larger QoS parameter value indicates less resources, e.g., Tolerated Grant Jitter)
 A is a subset of B if the parameter in A is greater than or equal to the same parameter in B
 if (the QoS parameter is not quantitative, e.g., Service Flow Scheduling Type)
 A is a subset of B if the parameter in A is equal to the same parameter in B

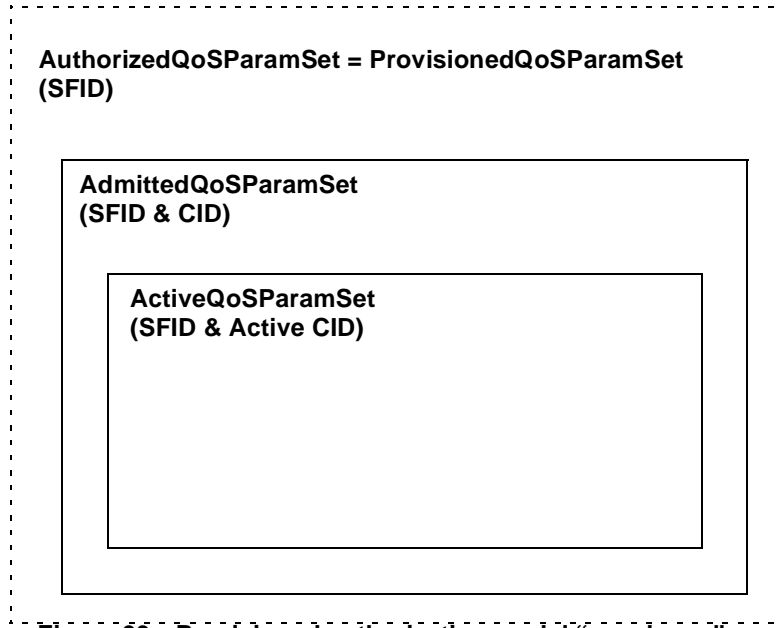

Figure 93—Provisioned authorization model “envelopes”

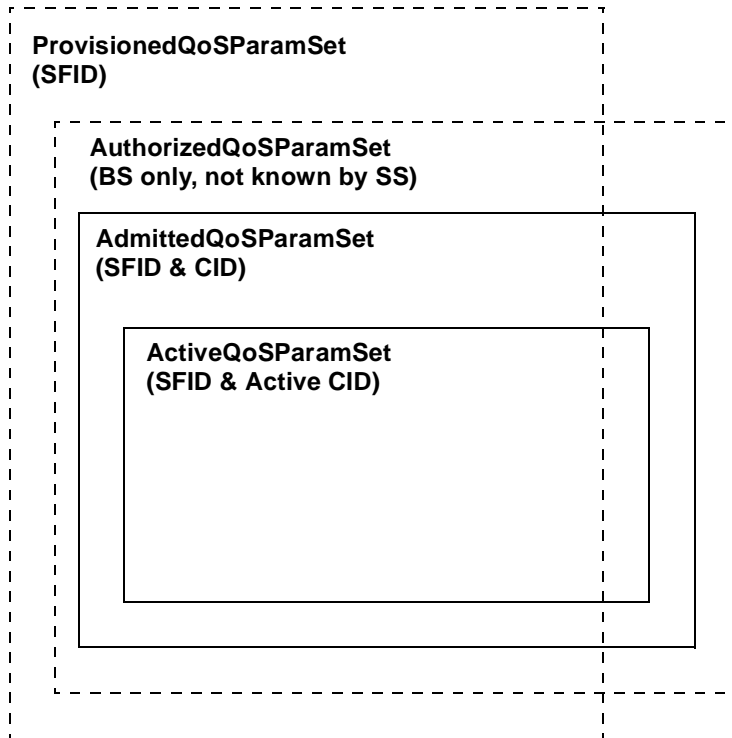

Figure 94—Dynamic authorization model “envelopes”

- 2) *Admitted*: This type of service flow has resources reserved by the BS for its AdmittedQoSParamSet, but these parameters are not active (i.e., its ActiveQoSParamSet is null). Admitted Service Flows may have been provisioned or may have been signalled by some other mechanism.
- 3) *Active*: This type of service flow has resources committed by the BS for its ActiveQoSParamSet, (e.g., is actively sending maps containing unsolicited grants for a UGS-based service flow). Its ActiveQoSParamSet is non-null.

6.3.14.3 Object model

The major objects of the architecture are represented by named rectangles in Figure 95. Each object has a number of attributes; the attribute names that uniquely identify it are underlined. Optional attributes are denoted with brackets. The relationship between the number of objects is marked at each end of the association line between the objects. For example, a service flow may be associated with from 0 to N (many) PDUs, but a PDU is associated with exactly one service flow. The service flow is the central concept of the MAC protocol. It is uniquely identified by a 32-bit (SFID). Service flows may be in either the uplink or downlink direction. Admitted and active service flows are mapped to a 16-bit CID.

Outgoing user data is submitted to the MAC SAP by a CS process for transmission on the MAC interface. The information delivered to the MAC SAP includes the CID identifying the connection across which the information is delivered. The service flow for the connection is mapped to MAC connection identified by the CID.

The Service Class is an optional object that may be implemented at the BS. It is referenced by an ASCII name, which is intended for provisioning purposes. A Service Class is defined in the BS to have a particular QoS Parameter Set. The QoS Parameter Sets of a service flow may contain a reference to the Service Class Name as a “macro” that selects all of the QoS parameters of the Service Class. The service flow QoS Parameter Sets may augment and even override the QoS parameter settings of the Service Class, subject to authorization by the BS.

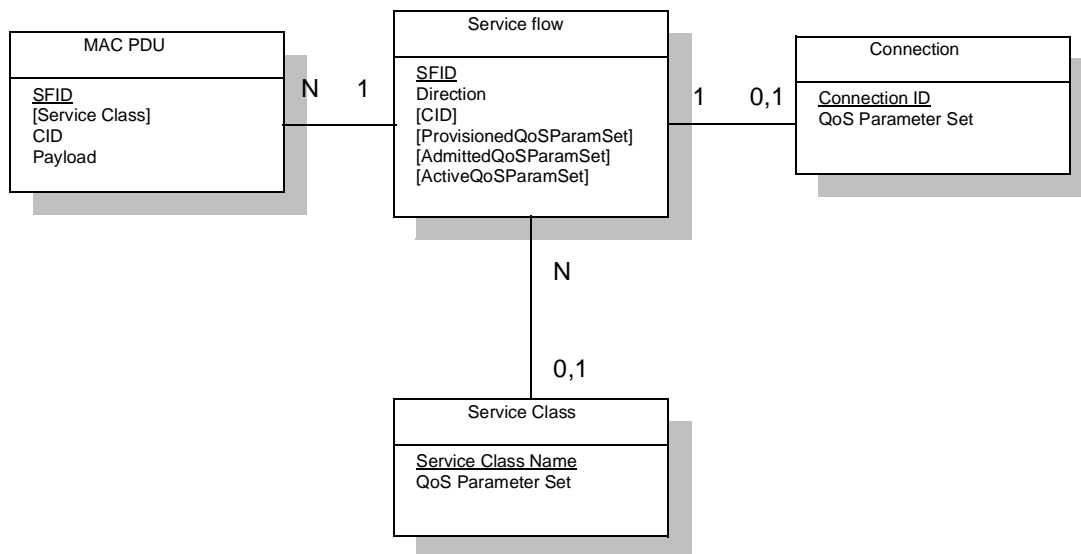

Figure 95—Theory of Operation Object Model

6.3.14.4 Service classes

The Service Class serves the following purposes:

- a) It allows operators, who so wish, to move the burden of configuring service flows from the provisioning server to the BS. Operators provision the SSs with the Service Class Name; the implementation of the name is configured at the BS. This allows operators to modify the implementation of a given service to local circumstances without changing SS provisioning. For example, some scheduling parameters may need to be tweaked differently for two different BSs to provide the same service. As another example, service profiles could be changed by time of day.
- b) It allows higher-layer protocols to create a service flow by its Service Class Name. For example, telephony signaling may direct the SS to instantiate any available provisioned service flow of class “G711.”

NOTE—Service classes are merely identifiers for a specific set of QoS parameter set values. Hence, the use of service classes is optional. A service identified by a service class is treated no differently, once established, than a service that has the same QoS parameter set explicitly specified.

Any service flow may have its QoS Parameter Set specified in any of three ways:

- By explicitly including all traffic parameters.
- By indirectly referring to a set of traffic parameters by specifying a Service Class Name.
- By specifying a Service Class Name along with modifying parameters.

The Service Class Name is “expanded” to its defined set of parameters at the time the BS successfully admits the service flow. The Service Class expansion can be contained in the following BS-originated messages: DSA-REQ, DSC-REQ, DSA-RSP, and DSC-RSP. In all of these cases, the BS shall include a service flow encoding that includes the Service Class Name and the QoS Parameter Set of the Service Class. If an SS-initiated request contained any supplemental or overriding service flow parameters, a successful response shall also include these parameters.

When a Service Class name is given in an admission or activation request, it is possible that the returned QoS Parameter Set may change from activation to activation. This can happen because of administrative changes to the Service Class’s QoS Parameter Set at the BS. If the definition of a Service Class Name is changed at the BS (e.g., its associated QoS Parameter Set is modified), it has no effect on the QoS Parameters of existing service flows associated with that Service Class. A BS may initiate DSC transactions to existing service flows that reference the Service Class Name to affect the changed Service Class definition.

When an SS uses the Service Class Name to specify the Admitted QoS Parameter Set, the expanded set of TLV encodings of the service flow shall be returned to the SS in the response message (DSA-RSP or DSC-RSP). Use of the Service Class Name later in the activation request may fail if the definition of the Service Class Name has changed and the new required resources are not available. Thus, the SS should explicitly request the expanded set of TLVs from the response message in its later activation request.

6.3.14.5 Authorization

Every change to the service flow QoS Parameters shall be approved by an authorization module. This includes every DSA-REQ message to create a new service flow and every DSC-REQ message to change a QoS Parameter Set of an existing service flow. Such changes include requesting an admission control decision (e.g., setting the AdmittedQoSParamSet) and requesting activation of a service flow (e.g., setting the ActiveQoSParamSet). Reduction requests regarding the resources to be admitted or activated are also checked by the authorization module.

In the static authorization model, the authorization module stores the provisioned status of all “deferred” service flows. Admission and activation requests for these provisioned service flows shall be permitted, as long as the Admitted QoS Parameter Set is a subset of the Provisioned QoS Parameter Set, and the Active QoS Parameter Set is a subset of the Admitted QoS Parameter Set. Requests to change the Provisioned QoS Parameter Set shall be refused, as shall requests to create new dynamic service flows. This defines a static system where all possible services are defined in the initial configuration of each SS.

In the dynamic authorization model, the authorization module also communicates through a separate interface to an independent policy server. This policy server may provide the authorization module with advance notice of upcoming admission and activation requests, and it specifies the proper authorization action to be taken on those requests. Admission and activation requests from an SS are then checked by the Authorization Module to ensure that the ActiveQoSParamSet being requested is a subset of the set provided by the policy server. Admission and activation requests from an SS that are signalled in advance by the external policy server are permitted. Admission and activation requests from an SS that are not presignalled by the external policy server may result in a real-time query to the policy server or may be refused.

Prior to initial connection setup, the BS shall retrieve the Provisioned QoS Set for an SS. This is handed to the Authorization Module within the BS. The BS shall be capable of caching the Provisioned QoS Parameter Set and shall be able to use this information to authorize dynamic flows that are a subset of the Provisioned QoS Parameter Set. The BS should implement mechanisms for overriding this automated approval process (such as described in the dynamic authorization model). For example it could:

- a) Deny all requests whether or not they have been preprovisioned.
- b) Define an internal table with a richer policy mechanism but seeded by the Provisioned QoS Set.
- c) Refer all requests to an external policy server.

6.3.14.6 Types of service flows

It is useful to think about three basic types of service flows. This subclause describes these three types of service flows in more detail. However, it is important to note that there are more than just these three basic types (see 11.13.4).

6.3.14.6.1 Provisioned service flows

A service flow may be provisioned but not immediately activated (sometimes called “deferred”). That is, the description of any such service flow contains an attribute that provisions but defers activation and admission (see 11.13.4). The network assigns a SFID for such a service flow. The BS may also require an exchange with a policy module prior to admission.

As a result of external action beyond the scope of this specification, the SS may choose to activate a provisioned service flow by passing the SFID and the associated QoS Parameter Sets to the BS in the DSC-REQ message. If authorized and resources are available, the BS shall respond by mapping the service flow to a CID.

As a result of external action beyond the scope of this specification, the BS may choose to activate a service flow by passing the SFID as well as the CID and the associated QoS Parameter Sets to the SS in the DSC-REQ message. Such a provisioned service flow may be activated and deactivated many times (through DSC exchanges). In all cases, the original SFID shall be used when reactivating the service flow.

6.3.14.6.2 Admitted service flows

This protocol supports a two-phase activation model that is often utilized in telephony applications. In the two-phase activation model, the resources for a “call” are first “admitted,” and then once the end-to-end

negotiation is completed (e.g., called party's gateway generates an "off-hook" event), the resources are "activated." The two-phase model serves the following purposes:

- 1) conserving network resources until a complete end-to-end connection has been established,
- 2) performing policy checks and admission control on resources as quickly as possible, and in particular, before informing the far end of a connection request, and
- 3) preventing several potential theft-of-service scenarios.

For example, if an upper-layer service were using UGS, and the addition of upper-layer flows could be adequately provided by increasing the Maximum Sustained Traffic Rate QoS parameter, then the following procedure might be used. When the first higher-layer flow is pending, the SS issues a DSA-REQ with the admitted Maximum Sustained Traffic Rate parameter equal to that required for one higher-layer flow, and the active Maximum Sustained Traffic Rate parameter equal to zero. Later when the higher-layer flow becomes active, it issues a DSC-REQ with the instance of the active Maximum Sustained Traffic Rate parameter equal to that required for one higher-layer flow. Admission control was performed at the time of the reservation, so the later DSC-REQ, having the active parameters within the range of the previous reservation, is guaranteed to succeed. Subsequent higher-layer flows would be handled in the same way. If there were three higher-layer flows establishing connections, with one flow already active, the service flow would have admitted Maximum Sustained Traffic Rate equal to that required for four higher-layer flows, and active Maximum Sustained Traffic Rate equal to that required for one higher-layer flow.

An activation request of a service flow where the new ActiveQoSParamSet is a subset of the AdmittedQoSParamSet shall be allowed, except in the case of catastrophic failure. An admission request where the AdmittedQoSParamSet is a subset of the previous AdmittedQoSParamSet, so long as the ActiveQoSParamSet remains a subset of the AdmittedQoSParamSet, shall succeed.

A service flow that has resources assigned to its AdmittedQoSParamSet, but whose resources are not yet completely activated, is in a transient state. It is possible in some applications that a long-term reservation of resources is necessary or desirable. For example, placing a telephone call on hold should allow any resources in use for the call to be temporarily allocated to other purposes, but these resources shall be available for resumption of the call later. The AdmittedQoSParamSet is maintained as "soft state" in the BS; this state shall be maintained without releasing the nonactivated resources. Changes may be signaled with a DSC-REQ message.

6.3.14.6.3 Active service flows

A service flow that has a non-NULL ActiveQoSParamSet is said to be an active service flow. It is requesting (according to its Request/Transmission Policy, as in 11.13.12) and being granted bandwidth for transport of data packets. An admitted service flow may be activated by providing an ActiveQoSParamSet, signaling the resources actually desired at the current time. This completes the second stage of the two-phase activation model (see 6.3.14.6.2).

A service flow may be provisioned and immediately activated. Alternatively, a service flow may be created dynamically and immediately activated. In this case, two-phase activation is skipped and the service flow is available for immediate use upon authorization.

6.3.14.7 Service Flow Creation

The provisioning of service flows is done via means outside of the scope of this standard, such as the network management system. During provisioning, a service flow is instantiated, gets a service flow ID and a "provisioned" type. For some service flows it may be specified that DSA procedure must be activated by Network Entry procedure. Enabling service flows follows the transfer of the operational parameters, as

shown in Figure 55. In this case, the service flow type may change to “admitted” or to “active;” in the latter case, the Service Flow is mapped onto a certain connection.

Service flow encodings contain either a full definition of service attributes (omitting defaultable items if desired) or a service class name. A service class name is an ASCII string, which is known at the BS and which indirectly specifies a set of QoS Parameters.

Triggers, other than network entry, also may cause creation, admission, or activation of service flows. Such triggers lay outside the scope of the standard.

Capability of handling each specific Service Flow parameter is optional.

6.3.14.7.1 Dynamic service flow creation

6.3.14.7.1.1 Dynamic service flow creation—SS-initiated

Creation of service flows may be initiated by either BS (mandatory capability) or by SS (optional capability).

The SS-initiated protocol is illustrated in Figure 96 and described in detail in 6.3.14.9.3.1.

A DSA-REQ from an SS contains a service flow reference and QoS Parameter set (marked either for admission-only or for admission and activation).

BS responds with DSA-RSP indicating acceptance or rejection. In the case when rejection was caused by presence of non-supported parameter or non-supported value, specific parameter may be included into DSA-RSP.

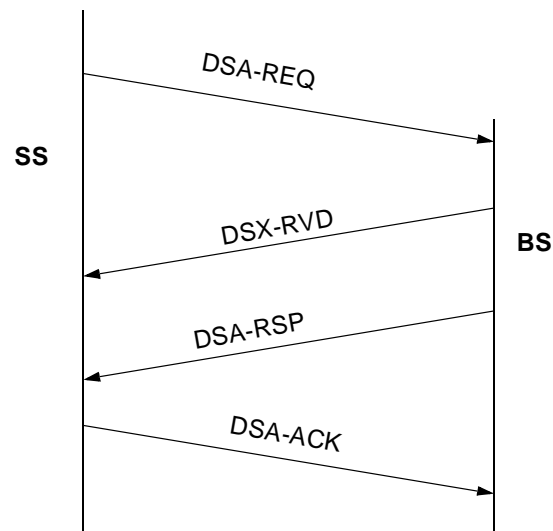

Figure 96—DSA message flow—SS-initiated

6.3.14.7.1.2 Dynamic service flow creation—BS-initiated

A DSA-REQ from a BS contains an SFID for either one uplink or one downlink Service flow, possibly its associated CID, and a set of active or admitted QoS Parameters. The protocol is illustrated in Figure 97 and is described in detail in 6.3.14.9.3.3.

SS responds with DSA-RSP indicating acceptance or rejection. In the case when rejection was caused by presence of non-supported parameter or non-supported value, specific parameter may be included into DSA-RSP.

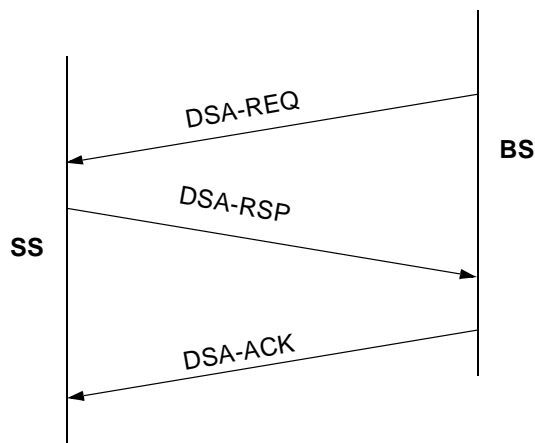

Figure 97—DSA message flow—BS-initiated

6.3.14.8 Dynamic service flow modification and deletion

In addition to the methods presented in 6.3.14.7 for creating service flows, protocols are defined for modifying and deleting service flows; see 6.3.14.9.4 and 6.3.14.9.5.

Both provisioned and dynamically created service flows are modified with the DSC message, which can change the Admitted and Active QoS Parameter sets of the flow.

A successful DSC transaction changes a service flow's QoS parameters by replacing both the Admitted and Active QoS parameter sets. If the message contains only the Admitted set, the Active set is set to null and the flow is deactivated. If the message contains neither set ("000" value used for QoS Parameter Set type, see 11.13.4), then both sets are set to null and the flow is de-admitted. When the message contains both QoS parameter sets, the Admitted set is checked first, and if admission control succeeds, the Active set in the message is checked against the Admitted set in the message to ensure that it is a subset. If all checks are successful, the QoS parameter sets in the message become the new Admitted and Active QoS parameter sets for the service flow. If either of the checks fails, the DSC transaction fails and the service flow QoS parameter sets are unchanged.

6.3.14.9 Service flow management

6.3.14.9.1 Overview

Service flows may be created, changed, or deleted. This is accomplished through a series of MAC management messages referred to as DSA, DSC, and DSD. The DSA messages create a new service flow.

The DSC messages change an existing service flow. The DSD messages delete an existing service flow. This is illustrated in Figure 98.

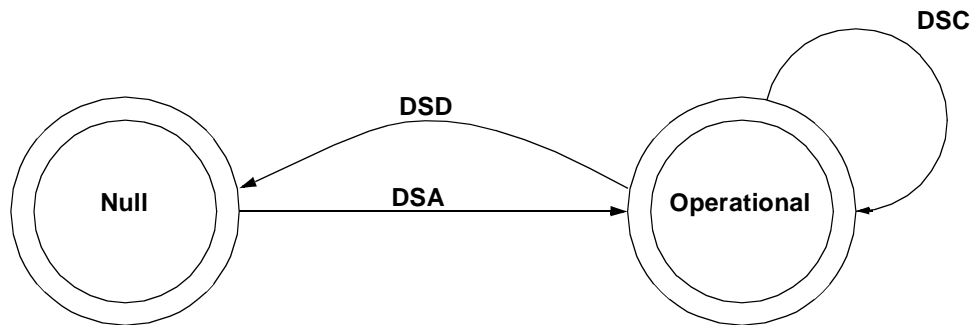

Figure 98—Dynamic service flow overview

The Null state implies that no service flow exists that matches the SFID and/or Transaction ID in a message. Once the service flow exists, it is operational and has an assigned SFID. In steady-state operation, a service flow resides in a Nominal state. When DSx messaging is occurring, the service flow may transition through other states, but remains operational. Since multiple service flows may exist, there may be multiple state machines active, one for every service flow. DSx messages only affect those state machines that match the SFID and/or Transaction ID. Both the SS and BS shall verify the HMAC-Digest on all DSx messages before processing them, and discard any messages that fail.

Transaction IDs are unique per transaction and are selected by the initiating device (SS or BS). To help prevent ambiguity and provide simple checking, the Transaction ID number space is split between the SS and BS. The SS shall select its Transaction IDs from the first half of the number space (0x0000 to 0x7FFF). The BS shall select its Transaction IDs from the second half of the number space (0x8000 to 0xFFFF).

Each DSx message sequence is a unique transaction with an associated unique transaction identifier. The DSA/DSC transactions consist of a request/response/acknowledge sequence. The DSD transactions consist of a request/response sequence. The response messages shall return a CC of OK unless some exception condition was detected. The acknowledge messages shall return the CC in the response unless a new exception condition arises. A more detailed state diagram, including transition states, is shown in Figure 99 through Figure 105. The detailed actions for each transaction shall be given in the following subclauses.

6.3.14.9.2 Dynamic Service Flow state transitions

The Dynamic Service Flow state transition diagram (Figure 99) is the top-level state diagram and controls the general service flow state. As needed, it creates transactions, each represented by a Transaction state transition diagram, to provide the DSA, DSC, and DSD signaling. Each Transaction state transition diagram communicates only with the parent Dynamic Service Flow state transition diagram. The top-level state transition diagram filters DSx messages and passes them to the appropriate transaction based on SFID, service flow reference number, and Transaction ID.

There are six different types of transactions, which are locally initiated or remotely initiated for each of the DSA, DSC, and DSD messages (Figure 100–Figure 105). Most transactions have three basic states—pending, holding, and deleting. The pending state is typically entered after creation and is where the transaction is waiting for a reply. The holding state is typically entered once the reply is received. The purpose of this state is to allow for retransmissions in case of a lost message, even though the local entity has perceived that the transaction has completed. The deleting state is only entered if the service flow is being deleted while a transaction is being processed.

The flow diagrams provide a detailed representation of each of the states in the Transaction state transition diagrams. All valid transitions are shown. Any inputs not shown should be handled as a severe error condition.

With one exception, these state diagrams apply equally to the BS and SS. In the Dynamic Service Flow Changing-Local state, there is a subtle difference in the SS and BS behaviors. This is called out in the state transition and detailed flow diagrams.

NOTE—The “Num Xacts” variable in the Dynamic Service Flow state transition diagram is incremented every time the top-level state diagram creates a transaction and is decremented every time a transaction terminates. A dynamic service flow shall not return to the Null state until it is deleted and all transactions have terminated.

The inputs for the state diagrams are identified below.

Dynamic Service Flow state transition diagram inputs from unspecified local, higher level entities:

- a) Add
- b) Change
- c) Delete

Dynamic Service Flow state transition diagram inputs from DSx Transaction state transition diagrams:

- a) DSA Succeeded
- b) DSA Failed
- c) DSA-ACK Lost
- d) DSA Erred
- e) DSA Ended

- a) DSC Succeeded
- b) DSC Failed
- c) DSC-ACK Lost
- d) DSC Erred
- e) DSC Ended

- a) DSD Succeeded
- b) DSD Erred
- c) DSD Ended

DSx Transaction state transition diagram inputs from the Dynamic Service Flow state transition diagram:

- a) SF Add
- b) SF Change
- c) SF Delete

- a) SF Abort Add
- b) SF Change-Remote
- c) SF Delete-Local
- d) SF Delete-Remote

- a) SF DSA-ACK Lost

- b) SF DSC-REQ Lost
- c) SF DSC-ACK Lost
- d) SF DSC-REQ Lost

- a) SF Changed
- b) SF Deleted

The creation of DSx transactions by the Dynamic Service Flow state transition diagram is indicated by the notation:

DSx – [Local | Remote] (initial_input)

where initial_input may be SF Add, DSA-REQ, SF Change, DSC-REQ, SF Delete, or DSD-REQ, depending on the transaction type and initiator.

State transitions (i.e., the lines between states) are labeled with <what causes the transition>/<messages and events triggered by the transition>. If there are multiple events or messages before the slash “/” separated by a comma, any of them can cause the transition. If there are multiple events or messages listed after the slash, all of the specified actions shall accompany the transition.

For example, “DSD-REQ/SF Delete Remote, DSD-Remote(DSD-REQ)” should be read as follows: Once DSD-REQ is received, it triggers sending a “SF Delete Remote” event to transactions running for this service flow AND starting the “DSD-Remote” transaction and pass the event DSD-REQ to it.

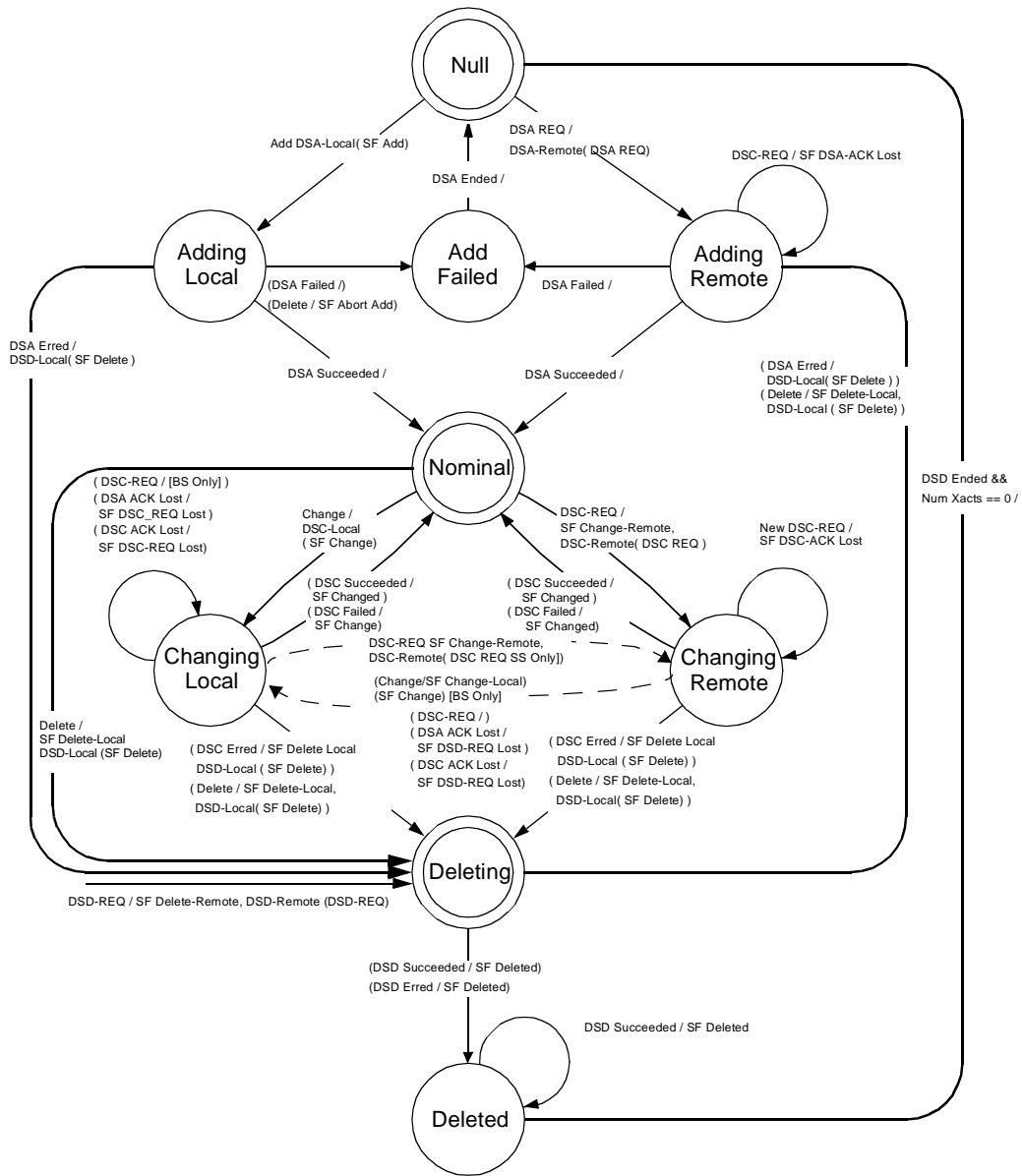

Figure 99—Dynamic Service Flow state transition diagram

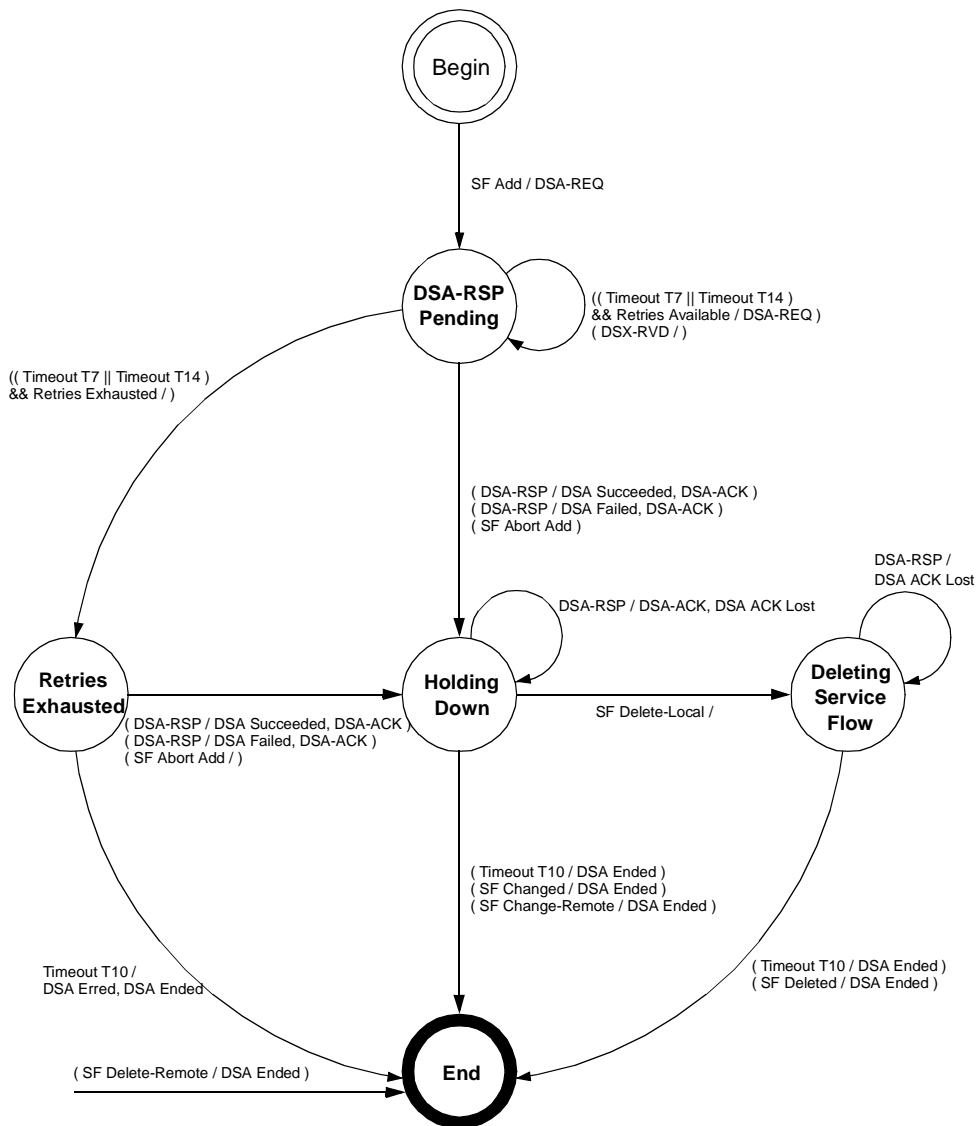

Figure 100—DSA—Locally Initiated Transaction state transition diagram

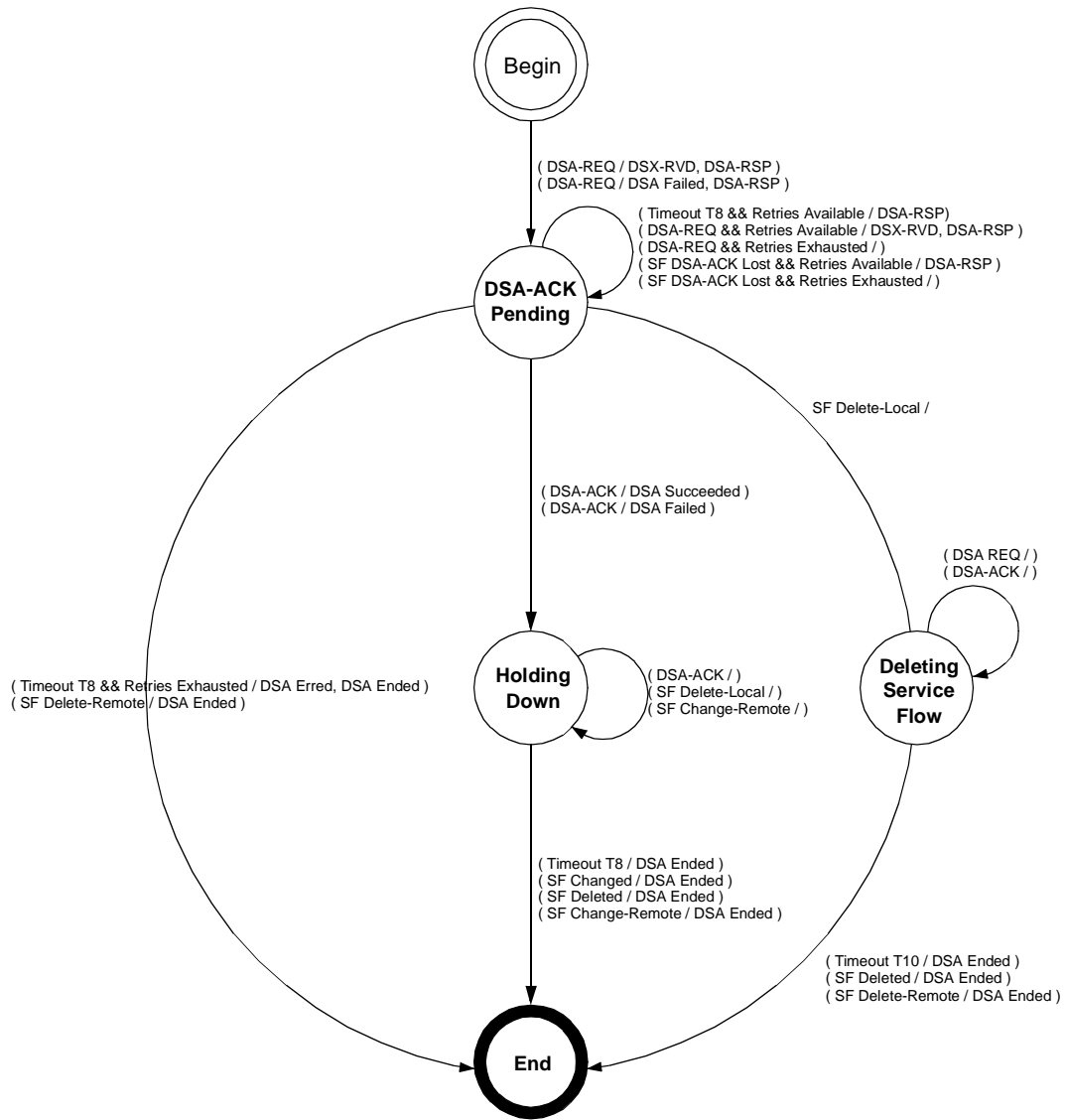

Figure 101—DSA—Remotely Initiated Transaction state transition diagram

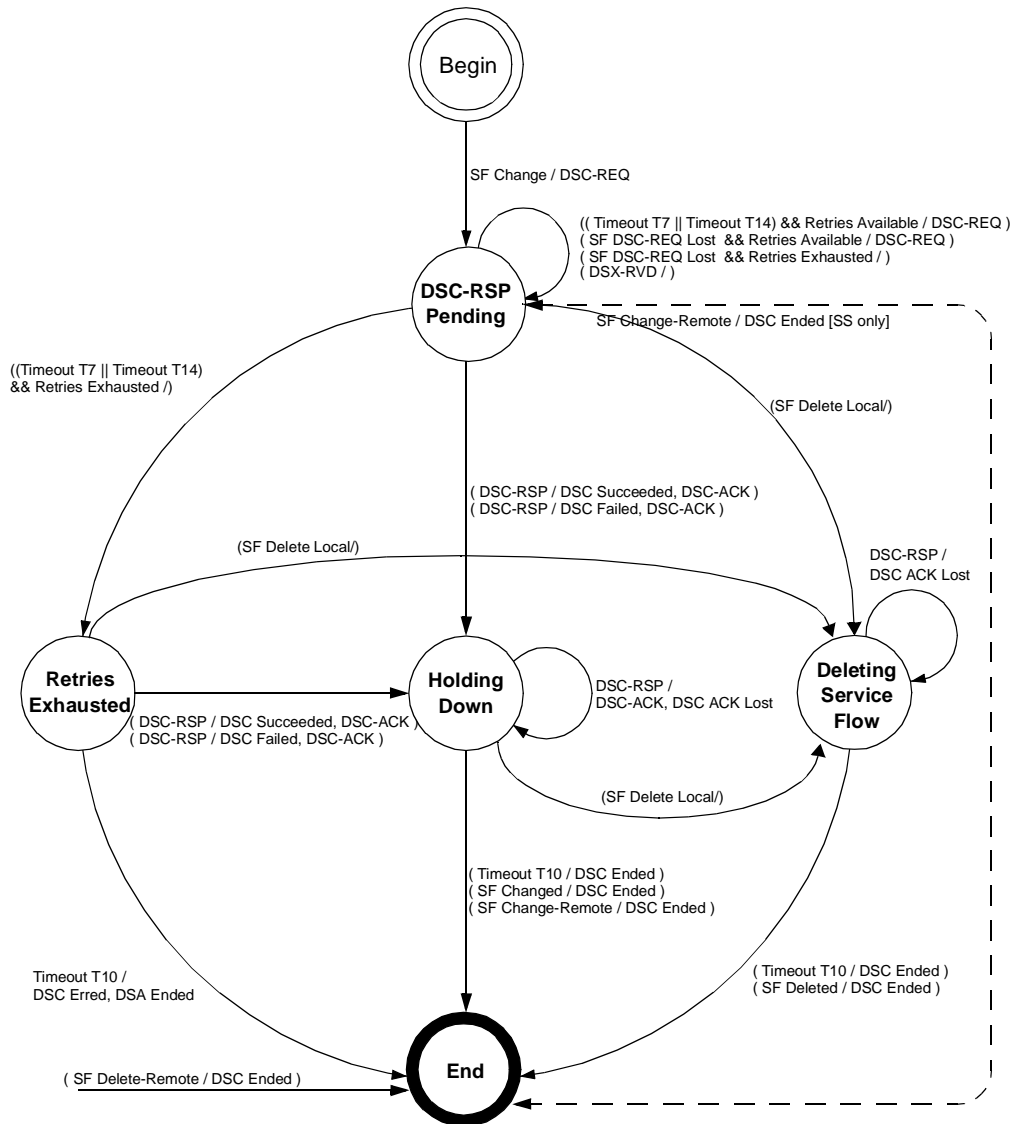

Figure 102—DSC—Locally Initiated Transaction state transition diagram

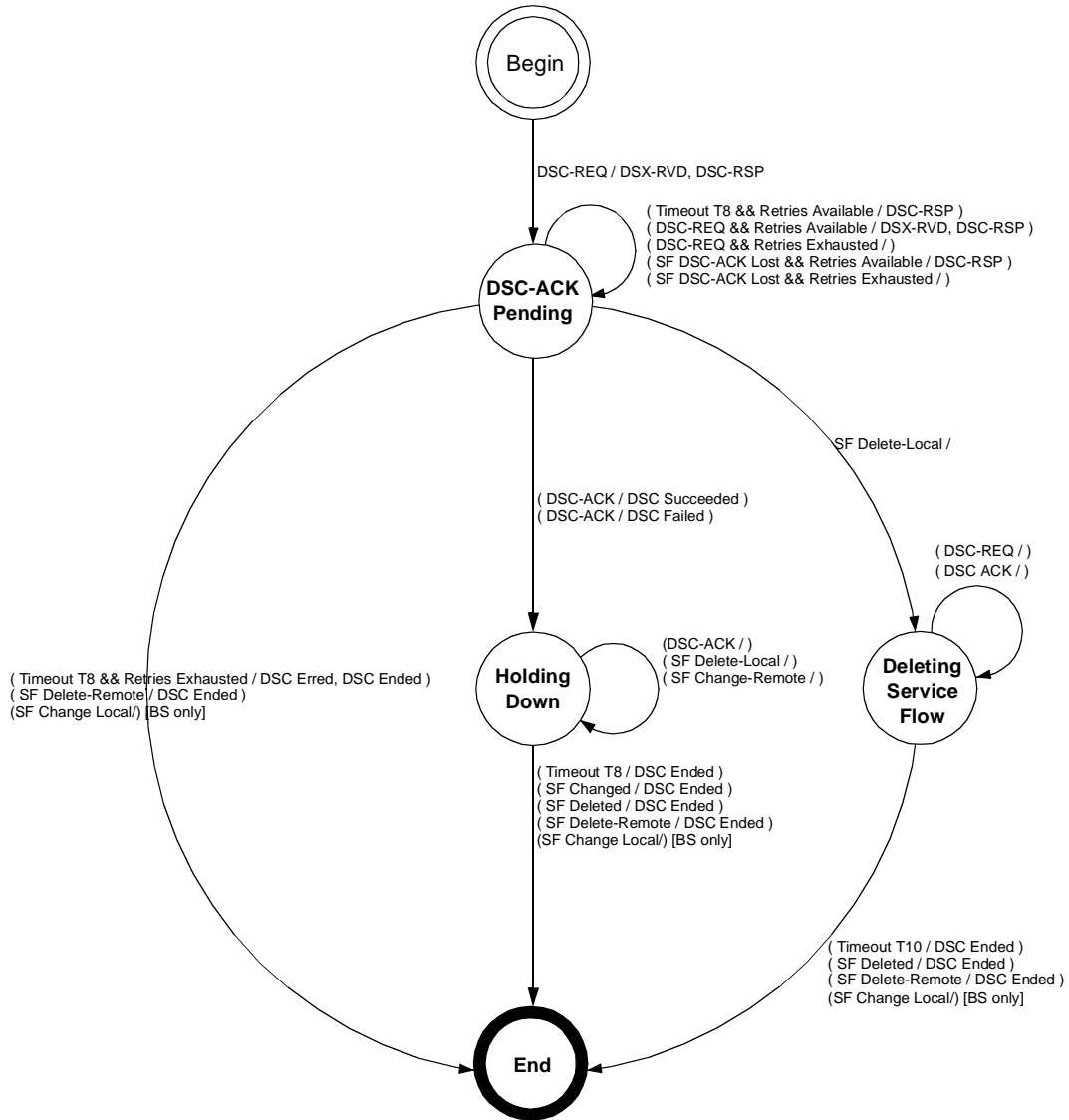

Figure 103—DSC—Remotely Initiated Transaction state transition diagram

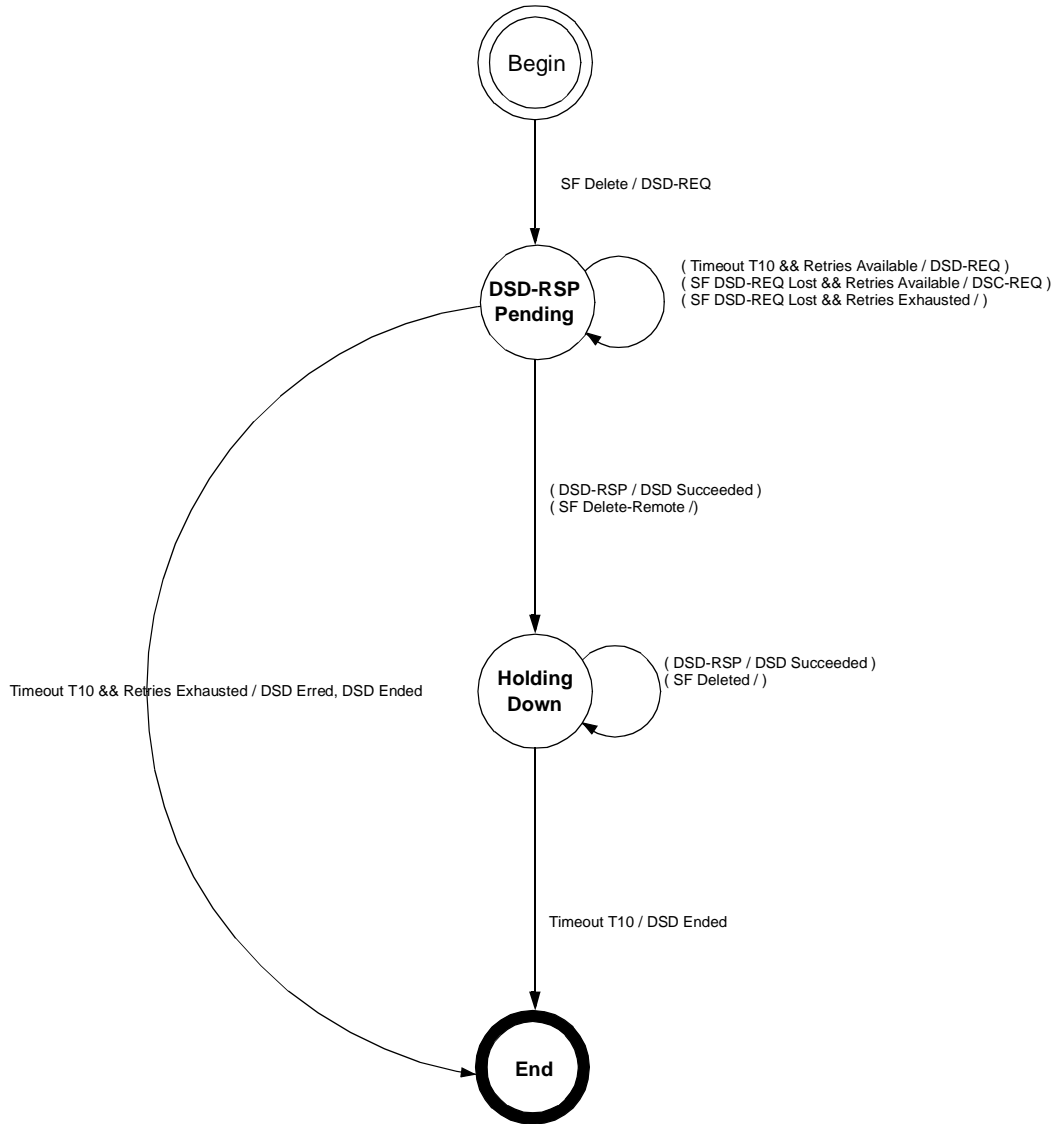

Figure 104—DSD—Locally Initiated Transaction state transition diagram

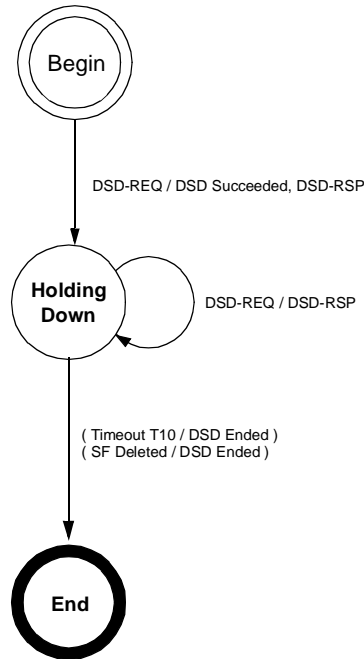

Figure 105—DSD—Remotely Initiated Transaction state transition diagram

6.3.14.9.3 DSA

6.3.14.9.3.1 SS-initiated DSA

An SS wishing to create either an uplink or downlink service flow sends a request to the BS using a DSA-REQ message. The BS checks the integrity of the message and, if the message is intact, sends a message received (DSX-RVD) response to the SS. The BS checks the SS’s authorization for the requested service and whether the QoS requirements can be supported, generating an appropriate response using a DSA-RSP message. The SS concludes the transaction with an acknowledgment message (DSA-ACK). This process is illustrated in Table 125.

Table 125—DSA initiated from SS

SS		BS
New service flow needed		
Check if resources are available		
Send DSA-REQ Set Timers T7 and T14	--DSA-REQ-->	Receive DSA-REQ
Timer T14 Stops	<-- DSX-RVD--	DSA-REQ integrity valid
		Check whether SS is authorized for Service ^a

Table 125—DSA initiated from SS (continued)

SS		BS
		Check whether service flow QoS can be supported
		Create SFID
		If uplink AdmittedQoSParamSet is non-null, map service flow to CID
		If uplink ActiveQoSParamSet is non-null, Enable reception of data on new uplink service flow
Receive DSA-RSP Timer T7 Stops	<--DSA-RSP-->	Send DSA-RSP
If ActiveQoSParamSet is non-null, Enable transmission and/or reception of data on new service flow		
Send DSA-ACK	--DSA-ACK-->	Receive DSA-ACK
		If downlink ActiveQoSParamSet is non-null, Enable transmission of data on new downlink service flow

^aAuthorization happens prior to the DSA-REQ being received by the BS. The details of BS signalling to anticipate a DSA-REQ are beyond the scope of this standard.

6.3.14.9.3.2 BS-initiated DSA

A BS wishing to establish either an uplink or a downlink dynamic service flow with an SS performs the following operations. The BS checks the authorization of the destination SS for the requested class of service and to determine whether the QoS requirements can be supported. If the service can be supported, the BS generates a new SFID with the required class of service and informs the SS using a DSA-REQ message. If the SS checks that it can support the service, it responds using a DSA-RSP message. The transaction completes with the BS sending the acknowledge message (DSA-ACK). This process is illustrated in Table 126.

Table 126—DSA initiated from BS

SS		BS
		New service flow required for SS
		Check whether SS is authorized for Service
		Check whether service flow(s) QoS can be supported
		Create SFID
		If AdmittedQoSParamSet is non-null, map service flow to CID
Receive DSA-REQ	<--DSA-REQ-->	Send DSA-REQ Set Timer T7

Table 126—DSA initiated from BS (continued)

SS		BS
Confirm that SS can support service flow		
Add Downlink SFID (if present)		
Enable reception on any new downlink service flow		
Send DSA-RSP	---DSA-RSP-->	Receive DSA-RSP Timer T7 Stops
		Enable transmission (downlink) or reception (uplink) of data on new service flow
Receive DSA-ACK	<--DSA-ACK---	Send DSA-ACK
Enable transmission on new uplink service flow		

6.3.14.9.3.3 DSA state transition diagrams

DSA state transition diagrams are shown in Figure 106–Figure 114.

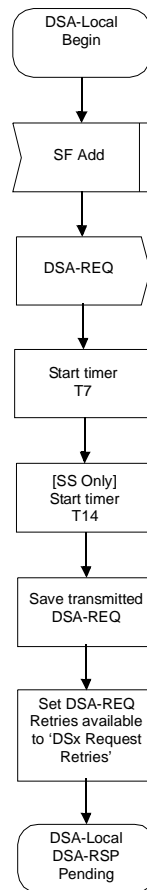

Figure 106—DSA—Locally Initiated Transaction Begin state flow diagram

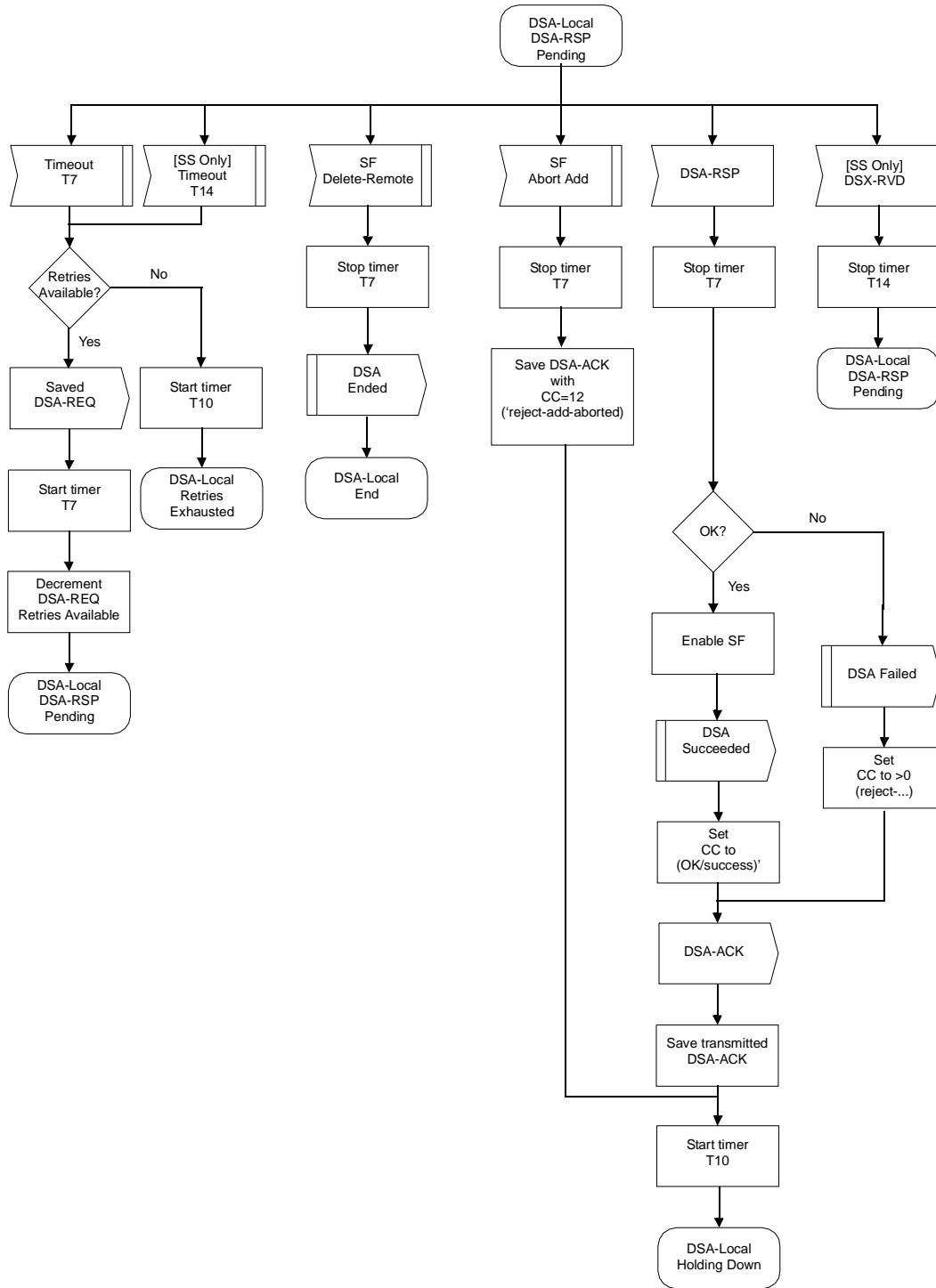

Figure 107—DSA—Locally Initiated Transaction DSA-RSP Pending state flow diagram

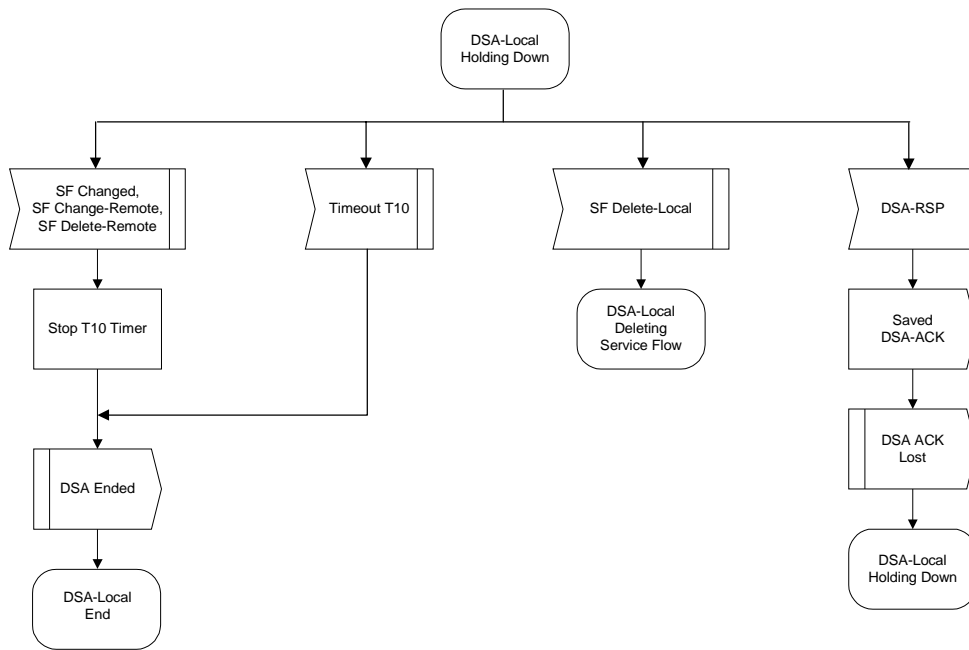

Figure 108—DSA—Locally Initiated Transaction Holding state flow diagram

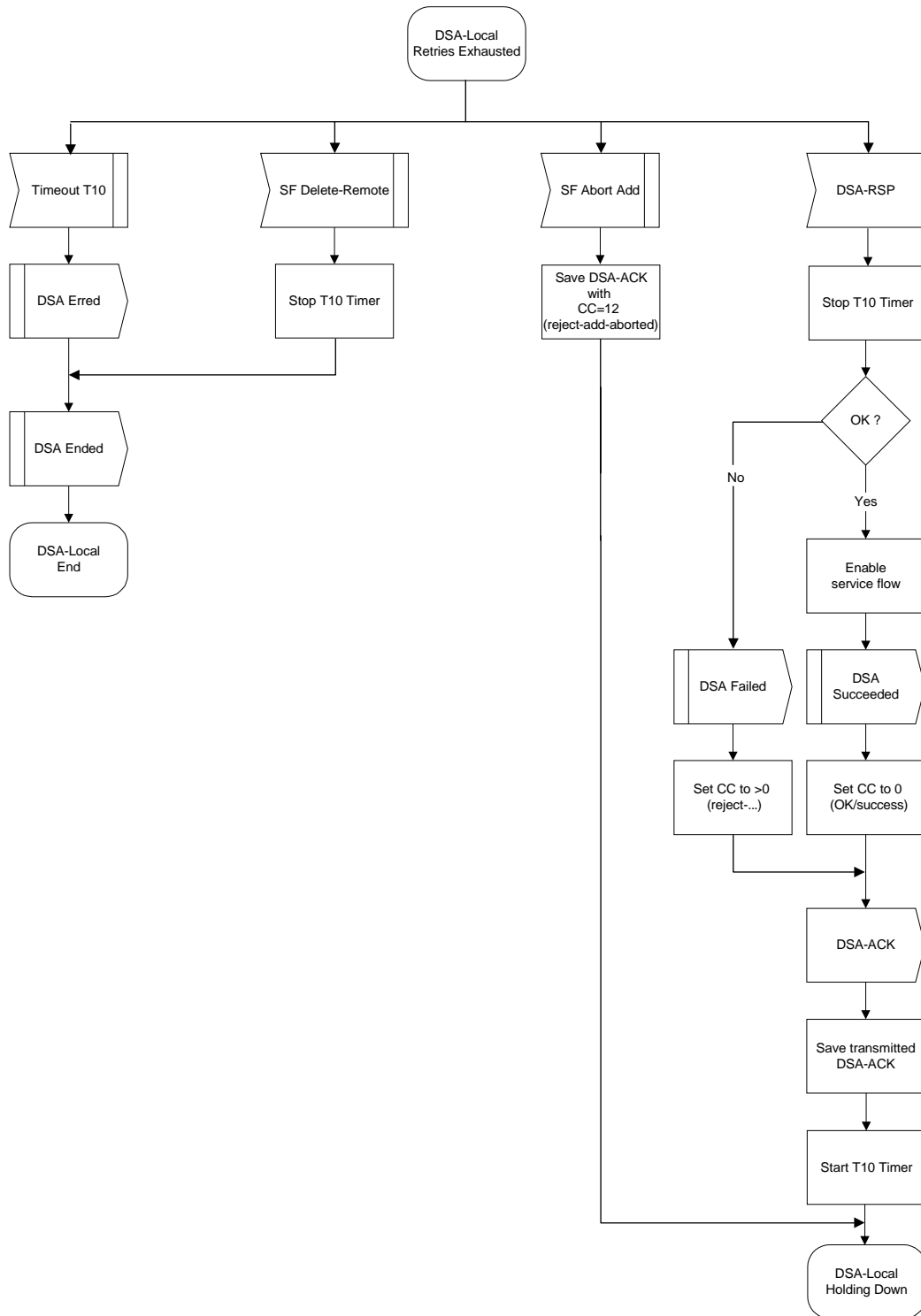

Figure 109—DSA—Locally Initiated Transaction Retries Exhausted state flow diagram

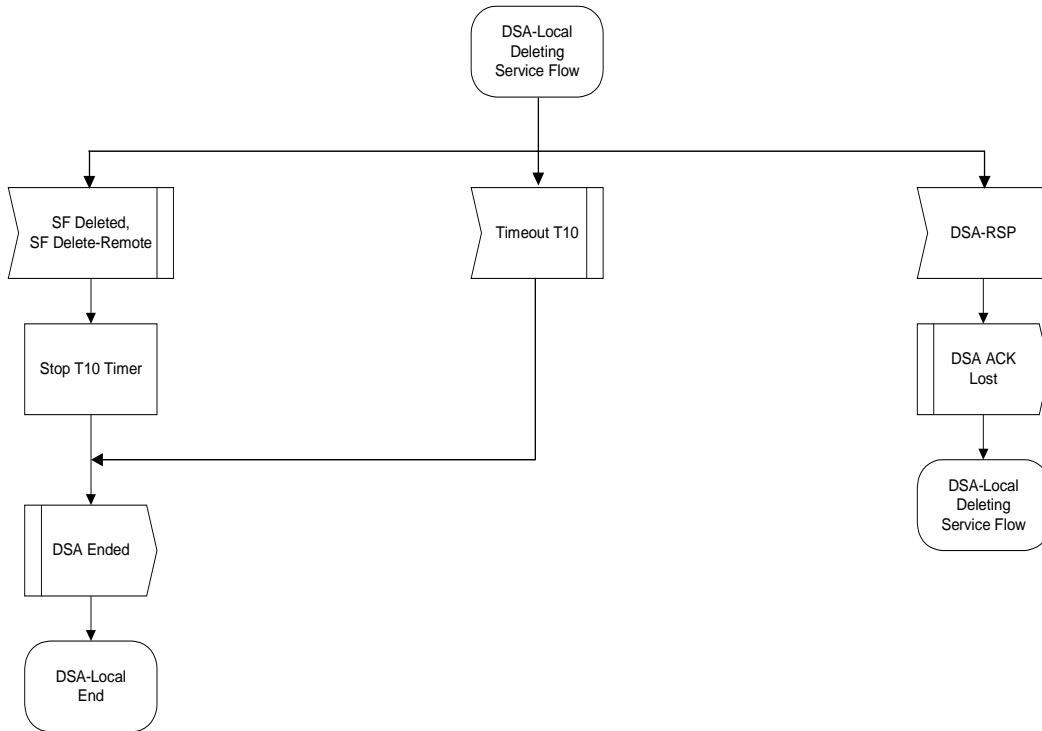

Figure 110—DSA—Locally Initiated Transaction Deleting Service Flow state flow diagram

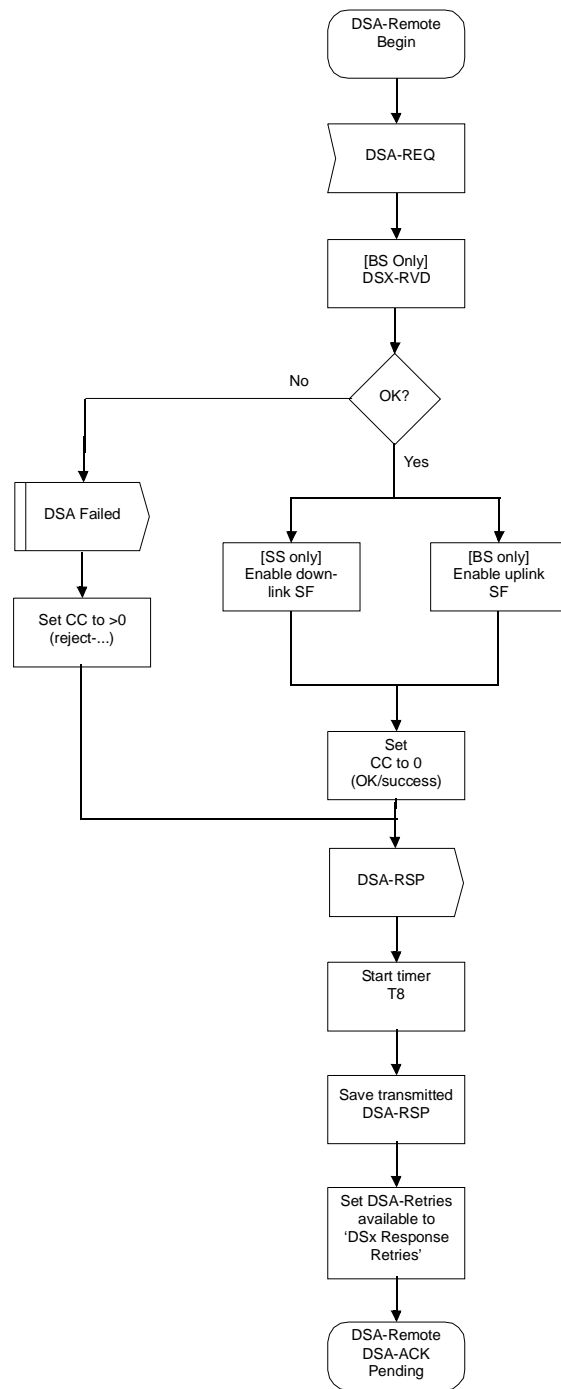

Figure 111—DSA—Remotely Initiated Transaction Begin state flow diagram

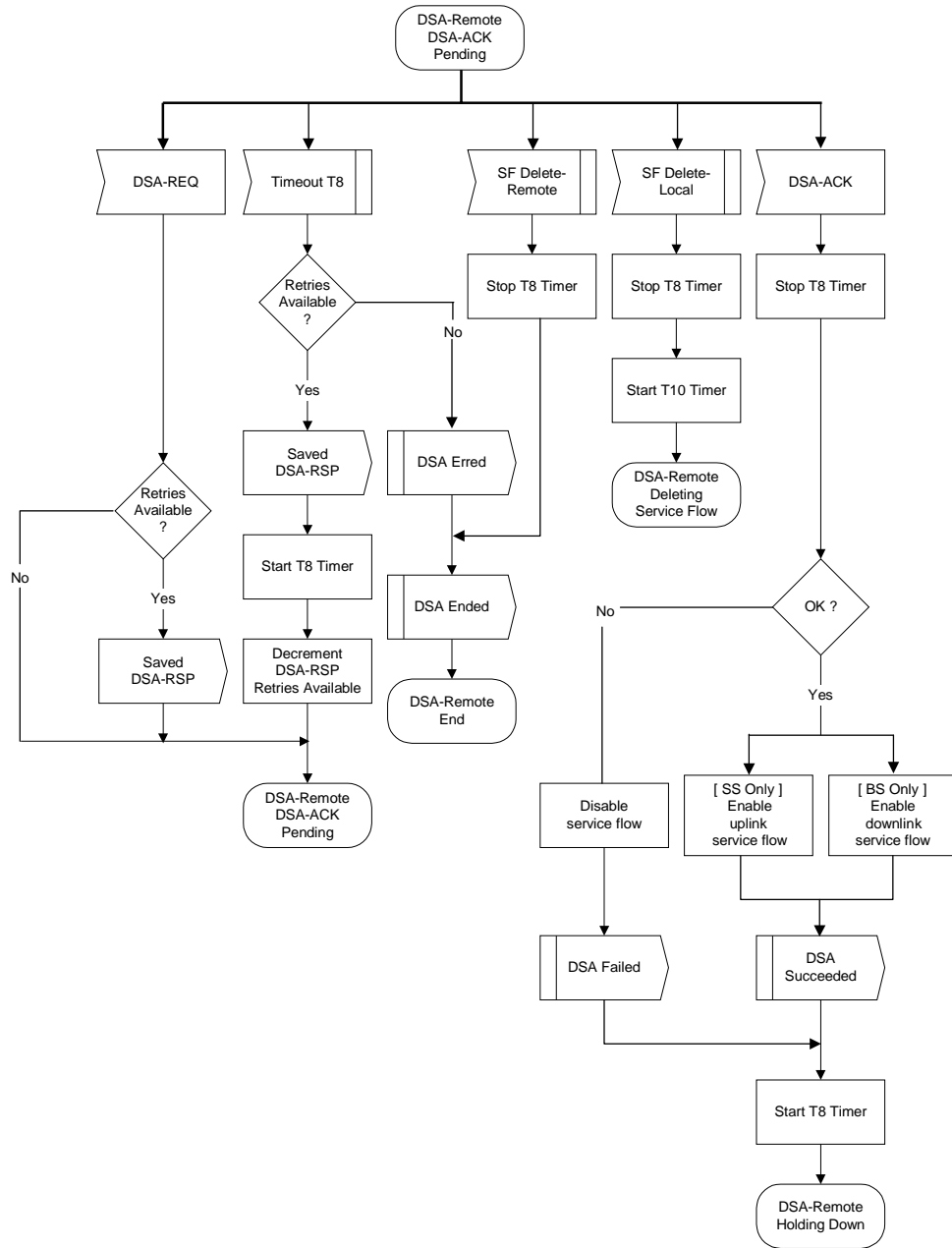

Figure 112—DSA—Remotely Initiated Transaction DSA-ACK Pending state flow diagram

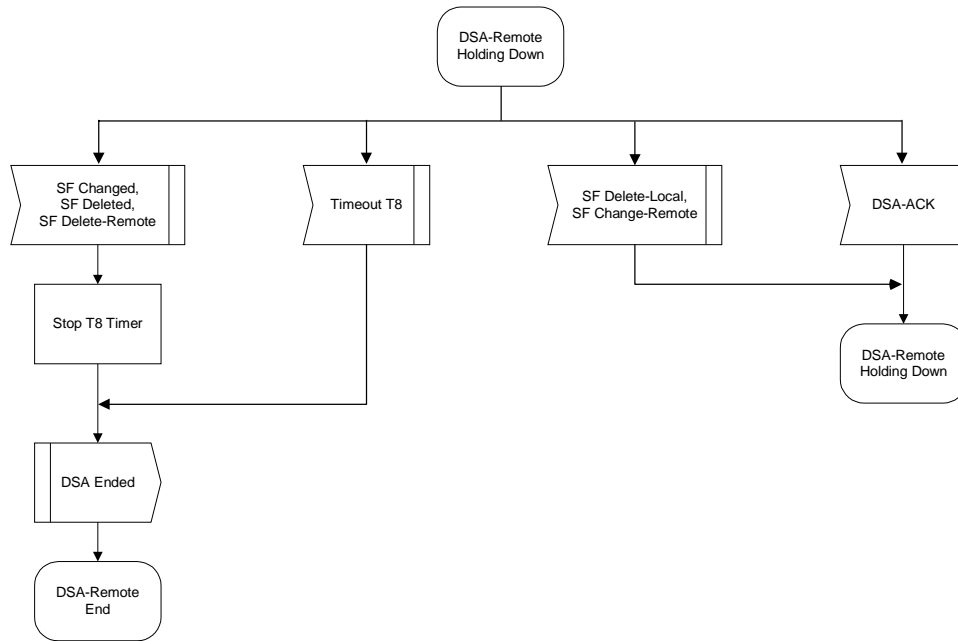

Figure 113—DSA—Remotely Initiated Transaction Holding Down state flow diagram

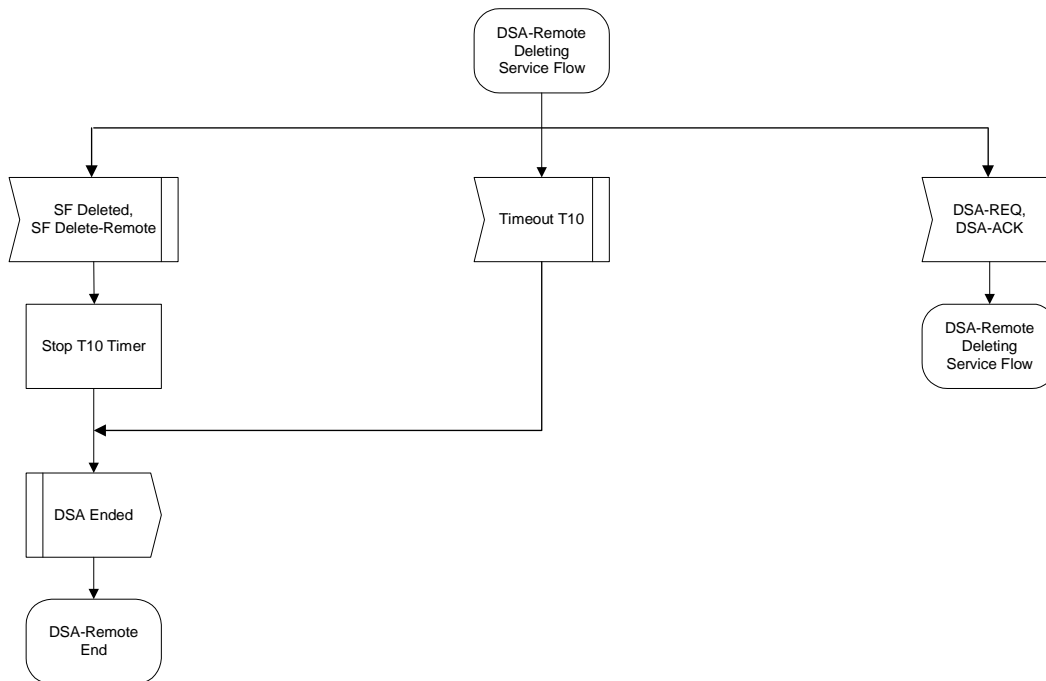

Figure 114—DSA—Remotely Initiated Transaction Deleting Service state flow diagram

6.3.14.9.4 DSC

The DSC set of messages is used to modify the flow parameters associated with a service flow. Specifically, DSC can modify the service flow Specification.

A single DSC message exchange can modify the parameters of either one downlink service flow or one uplink service flow.

To prevent packet loss, any required bandwidth change is sequenced between the SS and BS.

The BS controls both uplink and downlink scheduling. The timing of scheduling changes is independent of direction AND whether it is an increase or decrease in bandwidth. The BS always changes scheduling on receipt of a DSC-REQ (SS-initiated transaction) or DSC-RSP (BS-initiated transaction).

The BS also controls the downlink transmit behavior. The change in downlink transmit behavior is always coincident with the change in downlink scheduling (i.e., BS controls both and changes both simultaneously).

The SS controls the uplink transmit behavior. The timing of SS transmit behavior changes is a function of which device initiated the transaction AND whether the change is an “increase” or “decrease” in bandwidth.

If an uplink service flow’s bandwidth is being reduced, the SS reduces its payload bandwidth first and then the BS reduces the bandwidth scheduled for the service flow. If an uplink service flow’s bandwidth is being increased, the BS increases the bandwidth scheduled for the service flow first and then the SS increases its payload bandwidth.

Any service flow can be deactivated with a DSC command by sending a DSC-REQ message, referencing the SFID, and including a null ActiveQoSParamSet. However, if a Basic, Primary Management, or Secondary Management Connection of an SS is deactivated, that SS is deregistered and shall re-register. Therefore, care should be taken before deactivating such service flows. If a service flow that was provisioned is deactivated, the provisioning information for that service flow shall be maintained until the service flow is reactivated.

An SS shall have only one DSC transaction outstanding per service flow. If it detects a second transaction initiated by the BS, the SS shall abort the transaction it initiated and allow the BS-initiated transaction to complete.

A BS shall have only one DSC transaction outstanding per service flow. If it detects a second transaction initiated by the SS, the BS shall abort the transaction that the SS initiated and allow the BS-initiated transaction to complete.

The following service flow parameters may not be changed, and shall not be present in the DSC-REQ or DSC-RSP messages:

- Service Flow Scheduling Type
- Request/Transmission Policy
- Convergence Sublayer Specification
- Fixed-Length versus Variable-Length SDU Indicator
- SDU Size
- ATM switching (ATM Services only)
- ARQ parameters, in accordance with individual TLV definitions

NOTE—Currently anticipated applications would probably control a service flow through either the SS or BS, and not both. Therefore, the case of a DSC being initiated simultaneously by the SS and BS is considered as an exception condition and treated as one.

6.3.14.9.4.1 SS-initiated DSC

An SS that needs to change a service flow definition performs the following operations.

The SS informs the BS using a DSC-REQ. The BS checks the integrity of the message and, if the message is intact, sends a message received (DSX-RVD) response to the SS. The BS shall decide if the referenced service flow can support this modification. The BS shall respond with a DSC-RSP indicating acceptance or rejection. In the case when rejection was caused by presence of non-supported parameter of non-supported value, specific parameter may be included into DSC-RSP. The SS reconfigures the service flow if appropriate, and then shall respond with a DSC-ACK. This process is illustrated in Table 127.

Table 127—SS-initiated DSC

BS		SS
		Service flow requires modifying
Receive DSC-REQ	<----- DSC-REQ ----->	Send DSC-REQ Set Timers T7 and T14
DSC_REQ integrity valid	----- DSX-RVD ----->	Timer T14 Stops
Validate Request		
Modify service flow		
Increase Channel Bandwidth if Required		
Send DSC-RSP	----- DSC-RSP ----->	Receive DSC-RSP Timer T7 Stops
		Modify service flow
		Adjust Payload Bandwidth
Receive DSC-ACK	<----- DSC-ACK ----->	Send DSC-ACK
Decrease Channel Bandwidth if Required		

6.3.14.9.4.2 BS-initiated DSC

A BS that needs to change a service flow definition performs the following operations.

The BS shall decide if the referenced service flow can support this modification. If so, the BS informs the SS using a DSC-REQ. The SS checks that it can support the service change, and shall respond using a DSC-RSP indicating acceptance or rejection. In the case when rejection was caused by presence of non-supported parameter of non-supported value, specific parameter may be included into DSC-RSP. The BS reconfigures the service flow if appropriate, and then shall respond with a DSC-ACK. This process is illustrated in Table 128.

6.3.14.9.4.3 DSC state transition diagrams

DSC state transition diagrams are shown in Figure 115–Figure 123.

Table 128—BS-initiated DSC

BS		SS
Service flow requires modifying		
Send DSC-REQ Set Timer T7	----- DSC-REQ ----->	Receive DSC-REQ
		Validate request
		Modify service flow
		Decrease Payload Bandwidth if Required
Receive DSC-RSP Timer T7 Stops	<----- DSC-RSP -----	Send DSC-RSP
Modify service flow		
Adjust Channel Bandwidth		
Send DSC-ACK	----- DSC-ACK ----->	Receive DSC-ACK
		Increase Payload Bandwidth if Required

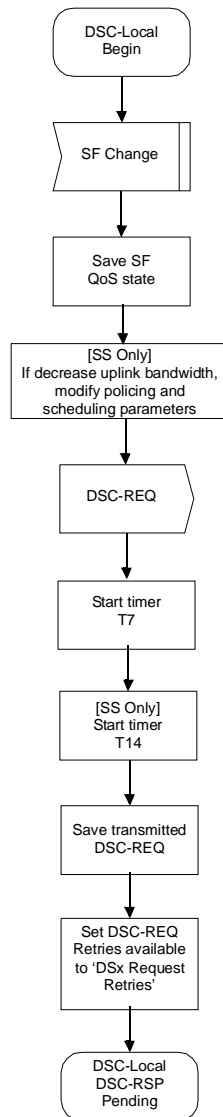

Figure 115—DSC—Locally Initiated Transaction Begin state flow diagram

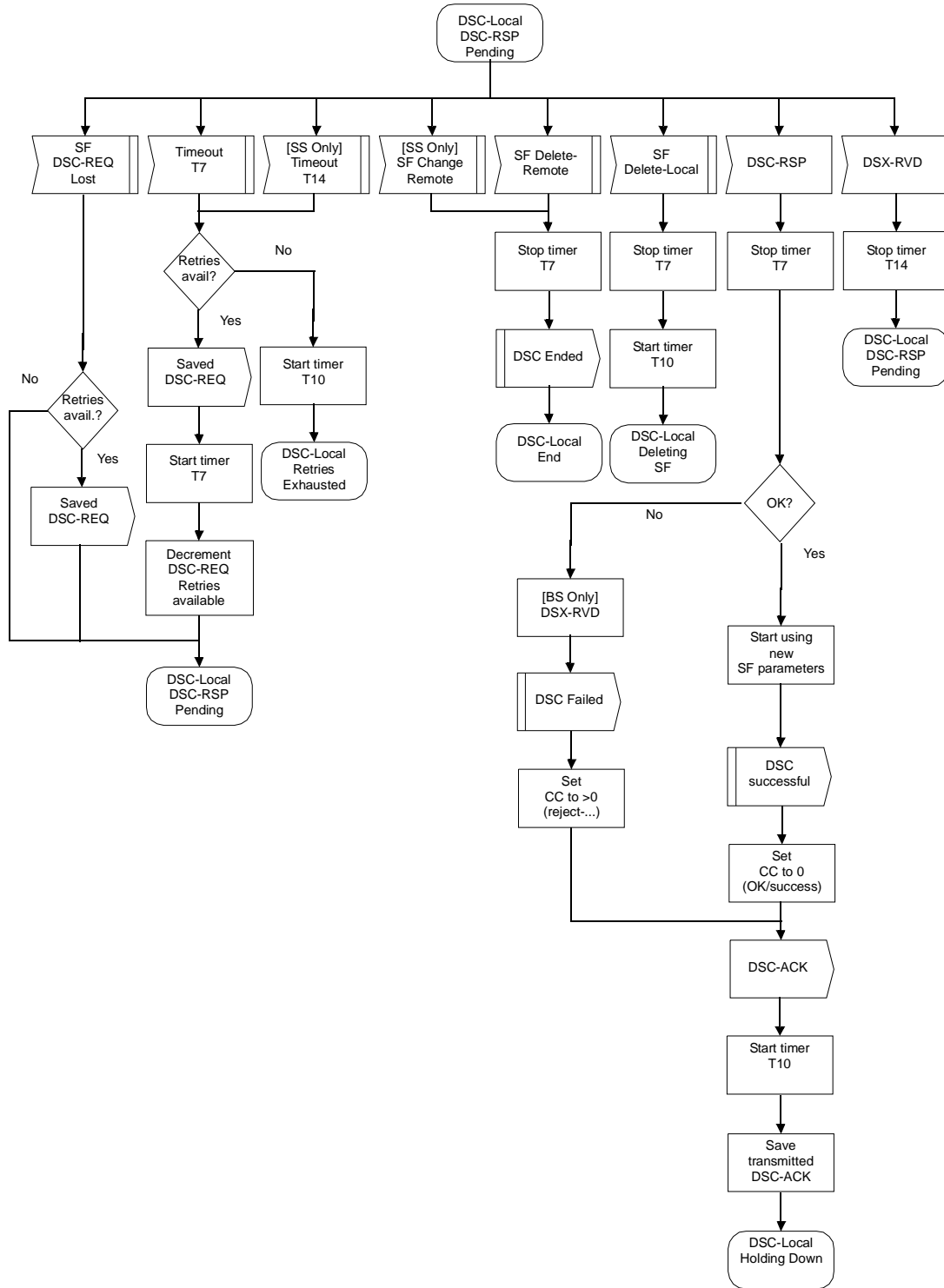

Figure 116—DSC—Locally Initiated Transaction DSC-RSP Pending state flow diagram

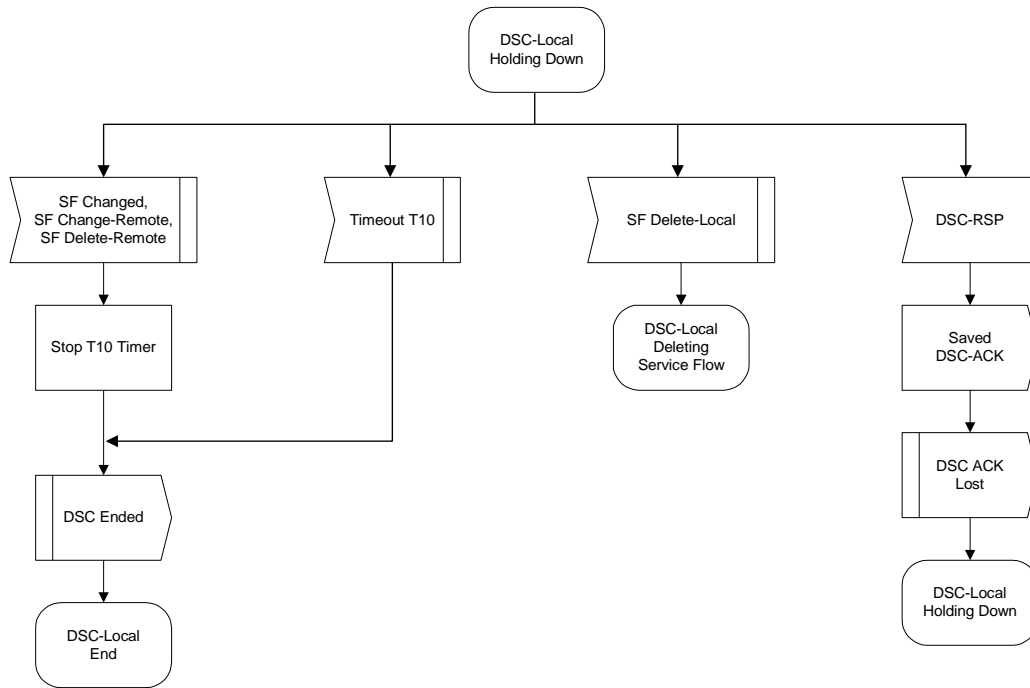

Figure 117—DSC—Locally iNitiated Transaction Holding Down state flow diagram

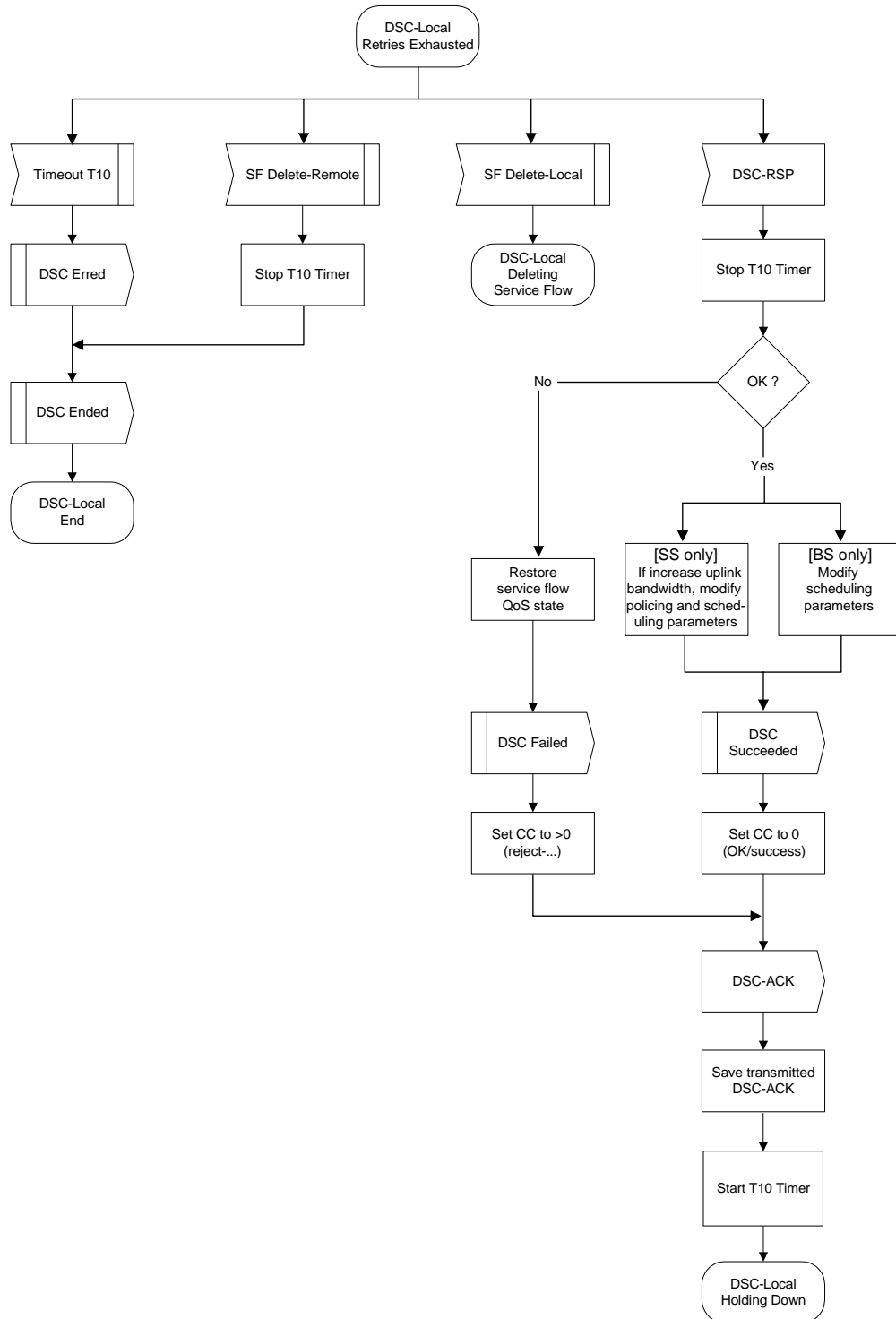

Figure 118—DSC—Locally Initiated Transaction Retries Exhausted state flow diagram

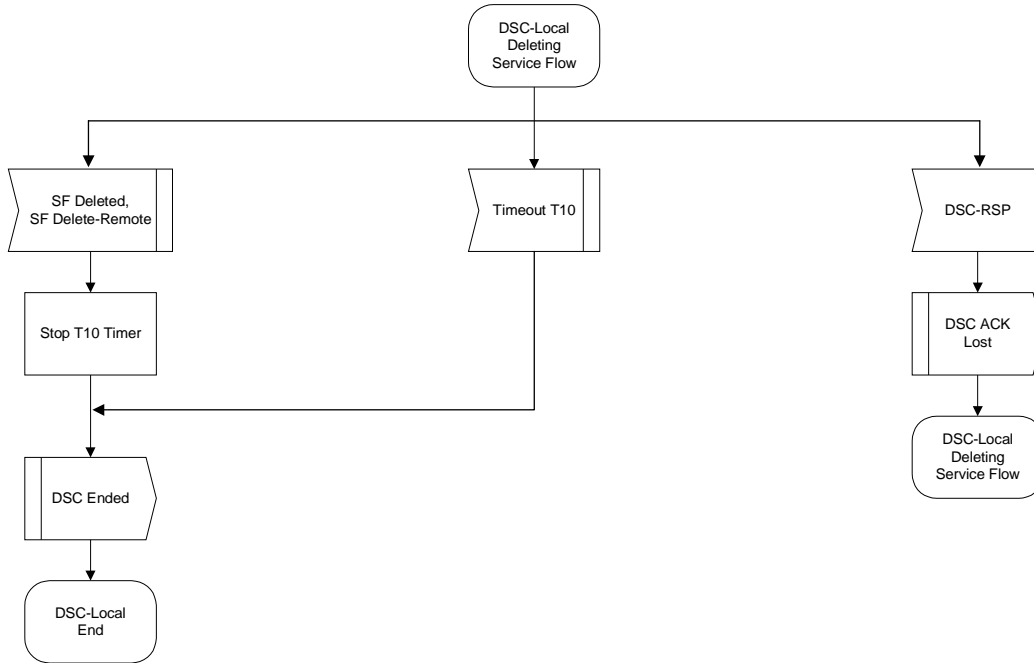

Figure 119—DSC—Locally Initiated Transaction Deleting Service Flow state flow diagram

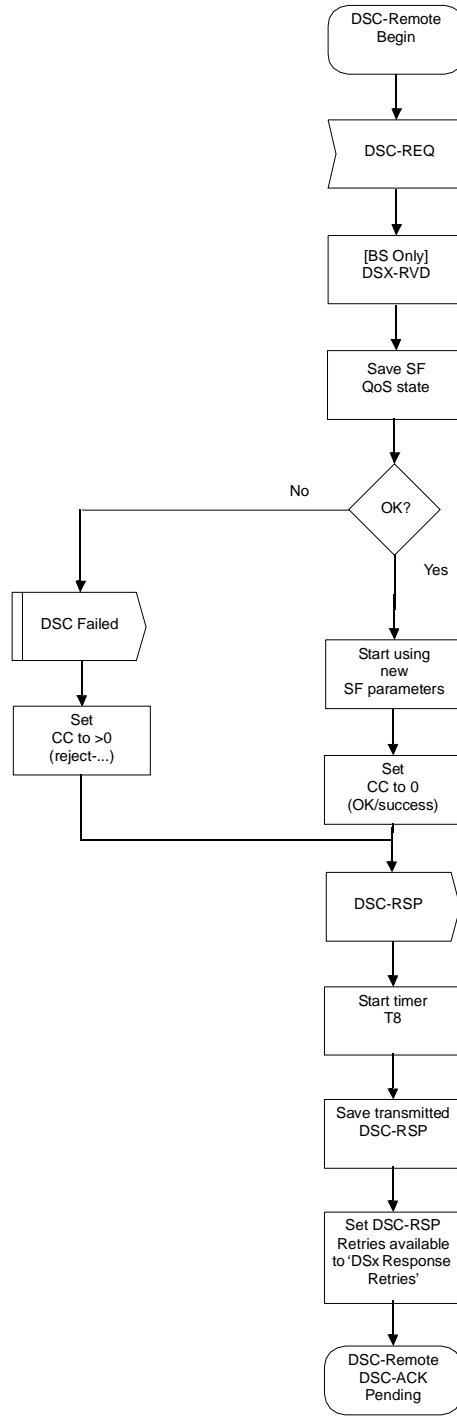

Figure 120—DSC—Remotely Initiated Transaction Begin state flow diagram

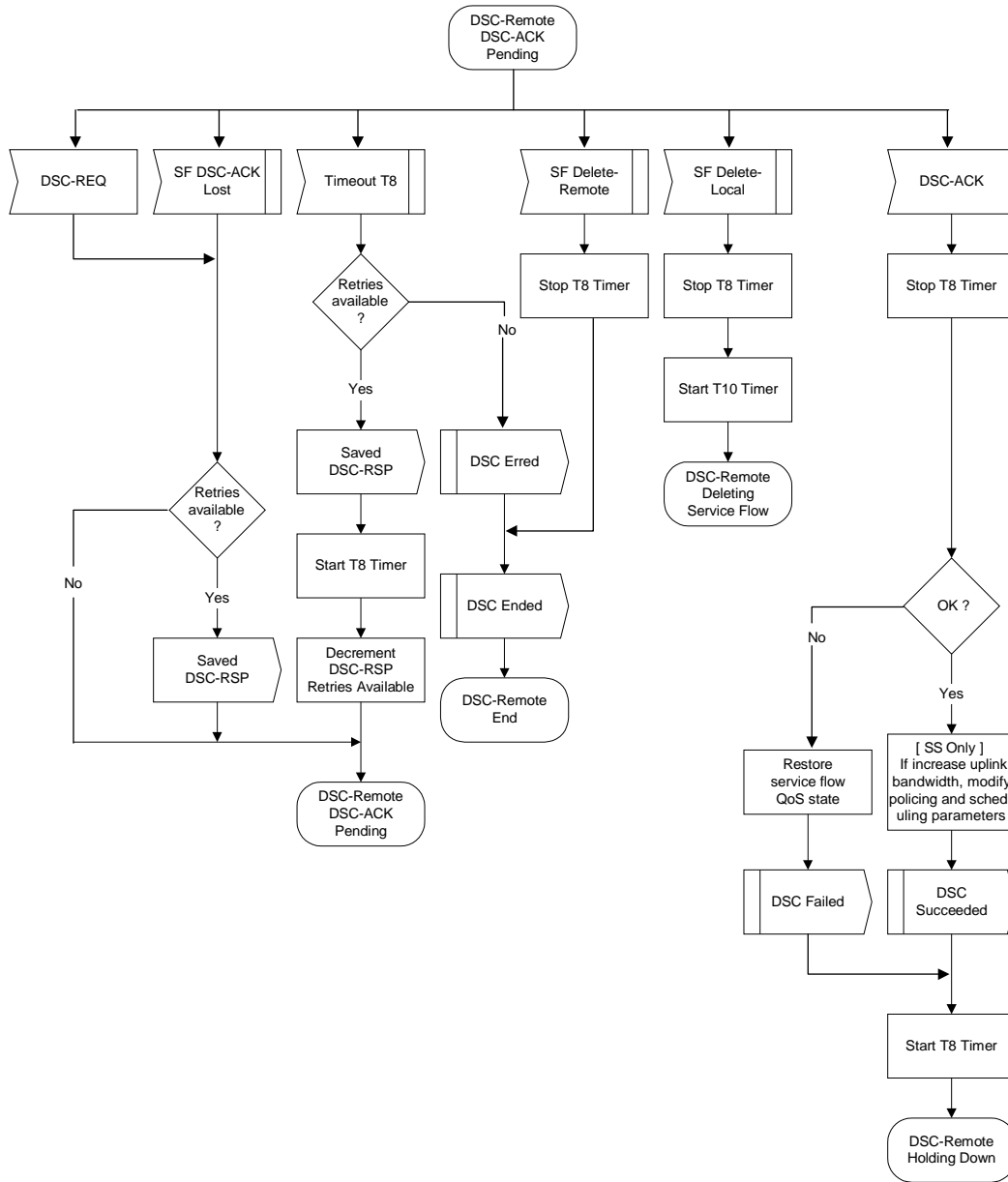

Figure 121—DSC—Remotely Initiated Transaction DSC-ACK Pending state flow diagram

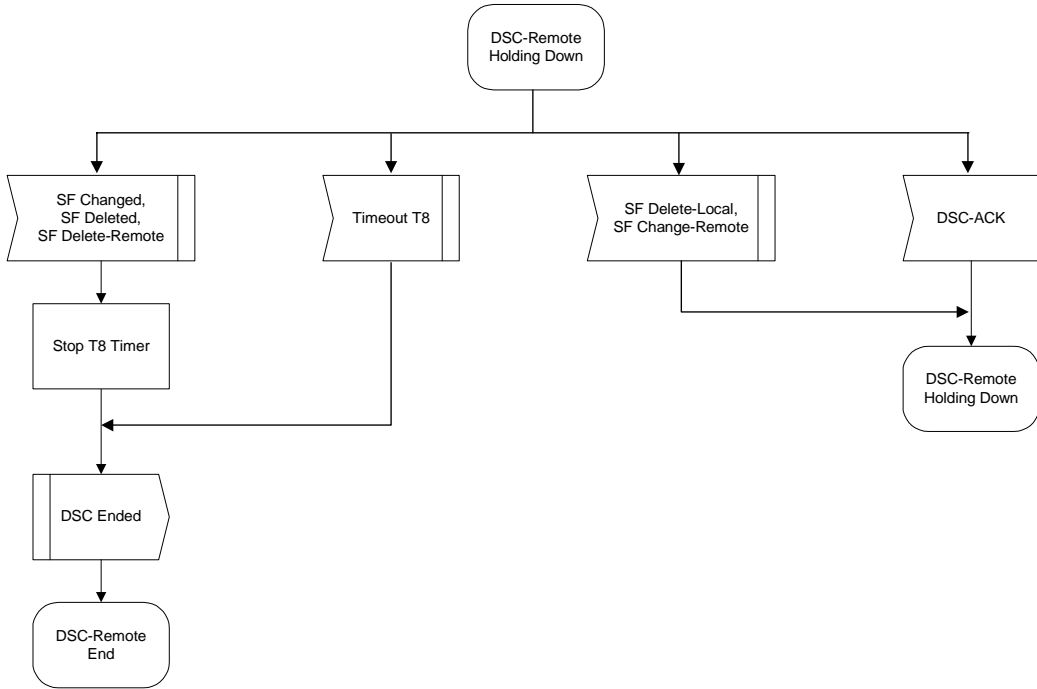

Figure 122—DSC—Remotely Initiated Transaction Holding Down state flow diagram

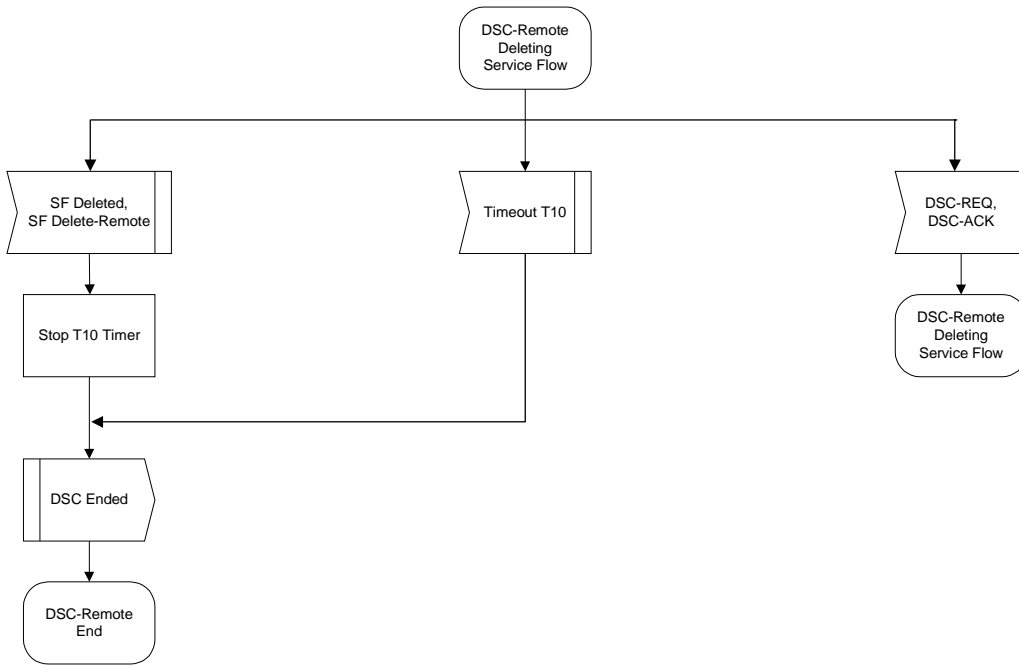

Figure 123—DSC—Remotely Initiated Transaction Deleting Service Flow state flow diagram

6.3.14.9.5 Connection release

Any service flow can be deleted with the DSD messages. When a service flow is deleted, all resources associated with it are released. If a service flow for a provisioned service is deleted, the ability to re-establish the service flow for that service is network management dependent. Therefore, care should be taken before deleting such service flows. However, the deletion of a provisioned service flow shall not cause an SS to reinitialize.

6.3.14.9.5.1 SS-initiated DSD

An SS wishing to delete a service flow generates a delete request to the BS using a DSD-REQ message. The BS removes the service flow and generates a response using a DSD-RSP message. This process is illustrated in Table 129. Only one service flow can be deleted per DSD-REQ.

Table 129—DSD-initiated from SS

SS		BS
Service flow no longer needed		
Delete service flow		
Send DSD-REQ	--DSD-REQ-->	Receive DSD-REQ
		Verify SS is service flow “owner”
		Delete service flow
Receive DSD-RSP	<--DSD-RSP---	Send DSD-RSP

6.3.14.9.5.2 BS-initiated DSD

A BS wishing to delete a dynamic service flow generates a delete request to the associated SS using a DSD-REQ. The SS removes the service flow and generates a response using a DSD-RSP. This process is illustrated in Table 130. Only one service flow can be deleted per DSD-REQ.

Table 130—DSD-initiated from BS

SS		BS
		Service flow no longer needed
		Delete service flow
		Determine associated SS for this service flow
Receive DSD-REQ	<---DSD-REQ--	Send DSD-REQ
Delete service flow		
Send DSD-RSP	--DSD-RSP-->	Receive DSD-RSP

6.3.14.9.5.3 DSD state transition diagrams

DSD state transition diagrams are shown in Figure 124–Figure 128.

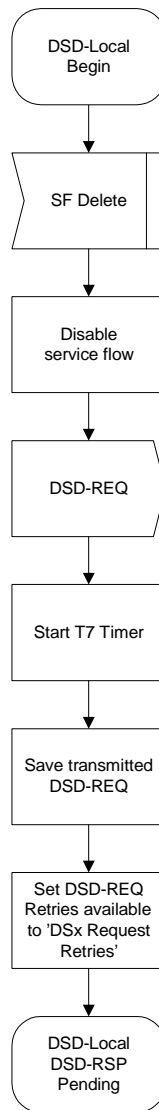

Figure 124—DSD—Locally Initiated Transaction Begin state flow diagram

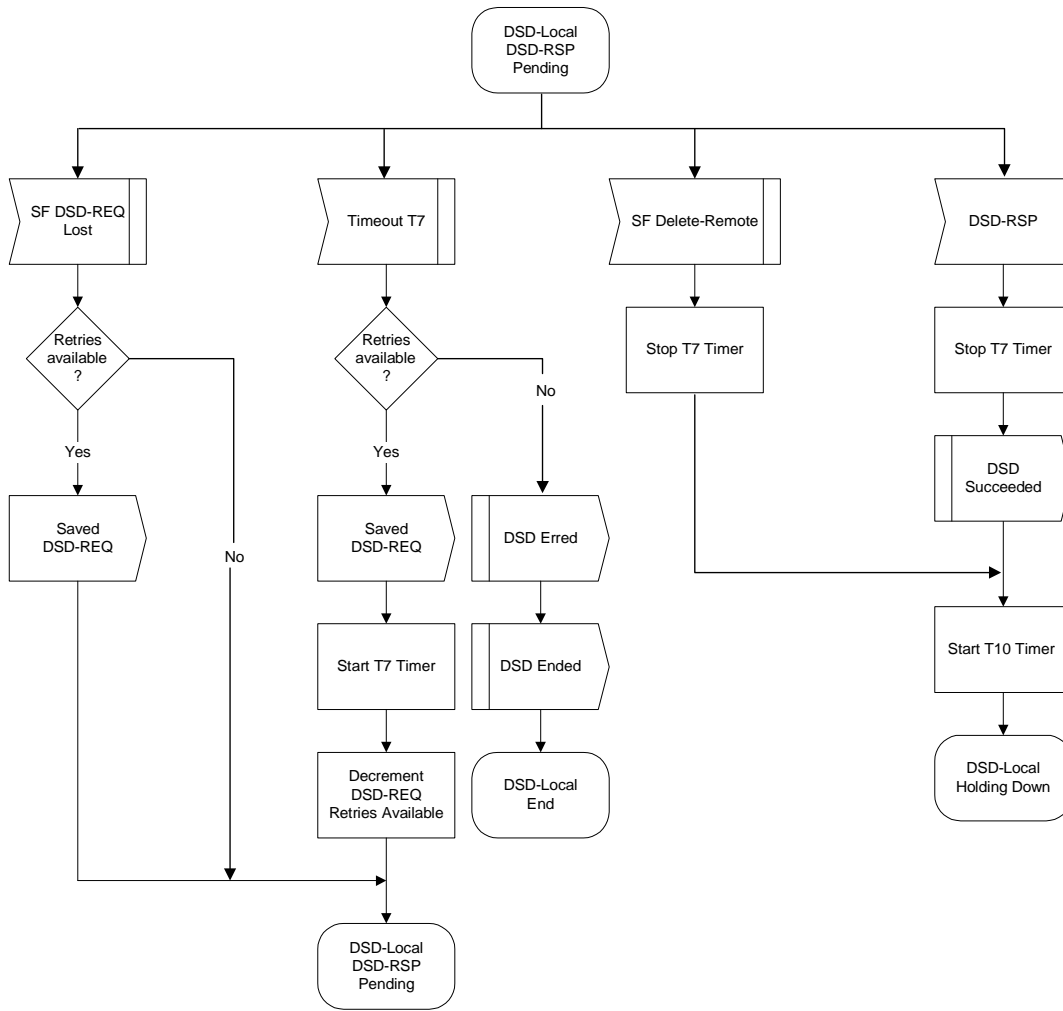

Figure 125—DSD—Locally Initiated Transaction DSD-RSP Pending state flow diagram

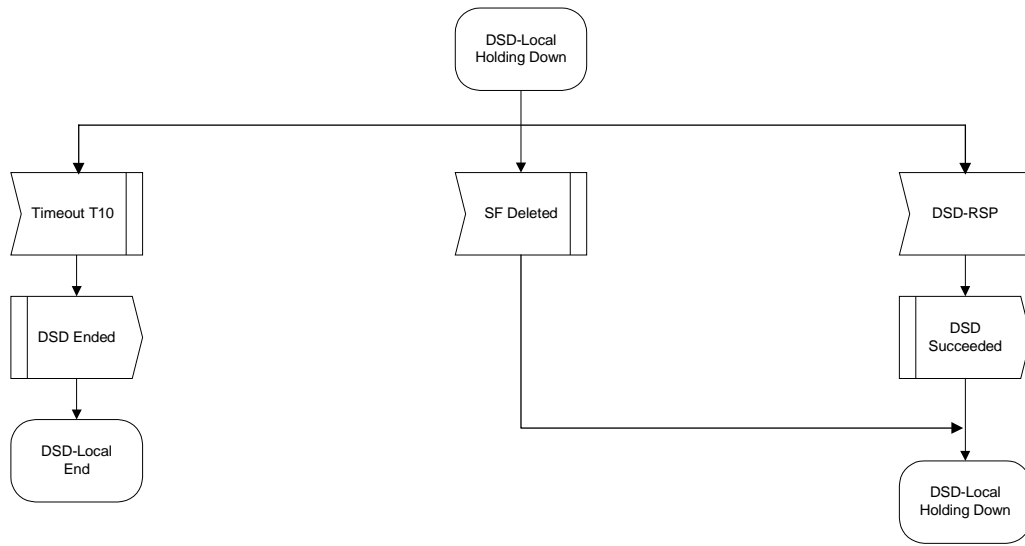

Figure 126—DSD—Locally Initiated Transaction Holding Down state flow diagram

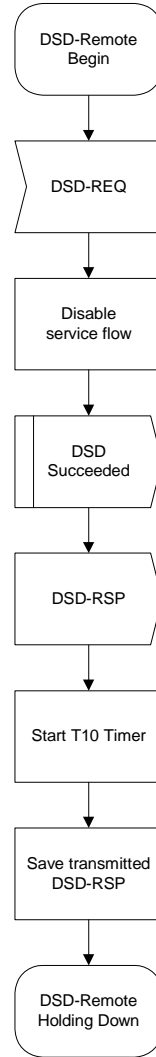

Figure 127—DSD—Remotely Initiated Transaction Begin state flow diagram

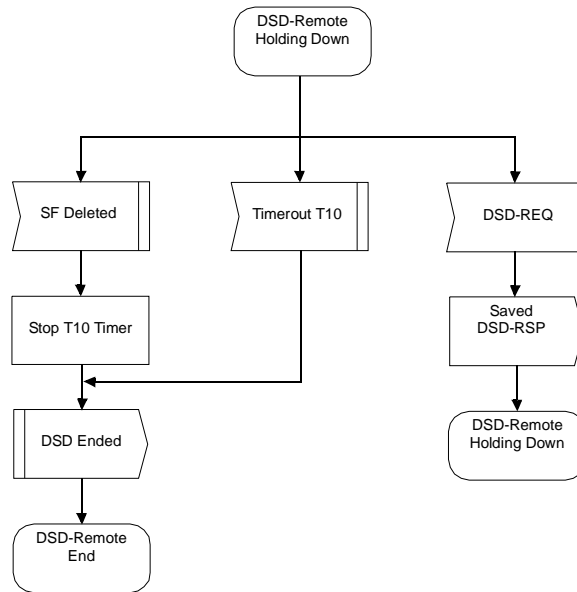

Figure 128—DSD—Remotely Initiated Transaction Holding Down state flow diagram

6.3.15 DFS for license-exempt operation

6.3.15.1 Introduction

DFS is mandatory for license-exempt operation. Systems should detect and avoid primary users. Further, the use of channel selection algorithms is required, which result in uniform channel spreading across a minimum number of channels. This specification is intended to be compliant with the regulatory requirements set forth in ERC/DEC/(99)23 [B10]. The timing parameters used for DFS are specified by each regulatory administration.

The DFS procedures provide for:

- Testing channels for primary users (6.3.15.2)
- Discontinuing operations after detecting primary users (6.3.15.3)
- Detecting primary users (6.3.15.4)
- Scheduling for channel testing (6.3.15.5).
- Requesting and reporting of measurements (6.3.15.6)
- Selecting and advertising a new channel (6.3.15.7)

6.3.15.2 Testing channels for primary users

A BS or SS shall not use a channel that it knows contains primary users or has not been tested recently for the presence of primary users. A BS shall test for the presence of primary users for at least the following:

- **Startup Test Period** before operating in a new channel if the channel has not been tested for primary users for at least **Startup Test Period** during the last **Startup Test Valid**.

- **Startup Test Period** before operating in a new channel if a channel was previously determined to contain primary users during the last **Startup Test Valid**.
- **Operating Test Period** (where the period is only accumulated during testing) of each **Operating Test Cycle** period while operating in a channel. Testing may occur in quiet periods or during normal operation.

An SS may start operating in a new channel without following the above start-up testing procedures if:

- The SS moves to the channel as a result of the receipt of a Channel Switch Announcement from the BS.
- The SS is initializing with a BS that is not currently advertising, using the Channel Switch Announcement that it is about to move to a new channel.

A BS may start operating in a new channel without following the above start-up testing procedures if it has learned from another BS by means outside the scope of this standard that it is usable.

6.3.15.3 Discontinuing operations after detecting primary users

If a BS or an SS is operating in a channel and detects primary users, which interference might be caused in the channel, it shall discontinue any transmission of the following:

- MAC PDUs carrying data within **Max Data Operations Period**.
- MAC PDUs carrying MAC Management messages within **Management Operations Period**.

6.3.15.4 Detecting primary users

Each BS and SS shall use a method to detect primary users operating in a channel that satisfies the regulatory requirements. The particular method used to perform the primary user detection is outside the scope of this specification.

6.3.15.5 Scheduling for channel testing

A BS may measure one or more channels itself and request any SS to measure one or more channels on its behalf, either in a quiet period or during normal operation.

To request the SSs to measure one channel, the BS shall include in the DL-MAP a Report Measurement IE as specified in 8.3.6.2.3. The BS that requests the SSs to perform a measurement shall not transmit MAC PDUs to any SS during the measurement interval. If the channel measured is the operational channel, the BS shall not schedule any uplink transmissions from SSs to take place during the measurement period.

Upon receiving a DL-MAP with the DFS Measurement IE, an SS shall start to measure the indicated channel no later than **Max. Channel Switch Time** after the start of the measurement period. An SS may stop the measurement no sooner than **Max. Channel Switch Time** before the expected start of the next frame or the next scheduled uplink transmission (of any SS). If the channel to be measured is the operating channel, **Max. Channel Switch Time** shall be equal to the value of RTG, as specified in Table 358. **Max. Channel Switch Time** shall not exceed 2 ms.

6.3.15.6 Requesting and reporting of measurements

The SS shall, for each measured channel, keep track of the following information:

- Frame Number of the frame during which the first measurement was made
- Accumulated time measured

- Existence of a Primary User on the channel
- Whether a WirelessHUMAN using the same PHY system was detected on the measured channel
- Whether unknown transmissions [such as radio local area network (RLAN) transmissions] were detected on the channel

The BS may request a measurement report by sending a REP-REQ message. This is typically done after the aggregated measurement time for one or more channels exceeds the regulatory required measurement time. Upon receiving a REP-REQ the SS shall reply with a REP-RSP message and reset its measurement counters for each channel on which it reported.

If the SS detects a primary user on the channel it is operating during a measurement interval or during normal operation it shall immediately cease to send any user data and send at the earliest possible opportunity an unsolicited REP-RSP. The BS shall provide transmission opportunities for sending an unsolicited REP-RSP frequently enough to meet regulatory requirements. The SS may also send, in an unsolicited fashion, a REP-RSP when non-primary user interference is detected above a threshold value.

6.3.15.7 Selecting and advertising a new channel

A BS may decide to stop operating in a channel at any time. The algorithm used to decide to stop operating in a channel is outside the scope of this standard, but shall satisfy any regulatory requirements.

A BS may use a variety of information, including information learned during SS initialization and information gathered from measurements undertaken by the BS and the SSs, to assist in the selection of the new channel. The algorithm to choose a new channel is not standardized but shall satisfy any regulatory requirements, including uniform spreading rules and channel testing rules. If a BS would like to move to a new channel, a channel supported by all SSs in the sector should be selected.

A BS shall inform its associated SSs of the new channel using the Channel Nr in the DCD message. The new channel shall be used starting from the frame with the number given by the Channel Switch Frame Number in the DCD message. The BS shall not schedule any transmissions during the last **Max. Channel Switch Time** before the channel change is to take place.

The uplink burst profiles used on the old channel defined shall be considered valid also for the new channel, i.e., the BS need not define new uplink Burst Profiles when changing channels. When operating in license-exempt bands, the BS shall not send the Frequency (Type=3) parameter as a part of UCD message.

6.3.16 MAC Management message tunneling in Mesh Mode

In Mesh networks during network entry, certain MAC message protocols take place between entities separated by multiple hops. In these cases, the Sponsor Node shall relay the MAC messages from the New Node acting as the SS to the peer performing the duties of the PMP BS. The sponsor shall also relay the messages from the BS entity to the New Node.

The Sponsor shall tunnel the MAC messages received from the New Node (SS), listed in Table 131 over UDP as shown in Figure 129, to the entity performing the BS part of the protocol. The sponsor shall also extract the MAC messages from the UDP packets arriving from the BS entity and transmit them over the air to the New Node.

Table 131—MAC Management messages tunneled over UDP during network entry

Message	Action of sponsor	Direction of message
PKM-REQ:Auth Request	Tunnel	SS to BS
PKM-REQ:Auth Info	Tunnel	SS to BS
PKM-RSP:Auth Reply	Extract	BS to SS
PKM-RSP:Auth Reject	Extract	BS to SS
REG-REQ	Tunnel	SS to BS
REG-RSP	Extract	BS to SS

**Figure 129—MAC over UDP/IP tunneling**

The format of the Tunnel subheader is defined in Table 132.

Table 132—Tunnel subheader Format

Syntax	Size	Notes
Tunnel_Subheader(){		
Type	1 byte	0 = <i>Reserved</i> 1 = WirelessMAN MAC header 2–255 = <i>Reserved</i>
}		

Also, MAC messages may need to be tunneled end-to-end in cases when the protocol takes place between peers separated by several hops. The packet format in Figure 129 shall be used in these cases with the Tunnel subheader format defined in Table 132.

6.3.17 MAC support for H-ARQ

Hybrid automatic repeat request (H-ARQ) scheme is an optional part of the MAC and can be enabled on a per-terminal basis. H-ARQ may be supported only for the OFDMA PHY. The per-terminal H-ARQ and associated parameters shall be specified and negotiated during initialization procedure. A burst cannot have a mixture of H-ARQ and non-H-ARQ traffic.

One or more MAC PDUs can be concatenated and an H-ARQ packet formed by adding a CRC to the PHY burst. Figure 130 shows how the H-ARQ encoder packet is constructed.

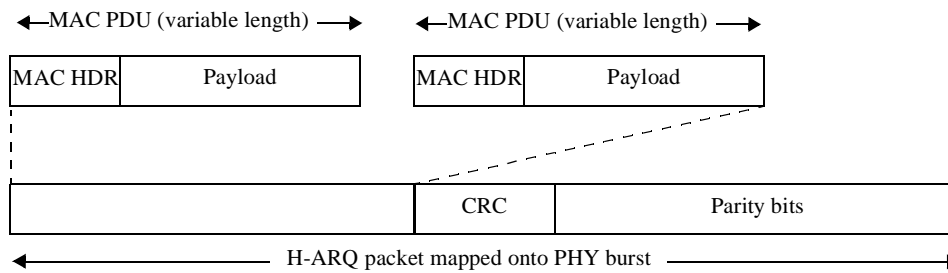

Figure 130—Construction of H-ARQ encoder packet

Each H-ARQ packet is encoded according to the PHY specification, and four subpackets are generated from the encoded result. A subpacket identifier (SPID) is used to distinguish the four subpackets. In case of down-link communication, a BS can send one of the subpackets in a burst transmission. Because of the redundancy among the subpackets, SS can correctly decode the original encoder packet even before it receives all four subpackets. Whenever receiving the first subpacket, the SS attempts to decode the original encoder packet from it. If it succeeds, the SS sends an ACK to the BS, so that the BS stops sending additional subpackets of the encoder packet. Otherwise, the SS sends a NAK, which causes the BS to transmit one subpacket selected from the four. These procedures go on until the SS successfully decodes the encoder packet. When the SS receives more than one subpacket, it tries to decode the encoder packet from ever-received subpackets.

The rule of subpacket transmission is as follows,

- 1) At the first transmission, BS shall send the subpacket labeled '00'.
- 2) BS may send one among subpackets labeled '00', '01', '10', or '11' in any order.
- 3) BS can send more than one copy of any subpacket, and can omit any subpacket except the subpacket labeled '00'.

In order to specify the start of a new transmission, one-bit H-ARQ identifier sequence number (AI_SN) is toggled on every successful transmission of an encoder packet on the same H-ARQ channel. If the AI_SN changes, the receiver treats the corresponding subpacket as a subpacket belongs to a new encoder packet, and discards ever-received subpackets with the same ARQ identifier.

The H-ARQ scheme is basically a stop-and-wait protocol. The ACK is sent by the SS after a fixed delay (synchronous ACK) defined by H-ARQ DL ACK delay offset, which is specified in DCD message. Timing of retransmission, however, is flexible and corresponds to the asynchronous part of the H-ARQ. The ACK/NAK is sent by the BS using the H-ARQ Bitmap IE, and sent by an SS using the fast feedback UL subchannel.

The H-ARQ scheme supports multiple H-ARQ channels per a connection, each of which may have an encoder packet transaction pending. The number of H-ARQ channels in use is determined by BS. These ARQ channels are distinguished by an H-ARQ channel identifier (ACID). The ACID for any subpackets can be uniquely identified by the control information carried in the MAPs.

H-ARQ can be used to mitigate the effect of channel and interference fluctuation. H-ARQ renders performance improvement due to SNR gain and time diversity achieved by combining previously erroneously decoded packet and retransmitted packet, and due to additional coding gain by Incremental Redundancy (IR).

6.3.17.1 Subpacket generation

H-ARQ operates at the FEC block level. The FEC encoder is responsible for generating the H-ARQ subpackets, as defined in the relevant PHY section. The subpackets are combined by the receiver FEC decoder as part of the decoding process.

6.3.17.2 DL/UL ACK/NAK signaling

For DL/UL H-ARQ, fast ACK/NAK signaling is necessary. For the fast ACK/NAK signaling of DL H-ARQ channel, a dedicated PHY layer ACK/NAK channel is designed in UL. For the fast ACK/NAK signaling of UL fast feedback, H-ARQ ACK message is designed.

6.3.17.3 H-ARQ parameter signaling

The parameters for each subpacket should be signaled independent of the subpacket burst itself. The parameters for each subpacket include

- SPID: The BS shall set this field to the subpacket identifier for the subpacket transmission.
- ACID: The BS shall set this field to the ARQ channel identifier for the subpacket transmission.
- AI_SN: This toggles between “0” and “1” on successfully transmitting each encoder packet with the same ARQ channel.

For the signaling of those parameters, H-ARQ Allocation IE is defined and the IE is to be placed in a DL-MAP or UL-MAP for a burst where H-ARQ is used.

6.3.17.4 CQICH Operations

This subclause describes the operation scenarios and requirements of CQICH, which is designed for H-ARQ enabled SS. After an SS turns on its power, the only appropriate subchannels that can be allocated to the MSS are normal subchannels. To determine the M/C level of normal subchannels, the average CINR measurement is enough for the BS to determine the M/C levels of uplink and downlink. As soon as the BS and the SS know the capabilities of both entities modulation and coding, the BS may allocate a CQICH subchannel using a CQICH Control IE. Then, the MSS reports the average CINR of the BS preamble. From then on, the BS is able to determine the M/C level. A CINR measurement is quantized into 32 levels and encoded into 5 information bits.

At any time, the BS may de-allocate the SS' CQICH by putting another CQICH Control IE with Duration $d = 0000$. Before the CQICH life timer (which is set at the receipt of the CQICH Control IE expires) sending another CQICH Control IE overwrites all the information related to the CQICH such as Allocation Index, Period, Frame offset, and Duration. Hence, unless the BS refreshes the timer, the SS should stop reporting as soon as the timer expires. However, in case of sending the MAP IE for re-allocation or deallocation, the BS should make sure if the previous CQICH is released before it is re-allocated to another SS.

The SS sends the REP-RSP message in an unsolicited fashion to BS to trigger Band AMC operation. The triggering conditions are given by TLV encodings in UCD messages. The REP-RSP (see 11.12 for the TLV encodings) includes the CINR measurements of five best bands. Only when an SS reports its BS the CINR measurements of Band AMC channels, its logical definition is made differently, as follows. If the number of bands is 48 (2048 FFT in 20 MHz), the two contiguous bands are paired and renumbered the same as a 24 band system. Then, if the LSB of an SS MAC address is 1, it only uses the odd-numbered bands. If not, it only uses the even-numbered bands. Hence, for example, the LSB of an SS MAC address is 1, (4m+2, 4m+3) bands are paired and the paired band is the m-th band of the SS. Similarly, for an even-numbered SS, (4m, 4m+1) bands are paired and the paired band is the m-th band of the SS.

The BS acknowledges the trigger by allocating Band AMC subchannels. From the next frame when the SS sent the REP-RSP, the SS starts reporting the differential of CINR five selected bands (increment: 1 and decrement: 0 with a step of 1 dB) on its CQICH. If the BS does not allocate the Band AMC subchannels within the specified delay (CQICH Band AMC Transition Delay) in the UCD message, the SS reports the updated average CINR of the preamble for normal subchannel allocations.

When the BS wants to trigger the transition to Band AMC mode or update the CINR reports, it sends the REP-REQ message (see 11.11 for the TLV encodings). When the SS receives the message, it replies with REP-RSP. When the BS receives the REP-RSP, it should synchronize the selection of bands reported and their CINR. Unless the BS allocates normal subchannels, the SS reports the differential increment compared to the most up-to-date report from the next CQI reporting frame.

7. Security sublayer

Security provides subscribers with privacy across the fixed broadband wireless network. It does this by encrypting connections between SS and BS.

In addition, security provides operators with strong protection from theft of service. The BS protects against unauthorized access to these data transport services by enforcing encryption of the associated service flows across the network. Privacy employs an authenticated client/server key management protocol in which the BS, the server, controls distribution of keying material to client SS. Additionally, the basic privacy mechanisms are strengthened by adding digital-certificate-based SS authentication to its key management protocol.

If during capabilities negotiation, the SS specifies that it does not support IEEE 802.16 security, step of authorization and key exchange shall be skipped. The BS, if provisioned so, shall consider the SS authenticated; otherwise, the SS shall not be serviced. Neither key exchange nor data encryption performed.

7.1 Architecture

Privacy has two component protocols as follows:

- a) An encapsulation protocol for encrypting packet data across the fixed BWA network. This protocol defines (1) a set of supported *cryptographic suites*, i.e., pairings of data encryption and authentication algorithms, and (2) the rules for applying those algorithms to a MAC PDU payload.
- b) A key management protocol (PKM) providing the secure distribution of keying data from BS to SS. Through this key management protocol, the SS and the BS synchronize keying data; in addition, the BS uses the protocol to enforce conditional access to network services.

7.1.1 Packet data encryption

Encryption services are defined as a set of capabilities within the MAC security sublayer. MAC Header information specific to encryption is allocated in the generic MAC header format.

Encryption is always applied to the MAC PDU payload; the generic MAC header is not encrypted. All MAC management messages described in 6.3.2.3 shall be sent in the clear to facilitate registration, ranging, and normal operation of the MAC.

The format of MAC PDUs carrying encrypted packet data payloads is specified in 6.3.3.6.

7.1.2 Key management protocol

An SS uses the PKM protocol to obtain authorization and traffic keying material from the BS, and to support periodic reauthorization and key refresh. The key management protocol uses X.509 digital certificates (IETF RFC 3280), the RSA public-key encryption algorithm [PKCS #1], and strong encryption algorithms to perform key exchanges between SS and BS.

The PKM protocol adheres to a client/server model, where the SS, a PKM “client,” requests keying material, and the BS, a PKM “server,” responds to those requests, ensuring that individual SS clients receive only keying material for which they are authorized. The PKM protocol uses MAC management messaging, i.e., PKM-REQ and PKM-RSP messages defined in 6.3.2.3.

The PKM protocol uses public-key cryptography to establish a shared secret (i.e., an AK) between the SS and the BS. The shared secret is then used to secure subsequent PKM exchanges of TEKs. This two-tiered

mechanism for key distribution permits refreshing of TEKs without incurring the overhead of computation-intensive public-key operations.

A BS authenticates a client SS during the initial authorization exchange. Each SS carries a unique X.509 digital certificate issued by the SS's manufacturer. The digital certificate contains the SS's Public Key and SS MAC address. When requesting an AK, an SS presents its digital certificate to the BS. The BS verifies the digital certificate, and then uses the verified Public Key to encrypt an AK, which the BS then sends back to the requesting SS.

The BS associates an SS's authenticated identity to a paying subscriber, and hence to the data services that subscriber is authorized to access. Thus, with the AK exchange, the BS establishes an authenticated identity of a client SS and the services (i.e., specific TEKs) the SS is authorized to access.

Since the BS authenticates the SS, it can protect against an attacker employing a *cloned* SS, masquerading as a legitimate subscriber's SS. The use of the X.509 certificates prevents cloned SSs from passing fake credentials onto a BS.

All SSs shall have factory-installed RSA private/public key pairs or provide an internal algorithm to generate such key pairs dynamically. If an SS relies on an internal algorithm to generate its RSA key pair, the SS shall generate the key pair prior to its first AK exchange, described in 7.2.1. All SSs with factory-installed RSA key pairs shall also have factory-installed X.509 certificates. All SSs that rely on internal algorithms to generate an RSA key pair shall support a mechanism for installing a manufacturer-issued X.509 certificate following key generation.

The PKM protocol is defined in detail in 7.2.

7.1.3 Security Associations

A Security Association (SA) is the set of security information a BS and one or more of its client SSs share in order to support secure communications across the IEEE Std 802.16 network. Three types of SAs are defined: *Primary*, *Static*, and *Dynamic*. Each manageable SS establishes a Primary Security association during the SS initialization process. Static SAs are provisioned within the BS. Dynamic SAs are established and eliminated, on the fly, in response to the initiation and termination of specific service flows. Both Static and Dynamic SAs can be shared by multiple SSs.

An SA's shared information shall include the Cryptographic Suite employed within the SA. The shared information may include TEKs and Initialization Vectors. The exact content of the SA is dependent on the SA's Cryptographic Suite.

SAs are identified using SAIDs.

Each manageable SS shall establish an exclusive Primary SA with its BS. The SAID of any SS's Primary SA shall be equal to the Basic CID of that SS.

Using the PKM protocol, an SS requests from its BS an SA's keying material. The BS shall ensure that each client SS only has access to the SAs it is authorized to access.

An SA's keying material [e.g., Data Encryption Standard (DES) key and CBC Initialization Vector] has a limited lifetime. When the BS delivers SA keying material to an SS, it also provides the SS with that material's remaining lifetime. It is the responsibility of the SS to request new keying material from the BS before the set of keying material that the SS currently holds expires at the BS. Should the current keying material expire before a new set of keying material is received, the SS shall perform network entry as described in 6.3.9. The PKM protocol specifies how SS and BS maintain key synchronization.

7.1.4 Mapping of connections to SAs

The following rules for mapping connections to SAs apply:

- 1) All Transport Connections shall be mapped to an existing SA.
- 2) Multicast Transport Connections may be mapped to any Static or Dynamic SA.
- 3) The Secondary Management Connection shall be mapped to the Primary SA.
- 4) The Basic and the Primary Management connections shall not be mapped to an SA.

The actual mapping is achieved by including the SAID of an existing SA in the DSA-xxx messages together with the CID. No explicit mapping of Secondary Management Connection to the Primary SA is required.

7.1.5 Cryptographic Suite

A Cryptographic Suite is the SA's set of methods for data encryption, data authentication, and TEK exchange. A Cryptographic Suite is specified as described in 11.9.14. The Cryptographic Suite shall be one of the ones listed in Table 378.

7.2 PKM protocol

7.2.1 SS authorization and AK exchange overview

SS authorization, controlled by the Authorization state machine, is the process of

- a) The BS authenticating a client SS's identity.
- b) The BS providing the authenticated SS with an AK, from which a key encryption key (KEK) and message authentication keys are derived.
- c) The BS providing the authenticated SS with the identities (i.e., the SAIDs) and properties of primary and static SAs the SS is authorized to obtain keying information for.

After achieving initial authorization, an SS periodically seeks reauthorization with the BS; reauthorization is also managed by the SS's Authorization state machine. An SS must maintain its authorization status with the BS in order to be able to refresh aging TEKs. TEK state machines manage the refreshing of TEKs.

An SS begins authorization by sending an Authentication Information message to its BS. The Authentication Information message contains the SS manufacturer's X.509 certificate, issued by the manufacturer itself or by an external authority. The Authentication Information message is strictly informative; i.e., the BS may choose to ignore it. However, it does provide a mechanism for a BS to learn the manufacturer certificates of its client SS.

The SS sends an Authorization Request message to its BS immediately after sending the Authentication Information message. This is a request for an AK, as well as for the SAIDs identifying any Static Security SAs the SS is authorized to participate in. The Authorization Request includes

- a) A manufacturer-issued X.509 certificate.
- b) A description of the cryptographic algorithms the requesting SS supports; an SS's cryptographic capabilities are presented to the BS as a list of cryptographic suite identifiers, each indicating a particular pairing of packet data encryption and packet data authentication algorithms the SS supports.
- c) The SS's Basic CID. The Basic CID is the first static CID the BS assigns to an SS during initial ranging—the primary SAID is equal to the Basic CID.

In response to an Authorization Request message, a BS validates the requesting SS's identity, determines the encryption algorithm and protocol support it shares with the SS, activates an AK for the SS, encrypts it with the SS's public key, and sends it back to the SS in an Authorization Reply message. The authorization reply includes:

- a) An AK encrypted with the SS's public key.
- b) A 4-bit key sequence number, used to distinguish between successive generations of AKs.
- c) A key lifetime.
- d) The identities (i.e., the SAIDs) and properties of the single primary and zero or more static SAs the SS is authorized to obtain keying information for.

While the Authorization Reply shall identify Static SAs in addition to the Primary SA whose SAID matches the requesting SS's Basic CID, the Authorization Reply shall not identify any Dynamic SAs.

The BS, in responding to an SS's Authorization Request, shall determine whether the requesting SS, whose identity can be verified via the X.509 digital certificate, is authorized for basic unicast services, and what additional statically provisioned services (i.e., Static SAIDs) the SS's user has subscribed for. Note that the protected services a BS makes available to a client SS can depend upon the particular cryptographic suites the SS and the BS share support for.

An SS shall periodically refresh its AK by reissuing an Authorization Request to the BS. Reauthorization is identical to authorization with the exception that the SS does not send Authentication Information messages during reauthorization cycles. The description of the authorization state machine in 7.2.4 clearly indicates when Authentication Information messages are sent.

To avoid service interruptions during reauthorization, successive generations of the SS's AKs have overlapping lifetimes. Both SS and BS shall be able to support up to two simultaneously active AKs during these transition periods. The operation of the Authorization state machine's Authorization Request scheduling algorithm, combined with the BS's regimen for updating and using a client SS's AKs (see 7.4), ensures that the SS can refresh TEK keying information without interruption over the course of the SS's reauthorization periods.

7.2.2 TEK exchange overview

7.2.2.1 TEK exchange overview for PMP topology

Upon achieving authorization, an SS starts a separate TEK state machine for each of the SAIDs identified in the Authorization Reply message. Each TEK state machine operating within the SS is responsible for managing the keying material associated with its respective SAID. TEK state machines periodically send Key Request messages to the BS, requesting a refresh of keying material for their respective SAIDs.

The BS responds to a Key Request with a Key Reply message, containing the BS's active keying material for a specific SAID.

The TEK is encrypted using appropriate KEK derived from the AK.

Note that at all times the BS maintains two active sets of keying material per SAID. The lifetimes of the two generations overlap such that each generation becomes active halfway through the life of its predecessor and expires halfway through the life of its successor. A BS includes in its Key Replies *both* of an SAID's active generations of keying material.

The Key Reply provides the requesting SS, in addition to the TEK and CBC initialization vector, the remaining lifetime of each of the two sets of keying material. The receiving SS uses these remaining lifetimes to estimate when the BS will invalidate a particular TEK, and therefore when to schedule future

Key Requests such that the SS requests and receives new keying material before the BS expires the keying material the SS currently holds.

The operation of the TEK state machine's Key Request scheduling algorithm, combined with the BS's regimen for updating and using an SAID's keying material (see 7.4), ensures that the SS will be able to continually exchange encrypted traffic with the BS.

A TEK state machine remains active as long as

- a) The SS is authorized to operate in the BS's security domain, i.e., it has a valid AK, and
- b) The SS is authorized to participate in that particular SA, i.e., the BS continues to provide fresh keying material during rekey cycles.

The parent Authorization state machine stops *all* of its child TEK state machines when the SS receives from the BS an Authorization Reject during a reauthorization cycle. Individual TEK state machines can be started or stopped during a reauthorization cycle if an SS's Static SAID authorizations changed between successive re-authorizations.

Communication between Authorization and TEK state machines occurs through the passing of events and protocol messaging. The Authorization state machine generates events (i.e., Stop, Authorized, Authorization Pending, and Authorization Complete events) that are targeted at its child TEK state machines. TEK state machines do not target events at their parent Authorization state machine. The TEK state machine affects the Authorization state machine indirectly through the messaging a BS sends in response to an SS's requests: a BS may respond to a TEK machine's Key Requests with a failure response (i.e., Authorization Invalid message) to be handled by the Authorization state machine.

7.2.2.2 TEK exchange overview for Mesh Mode

Upon achieving authorization, a Node starts for each Neighbor a separate TEK state machine for each of the SAIDs identified in the Authorization Reply message. Each TEK state machine operating within the Node is responsible for managing the keying material associated with its respective SAID. The Node is responsible for maintaining the TEKs between itself and all nodes it initiates TEK exchange with. Its TEK state machines periodically send Key Request messages to the Neighbors of the node, requesting a refresh of keying material for their respective SAIDs.

The Neighbor replies to a Key Request with a Key Reply message, containing the BS's active keying material for a specific SAID.

The TEK in the Key Reply is encrypted, using the node's public key found in the SS-Certificate attribute.

Note that at all times the node maintains two active sets of keying material per SAID per neighbor. The lifetimes of the two generations overlap such that each generation becomes active halfway through the life of its predecessor and expires halfway through the life of its successor. A neighbor includes in its Key Replies *both* of an SAID's active generations of keying material.

The Key Reply provides the requesting Node, in addition to the TEK, the remaining lifetime of each of the two sets of keying material. The receiving Node uses these remaining lifetimes to estimate when the Neighbor invalidates a particular TEK, and therefore when to schedule future Key Requests. The transmit regime between the initiating Node and the Neighbor provides for seamless key transition.

7.2.3 Security capabilities selection

As part of their authorization exchange, the SS provides the BS with a list of all the cryptographic suites (pairing of data encryption and data authentication algorithms) the SS supports. The BS selects from this list

a single cryptographic suite to employ with the requesting SS's primary SA. The Authorization Reply the BS sends back to the SS includes a primary SA-Descriptor that, among other things, identifies the cryptographic suite the BS selected to use for the SS's primary SA. A BS shall reject the authorization request if it determines that none of the offered cryptographic suites are satisfactory.

The Authorization Reply also contains an optional list of static SA-Descriptors; each static SA-Descriptor identifies the cryptographic suite employed within the SA. The selection of a static SA's cryptographic suite is typically made independent of the requesting SS's cryptographic capabilities. A BS may include in its Authorization Reply static SA-Descriptors identifying cryptographic suites the requesting SS does not support; if this is the case, the SS shall not start TEK state machines for static SAs whose cryptographic suites the SS does not support.

7.2.4 Authorization state machine

The Authorization state machine consists of six states and eight distinct events (including receipt of messages) that can trigger state transitions. The Authorization finite state machine (FSM) is presented below in a graphical format, as a state flow model (Figure 131), and in a tabular format, as a state transition matrix (Table 133).

The state flow diagram depicts the protocol messages transmitted and internal events generated for each of the model's state transitions; however, the diagram does not indicate additional internal actions, such as the clearing or starting of timers, that accompany the specific state transitions. Accompanying the state transition matrix is a detailed description of the specific actions accompanying each state transition; the state transition matrix shall be used as the definitive specification of protocol actions associated with each state transition.

The following legend applies to the Authorization State Machine flow diagram depicted in Figure 131.

- a) Ovals are states.
- b) Events are in *italics*.
- c) Messages are in normal font.
- d) State transitions (i.e., the lines between states) are labeled with <what causes the transition>/<messages and events triggered by the transition>. So "*timeout*/Auth Request" means that the state received a "timeout" event and sent an Authorization Request ("Auth Request") message. If there are multiple events or messages before the slash "/" separated by a comma, *any* of them can cause the transition. If there are multiple events or messages listed after the slash, *all* of the specified actions shall accompany the transition.

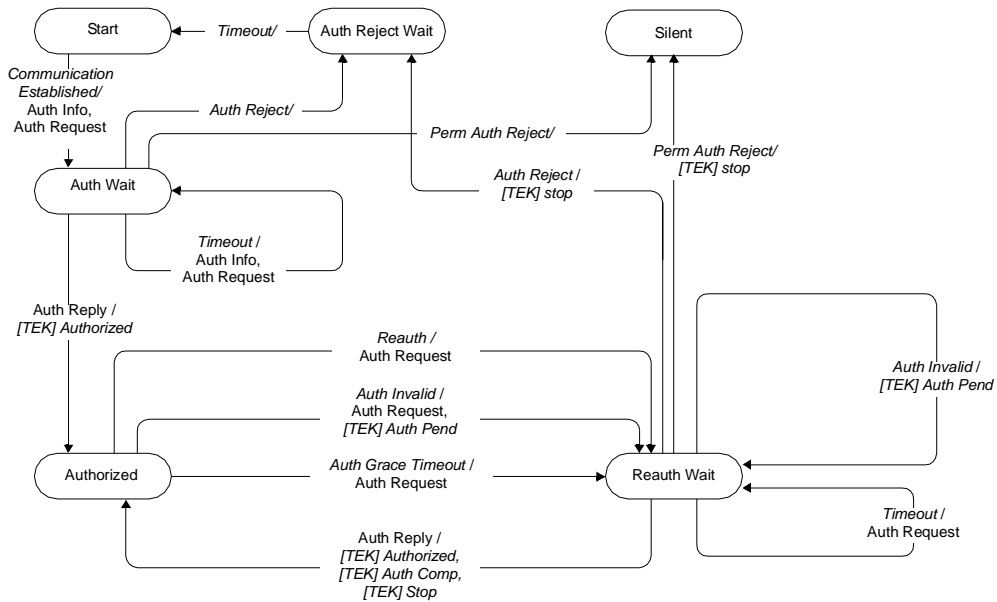

Figure 131—Authorization state machine flow diagram

Table 133—Authorization FSM state transition matrix

State Event or Rcvd Message	(A) Start	(B) Auth Wait	(C) Authorized	(D) Reauth Wait	(E) Auth Reject Wait	(F) Silent
(1) Communication Established	Auth Wait					
(2) Auth Reject		Auth Reject Wait		Auth Reject Wait		
(3) Perm Auth Reject		Silent		Silent		
(4) Auth Reply		Authorized		Authorized		
(5) Timeout		Auth Wait		Reauth Wait	Start	
(6) Auth Grace Timeout			Reauth Wait			
(7) Auth Invalid			Reauth Wait	Reauth Wait		
(8) Reauth			Reauth Wait			

The Authorization state transition matrix presented in Table 133 lists the six Authorization machine states in the topmost row and the eight Authorization machine events (includes message receipts) in the leftmost column. Any cell within the matrix represents a specific combination of state and event, with the next state (the state transitioned to) displayed within the cell. For example, cell 4-B represents the receipt of an Authorization Reply (Auth Reply) message when in the Authorize Wait (Auth Wait) state. Within cell 4-B is the name of the next state, “Authorized.” Thus, when an SS’s Authorization state machine is in the Auth Wait state and an Auth Reply message is received, the Authorization state machine will transition to the Authorized state. In conjunction with this state transition, several protocol actions shall be taken; these are described in the listing of protocol actions, under the heading 4-B, in 7.2.4.5.

A shaded cell within the state transition matrix implies that either the specific event cannot or should not occur within that state, and if the event does occur, the state machine shall ignore it. For example, if an Auth Reply message arrives when in the Authorized state, that message should be ignored (cell 4-C). The SS may, however, in response to an improper event, log its occurrence, generate an SNMP event, or take some other vendor-defined action. These actions, however, are not specified within the context of the Authorization state machine, which simply ignores improper events.

7.2.4.1 States

- a) *Start*: This is the initial state of the FSM. No resources are assigned to or used by the FSM in this state—e.g., all timers are off, and no processing is scheduled.
- b) *Authorize Wait (Auth Wait)*: The SS has received the “Communication Established” event indicating that it has completed basic capabilities negotiation with the BS. In response to receiving the event, the SS has sent both an Authentication Information and an Auth Request message to the BS and is waiting for the reply.
- c) *Authorized*: The SS has received an Auth Reply message that contains a list of valid SAIDs for this SS. At this point, the SS has a valid AK and SAID list. Transition into this state triggers the creation of one TEK FSM for each of the SS’s privacy-enabled SAIDs.
- d) *Reauthorize Wait (Reauth Wait)*: The SS has an outstanding reauthorization request. The SS was either about to expire (see Authorization Grace Time in Table 343) its current authorization or received an indication (an Authorization Invalid message from the BS) that its authorization is no longer valid. The SS sent an Auth Request message to the BS and is waiting for a response.
- e) *Authorize Reject Wait (Auth Reject Wait)*: The SS received an Authorization Reject (Auth Reject) message in response to its last Auth Request. The Auth Reject’s error code indicated the error was not of a permanent nature. In response to receiving this reject message, the SS set a timer and transitioned to the Auth Reject Wait state. The SS remains in this state until the timer expires.
- f) *Silent*: The SS received an Auth Reject message in response to its last Auth Request. The Auth Reject’s error code indicated the error was of a permanent nature. This triggers a transition to the Silent state, where the SS is not permitted to pass subscriber traffic. The SS shall, however, respond to management messages from the BS issuing the Perm Auth Reject.

7.2.4.2 Messages

Note that the message formats are defined in detail in 6.3.2.3.9.

Authorization Request (Auth Request): Request an AK and list of authorized SAIDs. Sent from SS to BS.

Authorization Reply (Auth Reply): Receive an AK and list of authorized, static SAIDs. Sent from BS to SS. The AK is encrypted with the SS’s public key.

Authorization Reject (Auth Reject): Attempt to authorize was rejected. Sent from the BS to the SS.

Authorization Invalid (Auth Invalid): The BS may send an Authorization Invalid message to a client SS as follows:

- a) An unsolicited indication, or
- b) A response to a message received from that SS.

In either case, the Auth Invalid message instructs the receiving SS to re-authorize with its BS.

The BS responds to a Key Request with an Auth Invalid message if (1) the BS does not recognize the SS as being authorized (i.e., no valid AK associated with SS) or (2) verification of the Key Request's keyed message digest (in HMAC-Digest attribute) failed. Note that the Authorization Invalid *event*, referenced in both the state flow diagram and the state transition matrix, signifies either the receipt of an Auth Invalid message or an internally generated event.

Authentication Information (Auth Info): The Auth Info message contains the SS manufacturer's X.509 Certificate, issued by an external authority. The Auth Info message is strictly an informative message the SS sends to the BS; with it, a BS may dynamically learn the manufacturer certificate of client SS. Alternatively, a BS may require out-of-band configuration of its list of manufacturer certificates.

7.2.4.3 Events

Communication Established: The Authorization state machine generates this event upon entering the Start state if the MAC has completed basic capabilities negotiation. If the basic capabilities negotiation is not complete, the SS sends a Communication Established event to the Authorization FSM upon completing basic capabilities negotiation. The Communication Established event triggers the SS to begin the process of getting its AK and TEKs.

Timeout: A retransmission or wait timer timed out. Generally a request is resent.

Authorization Grace Timeout (Auth Grace Timeout): The Authorization Grace timer timed out. This timer fires a configurable amount of time (the Authorization Grace Time) before the current authorization is supposed to expire, signalling the SS to reauthorize before its authorization actually expires. The Authorization Grace Time takes the default value from Table 343 or may be specified in a configuration setting within the Auth Reply message.

Reauthorize (Reauth): SS's set of authorized static SAIDs may have changed. This event is generated in response to an SNMP set and meant to trigger a reauthorization cycle.

Authorization Invalid (Auth Invalid): This event is internally generated by the SS when there is a failure authenticating a Key Reply or Key Reject message, or externally generated by the receipt of an Auth Invalid message, sent from the BS to the SS. A BS responds to a Key Request with an Auth Invalid if verification of the request's message authentication code fails. Both cases indicate BS and SS have lost AK synchronization.

A BS may also send to an SS an unsolicited Auth Invalid message, forcing an Auth Invalid event.

Permanent Authorization Reject (Perm Auth Reject): The SS receives an Auth Reject in response to an Auth Request. The error code in the Auth Reject indicates the error is of a permanent nature. What is interpreted as a permanent error is subject to administrative control within the BS. Auth Request processing errors that can be interpreted as permanent error conditions include the following:

- a) Unknown manufacturer (do not have CA certificate of the issuer of the SS Certificate).
- b) Invalid signature on SS certificate.

- c) ASN.1 parsing failure.
- d) Inconsistencies between data in the certificate and data in accompanying PKM data attributes.
- e) Incompatible security capabilities.

When an SS receives an Auth Reject indicating a permanent failure condition, the Authorization State machine moves into a Silent state, where the SS is not permitted to pass subscriber traffic. The SS shall, however, respond to management messages from the BS issuing the Perm Auth Reject. The SS shall also issue an SNMP Trap upon entering the Silent state.

Authorization Reject (Auth Reject): The SS receives an Auth Reject in response to an Auth Request. The error code in the Auth Reject does not indicate the failure was due to a permanent error condition. As a result, the SS's Authorization state machine shall set a wait timer and transition into the Auth Reject Wait State. The SS shall remain in this state until the timer expires, at which time it shall reattempt authorization.

NOTE—The following events are sent by an Authorization state machine to the TEK state machine:

[TEK] Stop: Sent by the Authorization FSM to an active (non-START state) TEK FSM to terminate the FSM and remove the corresponding SAID's keying material from the SS's key table.

[TEK] Authorized: Sent by the Authorization FSM to a nonactive (START state), but valid TEK FSM.

[TEK] Authorization Pending (Auth Pend): Sent by the Authorization FSM to a specific TEK FSM to place that TEK FSM in a wait state until the Authorization FSM can complete its reauthorization operation.

[TEK] Authorization Complete (Auth Comp): Sent by the Authorization FSM to a TEK FSM in the Operational Reauthorize Wait (Op Reauth Wait) or Rekey Reauthorize Wait (Rekey Reauth Wait) states to clear the wait state begun by a TEK FSM Authorization Pending event.

7.2.4.4 Parameters

All configuration parameter values take the default values from Table 343 or may be specified in the Auth Reply message.

Authorize Wait Timeout (Auth Wait Timeout): Timeout period between sending Authorization Request messages from Auth Wait state (see 11.9.19.2).

Authorization Grace Timeout (Auth Grace Timeout): Amount of time before authorization is scheduled to expire that the SS starts reauthorization (see 11.9.19.3).

Authorize Reject Wait Timeout (Auth Reject Wait Timeout): Amount of time an SS's Authorization FSM remains in the Auth Reject Wait state before transitioning to the Start state (see 11.9.19.7).

7.2.4.5 Actions

Actions taken in association with state transitions are listed by <event> (<rcvd message>) --> <state> below:

- 1-A Start (*Communication Established*) → Auth Wait
 - a) Send Auth Info message to BS
 - b) Send Auth Request message to BS
 - c) Set Auth Request retry timer to Auth Wait Timeout

- 2-B Auth Wait (*Auth Reject*) → Auth Reject Wait
- Clear Auth Request retry timer
 - Set a wait timer to Auth Reject Wait Timeout
- 2-D Reauth Wait (*Auth Reject*) → Auth Reject Wait
- Clear Auth Request retry timer
 - Generate TEK FSM Stop events for all active TEK state machines
 - Set a wait timer to Auth Reject Wait Timeout
- 3-B Auth Wait (*Perm Auth Reject*) → Silent
- Clear Auth Request retry timer
 - Disable all forwarding of SS traffic
- 3-D Reauth Wait (*Perm Auth Reject*) → Silent
- Clear Auth Request retry timer
 - Generate TEK FSM Stop events for all active TEK state machines
 - Disable all forwarding of SS traffic
- 4-B Auth Wait (Auth Reply) → Authorized
- Clear Auth Request retry timer
 - Decrypt and record AK delivered with Auth Reply
 - Start TEK FSMs for all SAIDs listed in Authorization Reply (provided the SS supports the cryptographic suite that is associated with an SAID) and issue a TEK FSM Authorized event for each of the new TEK FSMs
 - Set the Authorization Grace timer to go off “Authorization Grace Time” seconds prior to the supplied AK’s scheduled expiration
- 4-D Reauth Wait (Auth Reply) → Authorized
- Clear Auth Request retry timer
 - Decrypt and record AK delivered with Auth Reply
 - Start TEK FSMs for any newly authorized SAIDs listed in Auth Reply (provided the SS supports the cryptographic suite that is associated with the new SAID) and issue TEK FSM Authorized event for each of the new TEK FSMs
 - Generate TEK FSM Authorization Complete events for any currently active TEK FSMs whose corresponding SAIDs were listed in Auth Reply
 - Generate TEK FSM Stop events for any currently active TEK FSMs whose corresponding SAIDs were not listed in Auth Reply
 - Set the Authorization Grace timer to go off “Authorization Grace Time” seconds prior to the supplied AK’s scheduled expiration

- 5-B Auth Wait (*Timeout*) → Auth Wait
- Send Auth Info message to BS
 - Send Auth Request message to BS
 - Set Auth Request retry timer to Auth Wait Timeout
- 5-D Reauth Wait (*Timeout*) → Reauth Wait
- Send Auth Request message to BS
 - Set Auth Request retry timer to Reauth Wait Timeout
- 5-E Auth Reject Wait (*Timeout*) → Start
- No protocol actions associated with state transition
- 6-C Authorized (*Auth Grace Timeout*) → Reauth Wait
- Send Auth Request message to BS
 - Set Auth Request retry timer to Reauth Wait Timeout
- 7-C Authorized (*Auth Invalid*) → Reauth Wait
- Clear Authorization Grace timer
 - Send Auth Request message to BS
 - Set Auth Request retry timer to Reauth Wait Timeout
 - If the Auth Invalid event is associated with a particular TEK FSM, generate a TEK FSM Authorization Pending event for the TEK state machine responsible for the Auth Invalid event (i.e., the TEK FSM that either generated the event, or sent the Key Request message the BS responded to with an Auth Invalid message)
- 7-D Reauth Wait (*Auth Invalid*) → Reauth Wait
- If the Auth Invalid event is associated with a particular TEK FSM, generate a TEK FSM Authorization Pending event for the TEK state machine responsible for the Auth Invalid event (i.e., the TEK FSM that either generated the event, or sent the Key Request message the BS responded to with an Auth Invalid message)
- 8-C Authorized (*Reauth*) → Reauth Wait
- Clear Authorization Grace timer
 - Send Auth Request message to BS
 - Set Auth Request retry timer to Reauth Wait Timeout

7.2.5 TEK state machine

The TEK state machine consists of six states and nine events (including receipt of messages) that can trigger state transitions. Like the Authorization state machine, the TEK state machine is presented in both a state flow diagram (Figure 132) and a state transition matrix (Table 134). As was the case for the Authorization state machine, the state transition matrix shall be used as the definitive specification of protocol actions associated with each state transition.

Shaded states in Figure 132 (Operational, Rekey Wait, and Rekey Reauthorize Wait) have valid keying material and encrypted traffic can be passed.

The Authorization state machine starts an independent TEK state machine for each of its authorized SAIDs.

As mentioned in 7.2.2, the BS maintains two active TEKs per SAID. The BS includes in its Key Replies both of these TEKs, along with their remaining lifetimes. The BS encrypts downlink traffic with the older of its two TEKs and decrypts uplink traffic with either the older or newer TEK, depending upon which of the two keys the SS was using at the time. The SS encrypts uplink traffic with the newer of its two TEKs and decrypts downlink traffic with either the older or newer TEK, depending upon which of the two keys the BS was using at the time. See 7.4 for details on SS and BS key usage requirements.

Through operation of a TEK state machine, the SS attempts to keep its copies of an SAID’s TEKs synchronized with those of its BS. A TEK state machine issues Key Requests to refresh copies of its SAID’s keying material soon after the scheduled expiration time of the older of its two TEKs and before the expiration of its newer TEK. To accommodate for SS/BS clock skew and other system processing and transmission delays, the SS schedules its Key Requests a configurable number of seconds before the newer TEK’s estimated expiration in the BS. With the receipt of the Key Reply, the SS shall always update its records with the TEK Parameters from both TEKs contained in the Key Reply message. Figure 132 illustrates the SS’s scheduling of its key refreshes in conjunction with its management of an SA’s active TEKs.

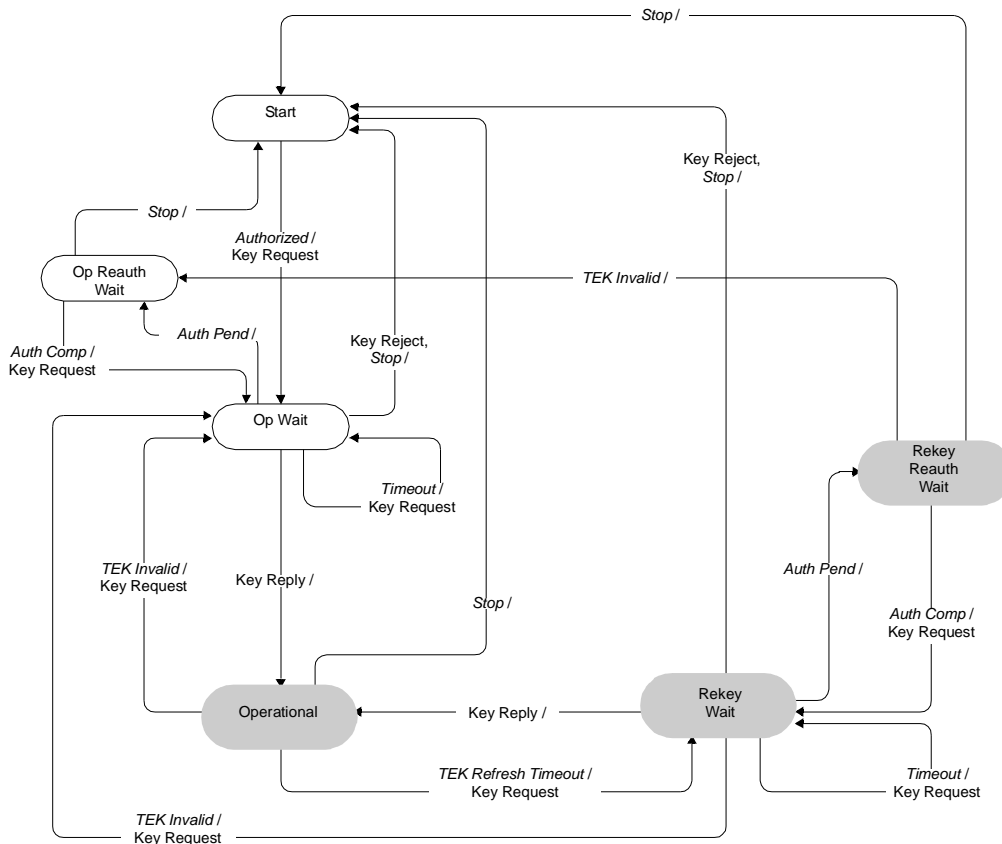

Figure 132—TEK state machine flow diagram

Table 134—TEK FSM state transition matrix

<i>State Event or Rcvd Message</i>	(A) Start	(B) Op Wait	(C) Op Reauth Wait	(D) Op	(E) Rekey Wait	(F) Rekey Reauth Wait
(1) <i>Stop</i>		Start	Start	Start	Start	Start
(2) <i>Authorized</i>	Op Wait					
(3) <i>Auth Pend</i>		Op Reauth Wait			Rekey Reauth Wait	
(4) <i>Auth Comp</i>			Op Wait			Rekey Wait
(5) <i>TEK Invalid</i>				Op Wait	Op Wait	Op Reauth Wait
(6) <i>Timeout</i>		Op Wait			Rekey Wait	
(7) <i>TEK Refresh Timeout</i>				Rekey Wait		
(8) <i>Key Reply</i>		Operational			Operational	
(9) <i>Key Reject</i>		Start			Start	

7.2.5.1 States

Start: This is the initial state of the FSM. No resources are assigned to or used by the FSM in this state—e.g., all timers are off, and no processing is scheduled.

Operational Wait (Op Wait): The TEK state machine has sent its initial request (Key Request) for its SAID's keying material (TEK and CBC initialization vector), and is waiting for a reply from the BS.

Operational Reauthorize Wait (Op Reauth Wait): The wait state the TEK state machine is placed in if it does not have valid keying material while the Authorization state machine is in the middle of a reauthorization cycle.

Operational: The SS has valid keying material for the associated SAID.

Rekey Wait: The TEK Refresh Timer has expired and the SS has requested a key update for this SAID. Note that the newer of its two TEKs has not expired and can still be used for both encrypting and decrypting data traffic.

Rekey Reauthorize Wait (Rekey Reauth Wait): The wait state the TEK state machine is placed in if the TEK state machine has valid traffic keying material, has an outstanding request for the latest keying material, and the Authorization state machine initiates a reauthorization cycle.

7.2.5.2 Messages

Note that the message formats are defined in detail in 6.3.2.3.9.

Key Request: Request a TEK for this SAID. Sent by the SS to the BS and authenticated with keyed message digest. The message authentication key is derived from the AK.

Key Reply: Response from the BS carrying the two active sets of traffic keying material for this SAID. Sent by the BS to the SS, it includes the SAID's TEKs, encrypted with a KEK derived from the AK. The Key Reply message is authenticated with a keyed message digest; the authentication key is derived from the AK.

Key Reject: Response from the BS to the SS to indicate this SAID is no longer valid and no key will be sent. The Key Reject message is authenticated with a keyed message digest; the authentication key is derived from the AK.

TEK Invalid: The BS sends an SS this message if it determines that the SS encrypted an uplink PDU with an invalid TEK, i.e., an SAID's TEK key sequence number, contained within the received PDU's MAC Header, is out of the BS's range of known, valid sequence numbers for that SAID.

7.2.5.3 Events

Stop: Sent by the Authorization FSM to an active (non-START state) TEK FSM to terminate TEK FSM and remove the corresponding SAID's keying material from the SS's key table. See Figure 131.

Authorized: Sent by the Authorization FSM to a nonactive (START state) TEK FSM to notify TEK FSM of successful authorization. See Figure 131.

Authorization Pending (Auth Pend): Sent by the Authorization FSM to TEK FSM to place TEK FSM in a wait state while Authorization FSM completes re-authorization. See Figure 131.

Authorization Complete (Auth Comp): Sent by the Authorization FSM to a TEK FSM in the Operational Reauthorize Wait or Rekey Reauthorize Wait states to clear the wait state begun by the prior Authorization Pending event. See Figure 131.

TEK Invalid: This event is triggered by either an SS's data packet decryption logic or by the receipt of a TEK Invalid message from the BS.

An SS's data packet decryption logic triggers a TEK Invalid event if it recognizes a loss of TEK key synchronization between itself and the encrypting BS. For example, an SAID's TEK key sequence number, contained within the received downlink MAC PDU Header, is out of the SS's range of known sequence numbers for that SAID.

A BS sends an SS a TEK Invalid message, triggering a TEK Invalid event within the SS, if the BS's decryption logic recognizes a loss of TEK key synchronization between itself and the SS.

Timeout: A retry timer timeout. Generally, the particular request is retransmitted.

TEK Refresh Timeout: The TEK refresh timer timed out. This timer event signals the TEK state machine to issue a new Key Request in order to refresh its keying material. The refresh timer is set to fire a configurable duration of time (*TEK Grace Time*) before the expiration of the newer TEK the SS currently holds. This is configured via the BS to occur after the scheduled expiration of the older of the two TEKs.

7.2.5.4 Parameters

All configuration parameter values take the default values from Table 343 or may be specified in Auth Reply message.

Operational Wait Timeout: Timeout period between sending of Key Request messages from the Op Wait state (see 11.9.19.4).

Rekey Wait Timeout: Timeout period between sending of Key Request messages from the Rekey Wait state (see 11.9.19.5).

TEK Grace Time: Time interval, in seconds, before the estimated expiration of a TEK that the SS starts rekeying for a new TEK. TEK Grace Time takes the default value from Table 343 or may be specified in a configuration setting within the Auth Reply message and is the same across all SAIDs (see 11.9.19.6).

7.2.5.5 Actions

Actions taken in association with state transitions are listed by <event> (<rcvd message>) --> <state>:

1-B Op Wait (*Stop*) → Start

- a) Clear Key Request retry timer
- b) Terminate TEK FSM

1-C Op Reauth Wait (*Stop*) → Start

- a) Terminate TEK FSM

1-D Operational (*Stop*) → Start

- a) Clear TEK refresh timer, which is timer set to go off “*TEK Grace Time*” seconds prior to the TEK’s scheduled expiration time
- b) Terminate TEK FSM
- c) Remove SAID keying material from key table

1-E Rekey Wait (*Stop*) → Start

- a) Clear Key Request retry timer
- b) Terminate TEK FSM
- c) Remove SAID keying material from key table

1-F Rekey Reauth Wait (*Stop*) → Start

- a) Terminate TEK FSM
- b) Remove SAID keying material from key table

2-A Start (*Authorized*) → Op Wait

- a) Send Key Request message to BS
- b) Set Key Request retry timer to Operational Wait Timeout

- 3-B Op Wait (*Auth Pend*) → Op Reauth Wait
 - a) Clear Key Request retry timer
- 3-E Rekey Wait (*Auth Pend*) → Rekey Reauth Wait
 - a) Clear Key Request retry timer
- 4-C Op Reauth Wait (*Auth Comp*) → Op Wait
 - a) Send Key Request message to BS
 - b) Set Key Request retry timer to Operational Wait Timeout
- 4-F Rekey Reauth Wait (*Auth Comp*) → Rekey Wait
 - a) Send Key Request message to BS
 - b) Set Key Request retry timer to Rekey Wait Timeout
- 5-D Operational (*TEK Invalid*) → Op Wait
 - a) Clear TEK refresh timer
 - b) Send Key Request message to BS
 - c) Set Key Request retry timer to Operational Wait Timeout
 - d) Remove SAID keying material from key table
- 5-E Rekey Wait (*TEK Invalid*) → Op Wait
 - a) Clear TEK refresh timer
 - b) Send Key Request message to BS
 - c) Set Key Request retry timer to Operational Wait Timeout
 - d) Remove SAID keying material from key table
- 5-F Rekey Reauth Wait (*TEK Invalid*) → Op Reauth Wait
 - a) Remove SAID keying material from key table
- 6-B Op Wait (*Timeout*) → Op Wait
 - a) Send Key Request message to BS
 - b) Set Key Request retry timer to Operational Wait Timeout
- 6-E Rekey Wait (*Timeout*) → Rekey Wait
 - a) Send Key Request message to BS
 - b) Set Key Request retry timer to Rekey Wait Timeout
- 7-D Operational (*TEK Refresh Timeout*) → Rekey Wait
 - a) Send Key Request message to BS
 - b) Set Key Request retry timer to Rekey Wait Timeout

- 8-B Op Wait (Key Reply) → Operational
- a) Clear Key Request retry timer
 - b) Process contents of Key Reply message and incorporate new keying material into key database
 - c) Set the TEK refresh timer to go off “TEK Grace Time” seconds prior to the key’s scheduled expiration
- 8-E Rekey Wait (Key Reply) → Operational
- a) Clear Key Request retry timer
 - b) Process contents of Key Reply message and incorporate new keying material into key database
 - c) Set the TEK refresh timer to go off “TEK Grace Time” seconds prior to the key’s scheduled expiration
- 9-B Op Wait (Key Reject) → Start
- a) Clear Key Request retry timer
 - b) Terminate TEK FSM
- 9-E Rekey Wait (Key Reject) → Start
- a) Clear Key Request retry timer
 - b) Terminate TEK FSM
 - c) Remove SAID keying material from key table

7.3 Dynamic SA creation and mapping

Dynamic Security Associations are SAs that a BS establishes and eliminates dynamically in response to the enabling or disabling of specific downlink service flows. SSs learn the mapping of a particular privacy-enabled service flow to that flow’s dynamically assigned SA through the exchange of DSx messages.

7.3.1 Dynamic SA creation

The BS may dynamically establish SAs by issuing an SA Add message. Upon receiving an SA Add message, the SS shall start a TEK state machine for each SA listed in the message.

7.3.2 Dynamic mapping of SA

When creating a new service flow, an SS may request an existing SA be used by passing the SAID of the SA in a DSA-REQ or DSC-REQ message. The BS checks the SS’s authorization for the requested SA and generates appropriate response using a DSA-RSP or DSC-RSP message correspondingly.

With BS-initiated dynamic service creations, a BS may also map a new service flow to an existing SA that is supported by a specific SS. The SAID of the SA shall be communicated to the SS in a DSA-REQ or DSC-REQ message.

7.4 Key usage

7.4.1 BS key usage

The BS is responsible for maintaining keying information for all SAs. The PKM protocol defined in this specification describes a mechanism for synchronizing this keying information between a BS and its client SS.

7.4.1.1 AK key lifetime

After an SS completes basic capabilities negotiation, it shall initiate an authorization exchange with its BS. The BS's first receipt of an Auth Request message from the unauthorized SS shall initiate the activation of a new AK, which the BS sends back to the requesting SS in an Auth Reply message. This AK shall remain active until it expires according to its predefined *AK Lifetime*, a BS system configuration parameter.

The AK's active lifetime a BS reports in an Authorization Reply message shall reflect, as accurately as an implementation permits, the remaining lifetimes of AK at the time the Authorization Reply message is sent.

If an SS fails to reauthorize before the expiration of its current AK, the BS shall hold no active AKs for the SS and shall consider the SS *unauthorized*. A BS shall remove from its keying tables all TEKs associated with an unauthorized SS's Primary SA.

7.4.1.2 AK transition period on BS side

The BS shall always be prepared to send an AK to an SS upon request. The BS shall be able to support two simultaneously active AKs for each client SS. The BS has two active AKs during an AK transition period; the two active keys have overlapping lifetimes.

An AK transition period begins when the BS receives an Auth Request message from an SS and the BS has a single active AK for that SS. In response to this Auth Request, the BS activates a second AK [see point (a) and (d) in Figure 133], which shall have a key sequence number one greater (modulo 16) than that of the existing AK and shall be sent back to the requesting SS in an Auth Reply message. The BS shall set the active lifetime of this second AK to be the remaining lifetime of the first AK [between points (a) and (c) in Figure 133], plus the predefined *AK Lifetime*; thus, the second, "newer" key shall remain active for one *AK Lifetime* beyond the expiration of the first, "older" key. The key transition period shall end with the expiration of the older key. This is depicted on the right-hand side of Figure 133.

As long as the BS is in the midst of an SS's AK transition period, and thus is holding two active AKs for that SS, it shall respond to Auth Request messages with the newer of the two active keys. Once the older key expires, an Auth Request shall trigger the activation of a new AK, and the start of a new key transition period.

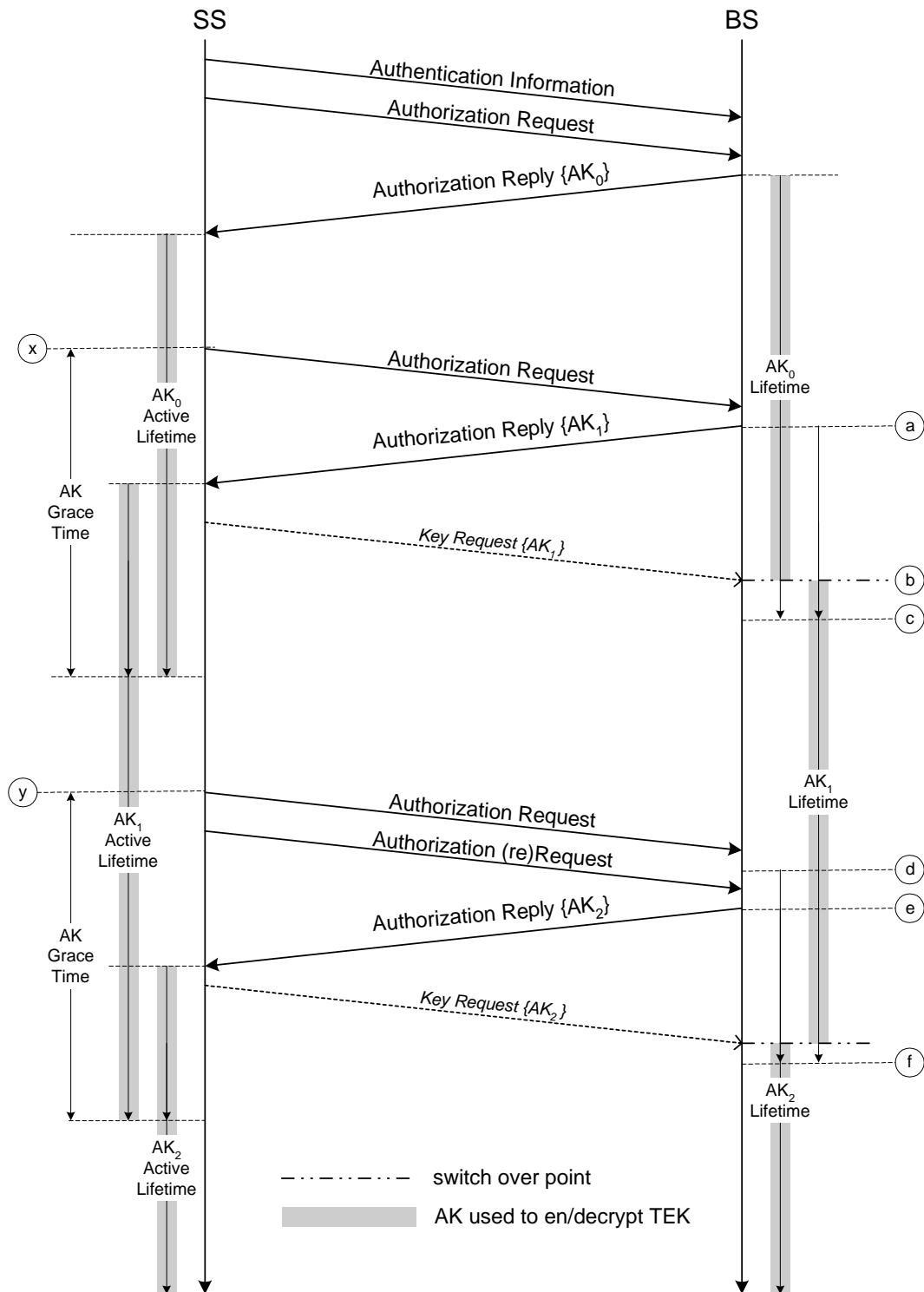

Figure 133—AK management in BS and SS

7.4.1.3 BS usage of AK

The BS shall use keying material derived from the SS's AK for the following:

- a) Verifying the HMAC-Digests in Key Request messages received from that SS,
- b) Calculating the HMAC-Digests it writes into Key Reply, Key Reject, and TEK Invalid messages sent to that SS, and
- c) Encrypting the TEK in the Key Reply messages it sends to that SS.

A BS shall use an HMAC_KEY_U (see 7.5.4.3) derived from one of the SS's active AKs to verify the HMAC-Digest in Key Request messages received from the SS. The AK Key Sequence Number accompanying each Key Request message allows the BS to determine which HMAC_KEY_U was used to authenticate the message. If the AK Key Sequence Number indicates the newer of the two AKs, the BS shall identify this as an *implicit acknowledgment* that the SS has obtained the newer of the SS's two active AKs [see points (b) in Figure 133].

A BS shall use an HMAC_KEY_D derived from the active AK selected above (see also 7.5.4.3) when calculating HMAC-Digests in Key Reply, Key Reject, and TEK Invalid message. When sending Key Reply, Key Reject, or TEK Invalid messages within a key transition period (i.e., when two active AKs are available), if the newer key has been implicitly acknowledged, the BS shall use the newer of the two active AKs. If the newer key has not been implicitly acknowledged, the BS shall use the older of the two active AKs to derive the KEK and the HMAC_KEY_D.

The BS shall use a KEK derived from an active AK when encrypting the TEK in the Key Reply messages. The right-hand side of Figure 133 illustrates the BS's policy regarding its use of AKs, where the shaded portion of an AK's lifetime indicates the time period during which that AK shall be used to derive the HMAC_KEY_U, HMAC_KEY_D, and KEK.

For calculating the HMAC-Digest in the HMAC Tuple attribute, the BS shall use the HMAC_KEY_U and HMAC_KEY_D derived from one of the active AKs. For signing messages, if the newer AK has been implicitly acknowledged, the BS shall use the newer of the two active AKs to derive the HMAC_KEY_D. If the newer key has not been implicitly acknowledged, the BS shall use the older of the two active AKs to derive the HMAC_KEY_D. The HMAC Key Sequence Number in the HMAC Tuple, equal to the AK's sequence number from which the HMAC_KEY_D was derived, enables the SS to correctly determine which HMAC_KEY_D was used for message authentication.

When receiving messages containing the HMAC Tuple attribute, the BS shall use the HMAC_KEY_U indicated by the HMAC Key Sequence Number to authenticate the messages.

7.4.1.4 TEK lifetime

The BS shall maintain two sets of active TEKs (and their associated Initialization Vectors, or IVs) per SAID, corresponding to two successive generations of keying material. The two generations of TEKs shall have overlapping lifetimes determined by *TEK Lifetime*, a predefined BS system configuration parameter. The newer TEK shall have a key sequence number one greater (modulo 4) than that of the older TEK. Each TEK becomes active halfway through the lifetime of its predecessor and expires halfway through the lifetime of its successor. Once a TEK's lifetime expires, the TEK becomes inactive and shall no longer be used.

The Key Reply messages sent by a BS contain TEK parameters for the two active TEKs. The TEKs' active lifetimes a BS reports in a Key Reply message shall reflect, as accurately as an implementation permits, the remaining lifetimes of these TEKs at the time the Key Reply message is sent.

7.4.1.5 BS usage of TEK

The BS transitions between the two active TEKs differently, depending on whether the TEK is used for downlink or uplink traffic. For each of its SAIDs, the BS shall transition between active TEKs according to the following rules:

- a) At expiration of the older TEK, the BS shall immediately transition to using the newer TEK for encryption.
- b) The uplink transition period begins from the time the BS sends the newer TEK in a Key Reply message and concludes once the older TEK expires.

It is the responsibility of the SS to update its keys in a timely fashion; the BS shall transition to a new downlink encryption key regardless of whether a client SS has retrieved a copy of that TEK.

The BS uses the two active TEKs differently, depending on whether the TEK is used for downlink or uplink traffic. For each of its SAIDs, the BS shall use the two active TEKs according to the following rules:

- a) The BS shall use the older of the two active TEKs for encrypting downlink traffic.
- b) The BS shall be able to decrypt uplink traffic using either the older or newer TEK.

Note that the BS encrypts with a given TEK for only the second half of that TEK's total lifetime. The BS is able, however, to decrypt with a TEK for the TEK's entire lifetime.

The right-hand side of Figure 134 illustrates the BS's management of an SA's TEKs, where the shaded portion of a TEK's lifetime indicates the time period during which that TEK shall be used to encrypt MAC PDU payloads.

7.4.1.6 Node re-authorization in Mesh Mode during normal operation

When re-authorizing with the network, the re-authorizing node shall tunnel the authorization messages as shown in Figure 131 over UDP.

7.4.2 SS key usage

The SS is responsible for sustaining authorization with its BS and maintaining an active AK. An SS shall be prepared to use its two most recently obtained AKs according to the following manner.

7.4.2.1 SS reauthorization

AKs have a limited lifetime and shall be periodically refreshed. An SS refreshes its AK by reissuing an Auth Request to the BS. The Authorization State Machine (7.2.4) manages the scheduling of Auth Requests for refreshing AKs.

An SS's Authorization state machine schedules the beginning of reauthorization a configurable duration of time, the *Authorization Grace Time*, [see points (x) and (y) in Figure 133], before the SS's latest AK is scheduled to expire. The *Authorization Grace Time* is configured to provide an SS with an authorization retry period that is sufficiently long to allow for system delays and provide adequate time for the SS to successfully complete an Authorization exchange before the expiration of its most current AK.

Note that the BS does not require knowledge of the *Authorization Grace Time*. The BS, however, shall track the lifetimes of its AKs and shall deactivate a key once it has expired.

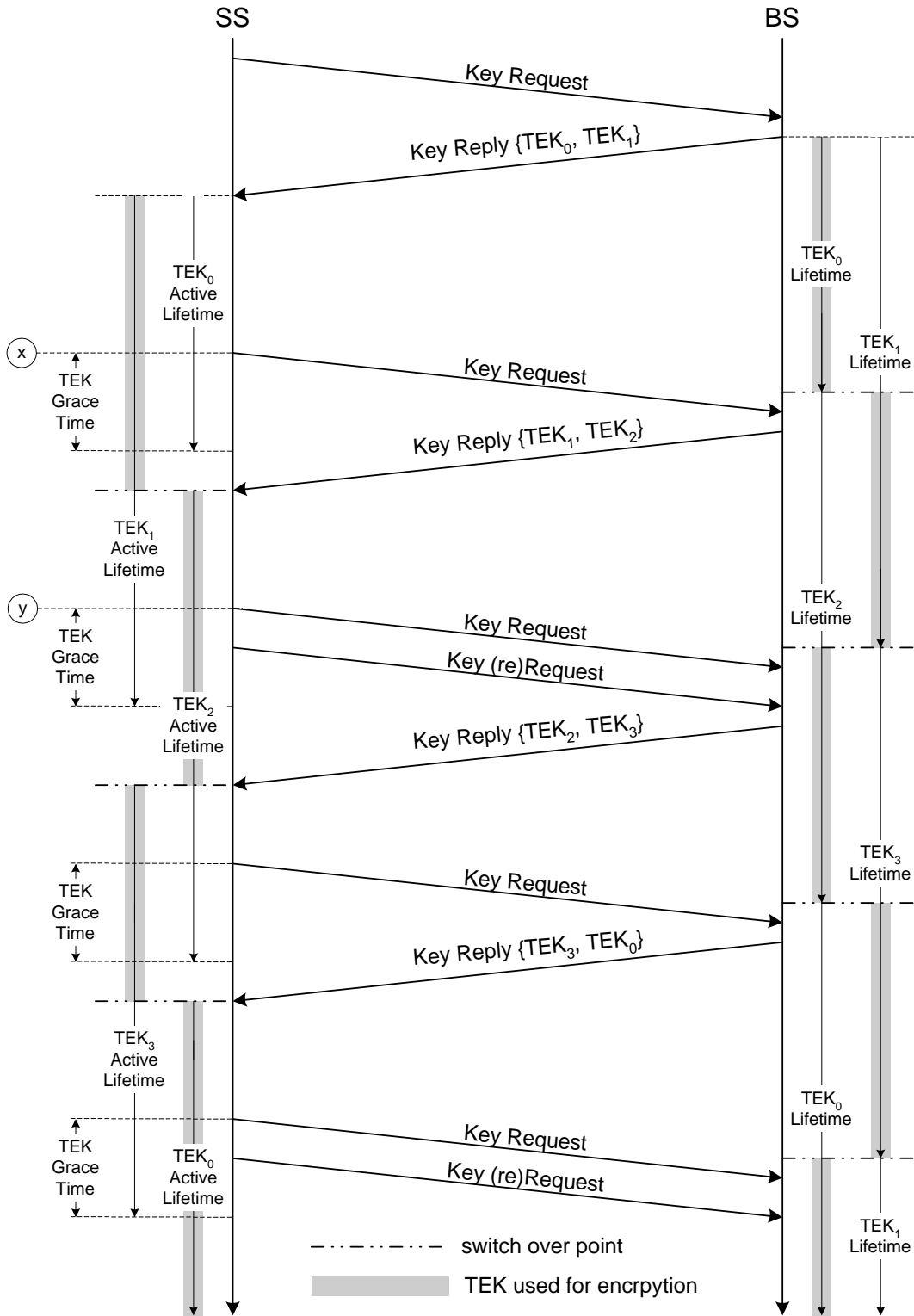

Figure 134—TEK management in BS and SS

7.4.2.2 SS usage of AK

An SS shall use the HMAC_KEY_U derived from the newer of its two most recent AKs when calculating the HMAC-Digests it attaches to Key Request messages.

The SS shall be able to use the HMAC_KEY_D derived from either of its two most recent AKs to authenticate Key Reply, Key Reject, and TEK Reject messages. The SS shall be able to decrypt an encrypted TEK in a Key Reply message with the KEK derived from either of its two most recent AKs. The SS shall use the accompanying AK Key Sequence Number to determine which set of keying material to use.

The left-hand side of Figure 133 illustrates an SS's maintenance and usage of its AKs, where the shaded portion of an AK's lifetime indicates the time period during which that AK shall be used to decrypt TEKs. Even though it is not part of the message exchange, Figure 133 also shows the implicit acknowledgment of the reception of a new AK via the transmission of a Key Request message using the key sequence of the new AK.

An SS shall use the HMAC_KEY_U derived from the newer of its two most recent AKs when calculating the HMAC-Digests of the HMAC Tuple attribute.

7.4.2.3 SS usage of TEK

An SS shall be capable of maintaining two successive sets of traffic keying material per authorized SAID. Through operation of its TEK state machines, an SS shall request a new set of traffic keying material a configurable amount of time, the *TEK Grace Time* [see points (x) and (y) in Figure 134], before the SS's latest TEK is scheduled to expire.

For each of its authorized SAIDs, the SS

- a) Shall use the newer of its two TEKs to encrypt uplink traffic, and
- b) Shall be able to decrypt downlink traffic encrypted with either of the TEKs.

The left-hand side of Figure 134 illustrates the SS's maintenance and usage of an SA's TEKs, where the shaded portion of a TEK's lifetime indicates the time period during which that TEK shall be used to encrypt MAC PDU payloads.

7.4.2.4 TEK usage in Mesh Mode

For each of its SAIDs, the Neighbor shall transition between active TEKs according to the following rules:

- a) At expiration of the older TEK, the Neighbor shall immediately transition to using the newer TEK for encryption.
- b) The Neighbor that generated the TEK shall use the older of the two active TEKs for encrypting traffic towards the Node that initiated the TEK exchange.
- c) The Neighbor that generated the TEK shall be able to decrypt traffic from each Node using either the older or newer TEK.

For each of its authorized SAIDs, the initiator Node

- a) Shall use the newer of its two TEKs to encrypt traffic towards its Neighbors with which it initiated a TEK exchange, and
- b) Shall be able to decrypt traffic from the Neighbor encrypted with either of the TEKs.

7.4.2.5 Node usage of the Operator Shared Secret in Mesh Nodes

Each node shall be capable of maintaining two active Operator Shared Secrets. A Node shall use the Operator Shared Secret to calculate a HMAC-Digest for the Key Request and Key Reply messages when exchanging TEKs with its neighboring nodes.

7.5 Cryptographic methods

This subclause specifies the cryptographic algorithms and key sizes used by the PKM protocol. All SS and BS implementations shall support the method of packet data encryption defined in 7.5.1.1, encryption of the TEK as specified in 7.5.2, and message digest calculation as specified in 7.5.3.

7.5.1 Data Encryption methods

7.5.1.1 Data encryption with DES in CBC mode

If the data encryption algorithm identifier in the cryptographic suite of an SA equals 0x01, data on connections associated with that SA shall use the CBC mode of the US Data Encryption Standard (DES) algorithm (FIPS 46-3, FIPS 74, FIPS 81) to encrypt the MAC PDU payloads.

The CBC IV shall be calculated as follows: in the downlink, the CBC shall be initialized with the exclusive-or (XOR) of (1) the IV parameter included in the TEK keying information, and (2) the content of the PHY Synchronization field (right justified) of the latest DL-MAP. In the uplink, the CBC shall be initialized with the XOR of (1) the IV parameter included in the TEK keying information, and (2) the content of the PHY Synchronization field of the DL-MAP that is in effect when the UL-MAP for the uplink transmission is created/received.

Residual termination block processing shall be used to encrypt the final block of plaintext when the final block is less than 64 bits. Given a final block having n bits, where n is less than 64, the next-to-last ciphertext block shall be DES encrypted a second time, using the electronic code book (ECB) mode, and the most significant n bits of the result are XORed with the final n bits of the payload to generate the short final cipher block. In order for the receiver to decrypt the short final cipher block, the receiver DES encrypts the next-to-last ciphertext block, using the ECB mode, and XORs the most significant n bits with the short final cipher block in order to recover the short final cleartext block. This encryption procedure is depicted in Figure 9.4 of Schneier [B42].

In the special case when the payload portion of the MAC PDU is less than 64 bits, the IV shall be DES encrypted and the most significant n bits of the resulting ciphertext, corresponding to the number of bits of the payload, shall be XORed with the n bits of the payload to generate the short cipher block.¹⁵

7.5.1.2 Data encryption with AES in CCM mode

If the data encryption algorithm identifier in the cryptographic suite of an SA equals 0x02, data on connections associated with that SA shall use the CCM mode of the US Advanced Encryption Standard (AES) algorithm (NIST Special Publication 800-38C, FIPS-197) to encrypt the MAC PDU payloads.

¹⁵If two or more PDUs with less than 8 byte payloads are transmitted in the same frame using the same SA, the XOR of the payload plaintexts can be found easily. In practice, this situation is very unlikely to occur, as payloads are typically larger than 8 bytes. In the case that multiple payloads of less than 8 bytes are to be transmitted in the same frame on the same SA and service, packing of the short SDUs into a single PDU will eliminate this weakness. If the SDUs are for different services, packing the SDUs with zero-length fictitious SDUs allows the use of the Packing subheader to extend the size of the PDU to at least 8 bytes.

7.5.1.2.1 PDU Payload Format

The PDU payload shall be prepended with a 4-byte PN (Packet Number). The PN shall be transmitted in little endian byte order. The PN shall not be encrypted.

The plaintext PDU shall be encrypted and authenticated using the active TEK, according to the CCM specification. This includes appending an 8-byte ICV (Integrity Check Value) to the end of the payload and encrypting both the plaintext payload and the appended ICV.

The ciphertext ICV is transmitted in little endian byte order.

The processing yields a payload that is 12 bytes longer than the plaintext payload.

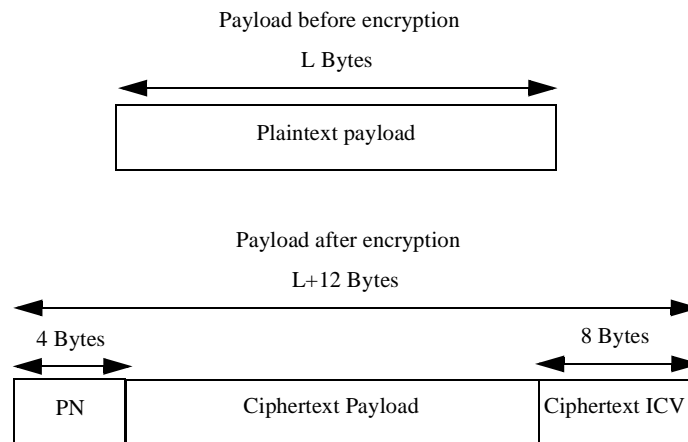

Figure 135—TEK management in BS and SS

7.5.1.2.2 PN (Packet Number)

The PN associated with an SA shall be set to 1 when the SA is established and when a new TEK is installed. The PN shall be transmitted in little endian order in the MAC PDU as described in 7.5.1.2.1. After each PDU transmission, the PN shall be incremented by 1. On uplink connections, the PN shall be XORed with 0x80000000 prior to encryption and transmission. On downlink connections, the PN shall be used without such modification.¹⁶

Any tuple value of {PN, KEY} shall not be used more than once for the purposes of transmitting data.¹⁷ The SS shall ensure that a new TEK is requested and transferred before the PN on either the SS or BS reaches 0x7FFFFFFF. If the PN in either the SS or BS reaches 0x7FFFFFFF without new keys being installed, transport communications on that SA shall be halted until new TEKs are installed.

7.5.1.2.3 CCM Algorithm

The NIST CCM specification defines a number of algorithm parameters. These parameters shall be fixed to specific values when used in SAs with a data encryption algorithm identifier of 0x02.

¹⁶This achieves the splitting of the PN space. 0x00000001 – 0x7FFFFFFF for the downlink and 0x80000001 – 0xFFFFFFFF on the uplink, preventing a PN collision between the uplink and downlink

¹⁷Sending two packets encoded with the same key and PN will eliminate all security guarantees of CCM mode.

The number of octets in the authentication field M shall be set to 8. Consistent with the CCM specification the 3 bit binary encoding of M shall be 011.

The size of the length field shall be set to 2. Consistent with the CCM specification, the 3-bit binary encoding of the DLEN size field shall be 001.

The length of the additional authenticated data string l(a) shall be set to 0.

The nonce shall be 13 bytes long. Bytes 1 through 5 shall be set to the first five byte of the GMH (thus excluding the HCS). Bytes 6 through 9 are reserved and shall be set to 0x00000000. Bytes 10 through 13 shall be set to the value of the PN. Byte 10 shall take the least significant byte and byte 13 shall take the most significant byte.

Consistent with the CCM specification, the initial block B₀ is formatted as shown in Figure 136.

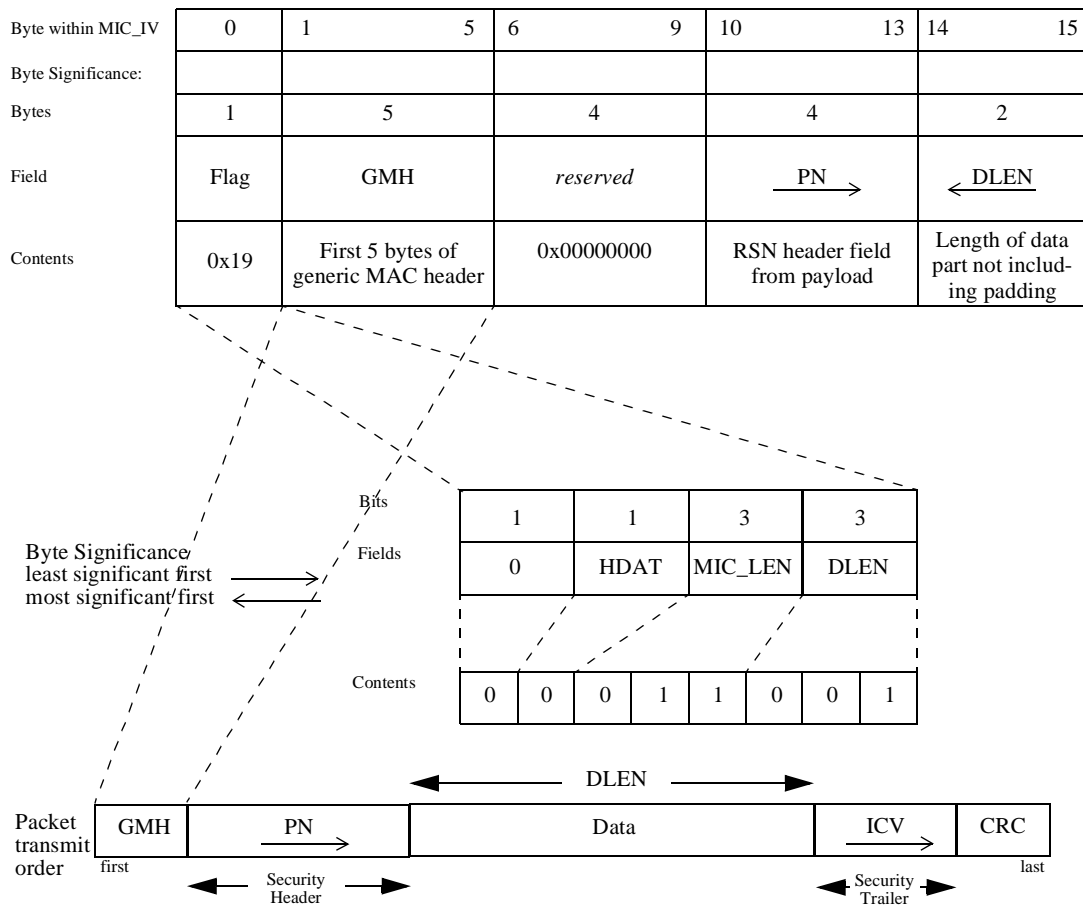

Figure 136—Initial CCM Block B₀

Note the big endian ordering of the DLEN value is opposite that of the normal little endian representation. This is to remain compliant with the letter of the NIST CCM specification.

The sixth byte of the GMH is not included in the nonce since it is redundant.

Consistent with the NIST CCM specification the counter blocks A_i are formatted as shown in Figure 137.

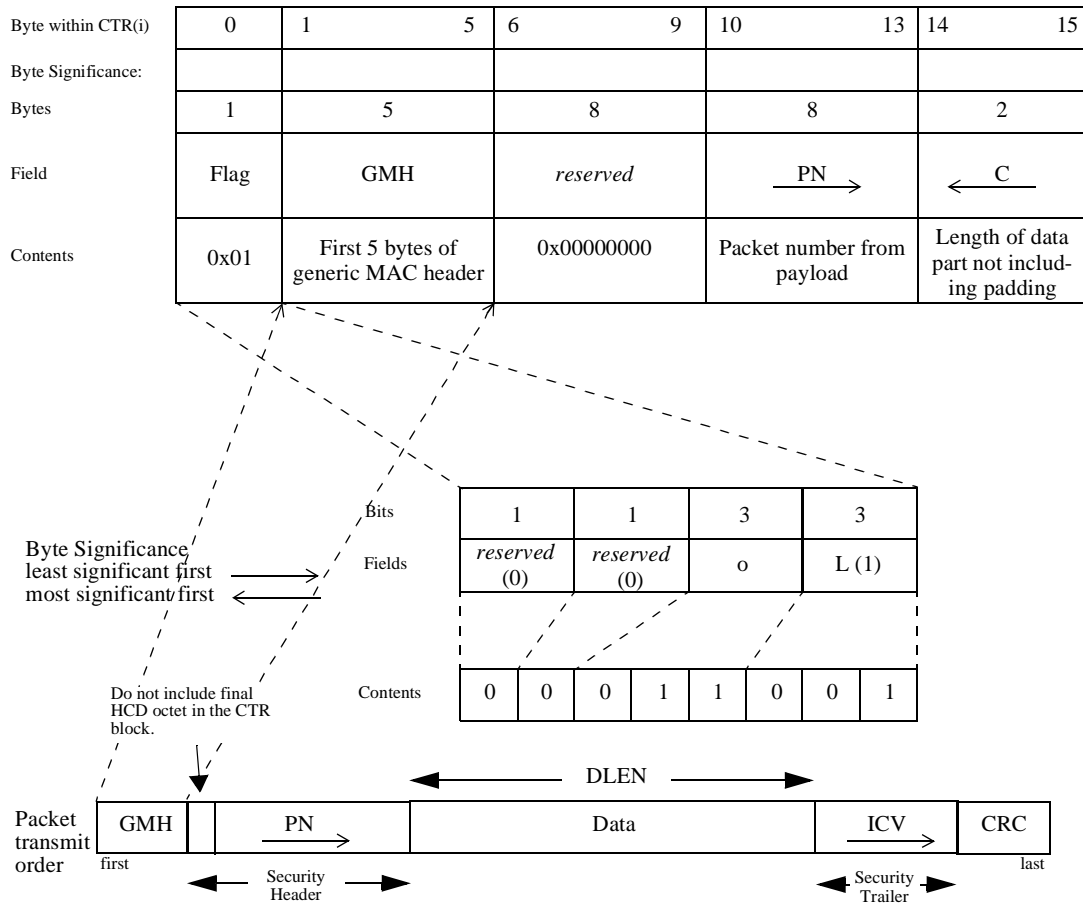

Figure 137—Construction of A_i

7.5.1.2.4 Receive Processing Rules

On receipt of a PDU the receiving SS or BS shall decrypt and authenticate the PDU consistent with the NIST CCM specification configured as specified in 7.5.1.2.3.

Packets that are found to be not authentic shall be discarded.

Receiving BS or SSs shall maintain a record of the highest value PN receive for each SA. If a packet is received with a PN that is equal to or less than the recorded maximum for the SA is protected under, then the packet shall be discarded as a replay attempt.

7.5.2 Encryption of TEK

The following options listed in 7.5.2.1 through 7.5.2.3 may be used.

7.5.2.1 Encryption of TEK with 3-DES

This method of encrypting the TEK shall be used for SAs with the TEK encryption algorithm identifier in the cryptographic suite equal to 0x01.

The BS encrypts the value fields of the TEK in the Key Reply messages it sends to client SS. This field is encrypted using two-key 3-DES in the EDE mode (Schneier [B42]):

encryption: $C = Ek1[Dk2[Ek1[P]]]$
decryption: $P = Dk1[Ek2[Dk1[C]]]$
P = Plaintext 64-bit TEK
C = Ciphertext 64-bit TEK
k1 = leftmost 64 bits of the 128-bit KEK
k2 = rightmost 64 bits of the 128-bit KEK
E[] = 56-bit DES ECB mode encryption
D[] = 56-bit DES ECB decryption

Subclause 7.5.4 describes how the KEK is derived from the AK.

7.5.2.2 Encryption of TEK with RSA

The RSA method of encrypting the TEK (PKCS #1 v2.0) shall be used for SAs with the TEK encryption algorithm identifier in the cryptographic suite equal to 0x02.

7.5.2.3 Encryption of TEK-128 with AES

This method of encrypting the TEK-128 shall be used for SAs with the TEK encryption algorithm identifier in the cryptographic suite equal to 0x03.

The BS encrypts the value fields of the TEK-128 in the Key Reply messages it sends to client SS. This field is encrypted using 128-bit AES in ECB mode.

encryption: $C = Ek1[P]$
decryption: $P = Dk1[C]$
P = Plaintext 128-bit TEK
C = Ciphertext 128-bit TEK
k1 = the 128-bit KEK
E[] = 128-bit AES ECB mode encryption
D[] = 128-bit AES ECB decryption

Subclause 7.5.4 describes how the KEK is derived from the AK.

7.5.3 Calculation of HMAC-Digests

The calculation of the keyed hash in the HMAC-Digest attribute and the HMAC Tuple shall use the HMAC (IETF RFC 2104) with the secure hash algorithm SHA-1 (FIPS 180-1). The downlink authentication key HMAC_KEY_D shall be used for authenticating messages in the downlink direction. The uplink authentication key HMAC_KEY_U shall be used for authenticating messages in the uplink direction. Uplink and downlink message authentication keys are derived from the AK (see 7.5.4 for details). The HMAC Sequence number in the HMAC Tuple shall be equal to the AK Sequence Number of the AK from which the HMAC_KEY_x was derived.

In Mesh Mode HMAC-Digests calculated with the key HMAC_KEY_S shall be supported. When calculating the digest with this key the HMAC sequence Number in the HMAC tuple shall be equal to the Operator Shared Secret Sequence Number.

The digest shall be calculated over the entire MAC Management message with the exception of the HMAC-Digest and HMAC Tuple attributes.

7.5.4 Derivation of TEKs, KEKs, and message authentication keys

The BS generates AKs, TEKs, and IVs. A random or pseudo-random number generator shall be used to generate AKs and TEKs. A random or pseudo-random number generator may also be used to generate IVs. Regardless of how they are generated, IVs shall be unpredictable. Recommended practices for generating random numbers for use within cryptographic systems are provided in IETF RFC 1750 [B30].

7.5.4.1 DES Keys

FIPS 81 defines 56-bit DES keys as 8-byte (64-bit) quantities where the seven most significant bits (i.e., seven leftmost bits) of each byte are the independent bits of a DES key, and the least significant bit (i.e., rightmost bit) of each byte is a parity bit computed on the preceding seven independent bits and adjusted so that the byte has odd parity.

PKM does not require odd parity. The PKM protocol generates and distributes 8-byte DES keys of arbitrary parity, and it requires that implementations ignore the value of the least significant bit of each.

7.5.4.2 3-DES KEKs

The keying material for two-key 3-DES consists of two distinct (single) DES keys.

The 3-DES KEK used to encrypt the TEK is derived from a common AK. The KEK shall be derived as follows:

$$\begin{aligned} \text{KEK} &= \text{Truncate}(\text{SHA}(\text{K_PAD_KEK} \mid \text{AK}), 128) \\ \text{K_PAD_KEK} &= \text{0x53 repeated 64 times, i.e., a 512-bit string.} \end{aligned}$$

$\text{Truncate}(x, n)$ denotes the result of truncating x to its leftmost n bits.

$\text{SHA}(x/y)$ denotes the result of applying the SHA-1 function to the concatenated bit strings x and y .

The keying material of 3-DES consists of two distinct DES keys. The 64 most significant bits of the KEK shall be used in the encrypt operation. The 64 least significant bits shall be used in the decrypt operation.

7.5.4.3 HMAC authentication keys

The HMAC authentication keys are derived as follows:

$$\begin{aligned} \text{HMAC_KEY_D} &= \text{SHA}(\text{H_PAD_D} \mid \text{AK}) \\ \text{HMAC_KEY_U} &= \text{SHA}(\text{H_PAD_U} \mid \text{AK}) \\ \text{HMAC_KEY_S} &= \text{SHA}(\text{H_PAD_D} \mid \text{Operator Shared Secret}) \end{aligned}$$

with

$$\begin{aligned} \text{H_PAD_D} &= \text{0x3A repeated 64 times} \\ \text{H_PAD_U} &= \text{0x5C repeated 64 times} \end{aligned}$$

7.5.5 Public-key encryption of AK

AKs in Auth Reply messages shall be RSA public-key encrypted, using the SS's public key. The protocol uses 65537 (0x010001) as its public exponent and a modulus length of 1024 bits. The PKM protocol employs the RSAES-OAEP encryption scheme (PKCS #1). RSAES-OAEP requires the selection of a hash function, a mask-generation function, and an encoding parameter string. The default selections specified in PKCS #1 shall be used when encrypting the AK. These default selections are SHA-1 for the hash function, MGF1 with SHA-1 for the mask-generation function, and the empty string for the encoding parameter string.

7.5.6 Digital signatures

The Protocol employs the RSA Signature Algorithm (PKCS #1) with SHA-1 (FIPS 186-2) for both of its certificate types.

As with its RSA encryption keys, Privacy uses 65537 (0x010001) as the public exponent for its signing operation. Manufacturer CAs shall employ signature key modulus lengths of at least 1024 bits and no greater than 2048 bits.

7.6 Certificate profile

7.6.1 Certificate format

This subclause describes the X.509 (IETF RFC 2459) Version 3 certificate format and certificate extensions used in IEEE 802.16-compliant SSs. Table 135 summarizes the basic fields of an X.509 Version 3 certificate.

Table 135—Basic fields of an X.509 Version 3 certificate

X.509 v3 field	Description
tbsCertificate.version	Indicates the X.509 certificate version. Always set to v3 (value of 2).
tbsCertificate.serialNumber	Unique integer the issuing CA assigns to the certificate.
tbsCertificate.signature	Object identifier (OID) and optional parameters defining algorithm used to sign the certificate. This field shall contain the same algorithm identifier as the signatureAlgorithm field.
tbsCertificate.issuer	Distinguished Name of the CA that issued the certificate.
tbsCertificate.validity	Specifies when the certificate becomes active and when it expires.
tbsCertificate.subject	Distinguished Name identifying the entity whose public key is certified in the subjectpublic key information field.
tbsCertificate.subjectPublicKeyInfo	Field contains the public key material (public key and parameters) and the identifier of the algorithm with which the key is used.
tbsCertificate.issuerUniqueID	Optional field to allow reuse of issuer names over time.
tbsCertificate.subjectUniqueID	Optional field to allow reuse of subject names over time.
tbsCertificate.extensions	The extension data.

Table 135—Basic fields of an X.509 Version 3 certificate (continued)

X.509 v3 field	Description
signatureAlgorithm	OID and optional parameters defining algorithm used to sign the certificate. This field shall contain the same algorithm identifier as the signature field in tbsCertificate.
signatureValue	Digital signature computed upon the ASN.1 DER encoded tbsCertificate.

All certificates described in this specification shall be signed with the RSA signature algorithm using SHA-1 as the one-way hash function. The RSA signature algorithm is described in PKCS #1; SHA-1 is described in FIPS 180-1. Restrictions posed on the certificate values are described in the following subclauses:

7.6.1.1 tbsCertificate.validity.notBefore and tbsCertificate.validity.notAfter

SS certificates shall not be renewable and shall thus have a validity period greater than the operational lifetime of the SS. A Manufacturer CA certificate's validity period should exceed that of the SS certificates it issues. The validity period of an SS certificate shall begin with the date of generation of the device's certificate; the validity period should extend out to at least 10 years after that manufacturing date. Validity periods shall be encoded as UTCTime. UTCTime values shall be expressed Greenwich Mean Time (Zulu) and shall include seconds (i.e., times are YYMMDDHHMMSSZ), even where the number of seconds is zero.

7.6.1.2 tbsCertificate.serialNumber

Serial numbers for SS certificates signed by a particular issuer shall be assigned by the manufacturer in increasing order. Thus, if the tbsCertificate.validity.notBefore field of one certificate is greater than the tbsCertificate.validity.notBefore field of another certificate, then the serial number of the first certificate shall be greater than the serial number of the second certificate.

7.6.1.3 tbsCertificate.signature and signatureAlgorithm

All certificates described in this specification shall be signed with the RSA signature algorithm, using SHA-1 as the one-way hash function. The RSA signature algorithm is described in PKCS #1; SHA-1 is described in FIPS 180-1. The ASN.1 OID used to identify the "SHA-1 with RSA" signature algorithm is

```
sha-1WithRSAEncryption OBJECT IDENTIFIER ::=
  { iso(1) member-body(2) us(840) rsadsi(113549) pkcs(1) pkcs-1(1) 5 }
```

When the sha-1WithRSAEncryption OID appears within the ASN.1 type AlgorithmIdentifier, as is the case with both tbsCertificate.signature and signatureAlgorithm, the parameters component of that type is the ASN.1 type NULL.

7.6.1.4 tbsCertificate.issuer and tbsCertificate.subject

X.509 Names are SEQUENCES of RelativeDistinguishedNames, which are in turn SETs of AttributeTypeAndValue. AttributeTypeAndValue is a SEQUENCE of an AttributeType (an OBJECT IDENTIFIER) and an AttributeValue. The value of the countryName attribute shall be a two-character PrintableString, chosen from ISO 3166; all other AttributeValues shall be encoded as either

T.61/TeletexString or PrintableString character strings. The PrintableString encoding shall be used if the character string contains only characters from the PrintableString set. Specifically:

```

abcdefghijklmnopqrstuvwxyz
ABCDEFGHIJKLMNOPQRSTUVWXYZ
0123456789
`()+,-./:=? and space

```

The T.61/TeletexString shall be used if the character string contains other characters. The following OIDs are needed for defining issuer and subject Names in PKM certificates:

```

id-at OBJECT IDENTIFIER ::= {joint-iso-ccitt(2) ds(5) 4}
id-at-commonName OBJECT IDENTIFIER ::= {id-at 3}
id-at-countryName OBJECT IDENTIFIER ::= {id-at 6}
id-at-localityName OBJECT IDENTIFIER ::= {id-at 7}
id-at-stateOrProvinceName OBJECT IDENTIFIER ::= {id-at 8}
id-at-organizationName OBJECT IDENTIFIER ::= {id-at 10}
id-at-organizationalUnitName OBJECT IDENTIFIER ::= {id-at 11}

```

The following subclauses describe the attributes that comprise the subject Name forms for each type of PKM certificate. Note that the issuer name form is the same as the subject of the issuing certificate. Additional attribute values that are present but unspecified in the following forms should not cause a device to reject the certificate.

7.6.1.4.1 Manufacturer certificate

```

countryName=<Country of Manufacturer>
[stateOrProvinceName=<state/province>]
[localityName=<City>]
organizationName=<Company Name>
organizationalUnitName=WirelessMAN
[organizationalUnitName=<Manufacturing Location>]
commonName=<Company Name> <Certification Authority>

```

The countryName, organizationName, and commonName attributes shall be included and shall have the values shown. The organizationalUnitName having the value “WirelessMAN” shall be included. The organizationalUnitName representing manufacturing location should be included. If included, it shall be preceded by the organizationalUnitName having value “WirelessMAN.” The stateOrProvinceName and localityName may be included. Other attributes are not allowed and shall not be included.

7.6.1.4.2 SS certificate

```

countryName=<Country of Manufacturer>
organizationName=<Company Name>
organizationalUnitName=<manufacturing location>
commonName=<Serial Number>
commonName=<MAC Address>

```

The MAC address shall be the SS’s MAC address. It is expressed as six pairs of hexadecimal digits separated by colons (:), e.g., “00:60:21:A5:0A:23.” The Alpha HEX characters (A–F) shall be expressed as uppercase letters.

The organizationalUnitName in an SS certificate, which describes the modem’s manufacturing location, should be the same as the organizationalUnitName in the issuer Name describing a manufacturing location.

The `countryName`, `organizationName`, `organizationalUnitName`, and `commonName` attributes shall be included. Other attributes are not allowed and shall not be included.

7.6.1.5 `tbsCertificate.subjectPublicKeyInfo`

The `tbsCertificate.subjectPublicKeyInfo` field contains the public key and the public key algorithm identifier. The `tbsCertificate.subjectPublicKeyInfo.algorithm` field is an `AlgorithmIdentifier` structure. The `AlgorithmIdentifier`'s algorithm shall be RSA encryption, identified by the following OID:

```
pkcs-1 OBJECT IDENTIFIER ::= { iso(1) member-body(2) us(840)
  rsadsi(113549) pkcs(1) 1 }
rsaEncryption OBJECT IDENTIFIER ::= { pkcs-1 1 }
```

The `AlgorithmIdentifier`'s parameters field shall have ASN.1 type NULL. The RSA public key shall be encoded using the ASN.1 type `RSAPublicKey`:

```
RSAPublicKey ::= SEQUENCE {
  modulus INTEGER, -- n
  publicExponent INTEGER, -- e -- }
```

where modulus is the modulus n , and publicExponent is the public exponent e . The DER encoded `RSAPublicKey` is the value of the BIT STRING `tbsCertificate.subjectPublicKeyInfo.subjectPublicKey`.

7.6.1.6 `tbsCertificate.issuerUniqueID` and `tbsCertificate.subjectUniqueID`

The `issuerUniqueID` and `subjectUniqueID` fields shall be omitted for both of the PKM's certificate types.

7.6.1.7 `tbsCertificate.extensions`

7.6.1.7.1 SS certificates

SS certificates may contain noncritical extensions; they shall not contain critical extensions. If the Key-Usage extension is present, the `keyAgreement` and `keyEncipherment` bits shall be turned on, `keyCertSign` and `cRLSign` bits shall be turned off, and all other bits should be turned off.

7.6.1.7.2 Manufacturer certificates

Manufacturer certificates may contain the Basic Constraints extension. If included, the Basic Constraints extension may appear as a critical extension or as a noncritical extension. Manufacturer certificates may contain noncritical extensions; they shall not contain critical extensions other than, possibly, the Basic Constraints extension. If the `KeyUsage` extension is present in a Manufacturer certificate, the `keyCertSign` bit shall be turned on and all other bits should be turned off.

7.6.1.8 `signatureValue`

In all three PKM certificate types, the `signatureValue` contains the RSA (with SHA-1) signature computed over the ASN.1 DER encoded `tbsCertificate`. The ASN.1 DER encoded `tbsCertificate` is used as input to the RSA signature function. The resulting signature value is ASN.1 encoded as a bit string and included in the Certificate's `signatureValue` field.

7.6.2 SS certificate storage and management in the SS

Manufacturer-issued SS certificates shall be stored in SS permanent, write-once memory. SSs that have factory-installed RSA private/public key pairs shall also have factory-installed SS certificates. SSs that rely

on internal algorithms to generate an RSA key pair shall support a mechanism for installing a manufacturer-issued SS certificate following key generation. The CA certificate of the Manufacturer CA that signed the SS certificate shall be embedded into the SS software. If a manufacturer issues SS certificates with multiple Manufacturer CA certificates, the SS software shall include ALL of that manufacturer's CA certificates. The specific Manufacturer CA certificate installed by the SS [i.e., advertised in Authentication Information messages and returned by the management information base (MIB) object] shall be that identifying the issuer of that modem's SS certificate.

7.6.3 Certificate processing and management in the BS

PKM employs digital certificates to allow BSs to verify the binding between an SS's identity (encoded in an X.509 digital certificate's subject names) and its public key. The BS does this by validating the SS certificate's certification path or chain. Validating the chain means verifying the Manufacturer CA Certificate through some means.

8. PHY

8.1 WirelessMAN-SC PHY specification

8.1.1 Overview

This PHY specification, targeted for operation in the 10–66 GHz frequency band, is designed with a high degree of flexibility in order to allow service providers the ability to optimize system deployments with respect to cell planning, cost, radio capabilities, services, and capacity.

In order to allow for flexible spectrum usage, both TDD and FDD configurations (8.1.3) are supported. Both cases use a burst transmission format whose framing mechanism (8.1.4.1) supports adaptive burst profiling in which transmission parameters, including the modulation and coding schemes, may be adjusted individually to each SS on a frame-by-frame basis. The FDD case supports full-duplex SSs as well as half-duplex SSs, which do not transmit and receive simultaneously.

The uplink PHY is based on a combination of TDMA and DAMA. In particular, the uplink channel is divided into a number of time slots. The number of slots assigned for various uses (registration, contention, guard, or user traffic) is controlled by the MAC in the BS and may vary over time for optimal performance. The downlink channel is TDM, with the information for each SS multiplexed onto a single stream of data and received by all SSs within the same sector. To support half-duplex FDD SSs, provision is also made for a TDMA portion of the downlink.

The downlink PHY includes a Transmission Convergence sublayer that inserts a pointer byte at the beginning of the payload to help the receiver identify the beginning of a MAC PDU. Data bits coming from the Transmission Convergence sublayer are randomized, FEC encoded, and mapped to a QPSK, 16 quadrature amplitude modulation (QAM), or 64-QAM (optional) signal constellation.

The uplink PHY is based upon TDMA burst transmission. Each burst is designed to carry variable-length MAC PDUs. The transmitter randomizes the incoming data, FEC encodes it, and maps the coded bits to a QPSK, 16-QAM (optional), or 64-QAM (optional) constellation.

8.1.2 Framing

This PHY specification operates in a framed format (6.3.7). Within each frame are a downlink subframe and an uplink subframe. The downlink subframe begins with information necessary for frame synchronization and control. In the TDD case, the downlink subframe comes first, followed by the uplink subframe. In the FDD case, uplink transmissions occur concurrently with the downlink frame.

Each SS shall attempt to receive all portions of the downlink except for those bursts whose burst profile is either not implemented by the SS or is less robust than the SS's current operational downlink burst profile. Half-duplex SSs shall not attempt to listen to portions of the downlink coincident with their allocated uplink transmission, if any, adjusted by their Tx time advance.

8.1.2.1 Supported frame durations

Table 136 indicates the supported frame durations.

8.1.3 Duplexing techniques and PHY Type parameter encodings

Both FDD and TDD are supported. The duplexing method shall be reflected in the PHY Type parameter (11.4.1) as shown in Table 137.

Table 136—Frame durations and frame duration codes

Frame duration code (4 bits)	Frame duration (T_F)	Units
0x01	0.5	ms
0x02	1	ms
0x03	2	ms
0x04 - 0x0F	<i>reserved</i>	

Table 137—PHY Type parameter encoding

PHY Type	Value
TDD	0
FDD	1

8.1.3.1 FDD operation

In FDD operation, the uplink and downlink channels are on separate frequencies. The capability of the downlink to be transmitted in bursts facilitates the use of different modulation types and allows the system to simultaneously support full-duplex SSs (which can transmit and receive simultaneously) and half-duplex SSs (which do not). Note that the downlink carrier may be continuous, as demonstrated in Figure 138 (third frame). Figure 138 describes the basics of the FDD operation.

In the case of a half-duplex SS, transition gaps, as described in 8.1.3.2.1 and 8.1.3.2.2, apply.

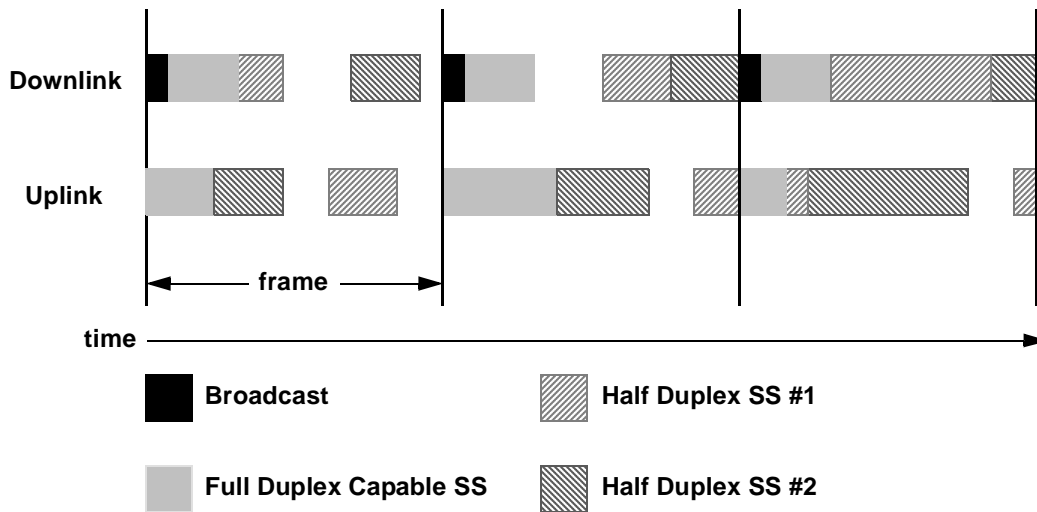

Figure 138—Example of FDD bandwidth allocation

8.1.3.2 TDD operation

In the case of TDD, the uplink and downlink transmissions share the same frequency but are separated in time, as shown in Figure 139. A TDD frame also has a fixed duration and contains one downlink and one uplink subframe. The TDD framing is adaptive in that the link capacity allocated to the downlink versus the uplink may vary.

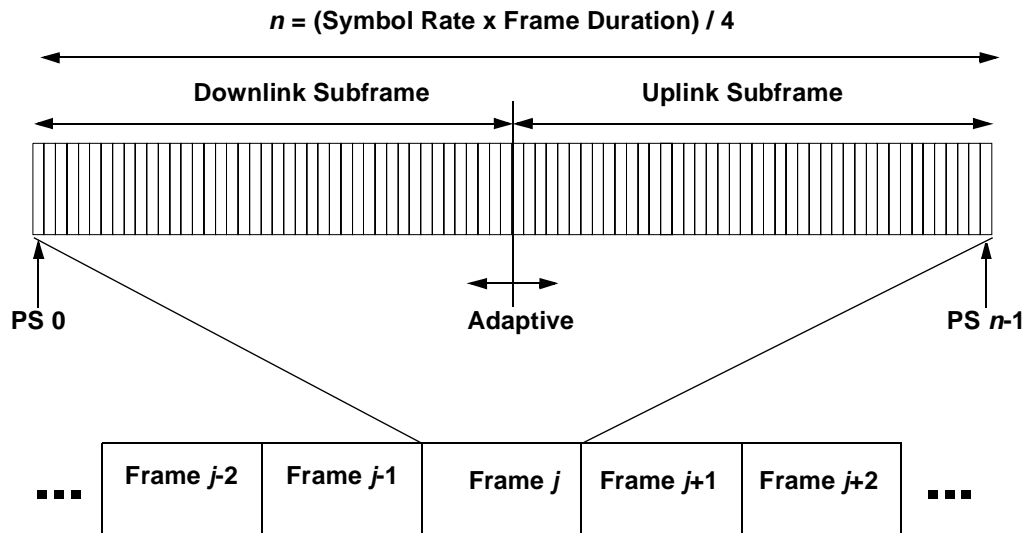

Figure 139—TDD frame structure

8.1.3.2.1 TTG

The TTG is a gap between the downlink burst and the subsequent uplink burst. This gap allows time for the BS to switch from transmit to receive mode and SSs to switch from receive to transmit mode. During this gap, the BS and SS are not transmitting modulated data but simply allowing the BS transmitter carrier to ramp down, the transmit/receive (Tx/Rx) antenna switch to actuate, and the BS receiver section to activate. After the gap, the BS receiver shall look for the first symbols of uplink burst. This gap is an integer number of PS durations and starts on a PS boundary.

8.1.3.2.2 RTG

The RTG is a gap between the uplink burst and the subsequent downlink burst. This gap allows time for the BS to switch from receive to transmit mode and SSs to switch from transmit to receive mode. During this gap, the BS and SS are not transmitting modulated data but simply allowing the BS transmitter carrier to ramp up, the Tx/Rx antenna switch to actuate, and the SS receiver sections to activate. After the gap, the SS receivers shall look for the first symbols of QPSK modulated data in the downlink burst. This gap is an integer number of PS durations and starts on a PS boundary.

8.1.4 Downlink PHY

The available bandwidth in the downlink direction is defined with a granularity of one PS. The available bandwidth in the uplink direction is defined with a granularity of one minislot, where the minislot length is 2^m PSs (m ranges from 0 through 7). The number of PSs with each frame is a function of the symbol rate.

The symbol rate is selected in order to obtain an integral number of PSs within each frame. For example, with a 20 MBd symbol rate, there are 5000 PSs within a 1 ms frame.

8.1.4.1 Downlink subframe

The structure of the downlink subframe using TDD is illustrated in Figure 140. The downlink subframe begins with a Frame Start Preamble used by the PHY for synchronization and equalization. This is followed by the frame control section, containing DL-MAP and UL-MAP stating the PSs at which bursts begin. The following TDM portion carries the data, organized into bursts with different burst profiles and therefore different level of transmission robustness. The bursts are transmitted in order of decreasing robustness. For example, with the use of a single FEC type with fixed parameters, data begins with QPSK modulation, followed by 16-QAM, followed by 64-QAM. In the case of TDD, a TTG separates the downlink subframe from the uplink subframe.

Each SS receives and decodes the control information of the downlink and looks for MAC headers indicating data for that SS in the remainder of the downlink subframe.

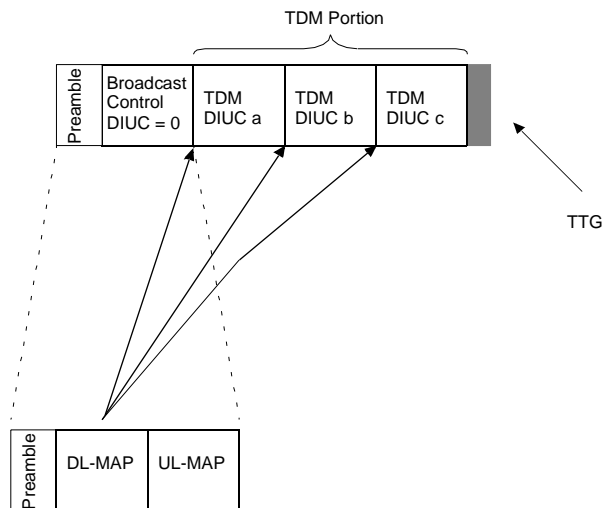

Figure 140—TDD downlink subframe structure

In the FDD case, the structure of the downlink subframe is illustrated in Figure 141. Like the TDD case, the downlink subframe begins with a Frame Start Preamble followed by a frame control section and a TDM portion organized into bursts transmitted in decreasing order of burst profile robustness. This TDM portion of the downlink subframe contains data transmitted to one or more of the following:

- Full-duplex SSs
- Half-duplex SSs scheduled to transmit later in the frame than they receive
- Half-duplex SSs not scheduled to transmit in this frame

The FDD downlink subframe continues with a TDMA portion used to transmit data to any half-duplex SSs scheduled to transmit earlier in the frame than they receive. This allows an individual SS to decode a specific portion of the downlink without the need to decode the entire downlink subframe. In the TDMA portion, each burst begins with the Downlink TDMA Burst Preamble for phase resynchronization. Bursts in

the TDMA portion need not be ordered by burst profile robustness. The FDD frame control section includes a map of both the TDM and TDMA bursts.

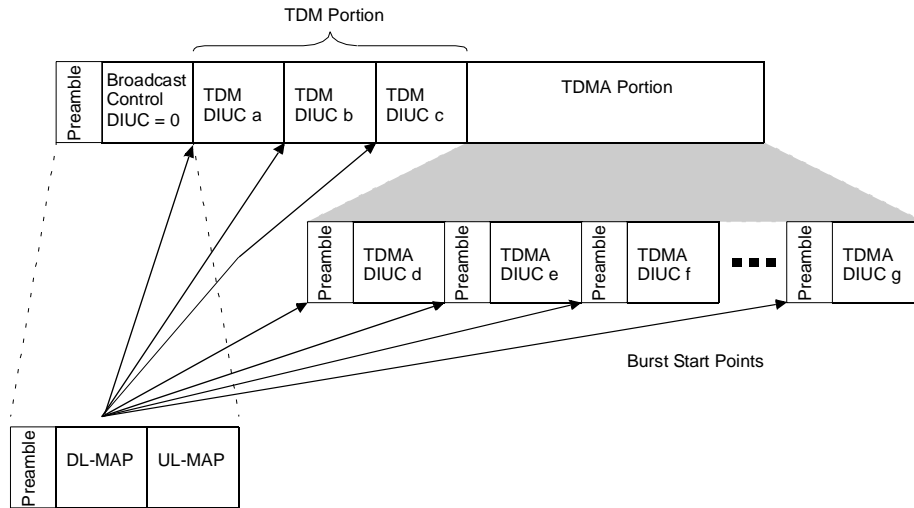

Figure 141—FDD downlink subframe structure

The TDD downlink subframe, which inherently contains data transmitted to SSs that transmit later in the frame than they receive, is identical in structure to the FDD downlink subframe for a frame in which no half-duplex SSs are scheduled to transmit before they receive.

8.1.4.1.1 Downlink burst preambles

As shown in Table 138, two downlink burst preambles are used. The Frame Start Preamble shall begin each downlink frame. The Downlink TDMA Burst Preamble shall begin each TDMA burst in the TDMA portion of the downlink subframe.

Table 138—Downlink burst preambles

Preamble name	Burst profile	Preamble type	Modulation type
Frame Start Preamble	TDM Burst	1	QPSK
Downlink TDMA Burst Preamble	TDMA Burst	2	QPSK

Both preambles use QPSK modulation and are based upon +45 degrees rotated constant amplitude zero autocorrelation (CAZAC) sequences (Milewski [B38]). The amplitude of the preamble shall depend on the downlink power adjustment rule (8.1.4.4.7). In the case of the constant peak power scheme (power adjustment rule = 0), the preamble shall be transmitted such that its constellation points coincide with the outermost constellation points of the modulation(s) scheme in the burst. In the case of the constant mean power scheme (power adjustment rule = 1), it shall be transmitted with the mean power of the constellation points of the modulation scheme(s) in the burst.

The Frame Start Preamble (Table 139) consists of a 32-symbol sequence generated by repeating a 16-symbol CAZAC sequence. The Downlink TDMA Burst Preamble (Table 140) consists of a 16-symbol sequence generated by repeating an 8-symbol CAZAC sequence.

Table 139—Frame start preamble

Symbol	I	Q	B(1)	B(2)
1 and 17	1	1	0	0
2 and 18	1	1	0	0
3 and 19	-1	1	1	0
4 and 20	-1	-1	1	1
5 and 21	-1	1	1	0
6 and 22	1	-1	0	1
7 and 23	-1	1	1	0
8 and 24	1	1	0	0
9 and 25	-1	-1	1	1
10 and 26	-1	-1	1	1
11 and 27	-1	1	1	0
12 and 28	-1	-1	1	1
13 and 29	1	-1	0	1
14 and 30	-1	1	1	0
15 and 31	-1	1	1	0
16 and 32	1	1	0	0

Table 140—Downlink TDMA burst preamble

Symbol	I	Q	B(1)	B(2)
1 and 9	-1	-1	1	1
2 and 10	-1	1	1	0
3 and 11	-1	-1	1	1
4 and 12	1	1	0	0
5 and 13	1	1	0	0
6 and 14	-1	1	1	0
7 and 15	1	1	0	0
8 and 16	1	1	0	0

8.1.4.1.2 Frame control section

The frame control section is the first portion of the downlink frame following the preamble. It is used for control information destined for all SSs. This control information shall not be encrypted. The information transmitted in this section always uses the well-known downlink burst profile with DIUC=0.

The frame control section shall contain a DL-MAP message (6.3.2.3.2) for the channel followed by one UL-MAP message (6.3.2.3.4) for each associated uplink channel. In addition, it may contain DCD and UCD messages (6.3.2.3.1 and 6.3.2.3.3) following the last UL-MAP message. No other messages shall be sent in the frame control section.

8.1.4.1.2.1 DL-MAP elements

The IEs as defined in Table 141 follow the Number of DL-MAP Elements field of the DL-MAP message, as described in 6.3.2.3.2. The Map IEs shall be in chronological order. Note that this is not necessarily DIUC order (as DIUC numbering does not necessarily reflect robustness of the burst profile) or CID order.

Table 141—SC DL-MAP_IE

Syntax	Size	Notes
DL-MAP_IE() {		
DIUC	4	
StartPS	16	The starting point of the burst, in units of PS where the first PS in a given frame has StartPS=0
if (CID use enabled by burst profile) {		
CID	16 bits	Unicast, multicast, or broadcast value
}		
}		

8.1.4.1.2.2 DL-MAP PHY synchronization field definition

The format of the PHY Synchronization Field of the DL-MAP message, as described in 6.3.2.3.2, is given in Table 142.

Network Configuration Type

Defines the network configuration type. If the network is DM then an FCH expected field is included. This is a 16-bit field that defines when the frame preamble and FCH will next be transmitted. As this transmission will be directed to a given SS, it is effectively a private transmission to that SS.

Frame Duration Code

Defined in Table 136.

Frame Number

Incremented by 1 each frame and eventually wraps around to zero.

FCH expected

The FCH expected will indicate the transmission of a DL-MAP, UL-MAP, DCD or UCD. For network entry of DM it is possible to increase the frequency of occurrence of FCH transmission to

assist new nodes to enter the network. The frequency can be reduced for the case of steady state network operation.

Table 142—SC PHY synchronization field

Syntax	Size	Notes
PHY Synchronization Field() {		
Network Configuration Type (NCT)	4 bits	Flag to indicate network configuration Type 0 = PMP, 1 = DM, 2 = PtP, 3 – 15 <i>Reserved</i>
Frame Duration Code	4 bits	
Frame Number	24 bits	
if (NCT == DM) {		
FCH expected	16 bits	The number of frames before the Frame Preamble and FCH will be transmitted again.
}		
}		

8.1.4.1.2.3 UL-MAP allocation start time definition

The allocation start time is the effective start time of the uplink allocation defined by the UL-MAP in units of minislots. The start time is relative to the start of the frame in which the UL-MAP message is transmitted.

8.1.4.1.2.4 Required DCD parameters

The following parameters shall be included in the DCD message:

- BS Transmit Power

NOTE—to be used by SSs to validate radio link conditions

- PHY type
- FDD/TDD frame duration

8.1.4.1.2.5 Downlink_Burst_Profile

Each Downlink_Burst_Profile in the DCD message (6.3.2.3.1) shall include the following parameters:

- Modulation type
- FEC Code Type
- Last codeword length
- DIUC mandatory exit threshold
- DIUC minimum entry threshold
- Preamble Presence

If the FEC Code Type is 1, 2, or 3 (RS codes), the Downlink_Burst_Profile shall also include

- RS information bytes (K)
- RS parity bytes (R)

If the FEC Code Type is 2, the Downlink_Burst_Profile shall also include

- BCC code type

If the FEC Code Type is 4, the Downlink_Burst_Profile shall also include

- Block Turbo Code (BTC) row code type
- BTC column code type
- BTC interleaving type

The mapping between Burst Profile and DIUC is given in Table 143.

Table 143—Mapping of burst profile to DIUC

Burst profile	DIUC
Downlink Burst Profile 1	0
Downlink Burst Profile 2	1
Downlink Burst Profile 3	2
Downlink Burst Profile 4	3
Downlink Burst Profile 5	4
Downlink Burst Profile 6	5
Downlink Burst Profile 7	6
Downlink Burst Profile 8	7
Downlink Burst Profile 9	8
Downlink Burst Profile 10	9
Downlink Burst Profile 11	10
Downlink Burst Profile 12	11
Downlink Burst Profile 13	12
<i>reserved</i>	13
Gap	14
End of DL-MAP	15

The Downlink Burst Profile 1 (DIUC = 0) parameters defined in 8.1.4.4.5 shall be stored in the SS and shall not be included in the DCD message.

The Gap Downlink Burst Profile (DIUC = 14) indicates a silent interval in downlink transmission. It is well-known and shall not be defined in the DCD message.

The End of DL-MAP Burst Profile (DIUC = 15) indicates the first PS after the end of the downlink subframe. It is well known and shall not be included in the DCD message.

Table 144 defines the format of the Downlink_Burst_Profile, which is used in the DCD message (6.3.2.3.1). The Downlink_Burst_Profile is encoded with a Type of 1, an 8-bit length, and a 4-bit DIUC. The DIUC field is associated with the Downlink Burst Profile and Thresholds. The DIUC value is used in the DL-MAP message to specify the Burst Profile to be used for a specific downlink burst.

Table 144—SC Downlink_Burst_Profile format

Syntax	Size	Notes
Type=1	8 bits	
Length	<i>variable</i>	
<i>reserved</i>	4 bits	Shall be set to zero
DIUC	4 bits	
TLV encoded information	<i>variable</i>	TLV Specific

8.1.4.2 Downlink burst allocation

The downlink data sections are used for transmitting data and control messages to the specific SSs. The data are always FEC coded and are transmitted at the current operating modulation of the individual SS. In the TDM portion, data shall be transmitted in order of decreasing burst profile robustness. In the case of a TDMA portion, the data are grouped into separately delineated bursts that need not be in robustness order (see 8.1.4.1). The DL-MAP message contains a map stating at which PS the burst profile changes occur. In the case of TDMA, if the downlink data does not fill the entire downlink subframe, the transmitter is shut down. FEC codewords within a burst are arranged in a compact form aligned to bit-level boundaries. This implies that, while the first FEC codeword shall start on the first PS boundary, succeeding FEC codewords may start even within a modulation symbol or within a PS if the succeeding FEC codeword ended within a modulation symbol or within a PS. The exact alignment conditions depend on the burst profile parameters.

In the case of shortening the last FEC block within a burst (optional, see 11.4.2), the DL-MAP provides an implicit indication.

In general, the number of PSs i (which shall be an integer) allocated to a particular burst can be calculated from the DL-MAP, which indicates the starting position of each burst as well as the burst profiles. Let n denote the minimum number of PSs required for one FEC codeword of the given burst profile (note that n is not necessarily an integer). Then, $i = kn + j + q$, where k is the number of whole FEC codewords that fit in the burst, j (not necessarily an integer) is the number of PSs occupied by the largest possible shortened codeword, and q ($0 \leq q < 1$) is the number of PSs occupied by pad bits inserted at the end of the burst to guarantee that i is an integer. In Fixed Codeword Operation (8.1.4.4.1), j is always 0. Recall that a codeword can end partway through a modulation symbol as well as partway through a PS. When this occurs, the next codeword shall start immediately, with no pad bits inserted. At the end of the burst (i.e., when there is no next codeword), then $4q$ symbols are added as padding (if required) to complete the PS allocated in the DL-MAP. The number of padding bits in these padding symbols is $4q$ times the modulation density, where the modulation density is 2 for QPSK, 4 for 16-QAM, and 6 for 64-QAM. Note that padding bits may be required with or without shortening. Either k or j , but not both, may be zero. The number j implies some number of bits b . Assuming j is nonzero, it shall be large enough such that b is larger than the number of FEC bits, r , added by the FEC scheme for the burst. The number of bits (preferably an integral number of bytes) available for user data in the shortened FEC codeword is $b-r$. Any bits that may be left over from a

fractional byte are encoded as binary 1 to ensure compatibility with the choice of 0xFF for pad. A codeword cannot have less than six information bytes. This is illustrated in Figure 142.

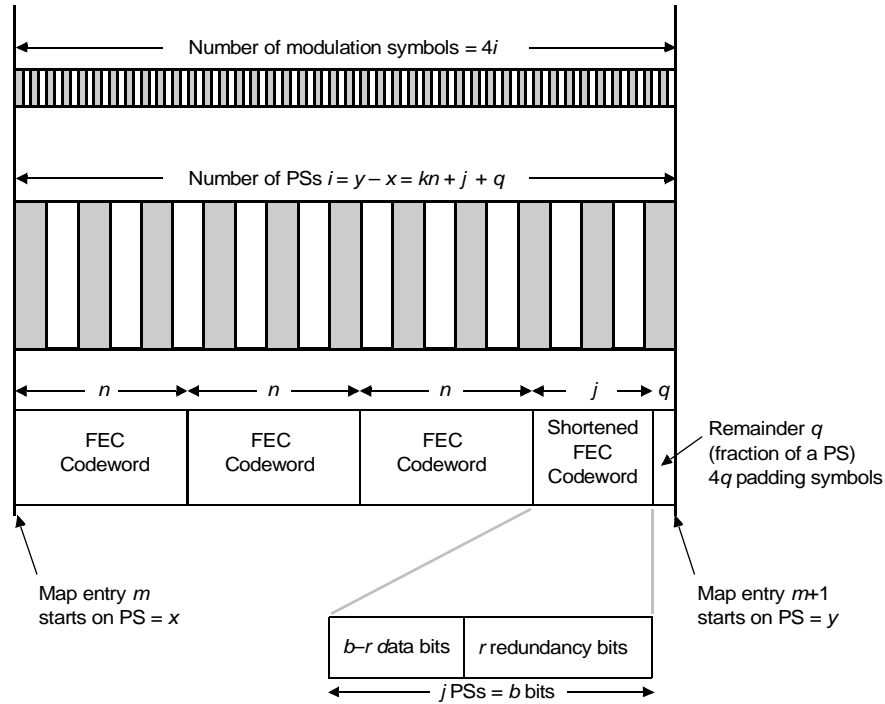
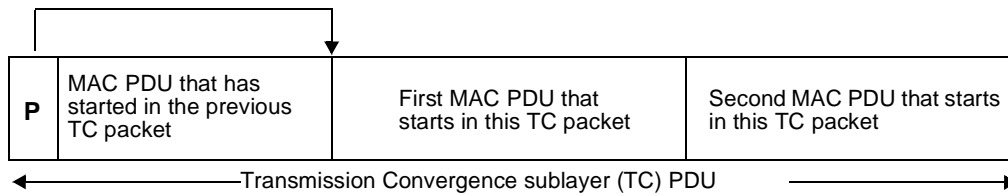

Figure 142—DL-MAP usage with shortened FEC blocks—TDM case

In the case of TDMA downlink, a burst includes the Downlink TDMA Burst Preamble of length p PSs, and the DL-MAP entry points to its beginning (Figure 143).

8.1.4.3 Downlink Transmission Convergence sublayer

The downlink payload shall be segmented into blocks of data designed to fit into the proper codeword size after the CS pointer byte is added. Note that the payload length may vary, depending on whether shortening of codewords is allowed or not for this burst profile. A pointer byte shall be added to each payload segment, as illustrated in Figure 144.



P = 1 byte pointer field

Figure 144—Format of the downlink Transmission Convergence sublayer PDU

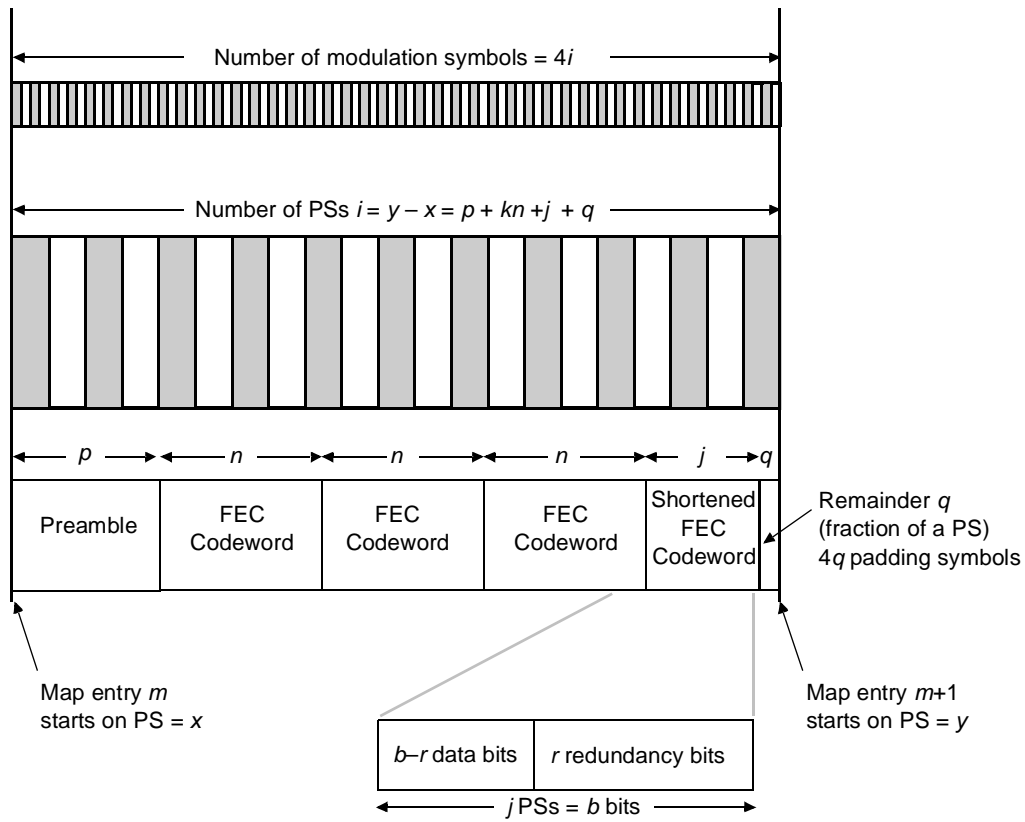

Figure 143—DL-MAP usage with shortened FEC blocks—TDMA case

The pointer field identifies the byte number in the packet, which indicates either the beginning of the first MAC PDU to start in the packet or the beginning of any stuff bytes that precede the next MAC PDU. For reference, the first byte in the packet is referred to as byte number 1. If no MAC PDU or stuff bytes begin in the CS packet, then the pointer byte is set to 0. When no data is available to transmit, a stuff_byte pattern having a value (0xFF) shall be used within the payload to fill any gaps between the IEEE 802.16 MAC PDUs. This value is chosen as an unused value for the first byte of the IEEE 802.16 MAC PDU, which is designed to never have this value.

8.1.4.4 Downlink PMD sublayer

The downlink PHY coding and modulation for this mode is summarized in the block diagram in Figure 145.

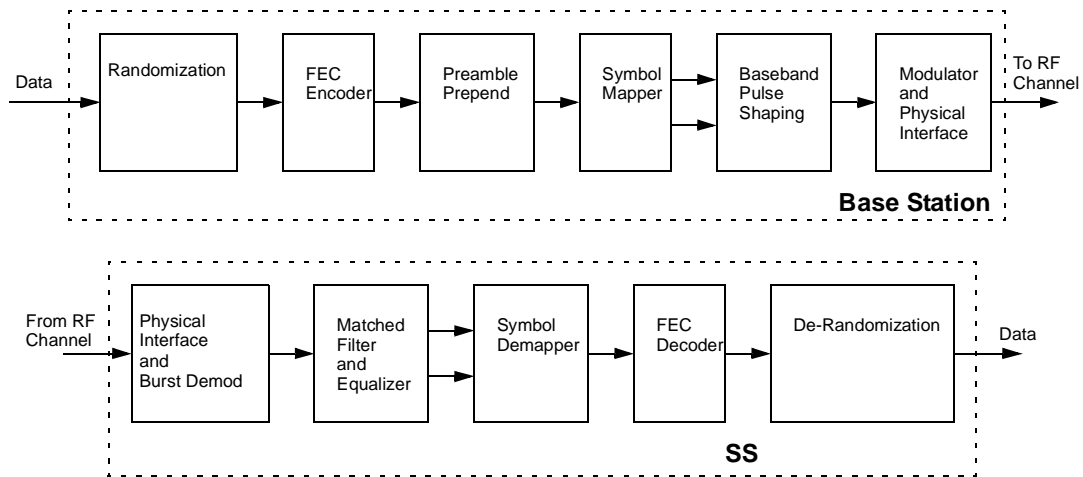

Figure 145—Conceptual block diagram of the downlink PMD sublayer

8.1.4.4.1 Burst profile definitions

The downlink channel supports adaptive burst profiling on the user data portion of the frame. Up to twelve burst profiles can be defined. The parameters of each are communicated to the SSs via MAC messages during the frame control section of the downlink frame (see 8.1.4.1). The downlink channel and burst profiles are communicated to the SSs via the MAC messages described in 6.3.2.3.1.

The use of DIUCs shall be constrained as shown in Table 145.

Table 145—SC DIUC allocation

DIUC	Usage
0	frame control (well known, not in DCD message)
1–6	TDM Burst Profiles (no preamble)
7–12	TDMA Burst Profiles (preamble prefixed)
13	<i>reserved</i>
14	Gap (well known, not in DCD message)
15	End of Map

8.1.4.4.2 Downlink PHY SS capability set parameters

Since there are optional modulation and FEC schemes that can be implemented at the SS, a method for identifying the capability to the BS is required (i.e., including the highest order modulation supported, the

optional FEC coding schemes supported, and the minimum shortened last codeword length supported). This information shall be communicated to the BS during the subscriber registration period.

8.1.4.4.3 Randomization

Randomization shall be employed to minimize the possibility of transmission of an unmodulated carrier and to ensure adequate numbers of bit transitions to support clock recovery. The stream of downlink packets shall be randomized by modulo-2 addition of the data with the output of the pseudo-random binary sequence (PRBS) generator, as illustrated in Figure 146. The generator polynomial for the PRBS shall be $c(x) = x^{15} + x^{14} + 1$.

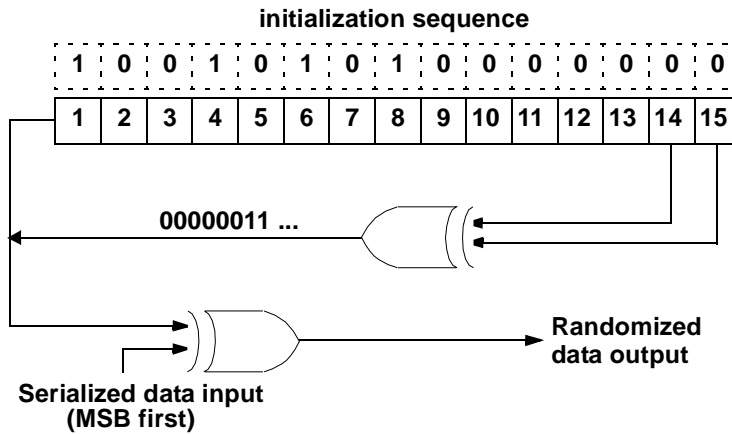

Figure 146—Randomizer logic diagram

At the beginning of each burst, the PRBS register is cleared and the seed value of 100101010000000 is loaded. A burst corresponds to either a TDM burst beginning with the Frame Start Preamble or a TDMA burst beginning with a Downlink TDMA Burst Preamble (8.1.4.1.1). The seed value shall be used to calculate the randomization bits, which are combined in an XOR operation with the serialized bit stream of each burst. The randomizer sequence is applied only to information bits.

8.1.4.4.4 Downlink FEC

The FEC schemes are selectable from the types in Table 146.

Table 146—FEC Code Types

Code Type	Outer Code	Inner Code
1	Reed–Solomon over Galois field (GF) (256)	None
2	Reed–Solomon over GF(256)	(24,16) Block convolutional code
3 (Optional)	Reed–Solomon over GF(256)	(9,8) Parity check code
4 (Optional)	BTC	—

Implementation and use of Code Types 3 and 4 is optional. Code Types 1 and 2 shall be implemented by all BSs and SSs. Code Type 2 shall not be used except in the case of QPSK modulation. In the case of QPSK, any of the four Code Types may be used, with one exception: Code Type 2 shall always be used for the control channel (DIUC=0).

Following is a summary of the four Code Types:

- a) **Code Type 1: Reed–Solomon only:** This case is useful either for a large data block or when high coding rate is required. The protection could vary between $t = 0$ to $t = 16$.
- b) **Code Type 2: Reed–Solomon + Block convolutional code (soft decodable):** This case is useful for low to moderate coding rates providing good carrier-to-noise ratio (C/N) enhancements. The coding rate of the inner block convolutional code (BCC) is $2/3$. Note: The number of information bytes shall be even in this case.
- c) **Code Type 3: Reed–Solomon + Parity check:** This optional code is useful for moderate to high coding rates with small to medium size blocks (i.e., $K = 16, 53,$ or 128). The code itself is a simple bit wise parity check operating on byte (8 bit) level. The parity code can be used for error correction, preferably employing a soft decoder.
- d) **Code Type 4: BTC:** This optional code is used to significantly lower the required carrier-to-interference ratio (C/I) level needed for reliable communication, and can be used to either extend the range of a BS or increase the code rate for greater throughput.

8.1.4.4.1 Outer code for Code Types 1–3, downlink

The outer block code for Code Types 1–3 shall be a shortened, systematic Reed–Solomon code generated from GF(256) with information block length K variable from 6–255 bytes and error correction capability T able to correct from 0 to 16 byte errors. The specified code generator polynomials are given by:

$$\text{Code Generator Polynomial: } g(x) = (x + \mu^0)(x + \mu^1)(x + \mu^2) \dots (x + \mu^{2T-1}), \text{ where } \mu = 02_{\text{hex}}$$

$$\text{Field Generator Polynomial: } p(x) = x^8 + x^4 + x^3 + x^2 + 1$$

The specified code has a block length of 255 bytes and shall be configured as an RS(255,255- R) code with information bytes preceded by (255- N) zero symbols, where N is the codeword length and R the number of redundancy bytes ($R = 2 \times T$ ranges from 0 to 32, inclusive).

The value of K and T are specified for each burst profile by the MAC. Both Fixed Codeword Operation and Shortened Last Codeword Operation, as defined below, are allowed.

When using Code Type 2, the number of information bytes K shall always be an even number so that the total codeword size ($K+R$) is also an even number. This is due to the fact that the BCC code requires a pair of bytes on which to operate.

a) Fixed Codeword Operation

In Fixed Codeword Operation, the number of information bytes K is the same in each Reed–Solomon codeword. If the MAC messages in a burst require fewer bytes than are carried by an integral number of codewords, stuff bytes (FF_{hex}) shall be added between MAC messages or after the last MAC message so that the total message length is an integral multiple of K bytes.

The SS determines the number of codewords in its downlink burst from the DL-MAP message, which defines the beginning point of each burst, and hence the length. The BS determines the number of codewords in the downlink as it scheduled this transmission event and is aware about its length. Using the burst length, both the SS and the BS calculate the number of full-length RS codewords that can be carried by each burst.

The process used by the BS to encode each burst is described below:

When the number of randomized MAC message bytes (M) entering the FEC process is less than K bytes, Operation A shall be performed:

- A1) Add $(K-M)$ stuff bytes (FF_{hex}) to the M byte block as a suffix.**
- A2) RS encode the K bytes and append the R parity bytes.**
- A3) Serialize the bytes and transmit them to the inner coder or the modulator most significant bit first.**

When the number of randomized MAC message bytes (M) entering the FEC process is greater than or equal to K bytes, Operation B shall be performed:

- B1) RS encode the first K bytes and append the R parity bytes.**
- B2) Subtract K from M (Let $M = M - K$).**
- B3) If the new M is greater than or equal to K , then repeat with the next set of bytes (go to B1).**
- B4) If the new M is zero, then stop; otherwise go to step A1 above and process the $M < K$ case.**

b) Shortened Last Codeword Operation

In the Shortened Last Codeword Operation, the number of information bytes in the final Reed–Solomon block of each burst is reduced from the normal number K , while the number of parity bytes R remains the same. The BS tailors the number of information bytes in the last codeword in order to minimize the number of stuff bytes to add to the end of the MAC message. The length of the burst is then set to the minimum number of PSs required to transport all of the burst's bytes, which include preamble, information, and parity bytes. The BS implicitly communicates the number of bytes in the shortened last codeword to the SS via the DL-MAP message, which defines the starting PS of each burst. The SS uses the DL-MAP information to calculate the number of full-length RS codewords and the length of the shortened last codeword that can be carried within the specified burst size. The BS performs a similar calculation as the SS for its encoding purposes.

To allow the receiving hardware to decode the previous Reed–Solomon codeword, no Reed–Solomon codeword shall have less than 6 information bytes. The number of information bytes carried by the shortened last codeword shall be between 6 and K bytes, inclusive. If the number of information bytes needing to be sent by the BS is less than 6 bytes of data, stuff bytes (FF_{hex}) shall be appended to the end of the data to bring the total number of information bytes up to the minimum of 6.

When using Code Type 2, the number of information bytes in the shortened last codeword shall always be an even number so that the total codeword size is also an even number. If an odd number of information bytes needs to be sent, a stuff byte (FF_{hex}) shall be appended to the end of the message to obtain an even number of bytes.

The process used by the BS to encode each burst is described below:

First, the full-sized Reed–Solomon codewords that precede the burst's final codeword are encoded as in the Fixed Codeword Mode above. The number of bytes allocated for the shortened last codeword by the UL-MAP is k' bytes, which shall be between 6 and K bytes. The remaining M bytes of the message are then encoded into these k' bytes using the following procedure:

- A1) Add $(K-k')$ zero bytes to the M byte block as a prefix.**
- A2) RS encode the K bytes and append the R parity bytes.**
- A3) Discard all of the $(K-k')$ zero RS symbols.**
- A4) Serialize the bytes and transmit them to the inner coder or the modulator most significant bit first.**
- A5) Perform the inner coding operation (if applicable).**

8.1.4.4.2 Inner code for Code Type 2, downlink

The inner code in Code Type 2 consists of short block codes derived from a 4-state, nonsystematic, punctured convolutional code (7,5). The trellis shall use the tail-biting method, where the last 2 bits of the message block are used to initialize the encoder memory, in order to avoid the overhead required for trellis termination. Thus, the encoder has the same initial and ending state for a message block.

For this concatenated coding scheme, the inner code message block is selected to be 16 bits. The puncturing pattern is described in Table 147 for the (24,16) case.

Table 147—Parameters of the inner codes for the BCC

Inner code rate	Puncture pattern G1 = 7, G2 = 5
2/3	11, 10

Figure 147 describes the exact encoding parity equations.

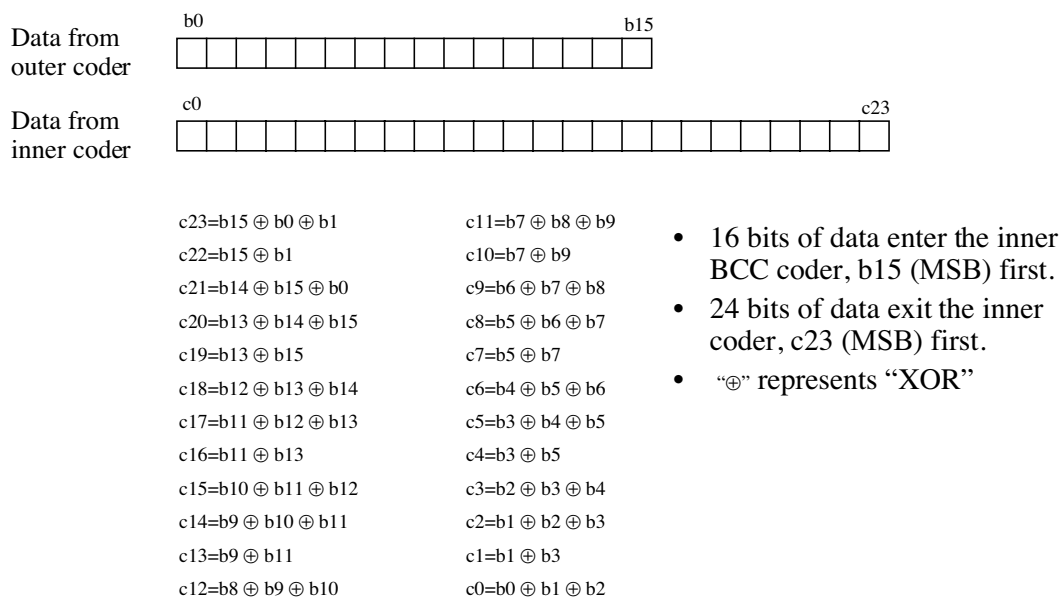

Figure 147—Inner code for Code Type 2 in the downlink

The number of information bytes shall be even since the BCC code operates on byte pairs.

8.1.4.4.3 Inner code for Code Type 3, downlink

For Code Type 3, a parity check bit is added to each Reed–Solomon (RS) symbol individually and inserted as the LSB of the resulting 9-bit word. The parity is an XOR operation on all 8 bits within the symbol.

8.1.4.4.4 Code Type 4, downlink

Code Type 4, the BTC, is a Turbo decoded Product Code (TPC). The idea of this coding scheme is to use extended Hamming block codes in a two-dimensional matrix. The two-dimensional code block is depicted in Figure 148. The k_x information bits in the rows are encoded into n_x bits, by using an extended Hamming binary block (n_x, k_x) code. Likewise, k_y information bits in the columns are encoded into n_y bits, by using the same or possibly different extended Hamming binary block (n_y, k_y) code. The resultant code block is comprised of multiple rows and columns of the constituent extended Hamming block codes.

For this standard, the rows shall be encoded first. After encoding the rows, the columns are encoded using another block code (n_y, k_y) , where the check bits of the first code are also encoded. The overall block size of such a product code is $n = n_x \times n_y$; the total number of information bits $k_x \times k_y$; and the code rate is $R = R_x \times R_y$, where $R_i = k_i/n_i$ and $i = x$ or y .

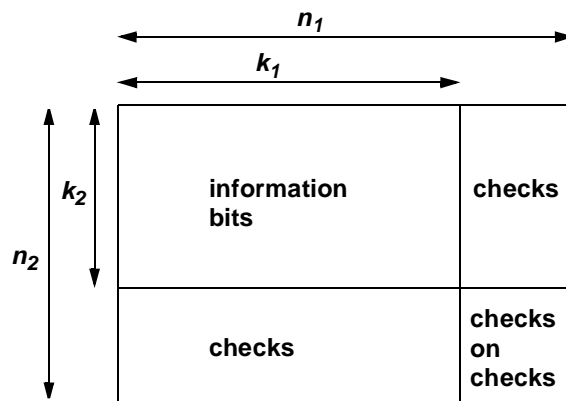

Figure 148—Two-dimensional product code matrix

Table 148 provides the generator polynomials of the constituent Hamming codes used in this specification.

Table 148—SC Hamming code generator polynomials

n	k	Generator polynomial
31	26	$x^5 + x^2 + 1$
63	57	$x^6 + x + 1$

The composite extended Hamming code specified requires addition of an overall even parity check bit at the end of each codeword.

The encoder for a BTC is composed of linear feedback shift registers (LFSRs), storage elements, and control logic. An example row (or column) encoder is shown here for clarification. The order of transmission is important so that the decoder may match for proper decoding. This specification mandates that the resultant code block be transmitted row by row, left to right, top to bottom, for the case when no interleaving is used (Interleaver Type 1 described below).

Figure 149 shows a sample LFSR based on a $x^4 + x + 1$ Hamming code polynomial to encode a (15,11) Hamming code. Also shown is an even parity computation register that results in an extended Hamming code. Note that encoders for the required (64,57) and (32,26) codes follow the same design concept. This figure is shown for clarification of the BTC encoder design and does not depict an actual design implementation.

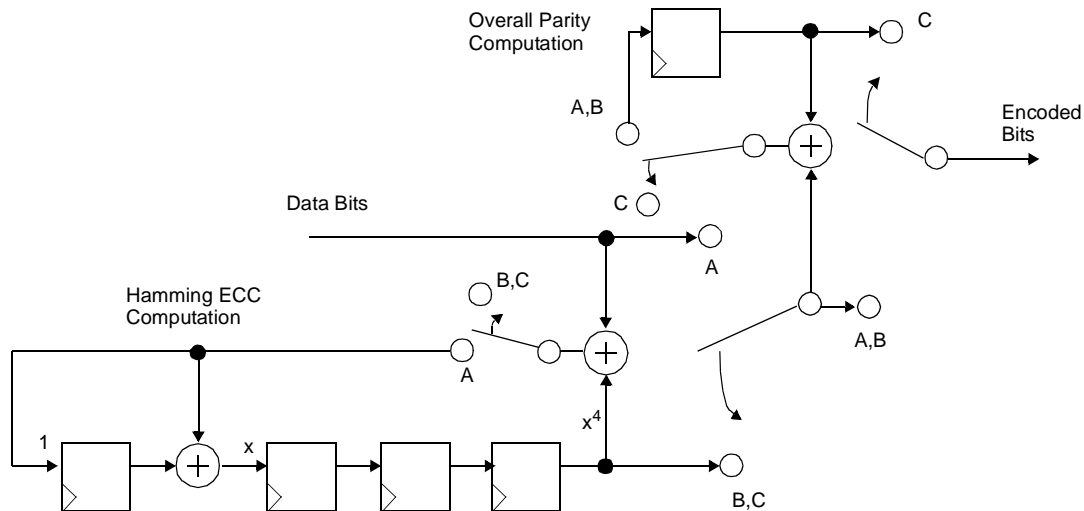

Figure 149—Example encoder for a (16,11) extended Hamming Code

The example circuit begins with all toggle switches in position A. Data to be encoded is fed as input one bit per clock (LSB first) to both the Hamming error correction code (ECC) computation logic and the overall even parity computation logic. Extended Hamming codes are systematic codes, so this data is also fed through as output on the encoded bit output. After all k bits are input, the toggle switches are moved to position B. At this point, data from the Hamming ECC logic is shifted out on the encoded bits bus. Finally, the overall parity bit is shifted out when the output select switch is moved to position C.

In order to encode the product code, each data bit is fed as input both into a row LFSR and a column LFSR. Note that only one row LFSR is necessary for the entire block, since data is written as input in row order. However, each column of the array shall be encoded with a separate LFSR. Each column LFSR is clocked for only one bit of the row, so a more efficient method of column encoding is to store the column LFSR states in a $k_x \times (n_y - k_y)$ storage memory. A single LFSR can then be used for all columns of the array. With each bit input, the appropriate column LFSR state is read from the memory, clocked, and written back to the memory.

The encoding process is demonstrated here with an example. Assume a two-dimensional $(8,4) \times (8,4)$ extended Hamming product code is to be encoded. This block has 16 data bits, and 64 total encoded bits. Table 149 shows the original 16 data bits denoted by D_{yx} , where y corresponds to a column and x corresponds to a row.

The first four bits of the array are fed into the row encoder input in the order $D_{11}, D_{21}, D_{31}, D_{41}$. Each bit is also fed as input into a unique column encoder. Again, a single column encoder may be used, with the state of each column stored in a memory. After the fourth bit is fed into the input, the first row encoder ECC bits are shifted out.

This process continues for all four rows of data. At this point, 32 bits have been taken as output from the encoder, and the four column encoders are ready to shift out the column ECC bits. This data is shifted out at

Table 149—Original data for encoding

D_{11}	D_{21}	D_{31}	D_{41}
D_{12}	D_{22}	D_{32}	D_{42}
D_{13}	D_{23}	D_{33}	D_{43}
D_{14}	D_{24}	D_{34}	D_{44}

the end of the row. This continues from the remaining three rows of the array. Table 150 shows the final encoded block with the 48 generated ECC bits denoted by E_{yx} .

Table 150—Encoded block

D_{11}	D_{21}	D_{31}	D_{41}	E_{51}	E_{61}	E_{71}	E_{81}
D_{12}	D_{22}	D_{32}	D_{42}	E_{52}	E_{62}	E_{72}	E_{82}
D_{13}	D_{23}	D_{33}	D_{43}	E_{53}	E_{63}	E_{73}	E_{83}
D_{14}	D_{24}	D_{34}	D_{44}	E_{54}	E_{64}	E_{74}	E_{84}
E_{15}	E_{25}	E_{35}	E_{45}	E_{55}	E_{65}	E_{75}	E_{85}
E_{16}	E_{26}	E_{36}	E_{46}	E_{56}	E_{66}	E_{76}	E_{86}
E_{17}	E_{27}	E_{37}	E_{47}	E_{57}	E_{67}	E_{77}	E_{87}
E_{18}	E_{28}	E_{38}	E_{48}	E_{58}	E_{68}	E_{78}	E_{88}

Transmission of the block over the channel occurs in a linear manner; all bits of the first row are transmitted left to right, followed by the second row, etc. This allows for the construction of a near zero-latency encoder, since the data bits can be sent immediately over the channel, with the ECC bits inserted as necessary. For the $(8,4) \times (8,4)$ example, the output order for the 64 encoded bits is $D_{11}, D_{21}, D_{31}, D_{41}, E_{51}, E_{61}, E_{71}, E_{81}, D_{12}, D_{22}, \dots, E_{88}$.

For easier readability, the following notation is used:

- The codes defined for the rows (x -axis) are binary (n_x, k_x) block codes.
 - The codes defined for the columns (y -axis) are binary (n_y, k_y) block codes.
 - Data bits are noted D_{yx} and parity bits are noted E_{yx} .
- a) *Shortened BTC*: To match packet sizes, removing symbols from the array shortens a product code. In general, rows or columns are removed until the appropriate size is reached. Codes selected shall have an integral number of information bytes. Different shortening approaches are applicable for BTC. In one method, rows and columns are deleted completely from an initial BTC array. For example, a 253 byte code is generated by starting with $(64, 57)$ constituent codes and deleting thirteen rows and eleven columns. Another method uses a more systematic two-dimensional shortening. For example, a 128 byte BTC code is composed of $(64, 57)$ constituent codes which are shortened by 25 rows and 25 columns, as described in Figure 150. The end result is a $(39, 32) \times (39, 32)$ array, which is capable of encoding $32 \times 32 = 1024$ bits (128 bytes) of data. Table 151 summarizes these example codes. A method for determining codes for payload sizes different than these examples is given at the end of this subclause.

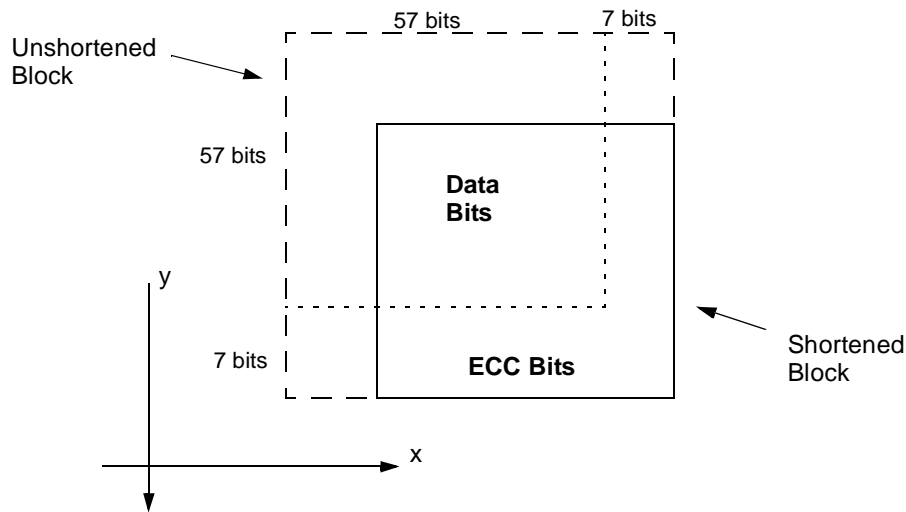

Figure 150—Structure of shortened 2 D block

Modifications to the encoder to support shortening are minimal. Since shortened bits are always zero, and zeros input to the encoder LFSR result in a zero state, the shortened bits can simply be ignored for the purpose of encoding. The encoder simply needs to know how many bits per row to input to the row LFSR before shifting out the result. Similarly, it must know the number of columns to input to the column encoders.

Transmission of the resultant code block shall start with the first data bit in the first row, proceed left to right and then row by row from top to bottom.

Table 151—Required block codes for the BTC option for the downlink channel

Code	(39,32)×(39,32)	(53,46)×(51,44)
Aggregate Code Rate	0.673	0.749
Uplink/Downlink/Both	Downlink	Downlink
Block size (payload bits)	1024 (128 bytes)	3136 (392 bytes)

- b) *Interleaving*: When using the Block Turbo Coding, two modes of bit interleaving shall be supported. The interleaver mechanism shall be implemented by writing information bits into the encoder memory and reading out the encoded bits as follows:
- 1) *Interleaver type 1*: No interleaver. In this mode, the encoded bits are read from the encoder row by row, in the order that they were written.
 - 2) *Interleaver type 2*: Block interleaver. In this mode, the encoded bits are read from the encoder after the first k_2 rows (Figure 148) are written into the encoder memory. The bits are read column by column, proceeding from the top position in the first column.
 - 3) *Interleaver type 3*: *Reserved*. It is expected that other interleaving methods may yield better performance in some cases. So, this Interleaver type 3 has been reserved for future definition.
- c) *Block mapping to the signal constellation*: The first encoded bit out shall be the LSB, which is the first bit written into the encoder.

- d) *Method for determining codes for payload size different than the listed examples:* The following text describes a method for performing additional codeword shortening when the input block of data does not match exactly the codeword information size.
- 1) Take the required payload as specified in bytes and convert it to bits (i.e., multiply by 8).
 - 2) Take the square root of the resultant number.
 - 3) Round the result up to the next highest integer.
 - 4) Select the smallest base constituent code from the available list that has a k value equal to or greater than the value determined in step 3).
 - 5) Subtract the value determined in step 3) from the k value selected in step 4). This value represents the number of rows and columns that need to be shortened from the base constituent code selected in step 4).

This method will generally result in a code block whose payload is slightly larger than required in step 1 above. In order to address the residual bits, the column dimension (n_y, k_y) should be shortened as needed and, as needed, zero bits may be stuffed into the last bits of the last row of the resulting code matrix. The zero bits in the last row should be discarded at the receiver.

Example: If a 20 byte payload code is desired, a (32,26)×(32,26) code is shortened by 13 rows and by 13 columns, resulting in a (19,13)×(19,13) code. There are 9 bits left over that are stuffed with zeros. Data input to the defined encoder is 160 data bits followed by 9 zero bits. The code block is transmitted starting with the bit in row 1 column 1 (the LSB), then left to right, and then row by row.

8.1.4.4.5 Definition of parameters for burst profile (DIUC=0)

The burst profile with DIUC=0 shall be configured with the parameters in Table 152.

Table 152—Parameters for burst profile (DIUC=0)

Parameter	Value	Comment
Modulation type	1	QPSK
FEC Code Type	2	RS + BCC
RS information bytes (K)	26	
RS parity bytes (R)	20	
BCC Code Type	1	(24,16)
Last codeword length	1	fixed

8.1.4.4.6 Coding of the control portion of the frame

The frame control section of the downlink frame (as defined in 8.1.4.1) shall be encoded with a fixed set of parameters known to the SS at initialization in order to ensure that all SSs can read the information. The modulation shall be QPSK, and the data shall be encoded with an outer (46,26) Reed–Solomon code and an inner (24,16) convolutional code. There shall be a minimum of two codewords per control portion of the frame when a downlink allocation map is present. When a UL-MAP is present, it shall be concatenated with the Downlink Allocation map to increase efficiency. This operation mode shall be designated as TDM Burst Profile 1 (DIUC = 0). Stuff bytes (FF_{hex}) shall be appended as necessary to the end of the control messages to fill up the minimum number of codewords.

8.1.4.4.7 Downlink modulation

To maximize utilization of the airlink, the PHY uses a multilevel modulation scheme. The modulation constellation can be selected per subscriber based on the quality of the RF channel. If link conditions permit, then a more complex modulation scheme can be utilized to maximize airlink throughput while still allowing reliable data transfer. If the airlink degrades over time, possibly due to environmental factors, the system can revert to the less complex constellations to allow more reliable data transfer.

In the downlink, the BS shall support QPSK and 16-QAM modulation and, optionally, 64-QAM.

The sequence of modulation bits shall be mapped onto a sequence of modulation symbols $S(k)$, where k is the corresponding symbol number. The number of bits per symbol depends on the modulation type. For QPSK, $n = 2$; for 16-QAM, $n = 4$; and for 64-QAM, $n = 6$. $B(m)$ denotes the modulation bit of a sequence to be transmitted, where m is the bit number (m ranges from 1 through n). In particular, $B(1)$ corresponds to the first bit entering the modulator, $B(2)$ corresponds to the second bit entering the modulation, and so on.

In changing from one burst profile to another, the BS shall use one of two power adjustment rules: maintaining constant constellation peak power (power adjustment rule = 0), or maintaining constant constellation mean power (power adjustment rule = 1). In the constant peak power scheme, corner points are transmitted at equal power levels regardless of modulation type. In the constant mean power scheme, the signal is transmitted at equal mean power levels regardless of modulation type. The power adjustment rule is configurable through the DCD Channel Encoding parameters (11.4.1).

At the end of each burst, the final FEC-encoded message might not end exactly on a PS boundary. If this is the case, the end of the encoded message to the start of the next burst shall be filled with zero bits.

The complex modulation symbol $S(k)$ shall take the value $I + jQ$. The following subclauses apply to the base-band part of the transmitter.

Figure 151 and Table 153 describe the bit mapping for QPSK modulation.

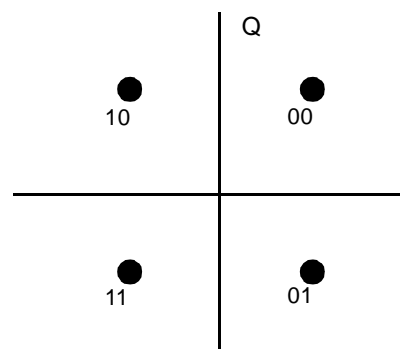

Figure 151—QPSK constellation

Table 153—QPSK bits to symbol mapping

B(1)	B(2)	I	Q
0	0	1	1
0	1	1	-1
1	0	-1	1
1	1	-1	-1

Figure 152 and Table 154 describe the bit mapping for 16-QAM modulation.

**Figure 152—16-QAM constellation (gray-coded)**

Table 154—16-QAM bits to symbol mapping

B(1)	B(2)	B(3)	B(4)	I	Q
0	1	0	1	3	3
0	1	0	0	3	1
0	1	1	0	3	-1
0	1	1	1	3	-3
0	0	0	1	1	3
0	0	0	0	1	1
0	0	1	0	1	-1
0	0	1	1	1	-3
1	0	0	1	-1	3
1	0	0	0	-1	1
1	0	1	0	-1	-1
1	0	1	1	-1	-3
1	1	0	1	-3	3
1	1	0	0	-3	1
1	1	1	0	-3	-1
1	1	1	1	-3	-3

Figure 153 and Table 155 describe the bit mapping for 64-QAM modulation.

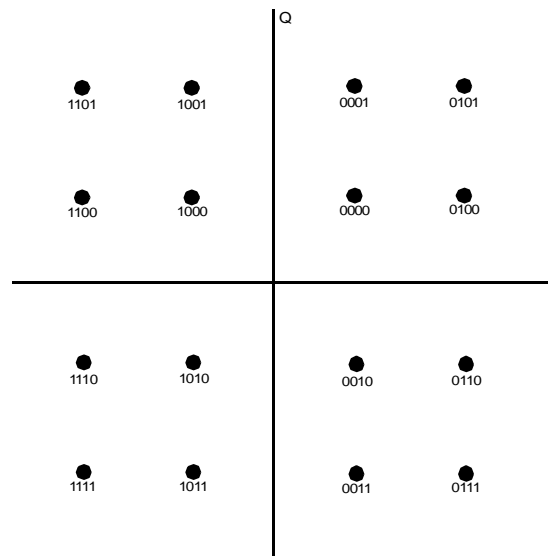
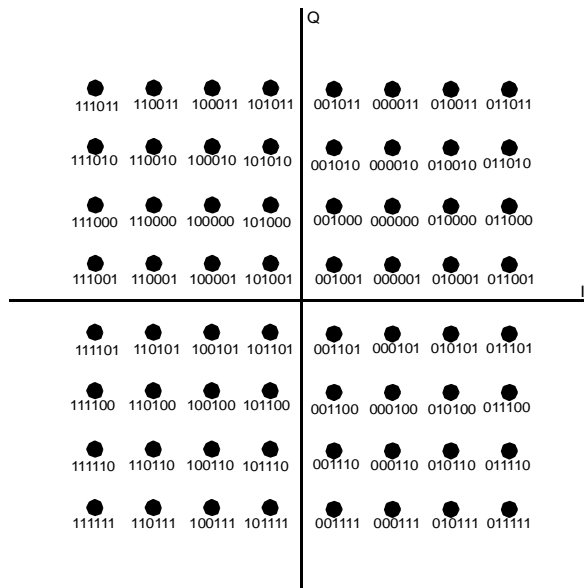

Figure 153—64-QAM constellation (gray-coded)

Table 155—64-QAM bits to symbol mapping

B(1)	B(2)	B(3)	B(4)	B(5)	B(6)	I	Q
0	1	1	0	1	1	7	7
0	1	1	0	1	0	7	5
0	1	1	0	0	0	7	3
0	1	1	0	0	1	7	1
0	1	1	1	0	1	7	-1
0	1	1	1	0	0	7	-3
0	1	1	1	1	0	7	-5
0	1	1	1	1	1	7	-7
0	1	0	0	1	1	5	7
0	1	0	0	1	0	5	5
0	1	0	0	0	0	5	3
0	1	0	0	0	1	5	1
0	1	0	1	0	1	5	-1
0	1	0	1	0	0	5	-3
0	1	0	1	1	0	5	-5
0	1	0	1	1	1	5	-7
0	0	0	0	1	1	3	7
0	0	0	0	1	0	3	5
0	0	0	0	0	0	3	3
0	0	0	0	0	1	3	1
0	0	0	1	0	1	3	-1
0	0	0	1	0	0	3	-3
0	0	0	1	1	0	3	-5
0	0	0	1	1	1	3	-7
0	0	1	0	1	1	1	7
0	0	1	0	1	0	1	5
0	0	1	0	0	0	1	3
0	0	1	0	0	1	1	1
0	0	1	1	0	1	1	-1
0	0	1	1	0	0	1	-3
0	0	1	1	1	0	1	-5
0	0	1	1	1	1	1	-7
1	0	1	0	1	1	-1	7

Table 155—64-QAM bits to symbol mapping (continued)

B(1)	B(2)	B(3)	B(4)	B(5)	B(6)	I	Q
1	0	1	0	1	0	-1	5
1	0	1	0	0	0	-1	3
1	0	1	0	0	1	-1	1
1	0	1	1	0	1	-1	-1
1	0	1	1	0	0	-1	-3
1	0	1	1	1	0	-1	-5
1	0	1	1	1	1	-1	-7
1	0	0	0	1	1	-3	7
1	0	0	0	1	0	-3	5
1	0	0	0	0	0	-3	3
1	0	0	0	0	1	-3	1
1	0	0	1	0	1	-3	-1
1	0	0	1	0	0	-3	-3
1	0	0	1	1	0	-3	-5
1	0	0	1	1	1	-3	-7
1	1	0	0	1	1	-5	7
1	1	0	0	1	0	-5	5
1	1	0	0	0	0	-5	3
1	1	0	0	0	1	-5	1
1	1	0	1	0	1	-5	-1
1	1	0	1	0	0	-5	-3
1	1	0	1	1	0	-5	-5
1	1	0	1	1	1	-5	-7
1	1	1	0	1	1	-7	7
1	1	1	0	1	0	-7	5
1	1	1	0	0	0	-7	3
1	1	1	0	0	1	-7	1
1	1	1	1	0	1	-7	-1
1	1	1	1	0	0	-7	-3
1	1	1	1	1	0	-7	-5
1	1	1	1	1	1	-7	-7

8.1.4.4.8 Baseband pulse shaping

Prior to modulation, the I and Q signals shall be filtered by square-root raised cosine filters. The excess bandwidth factor α shall be 0.25. The ideal square-root raised cosine filter is defined by the following transfer function H , as shown in Equation (12):

$$\begin{aligned}
 H(f) &= 1 && \text{for } |f| < f_N(1 - \alpha) \\
 H(f) &= \sqrt{\frac{1}{2} + \frac{1}{2} \sin \left[\frac{\pi}{2f_N} \left(\frac{f_N - |f|}{\alpha} \right) \right]} && \text{for } f_N(1 - \alpha) \leq |f| \leq f_N(1 + \alpha) \\
 H(f) &= 0 && \text{for } |f| > f_N(1 + \alpha)
 \end{aligned} \tag{12}$$

where $f_N = \frac{1}{2T_S} = \frac{R_S}{2}$ is the Nyquist frequency.

8.1.4.4.9 Transmitted waveform

The transmitted waveform at the antenna port $S(t)$ shall be:

$$S(t) = I(t)\cos(2\pi f_c t) - Q(t)\sin(2\pi f_c t) \tag{13}$$

where $I(t)$ and $Q(t)$ are the filtered baseband (pulse-shaped) signals of the I_k and Q_k symbols, k is the discrete symbol index, and f_c is the carrier frequency.

8.1.5 Uplink PHY

8.1.5.1 Uplink subframe

The structure of the uplink subframe used by the SS to transmit to the BS is shown in Figure 154. Three classes of bursts may be transmitted by the SS during the uplink subframe:

- Those that are transmitted in contention opportunities reserved for Initial Ranging.
- Those that are transmitted in contention opportunities defined by Request Intervals reserved for response to multicast and broadcast polls.
- Those that are transmitted in intervals defined by Data Grant IEs specifically allocated to individual SSs.

Any of these burst classes may be present in any given frame. They may occur in any order and any quantity (limited by the number of available PSs) within the frame, at the discretion of the BS uplink scheduler as indicated by the UL_MAP in the frame control section (part of the downlink subframe).

The bandwidth allocated for Initial Ranging and Request contention opportunities may be grouped together and is always used with the uplink burst profiles specified for Initial Ranging Intervals (UIUC = 2) and Request Intervals (UIUC = 1), respectively. The remaining transmission slots are grouped by the SS. During its scheduled bandwidth, an SS transmits with the burst profile specified by the BS.

SSTGs separate the transmissions of the various SSs during the uplink subframe. The gap allows for ramping down of the previous burst, followed by a preamble allowing the BS to synchronize to the new SS. The preamble and gap lengths are broadcast periodically in the UCD message.

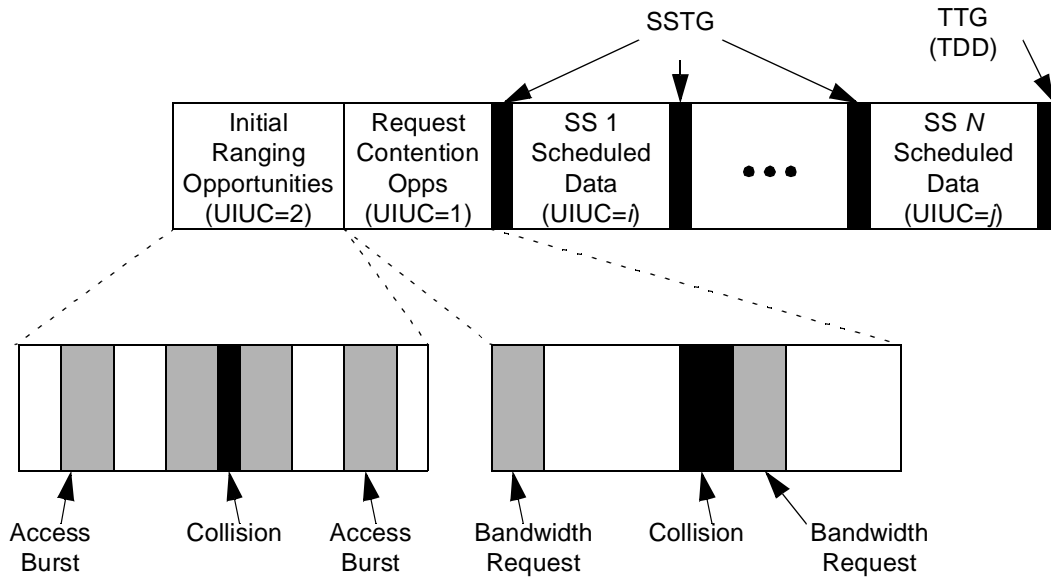

Figure 154—Uplink subframe structure

8.1.5.1.1 Uplink burst preamble

Each uplink burst shall begin with an uplink preamble. This preamble is based upon a repetition of a +45 degrees rotated constant amplitude zero auto-correlation (CAZAC) sequence (Milewski [B38]). The preamble length is either 16 symbols or 32 symbols. In the 16-symbol preamble (whose sequence is specified in Table 156), the CAZAC sequence is of length 8 and repeated once. In the 32-symbol preamble (whose sequence is specified in Table 157), the CAZAC sequence is of length 16 and repeated once.

Table 156—16-symbol uplink preamble sequence

Symbol	I	Q	$B(1)$	$B(2)$
1 and 9	1	1	0	0
2 and 10	-1	-1	1	1
3 and 11	-1	1	1	0
4 and 12	1	1	0	0
5 and 13	1	1	0	0
6 and 14	1	1	0	0
7 and 15	-1	1	1	0
8 and 16	-1	-1	1	1

The amplitude of the preamble shall depend on the uplink power adjustment rule (8.1.5.3.7). In the case of the constant peak power scheme (power adjustment rule = 0), the preamble shall be transmitted such that its constellation points coincide with the outermost constellation points of the modulation scheme in use. In the case of the constant mean power scheme (power adjustment rule = 1), it shall be transmitted with the mean power of the constellation points of the modulation scheme in use.

The BS defines the preamble length through the UCD message.

Table 157—32-symbol uplink preamble sequence

Symbol	<i>I</i>	<i>Q</i>	<i>B</i> (1)	<i>B</i> (2)
1 and 17	−1	−1	1	1
2 and 18	−1	−1	1	1
3 and 19	1	1	0	0
4 and 20	1	1	0	0
5 and 21	−1	−1	1	1
6 and 22	1	1	0	0
7 and 23	1	−1	0	1
8 and 24	1	1	0	0
9 and 25	1	−1	0	1
10 and 26	−1	−1	1	1
11 and 27	−1	−1	1	1
12 and 28	1	1	0	0
13 and 29	1	1	0	0
14 and 30	1	1	0	0
15 and 31	−1	1	1	0
16 and 32	1	1	0	0

8.1.5.1.2 UL-MAP_IE definition

The format of UL-MAP_IEs shall be as defined in Table 158 and utilized according to 6.3.2.3.4. The UIUC shall be one of the values defined in Table 159. The Offset indicates the start time, in units of minislots, of the burst relative to the Allocation Start Time given in the UL-MAP message. The end of the last allocated burst is indicated by allocating an End of map burst (CID = 0 and UIUC = 10) with zero duration. The time instants indicated by the offsets are the transmission times of the first symbol of the burst, including the preamble.

Table 158—SC UL-MAP_IE format

Syntax	Size	Notes
UL-MAP_IE() {		
CID	16 bits	
UIUC	4 bits	
if (UIUC == 15) {		
Extended UIUC dependent IE	<i>variable</i>	See subclauses following 8.1.5.1.2.1
} else {		
Offset	12 bits	Offset, in units of minislots, of the preamble relative to the Allocation Start Time
}		
}		

Table 159—SC UIUC values

IE name	UIUC	Connection ID	Description
	0	N/A	<i>reserved</i>
Request	1	any	Starting offset of request region.
Initial Ranging	2	broadcast	Starting offset of maintenance region (used in Initial Ranging).
	3	N/A	<i>reserved</i>
Data Grant Burst Type 1	4	unicast	Starting offset of Data Grant Burst Type 1 assignment.
Data Grant Burst Type 2	5	unicast	Starting offset of Data Grant Burst Type 2 assignment.
Data Grant Burst Type 3	6	unicast	Starting offset of Data Grant Burst Type 3 assignment.
Data Grant Burst Type 4	7	unicast	Starting offset of Data Grant Burst Type 4 assignment.
Data Grant Burst Type 5	8	unicast	Starting offset of Data Grant Burst Type 5 assignment.
Data Grant Burst Type 6	9	unicast	Starting offset of Data Grant Burst Type 6 assignment.
End of map	10	zero	Ending offset of the previous grant. Indicates the first minislot after the end of the uplink allocation. The burst profile is well known and shall not be included in the UCD message. Used to bound the length of the last actual interval allocation.
Gap	11	zero	Used to schedule gaps in transmission.
	12-14	N/A	<i>reserved</i>
Extended	15	N/A	See 8.1.5.1.2.1.

8.1.5.1.2.1 UL-MAP extended IE format

A UL-MAP IE entry with a UIUC value of 15, indicates that the IE carries special information and conforms to the structure shown in Table 160. A station shall ignore an extended IE entry with a subcode value for which the station has no knowledge. In the case of a known subcode value but with a length field longer than expected, the station shall process information up to the known length and ignore the remainder of the IE.

Table 160—SC UL-MAP extended IE format

Syntax	Size	Notes
UL_Extended_IE() {		
Subcode	4 bits	0x00..0x0F
Length	4 bits	Length in bytes of Unspecified data field
Unspecified data	<i>variable</i>	
}		

8.1.5.1.2.2 UL-MAP Power Control IE format

When a power change for the SS is needed, the extended UIUC = 15 is used with the subcode set to 0x00 as shown in Table 161. The power control value is an 8-bit signed integer expressing the change in power level (in 0.25 dB units) that the SS should apply to correct its current transmission power. The CID used in the IE shall be the Basic CID of the SS.

Table 161—SC Power Control IE format

Syntax	Size	Notes
Power_Control_IE() {		
Extended UIUC	4 bits	Fast power control = 0x00
Length	4 bits	Length = 1
Power control	8 bits	Signed integer, which expresses the change in power level (in 0.25 dB units) that the SS should apply to correct its current transmission power.
}		

8.1.5.1.3 Required UCD parameters

The following parameters shall be included in the UCD message:

- Preamble Length

The following parameters may be included in the UCD message and if absent shall have their default values:

- SSTG
- Roll-off Factor

Uplink Symbol Rate and Frequency are implied by the downlink symbol rate and frequency.

8.1.5.1.4 Uplink channel

Since SSs do not transmit in the uplink channel until they have received some minimal configuration information from the BS, it is possible to support several different configurations that can be adjusted on an uplink channel basis or on a burst by burst basis. These parameters, and their ranges, are supported through MAC signaling, as described in 6.3.2.3.3.

8.1.5.1.5 Uplink_Burst_Profile

Each Uplink_Burst_Profile in the UCD message (6.3.2.3.3) shall include the following parameters:

- Modulation type
- FEC Code Type
- Last codeword length
- Preamble Length
- Randomizer Seed

If the FEC Code Type is 1, 2, or 3 (RS codes), the Uplink_Burst_Profile shall also include

- RS information bytes (K)
- RS parity bytes (R)

If the FEC Code Type is 2, the Uplink_Burst_Profile shall also include

- BCC code type

If the FEC Code Type is 4, the Uplink_Burst_Profile shall also include

- BTC row code type
- BTC column code type
- BTC interleaving type

Table 162 illustrates the format of the Uplink_Burst_Profile, which is encoded with a Type of 1.

Table 162—SC Uplink_Burst_Profile format

Syntax	Size	Notes
Type=1	8 bits	
Length	<i>variable</i>	
<i>reserved</i>	4 bits	Shall be set to zero
UIUC	4 bits	
TLV encoded information	<i>variable</i>	TLV specific

Within each Uplink_Burst_Profile is an unordered list of PHY attributes, encoded as TLV values (see 11.3.1).

8.1.5.2 Uplink Transmission Convergence sublayer

The uplink Transmission Convergence sublayer operation shall be identical to the downlink Transmission Convergence sublayer operation, as described in 8.1.4.3.

8.1.5.3 Uplink PMD sublayer

The uplink PHY coding and modulation are summarized in the block diagram shown in Figure 155.

8.1.5.3.1 Randomization for spectrum shaping

The uplink modulator shall implement a randomizer using the polynomial $x^{15} + x^4 + 1$. At the beginning of each burst, the register is cleared and the Randomizer Seed value 100101010000000 is loaded. The Randomizer Seed value shall be used to calculate the randomizer bit, which is combined in an XOR with the first bit of data of each burst (which is the MSB of the first symbol following the last symbol of the preamble).

8.1.5.3.2 Uplink FEC

The uplink FEC schemes are as described in 8.1.4.4.4, including Table 146.

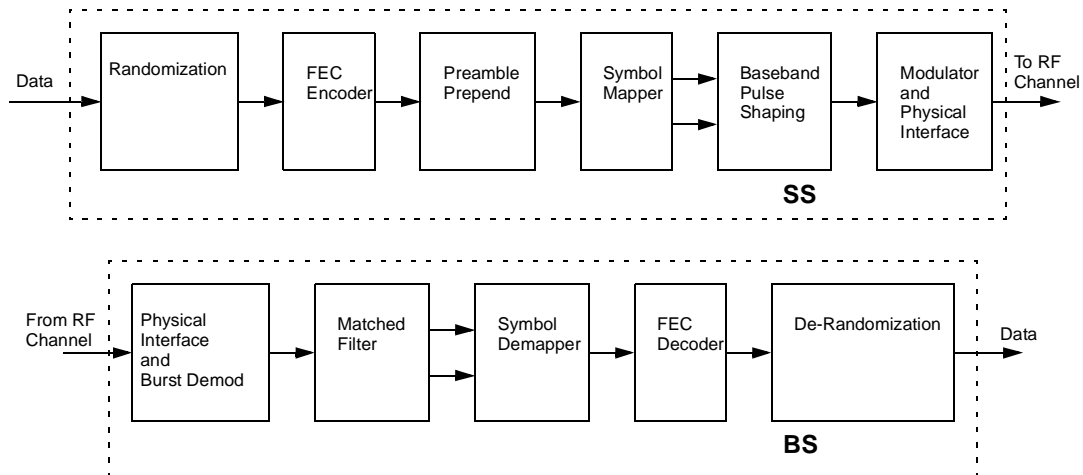

Figure 155—Conceptual block diagram of the uplink PHY

8.1.5.3.2.1 Outer code for Code Types 1–3, uplink

The Outer Codes for Code Types 1–3 are nearly identical to those of the downlink (8.1.4.4.1), with the following exceptions:

a) Fixed Codeword Operation

In the Fixed Codeword Operation, the number of information bytes in each codeword is always the same (K). If the MAC messages in a burst require fewer bytes than are carried by an integral number of Reed–Solomon codewords, stuff bytes (FF_{hex}) shall be added between MAC messages or after the last MAC message so that the total message length is an integral multiple of K bytes.

The SS determines the number of codewords in its uplink burst from the UL-MAP message, which defines the beginning point of each burst, and hence the length. The BS determines the number of codewords in the received uplink burst as it scheduled this transmission event and is aware about its length. Using the burst length, both the SS and the BS calculate the number of full-length RS codewords that can be carried by each burst.

The process used by the SS to encode each burst is identical to the process performed by the BS in Downlink Fixed Codeword Operation (8.1.4.4.1).

b) Shortened Last Codeword Operation

In the Shortened Last Codeword Operation, the number of information bytes in the final Reed–Solomon block of each burst is reduced from the normal number K , while the number of parity bytes R remains the same. The BS tailors the number of information bytes in the last codeword, allowing the SS to transport as many information bytes as possible in each uplink burst. The BS implicitly communicates the number of bytes in the shortened last codeword to the SS via the UL-MAP message, which defines the starting minislot of each burst. The SS uses the UL-MAP information to calculate the number of full-length RS codewords and the length of the shortened last codeword that can be carried within the specified burst size. This calculation shall take into account the number of bytes in the burst used for the preamble and coding bytes as well as the guard time. The BS performs a similar calculation as the SS for its decoding purposes.

To allow the receiving hardware to decode the previous Reed–Solomon codeword, no Reed–Solomon codeword shall have less than 6 information bytes. The number of information bytes carried by the shortened last codeword shall be between 6 and K bytes inclusive. In this mode, the BS shall only allocate bursts that result in shortened last codewords of the proper length.

When using Code Type 2, the number of information bytes in the shortened last codeword shall always be an even number so that the total codeword size is also an even number. Both BS and SS shall take this into account when calculating the number of information bytes in the last codeword.

The process used by the SS to encode each burst is identical to the process used by the BS in Downlink Shortened Last Codeword Operation (8.1.4.4.1).

8.1.5.3.2.2 Inner code for Code Type 2, uplink

See 8.1.4.4.2.

8.1.5.3.2.3 Inner code for Code Type 3, uplink

See 8.1.4.4.3.

8.1.5.3.2.4 Code Type 4, uplink

Code Type 4 in the uplink is similar to the downlink case (8.1.4.4.4). Some exceptions apply to the uplink due to the smaller payload expected within a burst. For example, using a similar two-dimensional shortening process, a 57-byte code is composed of (32,26) constituent codes which have been shortened by seven rows and two columns as described in Figure 156. The end result is a (30,24)×(25,19) array, which is capable of encoding $24 \times 19 = 456$ bits (57 bytes). Table 163 summarizes this code example.

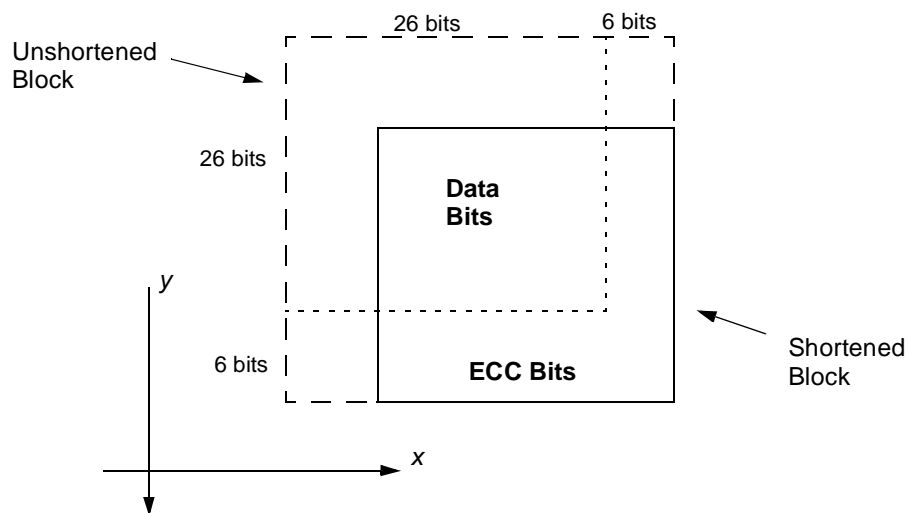

Figure 156—Structure of shortened 2 D block

Table 163—Required block codes for the BTC option for the uplink channel

Code	(30,24)×(25,19)
Aggregate Code Rate	0.608
Uplink/Downlink/Both	Uplink
Block size (payload bits)	456 (57 bytes)

8.1.5.3.3 Shortening of FEC blocks in uplink

Shortening of FEC blocks in the uplink is identical to the handling in the downlink as described in 8.1.4.2 or 8.1.4.4.1.

8.1.5.3.4 Number of scheduled uplink bursts per frame

Only one scheduled burst (UIUC 4–9) per SS shall be included in the UL-MAP for any given frame.

8.1.5.3.5 Coding of the Request IE Uplink_Burst_Profile

The uplink burst profile associated with the Request IE (UIUC = 1) shall use Modulation Type = 1 (QPSK) and shall use FEC Code Type = 1 or 2. The other parameters of the Uplink_Burst_Profile encoding shall be chosen such that the resulting uplink burst profile is no less robust than the most robust uplink burst profile associated with any of the Data Grant Burst Type IEs.

8.1.5.3.6 Coding of the Initial Ranging Uplink_Burst_Profile

The burst profile for the Initial Ranging UIUC shall be the same as for the frame control section, as defined in 8.1.4.4.6.

8.1.5.3.7 Uplink modulation

The modulation used on the uplink channel shall be variable and set by the BS. QPSK shall be supported, while 16-QAM and 64-QAM are optional, with the mappings of bits to symbols identical to those described in 8.1.4.4.7.

In changing from one burst profile to another, the SS shall use one of two power adjustment rules: maintaining constant constellation peak power (power adjustment rule = 0), or maintaining constant constellation mean power (power adjustment rule = 1). In the constant peak power scheme, corner points are transmitted at equal power levels regardless of modulation type. In the constant mean power scheme, the signal is transmitted at equal mean power levels regardless of modulation type. The power adjustment rule is configurable through the UCD Channel Encoding parameters (11.3.1).

In changing from one modulation scheme to another (i.e., during burst profile change), sufficient RF power amplifier margins should be maintained to prevent violation of emissions masks.

8.1.5.3.8 Baseband pulse shaping

Prior to modulation, the *I* and *Q* signals shall be filtered by square-root raised cosine filters as specified in 8.1.4.4.8.

8.1.5.3.9 Transmitted waveform

The transmitted waveform shall be as described in 8.1.4.4.9.

8.1.6 Baud rates and channel bandwidths

A large amount of spectrum is potentially available in the 10–66 GHz range for PMP systems. Although regulatory requirements vary between different regions, sufficient commonality exists for a default RF channel bandwidth to be specified for each major region. This is necessary in order to ensure that products built to this standard have interoperability over the air interface.

Systems shall use Nyquist square-root raised cosine pulse shaping with a roll-off factor of 0.25 and shall operate on the default RF channel arrangement shown in Table 164. Note that baud rates are chosen to provide an integer number of PSs per frame. The frame duration choice compromises between transport efficiency (with lower frame overhead) and latency.

Table 164—Baud rates and channel sizes for a roll-off factor of 0.25

Channel size (MHz)	Symbol rate (MBd)	Bit rate (Mb/s) QPSK	Bit rate (Mb/s) 16-QAM	Bit rate (Mb/s) 64-QAM	Recommended Frame Duration (ms)	Number of PSs/frame
20	16	32	64	96	1	4000
25	20	40	80	120	1	5000
28	22.4	44.8	89.6	134.4	1	5600

Due to wide variations in local regulations, no frequency plan is specified in this standard. No single plan can accommodate all cases. For example, the 24.5–26.5 GHz band in Europe is regulated by CEPT requirements concerning specific duplex spacing and rasters. This does not match a similar spectrum allocation in North America.

8.1.7 Radio subsystem control

8.1.7.1 Synchronization technique

The downlink demodulator typically provides an output reference clock that is derived from the downlink symbol clock. This reference can then be used by the SS to provide timing for rate critical interfaces when the downlink clock is locked to an accurate reference at the BS.

Accurate uplink time slot synchronization is supported through a ranging calibration procedure defined by the MAC to ensure that uplink transmissions by multiple users do not interfere with each other. Therefore, the PHY needs to support accurate timing estimates at the BS, and the flexibility to finely modify the timing at the SS according to the transmitter characteristics specified in 8.1.8.

8.1.7.2 Frequency control

In order to meet more stringent coexistence requirements in place today, the transmitted RF center frequency for both the BS and at each SS shall have an accuracy better than $\pm 10 \times 10^{-6}$. The value shall be guaranteed over the complete temperature range and time of operation, i.e., aging for FWA equipment. In order to meet this main requirement, the following additional requirements have been derived for both BS and SS. The carrier frequency accuracy for the BS shall be better than $\pm 8 \times 10^{-6}$. Therefore:

- The carrier frequency accuracy for the BS shall be $\pm 8 \times 10^{-6}$.
- The SS shall be locked in frequency to the BS.
- The carrier frequency of the SS shall be within $\pm 1 \times 10^{-6}$ of that of the BS.

8.1.7.3 Power control

The power control algorithm shall be supported for the uplink channel with both an initial calibration and periodic adjustment procedure without loss of data. The BS should be capable of providing accurate power measurements of the received burst signal. This value can then be compared against a reference level, and the resulting error can be fed back to the SS in a calibration message coming from the MAC. The power control algorithm shall be designed to support power attenuation due to distance loss or power fluctuations at rates of at most 20 dB/second with depths of at least 40 dB. The exact algorithm implementation is vendor-specific. The total power control range consists of both a fixed portion and a portion that is automatically controlled by feedback. The power control algorithm shall take into account the interaction of the RF power amplifier with different burst profiles. For example, when changing from one burst profile to another, margins should be maintained to prevent saturation of the amplifier and to prevent violation of emissions masks.

In support of FPC for SC, the CRABS report [B8] describes results that demonstrate LMDS frequency bands experiencing significant fast fading both due to rain and foliage impairments. FPC will also allow the decoupling of accurate rain fade margin setting on links and improve resilience. The report presented in Sydor [B43], although reporting measurements for the 5 GHz band, indicates fades up to 180dB/s based on obstruction from trees.

8.1.8 Minimum performance

This subclause details the minimum performance requirements for proper operation of systems in the frequency range of 24–32 GHz. The values listed in this subclause apply over the operational environmental ranges of the system equipment.

The philosophy taken in this subclause is to guarantee SS interoperability. Hence, the BS is described only in terms of its transmitter (Table 165), while the SS is described in terms of both its transmitter (Table 166) and receiver (Table 167). It is expected that BS manufacturers will use SS transmitter performance coupled with typical deployment characteristics (cell size, channel loading, near-far users, etc.) to profile their receiver equipment emphasizing specific performance issues as they require.

Table 165—Minimum BS transmitter performance

Tx symbol timing accuracy	Peak-to-peak symbol jitter, referenced to the previous symbol zero crossing, of the transmitted waveform, shall be less than 0.02 of the nominal symbol duration over a period of 2 s. The peak-to-peak cumulative phase error, referenced to the first symbol time and with any fixed symbol frequency offset factored out, shall be less than 0.04 of the nominal symbol duration over a period of 0.1 s. The Tx symbol timing shall be accurate to within $\pm 8 \times 10^{-6}$ (including aging and temperature variations).
Tx RF frequency/accuracy	10–66 GHz/ $\pm 8 \times 10^{-6}$ (including aging and temperature variations).
Spectral mask (out of band/block)	Per relevant local regulation requirements (see 8.1.8.2.2 for more details).
Spurious	Per relevant local regulatory requirements.

Table 165—Minimum BS transmitter performance (continued)

Maximum Ramp Up/Ramp Down Time	8 symbols (2 PSs).
Modulation accuracy (expressed in EVM, as in 8.1.8.2.3)	<p>12% (QPSK); 6% (16-QAM) (Measured with an Ideal Receiver without Equalizer, all transmitter impairments included), and 10% (QPSK); 3% (16-QAM), 1.5% (64-QAM) (Measured with an Ideal Receiver with an Equalizer, linear distortion removed).</p> <p>NOTE—Tracking loop bandwidth is assumed to be between 1% to 5% optimized per phase noise characteristics. The tracking loop bandwidth is defined in the following way. A lowpass filter with unity gain at DC and frequency response $H(f)$, has a tracking loop (noise) bandwidth (B_L), defined as the integral of $H(f)$ squared from 0 to the sampling frequency. The output power of white noise passed through an ideal brick wall filter of bandwidth B_L shall be identical to that of white noise passed through any lowpass filter with the same tracking loop (noise) bandwidth.</p>

Table 166—Minimum SS transmitter performance

Tx Dynamic range	40 dB.
Tx RMS Power Level at Maximum Power Level setting for QPSK	At least +15 dBm (measured at antenna port).
Tx power level adjustment steps and accuracy	The SS shall adjust its Tx power level, based on feedback from the BS via MAC messaging, in steps of 0.5 dB in a monotonic fashion. [This required resolution is due to the small gap in sensitivities between different burst profiles (3–4 dB typical).]
Tx symbol timing jitter	Peak-to-peak symbol jitter, referenced to the previous symbol zero crossing, of the transmitted waveform, shall be less than 0.02 of the nominal symbol duration over a period of 2 s. The peak-to-peak cumulative phase error, referenced to the first symbol time and with any fixed symbol frequency offset factored out, shall be less than 0.04 of the nominal symbol duration over a period of 0.1 s.
Symbol clock	Shall be locked to BS symbol clock.
Tx burst timing accuracy	Shall implement corrections to burst timing in steps of up to ± 0.5 of a symbol with step accuracy of up to ± 0.25 of a symbol.
Tx RF frequency/accuracy	SS frequency locking to BS carrier required. 10–66 GHz/ $\pm 1 \times 10^{-6}$ (including aging and temperature variations).
Spectral Mask (out of band/block)	Per relevant local regulation requirements (see 8.1.8.2.2 for more details).
Maximum Ramp Up/Ramp Down Time	8 symbols (2 PSs).
Maximum output noise power spectral density when Tx is not transmitting information	–80 dBm/MHz (measured at antenna port).
Modulation accuracy (expressed in EVM, as in 8.1.8.2.3)	As specified in Table 165.

Table 167—Minimum SS receiver performance

Bit error rate (BER) performance threshold	<p>For BER = 1×10^{-3}:</p> <p>QPSK: $-94 + 10\log_{10}(R)$ 16-QAM: $-87 + 10\log_{10}(R)$ 64-QAM: $-79 + 10\log_{10}(R)$</p> <p>For BER = 1×10^{-6}:</p> <p>QPSK: $-90 + 10\log_{10}(R)$ 16-QAM: $-83 + 10\log_{10}(R)$ 64-QAM: $-74 + 10\log_{10}(R)$</p> <p>NOTE— Measured uncoded in dBm, where R denotes carrier symbol rate in MBd.</p> <p>Propagation models of Type 0, 1, or 2 (Table 168) are used.</p>
Maximum Transition time from Tx to Rx and from Rx to Tx	<p>2 μs (TDD) 20 μs (FDD, half-duplex terminal)</p>
1st Adjacent Channel Interference	<p>At BER 10^{-3}, for 3 dB degradation: C/I = -9 (QPSK), -2 (16-QAM), and +5 (64-QAM)</p> <p>At BER 10^{-3}, for 1 dB degradation: C/I = -5 (QPSK), +2 (16-QAM), and +9 (64-QAM)</p> <p>At BER 10^{-6}, for 3 dB degradation: C/I = -5 (QPSK), +2 (16-QAM), and +9 (64-QAM)</p> <p>At BER 10^{-6}, for 1 dB degradation: C/I = -1 (QPSK), +6 (16-QAM), and +13 (64-QAM)</p> <p>NOTE— Measured uncoded, in dB.</p>
2nd Adjacent Channel Interference	<p>At BER 10^{-3}, for 3 dB degradation: C/I = -34 (QPSK), -27 (16-QAM), and -20 (64-QAM)</p> <p>At BER 10^{-3}, for 1 dB degradation: C/I = -30 (QPSK), -22 (16-QAM), and -16 (64-QAM)</p> <p>At BER 10^{-6}, for 3 dB degradation: C/I = -30 (QPSK), -23 (16-QAM), and -16 (64-QAM)</p> <p>At BER 10^{-6}, for 1 dB degradation: C/I = -26 (QPSK), -20 (16-QAM), and -12 (64-QAM)</p> <p>NOTE— Measured uncoded, in dB.</p>

NOTE—The interfering source shall be a continuous signal of the same modulation type as the primary signal. The spectral mask of the interfering signal shall depend on local regulatory requirements.

8.1.8.1 Propagation conditions

LOS radio propagation conditions between the BS and the SSs are required to achieve high quality and availability service. Also, the SSs need highly directional antennas, which minimize the number of multipaths and interference from unexpected sources. The intersymbol interference may occur as a consequence of multipaths.

8.1.8.1.1 Propagation models

In this subclause, the propagation models referred to in this specification are defined. No further BER performance degradation should be expected with all propagation model types.

The channel model is expressed as follows:

$$H(j\omega) = C_1 \exp(-j\omega T_1) + C_2 \exp(-j\omega T_2) + C_3 \exp(-j\omega T_3) \quad (14)$$

Here C_1, C_2 , and C_3 are the complex tap amplitudes and T_1, T_2 , and T_3 are the tap delays. These parameters are provided in Table 168, where R is the channel symbol rate in MBd and the resulting tap delay is in ns. For example, if $R = 20$ MBd, then the resulting Type 2 tap delays will be 0, 20, and 40 ns.

Table 168—Propagation models

Propagation model	Tap number i	Tap amplitude C_i	Tap delay T_i
Type 0	1	1.0	0
Type 1	1	0.995	0
	2	$0.0995 \exp(-j 0.75)$	$400/R$
Type 2	1	$0.286 \exp(-j 0.75)$	0
	2	0.953	$400/R$
	3	-0.095	$800/R$

NOTE—Propagation path parameters are valid for R from 15 to 25 MBd.

Type 0 represents a clear LOS scenario. Type 1 and Type 2 represent typical deployment scenarios with weak multipath components, Type 1 having better conditions.

8.1.8.1.2 Rain fades

For 10–66 GHz frequencies of operation, the predominant fade mechanism is that resulting from rain attenuation. Fade depths are geographically dependent by rain rate region and are also conditioned by both frequency of operation and link distance. For a given set of equipment transmission parameters and a specified link availability requirement, the rain rate criteria establish the maximum cell radius appropriate to system operation.

An internationally accepted method for computation of rain fade attenuation probability is that defined by ITU-R P.530-8 [B34]. As an example, typical 28 GHz equipment parameters result in a maximum cell radius of about 3.5 km in ITU rain region K. This criteria applies for a link BER = 10^{-6} at a link availability of 99.995%. Further details on this example system model may be found in IEEE Std 802.16.2-2004.

Another important issue is the impact of uncorrelated rain fading between an interference transmission link and a victim transmission link. Under rain fading conditions, the differential rain fading loss between the two transmission paths may have a significant impact on both intrasystem and intersystem link availability. At operational frequencies around 28 GHz, the estimated rain cell diameter is approximately 2.4 km (ITU-R P.452 [B33]). The effect of rain decorrelation may be estimated based on cell sector size and the specified frequency reuse plan.

A significant mitigation technique for the control of both intrasystem and intersystem interference is the angular discrimination provided by system antennas. The antenna radiation pattern envelope (RPE) discrimination has significance for both clear sky and rain faded propagation conditions. The RPE requirements for aggressive intrasystem frequency reuse plans may exceed the RPE requirements for the control of inter-system coexistence. Recommended antenna RPE characteristics are described in IEEE Std 802.16.2-2001.

8.1.8.2 Transmitter characteristics

Unless stated otherwise, the transmitter requirements are referenced to the transmitter output port and apply with the transmitter tuned to any channel.

8.1.8.2.1 Output power

In the following subclause, power is defined as the time-averaged power when emitting a signal (excluding off-time between bursts), measured over the randomized bits of one transmitted burst.

The power at which SS or BSs shall operate is specified in the following subclause.

8.1.8.2.1.1 BS

A BS shall not produce an effective isotropic radiated power (EIRP) spectral density exceeding either +28.5 dBm/MHz or local regulatory requirements.

8.1.8.2.1.2 SS

An SS shall not produce an EIRP spectral density exceeding either +39.5 dBm/MHz or local regulatory requirements.

8.1.8.2.2 Emission mask and adjacent channel performance (NFD)

Transmit parameters shall comply with existing ETSI standards having more stringent requirements, in particular:

- Frequency band 40.5 GHz to 43.5 GHz: EN 301 997-1
- Frequency band 24.25 GHz to 29.5 GHz: EN 301 213-3

In the downlink channel, the transmitted spectrum shall not exceed the spectrum mask defined by Table 169, which specifies more stringent requirements than System Type C spectrum mask defined in EN 301 213-3.

Table 169—Downlink spectrum mask at 28MHz channel

Frequency offset (MHz)	13	14	14.4	14.8	22.4	28	56	70
Relative attenuation (dB)	0	−15	−20	−28	−34	−42	−52	−52

In the uplink channel, the transmitted spectrum shall not exceed the spectrum mask defined by Table 170, which is derived from the requirements given by System Type B spectrum mask defined in EN 301 213-3.

The Net-Filter-Discriminator (NFD) mask, which shall be guaranteed by the system, is defined by Table 171.

Table 170—Uplink spectrum mask at 28MHz channel

Frequency offset (MHz)	11.2	13.5	14.5	22.4	28	56	70
Relative attenuation (dB)	0	-7	-17	-32	-37	-52	-52

Table 171—Downlink and uplink NFD mask

Offset (MHz)	FD - DL (dB)	FD - UL (dB)
28	35,5	29
31,5	39	34,5
35	42	38,5
38,5	45	41
42	46,5	43
49	49	46,5
56	51	50
59,5	51,5	51
63	52	51,5
70	52	52
77	52	52
84	52	52

8.1.8.2.3 Modulation accuracy and error vector magnitude (EVM)

The EVM defines the average constellation error with respect to the farthest constellation point power, as illustrated in Figure 157 and defined by the following equation:

$$EVM = \sqrt{\frac{\frac{1}{N} \sum_{i=1}^N (\Delta I^2 + \Delta Q^2)}{S_{\max}^2}} \quad (15)$$

where

N is the number of symbols in the measurement period and S_{\max} the maximum constellation amplitude.

The EVM shall be measured over the continuous portion of a burst occupying at least 1/4 of the total transmission frame at maximum power settings.

The required EVM can be estimated from the transmitter implementation margin if the error vector is considered noise, which is added to the channel noise.

The implementation margin means the excess power needed to keep the C/N constant when going from the ideal to the real transmitter. EVM cannot be measured at the antenna connector but should be measured by an “ideal” receiver with a certain carrier recovery loop bandwidth specified in percent of the symbol rate. In Table 172, the EVM-values for different modulation schemes are specified using parameters relevant to the system.

Based on the values in Table 172 the EVM values shall be the following:

- EVM 12% and 6% for 4-QAM, 16-QAM respectively when measured by an “ideal” receiver without an equalizer with a carrier recovery loop bandwidth of 1% to 5%; and
- EVM 10%, 3% and 1,5% for 4-QAM, 16-QAM, and 64-QAM respectively when measured by an “ideal” receiver with an equalizer with a carrier recovery loop bandwidth of 1% to 5%.

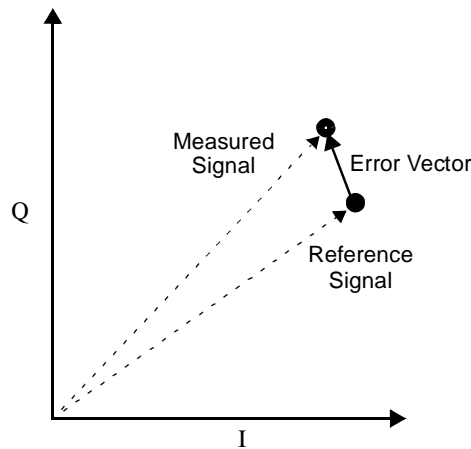

Figure 157—Illustration of EVM

The above EVM measured will include the transmit filter accuracy, D/A-converter, modulator imbalances, untracked phase noise, and power amplifier (PA) non-linearity.

Table 172—EVM values vs. modulation scheme

Modulation	Tx implementation margin	Rx-AWGN C/N (dB) BER = 10E-6 4 MAC-PDUs	Peak-to-average	EVM (%) Without equalization	EVM (%) With equalization
4-QAM + RS	0.5 dB	10	0 dB	12	10
16-QAM + RS	1.0 dB	17	2.55 dB	6	3
64-QAM + RS	1.5 dB	23	3.68 dB	N/A	1.5

8.1.9 Channel quality measurements

8.1.9.1 Introduction

RSSI and CINR signal quality measurements and associated statistics can aid in such processes as BS selection/assignment and burst adaptive profile selection. As channel behavior is time-variant, both mean and standard deviation are defined.

The process by which RSSI measurements are taken does not necessarily require receiver demodulation lock; for this reason, RSSI measurements offer reasonably reliable channel strength assessments even at low signal levels. On the other hand, although CINR measurements require receiver lock, they provide information on the actual operating condition of the receiver, including interference and noise levels, and signal strength.

8.1.9.2 RSSI mean and standard deviation

When collection of RSSI measurements is mandated by the BS, an SS shall obtain an RSSI measurement from the downlink burst preambles. From a succession of RSSI measurements, the SS shall derive and update estimates of the mean and the standard deviation of the RSSI, and report them via REP-RSP messages.

Mean and standard deviation statistics shall be reported in units of dBm. To prepare such reports, statistics shall be quantized in 1 dB increments, ranging from -40 dBm (encoded 0x53) to -123 dBm (encoded 0x00). Values outside this range shall be assigned the closest extreme value within the scale.

The method used to estimate the RSSI of a single message is left to individual implementation, but the relative accuracy of a single signal strength measurement, taken from a single message, shall be ± 2 dB, with an absolute accuracy of ± 4 dB. This shall be the case over the entire range of input RSSIs. In addition, the range over which these single-message measurements are measured should extend 3 dB on each side beyond the -40 dBm to -123 dBm limits for the final averaged statistics that are reported.

The (linear) mean RSSI statistics (in mW), derived from a multiplicity of single messages, shall be updated using Equation (16).

$$\hat{\mu}_{RSSI}[k] = \begin{cases} R[0] & k = 0 \\ (1 - \alpha_{avg})\hat{\mu}_{RSSI}[k-1] + \alpha_{avg}R[k] & k > 0 \end{cases} \quad \text{mW} \quad (16)$$

where

k is the time index for the message (with the initial message being indexed by $k = 0$, the next message by $k = 1$, etc.),

$R[k]$ is the RSSI in mW measured during message k , and α_{avg} is an averaging parameter specified by the BS. The mean estimate in dBm shall then be derived from Equation (17).

$$\hat{\mu}_{RSSI \text{ dBm}}[k] = 10\log(\hat{\mu}_{RSSI}[k]) \quad \text{dBm} \quad (17)$$

To solve for the standard deviation in dB, the expectation-squared statistic shall be updated using Equation (18).

$$\hat{x}_{RSSI}^2[k] = \begin{cases} |R[0]|^2 & k = 0 \\ (1 - \alpha_{avg})\hat{x}_{RSSI}^2[k-1] + \alpha_{avg}|R[k]|^2 & k > 0 \end{cases} \quad (18)$$

Apply the result to Equation (19).

$$\hat{\sigma}_{RSSI \text{ dB}} = 5\log\left(\left|\hat{x}_{RSSI}^2[k] - (\hat{\mu}_{RSSI}[k])^2\right|\right) \quad \text{dB} \quad (19)$$

8.1.9.3 CINR mean and standard deviation

When CINR measurements are mandated by the BS, an SS shall obtain a CINR measurement from the downlink burst preambles. From a succession of these measurements, the SS shall derive and update estimates of the mean and the standard deviation of the CINR, and report them via REP-RSP messages.

Mean and standard deviation statistics for CINR shall be reported in units of dB. To prepare such reports, statistics shall be quantized in 1 dB increments, ranging from a minimum of -20 dB (encoded 0x00) to a maximum of 40 dB (encoded 0x3C). Values outside this range shall be assigned the closest extreme value within the scale.

The method used to estimate the CINR of a single message is left to individual implementation, but the relative and absolute accuracy of a CINR measurement derived from a single message shall be ± 1 dB and ± 2 dB, respectively, for all input CINRs above 0 dB. In addition, the range over which these single-packet measurements are measured should extend 3 dB on each side beyond the -20 dB to 40 dB limits for the final reported, averaged statistics.

One possible method to estimate the CINR of a single message is by normalizing the mean-squared residual error of detected data symbols (and/or pilot symbols) by the average signal power using Equation (20).

$$CINR[k] = \frac{A[k]}{E[k]}, \quad (20)$$

where

$CINR[k]$ is the (linear) CINR for message k ,

$r[k,n]$ is received symbol n within message k ,

$s[k,n]$ is the corresponding detected or pilot symbol corresponding to received symbol n ;

$$A[k] = \sum_{n=0}^{N-1} |s[k,n]|^2 \quad (21)$$

is the average signal power, which is normally kept constant within a message by action of automatic gain control (AGC); and

$$E[k] = \sum_{n=0}^{N-1} |r[k,n] - s[k,n]|^2 \quad (22)$$

The mean CINR statistic (in dB) shall be derived from a multiplicity of single messages using Equation (23).

$$\hat{\mu}_{CINR\ dB}[k] = 10\log(\hat{\mu}_{CINR}[k]) \quad (23)$$

where

$$\hat{\mu}_{CINR}[k] = \begin{cases} CINR[0] & k = 0 \\ (1 - \alpha_{avg})\hat{\mu}_{CINR}[k-1] + \alpha_{avg}CINR[k] & k > 0 \end{cases} \quad (24)$$

where

k is the time index for the message (with the initial message being indexed by $k = 0$, the next message by $k = 1$, etc.),

$CINR[k]$ is a linear measurement of CINR (derived by any mechanism that delivers the prescribed accuracy) for message k ; and α_{avg} is an averaging parameter specified by the BS.

To solve for the standard deviation, the expectation-squared statistic shall be updated using Equation (25).

$$\hat{x}_{CINR}^2[k] = \begin{cases} |CINR[0]|^2 & k = 0 \\ (1 - \alpha_{\text{avg}})\hat{x}_{CINR}^2[k-1] + \alpha_{\text{avg}}|CINR[k]|^2 & k > 0 \end{cases} \quad (25)$$

and the result applied to Equation (26).

$$\hat{\sigma}_{CINR \text{ dB}} = 5 \log \left(\left| \hat{x}_{CINR}^2[k] - (\hat{\mu}_{CINR}[k])^2 \right| \right) \quad \text{dB} \quad (26)$$

8.2 WirelessMAN-SCa PHY

The WirelessMAN-SCa PHY is based on single-carrier technology and designed for NLOS operation in frequency bands below 11 GHz (per 1.3.4). For licensed bands, channel bandwidths allowed shall be limited to the regulatory provisioned bandwidth divided by any power of 2 no less than 1.25 MHz.

Elements within this PHY include the following:

- TDD and FDD definitions, one of which must be supported.
- TDMA uplink.
- TDM or TDMA downlink.
- Block adaptive modulation and FEC coding for both uplink and downlink.
- Framing structures that enable improved equalization and channel estimation performance over NLOS and extended delay spread environments.
- PS-unit granularity in burst sizes.
- Concatenated FEC using Reed–Solomon and pragmatic trellis coded modulation (TCM) with optional interleaving.
- Additional BTC and CTC FEC options.
- No-FEC option using ARQ for error control.
- Space time coding (STC) transmit diversity option.
- Robust modes for low CINR operation.
- Parameter settings and MAC/PHY messages that facilitate optional AAS implementations.

Within the discussion of the WirelessMAN-SCa PHY, five terms (payload, burst, burst set, burst frame, and MAC frame) are used in discussion of the organization of transmissions.

Payload refers to individual units of transmission content that are of interest to some entity at the receiver.

A burst contains payload data and is formed according to the rules specified by the burst profile associated with the burst. The existence of the burst is made known to the receiver through the contents of either the uplink or downlink maps. For the uplink, a burst is a complete unit of transmission that includes a leading preamble, encoded payload, and trailing termination sequence.

A burst set is a self-contained transmission entity consisting of a preamble, one or more concatenated bursts, and a trailing termination sequence. For the uplink, burst set is synonymous with burst.

A burst frame contains all information included in a single transmission. It consists of one or more burst sets.

A MAC frame refers to the fixed bandwidth intervals reserved for data exchange. For TDD, a MAC frame consists of one downlink and one uplink subframe, delimited by the TTG. For FDD, the MAC frame corresponds to the maximum length of the downlink subframe. FDD uplink subframes operate concurrently with downlink subframes but on a separate (frequency) channel.

The downlink and uplink subframes each hold a burst frame.

8.2.1 Transmit processing

Figure 158 illustrates the steps involved in transmit processing. Source data shall first be randomized, then FEC encoded and mapped to QAM symbols. QAM symbols shall be framed within a burst set, which typically introduces additional framing symbols. Symbols within a burst set shall be multiplexed into a duplex frame, which may contain multiple bursts. The I and Q symbol components shall be injected into pulse shaping filters, quadrature modulated up to a carrier frequency, and amplified with power control so that the proper output power is transmitted.

Except where indicated otherwise, transmit processing is the same for both the uplink and downlink.

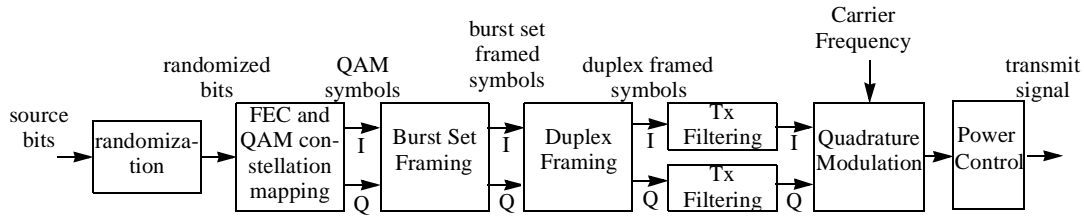

Figure 158—Transmit processing

8.2.1.1 Source Bit Randomization

Source bits, i.e., the original information bits prior to FEC encoding, shall be randomized during transmission.

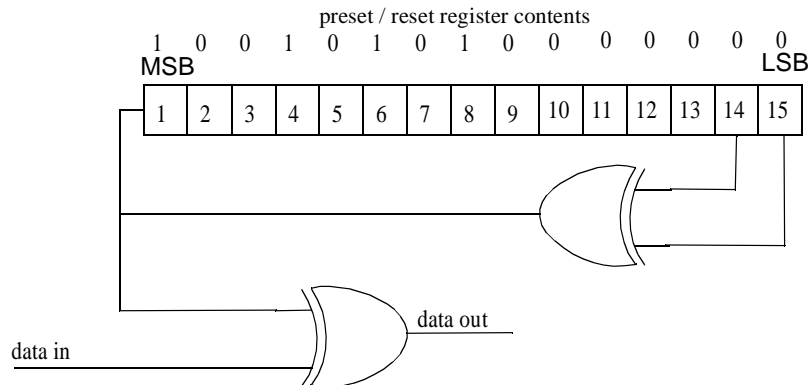

Figure 159—Randomizer for energy dispersal

As Figure 159 illustrates, source bit randomization shall be performed by modulo-2 addition (XORing) source (information) data with the output of a Linear-Feedback Shift Register (LFSR) possessing characteristic polynomial $1 + X^{14} + X^{15}$. The LFSR shall be preset at the beginning of each burst set (directly following the preamble) to the value 10010100000000, and shall be clocked once per processed bit. The LFSR is not preset between time division multiplexed allocations that may reside within a single burst.

Only source bits are randomized. This includes source payloads, plus uncoded null (zero) bits that may be used to fill empty payload segments. Elements that are not a part of the source data, such as framing elements and pilot symbols shall not be randomized. Null (zero) bits used to complete a QAM symbol (when an allocation does not fill an entire QAM symbol) shall not be randomized.

8.2.1.2 FEC

FCH payloads shall be encoded in accordance with 8.2.1.7. Adaptive modulation and the concatenated FEC of 8.2.1.2.1 shall be supported for all other payloads. The support of 8.2.1.2.3 as FEC as well as omitting the FEC and relying solely on ARQ for error control (see 8.2.1.2.2) is optional for payloads carried outside the FCH.

8.2.1.2.1 Concatenated FEC

The concatenated FEC is based on the serial concatenation of a Reed–Solomon outer code and a rate-compatible TCM inner code. Block interleaving between the outer and inner encoders is optional. Figure 160 illustrates the flow between blocks used by a concatenated FEC encoder.

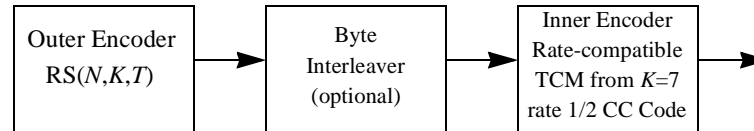

Figure 160—Concatenated FEC encoder blocks

8.2.1.2.1.1 Outer code

The outer code consists of a Reed–Solomon code.

This Reed–Solomon code shall be derived from a systematic RS ($N = 255$, $K = 239$) code using $GF(2^8)$. The following polynomials are used for the systematic code:

Code Generator Polynomial:
$$g(x) = (x + \lambda^0)(x + \lambda^1)(x + \lambda^2) \dots (x + \lambda^{2T-1}), \lambda = 02_{HEX}$$

Field Generator Polynomial:
$$p(x) = x^8 + x^4 + x^3 + x^2 + 1$$

The bit/byte conversion shall be MSB first.

This RS code may be shortened and punctured to enable variable block sizes and variable error-correction capability,

where

- N is the number of overall bytes after encoding,
- K is the number of data bytes before encoding,
- $R = N - K$ is the number of parity bytes.

When a block is shortened to K' data bytes, the first $239 - K'$ data bytes of the block to be encoded shall be set to zero, but shall not be transmitted. When a codeword is punctured to R' parity bytes, only the first R' of the total $R = 16$ parity bytes shall be transmitted.

Support of shortening K of the base code to values smaller than 239 bytes while maintaining $R = 16$ is mandatory, and is governed by the burst profile specification for K (see 11.3.1.1 or 11.4.2). The capability to also puncture, such that $R \leq 16$, is mandatory, and is governed by the burst profile specification for R . However, payloads that cannot be modified by burst profile changes, such as the contents of the FCH, shall not be punctured.

When a source allocation does not divide into an integer number of K byte Reed–Solomon code words, the last (fractional) RS code word shall be shortened to a smaller value $1 \leq K' < K$ that accommodates the remainder bytes. All code words, including the shortened last codeword, shall use the R specified by the burst profile (see Table 354 and Table 360) for the RS code words within that allocation.

8.2.1.2.1.2 Block Interleaver

Support of interleaving between the inner and outer code with a depth of $N_R = 10$ is mandatory. Interleaving shall not be defined in the FCH burst profile. When interleaving is used, its usage and parameters shall be specified within a burst profile.

The interleaver changes the order of bytes from the Reed–Solomon (RS) encoder output. A de-interleaver in the receiver restores the order of the bytes prior to RS decoding. The interleaver is a block interleaver, where a table is “written,” i.e., filled, a byte at a time row-wise (one row per RS code word) and “read” a byte at a time column-wise. The number of rows, N_R , used by the interleaver is a burst parameter. So that bursts are not generated that exceed an intended receiver’s capabilities, the largest N_R supported by a terminal is communicated during SS basic capability negotiation.

Operating parameters for the interleaver are summarized in Table 173.

Table 173—Operating parameters for block interleaver

Parameter	Description
C	Interleaver Width (number of columns), in bytes. Equivalent to the nominal Reed–Solomon codeword length, N .
N_R	Maximum Interleaver Depth (number of rows), in bytes. Equals the maximum number of RS codewords that the block interleaver may store at any given time.
B	Nominal Interleaver Block Size, in bytes. $B = C N_R$.
P	RS-encoded Size of Packet, in bytes, to be interleaved.

When $P \leq B$ and/or a RS codeword is shortened (so that not all of the columns within its row are filled), the interleaver shall be read column by column (taking a byte from each column), skipping empty elements within the table.

When $P > B$, data shall be parcelled into subblocks, and interleaving performed within each of the subblocks. The depth of these subblocks shall be chosen such that all subblocks have approximately the same depth (number of rows) using the following calculations:

$$\text{Total RS codewords in packet: } T = \left\lceil \frac{P}{C} \right\rceil$$

$$\text{Number of subblocks: } S = \left\lceil \frac{P}{B} \right\rceil$$

$$\text{Interleaver depth of longest subblocks: } C_{max} = \left\lceil \frac{T}{S} \right\rceil$$

$$\text{Number of blocks with depth } C_{max} : Q_{C_{max}} = T - S(C_{max} - 1)$$

$$\text{Number of blocks with depth } C_{min} = C_{max} - 1 : Q_{C_{min}} = S - Q_{C_{max}}$$

The first $Q_{C_{max}}$ subblocks within a packet shall use a (dynamic) interleaver depth C_{max} , and the remainder of the subblocks shall use an interleaver depth $C_{min} = C_{max} - 1$.

8.2.1.2.1.3 Inner code

The inner code is a rate-compatible pragmatic TCM code (Viterbi, et al [B46], Wolf and Zehavi [B47]) derived from a rate 1/2 constraint length $K = 7$, binary convolutional code.

The encoder for the rate 1/2 binary code shall use the following polynomials [Equation (27)] to generate its two code bit outputs, denoted X and Y :

$$\begin{aligned} G_1 &= 171_{OCT} && \text{For } X \\ G_2 &= 133_{OCT} && \text{For } Y \end{aligned} \tag{27}$$

A binary encoder that implements this rate 1/2 code is depicted in Figure 161.

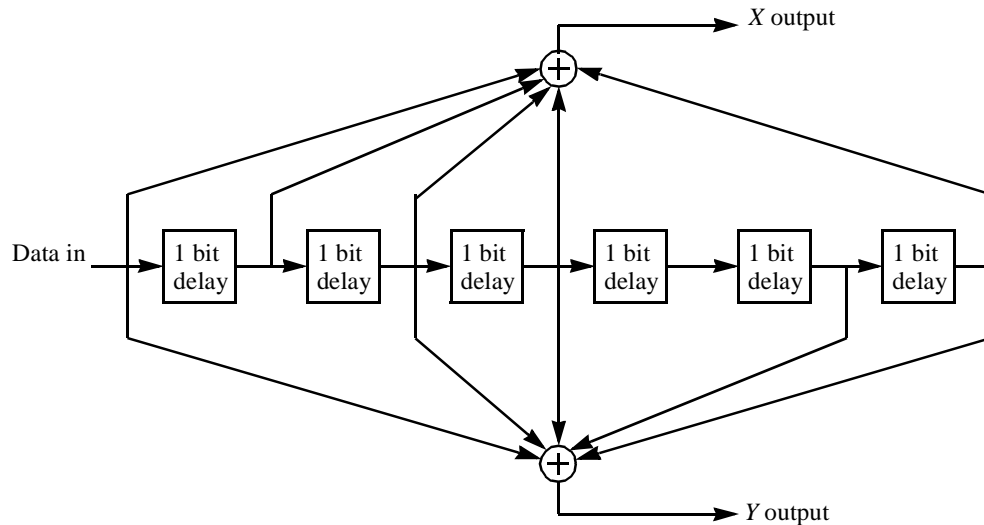

Figure 161—Binary rate 1/2 convolutional encoder

To generate binary code rates of 2/3, 3/4, 5/6, and 7/8, the rate 1/2 encoder outputs shall be punctured. The puncturing patterns and serialization order for the X and Y outputs are defined in Table 174. In the puncture patterns, a “1” denotes a transmitted output bit and a “0” denotes a nontransmitted (punctured) bit.

Table 174—Puncture patterns and serialization for convolution code

	Code rates				
Rate	1/2	2/3	3/4	5/6	7/8
X Output Puncture pattern	1	10	101	10101	1000101
Y Output Puncture pattern	1	11	110	11010	1111010
Punctured XY serialization	X_1Y_1	$X_1Y_1Y_2$	$X_1Y_1Y_2X_3$	$X_1Y_1Y_2X_3Y_4X_5$	$X_1Y_1Y_2Y_3Y_4X_5Y_6X_7$

A pragmatic TCM code is constructed from both nonsystematic coded bits (that are taken from the outputs of the punctured rate 1/2 binary convolutional encoder) and systematic uncoded bits (that are taken directly from the encoder input). The resulting coded bits are then mapped to symbol constellations. Supported modulations and code rates for uplink and downlink transmissions are listed in Table 175. The choice of a particular code rate and modulation is made via burst profile parameters

Since the RS outer code generates byte-denominated records but the inner code generates symbol-denominated outputs, some RS record sizes could require a fractional QAM symbol at the end of the data record. When this occurs, sufficient (nonrandomized) zero-valued (null) bits shall be appended to the end of the inner encoder's input record to complete the final symbol. A receiver shall discard these null bits after inner decoding.

Table 175—Supported modulations and inner (TCM) code rates

Modulation	Support (M = Mandatory, O = Optional)		Inner code rates	Bits/symbol
	UL	DL		
Spread BPSK	M	M	(pre-spread) 1/2, 3/4	(post-spread) 1/(2*Fs), 3/(4*Fs)
BPSK	M	M	1/2, 3/4	1/2, 3/4
QPSK	M	M	1/2, 2/3, 3/4, 5/6, 7/8	1, 4/3, 3/2, 5/3, 7/4
16-QAM	M	M	1/2, 3/4	2, 3
64-QAM	M	M	2/3, 5/6	4, 5
256-QAM	O	O	3/4, 7/8	6, 7

Inner code blocks are to be zero-state terminated in transitions between adaptive modulation (and FEC) types, at the ends of bursts, or as instructed by the MAC and frame control.

When using zero state termination, the baseline rate 1/2 convolutional encoder shall be initialized with its registers in the all-zeros state. Inner encoding shall begin from this state, by accepting bit inputs. To terminate the inner code (and return the encoder to the all-zeros state) at the end of a code block, at least six zero inputs shall be fed into the baseline rate 1/2 binary convolutional encoder to ensure its register memory is flushed, i.e., its state memory is driven to zero. Once the first flushing zero bit is introduced into the convolutional encoder memory, all input bits, including the systematic input bits that are parallel to the binary convolutional encoder inputs, shall have zero value.

Table 176 specifies the exact number of systematic and nonsystematic bits that shall be used to flush a pragmatic TCM encoder for a given modulation and code rate. It also tabulates the number of symbols consumed in the code termination process. Spread BPSK with a spreading factor of Fs consumes Fs-times more symbols than BPSK.

Table 176—Flushing bit requirements for inner code termination

Modulation	Inner code rate	Number of flushing bits			Number of consumed symbols
		Nonsystematic	Systematic	Total	
spread BPSK	1/2	(pre-spread) 6	(pre-spread) 0	(pre-spread) 6	(post-spread) 12*Fs
	3/4	(pre-spread) 6	(pre-spread) 0	(pre-spread) 6	(post-spread) 8*Fs
BPSK	1/2	6	0	6	12
	3/4	6	0	6	8

Table 176—Flushing bit requirements for inner code termination (continued)

Modulation	Inner code rate	Number of flushing bits			Number of consumed symbols
		Nonsystematic	Systematic	Total	
QPSK	1/2	6	0	6	6
	2/3	7	0	7	5
	3/4	6	0	6	4
	5/6	6	0	6	4
	7/8	7	0	7	4
16-QAM	1/2	6	0	6	3
	3/4	6	12	18	6
64-QAM	2/3	6	6	12	3
	5/6	6	4	10	2
256-QAM	3/4	6	12	18	3
	7/8	6	8	14	2

— **Encoding for spread BPSK, all rates**

See 8.2.1.3.2.

— **Encoding for BPSK and QPSK modulations, all rates**

For BPSK, the binary outputs of the punctured binary encoder shall be directly sent to the BPSK symbol mapper, using the multiplexed output sequence shown in the “XY”-headed row of Table 174. For QPSK, the multiplexed output sequence in Table 174 is alternately assigned to the I and Q coordinate QPSK mapper, with the I coordinate receiving the first assignment.

Subclause 8.2.1.3.1 describes the constellation mapping procedure and Figure 170 and Figure 171 depict bits-to-symbol-constellation maps that shall be used for BPSK and QPSK, respectively.

— **Encoding for rate 1/2 16-QAM**

Figure 162 illustrates the rate 1/2 pragmatic TCM encoder for 16-QAM. The baseline rate 1/2 binary convolutional encoder first generates a 2-bit constellation index, b_3b_2 , associated with the I symbol coordinate. Provided the next encoder input, it generates a two-bit constellation index, b_1b_0 , for the Q symbol coordinate. The I index generation shall precede the Q index generation. Note that this encoder should be interpreted as a rate 2/4 encoder, because it generates one 4-bit code symbol per two input bits. For this reason, input records of lengths divisible by two shall be fed to this encoder. Figure 171 depicts the bits-to-constellation map that shall be applied to the rate 1/2 16-QAM encoder output. This is a Gray code map.

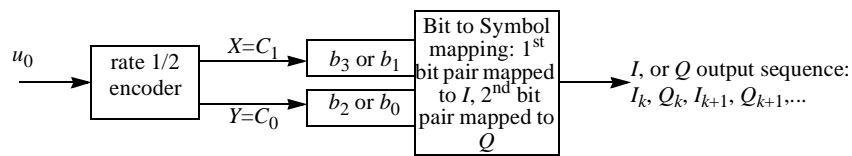

Figure 162—Pragmatic TCM encoder for rate 1/2 16-QAM

— Encoding for rate 3/4 16-QAM

Figure 163 illustrates the rate 3/4 pragmatic TCM encoder for 16-QAM. This encoder uses the baseline rate 1/2 binary convolutional encoder, along with two systematic bits that are passed directly from the encoder input to the encoder output. With this structure, the encoder is capable of simultaneously generating four output bits per three input bits. The sequence of arrival for the $u_2u_1u_0$ input into the encoder is u_2 arrives first, u_1 second, u_0 last. During the encoding process, the encoder generates a two-bit constellation index, b_3b_2 , for the I symbol coordinate, and simultaneously generates another two-bit constellation index, designated b_1b_0 , for the Q symbol coordinate. Note that whole symbols shall be transmitted, so input records of lengths divisible by three shall be fed to this encoder.

Figure 174 depicts the bits-to-symbol-constellation map that shall be applied to the rate 3/4 16-QAM encoder output. This is pragmatic TCM map.

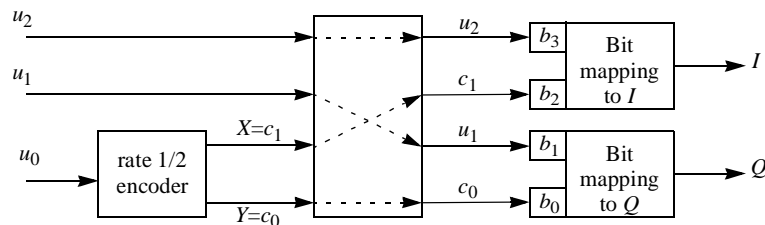

Figure 163—Pragmatic TCM encoder for rate 3/4 16-QAM

— Encoding for rate 2/3 64-QAM

Figure 164 illustrates the rate 2/3 pragmatic TCM encoder for 64-QAM. This encoder uses the baseline rate 1/2 binary convolutional encoder, along with one systematic bit that is passed directly from the encoder input to the encoder output. The sequence of arrival for the u_1u_0 input into the encoder is u_1 arrives first, u_0 last. The encoder (as a whole) then generates a 3-bit constellation index, $b_5b_4b_3$, which is associated with the I symbol coordinate. Provided another 2-bit encoder input, the encoder generates another 3-bit constellation index, $b_2b_1b_0$, which is associated with the Q symbol coordinate. The I index generation should precede the Q index generation. Note that this encoder should be interpreted as a rate 4/6 encoder, because it generates one 6-bit code symbol per four input bits. For this reason, input records of lengths divisible by four shall be fed to this encoder. Figure 174 depicts the bits-to-symbol-constellation map that shall be applied to the rate 2/3 64-QAM encoder output. This is a pragmatic TCM map.

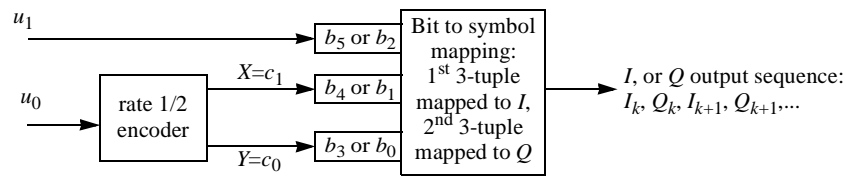

Figure 164—Pragmatic TCM encoder for rate 2/3 64-QAM

— Encoding for rate 5/6 64-QAM

Figure 165 illustrates the rate 5/6 pragmatic TCM encoder for 64-QAM. This encoder uses a rate 3/4 punctured version of the rate baseline rate 1/2 binary convolutional encoder, along with two systematic bits that are passed directly from the encoder input to the encoder output. The rate 3/4 punctured code is generated from the baseline rate 1/2 code using the rate 3/4 puncture mask definition in Table 174. Puncture samples are sequenced c_3 first, c_2 second, c_1 third, and c_0 last. The sequence of arrival for the $u_4u_3u_2u_1u_0$ input into the encoder is u_4 arrives first, u_3 arrives second, u_2 arrives third, u_1 arrives next to last, and u_0 arrives last. During the encoding process, the pragmatic encoder generates a 3-bit constellation index, $b_5b_4b_3$, for the I symbol coordinate, and simultaneously generates another 3-bit constellation index, $b_2b_1b_0$, for the Q symbol coordinate. Note that whole symbols shall be transmitted, so input records of lengths divisible by five shall be fed to this encoder.

Figure 174 depicts the bits-to-symbol-constellation map that shall be applied to the rate 5/6 64-QAM encoder output. This is a pragmatic TCM map.

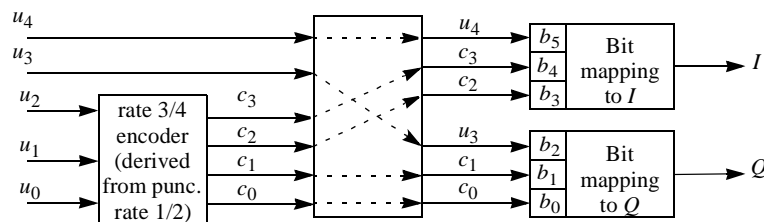

Figure 165—Pragmatic TCM encoder for rate 5/6 64-QAM

— Encoding for rate 3/4 256-QAM

Figure 166 illustrates the rate 3/4 pragmatic TCM encoder for 256-QAM. This encoder uses the baseline rate 1/2 binary convolutional encoder, along with two systematic bits that are passed directly from the encoder input to the encoder output. The sequence of arrival for the $u_2u_1u_0$ input into the encoder is u_2 arrives first, u_1 next, u_0 last. Note that the encoder (as a whole) first generates a 4-bit constellation index, $b_7b_6b_5b_4$, which is associated with the I symbol coordinate. Provided another 4-bit encoder input, it generates a 4-bit constellation index, $b_3b_2b_1b_0$, which is associated with the Q symbol coordinate. The I index generation should precede the Q index generation. Note that this encoder should be interpreted as a rate 6/8 encoder, because it generates one 8-bit code symbol per 6 input bits. For this reason, input records of lengths divisible by 6 shall be fed to this encoder.

Figure 166 depicts the bits-to-symbol-constellation map that shall be applied to the rate 3/4 256-QAM encoder output. This is a pragmatic TCM map.

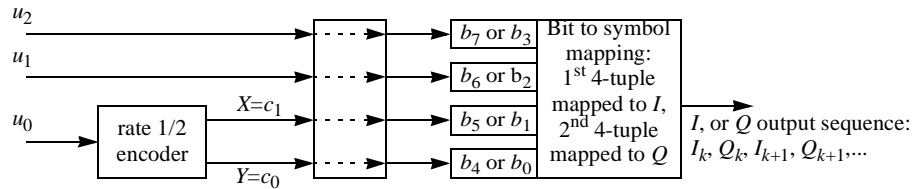

Figure 166—Optional pragmatic TCM encoder for rate 3/4 256-QAM

— Encoding for rate 7/8 256-QAM

Figure 167 illustrates the rate 7/8 pragmatic TCM encoder for 256-QAM. This encoder uses a rate 3/4 punctured version of the rate baseline rate 1/2 binary convolutional encoder, along with two systematic bits that are passed directly from the encoder input to the encoder output. The rate 3/4 punctured code is generated from the baseline rate 1/2 code using the rate 3/4 puncture mask definition in Table 174. Puncture samples are sequenced c_3 first, c_2 second, c_1 third, and c_0 last. The sequence of arrival for the $u_6u_5u_4u_3u_2u_1u_0$ input into the encoder (as a whole) is u_6 arrives first, u_5 arrives second, u_4 arrives third, u_3 arrives fourth, u_2 arrives fifth, u_1 arrives next to last, and u_0 arrives last. During the encoding process, the encoder generates a 4-bit constellation index, $b_7b_6b_5b_4$, for the I symbol coordinate, and simultaneously generates another 4-bit constellation index, $b_3b_2b_1b_0$, for the Q symbol coordinate. Note that whole 256-QAM symbols should be transmitted, so input records of lengths divisible by seven shall be fed to this encoder.

Figure 167 depicts the bits-to-symbol-constellation map that shall be applied to the rate 7/8 256-QAM encoder output. This is a pragmatic TCM map.

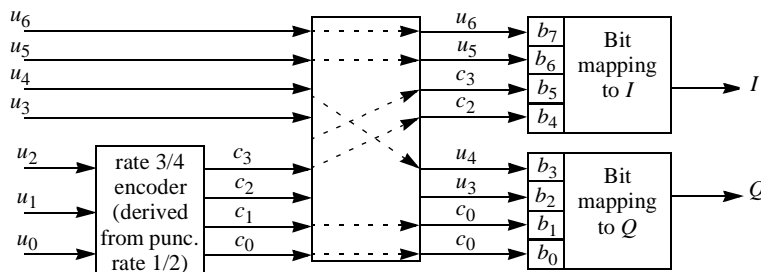

Figure 167—Optional pragmatic TCM encoder for rate 7/8 256-QAM

8.2.1.2.2 No FEC

In the No FEC option, randomized source data shall be mapped directly to a QAM symbol constellation, using the appropriate Gray coding map. These maps are found in Figure 170 (for BPSK), Figure 171 (for QPSK, 16-QAM), Figure 172 (for 64-QAM), and Figure 173 (for 256-QAM). No-FEC operation is mandatory for QPSK but optional for other modulation.

In the event that the source record size in bytes does not divide into an integral number of QAM symbols, sufficient derandomized zero-valued (null) bits shall be appended to the end of the data record to complete the last symbol. These null bits shall be discarded at the receiver.

8.2.1.2.3 BTCs

Support of the BTC FEC is optional.

A BTC is formed from block row codes, each with rate parameters (n_x, k_x) and block column codes, each with rate parameters (n_y, k_y) . The BTC is encoded by writing data bits row by row into a two-dimensional matrix as illustrated in Figure 168. The k_x information bits in each row are encoded into n_x bits by using a constituent block (n_x, k_x) row code. The k_y information bits in each column are encoded into n_y bits by using a constituent block (n_y, k_y) column code, where the checkbits of the rows are also encoded. The resulting BTC shall have block length $n = n_x \times n_y$ bits and information length $k = k_x \times k_y$.

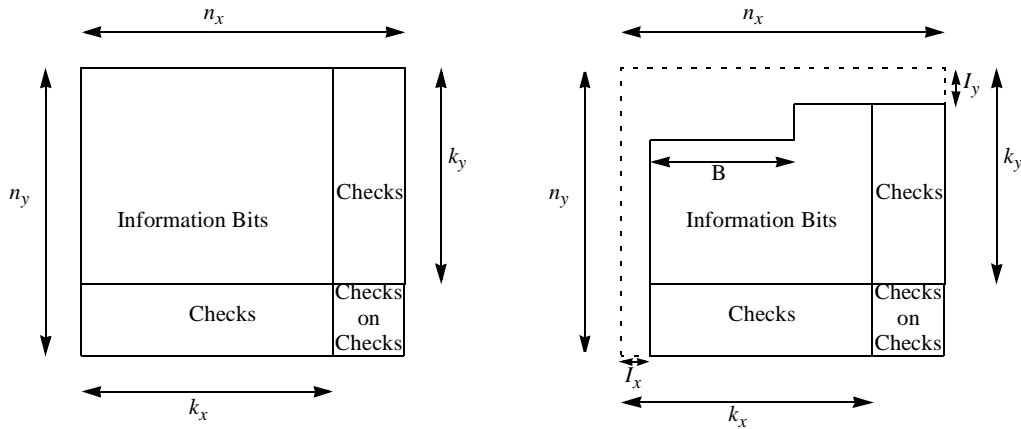

Figure 168—BTC and shortened BTC structures

The constituent row code and constituent column code used to form the rows and columns of a BTC shall be specified by BTC-specific burst profile parameters. The constituent codes available for specification are listed in Table 177. All codes in Table 177 shall be formed by appending a check bit or check bits to the end of the information bits. A parity check code shall use one check bit, derived by XORing the information bits.

An extended Hamming component code shall use $n-k$ check bits. The first $n-k-1$ check bits are the check bits of a $(n-1, k)$ Hamming code derived from one of the generator polynomials listed in Table 178, while the last check bit is a parity check bit, derived by XORing the $n-1$ information and parity bits of the $(n-1, k)$ Hamming code.

Table 177—BTC component codes

Component codes (n, k)	Code type
$(64,57), (32,26), (16,11), (8,4)$	Extended Hamming Code
$(64,63), (32,31), (16,15), (8,7)$	Parity Check Code

Table 178— $(n-1, k)$ Hamming code generator polynomials

$n-1$	k	Generator polynomial
7	4	X^3+X^1+1
15	11	X^4+X^1+1
31	26	X^5+X^2+1
63	57	X^6+X+1

To match an arbitrary required packet size, BTCs may be shortened by removing symbols from the BTC array. Rows, columns, or parts thereof can be removed until the appropriate size is reached. The following two steps, illustrated in Figure 168, are involved in the shortening of product codes:

- Step 1) Remove I_x rows and I_y columns from the two-dimensional code. This is equivalent to shortening the constituent codes that make up the product code.
- Step 2) Remove B individual bits from the first row of the two-dimensional code starting with the LSB.

The resulted block length of the code is $(n_x - I_x)(n_y - I_y) - B$. The corresponding information length is given as $(k_x - I_x)(k_y - I_y) - B$. Consequently, the code rate is given by Equation (28).

$$R = \frac{(k_x - I_x)(k_y - I_y) - B}{(n_x - I_x)(n_y - I_y) - B} \quad (28)$$

Data bit ordering for the composite BTC matrix is defined such that the leftmost bit in the first row is the LSB. The next bit in the first row is the next-to-LSB. The last data bit in the last data row is MSB. An encoded BTC block shall be read out of the encoded matrix (for transmission) as a serial bit stream, starting with the LSB and ending with the MSB. This bit stream shall be sent to a symbol mapper, which uses a Gray map, depicted in Figure 170 for BPSK, Figure 171 for QPSK, 16-QAM, and the Gray maps depicted in Figure 172 and Figure 173 for 64-QAM, and 256-QAM. If not enough encoded bits are available to fill the last symbol of an allocation, sufficient zero-valued bits (derandomized) shall be appended to the end of the serial stream to complete the symbol.

Two independent variables, C_{bank} and K , collectively specify the BTC encoding and shortening process. C_{bank} is a burst profile parameter specified by the MAC. Its values range from 1 to 3, where each integer refers to a unique set of constituent codes, chosen to set the code rate of the BTC. K is the desired information block length, in bits, to be transmitted within an allocation. Table 179 specifies three code selection banks, each containing four different base BTCs, covering a range of information and encoded data block lengths. Each base BTC is composed from the specified row and column codes. The code selection bank that most closely matches the desired performance should be chosen as the active code bank.

Table 179—BTC code banks

	Component row code (n_x, k_x) bits	Component column code (n_y, k_y) bits	Base BTC block ($n_y n_x, k_y k_x$) bits
$C_{bank=1}$ $R \cong 0.94$	(64,63)	(64,63)	(4096,3969)
	(32,31)	(32,31)	(1024,961)
	(16,15)	(16,15)	(256,225)
	(8,7)	(8,7)	(64,49)
$C_{bank=2}$ $R \cong 0.80$	(64,63)	(64,57)	(4096,3591)
	(32,31)	(32,26)	(1024,806)
	(16,15)	(16,11)	(256,165)
	(8,7)	(8,4)	(64,28)
$C_{bank=3}$ $R \cong 0.69$	(64,57)	(64,57)	(4096,3249)
	(32,26)	(32,26)	(1024,676)
	(16,11)	(16,11)	(256,121)
	(8,4)	(8,4)	(64,16)

From the selected C_{bank} , a corresponding row and column constituent code shall be chosen that best matches the total number of information bits, K , to be encoded. Then the result shall be shortened to the exact information block size. The procedure for doing so shall be as follows:

Step 1: Determine the row and column component codes.

Select the base BTC with the smallest $k_x \times k_y$, such that $K \leq k_x \times k_y$. If K exceeds the largest information block length available in the code selection bank, the K information bits shall be split across $N_{\text{blocks}} = \text{ceil}(K/8 * \text{maxInfoBlock})$, where maxInfoBlock is the number of information bytes in the largest BTC in the code selection bank. The first $N_{\text{blocks}} - 1$ blocks shall encode $\text{ceil}(K/8/N_{\text{blocks}})$ bytes. The final block shall encode the remaining $(K/8) - (N_{\text{blocks}} - 1) * \text{ceil}(K/8/N_{\text{blocks}})$ bytes. Each of the N_{blocks} blocks is encoded according to Step 2, substituting for K the number of information bits assigned to that block. Shortening of the BTC may be required for all N_{blocks} blocks. The code selection bank shall remain unchanged for the duration of the N_{blocks} .

Step 2: Determine the row and column component codes for remnant bits

Select the base BTC with the smallest $k_x \times k_y$, such that $K \leq k_x \times k_y$.

Should K be equal to $k_x \times k_y$, then K fits exactly into the base BTC and the information bits are encoded without shortening. If this is not the case, then the $(n_y \times n_x, k_y \times k_x)$ BTC shall be shortened according to Step 3 after which the K bits are encoded.

Step 3: Determine shortening parameters

Select i such that:

$$\arg \left[\min_i \left(\left(k_x - \left\lfloor \frac{i+1}{2} \right\rfloor \right) \cdot \left(k_y - \left\lfloor \frac{i}{2} \right\rfloor \right) - K \right) > 0 \right] \quad 0 \leq i < 2k_y - 1 \quad (29)$$

The obtained i specifies the shortening parameters: $I_x = \lfloor (i+1)/2 \rfloor$, $I_y = \lfloor i/2 \rfloor$, and $B = (k_x - I_x) \times (k_y - I_y) - K$.

8.2.1.2.4 Convolutional Turbo Codes

Support of the Convolutional Turbo Code FEC is optional.

8.2.1.2.4.1 CTC encoder

The Convolutional Turbo Code encoder, including its constituent encoder, is depicted in Figure 169. It uses a double binary Circular Recursive Systematic Convolutional code. The bits of the data to be encoded are alternately fed to inputs A and B , starting with the MSB of the first byte being fed to A . The encoder is fed by blocks of k bits or N couples ($k = 2 \times N$ bits). For all frame sizes, k is a multiple of 8 and N is a multiple of 4. Furthermore N shall be limited to: $8 \leq N/4 \leq 256$. Zero padding should be used for block sizes less than 32 bytes. For allocations longer than 256 bytes (i.e., 512 nibbles), the allocation (in units of nibbles), A_n determines the number of interleaver code blocks, n_B , that shall be transmitted. The first n_F of these blocks shall each use an interleaver of length N_F nibbles, whereas the remainder shall each use an interleaver of length $N_F + 1$ nibbles as defined in Equation 26.

$$\begin{aligned} n_B &= \left\lceil \frac{A_n}{512} \right\rceil \\ N_F &= \left\lceil \frac{A_n}{n_B} \right\rceil \end{aligned} \quad (30)$$

$$n_F = n_B(N_F + 1) - A_n$$

The polynomials defining encoder the connections are described in hexadecimal and binary symbol notations as follows:

- For the feedback branch: 0xB, equivalently $1 + D + D^3$ (in binary symbolic notation)
- For the Y parity bit: 0xD, equivalently $1 + D^2 + D^3$

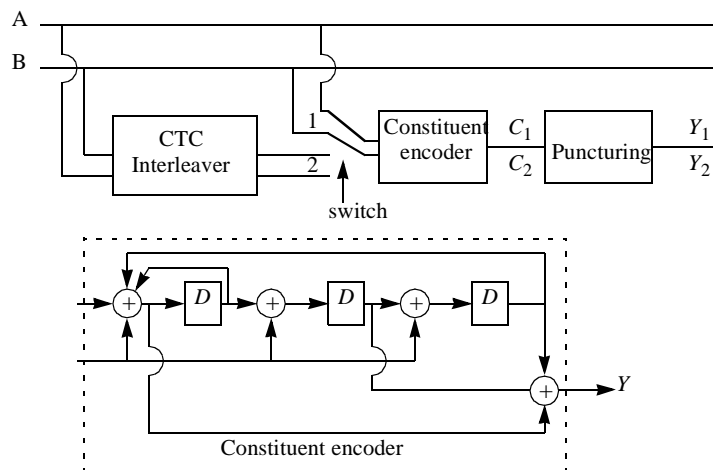

Figure 169—CTC encoder

First, the encoder (after initialization by the circulation state Sc_1 , see 8.2.1.2.4.2) is fed the sequence in the natural order (position 1) with the incremental address $i = 0, \dots, N-1$. This first encoding is called C_1 encoding. Then the encoder (after initialization by the circulation state Sc_2 , see in subclause 8.2.1.2.4.2) is fed by the interleaved sequence (switch in position 2) with incremental address $j = 0, \dots, N-1$. This second encoding is called C_2 encoding.

8.2.1.2.4.2 CTC interleaver

The interleaver requires the parameters P_0 , which shall be the nearest prime number greater than $\sqrt{N/2}$, with $P_0 \geq 3$, which is dependent on the block size N . The two-step interleaver shall be performed by:

Step 1: Switch alternate couples

for $j = 1 \dots N$

if $(j_{\text{mod}_2} == 0)$ let $(B, A) = (A, B)$ (i.e. switch the couple)

Step 2: $P_i(j)$

The function $P_i(j)$ provides the interleaved address i of the consider couple j .

for $j = 1 \dots N$

switch j_{mod_4} :

case 0 or 1: $i = (P_0 \cdot j + 1)_{\text{mod}_N}$

case 2 or 3: $i = (P_0 \cdot j + 1 + N/4)_{\text{mod}_N}$

8.2.1.2.4.3 Determination of CTC circulation states

The state of the encoder is denoted S ($0 \leq S \leq 7$) with S the value read binary (left to right) out of the constituent encoder memory (see Figure 169). The circulation states Sc_1 and Sc_2 are determined by the following operations:

- Step 1) Initialize the encoder with state 0. Encode the sequence in the natural order for the determination of Sc_1 or in the interleaved order for determination of Sc_2 . In both cases, the final state of the encoder is $S0_{N-1}$;
- Step 2) According to the length N of the sequence, use Table 180 to find Sc_1 or Sc_2 .

Table 180—Circulation state lookup table (Sc)

N_{mod_7}	$S0_{N-1}$							
	0	1	2	3	4	5	6	7
1	0	6	4	2	7	1	3	5
2	0	3	7	4	5	6	2	1
3	0	5	3	6	2	7	1	4
4	0	4	1	5	6	2	7	3
5	0	2	5	7	1	3	4	6
6	0	7	6	1	3	4	5	2

8.2.1.2.4.4 CTC puncturing

The various code-rates are achieved through selectively deleting the parity bits (puncturing). The puncturing patterns are identical for both codes C_1 and C_2 .

Table 181—Circulation state lookup table (Sc)

Rate $R_n/(R_n+1)$	Y															
	0	1	2	3	4	5	6	7	8	9	10	11	12	13	14	15
1/2	1	1														
2/3	1	0	1	0												
3/4	1	0	0	1	0	0										
5/6	1	0	0	0	0	1	0	0	0	0						
7/8	1	0	0	0	0	0	0	1	0	0	0	0	0	0	0	0

8.2.1.2.4.5 CTC modulation mapping

The encoded bit is fed into the mapper for BPSK and QPSK in the following order:

$$A_0, B_0 \dots A_{N-1}, B_{N-1}, Y_{10}, Y_{1,1} \dots Y_{1,M}, Y_{20}, Y_{2,1} \dots Y_{2,M},$$

where M is the number of parity bits and the I channel is fed first. The order in which the encoded bit are fed into the mapper for 16-QAM, 64-QAM and 256-QAM is:

$$A_0, B_0 \dots A_{Rn}, B_{Rn}, Y_{1,0}, A_{Rn+1}, B_{Rn+2} \dots A_{2Rn}, B_{2Rn}, Y_{2,0} \dots$$

Let S be half the number of bits in the modulation symbol. Then if (R_n+1) equals S , the parity bits are mapped to the two least protected locations in the constellation (16-QAM = $\{b_0, b_2\}$, 64-QAM = $\{b_0, b_3\}$, 256-QAM = $\{b_0, b_4\}$). If (R_n+1) equals $2S$, the parity bits are mapped to the least protected bit in the modulation scheme in the Q channel, using the mapping specified in the mandatory mode (b_0 for 16-QAM, 64-QAM and 256-QAM).

8.2.1.3 Modulations and constellation mapping

Table 182 lists supported modulations.

Table 182—Modulations supported

Modulation	Support (M=Mandatory, O=Optional)	
	UL	DL
Spread BPSK	M	M
BPSK	M	M
QPSK	M	M
16-QAM	M	M
64-QAM	M	M
256-QAM	O	O

With the exception of spread-BPSK, FEC-encoded bits are mapped directly to a modulation constellation using one of the constellation maps in 8.2.1.3.1. Since multiple mappings are defined for several of the modulations, the appropriate FEC and code rate description shall be consulted to determine the specific mapping to be used. Subclause 8.2.1.4 specifies the modulation procedure to be used for spread-BPSK modulation.

8.2.1.3.1 Constellation mapping

For the concatenated FEC, code bits shall be mapped to *I* and *Q* symbol coordinates using either a pragmatic TCM or Gray code symbol map, depending on the code rate and modulation scheme.

BPSK shall be alternately mapped to the orthogonal constellations illustrated in Figure 170. BPSK MAP0 shall be used for even-indexed bits, while BPSK MAP1 shall be used for odd indexed bits. The first symbol to be mapped in a spread BPSK allocation shall be considered even.

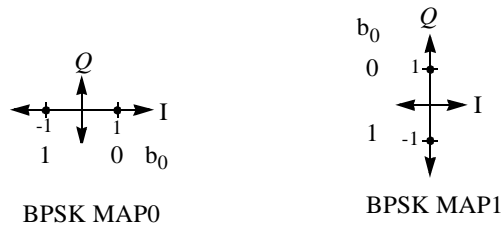

Figure 170— BPSK Constellation maps

All QPSK code rates and rate 1/2 16-QAM shall use the Gray coded constellation maps depicted in Figure 171.

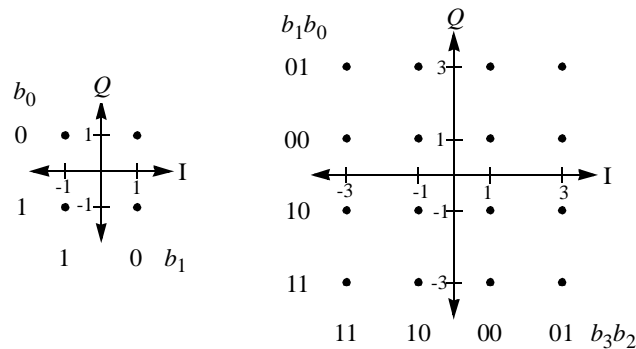

Figure 171—Gray maps for QPSK and 16-QAM constellations

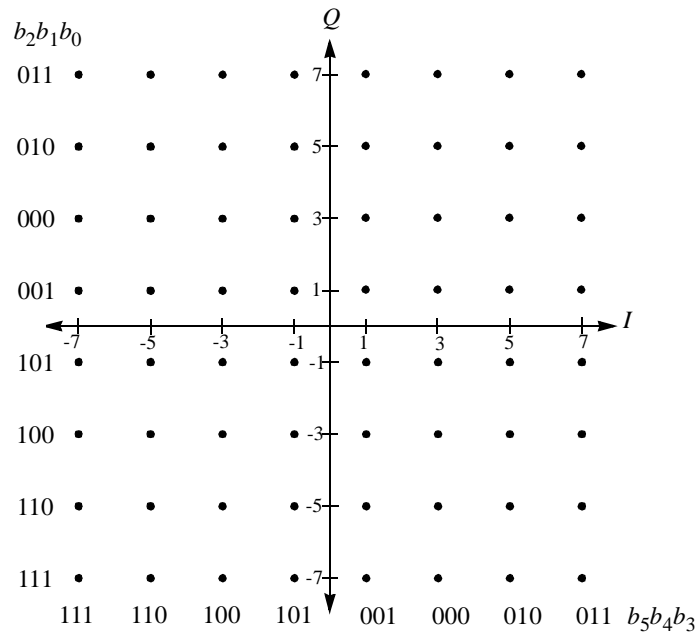

Figure 172—Gray map for 64-QAM constellation

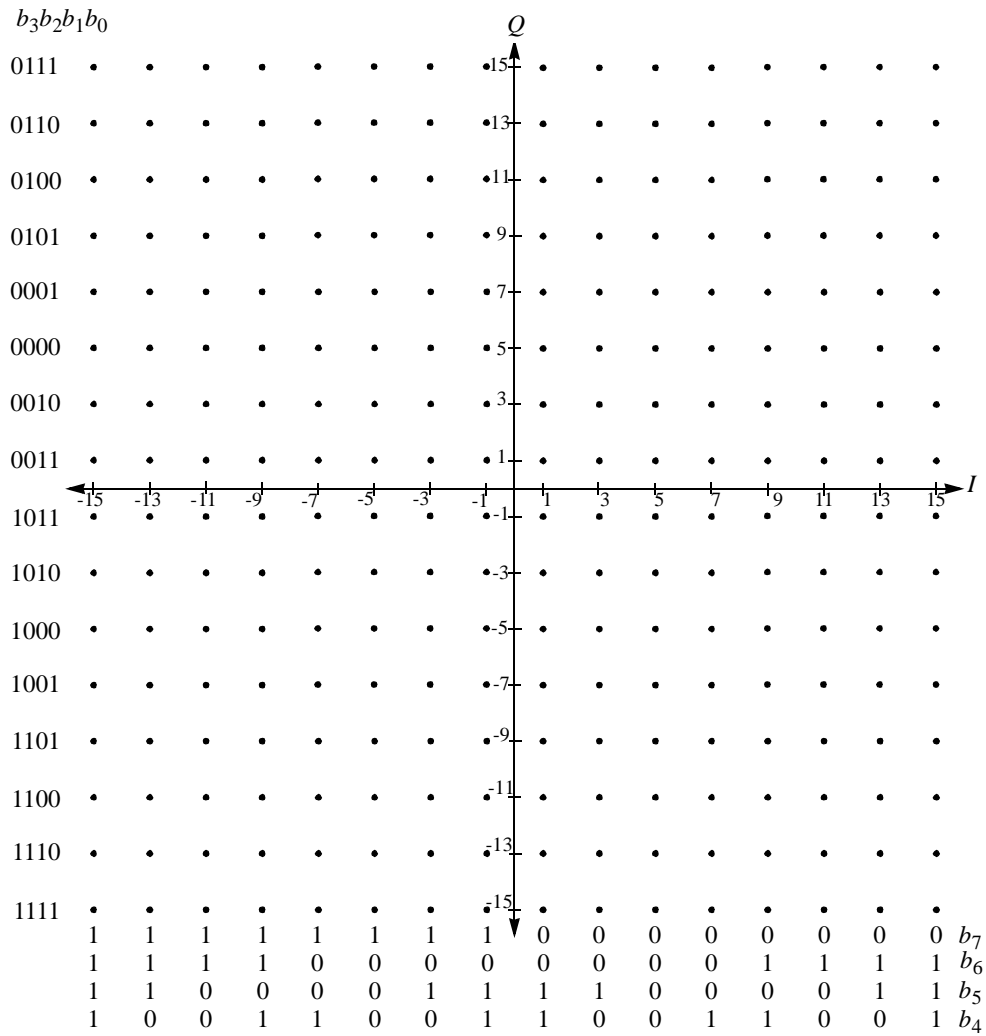

Figure 173—Gray map for 256-QAM constellation

Rate 3/4 16-QAM and all code rates for 64-QAM shall use the pragmatic TCM constellation map depicted in Figure 174.

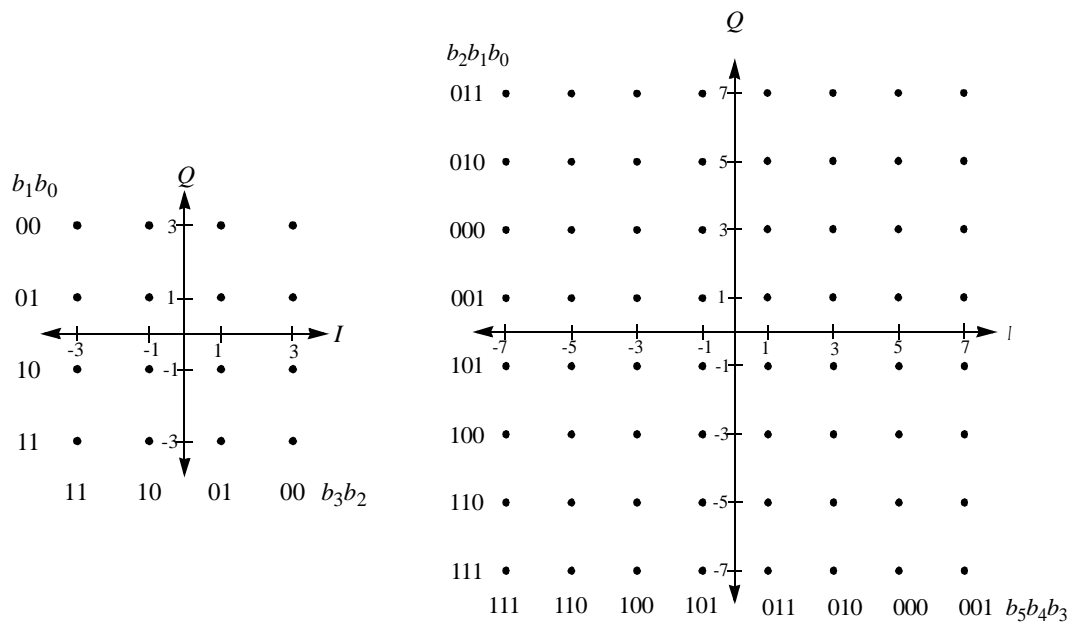

Figure 174—Pragmatic maps for 16-QAM and 64-QAM constellations

All code rates for 256-QAM shall use the pragmatic TCM constellation map depicted in Figure 175.

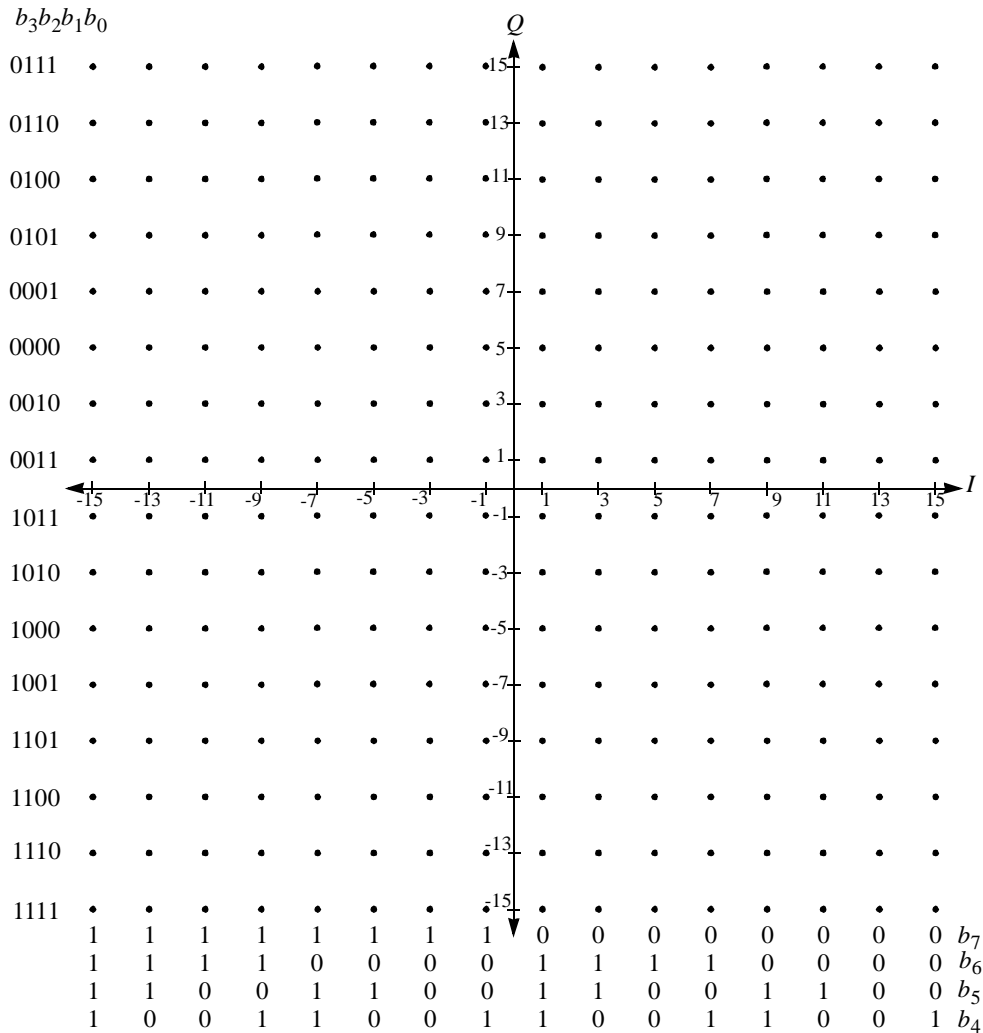

Figure 175—Pragmatic map for 256-QAM constellation

To obtain unity average power or unity peak power of transmitted sequences, I and Q coordinates of constellation points are multiplied by the appropriate factor for c listed in Table 183, depending on the normalization rule in effect. Excepting BPSK, with constant peak power normalization, corner points in the constellation are transmitted at equal power levels regardless of modulation type. With constant mean power normalization, the signal is transmitted at equal mean power levels regardless of modulation type.

Table 183—Unity average power normalization factors

Modulation scheme	Normalization constant for unity average power	Normalization constant for unity peak power
BPSK	$c = 1$	$c = 2$
QPSK	$c = 1/(\sqrt{2})$	$c = 1/(\sqrt{2})$
16-QAM	$c = 1/(\sqrt{10})$	$c = 1/(\sqrt{18})$
64-QAM	$c = 1/(\sqrt{42})$	$c = 1/(\sqrt{98})$
256-QAM	$c = 1/(\sqrt{170})$	$c = 1/(\sqrt{450})$

8.2.1.3.2 Spread BPSK modulation

Spread BPSK is a modulation format. Its selection is made by the burst profile encoding for modulation type.

The input to a spread BPSK modulator is a serial stream of bits derived from the FEC encoder output. Spread BPSK modulation shall only be matched with FEC code rates defined for conventional (non-spread) BPSK. Table 175 lists these code rates for the mandatory concatenated FEC.

Figure 176 illustrates the generation of spread BPSK-modulated data with a spreading factor of F_s . Each input bit shall be held for F_s symbol clocks as it is XORed with F_s consecutive outputs of a PN sequence generator operating at the symbol rate. The XOR output shall be mapped to BPSK symbols as described in 8.2.1.3.1.

PN chip generation rate = symbol rate

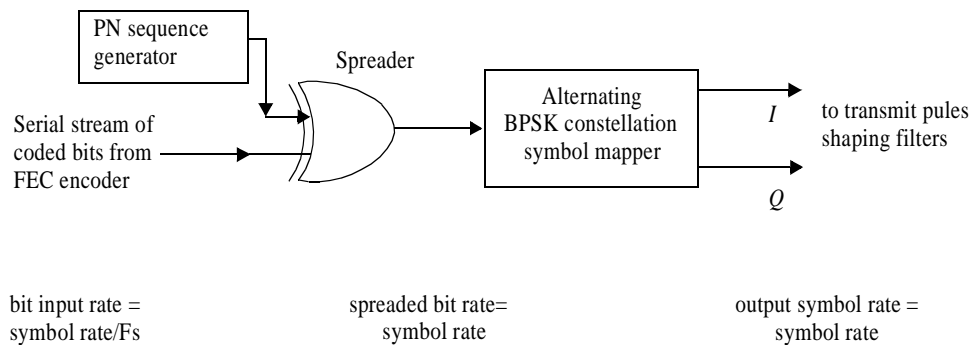
**Figure 176—Spread BPSK processing**

Only spreading factors from the set $F_s = 2^n, 0 \leq n \leq n_{max}$, where $n_{max} = 3$ (for downlink), 4 (for uplink) shall be used. Support of all spreading factors is mandatory. The spreading factor used by a burst is specified within its burst profile encoding for modulation type.

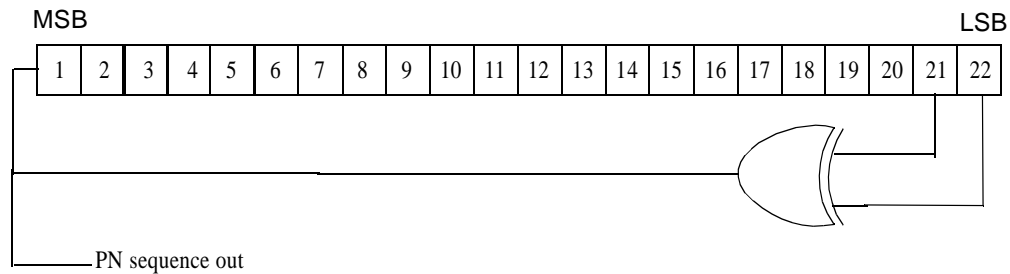

Figure 177—Spreading PN sequence generator

The spreading PN sequence generator shall be constructed from the Linear Feedback Shift Register (LFSR) illustrated in Figure 177. The characteristic polynomial for this LFSR is $1 + X^{21} + X^{22}$.

The PN sequence generator shall be preset at the beginning of a spread BPSK allocation with one of the seeds listed in Table 184. The burst profile setting for spreading is used to select the seed to be used.

On the uplink, a BS is not required to make, but may make multiple time-overlapping spread BPSK allocations. Each allocation must be to a different SS, and each must use the same seed. These allocations shall not time-overlap a non-spread allocation. To insure that spreading sequence phases and preambles of overlapping spread BPSK do not time-overlap at the BS receiver, the allocation start-time of a burst preamble shall commence at least one Unique Word length of symbols after the end of the preamble of any other spread-BPSK allocation that it may time-overlap.

Multiple time-overlapping spread BPSK allocations (from a single BS, over a single sector) shall not be transmitted on the downlink. A recommended practice within a coordinated cell plan is for each BS to assign the same seed for all spread BPSK transmissions, and for different BSs in nearby cells or sectors to assign different seeds.

Table 184—Spreading PN sequence generator seeds

Seed Label	Seed (Binary)		Seed (Hex)
	MSB	LSB	
0	1010110010111100110100		2B2F34
1	1011111010010011110111		2FA4F7
2	0011100001100010101111		E18AF
3	1010110001100110011001		2B1999
4	1110110011110001001111		3B3C4F
5	1011011111100110011011		2DF99B
6	1000100100010111100000		2245E0
7	0100001101111000101100		10DE2C
8	0100101000000010011011		12809B
9	0010000001001011101011		812EB
10	0010110110001011101010		B62EA
11	1001111101111000111100		27DE3C
12	0110010100110111100110		194DE6
13	1000010010111101011010		212F5A
14	0011010100100100111000		D4938
15	1000011011100000000001		21B801

Note that spread BPSK with a spreading factor of F_s divides the throughput by F_s on top of all other rate reductions such as FEC encoding and mapping to a BPSK symbol constellation.

8.2.1.4 Burst set framing

Both downlink and uplink data shall be formatted into framed burst sets. The downlink shall support one or more framed TDM burst sets, while the uplink shall support framed TDMA burst sets. The coordination of uplink and downlink bursts used to implement a TDD or FDD system is specified in 8.2.1.5.

The format used by a burst set is indicated by the Burst Set Frame Type burst profile encoding (on uplink) and extended IE (on downlink). Three formats are defined. The Standard format (8.2.1.4.2) shall be supported on both the uplink and downlink. This format is always used for data containing the FCH. The STC format (8.2.1.4.3) is optional and shall be used only for STC encoded data on the uplink or downlink. The Subchannel format (8.2.1.4.4) is optional and shall be used only on the uplink.

Although burst sets in the Standard, STC, and Subchannel formats may coexist on the same channel, they shall not overlap in time.

8.2.1.4.1 Unique Word

8.2.1.4.1.1 Selection

The length, U , in symbols of a Unique Word (UW) is a burst profile parameter (on uplink) and an extended IE (on downlink). For best performance, U should be at least as long as the intended channel's span of significant delay spread.

8.2.1.4.1.2 Definition

Unique Words are derived from Frank-Zadoff sequences [B21] and possess CAZAC (Constant Amplitude Zero [periodic] Auto-Correlation) properties. A burst profile specifies a Unique Word from the options listed in Table 185. The sequence lengths $U = 16$ and $U = 64$ shall be supported. The sequence length $U = 256$ shall be supported for bandwidths above 20 MHz.

Table 185—Unique Word lengths, types, and support

Length, U (symbols)	Support status
16	Mandatory
64	Mandatory
256	Mandatory for bandwidths above 20 MHz

The integer n -indexed I and Q components of a length U , $0 \leq n < u$, Unique Word sequence shall be generated from Equation (31).

$$\begin{aligned} I[n] &= \cos(\theta[n]) \\ Q[n] &= \sin(\theta[n]) \end{aligned} \quad (31)$$

where

$$\begin{aligned} \theta[n = p + q\sqrt{U}] &= \frac{2\pi pqr}{\sqrt{U}} \\ p &= 0, 1, \dots, \sqrt{U} - 1 \\ q &= 0, 1, \dots, \sqrt{U} - 1 \end{aligned} \quad (32)$$

and $r = 1, 3$ or co-prime with \sqrt{U} .

The length $U = 16, 64$, and 256 Unique Word sequences are composed of symbols from QPSK, 8-PSK, and 16-PSK alphabets, respectively. The error vector magnitude (EVM) for Unique Word symbols in a transmitter implementation should conform with the general requirements stated in 8.2.3.4.

For the downlink and uplink, an r -factor value of 1 shall be employed for all instances of UW usage unless otherwise specified. For the preamble appearing at the start of each downlink subframe, the r -factor value shall be either 1 or 3 and shall be specified by the MAC on a frame-by-frame basis.

For each downlink burst frame received, the SS PHY shall determine the r -factor of the corresponding preamble and provide an indication to the MAC, which provides the r -factor setting for the received frame. In addition, the PHY shall use the r -factor to select the appropriate burst profile settings for demodulation and decoding of the FCH immediately following the preamble. The FCH burst profile settings associated with each r -factor are statically defined at the BS. The SS shall determine these settings during downlink synchronization and retain them for use by the SS PHY during normal operation. The settings remain in effect until altered by reception of a DL-MAP containing an FCH burst profile change extended IE.

8.2.1.4.2 Standard burst set format

Figure 178 depicts a burst set with the standard format. As illustrated, the burst set consists of three fundamental framing elements: a burst set preamble that includes ramp-up; one or more bursts; and a Receiver Delay Spread Clearing (RxDS) interval that includes ramp-down.

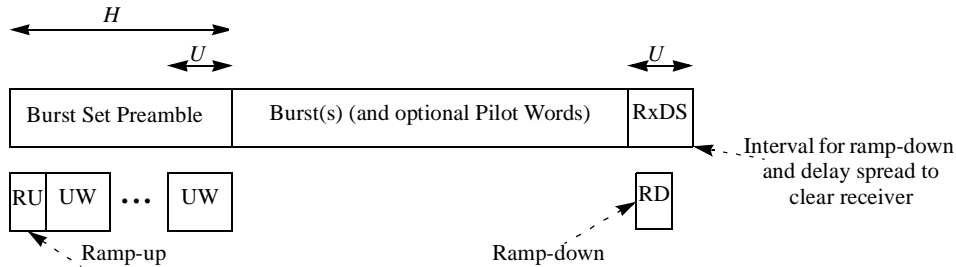

Figure 178—Fundamental framing elements in a standard format burst set

8.2.1.4.2.1 Burst set preamble

A burst set preamble shall consist of a ramp-up region followed by a preamble body. Burst profile (on uplink) or extended IE (on downlink) parameters shall specify R_r , the length of the ramp-up region in symbols, and m , the number of Unique Words composing the preamble body. The preamble specification shall also include U , the number of symbols in a Unique Word.

A burst set preamble shall be constructed from the last R_r symbols of a Unique Word (see Table 185) followed by an integer multiple $m \geq 0$ of Unique Words, each Unique Word being U symbols in length. Figure 179 illustrates this requirement.

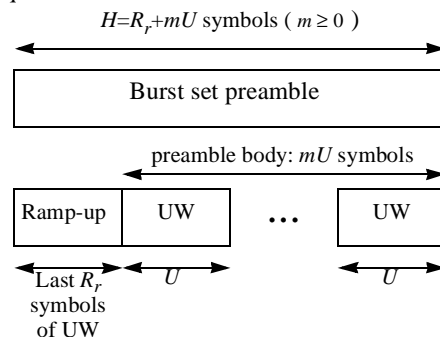

Figure 179—Burst set preamble composition

For $R_r > 0$, a ramp-up element of length R_r symbols shall be created and a power ramp-up applied to these ramp-up symbols. When creating a ramp-up element, the transmit filter memory is initialized with zero-valued (null) symbols. The ramp-up and preamble symbols shall then be sequentially fed into the transmit filter input stream. The transient samples preceding the first ramp-up symbol shall be suppressed at the transmit filter output until the central sample time of the first preamble symbol. A ramped power buildup shall be achieved by superimposing a multiplicative raised cosine half-window of duration R_r symbols upon the samples leaving the transmit filter.

For $R_r = 0$, dedicated ramp-up symbols are not inserted. If ramp-up is required, power ramp-up shall be applied to the first four symbols of the preamble using the same ramping procedure described for the $R_r > 0$ case.

8.2.1.4.2.2 Burst

The burst block depicted in Figure 178 contains payload data. The burst block may also contain periodically inserted Pilot Words (see 8.2.1.4.2.4). The capability to demodulate payloads of arbitrary length and PS-unit granularity is mandatory. The capability to insert Pilot Words at the transmitter and remove them at the receiver is also mandatory.

A downlink burst set may contain time division multiplexed bursts that are adaptively modulated for the intended recipients. When an FCH is to be transmitted within a downlink subframe, it shall always appear as the first burst in the first burst set, and shall be encoded in accordance with 8.2.1.7. Subsequent bursts within the burst set shall be sequenced in decreasing order of modulation robustness, beginning with the most robust modulation that is supported at the transmitter. The capability to transition between modulation types on any PS boundary within a burst set shall be supported. FEC blocks shall be terminated at every such transition.

One exception to the modulation sequencing rule is null payload fill, which if used, shall always appear as the final burst in a burst set, and shall be transmitted using QPSK.

An uplink burst set contains a single burst.

Burst profiles are used to specify the modulation and coding for each burst. In changing from the preamble to a burst or in changing from one burst (e.g., modulation type) to another, the BS or SS shall use one of two power adjustment rules: maintaining constant constellation peak power (power adjustment rule = 0), or maintaining constant constellation mean power (power adjustment rule = 1). The power adjustment rule is configurable through the DCD Channel Encoding parameters (11.4.1) and UCD Channel Encoding parameters (11.3.1).

The constellation normalization factors associated with power adjustment rules are listed in Table 183. Preambles and pilot words are derived from PSK alphabets, and use the QPSK normalization factor, regardless of the power adjustment rule.

In changing from one modulation scheme to another, sufficient RF power amplifier margins should be maintained to prevent violation of emissions masks.

Additional description of MAC/PHY support for adaptive modulation and coding is provided in 6.3.7.

8.2.1.4.2.3 Null payload fill

When additional payload data is necessary to fill the end of a burst frame, e.g., when a continuous downlink does not have enough data to fill a MAC frame, null payload fill may be inserted. The capability to insert null payload fill at a transmitter and discard it at a receiver is mandatory.

Null payload fill shall use the null fill data type. A MAC Frame control (map) message treats the null fill data type as an adaptive modulation type, and therefore shall indicate when and for how long this data type shall be transmitted within a burst set. Null payload fill data shall also be subject to pilot word patterning within a burst set.

The null fill data type is defined as zero-valued source bits that are randomized (see 8.2.1.1) and mapped directly to QPSK symbols using the Gray code map in Figure 171. The randomizer shall run (without reset) through both the preceding burst and the null payload fill, but null payload fill shall not be covered (in the MAC) by a CRC code.

8.2.1.4.2.4 Pilot Words

A Pilot Word is a contiguous sequence of symbols composed of an integer multiple of Unique Words, which may periodically pattern a burst set. As Figure 180 illustrates, the period of a Pilot Word, F (in symbols), is defined to include the length, P , of the Pilot Word. For the first downlink burst set containing the FCH, the presence of pilot words shall be autodetected during downlink synchronization. Valid values for F and n are included in the FCH burst profile definition in 8.2.1.7. For all other downlink burst sets, pilot word parameters are specified in the Burst Set Delimiter Extended IE. For uplink bursts, pilot word parameters are included in the burst profile specification.

SS demodulators shall support values of 1024, 2048, and 4096 for F and values of 1, 2, and 3 for n . SS modulators shall support values of 256, 512, 1024, 2048, and 4096 for F and values of 1, 2, 3, 4, and 5 for n .

When Pilot Words are patterned within a burst set, F for that burst set shall be constant, and the first symbol of the first Pilot Word shall commence $F - P + 1$ symbols into the burst set. As Figure 180 illustrates, Pilot Word patterning shall cease when $F - P$ or less payload data symbols remain in the burst set.

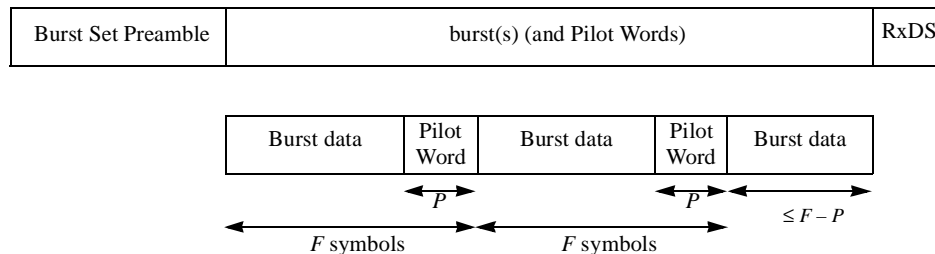

Figure 180—Pilot Word patterning within a burst set

8.2.1.4.2.5 RxDS

The RxDS illustrated in Figure 178 is a quiet period during which the transmitter ramps down, and the receiver collects delay-spread versions of symbols at the end of the burst set. The capability to insert the RxDS at the transmitter is mandatory. The length of the RxDS shall always be at least the length of a Unique Word, unless it is suppressed (i.e., set to length zero). The RxDS is subsumed within transmission gap allocations such as the SSTG (on the uplink) or DLBTG (on the downlink), so it requires no explicit allocation.

If the RxDS is nonzero in length, a transmitter shall ramp down during this RxDS by inserting zero inputs into the transmit filter memory following the last intended data symbol, and allowing the natural response of the filter to drive the filter output to zero.

8.2.1.4.3 STC burst set format

Implementation of STC transmit diversity is optional.

The STC transmit diversity scheme formats pairs of data blocks for transmission over two antennas.

8.2.1.4.3.1 Paired block transmit processing

Figure 181 illustrates block pairing that shall be used by the STC transmit diversity scheme. Let $\{s_0[n]\}$ and $\{s_1[n]\}$ represent two sequences, each of length F symbols ($0 \leq n < F$), which are to be delivered to a receiver using the STC transmit diversity scheme. Table 186 indicates the block multiplexing structure that a

two antenna transmitter shall use to transmit the two sequences using the paired blocks illustrated in Figure 181. As Table 186 indicates, Transmit Antenna 0 shall transmit its data sequences in order, with no modifications; however, Transmit Antenna 1 shall not only reverse the order in which its blocks are transmitted, but shall also conjugate the transmitted complex symbols and shall also time-reverse—cyclically about zero, modulo- F —the sequence of data symbols within each block. Subclause 8.2.1.4.3.4 provides details on the composition of the delay spread guard intervals between the blocks illustrated in Figure 181.

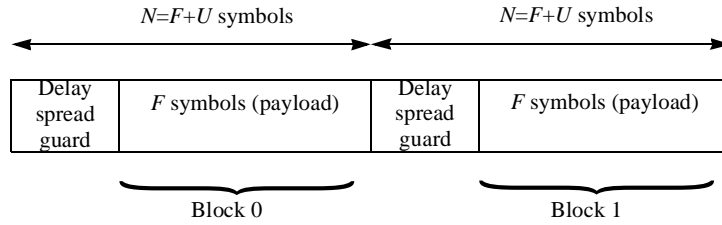

Figure 181—Paired blocks used in STC transmit diversity combining

Table 186—Multiplexing arrangement for block STC processing

Tx Antenna	Block 0	Block 1
0	$\{s_0[n]\}$	$\{s_1[n]\}$
1	$\{-s_1^*[(F-n) \bmod(F)]\}$	$\{s_0^*[(F-n) \bmod(F)]\}$

8.2.1.4.3.2 Paired block receive processing

If $S_0(e^{j\omega})$, $S_1(e^{j\omega})$, $H_0(e^{j\omega})$, $H_1(e^{j\omega})$, $N_0(e^{j\omega})$, and $N_1(e^{j\omega})$ represent the Discrete-time Fourier transforms, respectively, of the symbol sequences $\{s_0[n]\}$ and $\{s_1[n]\}$, channel impulse responses (for the channels associated with each transmitter antenna) $\{h_0[n]\}$ and $\{h_1[n]\}$, and additive noise sequences (associated with each block) $\{n_0[n]\}$ and $\{n_1[n]\}$, the received signals associated with each block, interpreted in the frequency domain, are shown in Equation (33) and Equation (34).

$$R_0(e^{j\omega}) = H_0(e^{j\omega})S_0(e^{j\omega}) - H_1(e^{j\omega})S_1^*(e^{j\omega}) + N_0(e^{j\omega}) \quad (33)$$

$$R_1(e^{j\omega}) = H_0(e^{j\omega})S_1(e^{j\omega}) + H_1(e^{j\omega})S_0^*(e^{j\omega}) + N_1(e^{j\omega}) \quad (34)$$

Assuming that the channel responses $H_0(e^{j\omega})$ and $H_1(e^{j\omega})$ are known, one may use the frequency domain combining scheme in Equation (35) and Equation (36).

$$C_0(e^{j\omega}) = H_0^*(e^{j\omega})R_0(e^{j\omega}) + H_1(e^{j\omega})R_1^*(e^{j\omega}) \quad (35)$$

$$C_1(e^{j\omega}) = -H_1(e^{j\omega})R_0^*(e^{j\omega}) + H_0^*(e^{j\omega})R_1(e^{j\omega}) \quad (36)$$

to obtain the combiner outputs in Equation (37) and Equation (38).

$$C_0(e^{j\omega}) = (|H_0(e^{j\omega})|^2 + |H_1(e^{j\omega})|^2)S_0(e^{j\omega}) + H_0^*(e^{j\omega})N_0(e^{j\omega}) + H_1(e^{j\omega})N_1^*(e^{j\omega}) \quad (37)$$

$$C_1(e^{j\omega}) = \left(|H_0(e^{j\omega})|^2 + |H_1(e^{j\omega})|^2 \right) S_1(e^{j\omega}) - H_1(e^{j\omega}) N_0^*(e^{j\omega}) + H_0^*(e^{j\omega}) N_1(e^{j\omega}) \tag{38}$$

The combiner outputs of Equation (37) and Equation (38) may be independently equalized using frequency domain techniques (for an example see Falconer and Ariyavisitakul [B18]) to obtain estimates for $\{s_0[n]\}$ and $\{s_1[n]\}$.

8.2.1.4.3.3 Channel estimation using pilot symbols

The channel responses used by the equalizer(s) can be estimated using data received during pilot symbol intervals. Under the assumption that pilot symbols are the same in the 0 and 1 blocks, i.e., $S_0^{pilot}(e^{j\omega}) = S_1^{pilot}(e^{j\omega}) = S_{pilot}(e^{j\omega})$, the sum and differences of Equation (6) and Equation (5) can be multiplied by $S_{pilot}^*(e^{j\omega})$ to yield (ignoring noise terms) Equation (39) and Equation (40).

$$S_{pilot}^*(e^{j\omega})(R_0^{pilot}(e^{j\omega}) + R_1^{pilot}(e^{j\omega})) = 2|S_{pilot}(e^{j\omega})|^2 H_0(e^{j\omega}) \tag{39}$$

$$S_{pilot}(e^{j\omega})(R_1^{pilot}(e^{j\omega}) - R_0^{pilot}(e^{j\omega})) = 2|S_{pilot}(e^{j\omega})|^2 H_1(e^{j\omega}) \tag{40}$$

The channel estimation task simply involves dividing the left hand sides of Equation (28) and Equation (29) by a constant independent of frequency, since pilot symbols are derived from the Unique Words of 8.2.1.4.1, and these Unique Words have a constant frequency domain magnitude, i.e., $|S_{pilot}(e^{j\omega})|^2 = |S_{UW}(e^{j\omega})|^2 = C$.

8.2.1.4.3.4 Paired block profiles

Figure 182 and Figure 183 illustrate two defined frame (burst) profiles for STC transmit diversity signaling.

Figure 182 illustrates the baseline framing structure for STC transmit multiplexing. This is cyclic-prefix-based frame structure, with U -symbol cyclic prefixes (CPs), and F -symbol payload repetitions. Note that although the CP is not composed of Unique Words, the length of the CP, U , shall be the same as the Unique Word length being used by the burst profile. Observe that the payload portions of Figure 182 reflect the STC antenna multiplexing format described in Table 186 for Transmit Antennas 0 and 1. As illustrated in Figure 183, a Unique Word may be inserted within Payloads 0 and 1 to facilitate decision feedback equalization at the receiver.

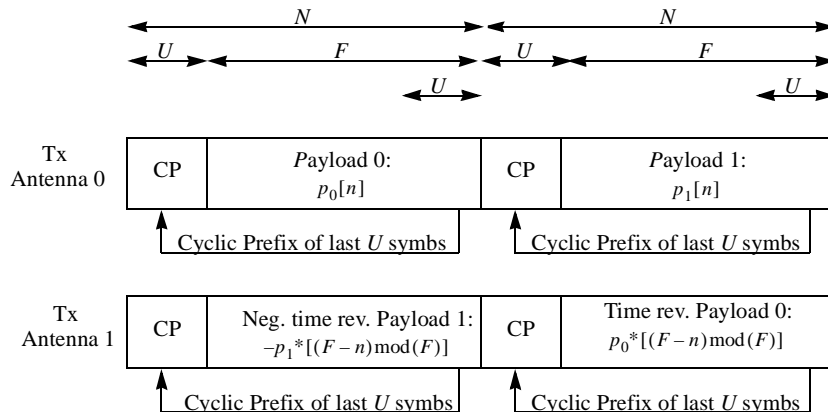

Figure 182—STC dual blocks without UWs

F , the length of an STC block, is a burst profile parameter. The choice of the burst profile for the paired blocks, i.e., the scheme illustrated in Figure 182 or the scheme illustrated in Figure 183, is also a burst profile parameter.

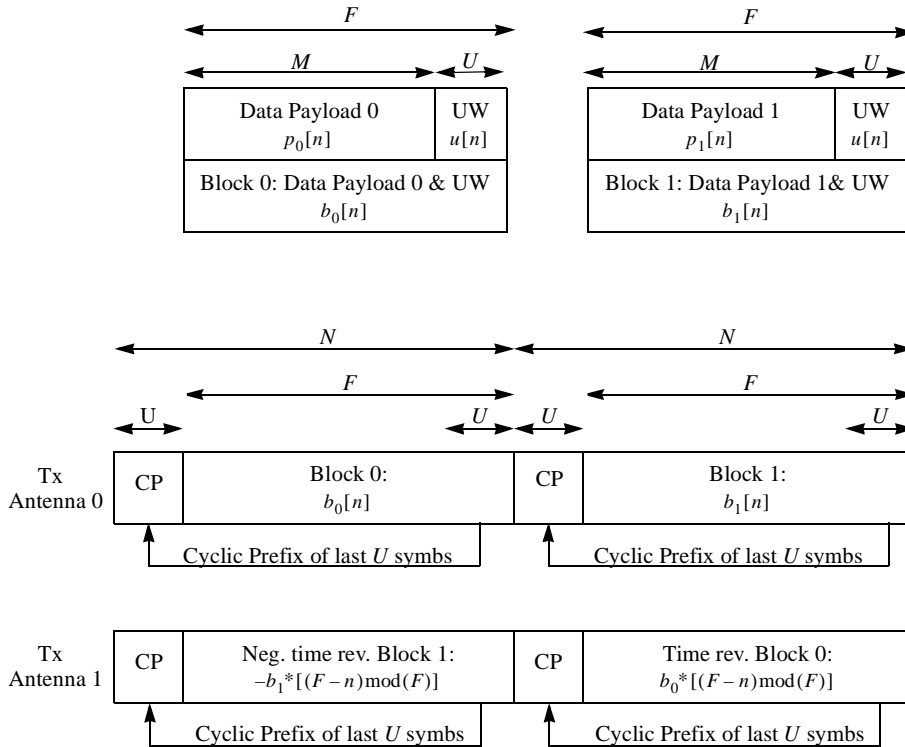

Figure 183—STC dual blocks with UWs

8.2.1.4.3.5 STC burst set elements

A STC burst set shall consist of a preamble, followed by burst(s). The burst set may consist of multiple pairs of STC blocks.

Unlike conventional burst sets, an RxDS element shall not appear at the conclusion of a STC burst set.

8.2.1.4.3.5.1 Burst set preamble

Figure 184 illustrates that the burst set preamble shall be used for burst sets utilizing STC transmit diversity encoding. The number of Unique Word blocks composing a STC burst set preamble is a parameter of the Burst Set Delimiter Extended IE (for downlink) or burst profile (for uplink). However, since two channels shall be estimated, the total number of UWs used to construct an STC burst set preamble shall be twice the parameter value specified.

Note that this preamble structure may also be inserted within a transmission as a group of contiguous Pilot Words, to assist in channel estimation and updating within a burst set. In such an instance, this contiguous pilot symbol structure is considered external to the paired STC payload data blocks illustrated in Figure 182, although the pilots may appear after every L^{th} paired payload block, where L is an integer greater than or equal to 1.

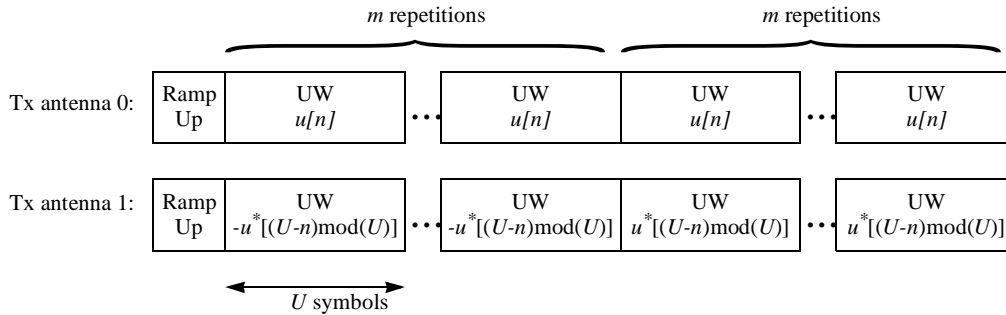

Figure 184—STC burst set preamble

Ramp-up shall use the same procedure described in 8.2.1.4.2.1, with the exception that the ramp-up symbols for each transmit antenna are duplicates of the last R_r symbols of the first length- U data element in the preamble. Note that this implies that the first transmit antenna derives its ramp-up symbols from a standard Unique Word sequence $\{u[n]\}$, while the second transmit antenna derives its ramp-up symbols from the sequence $\{-u[(U-n)\text{mod}(U)]\}$.

8.2.1.4.3.5.2 Burst set payload data

Payload data within an STC-encoded burst set shall be formatted into block pairs, with each block pair possessing one of the block pair profiles described in 8.2.1.4.3.4. If insufficient data is available to fill the last block pair, then the payload shall be filled with null payload fill, as specified in 8.2.1.4.2.1. Except for the payload fill, modulations are sequenced in terms of decreasing modulation robustness on the Tx Ant 0 channel.

The preamble structure of Figure 184, minus the ramp-up symbols, may also be inserted within a transmission, as a group of contiguous Pilot Words to assist in channel estimation and updates within a burst set. In such an instance, this contiguous pilot symbol structure is considered external to the paired STC payload data blocks illustrated in Figure 182, although the pilots may appear after every V^{th} paired payload block, where K is an integer greater than or equal to 1. The pilot word repetition interval, and the number of UWs composing a pilot word are parameters of the Burst Set Delimiter Extended IE (for downlink) or the burst profile (for uplink) defining the start of the STC-encoded burst set.

8.2.1.4.3.5.3 Ramp-down

Ramp-down follows the end of a burst set. A transmitter shall ramp down by inserting zero symbol inputs into the transmit filter memory following the last intended data symbol, and windowing the resulting, transmit-filtered output waveform with a multiplicative raised cosine window that diminishes to zero in R_r symbols. The (STC burst) ramp-down interval, R_r , shall be the same as the ramp-up interval.

8.2.1.4.3.6 Interoperability with non-STC-encoded burst sets

For interoperability reasons, STC-encoded data and conventionally-encoded data, shall not be time division multiplexed within the same burst set. Instead, STC data shall be encapsulated within its own burst set.

All burst sets with different STC pair block sizes, F , shall also be segregated, although they may share the same preamble.

8.2.1.4.4 Subchannel burst set format

The subchannel burst set format is used to frame burst sets that are transmitted on subchannels.

8.2.1.4.4.1 Framing procedure

A payload shall be formatted into a subchannel burst set using the following procedure:

- 1) Form a Base frame by attaching a burst set preamble to the burst(s) as shown in Figure 185. The preamble shall be constructed from m repeated Unique Words, as specified in the burst profile for Preamble parameters, but without the additional ramp-up symbols. The Unique Word length, U , is a burst profile parameter.

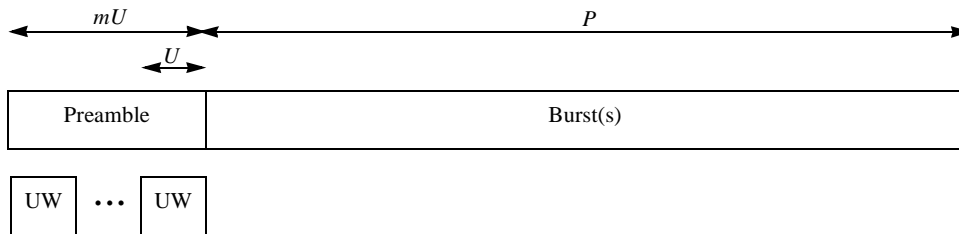

Figure 185—Base frame

- 2) Partition the Base frame into Blocks of length b as shown in Figure 186, padding the frame with MAC padding data as necessary to fill the last Block. The value to be used for b is indicated in 8.2.1.4.4.3.

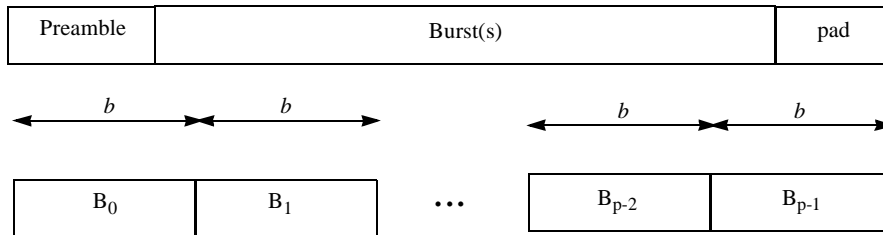

Figure 186—Base frame partitioning and padding

- 3) Suffix each Block with a Known Word composed of k Unique Words to form Appended Blocks, as shown in Figure 187, where k is a burst profile parameter.

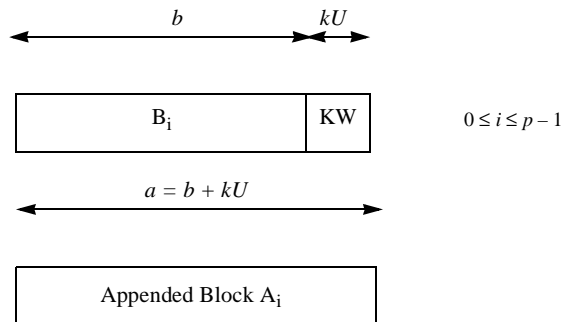

Figure 187—Forming an appended block

- 4) Form Repeat Segments as shown in Figure 188 by concatenating N_r copies of each Appended Block. The value to be used for N_r is indicated in 8.2.1.4.4.2.

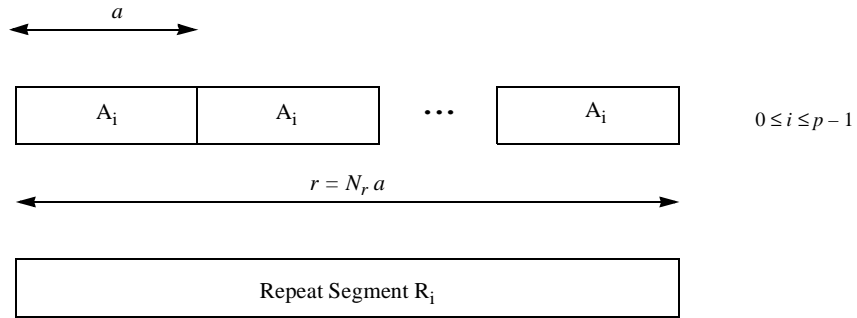

Figure 188—Forming a repeat segment

- 5) Form Burst Set Segments as shown in Figure 189, by prefixing each Repeat Segment with a Cyclic Prefix (CP) of length dU symbols and a Known Word. Each Cyclic Prefix of a Repeat Segment is composed of the last dU symbols in that Repeat Segment. d is a burst profile parameter.

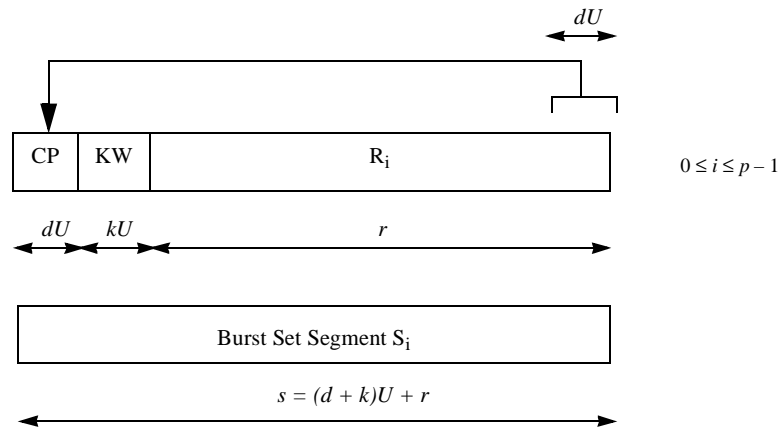

Figure 189—Forming a burst set segment from repeat segments

- 6) Concatenate Burst Set Segments to form a Subchannel Burst Set, as illustrated in Figure 190. Transmitter ramp-up processing is applied to the first data in the burst set; transmitter ramp-down processing occurs directly following the last data in burst set.

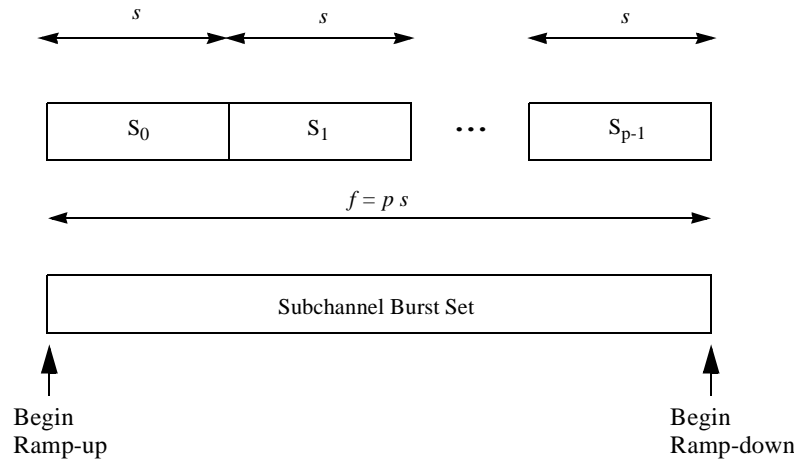

Figure 190—Forming of subchannel burst set from segments

- 7) Apply the ramp-up procedure of 8.2.1.4.2.1 to the first R_r symbols in the subchannel burst set, where R_r is specified in the Preamble length burst profile encoding. Note, however, that in the context of subchannel framing, the preamble length is mU rather than $mU + R_r$.
- 8) Ramp down by inserting zero inputs into the transmit filter memory following the last data symbol in the subchannel burst set, and allowing the natural response of the filter to drive the filter output to zero. The ramped down data is not considered part of the subchannel burst set from which it was derived.

The resulting subchannel burst set is transmitted using the procedure described in 8.2.1.4.4.2.

8.2.1.4.4.2 Subchannel burst set transmission

When a subchannel burst set is allocated, the UL MAP will indicate the start time and duration, as well as the starting subchannel index and number of consecutive subchannels assigned to the subchannel burst set. Subchannel assignments shall be selected from a set of $N_s = 8$ subchannels, with indices $h \in \{0, 1, \dots, N_s - 1\}$.

Assignments to different subchannels may overlap in time and differ in duration. The SSTG between subchannel burst sets on the same subchannel shall be of length zero, overriding any UCD channel encoding for SSTG. In addition, although the assignments for a standard burst set and a subchannel burst set shall not overlap, the SSTG between a subchannel burst set followed by a standard burst set shall also have a length of zero. However, the SSTG between a standard burst set followed by an SSTG shall comply with the UCD SSTG channel encoding. When assigned a starting subchannel index of h , a transmitter shall multiply the symbols $\{I[n], Q[n]\}$ composing a subchannel burst set by the complex exponential sequence in Equation (41)

$$c[n] = \exp\left(\frac{j2\pi n h}{r}\right) \quad (41)$$

to form output symbols

$$I^{out}[n] + jQ^{out}[n] = (I[n] + jQ[n])c[n] \quad (42)$$

where $[n]$ is the discrete time index of a symbol-spaced sampler and r is a burst profile encoding. Output symbols shall afterwards be fed to the pulse-shaping transmit filter.

Channel allocations shall always be consecutive, and allocated as a power of 2. When a subscriber is allocated $N_{alloc} = 2^g$ consecutive subchannels, $g \in \{0, 1, \dots, \lfloor \log_2(N_s) \rfloor\}$, a transmitter shall apply a repeat factor of

$$N_r = \frac{N_s}{2^g} \tag{43}$$

When transmissions on different subchannels overlap in time, their burst profile encodings for U , k , d , and r must all be common. Moreover, as illustrated in Figure 196, burst set start times must be allocated such that constituent segments are time-aligned, although the start time and duration of independent burst sets may be different.

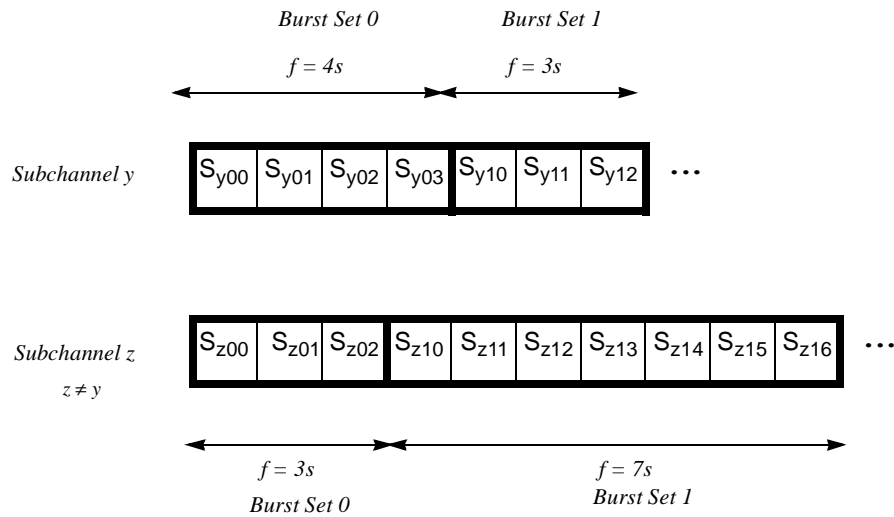

Figure 191—Segment alignment for overlapping burst sets on different subchannels

8.2.1.4.4.3 Burst profile parameters and derivations

Burst profile parameters associated specifically with subchannel framing are as follows:

- k – the number of Unique Words (of length U) composing a Known Word.
- d – the length of a Cyclic Word in integer multiples of U .
- r – the Repeat segment length in symbols.

UCD encodings for these parameters are found in Table 281, under the name Subchannel framing parameters. Note that the combination of $\{d = 0, k = 0\}$ is not allowed.

Parameters used in the framing procedure of 8.2.1.4.4.1 are derived as follows [Equation (44)–Equation (46)]:

$$\begin{aligned}
 a &= \frac{r}{N_r} \\
 &= \frac{rN_{alloc}}{N_s}
 \end{aligned}
 \tag{44}$$

$$b = a - kU \tag{45}$$

$$s = r + (k + d)U \tag{46}$$

A burst set of length P symbols, with Preamble of length mU would be formatted into a subchannel burst set composed of

$$p = \frac{(P + mU)N_s}{rN_{alloc} - kU} \tag{47}$$

segments, each of length s , for a total length of

$$L_{frame} = p(r + (k + d)U) \tag{48}$$

symbols.

8.2.1.5 Duplex framing

Subclause 8.2.1.5.1 specifies FDD operation, while 8.2.1.5.2 specifies TDD operation. Support of at least one of these two duplexing modes is mandatory. FDD SSs may be half-duplex FDD (H-FDD).

8.2.1.5.1 FDD

FDD segregates the uplink and downlink on different-frequency carriers—BSs transmit at the downlink carrier frequency, while SSs transmit at the uplink carrier frequency.

An SS in a FDD system shall be capable of operation over a burst downlink and uplink. Moreover, given appropriate parameterization of a burst downlink, an SS shall also be capable of continuous downlink operation.

8.2.1.5.1.1 FDD with burst downlink

An example FDD system with TDM downlink is illustrated in Figure 192. As Figure 192 illustrates, downlink and uplink subframes shall coincide in length, and shall repeat at regular (MAC-defined) constant intervals.

A downlink burst frame shall not exceed the length of a downlink subframe, but it need not fill the entire downlink subframe. Also, although not illustrated in Figure 192, the capability to support several downlink burst sets within a downlink subframe is mandatory.

The first burst set in each downlink subframe shall commence with a burst set preamble (BP), and shall be directly followed by a Frame Control Header (FCH), a payload that may contain DCD, UCD, and MAPs. Only the first burst set in a downlink subframe shall contain the FCH.

Data within the FCH payload shall be encoded in accordance with 8.2.1.7.

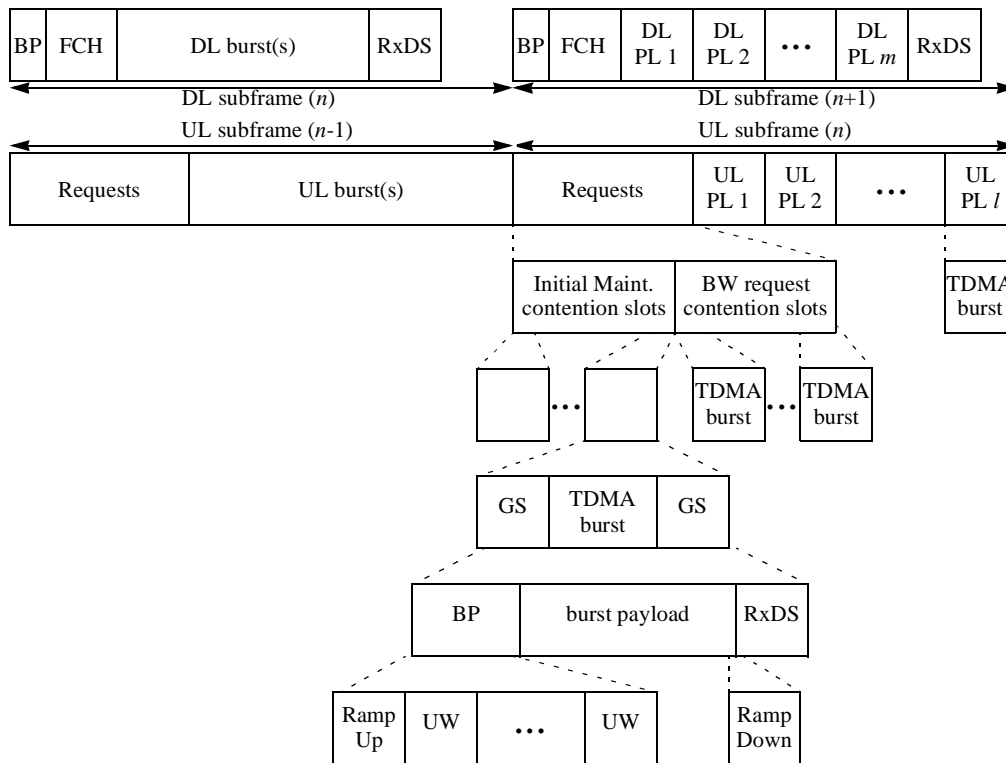

Figure 192—Example of FDD frame format

Time division multiplexed downlink bursts may follow the FCH. A downlink burst set concludes with an RxDS to allow delay spread to clear the receiver. In the event that a downlink MAC frame is entirely filled with data, bursts may be concatenated and the RxDS suppressed. In other words, an RxDS of zero length shall be used, so that no ramp-down occurs, and the Preamble of the next MAC frame may immediately commence. The preamble of that next MAC frame shall then use a ramp-up parameter R_r of zero, so that no ramp-up occurs.

When more than one burst set is to be transmitted within a single downlink MAC subframe, the DL-MAP shall include a Burst Delimiter Extended IE after the last data grant IE of each burst set and before the first data grant IE of the burst set's successor. The IE specifies the size of the gap (DLBTG) separating the burst sets. The gap includes the RxDS. As a result, the minimum length of the DLBTG is the length of the RxDS.

An uplink subframe contains three categories of bursts:

- Initial Ranging requests that are transmitted in contention slots reserved for station initial ranging.
- Bandwidth Requests that are transmitted in contention slots reserved for response to multicast and broadcast polls for bandwidth needs.
- Grants of bandwidth that are specifically allocated to individual SSSs.

As Figure 192 illustrates, uplink burst sets are TDMA, and shall be constructed from a burst set preamble (BP), including ramp-up; a burst; and an RxDS, including ramp-down. SSTGs separate the burst set transmissions of the various SSSs using the uplink. An SSTG specification includes the length of the RxDS, along with any additional guard symbols that may be inserted between uplink bursts to reflect reference time uncertainties.

All uplink burst sets excluding Initial Ranging slots shall use an SSTG (between bursts) that is specified as a UCD Channel Descriptor parameter. Since larger time uncertainties may be experienced on the Initial Ranging slots, a special Initial Ranging SSTG Channel Descriptor parameter shall be associated with the Initial Ranging slots. The Initial Ranging SSTG specification includes both the length of the RxDS and additional guard symbols. The additional guard symbols used by the Initial Ranging SSTG are designated by “GS” in Figure 192.

The UL-MAP in the downlink FCH governs the location, burst size, and burst profiles for exclusive bandwidth grants to SSSs. Burst profile selection may be based on the effects of distance, interference and environmental factors on transmission from the SS.

8.2.1.5.1.2 Generating a continuous downlink from a burst downlink

A continuous downlink may be derived from a burst downlink by null payload filling the end of a burst frame, to insure that it spans an entire downlink frame. By so doing, a burst downlink is forced to suppress both the RxDS and ramp-up burst elements, because burst downlinks are mandated to suppress these elements when a downlink MAC subframe is full. To insert null payload fill, the last entry in the DL-MAP of an FCH shall specify the burst profile for the null fill data type. Details on the null payload fill data type can be found in 8.2.1.4.2.3.

8.2.1.5.1.3 FDD Channel and Burst Descriptor field definitions

DL Channel Descriptor Parameters

Each DCD message channel descriptor shall include the following TLV encodings:

- Downlink_Burst_Profile
- BS EIRP
- Power adjustment rule
- $RSS_{IR,max}$
- MAC version

DL Burst Descriptor Parameters

Each DCD message burst descriptor shall include the following TLV encodings:

- Modulation type
- RS information bytes
- RS parity bytes
- DIUC mandatory exit threshold
- DIUC minimum entry threshold
- CC/CTC-specific parameters

Each DCD message burst descriptor may include the following additional TLV encodings:

- Block interleaver depth
- BTC code selector
- Spreading parameters
- CID_In_DL_IE

UL Channel Descriptor Parameters

Each UCD message channel descriptor shall include the following TLV encodings:

- Uplink_Burst_Profile
- Symbol rate
- Frequency
- SSTG
- Roll-off factor
- Power adjustment rule
- Contention-based reservation timeout
- Initial ranging SSTG

UL Burst Descriptor Parameters

Each UCD message burst descriptor shall include the following TLV encodings:

- Modulation type
- Preamble length
- RS information bytes
- RS parity bytes
- CC/CTC-specific parameters
- Unique Word Length
- Pilot word parameters
- Burst set type

Each UCD message burst descriptor may include the following additional TLV encodings:

- Block interleaver depth
- STC parameters
- BTC code selector
- Spreading parameters
- Subchannel framing parameters

8.2.1.5.2 TDD

TDD multiplexes the uplink and downlink on the same carrier, over different time intervals within the same MAC frame.

Figure 193 illustrates TDD operation with a single burst set on the TDM downlink. In TDD, the downlink and uplink alternate occupying a shared frame, with the downlink subframe preceding the uplink subframe. The size of the shared frame shall be constant; however, the downlink and uplink subframe sizes within the shared frame shall vary according to allocations directed by the FCH. Although Figure 193 illustrates a single TDM burst set per downlink subframe, the capability to accommodate several TDM burst sets is mandatory, with the first burst set in the downlink duplex subframe containing the FCH.

When more than one burst set is to be transmitted within a single downlink subframe, the DL-MAP shall include a Burst Delimiter Extended IE after the last data grant IE of each burst set and before the first data grant IE of the burst set's successor. The Burst Delimiter Extended IE specifies the size of the gap (DLBTG) separating the burst sets. The gap includes the RxDS. As a result, the minimum length of the DLBTG is the length of the RxDS.

Most framing elements within TDD are found in FDD and perform the same functions; therefore, for descriptions of these elements, consult 8.2.1.5.1.1. The only frame elements in TDD not found in FDD are TTG and RTG.

After the TTG, the BS receiver shall look for the first symbols of the uplink subframe. This gap is an integer number of PS durations and starts on a PS boundary.

After the RTG, SS receivers shall look for the first symbols of modulated data in the downlink subframe. This gap is an integer number of PS durations and starts on a PS boundary.

8.2.1.5.2.1 TDD Channel Descriptor field definitions**DL Channel Descriptor Parameters**

Each DCD message channel descriptor shall include the following TLV encodings:

- Downlink_Burst_Profile
- BS EIRP
- Power adjustment rule
- TTG

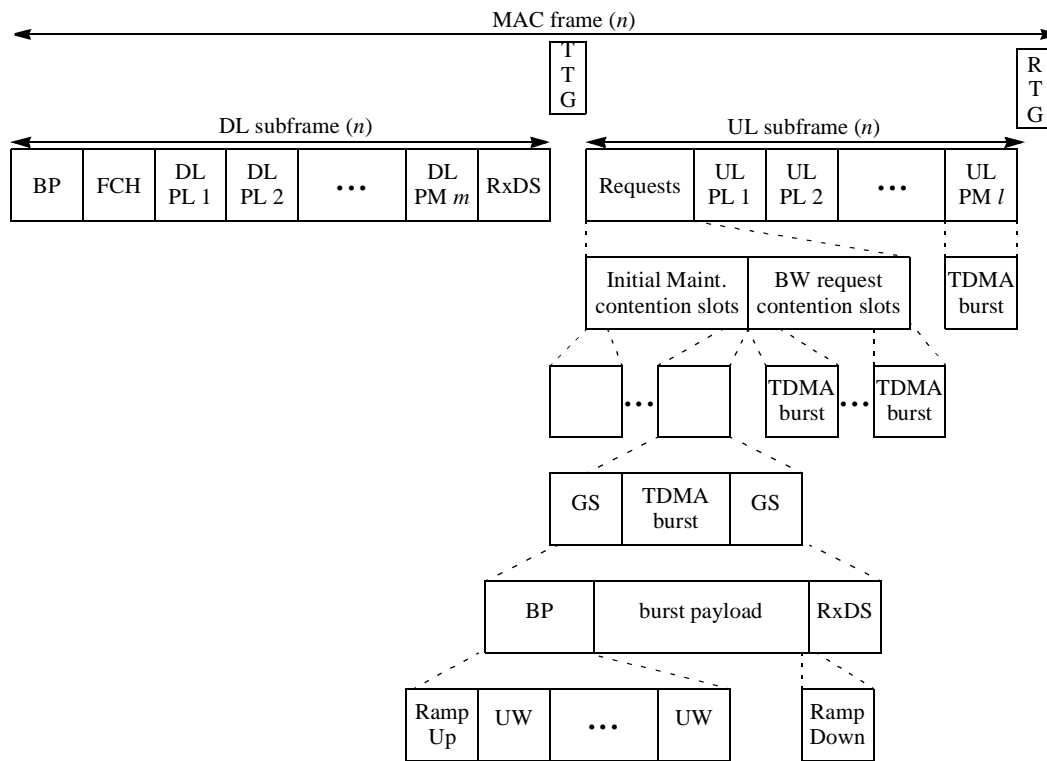

Figure 193—Example of TDD frame format

RTG
 RSS_{IR,max}
 MAC version

DL Burst Descriptor Parameters

Each DCD message burst descriptor shall include the following TLV encodings:

- Modulation type
- RS information bytes
- RS parity bytes
- DIUC mandatory exit threshold
- DIUC minimum entry threshold
- CC/CTC-specific parameters

Each DCD message burst descriptor may include the following additional TLV encodings:

- Block interleaver depth
- BTC code selector
- Spreading parameters
- CID_In_DL_IE

UL Channel Descriptor Parameters

Each UCD message channel descriptor shall include the following TLV encodings:

- Uplink_Burst_Profile
- Symbol rate
- Frequency
- SSTG

Roll-off factor
 Power adjustment rule
 Contention-based reservation timeout
 Initial ranging SSTG

UL Burst Descriptor Parameters

Each UCD message burst descriptor shall include the following TLV encodings:

Modulation type
 Preamble length
 RS information bytes
 RS parity bytes
 CC/CTC-specific parameters
 Unique word length
 Pilot word parameters
 Burst set type

Each UCD message burst descriptor may include the following additional TLV encodings:

Block interleaver depth
 STC Parameters
 BTC code selector
 Spreading parameters
 Subchannel framing parameters

8.2.1.6 Support for AAS

Discussion in 8.2.1.4 and 8.2.1.5 specifies the requirements for implementation of systems supporting unicast BS transmissions on the downlink, and except in special cases, non-overlapped SS transmissions on the uplink. AAS techniques provide the ability to relax some of those constraints with the benefit of enhancing overall system performance. This subclause describes WirelessMAN-SCa support for AAS. In instances regarding system operation using AAS where there is conflict between requirements imposed by other portions of this document and this subclause, the specifications provided by this subclause shall take precedence.

Implementation of support for AAS at either BS or SS is optional.

8.2.1.6.1 Preamble definitions

Two classes of AAS Preambles are defined, based on the baseline preamble definition with $r = 1$ and $r = 3$. Within each class are four preambles, indexed $p \in \{0, 1, 2, 3\}$.

An AAS preamble shall consist of a base preamble (parameterized by $r = 1$ or $r = 3$) multiplied by one of four different phase ramp sequences, selected by the index p .

A base preamble shall be constructed from 5 Unique Words, each of length U and parameterization $r = 1$ or $r = 3$ (see 8.2.1.4.2.1). U shall be the same as that used by Unique Words in the downlink broadcast FCH preamble. The AAS transmission context determines selection of the $r = 1$ or $r = 3$ parameterization.

The multiplicative phase ramp sequence associated with a preamble of index p is shown in Equation (49).

$$c_p[n] = \exp\left(\frac{j2\pi np}{4U}\right) \quad (49)$$

where $j = \sqrt{-1}$, $[n]$ is the discrete time index of a symbol-spaced sampler, $n = 0$ is the time index of the first symbol, and $n = 5U - 1$ is the time index of the last symbol.

8.2.1.6.2 Power ramp-up

Transmitter power shall be ramped up over the first four symbols in the preamble. When creating a ramp-up element, the transmit filter memory is initialized with zero-valued (null) symbols. The preamble symbols shall then be sequentially fed into the transmit filter input stream. The transient samples preceding the first ramp-up symbol shall be suppressed at the transmit filter output until the central sample time of the first preamble symbol. A ramped power buildup shall be achieved by superimposing a multiplicative raised cosine half-window of duration four symbols upon the samples leaving the transmit filter.

8.2.1.6.3 Power ramp-down

All AAS elements, including bursts and burst sets, shall ramp down their power at the end of transmission. Power is ramped down by using—the natural response of the pulse-shaping filter to gradually drive the transmitter output to zero once source symbols are exhausted.

8.2.1.6.4 Frame element formats

Elements associated with AAS transmission include an AAS-indicator, an AAS-alert slot, AAS-formatted downlink subframes, and AAS-formatted uplink bursts. An example of the content of MAC frames when AAS elements are included is presented in Figure 180.

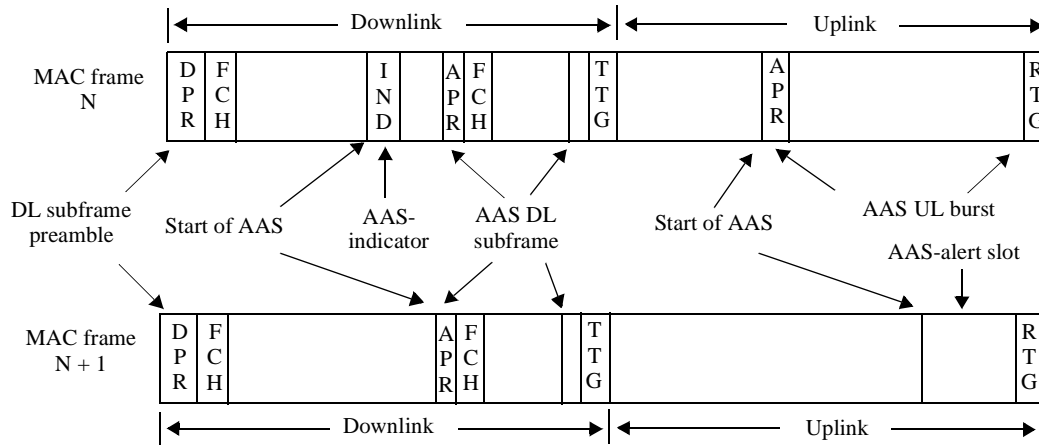

Figure 194—MAC frame contents with AAS elements

8.2.1.6.4.1 AAS-indicator

An AAS-indicator shall be composed of class $r = 3$ AAS preambles (one preamble per transmission antenna) and no payload.

An AAS-indicator is simultaneously transmitted on up to 4 BS antennas, with each antenna using a different multiplicative phase ramp index p . A larger total number of BS antennas may be accommodated by varying the set of antennas used from transmission to transmission.

An AAS-enabled SS shall be capable of phase deramping to separate each of the concurrent BS antenna transmissions and then estimating the CINR, RSSI, and carrier phase (measured over 4 UWs) for each transmission. Carrier phase measurement precision shall be no less than 11.25 degrees.

When it is included, the AAS-indicator shall appear as the first element of the AAS portion of the downlink subframe at the offset specified by the downlink subframe FCH DL-MAP AAS extended IE.

8.2.1.6.4.2 AAS-alert slot

An AAS-alert is transmitted within an AAS-alert slot on the uplink. An AAS-alert consists of an $r = 1$ AAS preamble followed by a payload of fixed length known to the MAC. The payload is encoded using the baseline concatenated FEC, with rate 1/2 BPSK convolutional code.

The index, p , of the preamble is selected randomly by the SS.

The alert slot, when it is present, is located at the end of the uplink subframe, immediately before the MAC frame RTG.

8.2.1.6.4.3 Downlink AAS subframe

A downlink AAS subframe contains payload data directed to one or more AAS subscribers. Subject to the capabilities of the BS, multiple AAS subframes may be transmitted within the AAS portion of the downlink subframe. Those subframes may be concurrent or sequential in time.

A downlink AAS subframe transmission consists of an AAS preamble followed by payload data consisting of one or more bursts or burst sets (standard or STC). The preamble parameter r is set to 3. Before and during initial network entry, the value of the index p shall be the same as the index value used by the SS for its uplink alert slot transmission. Once network entry has been achieved and the SS is receiving DL-MAPs, use of the original value employed during network entry is maintained until it is overridden by a notification from the BS. The modulation type, length, and FEC are determined by the AAS DL-MAP. The first burst following the preamble shall be an FCH that is encoded using the baseline concatenated FEC, with rate 1/2 BPSK convolutional code.

8.2.1.6.4.4 Uplink AAS burst

An uplink AAS burst is transmitted in the AAS portion of the uplink subframe. Subject to the capabilities of the BS, multiple AAS bursts may be transmitted within the AAS portion of the uplink subframe. Those bursts may be concurrent or sequential in time.

An AAS burst contains payload data from an AAS-enabled subscriber with formatting of the transmission specified by the contents of a UL-MAP arriving at the SS in either a downlink subframe FCH or an AAS-FCH. Burst types transmitted in the AAS portion of the uplink frame may be any of the frame types available to non-AAS enabled SS: standard, subchannel, or STC. For standard bursts, an AAS preamble shall be used with the value of r set to 1 and the value of p specified in the UL-MAP. For STC or subchannel bursts, the preamble used shall conform to the preamble format prescribed for the corresponding burst type.

8.2.1.6.5 AAS-enabled operations

WirelessMAN-SCa support for AAS follows the general discussion appearing in 6.3.7.6.

8.2.1.6.5.1 Downlink synchronization

Downlink network synchronization of AAS-enabled SS shall be accomplished by detecting and synchronizing with the FCH burst set preamble transmitted at the start of each downlink subframe.

8.2.1.6.5.2 Network entry

For AAS-enabled SS that can decode the downlink subframe FCH, network entry shall be carried out as prescribed in 6.3.9.

For situations where the FCH contents cannot be decoded, the procedure outlined in 6.3.9 shall apply except for the actions taken to initiate and complete the first initial ranging RNG-REQ/RSP dialog.

When FCH contents cannot be decoded, the SS shall monitor each downlink subframe transmission for the occurrence of an AAS-indicator sequence. The presence of this sequence shall indicate the availability of an AAS-alert slot in the frame following the frame containing the sequence.

An AAS-alert slot is similar to an initial ranging slot used for conventional network entry and shall be sized to allow transmission of a RNG-REQ message (the size prescribed in 6.3.2.3.5 and 6.3.9 for initial ranging request message plus the size of the SCa AAS feedback and AAS broadcast capability TLVs) and the appropriate burst preamble, and shall also account for the maximum round-trip propagation delay between a BS and the most distant SS to be serviced. The size and location of the slot in the uplink subframe shall be well-known. The SS shall initiate transmission in the alert slot assuming the SS is co-located with the BS.

The following discussion references start and end parameters for the exponential backoff algorithm used for the initial ranging dialog of AAS subscribers. The well-known values for these parameters shall be $start = 3$, and $end = 8$.

8.2.1.6.5.2.1 AAS-alert transmissions decodable at BS

Upon reception of an alert slot transmission, if the BS can decode the transmission, it shall format a response in the form of a RNG-RSP message based on the information provided in the AAS-alert RNG-REQ message and data collected during reception. The response shall be transmitted in the AAS portion of a subsequent DL frame using the same preamble index (p) as that used for the AAS alert RNG-REQ transmission. The RNG-RSP response is equivalent to the response to a decodable initial ranging RNG-REQ message as described in 6.4.9, terminating the initial net entry RNG-REQ dialog. The transmission containing the RNG-RSP message shall also include DCD and UCD messages.

Once an alert slot transmission has been made, the SS shall await a response as specified by 6.3.9. If no response is received, a new alert slot is selected in accordance with the exponential backoff algorithm specified in 6.3.8. The starting and end backoff values shall be well-known (8.2.1.6.5). Once the new alert slot has been selected, the RNG-REQ alert slot transmission process is repeated.

8.2.1.6.5.2.2 AAS-alert transmissions undecodable at BS

In the event a transmission is detected but the uplink alert message cannot be decoded, the BS shall format a RNG-RSP message based on the data collected during reception and specify the frame in which the alert was sent using the Frame number TLV. The message shall not include the Initial ranging opportunity TLV. The response shall be transmitted in the AAS portion of a subsequent DL frame using the same preamble index (p) as that used for the AAS-alert RNG-REQ transmission. The RNG-RSP response is similar to the response to an undecodable initial ranging RNG-REQ message as described in 6.3.9. The transmission containing the RNG-RSP message shall also include DCD and UCD messages.

Once the alert slot transmission has been made, the SS shall await a response as specified by 6.3.9. If no response is received, a new alert slot is selected in accordance with the exponential backoff algorithm specified in 6.3.8. The starting and end backoff values shall be well-known (8.2.1.6.5). Once the new alert slot has been selected, the RNG-REQ alert slot transmission process is repeated.

If the RNG-RSP message with the Frame number TLV is received, the SS shall await notification in an arriving AAS-FCH UL-MAP that an initial ranging contention slot grant has been scheduled. The size of this slot shall be the same as the AAS-alert slot. The SS shall respond to the grant by formatting and sending a RNG-REQ message (with SCa AAS feedback and AAS broadcast capability TLVs) in that slot. The preamble index shall be the same as that used in the most recent AAS-alert slot transmission.

If the transmission is detected at the BS, an appropriate RNG-RSP message is formatted based on whether or not the BS was able to decode the content of the transmission and the message is transmitted in the AAS portion of a subsequent DL frame using the same preamble index (p) as that used for the RNG-REQ transmission.

Successful reception of a response to a RNG-REQ decoded by the BS is equivalent to the response to a decodable initial ranging RNG-REQ message as described in 6.3.9, terminating the initial net entry RNG-REQ dialog.

Successful reception of a response to a RNG-REQ that could not be decoded by the BS indicates that the SS shall wait for another contention initial ranging grant opportunity and repeat the process described in this subclause.

If the SS does not receive a response to its contention slot transmission, in accordance with the timeout limits specified in 6.3.9, a new alert slot is selected in accordance with the exponential backoff algorithm specified in 6.3.8. The starting and end backoff values shall be well-known (8.2.1.6.5). Once the new alert slot has been selected, the RNG-REQ alert slot transmission process is repeated.

8.2.1.6.5.3 Data exchange

When AAS operations are active, the downlink and uplink subframes shall be partitioned into portions dedicated to AAS and non-AAS usage. The first part of each subframe shall be allocated to non-AAS operations, with any remainder allocated for AAS activities. AAS extended IEs are included in the FCH DL-MAP and the UL-MAP to specify the location of the boundary between the partitions.

Downlink AAS transmissions including responses to alert slot RNG-REQ messages shall consist of a preamble followed by an FCH burst, and optionally, one or more data bursts and/or additional burst sets. The BS shall not allow concurrent AAS transmissions that are initiated by the same AAS preamble.

The format of the content of an AAS FCH shall conform to the format of the FCH appearing at the start of the downlink subframe with the exception that RNG-RSP messages may be carried in the AAS-FCH rather than in a subsequent burst. The order of appearance of messages in the AAS-FCH shall be DL-MAP, UL-MAP, DCD, UCD, and RNG-RSP. In addition, WirelessMAN-SCa AAS implementations shall not support private maps where broadcast CID values are replaced with the basic CID of an SS.

For an AAS-capable SS able to decode the downlink subframe FCH, the SS shall enable its receiver for all non-AAS transmissions it is capable of receiving. It shall also enable its receiver at the start of the AAS portion of the downlink subframe, and having detected an appropriate preamble, it shall receive and decode the data stream (AAS-FCH and data bursts) following each such preamble. The receiver shall be disabled at the start of the TTG at the end of the DL subframe.

For AAS-capable SS unable to decode the downlink subframe FCH, the SS shall enable its receiver at an offset into the frame at or before the location corresponding to the end of the XFCH portion of the FCH, and having detected an appropriate preamble, it shall receive and decode the data stream (AAS-FCH and data bursts) following each such preamble. The receiver shall be disabled at the earlier of the following three frame locations—if known, at the end of the downlink subframe; at the start of the AAS-alert slot, if one is present; or at the start of the RTG at the end of the uplink frame.

Just as in the non-AAS case, AAS uplink transmissions after net entry are governed by the BS through bandwidth allocations. For AAS-capable SS able to decode the downlink subframe FCH, the SS may respond to either grants indicated in the downlink subframe FCH UL-MAP or in the UL-MAP appearing in an AAS-FCH burst. For AAS-capable SS unable to decode the downlink subframe FCH, the SS shall transmit only in grants indicated in the UL-MAP appearing in an AAS-FCH burst.

8.2.1.6.6 Channel measurement

8.2.1.6.6.1 DL subframe preamble

Measurements regarding the DL subframe preamble used for network synchronization and network entry shall be collected by the SS and reported to the BS using the REP-REQ/RSP message dialog. Reports to the BS may occur in response to a request from the BS or may be issued asynchronously by the SS.

8.2.1.6.6.2 AAS feedback

Information on BS AAS transmissions shall be collected by the SS each time it detects an AAS-indicator transmission. At the initial phase of network entry, this information shall be provided to the BS in the alert transmission.

Following network entry, the information shall be provided using the AAS-FBCK message dialog. Reports to the BS may occur in response to a request from the BS or may be issued asynchronously by the SS.

8.2.1.7 Frame Control Header burst profile

A compliant SS shall be capable of demodulating a FCH with the parameters listed in Table 187 and Table 188; a compliant BS shall be capable of transmitting FCHs using one of these sets. This information shall be well-known and shall not appear in the DCD burst profile definitions.

Table 187—Channel settings for FCH burst

DCD channel profile parameter	Default setting	Alternative that shall be supported by auto-detection
Roll-off factor	0.25	—
Preamble length	length = $mU + R_r$ $m = 3$ repeated UWs $R_r = 4$ ramp symbols	$0 \leq R_r \leq \min(U/2, 60)$ in increments of 4 symbols
Unique Word length	$U = 64$ symbols	$U = 16, 256$ symbols
Pilot Word Interval	No Pilot Words	1024, 2048 or 4096
Unique Word Count	No Pilot Words	1, 2, or 3
Power adjustment rule	0 (preserve peak power)	1 (preserve mean power)

Table 188—Burst profile settings for FCH burst

DCD burst Profile Parameter	Unique Word r-factor = 1	Unique Word r-factor = 3
Modulation type (FCH payload)	QPSK or 16-QAM determined by auto-detect. Concatenated FEC without block interleaving	DS-BPSK with spread length ($F_s = 1, 2, \text{ or } 8$) determined by auto-detect, Concatenated FEC without block interleaving
Inner (CC) code rate (FCH payload)	1/2	1/2
RS Parameters	base $K = 239$ bytes, K variable via shortening with fixed $R = N - K = 16$ bytes	base $K = 239$ bytes, K variable via shortening with fixed $R = N - K = 16$ bytes
Burst set type	Standard	Standard

The first X_{FCH} source bytes of the FCH shall be outer encoded using a shortened RS code word specified by $RS(N = X_{FCH} + 16, K = X_{FCH})$. This shortened code block shall then be inner encoded, and the inner code terminated at the end of the code block. The remainder of the FCH payload shall be encoded within one or more $RS(N = 255, K = 239)$ code words, with the last code word shortened to $RS(K_{last} + 16, K_{last})$ if $K_{last} < 39$.

X_{FCH} is constant and the minimum byte capacity of the FCH burst. Its value shall span the content of a compressed DL-MAP message (8.2.1.8.1) up to and including the contents of the second data grant IE appearing in the downlink subframe (if one exists). Any unused bytes in the X_{FCH} region of the FCH shall be filled in accordance with 6.3.3.7.

8.2.1.8 Compressed FCH maps

The DL-MAP appearing in the FCH shall conform to the compressed format presented in this subclause. UL-MAP messages appearing in the FCH may conform to either the standard format described in 6.3.2.3.4 or the compressed format presented in this subclause.

The presence of the compressed DL-MAP format is indicated by the contents of the most significant two bits of the first FCH data byte. These bytes overlay the HT and EC bits of a generic MAC header. When these bits are both set to 1 (an invalid combination for a standard header), the compressed DL-MAP format is present in the FCH. A compressed UL-MAP shall only appear after a compressed DL-MAP. The presence of a compressed UL-MAP is indicated by a bit in the compressed DL-MAP data structure.

8.2.1.8.1 Compressed DL-MAP

The compressed DL-MAP format is presented in Table 189. The message presents the same information as the standard format with one exception. In place of the DL-MAP's 48-bit Base Station ID, the compressed format provides a subset of the full value. When the compressed format is used, the full 48-bit Base Station ID shall be published in the DCD.

Compressed map indicator

A value of binary 11 in this field indicates the map message conforms to the compressed format described here. A value of binary 00 in this field indicates the map message conforms to the standard format described in 6.3.2.3.2. Any other value is an error.

Table 189—SCa compressed DL-MAP format

Syntax	Size	Notes
SCa_Compressed_DL-MAP() {		
Compressed map indicator	2 bits	Set to binary 11 for compressed format
<i>reserved</i>	1 bit	Shall be set to zero
Compressed UL-MAP appended	1 bit	
CRC appended	1 bit	
Compressed message length	11	
PHY Synchronization	24 bits	
DCD Count	8 bits	
Operator ID	8 bits	
Sector ID	8 bits	
DL IE count	8 bits	
for ($i = 1; i \leq \text{DL IE count}; i++$) {		
DL-MAP_IE()	<i>variable</i>	
}		
if !(byte boundary) {		
Padding Nibble	4 bits	Padding to reach byte boundary
}		
}		

Compressed UL-MAP appended

A value of 1 indicates a compressed UL-MAP (see 8.2.1.8.2) is appended to the current compressed DL-MAP data structure

CRC appended

A value of one indicates a CRC-32 value is appended to the end of the compressed map(s) data. The CRC is computed across all bytes of the compressed map(s) starting with the byte containing the Compressed map indicator through the last byte of the map(s) as specified by the Compressed message length field. The CRC calculation is the same as that used for standard MAC messages. A value of zero indicates that no CRC is appended.

Compressed message length

This value specifies the length of the compressed map message(s) beginning with the byte containing the Compressed map indicator and ending with the last byte of the compressed DL-MAP message if the UL-MAP appended bit is not set or the last byte of the UL-MAP compressed message if the UL-MAP appended bit is set. The length includes the computed 32-bit CRC value if the CRC appended indicator is on.

PHY Synchronization

This field holds frame number information. See 8.2.1.9.1 and Table 191.

DCD Count

Matches the value of the configuration change count of the DCD, which describes the downlink burst profiles that apply to this map.

Operator ID

This field holds the least significant 8 bits of the most significant 24 bits of the 48-bit Base Station ID.

Sector ID

This field holds the least significant 8 bits of the 48-bit Base Station ID.

DL IE count

This field holds the number of IE entries in the following list of DL-MAP IEs.

8.2.1.8.2 Compressed UL-MAP

The compressed UL-MAP format is presented in Table 190. The message may only appear after a compressed DL-MAP message to which it shall be appended. The message presents the same information as the standard format with one exception. The Uplink Channel ID is omitted. A value of zero shall be assigned to this parameter.

Table 190—SCa compressed UL-MAP format

Syntax	Size	Notes
SCa_Compressed_UL-MAP() {		
UCD Count	8 bits	
Allocation Start Time	32 bits	
while (map data remains){		
UL-MAP_IE()	<i>variable</i>	
}		
if !(byte boundary) {		
Padding Nibble	4 bits	Padding to reach byte boundary
}		
}		

UCD Count

Matches the value of the Configuration Change Count of the UCD which describes the uplink burst profiles that apply to this map.

Allocation Start Time

Effective start time of the uplink allocation defined by the UL-MAP.

8.2.1.9 MAP message fields and IEs**8.2.1.9.1 DL-MAP PHY synchronization field**

Table 191 provides the format of the PHY synchronization field of the frame control message described in 6.3.2.3.2.

Table 191—SCa PHY synchronization field

Syntax	Size	Notes
PHY_synchronization_field() {		
Frame number	24 bits	
}		

Frame number:

Identifier assigned to the frame containing the DL-MAP message. The value shall be incremented by one for each frame transmitted. The value wraps around to zero when the field's maximum value is incremented.

8.2.1.9.2 DL-MAP IE formats

The IEs of Table 193 are used in DL-MAP messages. The format for these DL-MAP messages is specified in Table 192. Since the location in each frame and attributes of the FCH are well-known or are deduced during downlink initial ranging, a data grant IE identifying the start of the FCH shall not appear in the DL-MAP. The attributes associated with the Fill, Gap, and End of map IEs are also well-known and shall not be defined in the DCD.

Table 192—SCa DL-MAP IE format

Syntax	Size	Notes
DL-MAP_IE() {		
DIUC	4 bits	
if (DIUC == 15) {		
Extended UIUC dependent IE	<i>variable</i>	See subclauses following in 8.2.1.9.2.1
} else {		
Offset	16 bits	
if (CID used enabled by burst profile) {		
CID	16 bits	
}		
}		
}		

Offset: Offset (in units of PSs) to the start of the data burst from the start of the frame.

CID: Represents the assignment of the IE to a unicast, multicast, or broadcast address. The value is only present in an IE if the burst profile associated with the DIUC value specifies that CID usage is enabled.

Table 193—SCa DIUCs

IE name	DIUC	Offset
Fill	0	Start of allocation for uncoded QPSK zero-fill
Data Grant 1	1	Starting offset of data grant 1 burst type
Data Grant 2	2	Starting offset of data grant 2 burst type.
Data Grant 3	3	Starting offset of data grant 3 burst type
Data Grant 4	4	Starting offset of data grant 4 burst type
Data Grant 5	5	Starting offset of data grant 5 burst type
Data Grant 6	6	Starting offset of data grant 6 burst type
Data Grant 7	7	Starting offset of data grant 7 burst type
Data Grant 8	8	Starting offset of data grant 8 burst type
Data Grant 9	9	Starting offset of data grant 9 burst type
Data Grant 10	10	Starting offset of data grant 10 burst type
Data Grant 11	11	Starting offset of data grant 11 burst type
Data Grant 12	12	Starting offset of data grant 12 burst type
Gap	13	Start offset of an unallocated frame interval
End of map	14	Ending offset of the previous grant. Used to bound the length of the last actual interval allocation
Extended DIUC	15	

8.2.1.9.2.1 DL-MAP extended IE

A DL-MAP IE entry with a DIUC value of 15, indicates that the IE carries special information and conforms to the structure shown in Table 194. A station shall ignore an extended IE entry with a Subcode value for which the station has no knowledge. In the case of a known subcode value but with a length field longer than expected, the station shall process information up to the known length and ignore the remainder of the IE.

Table 194—SCa DL-MAP extended IE format

Syntax	Size	Notes
DL_Extended_IE() {		
Subcode	4 bits	0x00..0x0F
Length	4 bits	Length in bytes of Unspecified data field
Unspecified data	<i>variable</i>	
}		

8.2.1.9.2.2 Channel measurement extended IE

An extended IE with a Subcode value of 0x00 is issued by the BS to request a channel measurement report (see 6.3.15). The IE includes an 8-bit Channel Nr value as shown in Table 195. The Channel_Measurement_IE shall be followed by the End of Map IE (DIUC=14).

Table 195—SCa Channel measurement extended IE format

Syntax	Size	Notes
Channel_Measurement_IE() {		
Subcode	4 bits	CHM = 0x00
Length	4 bits	Length = 5
Channel Nr	8 bits	Channel number (see 8.5.1) Set to 0x00 for licensed bands
CID	16 bits	Identifies SS to perform measurement Basic CID for specific SS Broadcast CID for all stations
Offset	16 bits	
}		

8.2.1.9.2.3 FCH burst profile change extended IE

Signaling a pending change to the FCH burst profile definition is accomplished by using an extended IE with the subcode set to 0x01 (see Table 196). When included, this IE shall be located at or near the end of the DL-MAP IE list after all data grant IEs.

When a change is to be made, the BS shall use this IE to notify all operating subscribers that a parameter change is imminent. Transmission of the IE shall be initiated at a sufficient interval prior to the scheduled

change to assure that all SS have received the notification and can prepare to implement the specified changes. Once initiated, the extended IE shall be included in all subsequent DL-MAP transmissions up to but not including the frame in which the specified parameter changes take effect.

Table 196—SCa FCH burst profile change extended IE format

Syntax	Size	Notes
FCH_BP_Change_IE() {		
Subcode	4 bits	FCHBP = 0x01
Length	4 bits	Length = 4
Pilot Word Interval	4 bits	0 = no pilot words, 1 = 1024 symbols, 2 = 2048 symbols, 3 = 4096 symbols, 4 - 15: <i>Reserved</i>
Pilot Word length	4 bits	Number of contiguous Unique Words composing a Pilot Word (1, 2 or 3)
R=1 Modulation	4 bits	0 = QPSK, 1 = 16-QAM
R=3 Modulation	4 bits	0 = Fs:1, 1 = Fs:2, 2 = Fs:8
Frame number	16 bits	Least significant 16 bits of frame number when specified FCH burst profile settings take effect
}		

8.2.1.9.2.4 AAS DL extended IE

Within a frame, the switch from non-AAS to AAS-enabled traffic is marked by using an extended IE with the subcode set to 0x02. This IE indicates that the subsequent allocations (until the start of the uplink portion of the frame using TDD, and until the end of the frame using FDD) shall be for downlink AAS traffic.

Table 197—SCa AAS DL extended IE format

Syntax	Size	Notes
AAS_IE() {		
Subcode	4 bits	AAS = 0x02
Length	4 bits	Length = 2
Offset	16 bits	
}		

8.2.1.9.2.5 Burst set delimiter extended IE

Termination of one burst set and the start of another is specified by the inclusion of the burst set delimiter extended IE. This IE (subcode = 3) specifies the size of the DLBTG, which terminates the previous burst set as well as the preamble, unique word, pilot word, and STC settings that shall apply to the next burst set defined in the map. A length of two, indicates that the parameter values in force for the previous burst set shall remain in effect for the new burst set. In this case, only the Offset field follows the Length specification.

Table 198—SCa burst set delimiter extended IE format

Syntax	Size	Notes
Burst_Set_Delimiter_IE() {		
Subcode	4 bits	BSD = 0x03
Length	4 bits	Length = 6 if parameters specified for a standard burst set 7 if parameters specified for an STC burst set 2 if parameters from last burst set are to be repeated
Offset	16 bits	Offset (in PS) from start of frame to start of DLBTG
DLBTG	8 bits	The time, expressed in PSs, between the end of a BS burst set and the beginning of the next burst set within the same MAC downlink frame. The minimum (and default) length of the DLBTG shall be at least one RxDS interval, so that ramp-down can occur and delay spread can clear receivers.
Burst set type	1 bit	0 = standard, 1 = STC
Unique Word length	3 bits	Number of symbols in a Unique Word: 0 = 16 symbols, 1 = 64 symbols, 2 = 256 symbols
Preamble length	4 bits	Number of Unique Words in preamble (0–7)
Preamble ramp-up	4 bits	Number of PSs in preamble ramp-up (0–15)
Pilot Word interval	4 bits	[regular bursts, Burst set type = 0] (Pilot word's length in symbols included in interval). 0 = no pilot words, 1 = 1024 symbols, 2 = 2048 symbols, 3 = 4096 symbols, 4–15: <i>Reserved</i> [STC-encoded bursts, Burst set type = 1] 0=no pilot words, 1–15 = number of paired blocks between pilot words
Pilot Word length	4 bits	Number of contiguous Unique Words composing a Pilot Word (1, 2, or 3)
Roll-off	4 bits	0 = 0.15, 2 = 0.18, 2 = .25, 3–15: <i>Reserved</i>

Table 198—SCa burst set delimiter extended IE format (continued)

Syntax	Size	Notes
if (Burst Set Type == STC) {		
STC Parameters	8 bits	4 MSB: block length (segments are paired), in symbols 1 = 64, 2 = 128, 3 = 256, 4 = 512, ..., 7 = 4096, 8–15: <i>Reserved</i> 4 LSB: block burst profile type 0 = CP derived from data and no UWs embedded within block 1 = CP derived from data an additional UW as first payload data element in block 2 = CP derived from UWs at beginning and end of segment 3–15: <i>Reserved</i>
}		
}		

8.2.1.9.2.6 AAS DL preamble index extended IE

The presence of this extended IE in a DL-MAP notifies the AAS-enabled SS identified by the specified basic CID value that the preamble used for future BS transmissions to the SS shall be generated using the specified index value.

Table 199—SCa AAS DL preamble index extended IE format

Syntax	Size	Notes
INDX_IE() {		
Subcode	4 bits	INDX = 0x04
Length	4 bits	Length = 3
CID	16 bits	Basic CID of targeted SS
Index	8 bits	0..3
}		

8.2.1.9.2.7 Concurrent transmission extended IE

In the DL-MAP, a BS may transmit DIUC=15 with a DL_Concurrent_IE() to specify one of a set of parallel downlink bursts for transmission. The extended format explicitly specifies the duration and the CID of the corresponding downlink burst. A preamble may precede the downlink burst specified by this IE. When

present, the preamble shall have the same characteristics as the burst set preamble of the current DL subframe.

Table 200—SCa concurrent transmission extended IE format

Syntax	Size	Notes
DL_Concurrent_IE() {		
Subcode	4 bits	CONC = 0x05
Length	4 bits	Length = 7
Preamble present	1 bit	0—No preamble precedes burst 1—Preamble precedes burst
<i>reserved</i>	3 bits	Shall be set to zero
DIUC	4 bits	
Offset	16 bits	
CID	16 bits	
Duration	16 bits	Duration of burst in PS
}		

DIUC:

A 4-bit DIUC shall be used to define the burst type associated with that burst. Burst Descriptor shall be included into DCD message for each DIUC used in the DL-MAP. The DIUC shall be one of the Data Grant (1-12) values defined in Table 193.

Offset:

Offset (in units of PS) to the start of the data burst from the start of the frame.

CID:

Identifies the target of the concurrent burst. The value may be a unicast or multicast address. When specifically addressed, the CID shall be the Basic CID of the SS.

Duration:

Specifies the length of the associated burst in PS.

8.2.1.9.3 UL-MAP IE formats

The IEs of Table 202 are used in UL-MAP messages. The format for these UL-MAP messages is specified in Table 201.

Table 201—SCa UL-MAP IE format

Syntax	Size	Notes
UL-MAP_IE() {		
CID	16 bits	
UIUC	4 bits	
if (UIUC == 15) {		
Extended UIUC dependent IE	<i>variable</i>	See subclauses following in 8.2.1.9.3.1
} else {		
Offset	12 bits	
If (Burst set type is Subchannel or Modulation Type is Spread BPSK){		
Duration	12 bits	
If (Burst set type is Subchannel) {		
Starting subchannel	4 bits	
Subchannel count	4 bits	
}		
}		
}		
}		

CID:

Represents the assignment of the IE to a unicast, multicast, or broadcast address. When specifically addressed to allocate a bandwidth grant, the CID shall be the Basic CID of the SS.

UIUC:

A 4-bit code used to define the type of uplink access and the burst type associated with that access. A Burst Descriptor shall be included in an UCD message for each UIUC that is to be used in the UL-MAP. The UIUC shall be one of the values defined in Table 202.

Offset:

Indicates the start time, in units of minislots, of the burst relative to the Allocation Start Time given in the UL-MAP message. Consequently, the first IE shall have an offset of 0. The end of the last allocated burst is indicated by allocating a End of map burst (CID = 0 and UIUC = 14). The time instants indicated by offsets are the transmission times of the first symbol of the burst including preamble.

Duration:

For bursts associated with one of the spread BPSK modulation types or the subchannel burst set type, this parameter specifies the length of the associated burst in minislots. (For bursts not assigned one of these types in which overlapped transmissions can occur, the duration of the burst

is determined by the Offset appearing in the following IE entry and the offset of the current IE entry.)

Starting subchannel:

For bursts associated with the subchannel burst frame type, this parameter specifies starting subchannel assigned to the transmission.

Subchannel count:

For bursts associated with the subchannel burst set type, this parameter specifies the number of adjacent subchannels assigned to the transmission.

Table 202—SCa UL-MAP IEs

IE name	UIUC	CID	Minislot offset
	0	N/A	<i>reserved</i>
Request	1	any	Starting offset of REQ region
Initial ranging	2	broadcast	Starting offset of maintenance region (used in Initial Ranging)
Data grant burst type 0	3	unicast	Starting offset of Data Grant Burst Type 0 assignment
Data grant burst type 1	4	unicast	Starting offset of Data Grant Burst Type 1 assignment
Data grant burst Type 2	5	unicast	Starting offset of Data Grant Burst Type 2 assignment
Data grant burst type 3	6	unicast	Starting offset of Data Grant Burst Type 3 assignment
Data grant burst type 4	7	unicast	Starting offset of Data Grant Burst Type 4 assignment
Data grant burst type 5	8	unicast	Starting offset of Data Grant Burst Type 5 assignment
Data grant burst type 6	9	unicast	Starting offset of Data Grant Burst Type 6 assignment
Data grant burst type 7	10	unicast	Starting offset of Data Grant Burst Type 10 assignment
Data grant burst type 8	11	unicast	Starting offset of Data Grant Burst Type 11 assignment
Data grant burst type 12	12	unicast	Starting offset of Data Grant Burst Type 12 assignment
Gap	13	zero	Used to schedule gaps in transmission
End of map	14	zero	Ending offset of the previous grant. Used to bound the length of the last actual interval allocation.
Extended UIUC	15	extended UIUC	

A BS supporting the AAS option shall allocate at the end of the uplink frame an initial ranging slot for AAS SS that have to initially alert the BS to their presence. This period shall be marked in the UL-MAP as Initial Ranging (UIUC=2), but shall be marked by an AAS initial ranging CID such that no non-AAS subscriber (or AAS subscriber that can decode the UL-MAP message) uses this interval for Initial Ranging.

8.2.1.9.3.1 UL-MAP extended IE

A UL-MAP IE entry with a UIUC value of 15, indicates that the IE carries special information and conforms to the structure shown in Table 203. A station shall ignore an extended IE entry with a Subcode value for which the station has no knowledge. In the case of a known subcode value but with a length field longer than expected, the station shall process information up to the known length and ignore the remainder of the IE.

Table 203—SCa UL-MAP extended IE format

Syntax	Size	Notes
UL_Extended_IE() {		
Subcode	4 bits	0x00..0x0F
Length	4 bits	Length in bytes of Unspecified data field
Unspecified data	<i>variable</i>	
}		

8.2.1.9.3.2 Power control extended IE

To command a change in SS transmission power, the BS may issue an extended IE with the subcode set to 0. The IE specifies the desired change in transmission power to be implemented by the SS. The CID in the UL-MAP_IE() shall be set to the Basic CID of the SS.

Table 204—SCa power control extended IE format

Syntax	Size	Notes
Power_Control_IE() {		
Subcode	4 bits	FPC = 0x00
Length	4 bits	Length = 1
Power delta	8 bits	Signed integer, which expresses the change in power level (in 0.25 dB units) that the SS should apply to correct its current transmission power.
}		

8.2.1.9.3.3 AAS UL extended IE

Within a frame, the switch from non-AAS to AAS-enabled traffic is marked by using an extended IE with the subcode set to 0x02. This IE indicates that the subsequent allocations up to the end of the uplink sub-frame shall be for AAS traffic. The CID in the UL-MAP_IE() shall be set to the broadcast CID.

Table 205—SCa AAS UL extended IE format

Syntax	Size	Notes
AAS_UL_IE() {		
Subcode	4 bits	AAS = 0x02
Length	4 bits	Length = 2
Offset	12 bits	
<i>reserved</i>	4 bits	Shall be set to zero
}		

8.2.1.9.3.4 AAS UL preamble index extended IE

The presence of this extended IE in a UL-MAP instructs the AAS-enabled SS associated with the basic CID value appearing in the parent IE CID field to use the AAS preamble associated with the specified index value for any future transmissions. This includes transmissions associated with data grants appearing later in the same UL-MAP.

Table 206—SCa AAS UL preamble index extended IE format

Syntax	Size	Notes
INDX_IE() {		
Subcode	4 bits	INDX = 0x03
Length	4 bits	Length = 1
Index	8 bits	0..3
}		

8.2.1.9.3.5 Concurrent transmission extended IE

In the UL-MAP, a BS may transmit UIUC=15 with the UL_Concurrent_IE() to specify one of a set of parallel uplink allocations for transmission. This format explicitly specifies the duration of the corresponding uplink burst.

Table 207—SCa concurrent transmission extended IE format

Syntax	Size	Notes
UL_Concurrent_IE() {		
Subcode	4 bits	CONC = 0x04
Length	4 bits	Length = 4 if Burst set type is not Subchannel 5 if Burst set type is Subchannel
UIUC	4 bits	
Offset	12 bits	
Duration	12 bits	Duration of burst in minislots
<i>reserved</i>	4 bits	Shall be set to zero
if (Burst set type is subchannel) {		
Starting subchannel	4 bits	
Subchannel count	4 bits	
}		

UIUC:

UIUC shall be used to define the type of uplink access and the burst type associated with that access. A Burst Descriptor shall be included into an UCD message for each UIUC used in the UL-MAP. The UIUC shall be one of the values defined in Table 179 except Gap, End of map or Extended UIUC.

Offset:

Indicates the start time, in units of minislots, of the burst relative to the Allocation Start Time given in the UL-MAP message.

Duration:

Specifies the length of the associated burst in minislots.

Starting subchannel:

For bursts associated with the subchannel burst frame type, this parameter specifies starting subchannel assigned to the transmission. Specifies the length of the associated burst in minislots.

Subchannel count:

For bursts associated with the subchannel burst set type, this parameter specifies the number of adjacent subchannels assigned to the transmission.

8.2.1.10 Burst profile formats

Table 208 defines the format of the Downlink_Burst_Profile, which is used in the DCD message (6.3.2.3.1). The Downlink_Burst_Profile is encoded with a Type of 1, an 8-bit length, and a 4-bit DIUC. The DIUC field is associated with the Downlink Burst Profile and Thresholds. The DIUC value is used in the DL-MAP message to specify the Burst Profile to be used for a specific downlink burst.

Table 208—SCa Downlink_Burst_Profile format

Syntax	Size	Notes
Downlink_Burst_Profile {		
Type=1	8 bits	
Length	8 bits	
<i>reserved</i>	4 bits	Shall be set to zero
DIUC	4 bits	
TLV encoded information	<i>variable</i>	
}		

Table 209 defines the format of the Uplink_Burst_Profile, which is used in the UCD message (6.3.2.3.3). The Uplink_Burst_Profile is encoded with a Type of 1, an 8-bit length, and a 4-bit UIUC. The UIUC field is associated with the Uplink Burst Profile and Thresholds. The UIUC value is used in the UL-MAP message to specify the Burst Profile to be used for a specific uplink burst.

Table 209—SCa Uplink_Burst_Profile format

Syntax	Size	Notes
Uplink_Burst_Profile {		
Type=1	8 bits	
Length	8 bits	
<i>reserved</i>	4 bits	Shall be set to zero
UIUC	4 bits	
TLV encoded information	<i>variable</i>	
}		

8.2.1.11 AAS-FBCK-REQ/RSP message bodies

The format of the AAS Feedback Request message body is shown in Table 210.

Table 210—SCa AAS Feedback Request message body

Syntax	Size	Notes
SCa-AAS-FBCK-REQ_Message_Body() {		
Frame Number	8 bits	
Number of Frames	8 bits	
Feedback Request Number	8 bits	
Data Source	2 bits	0—Preamble of AAS transmissions holding data for SS 1—AAS-indicator sequence 2, 3— <i>Reserved</i>
Measurement Requests	6 bits	Bit #0—Report relative phase offsets Bit #1—Report CINR mean Bit #2—Report CINR std dev Bit #3—Report RSSI mean Bit #4 —Report RSSI std dev Bit #5 — <i>Reserved</i>
}		

Frame Number

The least significant 8 bits of the frame number in which to start the measurement.

Number Of Frames

The number of frames over which to measure.

Feedback Request Number

Incremented each time an AAS-FBCK-REQ is sent to an SS. Valid values are 0–254.

Unique counters shall be maintained for each SS.

Data Source

Specifies the frame entity to be measured.

Measurement Requests

Specifies the measurements to be performed on the indicated data source.

The format of the SCA AAS Feedback Response message body is shown in Table 211.

Table 211—SCa AAS Feedback Request message body

Syntax	Size	Notes
SCa-AAS-FBCK-RSP_Message_Body() {		
Feedback Request Number	8 bits	
Number of Observations	8 bits	
Data Source	2 bits	0—Preamble of AAS transmissions directed at SS 1—AAS-indicator sequence. 2, 3 — <i>Reserved</i>
Measurements Reported	6 bits	Bit #0 —Relative phase offsets Bit #1—CINR mean Bit #2—CINR std dev Bit #3— RSSI mean Bit #4—RSSI std dev Bit #5— <i>Reserved</i>
if (Relative phase offsets reported) {		
Phase offset—antenna 1 vs 0	5 bits	Units of $360^{\circ}/32$
Phase offset—antenna 2 vs 0	5 bits	Units of $360^{\circ}/32$
Phase offset—antenna 3 vs 0	5 bits	Units of $360^{\circ}/32$
<i>reserved</i>	1 bit	Shall be set to zero
}		
if (CINR mean reported)		
CINR mean	8 bits	See 8.2.2
if (CINR std dev reported)		
CINR std dev	8 bits	See 8.2.2
if (RSSI mean reported)		
RSSI mean	8 bits	See 8.2.2
if (RSSI std dev reported) {		
RSSI std dev	8 bits	See 8.2.2
}		

Feedback Request Number

Frame Request Number from the AAS-FBCK-REQ messages to which this is the response.

A value of 255 indicates that measurements reported were not requested by the BS.

Number of Observations

Number of instances of the data source item contributing to the measurements reported.

Data Source

Specifies the frame entity that was measured.

Measurements Reported

Specifies the measurements performed on the indicated data source and reported in this message.

8.2.1.12 Baseband Pulse Shaping

Prior to modulation, I and Q signals shall be filtered by square-root raised cosine. A roll-off factor of $\alpha = 0.25$ shall be supported; 0.15 and 0.18 are optional, but defined settings. The ideal square-root cosine is defined in the frequency domain by the transfer function shown in Equation (50).

$$H(f) = \begin{cases} 1 & |f| < f_N(1 - \alpha) \\ \sqrt{\frac{1}{2} + \frac{1}{2} \sin\left(\frac{\pi}{2f_N} \left[\frac{f_N - |f|}{\alpha}\right]\right)} & f_N(1 - \alpha) \leq |f| \leq f_N(1 + \alpha) \\ 0 & |f| \geq f_N(1 + \alpha) \end{cases} \quad (50)$$

where

$$f_N = \frac{1}{2T_s} = \frac{R_s}{2}, \quad (51)$$

f_N is the Nyquist frequency,
 T_s is the modulation symbol duration,
 R_s is the symbol rate.

8.2.1.13 Quadrature modulation

Define the quadrature modulated transmit waveform $s(t)$ as

$$s(t) = I(t) \cos(2\pi f_c t) - Q(t) \sin(2\pi f_c t) \quad (52)$$

where $I(t)$ and $Q(t)$ are the filtered baseband signals of the I and Q symbols and f_c is the carrier frequency.

8.2.1.14 Power control

Power control shall be supported on the uplink, using both initial calibration and periodic adjustment procedures, and without loss of data. To support this, a BS shall be capable of making accurate power measurements of a received signal burst, nominally using the specifications for measurements found in 8.2.2.2. This measurement can then be compared against a reference level, and the resulting error fed back to an SS in a calibration message from the MAC.

Although its exact implementation is not specified, the power control algorithm shall be designed to respond power fluctuations at rates of no more than 30 dB/second and depths of at least 10 dB. Subclause 8.2.3.5 provides recommendations on overall power control range, stepsize, and absolute accuracy in an implementation.

A power control algorithm shall also account for the interaction of the RF power amplifier with different burst profiles. For example, when changing from the QAM modulation of one burst profile to another, amplifier backoff margins shall be maintained to prevent peak clipping and violation of emissions masks and/or excessive transmitter EVM.

8.2.2 Channel quality measurements

8.2.2.1 Introduction

RSSI and CINR signal quality measurements and associated statistics can aid in such processes as BS selection/assignment and burst adaptive profile selection. As channel behavior is time-variant, both mean and standard deviation are defined.

The process by which RSSI measurements are taken does not necessarily require receiver demodulation lock; for this reason, RSSI measurements offer reasonably reliable channel strength assessments even at low signal levels. On the other hand, although CINR measurements require receiver lock, they provide information on the actual operating condition of the receiver, including interference and noise levels, and signal strength.

8.2.2.2 RSSI mean and standard deviation

When collection of RSSI measurements is mandated by the BS, an SS shall obtain an RSSI measurement from the downlink burst set preambles. From a succession of RSSI measurements, the SS shall derive and update estimates of the mean and the standard deviation of the RSSI, and report them via REP-RSP messages.

Mean and standard deviation statistics shall be reported in units of dBm. To prepare such reports, statistics shall be quantized in 1 dB increments, ranging from -40 dBm (encoded 0x53) to -123 dBm (encoded 0x00). Values outside this range shall be assigned the closest extreme value within the scale.

The method used to estimate the RSSI of a single message is left to individual implementation, but the relative accuracy of a single signal strength measurement, taken from a single message, shall be ± 2 dB, with an absolute accuracy of ± 4 dB. This shall be the case over the entire range of input RSSIs. In addition, the range over which these single-message measurements are measured should extend 3 dB on each side beyond the -40 dBm to -123 dBm limits for the final averaged statistics that are reported.

One possible method to estimate the RSSI of a signal of interest at the antenna connector is given by Equation (53).

$$RSSI = 10^{-\frac{G_r}{10}} \frac{1.2567 \times 10^4 V_c^2}{(2^{2B})R} \left(\frac{1}{N} \sum_{n=0}^{N-1} |Y_{I \text{ or } Q}[k, n]| \right)^2 \text{ mW} \quad (53)$$

where

B	is ADC precision, number of bits of ADC,
R	is ADC input resistance [Ohm],
V_c	is ADC input clip level [Volts],
G_r	is analog gain from antenna connector to ADC input,
$Y_{I \text{ or } Q}[k, n]$	is n^{th} sample at the ADC output of I or Q -branch within signal k ,
N	is number of samples.

The (linear) mean RSSI statistics (in mW), derived from a multiplicity of single messages, shall be updated using Equation (54).

$$\hat{\mu}_{RSSI}[k] = \begin{cases} R[0] & k = 0 \\ (1 - \alpha_{\text{avg}})\hat{\mu}_{RSSI}[k-1] + \alpha_{\text{avg}}R[k] & k > 0 \end{cases} \quad \text{mW} \quad (54)$$

where k is the time index for the message (with the initial message being indexed by $k = 0$, the next message by $k = 1$, etc.); $R[k]$ is the RSSI in mW measured during message k ; and α_{avg} is an averaging parameter specified by the BS. The mean estimate in dBm shall then be derived from Equation (55).

$$\hat{\mu}_{RSSI \text{ dBm}}[k] = 10\log(\hat{\mu}_{RSSI}[k]) \quad \text{dBm} \quad (55)$$

To solve for the standard deviation in dB, the expectation-squared statistic shall be updated using Equation (56),

$$\hat{x}_{RSSI}^2[k] = \begin{cases} |R[0]|^2 & k = 0 \\ (1 - \alpha_{\text{avg}})\hat{x}_{RSSI}^2[k-1] + \alpha_{\text{avg}}|R[k]|^2 & k > 0 \end{cases} \quad (56)$$

and the result applied to Equation (57).

$$\hat{\sigma}_{RSSI \text{ dB}} = 5\log\left(\hat{x}_{RSSI}^2[k] - (\hat{\mu}_{RSSI}[k])^2\right) \quad \text{dB} \quad (57)$$

8.2.2.3 CINR mean and standard deviation

When CINR measurements are mandated by the BS, an SS shall obtain a CINR measurement from the downlink burst preambles. From a succession of these measurements, the SS shall derive and update estimates of the mean and the standard deviation of the CINR, and report them via REP-RSP messages.

Mean and standard deviation statistics for CINR shall be reported in units of dB. To prepare such reports, statistics shall be quantized in 1 dB increments, ranging from a minimum of -20 dB (encoded 0x00) to a maximum of 37 dB (encoded 0x29). Values outside this range shall be assigned the closest extreme value within the scale.

The method used to estimate the CINR of a single message is left to individual implementation, but the relative and absolute accuracy of a CINR measurement derived from a single message shall be ± 1 dB and ± 2 dB, respectively, for all input CINRs above 0 dB. In addition, the range over which these single-packet measurements are measured should extend 3 dB on each side beyond the -20 dB to 37 dB limits for the final reported, averaged statistics.

One possible method to estimate the CINR of a single message is by normalizing the mean-squared residual error of detected data symbols (and/or pilot symbols) by the average signal power using Equation (58).

$$\text{CINR}[k] = \frac{A[k]}{E[k]} \quad (58)$$

where $\text{CINR}[k]$ is the (linear) CINR for message k ; $r[k,n]$ is received symbol n within message k ; $r[k,n]$ the corresponding detected or pilot symbol corresponding to received symbol n ;

$$A[k] = \sum_{n=0}^{N-1} |s[k, n]|^2 \quad (59)$$

is the average signal power, which is normally kept constant within a message by action of automatic gain control (AGC); and

$$E[k] = \sum_{n=0}^{N-1} |r[k, n] - s[k, n]|^2 \quad (60)$$

The mean CINR statistic (in dB) shall be derived from a multiplicity of single messages using Equation (61)

$$\hat{\mu}_{\text{CINR dB}}[k] = 10 \log(\hat{\mu}_{\text{CINR}}[k]) \quad (61)$$

where

$$\hat{\mu}_{\text{CINR}}[k] = \begin{cases} \text{CINR}[0] & k = 0 \\ (1 - \alpha_{\text{avg}})\hat{\mu}_{\text{CINR}}[k-1] + \alpha_{\text{avg}} \text{CINR}[k] & k > 0 \end{cases} \quad (62)$$

k is the time index for the message (with the initial message being indexed by $k = 0$, the next message by $k = 1$, etc.); $\text{CINR}[k]$ is a linear measurement of CINR (derived by any mechanism that delivers the prescribed accuracy) for message k ; and α_{avg} is an averaging parameter specified by the BS.

To solve for the standard deviation, the expectation-squared statistic shall be updated using Equation (63),

$$\hat{x}_{\text{CINR}}^2[k] = \begin{cases} |\text{CINR}[0]|^2 & k = 0 \\ (1 - \alpha_{\text{avg}})\hat{x}_{\text{CINR}}^2[k-1] + \alpha_{\text{avg}}|\text{CINR}[k]|^2 & k > 0 \end{cases} \quad (63)$$

and the result applied to Equation (64).

$$\hat{\sigma}_{\text{CINR dB}} = 5 \log \left(\left| \hat{x}_{\text{CINR}}^2[k] - (\hat{\mu}_{\text{CINR}}[k])^2 \right| \right) \text{ dB} \quad (64)$$

8.2.3 System requirements

8.2.3.1 Channel frequency accuracy

RF channel frequency accuracy for an SS shall be within $\pm 15 \cdot 10^{-6}$ of the selected RF carrier over a temperature range of -40 to $+65$ °C operational and up to five years from the date of manufacture of the equipment manufacture. The frequency accuracy for a BS shall be within $\pm 8 \cdot 10^{-6}$ of the selected RF carrier over an operational temperature range of -40 to $+65$ °C, up to ten years from the date of equipment manufacture.

8.2.3.2 Symbol rate

For a roll-off factor of x , the nominal symbol rate, SR (in MBd/s), for an implemented channel bandwidth, BW (in MHz), shall be $SR = (BW - 0.088)/(1 + \alpha)$.

8.2.3.3 Symbol timing jitter

The minimum-to-maximum difference of symbol timing over a period of 2 s shall be less than 2% of the nominal symbol period. This jitter specification shall be maintained over an operational temperature range of -40 to $+65$ °C.

8.2.3.4 Transmitter minimum SNR and EVM

A transmitted signal shall have an SNR of no less than 40 dB at the transmit antenna feed point. The transmitter EVM should be no greater than 3.1%, assuming 64-QAM.

8.2.3.5 Transmitter power level control

An SS and BS transmitter shall provide, respectively, ≥ 30 dB and ≥ 20 dB of monotonic power level control, with a step size granularity of 1 dB. The relative accuracy of the power control mechanism for both SS and BS is $\pm 25\%$ of the control step in dB, but no more than 4 dB. (As an example, for a step size of 10 dB the relative accuracy is 2.5 dB).

The power level absolute accuracy for both SS and BS transmitters shall be within ± 6 dB.

8.2.3.6 Ramp-up/down requirements

Transmit output power shall settle to within the tolerances specified in 8.2.3.5 within 5 μ s. Transients due to the transmit filter impulse response shall be factored into settling time calculations.

8.2.3.7 Spurious emissions during burst on/off transients

A transmitter shall control spurious emissions to conform with applicable regulatory requirements. This includes prior to and during ramp-up, during and following ramp-down, and before and after a burst set in a TDM/TDMA scheme.

8.2.3.8 Out of band spurious emissions

Out of band spurious emissions shall conform with applicable local regulatory spectral masks.

8.2.3.9 Receiver sensitivity

Receiver sensitivity shall be better than the values listed below (computed at 10^{-3} uncoded BER, and a total of 7 dB in receiver noise figure and 3 dB implementation loss). BW is specified in MHz.

$$\begin{aligned} \text{QPSK: } & -93.2 + 10 \cdot \log(BW) \\ \text{16-QAM: } & -86.2 + 10 \cdot \log(BW) \\ \text{64-QAM: } & -80 + 10 \cdot \log(BW) \end{aligned}$$

SNR_{req} assumptions (for uncoded signals at 10^{-3} BER) are the following:

$$\begin{aligned} \text{QPSK: } & 9.8 \text{ dB} \\ \text{16-QAM: } & 16.8 \text{ dB} \\ \text{64-QAM: } & 23.0 \text{ dB} \end{aligned}$$

8.2.3.10 Receiver maximum input signal

A BS shall be capable of receiving a maximum on-channel operational signal of -40 dBm and should tolerate a maximum input signal of 0 dBm without damage to circuitry. An SS shall be capable of receiving a maximum on-channel operational signal of -20 dBm and should tolerate a maximum input signal of 0 dBm without damage to circuitry.

8.2.3.11 Receiver adjacent channel interference

A system shall achieve the minimum adjacent and alternate adjacent channel interference performance as shown in Table 212. All measurements shall be performed uncoded.

Table 212—Minimum adjacent and alternate adjacent channel interference performance

	At BER 10^{-3} , for 3 dB degradation	At BER 10^{-3} , for 1 dB degradation
1st adjacent channel interference C/I	BPSK: -12 QPSK: -9 16-QAM: -2 64-QAM: $+5$ 256-QAM: $+12$	BPSK: -8 QPSK: -5 16-QAM: $+2$ 64-QAM: $+9$ 256-QAM: $+16$
2nd adjacent channel interference C/I	BPSK: -37 QPSK: -34 16-QAM: -27 64-QAM: -20 256-QAM: -13	BPSK: -33 QPSK: -30 16-QAM: -22 64-QAM: -16 256-QAM: -9

8.3 WirelessMAN-OFDM PHY

8.3.1 Introduction

The WirelessMAN-OFDM PHY is based on OFDM modulation and designed for NLOS operation in the frequency bands below 11 GHz as per 1.3.4.

8.3.1.1 OFDM symbol description

8.3.1.1.1 Time domain

Inverse-Fourier-transforming creates the OFDM waveform; this time duration is referred to as the useful symbol time T_b . A copy of the last T_g of the useful symbol period, termed CP, is used to collect multipath, while maintaining the orthogonality of the tones. Figure 195 illustrates this structure.

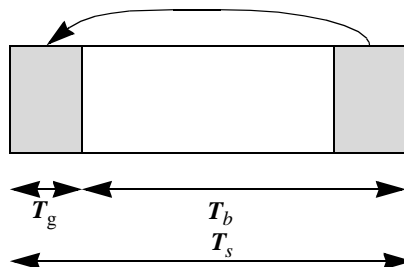

Figure 195—OFDM symbol time structure

The transmitter energy increases with the length of the guard time while the receiver energy remains the same (the cyclic extension is discarded), so there is a $10\log(1 - T_g/(T_b + T_g))/\log(10)$ dB loss in E_b/N_0 . The CP overhead fraction and resultant SNR loss could be reduced by increasing the FFT size, which would however, among other things, adversely affect the sensitivity of the system to phase noise of the oscillators. Using a cyclic extension, the samples required for performing the FFT at the receiver can be taken anywhere over the length of the extended symbol. This provides multipath immunity as well as a tolerance for symbol time synchronization errors.

On initialization, an SS should search all possible values of CP until it finds the CP being used by the BS. The SS shall use the same CP on the uplink. Once a specific CP duration has been selected by the BS for operation on the downlink, it should not be changed. Changing the CP would force all the SSs to resynchronize to the BS.

8.3.1.1.2 Frequency domain

The frequency domain description includes the basic structure of an OFDM symbol.

An OFDM symbol (see Figure 196) is made up from subcarriers, the number of which determines the FFT size used. There are three subcarrier types:

- Data subcarriers: For data transmission
- Pilot subcarriers: For various estimation purposes
- Null subcarriers: No transmission at all, for guard bands, non-active subcarriers and the DC subcarrier.

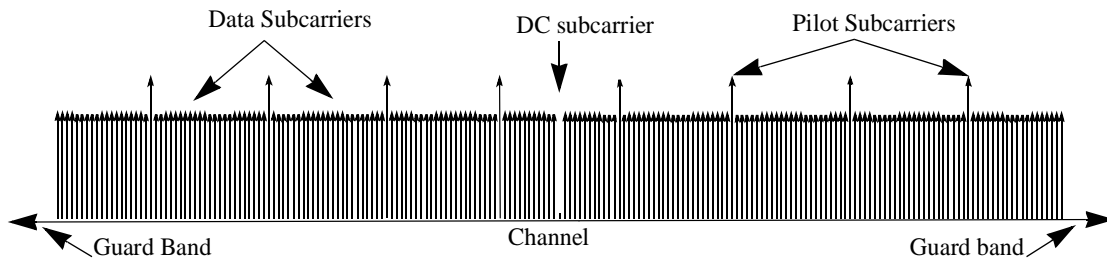

Figure 196—OFDM frequency description

NOTE —The example in Figure 196 shows the amplitude of the real (in-phase) component of an OFDM symbol with QPSK modulated data.

The purpose of the guard bands is to enable the signal to naturally decay and create the FFT “brick Wall” shaping. Subcarriers are non-active only in the case of subchannelized transmission by an SS.

Subchannelized transmission in the uplink is an option for an SS, and shall only be used if the BS signals its capability to decode such transmissions.

8.3.2 OFDM symbol parameters and transmitted signal

8.3.2.1 Primitive parameter definitions

Four primitive parameters characterize the OFDM symbol:

- *BW*. This is the nominal channel bandwidth.
- N_{used} . Number of used subcarriers.
- *n*. Sampling factor. This parameter, in conjunction with *BW* and N_{used} determines the subcarrier spacing, and the useful symbol time. Required values of this parameter are specified in 8.3.2.4
- *G*. This is the ratio of CP time to “useful” time. Required values of this parameter are specified in 8.3.2.4.

8.3.2.2 Derived parameter definitions

The following parameters are defined in terms of the primitive parameters of 8.3.2.1.

- N_{FFT} : Smallest power of two greater than N_{used}
- Sampling Frequency: $F_s = \text{floor}(n \cdot BW / 8000) \times 8000$
- Subcarrier spacing: $\Delta f = F_s / N_{FFT}$
- Useful symbol time: $T_b = 1 / \Delta f$
- CP Time: $T_g = G \cdot T_b$
- OFDM Symbol Time: $T_s = T_b + T_g$
- Sampling time: T_b / N_{FFT}

8.3.2.3 Transmitted signal

Equation (65) specifies the transmitted signal voltage to the antenna, as a function of time, during any OFDM symbol.

$$s(t) = \operatorname{Re} \left\{ e^{j2\pi f_c t} \sum_{\substack{k = -N_{used}/2 \\ k \neq 0}}^{N_{used}/2} c_k \cdot e^{j2\pi k \Delta f (t - T_g)} \right\} \quad (65)$$

where

- t is the time, elapsed since the beginning of the subject OFDM symbol, with $0 < t < T_s$,
- c_k is a complex number; the data to be transmitted on the subcarrier whose frequency offset index is k , during the subject OFDM symbol. It specifies a point in a QAM constellation. In subchannelized transmissions, c_k is zero for all unallocated subcarriers.

8.3.2.4 Parameters of transmitted signal

The parameters of the transmitted OFDM signal, transmitted as in 8.3.2.3, are given in Table 213.

Table 213—OFDM symbol parameters

Parameter	Value
N_{FFT}	256
N_{used}	200
n	For channel bandwidths that are a multiple of 1.75 MHz then $n = 8/7$ else for channel bandwidths that are a multiple of 1.5 MHz then $n = 86/75$ else for channel bandwidths that are a multiple of 1.25 MHz then $n = 144/125$ else for channel bandwidths that are a multiple of 2.75 MHz then $n = 316/275$ else for channel bandwidths that are a multiple of 2.0 MHz then $n = 57/50$ else for channel bandwidths not otherwise specified then $n = 8/7$
G	1/4, 1/8, 1/16, 1/32
Number of lower frequency guard subcarriers	28
Number of higher frequency guard subcarriers	27

Table 213—OFDM symbol parameters (continued)

Parameter	Value
Frequency offset indices of guard subcarriers	-128,-127,...,-101 +101,+102,...,127
Frequency offset indices of pilot carriers	-88,-63,-38,-13,13,38,63,88
Subchannel Index:	Allocated Frequency offset indices of subcarriers:
<div style="display: flex; align-items: center;"> <div style="margin-right: 10px;">0b10000: {</div> <div style="margin-right: 10px;">{</div> <div style="margin-right: 10px;">0b01000: {</div> <div style="margin-right: 10px;">{</div> <div style="margin-right: 10px;">0b00010: {</div> <div style="margin-right: 10px;">0b00001: {</div> <div style="margin-right: 10px;">0b00011: {</div> <div style="margin-right: 10px;">0b00101: {</div> <div style="margin-right: 10px;">0b00110: {</div> <div style="margin-right: 10px;">0b00111: {</div> <div style="margin-right: 10px;">0b01001: {</div> <div style="margin-right: 10px;">0b01010: {</div> <div style="margin-right: 10px;">0b01011: {</div> <div style="margin-right: 10px;">0b01101: {</div> <div style="margin-right: 10px;">0b01110: {</div> <div style="margin-right: 10px;">0b10010: {</div> <div style="margin-right: 10px;">0b10011: {</div> <div style="margin-right: 10px;">0b10101: {</div> <div style="margin-right: 10px;">0b10110: {</div> <div style="margin-right: 10px;">0b10111: {</div> <div style="margin-right: 10px;">0b11001: {</div> <div style="margin-right: 10px;">0b11010: {</div> <div style="margin-right: 10px;">0b11011: {</div> <div style="margin-right: 10px;">0b11101: {</div> <div style="margin-right: 10px;">0b11110: {</div> <div style="margin-right: 10px;">0b11111: {</div> </div> <div style="margin-right: 10px;">{</div> <div style="margin-right: 10px;">{</div> <div style="margin-right: 10px;">{</div> <div style="margin-right: 10px;">{</div> <div style="margin-right: 10px;">{</div> <div style="margin-right: 10px;">{-100:-98, -37:-35, 1:3, 64:66}</div> <div style="margin-right: 10px;">{-38}</div> <div style="margin-right: 10px;">{-97:-95, -34:-32, 4:6, 67:69}</div> <div style="margin-right: 10px;">{-94:-92, -31:-29, 7:9, 70:72}</div> <div style="margin-right: 10px;">{13}</div> <div style="margin-right: 10px;">{-91:-89, -28:-26, 10:12, 73:75}</div> <div style="margin-right: 10px;">{-87:-85, -50:-48, 14:16, 51:53}</div> <div style="margin-right: 10px;">{-88}</div> <div style="margin-right: 10px;">{-84,-82, -47:-45, 17: 19, 54:56}</div> <div style="margin-right: 10px;">{-81:-79, -44:-42, 20:22, 57:59}</div> <div style="margin-right: 10px;">{63}</div> <div style="margin-right: 10px;">{-78:-76, -41:-39, 23:25, 60:62}</div> <div style="margin-right: 10px;">{-75:-73, -12:-10, 26:28, 89:91}</div> <div style="margin-right: 10px;">{-13}</div> <div style="margin-right: 10px;">{-72:-70, -9: -7, 29:31, 92:94}</div> <div style="margin-right: 10px;">{-69:-67, -6: -4, 32:34, 95:97}</div> <div style="margin-right: 10px;">{38}</div> <div style="margin-right: 10px;">{-66:-64, -3: -1, 35:37, 98:100}</div> <div style="margin-right: 10px;">{-62:-60, -25:-23, 39:41, 76:78}</div> <div style="margin-right: 10px;">{-63}</div> <div style="margin-right: 10px;">{-59:-57, -22:-20, 42:44, 79:81}</div> <div style="margin-right: 10px;">{-56:-54, -19:-17, 45:47, 82:84}</div> <div style="margin-right: 10px;">{88}</div> <div style="margin-right: 10px;">{-53:-51, -16:-14, 48:50, 85:87}</div>	

Note that pilot subcarriers are allocated only if two or more subchannels are allocated.

8.3.3 Channel coding

Channel coding is composed of three steps: randomizer, FEC, and interleaving. They shall be applied in this order at transmission. The complementary operations shall be applied in reverse order at reception.

8.3.3.1 Randomization

Data randomization is performed on each burst of data on the downlink and uplink. The randomization is performed on each allocation (downlink or uplink), which means that for each allocation of a data block (subchannels on the frequency domain and OFDM symbols on the time domain) the randomizer shall be used independently. If the amount of data to transmit does not fit exactly the amount of data allocated, padding of 0xFF (“1” only) shall be added to the end of the transmission block. For RS-CC and CC encoded data (see 8.3.3.2.1), padding will be added to the end of the transmission block, up to the amount of data allocated minus one byte, which shall be reserved for the introduction of a 0x00 tail byte by the FEC. For BTC (8.3.3.2.2) and CTC (8.3.3.2.3), if implemented, padding will be added to the end of the transmission block, up to the amount of data allocated.

The shift-register of the randomizer shall be initialized for each new allocation.

The PRBS generator shall be $1 + X^{14} + X^{15}$ as shown in Figure 197. Each data byte to be transmitted shall enter sequentially into the randomizer, MSB first. Preambles are not randomized. The seed value shall be used to calculate the randomization bits, which are combined in an XOR operation with the serialized bit stream of each burst. The randomizer sequence is applied only to information bits.

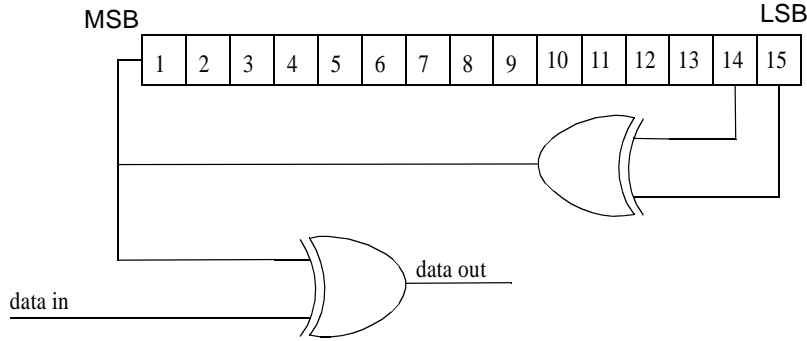

Figure 197—PRBS for data randomization

The bits issued from the randomizer shall be applied to the encoder.

On the downlink, the randomizer shall be re-initialized at the start of each frame with the sequence: 1 0 0 1 0 1 0 1 0 0 0 0 0 0. The randomizer shall not be reset at the start of burst #1. At the start of subsequent bursts, the randomizer shall be initialized with the vector shown in Figure 198. The frame number used for initialization refers to the frame in which the downlink burst is transmitted.

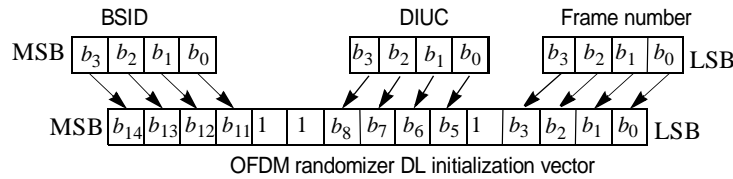

Figure 198—OFDM randomizer downlink initialization vector for burst #2...N

On the uplink, the randomizer is initialized with the vector shown in Figure 199. The frame number used for initialization is that of the frame in which the UL map that specifies the uplink burst was transmitted.

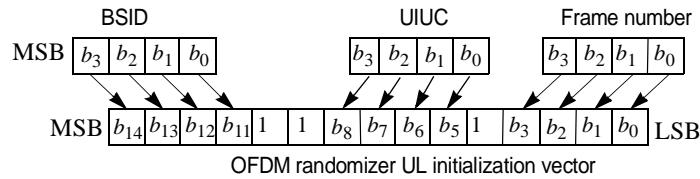

Figure 199—OFDM randomizer uplink initialization vector

8.3.3.2 FEC

An FEC, consisting of the concatenation of a Reed–Solomon outer code and a rate-compatible convolutional inner code, shall be supported on both uplink and downlink. Support of BTC and CTC is optional. The Reed–Solomon–Convolutional coding rate 1/2 shall always be used as the coding mode when requesting access to the network (except in subchannelization modes, which uses only convolutional coding 1/2) and in the FCH burst.

The encoding is performed by first passing the data in block format through the RS encoder and then passing it through a zero-terminating convolutional encoder.

8.3.3.2.1 Concatenated Reed–Solomon-convolutional code (RS-CC)

The Reed–Solomon encoding shall be derived from a systematic RS ($N = 255$, $K = 239$, $T = 8$) code using $GF(2^8)$,

where

- N is the number of overall bytes after encoding,
- K is the number of data bytes before encoding,
- T is the number of data bytes which can be corrected.

The following polynomials are used for the systematic code:

$$\text{Code Generator Polynomial: } g(x) = (x + \lambda^0)(x + \lambda^1)(x + \lambda^2) \dots (x + \lambda^{2T-1}), \lambda = 02_{HEX} \quad (66)$$

$$\text{Field Generator Polynomial: } p(x) = x^8 + x^4 + x^3 + x^2 + 1 \quad (67)$$

This code is shortened and punctured to enable variable block sizes and variable error-correction capability. When a block is shortened to K' data bytes, add $239 - K'$ zero bytes as a prefix. After encoding discard these $239 - K'$ zero bytes. When a codeword is punctured to permit T' bytes to be corrected, only the first $2T'$ of the total 16 parity bytes shall be employed. The bit/byte conversion shall be MSB first.

Each RS block is encoded by the binary convolutional encoder, which shall have native rate of 1/2, a constraint length equal to 7, and shall use the generator polynomials codes shown in Equation (68) to derive its two code bits:

$$\begin{aligned} G_1 &= 171_{OCT} && \text{FOR } X \\ G_2 &= 133_{OCT} && \text{FOR } Y \end{aligned} \quad (68)$$

The generator is depicted in Figure 200.

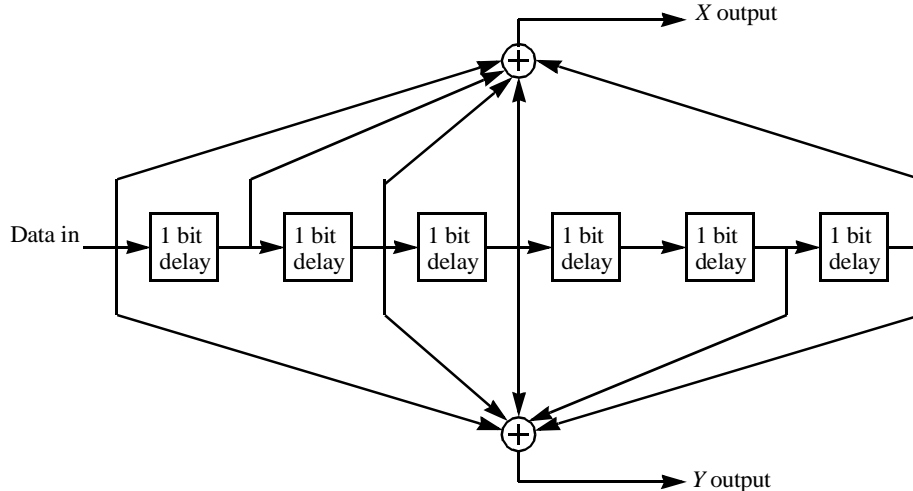

Figure 200—Convolutional encoder of rate 1/2

Puncturing patterns and serialization order that shall be used to realize different code rates are defined in Table 214. In the table, “1” means a transmitted bit and “0” denotes a removed bit, whereas X and Y are in reference to Figure 200.

Table 214—The inner convolutional code with puncturing configuration

Rate	Code rates			
	1/2	2/3	3/4	5/6
d_{free}	10	6	5	4
X	1	10	101	10101
Y	1	11	110	11010
XY	X_1Y_1	$X_1Y_1Y_2$	$X_1Y_1Y_2X_3$	$X_1Y_1Y_2X_3Y_4X_5$

The RS-CC rate 1/2 shall always be used as the coding mode when requesting access to the network.

The encoding is performed by first passing the data in block format through the RS encoder and then passing it through a convolutional encoder. A single 0x00 tail byte is appended to the end of each burst. This tail byte shall be appended after randomization. In the RS encoder, the redundant bits are sent before the input bits, keeping the 0x00 tail byte at the end of the allocation. When the total number of data bits in a burst is not an integer number of bytes, zero pad bits are added after the zero tail bits. The zero pad bits are not randomized. Note that this situation can occur only in subchannelization. In this case, the RS encoding is not employed.

Table 215 gives the block sizes and the code rates used for the different modulations and code rates. As 64-QAM is optional for license-exempt bands, the codes for this modulation shall only be implemented if the modulation is implemented.

Table 215—Mandatory channel coding per modulation

Modulation	Uncoded block size (bytes)	Coded block size (bytes)	Overall coding rate	RS code	CC code rate
BPSK	12	24	1/2	(12,12,0)	1/2
QPSK	24	48	1/2	(32,24,4)	2/3
QPSK	36	48	3/4	(40,36,2)	5/6
16-QAM	48	96	1/2	(64,48,8)	2/3
16-QAM	72	96	3/4	(80,72,4)	5/6
64-QAM	96	144	2/3	(108,96,6)	3/4
64-QAM	108	144	3/4	(120,108,6)	5/6

When subchannelization is applied in the uplink, the FEC shall bypass the RS encoder and use the Overall Coding Rate as indicated in Table 215 as CC Code Rate. The Uncoded Block Size and Coded Block size may be computed by multiplying the values listed in Table 215 by the number of allocated subchannels divided by 16.

In the case of BPSK modulation, the RS encoder should be bypassed.

8.3.3.2.2 Block Turbo Coding (optional)

BTC is based on the product of two simple component codes, which are binary extended Hamming codes or parity check codes from the set depicted in Table 216.

Table 216—BTC component codes

Component code (n,k)	Code type
(64,57)	Extended Hamming code
(32,26)	Extended Hamming code
(16,11)	Extended Hamming code
(64,63)	Parity check code
(32,31)	Parity check code
(16,15)	Parity check code
(8,7)	Parity check code

Table 217 specifies the generator polynomials for the Hamming codes. To create extended Hamming codes, an overall even parity check bit is added at the end of each code word.

Table 217—OFDM Hamming code generator polynomials

n'	k'	Generator polynomial
7	4	X^3+X^1+1
15	11	X^4+X^1+1
31	26	X^5+X^2+1
63	57	X^6+X+1

The component codes are used in a two-dimensional matrix form, which is depicted in Figure 201. The k_x information bits in the rows are encoded into n_x bits, by using the component block (n_x, k_x) code specified for the respective composite code. After encoding the rows, the columns are encoded using a block code (n_y, k_y) , where the check bits of the first code are also encoded. The overall block size of such a product code is $n = n_x \times n_y$, the total number of information bits $k = k_x \times k_y$ and the code rate is $R = R_x \times R_y$, where $R_i = k_i/n_i$, $i = x, y$. The Hamming distance of the product code is $d = d_x \times d_y$. Data bit ordering for the composite BTC matrix is defined such that the first bit in the first row is the LSB, and the last data bit in the last data row is the MSB.

Transmission of the block over the channel shall occur in a linear fashion, with all bits of the first row transmitted left to right followed by the second row, and so on.

To match a required packet size, BTCs may be shortened by removing symbols from the BTC array. In the two-dimensional case, rows, columns, or parts thereof can be removed until the appropriate size is reached. There are three steps in the process of shortening product codes:

- Step 1) Remove I_x rows and I_y columns from the two-dimensional code. This is equivalent to shortening the constituent codes that make up the product code.
- Step 2) Remove B individual bits from the first row of the two-dimensional code starting with the LSB.
- Step 3) Use if the product code specified from Step 1) and Step 2) has a non-integral number of data bytes. In this case, the Q leftover LSB are zero-filled by the encoder. After decoding at the receive end, the decoder shall strip off these unused bits and only the specified data payload is passed to the next higher level in the PHY.

The same process is used for shortening the last code word in a message where the available data bytes do not fill the available data bytes in a code block.

These three processes of code shortening are depicted in Figure 201. In the first two-dimensional BTC, a nonshortened product code is shown. By comparison, a shortened BTC is shown in the adjacent two-dimensional array. The new coded block length of the code is $(n_x - I_x)(n_y - I_y) - B$. The corresponding information length is given as $(k_x - I_x)(k_y - I_y) - B - Q$. Consequently, the code rate is given by Equation (69).

$$R = \frac{(k_x - I_x)(k_y - I_y) - B - Q}{(n_x - I_x)(n_y - I_y) - B} \quad (69)$$

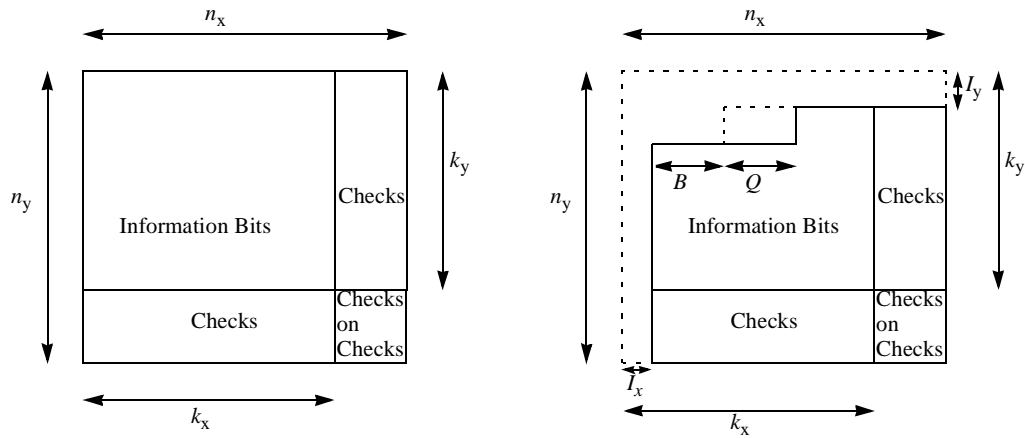

Figure 201—BTC and shortened BTC structure

Table 218 gives the block sizes, code rates, channel efficiency, and code parameters for the different modulation and coding schemes. As 64-QAM is optional for license-exempt bands, the codes for this modulation shall only be implemented if the modulation is implemented.

Table 218—Optional BTC channel coding per modulation

Modulation	Data block size (bytes)	Coded block size (bytes)	Overall code rate	Efficiency (bit/s/Hz)	Constituent codes (n_x, k_x)(n_y, k_y)	Code parameter
QPSK	23	48	~1/2	1.0	(32,26)(16,11)	$I_x=4, I_y=2, B=8, Q=6$
QPSK	35	48	~3/4	1.5	(32,26)(16,15)	$I_x=0, I_y=4, B=0, Q=6$
16-QAM	58	96	~3/5	2.4	(32,26)(32,26)	$I_x=0, I_y=8, B=0, Q=4$
16-QAM	77	96	~4/5	3.3	(64,57)(16,15)	$I_x=7, I_y=2, B=30, Q=4$
64-QAM	96	144	~2/3	3.8	(64,63)(32,26)	$I_x=3, I_y=13, B=7, Q=5$
64-QAM	120	144	~5/6	5.0	(32,31)(64,57)	$I_x=13, I_y=3, B=7, Q=5$

When subchannelization is used, the coding block size is limited to blocks at least 96 bits in length. The number of bits is calculated as shown in Equation (70).

$$\frac{N_{full}}{16} \cdot N_{Sub} \tag{70}$$

where

- N_{full} is number of bits for 16-subchannel (full) mode,
- N_{Sub} is number of active subchannels (1–16).

Table 219—Optional BTC channel coding with subchannelization

Coded bits	Approximate Rate	Constituent code	Code parameter
96	1/2	(8,7), (32,26)	$I_x=4, I_y=8, B=0, Q=6$
	3/4	(16,15), (16,15)	$I_x=6, I_y=6, B=4, Q=5$
144	3/5	(16,15), (16,11)	$I_x=7, I_y=0, B=0, Q=0$
	5/6	(16,15), (16,15)	$I_x=4, I_y=4, B=0, Q=1$
192	3/8	(16,11), (16,11)	$I_x=2, I_y=2, B=4, Q=5$
	2/3	(8,7), (32,26)	$I_x=2, I_y=0, B=0, Q=2$
	5/6	(16,15), (16,15)	$I_x=2, I_y=2, B=4, Q=5$
288	1/2	(16,11), (32,26)	$I_x=0, I_y=14, B=0, Q=4$
	3/4	(16,15), (32,26)	$I_x=7, I_y=0, B=0, Q=0$
384	1/2	(16,11), (32,26)	$I_x=0, I_y=8, B=0, Q=6$
	3/4	(16,15), (32,26)	$I_x=4, I_y=0, B=0, Q=6$
576	1/2	(32,26), (32,26)	$I_x=8, I_y=8, B=0, Q=4$
	3/4	(16,15), (64,57)	$I_x=7, I_y=0, B=0, Q=0$
768	3/5	(32,26), (32,26)	$I_x=4, I_y=4, B=16, Q=4$
	4/5	(64,57), (16,15)	$I_x=6, I_y=2, B=44, Q=3$
1152	2/3	(64,57), (32,26)	$I_x=28, I_y=0, B=0, Q=2$
	5/6	(32,31), (64,57)	$I_x=13, I_y=3, B=7, Q=5$

8.3.3.2.3 Convolutional Turbo Codes (optional)

8.3.3.2.3.1 CTC encoder

The Convolutional Turbo Code encoder, including its constituent encoder, is depicted in Figure 202. It uses a double binary Circular Recursive Systematic Convolutional code. The bits of the data to be encoded are alternately fed to *A* and *B*, starting with the MSB of the first byte being fed to *A*. The encoder is fed by blocks of *k* bits or *N* couples ($k = 2 \times N$ bits). For all the frame sizes, *k* is a multiple of 8 and *N* is a multiple of 4. *N* shall be limited to: $8 \leq N/4 \leq 1024$. For subchannelization mode, the coding block size is limited to blocks at least 48 bits in length, and no more than 1024 bits in length. In addition, *k* cannot be a multiple of 7.

The polynomials defining the connections are described in octal and symbol notations as follows:

- For the feedback branch: 0xB, equivalently $1 + D + D^3$ (in symbolic notation)
- For the *Y* parity bit: 0xD, equivalently $1 + D^2 + D^3$

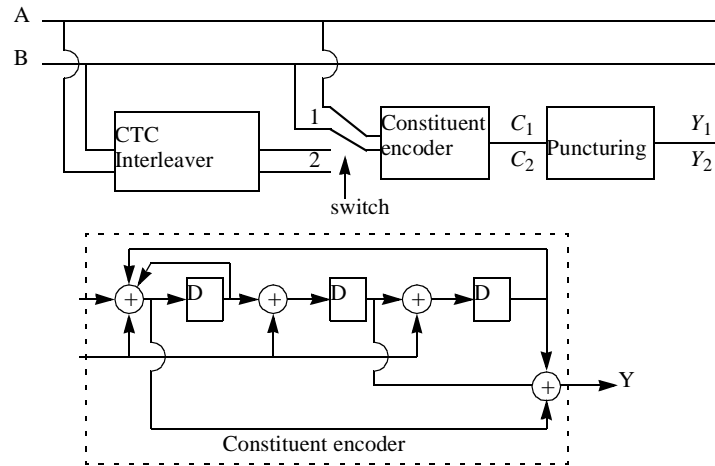

Figure 202—CTC encoder

First, the encoder (after initialization by the circulation state S_{c1} , see 8.3.3.2.3.3) is fed the sequence in the natural order (position 1) with the incremental address $i = 0 \dots N-1$. This first encoding is called C_1 encoding. Then the encoder (after initialization by the circulation state S_{c2} , see 8.3.3.2.3.3) is fed by the interleaved sequence (switch in position 2) with incremental address $j = 0, \dots N-1$. This second encoding is called C_2 encoding.

The order that the encoded bit shall be fed into the interleaver (8.3.3.3) is as follows:

$$A_0, B_0 \dots A_{N-1}, B_{N-1}, Y_{10}, Y_{1,1} \dots Y_{1,M}, Y_{20}, Y_{2,1} \dots Y_{2,M}$$

where M is the number of parity bits.

Table 220 gives the block sizes, code rates, channel efficiency, and code parameters for the different modulation and coding schemes. As 64-QAM is optional for license-exempt bands, the codes for this modulation shall only be implemented if the modulation is implemented.

Table 220—Optional CTC channel coding per modulation

Modulation	N	Overall code rate	P_0
QPSK	$6 \times N_{sub}$	1/2	7
QPSK	$8 \times N_{sub}$	2/3	11
QPSK	$9 \times N_{sub}$	3/4	17
16-QAM	$12 \times N_{sub}$	1/2	11

Table 220—Optional CTC channel coding per modulation (continued)

Modulation	N	Overall code rate	P_0
16-QAM	$18 * N_{sub}$	3/4	13
64-QAM	$24 * N_{sub}$	2/3	17
64-QAM	$27 * N_{sub}$	3/4	17

In Table 220, N_{sub} denotes the number of subchannels of the allocation in which the encoded data will be transmitted. The data block size (in bytes per OFDM symbol) may be calculated as $N/4$. Further, P_1 equals $3N/4$.

8.3.3.2.3.2 CTC Interleaver

The interleaver requires the parameters P_0 , shown in Table 220.

The two-step interleaver shall be performed by:

Step 1: Switch alternate couples

for $j = 1 \dots N$

if $(j_{mod_2} == 0)$ let $(B,A) = (A,B)$ (i.e., switch the couple)

Step 2: $P_i(j)$

The function $P_i(j)$ provides the interleaved address i of the consider couple j .

for $j = 1 \dots N$

switch j_{mod_4} :

case 0 or 1: $i = (P_0 \cdot j + 1)_{mod_N}$

case 2: $i = (P_0 \cdot j + 1 + N/4)_{mod_N}$

case 3: $i = (P_0 \cdot j + 1 + N/2 + P_1)_{mod_N}$

8.3.3.2.3.3 Determination of CTC circulation states

The state of the encoder is denoted S ($0 \leq S \leq 7$) with S the value read binary (left to right) out of the constituent encoder memory (see Figure 202). The circulation states S_{c1} and S_{c2} are determined by the following operations:

- Step 1) Initialize the encoder with state 0. Encode the sequence in the natural order for the determination of S_{c1} or in the interleaved order for determination of S_{c2} . In both cases, the final state of the encoder is S_{0N-1} ;
- Step 2) According to the length N of the sequence, use Table 221 to find S_{c1} or S_{c2} .

Table 221—Circulation state lookup table (S_c)

N_{mod_7}	S_{0N-1}							
	0	1	2	3	4	5	6	7
1	0	6	4	2	7	1	3	5
2	0	3	7	4	5	6	2	1
3	0	5	3	6	2	7	1	4
4	0	4	1	5	6	2	7	3
5	0	2	5	7	1	3	4	6
6	0	7	6	1	3	4	5	2

8.3.3.2.3.4 CTC puncturing

The three code-rates are achieved through selectively deleting the parity bits (puncturing). The puncturing patterns are identical for both codes C_1 and C_2 .

Table 222—CTC puncturing (S_c)

Rate $R_n/(R_n+1)$	Y					
	0	1	2	3	4	5
1/2	1	1				
2/3	1	0	1	0		
3/4	1	0	0	1	0	0

8.3.3.3 Interleaving

All encoded data bits shall be interleaved by a block interleaver with a block size corresponding to the number of coded bits per the allocated subchannels per OFDM symbol, N_{cbps} . The interleaver is defined by a two step permutation. The first ensures that adjacent coded bits are mapped onto nonadjacent subcarriers. The second permutation insures that adjacent coded bits are mapped alternately onto less or more significant bits of the constellation, thus avoiding long runs of lowly reliable bits.

Let N_{cpc} be the number of coded bits per subcarrier, i.e., 1, 2, 4 or 6 for BPSK, QPSK, 16-QAM, or 64-QAM, respectively. Let $s = \text{ceil}(N_{cpc}/2)$. Within a block of N_{cbps} bits at transmission, let k be the index of the coded bit before the first permutation; m_k be the index of that coded bit after the first and before the second permutation; and let j_k be the index after the second permutation, just prior to modulation mapping.

The first permutation is defined by Equation (71):

$$m_k = (N_{cbps}/12) \cdot k_{mod12} + \text{floor}(k/12) \quad k = 0, 1, \dots, N_{cbps} - 1 \quad (71)$$

The second permutation is defined by Equation (72):

$$j_k = s \cdot \text{floor}(m_k/s) + (m_k + N_{\text{cbps}} - \text{floor}(12 \cdot m_k/N_{\text{cbps}}))_{\text{mod}(s)} \quad k = 0, 1, \dots, N_{\text{cbps}} - 1 \quad (72)$$

The de-interleaver, which performs the inverse operation, is also defined by two permutations. Within a received block of N_{cbps} bits, let j be the index of a received bit before the first permutation; m_j be the index of that bit after the first and before the second permutation; and let k_j be the index of that bit after the second permutation, just prior to delivering the block to the decoder.

The first permutation is defined by Equation (73):

$$m_j = s \cdot \text{floor}(j/s) + (j + \text{floor}(12 \cdot j/N_{\text{cbps}}))_{\text{mod}(s)} \quad j = 0, 1, \dots, N_{\text{cbps}} - 1 \quad (73)$$

The second permutation is defined by Equation (74):

$$k_j = 12 \cdot m_j - (N_{\text{cbps}} - 1) \cdot \text{floor}(12 \cdot m_j/N_{\text{cbps}}) \quad j = 0, 1, \dots, N_{\text{cbps}} - 1 \quad (74)$$

The first permutation in the de-interleaver is the inverse of the second permutation in the interleaver, and conversely.

Table 223 shows the bit interleaver sizes as a function of modulation and coding.

Table 223—Block sizes of the Bit Interleaver

	Default (16 subchannels)	8 subchannels	4 subchannels	2 subchannels	1 subchannel
	N_{cbps}				
BPSK	192	96	48	24	12
QPSK	384	192	96	48	24
16-QAM	768	384	192	96	48
64-QAM	1152	576	288	144	72

The first bit out of the interleaver shall map to the MSB in the constellation.

8.3.3.4 Modulation

8.3.3.4.1 Data modulation

After bit interleaving, the data bits are entered serially to the constellation mapper. BPSK, Gray-mapped QPSK, 16-QAM, and 64-QAM as shown in Figure 203 shall be supported, whereas the support of 64-QAM is optional for license-exempt bands. The constellations (as shown in Figure 203) shall be normalized by multiplying the constellation point with the indicated factor c to achieve equal average power. For each modulation, b_0 denotes the LSB.

Per-allocation adaptive modulation and coding shall be supported in the downlink. The uplink shall support different modulation schemes for each SS based on the MAC burst configuration messages coming from the BS. Complete description of the MAC/PHY support of adaptive modulation and coding is provided in 6.3.7.

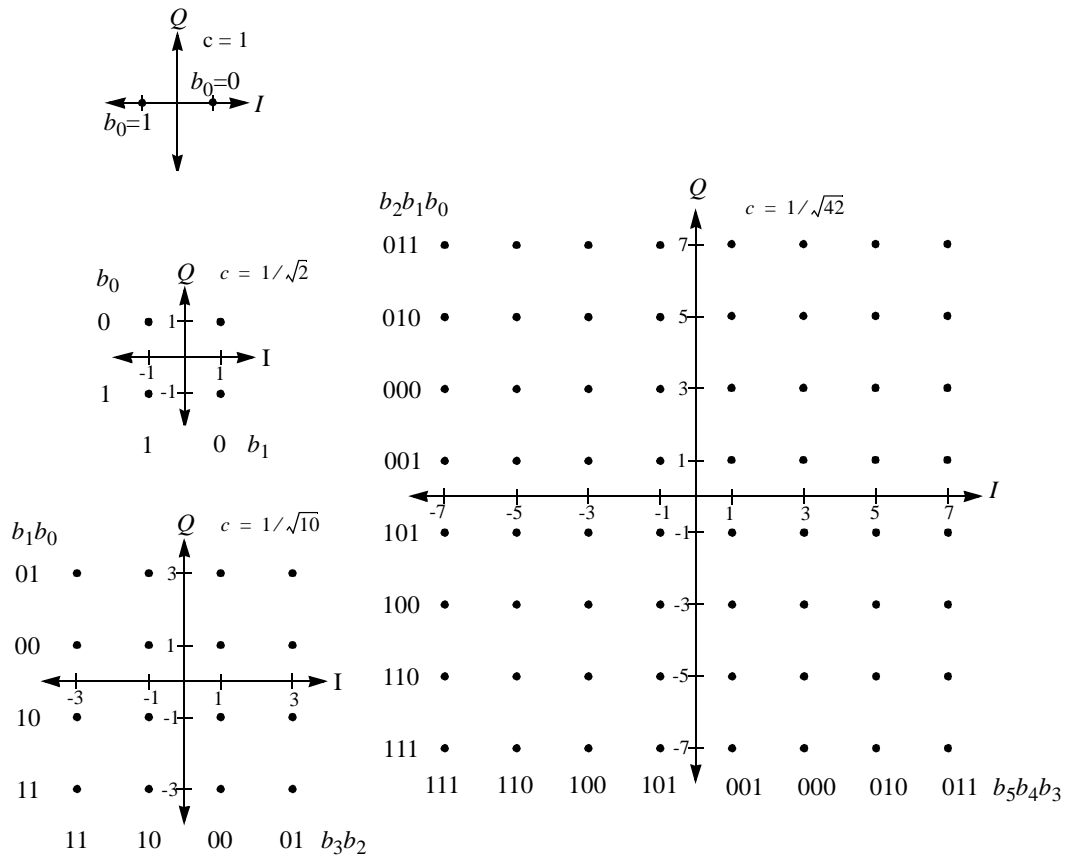

Figure 203—BPSK, QPSK, 16-QAM, and 64-QAM constellations

The constellation-mapped data shall be subsequently modulated onto all allocated data subcarriers in order of increasing frequency offset index. The first symbol out of the data constellation mapping shall be modulated onto the allocated subcarrier with the lowest frequency offset index.

8.3.3.4.2 Pilot modulation

Pilot subcarriers shall be inserted into each data burst in order to constitute the Symbol and they shall be modulated according to their carrier location within the OFDM symbol. The PRBS generator depicted hereafter shall be used to produce a sequence, w_k . The polynomial for the PRBS generator shall be $X^{11} + X^9 + 1$.

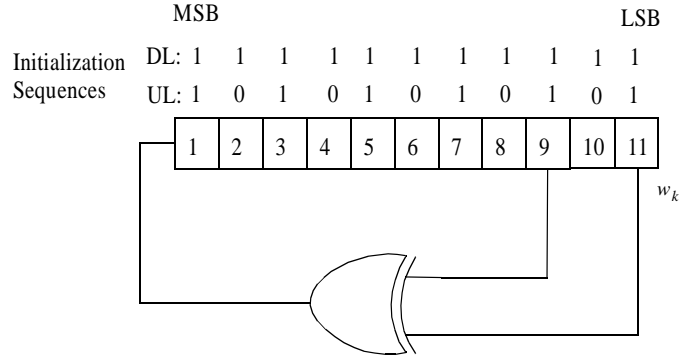

Figure 204—PRBS for pilot modulation

The value of the pilot modulation for OFDM symbol k is derived from w_k . On the downlink the index k represents the symbol index relative to the beginning of the downlink subframe. On the uplink the index k represents the symbol index relative to the beginning of the burst. On both uplink and downlink, the first symbol of the preamble is denoted by $k = 0$. The initialization sequences that shall be used on the downlink and uplink are shown in Figure 204. On the downlink, this shall result in the sequence 111111111100000000110... where the third 1, i.e., $w_2 = 1$, shall be used in the first OFDM downlink symbol following the frame preamble. For each pilot (indicated by frequency offset index), the BPSK modulation shall be derived as shown in Equation (75) and Equation (76).

$$DL: \quad c_{-88} = c_{-38} = c_{63} = c_{88} = 1 - 2w_k \quad \text{and} \quad c_{-63} = c_{-13} = c_{13} = c_{38} = 1 - 2\overline{w_k} \quad (75)$$

$$UL: \quad c_{-88} = c_{-38} = c_{13} = c_{38} = c_{63} = c_{88} = 1 - 2w_k \quad \text{and} \quad c_{-63} = c_{-13} = 1 - 2\overline{w_k} \quad (76)$$

8.3.3.4.3 Rate ID encodings

Rate_IDs, which indicate modulation and coding to be used in the first downlink burst immediately following the FCH, are shown in Table 224. The Rate_ID encoding is static and cannot be changed during system operation.

Table 224—OFDM Rate ID encodings

Rate_ID	Modulation RS-CC rate
0	BPSK 1/2
1	QPSK 1/2
2	QPSK 3/4
3	16-QAM 1/2
4	16-QAM 3/4

Table 224—OFDM Rate ID encodings (continued)

Rate_ID	Modulation RS-CC rate
5	64-QAM 2/3
6	64-QAM 3/4
7–15	<i>reserved</i>

8.3.3.5 Example OFDM uplink RS-CC encoding

To illustrate the use of the RS-CC encoding, three examples are provided, each of one burst of OFDM uplink data, illustrating each process from randomization through subcarrier modulation.

8.3.3.5.1 Full bandwidth (16 subchannels)

Modulation Mode: QPSK, rate 3/4, Symbol Number within burst: 1, UIUC: 7, BSID: 1, Frame Number 1 (decimal values)

Input Data (Hex)

45 29 C4 79 AD 0F 55 28 AD 87 B5 76 1A 9C 80 50 45 1B 9F D9 2A 88 95 EB AE B5 2E 03 4F 09
14 69 58 0A 5D

Randomized Data (Hex)

D4 BA A1 12 F2 74 96 30 27 D4 88 9C 96 E3 A9 52 B3 15 AB FD 92 53 07 32 C0 62 48 F0 19 22
E0 91 62 1A C1

Reed–Solomon encoded Data (Hex)

49 31 40 BF D4 BA A1 12 F2 74 96 30 27 D4 88 9C 96 E3 A9 52 B3 15 AB FD 92 53 07 32 C0 62
48 F0 19 22 E0 91 62 1A C1 00

Convolutionally Encoded Data (Hex)

3A 5E E7 AE 49 9E 6F 1C 6F C1 28 BC BD AB 57 CD BC CD E3 A7 92 CA 92 C2 4D BC 8D 78
32 FB BF DF 23 ED 8A 94 16 27 A5 65 CF 7D 16 7A 45 B8 09 CC

Interleaved Data (Hex)

77 FA 4F 17 4E 3E E6 70 E8 CD 3F 76 90 C4 2C DB F9 B7 FB 43 6C F1 9A BD ED 0A 1C D8 1B
EC 9B 30 15 BA DA 31 F5 50 49 7D 56 ED B4 88 CC 72 FC 5C

Subcarrier Mapping (frequency offset index: I value Q value)

-100: 1 -1, -99: -1 -1, -98: 1 -1, -97: -1 -1, -96: -1 -1, -95: -1 -1, -94: -1 1, -93: -1 1, -92: 1 -1, -91: 1
1, -90: -1 -1, -89: -1 -1, -88: pilot= 1 0, -87: 1 1, -86: 1 -1, -85: 1 -1, -84: -1 -1, -83: 1 -1, -82: 1 1, -81:
-1 -1, -80: -1 1, -79: 1 1, -78: -1 -1, -77: -1 -1, -76: -1 1, -75: -1 -1, -74: -1 1, -73: 1 -1, -72: -1 1, -71:
1 -1, -70: -1 -1, -69: 1 1, -68: 1 1, -67: -1 -1, -66: -1 1, -65: -1 1, -64: 1 1, -63: pilot= -1 0, -62: -1 -1, -
61: 1 1, -60: -1 -1, -59: 1 -1, -58: 1 1, -57: -1 -1, -56: -1 -1, -55: -1 -1, -54: 1 -1, -53: -1 -1, -52: 1 -1,
-51: -1 1, -50: -1 1, -49: 1 -1, -48: 1 1, -47: 1 1, -46: -1 -1, -45: 1 1, -44: 1 -1, -43: 1 1, -42: 1 1,

-41: -1 1, -40: -1 -1, -39: 1 1, -38:pilot= 1 0, -37: -1 -1, -36: 1 -1, -35: -1 1, -34: -1 -1, -33: -1 -1, -32: -1 -1, -31: -1 1, -30: 1 -1, -29: -1 1, -28: -1 -1, -27: 1 -1, -26: -1 -1, -25: -1 -1, -24: -1 -1, -23: -1 1, -22: -1 -1, -21: 1 -1, -20: 1 1, -19: 1 1, -18: -1 -1, -17: 1 -1, -16: -1 1, -15: -1 -1, -14: 1 1, -13:pilot= -1 0, -12: -1 -1, -11: -1 -1, -10: 1 1, -9: 1 -1, -8: -1 1, -7: 1 -1, -6: -1 1, -5: -1 1, -4: -1 1, -3: -1 -1, -2: -1 -1, -1: 1 -1, 0: 0 0, 1: -1 -1, 2: -1 1, 3: -1 -1, 4: 1 -1, 5: 1 1, 6: 1 1, 7: -1 1, 8: -1 1, 9: 1 1, 10: 1 -1, 11: -1 -1, 12: 1 1, 13:pilot= 1 0, 14: -1 -1, 15: 1 -1, 16: -1 1, 17: 1 1, 18: 1 1, 19: 1 -1, 20: -1 1, 21: -1 -1, 22: -1 -1, 23: -1 1, 24: -1 -1, 25: 1 1, 26: -1 1, 27: 1 -1, 28: -1 1, 29: -1 -1, 30: 1 1, 31: -1 -1, 32: 1 1, 33: 1 1, 34: 1 1, 35: 1 -1, 36: 1 -1, 37: 1 -1, 38:pilot= 1 0, 39: -1 1, 40: -1 -1, 41: -1 1, 42: -1 1, 43: -1 -1, 44: 1 -1, 45: -1 1, 46: -1 1, 47: 1 1, 48: -1 -1, 49: 1 1, 50: 1 -1, 51: -1 -1, 52: -1 -1, 53: 1 -1, 54: 1 -1, 55: 1 -1, 56: 1 -1, 57: 1 1, 58: 1 1, 59: 1 -1, 60: 1 1, 61: -1 1, 62: 1 -1, 63:pilot= 1 0, 64: 1 -1, 65: -1 -1, 66: -1 -1, 67: 1 -1, 68: 1 -1, 69: 1 -1, 70: 1 -1, 71: -1 1, 72: -1 -1, 73: -1 1, 74: -1 -1, 75: 1 -1, 76: -1 1, 77: -1 -1, 78: 1 -1, 79: 1 1, 80: -1 1, 81: 1 1, 82: -1 1, 83: 1 1, 84: -1 -1, 85: 1 1, 86: -1 -1, 87: 1 1, 88:pilot= 1 0, 89: 1 -1, 90: -1 -1, 91: 1 1, 92: -1 1, 93: -1 -1, 94: -1 -1, 95: -1 -1, 96: 1 1, 97: 1 -1, 98: 1 -1, 99: -1 -1, 100: 1 1

Note that the above QPSK values (all values with exception of the BPSK pilots) are to be normalized with a factor $1/\sqrt{2}$ as indicated in Figure 203.

8.3.3.5.2 Subchannelization (2 subchannels)

Modulation Mode: 16-QAM, rate 3/4, Symbol Numbers within burst: 1–3, UIUC: 7, BSID: 1, Frame Number: 1, subchannel index: 0b00010 (decimal values)

Input Data (Hex)

45 29 C4 79 AD 0F 55 28 AD 87 B5 76 1A 9C 80 50 45 1B 9F D9 2A 88 95 EB AE B5

Randomized Data (Hex)

D4 BA A1 12 F2 74 96 30 27 D4 88 9C 96 E3 A9 52 B3 15 AB FD 92 53 07 32 C0 62 00

Convolutionally Encoded Data (Hex)

EE C6 A1 CB 7E 04 73 6C BC 61 95 D3 B7 C4 EF 0E 4C 76 CF DC 70 69 B3 CE DB E0 E5 B7 B5
4E 88 7D A4 AE 31 30

Interleaved Data (Hex)

B4 FF DA 06 E5 42 EC 1F 86 7C 29 93 9C AD 83 42 6B FE FC 6D CB F6 53 85 AE 68 22 7A CE
B1 E7 52 B0 EC BA 95

Subcarrier Mapping (frequency offset index: I value Q value)

1st data symbol:

-100: -1 -3, -99: 3 1, -98: -3 -3, -97: -3 -3, -96: -3 3, -95: -1 -1, -38: pilot = 1 0, -37: 1 1, -36: 3 -1, -35: -3 -1, -34: 3 3, -33: 3 1, -32: 1 -1, 1: -3 -1, 2: -3 1, 3: 1 3, 4: -3 -3, 5: -1 1, 6: 3 -1, 64: 3 -3, 65: -3 1, 66: 1 -1, 67: -1 3, 68: -1 3, 69: 1 -3

2nd data symbol:

-100: -1 3, -99: -3 1, -98: -1 -1, -97: -3 3, -96: -1 1, -95: 1 -3, -38: pilot = -1 0, -37: 3 1, -36: 1 -1, -35: 3 -1, -34: -1 -3, -33: -3 -3, -32: -3 -1, 1: -3 -3, 2: -3 1, 3: 3 -1, 4: -3 3, 5: -3 1, 6: -1 -3, 64: -3 -3, 65: 3 -1, 66: 3 3, 67: 1 -3, 68: -1 1, 69: 3 3

3rd data symbol:

-100: -1 -1, -99: -3 -1, -98: 3 -1, -97: -1 1, -96: 1 -1, -95: 1 -1, -38: pilot = 1 0, -37: 3 -3, -36: -1
-1, -35: -3 1, -34: -3 -1, -33: -1 -3, -32: 1 3, 1: -3 -1, 2: 3 -3, 3: 3 3, 4: 1 -1, 5: -1 -3, 6: 1 1, 64: -3
-1, 65: -3 1, 66: -1 -3, 67: -1 -1, 68: -1 3, 69: 3 3

Note that the above 16-QAM values (all values with exception of the BPSK pilots) are to be normalized with a factor $1/\sqrt{10}$ as indicated in Figure 203.

8.3.3.5.3 Subchannelization (1 subchannel)

Modulation Mode: QPSK, rate 3/4, Symbol Numbers within burst: 1-5, UIUC: 7, BSID: 1, Frame Number: 1, subchannel index: 0b00001 (decimal values)

Input Data (Hex)

45 29 C4 79 AD 0F 55 28 AD 87

Randomized Data (Hex)

D4 BA A1 12 F2 74 96 30 27 D4 00 00

Convolutionally Encoded Data (Hex)

EE C6 A1 CB 7E 04 73 6C BC 61 95 D3 B7 DF 00

Interleaved Data (Hex)

BC EC A1 F4 8A 3A 7A 4F 78 39 53 87 DF 2A A2

Subcarrier Mapping (frequency offset index: I value Q value)

1st data symbol:

-100: -1 1, -99: -1 -1, -98: -1 -1, -37: 1 1, -36: -1 -1, -35: -1 1, 1: -1 -1, 2: 1 1, 3: -1 1, 64: -1 1,
65: 1 1, 66: 1 -1

2nd data symbol:

-100: -1 -1, -99: -1 -1, -98: 1 -1, -37: 1 1, -36: -1 1, -35: 1 1, 1: -1 1, 2: -1 1, 3: 1 1, 64: -1 -1, 65:
-1 1, 66: -1 1

3rd data symbol:

-100: 1 -1, -99: -1 -1, -98: -1 1, -37: -1 1, -36: 1 -1, -35: 1 1, 1: -1 -1, 2: -1 -1, 3: 1 -1, 64: -1 -1,
65: -1 1, 66: 1 1

4th data symbol:

-100: 1 1, -99: -1 -1, -98: -1 1, -37: 1 -1, -36: 1 -1, -35: 1 -1, 1: 1 1, 2: -1 -1, 3: -1 1, 64: 1 1, 65:
1 -1, 66: -1 -1

5th data symbol:

-100: -1 -1, -99: 1 -1, -98: -1 -1, -37: -1 -1, -36: 1 1, -35: -1 1, 1: -1 1, 2: -1 1, 3: -1 1, 64: -1 1,
65: 1 1, 66: -1 1

Note that the above QPSK values are to be normalized with a factor $1/\sqrt{2}$ as indicated in Figure 203.

8.3.3.6 Preamble structure and modulation

All preambles are structured as either one of two OFDM symbols. The OFDM symbols are defined by the values of the composing subcarriers. Each of those OFDM symbols contains a cyclic prefix, which length is the same as the CP for data OFDM symbols.

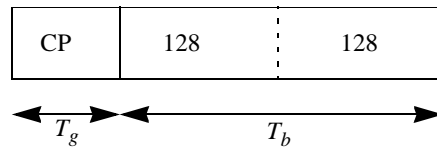

Figure 206— P_{EVEN} time domain structure

In the downlink bursts, which start with a preamble and which fall within the STC-encoded region, the preamble shall be transmitted from both transmit antennas simultaneously and shall consist of a single OFDM symbol. The preamble transmitted from the first antenna shall use only even subcarriers, the values of which are set according to the sequence P_{EVEN} . The preamble transmitted from the second antenna shall use only odd subcarriers, the values of which shall be set according to the sequence P_{ODD} .

$$P_{\text{ODD}(k)} = \begin{cases} 0 & k_{\text{mod}2} = 0 \\ \sqrt{2} \cdot P_{\text{ALL}}(k) & k_{\text{mod}2} \neq 0 \end{cases} \quad (80)$$

The AAS preamble shall be composed of two identical OFDM symbols. Each symbol shall be transmitted from up to four beams. The same beams shall be used in the first and second symbols. This preamble shall be used to mark AAS DL zone slots and to perform channel estimation. If the BS supports more than four antennas, the subset that is transmitted on a single AAS preamble may be varied from frame to frame. The preamble from beam m , $m = 0 \dots 3$, shall be transmitted on subcarriers $m \bmod 4$ and shall use the sequence $P_{\text{AAS}}^{(m)}$ given by the following equations.

For $m = 0$

$$P_{\text{AAS}}^{(m)}(k) = \begin{cases} 0 & k \bmod 4 \neq 0 \\ \text{conj}\{P_{\text{ALL}}(k)\} & k \bmod 4 = 0 \end{cases} \quad (81)$$

For $m = 1 \dots 3$

$$P_{\text{AAS}}^{(m)}(k) = \begin{cases} 0 & k \bmod 4 \neq m \\ \text{conj}\{P_{\text{ALL}}(k + 2 - m)\} & k \bmod 4 = m \end{cases} \quad (82)$$

Using mesh, bursts sent in the control subframe shall start with the long preamble. In the data subframe, the bursts shall by default start with the long preamble, but neighbors may negotiate to use the short preamble by setting the preamble flag in the Neighbor Link Info field.

In mesh mode, bursts sent in the control subframe shall start with the long preamble. In the mesh data subframe, the bursts shall be default start with the long preamble, but neighbors may negotiate to use the short preamble by setting the preamble flag in the Neighbor Link Info field.

In the uplink, when subchannelization transmissions are employed, the data preamble consists of a 256 sample sequence preceded by a CP whose length is the same as the cyclic prefix for data OFDM symbols. This preamble is referred to as the subchannelization preamble. The frequency domain sequence for the 256 samples is defined by P_{SUB} . Preamble subcarriers that do not fall within the allocated subchannels shall be set to zero.

$$P_{\text{SUB}}(-100:100) = \{1+j, 1+j, -1-j, 1+j, -1+j, 1+j, 1+j, 1+j, -1-j, -1-j, 1-j, -1-j, 1-j, 1+j, 1-j, 1+j, 1+j, -1-j, -1-j, 1+j, 1-j, 1+j, -1-j, -1-j, 1+j, 1+j, 1+j, 1+j, -1-j, 1+j, -1+j, 1+j, 1+j, 1+j, 1+j, -1-j, 1+j, -1+j, 1+j, 1+j, 1+j, -1-j, -1-j, 1-j, -1-j, 1-j, -1-j, 1-j, -1-j, -1+j, -1-j, -1-j, 1+j, 1+j, -1-j, -1+j, -1-j, 1+j, 1+j, -1-j, 1+j, -1-j, 1+j, 1+j, -1-j, 1+j, -1+j, 1+j, 1+j, -1-j, -1-j, 0, 1+j, 1+j, -1-j, 1+j, -1+j, 1+j, 1+j, 1+j, -1-j, -1-j, 1-j, -1-j, 1-j, 1+j\}$$

$$\begin{aligned}
 &1-j, 1+j, 1+j, -1-j, -1-j, 1+j, 1-j, 1+j, -1-j, 1+j, 1+j, -1-j, -1-j, 1+j, -1-j, 1-j, -1-j, -1-j, -1-j, \\
 &1+j, 1+j, -1+j, 1+j, 1-j, -1-j, -1+j, -1-j, -1-j, 1+j, 1+j, -1-j, -1+j, -1-j, 1+j, -1-j, -1-j, -1-j, -1- \\
 &j, 1+j, -1-j, 1-j, -1-j, -1-j, -1-j, 1+j, 1+j, -1+j, 1+j, -1+j, 1+j, 1-j, 1+j, 1+j, -1-j, -1-j, 1+j, 1-j, \\
 &1+j, -1-j, 1+j, 1+j, 1+j, 1+j, -1-j, 1+j, -1+j, 1+j, 1+j, 1+j, -1-j, -1-j, 1-j, -1-j, -1-j, -1+j, \\
 &-1-j, -1-j, 1+j, 1+j, -1-j, -1+j, 1+j, -1-j, -1-j} \quad (83)
 \end{aligned}$$

In the case that the uplink allocation contains midambles, the midambles will consist of one OFDM symbol and shall be identical to the preamble used with the allocation.

UL preambles and midambles may be cyclically delayed by an integer number of samples. This is indicated by the UL-Physical modifier IE (8.3.6.3.7).

8.3.4 Transmission convergence (TC) sublayer

The transmission convergence sublayer, as described in 8.1.4.3, is an optional mechanism for the OFDM PHY and can be enabled on a per-burst basis for both uplink and downlink through the DIUC/UIUC definitions in the DCD/UCD messages, respectively. The TCS_ENABLE parameter is coded as a TLV tuple as defined in 11.4.2 (i.e., DCD burst profile encodings) and 11.3.1.1 (i.e., UCD burst profile encodings).

At SS initialization, the TC sublayer capability is negotiated between the BS and SS through SBC-REC/SBC-RSP messages as an OFDM PHY specific parameter. The TC sublayer capability parameter is coded as a TLV tuple as defined in 11.8.3.6.5.

8.3.5 Frame structure

8.3.5.1 PMP

In licensed bands, the duplexing method shall be either FDD or TDD. FDD SSs may be H-FDD. In license-exempt bands, the duplexing method shall be TDD.

The frame interval contains transmissions (PHY PDUs) of BS and SSs, gaps and guard intervals.

The OFDM PHY supports a frame-based transmission. A frame consists of a downlink subframe and an uplink subframe. A downlink subframe consists of only one downlink PHY PDU. A uplink subframe consists of contention intervals scheduled for initial ranging and bandwidth request purposes and one or multiple uplink PHY PDUs, each transmitted from a different SS.

A downlink PHY PDU starts with a long preamble, which is used for PHY synchronization. The preamble is followed by a FCH burst. The FCH burst is one OFDM symbol long and is transmitted using BPSK rate 1/2 with the mandatory coding scheme. The FCH contains DL_Frame_Prefix to specify burst profile and length of one or several downlink bursts immediately following the FCH. A DL-MAP message, if transmitted in the current frame, shall be the first MAC PDU in the burst following the FCH. An UL-MAP message shall immediately follow either the DL-MAP message (if one is transmitted) or the DLFP. If UCD and DCD messages are transmitted in the frame, they shall immediately follow the DL-MAP and UL-MAP messages. Although burst #1 contains broadcast MAC control messages, it is not necessary to use the most robust well-known modulation/coding. A more efficient modulation/coding may be used if it is supported and applicable to all the SSs of a BS.

The FCH is followed by one or multiple downlink bursts, each transmitted with different burst profile. Each downlink burst consists of an integer number of OFDM symbols. Location and profile of the first downlink burst is specified in the Downlink Frame Prefix (DLFP). The location and profile of the maximum possible number of subsequent bursts shall also be specified in the DLFP. At least one full DL-MAP must be broadcast in burst #1 within the Lost DL-MAP Interval specified in Table 342. Location and profile of other bursts are specified in DL-MAP. Profile is specified either by a 4-bit Rate_ID (for the first DL burst) or by DIUC. The DIUC encoding is defined in the DCD messages. HCS field occupies the last byte of DLFP. If there are unused IEs in DLFP, the first unused IE must have all fields encoded as zeros.

The DL Subframe may optionally contain an STC zone in which all DL bursts are STC encoded. If an STC zone is present, the last used IE in the DLFP shall have DIUC = 0 (see Table 237) and the IE shall contain information on the start time of the STC zone (see Table 241). The STC zone ends at the end of the frame.

The STC zone starts from a preamble and an STC encoded FCH-STC burst, which is one symbol with the same payload format as specified in Table 241. The FCH-STC burst is transmitted at BPSK rate 1/2. It is followed by one or several STC encoded PHY bursts. The first burst in the STC zone may contain a DL-MAP applicable only to the STC zone. If DL-MAP is present, it shall be the first MAC PDU in the payload of the burst.

With the OFDM PHY, a PHY burst, either a downlink PHY burst or an uplink PHY burst, consists of an integer number of OFDM symbols, carrying MAC messages, i.e., MAC PDUs. To form an integer number of OFDM symbols, unused bytes in the burst payload may be padded by the bytes 0xFF. Then the payload should be randomized, encoded, and modulated using the burst PHY parameters specified by this standard. If an SS does not have any data to be transmitted in an UL allocation, the SS shall transmit an UL PHY burst containing a bandwidth request header as defined in Figure 20, with BR = 0 and its basic CID. If the allocation is large enough, an AAS enabled SS may also provide an AAS Feedback Response (AAS-FBCK-RSP) message (6.3.2.3.40). An SS shall transmit during the entirety of all of its UL allocations, using the standard padding mechanism (6.3.3.7) to fill allocations if necessary.

In each TDD frame (see Figure 207), the TTG and RTG shall be inserted between the downlink and uplink subframe and at the end of each frame, respectively, to allow the BS to turn around.

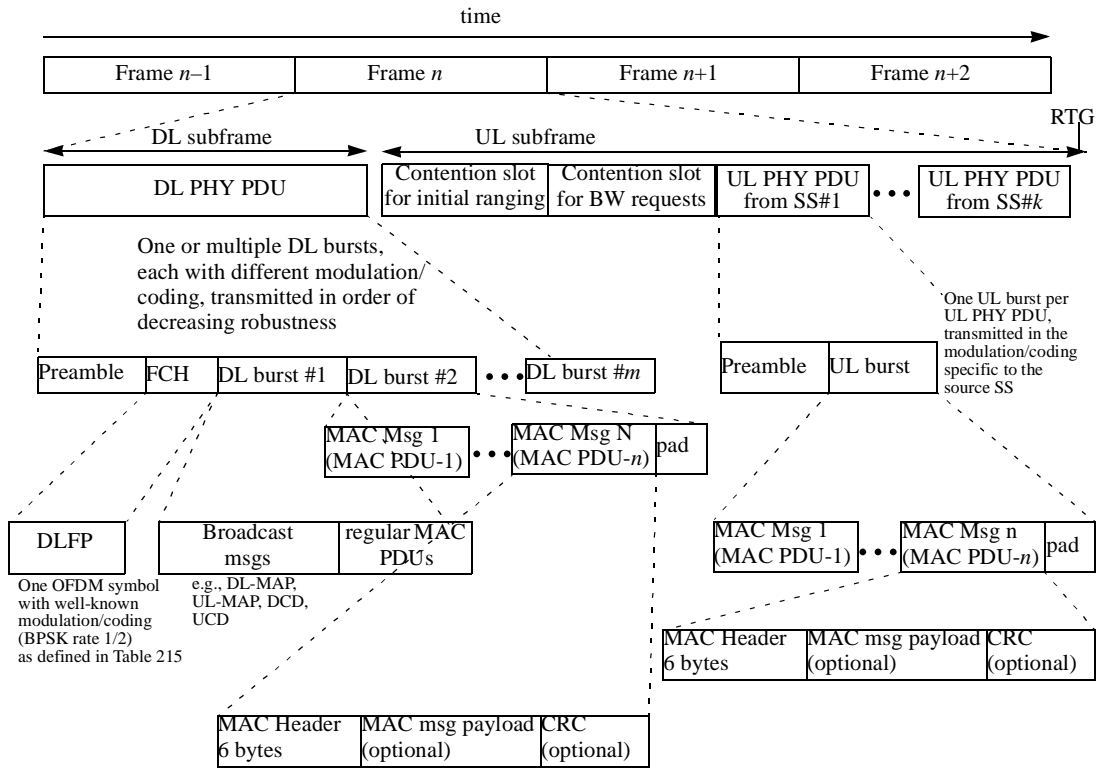

Figure 207—Example of OFDM frame structure with TDD

In TDD and H-FDD systems, subscriber station allowances must be made by a transmit-receive turnaround gap SSTTG and by a receive-transmit turnaround gap SSRTG. The BS shall not transmit downlink information to a station later than (SSRTG+RTD) before its scheduled uplink allocation, and shall not transmit downlink information to it earlier than (SSTTG-RTD) after the end of scheduled uplink allocation, where RTD denotes Round-Trip Delay. The parameters SSRTG and SSTTG are capabilities provided by the SS to BS upon request during network entry (see 11.8.3.1).

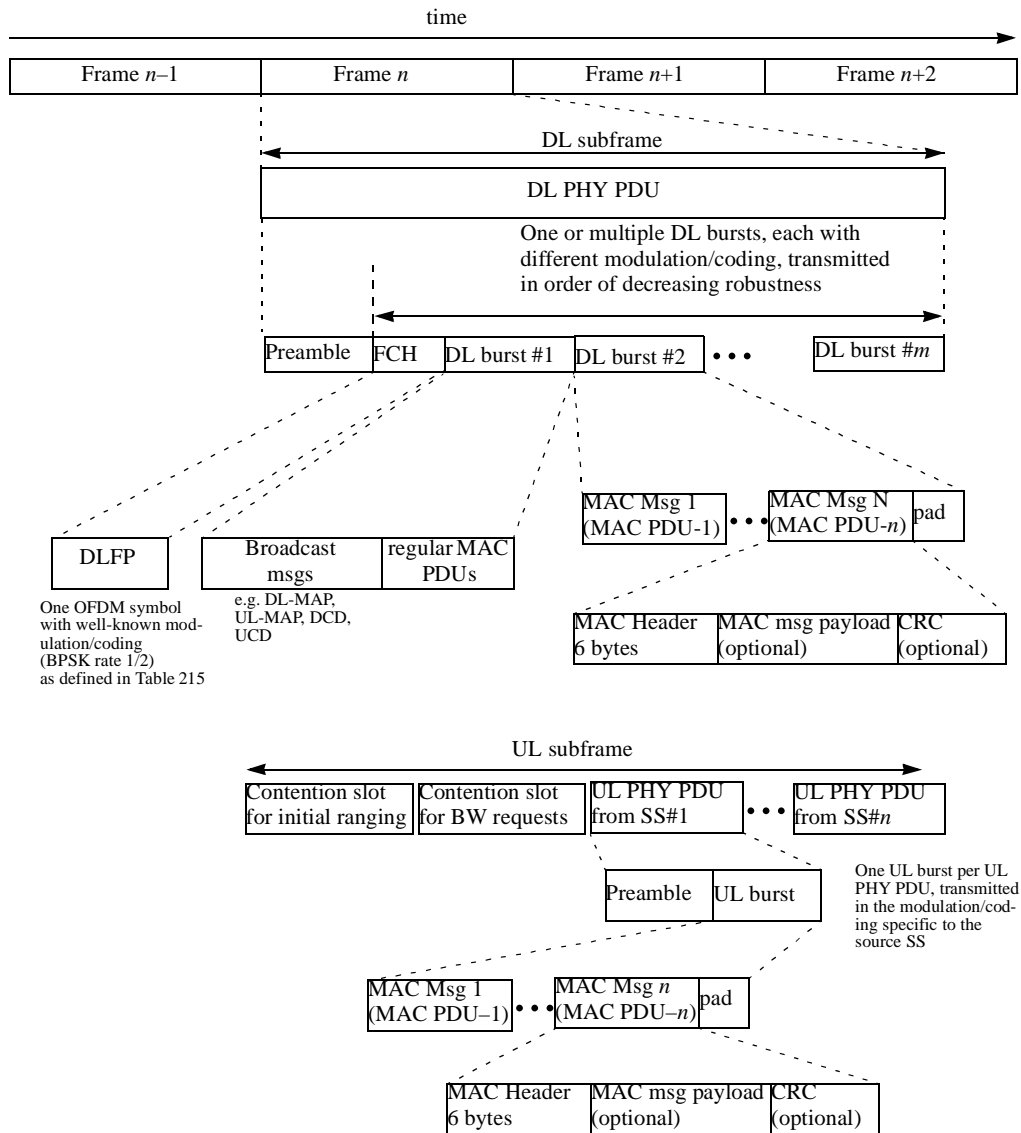

Figure 208—Example of OFDM frame structure with FDD

Table 225—OFDM downlink frame prefix format

Syntax	Size	Notes
DL_Frame_Prefix_Format() {		
Base_Station_ID	4 bits	4 LSB of BS ID. The burst specified by the DLFP shall not be decoded if these bits do not match those of the BS on which it is registered.
Frame_Number	4 bits	4 LSB of the Frame Number DCD Channel Encoding as specified in Table 358.
Configuration_Change_Count	4 bits	4 LSB of Change Count value as specified in 6.3.2.3.1.
<i>reserved</i>	4 bits	Shall be set to zero.
for (n=0; n < 4; n++) {		
DL_Frame_Prefix_IE() {		
Rate_ID/ DIUC	4 bits	For the first information element it shall be Rate_ID encoded according to the Table 224. For following IEs this field is DIUC that defines the burst profile of the corresponding burst.
if (DIUC != 0){		
Preamble present	1 bits	If “1,” preamble is placed before the burst.
Length	11 bits	Number of OFDM symbols in the burst.
} else {		
Start Time	12 bits	Start time of STC zone in units of symbol duration counted from the beginning of the frame.
}		
}		
}		
HCS	8 bits	An 8-bit Header Check Sequence; calculated as specified in Table 5.
}		

HCS

An 8-bit Header Check Sequence used to detect errors in the DL Frame Prefix. The generator polynomial is $g(D) = D^8 + D^2 + D + 1$. The transmitter shall take all the bytes in the DL Frame Prefix except the byte reserved for the HCS and divide them by $g(x)$ and use the remainder as HCS code. At the receiver, dividing the DL_Frame_Prefix by $g(x)$ then gives the remainder 0 if correct.

(Example: BS_ID=0x0319B812A9B8 (4LSB=0x8), Frame_Number=187662 (4LSB=0xE), Configuration_Change_Count=159 (4LSB=0xF), *Reserved*=0xF, Rate_ID=1 (0x1), Length=204 (0x0CC), DLFP_IE(1) DIUC=1 (0x1), DLFP_IE(1) Midamble Present = 1 / Burst_Length=50 (0x832), all following DLFP_IEs=0 (8 times 0x0000). Encode byte sequence [0x8EFF10CC183200000000] and obtain 0x99 as the HCS byte.)

8.3.5.2 PMP-AAS Zone

DL transmission to an SS or group of SSs consists of two fractions. The first fraction of the transmission consists of one or several repetitions of a short preamble followed by FCH symbol (Figure 3). The second fraction is called Body.

FCH payload is called “AAS DL Frame Prefix” (AAS_DLFP). FCH shall be transmitted at the lowest possible modulation. Each pair preamble-FCH may be transmitted either at narrow beam or at wide beam. Optionally, the same preamble-FCH pair may be repeated at several beams thus implementing space diversity. In the case when FCH is repeated for diversity, all copies have the same content and therefore soft combining might be employed at the SS receiver.

AAS_DLFP contains information (DL IEs or UL IEs) on location and transmission rate of PHY bursts. There is a possibility of more than one concatenated DL PHY bursts, each one described by a DL IE. UL IEs specify either UL PHY burst (a single burst per SS) or contention region for initial ranging or bandwidth requesting.

Body may be transmitted at a directed beam and may start either immediately after FCH or at some distance. In the latter case, it shall start from a preamble. The payload of the burst may contain private DL-MAP and/or UL-MAP messages.

Alternatively, AAS_DLFP may contain UL IEs. There are two options:

- 1) A single UL IE.
- 2) “Compressed” UL IE, which contains a network entry allocation and a regular allocation.

An example of AAS Zone layout is shown at Figure 209.

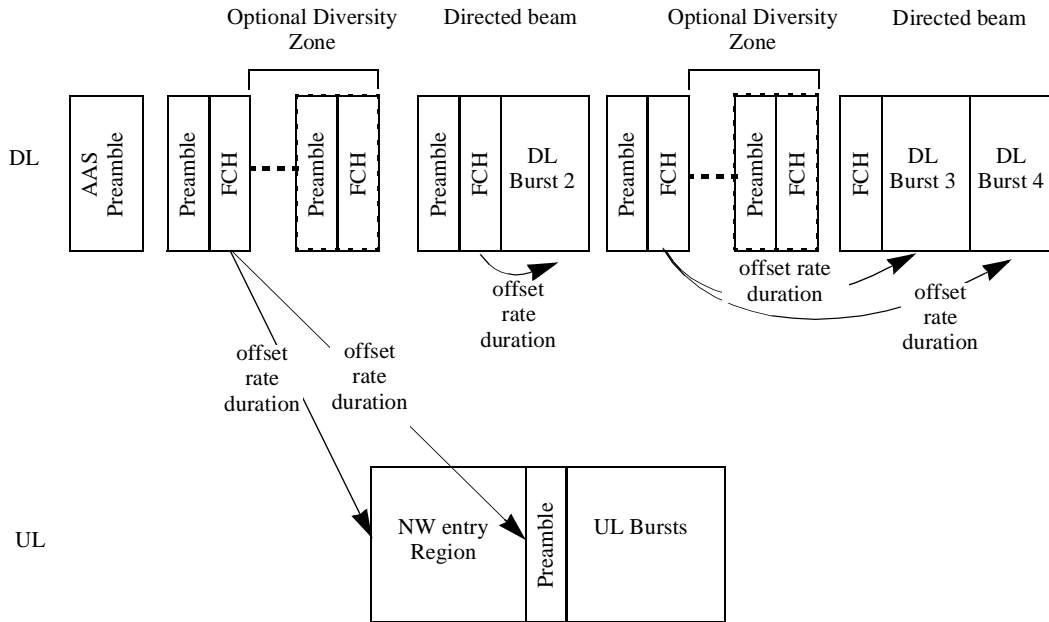

Figure 209—Structure of AAS Zone

The structure of AAS_DLFP is specified in Table 226.

Table 226—AAS_DLFP Structure

Syntax	Size	Notes
AAS_DLFP(){		
Base_Station_ID	4 bits	4 LSB of BS ID.
Frame_Number	4 bits	4 LSB of the Frame Number DCD Channel Encoding as specified in Table 312.
<i>reserved</i>	6 bits	Shall be set to zero.
Dir	1 bit	Allocation direction: Dir = '1' means UL.
Allocation Start	13 bits	Points to the start of Body fraction; expressed in the terms of offset from the beginning of the AAS preamble.
if (Dir == '1') {		
UCD_Configuration_Change_Count	3 bits	3 LSB of UCD Change Count value as specified in 6.3.2.3.3.

Table 226—AAS_DLFP Structure (continued)

Syntax	Size	Notes
Comp_UL	1 bit	Compressed UL IE is present if bit is set to 1, else full UL IE.
If (Comp_UL == '1'){		
AAS_COMP_UL_IE()	48 bits	
} else {		
AAS_DLFP_UL_IE()	48 bits	
}		
} else {		
<i>reserved</i>	1 bit	Shall be set to zero
DCD_Configuration_Change_Count	3 bits	3 LSB of DCD Change Count value as specified in 6.3.2.3.1.
AAS_DLFP_DL_IE()	16 bits	
AAS_DLFP_DL_IE()	16 bits	
AAS_DLFP_DL_IE()	16 bits	
}		
HCS	8 bits	An 8-bit Header Check Sequence; calculated as specified in Table 5.
}		

Table 227—AAS_DLFP_DL IE format

Syntax	Size	Notes
AAS_DLFP_DL_IE() {		
Rate_ID /DIUC	4 bits	For the first information element it shall be Rate_ID encoded according to the Table 224. For following IEs this field is DIUC that defines the burst profile of the corresponding burst.
Preamble present	1 bit	If '1', preamble is placed before the burst.
Length	11 bits	Number of OFDM symbols in the burst.
}		

Table 228—AAS_DLFP_UL IE format

Syntax	Size	Notes
AAS_DLFP_UL_IE() {		
UIUC	4 bits	UIUC value; see Table 230.
If (UIUC == 1) {		
AAS_NW_Entry_Response_IE()	16 bits	
} else If (UIUC == 3) {		
Focused_Contention_Response_IE()	16 bits	
} else {		
CID	16 bits	If UIUC = 2, must be multicast or broadcast CID, the allocation will be used for multicast polling.
}		
Preamble time shift	8 bits	Shift to be performed on preamble and midambles. See 8.3.6.3.7.
<i>reserved</i>	1 bits	Shall be set to zero.
Subchannel Index	5 bits	
Midamble repetition interval	2 bits	0b00: Preamble only 0b01: Midamble after every 8 data symbols 0b10: Midamble after every 16 data symbols 0b11: Midamble after every 32 data symbols
Duration	9 bits	In OFDM symbols.
}		

AAS_COMP_UL_IE shall be used to specify two UL allocations; one of them must be for NW entry; another one is either unicast allocation or multicast/broadcast polling allocation.

Table 229—AAS_COMP_UL IE format

Syntax	Size	Notes
AAS_COMP_UL_IE() {		
UIUC	4 bits	UIUC value; see Table 230.
If (UIUC == 1) {		
AAS_NW_Entry_Response_IE()	16 bits	
} else If (UIUC == 3) {		
Focused_Contention_Response_IE()	16 bits	

Table 229—AAS_COMP_UL IE format (continued)

Syntax	Size	Notes
} else {		
CID	16 bits	For regular allocation.
}		
Subchannel_Index_NW_Entry	5 bits	For NW entry allocation.
Duration_NW_entry	9 bits	Duration of NW entry allocation in OFDM symbols.
Subchannel_Index	5 bits	For regular allocation.
Duration	12 bits	Duration of regular allocation in OFDM symbols.
}		

Table 230—UIUC Usage in AAS Zone

UIUC	Usage
0	<i>reserved</i>
1	AAS NW Entry Response
2	REQ Region Full
3	REQ Region Focused
4	Focused Contention response IE
5–13	Burst Profiles

Table 231—AAS NW Entry Response IE format

Syntax	Size	Notes
AAS_NW_Entry_Response_IE(){		
Frame Number Index	4 bits	4 LSB of Frame Number field.
Network Entry Code	4 bits	Random code sent by the SS in AAS Network Entry Request.
<i>reserved</i>	8 bits	Shall be set to zero.
}		

Frame Number Index

Identifies the frame in which the network entry request, which this message responds to, was transmitted. The four least significant bits of the frame number are used as the frame number index.

Network Entry Code

Random code sent by the SS in AAS Network Entry Request.

8.3.5.3 Mesh

In addition to the PMP frame structure in 8.3.5.1, an optional frame structure (see Figure 210) is defined to facilitate Mesh networks.

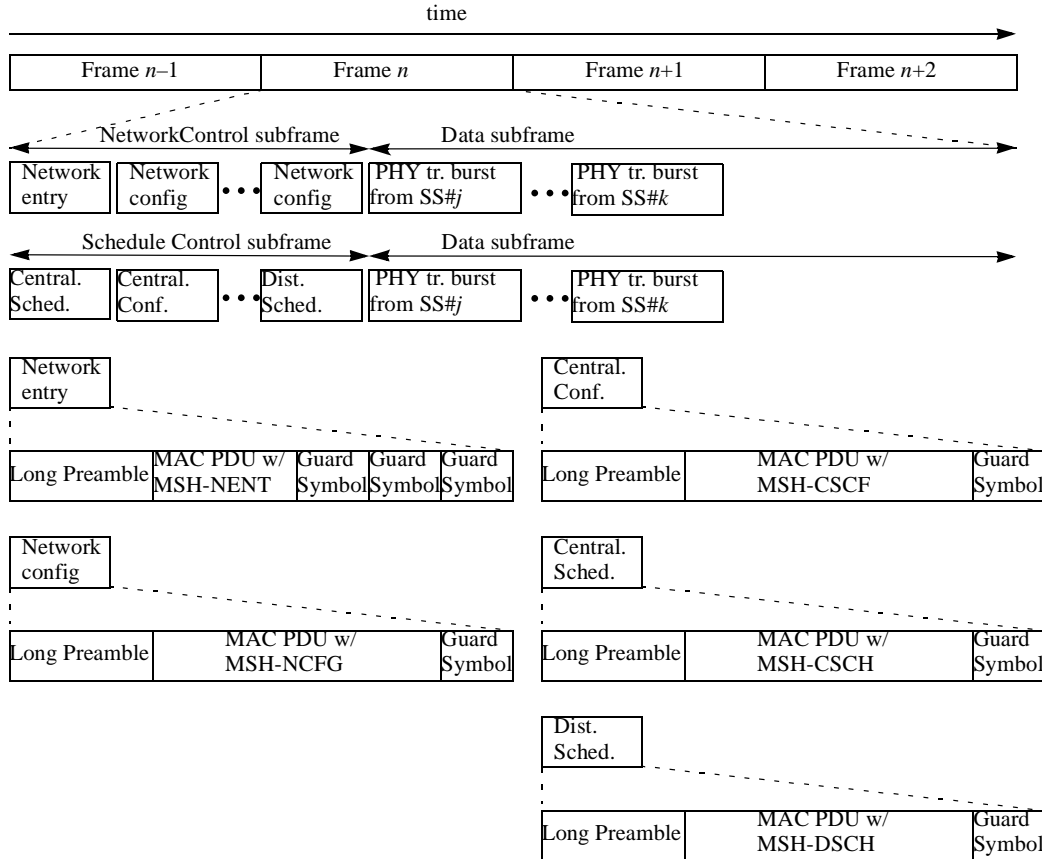

Figure 210—Mesh frame structure

A Mesh frame consists of a control and data subframe. The control subframe serves two basic functions. One is the creation and maintenance of cohesion between the different systems, termed “network control” in Figure 210. The other is the coordinated scheduling of data-transfers between systems, termed “schedule control” in Figure 210. Frames with a network control subframe occur periodically, as indicated in the Network Descriptor. All other frames have a schedule control subframe. The length of the control subframe is fixed and of length $MSH-CTRL-LEN \times 7$ OFDM symbols, with $MSH-CTRL-LEN$ indicated in the Network Descriptor.

During a network control subframe, the first seven symbols are allocated for network entry, followed by $MSH-CTRL-LEN - 1$ sets of seven symbols for network configuration. During a schedule control subframe, the Network Descriptor indicates how many ($MSH-DSCH-NUM$) Distributed Scheduling messages may occur in the control subframe. The first $(MSH-CTRL-LEN - MSH-DSCH-NUM) \times 7$ symbols are allocated to transmission bursts containing MSH-CSCH and MSH-CSCF PDUs, whereas the remainder is allocated to transmission bursts containing MSH-DSCH PDUs.

Distributed Scheduling messages (using the long preamble) may further occur in the data subframe if not in conflict with the scheduling dictated in the control subframe.

All transmissions in the control subframe are sent using QPSK-1/2 with the mandatory coding scheme. The data subframe is divided into minislots, which are, with possible exception of the last minislot in the frame, of size ceiling $[(\text{OFDM symbols per frame} - \text{MSH-CTRL-LEN} \times 7)/256]$. A scheduled allocation consists of one or more minislots.

8.3.5.4 Frame duration codes

Table 232 indicates the specific frame durations that are allowed. The frame duration used can be determined by the periodicity of the frame start preambles. Once a specific frame duration has been selected by the BS, it should not be changed. Changing the frame duration shall force all SSs to resynchronize to the BS.

Table 232—OFDM frame duration (T_F ms) codes

Code	Frame duration (ms)	Frames per second
0	2.5	400
1	4	250
2	5	200
3	8	125
4	10	100
5	12.5	80
6	20	50
7–255	<i>reserved</i>	<i>reserved</i>

8.3.5.5 Burst Profile format

Table 233 defines the format of the Downlink_Burst_Profile, which is used in the DCD message (6.3.2.3.1). The Downlink_Burst_Profile is encoded with a Type of 1, an 8-bit length, and a 4-bit DIUC. The DIUC field is associated with the Downlink Burst Profile and Thresholds. The DIUC value is used in the DL-MAP message and in DLFP to specify the Burst Profile to be used for a specific downlink burst.

Table 233—OFDM Downlink_Burst_Profile format

Syntax	Size	Notes
Downlink_Burst_Profile {		
Type=1	8 bits	
Length	8 bits	
<i>reserved</i>	4 bits	Shall be set to zero
DIUC	4 bits	
TLV encoded information	variable	
}		

Table 234 defines the format of the Uplink_Burst_Profile, which is used in the UCD message (6.3.2.3.3). The Uplink_Burst_Profile is encoded with a Type of 1, an 8-bit length, and a 4-bit UIUC. The UIUC field is associated with the Uplink Burst Profile and Thresholds. The UIUC value is used in the UL-MAP message to specify the Burst Profile to be used for a specific uplink burst.

Table 234—OFDM Uplink_Burst_Profile format

Syntax	Size	Notes
Uplink_Burst_Profile {		
Type=1	8 bits	
Length	8 bits	
<i>reserved</i>	4 bits	Shall be set to zero
UIUC	4 bits	
TLV encoded information	<i>variable</i>	
}		

8.3.6 Map message fields and IEs

8.3.6.1 DL-MAP PHY synchronization field

The PHY synchronization field of the DL-MAP message is structured as follows.

Table 235—OFDM PHY synchronization field

Syntax	Size	Notes
Synchronization_field {		The OFDM PHY synchronization field is empty (zero bytes long).
}		

8.3.6.2 DL-MAP IE format

DL-MAP IEs have the format listed in Table 236:

Table 236—OFDM DL-MAP IE

Syntax	Size	Notes
DL-MAP_IE() {		
CID	16 bits	
DIUC	4 bits	

Table 236—OFDM DL-MAP IE (continued)

Syntax	Size	Notes
Preamble present	1 bit	0 = not present, 1 = present if (DIUC==15 and not Extended DIUC = 3), shall be 0.
Start Time	11 bits	
if (DIUC == 15)		
Extended DIUC dependent IE	<i>variable</i>	See subclauses following 8.3.6.2.2.
Padding nibble, if needed	4 bits	Completing to nearest byte.
}		

Connection Identifier (CID)

Represents the assignment of the IE to a broadcast, multicast or unicast address.

If the broadcast or multicast CID is used then it is possible to concatenate unicast MAC PDUs (with different CIDs) into a single DL burst. During a broadcast or multicast DL burst it is the responsibility of the BS to ensure that any MAC PDUs sent to an HFDD SS do not overlap (in time; taking TTG and RTG into account) any UL allocations for that SS. An HFDD SS for which a DL MAP IE and UL MAP IE overlap in time shall use the UL allocation and discard DL traffic during the overlapping period.

DIUC

A 4-bit DIUC shall be used to define the burst type associated with that time interval. Burst Descriptor shall be included into DCD message for each DIUC used in the DL-MAP except those associated with Gap, End of Map and Extended. The DIUC shall be one of the values defined in Table 237.

Preamble present

If set, the indicated burst shall start with the short preamble.

Start Time

Indicates the start time, in units of symbol duration, relative to the start of the first symbol of the PHY PDU (including preamble) where the DL-MAP message is transmitted. The end of the last allocated burst is indicated by allocating an End of Map burst (DIUC = 14) with zero duration. The time instants indicated by the Start Time values are the transmission times of the first symbol of the burst including preamble (if present).

8.3.6.2.1 DIUC allocations

Table 237 contains the DIUC values used in DL-MAP_IE().

Table 237—OFDM DIUC values

DIUC	Usage
0	STC zone
1–11	Burst Profiles
12	<i>reserved</i>
13	Gap
14	End of Map
15	Extended DIUC

8.3.6.2.2 DL-MAP extended IE format

A DL-MAP IE entry with a DIUC value of 15, indicates that the IE carries special information and conforms to the structure shown in Table 238. A station shall ignore an extended IE entry with an extended DIUC value for which the station has no knowledge. In the case of a known extended DIUC value but with a length field longer than expected, the station shall process information up to the known length and ignore the remainder of the IE.

Table 238—DL-MAP extended IE format

Syntax	Size	Notes
DL_Extended_IE() {		
Extended DIUC	4 bits	0x00..0x0F
Length	4 bits	Length in bytes of Unspecified data field
Unspecified data	<i>variable</i>	
}		

8.3.6.2.3 Channel measurement IE format

An extended IE with an extended DIUC value of 0x00 is issued by the BS to request a channel measurement report (see 6.3.2.3.33). The Channel_Measurement_IE() shall be followed by the End of map IE (DIUC = 14).

Table 239—OFDM Channel measurement IE format

Syntax	Size	Notes
Channel_Measurement_IE() {		
Extended DIUC	4 bits	CHM = 0x00
Length	4 bits	Length = 0x01
Channel Nr	8 bits	Channel number (see 8.5.1) Set to 0x00 for licensed bands
}		

8.3.6.2.4 DL-MAP AAS IE format

Within a frame, the switch from non-AAS to AAS-enabled traffic is marked by using the DIUC = 15 with the AAS_IE() to indicate that the subsequent allocations, until the start of the first UL-MAP allocation using TDD, and until the end of the frame using FDD, shall be for AAS traffic. When used, the CID in the DL-MAP_IE() shall be set to the broadcast CID. Subsequent AAS PHY bursts shall all start with the short preamble.

Table 240—OFDM AAS DL IE format

Syntax	Size	Notes
AAS_DL_IE() {		
Extended DIUC	4 bits	AAS = 0x02
Length	4 bits	Length = 0x00
}		

8.3.6.2.5 DL-MAP STC IE format

In the DL-MAP, an STC enabled BS (see 8.3.8) may transmit DIUC=15 with the STC_IE() to indicate that the subsequent allocations shall be STC encoded. No preceding downlink allocations shall be STC encoded and all subsequent downlink allocations until the end of the frame shall be STC encoded. After this allocation, the BS shall transmit from both its antennas until the end of the frame. The first downlink allocation following the STC_IE shall contain a preamble. The number of OFDM data symbols between two preambles and the number of OFDM data symbols between the last preamble and the end of the downlink subframe must be even.

Table 241—OFDM STC IE format

Syntax	Size	Notes
STC_IE() {		
Extended DIUC	4 bits	STC = 0x04
Length	4 bits	Length = 0x00
}		

8.3.6.2.6 DL-MAP concurrent transmission IE format

In the DL-MAP, a BS may transmit UIUC=15 with the DL_Concurrent_IE() to specify one of a set of parallel downlink bursts for transmission. This format explicitly specifies the duration of the corresponding downlink burst. A preamble may precede the downlink burst specified by this IE.

Table 242—OFDM DL-MAP Concurrent transmission IE format

Syntax	Size	Notes
DL_Concurrent_IE() {		
Extended DIUC	4 bits	CONC = 0x03
Length	4 bits	Length = 2
DIUC	4 bits	
Duration	12 bits	Duration of burst in OFDM symbols
}		

DIUC:

A 4-bit DIUC shall be used to define the burst type associated with that time interval. Burst Descriptor shall be included into DCD message for each DIUC used in the DL-MAP. The DIUC shall be one of the Burst Profile values (1–12) defined in Table 237.

Duration:

Indicates the duration of the burst, in units of OFDM symbols. The duration is inclusive of the preamble contained in the allocation, if present.

8.3.6.2.7 DL-MAP Physical Modifier IE format

The Physical Modifier Information Element indicates that the subsequent bursts utilize a preamble, if present, which is cyclically delayed in time by M samples. Equation (84) defines the waveform transmitted during these training symbols. The PHYMOD_DL_IE can appear anywhere in the DL map, and it shall remain in effect until another PHYMOD_DL_IE is encountered, or until the end of the DL map.

Only stations that are allocated in bursts specified by a DL-MAP concurrent transmission IE format (8.3.6.2.6) shall receive the timely shifted preamble.

Table 243—OFDM DL-MAP Physical Modifier IE format

Syntax	Size	Notes
PHYMOD_DL_IE() {		
Extended DIUC	4 bits	PHYMOD = 0x01
Length	4 bits	Length = 1
Preamble Time Shift	8 bits	
}		

Preamble Time Shift

The parameter indicating how many samples of cyclic shift are introduced into the training symbols of the following bursts [M in Equation (84)].

8.3.6.2.8 DL-MAP dummy IE format

An SS shall be able to decode the DL-MAP Dummy IE. A BS shall not transmit this IE (unless under test). An SS may skip decoding downlink bursts scheduled after the Start Time of this IE within the current frame.

Table 244—OFDM DL-MAP dummy IE format

Syntax	Size	Notes
Dummy_IE() {		
Extended DIUC	4 bits	0x05...0x0F
Length	4 bits	0..15
Unspecified data	<i>variable</i>	The “Length” field specifies the size of this field in bytes
}		

8.3.6.3 UL-MAP IE format

The UL-MAP IE defines the physical parameters and the start time for uplink PHY bursts. The format of UL-MAP elements is shown in Table 245. Appearance of the Extended UIUC, means that the UL-MAP IE contains information that conforms to the format described in 8.3.6.3.4. The BS shall not assign, to any given SS, two or more overlapping subchannelized allocations in time. An HFDD SS for which a DL MAP IE and UL MAP IE overlap in time shall use the UL allocation and discard DL traffic during the overlapping period.

Table 245—OFDM UL-MAP IE format

Syntax	Size	Notes
UL-MAP_IE() {		
CID	16 bits	
Start Time	11 bits	
Subchannel Index	5 bits	
UIUC	4 bits	
Duration	10 bits	in OFDM symbols
Midamble repetition interval	2 bits	0b00: Preamble only 0b01: Midamble after every 8 data symbols 0b10: Midamble after every 16 data symbols 0b11: Midamble after every 32 data symbols
if (UIUC == 4)		
Focused_Contention_IE()	16 bits	
if (UIUC == 13)		
Subchannelized_Network_Entry_IE()	12 bits	
if (UIUC == 15)		
UL_Extended_IE()	<i>variable</i>	See subclauses following 8.3.6.3.4
Padding nibble, if needed	4 bits	Completing to nearest byte, shall be set to 0x0
}		

CID

Represents the assignment of the IE to a unicast, multicast, or broadcast address. When specifically addressed to allocate a bandwidth grant, the CID shall be the Basic CID of the SS.

UIUC

A 4-bit UIUC shall be used to define the type of uplink access and the burst type associated with that access. A Burst Descriptor shall be included into an UCD message for each UIUC that is to be used in the UL-MAP. The UIUC shall be one of the values defined in Table 246.

Start Time

Indicates the start time, in units of symbol duration, relative to the Allocation Start Time given in the UL-MAP message. The end of the last allocated burst is indicated by allocating an End of Map burst (CID = 0 and UIUC = 14).

Duration

Indicates the duration, in units of OFDM symbols, of the allocation. The duration is inclusive of the preamble, the midambles and the postamble, contained in the allocation.

Subchannel Index

See Table 213

Midamble Repetition Interval

Indicates the preamble repetition interval in OFDM symbols. When the last section of symbol after the last midamble is higher than half the midamble repetition interval (i.e., 4, 8, 16 for 0b01, 0b010, 0b11) a postamble shall be added at the end of the allocation.

8.3.6.3.1 UIUC allocations

Table 246 contains the UIUC values used in the UL-MAP_IE().

Table 246—OFDM UIUC values

UIUC	Usage
0	<i>reserved</i>
1	Initial ranging
2	REQ Region Full
3	REQ Region Focused
4	Focused Contention IE
5–12	Burst Profiles
13	Subchannelization network entry
14	End of Map
15	Extended UIUC

8.3.6.3.2 UL-MAP focused contention IE format

Table 247 defines the UL-MAP IE for allocation of bandwidth for an SS that requested bandwidth using Focused Contention Reservation Requests (see 6.3.6.4). This UL-MAP IE is identified by UIUC = 4 (see Table 246). An SS responding to a bandwidth allocation using the Focused Contention IE shall start its burst with a short preamble (see 8.3.3.6) and use only the most robust mandatory burst profile in that burst.

Table 247—OFDM focused contention IE format

Syntax	Size	Notes
Focused_Contention_IE() {		
Frame Number Index	4 bits	
Transmit Opportunity Index	3 bits	
Contention Channel Index	6 bits	
Contention Code Index	3 bits	
}		

Frame Number Index

Identifies the frame in which the network entry request, which this message responds to, was transmitted. The four least significant bits of the frame number are used as the frame number index.

Transmit Opportunity Index

Index number of the Transmit Opportunity (used in the Bandwidth Request) that this message is responding to. The Transmit Opportunities are numbered from 0x0 to 0x7, where Transmit

Opportunity 0x0 indicates the first Transmit Opportunity in the frame pointed by the Frame Number Index.

Contention Channel Index

Index number of the Contention Channel (used in the Bandwidth Request) that this message is responding to.

Contention Code Index

Index number of the Contention Code (used in the Bandwidth Request) that this message is responding to.

8.3.6.3.3 Subchannelized network entry IE

Table 248 defines the UL-MAP IE for allocation of bandwidth in response to a subchannelized network entry signal (See 8.3.7.2). This UL-MAP IE is identified by UIUC = 13 in the subchannelized section of the UL-MAP. An SS responding to a bandwidth allocation using the Subchannelized Network entry IE shall start its burst with a short preamble (see 8.3.3.6) and use only the most robust mandatory burst profile in that burst.

Table 248—Subchannelized network entry IE format

Syntax	Size	Notes
Subchannelized_Network_Entry_IE() {		
Frame Number Index	4 bits	
Transmit Opportunity Index	4 bits	
Contention Subchannel	4 bits	
}		

Frame Number Index

Identifies the frame in which the network entry request, which this message responds to, was transmitted. The four least significant bits of the frame number are used as the Frame Number Index.

Transmit Opportunity Index

Index number of the Transmit Opportunity that was used in the network entry, within the frame pointed by the Frame Number Index.

Contention Subchannel

The number of the subchannel that was used for network entry. The contention subchannels are numbered from 0 to 0xF and this number (n) represents the subchannel index (i) as specified in Table 213 according to $i = 2*n + 1$.

8.3.6.3.4 UL-MAP extended IE format

A UL-MAP IE entry with a UIUC value of 15, indicates that the IE carries special information and conforms to the structure shown in Table 249. A station shall ignore an extended IE entry with an extended UIUC value for which the station has no knowledge. In the case of a known extended UIUC value but with a length field longer than expected, the station shall process information up to the known length and ignore the remainder of the IE.

Table 249—OFDM UL-MAP extended IE format

Syntax	Size	Notes
UL_Extended_IE() {		
Extended UIUC	4 bits	0x00..0x0F
Length	4 bits	Length in bytes of Unspecified data field
Unspecified data	<i>variable</i>	
}		

8.3.6.3.5 UL-MAP power control IE format

When a power change for the SS is needed, UIUC = 15 is used with extended UIUC set to 0x00 and with 8-bit Power control value as shown in Table 250. The power control value is an 8-bit signed integer expressing the change in power level (in 0.25 dB units) that the SS should apply to correct its current transmission power.

The CID used in the IE should be the Basic CID of the SS.

Table 250—OFDM power control IE format

Syntax	Size	Notes
Power_Control_IE() {		
Extended UIUC	4 bits	Fast power control = 0x00
Length	4 bits	Length = 1
Power control	8 bits	Signed integer, which expresses the change in power level (in 0.25 dB units) that the SS should apply to correct its current transmission power.
}		

8.3.6.3.6 UL-MAP AAS IE format

Within a frame, the switch from non-AAS to AAS-enabled traffic is marked by using the UIUC = 15 with the AAS_IE() to indicate that the subsequent allocation until the end of the frame shall be for AAS traffic. When used, the CID in the UL-MAP_IE() shall be set to the broadcast CID. Subsequent AAS PHY bursts shall all start with the short preamble. Stations not supporting the AAS functionality shall ignore the portion

of the frame marked for AAS traffic. The AAS_IE() shall not be used in AAS private map messages.

Table 251—OFDM AAS UL IE format

Syntax	Size	Notes
AAS_IE() {		
Extended UIUC	4 bits	AAS = 0x02
Length	4 bits	Length = 0x00
}		

8.3.6.3.7 UL-MAP Physical Modifier IE

The Physical Modifier Information Element indicates that the subsequent allocations shall utilize a preamble and midambles, which are cyclically delayed in time by M samples, meaning that the waveform transmitted during these training symbols shall be as shown in Equation (84):

$$s(t) = \operatorname{Re} \left\{ e^{2j\pi f_c t} \sum_{\substack{k = N_{used}/2 \\ k = -N_{used}/2 \\ k \neq 0}} c_k \times e^{2j\pi k \Delta f (t - T_g - M/F_s)} \right\} \quad (84)$$

where

t is the time, elapsed since the beginning of the OFDM symbol, with $0 < t < T_s$.

The PHYMOD_UL_IE can appear anywhere in the UL map, and it shall remain in effect until another PHYMOD_UL_IE is encountered, or until the end of the UL map.

Table 252—OFDM UL-MAP Physical Modifier IE format

Syntax	Size	Notes
PHYMOD_UL_IE() {		
Extended UIUC	4 bits	PHYMOD = 0x01
Length	4 bits	Length = 1
Preamble Time Shift	8 bits	Preamble time shift
}		

Preamble Time Shift

The parameter indicating how many samples of cyclic shift are introduced into the training symbols of the following allocations [M in Equation (84)].

8.3.6.3.8 UL-MAP dummy IE format

An SS shall be able to decode the UL-MAP Dummy IE. A BS shall not transmit this IE (unless under test).

Table 253—OFDM UL-MAP dummy IE format

Syntax	Size	Notes
Dummy_IE() {		
Extended UIUC	4 bits	0x03..0x0F
Length	4 bits	0..15
Unspecified data	<i>variable</i>	The “Length” field specifies the size of this field in bytes
}		

8.3.6.4 AAS-FBCK-REQ/RSP message bodies

The AAS-FBCK-REQ/RSP messages are used to request and return measurements that assist beam forming in AAS systems. The format of the AAS-FBCK-REQ message body is shown in Table 254.

Table 254—OFDM AAS Feedback Request message body

Syntax	Size	Notes
OFDM-AAS-FBCK-REQ_Message_Body() {		
Frame Number	8 bits	
Start time	11 bits	
Feedback Request Counter	3 bits	
Frequency measurement resolution	2 bits	
}		

Frame Number

The least significant bits of the frame number of the burst on which the measurement shall be performed. Shall always point to a future frame.

Start time:

Indicates the start time, in units of symbol duration, of the burst on which to perform the measurement. Shall be relative to the start of the frame pointed to by the “Frame Number” field.

Feedback Request Counter

Increases every time an AAS-FBCK-REQ is sent to the SS. Individual counters shall be maintained for each SS. The value 0 shall not be used.

Frequency measurement resolution

Indicates the frequency measurement points to report on.

0b00 : Carriers -100, -96, -92, -88, -84, -80, -76, -72, -68, -64, -60, -56, -52, -48, -44, -40, -36, -32, -28, -24, -20, -16, -12, -8, -4, 4, 8, 12, 16, 20, 24, 28, 32, 36, 40, 44, 48, 52, 56, 60, 64, 68, 72, 76, 80, 84, 88, 92, 96, 100

0b01 : Carriers -100, -92, -84, -76, -68, -60, -52, -44, -36, -28, -20, -12, -4, 4, 12, 20, 28, 36, 44, 52, 60, 68, 76, 84, 92, 100

0b10 : Carriers -100, -84, -68, -52, -36, -20, -4, 4, 20, 36, 52, 68, 84, 100

0b11 : Carriers -100, -68, -36, -4, 4, 36, 68, 100

The measurements shall be transmitted in order of increasing frequency index.

The format of the AAS-FBCK-RSP message body is shown in Table 255.

Table 255—OFDM AAS Feedback Response message body

Syntax	Size	Notes
OFDM-AAS-FBCK-RSP_Message_Body() {		
Frame number	8 bits	
Start time	11 bits	
Feedback Request Counter	3 bits	
Frequency measurement resolution	2 bits	Indicates the frequency measurement points as defined in Table 254.
for ($i=0$; $i<$ Number of Frequencies; $i++$){		Number of frequencies is either 50, 26, 14, or 8 as appropriate and depending on the value of the Frequency measurement resolution field.
Re(Frequency_value[i])	8 bits	
Im(Frequency_value[i])	8 bits	
}		
RSSI mean value	8 bits	
CINR mean value	8 bits	
}		

Frame number

The least significant bits of the frame number of the burst on which the measurement was performed. Shall always point to a past frame.

Start time

Indicates start time, in units of symbol duration, of the burst on which the measurement was performed. Shall be relative to the start of the frame pointed to by the “frame number” field.

Feedback Request Counter

Counter from the AAS-FBCK-REQ messages to which this is the response. The value 0 indicates that the response is unsolicited. In this case, the measurement corresponds to the preceding frame.

Frequency Measurement Resolution

Indicates the frequency measurement points reported on.

Number of Frequencies

The number of frequencies to be reported and as implied by the Frequency measurement resolution field.

Re(Frequency_value[i]) and Im(Frequency_value[i])

The real (Re) and imaginary (Im) part of the measured amplitude on the frequency measurement point (low to high frequency) in signed integer fixed point format ($[\pm][2 \text{ bits}].[5 \text{ bits}]$).

RSSI mean value

The mean RSSI as measured on the element pointed to by data measurement type, frame number, and number of frames in the corresponding request. The RSSI is quantized as described in 8.3.9.2. When the AAS feedback response is unsolicited, this value corresponds to preceding frame.

CINR mean value

The mean CINR as measured on the element pointed to by data measurement type, frame number, and number of frames in the corresponding request. The RSSI is quantized as described in 8.3.9.2. When the AAS feedback response is unsolicited, this value corresponds to preceding frame.

8.3.6.5 AAS-BEAM-REQ/RSP message

The AAS Beam Request/Response messages shall be used by a system supporting AAS. This message serves to request channel measurement that will help in adjusting the direction of the adaptive array. This shall be used in conjunction with the AAS preamble.

Table 256—AAS Beam request message format

Syntax	Size	Notes
AAS_BEAM_REQ_message format(){		
Management message type = 47	8 bits	
Frame number	8 bits	
Feedback request number	3 bits	
Measurement Report Type	2 bits	0b00: BEAM_REP_IE() Otherwise: <i>Reserved</i>
Resolution parameter	3 bits	
Beam bit mask	4 bits	A bit corresponds to a requested report on the beam
<i>reserved</i>	4 bits	Shall be set to zero
}		

Frame Number

The eight least significant bits of the frame Number in which to perform the measurement.

Feedback Request Counter

Every time an AAS-BEAM-REQ is sent to the SS. Individual counters shall be maintained for each SS. The value 0 shall not be used.

Measurement report type

The report type to be used.

Beam Bit Mask

A bit value of 1 signifies that the corresponding beam is to be reported on.

Table 257—AAS Beam response message format

Syntax	Size	Notes
AAS_BEAM_RSP_message format(){		
Management message type = 48	8 bits	
Frame number	8 bits	
Feedback request number	3 bits	
Measurement Report Type	2 bits	0b00: BEAM_REP_IE() Otherwise: <i>Reserved</i> .
Resolution parameter	3 bits	
Beam bit mask	4 bits	A bit corresponds to a requested report on the beam
<i>reserved</i>	4 bits	Shall be set to zero
if (Measurement Report Type==0)		
AAS_BEAM_REP_IE()		
}		
RSSI mean value	8 bits	
CINR mean value	8 bits	
}		

Frame Number

The eight least significant bits of the Frame Number in which to perform the measurement. If the message is unsolicited corresponds to the previous frame.

Feedback Request Counter

Counter from the AAS-BEAM-REQ messages to which this is the response. The value 0 indicates that the response is unsolicited.

Measurement report type

The report type to be used.

Beam Bit Mask

A bit value of 1 signifies that the corresponding beam is to be reported on.

RSSI mean value

The mean RSSI as measured on the element pointed to by data measurement type, frame number, and number of frames in the corresponding request. The RSSI is quantized as described in 8.3.9.2. When the AAS feedback response is unsolicited, this value corresponds to preceding frame.

CINR mean value

The mean CINR as measured on the element pointed to by data measurement type, frame number, and number of frames in the corresponding request. The RSSI is quantized as described in 8.3.9.2. When the AAS feedback response is unsolicited, this value corresponds to preceding frame.

The AAS beam pattern report IE shall be used in conjunction with the AAS_BEAM_REQ/RSP messages. This report IE contain the frequency response of the beams transmitted during the AAS_preamble of the corresponding frame. only the beams which corresponds to the Beam Bit mask are reported. The resolution parameter is interpreted as follows:

resolution parameter ==0b000 => report every 4th subcarrier
 resolution parameter ==0b001 => report every 8th subcarrier
 resolution parameter ==0b010 => report every 16th subcarrier
 resolution parameter ==0b011 => report every 32th subcarrier
 resolution parameter ==0b100 => report every 64th subcarrier

Measurement points shall be on the frequencies corresponding to the negative subcarrier offset indices $-N_{used}/2$ plus n times the indicated subcarrier resolution and corresponding to the positive subcarrier offset indices $N_{used}/2$ minus n times the indicated subcarrier resolution where n is a positive integer.

Table 258—AAS Beam report IE format

Syntax	Size	Notes
AAS_BEAM_REP_IE_message-format(){		
for ($m=0$; $m < \text{NumberOfBeams}$; $m++$){		
for ($n=0$; $n < \text{NumberOfFrequencies}$; $n++$){		
Re {Frequency_value_beam[m,n]	8 bits	
Im {Frequency_value_beam[m,n]	8 bits	
}		
}		
}		

Re(Frequency_value_beam[m,n]) and Im(Frequency_value_beam[m,n])

The real (Re) and imaginary (Im) part of the measured amplitude on the frequency measurement point n (low to high frequency) from beam m in signed integer fixed point format ($[\pm][2 \text{ bits}].[5 \text{ bits}]$).

8.3.7 Control mechanisms

8.3.7.1 Synchronization

8.3.7.1.1 Network synchronization

For TDD and FDD realizations, it is recommended (but not required) that all BSs be time synchronized to a common timing signal. In the event of the loss of the network timing signal, BSs may continue to operate and shall automatically resynchronize to the network timing signal when it is recovered. The synchronizing reference shall be a 1 pps timing pulse. A 10 MHz frequency reference may also be used. These signals are typically provided by a GPS receiver.

For both FDD and TDD realizations, frequency references derived from the timing reference may be used to control the frequency accuracy of Base-Stations provided that they meet the frequency accuracy requirements of 8.3.12. This applies during normal operation and during loss of timing reference.

8.3.7.2 Ranging

There are two types of ranging processes—initial ranging (see 6.3.9.5) and periodic ranging (see 6.3.10). Initial ranging (coarse synchronization) and power are performed during two phases of operation; during (re)registration and when synchronization is lost; and secondly, during transmission on a periodic basis. Initial ranging uses the initial ranging contention-based interval, which requires a long preamble. The periodic ranging uses the regular uplink burst.

During registration, a new subscriber registers during the random access channel, and, if successful, it is entered into a ranging process under control of the BS. The ranging process is cyclic in nature where default time and power parameters are used to initiate the process followed by cycles where (re)calculated parameters are used in succession until parameters meet acceptance criteria for the new subscriber. These parameters are monitored, measured and stored at the BS, and transmitted to the subscriber unit for use during normal exchange of data. During normal exchange of data, the stored parameters are updated in a periodic manner based on configurable update intervals to ensure that changes in the channel can be accommodated. The update intervals shall vary in a controlled manner on a subscriber unit by subscriber unit basis. Initial ranging transmissions shall use a long preamble and the most robust mandatory burst profile.

Ranging on re-registration follows the same process as new registration.

Regardless of duplexing type, the appropriate duration of the Initial Ranging slot used for initial system access depends on the intended cell radius.

SSs that compute their $P_{TX_IR_max}$ to exceed their maximum power level and SSs that have attempted initial ranging with the maximum power level using RNG-REQ may, if the BS supports subchannelization, attempt initial ranging in an initial ranging slot using the following burst format:

The SS shall transmit the long preamble as defined in 8.3.3.6. This shall be followed by two identical symbols containing a subchannelized preamble, on a single randomly selected subchannel. Note that the long preamble is transmitted on the entire BW while the subchannelized preamble is transmitted on 1/16 of the BW.

The long preamble and the subchannelized preamble shall be transmitted using the same total power. As a result the spectral density of the long preamble shall be lower by a factor of 16 (about 12dB) than the power spectral density of the subchannelized preamble.

The BS need only detect that energy is sent on a single subchannel and may respond by allocating a single subchannel identifying the SS by the Transmit Opportunity, Frame Number and ranging subchannel in which the transmission was received. The allocation is accomplished by sending an UL-MAP IE containing a Subchannelized_Network_Entry_IE (see 8.3.6.3.3) and transmitted using the Initial Ranging CID. The allocated bandwidth shall be big enough as to contain at least one RNG-REQ message.

A SS attempting subchannelized initial ranging shall use its maximum power setting for the initial ranging burst.

8.3.7.2.1 Initial Ranging in AAS systems

A BS supporting the AAS option may allocate in the uplink subframe an AAS alert slot for AAS SSs that have to initially alert the BS of their presence. This period shall be marked as Initial-Ranging (UIUC=1), but shall be marked by an AAS initial ranging CID such that no non-AAS subscriber (or AAS subscriber that can decode the UL-MAP message) uses this interval for Initial Ranging. Additionally, this period shall be marked using AAS map (see Table 251). The SS shall transmit the long preamble as defined in 8.3.3.6. This shall be followed by a burst carrying the AAS_NW_ENTRY_REQ message (see Table 259). This burst shall use the most robust mandatory rate.

The BS may respond to the network entry request by transmitting a RNG-RSP message indicating the required changes to the ranging parameters. The SS is identified by specifying the transmit opportunity and the entry code of the AAS_NW_ENTRY_REQ message. When transmitting the response, the BS may use the feedback information embedded in the AAS_NW_ENTRY_REQ to direct the beam to the SS.

The BS may additionally assign subchannelized AAS alert slot for SSs supporting subchannelization. AAS SSs that have attempted initial ranging with the maximum power level using AAS_NW_ENTRY_REQ may attempt initial ranging in the subchannelized AAS alert slot. The SS shall transmit the long preamble as defined in 8.3.3.6. This shall be followed by subchannelized burst carrying the AAS_SBCH_NW_ENTRY_REQ message (see Table 260). This message shall be sent on the subchannel indicated by the UL-MAP information element used to allocate the ranging period.

Table 259—OFDM AAS_NW_ENTRY_REQ format

Syntax	Size	Notes
AAS_NW_ENTRY_REQ(){		
Network entry code	4 bits	A randomly selected code.
Measurement frame index	4 bits	The 4 LSB of the frame number to which the beam measurements refer.
for ($i=0; i<4; i++$){		
Re(beam_value[i])	8 bits	
Im(beam_value[i])	8 bits	
}		
RSSI mean value	8 bits	
HCS	8 bits	
}		

Network entry code

A 4 bit number selected at random.

Measurement frame index

The 4 LSB of the frame number to which the beam measurements refer.

Re(beam_value[m]) and Im(beam_value[m])

The real (Re) and imaginary (Im) part of the measured amplitude of beam m in signed integer fixed point format ([±][2 bits].[5 bits]). These values are measured on the AAS preamble pointed to by measurement frame index. A single value shall be used for the entire bandwidth.

RSSI

The RSSI of the AAS preamble information pointed to by measurement frame index. This value is averaged over the four beams. The RSSI value shall be quantized as in 8.3.9.2.

Table 260—OFDM SBCH_AAS_NW_ENTRY_REQ format

Syntax	Size	Notes
SBCH_AAS_NW_ENTRY_REQ(){		
Network entry code	4 bits	A randomly selected code.
Phase offset 1	4 bits	The mean phase offset of beam 1 relative to beam 0. 4-bit signed number, in units of $360^\circ/16$.
Phase offset 2	4 bits	The mean phase offset of beam 2 relative to beam 0. 4-bit signed number, in units of $360^\circ/16$.
Phase offset 3	4 bits	The mean phase offset of beam 3 relative to beam 0. 4-bit signed number, in units of $360^\circ/16$.
Measurement frame index	1 bit	0: Phase information corresponds to beams in previous frame 1: Phase information corresponds to beams in one before previous frame.
RSSI mean value	5 bits	
}		

Network entry code

A 4-bit number selected at random.

Phase offset 1...3

The phase offsets that are required to be performed by the BS, in order to from the beam towards the SS. The phase offsets are estimated using the AAS preamble and are given relative to the first beam.

Measurement frame index

Indicates whether the phase information corresponds to the previous frame or to the one before the previous frame.

RSSI

The RSSI of the AAS preamble information pointed to by measurement frame index. This value is averaged over the four beams. This value shall be quantized in 2 dB increments, ranging from -110 dBm (encoded 0x00) to -48 dBm (encoded 0x1F). Values outside this range shall be assigned the closest extreme value within the scale.

8.3.7.3 Bandwidth requesting

There may be two types of REQ Regions in a frame. These two types are REQ Region-Full and REQ Region-Focused.

In a REQ Region-Full, when subchannelization is not active, each Transmit Opportunity shall consist of a short preamble and one OFDM symbol using the most robust mandatory burst profile. When subchannelization is active, the allocation is partitioned into Transmission Opportunities (TOs) both in frequency and in time. The width (in subchannels) and length (in OFDM symbols) of each transmission opportunity (TO) is defined in the UCD message defining (see Table 352). The transmission of an SS shall

contain a subchannelized preamble corresponding to the TO chosen, followed by data OFDM symbols using the most robust mandatory burst profile.

In a REQ Region-Focused, a station shall send a short code over a Transmit Opportunity that consists of four subcarriers by two OFDM symbols. Each Transmit Opportunity within a frame shall be indexed by consecutive Transmit Opportunity Indices. The first occurring Transmit Opportunity shall be indexed 0.

All SS shall be capable of the Full Contention Transmission. Capability of the Focused Contention Transmission is optional. The SS shall follow the backoff procedure as described in 6.3.8.

8.3.7.3.1 Parameter selection

The SS shall examine the UL_MAP message for a future frame and select (in accordance with 6.3.8) a future REQ Region during which to make its request. If Focused Contention Supported = 1 was returned by the BS in SBC-RSP message during SS initialization and if the SS is capable of focused contention, it may choose either a REQ Region-Full or REQ Region-Focused. Otherwise, it shall choose a REQ Region-Full.

If the chosen REQ Region is a REQ Region-Focused, the SS shall also select a contention code from Table 261 and similarly a contention channel from Table 262. The contention channel shall be selected from Table 261 based upon a random selection with equal probability among the group of possible contention channels that are consistent with the allocation, as indicated in Table 262. The indices $\{-100$ to $+100\}$ in the body of Table 262 refer to the subcarrier indices as defined in 8.3.2.4. The number of contention codes that can be used by a subchannelized capable SS is denoted by C_{SE} . The contention code shall be selected at random with equal probability from the appropriate subset of codes in Table 261 according to the value of C_{SE} .

If the BS supports subchannelization, the last C_{SE} contention codes shall only be used by subchannelization-enabled SSs that wish to receive a subchannelized allocation. In response, the BS may provide the requested allocation as a subchannelized allocation; may provide the requested allocation as a full (default) allocation, or may provide no allocation at all. The value of C_{SE} is transmitted in the UCD channel encoding TLV messages. The default value of C_{SE} is 0.

A BS that supports Focused Contention may allocate the Focused Contention region based upon the BSID, thereby reducing the probability of interference from SSs operating in nearby cells operating on the same frequency.

Any Focused Contention region allocation shall be restricted to an even Subchannel Index (meaning that it be no finer than a 1/8 subchannel—see Table 213), providing between 6 and 48 contention channels.

Table 261—OFDM Contention codes

Contention code index	Bit 0	Bit 1	Bit 2	Bit 3
0	1	1	1	1
1	1	-1	1	-1
2	1	1	-1	-1
3	1	-1	-1	1
4	-1	-1	-1	-1
5	-1	1	-1	1
6	-1	-1	1	1
7	-1	1	1	-1

Table 262—OFDM Contention channels

Contention channel index	Frequency offset index 0	Frequency offset index 1	Frequency offset index 2	Frequency offset index 3	Contention Channel belongs to subchannel (See Table 213)
0	-100	-37	1	64	0b00010
1	-99	-36	2	65	0b00010
2	-98	-35	3	66	0b00010
3	-97	-34	4	67	0b00010
4	-96	-33	5	68	0b00010
5	-95	-32	6	69	0b00010
6	-94	-31	7	70	0b00110
7	-93	-30	8	71	0b00110
8	-92	-29	9	72	0b00110
9	-91	-28	10	73	0b00110
10	-90	-27	11	74	0b00110
11	-89	-26	12	75	0b00110
12	-87	-50	14	51	0b01010
13	-86	-49	15	52	0b01010
14	-85	-48	16	53	0b01010
15	-84	-47	17	54	0b01010
16	-83	-46	18	55	0b01010

Table 262—OFDM Contention channels (continued)

Contention channel index	Frequency offset index 0	Frequency offset index 1	Frequency offset index 2	Frequency offset index 3	Contention Channel belongs to subchannel (See Table 213)
17	-82	-45	19	56	0b01010
18	-81	-44	20	57	0b01110
19	-80	-43	21	58	0b01110
20	-79	-42	22	59	0b01110
21	-78	-41	23	60	0b01110
22	-77	-40	24	61	0b01110
23	-76	-39	25	62	0b01110
24	-75	-12	26	89	0b10010
25	-74	-11	27	90	0b10010
26	-73	-10	28	91	0b10010
27	-72	-9	29	92	0b10010
28	-71	-8	30	93	0b10010
29	-70	-7	31	94	0b10010
30	-69	-6	32	95	0b10110
31	-68	-5	33	96	0b10110
32	-67	-4	34	97	0b10110
33	-66	-3	35	98	0b10110
34	-65	-2	36	99	0b10110
35	-64	-1	37	100	0b10110
36	-62	-25	39	76	0b11010
37	-61	-24	40	77	0b11010
38	-60	-23	41	78	0b11010
39	-59	-22	42	79	0b11010
40	-58	-21	43	80	0b11010
41	-57	-20	44	81	0b11010
42	-56	-19	45	82	0b11110
43	-55	-18	46	83	0b11110
44	-54	-17	47	84	0b11110
45	-53	-16	48	85	0b11110
46	-52	-15	49	86	0b11110
47	-51	-14	50	87	0b11110

8.3.7.3.2 Full Contention transmission

If the chosen REQ Region is a REQ Region-Full, the SS shall transmit the short preamble as defined in 8.3.3.6, followed by a Bandwidth Request MAC Header as defined in 6.3.2.1.2.

If the Full Contention allocation appears in subchannelized region, the allocation is partitioned into transmission opportunities (TOs) both in frequency and in time. The width (in subchannels) and length (in OFDM symbols) of each transmission opportunity is defined in the UCD message defining $UIUC = 2$. The transmission of an SS shall contain a subchannelized preamble corresponding to the TO chosen, followed by data OFDM symbols using the most robust mandatory burst profile.

8.3.7.3.3 Focused Contention transmission

The REQ Region-Focused bandwidth requesting mechanism consists of two phases. The Phase-1 is that an SS requesting bandwidth sends a signal to the BS in the uplink TO of REQ Region Focused identified by $UIUC = 3$. One REQ Region Focused uplink interval with $UIUC = 3$ shall be four subcarriers by two OFDM symbols. The Phase-1 bandwidth requesting signal transmission is described in this subclause. Following the Phase-1, the BS may include in its UL-MAP an allocation for the SS using $UIUC = 4$ and the Focused_Contention_IE as defined in Table 247. The SS is identified in this Focused_Contention_IE by the Frame Number index, Transmit Opportunity index, Contention Channel index, and Contention Code index that the SS used to send the Phase-1 bandwidth requesting signal. The Phase-2 is that the SS requesting bandwidth responds to this UL-MAP allocation with a bandwidth request MAC header as defined in 6.3.2.1.2. The Phase-2 uplink interval with $UIUC = 4$ shall consist of a short preamble and shall have the duration indicated by the relevant field of the UL-MAP_IE() and shall use the most robust mandatory burst profile.

If the chosen REQ Region is a REQ Region-Focused, after choosing its four parameters, the SS shall transmit, during the chosen Transmit Opportunity in the chosen frame, four subcarriers that comprise the chosen contention channel. The amplitude of all other subcarriers shall be zero.

During both OFDM symbols, the amplitude of each of the four subcarriers shall be boosted somewhat above its *normal* amplitude, i.e., the amplitude used during a noncontention OFDM symbol, including the current power-control correction. The boost in dB shall equal the value of the Focused Contention Power Boost parameter in the current UCD.

During the first OFDM symbol of the Transmit Opportunity, the phase of the four subcarriers is not specified.

During the second OFDM symbol of the Transmit Opportunity, the phases shall depend on the corresponding bit in the chosen contention code, and the phase transmitted during the first OFDM symbol on the same subcarrier. If the code bit is +1, the phase shall be the same as that transmitted during the first OFDM symbol. If the code bit is -1, the phase shall be inverted, 180 degrees with respect to the phase transmitted during the first OFDM symbol.

8.3.7.4 Power control

As with frequency control, a power control algorithm shall be supported for the uplink channel with both an initial calibration and periodic adjustment procedure without loss of data. The objective of the power control algorithm is to bring the received power density from a given subscriber to a desired level. The received power density is defined as total power received from a given subscriber divided by the number of active subcarriers. When subchannelization is not employed, the number of active subcarriers is equal for all the subscribers and the power control algorithm shall bring the total received power from a given subscriber to the desired level. The base station shall be capable of providing accurate power measurements of the received burst signal. This value can then be compared against a reference level, and the resulting error can

be fed back to the SS in a calibration message coming from the MAC. The power control algorithm shall be designed to support power attenuation due to distance loss or power fluctuations at rates to 30 dB/second with depths of at least 10 dB. The exact algorithm implementation is vendor-specific. The total power control range consists of both a fixed portion and a portion that is automatically controlled by feedback. The power control algorithm shall take into account the interaction of the RF power amplifier with different burst profiles. For example, when changing from one burst profile to another, margins should be maintained to prevent saturation of the amplifier and to prevent violation of emissions masks.

When subchannelization is employed, the SS shall maintain the same transmitted power density unless the maximum power level is reached. That is, when the number of active subchannels allocated to a user is reduced, the total transmitted power shall be reduced proportionally by the SS, without additional power control messages. When the number of subchannels is increased the total transmitted power shall also be increased proportionally. However, the transmitted power level shall not exceed the maximum levels dictated by signal integrity considerations and regulatory requirements. Subscriber stations shall report the maximum available power, and the normalized transmitted power.

Subscriber stations shall report the maximum available power and the current transmitted power. These parameters may be used by the Base station for optimal assignment of coding schemes and modulations and also for optimal allocation of subchannels. The algorithm is vendor-specific. These parameters are reported in the SBC-REQ message. The current transmitted power shall also be reported in the REP-RSP message if the relevant flag in the REP-REQ message has been set.

The current transmitted power is the power of the burst that carries the message. The maximum available power is reported for BPSK, QPSK QAM16, and QAM64 constellations. The current transmitted power and the maximum power parameters are reported in dBm. The parameters are quantized in 0.5 dBm steps ranging from -64 dBm (encoded 0x00) to 63.5 dBm (encoded 0xFF). Values outside this range shall be assigned the closest extreme. SSS that do not support QAM64 shall report the value of 0x00 in the maximum QAM64 power field.

8.3.8 Transmit diversity: Space-Time Coding (optional)

STC (see Alamouti [B1]) may be used on the downlink to provide second order (Space) transmit diversity.

There are two transmit antennas on the BS side and one reception antenna on the SS side. This scheme requires Multiple Input Single Output channel estimation. Decoding is very similar to maximum ratio combining.

Figure 211 shows STC insertion into the OFDM chain. Each Tx antenna has its own OFDM chain, but they have the same Local Oscillator for synchronization purposes.

Both antennas transmit in the same time two different OFDM data symbols. Transmission is performed twice to decode and to get second order diversity. Time domain (Space-Time) repetition is used.

8.3.8.1 Multiple input single output channel estimation and synchronization

Both antennas transmit in the same time, and they share the same Local Oscillator. Thus, the received signal has exactly the same auto-correlation properties as for a single antenna. So, time and frequency coarse and fine estimation can be performed in the same way as for a single antenna. The scheme requires MISO channel estimation, which is provisioned by inserting an STC preamble, transmitted from both antennas, using the STC_IE (see 8.3.6.2.5 and 8.3.3.6).

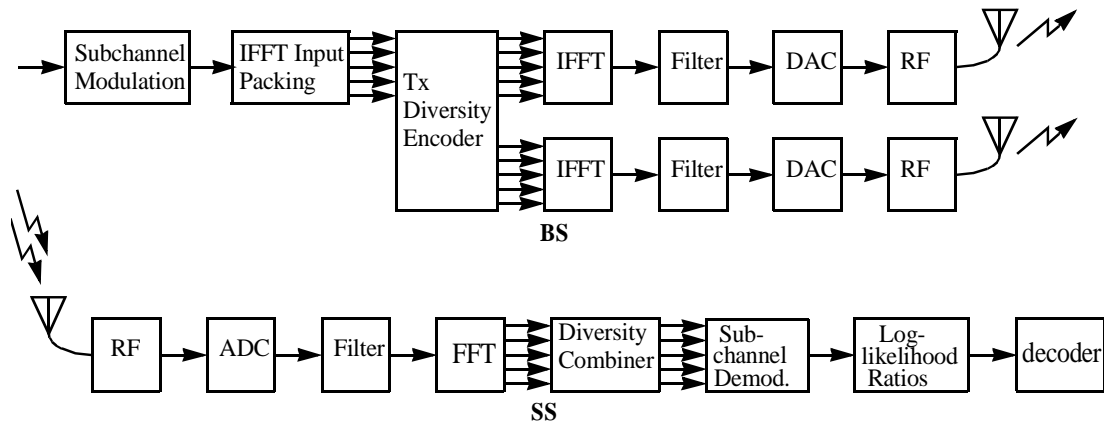

Figure 211—Illustration of STC

8.3.8.2 STC encoding

The basic scheme Alamouti [B1] transmits two complex symbols s_0 and s_1 , using the multiple input single output channel (two Tx, one Rx) twice with channel vector values h_0 (for antenna 0) and h_1 (for antenna 1).

First channel use: Antenna 0 transmits s_0 , antenna 1 transmits s_1 .

Second channel use: Antenna 0 transmits $-s_1^*$, antenna 1 transmits s_0^* .

Receiver gets r_0 (first channel use) and r_1 (second channel use) and computes s_0 and s_1 estimates:

$$\hat{s}_0 = h_0^* \cdot r_0 + h_1 \cdot r_1^* \quad (85)$$

$$\hat{s}_1 = h_1^* \cdot r_0 - h_0 \cdot r_1^* \quad (86)$$

These estimates benefit from second order diversity as in the 1Tx-2Rx Maximum Ratio Combining scheme. OFDM symbols are taken by pairs. The precoding operation, and consecutively the receive decoding [as described in Equation (85) and Equation (86)], is applied independently to same-numbered subcarriers in two consecutive OFDM data symbols. Note that the two OFDM symbols may belong to different PHY bursts and even use different constellations. An individual PHY burst may contain any integer number of symbols. The aggregate duration of all PHY bursts following the last STC preamble or between any two STC preambles shall be a multiple of 2.

On a given pilot subcarrier, the same pilot symbol is used for the STC block. If the STC block consists of OFDM symbol k and $k+1$ and p_s is the pilot symbol for pilot subcarrier s as derived for OFDM symbol k from 8.3.3.4.2, then the modulation on pilot subcarrier s during OFDM symbol k shall be p_s on both antenna 0 and 1. During OFDM symbol $k+1$, it shall be $-p_s$ on antenna 0 and p_s on antenna 1.

Figure 212 shows the STC scheme (note that only pilot subcarrier –88 is depicted).

8.3.8.3 STC decoding

The receiver waits for two symbols, and combines them on a subcarrier basis according to Equation (85) and Equation (86) in 8.3.8.2.

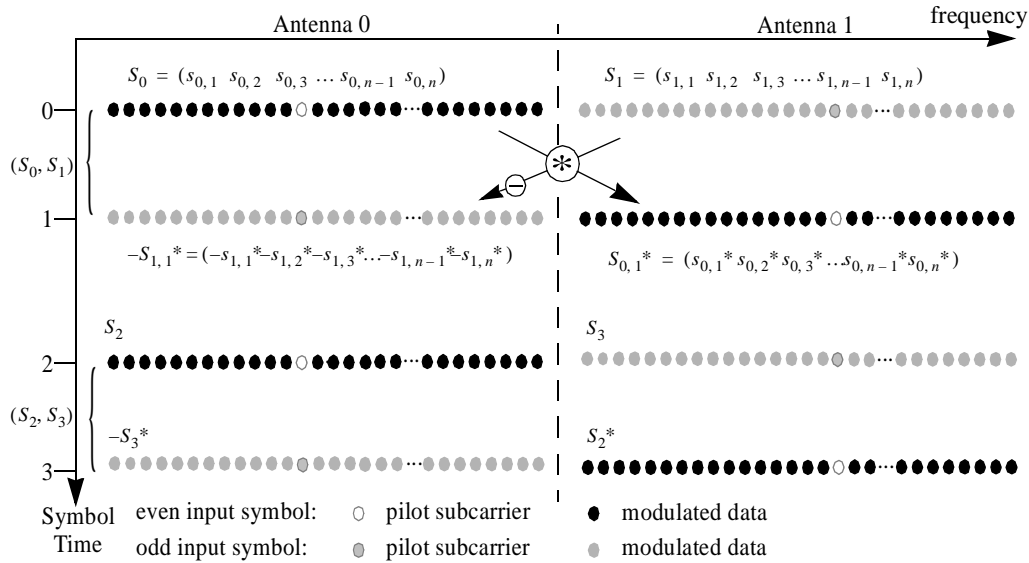

8.3.9 Channel quality measurements

8.3.9.1 Introduction

RSSI and CINR signal quality measurements and associated statistics can aid in such processes as BS selection/assignment and burst adaptive profile selection. As channel behavior is time-variant, both mean and standard deviation are defined. Implementation of the RSSI and CINR statistics and their reports is mandatory.

The process by which RSSI measurements are taken does not necessarily require receiver demodulation lock; for this reason, RSSI measurements offer reasonably reliable channel strength assessments even at low signal levels. On the other hand, although CINR measurements require receiver lock, they provide information on the actual operating condition of the receiver, including interference and noise levels, and signal strength.

8.3.9.2 RSSI mean and standard deviation

When collection of RSSI measurements is mandated by the BS, an SS shall obtain an RSSI measurement from the OFDM downlink preambles. From a succession of RSSI measurements, the SS shall derive and update estimates of the mean and the standard deviation of the RSSI, and report them via REP-RSP messages.

Mean and standard deviation statistics shall be reported in units of dBm. To prepare such reports, statistics shall be quantized in 1 dB increments, ranging from -40 dBm (encoded 0x53) to -123 dBm (encoded 0x00). Values outside this range shall be assigned the closest extreme value within the scale.

The method used to estimate the RSSI of a single message is left to individual implementation, but the relative accuracy of a single signal strength measurement, taken from a single message, shall be ± 2 dB, with an absolute accuracy of ± 4 dB. The specified accuracy shall apply to the range of RSSI values starting from 6 dB below the sensitivity level of the most robust mode or -123 dBm (whichever is higher) up to -40 dBm. In addition, the range over which these single-message measurements are measured should extend 3 dB on each side beyond the -40 dBm to -123 dBm limits for the final averaged statistics that are reported.

One possible method to estimate the RSSI of a signal of interest at the antenna connector is given by Equation (87):

$$RSSI = 10^{-\frac{G_{rf}}{10}} \frac{1.2567 \times 10^4 V_c^2}{(2^{2B})R} \left(\frac{1}{N} \sum_{n=0}^{N-1} |Y_{I \text{ or } Q}[k, n]| \right)^2 \text{ mW} \quad (87)$$

where

- B is the ADC precision, number of bits of ADC,
- R is the ADC input resistance [Ohm],
- V_c is the ADC input clip level [Volts],
- G_{rf} is the analog gain from antenna connector to ADC input,
- $Y_{I \text{ or } Q}[k, n]$ is the n^{th} sample at the ADC output of I or Q-branch within signal k ,
- N is the number of samples.

The (linear) mean RSSI statistics (in mW), derived from a multiplicity of single messages, shall be updated using Equation (88),

$$\hat{\mu}_{RSSI}[k] = \begin{cases} R[0] & k = 0 \\ (1 - \alpha_{\text{avg}})\hat{\mu}_{RSSI}[k-1] + \alpha_{\text{avg}}R[k] & k > 0 \end{cases} \text{ mW} \quad (88)$$

where k is the time index for the message (with the initial message being indexed by $k = 0$, the next message by $k = 1$, etc.), $R[k]$ is the RSSI in mW measured during message k , and α_{avg} is an averaging parameter specified by the BS. The mean estimate in dBm shall then be derived from Equation (89).

$$\hat{\mu}_{RSSI \text{ dBm}}[k] = 10 \log(\hat{\mu}_{RSSI}[k]) \text{ dBm} \quad (89)$$

To solve for the standard deviation in dB, the expectation-squared statistic shall be updated using Equation (90),

$$\hat{\chi}_{RSSI}^2[k] = \begin{cases} |R[0]|^2 & k = 0 \\ (1 - \alpha_{\text{avg}})\hat{\chi}_{RSSI}^2[k-1] + \alpha_{\text{avg}}|R[k]|^2 & k > 0 \end{cases} \quad (90)$$

and the result applied to Equation (91).

$$\hat{\sigma}_{RSSI \text{ dB}} = 5 \log \left(\hat{\chi}_{RSSI}^2[k] - (\hat{\mu}_{RSSI}[k])^2 \right) \text{ dB} \quad (91)$$

8.3.9.3 CINR mean and standard deviation

When CINR measurements are mandated by the BS, an SS shall obtain a CINR measurement (implementation-specific). From a succession of these measurements, the SS shall derive and update estimates of the mean and the standard deviation of the CINR, and report them via REP-RSP messages.

Mean and standard deviation statistics for CINR shall be reported in units of dB. To prepare such reports, statistics shall be quantized in 1 dB increments, ranging from a minimum of -10 dB (encoded 0x00) to a maximum of 53 dB (encoded 0x3F). Values outside this range shall be assigned the closest extreme value within the scale.

The method used to estimate the CINR of a single message is left to individual implementation, but the relative and absolute accuracy of a CINR measurement derived from a single message shall be ± 1 dB and ± 2 dB, respectively. The specified accuracy shall apply to the range of CINR values starting from 3 dB below SNR of the most robust rate, to 10 dB above the SNR of the least robust rate. See Table 266. In addition, the range over which these single-packet measurements are measured should extend 3 dB on each side beyond the -10 dB to 53 dB limits for the final reported, averaged statistics.

One possible method to estimate the CINR of a single message is to compute the ratio of the sum of signal power and the sum of residual error for each data sample, using Equation (92).

$$\text{CINR}[k] = \frac{\sum_{n=0}^{N-1} |s[k, n]|^2}{\sum_{n=0}^{N-1} |r[k, n] - s[k, n]|^2} \quad (92)$$

where $r[k, n]$ received sample n within message k ; $s[k, n]$ the corresponding detected or pilot sample (with channel state weighting) corresponding to received symbol n .

The mean CINR statistic (in dB) shall be derived from a multiplicity of single messages using Equation (93).

$$\hat{\mu}_{\text{CINR dB}}[k] = 10 \log(\hat{\mu}_{\text{CINR}}[k]) \quad (93)$$

where

$$\hat{\mu}_{\text{CINR}}[k] = \begin{cases} \text{CINR}[0] & k = 0 \\ (1 - \alpha_{\text{avg}})\hat{\mu}_{\text{CINR}}[k-1] + \alpha_{\text{avg}} \text{CINR}[k] & k > 0 \end{cases} \quad (94)$$

k is the time index for the message (with the initial message being indexed by $k=0$, the next message by $k=1$, etc.); $\text{CINR}[k]$ is a linear measurement of CINR (derived by any mechanism that delivers the prescribed accuracy) for message k ; and α_{avg} is an averaging parameter specified by the BS.

To solve for the standard deviation, the expectation-squared statistic shall be updated using Equation (95),

$$\hat{\nu}_{\text{CINR}}^2[k] = \begin{cases} |\text{CINR}[0]|^2 & k = 0 \\ (1 - \alpha_{\text{avg}})\hat{\nu}_{\text{CINR}}^2[k-1] + \alpha_{\text{avg}}|\text{CINR}[k]|^2 & k > 0 \end{cases} \quad (95)$$

and the result applied to Equation (96).

$$\hat{\sigma}_{\text{CINR dB}} = 5 \log(\hat{\nu}_{\text{CINR}}^2[k] - (\hat{\mu}_{\text{CINR}}[k])^2) \quad \text{dB} \quad (96)$$

8.3.10 Transmitter requirements

8.3.10.1 Transmit power level control

For an SS not supporting subchannelization, the transmitter shall support a monotonic power level control of 30 dB minimum. For an SS supporting subchannelization, the transmitter shall support a monotonic power level control of 50 dB minimum. The minimum step size shall be no more than 1 dB. The relative accuracy of the power control mechanism is ± 1.5 dB for step sizes not exceeding 30dB and ± 3 dB for step sizes greater than 30 dB. For a BS, the transmitter shall support a monotonic power level control of 10 dB minimum.

8.3.10.1.1 Transmitter spectral flatness

The average energy of the constellations in each of the n spectral lines shall deviate no more than indicated in Table 263. The absolute difference between adjacent subcarriers shall not exceed 0.1 dB.

Table 263—OFDM Spectral flatness

Spectral lines	Spectral flatness
Spectral lines from -50 to -1 and $+1$ to $+50$	± 2 dB from the measured energy averaged over all 200 active tones
Spectral lines from -100 to -50 and $+50$ to $+100$	$+2/-4$ dB from the measured energy averaged over all 200 active tones

This data shall be taken from the channel estimation step.

8.3.10.1.2 Transmitter constellation error and test method

To ensure that the receiver SNR does not degrade more than 0.5 dB due to the transmitter SNR, the relative constellation RMS error, averaged over subcarriers, OFDM frames, and packets, shall not exceed a burst profile dependent value according to Table 264.

Table 264—Allowed relative constellation error versus data rate

Burst type	Relative constellation error (dB)
BPSK-1/2	-13.0
QPSK-1/2	-16.0
QPSK-3/4	-18.5
16-QAM-1/2	-21.5
16-QAM-3/4	-25.0
64-QAM-2/3	-28.5
64-QAM-3/4	-31.0

The sampled signal shall be processed in a manner similar to an actual receiver, according to the following steps, or an equivalent procedure (IEEE Std 802.11a-1999 [B29]):

- a) Start of frame shall be detected.
- b) Transition from short sequences to channel estimation sequences shall be detected, and fine timing (with one sample resolution) shall be established.
- c) Coarse and fine frequency offsets shall be estimated.
- d) The packet shall be de-rotated according to estimated frequency offset.
- e) The complex channel response coefficients shall be estimated for each of the subcarriers.
- f) For each of the data OFDM symbols, transform the symbol into subcarrier received values, estimate the phase from the pilot subcarriers, de-rotate the subcarrier values according to estimated phase, and divide each subcarrier value with a complex estimated channel response coefficient. In the case of subchannelization transmission, the estimated channel coefficient of the nearest allocated subcarrier shall be used for those subcarriers not part of the allocated subchannels.
- g) For each data-carrying subcarrier, find the closest constellation point and compute the Euclidean distance from it. In the case of subchannelization transmission, for data-carrying subcarriers not part of the allocated subchannels, the Euclidean distance shall be computed relative to $0+0j$.
- h) Compute the RMS average of all errors in a packet. It is given by:

$$\text{Error}_{RMS} = \frac{1}{N_f} \sum_{i=1}^{N_f} \frac{\sum_{j=1}^{L_P} \left[\sum_{\substack{k=-N_{used}/2 \\ k \neq 0}}^{N_{used}/2} \left\{ (I(i,j,k) - I_0(i,j,k))^2 + (Q(i,j,k) - Q_0(i,j,k))^2 \right\} \right]}{\sum_{j=1}^{L_P} \left[\sum_{\substack{k=-N_{used}/2 \\ k \neq 0}}^{N_{used}/2} \left\{ I_0(i,j,k)^2 + Q_0(i,j,k)^2 \right\} \right]} \quad (97)$$

where

L_P	is the length of the packet,
N_f	is the number of frames for the measurement,
$(I_0(i,j,k), Q_0(i,j,k))$	denotes the ideal symbol point of the i^{th} frame, j^{th} OFDM symbol of the frame, k^{th} subcarrier of the OFDM symbol in the complex plane,
$(I(i,j,k), Q(i,j,k))$	denotes the observed point of the i^{th} frame, j^{th} OFDM symbol of the frame, k^{th} subcarrier of the OFDM symbol in the complex plane.

8.3.10.2 Transmitter channel bandwidth and RF carrier frequencies

For licensed bands, channel bandwidths allowed shall be limited to the regulatory provisioned bandwidth divided by any power of 2, rounded down to the nearest multiple of 250 kHz, resulting in a channel bandwidth no less than 1.25 MHz.

If the resulting channel bandwidth is an odd multiple of 250 kHz, then for any band for which support is claimed, the RF carrier shall only be tunable to every odd multiple of 125 kHz within that band. If the resulting channel bandwidth is an even multiple of 250 kHz, then for any band for which support is claimed, the RF carrier shall only be tunable to every even multiple of 125 kHz within that band. For FDD systems, support shall be claimed separately for uplink and downlink.

For example, if the regulatory provisioned bandwidth is 14 MHz between 3400 and 3414 MHz, then the allowed channelled bandwidths are those shown in Table 265.

Table 265—Example of channelization for licensed bands

Channelization (MHz)	Center frequencies (MHz)
14 MHz	3407
7 MHz	$3403.5 + n \cdot 0.25$ $n \in \{0 \dots 28\}$
3.5 MHz	$3401.75 + n \cdot 0.25$ $n \in \{0 \dots 42\}$
1.75 MHz	$3400.875 + n \cdot 0.25$ $n \in \{0 \dots 49\}$

8.3.11 Receiver requirements

8.3.11.1 Receiver sensitivity

The BER measured after FEC shall be less than 10^{-6} at the power levels given by Equation (98) for standard message and test conditions. If the implemented bandwidth is not listed, then the values for the nearest smaller listed bandwidth shall apply. The minimum input levels are measured as follows:

- At the antenna connector or through a calibrated radiated test environment,
- Using the defined standardized message packet formats, and
- Using an AWGN channel.

The receiver minimum input level sensitivity (R_{SS}) shall be (assuming 5 dB implementation margin and 7 dB Noise Figure):

$$R_{SS} = -102 + SNR_{Rx} + 10 \cdot \log\left(F_S \cdot \frac{N_{used}}{N_{FFT}} \cdot \frac{N_{subchannels}}{16}\right) \quad (98)$$

where

SNR_{Rx}	the receiver SNR as per Table 266 in dB,
F_S	sampling frequency in MHz as defined in 8.3.2.2,
$N_{subchannels}$	the number of allocated subchannels (default 16 if no subchannelization is used).

Table 266—Receiver SNR assumptions

Modulation	Coding rate	Receiver SNR (dB)
BPSK	1/2	6.4
QPSK	1/2	9.4
	3/4	11.2

Table 266—Receiver SNR assumptions (continued)

Modulation	Coding rate	Receiver SNR (dB)
16-QAM	1/2	16.4
	3/4	18.2
64-QAM	2/3	22.7
	3/4	24.4

Test messages for measuring Receiver Sensitivity shall be based on a continuous stream of MAC PDUs, each with a payload consisting of a R times repeated sequence $S_{modulation}$. For each modulation, a different sequence applies:

$$\begin{aligned}
 S_{BPSK} &= [0xE4, 0xB1] \\
 S_{QPSK} &= [0xE4, 0xB1, 0xE1, 0xB4] \\
 S_{16-QAM} &= [0xA8, 0x20, 0xB9, 0x31, 0xEC, 0x64, 0xFD, 0x75] \\
 S_{64-QAM} &= [0xB6, 0x93, 0x49, 0xB2, 0x83, 0x08, 0x96, 0x11, 0x41, 0x92, 0x01, 0x00, \\
 &0xBA, 0xA3, 0x8A, 0x9A, 0x21, 0x82, 0xD7, 0x15, 0x51, 0xD3, 0x05, \\
 &0x10, 0xDB, 0x25, 0x92, 0xF7, 0x97, 0x59, 0xF3, 0x87, 0x18, 0xBE, \\
 &0xB3, 0xCB, 0x9E, 0x31, 0xC3, 0xDF, 0x35, 0xD3, 0xFB, 0xA7, \\
 &0x9A, 0xFF, 0xB7, 0xDB]
 \end{aligned} \tag{99}$$

For each mandatory test message, the $(R, S_{modulation})$ tuples that shall apply are:

$$\begin{aligned}
 &\text{Short length test message payload (288 data bytes): } (144, S_{BPSK}), (72, S_{QPSK}), (36, S_{16QAM}), \\
 &\quad (6, S_{64QAM}) \\
 &\text{Mid length test message payload (864 data bytes): } (432, S_{BPSK}), (216, S_{QPSK}), (108, S_{16QAM}), \\
 &\quad (18, S_{64QAM}) \\
 &\text{Long length test message payload (1536 data bytes): } (768, S_{BPSK}), (384, S_{QPSK}), (192, S_{16QAM}), \\
 &\quad (32, S_{64QAM})
 \end{aligned}$$

The test condition requirements are: ambient room temperature, shielded room, conducted measurement at the RF port if available, radiated measurement in a calibrated test environment if the antenna is integrated, and RS FEC is enabled. The test shall be repeated for each test message length and for each $(R, S_{modulation})$ tuple as identified above, using the mandatory FEC scheme. The results shall meet or exceed the sensitivity requirements set out in Equation (98).

8.3.11.2 Receiver adjacent and alternate channel rejection

The receiver adjacent and alternate channel rejection shall be met over the required dynamic range of the receiver, from 3 dB above the reference sensitivity level specified in 8.3.11.1 to the maximum input signal level as specified in 8.3.11.3.

The adjacent channel rejection and alternate channel rejection shall be measured at minimum sensitivity by setting the desired signal's strength 3 dB above the rate dependent receiver sensitivity [see Equation (98)] and raising the power level of the interfering signal until the error rate specified in 8.3.11.1 is obtained. The adjacent channel rejection and alternate channel rejection shall also be measured at maximum input level by setting the interfering channel signal strength to the receiver maximum signal level as specified in 8.3.10.3 and decreasing the power level of the desired signal until the specified error rate is obtained. In both cases, the power difference between the desired signal and the interfering channel is the corresponding C/I ratio.

The interfering signal shall be a conforming OFDM signal, unsynchronized with the signal in the channel under test. The requirement shall be met on both sides of the desired signal channel. For nonadjacent channel testing, the test method is identical except the interfering channel shall be any channel other than the adjacent channel or the co-channel. For the PHY to be compliant, the minimum rejection shall exceed the values shown in Table 267:

Table 267—Adjacent and nonadjacent channel rejection

Modulation/coding	Adjacent Channel Interference C/I (dB)	Nonadjacent channel rejection C/I (dB)
16-QAM-3/4	−11	−30
64-QAM-3/4	−4	−23

8.3.11.3 Receiver maximum input signal

The receiver shall be capable of decoding a maximum on-channel signal of −30 dBm.

8.3.11.4 Receiver maximum tolerable signal

The receiver shall tolerate a maximum signal of 0 dBm without damage.

8.3.11.5 Receiver image rejection

The receiver shall provide a minimum image rejection of 60 dB. The image rejection requirement shall be inclusive of all image terms originating at the receiver RF and subsequent intermediate frequencies.

8.3.12 Frequency and timing requirements

At the BS, the transmitted center frequency, receive center frequency and the symbol clock frequency shall be derived from the same reference oscillator. At the BS the reference frequency tolerance shall be better than $\pm 8 \times 10^{-6}$ in licensed bands up to 10 years from the date of equipment manufacture.

At the SS, both the transmitted center frequency and the symbol clock frequency shall be synchronized and locked to the BS with a tolerance of maximum 2% of the subcarrier spacing.

For Mesh capable devices, all device frequencies shall be accurate to within $\pm 20 \times 10^{-6}$ and achieve synchronization to its neighboring nodes with a tolerance of maximum 3% of the subcarrier spacing.

During the synchronization period, the SS shall acquire frequency synchronization within the specified tolerance before attempting any uplink transmission. During normal operation, the SS shall track the frequency changes and shall defer any transmission if synchronization is lost.

All SSs shall acquire and adjust their timing such that all uplink OFDM symbols arrive time coincident at the Base-Station to a accuracy of $\pm 50\%$ of the minimum guard-interval or better.

8.4 WirelessMAN-OFDMA PHY

8.4.1 Introduction

The WirelessMAN-OFDMA PHY (Sari and Karam [B39]), based on OFDM modulation, is designed for NLOS operation in the frequency bands below 11 GHz per 1.3.4. For licensed bands, channel bandwidths allowed shall be limited to the regulatory provisioned bandwidth divided by any power of 2 no less than 1.0 MHz.

8.4.2 OFDMA symbol description, symbol parameters and transmitted signal

8.4.2.1 Time domain description

Inverse-Fourier-transforming creates the OFDMA waveform; this time duration is referred to as the useful symbol time T_b . A copy of the last T_g of the useful symbol period, termed CP, is used to collect multipath, while maintaining the orthogonality of the tones. Figure 213 illustrates this structure.

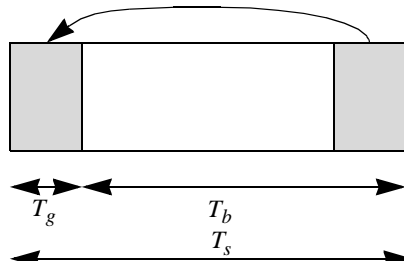

Figure 213—OFDMA symbol time structure

The transmitter energy increases with the length of the guard time while the receiver energy remains the same (the cyclic extension is discarded), so there is a $10\log(1 - T_g/(T_b + T_g))/\log(10)$ dB loss in E_b/N_0 . Using a cyclic extension, the samples required for performing the FFT at the receiver can be taken anywhere over the length of the extended symbol. This provides multipath immunity as well as a tolerance for symbol time synchronization errors.

On initialization, an SS should search all possible values of CP until it finds the CP being used by the BS. The SS shall use the same CP on the uplink. Once a specific CP duration has been selected by the BS for operation on the downlink, it should not be changed. Changing the CP would force all the SSs to resynchronize to the BS.

8.4.2.2 Frequency domain description

The frequency domain description includes the basic structure of an OFDMA symbol.

An OFDMA symbol is made up of subcarriers, the number of which determines the FFT size used. There are several subcarrier types:

- Data subcarriers: for data transmission
- Pilot subcarriers: for various estimation purposes
- Null carrier: no transmission at all, for guard bands and DC carrier

The purpose of the guard bands is to enable the signal to naturally decay and create the FFT “brick wall” shaping.

In the OFDMA mode, the active subcarriers are divided into subsets of subcarriers, each subset is termed a subchannel. In the downlink, a subchannel may be intended for different (groups of) receivers; in the uplink, a transmitter may be assigned one or more subchannels, several transmitters may transmit simultaneously. The subcarriers forming one subchannel may, but need not be adjacent. The concept is shown in Figure 214.

The symbol is divided into logical subchannels to support scalability, multiple access, and advanced antenna array processing capabilities.

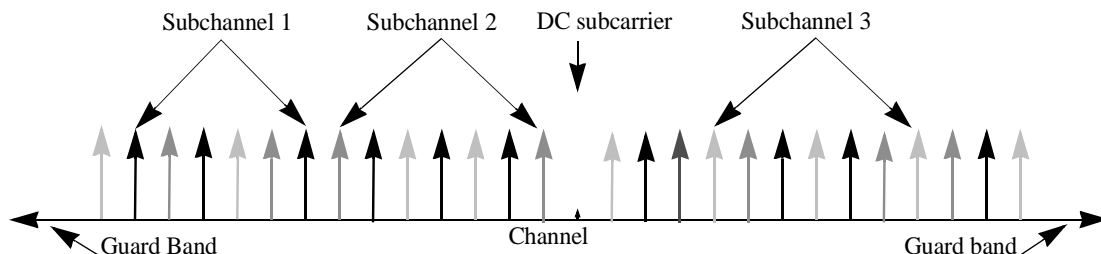

Figure 214—OFDMA frequency description (3 channel schematic example)

8.4.2.3 Primitive parameters

The following four primitive parameters characterize the OFDMA symbol:

- BW : This is the nominal channel bandwidth.
- N_{used} : Number of used subcarriers (which includes the DC subcarrier).
- n : Sampling factor. This parameter, in conjunction with BW and N_{used} determines the subcarrier spacing, and the useful symbol time. This value is set to 8/7.
- G : This is the ratio of CP time to “useful” time. The following values shall be supported: 1/32, 1/16, 1/8, and 1/4.

8.4.2.4 Derived parameters

The following parameters are defined in terms of the primitive parameters of 8.4.2.3:

- N_{FFT} : Smallest power of two greater than N_{used}
- Sampling Frequency: $F_s = \text{floor}(n \cdot BW/8000) \times 8000$
- Subcarrier spacing: $\Delta f = F_s / N_{FFT}$
- Useful symbol time: $T_b = 1/\Delta f$
- CP Time: $T_g = G \cdot T_b$
- OFDMA Symbol Time: $T_s = T_b + T_g$
- Sampling time: T_b/N_{FFT}

8.4.2.5 Transmitted signal

Equation (100) specifies the transmitted signal voltage to the antenna, as a function of time, during any OFDMA symbol.

$$s(t) = \text{Re} \left\{ e^{j2\pi f_c t} \sum_{\substack{k = -(N_{\text{used}}-1)/2 \\ k \neq 0}}^{(N_{\text{used}}-1)/2} c_k \cdot e^{j2\pi k \Delta f (t - T_g)} \right\} \quad (100)$$

where

t is the time, elapsed since the beginning of the subject OFDMA symbol, with $0 < t < T_s$.

c_k is a complex number; the data to be transmitted on the subcarrier whose frequency offset index is k , during the subject OFDMA symbol. It specifies a point in a QAM constellation.

T_g is the guard time.

T_s is the OFDMA symbol duration, including guard time.

Δf is the subcarrier frequency spacing.

8.4.3 OFDMA basic terms definition

8.4.3.1 Slot and Data Region

A slot in the OFDMA PHY requires both a time and subchannel dimension for completeness (subchannels are defined in 8.4.6.) and is the minimum possible data allocation unit.

The definition of an OFDMA slot depends on the OFDMA symbol structure, which varies for uplink and downlink, for FUSC and PUSC, and for the distributed subcarrier permutations and the adjacent subcarrier permutation.

- For downlink FUSC using the distributed subcarrier permutation (defined in 8.4.6.1.2.2 and 8.4.6.1.2.3), one slot is one subchannel by one OFDMA symbol.
- For downlink PUSC using the distributed subcarrier permutation (defined in 8.4.6.1.2.1), one slot is one subchannel by two OFDMA symbols.
- For uplink PUSC using either of the distributed subcarrier permutations (defined in 8.4.6.2.1 and 8.4.6.2.5), one slot is one subchannel by three OFDMA symbols.
- For uplink and downlink using the adjacent subcarrier permutation (defined in 8.4.6.3), one slot is one subchannel by one OFDMA symbol.

In OFDMA, a Data Region is a two-dimensional allocation of a group of contiguous subchannels, in a group of contiguous OFDMA symbols. This allocation may be visualized as a rectangle, such as the 4×3 rectangle shown in Figure 215.

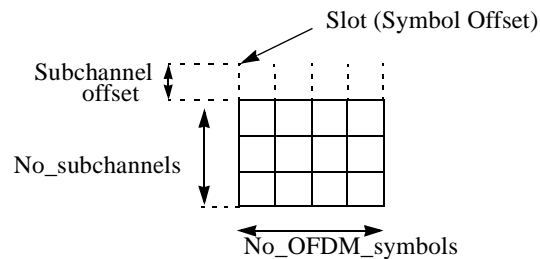

Figure 215—Example of the data region which defines the OFDMA allocation

A data region can be transmitted in the downlink by the BS as a transmission to a (group of) SS(s).

8.4.3.2 Segment

A Segment is a subdivision of the set of available OFDMA subchannels (that may include all available subchannels). One segment is used for deploying a single instance of the MAC.

8.4.3.3 Permutation Zone

Permutation Zone is a number of contiguous OFDMA symbols, in the DL or the UL, that use the same permutation formula. The DL subframe or the UL subframe may contain more than one permutation zone.

8.4.3.4 OFDMA data mapping

MAC data shall be processed as described in 8.4.9 and shall be mapped to an OFDMA Data Region (see 8.4.3.1) for downlink and uplink using the algorithms defined below.

Downlink:

- 1) Segment the data into blocks sized to fit into one OFDMA slot.
- 2) Each slot shall span one or more subchannels in the subchannel axis and two OFDMA symbols in the time axis (see Figure 216). Map the slots such that the lowest numbered slot occupies the lowest numbered subchannel in the lowest numbered OFDMA symbol.
- 3) Continue the mapping such that the OFDMA symbol index is increased. When the edge of the Data Region is reached, continue the mapping from the lowest numbered OFDMA symbol in the next subchannel.

Uplink:

- 1) Segment the data into blocks sized to fit into one OFDMA slot.
- 2) Each slot shall span one or more subchannels in the subchannel axis and three OFDMA symbol in the time axis (see Figure 217). Map the slots such that the lowest numbered slot occupies the lowest numbered subchannel in the lowest numbered OFDMA symbol.
- 3) Continue the mapping such that the OFDMA symbol index is increased. When the edge of the UL zone (which is marked with Zone_switch_IE) is reached, continue the mapping from the lowest numbered OFDMA symbol in the next available subchannel.

Figure 216 and Figure 217 illustrates the order in which OFDMA slots are mapped to subchannels and OFDMA symbols.

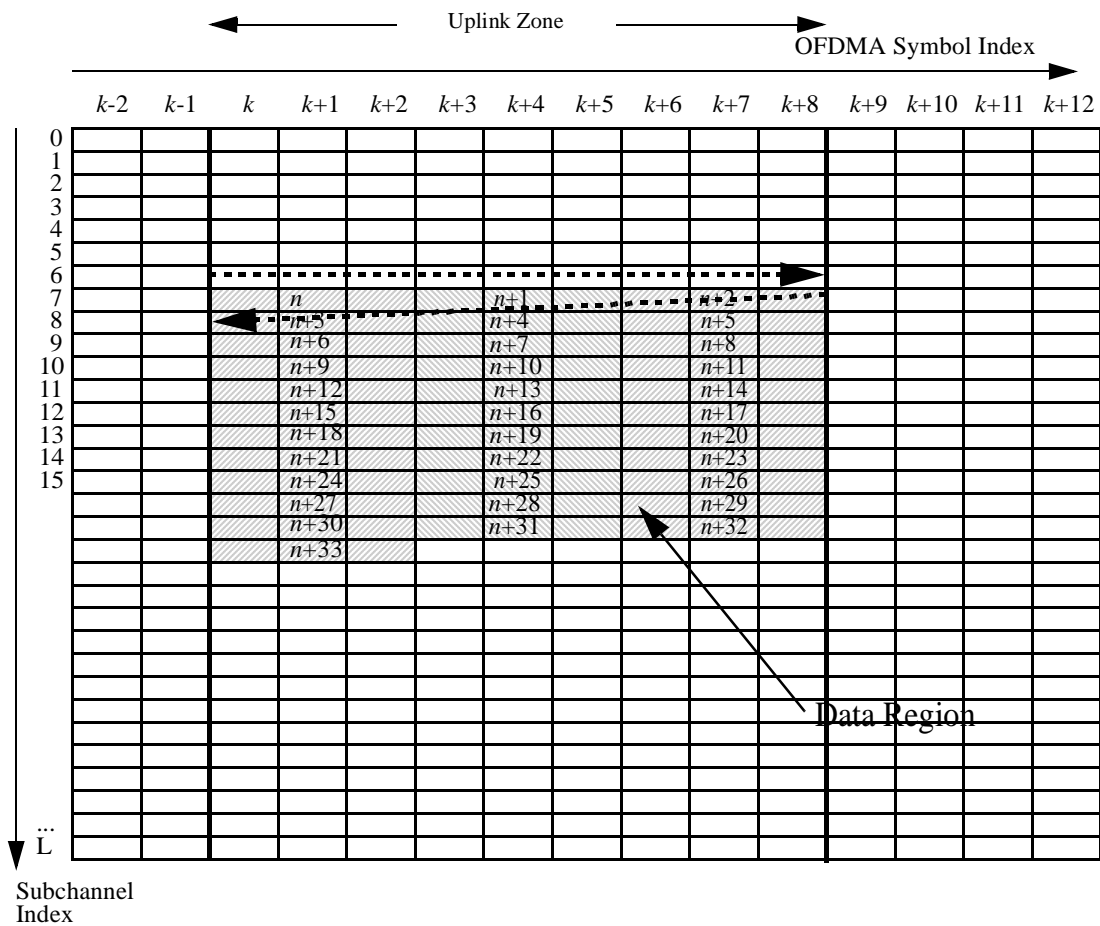

Figure 217—Example of mapping OFDMA slots to subchannels and symbols in the uplink

8.4.4 Frame structure

8.4.4.1 Duplexing modes

In licensed bands, the duplexing method shall be either FDD or TDD. FDD SSs may be H-FDD. In license-exempt bands, the duplexing method shall be TDD.

8.4.4.2 PMP frame structure

When implementing a TDD system, the frame structure is built from BS and SS transmissions. Each frame in the downlink transmission begins with a preamble followed by a DL transmission period and an UL transmission period. In each frame, the TTG and RTG shall be inserted between the downlink and uplink and at the end of each frame, respectively, to allow the BS to turn around.

In TDD and H-FDD systems, subscriber station allowances must be made by a SSRTG and by a SSTTG. The BS shall not transmit downlink information to a station later than (SSRTG+RTD) before its scheduled uplink allocation, and shall not transmit downlink information to it earlier than (SSTTG-RTD) after the end of scheduled uplink allocation, where RTD denotes Round-Trip Delay. The parameters SSRTG and SSTTG are capabilities provided by the SS to BS upon request during network entry (see 11.8.3.1).

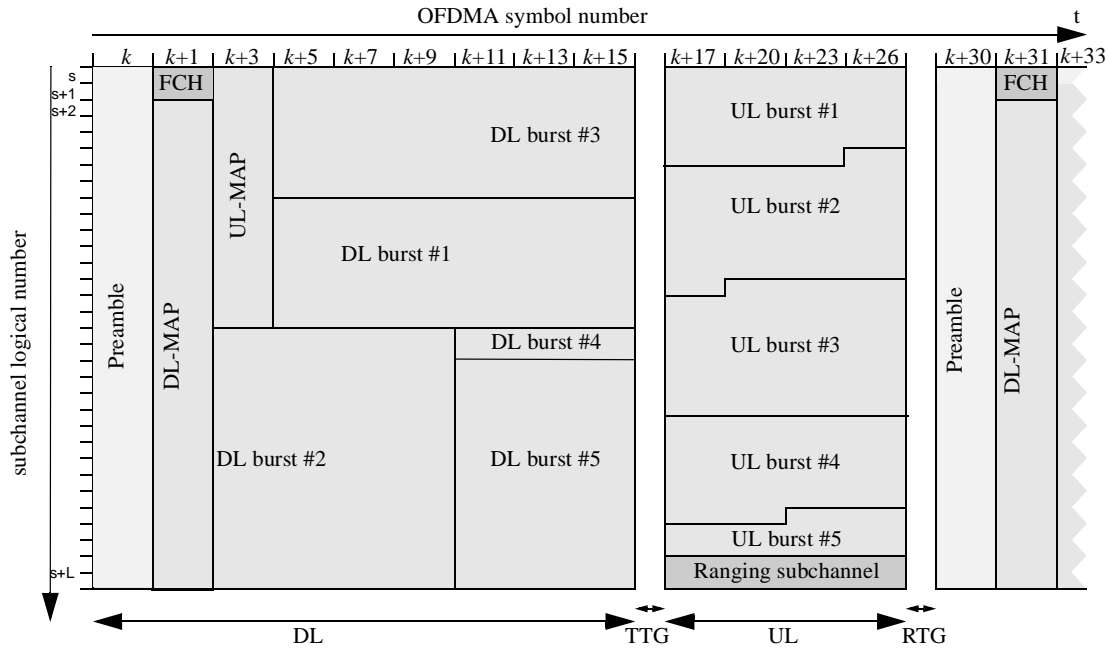

Figure 218—Time plan - one TDD time frame (with only mandatory zone)

Subchannel allocation in the downlink may be performed in the following ways: partial usage of subchannels (PUSC) where some of the subchannels are allocated to the transmitter, and full usage of the subchannels (FUSC) where all subchannels are allocated to the transmitter. The first two transmitted subchannels in the first data symbol of the downlink is called FCH. The FCH shall be transmitted using QPSK rate 1/2 with four repetitions using the mandatory coding scheme (e.g., the FCH information will be sent on four adjacent subchannels) in a PUSC zone. The FCH contains the DL_Frame Prefix as described in 8.4.4.3, and specifies the length of the DL-MAP message that immediately follows the DL_Frame_Prefix and the repetition coding used for the DL-MAP message.

The transitions between modulations and coding take place on OFDMA symbol boundaries in time domain and on subchannels within an OFDMA symbol in frequency domain.

The OFDMA frame may include multiple zones (such as PUSC, FUSC, PUSC with all subchannels, optional FUSC, AMC and optional FUSC with all subchannels), the transition between zones is indicated in the DL-Map by the Zone_switch IE (see 8.4.5.3.4). No DL-MAP or UL-MAP allocations can span over multiple zones. Figure 219 depicts OFDMA frame with multiple zones.

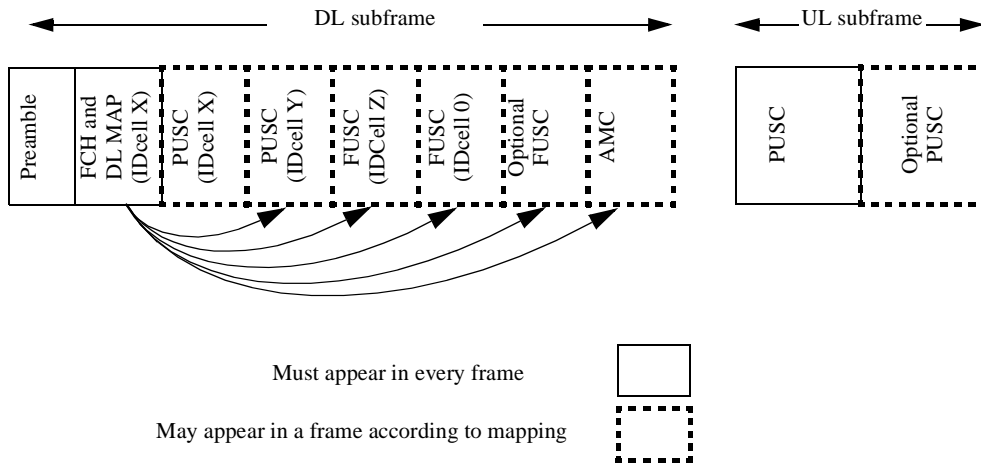

Figure 219—Illustration of OFDMA frame with multiple zones

8.4.4.3 DL Frame Prefix

The DL_Frame_Prefix is a data structure transmitted at the beginning of each frame and contains information regarding the current frame and is mapped to the FCH. Table 268 defines the structure of DL_Frame_Prefix

Table 268—OFDMA downlink Frame Prefix format

Syntax	Size	Notes
DL_Frame_Prefix_Format() {		
Used subchannel bitmap	6 bits	Bit #0: Subchannels 0-11 are used Bit #1: Subchannels 12-19 are used Bit #2: Subchannels 20-31 are used Bit #3: Subchannels 32-39 are used Bit #4: Subchannels 40-51 are used Bit #5: Subchannels 52-59 are used
Ranging_Change_Indication	1 bit	
Repetition_Coding_Indication	2 bits	00 – No repetition coding on DL-MAP 01 – Repetition coding of 2 used on DL-MAP 10 – Repetition coding of 4 used on DL-MAP 11 – Repetition coding of 6 used on DL-MAP
Coding_Indication	3 bits	0b000 – CC encoding used on DL-MAP 0b001 – BTC encoding used on DL-MAP 0b010 – CTC encoding used on DL-MAP 0b011 – ZT CC used on DL-MAP 0b100 to 0b111 –Reserved

Table 268—OFDMA downlink Frame Prefix format (continued)

Syntax	Size	Notes
DL-Map_Length	8 bits	
reserved	4 bits	Shall be set to zero
}		

Used subchannel bitmap

A bitmap indicating which groups of subchannel are used on the PUSC zone.

Ranging_Change_Indication

A flag that indicates whether this frame contains a change of the allocation of Periodic Ranging/BW Request uplink regions comparing to the previous frame. A value of “1” means that a change has occurred, and value of “0” means that the allocations of Periodic Ranging/BW Request regions in the current frame are the same as in the previous frame.

Repetition_Coding_Indication

Indicates the repetition code used for the DL-MAP. Repetition code may be 0 (no additional repetition), 1 (one additional repetition), 2 (three additional repetitions) or 3 (five additional repetitions).

Coding_Indication

Indicates the FEC encoding code used for the DL-MAP. The DL-MAP shall be transmitted with QPSK modulation at FEC rate 1/2. Note that the BS must ensure that DL-MAP (and other MAC messages required for SS operation) are sent with the mandatory coding scheme often enough to ensure uninterrupted operation of SS supporting only the mandatory coding scheme.

DL-Map_Length

Defines the length in slots of the DL-MAP message that follows immediately the DL_Frame_Prefix.

Before being mapped to the FCH, the 24-bit DL Frame Prefix shall be duplicated to form a 48-bit block, which is the minimal FEC block size.

8.4.4.4 Allocation of subchannels for FCH, and logical subchannel numbering

In PUSC, any segment used shall be allocated at least 12 subchannels. The first 4 slots in the downlink part of the segment contain the FCH as defined in 8.4.4.2. These slots contain 48 bits modulated by QPSK with coding rate 1/2 and repetition coding of 4. The basic allocated subchannel sets for Segments 0, 1, and 2 are Subchannels 0–11, 20–31, and 40–51, respectively. Figure 220 depicts this structure.

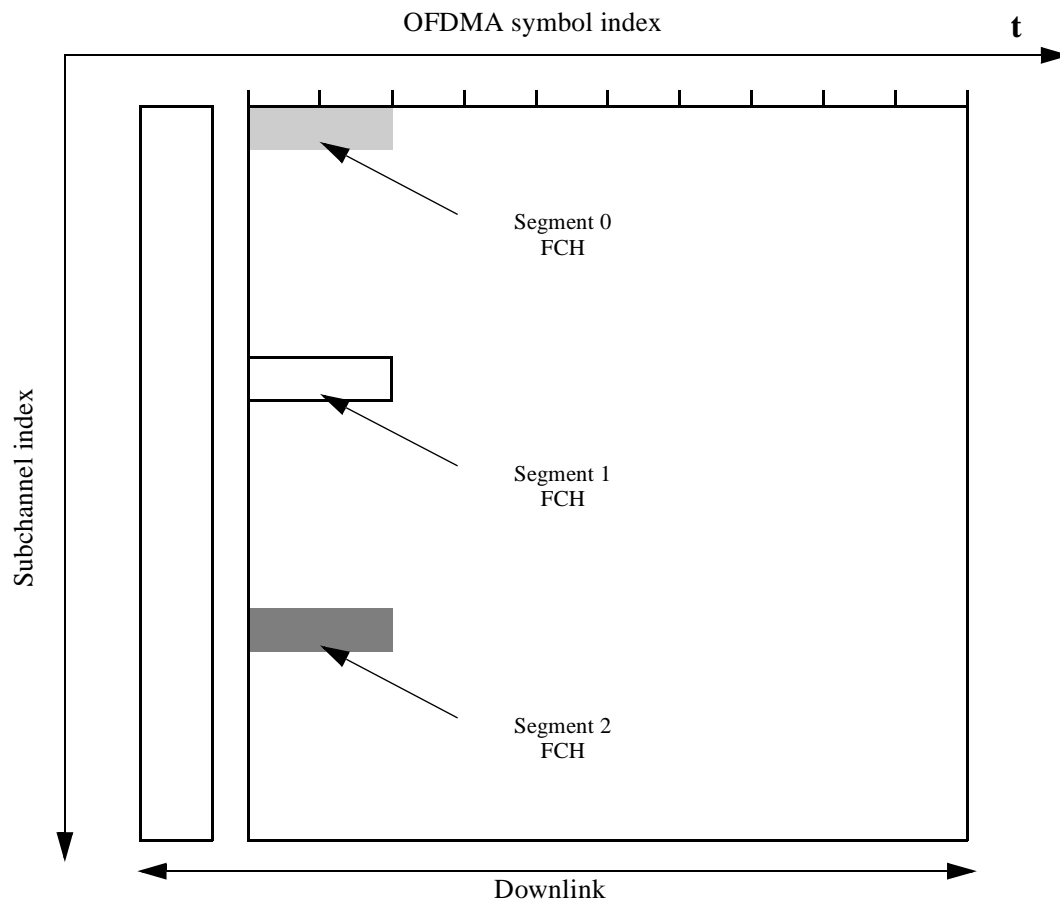

Figure 220—FCH subchannel allocation for all 3 segments

After decoding the DL_Frame_Prefix message within the FCH, the SS has the knowledge of how many and which subchannels are allocated to the PUSC segment. In order to observe the allocation of the subchannels in the downlink as a contiguous allocation block, the subchannels shall be renumbered. The renumbering shall start from the FCH subchannels (renumbered to values 0...11), then continue numbering the subchannels in a cyclic manner to the last allocated subchannel and from the first allocated subchannel to the FCH subchannels. Figure 221 gives an example of such renumbering for segment 1. For uplink, in order to observe the allocation of the subchannels as a contiguous allocation block, the subchannels shall be renumbered, the renumbering shall start from the lowest numbered allocated subchannel (renumbered to value 0), up to the highest numbered allocated subchannel, skipping non-allocated subchannels. Figure 222 gives an example of such renumbering for segment 1.

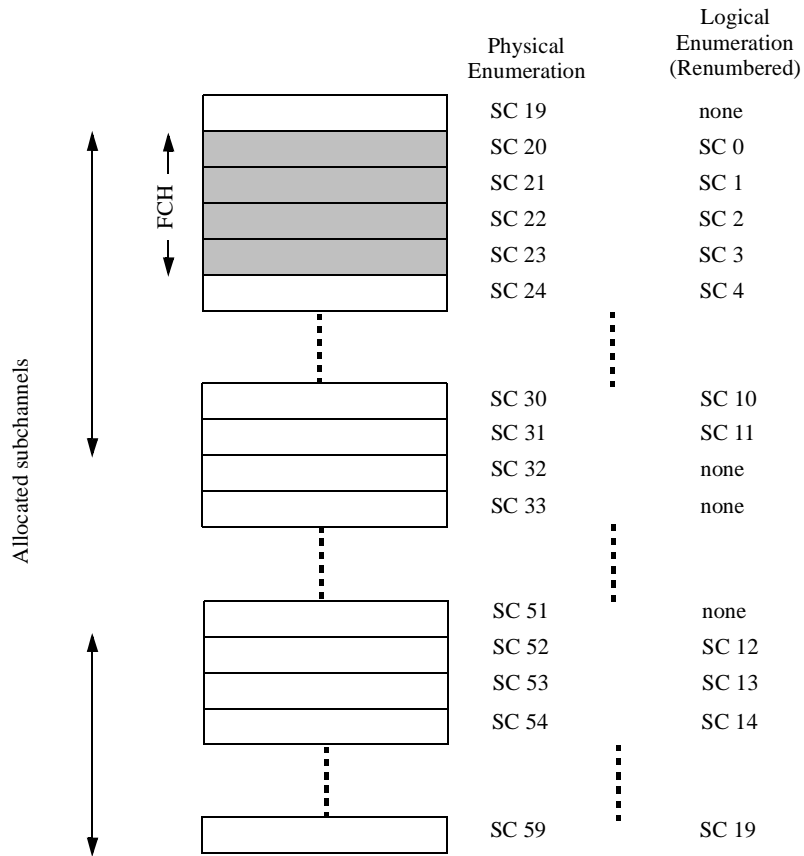

Figure 221—Example of DL renumbering the allocated subchannels for segment 1 in PUSC

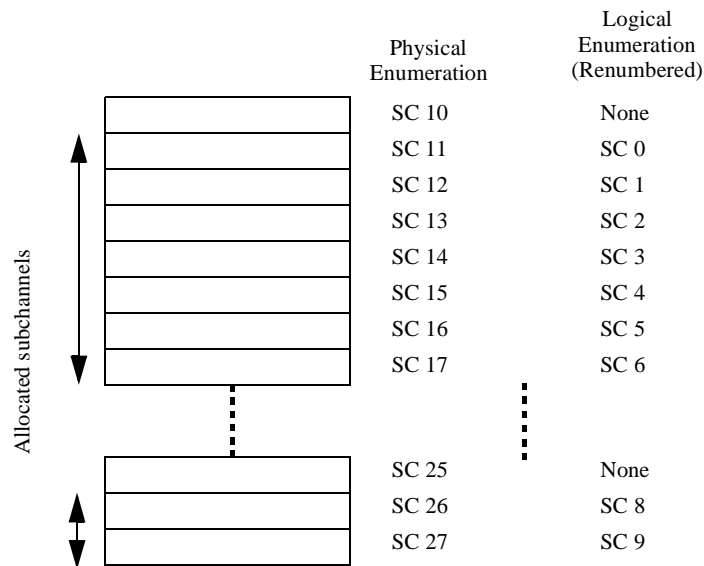

Figure 222—Example of UL renumbering the allocated subchannels for segment 1 in PUSC

8.4.4.5 Uplink transmission allocations

The allocation for a user uplink transmission is a number of subchannels over a number of OFDMA symbols. The number of symbols shall be equal to $3 \cdot N$, where N is a positive integer.

The basic allocation structure is one subchannel for a duration of 3 times the OFDMA symbol duration T_s , ($N = 1$). Larger allocation are repetitions of the basic structure ($N = k$, for a positive integer k).

The framing structure used for the uplink includes an allocation for ranging and an allocation for data transmission. The MAC layer sets the length of the uplink framing and the uplink mapping.

8.4.4.6 Optional Diversity-Map Scan

8.4.4.6.1 AAS frame structure

The two highest numbered subchannels of the DL frame may be dedicated at the discretion of the BS for the AAS Diversity-Map Zone in PUSC, FUSC, and optional FUSC permutation. In the AMC permutation, the fourth and $(N-4)$ th subchannels of the total N subchannels of the DL frame may be dedicated at the discretion of the BS for the AAS Diversity-Map Zone. For AMC permutation, each subchannel for the AAS diversity MAP consists of 3 bins by 2 symbols. When these subchannels are used for this purpose, they shall not be allocated in the normal DL-MAP message and shall be used only on the AAS portion of the DL subframe. These subchannels will be used to transmit the AAS-DLFP() whose physical construction is shown in Figure 223.

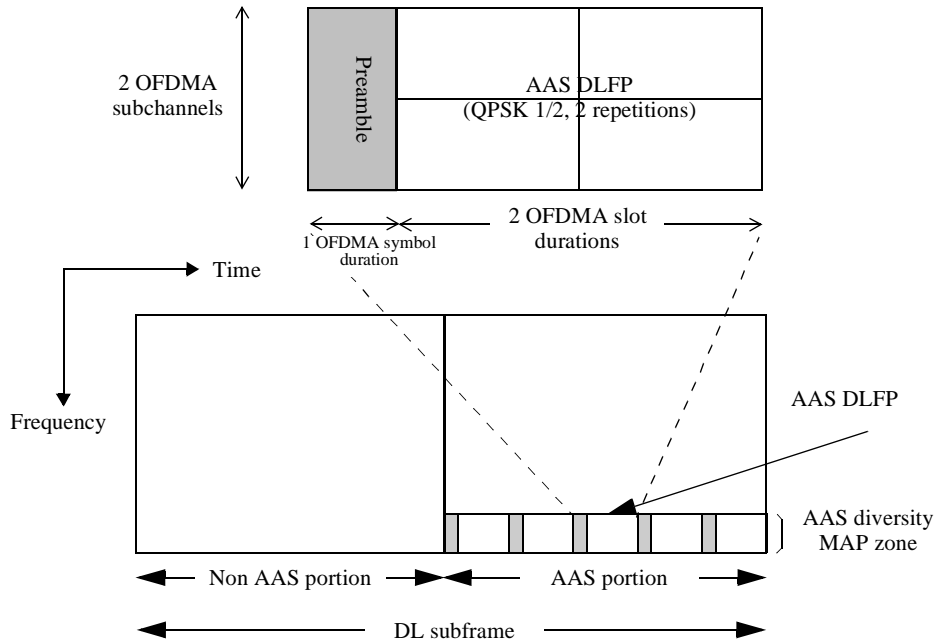

Figure 223—Example of allocation for AAS_DL_Scan IE

The AAS portion in the DL (or UL) may be transmitted either by the FUSC/PUSC permutation or by the optional AMC permutation. Figure 224 shows an example of a DL subframe for each of these two possible variations.

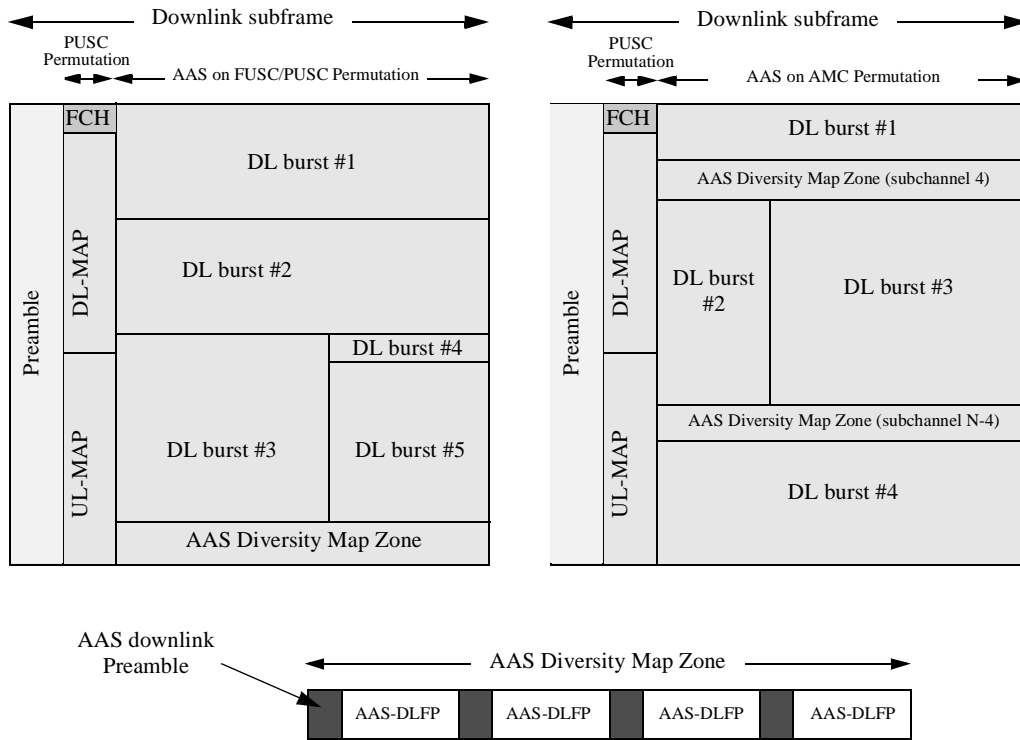

Figure 224—AAS Diversity Map Frame Structure

8.4.4.6.2 AAS-DLFP Format

The purpose of the AAS-DLFP is to provide a robust transmission of the required base station parameters to enable SS initial ranging, as well as SS paging and access allocation. This is achieved through using a highly robust form of modulation and coding (namely QPSK-1/2 rate with 2 repetitions). The start of an AAS-DLFP is marked by an AAS DL preamble. The AAS-DLFPs transmitted within the AAS Diversity Map Zone need not carry the same information. Different beams may be used within the AAS Diversity Map Zone; however, each AAS Downlink Preamble and associated AAS-DLFP must be transmitted on the same beam.

The AAS-DLFP supports the ability to transmit a MAP IE that carries a compressed DL-MAP. This allocation message can point to a broadcast DL-MAP that is beamformed or can be used to “page” a specific SS that cannot receive the normal DL-MAP. Once the initial allocations are provided to the user, private DL-MAPs and UL-MAPs can be sent on a beamformed transmission to the user at the highest modulation and lowest coding rate that can be supported by the link. The AAS-DLFP also has an uplink initial ranging allocation for AAS subscribers.

The contents of the AAS-DLFP() payload is described by Table 269.

Table 269—AAS-DLFP Structure, Diversity-Map Scan

Syntax	Size	Notes
AAS-DLFP() {		
AAS beam index	6 bits	This index is the index referred to by the AAS_Beam_Select message (see 6.3.2.3.41).
Preamble select	1 bit	0 – Frequency shifted Preamble 1 – Time shifted Preamble
Uplink_Preamble_Config	2 bits	00 – 0 symbols 01 – 1 symbols 10 – 2 symbols 11 – 3 symbols
Downlink_Preamble_Config	2 bits	00 – 0 symbols 01 – 1 symbols 10 – 2 symbols 11 – 3 symbols
Initial_Ranging_Allocation_IE(){		
OFDMA Symbol Offset	8 bits	
Subchannel offset	6 bits	
No of OFDMA Symbols	7 bits	
No of Subchannels	6 bits	
Ranging Method	2 bits	00 – Initial Ranging over two symbols 01 – Initial Ranging over four symbols 10 – BW Request/Periodic Ranging over one symbol 11 – BW Request/Periodic Ranging over three symbols
}		
AAS_Comp_DL_IE()	50 bits	
HCS	8 bits	
}		

Table 270—Structure of AAS_COMP_DL_IE ()

Syntax	Size	Notes
AAS_COMP_DL_IE()		
CID	16 bits	
DIUC	4 bits	Set DIUC = 15 to indicate the well known modulation of QPSK, encoded with the mandatory CC at rate 1/2
OFDMA Symbol Offset	8 bits	
Subchannel offset	6 bits	
No of OFDMA Symbols	7 bits	
No of Subchannels	6 bits	
Boosting	3 bits	
}		

8.4.4.6.3 AAS Downlink Preamble

The AAS-DLFP is preceded by an AAS downlink preamble. In addition, the “Preamble Presence” field of the AAS_DLFP indicates the presence of an AAS downlink preamble on any downlink allocation made by the DLFP. An AAS downlink preamble is formed by appropriately combining different preamble sequences defined in 8.4.6.1.1. An AAS allocation could be in the FUSC/PUSC/AMC allocation and therefore, depending on the type of allocation, a preamble may span more than one original preamble sequence defined in 8.4.6.1.1. In AMC allocation, the AAS downlink preamble occupies 9 subcarriers in each bin of the subchannels in AAS operation. The AAS down link preamble number, K , is derived from the AAS beam index carried by the AAS_DLFP(), and is limited to maximum 16 beams per segment (mainly in switching beams approach). When using the cyclic frequency shift preamble defined in 8.4.5.3.11, beams that use the same subchannels at the same time instance shall use a different AAS down link preamble number (K).

8.4.4.6.4 AAS Uplink Preamble

The “Preamble Presence” field of the AAS_DLFP indicates the presence of a preamble on any uplink bandwidth allocation made by the DLFP. The “Uplink_Preamble_Config” field indicates the size of the AAS uplink preamble. In the PUSC region, the AAS uplink preambles occupy 4 subcarriers and 1/2/3 symbols. The basic AAS preamble (4 subcarrier \times 1 symbol for PUSC or 9 subcarrier \times 1 symbol for AMC or 3 subcarrier \times 1 symbol for optional PUSC) is derived from the preambles defined in 8.4.6.1.1 similar to the downlink. In AMC allocation, the AAS uplink preamble occupies 9 subcarriers in each bin of the subchannels and 1, 2, or 3 symbols as specified in the AAS-DLFP.

8.4.4.7 Optional Direct Signaling Method

The purpose of the AAS-DLFP2 using the direct signaling method is to provide a robust transmission of the basic base station parameters to enable AAS SS initial ranging and access requests. Once initial ranging is successful, the SS is provisioned with AAS signaling and training codes that provide the mechanism to adapt the antenna arrays at the base station (and SS). The SS can then receive compressed DL-Map and UL-Map messages from the base station with the required antenna array gain. Additionally, Method 2 provides multi-user beamforming in K spatial channels (where $K < M$ antennas) that transport private access requests and private bandwidth allocations.

The AAS-DLFP2 message is sent in the BW allocation/access channel. This channel is constructed by using paired partitions in the frame. A partition is defined as a region that is $1 \text{ bin} \times J \text{ symbol slots}$ where J is the number of symbol slots in a frame and an AMC bin is 9 adjacent subcarriers as defined in Figure 238. Only the transfer of basic base station parameters is conducted without beamforming using the most robust form of modulation and coding (namely QPSK-1/2 rate) together with redundant transmission that exploits spatial/spectral beam diversity.

Method 2 supports the ability to transmit UL and DL MAPs simultaneously to multiple users on the BW allocation/access channel and to provide lower latency, direct AAS paging method described in the following text once these maps are received. The direct method provides the capability to start multiple data flows per frame in multiple regions of the frame over K spatial channels per region.

8.4.4.7.1 Framing

At least one BW allocation/access (BWAA) channel is allocated in the TDD AAS frame for network entry, ranging, bandwidth request, and AAS MAP communications. One BWAA channel is shown in Figure 225. Up to four of these channels may be provisioned as indicated in AAS-DLFP2. The location is identified in the UL-MAP as Initial-Ranging (UIUC=12), but shall be marked by an AAS initial ranging CID to ensure that no non-AAS subscribers use this region for initial ranging. The channel is formed using the first and last partition in the frame to improve channel reliability and SINR through beamforming and diversity combining methods. In the case that multiple BW allocation/access channels are specified, the first channel shall be constructed from the first partition and the partition indexed by $P-(N_{ac}-1)$ where P is the number of partitions and N_{ac} is the number of BW allocation/access channels provisioned. AAS with FDHC (subclause 8.4.8.1.3) is used as the combining method on the BWAA channel. The channel is power boosted.

At least one BW allocation/access channel is provisioned per RF channel. In addition, sectorized base stations provision at least one BWAA channel per sector. For the case where the RF band has been divided into sub-bands, at least one BWAA channel is provisioned per sub-band.

The BW allocation/access channel is contention based. If collisions occur, SSSs use the random back-off algorithm to randomize retry timing per 6.3.8. By using the signaling methods described below, an AAS base station is able to spatially separate K subscriber stations on the BWAA channel. This minimizes contention and linearly increases the number of logical BW allocation/access channels in proportion to the number of antennas used in the antenna array.

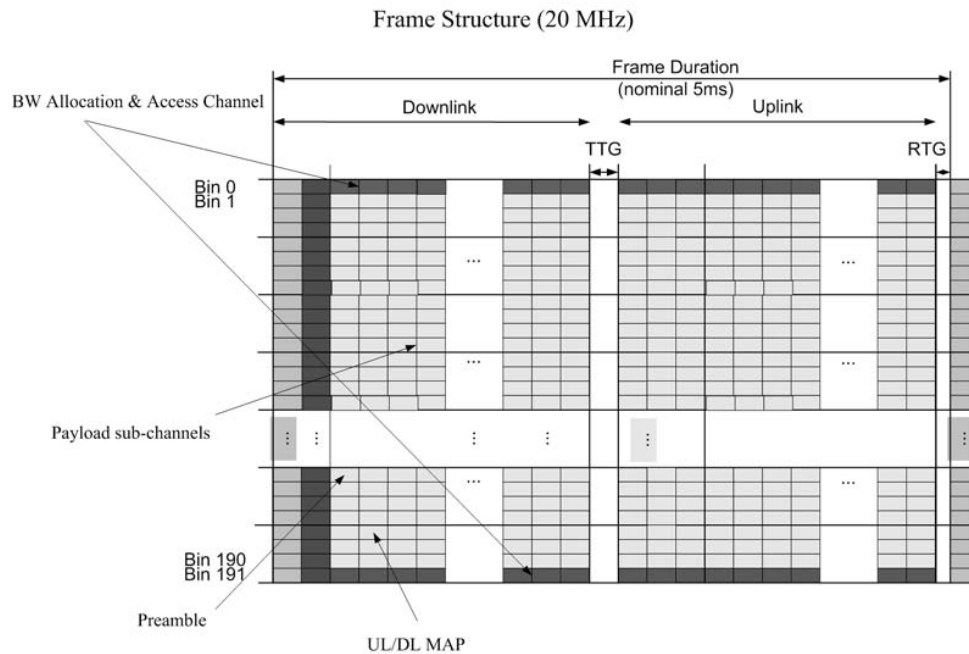

The structure of the BW allocation/access channel is illustrated in Figure 226. In this figure, the two partitions forming the BW allocation/access channel are shown. This channel immediately follows the FUSC/PUSC DL and UL Map region in the downlink frame and is identified uniquely by the AAS AMC preamble. The channel shows a DLFP zone using fourth-order beam-pattern diversity and a payload region of six subchannels for the frame duration illustrated by this example. Two AAS control signals are also shown (FLI and FLT), which will be described the text below. Table 271 provides the AAS-DLFP2 data structure. This 6-byte data structure is repeated four times. It provides the necessary information for initial ranging and for reception of the initial ranging response messages to included the basic CID. This CID maps one-to-one into the Reverse Link Training (RLT) sequence index. The RLT is transmitted by the SS and is used to adapt the base station array. The data subchannels shown in Figure 226 support DL MAP and UL MAP messages.

Access/SICH Partition

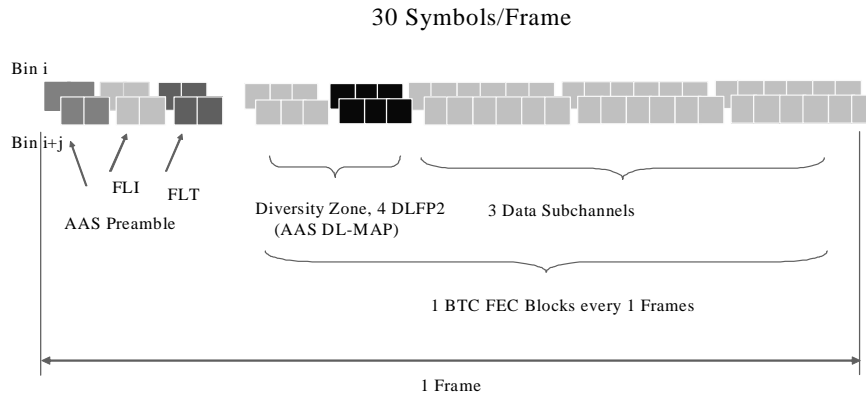

Page 2

Figure 226—Downlink BW Allocation/Access channel

Table 271—AAS-DLFP2 Structure, Directed Signaling

Syntax	Size	Notes
AAS-DLFP2() {		
Frame_Number	4 bits	4 LSB of Frame Number field as specified in Table 273
Base Station ID	4 bits	4 LSB
Multiframe	2 bits	00 = 1 frame per multiframe 01 = 2 frames per multiframe 10 = 4 frames per multiframe 11 = <i>Reserved</i>
Uplink_Training_Config Downlink_Paging_Config AMC Subchannel Definition	2 bits	00 – 1x4 Training sequence 01 – 2x2 Training sequence 10 – 2x4 Training sequence 11 – 1x8 Training sequence 0x – 1-FLI Paging sequence 1x – 2-FLI Paging sequence x0 – 1 bin x 6 slots subchannel x1 – 2 bins x 3 slots subchannel
Number of Access/DLFP Channels	2 bits	00 – 1 Channels 01 – 2 Channels 10 – 3 Channels 11 – 4 Channels
Initial Access Codes	4 bits	

Table 271—AAS-DLFP2 Structure, Directed Signaling (continued)

Syntax	Size	Notes
BS_EIRP+ EIRxP_{I_{rmax}}	16 bits	
BW Allocation	1 bit	0 = UL/DL map only 1 = UL/DL map w/ direct signaling
HCS	8 bits	
<i>reserved</i>	5 bits	Shall be set to zero
}		

8.4.4.7.2 TDD Framing

In the informative text that follows, which describes this signaling, the example AAS system a frame duration of 5 ms and 48 OFDMA symbols per frame. The frame contains 192 bins \times 48 symbols slots for the 20 MHz RF channel described here. It is assumed for illustration purposes that 33 symbols are allocated to the forward link and 15 symbols are allocated to the reverse link resulting in 2 to 1 asymmetry (as determined by the base station) in the forward and reverse link rates. An AAS subchannel is defined as six consecutive bins in time (1 bin \times 6 symbol slots). An alternate AAS subchannel, defined as a 2 bins \times 3 symbols cluster, is also supported as defined in the AAS-DLFP2. Mandatory CC coding and optional BTC or CTC FEC is supported by this frame structure. Figure 225 illustrates an AAS frame comprised of a forward and reverse link data area, the downlink preamble, map area, and dedicated BW allocation/access channel.

8.4.4.7.3 Reverse link AAS control signals

The reverse link partition in the TDD RL subframe is shown in Figure 227 for one of P ($P = 192$ for 20 MHz) partitions. The reverse link in this example provides 15 symbol slots and is organized as two AAS subchannels. One of the 2 AAS subchannels contains one AAS reverse link control signal that is transmitted once every multiframe. A multiframe is 1, 2, or 4 frames.

Two physical layer control signals are defined for the reverse link. The first is a reverse link training (RLT) signal, which allows an SS to send an AAS training signal to the base for a given subchannel. The RLT provides the time-bandwidth product necessary to adapt up to 12 antennas at the base station. The RLT signal shall occur at the beginning of the reverse link frame as shown in Figure 227 and is sent alternately every frame, every other frame, or every fourth frame as provisioned by the “multiframe parameter” in the AAS-DLFP2. MAC messages or traffic data are sent after the RLT in the first data subchannel and in subsequent subchannels thereafter also shown in Figure 227. The RLT occupies a maximum of eight symbol slots per partition providing 64 QPSK symbols for base station training. When used with fewer antennas, the RLT may be set to 32 QPSK symbols spanning 4 symbol slots to minimize training overhead. In addition, the RLT symbol sequence may span two adjacent bins. Accordingly, supported RLT cluster configurations are 1 \times 8, 1 \times 4, 2 \times 4, and 2 \times 2 (bins \times symbol slots).

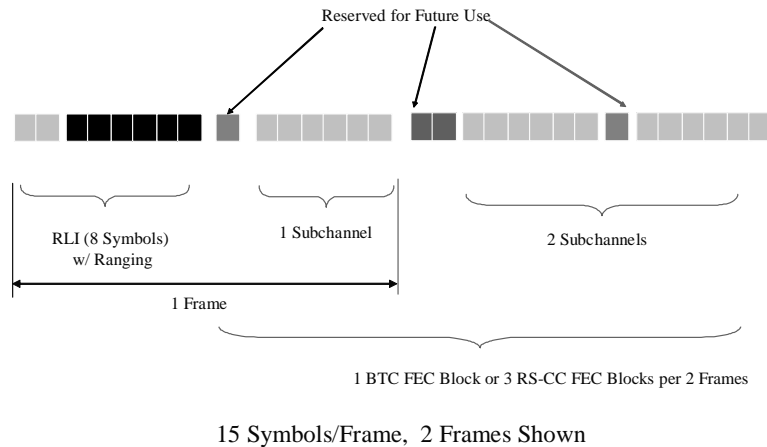

Page 3

Figure 227—Reverse link AAS subframe structure showing RLT signaling

The second control signal is the reverse link access (RLA) signal. The SS uses the RLA to train the base station antenna array on the BWAA channel. The RLA is sent ahead of the BW request message to inform the base that it has information to send on the uplink. The reverse link access partition is identical to the traffic partition shown in Figure 227 and the RLA sequence is identical to the RLT. The base in turn, with coordination through its scheduling mechanism, sets up traffic subchannels using map allocations followed by direct forward link control signaling as described below if enabled.

8.4.4.7.4 Forward link AAS control signals

The forward link partition is shown in Figure 228 for one of 192 partitions. The forward link partition in this example provides 33 symbol slots and is organized as five AAS subchannels. One of the five AAS subchannels contains three forward link control signals of two types applied once every multiframe.

There are two types of AAS control signals used by the forward link. The first is the forward link initiation (FLI) signal. The FLI signals to the SS to initiate communications on traffic subchannels. This “paging” and “link initiation” signal is shown for the downlink frame structure shown in Figure 228 and has coding unique to an SS. One or two FLI signals are provisioned per AAS signaling subchannel in every multiframe frame. Each FLI signal modulates 16 tones (1 bin \times 2 symbol slots) with 16 QPSK symbols. The FLI provides 12 dB (or 15 dB with soft combining) of processing gain to signal subscriber stations without directed beam steering knowledge.

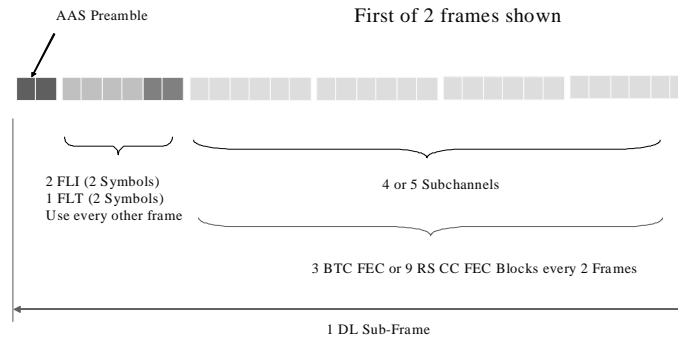

Figure 228—Forward link subframe structure showing FLI and FLT signaling

The forward link training (FLT) signal opportunity occupies the two bins located after the two FLI opportunities. The FLT transmits a known training sequence unique to the SS so that an SS can estimate and update the vector channel response. The FLT is sent in TDD systems with full beamforming gain. Multiple SSs may be trained on the same subchannel during the same time slot.

8.4.4.7.5 Forward and reverse link bandwidth Request/Grant, Ranging

If the RU is not yet ranged with the base station and hence, does not know the proper timing for reverse link transmissions, it randomly chooses an initial ranging access code, sends a RLA signal, detects a FLI response from the base, then adjusts its delay and transmit power based iteratively until an FLI is detected with maximum strength. This process is repeated until the best delay and transmit power have been identified. Once this has been accomplished, other periodic ranging mechanisms manage the transmit window time. The RU uses the RSS derived from forward link preamble measurements and the Base Station EIRP to set its initial transmit power level during initial ranging.

8.4.4.7.6 PHY layer control signal sequencing

The AAS physical layer is controlled via the signaling sequences described in this subclause. The following list provides a list of sequence actions keyed to the sequence diagram shown in Figure 229. For the first case, a base station initiated data flows subsequent to the receipt of the DL_MAP and UL_MAP is considered.

The base station uses the assigned SS access code to open subchannel(s) to an SS:

- 1) Base station sends the FLI of the SS being addressed in the intended subchannel(s).
- 2) SS looks for its assigned FLI in all subchannels. When it receives a FLI in a subchannel, it starts transmitting its RLT in the next reverse link time slot, followed by data in the subchannel.
- 3) When base station receives the RLT, it performs the necessary training for both RL and FL directions. A beam is formed and the link is established.
- 4) Base station transmits FLT in forward link time slot and user data in the subsequent subchannel.

- 5) The (RLT + Data, FLT + Data) exchange continues as long as the subchannel is open. The absence of the FLT terminates the exchange.
- 6) When the exchange stops, the SS stops transmitting RLT.

The diagram on the left side of Figure 229 also illustrates the directed SS initiated connection. In this case, an RLA at step 0 is sent to the base station. The base station responds with a map allocation on the BWAA channel and FLIs and data in the appropriate data regions. The control sequence then is identical to the base initiated connection.

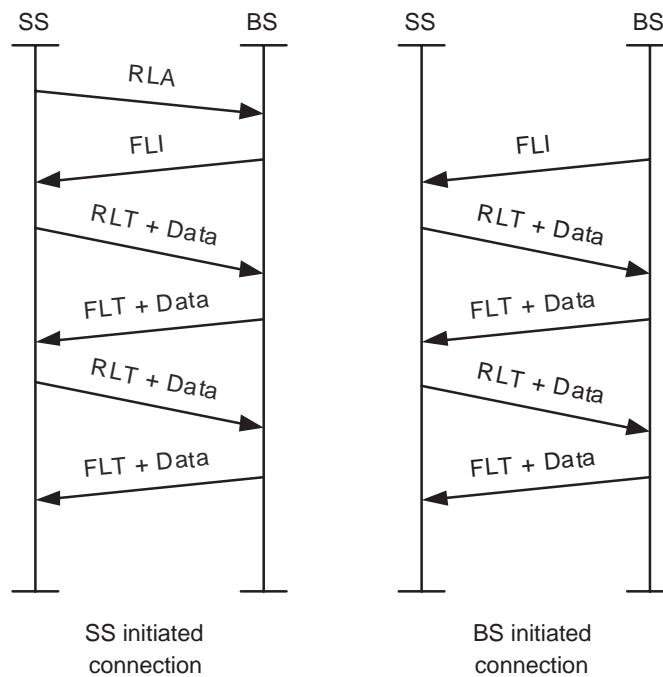

Figure 229—PHY control signal sequence diagrams

8.4.4.7.7 Granularity

In the illustrated multiframe structure (see 8.4.4.7.3), an SS is allocated a continuous set of AAS subchannels spanning two frames (10 ms). The following table tabulates the granularity of bandwidth allocation in this scenario with forward and reverse link asymmetry parameter set to 50%.

Table 272—Bandwidth Granularity with AAS and AMC subchannels

Modulation Scheme	Bytes / subchannel	Bytes/10 ms (50% asymmetry)
QPSK 1/2	6	36
QPSK 3/4	9	54
16-QAM 1/2	12	72
16-QAM 3/4	18	108
64-QAM 1/2	18	108
64-QAM 2/3	24	144
64-QAM 3/4	27	162

8.4.4.7.8 AMC Subchannel definition

The AMC subchannel shall be defined as a region of 1 bin \times 6 symbol slots or 2 bins \times 3 symbol slots as configured in the AAS-DLFP2. The UL-MAP and DL-MAP IEs shall specify 192 (8 bits) bin locations in the frequency domain.

8.4.4.7.9 PHY control signaling and coding structure

The following subclauses describe the details of the AAS control signals.

8.4.4.7.9.1 RLT and RLA code properties

The properties of these signals are as follows:

- Provides a spatial training sequence for up to 12 antennas with the appropriate time bandwidth product.
- Provides unique SS identification at the base station. Both signals are detected with beamforming gain.
- Provides a fine ranging structure within the symbol modulation.
- 8064 codes are available based on 64 symbols.
- High probability of detection, low false alarm rate consistent with modest cross-correlation properties between assigned codes at various code delays.
- The same codes may be reused multiple times at the base station if sectors or sub-bands are used.
- Robust code reuse factor of 4 between base stations. Further code de-correlation occurs for distance base stations due to base station to base station range differences.
- The base station can separate multiple SS on the access subchannel using different RLAs.

8.4.4.7.9.2 RLT and RLA code construction

The RLT and RLA PHY control signals shall be based upon a compact 64 QPSK symbol message constructed from Hadamard sequences. The RLT and RLA shall be sent in the first symbol slots of the reverse link subframe. Each SS registered to a base is assigned a unique training and access code (RLT or RLA). The code index shall have a one-to-one mapping with the basic CID. The RLT and RLA code construction is identical. The RLT/RLAs shall be inserted into AAS partitions only at the start of the multiframe in the zeroth frame number of the zeroth partition and in the first frame of the first partition, etc. until the pattern repeats. The multiframe is defined in the AAS-DLFP2.

The access code may be reused from sub-band to sub-band or reused from sector to sector. Thus, within a given sub-band or sector, each SS has its own unique access code. There are a maximum of 8064 access codes. The access codes, $a = 2016t + c$, are divided into four equal sets; $0 \leq t < 4$, where t is the base descriptor code. Each set of 2016 access codes is divided into three types with each type allocated a certain number of access codes: there are 2000 traffic access codes, c , for assigned SS: $0 \leq c \leq 1999$, there are eight access codes, c , for SS initial registration: $2000 \leq c \leq 2007$, and there are eight access codes, c , for SS initial ranging: $2008 \leq c \leq 2015$.

RLT and RLA codewords are based on Hadamard basis functions. RLTs and RLAs are described by an access index, a , $0 \leq a \leq 8064$. A codeword, $P_{i_1 i_0}$ contains 64 QPSK symbols and has in-phase and quadrature components taken from the columns of a 64 by 64 Hadamard matrix,

$$\begin{aligned} P_{i_1 i_0} &= AF_1 h_{i_1} + jAF_1 h_{i_0} & i_1 \neq i_0 \\ P_{i_3 i_2} &= AF_2 h_{i_1} + jAF_2 h_{i_0} & i_3 \neq i_2 \end{aligned} \quad (101)$$

where, h_{i_1} and h_{i_0} are different columns from the Hadamard matrix, A is an amplitude scaling factor and F_1 and F_2 are toggling matrices. The indices i_3 , i_2 , i_1 , and i_0 select a particular RLT code. For a given access index,

$$\begin{aligned} i_1 &= \text{mod}(a, 64) \\ i_0 &= \text{mod}(\lfloor a/64 \rfloor + i_1 + 1, 64) \end{aligned} \quad (102)$$

For two given column indices, the access code is,

$$a = 64 \text{mod}(i_0 - i_1 + 64, 64) + i_1 \quad (103)$$

8.4.4.7.9.3 FLI and FLT code properties

The FLI and FLT control signals are based upon a compact 16 QPSK tones (8 tones/symbols, 2 symbols) message constructed from Kronecker products. The properties of these signals are as follows:

- The FLT provides a vector channel training sequence for up to 4 degrees of freedom with the appropriate time bandwidth product.
- The FLT are multi-user directed transmissions and benefit from beamforming gain.
- The FLT and FLI are uniquely coded and assigned to the SS by the base station.
- 8064 codes are available based on 16 tones (8 tones/symbol, 2 symbols).
- High probability of detection, low false alarm rate consistent with modest cross-correlation properties between assigned codes at various code delays.
- The same codes may be reused multiple times at base station if sectors or sub-bands are used.
- Robust code reuse factor of 4 between base stations. Code de-correlation occurs for distance base stations due to base station to base station range differences.
- The FLI does identify which base is sending the FLI via recognition of the base descriptor code.

8.4.4.7.9.4 FLI and FLT code construction

Each SS registered with a base is assigned a unique link initiation and training code (FLI or FLT). Coding is the same for the FLI and FLT. There is a one-to-one mapping between the basic CID and FLI/FLT index. One or two FLI opportunities, as specified in the AAS-DLFP2, shall follow the AAS preamble in each partition. The FLT opportunity shall follow the last FLI. The FLI/FLTs shall be inserted into AAS partitions only at the start of the multiframe in the zero indexed frame number of the zero indexed partition and in the

first indexed frame of the first indexed partition, etc. until the pattern repeats. The multiframe is defined in the AAS-DLFP2.

The modulation on each tone of a FLI message is QPSK and thus can be represented by two bits of information. Each FLI message is described in a compact format by 32 bits: 16 tones by 2 bits per tone. A table can be used to represent these compact codewords. Annex B.5 lists 8064*2 FLI modulation codeword sequences, first codeword representing in-phase and second codeword representing quadrature-phase. Also, in each codeword, LSB represents lowest frequency tone and MSB represents highest frequency tone.

8.4.4.7.9.5 AAS preamble

The AAS preamble defines the AAS sub-region of the downlink subframe and shall be inserted as the first two symbol slots of the AAS partition as shown in Figure 226. The AAS preambles are based upon a compact 16 BPSK data symbol modulating the subcarriers in two adjacent AMC bins and is constructed by adaptively optimizing sequences based on the properties listed below:

- The AAS preamble provides a preamble structure permitting SSSs to rapidly acquire frequency, time, and frame, and multiframe synchronization with the base station
- The AAS preamble shall be placed at the beginning of the AAS region
- The AAS preamble codewords are selected so as to maximize the probability that the SS would lock onto the correct base, at the correct multiframe sequence, and the correct frequency.
- The AAS preamble provides a preamble sequence with up to K ($4 \leq K \leq 8$) degrees of freedom to enhance SINR and reduce interference via adaptive combining.
- The pattern of AAS preamble codewords is unique within a multiframe, and repeats from multiframe to multiframe.
- The AAS preamble transmission uses a random space/frequency weight vector. Each AAS preamble coding cluster, defined as a 2×2 cluster of adjacent bins uses a different weight vector in the same time epoch.
- 12 unique AAS preamble sequences indexed by base ID code are available.
- Robust code reuse factor of 12 between base stations.

8.4.4.7.9.6 AAS preamble construction

The AAS preamble is a constant modulus BPSK code unique to a given base station defining the AAS region of the frame. The code uses nonlinear phase construction and is uncorrelated to the codes used by the other bases. Furthermore, the codeword in the second AAS preamble symbol slot does not resemble a complex scalar multiplying the codeword in the first AAS preamble symbol slot. The code is split into two codewords for the two AAS symbol slots in a forward link. Each length 16 codewords modulates the data subcarriers in two adjacent bins (a bin pair).

The 32-element vector containing the code is multiplied by a pseudo random complex scalar for each of the K spread AAS preamble bin pairs. For each AAS preamble bin pair, the resulting 32 complex gain elements are split between the consecutive AAS symbol slots. The AAS preamble of the first symbol slot has the first 16 complex elements and the AAS preamble of the second symbol slot has the second 16 complex elements. The base then transmits the code over the assigned AAS preamble bins pairs.

An AAS base selects random transmit weight vectors for AAS preambles for each bin pair and spreading location. Each element of each transmit weight vector has the same amplitude and a randomly selected phase. The random number generator use at one base should not be correlated with or have the same repeat period as the generator of another bin pair of any base with a different base offset code.

Every base uses a particular set of AAS codewords. The base offset code associated with the base forms part of the AAS codewords used by that base. AAS codeword sequences, like the base offset codes, may be reused every 12 cells.

8.4.5 Map message fields and IEs

8.4.5.1 DL-MAP PHY Synchronization Field

The format of the PHY Synchronization Field of the DL-MAP message, as described in 6.3.2.3.2 or Compressed_DL-MAP, as defined in 8.4.5.6, is given in Table 273. The Frame Duration Codes are given in Table 274. The Frame number is incremented by one each frame and eventually wraps around to zero.

Table 273—OFDMA PHY Synchronization Field

Syntax	Size	Notes
PHY_synchronization_field() {		
Frame duration code	8 bits	
Frame number	24 bits	
}		

A BS shall generate DL-MAP messages in the format shown in Table 16, including all of the following parameters:

Frame number

The frame number is incremented by 1 MOD 2^{24} each frame.

Frame Duration Code

The frame duration Code values are specified in Table 274.

8.4.5.2 Frame duration codes

Table 274 defines the various frame durations that are allowed. The frame durations defined in the table indicate the periodicity of the downlink frame start preamble in both FDD and TDD cases.

Table 274—OFDMA frame duration (T_F ms) codes

Code (N)	Frame duration (ms)	Frames per second
0	N/A	AAS-only gap up to 200 ms following (see 8.4.6.3)
1	2	500
2	2.5	400
3	4	250
4	5	200
5	8	125
6	10	100
7	12.5	80
8	20 ms	50
9–255	<i>reserved</i>	

Note that the frame durations indicated in Table 274 typically are not integer multiples of one OFDMA symbol duration. Therefore some time padding may be necessary between the last useful OFDMA symbol of a frame and the beginning of the next frame. In addition, in the TDD case, note that the RTG and TTG guard intervals must be included in a frame. Both RTG and TTG shall be no less than 5 μ s in duration.

8.4.5.3 DL-MAP IE format

The OFDMA DL-MAP IE defines a two-dimensional allocation pattern as defined in Table 275:

Table 275—OFDMA DL-MAP_IE format

Syntax	Size	Notes
DL-MAP_IE() {		
DIUC	4 bits	
if (DIUC == 15) {		
Extended DIUC dependent IE	<i>variable</i>	See subclauses following 8.4.5.3.1
} else {		
if (INC_CID == 1) {		The DL-MAP starts with INC_CID = 0. INC_CID is toggled between 0 and 1 by the CID-SWITCH_IE() (8.4.5.3.7)
N_CID	8 bits	Number of CIDs assigned for this IE
for ($n=0$; $n < N_CID$; $n++$) {		
CID	16 bits	
}		
}		
OFDMA Symbol offset	8 bits	
Subchannel offset	6 bits	
Boosting	3 bits	000: normal (not boosted); 001: +6dB; 010: -6dB; 011: +9dB; 100: +3dB; 101: -3dB; 110: -9dB; 111: -12dB;
No. OFDMA Symbols	7 bits	
No. Subchannels	6 bits	
Repetition Coding Indication	2 bits	0b00 – No repetition coding 0b01 – Repetition coding of 2 used 0b10 – Repetition coding of 4 used 0b11 – Repetition coding of 6 used
}		
}		

DIUC

DIUC used for the burst.

Connection Identifier (CID)

Represents the assignment of the IE to a broadcast, multicast, or unicast address.

OFDMA Symbol offset

The offset of the OFDMA symbol in which the burst starts, measured in OFDMA symbols from beginning of the downlink frame in which the DL-MAP is transmitted.

Subchannel offset

The lowest index OFDMA subchannel used for carrying the burst, starting from subchannel 0.

Boosting

Indication whether the subcarriers for this allocation are power boosted.

No. OFDMA Symbols

The number of OFDMA symbols that are used (fully or partially) to carry the downlink PHY Burst.

No. of subchannels

The number of subchannels with subsequent indexes, used to carry the burst.

Repetition coding Indication

Indicates the repetition code used inside the allocated burst.

8.4.5.3.1 DIUC allocation

Table 276 defines the DIUC encoding that should be used in the DL-MAP IEs.

Table 276—OFDMA DIUC values

DIUC	Usage
0–12	Different burst profiles
13	Gap/PAPR reduction
14	End of map
15	Extended DIUC

DIUC = 0 shall have burst profile parameters that are the same as those used for transmission of the DL-MAP message.

DIUC = 13 may be used for allocation of Subchannels for PAPR reduction schemes. DIUC = 13 may also be used by the BS to create coverage enhancing safety zones. This is intended to provide reduced interference zones within the coverage area of the BS. The reduced interference zones are useful when the BS interfere with other BS. In such situations, the reduced interference zones may be used by the interfered BS to transmit data to SS that are registered with it, which would otherwise suffer from interference.

8.4.5.3.2 DL-MAP extended IE format

A DL-MAP IE entry with a DIUC value of 15, indicates that the IE carries special information and conforms to the structure shown in Table 277. A station shall ignore an extended IE entry with an extended DIUC value for which the station has no knowledge. In the case of a known extended DIUC value but with a length field longer than expected, the station shall process information up to the known length and ignore the remainder of the IE.

Table 277—DL-MAP extended IE format

Syntax	Size	Notes
DL_Extended_IE() {		
Extended DIUC	4 bits	0x00..0x0F
Length	4 bits	Length in bytes of Unspecified data field
Unspecified data	<i>variable</i>	
}		

8.4.5.3.3 AAS IE format

Within a frame, the switch from non-AAS to AAS-enabled traffic is marked by using the extended DIUC = 15 with the AAS_DL_IE() to indicate that the subsequent allocations, until the start of the first UL-MAP allocation using TDD, and until the end of the frame using FDD, shall be for AAS traffic. When used, the CID in the DL-MAP_IE() shall be set to the broadcast CID. All DL bursts in the AAS portion of the frame may be preceded by a preamble based on the indication in the AAS_DL_IE(). The preamble is defined in 8.4.6.1.1, and shall be selected to have the same segment number as the DL frame preamble, and the cell ID shall equal to $(DL\text{-Preamble } ID_{cell} + 16) \bmod 32$. The preamble shall exist only on those subchannels used by the DL burst.

Table 278—OFDMA downlink AAS IE

Syntax	Size	Notes
AAS_DL_IE() {		
Extended DIUC	4 bits	AAS = 0x02
Length	4 bits	Length = 0x03
Permutation	2 bits	0b00 = PUSC permutation 0b01 = FUSC permutation 0b10 = Optional FUSC permutation 0b11 = adjacent-subcarrier permutation
Preamble indication	2 bits	0b00 = No preamble 0b01 = Preamble used 0b10-0b11 = <i>Reserved</i>
First bin index	6 bits	When Permutation=0b10, this indicates the index of the first band allocated to this AMC segment
Last bin index	6 bits	When Permutation=0b10, this indicates the index of the last band allocated to this AMC segment
}		

8.4.5.3.4 Transmit diversity (TD)/Zone switch IE format

In the DL-MAP, a BS may transmit DIUC=15 with the TD_ZONE_IE() to indicate that the subsequent allocations shall use a specific permutation, or be transmit diversity encoded. The downlink frame shall start in PUSC mode with IDcell = 0 and no transmit diversity. Allocations subsequent to this IE shall use the permutation and transmit diversity mode it instructs.

Table 279—OFDMA downlink TD_ZONE IE format

Syntax	Size	Notes
TD_ZONE_IE() {		
Extended DIUC	4 bits	TD/ZONE_SWITCH = 0x01
Length	4 bits	Length = 0x02
Permutation	2 bits	0b00 = PUSC permutation 0b01 = FUSC permutation 0b10 = Optional FUSC permutation 0b11 = Adjacent subcarrier permutation
Use All SC indicator	1 bits	0 = Do not use all subchannels 1 = Use all subchannels
Transmit Diversity	2 bits	0b00 = No transmit diversity 0b01 = STC using 2 antennas 0b10 = STC using 4 antennas 0b11 = FHDC using 2 antennas
Matrix Indicator	2 bits	Antenna STC/FHDC matrix (see 8.4.8) 0b00 = Matrix A 0b01 = Matrix B 0b10 = Matrix C (applicable to 4 antennas only) 0b11 = <i>Reserved</i>
IDcell	6 bits	
<i>reserved</i>	2 bits	Shall be set to zero
}		

Permutation

Indicates the permutation that shall be used by the transmitter for allocations following this IE. Permutation changes are only allowed on a zone boundary. The IDcell indicated by the IE shall be used as the basis of the permutation (see 8.4.6.1).

Use All SC indicator

When set, this indicator indicates transmission on all available subchannels. For FUSC permutation, transmission is always on all subchannels.

Transmit diversity

Indicates the transmit diversity mode that shall be used by the transmitter for allocations following this IE (see 8.4.8). All allocations without transmit diversity shall be transmitted only from one antenna (antenna 0). The BS shall transmit from both its antennas for all allocations with transmit diversity.

8.4.5.3.5 Channel measurement IE

An extended IE with an extended DIUC value of 0x00 is issued by the BS to request a channel measurement report (see 6.3.15). The IE includes an 8-bit Channel Nr value as shown in Table 280.

Table 280—OFDMA channel measurement IE

Syntax	Size	Notes
Channel_Measurement_IE() {		
Extended DIUC	4 bits	CHM = 0x00
Length	4 bits	Length = 0x04
Channel Nr	8 bits	Channel number (see 8.5.1) Set to zero for licensed bands
OFDMA symbol offset	8 bits	
CID	16 bits	Basic CID of the SS for which the Channel measurement IE is directed
}		

8.4.5.3.6 Data location in another BS IE

In the DL-MAP, a BS may transmit DIUC=15 with the Data_location_in_another_BS_IE() to indicate that data is transmitted to the SS through another BS. This IE shall be sent right after the IE defining the same data received in the current BS.

Table 281—OFDMA Data location in another BS IE

Syntax	Size	Notes
Data_location_in_another_BS_IE() {		
Extended DIUC	4 bits	Data_location_in_another_BS = 0x3
Length	4 bits	Length = 0x0A
<i>reserved</i>	6 bits	Shall be set to zero
Segment	2 bits	Segment number
Used subchannels	6 bits	Used subchannels at other BS Bit #0: 0–11 Bit #1: 12–19 Bit #2: 20–31 Bit #3: 32–39 Bit #4: 40–51 Bit #5: 52–59
IDcell	5 bits	Cell ID of other BS
Frame Advance	3 bits	The number of frames offset from the current frame where the data will be transmitted (0 = Next frame)
OFDMA Symbol offset	8 bits	

Table 281—OFDMA Data location in another BS IE (continued)

Syntax	Size	Notes
Subchannel offset	6 bits	
Boosting	3 bits	000: normal (not boosted); 001: +6dB; 010: -6dB; 011: +9dB; 100: +3dB; 101: -3dB; 110: -9dB; 111: -12dB;
No. OFDM Symbols	8 bits	
No. Subchannels	6 bits	
Repetition Coding Indication	2 bits	00 – No repetition coding 01 – Repetition coding of 2 used 10 – Repetition coding of 4 used 11 – Repetition coding of 6 used
}		

8.4.5.3.7 CID Switch IE

In the DL-MAP, a BS may transmit DIUC=15 with the CID-Switch_IE() to toggle the inclusion of the CID parameter in DL-MAP allocations. The DL-MAP shall begin in the mode where CIDs are not included. The first appearance of the CID-Switch_IE() shall toggle the DL-MAP mode to include CIDs. Any subsequent appearance of the CID-Switch_IE() shall toggle the DL-MAP CID inclusion mode.

Table 282—OFDMA downlink CID Switch IE format

Syntax	Size	Notes
CID-Switch_IE() {		
Extended DIUC	4 bits	CID-Switch = 0x04
Length	4 bits	Length = 0x00
}		

8.4.5.3.8 MIMO DL basic IE format

In the DL-MAP, a MIMO-enabled BS may transmit DIUC = 15 with the MIMO_DL_Basic_IE() to indicate the MIMO configuration of the subsequent downlink allocation to a specific MIMO-enabled SS CID. The MIMO mode indicated in the MIMO_DL_Basic_IE() shall only apply to the subsequent downlink allocation until the end of frame.

Table 283—MIMO DL basic IE format

Syntax	Size	Notes
MIMO_DL_Basic_IE () {		
Extended DIUC	4 bits	MIMO = 0x05
Length	4 bits	Length of the message in bytes (variable)
Num_Region	4 bits	
for (i = 0; i < Num_Region; i++) {		
OFDMA Symbol offset	10 bits	
Subchannel offset	5 bits	
Boosting	3 bits	
No. OFDMA Symbols	9 bits	
No. subchannels	5 bits	
Matrix_indicator	2 bits	STC matrix (see 8.4.8.1.4.) Transmit_diversity = transmit diversity mode indicated in the latest TD_Zone_IE(). if (Transmit_Diversity == 0b01) { 00 = Matrix A 01 = Matrix B 10 – 11 = Reserved } elseif (Transmit_Diversity == 0b10) { 00 = Matrix A 01 = Matrix B 10 = Matrix C 11 = Reserved }
Num_layer	2 bits	
for (j = 0; j < Num_layer; j++) {		
if (INC_CID == 1) {		
CID	16 bits	
}		
Layer_index	2 bits	
DIUC	4 bits	
}		
}		
}		

Num_Region

This field indicates the number of the regions defined by OFDMA_Symbol_offset, Subchannel_offset, Boosting, No_OFDMA_Symbols and No_subchannels in this IE.

Matrix_indicator

The values of these two bits indicate the STC matrix (see 8.4.8.1.4).

Num_layer

The value of these 2 bits plus one indicate the number of MIMO transmission layers.

Layer_index

This field specifies the layer index.

8.4.5.3.9 MIMO DL Enhanced IE format

In the DL-MAP, a MIMO-enabled BS may transmit DIUC = 15 with the MIMO_DL_Enhanced_IE() to indicate the MIMO mode of the subsequent downlink allocation to a specific MIMO-enabled SS identified by the CQICH_ID previously assigned to the SS. The MIMO mode indicated in the MIMO_DL_Enhanced_IE() shall only apply to the subsequent downlink allocation until the end of frame.

Table 284—MIMO DL enhanced IE format

Syntax	Size	Notes
MIMO_DL_Enhanced_IE() {		
Extended DIUC	4 bits	EN_MIMO = 0x06
Length	4 bits	Length of the message in bytes (variable)
Num_Region	4 bits	
for (i = 0; i < Num_Region; i++) {		
OFDMA Symbol offset	10 bits	
Subchannel offset	5 bits	
Boosting	3 bits	
No. OFDMA Symbols	9 bits	
No. subchannels	5 bits	
Matrix_indicator	2 bits	STC matrix (see 8.4.8.1.4.) Transmit_diversity = transmit diversity mode indicated in the latest TD_Zone_IE(). if (Transmit_Diversity == 0b01) { 00 = Matrix A 01 = Matrix B 10 – 11 = Reserved } elseif (Transmit_Diversity == 0b10) { 00 = Matrix A 01 = Matrix B 10 = Matrix C 11 = Reserved }
Num_layer	2 bits	
for (j = 0; j < Num_layer; j++) {		
if (INC_CID == 1) {		

Table 284—MIMO DL enhanced IE format (continued)

Syntax	Size	Notes
CQICID	<i>variable</i>	Index to uniquely identify the CQICH resource assigned to the SS. The size of this field is dependent on system parameter defined in DCD.
}		
Layer_index	2 bits	
DIUC	4 bits	
}		
}		
}		

Num_Region

This field indicates the number of the regions defined by OFDMA_Symbol_offset, Subchannel_offset, Boosting, No_OFDMA_Symbols and No_subchannels in this IE.

Matrix_indicator

The values of these two bits indicate the STC matrix (see 8.4.8.1.4).

CQICH_ID

This is the CQICH_ID assigned to an SS in the CQICH_Alloc_IE(). The CQICH_ID is used to uniquely identify an SS that is assigned a CQICH.

Num_layer

The value of these 2 bits plus one indicate the number of MIMO transmission layers.

Layer_index

This field specifies the layer index.

8.4.5.3.10 H-ARQ MAP Pointer IE

This IE shall only be used by a BS supporting H-ARQ, for SS supporting H-ARQ.

Table 285—H-ARQ MAP pointer IE format

Syntax	Size	Notes
MIMO_DL_Enhanced_IE() {		
Extended DIUC	4 bits	HARQ_P = 0x07
Length	4 bits	Length = 0x02
AMC DIUC	4 bits	Indicates the AMC level of the burst containing a H-ARQ MAP message.
No. Slots	8 bits	The number of slots allocated for the burst containing a H-ARQ MAP message.
<i>reserved</i>	4 bits	Shall be set to zero.
}		

AMC DIUC

Indicates the burst profile used for the H-ARQ MAP message.

No. Slots

The number of OFDMA slots allocated for the burst containing a H-ARQ MAP message. The H-ARQ MAP message shall directly follows the DL MAP, the number of the slots allocated for the H-ARQ MAP message.

8.4.5.3.11 DL-MAP Physical Modifier IE

The Physical Modifier Information Element indicates that the subsequent allocations shall utilize a preamble, which is either cyclically delayed in time or cyclically rotated in frequency.

In the case when the preamble is cyclically delayed in time by k samples, the preamble will contribute a component $s(t)$ to the transmitted waveform as defined in Equation (104).

$$s(t) = \operatorname{Re} \left\{ e^{2j\pi f_c t} \sum_{\substack{k = -N_{used}/2 \\ k \neq 0}}^{k = N_{used}/2} c_k \times e^{2j\pi k/N_{FFT}} \right\} \quad (104)$$

where c_k are the preamble tone values, and t is the time, elapsed since the beginning of the OFDMA symbol, with $0 < t < T_s$. The PHYMOD_DL_IE can appear anywhere in the DL map, and it shall remain in effect until another PHYMOD_DL_IE is encountered, or until the end of the DL map.

In the case when the preamble is cyclically shifted in frequency, the preamble subcarriers will be shifted such that:

$$C_{New,K} = (C_{Original} + 5 \cdot K) \bmod N_{Used-Subcarriers} \quad (105)$$

Where $C_{New,K}$ is the new subcarrier index and $C_{Original}$ is the original subcarrier index, and K is the frequency shift index indicated in the PHYMOD_DL_IE.

Table 286—OFDMA DL-MAP Physical Modifier IE format

Syntax	Size	Notes
PHYMOD_DL_IE() {		
Extended DIUC	4 bits	PHYMOD = 0x08
Length	4 bits	Length = 0x03
Preamble Modifier Type	1 bit	0 – Randomized preamble 1 – Cyclically shifted Preamble
if (Preamble Modifier Type == 0) {		
Preamble frequency shift index	4 bits	Indicates the value of K in Equation (105)
} else {		
Time index shift type	1 bit	0 – Rounded down shift 1 – Exact shift
if (Time index shift type == 0) {		

Table 286—OFDMA DL-MAP Physical Modifier IE format (continued)

Syntax	Size	Notes
Preamble Time Shift Index	4 bits	For PUSC, 0 – 0 sample cyclic shift 1 – $\text{floor}(N_{FFT}/14)$ sample cyclic shift 13 – $\text{floor}(N_{FFT}/14*13)$ sample cyclic shift 14-15 – reserved For AMC permutation, 0 – 0 sample cyclic shift 1 – $\text{floor}(N_{FFT}/9)$ sample cyclic shift 8 – $\text{floor}(N_{FFT}/9*8)$ sample cyclic shift 9-15 – reserved
} else {		
Preamble Time Shift Index	4 bits	For PUSC, 0 – 0 sample cyclic shift 1 – $\text{floor}(N_{FFT}/14)$ sample cyclic shift 13 – $\text{floor}(N_{FFT}/14*13)$ sample cyclic shift 14-15 – reserved For AMC permutation, 0 – 0 sample cyclic shift 1 – $\text{floor}(N_{FFT}/9)$ sample cyclic shift 8 – $\text{floor}(N_{FFT}/9*8)$ sample cyclic shift 9-15 – reserved
}		
}		
<i>reserved</i>	2 bits	Shall be set to zero
}		

Preamble Modifier Type

This parameter defines whether the preamble will be cyclically shifted in time or in frequency.

Preamble frequency shift index

This parameter effects the cyclic shift of the preamble in frequency axis, as defined by Equation (105).

Preamble Time Shift Index

This parameter defines how many samples of cyclic shift shall be introduced into the preamble symbols. The unit of cyclic shift depends on the subchannel permutation to ensure the frequency-domain orthogonality between the different preambles in the same subchannel.

8.4.5.4 UL-MAP IE format

The OFDMA UL-MAP IE defines uplink bandwidth allocations. If OFDMA UL-MAP IE with UIUC = 12 or UIUC = 13 exists, they must be always allocated first. The first OFDMA UL-MAP IE, with UIUC other than 12 or 13, shall start at the lowest numbered non-allocated subchannel on the first non-allocated OFDMA symbol defined by the allocation start time field of the UL-MAP message that is not allocated with UIUC = 12 or UIUC = 13 (See Figure 217 for an example). These IEs shall represent the number of slots provided for the allocation. Each allocation IE shall start immediately following the previous allocation and

shall advance in the time domain. If the end of the UL frame has been reached, the allocation shall continue at the next subchannel at first OFDMA symbol (define by the allocation start time field) that is not allocated with UIUC = 12 or UIUC = 13. The CID represents the assignment of the IE to either a unicast, multicast, or broadcast address. A UIUC shall be used to define the type of uplink access and the burst type associated with that access. A Burst Descriptor shall be specified in the UCD for each UIUC to be used in the UL-MAP. The format of the UL-MAP IE is defined in Table 287.

Table 287—OFDMA UL-MAP IE format

Syntax	Size	Notes
UL-MAP_IE() {		
CID	16 bits	
UIUC	4 bits	
if (UIUC == 12) {		
OFDMA Symbol offset	8 bits	
Subchannel offset	7 bits	
No. OFDMA Symbols	7 bits	
No. Subchannels	7 bits	
Ranging Method	2 bits	0b00 – Initial Ranging over two symbols 0b01 – Initial Ranging over four symbols 0b10 – BW Request/Periodic Ranging over one symbol 0b11 – BW Request/Periodic Ranging over three symbols
<i>reserved</i>	1 bit	Shall be set to zero
} else if (UIUC == 14) {		
CDMA_Allocation_IE()	32 bits	
} else if (UIUC == 15) {		
Extended UIUC dependent IE	<i>variable</i>	See subclauses following 8.4.5.4.3
} else {		
Duration	10 bits	In OFDMA slots (see 8.4.3.1)
Repetition coding indication	2 bits	0b00 – No repetition coding 0b01 – Repetition coding of 2 used 0b10 – Repetition coding of 4 used 0b11 – Repetition coding of 6 used
}		
Padding nibble, if needed	4 bits	Completing to nearest byte, shall be set to 0.
}		

CID

Represents the assignment of the IE.

UIUC

UIUC used for the burst.

OFDMA Symbol offset

The offset of the OFDMA symbol in which the burst starts, the offset value is defined in units of OFDMA symbols and is relevant to the Allocation Start Time field given in the UL-MAP message.

Subchannel offset

The lowest index subchannel used for carrying the burst, starting from subchannel 0. When allocation of mini-subchannels is used, this offset will always be even numbered and will point to the first subchannel of the couple splitted into mini-subchannels and used in the allocation.

No. OFDMA Symbols

The number of OFDMA symbols that are used to carry the uplink Burst.

No. subchannels

The number of subchannels with subsequent indices.

Duration

Indicates the duration, in units of OFDMA slots, of the allocation.

Repetition coding indication

Indicates the repetition code used inside the allocated burst.

8.4.5.4.1 UIUC Allocation

Table 288 defines the UIUC encoding that should be used in the UL-MAP_IE().

Table 288—OFDMA UIUC values

UIUC	Usage
0	FAST-FEEDBACK Channel
1–10	Different burst profiles
11	End of Map IE
12	CDMA Bandwidth Request, CDMA ranging
13	PAPR reduction allocation, Safety zone
14	CDMA Allocation IE
15	Extended UIUC

The UIUC = 13 is used for allocation of Subchannels for PAPR reduction schemes. These tones may be used by all SSs to reduce PAPR of their transmissions. Alternatively, it can also be used by the BS to create coverage enhancing safety zones for uplink. This is intended to provide reduced interference zones within the coverage area of the SS. The reduced interference zones are useful when the SS in the neighboring BS are near the cell edge and interfering with SS in the current BS. In such situations, the reduced interference zones may be used by the SS in the neighboring BS so that the SS in the current BS do not suffer from interference.

NOTE—The CDMA allocation UIUC provides (among other things) a function similar to the initial ranging UIUC used in other PHY options; therefore, instructions that relate to messages transmitted in the initial ranging UIUC shall apply to messages transmitted in the CDMA allocation UIUC as well.

8.4.5.4.2 PAPR reduction/Safety zone allocation IE

Table 289 defines the PAPR reduction allocation and safety zone allocation IE. This IE is identified by UIUC = 13.

Table 289—PAPR reduction and safety zone allocation IE format

Syntax	Size	Notes
PAPR_Reduction_and_Safety_Zone_Allocation_IE() {		
OFDMA symbol offset	8 bits	
Subchannel offset	7 bits	
No. OFDMA symbols	7 bits	
No. subchannels	7 bits	
PAPR Reduction/Safety Zone	1 bit	0 = PAPR reduction allocation 1 = Safety zone allocation
<i>reserved</i>	2 bits	Shall be set to zero
}		

OFDMA Symbol offset

The offset of the OFDMA symbol in which the burst starts, the offset value is defined in units of OFDMA symbols and is relevant to the Allocation Start Time field given in the UL-MAP message.

Subchannel offset

The lowest index subchannel used for carrying the burst, starting from subchannel 0.

No. OFDMA Symbols.

The number of OFDMA symbols that are used to carry the uplink Burst.

Number of subchannels

The number subchannels with subsequent indexes, used to carry the burst.

8.4.5.4.3 CDMA allocation UL-MAP IE format

Table 290 defines the UL-MAP_IE for allocation of bandwidth to a user that requested bandwidth using a CDMA request code. This IE is identified by UIUC = 14.

Table 290—CDMA Allocation IE format

Syntax	Size	Notes
CDMA_Allocation_IE() {		
Duration	6 bits	
Repetition Coding Indication	2 bits	0b00 – No repetition coding 0b01 – Repetition coding of 2 used 0b10 – Repetition coding of 4 used 0b11 – Repetition coding of 6 used
Ranging Code	8 bits	

Table 290—CDMA Allocation IE format (continued)

Syntax	Size	Notes
Ranging Symbol	8 bits	
Ranging subchannel	7 bits	
BW request mandatory	1 bit	1= yes, 0= no
}		

Duration

Indicates the duration, in units of OFDMA slots, of the allocation.

Repetition coding indication

Indicates the repetition code used inside the allocated burst.

Ranging Code

Indicates the CDMA Code sent by the SS.

Ranging Symbol

Indicates the OFDMA symbol used by the SS.

Ranging subchannel

Identifies the Ranging subchannel used by the SS to send the CDMA code.

BW request mandatory

Indicates whether the SS shall include a Bandwidth (BW) Request in the allocation.

8.4.5.4.4 UL-MAP extended IE format

A UL-MAP IE entry with a UIUC value of 15, indicates that the IE carries special information and conforms to the structure shown in Table 291. A station shall ignore an extended IE entry with an extended UIUC value for which the station has no knowledge. In the case of a known extended UIUC value but with a length field longer than expected, the station shall process information up to the known length and ignore the remainder of the IE.

Table 291—OFDMA UL-MAP extended IE format

Syntax	Size	Notes
UL_Extended_IE() {		
Extended UIUC	4 bits	0x00..0x0F
Length	4 bits	Length in bytes of Unspecified data field
Unspecified data	<i>variable</i>	
}		

8.4.5.4.5 Power Control IE format

When a power change for the SS is needed, the extended UIUC = 15 may be used with the subcode 0x00 and with 8-bit power control value as shown in Table 292. The power control value is an 8-bit signed integer expressing the change in power level (in 0.25 dB units) that the SS should apply to correct its current transmission power.

The CID used in the IE should be the Basic CID of the SS.

Table 292—OFDMA Power Control IE

Syntax	Size	Notes
Power_Control_IE() {		
Extended UIUC	4 bits	Fast power control = 0x00
Length	4 bits	Length = 0x01
Power control	8 bits	Signed integer, which expresses the change in power level (in 0.25 dB units) that the SS should apply to correct its current transmission power.
}		

8.4.5.4.6 AAS IE format

Within a frame, the switch from non-AAS to AAS-enabled traffic is marked by using the extended UIUC = 15 with the AAS_UL_IE() to indicate that the subsequent allocation until the end of the frame shall be for AAS traffic. When used, the CID in the UL-MAP_IE() shall be set to the broadcast CID. All UL bursts in the AAS portion of the frame may be preceded by a preamble based on the indication in the AAS_UL_IE(). The preamble is defined in 8.4.9.4.3.1

Table 293—OFDMA uplink AAS IE

Syntax	Size	Notes
AAS_UL_IE() {		
Extended UIUC	4 bits	AAS = 0x02
Length	4 bits	Length = 0x03
Permutation	2 bits	0b00 = PUSC permutation 0b01 = Optional PUSC permutation 0b10 = adjacent-subcarrier permutation 0b11 = <i>Reserved</i>
OFDMA symbol offset	8 bits	
Preamble indication	2 bits	0b00 = No preamble 0b01 = Preamble used 0b10-0b11 = <i>Reserved</i>
First bin index	6 bits	When Permutation = 0b10, this indicates the index of the first band allocated to this AMC segment
Last bin index	6 bits	When Permutation = 0b10, this indicates the index of the last band allocated to this AMC segment
}		

8.4.5.4.7 UL Zone switch IE format

In the UL-MAP, a BS may transmit UIUC = 15 with the ZONE_IE() to indicate that the subsequent allocations shall use a specific permutation. The uplink frame shall start in PUSC mode with UL_IDcell as indicated in the UCD message. Allocations subsequent to this IE shall use the permutation it instructs.

Table 294—OFDMA uplink ZONE IE format

Syntax	Size	Notes
ZONE_IE() {		
Extended DIUC	4 bits	ZONE = 0x04
Length	4 bits	Length = 0x03
OFDMA symbol offset	7 bits	
Permutation	2 bits	0b00 = PUSC permutation 0b01 = PUSC permutation 0b10 = Optional PUSC permutation 0b11 = Adjacent subcarrier permutation
PUSC UL_IDcell	7 bits	
}		

OFDMA symbol offset

The offset of the OFDMA symbol in which the zone starts, the offset value is defined in units of OFDMA symbols and is relevant to the Allocation Start Time field given in the UL-MAP message.

Permutation

Indicates the permutation that shall be used by the transmitter for allocations following this IE. Permutation changes are only allowed on a zone boundary. The UL_IDcell indicated by the IE shall be used as the basis of the permutation (see 8.4.6.2.2, 8.4.6.2.3).

8.4.5.4.8 Mini-subchannel allocation IE

The mini-subchannel allocation IE is used for subdividing subchannels into mini-subchannels. This IE uses the extended UIUC = 15 with the subcode 0x01 with the structure shown in Table 295. The CID in the UL-MAP when using the mini-subchannel allocation IE shall be set to the broadcast CID.

Table 295—Mini-subchannel allocation IE format

Syntax	Size	Notes
Mini_subchannel_allocation_IE() {		
Extended DIUC	4 bits	Mini_subchannel_allocation = 0x01
Length	4 bits	Length(M) = 0x03 if $M=2$ 0x04 if $M=3$ 0x06 if $M=6$
CType	2 bits	0b00 – 2 mini-subchannels (defines $M=2$) 0b01 – 2 mini-subchannels (defines $M=2$) 0b10 – 3 mini-subchannels (defines $M=3$) 0b11 – 6 mini-subchannels (defines $M=6$)

Table 295—Mini-subchannel allocation IE format (continued)

Syntax	Size	Notes
Duration	10 bits	In OFDMA slots
For ($j=0; j<M; j++$) {		
CID(j)	16 bits	
UIUC(j)	4 bits	Allowed values are 1–10
Repetition(j)	2 bits	Indicates the repetition code used inside the allocated burst for minisubchannel with index j 0b00 – No repetition coding 0b01 – Repetition coding of 2 used 0b10 – Repetition coding of 4 used 0b11 – Repetition coding of 6 used
}		
Padding	n bits	Padding bits shall be set to zero $n = 0$ if $M=2$ 2 if $M=3$ 0 if $M=6$
}		

Ctype

Defines M , the number of mini-subchannels allocated by this IE.

Duration

Defines the allocation duration in OFDMA slots. The duration shall be an integer multiple of M .

CID(j)

CID to use for mini-subchannel with index j .

UIUC(j)

UIUC to use for mini-subchannel with index j . Allowed values are 1–10.

Repetition(j)

Indicates the repetition code used inside the allocated burst for mini-subchannel with index j .

8.4.5.4.9 FAST-FEEDBACK message mapping

Each FAST-FEEDBACK message occupies one UL slot. FAST-FEEDBACK messages are mapped in to the region marked by UIUC=0 in the UL-MAP, in a time-first order, as shown in Figure 230.

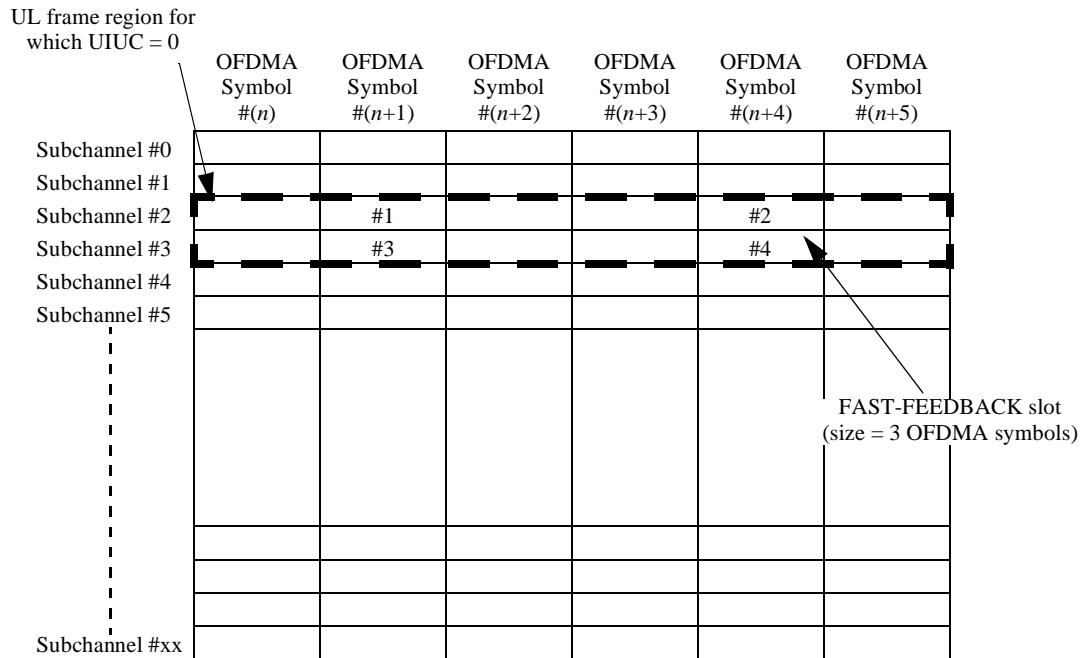

Figure 230—Mapping order of FAST-FEEDBACK messages to the FAST-FEEDBACK region

8.4.5.4.10 FAST_FEEDBACK channels

Fast feedback slots may be individually allocated to SS for transmission of PHY related information that requires fast response from the SS. The allocations are done in unicast manner through the FAST_FEEDBACK MAC subheader (see 6.3.2.2.6), and the transmission takes place in a specific UL region designated by UIUC = 0.

Each Fast-feedback slot consists of 1 OFDMA slots mapped in a manner similar to the mapping of normal uplink data. A fast feedback slot uses QPSK modulation on the 48 data subcarriers it contains, and can carry a data payload of 4 bits. Table 296 defines the mapping between the payload bit sequences and the subcarriers modulation.

Table 296—FAST_FEEDBACK channel subcarrier modulation

4 bit payload	Fast Feedback vector indices per Tile Tile(0), Tile(1), ... ,Tile(5)
0b0000	0,0,0,0,0,0
0b0001	1,1,1,1,1,1
0b0010	2,2,2,2,2,2
0b0011	3,3,3,3,3,3

Table 296—FAST_FEEDBACK channel subcarrier modulation (continued)

4 bit payload	Fast Feedback vector indices per Tile Tile(0), Tile(1), ... ,Tile(5)
0b0100	4,4,4,4,4,4
0b0101	5,5,5,5,5,5
0b0110	6,6,6,6,6,6
0b0111	7,7,7,7,7,7
0b1000	0,1,2,3,4,5
0b1001	1,2,3,4,5,6
0b1010	2,3,4,5,6,7
0b1011	3,4,5,6,7,0
0b1100	4,5,6,7,0,1
0b1101	5,6,7,0,1,2
0b1110	6,7,0,1,2,3
0b1111	7,0,1,2,3,4

The fast-feedback code words used in Table 296 belong to a set of orthogonal vectors and are mapped directly to the subcarriers (see 8.4.9.4.2), where subcarriers(0) is the lowest numbered data subcarrier in the tile, and the tile indices are defined by the permutation (see 8.4.6.2). The vectors are defined in Table 297.

Table 297—FAST_FEEDBACK subcarrier modulation in each vector

Vector index	Data subcarrier modulation per Code word Subcarrier(0), Subcarrier(1), ... Subcarrier(7)
0	$P_0, P_1, P_2, P_3, P_0, P_1, P_2, P_3$
1	$P_0, P_3, P_2, P_1, P_0, P_3, P_2, P_1$
2	$P_0, P_0, P_1, P_1, P_2, P_2, P_3, P_3$
3	$P_0, P_0, P_3, P_3, P_2, P_2, P_1, P_1$
4	$P_0, P_0, P_0, P_0, P_0, P_0, P_0, P_0$
5	$P_0, P_2, P_0, P_2, P_0, P_2, P_0, P_2$
6	$P_0, P_2, P_0, P_2, P_2, P_0, P_2, P_0$
7	$P_0, P_2, P_2, P_0, P_2, P_0, P_0, P_2$

Where,

$$\begin{aligned}
 P0 &= \frac{1}{\sqrt{2}} \cdot \exp\left(j \cdot \frac{\pi}{4}\right) \\
 P1 &= \frac{1}{\sqrt{2}} \cdot \exp\left(j \cdot \frac{3\pi}{4}\right) \\
 P2 &= \frac{1}{\sqrt{2}} \cdot \exp\left(-j \cdot \frac{3\pi}{4}\right) \\
 P3 &= \frac{1}{\sqrt{2}} \cdot \exp\left(-j \cdot \frac{\pi}{4}\right)
 \end{aligned} \tag{106}$$

The fast feedback slot includes 4 bits of payload data, whose encoding depended on the instruction given in the FAST_FEEDBACK subheader. The following subclauses define these encodings.

8.4.5.4.10.1 Fast DL measurement feedback

When the FAST_FEEDBACK subheader Feedback Type field is “00” the SS shall report the S/N it measures on the DL. Equation (107) shall be used:

$$\text{Payload bits nibble} = \begin{cases} 0 & S/N < -2dB \\ n & 2 \cdot n - 4 < S/N < 2 \cdot n - 2 \quad 0 < n < 15 \\ 15 & S/N > 26dB \end{cases} \tag{107}$$

8.4.5.4.10.2 Fast MIMO feedback

When the FAST_FEEDBACK subheader Feedback Type field is “01” or “10” the SS shall report the MIMO coefficient the BS should use for best DL reception (see 8.4.8.1.6). The mapping for the complex weights is shown in Figure 231.

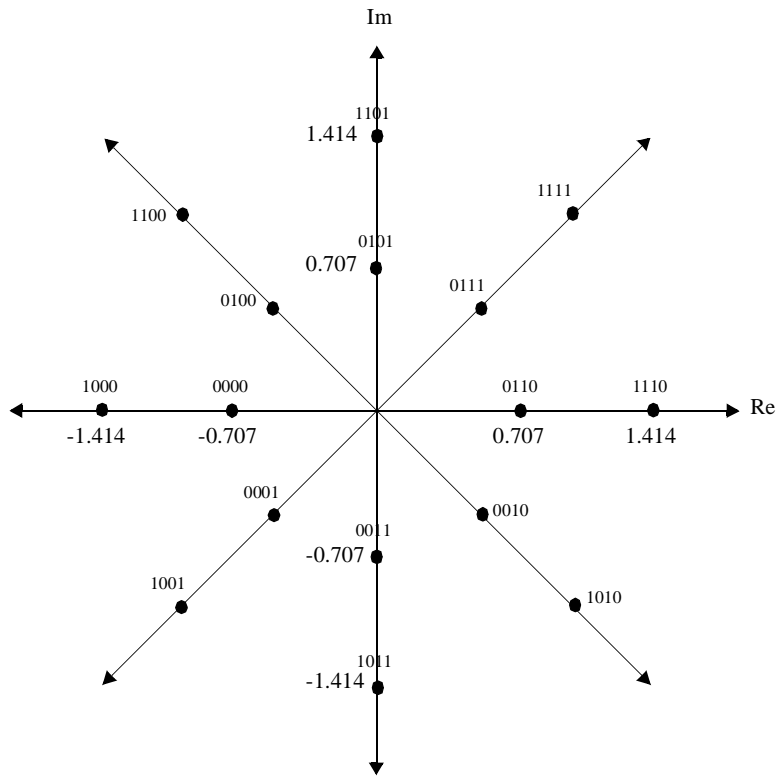

Figure 231—Mapping of MIMO coefficients to fast MIMO feedback payload bits

8.4.5.4.10.3 Mode Selection Feedback

When the FAST-FEEDBACK subheader Feedback Type field is “11” or at a specific frame indicated in the CQICH_Alloc_IE(), the SS shall send its selection in terms of MIMO mode (STTD versus SM) or permutation mode on the assigned FAST-FEEDBACK channel. Table 298 shows the encoding of payload bits for the FAST-FEEDBACK slot (see 8.4.5.4.9).

Table 298—Encoding of payload bits for FAST-FEEDBACK slot

Value	Description
0b0000	STTD and PUSC/FUSC permutation
0b0001	STTD and adjacent-subcarrier permutation
0b0010	SM and PUSC/FUSC permutation
0b0011	SM and adjacent-subcarrier permutation
0b0100	<i>reserved</i>

8.4.5.4.11 MIMO UL Basic IE format

In the UL-MAP, a MIMO-enabled BS may transmit $UIUC = 15$ with the `MIMO_UL_Basic_IE()` to indicate the MIMO mode of the subsequent uplink allocation to a specific MIMO-enabled SS CID. The MIMO mode indicated in the `MIMO_UL_Basic_IE()` shall only apply to the subsequent uplink allocation until the end of frame (see Table 299).

Table 299—MIMO UL basic IE format

Syntax	Size	Notes
<code>MIMO_UL_Basic_IE () {</code>		
Extended DIUC	4 bits	MIMO = 0x02
Length	4 bits	Length of the message in bytes (variable)
Num_Assign	4 bits	Number of burst assignment
For ($j=0; j<Num_assign; j++$) {		
CID	16 bits	SS basic CID
UIUC	4 bits	
MIMO_Control	1 bit	For dual transmission capable SS 0: STTD 1: SM For Collaborative SM capable SS 0: pilot pattern A 1: pilot pattern B
Duration	10 bits	In OFDMA slots (see 8.4.3.1)
}		
}		

Num_assign

This field specifies the number of assignments in this IE.

MIMO_Control

MIMO_Control field specifies the MIMO mode of UL burst. For a dual transmission-capable SS, the value of 0 indicates STTD mode, the value of 1 indicates SM mode. For a collaborative SM-capable SS, the value of 0 indicates pilot pattern A, the value of 1 indicates pilot pattern B.

8.4.5.4.12 CQICH Allocation IE Format

CQICH_Alloc_IE(), is introduced to dynamically allocate or de-allocate a CQICH to an SS. Once allocated, the SS transmit channel quality information on the assigned CQICH on every subsequent frames, until the SS receives a CQICH_Alloc_IE() to de-allocate the assigned CQICH.

Table 300—CQICH alloc IE format

Syntax	Size	Notes
CQICH_Alloc_IE() {		
Extended DIUC	4 bits	CQICH = 0x03
Length	4 bits	Length of the message in bytes (variable).
CQICH_ID	variable	Index to uniquely identify the CQICH resource assigned to the SS. The size of this field is dependent on system parameter defined in DCD.
Allocation offset	6 bits	Index to the fast feedback channel region marked by UIUC = 0.
Period (p)	2 bits	A CQI feedback is transmitted on the CQICH every 2 ^p frames.
Frame offset	3 bits	The SS starts reporting at the frame of which the number has the same 3 LSB as the specified frame offset. If the current frame is specified, the SS should start reporting in eight frames
Duration (d)	3 bits	A CQI feedback is transmitted on the CQI channels indexed by the CQICH_ID for 10 × 2 ^d frames. If d == 0, the CQI-CH is deallocated. If d == 0b111, the SS should report until the BS command for the SS to stop.
MIMO_permutation_feedback_cycle	2 bits	0b00 = No MIMO and permutation mode feedback 0b01 = The MIMO and permutation mode indication shall be transmitted on the CQICH indexed by the CQICH_ID every four frames. The first indication is sent on the eighth CQICH frame. 0b10 = The MIMO mode and permutation mode indication shall be transmitted on the CQICH indexed by the CQICH_ID every eight frames. The first indication is sent on the eighth CQICH frame. 0b11 = The MIMO mode and permutation mode indication shall be transmitted on the CQICH indexed by the CQICH_ID every 16 frames. The first indication is sent on the 16th CQICH frame.
Padding	<i>variable</i>	The padding bits is used to ensure the IE size is integer number of bytes.
}		

CQICH_ID

The CQICH_ID uniquely identifies a fast feedback channel on which an SS can transmit fast feedback information. With this allocation, a one-to-one relationship is established between the CQICH_ID and the SS.

MIMO_permutation_feedback_Cycle

This field specifies the MIMO and permutation mode fast feedback cycle. See 8.4.5.4.10.2 for fast feedback channel payload encoding for MIMO and permutation feedback.

8.4.5.4.13 UL ACK channel

The uplink ACK (Acknowledgement) provides feedback for Downlink Hybrid ARQ. This channel shall only be supported by SS supporting H-ARQ. The SS transmits ACK or NAK feedback for Downlink packet data. One ACK channel occupies half subchannel (three pieces of 3x3 uplink tile) of the PUSC optional permutation.

The ACK channel is orthogonally modulated. The acknowledgement bit B_n^{ACK} of the n -th ACK channel shall be “0” (ACK) if the corresponding downlink packet has been successfully received; otherwise, it shall be a “1” (NAK). The k -th orthogonal modulation symbol of the n -th ACK channel, $M_{n,k}^{ACK}$, ($k = 0, 1, \dots, 8$ and $n=0, 1, \dots, 1 - N_{ACK}$) is made as shown in Table 301.

Table 301—Orthogonal Modulation for ACK channel

B_n^{ACK}	$M_{n,k}^{ACK}$
0	1 1 1 1 1 1 1 1 1
1	$1 \exp\left(j \cdot \frac{2\pi}{3}\right) \exp\left(j \cdot \frac{4\pi}{3}\right) \exp\left(j \cdot \frac{2\pi}{3}\right) \exp\left(j \cdot \frac{4\pi}{3}\right)$ $1 \exp\left(j \cdot \frac{4\pi}{3}\right) \exp\left(j \cdot \frac{2\pi}{3}\right)$

Then the modulated symbols are mapped to the subcarriers allocated to the n -th ACK channel, as follows.

$$C_{n,k}^{ACK} = \begin{cases} M_{n,k}^{ACK} & \text{if } k = 0, 1, \dots, 8 \\ \exp\left(j \cdot \frac{2\pi}{3}\right) M_{n,k-9}^{ACK} & \text{if } k = 9, 10, \dots, 17 \\ \exp\left(j \cdot \frac{4\pi}{3}\right) M_{n,k-18}^{ACK} & \text{if } k = 18, 19, \dots, 26 \end{cases} \quad (108)$$

where

$C_{n,k}^{ACK}$ mapping symbol of the k -th ACK subcarrier in the n -th ACK channel,

$M_{n,k}^{ACK}$ modulation symbol index of the k -th modulation symbol made from the n -th ACK bit as shown in Table 301,

- n ACK channel index from the set $[0 \dots 1 - N_{ACK}]$,
 k ACK subcarrier index of an ACK channel from the set $[0 \dots 26]$.

8.4.5.4.14 UL-MAP Physical Modifier IE

The Physical Modifier Information Element indicates that the subsequent allocations shall utilize a preamble, which is either cyclically rotated in frequency or cyclically delayed [see Equation (104) and Equation (105)]. The PHYMOD_UL_IE can appear anywhere in the UL map, and it shall remain in effect until another PHYMOD_UL_IE is encountered, or until the end of the UL map.

Table 302—OFDMA UL-MAP Physical Modifier IE format

Syntax	Size	Notes
PHYMOD_UL_IE() {		
Extended UIUC	4 bits	PHYMOD = 0x05
Length	4 bits	Length = 0x03
Preamble Modifier Type	1 bit	0 – Randomized preamble 1 – Cyclically shifted Preamble
if (Preamble Modifier Type == 0) {		
Preamble frequency shift index	4 bits	Indicates the value of K in Equation (105)
} else {		
Preamble Time Shift Index	4 bits	Indicates the value of K in equation (1) For PUSC, 0 – 0 sample cyclic shift 1 – $\text{floor}(N_{FFT}/4)$ sample cyclic shift 3 – $\text{floor}(N_{FFT}/4*3)$ sample cyclic shift 4–15 – reserved For optional PUSC, 0 – 0 sample cyclic shift 1 – $\text{floor}(N_{FFT}/3)$ sample cyclic shift 2 – $\text{floor}(N_{FFT}/3*2)$ sample cyclic shift 3–15 – reserved For AMC permutation, 0 – 0 sample cyclic shift 1 – $\text{floor}(N_{FFT}/9)$ sample cyclic shift 8 – $\text{floor}(N_{FFT}/9*8)$ sample cyclic shift 9–15 – reserved
}		
<i>reserved</i>	7 bits	Shall be set to zero
}		

Preamble Modifier Type

This parameter defines whether the preamble will be cyclically shifted in time or in frequency.

Preamble frequency shift index

This parameter effects the cyclic shift of the preamble in frequency axis, as defined by Equation (105).

Preamble Time Shift Index

This parameter defines how many samples of cyclic shift shall be introduced into the preamble symbols. The unit of cyclic shift depends on the subchannel permutation to ensure the frequency-domain orthogonality between the different preambles in the same subchannel.

8.4.5.5 Burst profile format

Table 303 defines the format of the Downlink_Burst_Profile, which is used in the DCD message (6.3.2.3.1). The Downlink_Burst_Profile is encoded with a Type of 1, an 8-bit length, and a 4-bit DIUC. The DIUC field is associated with the Downlink Burst Profile and Thresholds. The DIUC value is used in the DL-MAP message to specify the Burst Profile to be used for a specific downlink burst.

Table 303—OFDMA Downlink_Burst_Profile TLV format

Syntax	Size	Notes
Downlink_Burst_Profile {		
Type=1	8 bits	
Length	8 bits	
<i>reserved</i>	4 bits	Shall be set to zero
DIUC	4 bits	
TLV encoded information	<i>variable</i>	
}		

Table 304 defines the format of the Uplink_Burst_Profile, which is used in the UCD message (6.3.2.3.1). The Uplink_Burst_Profile is encoded with a Type of 1, an 8-bit length, and a 4-bit UIUC. The UIUC field is associated with the Uplink Burst Profile and Thresholds. The UIUC value is used in the UL-MAP message to specify the Burst Profile to be used for a specific uplink burst.

Table 304—OFDMA Uplink_burst_profile TLV format

Syntax	Size	Notes
Uplink_Burst_Profile {		
Type=1	8 bits	
Length	8 bits	
<i>reserved</i>	4 bits	Shall be set to zero
UIUC	4 bits	
TLV encoded information	<i>variable</i>	
}		

8.4.5.6 Compressed maps

In addition to the standard DL-MAP and UL-MAP formats described in 6.3.2.3.2 and 6.3.2.3.4, the DL-MAP and UL-MAP may conform to the format presented in the following subclauses. The presence of the compressed DL-MAP format is indicated by the contents of the most significant two bits of the first data byte following the DL Frame Prefix. These bytes overlay the HT and EC bits of a generic MAC header. When these bits are both set to 1 (an invalid combination for a standard header), the compressed DL-MAP format is present. A compressed UL-MAP shall only appear after a compressed DL-MAP. The presence of a compressed UL-MAP is indicated by a bit in the compressed DL-MAP data structure.

8.4.5.6.1 Compressed DL-MAP

The compressed DL-MAP format is presented in Table 305. The message presents the same information as the standard format with one exception. In place of the DL-MAP's 48-bit Base Station ID, the compressed format provides a subset of the full value. When the compressed format is used, the full 48-bit Base Station ID shall be published in the DCD.

Table 305—Compressed DL-MAP message format

Syntax	Size	Notes
Compressed_DL-MAP() {		
Compressed map indicator	2 bits	Set to binary 11 for compressed format
<i>reserved</i>	1 bit	Shall be set to zero
UL-MAP appended	1 bit	
CRC appended	1 bit	
Map message length	11	
PHY Synchronization Field	32 bits	
DCD Count	8 bits	
Operator ID	8 bits	
Sector ID	8 bits	
DL IE count	8 bits	
for ($i = 1; i \leq \text{DL IE count}; i++$) {		
DL-MAP_IE()	<i>variable</i>	
}		
if !(byte boundary) {		
Padding Nibble	4 bits	Padding to reach byte boundary
}		
}		

Compressed map indicator

A value of binary 11 in this field indicates the map message conforms to the compressed format described here. A value of binary 00 in this field indicates the map message conforms to the standard format described in 6.3.2.3.2. Any other value is an error.

UL-MAP appended

A value of 1 indicates a compressed UL-MAP (see 8.5.5.2.4.2) is appended to the current compressed DL-MAP data structure

CRC appended

A value of one indicates a CRC-32 value is appended to the end of the compressed map(s) data. The CRC is computed across all bytes of the compressed map(s) starting with the byte containing the Compressed map indicator through the last byte of the map(s) as specified by the Map message length field. The CRC calculation is the same as that used for standard MAC messages. A value of zero indicates that no CRC is appended.

Map message length

This value specifies the length of the compressed map message(s) beginning with the byte containing the Compressed map indicator and ending with the last byte of the compressed DL-MAP message if the UL-MAP appended bit is not set or the last byte of the UL-MAP compressed message if the UL-MAP appended bit is set. The length includes the computed 32-bit CRC value if the CRC appended indicator is on.

PHY Synchronization

This field holds frame number and frame duration information. See 8.4.5.1 and Table 273

DCD Count

Matches the value of the configuration change count of the DCD, which describes the downlink burst profiles that apply to this map.

Operator ID

This field holds the least significant 8 bits of the most significant 24 bits of the 48-bit Base Station ID.

Sector ID

This field holds the least significant 8 bits of the 48-bit Base Station ID.

DL IE count

This field holds the number of IE entries in the following list of DL-MAP IEs.

8.4.5.6.2 Compressed UL-MAP

The compressed UL-MAP format is presented in Table 306. The message may only appear after a compressed DL-MAP message to which it shall be appended. The message presents the same information as the standard format with the exception that the Generic MAC header and the Uplink Channel ID are omitted.

Table 306—Compressed UL-MAP message format

Syntax	Size	Notes
Compressed_UL-MAP() {		
UCD Count	8 bits	
Allocation Start Time	32 bits	
while (map data remains){		
UL-MAP_IE()	<i>variable</i>	
}		
if !(byte boundary) {		
Padding Nibble	4 bits	Padding to reach byte boundary.
}		
}		

UCD Count

Matches the value of the Configuration Change Count of the UCD, which describes the uplink burst profiles that apply to this map.

Allocation Start Time

Effective start time of the uplink allocation defined by the UL-MAP.

8.4.5.7 AAS-FBCK-REQ/RSP message bodies

The format of the AAS Feedback Request message body is shown in Table 307.

Table 307—OFDMA AAS Feedback Request message body

Syntax	Size	Notes
OFDMA-AAS-FBCK-REQ_Message_Body() {		
Frame Number	8 bits	
Number of Frames	7 bits	
Measurement Data Type	1 bit	0 = measure on downlink preamble only 1 = measure on downlink data (for this SS) only
Feedback Request Counter	3 bits	
Frequency measurement resolution	2 bits	0b00 = 32 subcarriers 0b01 = 64 subcarriers 0b10 = 128 subcarriers 0b11 = 256 subcarriers
<i>reserved</i>	3 bits	Shall be set to zero
}		

Frame Number

The least significant 8 bits of the frame number in which to start the measurement.

Number of Frames

The number of frames over which to measure.

Feedback Request Counter

Increases every time an AAS-FBCK-REQ is sent to the SS. Individual counters shall be maintained for each SS. The value 0 shall not be used.

Frequency measurement resolution

Indicates the frequency measurement points to report on. Measurement points shall be on the frequencies corresponding to the negative subcarrier offset indices $-N_{used}/2 + n$ times the indicated subcarrier resolution and corresponding to the positive subcarrier offset indices $N_{used}/2 - n \times$ the indicated subcarrier resolution where n is a positive integer.

The format of the AAS Feedback Response message body is shown in Table 308.

Table 308—OFDMA AAS Feedback Response message body

Syntax	Size	Notes
OFDMA-AAS-FBCK-RSP_Message_Body() {		
<i>reserved</i>	2 bits	Shall be set to zero
Measurement data type	1 bit	0 = measure on downlink preamble only 1 = measure on downlink data (for this SS) only
Feedback Request Counter	3 bits	
Frequency measurement resolution	2 bits	
for (i=0; i<Number of Frequencies; i++){		
Re(Frequency_value [i])	8 bits	
Im(Frequency_value [i])	8 bits	
}		
RSSI mean value	8 bits	
CINR mean value	8 bits	
}		

Feedback Request Counter

Counter from the AAS-FBCK-REQ messages to which this is the response. The value 0 indicates that the response is unsolicited. In this case, the measurement corresponds to the preceding frame.

Re(**Frequency_value**[i]) and Im(**Frequency_value**[i])

The real (Re) and imaginary (Im) part of the measured amplitude on the frequency measurement point (low to high frequency) in signed integer fixed point format ([±][2 bits].[5 bits]).

RSSI mean value

The mean RSSI as measured on the element pointed to by data measurement type, frame number and number of frames in the corresponding request. The RSSI is quantized as described in 8.3.9.2. When the AAS feedback response is unsolicited, this value corresponds to preceding frame.

CINR mean value

The mean CINR as measured on the element pointed to by data measurement type, frame number, and number of frames in the corresponding request. The RSSI is quantized as described in 8.3.9.2. When the AAS feedback response is unsolicited, this value corresponds to preceding frame.

8.4.6 OFDMA subcarrier allocations

For OFDMA, $F_s = \text{floor}(8/7 \cdot BW/8000) \cdot 8000$. Subtracting the guard tones from N_{FFT} , one obtains the set of “used” subcarriers N_{used} . For both uplink and downlink, these used subcarriers are allocated to pilot subcarriers and data subcarriers. However, there is a difference between the different possible zones. For FUSC, in the downlink, the pilot tones are allocated first; what remains are data subcarriers, which are divided into subchannels that are used exclusively for data. For PUSC in the downlink or in the uplink, the set of used subcarriers is first partitioned into subchannels, and then the pilot subcarriers are allocated from within each subchannel. Thus, in FUSC, there is one set of common pilot subcarriers, but in PUSC, each subchannel contains its own set of pilot subcarriers.

8.4.6.1 Downlink

The downlink can be divided into a three segment structure and includes a preamble which begins the transmission. This preamble subcarriers are divided into three carrier-sets. There are three possible groups consisting of a carrier-sets each, that may be used by any segment.

A downlink period will follow Figure 232.

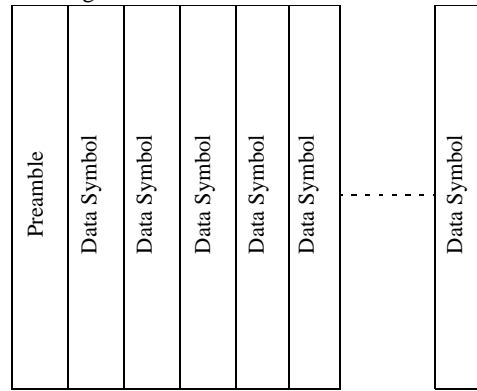

Figure 232—Downlink transmission basic structure

8.4.6.1.1 Preamble

The first symbol of the downlink transmission is the preamble; there are six types of preamble carrier-sets, those are defined by allocation of different subcarriers for each one of them; those subcarriers are modulated using a boosted BPSK modulation with a specific Pseudo-Noise (PN) code.

The preamble carrier-sets are defined using Equation (109).

$$PreambleCarrierSet_n = n + 3 \cdot k \quad (109)$$

where:

- $PreambleCarrierSet_n$ specifies all subcarriers allocated to the specific preamble,
- n is the number of the preamble carrier-set indexed 0...2,
- k is a running index 0...576.

Each segment uses two types of preamble out of the six sets in the following manner:

Each segment uses a preamble composed of a carrier-set out of the three available carrier-sets in the following manner: (In the case of segment 1, the DC carrier will not be modulated at all and the appropriate PN will be discarded; therefore, DC carrier shall always be zeroed. For segment 2, the last carrier shall not be modulated).

- Segment 0 uses preamble carrier-set 0
- Segment 1 uses preamble carrier-set 1
- Segment 2 uses preamble carrier-set 2

Therefore, each segment eventually modulates each third subcarrier. As an example, Figure 233 depicts the preamble of segment 1.

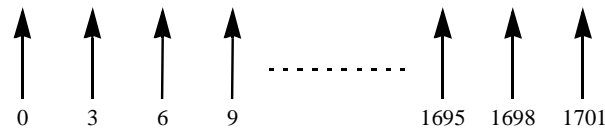

Figure 233—Downlink basic structure

The PN series modulating the pilots are defined in Table 309. The series modulated depends on the segment used and IDcell parameter. The defined series shall be mapped onto the preamble subcarriers in ascending order. Table 309 includes the PN sequence in an Hexadecimal format. The value of the PN is obtained by converting the series to a binary series (W_k) and starting mapping the PN from the MSB of each symbol to the LSB (0 mapped to +1 and 1 mapped to -1, for example for Index=0, segment =0, $W_k = 110000010010...$, and the mapping shall follow: -1 -1 +1 +1 +1 +1 -1 +1 +1 -1 +1 ...).

Table 309—Preamble modulation series per segment

Index	IDcell	Segment	Series to modulate (W_k)	PAPR (informative)
0	0	0	0xC12B7F736CFFB14B6ABF4EB50A60B7A3B4163EA3360F697C45075997ACE17BB1512C7C0CEBB34B389D8784553C0FC60BDE4F166CF7B04856442D97539FB915D80820CEDD858483	4.33
1	1	0	0xA9F7AC1BD0A4BD694D3EDC2991CC3B2D24BF26A22346F8DB370202CDA25D382D4119AAC676E320A938A95762C4078689B6024E477F0EDA8F563106F0D70EBE3E006F75B50B537D	4.21
2	2	0	0x56531FBB87033E4F362273BAF0F8879B45B9F19143E5494F7B025D138DF057756DE625196292AF6D28FD0AA08453E5B9871EDAE3E680B848C67BFBD7ADE73CFBBBA4E81191267A	4.32
3	3	0	0xB397F552DEB2717CC19DDF0D59674DD6F6D3866A3FD023A009F592B56460660F1D585E3078AFE272D97FDF4280790C3A9E5FCF9910895E9DAF2BF65728F7390C930428B4E6793C	4.36
4	4	0	0x1BD4C84B42DF6B7DC53F6C7B8E223A3B16D8E214CFA5469A8D22246BCF297E5F92159406608B8A0BB55EF64A85B1241C5CDFA048CF0492AB3BCF46A8E8FE986F06E246F1E06C68	4.49
5	5	0	0x4E00947B6722B09389EFB4F6951C488B368393E8254948359287441709C6F0E4463C067733C42A7FA89645D7D69AF2ACE5402AC473DBF2C75ECB8B630BAF4B27F282249BD52660	4.49
6	6	0	0x494CAB6935E10DB5D6E985997849EA45F0D5E2EDF7670BFD9643531760D9F7CC01DD63BEEDFECB7E806F3F189291C074C8289D93A95324D131391E23EB9CEEAB0E789DA1F5B9CB	4.35
7	7	0	0x4C5F10264D6C5085346E86BF8567294523C1B683D2A220D9BEDCEBBA110620BB53ECB0338BE7109240E22EC902FCA05F97338BB9DF2DDEAF7C795BCB160BD4F01A6DBF2A729373	4.48

Table 309—Preamble modulation series per segment (continued)

Index	IDcell	Segment	Series to modulate (W_k)	PAPR (informative)
8	8	0	0x79797D9AB260C20D5A460CDC49B2D0285E095E835EAF 2ECC74E010DD8A53797CE0EC2EEBA51E779AA6B749B8 E69FFDD632AC79D64143467E73017113BCDF45E787D0A9 EAC3D22E	4.48
9	9	0	0xA1B9AC2C3D5B9BAAE5067C9E4A83C167076BE7D8699 ACA710FF205DE774FD46DD5F7851A2149D61E57152B98B 6AF4194B6FED90ADA008D1D5F8DD87E8060F943BC9124 C1999236	4.55
10	10	0	066E5FA91D00D63B26036009F8C69142B9D936396FF9E137 86478BBFF5DE6F184A0F844663950F69AFEDEA93CA4A3 BF94B13175A2CBBA3836A34E5CE6D763767B35515F332D 836	4.54
11	11	0	0xF443E9FBF763DA2A5137A57C7DA504D194EC1797AD3 3365BAC2F0C94541F4D47A664A7A17308C37E06BB0826F F999C15EE430A3CC54159E3B7EEBD5FF307BB24A939AB 261E2B3C	4.53
12	12	0	0xF38BE6D2108483C056088C5E7C8BF92E9C973E0B2ADA 9342B46C06C4C2516CF7B9E6043E2947AD40F41734E02A9 ADCE9C70E03C4D50E7EAC73DAD56BDBB796289DDCC3 57776DE2	4.55
13	13	0	0x104AA84E70B163A42654A45995182B1C3DD63F4BCB09 ECA79A0D6D2D2A784DD6015794598310BE087F75019227 F899744B7C73A9008C83C0923D5DC154FB2DCBF8983E70 9BCDF3	4.54
14	14	0	0x0B49A507AC4EAAC7551FC4B00658A28D951FC81723C C1C024AAC6A9DE9686383C28036C762C020012D797866D E589B36BB95DFDAC2B3D0AB9DDE0B9719918062FE824E 063BA3EC	4.52
15	15	0	0x64C14C7D3725A74923E6B2FB1C3BDC77FEE58CB0AF3 10EC37F22C93E2C809AE8410963E6CF5E7E192502960F027 2244A31D2CDDC657BCFF422E29C50D5E82EDCB4457918 1BBA4D	4.41
16	16	0	0x210D8A8E602BD53F981BE763E10F4730BDA53D2F89BD 1D91C8F2DD5B96732935F789F643911937344E9F2ECF3222 AB076BC2B5EE407DC581F0EF9FFBD56D14D137A0418A DA06D0	4.47
17	17	0	0x88960A88E3F79C95D525DB49679C20A736D0E9E4D1FC B9DE7735AE1E947F4E93637E98143D6BB779394C58F2AC 5A9BD7B2074E98F1B2026B67B507CAAD8076082B09FB34 5DA02D	4.54
18	18	0	0x1D2D5C8CDEAFCA5EC180D9638CD0F277AF08AB5133 E6D60C919AADAD00569E5F902D40500542631FB729FC3A F456C9A47E3EB967D51E09D712D8D49A028E738BEC9006 1B089C9F	4.55
19	19	0	0xA063E03DE6C137F3FC56F970052BCF7333C8451BF5D18 D1B9AA5342E79C25451C1D862ECB5CFF21B7CC203817D 78C192EE1A68976652E1740C4B123552C85CEE524A2AA90 D428B	4..66

Table 309—Preamble modulation series per segment (continued)

Index	IDcell	Segment	Series to modulate (W_k)	PAPR (informative)
20	20	0	0xD2A7F126A9599093A9262E66A2471B6B6A2ACB0A4330A114011366CBC3B01CC85CF1915982BE64DDDF8EEA0985D8F47BC4B41381C58271C30578960EEFB054F299C721B81D5DFE	4.52
21	21	0	0x7682842351C76BC8E4A7EA4EDDB0F92F6E876FCDFDAA4987B38FC4FA47C52EF0070DCC8C77FA622B20BEB2373011660B4960EF49FB5E519D79E12029C7D13C553EDC48564A52	4.58
22	22	0	0xAD6143F875C4C965A7018B8230D8D50297DA2C54A6DD52EA6207620F4A66EAFEB4DD56233FF5DF78FB20CD74ECC6D01232FCFB9CBD36B3381F0224EF5DE7BE0AFEF0A1AEF3D82	4.63
23	23	0	0x9A14B722E05D8455A80B4A1B1D12A30C1E25D9488BAD486C639CC7BDF651E957E041A7C092A916BF3E3642121350579B3F8F8F4A30570237E722A6DC532A26F4FD4A0767D91A8B	4.72
24	24	0	0xE6944DEEE85D75E3C5D9B90912177D8A85909D87AC21FA4A51660E11D30DBEED391E5972D000EF4E9BF30B63B18C0285FE4151A4231C289A824D405142B7C775C3C68D8AA1D8A7	4.64
25	25	0	0x9927326FDFEC99025AA1B79364F06C63AFE4A96C2A20FF8B151EF97AFD08E161EA6B10A1FA74794521DE02645C2561D3BEA5D382AE3707112619403E23C724B36B791DFAFEAA3A	4.52
26	26	0	0x03C19F38117AE5BDADF256FB4A223A660E2D626598F56580E30FA2E40A521FE5D68709B7F62E4C08CB9A26AE12002AD2FA9DE6C2B298538556EFBA71626A02745C3DB5EBADD3F3	4.43
27	27	0	0xCBA035B40EB7C8A3A048C490E38935CBF956C58AFC891A6C112C0321CF5262498915794DCA703BD31A96FF4C0636F2D5E9F17C23F1486B90715597D565017CB8E424DE9A8E464E	4.76
28	28	0	0x9321B7BE085143649644BCDF8342FCAD3462DA1C572227B039BBC6F58B52EEED2ACFB38F9CAA2BA2F513A87B10DD19DEFB6A9972EE12D81C83DBFB3CFCC93D35ED252D0E1A3D1E	4.67
29	29	0	0x215F6EA7C7F95C74828485AABF6A5F54FD32D1A8F4F6F1C20E6CDB57FA81ED70DFE44ACCD4B37D4F01AD3BF31AFBB38A4DDBC613C8809E46C1247222E5041D8CDC08F37F679878	4.51
30	30	0	0xB5ABE9FC329600031F97DEA8CF5B17EC432BB9F19082A3CFA2682AAF121EE855873119A78869AF988BD90C64A7F31224727D22F74D7499AF6CD3B649C54AED6DC84DD8AB876B84	4.74
31	31	0	0x956D097E914338D226020B8A3BA5B3BB8733A9723CF19485DD9D22670B1328B825A6BA154586EDE60EB328AF8DF114182EDAEE401620A1E870BFFFF430922893C1F54A87A90BD3	4.78

Table 309—Preamble modulation series per segment (continued)

Index	IDcell	Segment	Series to modulate (W_k)	PAPR (informative)
32	0	1	0x251D994101EDA04D8BD0B8EA6FA20AE590C2CC199AB083C6AE61F091F2DD41D989EC164B1481D611BE9CEA0094AFE9DB56A4763F55B26E54EAB73ACD7D4BBA64C1421BC3EB9D67	4.61
33	1	1	0x113A5FB9C529AADC9CAB1FB882905601778659CDB69AFCBADD8F8B42314A7985B5F87C20692309D350454FF9326481683FADAE4711DD0CC5DACEDF7CD5DF1177D60EB A4DBE657F1	4.68
34	2	1	0x9F08189EFC6B5DE6C2CFD13195DE077586B8EE01E00B6468B10A53FAAC1DD846E2A01681980D444B6AD0D34C34EC9CFD9341507878EC9FBAE498F5A20614BDF3E4B22DD285E6	4.63
35	3	1	0x3ECD476669A04A260414FD16F3F525AA060F20ADD9334A29A9D9F90618916EF51840C8F53AB596297F0782BEF426E8B8539C9FDE970455B58F533FDAC1711DE6310E7596E D285E	4.58
36	4	1	0x3D6BD09A3DBD9ECC1C584E71C87221CD266087C7A692D3EFF2D5F84DF2011EA3675853A61CD75D23600F8C115E03406AF914938170256B86DA5646CE0211FFDCD76A9A5E8D840	4.68
37	5	1	0x27F0DA91D4AD1F39F0EAD459E2705CB2CA029A8E57592F1697877199FF707D0411D6068A0664594D89568460F268A225BB2AC0ED043659D779EA84656DEC0322F8C0CB111AD2C8	4.60
38	6	1	0x616FBCE479AAAC98B483FCF6EC06BBA84580EA98FA517B3065A418CAF2C965B7AF2E7866B257390517016F2521490088193372879FAA8954651E7B3C80BA1725CB781726F32328	4.71
39	7	1	0x357714863C5F477BE963806EA9D6EF6350BAFC1C183FC6BB47FFFEAA9FFD86358918F6A218266D624CA07092EC24466C7F7120C1887A3F59A48EBA8B67F24A6E8930B862F509A3	4.60
40	8	1	0xABE49D0F8B9C8406BD70B3FD83758768CDBA98164B929A1EA18D59BD44B80F9BBEF9D1CE51E4EE1CF21F6CCF18A7D4A92C26C121A22FC95663F0B55B892CF7D3D65812A503DA48	4.63
41	9	1	0x6898A2FC8C36DF0B84380FBCDE70812390B644E3B5BEA87D76C9123477638B331BEB075664EA58C15680263664C48BF3411C3C13789C504A01FB4C7B9AC86AA524075E52C6A90	4.65
42	10	1	0xE7709988D2D2D6ABC6CEFB025FFCAFCA4C0E75C883529EA439B75229ECE88FB5BD5D3BCA17C25BEB6575D932D01B5A63E044102E208C071C734EBA55712E122822ED2F2B379A11	4.84
43	11	1	0xE49DCC8627542BA30FA500DCC23EEBF5A54B490EE7632C6BE57C724C3E74CD199930AB1D929D425185E2E1220CD2300F487392F4DC29416D332F13F8E760571D99617B263F387D	4.66

Table 309—Preamble modulation series per segment (continued)

Index	IDcell	Segment	Series to modulate (W_k)	PAPR (informative)
44	12	1	0xEE4CBD9B0EC65DE6DA78A2A205E5908B74127BDE612A9BD2D8F0C6A2B9E675401A9DDAA30FF9A55E87DAFFA3A33E53AAA1D96A60B326D7F6FA147098DD825BD0FB13ADDFE01569	4.65
45	13	1	0xAD7DAD0BCA42DEDAFCCF7E57DC58D00E691E81C04B98B2EDB66C66570B204B8352A08744D8A603C2A7769C7A9EE938189A45737B86871E5C4025EE594D827C603E3A49FD45519F	4.58
46	14	1	0xF8F29BA0D2FA2D529EAF2CE9383E614F5AE8CA06658DD039AB2C9912DFC7CD1BA9744339E537850B7E4EA564819772D3320B1C7BA73EC24D90B8DCE17EA5DAD53771F68B050F43	4.68
47	15	1	0x9CC0ECC9E7E8940DFED1332AF492CFD39A21F2820394EF0523019EE5290A2B4281FF032C238A6BE41116C274E918F34F3A27B5F147E10D41658CDC7EFEDC3135255C2B83B0AE6A	4.81
48	16	1	0xFCE9C41A74CBB56634447836109869E557C5A0FAA1D4566E36A51258CE6D096FBD3E0B7193418D9DFCDBD27693F8A5072425D4E3F33DB5AB45B1EF3E11A6730BED42961DF0354CD	4.72
49	17	1	0x7941B66A275FB8F0BAA8EF7FFCC36AAA660113B66BE476D629AE512E489341F6C9F84EC1BE1C05CA3C850D20B1A12AA9C94E1A6541C29A9B4BCD41B94460DEF2E9643ADCE86728	4.62
50	18	1	0x0A91F390213C9B2ED372BA19FC42EE85AAB2598B58D2F7184EA920546D6A81ED316551B74B341E238A7FB83A4EF7D9EB0939B7771A6F4D0AF1F7275FE3234793D3CDC19BDFE08	4.85
51	19	1	0x96949ACCD785385AE8DE99CE42BBB73B996A886115A78D0606AEC14D2E46E849BF88F9A2E17C2494704F1020CEF85FFDE16B7483DBC6A130488E3AC586E528A00B90134776E08C	4.59
52	20	1	0x53FFBA26676A4FD1A6C30B8E4EA02DF535C922978CD24F6099C25003567F207CC5851656C5FD0D3F071942A16F1DB48DFBC26BACC15A1E618FF35F3DC3E141E3666BCA507ED72E	4.70
53	21	1	0x7F3219ABE1389DBED8FC2F1C9C0FCE1974E71C224E1922F4CAD42E40AF15A5ECDB14221480F964E67BBD345C44DCA0853548B399E3DF4D054D176C0804D1B1154152BE973A8896	4.66
54	22	1	0x8D5552CCA9EA46C991FF81A35873F43C963E02ED24C4102A79F5EB5EC25814511BA5DD2FE9FB9699E7ED76F965B24748AE1A4A3A590F4F13E4722CCE399006F79AD8CE673178F7	4.88
55	23	1	0xDB74EFA478268CDDE2596ADF9410FD83FCEDBB07C6DEC7A3422A6CC66EF901C1534EC2A83E1A89BA207C721ECF3D42918FF40B3863379FDF3CED7A9CC86E348CAB032F8FAAD9CD	4.59

Table 309—Preamble modulation series per segment (continued)

Index	IDcell	Segment	Series to modulate (W_k)	PAPR (informative)
56	24	1	0x5811ADD9240A7B3AF35CACA6EFCFF4090A54EBF33D E54C077192354DDEB81CC968D18354090B09D7472C83E16 96E19545F08136EF20CD74656BCD31296066E03CC89E22E 47CF47	4.80
57	25	1	0x871ECE60EDD2E19360D13862A15242250635774424B224 65B3EF625E72072B7C45D81076DB4A5BFD5BE146F15CA A80DA031763DAC23BBBC54249E9878EC465F3EABE0B7 AA497B8	4.78
58	26	1	0xD8259BAF89D3E13242CC1CDBA9C0281A09919D24ECF 5BA83CDCD81E698EAA37DFE3E5802B3395B80A3DE91C F6C4BE2D34BBE985EE4041C4290D0A9185F115C963AD53 6E4133426	4.70
59	27	1	0x1203A1FD3F7B8E9D97A3812D4375D42BC9E8F0E393BD 669A8099407EC0356DC45FEF848C98F3EF32A9A850CC67 CE432339CBAF38BBA7DD0C94BC03B4704866509255E284 50E459	4.91
60	28	1	0x6A78A3F0DC5E4FA504580C37F5416BCC4A2BD51FC1A 71471BD1433EC3DD924E7130A7B2B331AB0B4AF6CF94C 045A9C246965F46478D939795887EE3320BBC2D5DD5FFB 06F894E8	4.73
61	29	1	0x3042F24E050BAB38880A07BDE5D28AEE4AD59E0D71A B59824122E80F8FF67BEA1ECC865F50B25CF5095C642B80 0E6A4D132B49E5968DEBDDA029A227AF332CF034BB937 B471603	4.74
62	30	1	0xC82853465FBB213A85A52888464E5D38D997F6C31966A 94B452A2DE853CE38010BF9EA930BBD318189D5D2D0BD B4465248A2E8B481021531BE01F5E0FF1BAB75370C57B36 BE6E9	4.80
63	31	1	0x2B17EC947632DABA3A2E11022033F20F873032F51F0647 11111D0C215E9E84C11A9E70950977527960700B37C6FECC A57C35A91873C935D7EDC22CB44DCC251396173CAC82B 912	4.63
64	0	2	0x83FC05D6DED982EB95B06E16C91EF94B441BBD4868C0 9E9B3A251AD72427F2124607E151796070C2819E395EB68 A2C597391636333A7E492B70D8EA7397FFA1B28C20E0820 CC45	4.89
65	1	2	0x45818FBAE49B983DB9B8FBEA1E816823430CE47BD159 3173605CA255CCEAE73C7283336BCBC94133DCA64D67 5BBA848A3E1C2EEE35D6085F06E72EAA696FBED6EA545 F27D3692	4.89
66	2	2	0xA005745E452ACE6BDDFC4A9F6253BF4B467C93ACFF0 F663A3F5949F15A1D266DEB0D26EC16D2A083F830E878A 0300D74CFA3266CBBF3F0244ED56344D6AD5D887B3179C E56890D	4.74
67	3	2	0xE52F56367EA45E4683E020856D05D08391D3D84766CA2 2531B3EC6BE682E76B6ED7BCAABC3AB6BDE32C4F700D 4CDFF26F79AE16499D2B70EC389AC3ED5E02FDF5C43B2 96CF965D	4.75

Table 309—Preamble modulation series per segment (continued)

Index	IDcell	Segment	Series to modulate (W_k)	PAPR (informative)
68	4	2	0xC5C62E3A911A0F28BF6A67E1DA2486FED7110B08F0A934C930AA035290D098857ECF3A069203A2560DADD5016802D9C1596526C7F1DA7C7B53360B0A673AA8634FB94D5838DC3E	4.77
69	5	2	0xF9E176A9837BF970D5FD51732ECB8D90FBD12F62B62F938BE07915BABB0C6596080C832CE7FF914C849B9DA66F2380F3058F66340A34CA43583EC8EDC1E5CB5A2A25436E72292D	4.64
70	6	2	0x5C26DB2489BE5197B20CD6B38B181B7789DCB90881AAC4B4317B2F40B44884144A1B15BCB53C8E30FEC419861C54B56158D9719E448B8A8F455F5B116275D796329059CDF682D3	4.64
71	7	2	0xEF35242D5C426C1EBD9563A761CFBF11A531ACB938922EBBA5227D8292585B777783972DA79C853A2A178601E6CFEA35380045B50EE628F13AE3EC5B72FED52F92F731BB594DE8	4.63
72	8	2	0x17FBB33193C68A1CAA8CEF5CB9A7FDFA1E89994F1779D2D0DE69DE75A6B338A07635C80A58722BB01398252F6C46AB7AEA79A6FC05F383F89ED65C49A2B9FB0D82A6EC03DD61F5	4.82
73	9	2	0x076C1A1DCA870DF36638307F891A52F737BA2B54EC0AD1FC5424D4F32DDE168ACE9B08653DEF8A23BF37CA3D306138D698A133834BFB65BDE57048B9EEC630B13E91EDB1B52E8F	4.86
74	10	2	0xA6800969ED0CE80A76F0F9BF7597ABE76DF60F243EE529C63AF72BAD6AB8B3F0B09DFC132C2B006827E55E352E3940A3BB8EE3526522ADF65AB76492BA41A393740A4B85CD5113	4.78
75	11	2	0x64817485E539E02AAB074982A56DC6E867C606313194BD66B4CF8B9E92C4F9FD138B0E6EF36F699A3E6DCC46741B8CB16389EBA2C745398A30EA3102B6BA4FE9A8DA9605F929FF	4.73
76	12	2	0xA3E438CB9EC48C4F4DD92C24950D0F1EAE7EEE920501C2C82531EDF8AEE3531F8D6B82D28C1FE0731088489FD215D19202DAEE0A57E3E1634C7A1BD5395CA64C64C14E5C02D436	4.68
77	13	2	0x8F9339B406037D35ADB9858576A62AF6139FD2B02D381C7DF147A274E145F76DE5687AEC5BD3A715E0E893EEB6F24573D4017B24B30D4357E339B104601FC2DD184DC9A8F0D76A	4.67
78	14	2	0xDA85062511E22DEDB53797BDBEC8B0281818E890D438CB5A48B2E4011FD5EFB2192C0FEDEE598372C7C06BEF25F9B9702A8A9F0F52B197E9C910BB63F467E53BF46A45F75C22F6	4.69
79	15	2	0x914DE1436839A8E2FDD4EACCD645C3D29E522E19E0055A2510679A977772830824C7363461CBF5D662456DB798BA72AEB67FEB2FC28DAAD3FAE0048727CF6E9B237A82489790D6	4.84

Table 309—Preamble modulation series per segment (continued)

Index	IDcell	Segment	Series to modulate (W_k)	PAPR (informative)
80	16	2	0xA21E09CF0A98EB012E8914A31BE5BE53F47AF5650B6BCE2812F65C994A100EA41F732830EB3F6C6F7028BC9FB3C5D108F63315DEDE8EE82CF5DE892032688E1C367D8567A20ACA	4.75
81	17	2	0x6E11F29AE45A99D74D911777D1DE60495C2DAF1705C7844FB7FC0A01247F3265F45D90A198ADCD0DB98A3CE22ACF24A77C737E5BF99DCD7EFA6B6096B70C572996B62E7814236B	4.72
82	18	2	0xE9F8FC17F5361DBCDD8F18F28CA90B618DF6B56D3481C9E3B7FDBEA6D55FAB32A4310A52AD7AAA26D082B38D4D8A2FCB70A3C6A4167515CA710E8F9B237F64B4D9A8C3CE8DF085	4.70
83	19	2	0x11FDC3B4712101D717D0EDD7556EAE0940AA1683D4CA4C22A7959436ECCA5E08A4BF2BF9EEF4BCE5E3E48DD77EB418F6B84BF8937CE0CF9DAD247A64E9E850373FEE3D673F47C2	4.74
84	20	2	0xE8784553C091233730B7DA704B8A02BEBE45E5DEF4361394E3B0E417FE3B571E641ADF2603402B8084A2D1318AF30CD95AD014D553408393AD345C05D62F435C708948233EF55B	4.86
85	21	2	0xCDD6E932F9D2FAD131E7AE666B758CC4BB60C60230FE14494D0F77E89A9BE726FAF8F9465AD0262D75C0A5374165A4FD2B4C602C0FF123F416360C112F6F95BD6790F81ACD858A	4.84
86	22	2	0xA2702DE422E1CBADAA8285C1C3B1F41D44561BCBF105466DF8070E604C733DE579755BCB8237C8DDB55A865B213D1929EDC553CE9B55994985F9EBEDF2A9F524301E3DA0498817	4.76
87	23	2	0x54487F7BDCDF87B1AA252798D7E5AD97E6F5263B7986B1E3E637852EDC83FA360676C04E35A1F5045B0A0B7DE9269F8A0E17F100D9AC78D873AE59BA0BA3E8AB3DDF928AD58F9E	4.99
88	24	2	0x3461AA27EDE0A9F7955B469C41AE1485EFBFE4EB233B0BBEB5F31BB36AC1E72CA6BF06B1E58F8612096CFA7289DEA8927B6368DC845DC8476074B83F3C1545A17F73EFE214A3C9	4.91
89	25	2	0x2DDBBF4F82EB33001E46F08D17DB89DCE3C7CC127F6B7D17839FE17A86F69178A1903E91857147348B491631336CB5D710382B59FF71416FEC2BAF0A0584F2155EEB71C54F84C4	4.89
90	26	2	0x762E2454401F66455358322AC0CFDF76EB18EFA9684A10F0F527537A54E75FAD77BD89E0D47980793C7B79B922C17792CC84BBEA81F6637192B74407A5B859EA1C873ED29D48FD	4.76
91	27	2	0xF74BBB6C4B97071EBC19F3FE7840A67A3959BD9936335A4F8BD10C9CFD925D8388C31B947BFD318FFC8B0967C132A602BC31B29835AE070006A50554CF3C5F85D56832ABA9CA5B	4.89

Table 309—Preamble modulation series per segment (continued)

Index	IDcell	Segment	Series to modulate (W_k)	PAPR (informative)
92	28	2	0x06493F32F3CA54692CAE2579388B97D99B5D540DE71F8B2405944C3A4FF18D7D45D4026DB9A867B85870BE6E23C9A8F84332D29B84B0303BB5179DFD89B56A14A37ABE053A0277	4.94
93	29	2	0xC88A3A3C0211A21661FD2B30937F0A187B6601E366A8FC5BCD4210E2D5D3365B22D4D63273F822D89EC1745304FBA4D0A9295AA51212C11C9D0A31FABB066289D8227B5BFDE8A0	4.82
94	30	2	0xA81E35C6A92953C584FE5FB3B6F1B0A532E91A49DB703D6E20D796F4532630C1D64DCEA580188BDDAB37722AD5DDCC9DFE7CFEDE1518D8E2ACA842F3570C7F381EAB9C5E4D485C	4.80
95	31	2	0x08C0CC1C53E52AA366AFA63A48EBE2F7389C8A33CEB20173432B4828D68A547D4673E27F942FCA95942029CFE9F413FDABE1D0BCF95022C5B99C1B229D151E9D3CA0A122F1BEEF	4.97
96	0	0	0x9774EF2FA326AB19DE599803EB48740C90995A4508064B6B19E58304229C5EDC578EF2C7030D4D2A01C9FB7618E7CB8564816354DD61EE144D7C94AFE8AB966875131B9F7C18BB	4.85
97	1	1	0xB9FBD947B7F9F3C8F6D3799E095BE558E6A2D0550C0DD0DDC92CC7BB53C1FE80D536B1FAE89C9224E3504629DBF0C5457944A72769B7162FBB0BBE18189749D3E7E264CFBA7A0E	4.75
98	2	2	0xFD0E15EC140B2E87817AECC16F134B66221C759CCF0E5000CDC0A3BADBB354D6845D745C22B1FB78C4205ABC F689495DE555CFFB4E4164A9ED06E484A192308A8CA89048A92C32	4.81
99	3	0	0x28237E963DE488B97083F5A76BF5A861773DB61108461A8CB8FAE918887897033207CEBFB83380BCC45748732F9752C86DEA5F5EE4BA741C6DAB59375DDCBDC6EFEDBCD10DF3C2	4.84
100	4	1	0x023B7D4F9CA92D1E796C749B7664CCC4E8558C5CF20BF702E39BC3AE525A9FAA6581F4A22EF6829A44156DAE4CABEA9C6A41D5A4325C02980C8FA4621A7FD08D874C687B68C706	4.94
101	5	2	0xB7FF5E696A6923C504E2A64A097EB201EC52D7963D9D5DA46051A4EBA8B2C2DB9FC4249ABF2D8CCC881F8AAD20230F1B66D5D48CF2BCC5CADE7217E25FB9F6CB93CE4111A33C6	4.86
102	6	0	0x6870AA97FE0FF504C4247EBFA8EF1A21B6EEE100E407F293086E1F48C7292BEC491DDAF0E2CF02455825089FCD985F77CDC4B561A6B8CD60CE31CBE6D467CFB4D153746FB7BE0D	4.92
103	7	1	0x91466310F3C4F355233B54C0AB8CB818780691443781B71AB6FB8F6CD516661E39075B4207E55400E081FD79C524628C8FE1277BE1A6165ACB5F154158D26593FED2C48EF66268	4.89

Table 309—Preamble modulation series per segment (continued)

Index	IDcell	Segment	Series to modulate (W_k)	PAPR (informative)
104	8	2	0x45F8EB9235B6DC375771B69789AFEEEEBB806965E6931A844F370CA14AA982635C54EA0BA973373D9FE010993B41EB8BF2C219B09AD13B4FE7FDC7295C55858834490674637ED95	4.93
105	9	0	0x3AA7974B18884644F5C782A5E71AF70D91220EB0C468D079AFB7DF8033D3AB54BC728657D60B349C575C8B3DEC403A6D406E3FC4D016655D406B0B78389CEFCFF8A37D867A44DF	4.89
106	10	1	0x1140B404D18CA769BDC1E1188BBB5BFA3B87668D158B0875F4D4EE90ED42974B5A02A6AAF6977EACD194CB9E8423E2931F2CD9AEF6C90F44EC626C56518360D20AE97219FDE89	4.90
107	11	2	0x76BE5786CE3C33A20A3776587F83E6C5280BD4DF20FE6C52D6BB582957E0CAEB988B32C3DB58027815D8618FB6FDB1BCF9E871D6C552AED5679BE98189D95708FE92750C5ADE33	4.84
108	12	0	0x33597C2D850E76B116A82F95C766D2002B9822D52E09B1968BEF3DFD48D9F53D5296F1559BEB0BC7791C1F6B666EE68C605A2098A4A0BD57CE4F7A843068A8BA3BF0065ACA53C6	4.95
109	13	1	0x894B11E2BB6884D9FFD78C6A8103F3BD44E6DFE48CD0DC89C63A4F8BA95858545D37EC1652AB2C073B99BC667D1F396C87F9902FCB08686E563D0D30EBF3D65756A63F0037C240	4.83
110	14	2	0xDD08538B0939E852443E8801AB36C0FF50A6A0B63BBBE969F6A5A60BD6EEF19D070C3A14366EC789D39D07CD8891491FDB3C7EF57A0A310C8A4DC0A03D5DB84DA0D6911C4CBA9B	5.03
111	15	0	0x7FFA4EF380C6504225EA6C8339E130DB7E69577E9C46CA494F66E2D5B25A256444606103A821615C2CDEA721D153669E5025CDC37904CFC16A84E3B745079E5F1F3E08B0684BBB	4.83
112	16	1	0x8A608CAD1CD85FD846FB2A39FB61EBF9A219B9B7499179C2C066F3F78F3B3EDEF15B7227C650BEFB63C950E1B52632D78D1A0F34552BA138C877F09FCCFD30511E340F794D154A	4.90
113	17	2	0x775CA156A4C0BDB8FE5FF3CFB91FC7BC9DEAF1B8B3362D06C9738D332868BBA3B18A0A907EE7918D95510298E42F44B7BFC39D9E002EE24D1806EE0436B92DEC06DA3FDA2230F6	5.14

The modulation used on the preamble is defined in 8.4.9.4.3.1.

8.4.6.1.2 Symbol structure

8.4.6.1.2.1 Symbol structure for PUSC

The symbol structure is constructed using pilots, data, and zero subcarriers. The symbol is first divided into basic clusters and zero carriers are allocated. Pilots and data carriers are allocated within each cluster. Table 310 summarizes the parameters of the symbol structure.

Table 310—OFDMA downlink carrier allocations—PUSC

Parameter	Value	Comments
Number of DC subcarriers	1	Index 1024
Number of Guard subcarriers, Left	184	
Number of Guard subcarriers, Right	183	
Number of used subcarriers (N_{used})	1681	Number of all subcarriers used within a symbol, including all possible allocated pilots and the DC carrier.
Number of subcarriers per cluster	14	
Number of clusters	120	
Renumbering sequence	1	Used to renumber clusters before allocation to subchannels: 6, 108, 37, 81, 31, 100, 42, 116, 32, 107, 30, 93, 54, 78, 10, 75, 50, 111, 58, 106, 23, 105, 16, 117, 39, 95, 7, 115, 25, 119, 53, 71, 22, 98, 28, 79, 17, 63, 27, 72, 29, 86, 5, 101, 49, 104, 9, 68, 1, 73, 36, 74, 43, 62, 20, 84, 52, 64, 34, 60, 66, 48, 97, 21, 91, 40, 102, 56, 92, 47, 90, 33, 114, 18, 70, 15, 110, 51, 118, 46, 83, 45, 76, 57, 99, 35, 67, 55, 85, 59, 113, 11, 82, 38, 88, 19, 77, 3, 87, 12, 89, 26, 65, 41, 109, 44, 69, 8, 61, 13, 96, 14, 103, 2, 80, 24, 112, 4, 94, 0
Number of data subcarriers in each symbol per subchannel	4	
Number of subchannels	60	
PermutationBase12 (for 12 subchannels)		6,9,4,8,10,11,5,2,7,3,1,0
PermutationBase8 (for 8 subchannels)	4	7,4,0,2,1,5,3,6

Figure 234 depicts the cluster structure.

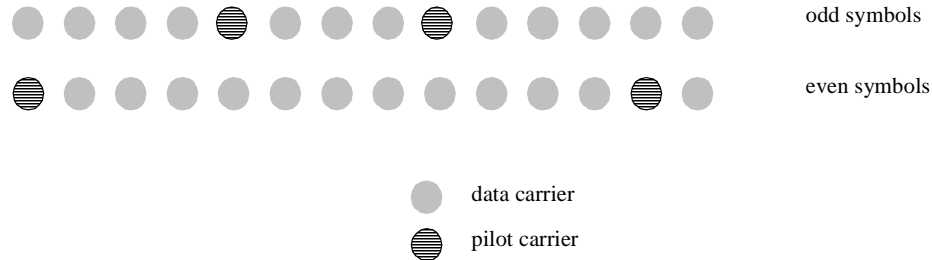

Figure 234—Cluster structure

8.4.6.1.2.1.1 Downlink subchannels subcarrier allocation in PUSC

The carrier allocation to subchannels is performed using the following procedure:

- 1) Dividing the subcarriers into 120 physical clusters containing 14 adjunct subcarriers each (starting from carrier 0).
- 2) Renumbering the physical clusters into logical clusters using the following formula:

$$\text{LogicalCluster} = \text{RenumberingSequence}(\text{PhysicalCluster} + 13 * \text{IDcell}) \bmod 120$$
 In the first PUSC zone of the downlink (first downlink zone), the default used IDcell is 0.
- 3) Dividing the clusters into six major groups. Group 0 includes clusters 0–23, group 1 includes clusters 24–39, group 2 includes clusters 40–63, group 3 includes clusters 64–79, group 4 includes clusters 80–103, group 5 includes clusters 104–119. These groups may be allocated to segments, if a segment is being used, then at least one group shall be allocated to it (by default group 0 is allocated to sector 0, group 2 is allocated to sector 1, and group 4 to is allocated sector 2).
- 4) Allocating carriers to subchannel in each major group is performed by first allocating the pilot carriers within each cluster, and then taking all remaining data carriers within the symbol and using the same procedure described in 8.4.6.1.2.2.2 (with the parameters from Table 310, using the PermutationBase appropriate for each major group, PermutationBase12 for even numbered major groups, and PermutationBase8 for odd numbered major groups) to partition the subcarriers into subchannels containing 24 data subcarriers in each symbol. Note that IDcell used for the first PUSC zone is 0.

8.4.6.1.2.2 Symbol structure for FUSC

The symbol structure is constructed using pilots, data, and zero subcarriers. The symbol is first allocated with the appropriate pilots and with zero subcarriers, and then all the remaining subcarriers are used as data subcarriers (these will be divided into subchannels).

There are two variable pilot-sets and two constant pilot-sets. In FUSC, each segment uses both sets of variable/constant pilot-sets. In STC mode (see 8.4.8), each antenna uses half of the pilot set resources compared to that of non-STC mode. Table 311 summarizes the parameters of the symbol.

Table 311—OFDMA downlink carrier allocations

Parameter	Value	Comments
Number of DC Subcarriers	1	Index 1024
Number of Guard Subcarriers, Left	173	
Number of Guard Subcarriers, Right	172	
Number of Used Subcarriers (N_{used})	1703	Number of all subcarriers used within a symbol, including all possible allocated pilots and the DC carrier.
Pilots		
VariableSet #0	24	0,72,144,216,288,360,432,504,576,648,720,792,864,936,1008,1080,1152,1224,1296,1368,1440,1512,1584,1656,48,120,192,264,336,408,480,552,624,696,768,840,912,984,1056,1128,1200,1272,1344,1416,1488,1560,1632,24,96,168,240,312,384,456,528,600,672,744,816,888,960,1032,1104,1176,1248,1320,1392,1464,1536,1608,1680
ConstantSet #0	4	39,645,1017,1407,330,726,1155,1461,351,855,1185,1545
VariableSet #1	24	36,108,180,252,324,396,468,540,612,684,756,828,900,972,1044,1116,1188,1260,1332,1404,1476,1548,1620,1692,12,84,156,228,300,372,444,516,588,660,732,804,876,948,1020,1092,1164,1236,1308,1380,1452,1524,1596,1668,60,132,204,276,348,420,492,564,636,708,780,852,924,996,1068,1140,1212,1284,1356,1428,1500,1572,1644
ConstantSet #1	4	261,651,1143,1419,342,849,1158,1530,522,918,1206,1701
Number of data subcarriers	1536	
Number of data subcarriers per subchannel	48	
Number of Subchannels	32	
PermutationBase		3, 18, 2, 8, 16, 10, 11, 15, 26, 22, 6, 9, 27, 20, 25, 1, 29, 7, 21, 5, 28, 31, 23, 17, 4, 24, 0, 13, 12, 19, 14, 30

The Variable set of pilots embedded within the symbol of each segment shall obey the following rule:

$$PilotsLocation = VariableSet\#x+6 \cdot (FUSC_SymbolNumber \bmod 2) \quad (110)$$

where $FUSC_SymbolNumber$ counts the FUSC symbols used in the transmission starting from 0.

Figure 235 depicts as an example of the symbol allocation for segment 0 on symbol number 1.

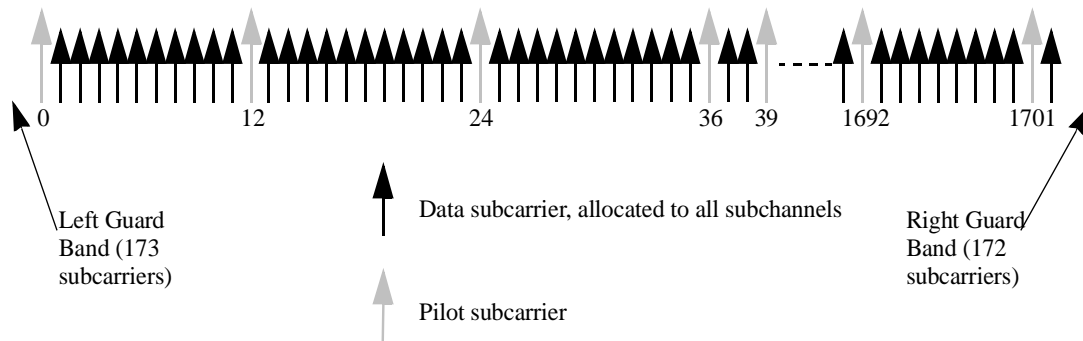

Figure 235—Downlink symbol structure for segment 0 on symbol number 1 using FUSC

8.4.6.1.2.2.1 Downlink subchannels subcarrier allocation

Each subchannel is composed of 48 subcarriers. The subchannel indices are formulated using a RS series, and is allocated out of the data subcarriers domain. The data subcarriers domain includes $48 \cdot 32 = 1536$ subcarriers, which are the remaining subcarriers after removing from the subcarrier's domain (0-2047) all possible pilots and zero subcarriers (including the DC subcarrier).

After allocating the data subcarriers domain, the procedure of partitioning those subcarriers into subchannels shall be as specified in 8.4.6.1.2.2.2.

8.4.6.1.2.2.2 Partitioning of data subcarriers into subchannels in downlink FUSC

After mapping all pilots, the remainder of the used subcarriers are used to define the data subchannels.

To allocate the data subchannels, the remaining subcarriers are partitioned into groups of contiguous subcarriers. Each subchannel consists of one subcarrier from each of these groups. The number of groups is therefore equal to the number of subcarriers per subchannel, and it is denoted $N_{subcarriers}$. The number of the subcarriers in a group is equal to the number of subchannels, and it is denoted $N_{subchannels}$. The number of data subcarriers is thus equal to $N_{subcarriers} \cdot N_{subchannels}$.

The exact partitioning into subchannels is according to Equation (111), called a permutation formula. (To clarify the operation of this formula, an example application is given subsequently in 8.4.6.2.3.)

$$subcarrier(k, s) = N_{subchannels} \cdot n_k + \{p_s[n_k \bmod N_{subchannels}] + ID_{cell}\} \bmod N_{subchannels} \quad (111)$$

where

$subcarrier(n, s)$ is the subcarrier index of subcarrier n in subchannel s ,
 s is the index number of a subchannel, from the set $[0 \dots N_{subchannels} - 1]$,
 $n_k = (k + 13 \cdot s) \bmod N_{subcarriers}$,
 where k is the subcarrier-in-subchannel index from the set $[0 \dots N_{subcarriers} - 1]$,
 $N_{(subchannel)s}$ is the number of subchannels,

- $p_s[l]$ is the series obtained by rotating $\{PermutationBase_0\}$ cyclically to the left s times,
- $ceil[]$ is the function that rounds its argument up to the next integer,
- $IDcell$ is an integer ranging from 0 to 31, which identifies the particular BS segment and is specified by MAC layer,
- $X_{mod(k)}$ is the remainder of the quotient X/k (which is at most $k - 1$).

and the numerical parameters are given in Table 311.

On initialization, an SS must search for the downlink preamble. After finding the preamble, the user shall know the $IDcell$ used for the data Subchannels.

8.4.6.1.2.3 Additional optional symbol structure for FUSC

The additional optional subchannel structure in the downlink supports 32 subchannels where each transmission uses 48 data carriers symbols as their minimal block of processing. In the downlink, all the pilot carriers are allocated first, and then the remaining carriers are used exclusively for data transmission. N_{used} subcarriers are divided into nine contiguous subcarriers in which one pilot carrier is allocated. The position of the pilot carrier in nine contiguous subcarriers varies according to the index of OFDM symbol which contains the subcarriers. If the nine contiguous subcarriers indexed as 0...8, the index of the pilot carrier shall be $3l+1$ where $l = m \bmod 3$ (m is the symbol index).

Table 312—OFDMA optional FUSC downlink subcarrier allocation

Parameter	Value	Comments
Number of DC subcarriers	1	
N_{used}	1728	
Guard subcarriers: Left, Right	159, 160	
Number of Pilot Subcarriers	192	
Pilot subcarrier index	$9k + 3m + 1$, for $k = 0, \dots, 191$ and $m = [symbol\ index] \bmod 3$	Symbol index 0 is the first symbol from which the diversity subchannelization is applied.
Number of Data Subcarriers	1536	

8.4.6.1.2.3.1 Downlink subchannels subcarrier allocation

To allocate the diversity subchannels, the whole data tones in a slot are partitioned into groups of contiguous data subcarriers. Each subchannel consists of one subcarrier from each of these groups. The number of groups is therefore equal to number of data subcarriers per subchannel, and its value is 48. The number of the subcarriers in a group is equal to the number of subchannels, 32. The exact partitioning into subchannels is according to Equation (112), called DL permutation formula.

$$Carrier(s, m) = \begin{cases} 32 \cdot k + [s + P_{1, c_1}(k) + P_{2, c_2}(k)] & 0 < c_1, c_2 < N_s \\ 32 \cdot k + [s + P_{1, c_1}(k)] & c_1 \neq 0, c_2 = 0 \\ 32 \cdot k + [s + P_{2, c_2}(k)] & c_1 = 0, c_2 \neq 0 \\ 32 \cdot k + s & c_1 = 0, c_2 = 0 \end{cases} \quad (112)$$

where

- $Carrier(s, m)$ is the index of m -th subcarrier in subchannel s at symbol n ,
 $k = (m + s \cdot 48) \bmod 48$,
- n is the data symbol index in slot, $n = \left\lfloor \frac{m}{48} \right\rfloor$,
- m is the subcarrier-in-subchannel index from the set $[0 \dots 47]$,
- s is the index number of a subchannel from the set $[0 \dots 31]$,
- $P_{1, c_1}(j)$ is the j -th element of the sequence obtained by rotating basic permutation sequence P_1 cyclically to the left c_1 times. $P_1 = \{1, 2, 4, 8, 16, 5, 10, 20, 13, 26, 17, 7, 14, 28, 29, 31, 27, 19, 3, 6, 12, 24, 21, 15, 30, 25, 23, 11, 22, 9, 18\}$,
- $P_{2, c_2}(j)$ is the j -th element of the sequence obtained by rotating basic permutation sequence P_2 cyclically to the left c_2 times. $P_2 = \{1, 4, 16, 10, 13, 17, 14, 29, 27, 3, 12, 21, 30, 23, 22, 18, 2, 8, 5, 20, 26, 7, 28, 31, 19, 6, 24, 15, 25, 11, 9\}$,
- $c_1 = ID_{cell} \bmod N_s, 0 \leq c_1 \leq N_s$,
- $c_2 = \left\lfloor \frac{ID_{cell}}{N_s} \right\rfloor, 0 \leq c_2 \leq N_s$.

In Equation (115), the operation in $[]$ is over $GF(2^5)$. In $GF(2^5)$, addition is binary XOR operation. For example, $29 + 12$ in $GF(2^5)$ is $[(11101)_2 \text{ XOR } (01100)_2] = (10001)_2 = 17$, where $(x)_2$ represents binary expansion of x .

8.4.6.2 Uplink

The following section defines the uplink transmission and symbol structure. The uplink follows the downlink model, therefore it also supports up to three segments.

The uplink supports 70 subchannels where each transmission uses 48 data carriers as the minimal block of processing. Each new transmission for the uplink commences with the parameters as given in Table 313.

Table 313—OFDMA uplink subcarrier allocations

Parameter	Value
Number of dc subcarriers	1
N_{used}	1681
Guard subcarriers: Left, Right	184, 183

Table 313—OFDMA uplink subcarrier allocations (continued)

Parameter	Value
TilePermutation	6, 48, 58, 57, 50, 1, 13, 26, 46, 44, 30, 3, 27, 53, 22, 18, 61, 7, 55, 36, 45, 37, 52, 15, 40, 2, 20, 4, 34, 31, 10, 5, 41, 9, 69, 63, 21, 11, 12, 19, 68, 56, 43, 23, 25, 39, 66, 42, 16, 47, 51, 8, 62, 14, 33, 24, 32, 17, 54, 29, 67, 49, 65, 35, 38, 59, 64, 28, 60, 0
$N_{subchannels}$	70
$N_{subcarriers}$	48
N_{tiles}	420
Tiles per subchannel	6

8.4.6.2.1 Symbol structure for subchannel (PUSC)

A burst in the uplink is composed of three time symbols and one subchannel, within each burst, there are 48 data subcarriers and 24 fixed-location pilot subcarrier.

The subchannel is constructed from six uplink tiles, each tile has four subcarriers and its configuration is illustrated in Figure 236.

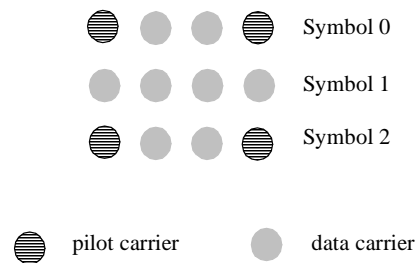
**Figure 236—Description of an uplink tile**

8.4.6.2.2 Partitioning of subcarriers into subchannels in the uplink

The allocated frequency band shall be divided into 420 tiles, the allocation of tiles to subchannels is performed in the following manner:

1. Divide the 420 tiles into six groups, containing 70 adjacent tiles each.
2. Choose six tiles per subchannel using Equation (113); for an example refer to 8.4.6.2.3.

$$Tile(s, n) = 70 \cdot n + (Pt[(s + n) \bmod 70] + UL_IDcell) \bmod 70 \quad (113)$$

where

- n is the tile index 0...5
- P_t is the tile permutation
- s is the subchannel number
- UL_IDcell is an integer value in the range 0...69, which is set by the MAC layer.

After allocating the tiles for each subchannel the data subcarriers per subchannel are enumerated by the following process:

1. After allocating the pilot carriers within each tile, indexing the data subcarriers within the subchannels is performed starting from the first symbol at the lowest subcarrier from the lowest tile and continuing in an ascending manner throughout the subcarriers in the same symbol, then going to next symbol at the lowest data subcarrier, and so on. Data subcarriers shall be indexed from 0 to 47.
2. The enumeration of the subcarriers will follow Equation (114). This enumeration sets the order to which the mapping of the data onto the subcarriers shall be performed.

$$\text{subcarrier}(n, s) = (n + 13 \cdot s) \bmod N_{\text{subcarriers}} \quad (114)$$

where

- n is a running index 0...47,
- s is the subchannel number,
- $N_{\text{subcarriers}}$ is the number of subcarriers per subchannel.

8.4.6.2.3 Uplink permutation example

To illustrate the use of the permutations, an example is provided to clarify the operation of the permutation formula, Equation (113).

The tiles used for subchannel $s = 3$ in $UL_IDcell = 2$ are computed.

The relevant parameters characterizing the uplink are therefore taken from Table 313.

- Number of subchannels: $N_{\text{subchannels}} = 70$
- Number of subcarriers in each OFDMA symbol: $N_{\text{subcarriers}} = 24$
- Number of data subcarriers in each subchannel = 48
- TilePermutation = {6, 48, 58, 57, 50, 1, 13, 26, 46, 44, 30, 3, 27, 53, 22, 18, 61, 7, 55, 36, 45, 37, 52, 15, 40, 2, 20, 4, 34, 31, 10, 5, 41, 9, 69, 63, 21, 11, 12, 19, 68, 56, 43, 23, 25, 39, 66, 42, 16, 47, 51, 8, 62, 14, 33, 24, 32, 17, 54, 29, 67, 49, 65, 35, 38, 59, 64, 28, 60, 0}

Using Equation (113),

- 1) The basic series of 70 numbers is: { 6, 48, 58, 57, 50, 1, 13, 26, 46, 44, 30, 3, 27, 53, 22, 18, 61, 7, 55, 36, 45, 37, 52, 15, 40, 2, 20, 4, 34, 31, 10, 5, 41, 9, 69, 63, 21, 11, 12, 19, 68, 56, 43, 23, 25, 39, 66, 42, 16, 47, 51, 8, 62, 14, 33, 24, 32, 17, 54, 29, 67, 49, 65, 35, 38, 59, 64, 28, 60, 0}
- 2) Apply the permutation due to the selection of the subchannel (s), rotate three times: { 57, 50, 1, 13, 26, 46, 44, 30, 3, 27, 53, 22, 18, 61, 7, 55, 36, 45, 37, 52, 15, 40, 2, 20, 4, 34, 31, 10, 5, 41, 9, 69, 63, 21, 11, 12, 19, 68, 56, 43, 23, 25, 39, 66, 42, 16, 47, 51, 8, 62, 14, 33, 24, 32, 17, 54, 29, 67, 49, 65, 35, 38, 59, 64, 28, 60, 0, 6, 48, 58}
- 3) Take the first six numbers, add the UL_IDcell (perform modulo operation if needed): {59, 52, 3, 15, 28, 48}
- 4) Finally, add the appropriate shift: {59, 122, 143, 225, 308, 398}

8.4.6.2.4 Partition a subchannel to mini-subchannels

An uplink subchannel is composed of six tiles. Mini-subchannels are created by concatenating multiples of two, three, or six subchannels, and allocating traffic for more than one SS on this concatenation by a subdivision of the tiles. Table 314 shows the four possibilities for subchannel partitioning into mini-subchannel. The tile indices are those referred to in Equation (113) for the mandatory uplink permutation, or in Equation (115) for the optional uplink permutation.

Table 314—Subchannel partitioning into mini-subchannels

Ctype	Number of concatenated subchannels	Number of mini-subchannels	Mini-subchannel index	Tile allocation as a function subchannel index in the concatenation					
				0	1	2	3	4	5
00	2	2	0	0,1,2	3,4,5				
			1	3,4,5	0,1,2				
01	2	2	0	0,2,4	0,2,4				
			1	1,3,5	1,3,5				
10	3	3	0	0,1	2,3	4,5			
			1	4,5	0,1	2,3			
			2	2,3	4,5	0,1			
11	6	6	0	0	1	2	3	4	5
			1	5	0	1	2	3	4
			2	4	5	0	1	2	3
			3	3	4	5	0	1	2
			4	2	3	4	5	0	1
			5	1	2	3	4	5	0

For example, when partitioning to three mini-subchannels, an allocation of $n \times 3$ subchannels is required, where n is an integer. Each group of three subchannels in this allocation is partitioned such that the tiles indexed 0,1 on the first subchannel; the tiles indexed 2,3 on the second subchannel and the tiles indexed 4,5 on the third subchannel belong to the mini-subchannel whose index is 0. The tiles indexed 4,5 on the first subchannel; the tiles indexed 0,1 on the second subchannel; and the tiles indexed 2,3 on the third subchannel belong to the minisubchannel whose index is 1, etc.

The mini-subchannels are mapped by the UL map like normal subchannels; only the mapping is done by the mini-subchannel allocation IE (see 8.4.5.4.8).

8.4.6.2.5 Additional optional symbol structure for PUSC

The additional optional subchannel structure for the uplink supports 96 subchannels where a subchannel consists of 48 data carriers and 6 pilot carriers. Each new transmission for the uplink commences with the parameters as given in Table 315.

Table 315—OFDMA uplink subcarrier allocations

Parameter	Value
Number of DC subcarriers	1
N_{used}	1728
Guard subcarriers: Left, Right	159, 160
$N_{subchannels}$	96
N_{tiles}	576
Number of subcarriers per tile	3
Tiles per subchannel	6
Number of data subcarriers per subchannel	48

8.4.6.2.5.1 Symbol structure for subchannel

A burst in the uplink is composed of three time symbols and one subchannel, within each burst, there are 48 data subcarriers and six fixed-location pilot subcarrier. The subchannel is constructed from six uplink tiles, each tile has three subcarriers and its configuration is illustrated in Figure 237.

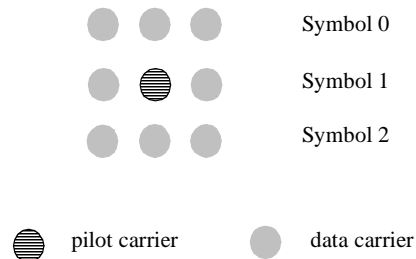

Figure 237—Description of an uplink tile

8.4.6.2.5.2 Partitioning of subcarriers into subchannels in the uplink

To allocate the subchannels, subcarriers are partitioned into tiles which is 3x3 frequency-time block containing nine tones (one pilot tones and eight data tones). The whole frequency bands are partitioned into groups of contiguous tiles. Each subchannel consists of six tiles, each of which is chosen from different groups.

For the parameters defined in Table 315, the number of tiles in a group is 32 and there are 18 groups in the whole frequency band. Since a subchannel consists of 6 tiles, 6 groups at equal distance (3 groups away from each) are chosen and each tile is selected from each group.

The exact partitioning into subchannels is according to Equation (115), called UL permutation formula.

$$Tile(s, m) = \begin{cases} 96 \cdot m + 32 \cdot S + [s' + P_{1,c_1}(m) + P_{2,c_2}(m)] & 0 < c_1, c_2 < N_s \\ 96 \cdot m + 32 \cdot S + [s' + P_{1,c_1}(m)] & c_1 \neq 0, c_2 = 0 \\ 96 \cdot m + 32 \cdot S + [s' + P_{2,c_2}(m)] & c_1 = 0, c_2 \neq 0 \\ 96 \cdot m + 32 \cdot S + s' & c_1 = 0, c_2 = 0 \end{cases} \quad (115)$$

where

$$\begin{aligned} Tile(s, m) & \text{ is the tile index of } m\text{-th tile in subchannel } s, \\ S & = \left\lfloor \frac{s}{32} \right\rfloor, \\ s' & = s \bmod 32, \\ m & \text{ is the tile-in-subchannel index from the set } [0 \dots 5], \\ s & \text{ is the index number of a subchannel from the set } [0 \dots 95], \\ P_{1,c_1}(j) & \text{ is the } j\text{-th element of the sequence obtained by rotating basic permutation sequence } P_1 \\ & \text{ cyclically to the left } c_1 \text{ times. } P_1 = \{1, 2, 4, 8, 16, 5, 10, 20, 13, 26, 17, 7, 14, 28, 29, 31, 27, \\ & 19, 3, 6, 12, 24, 21, 15, 30, 25, 23, 11, 22, 9, 18\}, \\ P_{2,c_2}(j) & \text{ is the } j\text{-th element of the sequence obtained by rotating basic permutation sequence } P_2 \\ & \text{ cyclically to the left } c_2 \text{ times. } P_2 = \{1, 4, 16, 10, 13, 17, 14, 29, 27, 3, 12, 21, 30, 23, 22, 18, 2, \\ & 8, 5, 20, 26, 7, 28, 31, 19, 6, 24, 15, 25, 11, 9\}, \\ c_1 & = ID_{cell} \bmod 32, \\ c_2 & = \left\lfloor \frac{ID_{cell}}{32} \right\rfloor. \end{aligned}$$

In Equation (115), the operation in $[]$ is over $GF(2^5)$. In $GF(2^5)$, addition is binary XOR operation. For example, $29 + 12$ in $GF(2^5)$ is $[(11101)_2 \text{ XOR } (01100)_2] = (10001)_2 = 17$, where $(x)_2$ represents binary expansion of x .

8.4.6.2.6 Data subchannel rotation scheme

A rotation scheme shall be applied per each OFDMA slot-duration in any zone, except zones marked as AAS zone, or zone using the adjacent-subcarriers permutations (8.4.6.3). Slot-duration is defined in 8.4.3.1. On each slot-duration, the rotation scheme shall be applied to all UL subchannels that belong to the segment (see 8.4.4.5), except those subchannels indicated in the UL-MAP by UIUC = 13 or UIUC = 12. The rotation scheme is defined by applying the following rules:

- 1) Per OFDMA slot duration, pick only subchannels that not indicated by either UIUC = 12 or UIUC = 13 (as defined above). Renumber these subchannels contiguously, such that the lowest numbered physical subchannel is renumbered with 0. The total number of subchannels picked shall be designated N_{subchn} .
- 2) The mapping function defined by item 1) above shall define a function, f , such that $temp1_subchannel_number = f(old_subchannel_number)$.
- 3) Mark the first UL OFDMA slot-duration with the slot index $S_{idx} = 0$. Increase S_{idx} by 1 in every slot-duration, such that subsequent slots are numbered 1,2,3... etc.

- 4) Apply the formula:

$$\text{temp2_subchannel_number} = (\text{temp1_subchannel_number} + 13 * S_{idx}) \bmod N_{\text{subchan}}$$
- 5) To get the new subchannel number, apply the formula

$$\text{new_subchannel_number} = f^{-1}(\text{temp2_subchannel_number})$$
 Where $f^{-1}(\cdot)$ is the inverse mapping of the mapping defined in item (2) above.
- 6) For subchannels in the UL-MAP indicated by either UIUC=12 or UIUC=13,

$$\text{new_subchannel_number} = \text{old_subchannel_number}$$

8.4.6.3 Optional permutations for AAS and AMC subchannels

A BS may change from the “distributed subcarrier permutation,” described in 8.4.6.1 and 8.4.6.2, to the “adjacent subcarrier permutation” when changing from non-AAS to AAS-enabled traffic to support AAS adjacent subcarrier user traffic in the cell. Alternatively, the adjacent subcarrier permutation can be used to take advantage of the structure of the adjacent subcarrier permutation in parts of DL subframe that are indicated accordingly by the DL-MAP. After this change, the BS shall only transmit/receive traffic using the adjacent subcarrier permutation during the allocated period. The BS shall always return to the distributed subcarrier permutation at the beginning of a new DL subframe. Note that an AAS-enabled SS, which does not provision the same permutation (PUSC/FUSC or adjacent) for AAS traffic selected by the BS for this purpose, is not capable of using its AAS capabilities with this BS.

While the BS does not have any SSs registered that are not capable of using the adjacent subcarrier permutation selected by the BS, the BS may employ the AAS superframe structure. Otherwise, it shall always return to the distributed subcarrier permutation at the end of each frame and provision broadcast traffic at the start of each frame.

The AAS superframe shall have the following structure:

- 1) The BS shall start each superframe with no less than 20 consecutive frames, which contain both downlink and uplink broadcast OFDMA symbols. Each of these frames shall provision DCD, UCD, DL-MAP, and UL-MAP messages, and at least one initial ranging opportunity. The frame duration code in each frame (except the last one) shall be set to the actual frame duration used. The frame duration code in the last frame shall be set to 0x00.
- 2) Subsequently, the BS shall transmit up to 200 ms of AAS only frames, followed by a minimum of one frame containing at least one downlink broadcast OFDMA symbol, which shall provision DCD, UCD, and DL-MAP messages. The frame duration code shall be set to 0x00.
- 3) The BS shall repeat Step 2) of this subclause, up to the AAS superframe duration, which shall be no more than 1 s.

With the adjacent subcarrier permutation, symbol data within a subchannel is assigned to adjacent subcarriers and the pilot and data subcarriers are assigned fixed positions in the frequency domain within an OFDMA symbol. This permutation is the same for both uplink and downlink. Within each frame, the BS shall indicate the switch to the optional permutation in the AAS_DL_IE() and AAS_UL_IE() when switching to AAS traffic. (See 8.4.5.3 and 8.4.5.4.) To define adjacent subcarrier permutation, a bin, which is the set of nine contiguous subcarriers within an OFDMA symbol, is a basic allocation unit both in downlink and uplink. A bin structure is shown in Figure 238.

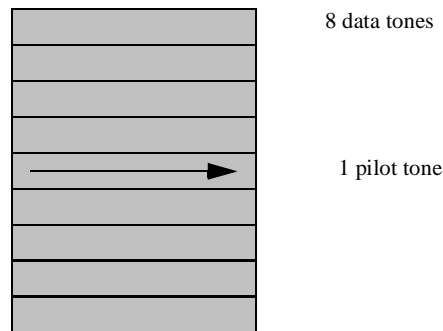

Figure 238—Bin structure

A group of four rows of bins is called a band. AMC subchannel consists of six contiguous bins in a same band.

Table 316—OFDMA AAS subcarrier allocations

Parameter	Value
Number of DC subcarriers	1
Number of guard subcarriers, left	160
Number of guard subcarriers, right	159
N_{used} , Number of used subcarriers (which includes the DC subcarrier)	1729
Total number of subcarriers	2048
Number of pilots	192
Number of data subcarriers	1536
Number of bands	48
Number of bin per band	4
Number of data subcarriers per subchannel	48

Let the index of the traffic subcarriers be numbered from 0 to 47 within an AMC subchannel. The index of first traffic subcarrier in the first bin is 1, next one is 2 and so on. The index of the subcarriers increases along the subcarriers first, then the bin. The j -th symbol of the 48 symbols where a band AMC subchannel is allocated is mapped onto the $(S_{\text{per}}^{\text{off}}(j) - 1)$ -th subcarrier of a subchannel. j is [0, 47].

$$S_{\text{per}}^{\text{off}}(j) = \begin{cases} P_{\text{per}}(j) + \text{off} & P_{\text{per}}(j) + \text{off} \neq 0 \\ \text{off} & P_{\text{per}}(j) + \text{off} = 0 \end{cases} \quad (116)$$

where

$P_{per(j)}$	is the j -th element of the left cyclic shifted version of basic sequence P_0 by per ,
P_0	Basic sequence defined in $GF(7^2)$: {01, 22, 46, 52, 42, 41, 26, 50, 05, 33, 62, 43, 63, 65, 32, 40, 04, 11, 23, 61, 21, 24, 13, 60, 06, 55, 31, 25, 35, 36, 51, 20, 02, 44, 15, 34, 14, 12, 45, 30, 03, 66, 54, 16, 56, 53, 64, 10} in hepta-notation,
per	$= ID_{cell} \bmod 48$,
off	$= (\lceil ID_{cell} \div 48 \rceil) \bmod 49$.

The addition between two element in $GF(7^2)$ is component-wise addition modulo 7 of two representation. For example, (56) + (34) in $GF(7^2) = (13)$.

8.4.7 OFDMA ranging

When used with the WirelessMAN-OFDMA PHY, the MAC layer shall define a single ranging channel. This ranging channel is composed of one or more groups of six adjacent subchannels, where the groups are defined starting from the first subchannel. Optionally, ranging channel can be composed of eight adjacent subchannels using the symbol structure defined in 8.4.6.2.5. The indices of the subchannels that compose the ranging channel are specified in the UL-MAP message. Users are allowed to collide on this ranging channel. To effect a ranging transmission, each user randomly chooses one ranging code from a bank of specified binary codes. These codes are then BPSK modulated onto the subcarriers in the ranging channel, one bit per subcarrier (subcarriers used for ranging shall be modulated with the waveform specified in 8.4.7.1/8.4.7.2 and are not restricted to any time grid specified for the data subchannels).

8.4.7.1 Initial-ranging transmissions

The initial ranging transmission shall be used by any SS that wants to synchronize to the system channel for the first time. An initial-ranging transmission shall be performed during two consecutive symbols. The same ranging code is transmitted on the ranging channel during each symbol, with no phase discontinuity between the two symbols. A time-domain illustration of the initial-ranging transmission is shown in Figure 239.

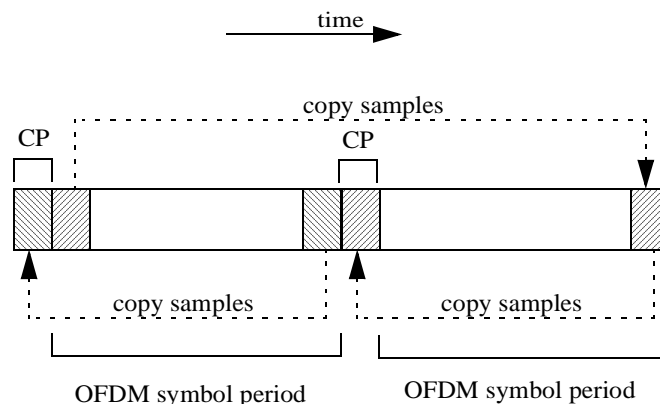

Figure 239—Initial-ranging transmission for OFDMA

The BS can allocate two consecutive initial ranging slots; onto those the SS shall transmit the two consecutive initial ranging codes (starting code shall always be a multiple of 2), as illustrated in Figure 240.

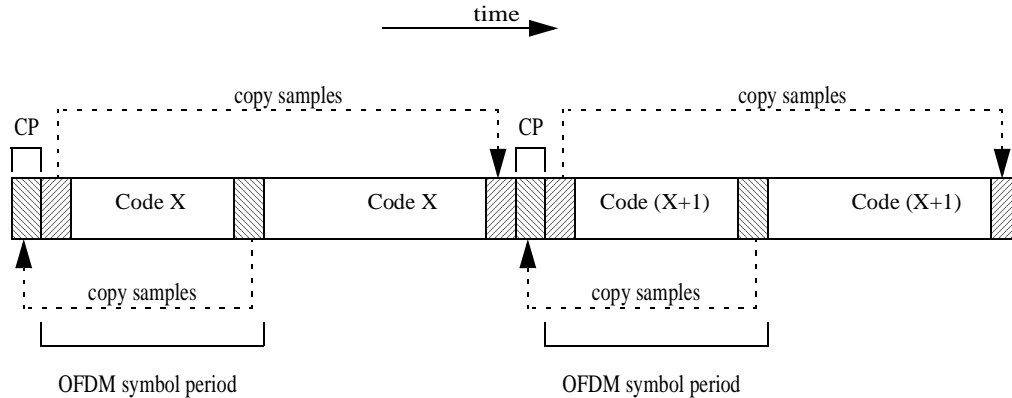

Figure 240—Initial-ranging transmission for OFDMA, using two consecutive initial ranging codes

8.4.7.2 Periodic-ranging and bandwidth-request transmissions

Periodic-ranging transmissions are sent periodically for system periodic ranging. Bandwidth-request transmissions are for requesting uplink allocations from the BS.

These transmissions shall be sent only by SS that have already synchronized to the system.

To perform either a periodic-ranging or bandwidth-request transmission, the SS can send a transmission in one of the following ways:

- a) Modulate one ranging code on the ranging subchannel for a period of one OFDMA symbol. Ranging subchannels are dynamically allocated by the MAC layer and indicated in the UL-MAP. A time-domain illustration of the periodic-ranging or bandwidth-request transmission is shown in Figure 241.

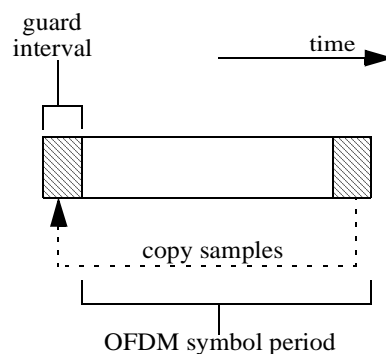

Figure 241—Periodic-ranging or bandwidth-request transmission for OFDMA using one code

- b) Modulating three consecutive ranging codes (starting code shall always be a multiple of 3) on the ranging subchannel for a period of three OFDMA symbols (one code per symbol). Ranging subchannels are dynamically allocated by the MAC layer and indicated in the UL-MAP. A time-

domain illustration of the periodic-ranging or bandwidth-request transmission is shown in Figure 242.

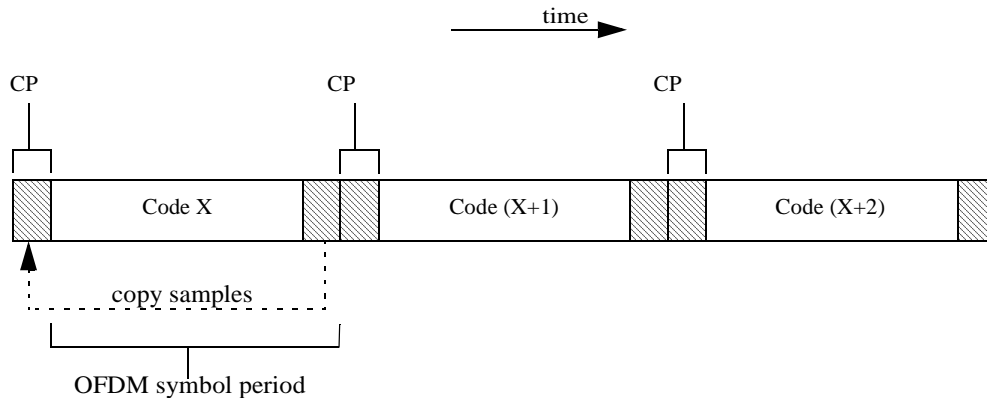

Figure 242—Periodic-ranging or bandwidth-request transmission for OFDMA using three consecutive codes

8.4.7.3 Ranging codes

The binary codes are the pseudonoise codes produced by the PRBS described in Figure 243, which implements the polynomial generator $1 + x^1 + x^4 + x^7 + x^{15}$. The PRBS generator shall be initialized by the seed $b_0...b_{15} = 0,0,1,0,1,0,1,1,s_0,s_1,s_2,s_3,s_4,s_5,s_6$ where s_6 is the MSB, and $s_6:s_0 = UL_IDcell$.

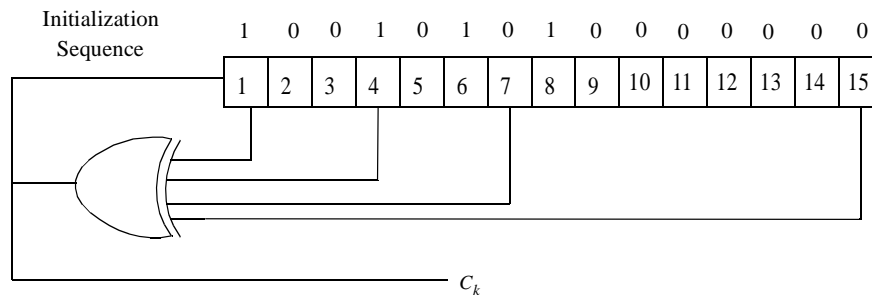

Figure 243—PRBS for ranging code generation

The binary ranging codes are subsequences of the pseudonoise sequence appearing at its output C_k . The length of each ranging code is 144 bits. These bits are used to modulate the subcarriers in a group of six (eight for the permutation defined in 8.4.6.2.5) adjacent subchannels. The index of the lowest numbered subchannel in the six (eight for the permutation defined in 8.4.6.2.5) shall be an integer multiple of six (eight for the permutation defined in 8.4.6.2.5). The six (eight for the permutation defined in 8.4.6.2.5) subchannels are called a ranging subchannel. The ranging subchannel is referenced in the ranging and Bandwidth Request messages by the index of lowest numbered subchannel.

For example, the first 144 bit code obtained by clocking the PN generator as specified, with $UL_IDcell = 0$, the first code shall be 01111000011111... The next ranging code is produced by taking the output of the 145th to 288th clock of the PRBS, etc.

The number of available codes is 256, numbered 0..255. Each BS uses a subgroup of these codes, where the subgroup is defined by a number S , $0 \leq S \leq 255$. The group of codes will be between S and $((S+N+M+L) \bmod 256)$.

- The first N codes produced are for initial-ranging. For example, for the default case of two subchannels in the ranging channel, clock the PRBS $120 \times (S \bmod 256)$ times to $120 \times ((S + N) \bmod 256) - 1$ times.
- The next M codes produced are for periodic-ranging. For example, for the default case of two subchannels in the ranging channel, clock the PRBS $120 \times ((N + S) \bmod 256)$ times to $120 \times ((N + M + S) \bmod 256) - 1$ times.
- The next L codes produced are for bandwidth-requests. For example, for the default case of two subchannels in the ranging channel, clock the PRBS $120 \times ((N + M + S) \bmod 256)$ times to $120 \times ((N + M + L + S) \bmod 256) - 1$ times.

The BS can separate colliding codes and extract timing (ranging) information and power. In the process of user code detection, the BS gets the Channel Impulse Response (CIR) of the code, thus acquiring for the BS vast information about the user channel and condition. The time (ranging) and power measurements allow the system to compensate for the near/far user problems and the propagation delay caused by large cells.

8.4.8 Transmit diversity (optional)

8.4.8.1 Transmit diversity using two antennas

Space-Time Coding (STC) (see Alamouti [B1]) or frequency hopping diversity coding (FHDC) may be used on the downlink to provide second order (Space) transmit diversity.

There are two transmit antennas on the BS side and one reception antenna on the SS side. This scheme requires multiple input single output channel estimation. Decoding is very similar to maximum ratio combining.

Figure 244 shows transmit diversity insertion into the OFDMA chain. Each Tx antenna has its own OFDMA chain, but they have the same Local Oscillator for synchronization purposes.

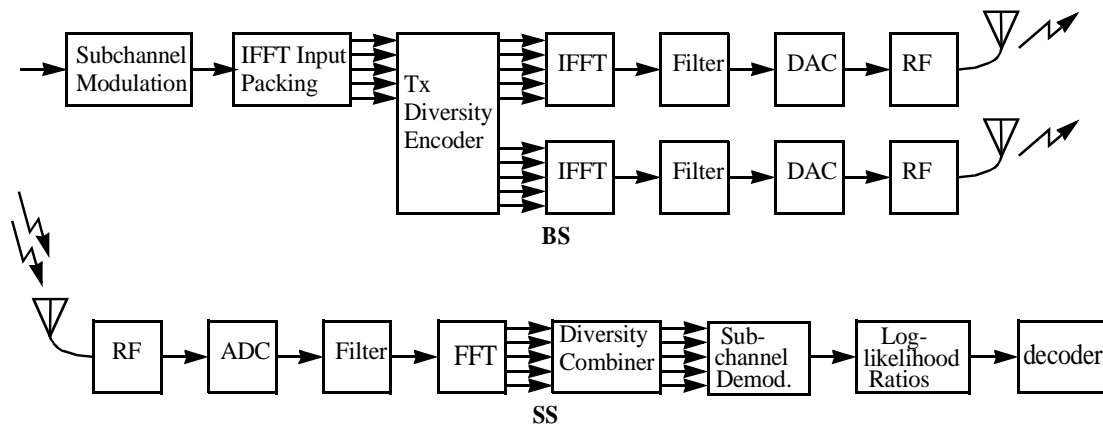

Figure 244—Illustration of STC

Both antennas transmit two different OFDMA data symbols in the same time. Time domain (Space-Time) or Frequency domain (Space-Frequency) repetition is used.

This mode of operation allows better performance with higher complexity in the receiver. The mode of operation introduced in the sequel defines a combined operation of the transmit diversity using PUSC or FUSC in the downlink only. The current PUSC mandatory mode of operation allows the splitting of the available Subchannels into three segments, each transmitting some (or all) of the subchannels as allocated by the FCH. The transmit diversity mode of operation shall be used in a combined way with the mandatory mode of operation; this is performed by allocating subchannels to either of the modes of operation.

The allocation of subchannels to STC operation shall be done by allocating one or more groups of subchannels as defined in 8.4.4.4.

The regular subchannel and preamble transmission in the downlink shall be performed from only one antenna (Antenna 0) while the transmit diversity Subchannels transmission shall be performed from both antennas obeying the formulas in 8.4.8.1.2.1 and 8.4.8.1.2.1.

8.4.8.1.1 Multiple input single output channel estimation and synchronization

Both antennas transmit in the same time and they share the same Local Oscillator. Thus, the received signal has exactly the same auto-correlation properties as for a single antenna. Time and frequency coarse and fine estimation can be performed in the same way as for a single antenna. The scheme requires multiple input single output channel estimation, which is allowed by splitting some pilots between the 2 Tx antennas, as described in 8.4.8.1.2.1 and 8.4.8.1.2.1.

8.4.8.1.2 Space time coding using 2 antennas

8.4.8.1.2.1 STC encoding

The basic scheme (Alamouti [B1]) transmits two complex symbols s_1 and s_2 , using the multiple input single output channel (two Tx, one Rx) with channel vector values h_0 (for antenna 0) and h_1 (for antenna 1).

First channel use: Antenna 0 transmits s_1 , antenna1 transmits s_2 .

Second channel use: Antenna 0 transmits $-s_2^*$, antenna1 transmits s_1^* .

Receiver gets r_0 (first channel use) and r_1 (second channel use) and computes s_1 and s_2 estimates:

$$\hat{s}_1 = h_0^* \cdot r_0 + h_1 \cdot r_1^* \quad (117)$$

$$\hat{s}_2 = h_1^* \cdot r_0 - h_0 \cdot r_1^* \quad (118)$$

These estimates benefit from second order diversity as in the 1Tx-2Rx Maximum Ratio Combining scheme.

The STC transmission may be used both in a PUSC and FUSC configurations.

8.4.8.1.2.1.1 STC using 2 antennas in PUSC

In PUSC, the data allocation to cluster is changed (Figure 245) to accommodate two antennas transmission with the same estimation capabilities, each cluster shall be transmitted twice from each antenna.

The clusters composing the subchannels used by the STC mode shall be allocated and subcarriers numbered as defined in 8.4.6.2. The cluster structure of the subchannels allocated for STC is slightly modified to fit the STC requirements. The structure shall be modified as depicted in Figure 245. (Switching two pilot carriers from the odd symbol with two data carriers from the even symbols, and switching of the data carriers and the pilots carriers shall be performed after constellation mapping, therefore maintaining all the encoding scheme

and the subchannel allocation scheme.) In this scheme, transmission on regular subchannels and STC subchannels is possible and is determined by the MAC layer (the allocation is performed by allocating major groups of subchannels for regular or STC transmission). The transmission of the data shall be performed in pairs of symbols as illustrated in Figure 246.

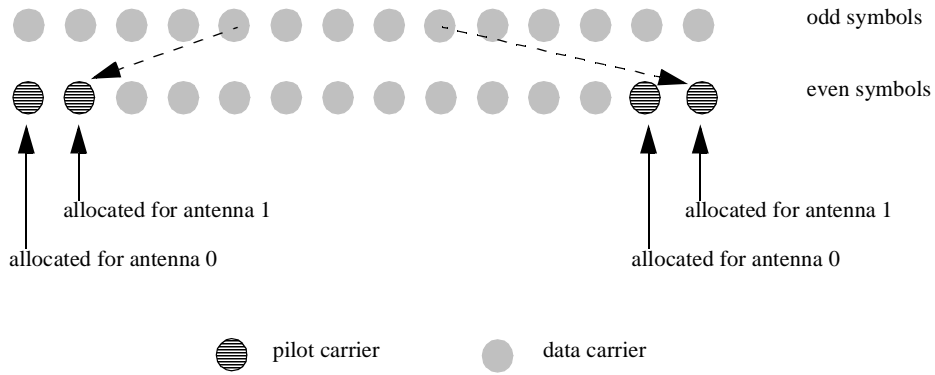

Figure 245—Cluster structure

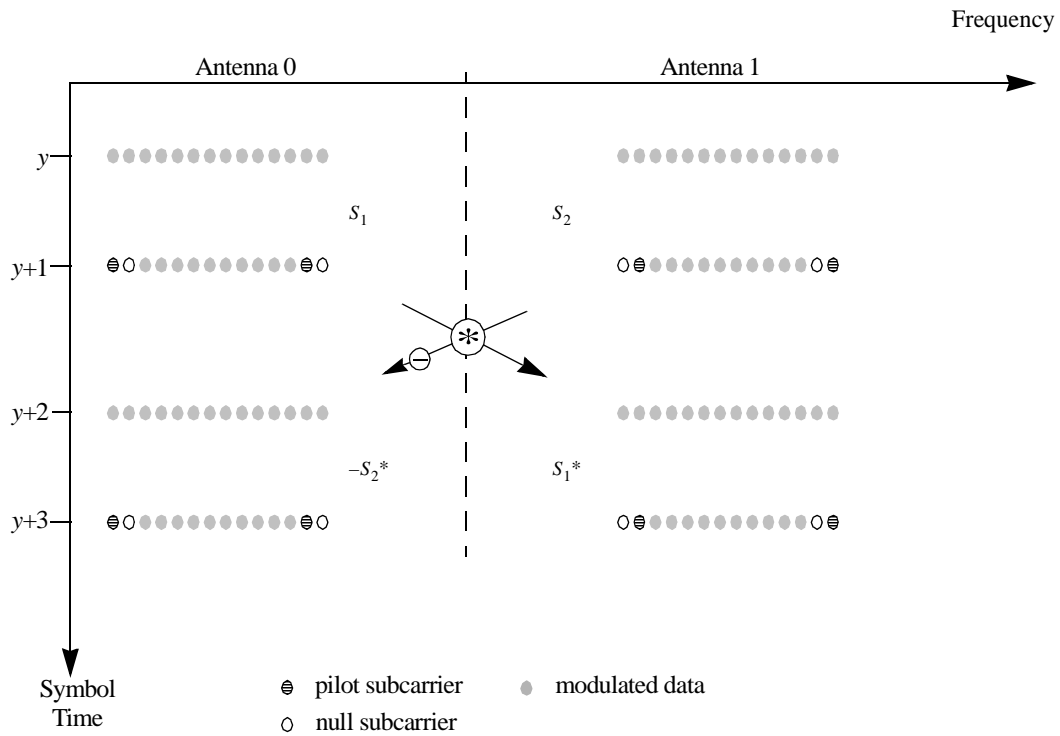

Figure 246—STC usage with PUSC

8.4.8.1.2.1.2 STC using using 2 antennas in FUSC

In FUSC, all subchannels shall be used for STC transmission. The pilots within the symbols shall be divided between the antennas—antenna 0 uses VariableSet#0 and ConstantSet#0 for even symbols while antenna 1 uses VariableSet#1 and ConstantSet#1 for even symbols, antenna 0 uses VariableSet#1 and ConstantSet#0 for odd symbols while antenna 1 uses VariableSet#0 and ConstantSet#1 for odd symbols (symbol counting starts at the starting point of the relevant STC zone), defined in 8.4.6.1.2.2. The transmission of the data shall be performed in pairs of symbols as illustrated in Figure 247.

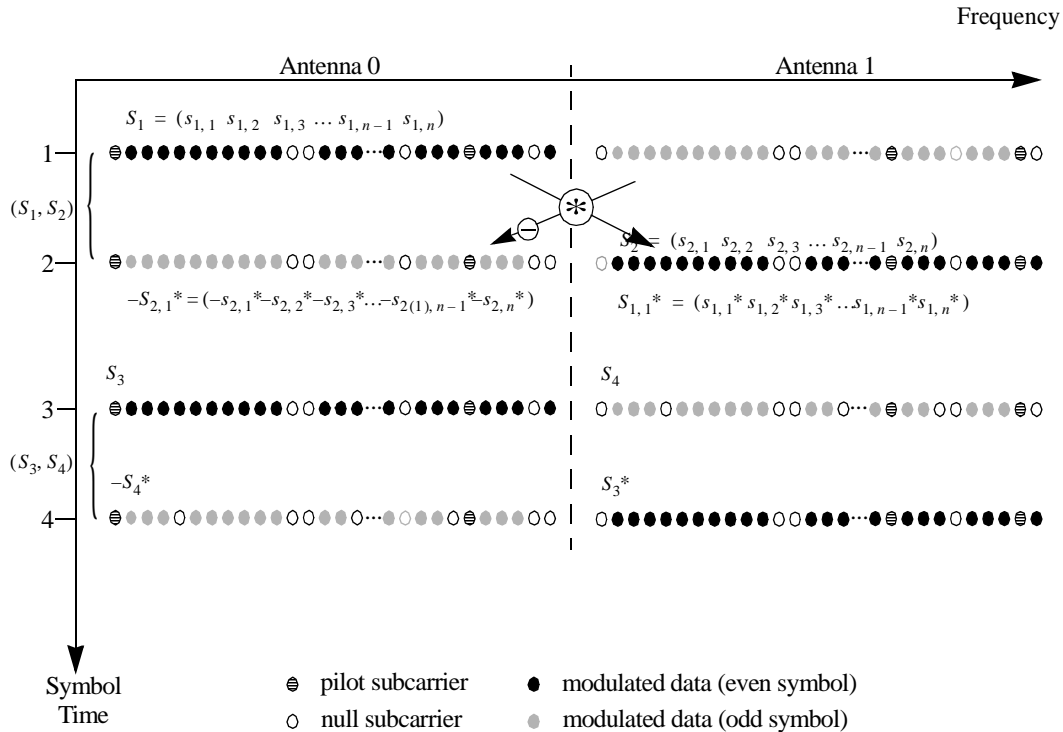

Figure 247—STC usage with FUSC

8.4.8.1.2.2 STC decoding

The receiver waits for two symbols, and combines them on a subcarrier basis according to Equation (117) and Equation (118) in 8.4.8.1.2.1.

8.4.8.1.3 Frequency hopping diversity coding (FHDC)

This scheme (as for STC) transmits two complex symbols, s_1 and s_2 , using the multiple input single output channel (two Tx, one Rx). Allocation of subchannels for FHDC transmission shall be even numbered in the same OFDMA symbol, and the first subchannel shall have an even logical index.

The transmission is based on transmitting the FHDC allocated subchannels from both antennas in the following format:

- Antenna 0 transmits mapped carriers for subchannel X (S_1) onto subchannel X and mapped carriers for subchannel $X + 1$ (S_2) onto subchannel $X + 1$
- Antenna 1 transmits $(-S_2^*)$ onto subchannel X and (S_1^*) onto subchannel $X + 1$

Receiver gets r_0 (reception of subchannel X) and r_1 (reception of subchannel $X + 1$), and the user shall extract signals S_1, S_2 :

$$\begin{aligned} r_0 &= h_{x,0} \cdot S_1 - h_{x,1} \cdot S_2^* \\ r_1 &= h_{x+1,0} \cdot S_2 + h_{x+1,1} \cdot S_1^* \end{aligned} \tag{119}$$

These estimates benefit from second order diversity as in the 1Tx-2Rx Maximum Ratio Combining scheme. The downlink preamble will be transmitted for the duration of one OFDMA symbol from both antennas, and subchannels used for FHDC are transmitted in adjunct pairs of subchannels.

The same data/pilot subcarrier structure as defined for the STC mode shall be used in the FHDC mode.

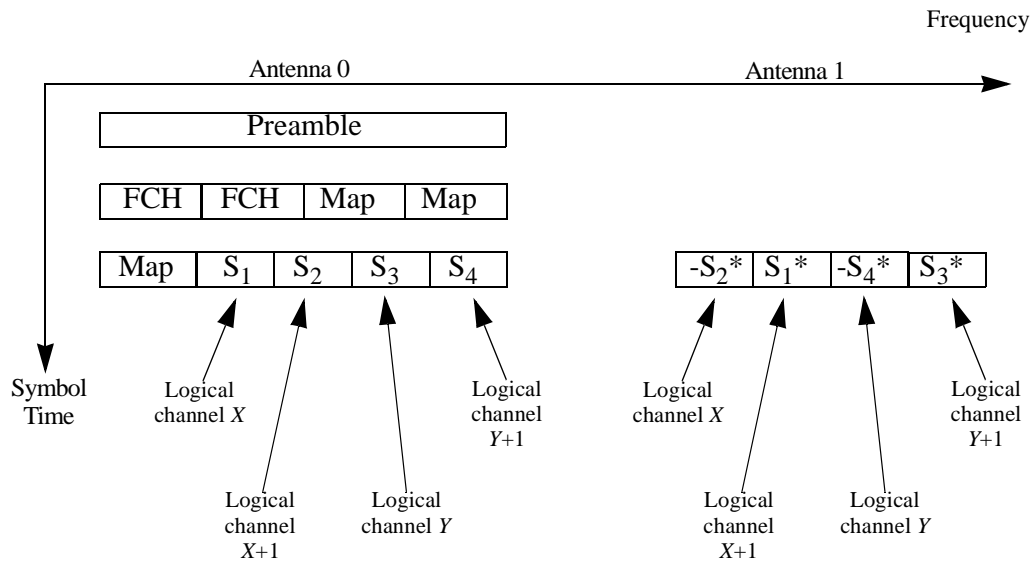

Figure 248— Example of using FHDC in PUSC

8.4.8.1.4 STC/FHDC configurations

Two transmission formats are allowed for the two antenna configuration, each format has its own capacity/diversity tradeoffs. The following matrices define the transmission format with the row index indicating the antenna number and column index indicating the subchannel symbol time (two symbols per entry). The entries define the transmission from a subchannel used for this transmission configuration (the same operation is repeated for all subchannels used in this format).

Transmission format A uses Matrix A (space time coding rate = 1, as explained in 8.4.8.1.2 and 8.4.8.1.3):

$$A = \begin{bmatrix} S_1 & -(S_2)^* \\ S_2 & (S_1)^* \end{bmatrix} \tag{120}$$

Transmission format B uses Matrix B (space time coding rate = 2):

$$B = \begin{matrix} S_1 \\ S_2 \end{matrix} \tag{121}$$

8.4.8.1.5 Uplink using STC

A user-supporting transmission using STC configuration in the uplink, shall use a modified uplink tile, 2-transmit diversity data, or 2-transmit spatial multiplexing data that can be mapped onto each subcarrier. The mandatory tile shall be modified to accommodate those configurations. Figure 249 depicts the UL tile for STC transmission.

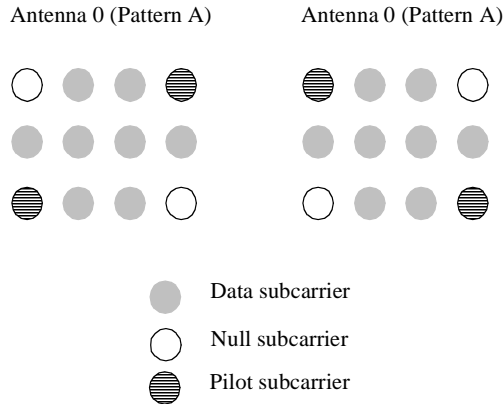

Figure 249—UL STC tile

Two single transmit antenna SS's can perform collaborative spatial multiplexing onto the same subcarrier. In this case, the one SS should use the uplink tile with pattern-A, and the other SS should use the uplink tile with pattern-B.

8.4.8.1.6 STC of two antennas using directivity through four antennas

The STC scheme for two antennas may be enhanced by using four antennas at the transmission site. Two antennas are now being used in order to transmit each symbol (the first antenna transmits the signal as defined in 8.4.8.1.2 and 8.4.8.1.3, and the second transmits the same signal with a complex multiplication factor). The BS may change the antenna weights using feedback from the user as described in 8.4.5.4.10.2. This scheme is presented in Figure 250.

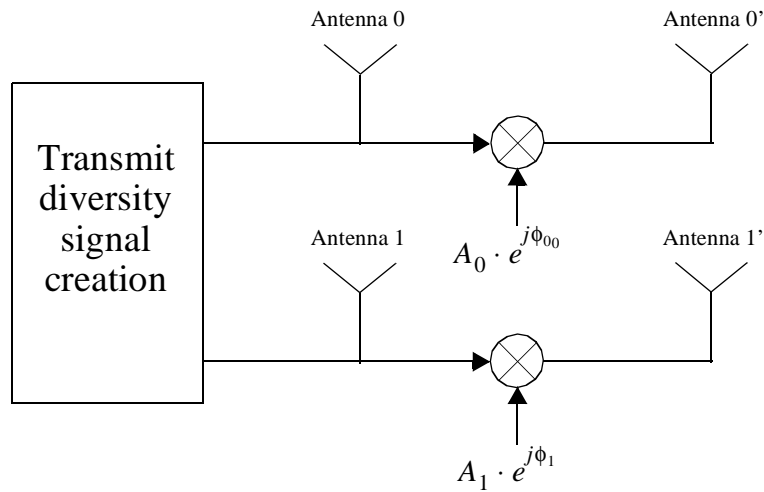

Figure 250—Illustration of Transmit diversity using four antennas

This method does not change the channel estimation process of the user; therefore, this scheme could be implemented without any changes made to the Transmit diversity user.

8.4.8.2 Transmit diversity for four antennas

The Transmit diversity schemes could be further enhanced by using four antennas at the transmission site. This configuration could be only used using STC encoding with PUSC or FUSC scheme.

8.4.8.2.1 STC for four antennas using PUSC

For this configuration, the basic cluster structure is changed (as indicated in Figure 251) to accommodate the transmission from four antennas. (Pilots for antennas 2/3 override data subcarriers in the even symbols. Switching and erasing of the data subcarriers shall be performed after constellation mapping; therefore, maintaining all the encoding scheme and the subchannel allocation scheme).

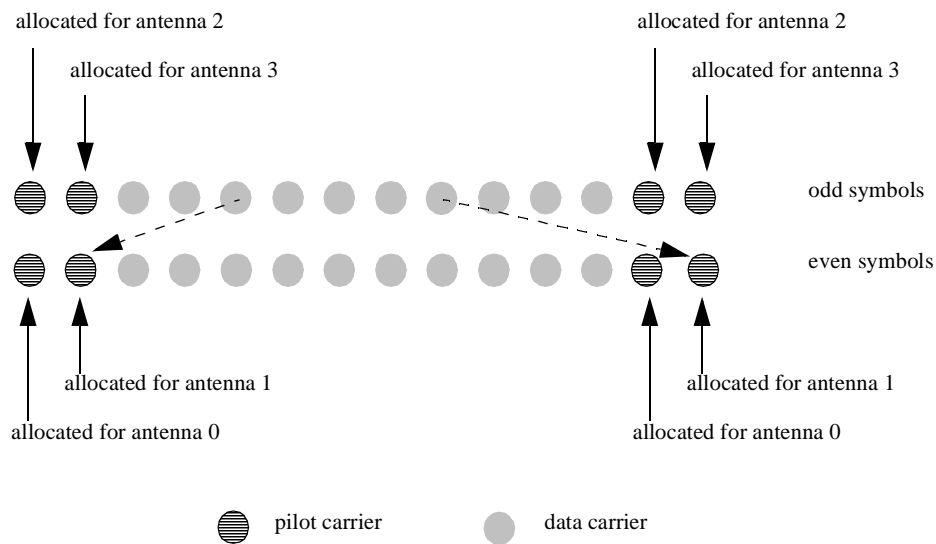

Figure 251—Cluster structure

8.4.8.2.2 STC for four antennas using FUSC

For the FUSC configuration, the pilots embedded within the symbol shall be further divided. The pilots shall be transmitted with a structure including four time symbols (repeating itself every four symbols) as follows:

- Symbol 0: antenna 0 uses VariableSet#0 and ConstantSet#0, antenna 1 uses VariableSet#1 and ConstantSet#1
- Symbol 1: antenna 2 uses VariableSet#0 and ConstantSet#0, antenna 3 uses VariableSet#1 and ConstantSet#1
- Symbol 2: antenna 0 uses VariableSet#1 and ConstantSet#0, antenna 1 uses VariableSet#0 and ConstantSet#1
- Symbol 3: antenna 2 uses VariableSet#1 and ConstantSet#0, antenna 3 uses VariableSet#0 and ConstantSet#1

8.4.8.2.3 STC configurations

Several transmission formats are allowed for this configuration. Each format has its own capacity/diversity tradeoffs.

The following matrices define the transmission format with the row index indicating the antenna number and column index indicating the subchannel symbol time (two symbols per entry). The entries define the transmission from a subchannel used for this transmission configuration (the same operation is repeated for all subchannels used in this format).

Transmission format A uses Matrix A (space time coding rate = 1):

$$A = \begin{bmatrix} S_1 & -(S_2)^* & 0 & 0 \\ S_2 & (S_1)^* & 0 & 0 \\ 0 & 0 & S_3 & -(S_4)^* \\ 0 & 0 & S_4 & (S_3)^* \end{bmatrix} \quad (122)$$

Transmission format B uses Matrix B (space time coding rate = 2):

$$B = \begin{bmatrix} S_1 & -(S_2)^* & S_5 & -(S_7)^* \\ S_2 & (S_1)^* & S_6 & -(S_8)^* \\ S_3 & -(S_4)^* & S_7 & (S_5)^* \\ S_4 & (S_3)^* & S_8 & (S_6)^* \end{bmatrix} \quad (123)$$

Transmission format C uses Matrix C (space time coding rate = 4):

$$C = \begin{bmatrix} S_1 \\ S_2 \\ S_3 \\ S_4 \end{bmatrix} \quad (124)$$

8.4.9 Channel coding

Channel coding procedures include randomization (see 8.4.9.1), FEC encoding (see 8.4.9.2), bit interleaving (see 8.4.9.3), and modulation (see 8.4.9.4). When repetition code is used, allocation for the transmission shall always include an even number of adjacent subchannels. The basic block shall pass the regular coding chain where the first subchannel shall set the randomization seed used in 8.4.9.1, and the data shall follow the coding chain up to the mapping. The data outputted from the modulation (8.4.9.4) shall be mapped onto the block of subchannels allocated for the basic block and then it will be also mapped on the following consecutive allocated subchannels (for repetition coding of 2, another block of subchannels of the same size is used; for repetition coding of 4, another 3 blocks of subchannels of the same size are used; and for repetition of 6, another 5 blocks of subchannels of the same size are used), the process of regular encoding and repetition encoding is shown in Figure 252.

Regular Channel Coding Process

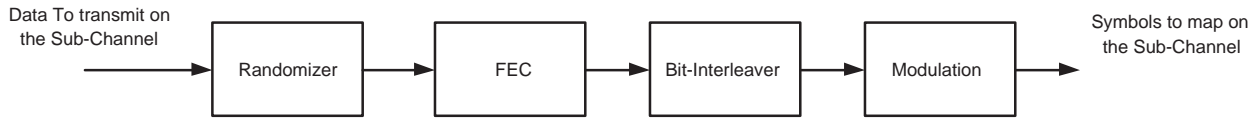

Repetition Coding - Channel Coding Process

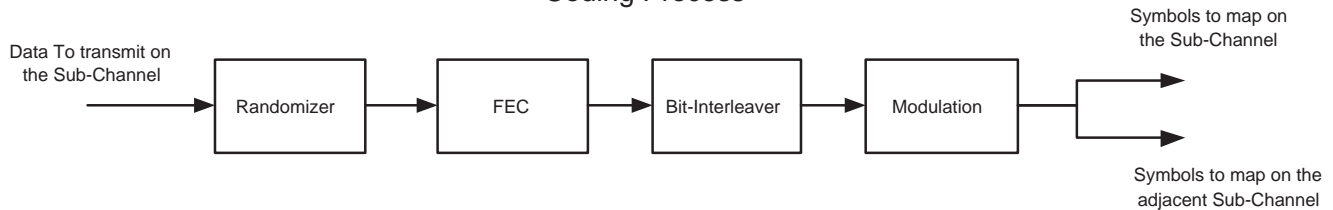

Figure 252—Channel coding process for regular and repetition coding transmission

8.4.9.1 Randomization

Data randomization is performed on data transmitted on the downlink and uplink. The randomization is initialized on each FEC block (using the first Subchannel offset and OFDMA symbol offset on which the FEC block is mapped. Symbol offset, for both UL and DL, shall be counted from the start of the frame, where the DL preamble shall be count 0). If the amount of data to transmit does not fit exactly the amount of data allocated, padding of 0xFF (“1” only) shall be added to the end of the transmission block, up to the amount of data allocated.

The PRBS generator shall be $1 + x^{14} + x^{15}$, as shown in Figure 253. Each data byte to be transmitted shall enter sequentially into the randomizer, MSB first. Preambles are not randomized. The seed value shall be used to calculate the randomization bits, which are combined in an XOR operation with the serialized bit stream of each FEC block. The randomizer sequence is applied only to information bits.

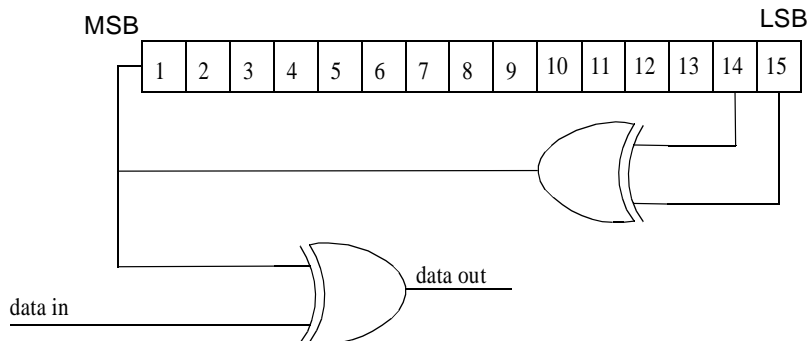

Figure 253—PRBS for data randomization

The bit issued from the randomizer shall be applied to the encoder.

The randomizer is initialized with the vector created as shown in Figure 254.

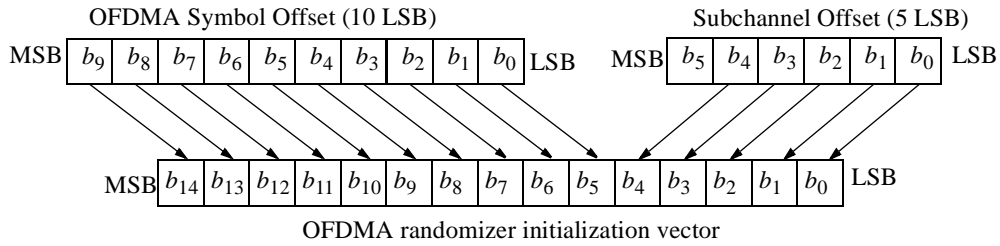

Figure 254—Creation of OFDMA randomizer initialization vector

8.4.9.2 Encoding

The coding method used as the mandatory scheme will be the tail-biting convolutional encoding specified in 8.4.9.2.1, and the optional modes of encoding in 8.4.9.2.2 and 8.4.9.2.3 shall be also supported.

The encoding block size shall depend on the number of subchannels allocated and the modulation specified for the current transmission.

Concatenation of a number of subchannels shall be performed in order to make larger blocks of coding where it is possible, with the limitation of not passing the largest block under the same coding rate (the block defined by 64-QAM modulation). Table 318 specifies the concatenation of subchannels for different allocations and modulations. The parameters in Table 317 and Table 318 shall apply to the CC encoding scheme (see 8.4.9.2.1) and the BTC encoding scheme (see 8.4.9.2.2); for the CTC encoding scheme (see 8.4.9.2.3), the concatenation rule is defined in 8.4.9.2.3.3.

For any modulation and FEC rate, given an allocation of n subchannels, the following parameters are defined:

- j : parameter dependent on the modulation and FEC rate
- n : number of allocated subchannels
- k : floor (n/j)
- m : n modulo j

Table 317 shows the rules used for subchannel concatenation.

Table 317—Subchannel concatenation rule

Number of subchannels	Subchannels concatenated
$n \leq j$	1 block of n subchannels
$n > j$	$(k-1)$ blocks of j subchannels 1 block of $\text{ceil}((m+j)/2)$ subchannels 1 block of $\text{floor}((m+j)/2)$ subchannels

Table 318—Encoding Subchannel concatenation for different allocations and modulations

Modulation and rate	<i>j</i>
QPSK 1/2	<i>j</i> = 6
QPSK 3/4	<i>j</i> = 4
16-QAM 1/2	<i>j</i> = 3
16-QAM 3/4	<i>j</i> = 2
64-QAM 1/2	<i>j</i> = 2
64-QAM 2/3	<i>j</i> = 1
64-QAM 3/4	<i>j</i> = 1

8.4.9.2.1 Convolutional coding (CC)

Each FEC block is encoded by the binary convolutional encoder, which shall have native rate of 1/2, a constraint length equal to $K = 7$, and shall use the following generator polynomials codes to derive its two code bits:

$$\begin{aligned}
 G_1 &= 171_{OCT} && \text{FOR } X \\
 G_2 &= 133_{OCT} && \text{FOR } Y
 \end{aligned}
 \tag{125}$$

The generator is depicted in Figure 255.

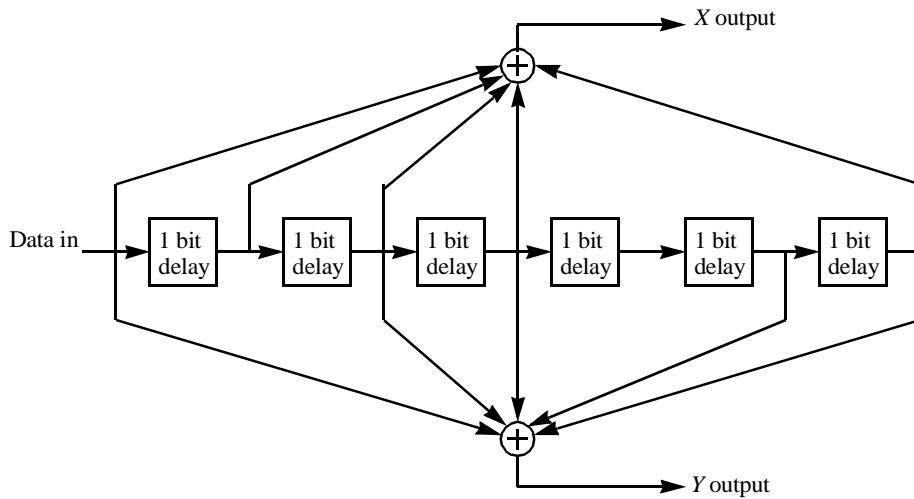

Figure 255—Convolutional encoder of rate 1/2

The puncturing patterns and serialization order that shall be used to realize different code rates are defined in Table 319. In the table, “1” means a transmitted bit and “0” denotes a removed bit, whereas X and Y are in reference to Figure 255.

Table 319—The inner convolutional code with puncturing configuration

Rate	Code Rates			
	1/2	2/3	3/4	5/6
d_{free}	10	6	5	4
X	1	10	101	10101
Y	1	11	110	11010
XY	X_1Y_1	$X_1Y_1Y_2$	$X_1Y_1Y_2X_3$	$X_1Y_1Y_2X_3Y_4X_5$

Each FEC block is encoded by a tail-biting convolutional encoder, which is achieved by initializing the encoders memory with the last data bits of the FEC block being encoded (the packet data bits numbered $b_{n-5} \dots b_n$).

Table 320 defines the basic sizes of the useful data payloads to be encoded in relation with the selected modulation type and encoding rate and concatenation rule.

Table 320—Useful data payload for a subchannel

Encoding rate	QPSK		16 QAM		64 QAM		
	R=1/2	R=3/4	R=1/2	R=3/4	R=1/2	R=2/3	R=3/4
Data payload (bytes)	6						
		9					
	12		12				
	18	18		18	18		
	24		24			24	
		27					27
	30						
	36	36	36	36	36		

8.4.9.2.2 Block Turbo Coding (optional)

The BTC is based on the product of two simple component codes, which are binary extended Hamming codes or parity check codes from the set depicted in Table 321.

Table 321 specifies the generator polynomials for the Hamming codes. To create extended Hamming codes, an overall even parity check bit is added at the end of each code word.

Table 321—OFDMA Hamming code generator polynomials

n'	k'	Generator polynomial
15	11	X^4+X^1+1
31	26	X^5+X^2+1
63	57	X^6+X+1

The component codes are used in a two-dimensional matrix form, which is depicted in Figure 256. The k_x information bits in the rows are encoded into n_x bits by using the component block (n_x, k_x) code specified for the respective composite code. After encoding the rows, the columns are encoded using a block code (n_y, k_y) , where the check bits of the first code are also encoded. The overall block size of such a product code is $n = n_x \times n_y$, the total number of information bits $k = k_x \times k_y$, and the code rate is $R = R_x \times R_y$, where $R_i = k_i/n_i$, $i = x, y$. The Hamming distance of the product code is $d = d_x \times d_y$. Data bit ordering for the composite BTC matrix is the first bit in the first row is the LSB and the last data bit in the last data row is the MSB.

Transmission of the block over the channel shall occur in a linear fashion, with all bits of the first row transmitted left to right followed by the second row, etc.

To match a required packet size, BTCs may be shortened by removing symbols from the BTC array. In the two-dimensional case, rows, columns, or parts thereof can be removed until the appropriate size is reached. There are three steps in the process of shortening product codes:

- Step 1) Remove I_x rows and I_y columns from the two-dimensional code. This is equivalent to shortening the constituent codes that make up the product code.
- Step 2) Remove B individual bits from the first row of the two-dimensional code starting with the LSB.
- Step 3) Use if the product code specified from Step 1) and Step 2) of this subclause has a non-integral number of data bytes. In this case, the Q leftover LSB are zero-filled by the encoder. After decoding at the receive end, the decoder shall strip off these unused bits and only the specified data payload is passed to the next higher level in the PHY. The same general method is used for shortening the last code word in a message where the available data bytes do not fill the available data bytes in a code block.

These three processes of code shortening are depicted in Figure 256. In the first two-dimensional BTC, a nonshortened product code is shown. By comparison, a shortened BTC is shown in the adjacent two-dimensional array. The new coded block length of the code is $(n_x - I_x)(n_y - I_y) - B$. The corresponding information length is given as $(k_x - I_x)(k_y - I_y) - B - Q$. Consequently, the code rate is given by Equation (126).

$$R = \frac{(k_x - I_x)(k_y - I_y) - B - Q}{(n_x - I_x)(n_y - I_y) - B} \quad (126)$$

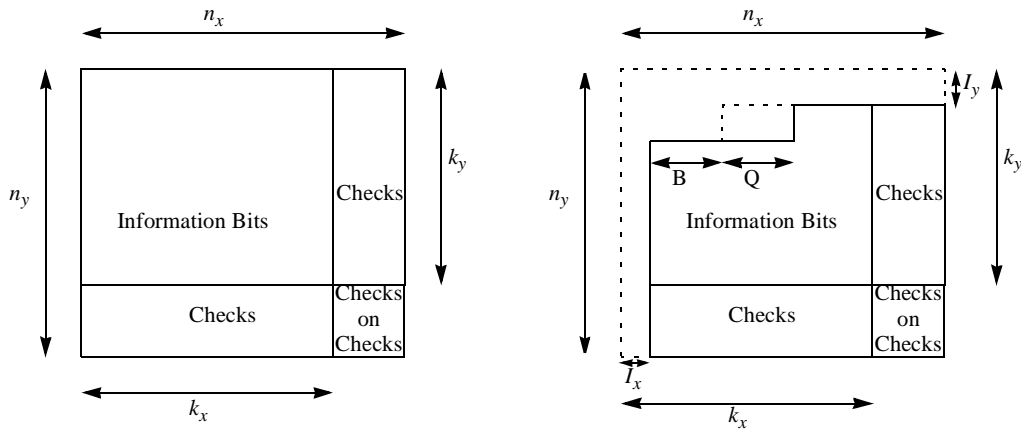

Figure 256—BTC and shortened BTC structure

Table 322 gives the block sizes for the optional modulation and coding schemes using BTC. Table 323 gives the code parameters for each of the possible data and coded block sizes.

Table 322—Useful data payload for a subchannel

Encoding Rate	QPSK		16-QAM		64-QAM		Coded Bytes
	R=1/2	R=3/4	R=1/2	R=3/4	R=1/2	R=3/4	
Allowed Data (Bytes)	6	9					12
	16	20	16	20			24
	16	25			16	25	36
	23	35	23	35			48
	31						60
	40		40		40		72

Table 323—Optional channel coding per modulation

Data Bytes	Coded Bytes	Constituent	Code parameters
6	12	(8,7)(32,26)	$I_x=4, I_y=8, B=0, Q=6$
9	12	(16,15)(16,15)	$I_x=6, I_y=6, B=4, Q=5$
16	24	(8,7)(32,26)	$I_x=2, I_y=0, B=0, Q=2$
20	24	(16,15)(16,15)	$I_x=2, I_y=2, B=4, Q=5$
16	36	(32,26)(16,11)	$I_x=11, I_y=2, B=6, Q=7$

Table 323—Optional channel coding per modulation (continued)

Data Bytes	Coded Bytes	Constituent	Code parameters
25	36	(8,7)(64,57)	$I_x=2, I_y=16, B=0, Q=5$
23	48	(32,26)(16,11)	$I_x=4, I_y=2, B=8, Q=6$
35	48	(32,26)(16,15)	$I_x=0, I_y=4, B=0, Q=6$
31	60	(32,26)(32,26)	$I_x=10, I_y=10, B=4, Q=4$
40	72	(32,26)(32,26)	$I_x=8, I_y=8, B=0, Q=4$

8.4.9.2.3 Convolutional turbo codes (optional)**8.4.9.2.3.1 CTC encoder**

The Convolutional Turbo Code (CTC) defined in this subclause is designed to enable support of hybrid ARQ (HARQ). HARQ implementation is optional. The CTC encoder, including its constituent encoder, is depicted in Figure 257. It uses a double binary Circular Recursive Systematic Convolutional code. The bits of the data to be encoded are alternately fed to *A* and *B*, starting with the MSB of the first byte being fed to *A*. The encoder is fed by blocks of *k* bits or *N* couples ($k = 2 * N$ bits). For all the frame sizes, *k* is a multiple of 8 and *N* is a multiple of 4. Further, *N* shall be limited to: $8 \leq N/4 \leq 1024$.

The polynomials defining the connections are described in octal and symbol notations as follows:

- For the feedback branch: 0xB, equivalently $1 + D + D^3$ (in symbolic notation)
- For the *Y* parity bit: 0xD, equivalently $1 + D^2 + D^3$
- For the *W* parity bit: 0x9, equivalently $1 + D^3$

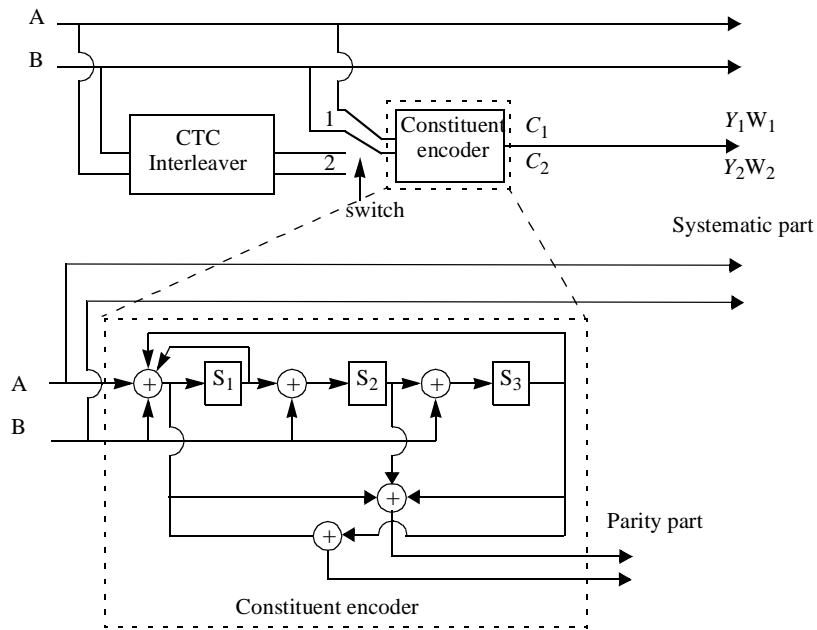

Figure 257—CTC encoder

First, the encoder (after initialization by the circulation state S_{c1} , see 8.4.9.2.3.3) is fed the sequence in the natural order (position 1) with the incremental address $i = 0 \dots N-1$. This first encoding is called C_1 encoding. Then the encoder (after initialization by the circulation state S_{c2} , see 8.4.9.2.3.3) is fed by the interleaved sequence (switch in position 2) with incremental address $j = 0, \dots, N-1$. This second encoding is called C_2 encoding.

The order in which the encoded bit shall be fed into the subpacket generation block (8.4.9.2.3.4) is:

$$A, B, Y_1, Y_2, W_1, W_2 =$$

$$A_0, B_0, \dots, A_{N-1}, B_{N-1}, Y_{1,0}, Y_{1,1}, \dots, Y_{1,N-1}, Y_{2,0}, Y_{2,1}, \dots, Y_{2,N-1}, W_{1,0}, W_{1,1}, \dots, W_{1,N-1}, W_{2,0}, W_{2,1}, \dots, W_{2,N-1}$$

Note that the interleaver (8.4.9.3) shall not be used when using CTC.

The encoding block size shall depend on the number of subchannels allocated and the modulation specified for the current transmission. Concatenation of a number of subchannels shall be performed in order to make larger blocks of coding where it is possible, with the limitation of not passing the largest block under the same coding rate (the block defined by 64-QAM modulation). Table 325 specifies the concatenation of subchannels for different allocations and modulations. The concatenation rule shall not be used when using H-ARQ.

For any modulation and FEC rate, given an allocation of n subchannels, the following parameters are defined:

- j parameter dependent on the modulation and FEC rate
- n number of allocated subchannels
- $k = \text{floor}(n/j)$
- $m = n \bmod j$

Table 324 shows the rules used for subchannel concatenation:

Table 324—Subchannel concatenation rule for CTC

Number of subchannels	Subchannels concatenated
$n \leq j$ $n \neq 7$	1 block of n subchannels
$n = 7$	1 block of 4 subchannels 1 block of 3 subchannels
$n > j$	($k-1$) blocks of j subchannels 1 block of L_{b1} subchannels 1 block of L_{b2} subchannels Where: $L_{b1} = \text{ceil}((m+j)/2)$ $L_{b2} = \text{floor}((m+j)/2)$ If ($L_{b1} = 7$) or ($L_{b2} = 7$) $L_{b1} = L_{b1} + 1$; $L_{b2} = L_{b2} - 1$;

Table 325—Encoding subchannel concatenation for different rates in CTC

Modulation and rate	j
QPSK 1/2	10
QPSK 3/4	6
16-QAM 1/2	5
16-QAM 3/4	3
64-QAM 1/2	3
64-QAM 2/3	2
64-QAM 3/4	2
64-QAM 5/6	2

Table 326 gives the block sizes, code rates, channel efficiency, and code parameters for the different modulation and coding schemes. As 64-QAM is optional, the codes for this modulation shall only be implemented if the modulation is implemented. Table 327 shows code parameters for HARQ.

Table 326—Optimal CTC channel coding per modulation

Modulation	Data block size (bytes)	Encoded data block size (bytes)	Code rate	N	P ₀	P ₁	P ₂	P ₃
QPSK	6	12	1/2	24	5	0	0	0
QPSK	12	24	1/2	48	13	24	0	24
QPSK	18	36	1/2	72	11	6	0	6
QPSK	24	48	1/2	96	7	48	24	72
QPSK	30	60	1/2	120	13	60	0	60
QPSK	36	72	1/2	144	17	74	72	2
QPSK	48	96	1/2	192	11	96	48	144
QPSK	54	108	1/2	216	13	108	0	108
QPSK	60	120	1/2	240	13	120	60	180
QPSK	9	12	3/4	36	11	18	0	18
QPSK	18	24	3/4	72	11	6	0	6
QPSK	27	36	3/4	108	11	54	56	2
QPSK	36	48	3/4	144	17	74	72	2
QPSK	45	60	3/4	180	11	90	0	90
QPSK	54	72	3/4	216	13	108	0	108
16-QAM	12	24	1/2	48	13	24	0	24
16-QAM	24	48	1/2	96	7	48	24	72
16-QAM	36	72	1/2	144	17	74	72	2
16-QAM	48	96	1/2	192	11	96	48	144
16-QAM	60	120	1/2	240	13	120	60	180
16-QAM	18	24	3/4	72	11	6	0	6
16-QAM	36	48	3/4	144	17	74	72	2
16-QAM	54	108	3/4	216	13	108	0	108
64-QAM	18	24	1/2	72	11	6	0	6
64-QAM	36	72	1/2	144	17	74	72	2
64-QAM	54	108	1/2	216	13	108	0	108
64-QAM	24	36	2/3	96	7	48	24	72
64-QAM	48	72	2/3	192	11	96	48	144
64-QAM	27	36	3/4	108	11	54	56	2

Table 326—Optimal CTC channel coding per modulation (continued)

Modulation	Data block size (bytes)	Encoded data block size (bytes)	Code rate	N	P ₀	P ₁	P ₂	P ₃
64-QAM	54	72	3/4	216	13	108	0	108
64-QAM	30	36	5/6	120	13	60	0	60
64-QAM	60	72	5/6	240	13	120	60	180

Table 327—Optimal CTC channel coding per modulation when supporting H-ARQ

Data block size (bytes)	N	P ₀	P ₁	P ₂	P ₃
6	24	5	0	0	0
12	48	13	24	0	24
18	72	11	6	0	6
24	96	7	48	24	72
36	144	17	74	72	2
48	192	11	96	48	144
60	240	13	120	60	180
120	480	13	240	120	360
240	960	13	480	240	720
360	1440	17	720	360	540
480	1920	17	960	480	1440
600	2400	17	1200	600	1800

8.4.9.2.3.2 CTC interleaver

The interleaver requires the parameters P_0 and P_j , shown in Table 326.

The two-step interleaver shall be performed by:

Step 1: Switch alternate couples

for $j = 0 \dots N - 1$

if $(j_{\text{mod}_2} == 0)$ let $(B, A) = (A, B)$ (i.e., switch the couple)

Step 2: $P_j(j)$

The function $P_j(j)$ provides the interleaved address i of the consider couple j .

for $j = 0 \dots N - 1$

switch j_{mod_4} :

case 0: $i = (P_0 \cdot j + 1)_{\text{mod}_N}$

$$\begin{aligned} \text{case 1: } i &= (P_0 \cdot j + 1 + N/2 + P_1)_{\text{mod}_N} \\ \text{case 2: } i &= (P_0 \cdot j + 1 + P_2)_{\text{mod}_N} \\ \text{case 3: } i &= (P_0 \cdot j + 1 + N/2 + P_3)_{\text{mod}_N} \end{aligned}$$

8.4.9.2.3.3 Determination of CTC circulation states

The state of the encoder is denoted S ($0 \leq S \leq 7$) with S the value read binary (left to right) out of the constituent encoder memory (see Figure 257). The circulation states Sc_1 and Sc_2 are determined by the following operations:

- 1) Initialize the encoder with state 0. Encode the sequence in the natural order for the determination of Sc_1 or in the interleaved order for determination of Sc_2 . In both cases the final state of the encoder is SO_{N-1} ;
- 2) According to the length N of the sequence, use Table 328 to find Sc_1 or Sc_2 .

Table 328—Circulation state lookup table (Sc)

N_{mod_7}	SO_{N-1}							
	0	1	2	3	4	5	6	7
1	0	6	4	2	7	1	3	5
2	0	3	7	4	5	6	2	1
3	0	5	3	6	2	7	1	4
4	0	4	1	5	6	2	7	3
5	0	2	5	7	1	3	4	6
6	0	7	6	1	3	4	5	2

8.4.9.2.3.4 Subpacket generation

Proposed FEC structure punctures the mother codeword to generate a subpacket with various coding rates. The subpacket is also used as HARQ packet transmission. Figure 258 shows a block diagram of subpacket generation. 1/3 CTC encoded codeword goes through interleaving block and the puncturing is performed. Figure 259 shows block diagram of the interleaving block. The puncturing is performed to select the consecutive interleaved bit sequence that starts at any point of whole codeword. For the first transmission, the subpacket is generated to select the consecutive interleaved bit sequence that starts from the first bit of the systematic part of the mother codeword. The length of the subpacket is chosen according to the needed coding rate reflecting the channel condition. The first subpacket can also be used as a codeword with the needed coding rate for a burst where HARQ is not applied.

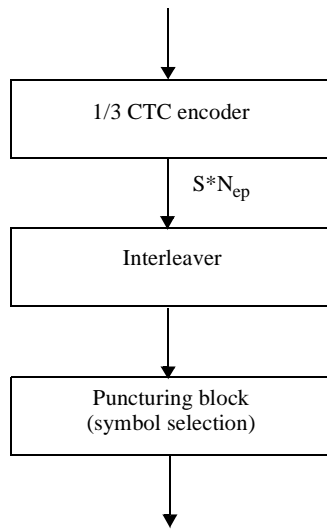

Figure 258—Block diagram of subpacket generation

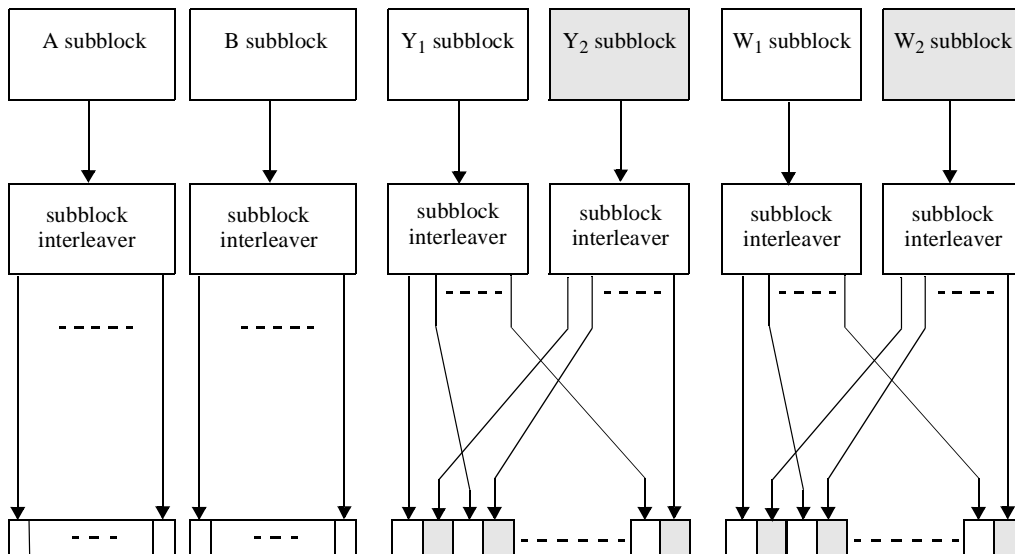

Figure 259—Block diagram of the interleaving scheme

8.4.9.2.3.4.1 Symbol separation

All of the encoded symbols shall be demultiplexed into six subblocks denoted A , B , Y_1 , Y_2 , W_1 , and W_2 . The encoder output symbols shall be sequentially distributed into six subblocks with the first encoder output

symbols going to the A subblock, the second encoder output going to the B subblock, the third to the Y_1 subblock, the fourth to the Y_2 subblock, the fifth to the W_1 subblock, the sixth to the W_2 subblock, etc.

8.4.9.2.3.4.2 Subblock interleaving

The six subblocks shall be interleaved separately. The interleaving is performed by the unit of symbol. The sequence of interleaver output symbols for each subblock shall be generated by the procedure described below. The entire subblock of symbols to be interleaved is written into an array at addresses from 0 to the number of the symbols minus one ($N-1$), and the interleaved symbols are read out in a permuted order with the i -th symbol being read from an address, AD_i ($i = 0 \dots N-1$), as follows:

3. Determine the subblock interleaver parameters, m and J . Table 329 gives these parameters.
4. Initialize i and k to 0.
5. Form a tentative output address T_k according to the formula:

$$T_k = 2^m(k \bmod J) + BRO_m(\lfloor k/J \rfloor)$$

where $BRO_m(y)$ indicates the bit-reversed m -bit value of y (i.e., $BRO_3(6) = 3$).

6. If T_k is less than $NAD_i = T_k$ and increment i and k by 1. Otherwise, discard T_k and increment k only.
7. Repeat steps 3) and 4) until all N interleaver output addresses are obtained.

The parameters for the subblock interleavers are specified in Table 329.

Table 329—Parameters for the subblock interleavers

Block size (bits) N_{EP}	N	Subblock interleaver parameters	
		m	J
48	24	3	3
72	36	4	3
96	48	4	3
144	72	5	3
192	96	5	3
216	108	6	3
240	120	6	2
288	144	6	3
384	192	6	3
432	216	6	4
480	240	7	2

Table 330—Parameters for the subblock interleavers when supporting H-ARQ

Block size (bits) N_{EP}	N	Subblock interleaver parameters	
		m	J
48	24	3	3
96	48	4	3
144	72	5	3
192	96	5	3
288	144	6	3
384	192	6	3
480	240	7	2
960	480	8	2
1920	960	9	2
2880	1440	9	3
3840	1920	10	2
4800	2400	10	3

8.4.9.2.3.4.3 Symbol grouping

The channel interleaver output sequence shall consist of the interleaved A and B subblock sequence, followed by a symbol-by-symbol multiplexed sequence of the interleaved Y_1 and Y_2 subblock sequences, followed by a symbol-by-symbol multiplexed sequence of the interleaved W_1 and W_2 subblock sequences. The symbol-by-symbol multiplexed sequence of interleaved Y_1 and Y_2 subblock sequences shall consist of the first output bit from the Y_1 subblock interleaver, the first output bit from the Y_2 subblock interleaver, the second output bit from the Y_1 subblock interleaver, the second output bit from the Y_2 subblock interleaver, etc. The symbol-by-symbol multiplexed sequence of interleaved W_1 and W_2 subblock sequences shall consist of the first output bit from the W_1 subblock interleaver, the first output bit from the W_2 subblock interleaver, the second output bit from the W_1 subblock interleaver, the second output bit from the W_2 subblock interleaver, etc. Figure 259 shows the interleaving scheme.

8.4.9.2.3.4.4 Symbol selection

Lastly, symbol selection is performed to generate the subpacket. The puncturing block is referred as symbols selection in the viewpoint of subpacket generation.

Mother code is transmitted with one of subpackets. The symbols in a subpacket are formed by selecting specific sequences of symbols from the interleaved CTC encoder output sequence. The resulting subpacket sequence is a binary sequence of symbols for the modulator.

Let

k be the subpacket index when HARQ is enabled. $k = 0$ for the first transmission and increases by one for the next subpacket. $k = 0$ when H-ARQ is not used.

N_{EP} be the number of bits in the encoder packet (before encoding).

- N_{SCHk} be the number of subchannel(s) allocated for the k -th subpacket.
 m_k be the modulation order for the k -th subpacket ($m_k = 2$ for QPSK, 4 for 16-QAM, and 6 for 64-QAM).
 $SPID_k$ be the subpacket ID for the k -th subpacket, (for the first subpacket, $SPID_{k=0} = 0$).

Also, let the scrambled and selected symbols be numbered from zero with the 0-th symbol being the first symbol in the sequence. Then, the index of the i -th symbol for the k -th subpacket shall be:

$$S_{k,i} = (F_k + i) \bmod (3 \cdot N_{EP}) \quad (127)$$

where:

$$\begin{aligned} i &= 0 \dots L_k - 1, \\ L_k &= 48 \cdot N_{SCHk} \cdot m_k, \\ F_k &= (SPID_k \cdot L_k) \bmod (3 \cdot N_{EP}). \end{aligned}$$

The N_{EP} , N_{SCHk} , m_k , and $SPID$ values are determined by the BS and can be inferred by the SS through the allocation size in the DL-MAP and UL-MAP. The above symbol selection makes the following possible.

- 1) The first transmission includes the systematic part of the mother code. Thus, it can be used as the codeword for a burst where the HARQ is not applied.
- 2) The location of the subpacket can be determined by the SPID itself without the knowledge of previous subpacket. It is very important property for HARQ retransmission.

8.4.9.2.3.5 Optional H-ARQ Support

H-ARQ implementation is optional. The randomization block in 8.4.9.1, the concatenation scheme in 8.4.9.2.3.1, and the interleaving in 8.4.9.3 shall not be applied for the encoding described in this subclause.

8.4.9.2.3.5.1 Padding

MAC PDU (or concatenated MAC PDUs) is a basic unit processed in this channel coding and modulation blocks. When the size of MAC PDU (or concatenated MAC PDUs) is not the element in the allowed set for H-ARQ, '1's are padded at the end of MAC PDU (or concatenated MAC PDUs). The amount of the padding is the same as the difference between the size of the PDU (or concatenated MAC PDUs) and the smallest element in the allowed set that is not less than the size of the PDU (or concatenated MAC PDUs). The padded packet is input into the randomization block.

The allowed set is {32, 80, 128, 176, 272, 368, 464, 944, 1904, 2864, 3824, 4784, 9584, 14384, 19184, 23984} bits.

8.4.9.2.3.5.2 Randomization

The randomization is performed on each allocation (burst), which means that for each allocation of a data block the randomizer shall be used independently.

The PRBS generator shall be $1 + X^{14} + X^{15}$ as shown in Figure 260. Each data byte to be transmitted shall enter sequentially into the randomizer, MSB first. Preambles are not randomized. The seed value shall be used to calculate the randomization bits, which are combined in an XOR operation with the serialized bit stream of each FEC block. The randomizer sequence is applied to the output from the padding block. The bit issued from the randomizer shall be applied to the CRC encoder.

8.4.9.2.3.5.5 CTC encoding and subpacket generation

The CTC encoding and subpacket generation is the same as the operation described in 8.4.9.2.3.1, 8.4.9.2.3.2, 8.4.9.2.3.3, and 8.4.9.2.3.4.

8.4.9.2.3.5.6 Modulation order of DL traffic burst

For DL, the modulation order (2 for QPSK, 4 for 16-QAM, and 6 for 64-QAM) shall be set for all the allowed transmission formats as shown in Table 331. The transmission format is given by the N_{EP} (Encoding Packet Size) and the N_{SCH} (number of allotted subchannels). N_{EP} per an encoding packet is {144, 192, 288, 384, 480, 960, 1920, 2880, 3840, 4800}. The N_{SCH} per an encoding packet is {1, ..., 480}. In Table 331, the numbers in the first row are N_{EP} 's and the numbers in the remaining rows are N_{SCH} 's and related parameters.

The supportable modulation schemes are QPSK, 16-QAM, and 64-QAM. When the N_{EP} and the N_{SCH} are given, the modulation order is determined by the value of MPR (Modulation order Product code Rate). The MPR means the effective number of the information bit transmitted per a subcarrier and is defined by Equation (128).

$$MPR = \frac{N_{EP}}{48 \cdot N_{SCH}} \quad (128)$$

Then, the modulation order is specified by the following rule:

If $0 < MPR < 1.5$, then a QPSK (modulation order 2) is used

If $1.5 \leq MPR < 3.0$, then a 16QAM (modulation order 4) is used

If $3.0 \leq MPR < 5.4$, then a 64QAM (modulation order 6) is used

The effective code rate is equal to MPR divided by the modulation order (i.e., 2 for QPSK).

The information of N_{EP} and N_{SCH} shall be signaled in UL MAP. Instead of the actual values of N_{EP} and N_{SCH} , the encoded value of N_{EP} (N_{EP} code) and N_{SCH} (N_{SCH} code) shall be used for the signaling. They are encoded by 4 bits, respectively. The encoding of N_{EP} (N_{EP} code) is shown in Table 332. The encoding of N_{SCH} (N_{SCH} code) is performed per N_{EP} value. For each N_{EP} , there are less than 16 kinds of N_{SCH} values and they are encoded from "0" (the smallest number of subchannels) to "15" in increasing order. When the number of N_{SCH} values for a N_{EP} is smaller than 16, the smallest number of the smallest codes are used. When the fragmentation is applied and the number of the subpackets for an allocation is n , $n \cdot N_{EP}$ and N_{SCH} (the number of subchannels allocated for a subpacket) should be signaled.

The encoding for $n \cdot N_{EP}$ (N_{EP} code) is also shown in Table 332. The encoded value of N_{SCH} (N_{SCH} code) should be interpreted as N_{SCH} for a subpacket, and $n \cdot N_{SCH}$ for the whole allocation.

Table 331—Transmission format and modulation level for DL

N_{EP}	144	192	288	384	480	960	1920	2880	3840	4800
<i>Sch</i>	1.00	1.00								
<i>MPR</i>	3.00	4.00								
<i>MOD</i>	6.00	6.00								
Rate	1/2	2/3								
Rate	0.50	0.67								
<i>Sch</i>	2.00	2.00	2.00	2.00	2.00					
<i>MPR</i>	1.50	2.00	3.00	4.00	5.00					
<i>MOD</i>	4.00	4.00	6.00	6.00	6.00					
Rate	3/8	1/2	1/2	2/3	5/6					
Rate	0.38	0.50	0.50	0.67	0.83					
<i>Sch</i>	3.00	3.00	3.00	3.00	3.00					
<i>MPR</i>	1.00	1.33	2.00	2.67	3.33					
<i>MOD</i>	2.00	2.00	4.00	4.00	6.00					
Rate	1/2	2/3	1/2	2/3	5/9					
Rate	0.50	0.67	0.50	0.67	0.56					
<i>Sch</i>		4.00	4.00	4.00	4.00	4.00				
<i>MPR</i>		1.00	1.50	2.00	2.50	5.00				
<i>MOD</i>		2.00	4.00	4.00	4.00	6.00				
Rate		1/2	3/8	1/2	5/8	5/6				
Rate		0.50	0.38	0.50	0.63	0.83				
<i>Sch</i>	5.00		5.00	5.00	5.00	5.00				
<i>MPR</i>	0.60		1.20	1.60	2.00	4.00				
<i>MOD</i>	2.00		2.00	4.00	4.00	6.00				
Rate	3/10		3/5	2/5	1/2	2/3				
Rate	0.30		0.60	0.40	0.50	0.67				
<i>Sch</i>	6.00	6.00	6.00	6.00	6.00	6.00				
<i>MPR</i>	0.50	0.67	1.00	1.33	1.67	3.33				
<i>MOD</i>	2.00	2.00	2.00	2.00	4.00	6.00				
Rate	1/4	1/3	1/2	2/3	5/12	5/9				
Rate	0.25	0.33	0.50	0.67	0.42	0.56				
<i>Sch</i>		8.00		8.00	8.00	8.00	8.00			
<i>MPR</i>		0.50		1.00	1.25	2.50	5.00			
<i>MOD</i>		2.00		2.00	2.00	4.00	6.00			
Rate		1/4		1/2	5/8	5/8	5/6			
Rate		0.25		0.50	0.63	0.63	0.83			
<i>Sch</i>	9.00		9.00				9.00			
<i>MPR</i>	0.33		0.67				4.44			
<i>MOD</i>	2.00		2.00				6.00			
Rate	1/6		1/3				20/27			
Rate	0.17		0.33				0.74			
<i>Sch</i>					10.00	10.00	10.00			
<i>MPR</i>					1.00	2.00	4.00			
<i>MOD</i>					2.00	4.00	6.00			
Rate					1/2	1/2	2/3			
Rate					0.50	0.50	0.67			

Table 331—Transmission format and modulation level for DL (continued)

N_{EP}	144	192	288	384	480	960	1920	2880	3840	4800
<i>Sch</i>	12.00	12.00	12.00	12.00				12.00		
<i>MPR</i>	0.25	0.33	0.50	0.67				5.00		
<i>MOD</i>	2.00	2.00	2.00	2.00				6.00		
Rate	1/8	1/6	1/4	1/3				5/6		
Rate	0.13	0.17	0.25	0.33				0.83		
<i>Sch</i>						13.00	13.00	13.00		
<i>MPR</i>						1.54	3.08	4.62		
<i>MOD</i>						4.00	6.00	6.00		
Rate						5/13	20/39	10/13		
Rate						0.38	0.51	0.77		
<i>Sch</i>					15.00	15.00	15.00	15.00		
<i>MPR</i>					0.67	1.33	2.67	4.00		
<i>MOD</i>					2.00	2.00	4.00	6.00		
Rate					1/3	2/3	2/3	2/3		
Rate					0.33	0.67	0.67	0.67		
<i>Sch</i>		16.00		16.00					16.00	
<i>MPR</i>		0.25		0.50					5.00	
<i>MOD</i>		2.00		2.00					6.00	
Rate		1/8		1/4					5/6	
Rate		0.13		0.25					0.83	
<i>Sch</i>	18.00		18.00						18.00	
<i>MPR</i>	0.17		0.33						4.44	
<i>MOD</i>	2.00		2.00						6.00	
Rate	1/12		1/6						20/27	
Rate	0.08		0.17						0.74	
<i>Sch</i>						20.00	20.00	20.00	20.00	20.00
<i>MPR</i>						0.50	1.00	2.00	3.00	5.00
<i>MOD</i>						2.00	2.00	4.00	6.00	6.00
Rate						1/4	1/2	1/2	1/2	5/6
Rate						0.25	0.50	0.50	0.50	0.83
<i>Sch</i>								22.00		22.00
<i>MPR</i>								2.73		4.55
<i>MOD</i>								4.00		6.00
Rate								15/22		25/33
Rate								0.68		0.76
<i>Sch</i>		24.00	24.00	24.00						
<i>MPR</i>		0.17	0.25	0.33						
<i>MOD</i>		2.00	2.00	2.00						
Rate		1/12	1/8	1/6						
Rate		0.08	0.13	0.17						
<i>Sch</i>							26.00		26.00	26.00
<i>MPR</i>							1.54		3.08	3.85
<i>MOD</i>							4.00		6.00	6.00
Rate							5/13		20/39	25/39
Rate							0.38		0.51	0.64
<i>Sch</i>					30.00	30.00	30.00	30.00	30.00	
<i>MPR</i>					0.33	0.67	1.33	2.00	2.67	
<i>MOD</i>					2.00	2.00	2.00	4.00	4.00	
Rate					1/6	1/3	2/3	1/2	2/3	
Rate					0.17	0.33	0.67	0.50	0.67	

Table 331—Transmission format and modulation level for DL (continued)

N_{EP}	144	192	288	384	480	960	1920	2880	3840	4800
<i>Sch</i> <i>MPR</i> <i>MOD</i> Rate Rate				32.00 0.25 2.00 1/8 0.13						32.00 3.13 6.00 25/48 0.52
<i>Sch</i> <i>MPR</i> <i>MOD</i> Rate Rate										38.00 2.63 4.00 25/38 0.66
<i>Sch</i> <i>MPR</i> <i>MOD</i> Rate Rate					40.00 0.25 2.00 1/8 0.13	40.00 0.50 2.00 1/4 0.25	40.00 1.00 2.00 1/2 0.50	40.00 1.50 4.00 3/8 0.38	40.00 2.00 4.00 1/2 0.50	
<i>Sch</i> <i>MPR</i> <i>MOD</i> Rate Rate								44.00 1.36 2.00 15/22 0.68		
<i>Sch</i> <i>MPR</i> <i>MOD</i> Rate Rate				48.00 0.17 2.00 1/12 0.08						
<i>Sch</i> <i>MPR</i> <i>MOD</i> Rate Rate										50.00 2.00 4.00 1/2 0.50
<i>Sch</i> <i>MPR</i> <i>MOD</i> Rate Rate									52.00 1.54 4.00 5/13 0.38	
<i>Sch</i> <i>MPR</i> <i>MOD</i> Rate Rate					60.00 0.17 2.00 1/12 0.08	60.00 0.33 2.00 1/6 0.17	60.00 0.67 2.00 1/3 0.33	60.00 1.00 2.00 1/2 0.50	60.00 1.33 2.00 2/3 0.67	
<i>Sch</i> <i>MPR</i> <i>MOD</i> Rate Rate										64.00 1.56 4.00 25/64 0.39
<i>Sch</i> <i>MPR</i> <i>MOD</i> Rate Rate										76.00 1.32 2.00 25/38 0.66

Table 331—Transmission format and modulation level for DL (continued)

N_{EP}	144	192	288	384	480	960	1920	2880	3840	4800
<i>Sch</i> <i>MPR</i> <i>MOD</i> Rate Rate						80.00 0.25 2.00 1/8 0.13	80.00 0.50 2.00 1/4 0.25		80.00 1.00 2.00 1/2 0.50	
<i>Sch</i> <i>MPR</i> <i>MOD</i> Rate Rate								90.00 0.67 2.00 1/3 0.33		
<i>Sch</i> <i>MPR</i> <i>MOD</i> Rate Rate										100.00 1.00 2.00 1/2 0.50
<i>Sch</i> <i>MPR</i> <i>MOD</i> Rate Rate						120.00 0.17 2.00 1/12 0.08	120.00 0.33 2.00 1/6 0.17	120.00 0.50 2.00 1/4 0.25	120.00 0.67 2.00 1/3 0.33	
<i>Sch</i> <i>MPR</i> <i>MOD</i> Rate Rate										150.00 0.67 2.00 1/3 0.33
<i>Sch</i> <i>MPR</i> <i>MOD</i> Rate Rate							160.00 0.25 2.00 1/8 0.13		160.00 0.50 2.00 1/4 0.25	
<i>Sch</i> <i>MPR</i> <i>MOD</i> Rate Rate								180.00 0.33 2.00 1/6 0.17		
<i>Sch</i> <i>MPR</i> <i>MOD</i> Rate Rate										200.00 0.50 2.00 1/4 0.25
<i>Sch</i> <i>MPR</i> <i>MOD</i> Rate Rate							240.00 0.17 2.00 1/12 0.08	240.00 0.25 2.00 1/8 0.13	240.00 0.33 2.00 1/6 0.17	
<i>Sch</i> <i>MPR</i> <i>MOD</i> Rate Rate										300.00 0.33 2.00 1/6 0.17

Table 331—Transmission format and modulation level for DL (continued)

N_{EP}	144	192	288	384	480	960	1920	2880	3840	4800
Sch MPR MOD Rate Rate									320.00 0.25 2.00 1/8 0.13	
Sch MPR MOD Rate Rate								360.00 0.17 2.00 1/12 0.08		
Sch MPR MOD Rate Rate										400.00 0.25 2.00 1/8 0.13
Sch MPR MOD Rate Rate									480.00 0.17 2.00 1/12 0.08	

Table 332— N_{EP} encoding

N_{EP}	48	96	144	192	288	384	480	960	1920	2880	3840	4800	9600	14400	19200	24000
Encoding	0	1	2	3	4	5	6	7	8	9	10	11	12	13	14	15

8.4.9.2.3.5.7 Modulation order of UL traffic burst

For UL, the modulation order (2 for QPSK and 4 for 16-QAM) shall be set for all the allowed transmission formats as shown in Table 333. The transmission format is given by the N_{EP} (Encoding Packet Size) and the N_{SCH} (number of allotted subchannels). N_{EP} per an encoding packet is {48, 96, 144, 192, 288, 384, 480, 960, 1920, 2880, 3840, 4800}. The N_{SCH} per an encoding packet is {1..288}. In Table 333, the numbers in the first row are N_{EP} 's and the numbers in the remaining rows are N_{SCH} 's and related parameters.

The supportable modulation schemes are QPSK and 16-QAM. When the N_{EP} and the N_{SCH} are given, the modulation order is determined by the value of MPR . The MPR means the effective number of the information bit transmitted per subcarrier and is defined by Equation (129).

$$MPR = \frac{N_{EP}}{48 \cdot N_{SCH}} \tag{129}$$

Then, the modulation order is specified by the following rule:

If $0 < MPR < 1.5$, then a QPSK (modulation order 2) is used.

If $1.5 \leq MPR < 3.4$, then a 16-QAM (modulation order 4) is used.

The effective code rate is equal to MPR divided by the modulation order (i.e., 2 for QPSK).

The information of N_{EP} and N_{SCH} shall be signaled in UL MAP. Instead of the actual values of N_{EP} and N_{SCH} , the encoded value of N_{EP} (N_{EP} code) and N_{SCH} (N_{SCH} code) shall be used for the signaling. They are encoded by 4 bits, respectively. The encoding of N_{EP} (N_{EP} code) is shown in Table 332. The encoding of N_{SCH} (N_{SCH} code) is performed per N_{EP} value. For each N_{EP} , there are less than 16 kinds of N_{SCH} values and they are encoded from “0” (the smallest number of subchannels) to “15” in increasing order. When the number of N_{SCH} values for a N_{EP} is smaller than 16, then the corresponding number of codes is used. When the fragmentation is applied and the number of the subpackets for an allocation is n , $n*N_{EP}$ and N_{SCH} (the number of subchannels allocated for a subpacket) should be signaled.

The encoding for $n*N_{EP}$ (N_{EP} code) is also shown in Table 332. The encoded value of N_{SCH} (N_{SCH} code) should be interpreted as N_{SCH} for a subpacket, and $n*N_{SCH}$ for the whole allocation.

Table 333—Transmission format and modulation level for UL

N_{EP}	48	96	144	192	288	384	480	960	1920	2880	3840	4800
<i>Sch</i>	1.00	1.00	1.00									
<i>MPR</i>	1.00	2.00	3.00									
<i>MOD</i>	2.00	4.00	4.00									
Rate	1/2	1/2	3/4									
Rate	0.50	0.50	0.75									
<i>Sch</i>	2.00	2.00	2.00	2.00	2.00							
<i>MPR</i>	0.50	1.00	1.50	2.00	3.00							
<i>MOD</i>	2.00	2.00	4.00	4.00	4.00							
Rate	1/4	1/2	3/8	1/2	3/4							
Rate	0.25	0.5	0.38	0.50	0.75							
<i>Sch</i>	3.00	3.00	3.00	3.00	3.00	3.00	3.00					
<i>MPR</i>	0.33	0.67	1.00	1.33	2.00	2.67	3.33					
<i>MOD</i>	2.00	2.00	2.00	2.00	4.00	4.00	4.00					
Rate	1/6	1/3	1/5	2/3	1/2	2/3	5/6					
Rate	0.17	0.33	0.50	0.67	0.5	0.67	0.83					
<i>Sch</i>	4.00	4.00		4.00	4.00	4.00	4.00					
<i>MPR</i>	0.25	0.50		1.00	1.50	2.00	2.50					
<i>MOD</i>	2.00	2.00		2.00	4.00	4.00	4.00					
Rate	1/8	1/4		1/2	3/8	1/2	5/8					
Rate	0.13	0.25		0.50	0.38	0.50	0.63					
<i>Sch</i>			5.00		5.00	5.00	5.00					
<i>MPR</i>			0.60		1.20	1.60	2.00					
<i>MOD</i>			2.00		2.00	4.00	4.00					
Rate			3/10		3/5	2/5	1/2					
Rate			0.30		0.60	0.40	0.50					
<i>Sch</i>	6.00	6.00	6.00	6.00	6.00	6.00	6.00	6.00				
<i>MPR</i>	0.17	0.33	0.50	0.67	1.00	1.33	1.67	3.33				
<i>MOD</i>	2.00	2.00	2.00	2.00	2.00	2.00	4.00	4.00				
Rate	1/12	1/6	1/4	1/3	1/2	2/3	5/12	5/6				
Rate	0.08	0.17	0.25	0.33	0.50	0.67	0.42	0.83				

Table 333—Transmission format and modulation level for UL (continued)

<i>N_{EP}</i>	48	96	144	192	288	384	480	960	1920	2880	3840	4800
<i>Sch</i> <i>MPR</i> <i>MOD</i> Rate Rate								7.00 2.86 4.00 5/7 0.714				
<i>Sch</i> <i>MPR</i> <i>MOD</i> Rate Rate		8.00 0.25 2.00 1/8 0.13		8.00 0.50 2.00 1/4 0.25		8.00 1.00 2.00 1/2 0.50	8.00 1.25 2.00 5/8 0.63	8.00 2.50 4.00 5/8 0.63				
<i>Sch</i> <i>MPR</i> <i>MOD</i> Rate Rate			9.00 0.33 2.00 1/6 0.17		9.00 0.67 2.00 1/3 0.33							
<i>Sch</i> <i>MPR</i> <i>MOD</i> Rate Rate							10.00 1.00 2.00 1/2 0.50	10.00 2.00 4.00 1/2 0.50				
<i>Sch</i> <i>MPR</i> <i>MOD</i> Rate Rate		12.0 0.17 2.0 1/12 0.08	12.00 0.25 2.00 1/8 0.13	12.0 0.33 2.00 1/6 0.17	12.0 0.50 2.00 1/4 0.25	12.0 0.67 2.00 1/3 0.33			12.0 3.33 4.00 5/6 0.83			
<i>Sch</i> <i>MPR</i> <i>MOD</i> Rate Rate									13.00 3.08 3.00 10/13 0.77			
<i>Sch</i> <i>MPR</i> <i>MOD</i> Rate Rate							15.00 0.67 2.00 1/3 0.33	15.00 1.33 2.00 2/3 0.67	15.00 2.67 4.00 2/3 0.67			
<i>Sch</i> <i>MPR</i> <i>MOD</i> Rate Rate				16.0 0 0.25 2.00 1/8 0.13		16.0 0 0.50 2.00 1/4 0.25						
<i>Sch</i> <i>MPR</i> <i>MOD</i> Rate Rate			18.00 0.17 2.00 1/12 0.08		18.0 0.33 2.00 1/6 0.17						18.00 3.33 4.00 5/6 0.83	
<i>Sch</i> <i>MPR</i> <i>MOD</i> Rate Rate								20.00 0.50 2.00 1/4 0.25	20.00 1.00 2.00 1/2 0.50	20.00 2.00 4.00 1/2 0.50	20.0 3.00 4.00 3/4 0.75	

Table 333—Transmission format and modulation level for UL (continued)

N_{EP}	48	96	144	192	288	384	480	960	1920	2880	3840	4800
<i>Sch</i>				24.0	24.0	24.0				24.0	24.0	
<i>MPR</i>				0.17	0.25	0.33				2.50	3.33	
<i>MOD</i>				2.00	2.00	2.00				4.00	4.0	
Rate				1/12	1/8	1/6				5/8	5/6	
Rate				0.08	0.13	0.17				0.63	0.83	
<i>Sch</i>									26.00		26.0	
<i>MPR</i>									1.54		3.08	
<i>MOD</i>									4.00		4.00	
Rate									5/13		10/13	
Rate									0.38		0.77	
<i>Sch</i>							30.00	30.00	30.00	30.00	30.00	30.0
<i>MPR</i>							0.33	0.67	1.33	2.00	2.67	3.33
<i>MOD</i>							2.00	2.00	2.00	4.00	4.00	3.00
Rate							1/6	1/3	2/3	1/2	2/3	5/6
Rate							0.17	0.33	0.67	0.50	0.67	0.83
<i>Sch</i>						32.0						
<i>MPR</i>						0.25						
<i>MOD</i>						2.00						
Rate						1/8						
Rate						0.13						
<i>Sch</i>												34.0
<i>MPR</i>												2.94
<i>MOD</i>												4.00
Rate												25/34
Rate												0.74
<i>Sch</i>					36.0							
<i>MPR</i>					0.17							
<i>MOD</i>					2.00							
Rate					1/12							
Rate					0.08							
<i>Sch</i>												38.00
<i>MPR</i>												2.63
<i>MOD</i>												4.00
Rate												25/38
Rate												0.66
<i>Sch</i>							40.00	40.00	40.00	40.00	40.00	
<i>MPR</i>							0.25	0.50	1.00	1.50	2.00	
<i>MOD</i>							2.00	2.00	2.00	4.00	4.00	
Rate							1/8	1/4	1/2	3/8	1/2	
Rate							0.13	0.25	0.50	0.38	0.50	
<i>Sch</i>										45.0		
<i>MPR</i>										1.33		
<i>MOD</i>										2.00		
Rate										2/3		
Rate										0.67		
<i>Sch</i>						48.0						
<i>MPR</i>						0.17						
<i>MOD</i>						2.00						
Rate						1/12						
Rate						0.08						

Table 333—Transmission format and modulation level for UL (continued)

<i>N_{EP}</i>	48	96	144	192	288	384	480	960	1920	2880	3840	4800
<i>Sch</i> <i>MPR</i> <i>MOD</i> Rate Rate												50.00 2.00 4.00 1/2 0.50
<i>Sch</i> <i>MPR</i> <i>MOD</i> Rate Rate											52.00 1.54 4.00 5/13 0.38	
<i>Sch</i> <i>MPR</i> <i>MOD</i> Rate Rate							60.00 0.17 2.00 1/12 0.08	60.00 0.33 2.00 1/6 0.17	60.00 0.67 2.00 1/3 0.33	60.00 1.00 2.00 1/2 0.50	60.00 1.33 2.00 2/3 0.67	
<i>Sch</i> <i>MPR</i> <i>MOD</i> Rate Rate												66.0 1.52 4.00 25/66 0.38
<i>Sch</i> <i>MPR</i> <i>MOD</i> Rate Rate												76.00 1.32 2.00 25/38 0.66
<i>Sch</i> <i>MPR</i> <i>MOD</i> Rate Rate								80.00 0.25 2.00 1/8 0.13	80.00 0.50 2.00 1/4 0.25		80.00 1.00 2.00 1/2 0.50	
<i>Sch</i> <i>MPR</i> <i>MOD</i> Rate Rate										90.00 0.67 2.00 1/3 0.33		
<i>Sch</i> <i>MPR</i> <i>MOD</i> Rate Rate												100.00 1.00 2.00 1/2 0.50
<i>Sch</i> <i>MPR</i> <i>MOD</i> Rate Rate								120.0 0.17 2.00 1/12 0.08	120.00 0.33 2.00 1/6 0.17	120.00 0.50 2.00 1/4 0.25	120.00 0.67 2.00 1/3 0.33	
<i>Sch</i> <i>MPR</i> <i>MOD</i> Rate Rate												150.00 0.67 2.00 1/3 0.33

Table 333—Transmission format and modulation level for UL (continued)

N_{EP}	48	96	144	192	288	384	480	960	1920	2880	3840	4800
Sch MPR MOD Rate Rate									160.00 0.25 2.00 1/8 0.13		160.00 0.50 2.00 1/4 0.25	
Sch MPR MOD Rate Rate										180.00 0.33 2.00 1/6 0.17		
Sch MPR MOD Rate Rate												200.00 0.50 2.00 1/4 0.25
Sch MPR MOD Rate Rate									240.00 0.17 2.00 1/12 0.08	240.00 0.25 2.00 1/8 0.13	240.00 0.33 2.00 1/6 0.17	

8.4.9.2.4 Zero tailed convolutional coding (optional)

The convolutional encoder (as described in 8.4.9.2.1) may employ the Zero Tailing technique. In this case, a single 0x00 tail byte is appended at the end of each burst. This tail byte shall be appended after randomization. The convolutional code and the puncturing shall be applied to the whole burst without partitioning it into blocks. The interleaving shall be applied to the coded bits in blocks of size described in 8.4.9.2.

8.4.9.3 Interleaving

All encoded data bits shall be interleaved by a block interleaver with a block size corresponding to the number of coded bits per the encoded block size N_{cbps} as set in 8.4.9.2. The interleaver is defined by a two-step permutation. The first ensures that adjacent coded bits are mapped onto nonadjacent subcarriers. The second permutation insures that adjacent coded bits are mapped alternately onto less or more significant bits of the constellation, thus avoiding long runs of lowly reliable bits.

Let N_{cpc} be the number of coded bits per subcarrier, i.e., 2, 4, or 6 for QPSK, 16-QAM or 64-QAM, respectively. Let $s = N_{cpc}/2$. Within a block of N_{cbps} bits at transmission, let k be the index of the coded bit before the first permutation, m_k be the index of that coded bit after the first and before the second permutation and let j_k be the index after the second permutation, just prior to modulation mapping, and d be the modulo used for the permutation.

The first permutation is defined by Equation (130): $k = 0, 1, \dots, N_{cbps} - 1$, $d = 16$

$$m_k = (N_{cbps}/d) \cdot k_{mod(d)} + floor(k/d) \quad k = 0, 1, \dots, N_{cbps} - 1 \quad d = 16 \quad (130)$$

The second permutation is defined by Equation (131):

$$j_k = s \cdot floor(m_k/s) + (m_k + N_{cbps} - floor(d \cdot m_k/N_{cbps}))_{mod(s)} \quad k = 0, 1, \dots, N_{cbps} - 1 \quad d = 16 \quad (131)$$

The de-interleaver, which performs the inverse operation, is also defined by two permutations. Within a received block of N_{cbps} bits, let j be the index of a received bit before the first permutation; m_j be the index of that bit after the first and before the second permutation; and let k_j be the index of that bit after the second permutation, just prior to delivering the block to the decoder.

The first permutation is defined by Equation (132):

$$m_j = s \cdot \text{floor}(j/s) + (j + \text{floor}(d \cdot j/N_{\text{cbps}}))_{\text{mod}(s)} \quad j = 0, 1, \dots, N_{\text{cbps}} - 1 \quad d = 16 \quad (132)$$

The second permutation is defined by Equation (133):

$$k_j = d \cdot m_j - (N_{\text{cbps}} - 1) \cdot \text{floor}(d \cdot m_j/N_{\text{cbps}}) \quad j = 0, 1, \dots, N_{\text{cbps}} - 1 \quad d = 16 \quad (133)$$

The first permutation in the de-interleaver is the inverse of the second permutation in the interleaver, and conversely.

8.4.9.4 Modulation

8.4.9.4.1 Permutation definition

The PRBS generator depicted hereafter shall be used to produce a sequence, w_k (see Figure 262). The polynomial for the PRBS generator shall be $X^{11} + X^9 + 1$.

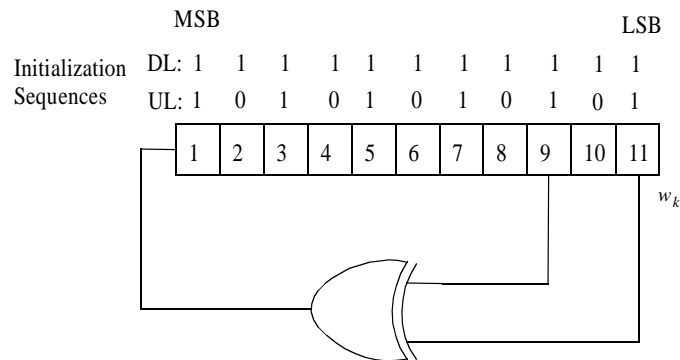

Figure 262—PRBS for pilot modulation

The value of the pilot modulation, on subcarrier k , shall be derived from w_k .

The initialization vector of the PRBS for both uplink and downlink shall be designated b10..b0, such that:

- b10..b6 = Five least significant bits of IDcell as indicated by the frame preamble, except for zones marked by “Use all SC indicator = 1,” where these bits shall be set to 1, in the downlink. Five least significant bits of UL_IDcell in the uplink
- b5..b4 = Set to the segment number + 1 as indicated by the frame preamble, except for zones marked by “Use all SC indicator = 1,” where these bits shall be set to 1
- b3..b0 = Four least significant bits of symbol offset from the first data symbol in the frame (i.e., the symbol in the frame in which the DL-MAP starts)

For example, should the initialization vector of the PRBS be b10..b0 = 101010101, the initializations result in the sequence $w_k = 10101010101000000000\dots$ in the uplink. The PRBS shall be initialized so that its first output bit coincides with the first usable subcarrier (as defined in Table 313). A new value shall be generated by the PRBS for every subcarrier up to the highest numbered usable subcarrier, including the DC subcarrier.

8.4.9.4.2 Data modulation

After bit interleaving, the data bits are entered serially to the constellation mapper. Gray-mapped QPSK and 16-QAM (as shown in Figure 263) shall be supported, whereas the support of 64-QAM is optional. The constellations (as shown in Figure 263) shall be normalized by multiplying the constellation point with the indicated factor c to achieve equal average power.

Per-allocation adaptive modulation and coding shall be supported in the downlink. The uplink shall support different modulation schemes for each SS based on the MAC burst configuration messages coming from the BS. Complete description of the MAC/PHY support of adaptive modulation and coding is provided in 6.3.7.

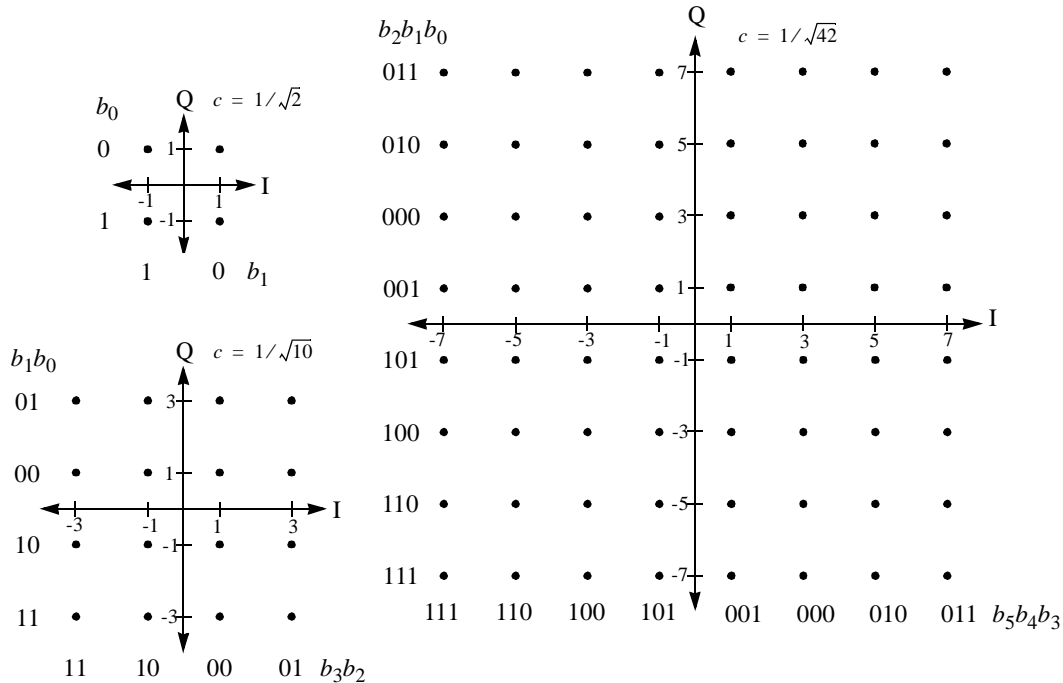

Figure 263—QPSK, 16-QAM, and 64-QAM constellations

The constellation-mapped data shall be subsequently modulated onto the allocated data subcarriers and each subcarrier multiplied by the factor $2^{*(1/2 - w_k)}$ according to the subcarrier index, k .

8.4.9.4.3 Pilot modulation

For the mandatory tile structure in the uplink, pilot subcarriers shall be inserted into each data burst in order to constitute the Symbol and they shall be modulated according to their subcarrier location within the OFDMA symbol.

The Pilot subcarriers shall be modulated according to Equation (134):

$$\begin{aligned}
 \text{Re}\{c_k\} &= 2\left(\frac{1}{2} - w_k\right) \\
 \text{Im}\{c_k\} &= 0
 \end{aligned}
 \tag{134}$$

In the downlink and for the optional uplink tile structure each pilot shall be transmitted with a boosting of 2.5 dB over the average power of each data tone. The Pilot subcarriers shall be modulated according to Equation (135):

$$\begin{aligned} \operatorname{Re}\{c_k\} &= \frac{8}{3} \left(\frac{1}{2} - w_k \right) \\ \operatorname{Im}\{c_k\} &= 0 \end{aligned} \quad (135)$$

8.4.9.4.3.1 Preambles/midambles pilot modulation

The pilots in the downlink preamble shall follow the instructions in 8.4.6.1.1, and shall be modulated according to Equation (136):

$$\begin{aligned} \operatorname{Re}\{PreamblePilotsModulated\} &= 4 \cdot \sqrt{2} \cdot \left(\frac{1}{2} - w_k \right) \\ \operatorname{Im}\{PreamblePilotsModulated\} &= 0 \end{aligned} \quad (136)$$

8.4.9.4.3.2 Ranging pilot modulation

The BPSK modulation on the ranging transmissions, real and imaginary parts, is defined by Equation (137):

$$\begin{aligned} \operatorname{Re}\{c_k\} &= 2 \cdot (1/2 - C_k) \\ \operatorname{Im}\{c_k\} &= 0 \end{aligned} \quad (137)$$

where c_k is the k -th subcarrier of the Ranging Channel, and C_k is the k -th bit of the code generated according to 8.4.7.3

8.4.9.4.4 Example of OFDMA uplink CC encoding

An example of one burst of OFDMA uplink using mandatory structure is provided, illustrating each process from randomization through subcarrier modulation. The scenario parameters are as follows:

- 1) OFDM symbol number start = 35
- 2) Number of time slots in UL allocation = 2
- 3) Starting Logical Slot = 6 (mapped onto physical subchannel 16 in the first time slot and physical subchannel 17 in the second time slot due to subchannel rotation)
- 4) IDcell = 5
- 5) Segment = 0
- 6) Modulation = QPSK
- 7) Coding scheme = Convolutional coding
- 8) Coding rate = 1/2

Input Data (Hex)

AC BC D2 11 4D AE 15 77 C6 DB F4 C9

Randomized Data (Hex)

06 DF 2F 59 42 1E 34 D7 03 19 68 46

Convolutional encoded Data (Hex)

36 F5 E1 7E E8 98 6E 27 EB B9 F2 A6 57 B6 A0 51 FA BD 4E E0 E5 A9 E7 F2

+0.707), (39,1814,-0.707/+0.707), (39,1815,-0.707/+0.707), (39,1816,-0.707/-0.707), (40,232,+1/0), (40,233,+1/0), (40,234,+0.707/-0.707), (40,235,+0.707/-0.707), (40,704,+1/0), (40,705,+1/0), (40,706,+0.707/-0.707), (40,707,+0.707/-0.707), (40,908,+1/0), (40,909,+1/0), (40,910,+0.707/-0.707), (40,911,-0.707/+0.707), (40,1225,+1/0), (40,1226,+1/0), (40,1227,+0.707/+0.707), (40,1228,+0.707/-0.707), (40,1473,+1/0), (40,1474,+1/0), (40,1475,+0.707/-0.707), (40,1476,-0.707/+0.707), (40,1813,+1/0), (40,1814,+1/0), (40,1815,+0.707/-0.707), (40,1816,-0.707/+0.707),

8.4.10 Control mechanisms

8.4.10.1 Synchronization

8.4.10.1.1 Network synchronization

For TDD and FDD realizations, it is recommended (but not required) that all BSs be time synchronized to a common timing signal. In the event of the loss of the network timing signal, BSs shall continue to operate and shall automatically resynchronize to the network timing signal when it is recovered. The synchronizing reference shall be a 1 pps timing pulse and a 10 MHz frequency reference. These signals are typically provided by a GPS receiver.

For both FDD and TDD realizations, frequency references derived from the timing reference may be used to control the frequency accuracy of Base-Stations provided that they meet the frequency accuracy requirements of 8.4.14. This applies during normal operation and during loss of timing reference.

8.4.10.1.2 SS synchronization

For any duplexing, all SSs shall acquire and adjust their timing such that all uplink OFDMA symbols arrive time coincident at the BS to a accuracy of $\pm 25\%$ of the minimum guard-interval or better.

8.4.10.2 Ranging

Ranging for time (coarse synchronization) and power is performed during two phases of operation: during (re)registration and when synchronization is lost; and second, during FDD or TDD transmission on a periodic basis.

During registration, a new subscriber registers using the random access channel, and if successful, is entered into a ranging process under control of the BS. The ranging process is cyclic in nature where default time and power parameters are used to initiate the process followed by cycles where (re)calculated parameters are used in succession until parameters meet acceptance criteria for the new subscriber. These parameters are monitored, measured, and stored at the BS, and transmitted to the subscriber unit for use during normal exchange of data. During normal exchange of data, the stored parameters are updated in a periodic manner based on configurable update intervals to ensure changes in the channel can be accommodated. The update intervals shall vary in a controlled manner on a subscriber unit by subscriber unit basis.

Ranging on re-registration follows the same process as new registration.

8.4.10.3 Power control

A power control algorithm shall be supported for the uplink channel with both an initial calibration and periodic adjustment procedure without loss of data. The BS should be capable of providing accurate power measurements of the received burst signal. This value can then be compared against a reference level, and the resulting error can be fed back to the SS in a calibration message coming from the MAC. The power control algorithm shall be designed to support power attenuation due to distance loss or power fluctuations at rates of at most 30 dB/s with depths of at least 10 dB for fixed deployment. The exact algorithm implementation is vendor-specific. The total power control range consists of both a fixed portion and a

portion that is automatically controlled by feedback. The power control algorithm shall take into account the interaction of the RF power amplifier with different burst profiles. For example, when changing from one burst profile to another, margins should be maintained to prevent saturation of the amplifier and to prevent violation of emissions masks.

A transmitting SS shall maintain the same transmitted power density regardless of the number of subchannels assigned, unless the maximum power level is reached. That is, when the number of active subchannels allocated to a user is reduced, the total transmitted power shall be reduced proportionally by the SS, without additional power control messages. When the number of subchannels is increased, the total transmitted power shall also be increased proportionally. However, the transmitted power level shall not exceed the maximum levels dictated by signal integrity considerations and regulatory requirements. The SS shall interpret power control messages as the required changes to the transmitted power density.

To maintain at the BS a power density consistent with the modulation and FEC rate used by each SS, the BS may change the SS TX power as well as the SS assigned modulation and FEC rate. There are, however, situations where the SS should automatically update its TX power, without being explicitly instructed by the BS. This happens when the SS transmits in region marked by $UIUC = 0$, $UIUC = 12$, or $UIUC = 14$. In all these situations, the SS shall use a temporary TX power value set according to Equation (138) (in dB),

$$P_{new} = P_{last} + (C/N_{new} - C/N_{last}) - (\log_{10}(R_{new}) - \log_{10}(R_{last})) \quad (138)$$

where,

- P_{new} is the temporary TX Power,
- P_{last} is the last used TX Power,
- C/N_{new} is the normalized C/N of new modulation/FEC rate instructed by the UIUC,
- C/N_{last} is the normalized C/N of the last used modulation/FEC rate,
- R_{new} is the number of repetitions for the new modulation/FEC rate instructed by the UIUC,
- R_{last} is the number of repetitions on the last used modulation/FEC rate.

The default normalized C/N values per modulation are given by Table 334. These values may be overridden by the BS by using a dedicated UCD message TLV.

Table 334—Normalized C/N per modulation

Modulation/ FEC rate	Normalized C/N
Fast_feedback IE	0
CDMA code	3
QPSK 1/2	6
QPSK 3/4	9
16-QAM 1/2	12
16-QAM 3/4	15
64-QAM 1/2	18

Table 334—Normalized C/N per modulation (continued)

Modulation/ FEC rate	Normalized C/N
64-QAM 2/3	20
64QAM 3/4	21
64QAM 5/6	23

To maintain at the BS a power density consistent with the modulation used by each SS, the BS may change the SS TX power as well as the SS assigned modulation and FEC rate. There are, however, situations where the SS should automatically update its TX power, without being explicitly instructed by the BS. This happens when the SS transmits in region marked by UIUC = 0, UIUC = 12, or UIUC = 14. In all these situations, the SS shall use a temporary TX power value set according to the formula $\text{Temporary_TX_Power} = \text{Last_TX_Power_Normalized_C/N_of_last_modulation} + \text{Normalized_C/N_of_QPSK_1/2_modulation}$.

The SS shall report the maximum available power and the normalized transmitted power. These parameters may be used by the base station for optimal assignment of coding schemes and modulations and also for optimal allocation of subchannels. The algorithm is vendor-specific. These parameters are reported in the REG-RSP message. The current transmitted power shall also reported in the RNG-RSP message if the relevant flag in the REP-REQ message has been set.

The current transmitted power is the power of the burst that carries the message. The maximum available power is reported for QPSK QAM16 and QAM64 constellations. The current transmitted power and the maximum power parameters are reported in dBm. The parameters are quantized in 0.5dBm steps ranging from -64dBm (encoded 0x00) to 63.5dBm (encoded 0xFF). Values outside this range shall be assigned the closest extreme. SSS that do not support QAM64 shall report the value of 0x00 in the maximum QAM64 power field.

8.4.11 Channel quality measurements

8.4.11.1 Introduction

RSSI and CINR signal quality measurements and associated statistics can aid in such processes as BS selection/assignment and burst adaptive profile selection. As channel behavior is time-variant, both mean and standard deviation are defined. Implementation of the RSSI and CINR statistics and their reports is mandatory.

The process by which RSSI measurements are taken does not necessarily require receiver demodulation lock; for this reason, RSSI measurements offer reasonably reliable channel strength assessments even at low signal levels. On the other hand, although CINR measurements require receiver lock, they provide information on the actual operating condition of the receiver, including interference and noise levels, and signal strength.

8.4.11.2 RSSI mean and standard deviation

When collection of RSSI measurements is mandated by the BS, an SS shall obtain an RSSI measurement (implementation-specific). From a succession of RSSI measurements, the SS shall derive and update estimates of the mean and the standard deviation of the RSSI, and report them via REP-RSP messages.

Mean and standard deviation statistics shall be reported in units of dBm. To prepare such reports, statistics shall be quantized in 1 dB increments, ranging from –40 dBm (encoded 0x53) to –123 dBm (encoded 0x00). Values outside this range shall be assigned the closest extreme value within the scale.

The method used to estimate the RSSI of a single message is left to individual implementation, but the relative accuracy of a single signal strength measurement, taken from a single message, shall be ± 2 dB, with an absolute accuracy of ± 4 dB. This shall be the case over the entire range of input RSSIs. In addition, the range over which these single-message measurements are measured should extend 3 dB on each side beyond the –40 dBm to –123 dBm limits for the final averaged statistics that are reported.

One possible method to estimate the RSSI of a signal of interest at the antenna connector is given by Equation (139):

$$RSSI = 10^{-\frac{G_{rt}}{10}} \frac{1.2567 \times 10^4 V_c^2}{(2^{2B})R} \left(\frac{1}{N} \sum_{n=0}^{N-1} |Y_{I \text{ or } Q}[k, n]| \right)^2 \text{ mW} \quad (139)$$

where

- B is ADC precision, number of bits of ADC,
- R is ADC input resistance [Ohm],
- V_c is ADC input clip level [Volts],
- G_{rt} is analog gain from antenna connector to ADC input,
- $Y_{I \text{ or } Q}[k, n]$ is n -th sample at the ADC output of I or Q -branch within signal k ,
- N is number of samples.

The (linear) mean RSSI statistics (in mW), derived from a multiplicity of single messages, shall be updated using Equation (140).

$$\hat{\mu}_{RSSI}[k] = \begin{cases} R[0] & k = 0 \\ (1 - \alpha_{\text{avg}})\hat{\mu}_{RSSI}[k-1] + \alpha_{\text{avg}}R[k] & k > 0 \end{cases} \text{ mW} \quad (140)$$

where

- k is the time index for the message (with the initial message being indexed by $k = 0$, the next message by $k = 1$, etc.),
- $R[k]$ is the RSSI in mW measured during message k , and α_{avg} is an averaging parameter specified by the BS.

The mean estimate in dBm shall then be derived from Equation (141).

$$\hat{\mu}_{RSSI \text{ dBm}}[k] = 10 \log(\hat{\mu}_{RSSI}[k]) \text{ dBm} \quad (141)$$

To solve for the standard deviation in dB, the expectation-squared statistic shall be updated using Equation (142),

$$\hat{\chi}_{RSSI}^2[k] = \begin{cases} |R[0]|^2 & k = 0 \\ (1 - \alpha_{\text{avg}})\hat{\chi}_{RSSI}^2[k-1] + \alpha_{\text{avg}}|R[k]|^2 & k > 0 \end{cases} \quad (142)$$

and the result applied to Equation (143).

$$\hat{\sigma}_{RSSI \text{ dB}} = 5 \log \left(\left| \hat{x}_{RSSI}^2[k] - (\hat{\mu}_{RSSI}[k])^2 \right| \right) \text{ dB} \quad (143)$$

8.4.11.3 CINR mean and standard deviation

When CINR measurements are mandated by the BS, an SS shall obtain a CINR measurement (implementation-specific). From a succession of these measurements, the SS shall derive and update estimates of the mean and the standard deviation of the CINR, and report them via REP-RSP messages.

Mean and standard deviation statistics for CINR shall be reported in units of dB. To prepare such reports, statistics shall be quantized in 1 dB increments, ranging from a minimum of -10 dB (encoded 0x00) to a maximum of 53 dB (encoded 0x3F). Values outside this range shall be assigned the closest extreme value within the scale.

The method used to estimate the CINR of a single message is left to individual implementation, but the relative and absolute accuracy of a CINR measurement derived from a single message shall be ± 1 dB and ± 2 dB, respectively. The specified accuracy shall apply to the range of CINR values starting from 3 dB below SNR of the most robust rate, to 10 dB above the SNR of the least robust rate. See Table 338. In addition, the range over which these single-packet measurements are measured should extend 3 dB on each side beyond the -10 dB to 53 dB limits for the final reported, averaged statistics.

One possible method to estimate the CINR of a single message is to compute the ratio of the sum of signal power and the sum of residual error for each data sample, using Equation (144).

$$\text{CINR}[k] = \frac{\sum_{n=0}^{N-1} |s[k, n]|^2}{\sum_{n=0}^{N-1} |r[k, n] - s[k, n]|^2} \quad (144)$$

where $r[k, n]$ received sample n within message k ; $s[k, n]$ the corresponding detected or pilot sample (with channel state weighting) corresponding to received symbol n .

The mean CINR statistic (in dB) shall be derived from a multiplicity of single messages using Equation (145).

$$\hat{\mu}_{\text{CINR dB}}[k] = 10 \log(\hat{\mu}_{\text{CINR}}[k]) \quad (145)$$

where

$$\hat{\mu}_{\text{CINR}}[k] = \begin{cases} \text{CINR}[0] & k = 0 \\ (1 - \alpha_{\text{avg}})\hat{\mu}_{\text{CINR}}[k-1] + \alpha_{\text{avg}} \text{CINR}[k] & k > 0 \end{cases} \quad (146)$$

k is the time index for the message (with the initial message being indexed by $k = 0$, the next message by $k = 1$, etc.); $\text{CINR}[k]$ is a linear measurement of CINR (derived by any mechanism which delivers the prescribed accuracy) for message k ; and α_{avg} is an averaging parameter specified by the BS.

To solve for the standard deviation, the expectation-squared statistic shall be updated using Equation (147).

$$\hat{x}_{\text{CINR}}^2[k] = \begin{cases} |\text{CINR}[0]|^2 & k = 0 \\ (1 - \alpha_{\text{avg}})\hat{x}_{\text{CINR}}^2[k-1] + \alpha_{\text{avg}}|\text{CINR}[k]|^2 & k > 0 \end{cases} \quad (147)$$

and the result applied to

$$\hat{\sigma}_{\text{CINR dB}} = 5 \log\left(\left|\hat{x}_{\text{CINR}}^2[k] - (\hat{\mu}_{\text{CINR}}[k])^2\right|\right) \quad \text{dB} \quad (148)$$

8.4.12 Transmitter requirements

8.4.12.1 Transmit power level control

The transmitter shall support monotonic power level control of 45 dB (30 dB for license-exempt bands) minimum with a minimum step size of 1 dB and a relative accuracy of ± 0.5 dB.

8.4.12.2 Transmitter spectral flatness

The average energy of the constellations in each of the n spectral lines shall deviate no more than indicated in Table 335. The absolute difference between adjacent subcarriers shall not exceed 0.1 dB, excluding intentional boosting or suppression of subcarriers and PAPR reduction subchannels are not allocated.

Table 335—Spectral flatness

Spectral lines	Spectral flatness
Spectral lines from $-N_{\text{used}}/4$ to -1 and $+1$ to $N_{\text{used}}/4$	± 2 dB from the measured energy averaged over all N_{used} active tones
Spectral lines from $-N_{\text{used}}/2$ to $-N_{\text{used}}/4$ and $+N_{\text{used}}/4$ to $N_{\text{used}}/2$	$+2/-4$ dB from the measured energy averaged over all N_{used} active tones

This data shall be taken from the channel estimation step.

8.4.12.3 Transmitter constellation error and test method

To ensure that the receiver SNR does not degrade more than 0.5 dB due to the transmitter SNR, the relative constellation RMS error, averaged over subcarriers, OFDMA frames, and packets, shall not exceed a burst profile dependent value according to Table 336.

Table 336—Allowed relative constellation error versus data rate

Burst type	Relative constellation error (dB)
QPSK-1/2	16.4
QPSK-3/4	18.2
16-QAM-1/2	23.4

Table 336—Allowed relative constellation error versus data rate

Burst type	Relative constellation error (dB)
16-QAM-3/4	25.2
64-QAM-2/3	29.7
64-QAM-3/4	31.4

All measurement errors taken together shall be 10 dB less than the required noise level, i.e., if a specification is TX S/N = 10 dB, the measurement S/N should be at least 20 dB. For all PHY modes, measurements shall be taken with all nonguard subcarriers active and no PAPR reduction subchannels used.

The sampled signal shall be processed in a manner similar to an actual receiver, according to the following steps, or an equivalent procedure (IEEE Std 802.11a-1999 [B29]):

- a) Start of frame shall be detected.
- b) Transition from short sequences to channel estimation sequences shall be detected, and fine timing (with one sample resolution) shall be established.
- c) Coarse and fine frequency offsets shall be estimated.
- d) The packet shall be de-rotated according to estimated frequency offset.
- e) The complex channel response coefficients shall be estimated for each of the subcarriers.
- f) For each of the data OFDMA symbols: transform the symbol into subcarrier received values, estimate the phase from the pilot subcarriers, de-rotate the subcarrier values according to estimated phase, and divide each subcarrier value with a complex estimated channel response coefficient.
- g) For each data-carrying subcarrier, find the closest constellation point and compute the Euclidean distance from it.
- h) Compute the RMS average of all errors in a packet, given by Equation (149).

$$\text{Error}_{RMS} = \frac{\sum_{i=1}^{N_f} \sum_{j=1}^{L_P} \left[\sum_{k=1}^{N_{FFT}} \left\{ (I(i,j,k) - I_0(i,j,k))^2 + (Q(i,j,k) - Q_0(i,j,k))^2 \right\} \right]}{N_f \cdot P_0 \cdot L_P \cdot N_{FFT}} \quad (149)$$

where

- L_P is the length of the packet,
 N_f is the number of frames for the measurement,
 $(I_0(i,j,k), Q_0(i,j,k))$ denotes the ideal symbol point of the i -th frame, j -th OFDMA symbol of the frame, k -th subcarrier of the OFDMA symbol in the complex plane,
 $(I(i,j,k), Q(i,j,k))$ denotes the observed point of the i -th frame, j -th OFDMA symbol of the frame, k -th subcarrier of the OFDMA symbol in the complex plane,
 P_0 is the average power of the constellation.

8.4.13 Receiver requirements

8.4.13.1 Receiver sensitivity

The BER shall be less than 10^{-6} at the power levels shown in Table 337 for standard message and test conditions. If the implemented bandwidth is not listed, then the values for the nearest smaller listed bandwidth shall apply. The minimum input levels are measured as follows:

- At the antenna connector or through a calibrated radiated test environment.
- Using the defined standardized message packet formats.
- Using an AWGN channel.

Table 337—Receiver minimum input level sensitivity (dBm)

Bandwidth (MHz)	QPSK		16-QAM		64-QAM	
	1/2	3/4	1/2	3/4	2/3	3/4
1.5	−91	−89	−84	−82	−78	−76
1.75	−90	−87	−83	−81	−77	−75
3	−88	−86	−81	−79	−75	−73
3.5	−87	−85	−80	−78	−74	−72
5	−86	−84	−79	−77	−72	−71
6	−85	−83	−78	−76	−72	−70
7	−84	−82	−77	−75	−71	−69
10	−83	−81	−76	−74	−69	−68
12	−82	−80	−75	−73	−69	−67
14	−81	−79	−74	−72	−68	−66
20	−80	−78	−73	−71	−66	−65

Table 337 (as well as Table 336) are derived assuming 5 dB implementation loss, a Noise Figure of 7 dB, and receiver SNR and E_b/N_0 values as listed in Table 338.

Table 338—Receiver SNR and E_b/N_0 assumptions

Modulation	E_b/N_0 (dB)	Coding rate	Receiver SNR (dB)
QPSK	10.5	1/2	9.4
		3/4	11.2

Table 338—Receiver SNR and E_b/N_0 assumptions

Modulation	E_b/N_0 (dB)	Coding rate	Receiver SNR (dB)
16-QAM	14.5	1/2	16.4
		3/4	18.2
64-QAM	19.0	2/3	22.7
		3/4	24.4

Test messages for measuring Receiver Sensitivity shall be based on a continuous stream of MAC PDUs, each with a payload consisting of a R times repeated sequence $S_{modulation}$. For each modulation, a different sequence applies:

$$S_{QPSK} = [0xE4, 0xB1, 0xE1, 0xB4]$$

$$S_{16QAM} = [0xA8, 0x20, 0xB9, 0x31, 0xEC, 0x64, 0xFD, 0x75] \quad (150)$$

$$S_{64QAM} = [0xB6, 0x93, 0x49, 0xB2, 0x83, 0x08, 0x96, 0x11, 0x41, 0x92, 0x01, 0x00, 0xBA, 0xA3, 0x8A, 0x9A, 0x21, 0x82, 0xD7, 0x15, 0x51, 0xD3, 0x05, 0x10, 0xDB, 0x25, 0x92, 0xF7, 0x97, 0x59, 0xF3, 0x87, 0x18, 0xBE, 0xB3, 0xCB, 0x9E, 0x31, 0xC3, 0xDF, 0x35, 0xD3, 0xFB, 0xA7, 0x9A, 0xFF, 0xB7, 0xDB]$$

For each mandatory test message, the $(R, S_{modulation})$ tuples that shall apply are:

Short length test message payload (288 data bytes): $(72, S_{QPSK})$, $(36, S_{16-QAM})$, $(6, S_{64-QAM})$

Mid length test message payload (864 data bytes): $(216, S_{QPSK})$, $(108, S_{16-QAM})$, $(18, S_{64-QAM})$

Long length test message payload (1536 data bytes): $(384, S_{QPSK})$, $(192, S_{16-QAM})$, $(32, S_{64-QAM})$

The test condition requirements are as follows:

- Ambient room temperature
- Shielded room
- Conducted measurement at the RF port if available
- Radiated measurement in a calibrated test environment if the antenna is integrated
- CC FEC is enabled

The test shall be repeated for each test message length and for each $(R, S_{modulation})$ tuple as identified above, using the mandatory FEC scheme. The results shall meet or exceed the sensitivity requirements set out in Table 337.

8.4.13.2 Receiver adjacent and alternate channel rejection

The adjacent channel rejection and alternate channel rejection shall be measured by setting the desired signal's strength 3 dB above the rate dependent receiver sensitivity (see Table 337) and raising the power level of the interfering signal until the specified error rate is obtained. The power difference between the interfering signal and the desired channel is the corresponding adjacent channel rejection. The interfering signal in the adjacent channel shall be a conforming OFDMA signal, not synchronized with the signal in the channel under test. For nonadjacent channel testing the test method is identical except the interfering channel shall be any channel other than the adjacent channel or the co-channel.

For the PHY to be compliant, the minimum rejection shall exceed the following:

Table 339—Adjacent and nonadjacent channel rejection

Modulation/coding	Adjacent channel rejection (dB)	Nonadjacent channel rejection (dB)
16-QAM-3/4	11	30
64-QAM-2/3	4	23

8.4.13.3 Receiver maximum input signal

The receiver shall be capable of decoding a maximum on-channel signal of -30 dBm.

8.4.13.4 Receiver maximum tolerable signal

The receiver shall tolerate a maximum signal of 0 dBm without damage.

8.4.14 Frequency control requirements

8.4.14.1 Center frequency and symbol clock frequency tolerance

At the BS, the transmitted center frequency, receive center frequency, and the symbol clock frequency shall be derived from the same reference oscillator. At the BS, the reference frequency accuracy shall be better than $\pm 2 \times 10^{-6}$.

At the SS, both the transmitted center frequency and the symbol clock frequency shall be synchronized to the BS with a tolerance of maximum 2% of the subcarrier spacing.

For Mesh capable devices, all device frequencies shall be accurate to within $\pm 20 \times 10^{-6}$ and achieve synchronization to its neighboring nodes with a tolerance of maximum 3% of the subcarrier spacing.

During the synchronization period, the SS shall acquire frequency synchronization within the specified tolerance before attempting any uplink transmission. During normal operation, the SS shall track the frequency changes and shall defer any transmission if synchronization is lost.

8.5 WirelessHUMAN specific components

8.5.1 Channelization

The channel center frequency shall follow Equation (151):

$$\text{Channel center frequency (MHz)} = 5000 + 5 n_{ch} \quad (151)$$

where $n_{ch} = 0, 1, \dots, 199$ is the Channel Nr. This definition provides an 8-bit unique numbering system for all channels, with 5 MHz spacing, from 5 GHz to 6 GHz. This provides flexibility to define channelization sets for current and future regulatory domains. The set of allowed channel numbers is shown in Table 340 for two regulatory domains. The support of any individual band in the table is not mandatory, but all channels within a band shall be supported.

Figure 264 depicts the 20 MHz channelization scheme listed in Table 340. Channelization has been defined to be compatible with IEEE Std 802.11a-1999 for interference mitigation purposes, even though this results in less efficient spectrum usage in the middle Unlicensed National Information Infrastructure (U-NII) band.

Table 340—Channelizations

Regulatory domain	Band (GHz)	Channelization (MHz)	
		20	10
USA	U-NII middle 5.25–5.35	56, 60, 64	55, 57, 59, 61, 63, 65, 67
	U-NII upper 5.725–5.825	149, 153, 157, 161, 165 ^a	148, 150, 152, 154, 156, 158, 160, 162, 164 ^a , 166 ^a
Europe	CEPT band B ^b 5.47–5.725	100, 104, 108, 112, 116, 120, 124, 128, 132, 136	99, 101, 103, 105, 107, 109, 111, 113, 115, 117, 119, 121, 123, 125, 127, 129, 131, 133, 135, 137
	CEPT band C ^b 5.725–5.875	148, 152, 156, 160, 164, 168	147, 149, 151, 153, 155, 157, 159, 161, 163, 165, 167, 169

^aSee CFR 47 Part 15.247.

^bCurrent applicable regulations do not allow this standard to be operated in the indicated band.

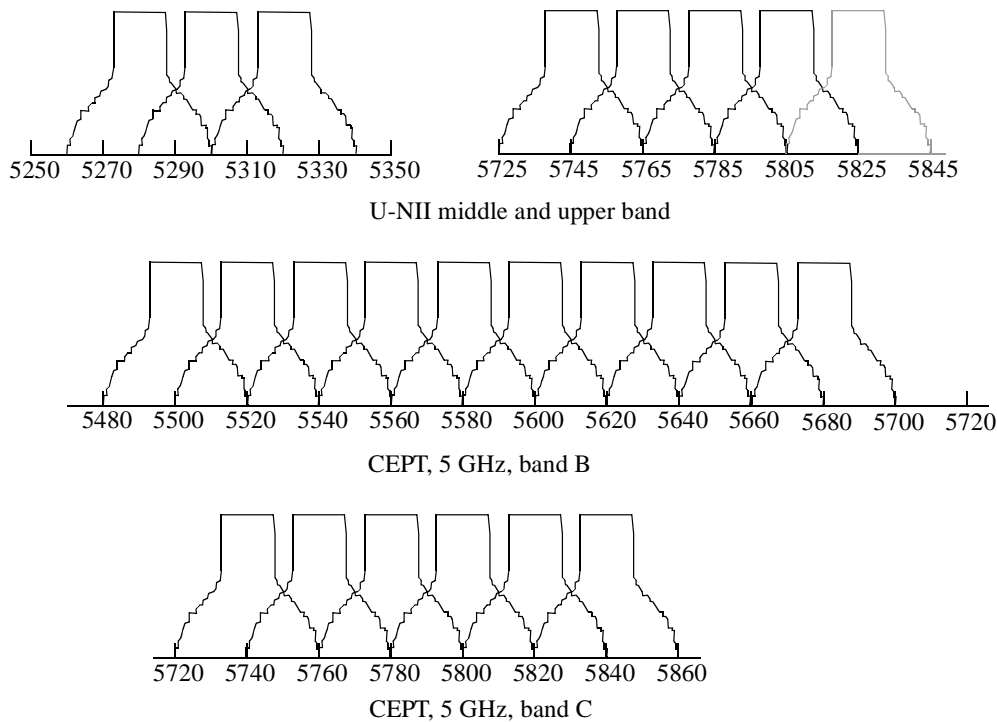

Figure 264—Channelization, 20 MHz

8.5.2 Transmit spectral mask

The transmitted spectral density of the transmitted signal shall fall within the spectral mask as shown Figure 265 and Table 341. The measurements shall be made using 100 kHz resolution bandwidth and a 30 kHz video bandwidth. The 0 dB_r level is the maximum power allowed by the relevant regulatory body.

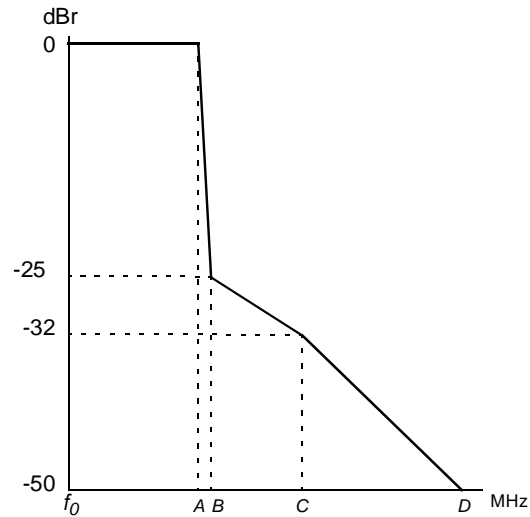

Figure 265—Transmit spectral mask (see Table 341)

Table 341—Transmit spectral mask parameters

Channelization (MHz)	A	B	C	D
20	9.5	10.9	19.5	29.5
10	4.75	5.45	9.75	14.75

9. Configuration

9.1 SS IP addressing

9.1.1 DHCP fields used by the SS

The following fields shall be present in the DHCP request from the SS and shall be set as described below and encoded as per IETF RFC 2131:

- a) The hardware type (h_{type}) shall be set to 1 (Ethernet).
- b) The hardware length (h_{len}) shall be set to 6.
- c) The client hardware address (ch_{addr}) shall be set to the 48-bit MAC address associated with the RF interface of the SS.
- d) The “client identifier” option shall be included, with the hardware type set to 1, and the value set to the same MAC address as the ch_{addr} field.
- e) The “parameter request list” option shall be included. The option codes that shall be included in the list are:
 - 1) Option code 1 (Subnet Mask)
 - 2) Option code 2 (Time Offset)
 - 3) Option code 3 (Router Option)
 - 4) Option code 4 (Time Server Option)
 - 5) Option code 7 (Log Server Option)
 - 6) Option code 60 (Vendor Class Identifier)—A compliant SS shall send the following ASCII coded string in Option code 60: “802.16.”

The following fields are expected in the DHCP response returned to the SS. The SS shall configure itself based on the DHCP response.

- a) The IP address to be used by the SS (yi_{addr}).
- b) The IP address of the TFTP server for use in the next phase of the bootstrap process (si_{addr}).
- c) If the DHCP server is on a different network (requiring a relay agent), then the IP address of the relay agent (gi_{addr}).
NOTE—This may differ from the IP address of the first hop router.
- d) The name of the SS configuration file to be read from the TFTP server by the SS (file).
- e) The subnet mask to be used by the SS (Subnet Mask, option 1).
- f) The time offset of the SS from UTC (Time Offset, option 2). This is used by the SS to calculate the local time for use in time-stamping error logs.
- g) A list of addresses of one or more routers to be used for forwarding SS-originated IP traffic (Router Option, option 3). The SS is not required to use more than one router IP address for forwarding.
- h) A list of time servers (IETF RFC 868) from which the current time may be obtained (Time Server Option, option 4).
- i) A list of SYSLOG servers to which logging information may be sent (Log Server Option, option 7).

9.2 SS Configuration file

9.2.1 SS binary configuration file format

The SS-specific configuration data shall be contained in the SS configuration file that is downloaded to the SS via TFTP. It shall consist of a number of configuration settings (1 per parameter), each in a TLV encoded form (see Clause 11). Note that SSs are not required to need a configuration file. In this case, the configuration file name will not be present in the DHCP response.

Configuration settings are divided into three types as follows:

- Standard configuration settings that shall be present
- Standard configuration settings that may be present
- Vendor-specific configuration settings

SSs shall be capable of processing all standard configuration settings. SSs shall ignore any configuration setting in the configuration file that it cannot interpret. To allow uniform management of SSs conformant to this specification, conformant SSs shall support a 8192 byte configuration file at a minimum.

Integrity of the configuration file information is provided by the SS message integrity check (MIC). The SS MIC is a digest that ensures the data sent from the provisioning server were not modified en route. This is not an authenticated digest (i.e., it does not include any shared secret).

The SS MIC shall immediately be followed by the End of Data marker equal to 0xFF.

In case the file is a non-integer number of 32-bit words, the file shall be padded with zeros until the next 32-bit boundary.

The file structure is shown in Figure 266:

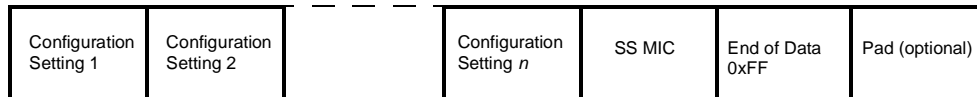

Figure 266—Configuration file structure

9.2.2 Configuration file settings

The following configuration settings shall be included in the configuration file and shall be supported by all SSs:

- a) SS MIC Configuration Setting
- b) TFTP Server Timestamp

The following configuration settings may be included in the configuration file and if present shall be supported by all SSs:

- a) Software Upgrade Filename Configuration Setting (see 11.2.2)
- b) Software Server IP Address (see 11.2.3)
- c) Authorization Node IP Address (11.2.5, Mesh only)
- d) Registration Node IP Address (11.2.6, Mesh only)
- e) Provisioning Node IP Address (11.2.7, Mesh only)
- f) Vendor-specific configuration settings

9.2.3 Configuration file creation

The sequence of operations required to create the configuration file is as shown in Figure 267, Figure 268, and Figure 269.

- a) Create the TLV entries for all the parameters required by the SS.

type, length, value for parameter 1
type, length, value for parameter 2
type, length, value for parameter n

Figure 267—Create TLV entries for parameters required by the SS

- b) Calculate the SS MIC configuration setting as defined in 9.2.3.1 and add to the file following the last parameter using code and length values defined for this field.

type, length, value for parameter 1
type, length, value for parameter 2
type, length, value for parameter n
type, length, value for SS MIC

Figure 268—Add SS MIC

- c) Add the end of data marker and pad with zeros to next 32-bit boundary if necessary.

type, length, value for parameter 1
type, length, value for parameter 2
type, length, value for parameter n
type, length, value for SS MIC
end of data marker pad (optional)

Figure 269—Add end of data marker and pad

9.2.3.1 SS MIC calculation

The SS MIC configuration setting shall be calculated by performing a SHA-1 digest over the bytes of the configuration setting fields. It is calculated over the bytes of these settings as they appear in the TFTPed image, without regard to TLV ordering or contents. There are two exceptions to this disregard of the contents of the TFTPed image:

- The bytes of the SS MIC TLV itself are omitted from the calculation. This includes the type, length, and value fields.
- On receipt of a configuration file, the SS shall recompute the digest and compare it to the SS MIC configuration setting in the file. If the digests do not match, then the configuration file shall be discarded.

10. Parameters and constants

10.1 Global values

The BS and SS shall meet the timing requirements contained in Table 342.

Table 342—Parameters and constants

System	Name	Time reference	Minimum value	Default value	Maximum value
BS	DCD Interval	Time between transmission of DCD messages			10 s
BS	UCD Interval	Time between transmission of UCD messages			10 s
BS	UCD Transition	The time the BS shall wait after repeating a UCD message with an incremented Configuration Change Count before issuing a UL-MAP message referring to Uplink_Burst_Profiles defined in that UCD message	2 MAC frames		
BS	DCD Transition	The time the BS shall wait after repeating a DCD message with an incremented Configuration Change Count before issuing a DL-MAP message referring to Downlink_Burst_Profiles defined in that DCD message	2 MAC frames		
BS	Max MAP Pending	Maximum validity of map			End of next frame
BS	Initial Ranging Interval	Time between Initial Ranging regions assigned by the BS			2 s
BS	CLK-CMP Interval	Time between the clock compare measurements used for the generation of CLK-CMP messages.	50 ms	50 ms	50 ms
SS	Lost DL-MAP Interval	Time since last received DL-MAP message before downlink synchronization is considered lost			600 ms
SS	Lost UL-MAP Interval	Time since last received UL-MAP message before uplink synchronization is considered lost			600 ms
SS	Contention Ranging Retries	Number of retries on contention Ranging Requests	16		
SS, BS	Invited Ranging Retries	Number of retries on inviting Ranging Requests	16		
SS	Request Retries	Number of retries on bandwidth allocation requests	16		

Table 342—Parameters and constants (continued)

System	Name	Time reference	Minimum value	Default value	Maximum value
SS	Registration Request Retries	Number of retries on registration requests	3		
BS	T_{proc}	Time provided between arrival of the last bit of a UL-MAP at an SS and effectiveness of that map	SC: 200 μ s OFDM: 1 ms OFDMA: 10 OFDMA symbols		
BS	SS Ranging Response Processing Time	Time allowed for an SS following receipt of a ranging response before it is expected to reply to an invited ranging request	10 ms		
SS, BS	Minislot size (SC/SCa only)	Size of minislot for uplink transmission. Shall be a power of 2 (in units of PS)	1 PS		
SS, BS	DSx Request Retries	Number of Timeout Retries on DSA/DSC/DSD Requests		3	
SS, BS	DSx Response Retries	Number of Timeout Retries on DSA/DSC/DSD Responses		3	
SS	TFTP Backoff Start	Initial value for TFTP backoff	1 s		
SS	TFTP Backoff End	Last value for TFTP backoff	16 s		
SS	TFTP Request Retries	Number of retries on TFTP request	16		
SS	TFTP Download Retries	Number of retries on entire TFTP downloads	3		
SS	TFTP Wait	The duration between two consecutive TFTP retries	2 min		
SS	Time of Day Retries	Number of Retries per Time of Day Retry Period	3		
SS	Time of Day Retry Period	Time period for Time of Day retries	5 min		
SS	T1	Wait for DCD timeout			5 * DCD interval maximum value
SS	T2	Wait for broadcast ranging timeout			5 * ranging interval
SS	T3	Ranging Response reception timeout following the transmission of a Ranging Request		200 ms	200 ms

Table 342—Parameters and constants (continued)

System	Name	Time reference	Minimum value	Default value	Maximum value
SS	T4	Wait for unicast ranging opportunity. If the pending-until-complete field was used earlier by this SS, then the value of that field shall be added to this interval.	30 s		35 s
BS	T5	Wait for Uplink Channel Change response			2 s
SS	T6	Wait for registration response			3 s
SS, BS	T7	Wait for DSA/DSC/DSD Response timeout			1 s
SS, BS	T8	Wait for DSA/DSC Acknowledge timeout			300 ms
BS	T9	Registration Timeout, the time allowed between the BS sending a RNG-RSP (success) to an SS, and receiving a SBC-REQ from that same SS	300 ms	300 ms	
SS, BS	T10	Wait for Transaction End timeout			3 s
SS	T12	Wait for UCD descriptor			5 * UCD Interval maximum value
BS	T13	The time allowed for an SS, following receipt of a REG-RSP message to send a TFTP-CPLT message to the BS	15 min	15 min	
SS	T14	Wait for DSX-RVD Timeout			200 ms
BS	T15	Wait for MCA-RSP	20 ms	20 ms	
SS	T16	Wait for bandwidth request grant	10 ms		service QoS dependent
BS	T17	Time allowed for SS to complete SS Authorization and Key Exchange	5 min	5 min	
SS	T18	Wait for SBC-RSP timeout		50 ms	<< T9
SS	T19	Time DL-channel remains unusable			
SS	T20	Time the SS searches for preambles on a given channel	2 MAC frames		
SS	T21	Time the SS searches for DL-MAP on a given channel			10 s
SS, BS	T22	Wait for ARQ-Reset			0.5 s

Table 342—Parameters and constants (continued)

System	Name	Time reference	Minimum value	Default value	Maximum value
Mesh node	T23	Network Entry: Detect network	1 s		
Mesh node	T24	Network Entry: Accumulate MSH-NCFG messages		120 s	
Mesh node	T25	Network Entry: Wait for MSH-NENT/MSH-NCFG		1 s	
SS	SBC Request Retries	Number of retries on SBC Request	3	3	16
SS	TFTP-CPLT Retries	Number of retries on TFTP-CPLT	3	3	16
SS	T26	Wait for TFTP-RSP	10 ms	200 ms	200 ms
BS	T27 as Idle Timer	Maximum time between unicast grants to SS when BS believes SS uplink transmission quality is <i>good enough</i>	SS Ranging Response Processing Time		
BS	T27 as Active Timer	Maximum time between unicast grants to SS when BS believes SS uplink transmission quality is <i>not good enough</i>	SS Ranging Response Processing Time		
SS	SS downlink management message processing time	Max. time between reception of Fast Power Control management message and compliance to its instructions by SS			200 μ s (OFDM only)

10.2 PKM parameter values

Table 343 defines the ranges and default values for the PKM configuration and operational parameters.

For the purposes of protocol testing, it is useful to run the privacy protocol with timer values well below the low end of the operational ranges. The shorter timer values “speed up” privacy’s clock, causing privacy protocol state machine events to occur far more rapidly than they would under an “operational” configuration. While privacy implementations need not be designed to operate efficiently at this accelerated privacy pace, the protocol implementation should operate correctly under these shorter timer values. Table 344 provides a list of shortened parameter values that are likely to be employed in protocol conformance and certification testing.

The TEK Grace Time shall be less than half the TEK lifetime.

Table 343—Operational ranges for privacy configuration settings

System	Name	Description	Minimum value	Default value	Maximum value
BS	AK Lifetime	Lifetime, in seconds, BS assigns to new AK	1 day (86 400 s)	7 days (604 800 s)	70 days (6 048 000 s)
BS	TEK Lifetime	Lifetime, in seconds, BS assigns to new TEK	30 min (1800 s)	12 h (43 200 s)	7 days (604 800 s)
SS	Authorize Wait Timeout	Auth Req retransmission interval from Auth Wait state	2 s	10 s	30 s
SS	Reauthorize Wait Timeout	Auth Req retransmission interval from Reauth Wait state	2 s	10 s	30 s
SS	Authorization Grace Time	Time prior to Authorization expiration SS begins reauthorization	5 min (300 s)	10 min (600 s)	35 days (3 024 000 s).
SS	Operational Wait Timeout	Key Req retransmission interval from Op Wait state	1 s	1 s	10 s
SS	Rekey Wait Timeout	Key Req retransmission interval from Rekey Wait state	1 s	1 s	10 s
SS	TEK Grace Time	Time prior to TEK expiration SS begins rekeying	5 min (300 s)	1 h (3600 s)	3.5 days (302 399 s)
SS	Authorize Reject Wait Timeout	Delay before resending Auth Request after receiving Auth Reject	10 s	60 s	10 min (600 s)

Table 344—Values for privacy configuration setting for protocol testing

Parameter	Shortened value
AK Lifetime	5 min (300 s)
TEK Lifetime	3 min (180 s)
Authorization Grace Time	1 min (60 s)
TEK Grace time	1 min (60 s)

10.3 PHY-specific values

10.3.1 WirelessMAN-SC parameter and constant definitions

10.3.1.1 PS

For the WirelessMAN-SC PHY, a PS is the duration of four modulation symbols at the symbol rate of the downlink transmission.

10.3.1.2 Symbol rate

The symbol rate shall be in the range 10–44.8 MBd, in increments of 100 kBd.

10.3.1.3 Uplink center frequency

The uplink center frequency shall be a multiple of 250 kHz.

10.3.1.4 Downlink center frequency

The downlink center frequency shall be a multiple of 250 kHz.

10.3.1.5 Tolerated poll jitter

For the 10–66 GHz PHY, the minimum value of the Tolerated Poll Jitter (see 11.13.13) shall be 3000 μ s.

10.3.1.6 Allocation Start Time

Unit of Allocation Start Time shall be minislots from the start of the downlink frame in which the UL-MAP message occurred.

10.3.1.7 Timing Adjust Units

The timing adjust units shall be 1/4 modulation symbols. During periodic ranging, the range of the value of this parameter shall be limited to ± 2 modulation symbols.

10.3.2 WirelessMAN-SCa parameters and constant definitions**10.3.2.1 Uplink Allocation Start Time**

Unit of Allocation Start Time shall be PSs from the start of the downlink frame in which the UL-MAP message occurred. The minimum value specified for this parameter shall correspond to one frame duration.

10.3.2.2 PS

PSs are defined as in Equation (152):

$$PS = 4 \times \text{Symbol duration} \quad (152)$$

10.3.2.3 Timing adjust units

The timing adjust units shall be 1/32 modulation symbols.

10.3.3 WirelessMAN-OFDM parameters and constant definitions**10.3.3.1 Uplink Allocation Start Time**

Unit of Allocation Start Time shall be PSs from the start of the downlink frame in which the UL-MAP message occurred. The minimum value specified for this parameter shall correspond to a point in the frame 1 ms after the last symbol of the UL-MAP.

10.3.3.2 PS

PSs are defined as in Equation (153):

$$PS = 4/F_s \quad (153)$$

10.3.3.3 Timing adjust units

The timing adjust units shall be $1/F_s$.

10.3.4 WirelessMAN-OFDMA parameters and constant definitions

10.3.4.1 Uplink Allocation Start Time

Unit of Allocation Start Time shall be PSs from the start of the downlink frame in which the UL-MAP message occurred. The minimum value specified for this parameter shall correspond to 10 OFDMA symbols.

10.3.4.2 PS

PSs are defined as Equation (154):

$$PS = 4/F_s \quad (154)$$

10.3.4.3 Timing adjust units

The timing adjust units shall be $1/F_s$.

10.4 Well-known addresses and identifiers

There are several CIDs defined in Table 345 that have specific meaning. These identifiers shall not be used for any other purposes.

Table 345—CIDs

CID	Value	Description
Initial ranging	0x0000	Used by SS and BS during initial ranging process.
Basic CID	0x0001– m	The same value is assigned to both the DL and UL connection.
Primary management	$m+1 - 2m$	The same value is assigned to both the DL and UL connection.
Transport CIDs and secondary Mgt CIDs	$2m+1-0xFEFE$	For the secondary management connection, the same value is assigned to both the DL and UL connection.
AAS initial ranging CID	0xFEFF	A BS supporting AAS shall use this CID when allocating a Initial Ranging period for AAS devices.
Multicast polling CIDs	0xFF00–0xFFFD	An SS may be included in one or more multicast polling groups for the purposes of obtaining bandwidth via polling. These connections have no associated service flow.
Padding CID	0xFFFE	Used for transmission of padding information by SS and BS.
Broadcast CID	0xFFFF	Used for broadcast information that is transmitted on a downlink to all SS.

11. TLV encodings

The following TLV encodings shall be used for parameters in both the configuration file (Clause 9) and MAC Management messages (6.3.2.3). TLV tuples with Type values not specified in this standard or specified as “*reserved*” should be silently discarded. The length of the Type field shall be one byte.

The format of the Length field shall be per the “definite form” of ITU-T X.690. Specifically, if the actual length of the Value field is less than or equal to 127 bytes, then

- The length of the Length field shall be one byte,
- The MSB of the Length field shall be set to 0, and
- The other 7 bits of the Length field shall be used to indicate the actual length of the value field in bytes.

If the length of the Value field is more than 127 bytes, then:

- The length of the length field shall be one byte more than what is actually used to indicate the length of the value field in bytes,
- The MSB of the first byte of the length field shall be set to 1,
- The other 7 bits of the first byte of the length field shall be used to indicate the number of additional bytes of the length field (i.e., excluding the first byte), and
- The remaining bytes (i.e., excluding the first byte) of the length field shall be used to indicate the actual length of the value field.

NOTE—Uniqueness of TLV Type values is assured by identifying the groups of IEEE 802.16 entities (configuration file and/or MAC Management messages) that share references to specific TLV encodings. Disjoint collections of TLVs are formed that correspond to each such functional grouping. Each set of TLVs that are explicitly defined to be members of a compound TLV structure form additional collections. Unique Type values are assigned to the member TLV encodings of each collection.

An additional collection, the Common encodings, is defined that consists of TLV encodings that are referenced by more than one of the functional groups. The Type values of the TLV members of this collection are assigned to assure uniqueness across all collections. This is the only collection for which global uniqueness is guaranteed.

In cases where a collection contains TLV encodings that are PHY specification specific, subcollections are formed that contain these TLV encodings. Type values assigned to members of each subcollection are assigned such that the values are unique within the subcollection and with non-PHY specification specific members of the collection. Type values are not unique across PHY-specific subcollections.

TLV Type values are assigned in accordance with the following rules:

- Common encodings start at 149, subsequent values are assigned in descending order.
- For individual collections, non-PHY specification specific encodings start at 1, subsequent values are assigned in ascending order.
- For individual collections, PHY specification specific encodings start at 150, subsequent values are assigned in ascending order.

11.1 Common encodings

Common TLV fields and their associated type codes are presented in Table 346.

Table 346—Type values for common TLV encodings

Type	Name
149	HMAC tuple
148	MAC version encoding
147	Current transmit power
146	Downlink service flow
145	Uplink service flow
144	Vendor ID encoding
143	Vendor-specific information

11.1.1 Current transmit power

The parameter indicates the transmitted power used for the burst which carried the message. The parameter is reported in dBm and is quantized in 0.5 dBm steps ranging from -64 dBm (encoded 0x00) to 63.5 dBm (encoded 0xFF). Values outside this range shall be assigned the closest extreme. The parameter is only applicable to systems supporting the SCA, OFDM, or OFDMA PHY specifications.

Type	Length	Value	Scope
147	1	Current transmitted power	SBC-REQ, REP-RSP

When included in an SBC-REQ message, the TLV is encapsulated in the Physical supported parameters compound TLV

11.1.2 HMAC tuple

This parameter contains the HMAC Key Sequence Number concatenated with an HMAC-Digest used for message authentication. The HMAC Key Sequence Number is stored in the four least significant bits of the first byte of the HMAC Tuple, and the most significant four bits are reserved. The HMAC-Tuple attribute format is shown in Table 347 and Table 348.

Table 347—HMAC Tuple definition

Type	Length	Value	Scope
149	21	See Table 348	DSx-REQ, DSx-RSP, DSx-ACK, REG-REQ, REG-RSP, RES-CMD, DREG-CMD, TFTP-CPLT

Table 348—HMAC Tuple value field

Field	Length	Notes
<i>reserved</i>	4 bits	
HMAC Key Sequence Number	4 bits	
HMAC-Digest	160 bits	HMAC with SHA-1

11.1.3 MAC version encoding

This parameter specifies the version of IEEE 802.16 to which the message originator conforms. If the MAC version values exchanged between a BS and SS during network entry and initialization differ, one of the following actions are taken:

- BS version > SS version ==> SS performs normal operations, but BS communicates with the SS per the version level specified by the SS.
- BS version < SS version ==> SS performs normal operations, but does so in conformance with the version level specified by BS. If backward-compatibility is not supported, SS disables any attempt for uplink transmission to BS.

Type	Length	Value	Scope
148	1	Version number of 802.16 supported on this channel. 1: Indicates conformance with IEEE Std 802.16-2001 2: Indicates conformance with IEEE Std 802.16c-2002 and its predecessors 3: Indicates conformance with IEEE Std 802.16a-2003 and its predecessors 4: Indicates conformance with IEEE Std 802.16-2004 5–255: <i>reserved</i>	PMP: DCD, RNG-REQ MESH: REG-REQ, REG-RSP

11.1.4 Service flow descriptors

Information regarding the attributes of an uplink or downlink service flow shall be encapsulated in a compound structure identified by the appropriate TLV Type value. The contents of the compound structure are defined in 11.13.

Type	Length	Value	Scope
146	<i>variable</i>	Compound: Downlink service flow	DSx-REQ, DSx-RSP, DSx-ACK
145	<i>variable</i>	Compound: Uplink service flow	DSx-REQ, DSx-RSP, DSx-ACK

11.1.5 Vendor ID encoding

The value field contains the vendor identification specified by the 3-byte, vendor-specific organizationally unique identifier of the SS or BS MAC address.

When used as a subfield of the TLVs Vendor-specific information, Vendor-specific QoS parameters, Vendor-specific classifier parameters, Vendor-specific PHS parameters, or Software upgrade descriptors, the Vendor ID encoding identifies the Vendor ID of the SSs that are intended to use this information. A vendor ID used in a Registration Request shall be the Vendor ID of the SS sending the request. A vendor ID used in a Registration Response shall be the Vendor ID of the BS sending the response.

Type	Length	Value	Scope
144	3	v1, v2, v3	REG-REQ (see 6.3.2.3.7), REG-RSP (see 6.3.2.3.8) DSx-REQ, DSx-RSP, DSx-ACK, Configuration File

11.1.6 Vendor-specific information

Vendor-specific information for SSs, if present, shall be encoded in the vendor-specific information field (VSIF) (type 143) using the Vendor ID field (11.1.5) to specify which tuples apply to which vendor's products. The Vendor ID shall be the first TLV embedded inside VSIF. If the first TLV inside VSIF is not a Vendor ID, then the TLV shall be discarded.

This configuration setting may appear multiple times. The same Vendor ID may appear multiple times. This configuration setting may be nested inside a Packet Classification Configuration Setting, a Service Flow Configuration Setting, or a Service Flow Response. However, there shall not be more than one Vendor ID TLV inside a single VSIF.

Type	Length	Value
143	<i>variable</i>	Per vendor definition

Example:

Configuration with vendor A specific fields and vendor B specific fields:

VSIF (143) + n (number of bytes inside this VSIF)
 8 (Vendor ID Type) + 3 (length field) + Vendor ID of Vendor A
 Vendor A Specific Type #1 + length of the field + Value #1
 Vendor A Specific Type #2 + length of the field + Value #2

VSIF (143) + n (number of bytes inside this VSIF)
 8 (Vendor ID Type) + 3 (length field) + Vendor ID of Vendor B
 Vendor B Specific Type + length of the field + Value

11.2 Configuration file encodings

These settings are found only in the configuration file. They shall not be forwarded to the BS in the Registration Request.

11.2.1 SS MIC configuration setting

This value field contains the SS MIC code. This is used to detect unauthorized modification or corruption of the configuration file.

Type	Length	Value
1	20	d1 d2..... d20

11.2.2 Software upgrade descriptors

This field defines the parameters associated with software upgrades. It is composed of one or more upgrade descriptors. An upgrade descriptor is defined by the set of all encapsulated tags defined in 11.2.2.1 through 11.2.2.4, occurring in order in the TFTP file. A new upgrade descriptor begins with the occurrence of the Vendor ID TLV.

Type	Length	Value
2	<i>variable</i>	Compound

When a managed SS decodes a descriptor with a matching Vendor ID, Hardware ID, and Software version different than the one currently running, it may initiate a TFTP transfer to upgrade its software.

11.2.2.1 Vendor ID

This value identifies the managed SS vendor to which the software upgrade is to be applied. Its format and value is described in 11.1.5.

Type	Length	Value
2.144	3	v1, v2, v3

11.2.2.2 Hardware ID

This value identifies the hardware version to which the software upgrade is to be applied. This value is administered by the vendor identified by the Vendor ID field.

Type	Length	Value
2.1	<i>n</i>	Hardware ID (string)

11.2.2.3 Software version

This value identifies the software version of the software upgrade file. The value is administered by the vendor identified in the Vendor ID field. It should be defined by the vendor to be unique with respect to a given Hardware ID.

Type	Length	Value
2.2	<i>n</i>	Software version (string)

11.2.2.4 Upgrade filename

The filename of the software upgrade file for the managed SS. The filename is a fully qualified directory-path name that is in a format appropriate to the server. There is no requirement that the character string be null-terminated; the length field always identifies the end of the string. The file is expected to reside on a TFTP server identified in a configuration setting option defined in 11.2.3.

Type	Length	Value
2.3	<i>n</i>	Filename

11.2.3 Software upgrade TFTP server

This object is the IP address of the TFTP server on which the software upgrade file for the SS resides.

Type	Length	Value
3	4 or 16	IP Address

11.2.4 TFTP Server Timestamp

This is the sending time of the configuration file in seconds. The definition of time is as in IETF RFC 868.

Type	Length	Value
4	4	Number of seconds since 00:00 1 January 1900

NOTE—The purpose of this parameter is to prevent replay attacks with old configuration files.

11.2.5 Authorization Node

The Authorization Node parameter contains the IP address of the Authorization Node. Applicable only to Mesh mode.

Type	Length	Value
5	4 or 16	IP Address

11.2.6 Registration Node

The Registration Node parameter contains the IP address of the Registration Node. Applicable only to Mesh mode.

Type	Length	Value
6	4 or 16	IP Address

11.2.7 Provisioning Node

The Provisioning Node parameter contains the IP address of the Provisioning Node. Applicable only to Mesh mode.

Type	Length	Value
7	4 or 16	IP Address

11.3 UCD management message encodings

The UCD message encodings are specific to the UCD message (see 6.3.2.3.3).

11.3.1 UCD channel encodings

UCD channel encodings shared across PHY specifications are provided in Table 349.

Table 349—UCD common channel encodings

Name	Type (1 byte)	Length	Value
Uplink_Burst_Profile	1		May appear more than once (see 6.3.2.3.3). The length is the number of bytes in the overall object, including embedded TLV items.
Contention-based reservation timeout	2	1	Number of UL-MAPs to receive before contention-based reservation is attempted again for the same connection.

Table 349—UCD common channel encodings (continued)

Name	Type (1 byte)	Length	Value
Bandwidth request opportunity size	3	2	Size (in units of PS) of PHY payload that SS may use to format and transmit a bandwidth request message in a contention request opportunity. The value includes all PHY overhead as well as allowance for the MAC data the message may hold.
Ranging request opportunity size	4	2	Size (in units of PS) of PHY bursts that an SS may use to transmit a RNG-REQ message in a contention ranging request opportunity. The value includes all PHY overhead as well as the maximum SS/BS round trip propagation delay.
Frequency	5	4	Uplink center frequency (kHz).

The UCD channel encodings unique to each PHY specifications are provided in Table 350, Table 351, Table 352, and Table 353.

Table 350—UCD PHY-specific channel encodings — WirelessMAN-SC

Name	Type (1 byte)	Length	Value
Symbol rate	150	2	Symbol rate, in increments of 10 kBd.
SSTG	151	1	The time, as measured at the BS and expressed in PSs, between the end of an SS burst and the beginning of the subsequent SS burst. The SS shall take this into account when determining the length of the burst. The SSTG consumes the last n PS of the intervals allocated in the UL-MAP. That is, UL-MAP entries include the time for a burst's ramp down.
Roll-off factor	152	1	2 = 0.25 0, 1, 3–255 <i>Reserved</i>
Power adjustment rule	153	1	0 = Preserve Peak Power 1 = Preserve Mean Power Describes the power adjustment rule when performing a transition from one burst profile to another.
Minislot Size	154	1	The size n of the minislot for this uplink channel in units of physical slots (PSs). Allowable values are $n = 2^m$, where m is an integer ranging from 0 through 7.
UL channel ID	155	1	The identifier of the uplink channel to which this message refers. This identifier is arbitrarily chosen by the BS and is only unique within the MAC domain.

Table 351—UCD PHY-specific channel encodings — WirelessMAN-SCa

Name	Type (1 byte)	Length	Value
Symbol rate	150	2	Symbol rate, in increments of 10 kBd.
SSTG	151	1	The time, as measured at the BS and expressed in PSs, between the end of an SS burst and the beginning of the subsequent SS burst. The SS shall take this into account when determining the length of the burst. The SSTG consumes the last n PS of the intervals allocated in the UL-MAP. That is, UL-MAP entries accommodate the RxDS burst element, which includes time for both ramp down and delay spread to clear the receiver.
Roll-off factor	152	1	0 = 0.15 1 = 0.18 2 = 0.25 (default) 3–255 = <i>Reserved</i>
Power adjustment rule	153	1	0 = Preserve Peak Power 1 = Preserve Mean Power Describes the power adjustment rule when performing a transition from one burst profile to another.
Initial Ranging SSTG	154	1	The time, as measured at the BS and expressed in PSs, between the end of an SS burst and the beginning of a subsequent burst residing in an Initial Ranging slot. Or, the time, as measured at the BS and expressed in PSs, between the end of burst in an Initial Ranging slot and beginning of a subsequent SS burst. An SS shall take this into account when determining the length of a burst in an Initial Ranging slot. The Initial Ranging SSTG consumes the last n PS of the intervals allocated in the UL-MAP. That is, UL-MAP entries accommodate the RxDS burst element, which includes time for both ramp down and delay spread to clear the receiver.
Minislot Size	155	1	The size n of the minislot for this uplink channel in units of physical slots (PSs). Allowable values are $n = 2^m$, where m is an integer ranging from 0 through 7.
UL channel ID	156	1	The identifier of the uplink channel to which this message refers. This identifier is arbitrarily chosen by the BS and is only unique within the MAC domain.

Table 352—UCD PHY-specific channel encodings — WirelessMAN-OFDM

Name	Type (1 byte)	Length	Value
Subchannelization REQ Region-Full Parameters	150	1	Bits 0...2: Number of subchannels used by each transmit opportunity when REQ Region-Full is allocated in subchannelization region, per the following enumeration: 0: 1 Subchannel. 1: 2 Subchannels. 2: 4 Subchannels. 3: 8 Subchannels. 4: 16 Subchannels. 5-7: Shall not be used. Bits 3...7: Number of OFDM symbols used by each transmit opportunity when REQ Region-Full is allocated in subchannelization region.
Subchannelization focused contention codes	151	1	Number of contention codes (C_{SE}) that shall only be used to request a subchannelized allocation. Default value 0. Allowed values 0–8.

Table 353—UCD PHY-specific channel encodings — WirelessMAN-OFDMA

Name	Type (1 byte)	Length	Value
Initial ranging codes	150	1	Number of initial ranging CDMA codes. Possible values are 0–255. ^a
Periodic ranging codes	151	1	Number of periodic ranging CDMA codes. Possible values are 0–255. ^a
Bandwidth request codes	152	1	Number of bandwidth request codes. Possible values are 0–255. ^a
Periodic ranging backoff start	153	1	Initial backoff window size for periodic ranging contention, expressed as a power of 2. Range: 0–15 (the highest order bits shall be unused and set to 0).
Periodic ranging backoff end	154	1	Final backoff window size for periodic ranging contention, expressed as a power of 2. Range: 0–15 (the highest order bits shall be unused and set to 0).
Start of ranging codes group	155	1	Indicates the starting number, S , of the group of codes used for this uplink. All the ranging codes used on this uplink will be between S and $((S+N+M+L) \bmod 256)$. Where, N is the number of initial-ranging codes M is the number of periodic-ranging codes L is the number of bandwidth-request codes The range of values is $0 \leq S \leq 255$.
Permutation base	156	1	Determines the UL_IDcell parameter for the subcarrier permutation to be used on this uplink channel.
UL allocated subchannels bitmap	157	9	This is a bitmap describing the subchannels allocated to the segment in the UL, when using the uplink PUSC permutation. The LSB of the first byte shall correspond to subchannel 0. For any bit that is not set, the corresponding subchannel shall not be used by the SS on that segment.
Optional permutation UL Allocated subchannels bitmap	158	13	This is a bitmap describing the subchannels allocated to the segment in the UL, when using the uplink optional PUSC permutation (see 8.4.6.2.5). The LSB of the first byte shall correspond to subchannel 0. For any bit that is not set, the corresponding subchannel shall not be used by the SS on that segment.
Band AMC Allocation Threshold	159	1	dB unit
Band AMC Release Threshold	160	1	dB unit
Band AMC Allocation Timer	161	1	Frame unit
Band AMC Release Timer	162	1	Frame unit
Band Status Reporting MAX Period	163	1	Frame unit
Band AMC Retry Timer	164	1	Frame unit
Safety Channel Allocation Threshold	165	1	dB unit
Safety Channel Release Threshold	166	1	dB unit
Safety Channel Allocation Timer	167	1	Frame unit

Table 353—UCD PHY-specific channel encodings — WirelessMAN-OFDMA (continued)

Name	Type (1 byte)	Length	Value
Safety Channel Release Timer	168	1	Frame unit
Bin Status Reporting MAX Period	169	1	Frame unit
Safety Channel Retry Timer	170	1	Frame unit
H-ARQ ACK delay for UL burst	171	1	1 = one frame offset 2 = two frames offset 3 = three frames offset
CQICH Band AMC-Transition Delay	172	1	Frame unit

^aThe total number of codes shall be equal or less than 256.

11.3.1.1 Uplink burst profile encodings

The uplink burst profile encodings unique to each PHY specification are provided in Table 354, Table 355, Table 356, and Table 357.

Table 354—UCD burst profile encodings—WirelessMAN-SC

Name	Type (1 byte)	Length	Value (variable-length)
Modulation type	150	1	1=QPSK, 2=16-QAM, 3=64-QAM
Preamble length	151	1	The number of symbols in the preamble pattern. The preamble consumes the first n PS of the intervals allocated in the UL-MAP. That is, UL-MAP entries include the bandwidth for a burst's preamble.
FEC Code Type	152	1	1 = Reed–Solomon only 2 = Reed–Solomon + Inner (24,16) Block Convolutional Code (BCC) 3 = Reed–Solomon + Inner (9,8) Parity Check Code 4 = BTC (Optional) 5–255 = <i>Reserved</i>
RS information bytes (K)	153	1	$K = 6–255$
RS parity bytes (R)	154	1	$R = 0–32$ (error correction capability $T = 0–16$)
BCC code type	155	1	1 = (24,16) 2–255 = <i>Reserved</i>
BTC row code type	156	1	1 = (64,57) Extended Hamming 2 = (32,26) Extended Hamming 3–255 = <i>Reserved</i> .
BTC column code type	157	1	1 = (64,57) Extended Hamming 2 = (32,26) Extended Hamming 3–255 = <i>Reserved</i>

Table 354—UCD burst profile encodings—WirelessMAN-SC

Name	Type (1 byte)	Length	Value (variable-length)
BTC interleaving type	158	1	1 = No interleaver, 2 = Block Interleaving, 3–255 = <i>Reserved</i> .
Randomizer seed	159	2	The 15 bit seed value left-justified in the 2 byte field. Bit 15 is the MSB of the first byte, and the LSB of the second byte is not used.
Last codeword length	160	1	1 = fixed; 2 = shortened

Table 355—UCD burst profile encodings—WirelessMAN-SCa

Name	Type (1 byte)	Length	Value (variable length)
Modulation type	150	1	4 MSB: 1 = QPSK, 2 = 16-QAM, 3 = 64-QAM, 4 = 256-QAM, 5 = BPSK, 6–10 = Spread BPSK with $F_s=0-4$, 11–15 = <i>Reserved</i> 4 LSB: 1 = CC+RS without block interleaving 2 = CC+RS with block interleaving 3 = no FEC, 4 = BTC, 5 = CTC, 6–15 = <i>Reserved</i>
Preamble length	151	1	4 MSB: Number of Unique Words in Preamble (0–7) 4 LSB: Number of PSs in ramp up (0–15)
RS Information bytes (K)	152	1	$K = 6-239$
RS Parity bytes (R)	153	1	$R = 0-16$ bytes (error correction capability = 0–8 bytes) $R = 17-255$ <i>Reserved</i>
Block interleaver depth	154	1	Number of rows (Reed–Solomon code words) used in block interleaver between Reed–Solomon and CC: rows = 2–66; <i>Reserved</i> = 0, 1, 67–255
CC/CTC-Specific parameters	155	1	0 = rate 1/2 (for BPSK, QPSK, 16-QAM) 1 = rate 2/3 (for QPSK, 64-QAM) 2 = rate 3/4 (for BPSK, QPSK, 16-QAM, 256-QAM) 3 = rate 5/6 (for QPSK, 64-QAM) 4 = rate 7/8 (for QPSK, 256-QAM) 5–255 = <i>Reserved</i>
Unique word length	156	1	Number of symbols (U) in a Unique Word: 0 = 16, 1 = 64, 2 = 256
Pilot word parameters	157	1	4 MSB: Pilot Word Interval [Regular bursts] (Pilot word's length in symbols included in interval). 0 = No pilot words, 1 = 256, 2 = 512, 3 = 1024, 4 = 2048, 5 = 4096, 6–15 <i>reserved</i> [STC-encoded bursts] 0 = No pilot words, 1–15 = Number of paired blocks between pilot words 4 LSB: Number of contiguous Unique Words composing a Pilot Word (1–5)

Table 355—UCD burst profile encodings—WirelessMAN-SCa (continued)

Name	Type (1 byte)	Length	Value (variable length)
Burst set type	158	1	0 = Standard, 1 = STC, 2 = Subchannel, 3–255 = <i>Reserved</i>
STC Parameters	159	2	4 MSB: Block length (segments are paired), in symbols: 1 = 64, 2 = 128, 3 = 256, 4 = 512, ..., 7 = 4096, 8–15 <i>Reserved</i> 4 LSB: Block burst profile type: 0 = CP derived from data and no UWs embedded within block 1 = CP derived from data an additional UW as first payload data element in block 2 = CP derived from UWs at beginning and end of segment 3–15 = <i>Reserved</i>
BTC Code selector	160	1	Value used to choose set of BTC row/column codes. 1–3 = C_{bank} 0, 4–255 = <i>Reserved</i>
Spreading Parameters	161	1	0–15 = PN sequence generator seed labels 0–15, 16–255 = <i>Reserved</i>
Subchannel framing parameters	162	1	4 MSB: {k,d} specification 0 = {0,1}, 1 = {0,2} 2 = {1,0}, 3 = {1,1}, 4 = {1,2}, 5 = {2,2}, 6–15 = <i>Reserved</i> 4 LSB: Repeat segment length, r, in symbols 0:7 = $2^{(\langle value \rangle + 8)}$, 7–15 = <i>Reserved</i>

Table 356—UCD burst profile encodings—WirelessMAN-OFDM

Name	Type (1 byte)	Length	Value (variable length)
FEC Code type and modulation type	150	1	0 = BPSK (CC) 1/2 11 = 64-QAM (BTC) 2/3 1 = QPSK (RS+CC/CC) 1/2 12 = 64-QAM (BTC) 5/6 2 = QPSK (RS+CC/CC) 3/4 13 = QPSK (CTC) 1/2 3 = 16-QAM (RS+CC/CC) 1/2 14 = QPSK (CTC) 2/3 4 = 16-QAM (RS+CC/CC) 3/4 15 = QPSK (CTC) 3/4 5 = 64-QAM (RS+CC/CC) 2/3 16 = 16-QAM (CTC) 1/2 6 = 64-QAM (RS+CC/CC) 3/4 17 = 16-QAM (CTC) 3/4 7 = QPSK (BTC) 1/2 18 = 64-QAM (CTC) 2/3 8 = QPSK (BTC) 3/4 19 = 64-QAM (CTC) 3/4 9 = 16-QAM (BTC) 3/5 20–255 = <i>Reserved</i> 10 = 16-QAM (BTC) 4/5
Focused contention power boost	151	1	The power boost in dB of focused contention carriers, as described in 8.3.7.3.3.
TCS_enable	152	1	0 = TCS disabled 1 = TCS enabled 2–255 = <i>Reserved</i>

Table 357—UCD burst profile encodings—WirelessMAN-OFDMA

Name	Type (1 byte)	Length	Value (variable length)
FEC Code type and modulation type	150	1	0 = QPSK (CC) 1/2 14 = QPSK (CTC) 3/4 1 = QPSK (CC) 3/4 15 = 16-QAM (CTC) 1/2 2 = 16-QAM (CC) 1/2 16 = 16-QAM (CTC) 3/4 3 = 16-QAM (CC) 3/4 17 = 64-QAM (CTC) 2/3 4 = 64-QAM (CC) 2/3 18 = 64-QAM (CTC) 3/4 5 = 64-QAM (CC) 3/4 19 = 64-QAM (CTC) 5/6 6 = QPSK (BTC) 1/2 20 = QPSK (ZT CC) 1/2 7 = QPSK (BTC) 2/3 21 = QPSK (ZT CC) 3/4 8 = 16-QAM (BTC) 3/5 22 = 16-QAM (ZT CC) 1/2 9 = 16-QAM (BTC) 4/5 23 = 16-QAM (ZT CC) 3/4 10 = 64-QAM (BTC) 5/8 24 = 64-QAM (ZT CC) 2/3 11 = 64-QAM (BTC) 4/5 25 = 64-QAM (ZT CC) 3/4 12 = QPSK (CTC) 1/2 26..255 = <i>Reserved</i> 13 = QPSK (CTC) 2/3
Ranging data ratio	151	1	Reducing factor in units of 1 dB, between the power used for this burst and power should be used for CDMA Ranging.
Normalized C/N override	152	5	This is a list of numbers, where each number is encoded by one nibble, and interpreted as a signed integer. The nibbles correspond in order to the list define by Table 334, starting from the second line, such that the LS nibble of the first byte corresponds to the second line in the table. The number encoded by each nibble represents the difference in normalized C/N relative to the previous line in the table.

11.4 DCD management message encodings

The DCD message encodings are specific to the DCD message (see 6.3.2.3.1).

11.4.1 DCD channel encodings

The DCD Channel Encoding are provided in Table 358.

Table 358—DCD channel encoding

Name	Type (1 byte)	Length	Value (variable length)	PHY scope
Downlink_Burst_Profile	1		May appear more than once (see 6.3.2.3.1). The length is the number of bytes in the overall object, including embedded TLV items.	All
BS EIRP	2	2	Signed in units of 1 dBm.	All
Frame duration	3	4	The number of PSs contained in a Burst FDD or TDD frame. Required only for framed downlinks.	SC
PHY Type	4	1	The PHY Type to be used.	SC
Power adjustment rule	5	1	0=Preserve Peak Power 1=Preserve Mean Power Describes the power adjustment rule when performing a transition from one burst profile to another.	SC, SCa
Channel Nr	6	1	Downlink channel number as defined in 8.5. Used for license-exempt operation only.	SCa, OFDM, OFDMA
TTG	7	1	TTG (in PSs).	SCa, OFDM, OFDMA
RTG	8	1	RTG (in PSs).	SCa, OFDM, OFDMA
$RSS_{IR,max}$	9	2	Initial Ranging Max. Received Signal Strength at BS Signed in units of 1 dBm.	All
Channel Switch Frame Number	10	3	Channel switch frame number as defined in 6.3.15.7. Used for license-exempt operation only.	SCa, OFDM, OFDMA
Frequency	12	4	Downlink center frequency (kHz).	All
BS ID	13	6	Base Station ID.	SCa, OFDM, OFDMA
Frame Duration Code	14	1	The duration of the frame. The frame duration code values are specified in Table 232.	OFDM
Frame Number	15	3	The number of the frame containing the DCD message.	OFDM

Table 358—DCD channel encoding (continued)

Name	Type (1 byte)	Length	Value (variable length)	PHY scope
Size of CQICH_ID field	16	1	0 = <i>Reserved</i> 1 = 3 bits 2 = 4 bits 3 = 5 bits 4 = 6 bits 5 = 7 bits 6 = 8 bits 7 = 9 bits 8...255 = <i>Reserved</i>	OFDMA
H-ARQ ACK delay for DL burst	17	1	1 = 1 frame offset 2 = 2 frame offset 3 = 3 frame offset	OFDMA
MAC version	148	1	See 11.1.3.	All

11.4.2 Downlink burst profile encodings

Downlink burst profile encodings are presented in Table 360. Encodings for TLVs common to all PHY specifications are presented in Table 359.

Table 359—DCD PHY-common burst profile encodings

Name	Type (1 byte)	Length	Value (variable length)
Frequency	1	4	Downlink frequency (kHz)

Downlink burst profile encodings that are unique to each PHY specification are provided in Table 360, Table 361, Table 362, and Table 363.

Table 360—DCD burst profile encodings—WirelessMAN-SC

Name	Type (1 byte)	Length	Value (variable-length)
Modulation Type	150	1	1 = QPSK 2 = 16-QAM 3 = 64-QAM
FEC Code Type	151	1	1 = Reed–Solomon only 2 = Reed–Solomon + Inner Block Convolutional Code (BCC) 3 = Reed–Solomon + Inner (9,8) Parity Check Code 4 = BTC (Optional) 5–255 = <i>Reserved</i>
RS information bytes (K)	152	1	$K = 6–255$
RS Parity Bytes (R)	153	1	$R = 0–32$ (error correction capability $T = 0–16$)

Table 360—DCD burst profile encodings—WirelessMAN-SC (continued)

Name	Type (1 byte)	Length	Value (variable-length)
BCC code type	154	1	1 = (24,16) 2–255 = <i>Reserved</i>
BTC Row code type	155	1	1 = (64,57) Extended Hamming 2 = (32,26) Extended Hamming 3–255 = <i>Reserved</i>
BTC Column code type	156	1	1 = (64,57) Extended Hamming 2 = (32,26) Extended Hamming 3–255 = <i>Reserved</i>
BTC Interleaving type	157	1	1 = No interleaver, 2 = Block Interleaving, 3–255 = <i>Reserved</i>
Last codeword length	158	1	1=fixed; 2=shortened allowed (optional) This allows for the transmitter to shorten the last codeword, based upon the allowable shortened codewords for the particular code type.
DIUC mandatory exit threshold	159	1	CINR at or below which this DIUC can no longer be used and at which a change to a more robust DIUC is required, in 0.25 dB units. See Figure 81.
DIUC minimum entry threshold	160	1	The minimum CINR required to start using this DIUC when changing from a more robust DIUC is required, in 0.25 dB units. See Figure 81.
Preamble presence	161	1	0 = burst not preceded with preamble 1 = burst preceded with preamble. If the preamble is present, it consumes the first PSs of the interval.
CID_In_DL_IE	162	1	0 – CID does not appear DL-MAP IE (default) 1 – CID does appear in DL-MAP IE 2..255 – <i>Reserved</i>

Table 361—DCD burst profile encodings—WirelessMAN-SCa

Name	Type (1 byte)	Length	Value (variable length)
Modulation type	150	1	4 MSB: 1 = QPSK, 2 = 16-QAM, 3 = 64-QAM, 4 = 256-QAM, 5 = BPSK, 6–9 = Spread BPSK with $F_s = 0-3$, 10–15 = <i>Reserved</i> 4 LSB: 1 = CC+RS without block interleaving, 2 = CC+RS with block interleaving 3 = no FEC, 4 = BTC, 5 = CTC, 6–15 = <i>Reserved</i>
RS Information bytes (K)	151	1	$K = 6 - 239$
RS Parity bytes (R)	152	1	$R = 0-16$ bytes (error correction capability = 0–8 bytes) $R = 17-255$ <i>Reserved</i>

Table 361—DCD burst profile encodings—WirelessMAN-SCa (continued)

Name	Type (1 byte)	Length	Value (variable length)
DIUC Mandatory exit threshold	153	1	0–63.75 dB CINR at or below where this DIUC can no longer be used and at which a change to a more robust DIUC is required, in 0.25 dB units. See Figure 81.
DIUC Minimum entry threshold	154	1	0–63.75 dB The minimum CINR required to start using this DIUC when changing from a more robust DIUC is required, in 0.25 dB units. See Figure 81.
CC/CTC-Specific parameters	155	1	0 = rate 1/2 (for BPSK, QPSK, 16-QAM) 1 = rate 2/3 (for QPSK, 64-QAM) 2 = rate 3/4 (for BPSK, QPSK, 16-QAM, 256-QAM) 3 = rate 5/6 (for QPSK, 64-QAM) 4 = rate 7/8 (for QPSK, 256-QAM) 5–255 = <i>Reserved</i>
Block interleaver depth	156	1	Number of rows (Reed–Solomon code words) used in block interleaver between Reed–Solomon and CC: 2–66 = rows 0, 1, 67–255 = <i>Reserved</i>
BTC Code selector	157	1	Value used to choose set of BTC row/column codes. 1–3 = C_{bank} 0, 4–255 = <i>Reserved</i>
Spreading Parameters	159	1	0–15 = PN sequence generator seed labels 0–15, 16–255 = <i>Reserved</i>
CID_In_DL_IE	160	1	0 = CID does not appear DL-MAP IE (default) 1 = CID does appear in DL-MAP IE 2–255 = <i>Reserved</i>

Table 362—DCD burst profile encodings—WirelessMAN-OFDM

Name	Type (1 byte)	Length	Value (variable length)
FEC Code type	150	1	0 = BPSK (CC) 1/2 11 = 64-QAM (BTC) 2/3 1 = QPSK (RS+CC/CC) 1/2 12 = 64-QAM (BTC) 5/6 2 = QPSK (RS+CC/CC) 3/4 13 = QPSK (CTC) 1/2 3 = 16-QAM (RS+CC/CC) 1/2 14 = QPSK (CTC) 2/3 4 = 16-QAM (RS+CC/CC) 3/4 15 = QPSK (CTC) 3/4 5 = 64-QAM (RS+CC/CC) 2/3 16 = 16-QAM (CTC) 1/2 6 = 64-QAM (RS+CC/CC) 3/4 17 = 16-QAM (CTC) 3/4 7 = QPSK (BTC) 1/2 18 = 64-QAM (CTC) 2/3 8 = QPSK (BTC) 3/4 or 2/3 19 = 64-QAM (CTC) 3/4 9 = 16-QAM (BTC) 3/5 20–255 = <i>Reserved</i> 10 = 16-QAM (BTC) 4/5
DIUC mandatory exit threshold	151	1	0–63.75 dB CINR at or below where this DIUC can no longer be used and where this change to a more robust DIUC is required, in 0.25 dB units. See Figure 81.
DIUC minimum entry threshold	152	1	0–63.75 dB The minimum CINR required to start using this DIUC when changing from a more robust DIUC is required, in 0.25 dB units. See Figure 81.
TCS_enable	153	1	0 = TCS disabled 1 = TCS enabled 2–255 = <i>Reserved</i>

Table 363—DCD burst profile encodings—WirelessMAN-OFDMA

Name	Type (1 byte)	Length	Value (variable length)
FEC Code type	150	1	0 = QPSK (CC) 1/2 14 = QPSK (CTC) 3/4 1 = QPSK (CC) 3/4 15 = 16-QAM (CTC) 1/2 2 = 16-QAM (CC) 1/2 16 = 16-QAM (CTC) 3/4 3 = 16-QAM (CC) 3/4 17 = 64-QAM (CTC) 2/3 4 = 64-QAM (CC) 2/3 18 = 64-QAM (CTC) 3/4 5 = 64-QAM (CC) 3/4 19 = 64-QAM (CTC) 5/6 6 = QPSK (BTC) 1/2 20 = QPSK (ZT CC) 1/2 7 = QPSK (BTC) 3/4 or 2/3 21 = QPSK (ZT CC) 3/4 8 = 16-QAM (BTC) 3/5 22 = 16-QAM (ZT CC) 1/2 9 = 16-QAM (BTC) 4/5 23 = 16-QAM (ZT CC) 3/4 10 = 64-QAM (BTC) 2/3 or 5/8 24 = 64-QAM (ZT CC) 2/3 11 = 64-QAM (BTC) 5/6 or 4/5 25 = 64-QAM (ZT CC) 3/4 12 = QPSK (CTC) 1/2 26..255 = <i>Reserved</i> 13 = QPSK (CTC) 2/3
DIUC Mandatory exit threshold	151	1	0–63.75 dB CINR at or below where this DIUC can no longer be used and where this change to a more robust DIUC is required, in 0.25 dB units. See Figure 81.
DIUC Minimum entry threshold	152	1	0–63.75 dB The minimum CINR required to start using this DIUC when changing from a more robust DIUC is required, in 0.25 dB units. See Figure 81.

11.5 RNG-REQ management message encodings

The encodings in Table 364 are specific to the RNG-REQ message (6.3.2.3.5).

Table 364—RNG-REQ message encodings

Name	Type (1 byte)	Length	Value (variable-length)	PHY Scope
Requested Downlink Burst Profile	1	1	Bits 0–3: DIUC of the downlink burst profile requested by the SS for downlink traffic. Bits 4–7: 4 LSB of Configuration Change Count value of DCD defining the burst profile associated with DIUC.	All
SS MAC Address	2	6	The MAC address of the SS	All
Ranging Anomalies	3	1	A parameter indicating a potential error condition detected by the SS during the ranging process. Setting the bit associated with a specific condition indicates that the condition exists at the SS. Bit #0 — SS already at maximum power. Bit #1 — SS already at minimum power. Bit #2 — Sum of commanded timing adjustments is too large.	All
AAS broadcast capability	4	1	0 = SS can receive broadcast messages 1 = SS cannot receive broadcast messages	SCa, OFDM, OFDMA

Table 365—SCa-specific RNG-REQ message encodings

Name	Type (1 byte)	Length	Value (variable-length)
SCa AAS feedback	150	6	Bytes #0–1: Phase offsets Bits #0–4: Antenna 1 relative to antenna 0 signed value units of $360^\circ/32$ Bits #5–9: Antenna 2 relative to antenna 0 signed value units of $360^\circ/32$ Bits #10–14: Antenna 3 relative to antenna 0 signed value units of $360^\circ/32$ Bit #15: <i>Reserved</i> ; shall be set to zero Antenna CINR values (see 8.2.2) Byte #2 – Antenna 0 Byte #3 – Antenna 1 Byte #4 – Antenna 2 Byte #5 – Antenna 3

11.6 RNG-RSP management message encodings

The encodings in Table 367 are specific to the RNG-RSP message (6.3.2.3.6).

Table 366—SCa-specific RNG-RSP message encodings

Name	Type (1 byte)	Length	Value (variable-length)
AAS preamble index	150	1	0, 1, 2, 3 = Index of the AAS preamble to be used on future AAS transmissions to the SS

Table 367—RNG-RSP message encodings

Name	Type (1 byte)	Length	Value (variable-length)	PHY Scope
Timing Adjust	1	4	Tx timing offset adjustment (signed 32-bit). The time required to advance SS transmission so frames arrive at the expected time instance at the BS. Units are PHY specific (see 10.3).	All
Power Level Adjust	2	1	Tx Power offset adjustment (signed 8-bit, 0.25 dB units) Specifies the relative change in transmission power level that the SS is to make in order that transmissions arrive at the BS at the desired power. When subchannelization is employed, the subscriber shall interpret the power offset adjustment as a required change to the transmitted power density.	All
Offset Frequency Adjust	3	4	Tx frequency offset adjustment (signed 32-bit, Hz units) Specifies the relative change in transmission frequency that the SS is to make in order to better match the BS. (This is fine-frequency adjustment within a channel, not reassignment to a different channel.)	All
Ranging Status	4	1	Used to indicate whether uplink messages are received within acceptable limits by BS. 1 = continue, 2 = abort, 3 = success, 4 = rerange	All
Downlink frequency override	5	4	Center frequency, in kHz, of new downlink channel where the SS should redo initial ranging. If this TLV is used, the Ranging Status value shall be set to 2. Shall be used for licensed bands only.	SCa OFDM OFDMA
Uplink channel ID override	6	1	Licensed bands: The identifier of the uplink channel with which the SS is to redo initial ranging (not used with PHYs without channelized uplinks). License-exempt bands: The Channel Nr (see 8.5.1) where the SS should redo initial ranging.	All

Table 367—RNG-RSP message encodings (continued)

Name	Type (1 byte)	Length	Value (variable-length)	PHY Scope
Downlink Operational Burst Profile	7	2	This parameter is sent in response to the RNG-REQ Requested Downlink Burst Profile parameter. Byte 0: Specifies the least robust DIUC that may be used by the BS for transmissions to the SS. Byte 1: Configuration Change Count value of DCD defining the burst profile associated with DIUC.	All
SS MAC Address	8	6	SS MAC Address in MAC-48 format	All
Basic CID	9	2	Basic CID assigned by BS at initial access.	All
Primary Management CID	10	2	Primary Management CID assigned by BS at initial access.	All
AAS broadcast permission	11	1	0 = SS may issue contention-based Bandwidth Requests permission 1 = SS shall not issue contention-based Bandwidth Request	SCa OFDM OFDMA
Frame number	12	3	Frame number where the associated RNG_REQ message was detected by the BS. Usage is mutually exclusive with SS MAC Address (Type 8). The opportunity within the frame is assumed to be 1 (the first) if the Initial Ranging Opportunity field is not supplied.	SCa OFDM
Initial ranging opportunity number	13	1	Initial Ranging opportunity (1–255) in which the associated RNG_REQ message was detected by the BS. Usage is mutually exclusive with SS MAC Address (Type 8).	SCa OFDM

In addition to the RNG-RSP TLVs listed in Table 367, which are applicable to multiple PHY specifications, sets of PHY specification specific RNG-RSP TLVs are provided in Table 368 and Table 369.

Table 368—OFDM-specific RNG-RSP message encodings

Name	Type	Length	Value
Ranging subchannel	150	1	Used to indicate the OFDM subchannel reference that was used to transmit the initial ranging message (OFDM with subchannelization). Ranging subchannels are numbered from 01 to 0x1F according to Table 213.

Table 369—OFDMA-specific RNG-RSP message encodings

Name	Type	Length	Value
Ranging code attributes	150	4	Bits 31:22 – Used to indicate the OFDM time symbol reference that was used to transmit the ranging code. Bits 21:16 – Used to indicate the OFDMA subchannel reference that was used to transmit the ranging code. Bits 15:8 – Used to indicate the ranging code index that was sent by the SS. Bits 7:0 – The 8 least significant bits of the frame number of the OFDMA frame where the SS sent the ranging code.

11.7 REG-REQ/RSP management message encodings

The TLV encodings defined in this subclause are specific to the REG-REQ (6.3.2.3.7), and REG-RSP (6.3.2.3.8) MAC Management messages.

11.7.1 ARQ Parameters

This field provides the fragmentation and ARQ parameters applied during the establishment of the secondary management connection. For purposes of ARQ parameter negotiation, the appearance of the field in the REG-REQ message is equivalent to its appearance in the DSA-REQ message. The appearance of the field in the REG-RSP message is equivalent to its appearance in the DSA-RSP message.

This field is a compound TLV that may take on any of the ARQ parameters described in 11.13.18. The subtype values defined for use within the 145/146 service flow definitions are applicable for this TLV as well.

Type	Length	Value	Scope
1	<i>variable</i>	Compound	REG-REQ REG-RSP

11.7.2 SS management support

This field indicates whether or not the SS is managed by standard-based IP messages over the secondary management connection. When the SS indicates in the REG-REQ that it is managed, the BS and SS shall perform stages g), h), and i) of the initial network entry process (see 6.3.9). Otherwise, these stages shall be skipped by the BS and SS.

Type	Length	Value	Scope
2	1	0: no secondary management connection 1: secondary management connection	REG-REQ REG-RSP

11.7.3 IP management mode

The IP management mode parameter dictates whether the provider intends to manage the SS on an ongoing basis via IP-based mechanisms.

Type	Length	Value	Scope
3	1	0 - Unmanaged mode 1 - IP-managed mode	REG-REQ (see 6.3.2.3.7), REG-RSP (see 6.3.2.3.8)

11.7.4 IP version

This field indicates the version of IP used on the Secondary Management Connection.

Type	Length	Value	Scope
4	1	Bits #0: 4 (default) Bits #1: 6 Bits #2-7: <i>Reserved</i> ; shall be set to zero	REG-REQ REG-RSP

11.7.5 Secondary Management CID

This parameter contains the Secondary Management CID issued to an SS .

Type	Length	Value	Scope
5	2	Secondary Management CID	REG- RSP

11.7.6 Number of uplink CID supported

This field shows the number of Uplink CIDs the SS can support. The minimum value is three for managed SSs and two for unmanaged SSs. An SS shall support a Basic CID, a Primary Management CID, and 0 or more Transport CIDs. A managed SS shall also support a Secondary Management CID.

Type	Length	Value	Scope
6	2	Number of Uplink CIDs the SS can support.	REG-REQ, REG-RSP

11.7.7 Convergence Sublayer Capabilities

11.7.7.1 Classification/PHS options and SDU encapsulation support

This parameter indicates which classification/PHS options and SDU encapsulation the SS supports. By default, Packet, IPv4 and 802.3/Ethernet shall be supported, thus absence of this parameter in REG-REQ means that named options are supported by the SS.

Type	Length	Value	Scope
7	2	Bit #0: ATM Bit #1: Packet, IPv4 Bit #2: Packet, IPv6 Bit #3: Packet, 802.3/Ethernet Bit #4: Packet, 802.1Q VLAN Bit #5: Packet, IPv4 over 802.3/Ethernet Bit #6: Packet, IPv6 over 802.3/Ethernet Bit #7: Packet, IPv4 over 802.1Q VLAN Bit #8: Packet, IPv6 over 802.1Q VLAN Bits #9–15: <i>Reserved</i> ; Shall be set to zero	REG-REQ REG-RSP

11.7.7.2 Maximum number of classifiers

This is the maximum number of admitted Classifiers that the SS supports.

Type	Length	Value	Scope
8	2	Maximum number of simultaneous admitted classifiers	REG-REQ REG-RSP

The default value is 0 (no limit).

11.7.7.3 PHS support

This parameter indicates the level of PHS support.

Type	Length	Value	Scope
9	2	0: no PHS support 1: ATM PHS 2: Packet PHS	REG-REQ REG-RSP

The default value is 0 (no PHS).

11.7.8 SS capabilities encodings

11.7.8.1 ARQ Support

This field indicates the availability of SS support for ARQ.

Type	Length	Value	Scope
10	1	0: No ARQ support capability 1: ARQ supported 2–255: <i>Reserved</i>	REG-REQ REG-RSP

11.7.8.2 DSx flow control

This field specifies the maximum number of concurrent DSA, DSC, or DSD transactions that may be outstanding.

Type	Length	Value	Scope
11	1	0 indicates no limit (default) 1–255 indicate maximum concurrent transactions	REG-REQ REG-RSP

11.7.8.3 MAC CRC support

This field indicates whether or not the SS supports MAC level CRC. A value of 0 indicates no CRC support. A value of 1 indicates that the SS supports MAC CRC.

Type	Length	Value	Scope
12	1	0 = No MAC CRC support 1 = MAC CRC support (default)	REG-REQ REG-RSP

11.7.8.4 MCA flow control

This field specifies the maximum number of concurrent MCA transactions that may be outstanding.

Type	Length	Value	Scope
13	1	0 indicates no limit (default) 1–255 indicate maximum concurrent transactions	REG-REQ REG-RSP

11.7.8.5 Multicast polling group CID support

This field indicates the maximum number of simultaneous Multicast Polling Groups the SS is capable of belonging to.

Type	Length	Value	Scope
14	1	0–255 default = 0	REG-REQ REG-RSP

11.7.8.6 PKM flow control

This field specifies the maximum number of concurrent PKM transactions that may be outstanding.

Type	Length	Value	Scope
15	1	0 indicates no limit (default) 1–255 indicate maximum concurrent transactions	REG-REQ REG-RSP

11.7.8.7 Authorization Policy Support

This field indicates authorization policy that both SS and BS need to negotiate and synchronize. A bit value of 0 indicates “not supported” while 1 indicates “supported.” If this field is omitted, then both SS and BS shall use the IEEE 802.16 security, constituting X.509 digital certificates and the RSA public key encryption algorithm, as authorization policy.

Type	Length	Value	Scope
16	1	Bit #0: IEEE 802.16 privacy supported Bits #1–7: <i>Reserved</i> ; shall be set to zero	REG-REQ REG-RSP

11.7.8.8 Maximum number of supported security associations

This field specifies the maximum number of supported security association of the SS.

Type	Length	Value	Scope
17	1	Maximum number of security association supported by the SS (default = 1)	REG-REQ REG-RSP

11.8 SBC-REQ/RSP management message encodings

The TLV encodings defined in this subclause are specific to the SBC-REQ (6.3.2.3.23), and SBC-RSP (6.3.2.3.24) MAC Management message dialog.

11.8.1 Bandwidth Allocation Support

This field indicates properties of the SS that the BS needs to know for bandwidth allocation purposes.

Type	Length	Value	Scope
1	1	Bit #0: <i>Reserved</i> ; shall be set to zero Bit #1 = 0: Half-Duplex (FDD only) Bit #1 = 1: Full-Duplex (FDD only) Bits #2–7: <i>Reserved</i> ; shall be set to zero	SBC-REQ (see 6.3.2.3.23) SBC-RSP (see 6.3.2.3.24)

11.8.2 Capabilities for Construction and Transmission of MAC PDUs

Type	Length	Value	Scope
4	1	Bit #0: Ability to receive requests piggybacked with data Bit #1: Specifies the size of FSN values used when forming MAC PDUs on non-ARQ connections 0: Only 3-bit FSN values are supported 1: Only 11-bit FSN values are supported Bits #2–7: <i>Reserved</i> ; shall be set to zero	SBC-REQ (see 6.3.2.3.23) SBC-RSP (see 6.3.2.3.24)

11.8.3 Physical Parameters Supported

11.8.3.1 Subscriber transition gaps

This field indicates the transition speed SSTTG and SSRTG for TDD and H-FDD SSs. This parameter is not used by WirelessMAN-SC. Instead, performance is mandated in Table 169.

Type	Length	Value	Scope
2	2	Bits #0–7: SSTTG (μ s) Bits #8–15: SSRTG (μ s) Allowed values: OFDM mode: TDD and H-FDD 0...100. Other modes: TDD: 0...50; H-FDD: 0...100	SBC-REQ (see 6.3.2.3.23) SBC-RSP (see 6.3.2.3.24)

11.8.3.2 Maximum transmit power

The maximum available power for BPSK, QPSK, 16-QAM, and 64-QAM constellations. The maximum power parameters are reported in dBm and quantized in 0.5 dBm steps ranging from -64 dBm (encoded 0x00) to 63.5 dBm (encoded 0xFF). Values outside this range shall be assigned the closest extreme. SSS that do not support QAM64 shall report the value of 0x00 in the maximum QAM64 power field. This parameter is only applicable to systems supporting the SCa, OFDM or OFDMA PHY specifications.

Type	Length	Value	Scope
3	4	Byte 0: Maximum transmitted power for BPSK. Byte 1: Maximum transmitted power for QPSK. Byte 2: Maximum transmitted power for 16-QAM. Byte 3: Maximum transmitted power for 64-QAM. SSS that do not support 64-QAM shall report the value 0x00.	SBC-REQ

11.8.3.3 Current transmit power

This parameter indicates the transmitted power used for the burst which carried the message. The parameter is defined in the common TLV encodings subclause (11.1.1). When included in an SBC-REQ message, the TLV is encapsulated in the physical supported parameters compound TLV.

Type	Length	Value	Scope
147	1	Current transmitted power (11.1.1)	SBC-REQ

11.8.3.4 WirelessMAN-SC specific parameters

11.8.3.4.1 SC SS demodulator types

This field indicates the different modulation types supported by an SS for downlink reception. This field is not used for other PHY specifications. A bit value of 0 indicates “not supported” while 1 indicates “supported.”

Type	Length	Value	Scope
150	1	Bit #0: QPSK Bit #1: 16-QAM Bit #2: 64-QAM Bits #3–7: <i>Reserved</i> ; shall be set to zero	SBC-REQ (see 6.3.2.3.23) SBC-RSP (see 6.3.2.3.24)

11.8.3.4.2 SC SS modulator types

This field indicates the different modulation types supported by an SS for uplink transmission. This field is not used for other PHY specifications. A bit value of 0 indicates “not supported” while 1 indicates “supported.”

Type	Length	Value	Scope
151	1	Bit #0: QPSK Bit #1: 16-QAM Bit #2: 64-QAM Bits #3–7: <i>Reserved</i> , shall be set to 0	SBC-REQ (see 6.3.2.3.23) SBC-RSP (see 6.3.2.3.24)

11.8.3.4.3 SC SS downlink FEC types

This field indicates the different FEC types supported by an SS for downlink reception. This field is not used for other PHY specifications. A bit value of 0 indicates “not supported” while 1 indicates “supported.”

Type	Length	Value	Scope
152	1	Bit #0: Code Type 1 as in Table 146 Bit #1: Code Type 2 as in Table 146 Bit #2: Code Type 3 as in Table 123 Bits #3–7: <i>Reserved</i> , shall be set to 0	SBC-REQ (see 6.3.2.3.23) SBC-RSP (see 6.3.2.3.24)

11.8.3.4.4 SC SS uplink FEC types

This field indicates the different FEC types supported by an SS for uplink transmission. This field is not used for other PHY specifications. A bit value of 0 indicates “not supported,” while 1 indicates “supported.”

Type	Length	Value	Scope
153	1	Bit #0: Code Type 1 as in Table 146 Bit #1: Code Type 2 as in Table 146 Bit #2: Code Type 3 as in Table 123 Bits #3–7: <i>Reserved</i> , shall be set to 0	SBC-REQ (see 6.3.2.3.23) SBC-RSP (see 6.3.2.3.24)

11.8.3.5 WirelessMAN-SCa specific parameters

11.8.3.5.1 SCa SS demodulation types

This field indicates the optional modulation (and FEC) types supported by an SS for downlink reception. Note that BPSK, QPSK, 16-QAM, and 64-QAM shall be supported, as is the Concatenated FEC and no-FEC QPSK. A bit value of 0 indicates “not supported” while 1 indicates “supported.”

Type	Length	Value	Scope
150	1	Bit #0: 256-QAM Bit #1: BTC Bit #2: CTC Bit #3: no FEC and QAM Bit #4: STC support, dual blocks without UWs Bit #5: STC support, dual blocks with UWs Bits #6–7: <i>Reserved</i> ; shall be set to zero	SBC-REQ (see 6.3.2.3.23) SBC-RSP (see 6.3.2.3.24)

11.8.3.5.2 SCa SS demodulator roll-off factor

This field indicates the optional roll-off factors supported by an SS for downlink reception. Note that support of a roll-factor of 0.25 is mandatory. A bit value of 0 indicates “not supported” while 1 indicates “supported.”

Type	Length	Value	Scope
151	1	Bit #0: 0.15 Bit #1: 0.18 Bits #2–7: <i>Reserved</i> ; shall be set to 0	SBC-REQ (see 6.3.2.3.23) SBC-RSP (see 6.3.2.3.24)

11.8.3.5.3 SCa SS demodulator Unique Word length

This field indicates the optional Unique Word lengths, in symbols, supported by an SS for downlink reception. Note that support of the 64-symbol Unique Word is mandatory. A bit value of 0 indicates “not supported” while 1 indicates “supported.”

Type	Length	Value	Scope
152	1	Bit #0: 256 Bits #1–7: <i>Reserved</i> ; shall be set to 0	SBC-REQ (see 6.3.2.3.23) SBC-RSP (see 6.3.2.3.24)

11.8.3.5.4 SCa SS demodulator block interleaver depth

This field indicates the interleaver depth (number of rows) supported by an SS for downlink reception. The value of 0 (interleaver depth 10 rows) shall be supported.

Type	Length	Value	Scope
153	1	0: interleaver depth of 10 rows 1–54: 11–64 rows 55–255: <i>Reserved</i>	SBC-REQ (see 6.3.2.3.23) SBC-RSP (see 6.3.2.3.24)

11.8.3.5.5 SCa SS demodulator STC block size

This field indicates the STC block size (block = 1/2 length of a “STC pair”) supported by an SS for downlink reception. A bit value of 0 indicates “not supported” while 1 indicates “supported.”

Type	Length	Value	Scope
155	1	Bit #0: 64 Bit #1: 128 Bit #2: 256 Bit #3: 512 Bit # 4: 1024 Bit #5: 2048 Bit #6: 4096 Bit #7: <i>Reserved</i> , shall be set to 0.	SBC-REQ (see 6.3.2.3.23) SBC-RSP (see 6.3.2.3.24)

11.8.3.5.6 SCa SS modulation types

This field indicates the optional modulation (and FEC) types supported by an SS for uplink transmission. Note that QPSK, 16-QAM, and 64-QAM shall be supported, as is the Concatenated FEC without block interleaving and no-FEC QPSK. A bit value of 0 indicates “not supported” while 1 indicates “supported.”

Type	Length	Value	Scope
156	1	Bit #0: 256-QAM Bit #1: BTC Bit #2: CTC Bit #3: no FEC and QAM Bit #4: STC support, dual blocks without UWs Bit #5: STC support, dual blocks with UWs Bits #6,7: <i>Reserved</i> , shall be set to 0.	SBC-REQ (see 6.3.2.3.23) SBC-RSP (see 6.3.2.3.24)

11.8.3.5.7 SCa SS modulator roll-off factor

This field indicates the optional roll-off factors supported by an SS for uplink transmission. Note that support of a roll-factor of 0.25 is mandatory. A bit value of 0 indicates “not supported” while 1 indicates “supported.”

Type	Length	Value	Scope
157	1	Bit #0: 0.15 Bit #1: 0.18 Bits #2–7: <i>Reserved</i> ; shall be set to 0.	SBC-REQ (see 6.3.2.3.23) SBC-RSP (see 6.3.2.3.24)

11.8.3.5.8 SCa SS modulator unique word length

This field indicates the optional Unique Word lengths, in symbols, supported by an SS for uplink transmission. Note that support of the 64-symbol Unique Word is mandatory. A bit value of 0 indicates “not supported” while 1 indicates “supported.”

Type	Length	Value	Scope
158	1	Bit #0: 256 Bits #1–7: <i>Reserved</i> ; shall be set to 0.	SBC-REQ (see 6.3.2.3.23) SBC-RSP (see 6.3.2.3.24)

11.8.3.5.9 SCa SS modulator block interleaver depth

This field indicates the interleaver depth (number of rows) supported by an SS for uplink transmission. The value of 0 (interleaver depth 10 rows) shall be supported.

Type	Length	Value	Scope
159	1	0: interleaver depth of 10 rows 1–54: 11–64 rows 55–255: <i>Reserved</i>	SBC-REQ (see 6.3.2.3.23) SBC-RSP (see 6.3.2.3.24)

11.8.3.5.10 SCa SS modulator STC block size

This field indicates the STC block size (block = 1/2 length of a “STC pair”) supported by an SS for uplink transmission. A bit value of 0 indicates “not supported” while 1 indicates “supported.”

Type	Length	Value	Scope
161	1	Bit #0: 64 Bit #1: 128 Bit #2: 256 Bit #3: 512 Bit #4: 1024 Bit #5: 2048 Bit #6: 4096 Bit #7: <i>Reserved</i> , shall be set to 0	SBC-REQ (see 6.3.2.3.23) SBC-RSP (see 6.3.2.3.24)

11.8.3.5.11 SCa SS modulator maximum uplink channel width

This field indicates the maximum uplink channel width over which an SS can transmit.

Type	Length	Value	Scope
162	2	Bits #0–15: Channel Width, in 10 kHz increments.	SBC-REQ (see 6.3.2.3.23) SBC-RSP (see 6.3.2.3.24)

11.8.3.5.12 SCa SS modulator minimum uplink channel width

This field indicates the minimum uplink channel width over which an SS can transmit.

Type	Length	Value	Scope
163	2	Bits #0–15: Channel Width, in 10 kHz increments.	SBC-REQ (see 6.3.2.3.23) SBC-RSP (see 6.3.2.3.24)

11.8.3.5.13 SCa SS modulator power control limits

This field indicates the maximum transmit power, power control range, and power control granularity that an SS can deliver to the transmit antenna over the given uplink channel.

Type	Length	Value	Scope
164	3	Bits #0–5: Maximum output power in dBm, from 0 to 63 Bits #6–12: Power control range, in dB, from 0 to 127 Bits #13–17: Power control granularity in 0.25 dB increments, from 0.25 to 8 dB. Bits #18–23: <i>Reserved</i> ; shall be set to zero	SBC-REQ (see 6.3.2.3.23) SBC-RSP (see 6.3.2.3.24)

11.8.3.5.14 SCa SS modulator Subchannel framing support

This field indicates the lengths of a Repeat Segment in a subchannel burst set supported by an SS for uplink transmission. A bit value of 0 indicates “not supported” while 1 indicates “supported.”

Type	Length	Value	Scope
165	1	Bit #0: r = 256 Bit #1: r = 512 Bit #2: r = 1024 Bit #3: r = 2048 Bit #4: r = 4096 Bit #5: r = 8096 Bits #6–7: <i>Reserved</i> ; shall be set to 0	SBC-REQ (see 6.3.2.3.23) SBC-RSP (see 6.3.2.3.24)

11.8.3.5.15 SCa maximum transmit power

This parameter indicates the maximum available power for BPSK, QPSK, 16-QAM, 64-QAM, and 256-QAM constellations. The maximum power parameters are reported in dBm and quantized in 0.5 dBm steps ranging from –64 dBm (encoded 0x00) to 63.5 dBm (encoded 0xFF). Values outside this range shall be assigned the closest extreme. SSs that do not support 256-QAM shall report the value of 0x00 in the maximum 256-QAM power field.

Type	Length	Value	Scope
166	5	Byte 0: Transmit power backoff for BPSK Byte 1: Transmit power backoff for QPSK Byte 2: Transmit power backoff for 16-QAM Byte 3: Transmit power backoff for 64-QAM Byte 4: Transmit power backoff for 256-QAM. SSs that do not support 256-QAM shall report the value 0x00.	SBC-REQ (see 6.3.2.3.23)

11.8.3.6 WirelessMAN-OFDM specific parameters

11.8.3.6.1 OFDM SS FFT sizes

This field indicates the FFT sizes supported by the SS. For each FFT size, a bit value of 0 indicates “not supported” while 1 indicates “supported.”

Type	Length	Value	Scope
150	1	Bit #0: FFT-256 Bit #1: FFT-2048 Bits #2–7: <i>Reserved</i> , shall be set to zero	SBC-REQ (see 6.3.2.3.23) SBC-RSP (see 6.3.2.3.24)

11.8.3.6.2 OFDM SS demodulator

This field indicates the different demodulator options supported by a WirelessMAN-OFDM PHY SS for downlink reception. This field is not used for other PHY specifications. A bit value of 0 indicates “not supported” while 1 indicates “supported.”

Type	Length	Value	Scope
151	1	Bit #0: 64-QAM Bit #1: BTC Bit #2: CTC Bit #3: STC Bit #4: AAS Bits #5–7: <i>Reserved</i> ; shall be set to zero	SBC-REQ (see 6.3.2.3.23) SBC-RSP (see 6.3.2.3.24)

11.8.3.6.3 OFDM SS modulator

This field indicates the different modulator options supported by a WirelessMAN-OFDM PHY SS for uplink transmission. This field is not used for other PHY specifications. A bit value of 0 indicates “not supported” while 1 indicates “supported.”

Type	Length	Value	Scope
152	1	Bit# 0: 64-QAM Bit# 1: BTC Bit# 2: CTC Bit# 3: Subchannelization Bit# 4: Focused contention BW request Bits# 5–7: <i>reserved</i> . Set to 0	SBC-REQ (see 6.3.2.3.23) SBC-RSP (see 6.3.2.3.24)

11.8.3.6.4 OFDM SS focused contention support

This field indicates whether the SS supports Focused Contention (see 8.3.7.3.3). A bit value of 0 indicates “not supported” while 1 indicates “supported”.

Type	Length	Value	Scope
153	1	Bit #0: Focused Contention Support Bits #1–7: <i>Reserved</i> , shall be set to zero	SBC-REQ (see 6.3.2.3.23) SBC-RSP (see 6.3.2.3.24)

11.8.3.6.5 OFDM SS TC sublayer support

This field indicates whether or not the SS supports the TC sublayer (see 8.3.4). A bit value of 0 indicates “not supported” while 1 indicates “supported.”

Type	Length	Value	Scope
154	1	Bit #0: TC sublayer support; default value = 0 Bits #1–7: <i>Reserved</i> , shall be set to zero	SBC-REQ (see 6.3.2.3.23) SBC-RSP (see 6.3.2.3.24)

11.8.3.7 WirelessMAN-OFDMA specific parameters

11.8.3.7.1 OFDMA SS FFT sizes

This field indicates the FFT sizes supported by the SS. For each FFT size, a bit value of 0 indicates “not supported” while 1 indicates “supported.”

Type	Length	Value	Scope
150	1	Bit #0: FFT-256 Bit #1: FFT-2048 Bits #2–7: <i>Reserved</i> , shall be set to zero	SBC-REQ (see 6.3.2.3.23) SBC-RSP (see 6.3.2.3.24)

11.8.3.7.2 OFDMA SS demodulator

This field indicates the different demodulator options supported by a WirelessMAN-OFDMA PHY SS for downlink reception. This field is not used for other PHY specifications. A bit value of 0 indicates “not supported” while 1 indicates “supported.”

Type	Length	Value	Scope
151	1	Bit #0: 64-QAM Bit #1: BTC Bit #2: CTC Bit #3: STC Bit #4: AAS Diversity Map Scan Bit #5: AAS Direct Signaling Bit #6: H-ARQ Bit #7: <i>Reserved</i> ; shall be set to zero	SBC-REQ (see 6.3.2.3.23) SBC-RSP (see 6.3.2.3.24)

11.8.3.7.3 OFDMA SS modulator

This field indicates the different modulator options supported by a WirelessMAN-OFDMA PHY SS for uplink transmission. This field is not used for other PHY specifications. A bit value of 0 indicates “not supported” while 1 indicates “supported.”

Type	Length	Value	Scope
152	1	Bit# 0: 64-QAM Bit# 1: BTC Bit# 2: CTC Bit# 3: AAS Diversity Map Scan Bit# 4: AAS Direct Signaling Bit# 5: H-ARQ Bits# 6–7: <i>Reserved</i> ; shall be set to zero	SBC-REQ (see 6.3.2.3.23) SBC-RSP (see 6.3.2.3.24)
153	1	The number of HARQ ACK Channel	SBC-REQ (see 6.3.2.3.23) SBC-RSP (see 6.3.2.3.24)

11.8.3.7.5 OFDMA SS Permutation support

This field indicates the different optional OFDMA permutation modes (optional PUSC, optional FUSC and AMC) supported by a WirelessMAN-OFDMA SS. A bit value of 0 indicates “not supported” while 1 indicates “supported.”

Type	Length	Value	Scope
154	1	Bit# 0: Optional PUSC support Bit# 1: Optional FUSC support Bit# 2: AMC support Bits# 3–7: <i>Reserved</i> , shall be set to zero	SBC-REQ (see 6.3.2.3.23) SBC-RSP (see 6.3.2.3.24)

11.9 PKM-REQ/RSP management message encodings

A summary of the TLV encoding format is shown below. The fields are transmitted from left to right.

Type	Length	Value
1 byte	<i>variable</i>	Length bytes

Type: The Type field is one byte. Values of the PKM Type field are specified in Table 370. Note that Type values between 0 and 127 are defined within the PKM Specification, while values between 128 and 255 are vendor-assigned Attribute Types.

- A PKM server shall ignore attributes with an unknown type.
- A PKM client shall ignore attributes with an unknown type.
- PKM client and server (i.e., SS and BS) may log receipt of unknown attribute types.

Length: The Length field indicates the length of this attribute's Value field, in bytes. The length field *does not include* the Type and Length fields.

Value: The Value field is zero or more bytes and contains information specific to the attribute. The format and length of the Value field is determined by the Type and Length fields.

- The format of the value field is one of the five data types shown in Table 371.

Table 370—PKM attribute types

Type	PKM attribute
0–5	<i>reserved</i>
6	Display-String
7	AUTH-Key
8	TEK
9	Key-Lifetime
10	Key-Sequence-Number
11	HMAC-Digest
12	SAID
13	TEK-Parameters
14	<i>reserved</i>
15	CBC-IV
16	Error-Code
17	CA-Certificate
18	SS-Certificate
19	Security-Capabilities
20	Cryptographic-Suite
21	Cryptographic-Suite-List
22	Version
23	SA-Descriptor
24	SA-Type
25	<i>reserved</i>
26	<i>reserved</i>
27	PKM Configuration Settings
28–255	<i>reserved</i>

Table 371—Attribute value data types

Data type	Structure
string	0 – n bytes
uint8	8-bit unsigned integer
uint16	16-bit unsigned integer
uint32	32-bit unsigned integer
compound	collection of attributes

11.9.1 Display string

Description: This attribute contains a textual message. It is typically used to explain a failure response and might be logged by the receiver for later retrieval by an SNMP manager. Display strings shall be no longer than 128 bytes. A summary of the Display-String attribute format is shown below. The fields are transmitted from left to right.

Type	Length	Value (string)
6	> 0 and \leq 128	A string of characters. The character string shall be null-terminated.

11.9.2 AUTH-Key

Description: The AK (AUTH-Key) is a 20 byte quantity, from which a KEK, and two message authentication keys (one for uplink requests, and a second for downlink replies) are derived. This attribute contains a 128 byte quantity containing the AK RSA-encrypted with the SS's 1024 bit RSA public key. Details of the RSA encryption procedure are given in 7.5. The ciphertext produced by the RSA algorithm shall be the length of the RSA modulus, i.e., 128 bytes.

Type	Length	Value (string)
7	128	128 byte quantity representing an RSA-encrypted AK.

11.9.3 TEK

Description: This attribute contains a quantity that is a TEK key, encrypted with a KEK derived from the AK.

Type	Length	Value (string)
8	8	Encrypted TEK.

11.9.4 Key lifetime

Description: This attribute contains the lifetime, in seconds, of an AK or a TEK. It is a 32-bit unsigned quantity representing the number of remaining seconds for which the associated key shall be valid. Note that this attribute can be used as top level attribute (AK) as well as a subattribute (TEK).

Type	Length	Value (uint32)
9	4	32-bit quantity representing key lifetime A key lifetime of zero indicates that the corresponding AK or TEK is not valid.

11.9.5 Key-Sequence-Number

Description: This attribute contains sequence number for a TEK or AK. The 2-bit or 4-bit quantity, however, is stored in a single byte, with the high-order 6 or 4 bits set to 0. A summary of the Key-Sequence-Number attribute format is shown below. Note that this attribute can be used as top level attribute (AK) as well as a subattribute (TEK).

Type	Length	Value (uint8)
10	1	2-bit sequence number (TEK) 4-bit sequence number (AK)

11.9.6 HMAC-Digest

Description: This attribute contains a keyed hash used for message authentication. The HMAC algorithm is defined in IETF RFC 2104.

Type	Length	Value (string)
11	20 bytes	A 160-bit (20 byte) keyed SHA hash

11.9.7 SAID

Description: This attribute contains a 16-bit SAID used by the Privacy Protocol to identify the SA.

Type	Length	Value (uint16)
12	2	16-bit quantity representing an SAID

11.9.8 TEK parameters

Description: This attribute is a compound attribute, consisting of a collection of subattributes. These subattributes represent all security parameters relevant to a particular generation of an SAID's TEK. A summary of the TEK-Parameters attribute format is shown below.

Type	Length	Value (compound)
13	variable	The Compound field contains the subattributes as defined in Table 372

Table 372—TEK-parameters subattributes

Attribute	Contents
TEK	TEK, encrypted with the KEK
Key-Lifetime	TEK Remaining Lifetime
Key-Sequence-Number	TEK Sequence Number
CBC-IV	CBC Initialization Vector

11.9.9 CBC-IV

Description: This attribute contains a value specifying a CBC Initialization Vector (CBC-IV). A summary of the CBC-IV attribute format is shown below. The fields are transmitted from left to right.

Type	Length	Value (string)
15	Equal to Block length of cipher	CBC-IV

11.9.10 Error code

Description: This attribute contains a 1-byte error code providing further information about an Authorization Reject, Key Reject, Authorization Invalid, or TEK Invalid. A summary of the Error-Code attribute format is shown below. Table 373 lists code values for use with this attribute. The BS may employ the nonzero error codes (1–6) listed below; it may, however, return a code value of zero (0). Error code values other than those defined in Table 373 shall be ignored. Returning a code value of zero sends no additional failure information to the SS; for security reasons, this may be desirable.

Type	Length	Value (uint8)	Scope
16	1	Error-Code	Authorization Reject, Authorization Invalid, Key Reject, TEK Invalid

Table 373—Error-code attribute code values

Error Code	Messages	Description
0	All	No information
1	Auth Reject, Auth Invalid	Unauthorized SS
2	Auth Reject, Key Reject	Unauthorized SAID
3	Auth Invalid	Unsolicited
4	Auth Invalid, TEK Invalid	Invalid Key Sequence Number
5	Auth Invalid	Message (Key Request) authentication failure
6	Auth Reject	Permanent Authorization Failure

Error Code 6 (Permanent Authorization Failure) is used to indicate a number of different error conditions affecting the PKM authorization exchange. These include:

- a) An unknown manufacturer; i.e., the BS does not have the CA certificate belonging to the issuer of an SS certificate
- b) SS certificate has an invalid signature
- c) ASN.1 parsing failure during verification of SS certificate
- d) SS certificate is on the “hot list”
- e) Inconsistencies between certificate data and data in accompanying PKM attributes
- f) SS and BS have incompatible security capabilities

The common property of these error conditions is that the failure condition is considered permanent; any reattempts at authorization would continue to result in Authorization Rejects. Details about the cause of a Permanent Authorization Failure may be reported to the SS in an optional Display-String attribute that may accompany the Error-Code attribute in Authorization Reject messages. Note that providing this additional detail to the SS should be administratively controlled within the BS. The BS may log these Authorization failures, or even trap them to an SNMP manager.

11.9.11 CA certificate

Description: This attribute is a string attribute containing an X.509 CA Certificate, as defined in 7.6. A summary of the CA-Certificate attribute format is shown below. The fields are transmitted from left to right.

Type	Length	Value (string)
17	Variable. Length shall not cause resulting MAC management message to exceed the maximum allowed size.	X.509 CA Certificate (DER-encoded ASN.1)

11.9.12 SS certificate

Description: This attribute is a string attribute containing an SS's X.509 User Certificate, as defined in 7.6. A summary of the SS-Certificate attribute format is shown below. The fields are transmitted from left to right.

Type	Length	Value (string)
18	<i>variable.</i> Length shall not cause resulting MAC management message to exceed the maximum allowed size.	X.509 SS Certificate (DER-encoded ASN.1)

11.9.13 Security capabilities

Description: The Security-Capabilities attribute is a compound attribute whose subattributes identify the version of PKM an SS supports and the cryptographic suite(s) an SS supports.

Type	Length	Value (compound)
19	<i>variable</i>	The Compound field contains the subattributes as defined in Table 374

Table 374—Security-capabilities subattributes

Attribute	Contents
Cryptographic-Suite-List	List of supported cryptographic suites
Version	Version of Privacy supported

11.9.14 Cryptographic suite

Table 375—Data encryption algorithm identifiers

Value	Description
0	No data encryption
1	CBC-Mode, 56-bit DES
2	AES, CCM mode
3–255	<i>reserved</i>

Table 376—Data authentication algorithm identifiers

Value	Description
0	No data authentication
1–255	<i>reserved</i>

Table 377—TEK encryption algorithm identifiers

Value	Description
0	<i>reserved</i>
1	3-DES EDE with 128-bit key
2	RSA with 1024-bit key
3	AES with 128-bit key
4–255	<i>reserved</i>

Type	Length	Value (uint8,uint8,uint8)
20	3	A 24-bit integer identifying the cryptographic suite properties. The most significant byte, as defined in Table 375, indicates the encryption algorithm and key length. The middle byte, as defined in Table 376 indicates the data authentication algorithm. The least significant byte, as defined in Table 377, indicates the TEK Encryption Algorithm.

The allowed cryptographic suites are itemized in Table 378.

Table 378—Allowed cryptographic suites

Value	Description
0x000001	No data encryption, no data authentication and 3-DES, 128
0x010001	CBC-Mode 56-bit DES, no data authentication and 3-DES, 128
0x000002	No data encryption, no data authentication and RSA, 1024
0x010002	CBC-Mode 56-bit DES, no data authentication and RSA, 1024
0x020003	CCM-mode AES, no data authentication and AES, 128
all remaining values	<i>reserved</i>

11.9.15 Cryptographic-Suite-List

This parameter contains a list of supported cryptographic suites.

Type	Length	Value (compound)
21	5*n, where n equals number of cryptographic suites listed	A list of cryptographic suites

11.9.16 Version

Table 379—Version attribute values

Value	Description
0	<i>reserved</i>
1	PKM (Initial standard release)
2–255	<i>reserved</i>

Type	Length	Value (uint8)
22	1	A 1-byte code identifying a version of PKM security as defined in Table 379.

11.9.17 SA-Descriptor

Description: The SA-Descriptor attribute is a compound attribute whose subattributes describe the properties of a Security Association (SA). These properties include the SAID, the SA type, and the cryptographic suite employed within the SA.

Table 380—SA-Descriptor subattributes

Attribute	Contents
SAID	Security Association ID
SA-Type	Type of SA
Cryptographic-Suite	Cryptographic suite employed within the SA

Type	Length	Value (compound)
23	<i>variable</i>	The Compound field contains the subattributes shown in Table 380.

11.9.18 SA type

Description: This attribute identifies the type of SA. Privacy defines three SA types: Primary, Static, Dynamic.

Type	Length	Value (uint8)
24	1	A 1 byte code identifying the value of SA-type as defined in Table 381.

Table 381—SA-type attribute values

Value	Description
0	Primary
1	Static
2	Dynamic
3–127	<i>reserved</i>
128–255	Vendor-specific

11.9.19 PKM configuration settings

This field defines the parameters associated with PKM operation. It is composed of a number of encapsulated TLV fields.

Type	Length	Value (compound)	Scope
27	<i>variable</i>		Auth Reply

11.9.19.1 Authorize wait timeout

The value of the field specifies retransmission interval, in seconds, of Authorization Request messages from the Authorize Wait state.

Type	Length	Value
27.1	4	Authorize Wait Timeout in seconds

11.9.19.2 Reauthorize wait timeout

The value of the field specifies retransmission interval, in seconds, of Authorization Request messages from Reauthorize Wait state.

Type	Length	Value
27.2	4	Reauthorize Wait Timeout in seconds

11.9.19.3 Authorization grace time

The value of this field specifies the grace period for reauthorization, in seconds.

Type	Length	Value
27.3	4	Authorization Grace Time in seconds

11.9.19.4 Operational wait timeout

The value of this field specifies the retransmission interval, in seconds, of Key Requests from the Operational Wait state.

Type	Length	Value
27.4	4	Operational Wait Timeout in seconds

11.9.19.5 Rekey wait timeout

The value of this field specifies the retransmission interval, in seconds, of Key Requests from the Rekey Wait state.

Type	Length	Value
27.5	4	Rekey Wait Timeout in seconds

11.9.19.6 TEK grace time

The value of this field specifies grace period, in seconds, for rekeying the TEK.

Type	Length	Value
27.6	4	TEK Grace time in seconds

11.9.19.7 Authorize reject wait timeout

The value of this field specifies how long (in seconds) an SS waits in the Authorize Reject Wait state after receiving an Authorization Reject.

Type	Length	Value
27.7	4	Authorize Reject Wait Timeout in seconds

11.10 MCA-REQ management message encodings

The type values used shall be those defined in Table 382.

Table 382—Multicast assignment request message encodings

Name	Type (1 byte)	Length	Value (variable-length)
Multicast CID	1	2	
Assignment	2	1	0x00 = Leave multicast group 0x01 = Join multicast group
Multicast group type	3	1	0 = regular (not AAS), default 1 = AAS
Periodic allocation parameters	4	4	Byte #0 (LS byte) = m Byte #1 = k Byte #2 = n Byte #3 = <i>Reserved</i> ; shall be set to zero

Table 382—Multicast assignment request message encodings

Name	Type (1 byte)	Length	Value (variable-length)
Periodic allocation type	5	1	0 = REQ region Full 1 = REQ region Focused Applicable for OFDM PHY only.
Operation	6	1	0 = allocate 1 = deallocate
<i>reserved</i>	7–255		Reserved for future use

Parameters m , k have the following meaning: multicast group gets a multicast polling allocation at the end of the frame # N if $N \bmod k = m$; size of the allocation is n .

11.11 REP-REQ management message encodings

Name	Type	Length	Value
Report request	1	<i>variable</i>	Compound

The Report Command consists of the following parameters:

Name	Type	Length	Value
Report type	1.1	1	Bit #0 = 1 Include DFS Basic report Bit #1 = 1 Include CINR report Bit #2 = 1 Include RSSI report Bit #3–6 α_{avg} \ in multiples of 1/32 (range [1/32, 16/32]) Bit #7 = 1 Include current transmit power report
Channel number	1.2	1	Physical channel number (see 8.5.1) to be reported on. (license-exempt bands only)
Channel Type request	1.3	1	00 = Normal subchannel, 01 = Band AMC Channel, 10 = Safety Channel, 11 = <i>Reserved</i>

11.12 REP-RSP management message encodings

Name	Type	Length	Value
Report	1	<i>variable</i>	Compound
Channel Type Report in WirelessMAN OFDMA PHY	2	<i>variable</i>	Compound
Current transmitted power	147	1	See 8.3.7.4 and 11.1.1

The report consists of the following parameters (see also 8.2.2, 8.3.9, or 8.4.11 for details).

REP-REQ Report type	Name	Type	Length	Value
bit #0 = 1	Channel number	1.1	1	Physical channel number (see 8.5.1) to be reported on
bit #0 = 1	Start frame	1.2	2	Frame number in which measurement for this channel started
bit #0 = 1	Duration	1.3	3	Cumulative measurement duration on the channel in multiples of T_s . For any value exceeding 0xFFFFFFFF, report 0xFFFFFFFF
bit #0 = 1	Basic report	1.4	1	Bit #0: WirelessHUMAN detected on the channel Bit #1: Unknown transmissions detected on the channel Bit #2: Primary User detected on the channel Bit #3: Unmeasured. Channel not measured
bit #1 = 1	CINR report	1.5	2	1 byte: mean (see also 8.2.2, 8.3.9, 8.4.11) for details 1 byte: standard deviation
bit #2 = 1	RSSI report	1.6	2	1 byte: mean (see also 8.2.2, 8.3.9, 8.4.11) for details 1 byte: standard deviation

REP-REQ Channel Type request	Name	Type	Length	Value
Channel Type = 00	Normal sub-channel Report	2.1	1	First 5 bits for the CINR measurement report and the rest for don't care
Channel Type = 01	Band AMC Report	2.2	4	First 12 bits for the band indicating bitmap and Next 25 bits for CINR reports (5 bits per each band)
Channel Type = 10	Safety Channel Report	2.3	5	The first 20 bits for the reported bin indices and the next 20 bits for CINR reports (5 bits for each bin)

11.13 Service Flow management encodings

The following fields define the parameters associated with uplink/downlink scheduling for a service flow. It is somewhat complex in that it is composed from a number of encapsulated TLV fields.

Note that the encapsulated uplink and downlink flow classification configuration setting strings share the same subtype field numbering plan, because many of the subtype fields defined are valid for both types of configuration settings except service flow encodings.

Uplink encodings use the type 145. Downlink encodings use the type 146. Entries of the form [145/146] indicate the encoding can be applied to either an uplink or downlink service flow.

Table 383—Service flow encodings

Type	Parameter
1	Service Flow Identifier
2	CID
3	Service Class Name
4	<i>reserved</i>
5	QoS Parameter Set Type
6	Traffic Priority
7	Maximum Sustained Traffic Rate
8	Maximum Traffic Burst
9	Minimum Reserved Traffic Rate
10	Minimum Tolerable Traffic Rate
11	Service Flow Scheduling Type
12	Request/Transmission Policy
13	Tolerated Jitter
14	Maximum Latency
15	Fixed-length versus Variable-length SDU Indicator
16	SDU Size
17	Target SAID
18	ARQ Enable
19	ARQ_WINDOW_SIZE
20	ARQ_RETRY_TIMEOUT - Transmitter Delay
21	ARQ_RETRY_TIMEOUT - Receiver Delay
22	ARQ_BLOCK_LIFETIME
23	ARQ_SYNC_LOSS
24	ARQ_DELIVER_IN_ORDER
25	ARQ_PURGE_TIMEOUT
26	ARQ_BLOCK_SIZE
27	<i>reserved</i>
28	CS Specification
143	Vendor-specific QoS Parameter
99–107	Convergence Sublayer Types

The CC indicates the status for the dynamic service (DSx-xxx) messages. The value may appear in the Confirmation Code field of a DSx message or as the value of a TLV-encoded error parameter.

The CC values are specified in Table 384.

Table 384—CC values

CC	Status
0	OK/success
1	reject-other
2	reject-unrecognized-configuration-setting
3	reject-temporary / reject-resource
4	reject-permanent / reject-admin
5	reject-not-owner
6	reject-service-flow-not-found
7	reject-service-flow-exists
8	reject-required-parameter-not-present
9	reject-header-suppression
10	reject-unknown-transaction-id
11	reject-authentication-failure
12	reject-add-aborted
13	reject-exceeded-dynamic-service-limit
14	reject-not-authorized-for-the-requested-SAID
15	reject-fail-to-establish-the-requested-SA
16	reject-not-supported-parameter
17	reject-not-supported-parameter-value

In the case CC = “reject-not-supported-parameter” or CC = “reject-not-supported-parameter-value”, the corresponding TLV(s) may be returned to caller in DSx-RSP message. In the case of CC = “reject-not-supported-parameter-value,” the value field of the returned TLV should contain the closest value that is supported.

11.13.1 SFID

The SFID is used by the BS as the primary reference of a service flow. Only the BS may issue a SFID. It uses this parameterization to issue SFIDs in BS-initiated DSA-REQ/DSC-REQ messages and in its DSA-RSP/DSC-RSP to SS-initiated DSA-REQ/DSC-REQ messages. The SS specifies the SFID of a service flow using this parameter in a DSC-REQ message.

Type	Length	Value	Scope
[145/146].1	4	1–4 294 967 295	DSx-REQ DSx-RSP DSx-ACK

11.13.2 CID

The value of this field specifies the CID assigned by the BS to a service flow with a non-null AdmittedQoSParamSet or ActiveQoSParamSet. The 16-bit value of this field is used in bandwidth requests and in MAC PDU headers. This field shall be present in a BS-initiated DSA-REQ or DSC-REQ message related to establishing an admitted or active service flow. This field shall also be present in DSA-RSP and DSC-RSP messages related to the successful establishment of an admitted or active service flow.

Even though a service flow has been successfully admitted or activated (i.e., has an assigned CID) the SFID shall be used for subsequent DSx message signalling as it is the primary handle for a service flow. If a service flow is no longer admitted or active (via DSC-REQ), its CID may be reassigned by the BS.

Type	Length	Value	Scope
[145/146].2	2	CID	DSx-REQ DSx-RSP DSx-ACK

11.13.3 Service Class Name

The value of this field refers to a predefined BS service configuration to be used for this service flow.

Type	Length	Value	Scope
[145/146].3	2 to 128	Null-terminated string of ASCII characters. The length of the string, including null-terminator may not exceed 128 bytes	DSx-REQ DSx-RSP DSx-ACK

When the Service Class Name is used in a service flow encoding, it indicates that all the unspecified QoS parameters of the service flow need to be provided by the BS. It is up to the operator to synchronize the definition of Service Class Names in the BS.

11.13.4 QoS parameter set type

This parameter shall appear within every service flow encoding. It specifies the proper application of the QoS Parameter Set: to the Provisioned set, the Admitted set, and/or the Active set. When two QoS Parameter Sets are the same, a multibit value of this parameter may be used to apply the QoS parameters to more than one set. A single message may contain multiple QoS parameter sets in separate type 145/146 service flow encodings for the same service flow. This allows specification of the QoS Parameter Sets when their parameters are different. Bit 0 is the LSB of the Value field.

For every service flow that is preprovisioned and for every provisioned service flow added after SS initialization, there shall be a service flow encoding that specifies a ProvisionedQoSParamSet. This service flow encoding, or other service flow encoding(s), may also specify an Admitted and/or Active set.

Type	Length	Value	Scope
[145/146].5	1	Bit 0: Provisioned Set Bit 1: Admitted Set Bit 2: Active Set Bits 3–7: <i>Reserved</i>	DSx-REQ DSx-RSP DSx-ACK

A BS shall handle a single update to each of the Active and Admitted QoS parameter sets. The ability to process multiple service flow encodings that specify the same QoS parameter set is not required and is left as a vendor-specific function. If a DSA/DSC contains multiple updates to a single QoS parameter set and the vendor does not support such updates, then the BS shall reply with CC 2 (reject-unrecognized-configuration-setting).

Table 385 lists values used in Dynamic Service messages.

Table 385—Values used in Dynamic Service messages

Value	Messages
001	Apply to Provisioned set only
011	Apply to Provisioned and Admitted set, and perform admission control
101	Apply to Provisioned and Active sets, perform admission control, and activate this service flow
111	Apply to Provisioned, Admitted, and Active sets; perform admission control; and activate this service flow
000	Set Active and Admitted sets to Null
010	Perform admission control and apply to Admitted set
100	Check against Admitted set in separate service flow encoding, perform admission control if needed, activate this service flow, and apply to Active set
110	Perform admission control and activate this service flow, apply parameters to both Admitted and Active sets

11.13.5 Traffic priority

The value of this parameter specifies the priority assigned to a service flow. Given two service flows identical in all QoS parameters besides priority, the higher priority service flow should be given lower delay and higher buffering preference. For otherwise nonidentical service flows, the priority parameter should not take precedence over any conflicting service flow QoS parameter. The specific algorithm for enforcing this parameter is not mandated here.

For uplink service flows, the BS shall use this parameter when determining precedence in request service and grant generation, and the SS shall preferentially select contention Request opportunities for Priority Request CIDs based on this priority and its Request/Transmission Policy (see 11.13.12).

Type	Length	Value	Scope
[145/146].6	1	0 to 7—Higher numbers indicate higher priority Default 0	DSx-REQ DSx-RSP DSx-ACK

11.13.6 Maximum sustained traffic rate

This parameter defines the peak information rate of the service. The rate is expressed in bits per second and pertains to the SDUs at the input to the system. Explicitly, this parameter does not include MAC overhead such as MAC headers or CRCs. This parameter does not limit the instantaneous rate of the service since this is governed by the physical attributes of the ingress port. However, at the SS in the uplink direction, the service shall be policed to conform to this parameter, on the average, over time. At the BS in the downlink direction, it may be assumed that the service was already policed at the ingress to the network and the BS is not required to do additional policing. If this parameter is omitted or set to zero, then there is no explicitly mandated maximum rate. This field specifies only a bound, not a guarantee that the rate is available. The algorithm for policing to this parameter is left to vendor differentiation and is outside the scope of the standard.

Type	Length	Value	Scope
[145/146].7	4	Rate (in bits per second)	DSx-REQ DSx-RSP DSx-ACK

11.13.7 Maximum traffic burst

This parameter defines the maximum burst size that shall be accommodated for the service. Since the physical speed of ingress/egress ports, the air interface, and the backhaul will, in general, be greater than the maximum sustained traffic rate parameter for a service, this parameter describes the maximum continuous burst the system should accommodate for the service, assuming the service is not currently using any of its available resources

Type	Length	Value	Scope
[145/146].8	4	Burst size (bytes)	DSx-REQ DSx-RSP DSx-ACK

11.13.8 Minimum reserved traffic rate

This parameter specifies the minimum rate reserved for this service flow. The rate is expressed in bits per second and specifies the minimum amount of data to be transported on behalf of the service flow when averaged over time. The specified rate shall only be honored when sufficient data is available for scheduling. When insufficient data exists, the requirement imposed by this parameter shall be satisfied by assuring that the available data is transmitted as soon as possible.

The BS shall be able to satisfy bandwidth requests for a service flow up to its Minimum Reserved Traffic Rate. If less bandwidth than its Minimum Reserved Traffic Rate is requested for a service flow, the BS may reallocate the excess reserved bandwidth for other purposes. The aggregate Minimum Reserved Traffic Rate of all service flows may exceed the amount of available bandwidth. The value of this parameter is calculated from the byte following the MAC header HCS to the end of the MAC PDU payload. If this parameter is omitted, then it defaults to a value of 0 bits per second (i.e., no bandwidth is reserved for the flow).

Type	Length	Value	Scope
[145/146].9	4	Rate (in bits per second)	DSx-REQ DSx-RSP DSx-ACK

11.13.9 Minimum tolerable traffic rate

Minimum Tolerable Traffic Rate = R (bits/s) with time base T (sec) means the following. Let S denote additional demand accumulated at the MAC SAP of the transmitter during an arbitrary time interval of the length T . Then the amount of data forwarded at the receiver to CS (in bits) during this interval should be not less than minimum $\{S, R * T\}$.

In the case of downlink connections, Minimum Tolerable Traffic Rate may be monitored by the BS to make decisions on rate change or deletion of the connection in the case of high SDU loss rate.

Type	Length	Value	Scope
[145/146].10	4	Rate (in bits per second)	DSx-REQ DSx-RSP DSx-ACK

11.13.10 Vendor-specific QoS parameters

This allows vendors to encode vendor-specific QoS parameters. The Vendor ID shall be the first TLV embedded inside vendor-specific QoS parameters. If the first TLV inside vendor-specific QoS parameters is not a Vendor ID, then the TLV shall be discarded (see 11.1.6).

Type	Length	Value	Scope
[145/146].143	<i>variable</i>	Compound	DSx-REQ DSx-RSP DSx-ACK

11.13.11 Service flow scheduling type

The value of this parameter specifies the scheduling service that shall be enabled for the associated service flow. If the parameter is omitted, BE service is assumed.

Type	Length	Value	Scope
[145/146].11	1	0: <i>Reserved</i> 1: for Undefined (BS implementation-dependent ^a) 2: for BE (default) 3: for nrtPS 4: for rtPS 5: <i>Reserved</i> 6: for UGS 7–255: <i>Reserved</i>	DSA-REQ DSA-RSP DSA-ACK

^aThe specific implementation-dependent scheduling service type could be defined in a message of Type 145/146.143 (vendor-specific QoS parameters).

11.13.12 Request/transmission policy

The value of this parameter provides the capability to specify certain attributes for the associated service flow. These attributes include options for PDU formation and, for uplink service flows, restrictions on the types of bandwidth request options that may be used. An attribute is enabled by setting the corresponding bit position to 1. For attributes affecting uplink bandwidth request types, a value of zero indicates the default actions described in the scheduling service description in 6.3.5 shall be used. A value of one indicates that the action associated with the attribute bit overrides the default action.

Type	Length	Value	Scope
[145/146].12	4	Bit #0 – Service flow shall not use broadcast bandwidth request opportunities. (Uplink only) Bit #1 – <i>Reserved</i> ; shall be set to zero Bit #2 – The service flow shall not piggyback requests with data. (Uplink only) Bit #3 – The service flow shall not fragment data. Bit #4 – The service flow shall not suppress payload headers (CS parameter) Bit #5 – The service flow shall not pack multiple SDUs (or fragments) into single MAC PDUs. Bit #6 – The service flow shall not include CRC in the MAC PDU. Bit #7 – <i>Reserved</i> ; shall be set to zero	DSA-REQ DSA-RSP DSA-ACK

11.13.13 Tolerated jitter

This parameter defines the maximum delay variation (jitter) for the connection.

Type	Length	Value	Scope
[145/146].13	4	ms	DSx-REQ DSx-RSP DSx-ACK

11.13.14 Maximum latency

The value of this parameter specifies the maximum latency between the reception of a packet by the BS or SS on its network interface and the forwarding of the packet to its RF Interface.

If defined, this parameter represents a service commitment (or admission criteria) at the BS or SS and shall be guaranteed by the BS or SS. A BS or SS does not have to meet this service commitment for service flows that exceed their minimum reserved rate.

Type	Length	Value	Scope
[145/146].14	4	ms	DSx-REQ DSx-RSP DSx-ACK

11.13.15 Fixed-length versus variable-length SDU indicator

The value of this parameter specifies whether the SDUs on the service flow are fixed-length or variable-length. The parameter is used only if packing is on for the service flow. The default value is 0, i.e., variable-length SDUs.

Type	Length	Value	Scope
[145/146].15	1	0 = variable-length SDUs 1 = fixed-length SDUs default = 0	DSA-REQ DSA-RSP DSA-ACK

11.13.16 SDU size

The value of this parameter specifies the length of the SDU for a fixed-length SDU service flow. This parameter is used only if packing is on and the service flow is indicated as carrying fixed-length SDUs. The default value is 49 bytes, i.e., VC-switched ATM cells with PHS. The parameter is relevant for both ATM and Packet Convergence Sublayers.

Type	Length	Value	Scope
[145/146].16	1	Number of bytes. default = 49	DSA-REQ DSA-RSP DSA-ACK

11.13.17 Target SAID

The target SAID parameter indicates the SAID onto which the service flow that is being set up shall be mapped.

Type	Length	Value	Scope
[145/146].17	2	SAID onto which SF is mapped	DSA-REQ DSA-RSP

11.13.18 ARQ TLVs for ARQ-enabled connections

11.13.18.1 ARQ Enable

This TLV indicates whether or not ARQ use is requested for the connection that is being setup. A value of 0 indicates that ARQ is not requested and a value of 1 indicates that ARQ is requested. The DSA-REQ shall contain the request to use ARQ or not. The DSA-RSP message shall contain the acceptance or rejection of

the request. ARQ shall be enabled for this connection only if both sides report this TLV to be non-zero. The SS shall either reject the connection or accept the connection with ARQ.

Type	Length	Value	Scope
[145/146].18 1.18	1	0 = ARQ Not Requested/Accepted 1 = ARQ Requested/Accepted	DSA-REQ, DSA-RSP REG-REQ, REG-RSP

11.13.18.2 ARQ_WINDOW_SIZE

This parameter is negotiated upon connection setup or during operation. The DSA-REQ/DSC-REQ message shall contain the suggested value for this parameter. The DSA-RSP/DSC-RSP message shall contain the confirmation value or an alternate value for this parameter. The smaller of the two shall be used as the **ARQ_WINDOW_SIZE**.

Type	Length	Value	Scope
[145/146].19 1.19	2	> 0 and $\leq (\text{ARQ_BSN_MODULUS}/2)$	DSx-REQ, DSx-RSP REG-REQ, REG-RSP

11.13.18.3 ARQ_RETRY_TIMEOUT

The **ARQ_retry_timeout** should account for the transmitter and receiver processing delays and any other delays relevant to the system.

TRANSMITTER_DELAY: This is the total transmitter delay, including sending (e.g., MAC PDUs) and receiving (e.g., ARQ feedback) delays and other implementation dependent processing delays. If the transmitter is the BS, it may include other delays such as scheduling and propagation delay.

RECEIVER_DELAY: This is the total receiver delay, including receiving (e.g., MAC PDUs) and sending (e.g., ARQ feedback) delays and other implementation-dependent processing delays. If the receiver is the BS, it may include other delays such as scheduling and propagation delay.

The DSA-REQ and DSA-RSP messages shall contain the values for these parameters, where the receiver and transmitter each declare their capabilities. When the DSA handshake is completed, each party shall calculate **ARQ_RETRY_TIMEOUT** to be the sum of **TRANSMITTER_DELAY** and **RECEIVER_DELAY**.

Type	Length	Value	Scope
[145/146].20 1.20	2	TRANSMITTER_DELAY 0–655350 (10 μ s granularity)	DSA-REQ, DSA-RSP REG-REQ, REG-RSP
[145/146].21 1.21	2	RECEIVER_DELAY 0–655350 (10 μ s granularity)	DSA-REQ, DSA-RSP REG-REQ, REG-RSP

11.13.18.4 ARQ_BLOCK_LIFETIME

The DSA-REQ message shall contain the value of this parameter as defined by the parent service flow. If this parameter is set to 0, then the **ARQ_BLOCK_LIFETIME** value shall be considered infinite.

Type	Length	Value	Scope
[145/146].22 1.22	2	0 = Infinite 1–655350 (10 μ s granularity)	DSA-REQ, DSA-RSP REG-REQ, REG-RSP

11.13.18.5 ARQ_SYNC_LOSS_TIMEOUT

The BS shall set this parameter. The DSA-REQ or DSA-RSP messages shall contain the value of this parameter as set by the BS. If this parameter is set to 0, then the **ARQ_SYNC_LOSS_TIMEOUT** value shall be considered infinite.

Type	Length	Value	Scope
[145/146].23 1.23	2	0 = Infinite 1–655350 (10 μ s granularity)	DSA-REQ, DSA-RSP REG-REQ, REG-RSP

11.13.18.6 ARQ_DELIVER_IN_ORDER

The DSA-REQ message shall contain the value of this parameter. This TLV indicates whether or not data is to be delivered by the receiving MAC to its client application in the order in which the data was handed off to the originating MAC.

Type	Length	Value	Scope
[145/146].24 1.24	1	0 – Order of delivery is not preserved 1 – Order of delivery is preserved	DSA-REQ, DSA-RSP REG-REQ, REG-RSP

If this flag is not set, then the order of delivery is not preserved. If this flag is set (to 1), then the order of delivery is preserved.

11.13.18.7 ARQ_RX_PURGE_TIMEOUT

The DSA-REQ message shall contain the value of this parameter as defined by the parent service flow. If this parameter is set to 0, then the **ARQ_RX_PURGE_TIMEOUT** value shall be considered infinite.

Type	Length	Value	Scope
[145/146].25 1.25	2	0 = Infinite 1–65535 (10 μ s granularity)	DSA-REQ, DSA-RSP REG-REQ, REG-RSP

11.13.18.8 ARQ_BLOCK_SIZE

This value of this parameter specifies the size of an ARQ block. This parameter shall be established by negotiation during the connection creation dialog.

The requester includes its desired setting in the REQ message. The receiver of the REQ message shall take the smaller of the value it prefers and value in the REQ message. This minimum value is included in the RSP message and becomes the agreed upon length value.

Absence of the parameter during a DSA dialog shall indicate the originator of the message desires the maximum value.

Type	Length	Value	Scope
[145/146].26 1.26	2	0 = <i>Reserved</i> 1–2040 = Desired/Agreed size in bytes 2041–65535 = <i>Reserved</i>	DSA-REQ, DSA-RSP REG-REQ, REG-RSP

11.13.19 CS specific service flow encodings**11.13.19.1 CS specification**

This parameter specifies the CS that the connection being set up shall use.

Type	Length	Value	Scope
[145/146].28	1	0: No CS 1: Packet, IPv4 2: Packet, IPv6 3: Packet, 802.3/Ethernet 4: Packet, 802.1Q VLAN 5: Packet, IPv4 over 802.3/Ethernet 6: Packet, IPv6 over 802.3/Ethernet 7: Packet, IPv4 over 802.1Q VLAN 8: Packet, IPv6 over 802.1Q VLAN 9: ATM 10–255 <i>Reserved</i>	DSA-REQ

11.13.19.2 CS parameter encoding rules

Each CS defines a set of parameters that are encoded within a subindex under the “cst” values listed below. In the cases of IP over IEEE 802.x, the relevant IP and IEEE 802.x parameters shall be included in the DSx-REQ message.

cst	CS
99	ATM
100	Packet, IPv4
101	Packet, IPv6
102	Packet, 802.3/Ethernet
103	Packet, 802.1Q VLAN
104	Packet IPV4 over 802.3/Ethernet
105	Packet IPV6 over 802.3/Ethernet
106	Packet IPV4 over 802.1Q VLAN
107	Packet IPV6 over 802.1Q VLAN

11.13.19.3 Packet CS encodings for configuration and MAC messaging

The following TLV encoded parameters shall be used in Dynamic Service messages. The CS specific type is denoted in the tables in the following subclauses by the variable “cst,” which takes its value from the table in 11.13.19.2 (e.g., 100, 101, ...) depending upon the exact packet CS used for the service.

11.13.19.3.1 QoS-related encodings

The following TLV encodings shall be used in registration messages and Dynamic Service messages to encode parameters for packet classification and scheduling.

The following configuration settings shall be supported by all SSS that are compliant with this specification.

11.13.19.3.2 Classifier DSC action

When received in a DSC-REQ, this indicates the action to be taken with this classifier.

Type	Length	Value
[145/146].cst.1	1	0 — DSC Add Classifier 1 — DSC Replace Classifier 2 — DSC Delete Classifier

11.13.19.3.3 Classifier error parameter set

This field defines the parameters associated with Classifier Errors.

Type	Length	Value
[145/146].cst.2	<i>variable</i>	Compound

A Classifier Error Parameter Set is defined by the following individual parameters: Packet Classifier Rule Index, Errored Parameter, Error Code, and Error Message.

The Classifier Error Parameter Set is returned in DSA-RSP and DSC-RSP messages to indicate the recipient's response to a Classifier establishment request in a DSA-REQ or DSC-REQ message.

On failure, the sender shall include one Classifier Error Parameter Set for each failed Classifier requested in the DSA-REQ or DSC-REQ message. Classifier Error Parameter Set for the failed Classifier shall include the Error Code and Errored Parameter and may include an Error Message. If some Classifier Sets are rejected but other Classifier Sets are accepted, then Classifier Error Parameter Sets shall be included for only the rejected Classifiers. On success of the entire transaction, the RSP or ACK message shall not include a Classifier Error Parameter Set.

Multiple Classifier Error Parameter Sets may appear in a DSA-RSP or DSC-RSP message, since multiple Classifier parameters may be in error. A message with even a single Classifier Error Parameter Set shall not contain any other protocol Classifier Encodings (e.g., IP, IEEE Std 802.1D-2004, IEEE Std 802.1Q, 2003 Edition).

A Classifier Error Parameter Set shall not appear in any DSA-REQ or DSC-REQ messages.

11.13.19.3.3.1 Errored parameter

The value of this parameter identifies the subtype of a requested Classifier parameter in error in a rejected Classifier request. A Classifier Error Parameter Set shall have exactly one Errored Parameter TLV within a given Classifier Encoding.

Subtype	Length	Value
[145/146].cst.2.1	<i>n</i>	Classifier Encoding Subtype in Error

If the length is 1, then the value is the single-level subtype where the error was found; e.g., 1 indicates an invalid Change Action. If the length is 2, then the value is the multilevel subtype where the error was found; e.g., 3-3 indicates an invalid IP Protocol value.

11.13.19.3.3.2 Error code

This parameter indicates the status of the request. A nonzero value corresponds to the CC as described in 11.13.1. A Classifier Error Parameter Set shall have exactly one Error Code within a given Classifier Encoding.

Subtype	Length	Value
[145/146].cst.2.2	1	CC except OK(0)

A value of OK(0) indicates that the Classifier request was successful. Since a Classifier Error Parameter Set applies only to errored parameters, this value shall not be used.

11.13.19.3.3.3 Error message

This subtype is optional in a Classifier Error Parameter Set. If present, it indicates a text string to be displayed on the SS console and/or log that further describes a rejected Classifier request. A Classifier Error Parameter Set may have zero or one Error Message subtypes within a given Classifier Encoding.

Subtype	Length	Value
[145/146].cst.2.3	<i>n</i>	Null-terminated string of ASCII characters The length of the string, including null-terminator may not exceed 128 bytes

11.13.19.3.4 Packet classification rule

This compound parameter contains the parameters of the classification rule. All parameters pertaining to a specific classification rule shall be included in the same Packet Classification Rule compound parameter.

Type	Length	Value
[145/146].cst.3	<i>variable</i>	Compound

11.13.19.3.4.1 Classifier rule priority

The value of the field specifies the priority for the Classifier, which is used for determining the order of the Classifier. A higher value indicates higher priority.

Classifiers may have priorities in the range 0–255 with the default value being 0.

Type	Length	Value
[145/146].cst.3.1	1	0–255

11.13.19.3.4.2 IP Type of service/differentiated services codepoint (DSCP) range and mask

The values of the field specify the matching parameters for the IP type of service/DSCP (IETF RFC 2474) byte range and mask. An IP packet with IP type of service (ToS) byte value “ip-tos” matches this parameter if $\text{tos-low} \leq (\text{ip-tos AND tos-mask}) \leq \text{tos-high}$. If this field is omitted, then comparison of the IP packet ToS byte for this entry is irrelevant.

Type	Length	Value
[145/146].cst.3.2	3	tos-low, tos-high, tos-mask

11.13.19.3.4.3 Protocol

The value of the field specifies a list of matching values for the IP Protocol field. For IPv6 (IETF RFC 2460), this refers to next header entry in the last header of the IP header chain. The encoding of the value field is that defined by the IANA document “Protocol Numbers.” If this parameter is omitted, then comparison of the IP header Protocol field for this entry is irrelevant.

Type	Length	Value
[145/146].cst.3.3	n	prot1, prot2,...prot n

11.13.19.3.4.4 IP masked source address

This parameter specifies a list of IP source addresses (designated “src_{*i*}”) and their corresponding address masks (designated “smask_{*i*}”). An IP packet with IP source address “ip-src” matches this parameter if $\text{src}_i = (\text{ip-src AND smask}_i)$ for any i from 1 to n . If this parameter is omitted, then comparison of the IP packet source address for this entry is irrelevant.

Type	Length	Value
[145/146].cst.3.4	$n*8$ (IPv4) or $n*32$ (IPv6)	src ₁ , smask ₁ ,..., src _{<i>i</i>} , smask _{<i>i</i>} ,..., src _{<i>n</i>} , smask _{<i>n</i>}

11.13.19.3.4.5 IP destination address

This parameter specifies a list of IP destination addresses (designated “dst_{*i*}”) and their corresponding address masks (designated “dmask_{*i*}”). An IP packet with IP destination address “ip-dst” matches this parameter if $\text{dst}_i = (\text{ip-dst AND dmask}_i)$ for any i from 1 to n . If this parameter is omitted, then comparison of the IP packet destination address for this entry is irrelevant.

Type	Length	Value
[145/146].cst.3.5	$n*8$ (IPv4) or $n*32$ (IPv6)	dst ₁ , dmask ₁ ,..., dst _{<i>i</i>} , dmask _{<i>i</i>} ,..., dst _{<i>n</i>} , dmask _{<i>n</i>}

11.13.19.3.4.6 Protocol source port range

The value of the field specifies a list of nonoverlapping ranges of protocol source port values. Classifier rules with port numbers are protocol specific; i.e., a rule on port numbers without a protocol specification shall not be defined. An IP packet with protocol port value “src-port” matches this parameter if src-port is greater than or equal to sportlow and src-port is less than or equal to sporthigh. If this parameter is omitted, the protocol source port is irrelevant. This parameter is irrelevant for protocols without port numbers.

Type	Length	Value
[145/146].cst.3.6	$n*4$	sportlow 1, sporthigh 2,...,sportlow n , sporthigh n

11.13.19.3.4.7 Protocol destination port range

The value of the field specifies a list of nonoverlapping ranges of protocol destination port values. Classifier rules with port numbers are protocol specific; i.e., a rule on port numbers without a protocol specification shall not be defined. An IP packet with protocol port value “dst-port” matches this parameter if dst-port is greater than or equal to dportlow and dst-port is less than or equal to dphorthigh. If this parameter is omitted the protocol destination port is irrelevant. This parameter is irrelevant for protocols without port numbers.

Type	Length	Value
[145/146].cst.3.7	$n*4$	dportlow 1, dphorthigh 2,...,dportlow n , dphorthigh n

11.13.19.3.4.8 IEEE 802.3/Ethernet destination MAC address

This parameter specifies a list of MAC destination addresses (designated “dst_{*i*}”) and their corresponding address masks (designated “msk_{*i*}”). An IEEE 802.3/Ethernet packet with MAC destination address “etherdst” corresponds to this parameter if dst_{*i*} = (etherdst AND msk_{*i*}) for any *i* from 1 to *n*. If this parameter is omitted, then comparison of the IEEE 802.3/Ethernet destination MAC address for this entry is irrelevant.

Type	Length	Value
[145/146].cst.3.8	$n*12$	dst ₁ , msk ₁ ..., dst _{<i>i</i>} , msk _{<i>i</i>} ..., dst _{<i>n</i>} , msk _{<i>n</i>}

11.13.19.3.4.9 IEEE 802.3/Ethernet source MAC address

This parameter specifies a list of MAC source addresses (designated “src_{*i*}”) and their corresponding address masks (designated “msk_{*i*}”). An IEEE 802.3/Ethernet packet with MAC source address “ethersrc” corresponds to this parameter if src_{*i*} = (ethersrc AND msk_{*i*}) for any *i* from 1 to *n*. If this parameter is omitted, then comparison of the IEEE 802.3/Ethernet source MAC address for this entry is irrelevant.

Type	Length	Value
[145/146].cst.3.9	n^*12	src ₁ , msk ₁ ,..., src _i , msk _i ,..., src _n , msk _n

11.13.19.3.4.10 Ethertype/IEEE 802.2 SAP

The format of the Layer 3 protocol ID in the Ethernet packet is indicated by type, eprot1, and eprot2 as follows:

If type = 0, the rule does not use the Layer 3 protocol type as a matching criteria. If type = 0, eprot1, eprot2 are ignored when considering whether a packet matches the current rule.

If type = 1, the rule applies only to SDUs that contain an Ethertype value. Ethertype values are contained in packets using the DEC-Intel-Xerox (DIX) encapsulation or the Sub-Network Access Protocol (SNAP) encapsulation (IEEE 802.2, IETF RFC 1042) format. If type = 1, then eprot1, eprot2 gives the 16 bit value of the Ethertype that the packet shall match in order to match the rule.

If type = 2, the rule applies only to SDUs using the IEEE 802.2 encapsulation format with a Destination Service (DSAP) other than 0xAA (which is reserved for SNAP). If type = 2, the lower 8 bits of the eprot1, eprot2 shall match the DSAP byte of the packet in order to match the rule.

If the Ethernet SDU contains an IEEE 802.1D and IEEE 802.1Q Tag header (i.e., Ethertype 0x8100), this object applies to the embedded Ethertype field within the IEEE 802.1D and IEEE 802.1Q header.

Other values of type are reserved. If this TLV is omitted, then comparison of either the Ethertype or IEEE 802.2 DSAP for this rule is irrelevant.

Type	Length	Value
[145/146].cst.3.10	3	type, eprot1, eprot2

11.13.19.3.4.11 IEEE 802.1D User_Priority

The values of this field specify the matching parameters for the IEEE 802.1D user_priority bits. An Ethernet packet with IEEE 802.1D user_priority value "priority" matches these parameters if priority is greater than or equal to pri-low and priority is less than or equal to pri-high. If this field is omitted, then comparison of the IEEE 802.1D user_priority bits for this entry is irrelevant.

If this parameter is specified for an entry, then Ethernet packets without IEEE 802.1Q encapsulation shall NOT match this entry. If this parameter is specified for an entry on an SS that does not support forwarding of IEEE 802.1Q encapsulated traffic, then this entry shall not be used for any traffic.

Type	Length	Value
[145/146].cst.3.11	2	pri-low, pri-high Valid Range: 0-7 for pri-low and pri-high

11.13.19.3.4.12 IEEE 802.1Q VLAN_ID

The value of the field specifies the matching value for the IEEE 802.1Q vlan_id bits. Only the first (i.e. left-most) 12 bits of the specified vlan_id field are significant; the final four bits shall be ignored for comparison. If this field is omitted, then comparison of the IEEE 802.1Q vlan_id bits for this entry is irrelevant.

If this parameter is specified for an entry, then Ethernet packets without IEEE 802.1Q encapsulation shall not match this entry. If this parameter is specified for an entry on an SS that does not support forwarding of IEEE 802.1Q encapsulated traffic, then this entry shall not be used for any traffic.

Type	Length	Value
[145/146].cst.3.12	2	vlan_id1, vlan_id2

11.13.19.3.4.13 Associated PHSI

The Associated PHSI has a value between 1 and 255, which shall mirror the PHSI value of a PHS rule. Packets matching the Packet Classification Rule containing the Associated PHSI parameter shall undergo PHS according to the corresponding PHS rule.

Type	Length	Value
[145/146].cst.3.13	1	Index value

11.13.19.3.4.14 Packet Classifier Rule Index

The Packet Classifier Rule Index identifies a Packet Classifier Rule. The Packet Classifier Rule Index is unique per service flow.

Type	Length	Value
[145/146].cst.3.14	2	Packet Classifier Rule Index

11.13.19.3.4.15 Vendor-specific classifier parameters

This allows vendors to encode vendor-specific classifier parameters. The Vendor ID shall be the first TLV embedded inside vendor-specific classifier parameters. If the first TLV inside vendor-specific classifier parameters is not a Vendor ID, then the TLV shall be discarded (see 11.1.6).

Type	Length	Value
[145/146].cst.3.143	<i>variable</i>	Compound

11.13.19.3.5 PHS DSC action

When received in a DSC-REQ, this indicates the action that shall be taken with this PHS byte string.

Type	Length	Value
[145/146].cst.4	1	0 — Add PHS Rule 1 — Set PHS Rule 2 — Delete PHS Rule 3 — Delete all PHS Rules

The “Set PHS Rule” command is used to add the specific TLVs for an undefined PHS rule. It shall NOT be used to modify existing TLVs.

When deleting all PHS Rules, any corresponding PHSI shall be ignored.

An attempt to add a PHS Rule that already exists is an error condition.

11.13.19.3.6 PHS error parameter set

This field defines the parameters associated with PHS errors.

Type	Length	Value
[145/146].cst.5	<i>variable</i>	Compound field

A PHS Error Parameter Set is defined by the following individual parameters:

- a) PHSI
- b) Errored Parameter
- c) Error Code
- d) Error Message

The PHS Error Parameter Set is returned in DSA-RSP and DSC-RSP messages to indicate the recipient’s response to a PHS Rule establishment request in a DSA-REQ or DSC-REQ message.

On failure, the sender shall include one PHS Error Parameter Set for each failed PHS Rule requested in the DSA-REQ or DSC-REQ message. PHS Error Parameter Set for the failed PHS Rule shall include the Error Code and Errored Parameter and may include an Error Message. If some PHS Rule Sets are rejected but other PHS Rule Sets are accepted, then PHS Error Parameter Sets shall be included for only the rejected PHS Rules. On success of the entire transaction, the RSP or ACK message shall not include a PHS Error Parameter Set.

Multiple PHS Error Parameter Sets may appear in a DSA-RSP or DSC-RSP message, since multiple PHS parameters may be in error. A message with even a single PHS Error Parameter Set shall not contain any other protocol PHS Encodings (e.g., IP or IEEE Std 802.1D-2004/IEEE Std 802.1Q, 2003 Edition).

A PHS Error Parameter Set shall not appear in any DSA-REQ or DSC-REQ messages.

11.13.19.3.6.1 Errored parameter

The value of this parameter identifies the subtype of a requested PHS Parameter in error in a rejected PHS request. A PHS Error Parameter Set shall have exactly one Errored Parameter TLV within a given PHS Encoding.

Type	Length	Value
[145/146].cst.5.1	1	PHS Encoding Subtype in Error

11.13.19.3.6.2 Error code

This parameter indicates the status of the request. A nonzero value corresponds to the CC as described in 11.13.1. A PHS Error Parameter Set shall have exactly one Error Code within a given PHS Encoding.

Type	Length	Value
[145/146].cst.5.2	1	CC except OK(0) as specified in Table 384

A value of OK(0) indicates that the PHS request was successful. Since a PHS Error Parameter Set only applies to errored parameters, this value shall not be used.

11.13.19.3.6.3 Error message

This subtype is optional in a PHS Error Parameter Set. If present, it indicates a text string to be displayed on the SS console and/or log that further describes a rejected PHS request. A PHS Error Parameter Set may have zero or one Error Message subtypes within a given PHS Encoding.

Type	Length	Value
[145/146].cst.5.3	<i>n</i>	Null-terminated string of ASCII characters

The length *n* may not exceed 128 including the terminating NULL.

11.13.19.3.7 PHS Rule

This field defines the parameters associated with a PHS Rule.

Type	Length	Value
[145/146].cst.6	<i>n</i>	

11.13.19.3.7.1 PHSI

The PHSI has a value between 1 and 255, which uniquely references the suppressed byte string. The index is unique per service flow. The uplink and downlink PHSI values are independent of each other.

Type	Length	Value
[145/146].cst.6.1	1	Index value

11.13.19.3.7.2 PHSF

The PHSF is a string of bytes containing the header information to be suppressed by the sending CS and reconstructed by the receiving CS. The most significant byte of the string corresponds to the first byte of the CS-SDU.

Type	Length	Value
[145/146].cst.6.2	n	String of bytes suppressed

The length n shall always be the same as the value for PHSS.

11.13.19.3.7.3 PHSM

The value of this field is used to interpret the values in the PHSF. It is used at both the sending and receiving entities on the link. The PHSM allows fields, such as sequence numbers or checksums (which vary in value), to be excluded from suppression with the constant bytes around them suppressed.

Type	Length	Value
[145/146].cst.6.3	n	bit 0: 0 = don't suppress first byte of the suppression field 1 = suppress first byte of the suppression field bit 1: 0 = don't suppress second byte of the suppression field 1 = suppress second byte of the suppression field bit x : 0 = don't suppress ($x+1$) byte of the suppression field 1 = suppress ($x+1$) byte of the suppression field

The length n is ceiling (PHSS/8). Bit 0 is the MSB of the Value field. The value of each sequential bit in the PHSM is an attribute for the corresponding sequential byte in the PHSF.

If the bit value is a "1," the sending entity should suppress the byte, and the receiving entity should restore the byte from its cached PHSF. If the bit value is a "0," the sending entity should not suppress the byte, and the receiving entity should restore the byte by using the next byte in the packet.

If this TLV is not included, the default is to suppress all bytes.

11.13.19.3.7.4 PHSS

The value of this field is the total number of bytes in the header to be suppressed and then restored in a service flow that uses PHS.

Type	Length	Value
[145/146].cst.6.4	1	Number of bytes in the suppression string

This TLV is used when a service flow is being created. For all packets that get classified and assigned to a service flow with PHS enabled, suppression shall be performed over the specified number of bytes as indicated by the PHSS and according to the PHSM. If this TLV is not included in a service flow definition, or is included with a value of 0 bytes, then PHS is disabled. A nonzero value indicates PHS is enabled.

11.13.19.3.7.5 PHSV

The value of this field indicates to the sending entity whether or not the packet header contents are to be verified prior to performing suppression. If PHSV is enabled, the sender shall compare the bytes in the packet header with the bytes in the PHSF that are to be suppressed as indicated by the PHSM.

Type	Length	Value
[145/146].cst.6.5	1	0 = verify 1 = don't verify

If this TLV is not included, the default is to verify. Only the sender shall verify suppressed bytes. If verification fails, the Payload Header shall NOT be suppressed.

11.13.19.3.7.6 Vendor-specific PHS parameters

This allows vendors to encode vendor-specific PHS parameters. The Vendor ID shall be the first TLV embedded inside vendor-specific PHS parameters. If the first TLV inside vendor-specific PHS parameters is not a Vendor ID, then the TLV shall be discarded.

Type	Length	Value
[145/146].cst.6.143	<i>variable</i>	Compound

11.13.19.3.8 IPv6 Flow label

The value of this field specifies a list of matching values for the IPv6 Flow label field. As the flow label field has a length of 20 bits, the first 4 bits of the most significant byte shall be set to 0x0 and disregarded.

Type	Length	Scope
[145/146].[101/105/107].3.15	n*3	Flow Label #'1...Flow label#n

11.13.19.4 ATM CS Encodings for Configuration and MAC Messaging

The TLV encodings listed in 11.13.19.4.1 through 11.13.19.4.3 shall be used in the configuration file, in SS registration requests (when applicable), and in Dynamic Service messages (when applicable). All ATM specific TLVs are prefixed to begin with a Type value of [145/146].99.

11.13.19.4.1 ATM switching encoding

This field defines the switching methodology for the service. If the field = 0, at least one VPI/VCI Classifier pair shall be defined for classifying the service. If the field = 1, exactly one VPI Classifier and zero or one VCI Classifier shall be specified for classifying the service. If the field = 2, exactly one VPI Classifier and one VCI Classifier shall be defined for classifying the service. If the field = 0, PHS is not allowed and the SDU size TLV shall equal 52. If the field = 1 and PHS is on for the service, the SDU size TLV shall equal 51; otherwise it shall be set equal to 52. If the field = 2 and PHS is on for the service, the SDU size TLV shall equal 49; otherwise it shall be set equal to 52.

Type	Length	Value
[145/146].99.1	1	0 = no switching methodology applied 1 = VP switching 2 = VC switching

11.13.19.4.2 ATM Classifier TLV

This field defines an ATM classifier. It is a compound TLV used to describe the VPI and associated VCIs for ATM classification.

Type	Length	Value
[145/146].99.2	<i>variable</i>	Compound

It shall have the following form:

Field	Note
ATM Classifier ID	Always present
VPI Classifier	Always present except for DSC Change action deleting classifier
VCI Classification	0 or more instances (number apparent from ATM Classifier length field) if VPI Classifier is present

11.13.19.4.2.1 VPI classifier

This field defines the VPI on which to classify ATM cells for the service flow.

Type	Length	Value
[145/146].99.2.1	2	8-bit or 12-bit VPI field value

11.13.19.4.2.2 VCI classification

This field defines the VCI on which to classify ATM cells for the service flow.

This TLV shall immediately follow the VPI TLV with which it is associated.

Type	Length	Value
[145/146].99.2.2	2	16-bit VCI field value

11.13.19.4.2.3 ATM Classifier ID

This field is used to identify an ATM classifier.

Type	Length	Value
[145/146].99.2.3	16	16-bit classifier ID

11.13.19.4.3 ATM Classifier DSC Action

When received in a DSC-REQ message, this indicates the action to be taken on a classifier. If the action TLV is Add or Replace, the action is followed by a complete ATM Classifier compound TLV. If the action is delete, the action TLV is followed by the ATM Classifier compound TLV composed only of the ATM Classifier ID TLV.

Type	Length	Value
[145/146].99.3	1	0 – DSC Add Classifier 1 – DSC Replace Classifier 2 – DSC Delete Classifier

11.13.19.4.4 ATM Classifier Error Parameter Set

This field defines the parameters associated with ATM classifier errors.

Type	Length	Value
[145/146].99.4	<i>variable</i>	Compound

The contents of the compound structure shall be identical to the encoding for the Classifier Error Parameter Set for packet services specified in 11.13.19.3.3.

12. System profiles

This clause defines system profiles that list sets of features to be used in typical implementation cases. Each profile is assigned an identifier for use in such documents as PICS proforma statements. Features specified in the standard as optional may be listed in a profile as “required” or “conditionally required.” Profiles do not change “mandatory” status if specified in the standard itself. Any feature that is specified in the standard as optional and does not appear in certain profile is optional for the profile, thus absence of this feature in specific implementation does not affect conformance to the profile. Optional features shall be implemented as specified in the standard.

12.1 WirelessMAN-SC (10–66 GHz) system profiles

This subclause defines system profiles for systems operating with the WirelessMAN-SC air interface.

Table 386—Profile definitions

Identifier	Description
profM1	Basic ATM MAC profile
profM2	Basic packet MAC profile
profP1	25 MHz channel PHY profile
profP1f	25 MHz channel PHY profile – FDD
profP1t	25 MHz channel PHY profile – TDD
profP2	28 MHz channel PHY profile
profP2f	28 MHz channel PHY profile – FDD
profP2t	28 MHz channel PHY profile – TDD

12.1.1 WirelessMAN-SC MAC system profiles

This subclause defines MAC profiles for systems operating with the WirelessMAN-SC air interface.

12.1.1.1 Basic ATM MAC system profile

Profile identifier: profM1.

Mandatory features:

- Support of PVCs.
- Support of VC-switched connections.
- Support of VP-switched connections.
- ATM PHS is mandatory as a capability, but may be turned on or off on a per connection basis.
- IPv4 on the Secondary Management connection.
- Packing of multiple ATM cells into a single MAC PDU is mandatory as a capability, but may be turned on or off on a per-connection basis.
- SDU fragmentation on the Primary Management and Secondary management connections.

Conditionally Mandatory features:

- If nrtPS or BE services are supported, then the SS responding to broadcast polling is mandatory.
- If multicast polling groups are supported, multicast polling must be supported.

12.1.1.2 Basic Packet MAC system profile

Profile identifier: profM2.

Mandatory features:

- Support of provisioned connections.
- IPv4 support on transport connection.
- Classification of packets in the SS based on the incoming physical port.
- Reception of multiple SDUs packed into a single MAC PDU is mandatory as a capability, but may be turned on or off on a per connection basis.
- Fragmentation of SDUs is mandatory as a capability, but may be turned on or off on a per-connection basis.

Conditionally Mandatory features:

- If nrtPS or BE services are supported, then the SS responding to broadcast polling is mandatory.
- If multicast polling groups are supported, multicast polling must be supported.

12.1.1.3 Conventions for MAC Management messages for profiles profM1 and profM2

The following rules shall be followed when reporting parameters in MAC Management messages:

- Service Class Names should not be used.
- No TLVs besides Error Encodings and HMAC Tuples shall be reported back in DSA-RSP and DSC-RSP messages.
- No TLVs besides HMAC Tuples shall be reported back in DSA-ACK messages.
- DSC-REQ messages shall not contain Request/Transmission Policy, Fixed vs. Variable Length SDU Indicator, SDU Size, ATM Switching, or Convergence Sublayer Specification TLVs.

12.1.1.4 MAC Management message Parameter Transmission Order

The following subclauses define the order in which systems meeting profiles profM1 and profM2 shall transmit the TLV encoded parameters for mandatory features in the respective messages. Systems implementing either profile shall only include the parameters listed under the respective message in its transmission of these messages plus any parameters necessary for optional features. Parameters for optional features shall occur after those listed for support of mandatory features. Parameters with defined default values should be omitted if the desired value coincides with the default one. PHY specific messages are described in 12.1.2.

12.1.1.4.1 DCD

The parameters of the DCD message are PHY profile specific.

12.1.1.4.2 DL-MAP

This message contains no TLV encoded information.

12.1.1.4.3 UCD

The parameters of the DCD message are PHY profile specific.

12.1.1.4.4 UL-MAP

This message contains no TLV encoded information.

12.1.1.4.5 RNG-REQ

- Requested downlink Burst Profile
- SS MAC Address
- Ranging Anomalies

12.1.1.4.6 RNG-RSP

If ranging status equals “success” or “continue”:

- Ranging Status
- Timing Adjust (default to 0)
- Power Adjust (default to 0)
- Downlink operational Burst profile (only if changed)
- SS MAC Address (only on CID 0x0000)
- Basic CID (only on CID 0x0000)
- Primary Management CID (only on CID 0x0000)
- Uplink Channel Override (only if allowed by PHY profile)

If ranging status equals “abort”:

- Ranging Status
- SS MAC Address (only on CID 0x0000)
- Downlink frequency Override (if needed)

12.1.1.4.7 REG-REQ

- Vendor ID Encoding (optional)
- Uplink CID Support
- PKM Flow Control (default = no limit)
- DSx Flow Control (default = no limit)
- MCA Flow Control (default = no limit)
- IP version (default = IPv4)
- MAC CRC support (default = support)
- Multicast Polling Group CID support (default = 4)
- Convergence Sublayer Support (1 instance for each CS supported)
- Maximum number of classifiers (default = 0, no limit)
- PHS support (default = 0, no PHS support)
- HMAC Tuple

12.1.1.4.8 REG-RSP

- Secondary Management CID
- Uplink CID Support
- Vendor ID Encoding (if present in REG-REQ)
- PKM Flow Control (if present in REG-REQ or changed from default)

- DSx Flow Control (if present in REG-REQ or changed from default)
- MCA Flow Control (if present in REG-REQ or changed from default)
- IP version (if present in REG-REQ or changed from default)
- MAC CRC support (if present in REG-REQ or changed from default)
- Multicast Polling Group CID support (if present in REG-REQ or changed from default)
- Vendor-specific information (Compound, only allowed if Vendor ID present in REG-REQ, and extensions provided)
- Vendor ID
- Vendor-specific extensions
- HMAC Tuple

12.1.1.4.9 PKM-REQ: Auth Info

- CA-Certificate

12.1.1.4.10 PKM-REQ: Auth Request

- SS-Certificate
- Security Capabilities
- Version (default = 1)
- Cryptographic-Suite-List (default is that both no encryption and 56-bit DES are supported, no data authentication, and 3-DES EDE with 128-bit key)
- SAID

12.1.1.4.11 PKM-REQ: Key Request

- Key Sequence Number
- SAID
- HMAC-Digest

12.1.1.4.12 PKM-RSP: SA Add

- Key-Sequence-Number
- SA-Descriptor(s)
- SAID
- SA-Type
- Cryptographic Suite
- HMAC-Digest

12.1.1.4.13 PKM-RSP: Auth Reply

- AUTH-Key
- Key-Lifetime
- Key-Sequence-Number
- SA-Descriptor(s)
- SAID
- SA-Type
- Cryptographic Suite

12.1.1.4.14 PKM-RSP: Auth Reject

- Error Code
- Display String (optional)

12.1.1.4.15 PKM-RSP: Key Reply

- Key Sequence Number
- SAID
- TEK-Parameters (Older)
- TEK
- Key Lifetime
- Key Sequence Number
- CBC-IV
- TEK-Parameters (Newer)
- TEK
- Key Lifetime
- Key Sequence Number
- CBC-IV
- HMAC-Digest

12.1.1.4.16 PKM-RSP: Key Reject

- Key Sequence Number
- SAID
- Error Code
- Display String (optional)
- HMAC-Digest

12.1.1.4.17 PKM-RSP: Auth Invalid

- Error Code
- Display String (optional)

12.1.1.4.18 PKM-RSP: TEK Invalid

- Key Sequence Number
- SAID
- Error Code
- Display String (optional)
- HMAC-Digest

12.1.1.4.19 DSA-REQ—BS Initiated Service Addition

- Uplink Service Parameters
- Service Flow ID
- Transport CID
- Target SAID
- QoS Parameter Set Type
- Service Flow Scheduling Type
- Request/Grant Transmission Policy
- Convergence Sublayer Specification
- Fixed vs Variable Length SDU Indicator (default = variable)
- SDU Size (required if fixed, forbidden if variable SDU)
- Maximum Sustained Traffic Rate
- Minimum Reserved Traffic Rate (default = 0 for BE, Max Sust Rate for UGS, required for rtPS and nrtPS)
- Maximum Traffic Burst (required for rtPS and nrtPS, excluded otherwise)
- Traffic Priority (optional, BE only)

- Tolerated Jitter (optional)
- Maximum Latency (optional)
- Convergence Sublayer Specific Parameters (see 12.1.1.5 and 12.1.1.6)
- Vendor-specific QoS Parameters
- Downlink Service Parameters
- Service Flow ID
- Transport CID
- Target SAID
- QoS Parameter Set Type
- Service Flow Scheduling Type
- Request/Grant Transmission Policy
- Convergence Sublayer Specification
- Fixed vs. Variable Length SDU Indicator (default = variable)
- SDU Size (required if fixed, forbidden if variable SDU)
- Convergence Sublayer Specific Parameters (see 12.1.1.5 and 12.1.1.6)
- Vendor-specific QoS Parameters
- HMAC Tuple

12.1.1.4.20 DSA-RSP—BS Initiated Service Addition

- Uplink Service Parameters
- Service Flow Error Parameter Set(s) (one per errored parameter)
 - Errored Parameter
 - Error Code
 - Error Message (optional)
- Downlink Service Parameter(s)
- Service Flow Error Parameter Set(s) (one per errored parameter)
 - Errored Parameter
 - Error Code
 - Error Message (optional)
- HMAC Tuple

12.1.1.4.21 DSA-ACK

- HMAC Tuple

12.1.1.4.22 DSC-REQ—BS Initiated Service Change

- Uplink Service Parameters
- Service Flow ID
- Transport CID
- QoS Parameter Set Type
- Maximum Sustained Traffic Rate
- Minimum Reserved Traffic Rate (default = 0 for BE, Max Sust Rate for UGS, required for rtPS and nrtPS)
- Maximum Traffic Burst (required for rtPS and nrtPS, excluded otherwise)
- Traffic Priority (optional, BE only)
- Tolerated Jitter (optional)
- Maximum Latency (optional)
- Convergence Sublayer Specific Parameters (see 12.1.1.5 and 12.1.1.6)
- Vendor-specific QoS Parameters
- Downlink Service Parameters
- Service Flow ID
- Transport CID

- QoS Parameter Set Type
- Convergence Sublayer Specific Parameters (see 12.1.1.5 and 12.1.1.6)
- Vendor-specific QoS Parameters
- HMAC Tuple

12.1.1.4.23 DSC-RSP—BS Initiated Service Change

- Uplink Service Parameters
- Service Flow Error Parameter Set(s) (one per errored parameter)
 - Errored Parameter
 - Error Code
 - Error Message (optional)
- Downlink Service Parameter(s)
- Service Flow Error Parameter Set(s) (one per errored parameter)
 - Errored Parameter
 - Error Code
 - Error Message (optional)
- HMAC Tuple

12.1.1.4.24 DSC-ACK

- HMAC Tuple

12.1.1.4.25 DSD-REQ

- HMAC Tuple

12.1.1.4.26 DSD-RSP

- HMAC Tuple

12.1.1.4.27 MCA-REQ

- Multicast CID
- Assignment

12.1.1.4.28 MCA-RSP

Message contains no TLV encoded information

12.1.1.4.29 DBPC-REQ

Message contains no TLV encoded information

12.1.1.4.30 DBPC-RSP

Message contains no TLV encoded information

12.1.1.4.31 RES-CMD

- HMAC Tuple

12.1.1.4.32 SBC-REQ

- WirelessMAN-SC PHY SS Demod Support
- WirelessMAN-SC PHY SS Modulator Support
- WirelessMAN-SC PHY SSdownlink FEC Types
- WirelessMAN-SC PHY SS uplink FEC Types
- Bandwidth Allocation Support

12.1.1.4.33 SBC-RSP

- WirelessMAN-SC PHY SS Demod Support
- WirelessMAN-SC PHY SS Modulator Support
- WirelessMAN-SC PHY SS downlink FEC Types
- WirelessMAN-SC PHY SS uplink FEC Types

12.1.1.4.34 CLK-CMP

The message contains no TLV encoded information.

12.1.1.4.35 DREG-CMD

- HMAC Tuple

12.1.1.4.36 DSX-RVD

The message contains no TLV encoded information.

12.1.1.4.37 TFTP-CPLT

- HMAC Tuple

12.1.1.4.38 TFTP-RSP

The message contains no TLV encoded information.

12.1.1.5 Message parameters specific to profM1

The following subclauses define the order in which systems meeting profile profM1 shall transmit the TLV encoded parameters specific to the ATM CS. Parameters with defined default values should be omitted if the desired value coincides with the default one.

12.1.1.5.1 ATM CS Parameters for DSA-REQ—BS Initiated

- ATM Switching
- ATM Classifier Rule(s) (default = don't classify)
- ATM Classifier ID
- VPI Classifier
- VCI Classifier(s) (must follow associated VPI, default = don't classify on VCI)

12.1.1.5.2 ATM CS Parameters for DSA-RSP—BS Initiated

- None

12.1.1.5.3 ATM CS Parameters for DSC-REQ—BS Initiated

- ATM Classifier Change Action
- ATM Classifier Rule(s) (default = don't classify)
- ATM Classifier ID
- VPI Classifier
- VCI Classifier(s) (must follow associated VPI, default = don't classify on VCI)

12.1.1.5.4 ATM CS Parameters for DSC-RSP—BS Initiated

- None

12.1.1.6 Message parameters specific to profM2**12.1.1.6.1 Packet CS Parameters for DSA-REQ—BS Initiated**

- Packet Classification Rule(s) (uplink service flows only, default is no classification)
- Classifier Rule ID
- Classifier Rule Priority (default to 0)
- IP Type of Service/DSCP (only for IP CSs, default = don't classify on this)
- Protocol (only for IP CSs, default = don't classify on this)
- IP Masked Source Address (only for IP CSs, default = don't classify on this)
- IP Destination Address (only for IP CSs, default = don't classify on this)
- Protocol Source Port Range (only for IP CSs, default = don't classify on this)
- Protocol Destination Port Range (only for IP CSs, default = don't classify on this)
- Ethernet Destination MAC Address (only for Ethernet CSs, default = don't classify on this)
- Ethernet Source MAC Address (only for Ethernet CSs, default = don't classify on this)
- Ethertype/IEEE 802.2 SAP (only for Ethernet CSs, default = don't classify on this)
- IEEE 802.1D User Priority (only for VLAN CSs, default = don't classify on this)
- IEEE 802.1Q VLAN_ID (only for VLAN CSs, default = don't classify on this)
- Associated PHSI (default is no PHS for this classifier match)
- Vendor-specific Classifier Parameters
- PHS Rule(s)
- PHSI
- PHSS
- PHSF
- PHSM (default is suppress all bytes of the suppression field)
- PHSV (default is verify)
- Vendor-specific PHS Parameters

12.1.1.6.2 Packet CS Parameters for DSA-RSP—BS Initiated

- Packet Classification Rule(s) (uplink service flows only, default is no classification)
- Classifier Error Parameter Set(s) (one per errored parameter)
 - Classifier Rule ID
 - Errored Parameter
 - Error Code
 - Error Message (optional)
- PHS Rule(s)
- PHS Error Parameter Set(s) (one per errored parameter)
- PHSI
 - Errored Parameter
 - Error Code
 - Error Message (optional)

12.1.1.6.3 Packet CS Parameters for DSC-REQ—BS Initiated

- Classifier Dynamic Service Change Action(s)
- Packet Classification Rule(s) (uplink service flows only, 1 per Action)
- Classifier Rule ID
- Classifier Rule Priority (default to 0)
- IP Type of Service/DSCP (only for IP CSs, default = don't classify on this)
- Protocol (only for IP CSs, default = don't classify on this)
- IP Masked Source Address (only for IP CSs, default = don't classify on this)
- IP Destination Address (only for IP CSs, default = don't classify on this)
- Protocol Source Port Range (only for IP CSs, default = don't classify on this)
- Protocol Destination Port Range (only for IP CSs, default = don't classify on this)
- Ethernet Destination MAC Address (only for Ethernet CSs, default = don't classify on this)
- Ethernet Source MAC Address (only for Ethernet CSs, default = don't classify on this)
- Ethertype/IEEE 802.2 SAP (only for Ethernet CSs, default = don't classify on this)
- IEEE 802.1D User Priority (only for VLAN CSs, default = don't classify on this)
- IEEE 802.1Q VLAN_ID (only for VLAN CSs, default = don't classify on this)
- Associated PHSI (default is no PHS for this classifier match)
- Vendor-specific Classifier Parameters
- PHS Dynamic Service Change Action
- PHS Rule(s) (1 per Action)
- PHSI
- PHSS
- PHSF
- PHSM (default is suppress all bytes of the suppression field)
- PHSV (default is verify)
- Vendor-specific PHS Parameters

12.1.1.6.4 Packet CS Parameters for DSC-RSP—BS Initiated

- Uplink Service Parameters
- Service Flow Error Parameter Set(s) (one per errored parameter)
 - Errored Parameter
 - Error Code
 - Error Message (optional)
- Downlink Service Parameter(s)
- Service Flow Error Parameter Set(s) (one per errored parameter)
 - Errored Parameter
 - Error Code
 - Error Message (optional)

12.1.2 WirelessMAN-SC PHY Profiles

This subclause defines PHY profiles for systems operating with the WirelessMAN-SC PHY.

12.1.2.1 WirelessMAN-SC 25 MHz Channel PHY Profile

Profile identifier: profP1.

Mandatory features:

- Frame Duration of 1 ms
- QPSK and QAM-16 in the DL
- QPSK in the UL

- Roll-off Factor = 0.25
- RS outer codes with $t \in \{0, 4, 8, 10, 12\}$.
- Fixed and shortened last code word operation.
- RS block lengths of 6–255.
- 20 MBd symbol rate
- 5000 PS per frame

SSs implementing profP1 shall meet the minimum SS performance requirements listed in Table 387.

Table 387—SS Minimum Performance requirements for profP1

Capability	Minimum performance
Tx Dynamic range	≥ 40 dB
Rx Dynamic Range	≥ 40 dB for QPSK
Tx RMS Power Level at Maximum Power Level Setting for QPSK	≥ 15 dBm
Tx Power Level minimum adjustment step	0.5 dB
Tx Power level adjustment step accuracy $0.5\text{dB} \leq \text{Step size} < 2\text{dB}$	monotonic
Tx Power level adjustment step accuracy $2\text{dB} \leq \text{Step size} < 5\text{dB}$	± 2 dB
Tx Power level adjustment step accuracy Step size ≥ 5 dB	± 3 dB
Peak-to-peak symbol jitter, referenced to the previous symbol zero crossing of the transmitted waveform, as percentage of the nominal symbol duration when measured over a period of 2 seconds	2%
Tx burst timing step size	± 0.25 of a symbol
Tx burst timing step accuracy	± 0.125 of a symbol
Spectral mask (OOB)	Local regulation
Ramp up/ramp down time	≤ 24 symbols
Output noise power spectral density when Tx is not transmitting	≤ -80 dBm/MHz
Modulation accuracy when measured with an ideal receiver without an equalizer for QPSK	12%
Modulation accuracy when measured with an ideal receiver without an equalizer for 16-QAM	6%
Modulation accuracy when measured with an ideal receiver with an equalizer for QPSK	10%
Modulation accuracy when measured with an ideal receiver with an equalizer for 16-QAM	3%
Modulation accuracy when measured with an ideal receiver with an equalizer for 64-QAM	1.5%
BER performance threshold for QPSK, $\text{BER}=10^{-3}$	$-94 + 10\log(25)$ dBm

Table 387—SS Minimum Performance requirements for profP1 (continued)

Capability	Minimum performance
BER performance threshold for 16-QAM, BER= 10^{-3}	$-87 + 10\log(25)$ dBm
BER performance threshold for 64-QAM, BER= 10^{-3}	$-79 + 10\log(25)$ dBm
BER performance threshold for QPSK, BER= 10^{-6}	$-90 + 10\log(25)$ dBm
BER performance threshold for 16-QAM, BER= 10^{-6}	$-83 + 10\log(25)$ dBm
BER performance threshold for 64-QAM, BER= 10^{-6}	$-74 + 10\log(25)$ dBm
Transition time from Tx to Rx and from Rx to Tx	TDD: 2 us H-FDD: 20 us FDD: n/a
1 st adjacent channel interference at BER= 10^{-3} for 3 dB degradation C/I for QPSK	-9 dB
1 st adjacent channel interference at BER= 10^{-3} for 3 dB degradation C/I for 16-QAM	-2 dB
1 st adjacent channel interference at BER= 10^{-3} for 3 dB degradation C/I for 64-QAM	+5 dB
1 st adjacent channel interference at BER= 10^{-3} for 1 dB degradation C/I for QPSK	-5 dB
1 st adjacent channel interference at BER= 10^{-3} for 1 dB degradation C/I for 16-QAM	+2 dB
1 st adjacent channel interference at BER= 10^{-3} for 1 dB degradation C/I for 64-QAM	+9 dB
1 st adjacent channel interference at BER= 10^{-6} for 3 dB degradation C/I for QPSK	-5 dB
1 st adjacent channel interference at BER= 10^{-6} for 3 dB degradation C/I for 16-QAM	+2 dB
1 st adjacent channel interference at BER= 10^{-6} for 3 dB degradation C/I for 64-QAM	+9 dB
1 st adjacent channel interference at BER= 10^{-6} for 1 dB degradation C/I for QPSK	-1 dB
1 st adjacent channel interference at BER= 10^{-6} for 1 dB degradation C/I for 16-QAM	+6 dB
1 st adjacent channel interference at BER= 10^{-6} for 1 dB degradation C/I for 64-QAM	+13 dB
2 nd adjacent channel interference at BER= 10^{-3} for 3 dB degradation C/I for QPSK	-34 dB
2 nd adjacent channel interference at BER= 10^{-3} for 3 dB degradation C/I for 16-QAM	-27 dB
2 nd adjacent channel interference at BER= 10^{-3} for 3 dB degradation C/I for 64-QAM	-20 dB
2 nd adjacent channel interference at BER= 10^{-3} for 1 dB degradation C/I for QPSK	-30 dB
2 nd adjacent channel interference at BER= 10^{-3} for 1 dB degradation C/I for 16-QAM	-22 dB

Table 387—SS Minimum Performance requirements for profP1 (continued)

Capability	Minimum performance
2 nd adjacent channel interference at BER=10 ⁻³ for 1 dB degradation C/I for 64-QAM	-16 dB
2 nd adjacent channel interference at BER=10 ⁻⁶ for 3 dB degradation C/I for QPSK	-30 dB
2 nd adjacent channel interference at BER=10 ⁻⁶ for 3 dB degradation C/I for 16-QAM	-23 dB
2 nd adjacent channel interference at BER=10 ⁻⁶ for 3 dB degradation C/I for 64-QAM	-16 dB
2 nd adjacent channel interference at BER=10 ⁻⁶ for 1 dB degradation C/I for QPSK	-26 dB
2 nd adjacent channel interference at BER=10 ⁻⁶ for 1 dB degradation C/I for 16-QAM	-20 dB
2 nd adjacent channel interference at BER=10 ⁻⁶ for 1 dB degradation C/I for 64-QAM	-12 dB
Tx Power Level absolute accuracy	± 6 dB

BSs implementing profP1 shall meet the minimum transmitter performance requirements listed in Table 388. The receiver shall meet the minimum performance requirements in Table 389.

Table 388—BS Tx minimum performance requirements for profP1

Capability	Minimum performance
Peak-to-peak symbol jitter, referenced to the previous symbol zero crossing of the transmitted waveform, as percentage of the nominal symbol duration when measured over a period of 2 seconds	2%
Tx RF frequency	10-66 GHz
Tx RF frequency accuracy	± 10*10 ⁻⁶
Spectral mask (OOB)	Local regulation
Spurious	Local regulation
Ramp up/ramp down time	≤ 24 symbols
Modulation accuracy when measured with an ideal receiver without an equalizer for QPSK	12%
Modulation accuracy when measured with an ideal receiver without an equalizer for 16-QAM	6%
Modulation accuracy when measured with an ideal receiver with an equalizer for QPSK	10%

Table 388—BS Tx minimum performance requirements for profP1 (continued)

Capability	Minimum performance
Modulation accuracy when measured with an ideal receiver with an equalizer for 16-QAM	3%
Modulation accuracy when measured with an ideal receiver with an equalizer for 64-QAM	1.5%

Table 389—BS Rx minimum performance for profP1

Capability	Minimum performance
Dynamic Range	27 dB for QPSK
BER performance threshold for QPSK, BER= 10^{-3}	$-94 + 10\log(25)$ dBm
BER performance threshold for 16-QAM, BER= 10^{-3}	$-87 + 10\log(25)$ dBm
BER performance threshold for 64-QAM, BER= 10^{-3}	$-79 + 10\log(25)$ dBm
BER performance threshold for QPSK, BER= 10^{-6}	$-90 + 10\log(25)$ dBm
BER performance threshold for 16-QAM, BER= 10^{-6}	$-83 + 10\log(25)$ dBm
BER performance threshold for 64-QAM, BER= 10^{-6}	$-74 + 10\log(25)$ dBm
1 st adjacent channel interference at BER= 10^{-3} for 3 dB degradation C/I for QPSK	-9 dB
1 st adjacent channel interference at BER= 10^{-3} for 3 dB degradation C/I for 16-QAM	-2 dB
1 st adjacent channel interference at BER= 10^{-3} for 3 dB degradation C/I for 64-QAM	+5 dB
1 st adjacent channel interference at BER= 10^{-3} for 1 dB degradation C/I for QPSK	-5 dB
1 st adjacent channel interference at BER= 10^{-3} for 1 dB degradation C/I for 16-QAM	+2 dB
1 st adjacent channel interference at BER= 10^{-3} for 1 dB degradation C/I for 64-QAM	+9 dB
1 st adjacent channel interference at BER= 10^{-6} for 3 dB degradation C/I for QPSK	-5 dB
1 st adjacent channel interference at BER= 10^{-6} for 3 dB degradation C/I for 16-QAM	+2 dB
1 st adjacent channel interference at BER= 10^{-6} for 3 dB degradation C/I for 64-QAM	+9 dB
1 st adjacent channel interference at BER= 10^{-6} for 1 dB degradation C/I for QPSK	-1 dB
1 st adjacent channel interference at BER= 10^{-6} for 1 dB degradation C/I for 16-QAM	+6 dB
1 st adjacent channel interference at BER= 10^{-6} for 1 dB degradation C/I for 64-QAM	+13 dB

Table 389—BS Rx minimum performance for profP1 (continued)

Capability	Minimum performance
2 nd adjacent channel interference at BER=10 ⁻³ for 3 dB degradation C/I for QPSK	-34 dB
2 nd adjacent channel interference at BER=10 ⁻³ for 3 dB degradation C/I for 16-QAM	-27 dB
2 nd adjacent channel interference at BER=10 ⁻³ for 3 dB degradation C/I for 64-QAM	-20 dB
2 nd adjacent channel interference at BER=10 ⁻³ for 1 dB degradation C/I for QPSK	-30 dB
2 nd adjacent channel interference at BER=10 ⁻³ for 1 dB degradation C/I for 16-QAM	-22 dB
2 nd adjacent channel interference at BER=10 ⁻³ for 1 dB degradation C/I for 64-QAM	-16 dB
2 nd adjacent channel interference at BER=10 ⁻⁶ for 3 dB degradation C/I for QPSK	-30 dB
2 nd adjacent channel interference at BER=10 ⁻⁶ for 3 dB degradation C/I for 16-QAM	-23 dB
2 nd adjacent channel interference at BER=10 ⁻⁶ for 3 dB degradation C/I for 64-QAM	-16 dB
2 nd adjacent channel interference at BER=10 ⁻⁶ for 1 dB degradation C/I for QPSK	-26 dB
2 nd adjacent channel interference at BER=10 ⁻⁶ for 1 dB degradation C/I for 16-QAM	-20 dB
2 nd adjacent channel interference at BER=10 ⁻⁶ for 1 dB degradation C/I for 64-QAM	-12 dB

12.1.2.1.1 FDD Specific WirelessMAN-SC 25 MHz Channel PHY Profile Features

Profile identifier: profP1f.

Mandatory features:

- FDD operation
- BS must respect half-duplex nature of half-duplex SSs

12.1.2.1.2 TDD Specific WirelessMAN-SC 25 MHz Channel PHY Profile Features

Profile identifier: profP1t.

Mandatory features:

- TDD operation

12.1.2.2 WirelessMAN-SC 28 MHz Channel PHY Profile

Profile identifier: profP2.

Mandatory features:

- Frame Duration of 1 ms
- QPSK and QAM-16 in the DL
- QPSK in the UL
- Roll-off Factor = 0.25
- RS outer codes with $t \in \{0, 4, 8, 10, 12\}$.
- Fixed and shortened last code word operation
- RS block lengths of 6–255
- 22.4 MBd symbol rate
- 5600 PS per frame

SSs implementing profP2 shall meet the minimum SS performance requirements as listed in Table 390.

Table 390—SS Minimum performance for profP2

Capability	Minimum performance
Tx Dynamic range	≥ 40 dB
Rx Dynamic Range	≥ 40 dB for QPSK
Tx RMS Power Level at Maximum Power Level Setting for QPSK	≥ 15 dBm
Tx Power Level minimum adjustment step	0.5 dB
Tx Power level adjustment step accuracy Step size [0.5, 2) dB	monotonic
Tx Power level adjustment step accuracy Step size [2, 5) dB	± 2 dB
Tx Power level adjustment step accuracy Step size ≥ 5 dB	± 3 dB
Peak-to-peak symbol jitter, referenced to the previous symbol zero crossing of the transmitted waveform, as percentage of the nominal symbol duration when measured over a 2 second period	2%
Tx burst timing step size	± 0.25 of a symbol
Tx burst timing step accuracy	± 0.125 of a symbol
Spectral mask (OOB)	Local regulation
Ramp up/ramp down time	≤ 24 symbols
Output noise power spectral density when Tx is not transmitting	≤ -80 dBm/MHz
Modulation accuracy when measured with an ideal receiver without an equalizer for QPSK	12%
Modulation accuracy when measured with an ideal receiver without an equalizer for 16-QAM	6%
Modulation accuracy when measured with an ideal receiver with an equalizer for QPSK	10%
Modulation accuracy when measured with an ideal receiver with an equalizer for 16-QAM	3%

Table 390—SS Minimum performance for profP2 (continued)

Capability	Minimum performance
Modulation accuracy when measured with an ideal receiver with an equalizer for 64-QAM	1.5%
BER performance threshold for QPSK, BER= 10^{-3}	-94 + 10log(28) dBm
BER performance threshold for 16-QAM, BER= 10^{-3}	-87 + 10log(28) dBm
BER performance threshold for 64-QAM, BER= 10^{-3}	-79 + 10log(28) dBm
BER performance threshold for QPSK, BER= 10^{-6}	-90 + 10log(28) dBm
BER performance threshold for 16-QAM, BER= 10^{-6}	-83 + 10log(28) dBm
BER performance threshold for 64-QAM, BER= 10^{-6}	-74 + 10log(28) dBm
Transition time from Tx to Rx and from Rx to Tx	TDD: 2 us H-FDD: 20 us FDD: n/a
1 st adjacent channel interference at BER= 10^{-3} for 3 dB degradation C/I for QPSK	-9 dB
1 st adjacent channel interference at BER= 10^{-3} for 3 dB degradation C/I for 16-QAM	-2 dB
1 st adjacent channel interference at BER= 10^{-3} for 3 dB degradation C/I for 64-QAM	+5 dB
1 st adjacent channel interference at BER= 10^{-3} for 1 dB degradation C/I for QPSK	-5 dB
1 st adjacent channel interference at BER= 10^{-3} for 1 dB degradation C/I for 16-QAM	+2 dB
1 st adjacent channel interference at BER= 10^{-3} for 1 dB degradation C/I for 64-QAM	+9 dB
1 st adjacent channel interference at BER= 10^{-6} for 3 dB degradation C/I for QPSK	-5 dB
1 st adjacent channel interference at BER= 10^{-6} for 3 dB degradation C/I for 16-QAM	+2 dB
1 st adjacent channel interference at BER= 10^{-6} for 3 dB degradation C/I for 64-QAM	+9 dB
1 st adjacent channel interference at BER= 10^{-6} for 1 dB degradation C/I for QPSK	-1 dB
1 st adjacent channel interference at BER= 10^{-6} for 1 dB degradation C/I for 16-QAM	+6 dB
1 st adjacent channel interference at BER= 10^{-6} for 1 dB degradation C/I for 64-QAM	+13 dB

Table 390—SS Minimum performance for profP2 (continued)

Capability	Minimum performance
2 nd adjacent channel interference at BER=10 ⁻³ for 3 dB degradation C/I for QPSK	-34 dB
2 nd adjacent channel interference at BER=10 ⁻³ for 3 dB degradation C/I for 16-QAM	-27 dB
2 nd adjacent channel interference at BER=10 ⁻³ for 3 dB degradation C/I for 64-QAM	-20 dB
2 nd adjacent channel interference at BER=10 ⁻³ for 1 dB degradation C/I for QPSK	-30 dB
2 nd adjacent channel interference at BER=10 ⁻³ for 1 dB degradation C/I for 16-QAM	-22 dB
2 nd adjacent channel interference at BER=10 ⁻³ for 1 dB degradation C/I for 64-QAM	-16 dB
2 nd adjacent channel interference at BER=10 ⁻⁶ for 3 dB degradation C/I for QPSK	-30 dB
2 nd adjacent channel interference at BER=10 ⁻⁶ for 3 dB degradation C/I for 16-QAM	-23 dB
2 nd adjacent channel interference at BER=10 ⁻⁶ for 3 dB degradation C/I for 64-QAM	-16 dB
2 nd adjacent channel interference at BER=10 ⁻⁶ for 1 dB degradation C/I for QPSK	-26 dB
2 nd adjacent channel interference at BER=10 ⁻⁶ for 1 dB degradation C/I for 16-QAM	-20 dB
2 nd adjacent channel interference at BER=10 ⁻⁶ for 1 dB degradation C/I for 64-QAM	-12 dB
Tx Power Level absolute accuracy	± 6 dB

BSs implementing profP2 shall meet the minimum transmitter performance requirements listed in Table 391. The receiver shall meet the minimum performance requirements in Table 392.

Table 391—BS Tx minimum performance for profP2

Capability	Minimum performance
Peak-to-peak symbol jitter, referenced to the previous symbol zero crossing of the transmitted waveform, as percentage of the nominal symbol duration when measured over a period of 2 seconds	2%
Tx RF frequency	10–66 GHz
Tx RF frequency accuracy	± 10*10 ⁻⁶

Table 391—BS Tx minimum performance for profP2 (continued)

Spectral mask (OOB)	local regulation
Spurious	local regulation
Ramp up/ramp down time	≤ 24 symbols
Modulation accuracy when measured with an ideal receiver without an equalizer for QPSK	12%
Modulation accuracy when measured with an ideal receiver without an equalizer for 16-QAM	6%
Modulation accuracy when measured with an ideal receiver with an equalizer for QPSK	10%
Modulation accuracy when measured with an ideal receiver with an equalizer for 16-QAM	3%
Modulation accuracy when measured with an ideal receiver with an equalizer for 64-QAM	1.5%

Table 392—BS Rx minimum performance for profP2

Capability	Minimum performance
Dynamic Range	27 dB for QPSK
BER performance threshold for QPSK, BER=10 ⁻³	-94 + 10log(28) dBm
BER performance threshold for 16-QAM, BER=10 ⁻³	-87 + 10log(28) dBm
BER performance threshold for 64-QAM, BER=10 ⁻³	-79 + 10log(28) dBm
BER performance threshold for QPSK, BER=10 ⁻⁶	-90 + 10log(28) dBm
BER performance threshold for 16-QAM, BER=10 ⁻⁶	-83 + 10log(28) dBm
BER performance threshold for 64-QAM, BER=10 ⁻⁶	-74 + 10log(28) dBm
1 st adjacent channel interference at BER=10 ⁻³ for 3 dB degradation C/I for QPSK	-9 dB
1 st adjacent channel interference at BER=10 ⁻³ for 3 dB degradation C/I for 16-QAM	-2 dB
1 st adjacent channel interference at BER=10 ⁻³ for 3 dB degradation C/I for 64-QAM	+5 dB
1 st adjacent channel interference at BER=10 ⁻³ for 1 dB degradation C/I for QPSK	-5 dB
1 st adjacent channel interference at BER=10 ⁻³ for 1 dB degradation C/I for 16-QAM	+2 dB
1 st adjacent channel interference at BER=10 ⁻³ for 1 dB degradation C/I for 64-QAM	+9 dB
1 st adjacent channel interference at BER=10 ⁻⁶ for 3 dB degradation C/I for QPSK	-5 dB
1 st adjacent channel interference at BER=10 ⁻⁶ for 3 dB degradation C/I for 16-QAM	+2 dB

Table 392—BS Rx minimum performance for profP2 (continued)

1 st adjacent channel interference at BER=10 ⁻⁶ for 3 dB degradation C/I for 64-QAM	+9 dB
1 st adjacent channel interference at BER=10 ⁻⁶ for 1 dB degradation C/I for QPSK	-1 dB
1 st adjacent channel interference at BER=10 ⁻⁶ for 1 dB degradation C/I for 16-QAM	+6 dB
1 st adjacent channel interference at BER=10 ⁻⁶ for 1 dB degradation C/I for 64-QAM	+13 dB
2 nd adjacent channel interference at BER=10 ⁻³ for 3 dB degradation C/I for QPSK	-34 dB
2 nd adjacent channel interference at BER=10 ⁻³ for 3 dB degradation C/I for 16-QAM	-27 dB
2 nd adjacent channel interference at BER=10 ⁻³ for 3 dB degradation C/I for 64-QAM	-20 dB
2 nd adjacent channel interference at BER=10 ⁻³ for 1 dB degradation C/I for QPSK	-30 dB
2 nd adjacent channel interference at BER=10 ⁻³ for 1 dB degradation C/I for 16-QAM	-22 dB
2 nd adjacent channel interference at BER=10 ⁻³ for 1 dB degradation C/I for 64-QAM	-16 dB
2 nd adjacent channel interference at BER=10 ⁻⁶ for 3 dB degradation C/I for QPSK	-30 dB
2 nd adjacent channel interference at BER=10 ⁻⁶ for 3 dB degradation C/I for 16-QAM	-23 dB
2 nd adjacent channel interference at BER=10 ⁻⁶ for 3 dB degradation C/I for 64-QAM	-16 dB
2 nd adjacent channel interference at BER=10 ⁻⁶ for 1 dB degradation C/I for QPSK	-26 dB
2 nd adjacent channel interference at BER=10 ⁻⁶ for 1 dB degradation C/I for 16-QAM	-20 dB
2 nd adjacent channel interference at BER=10 ⁻⁶ for 1 dB degradation C/I for 64-QAM	-12 dB

12.1.2.2.1 FDD Specific WirelessMAN-SC 28 MHz Channel PHY Profile Features

Profile identifier: profP2f.

Mandatory features:

- FDD operation
- BS must respect half-duplex nature of half-duplex SSs

12.1.2.2.2 TDD Specific WirelessMAN-SC 28 MHz Channel PHY Profile Features

Profile identifier: profP2t.

Mandatory features:

- TDD operation

12.1.2.3 Conventions for MAC Management messages for profiles profP1 and profP2

The following rules shall be followed when reporting parameters in MAC Management messages for systems operating PHY profiles profP1 or profP2:

- Symbol Rate, Frequency, and Roll-off Factor shall not be reported in UCD messages.
- BCC Code Type shall not be reported in UCD messages.
- Frame Duration shall not be reported in DCD messages.
- BCC Code Type shall not be reported in DCD messages.
- Uplink Channel Override shall not be reported in RNG-RSP messages.

12.1.2.4 UCD and DCD parameter transmission order for profP1 and profP2

The following subclauses define the order in which systems meeting profiles profP1 and profP2 shall transmit the TLV encoded parameters in the respective messages. Systems implementing either profile shall only include the parameters listed under the respective message in its transmission of these messages. Parameters with defined default values should be omitted if the desired value coincides with the default one.

12.1.2.4.1 DCD

- BS Transmit Power
- PHY Type
- Power Adj Rule
- Downlink Burst Profile(s)
- Modulation Type
- FEC Code Type (default to RS only if omitted)
- RS Information Bytes
- RS parity bytes
- Last Codeword Length (default to shortened if omitted)
- Exit Threshold
- Entry Threshold
- Preamble Present (default to “not present” if omitted)

12.1.2.4.2 UCD

- SS Transition Gap (default to 24 symbols if omitted)
- Power Adjustment Rule
- Contention-based Reservation Timeout
- Uplink Burst Profile(s)
- Modulation Type
- Preamble Length
- FEC Code Type (default to RS only)
- RS Information Bytes
- RS Parity Bytes

- Randomizer Seed
- Last Codeword Length (default to shortened)

12.1.2.5 Initial Ranging IE usage for profP1 and profP2

BSs implementing profP1 or profP2 shall include exactly one Initial Ranging IE in the UL-MAP for each intended opportunity for an SS to perform Initial Ranging.

12.2 WirelessMAN-SCa and WirelessHUMAN(-SCa) system profiles

This subclause specifies system profiles for systems using the WirelessMAN-SCa PHY. Its scope includes both licensed and license-exempt (WirelessHUMAN) operation.

A WirelessMAN-SCa system profile contains four components: MAC profiles (12.2.1), a power class profile (12.2.2), a PHY profile with an associated duplexing selection (12.2.3), and an RF channelization profile (12.2.4).

12.2.1 WirelessMAN-SCa MAC System Profiles

This subclause defines MAC profiles for systems operating with the WirelessMAN-SCa air interface.

12.2.1.1 Basic ATM MAC System Profile

Profile identifier: profM4.

Mandatory features:

- Support of PVCs
- Support of VC-switched connections
- Support of VP-switched connections
- ATM payload header suppression is mandatory as a capability, but may be turned on or off on a per connection basis
- IPv4 on the Secondary Management connection
- Packing of multiple ATM cells into a single MAC PDU is mandatory as a capability, but may be turned on or off on a per connection basis
- SDU fragmentation on the Primary Management and Secondary management connections
- ARQ is mandatory as a capability, but may be turned on or off on a per connection basis
- Handling of undecodable transmissions in an initial ranging slot

Conditionally mandatory features:

- If nrtPS or BE services are supported, then the SS responding to broadcast polling is mandatory
- If multicast polling groups are supported, multicast polling must be supported

12.2.1.2 Basic Packet MAC System Profile

Profile identifier: profM5.

Mandatory features:

- Support of provisioned connections
- IPv4 support on transport connection
- Classification of packets in the SS based on the incoming physical port

- Reception of multiple SDUs packed into a single MAC PDU is mandatory as a capability, but may be turned on or off on a per connection basis
- Fragmentation of SDUs is mandatory as a capability, but may be turned on or off on a per connection basis
- ARQ is mandatory as a capability, but may be turned on or off on a per connection basis
- Handling of undecodable transmissions in an initial ranging slot

Conditionally mandatory features:

- If nrtPS or BE services are supported, then the SS responding to broadcast polling is mandatory
- If multicast polling groups are supported, multicast polling must be supported

12.2.1.3 Conventions for MAC Management Messages for profiles profM4 and profM5

The following rules shall be followed when reporting parameters in MAC Management messages:

- Service Class Names should not be used
- DSC-REQ messages shall not contain Request/Transmission Policy, Fixed vs. Variable Length SDU Indicator, SDU Size, ATM Switching, or Convergence Sublayer Specification TLVs

12.2.2 WirelessMAN-SCa Power class profiles

A power class profile contains the class(es) of BS and SS transmitters used in a system. A power class profile may contain transmitters from more than one class, with the profile indicating the highest power level class permitted.

The power classes for BS and SS transmitters in a system are listed in Table 393.

The power ratings, $P_{Tx,max}$, associated with these classes are the maximum average output power ratings at which the appropriate transmitter requirements in Table 394 or Table 396 are met.

Table 393—Power classes

Class identifier	Transmit Power (dBm)
Class 1	$17 \leq P_{Tx,max} < 20$
Class 2	$20 \leq P_{Tx,max} < 23$
Class 3	$23 \leq P_{Tx,max} < 30$
Class 4	$30 \leq P_{Tx,max}$

12.2.3 WirelessMAN-SCa Physical Layer (PHY) Profiles

This subclause specifies PHY profiles for systems using the WirelessMAN-SCa PHY. The scope includes both licensed and license-exempt (WirelessHUMAN) operation.

Table 394 and Table 395 list minimum Tx and Rx performance requirements for an SS. Table 396 and Table 397 list minimum Tx and Rx performance requirements for a BS. Elements in these tables that are not applicable to a particular profile (such as those governing modulations not used by a profile) may be disregarded.

Table 394—SS minimum Tx performance requirements

Capability	Minimum performance
RF frequency	A frequency band (but not necessarily all bands) below 11 GHz
RF frequency accuracy	$\pm 15 * 10^{-6}$
Tx dynamic range	≥ 30 dB
RMS power level at maximum power level setting	≥ 15 dBm
Power level minimum adjustment step	1 dB
Power level adjustment step relative accuracy	Monotonic, $\pm 25\%$ of adjustment step, but ≤ 4 dB
Power level absolute accuracy	± 6 dB
Peak-to-peak symbol jitter, referenced to the previous symbol zero-crossing of the transmitted waveform, as percentage of nominal symbol duration when measured over period of 2 seconds	2%
Burst timing step size	± 0.25 of a symbol
Burst timing step size accuracy	± 0.125 of a symbol
Spectral mask (OOB)	Local regulation
Ramp up/ramp down time	≤ 5 μ s
Output noise power spectral density when not transmitting	Local regulation; ≤ -80 dBm/Hz when no regulation
Transmitter minimum SNR at antenna feed point	40 dB
Transition time from Tx to Rx and from Rx to Tx	TDD: 2 μ s H-FDD: 20 μ s FDD: n/a

Table 395—SS minimum Rx performance requirements

Capability	Minimum performance
Maximum on-channel input level	-20 dBm
Maximum on-channel input level without Rx damage	0 dBm

Table 395—SS minimum Rx performance requirements (continued)

Capability	Minimum performance
Transition time from Tx to Rx and from Rx to Tx	TDD: 2 μ s H-FDD: 20 μ s FDD: n/a
Uncoded sensitivity at BER = 10^{-3}	BPSK: $-96.2 + 10 \log(\text{BW in MHz})$ dBm QPSK: $-93.2 + 10 \log(\text{BW in MHz})$ dBm 16-QAM: $-86.2 + 10 \log(\text{BW in MHz})$ dBm 64-QAM: $-80.0 + 10 \log(\text{BW in MHz})$ dBm 256-QAM: $-73.8 + 10 \log(\text{BW in MHz})$ dBm
Transition time from Tx to Rx and from Rx to Tx	TDD: 2 μ s H-FDD: 20 μ s FDD: n/a
C/I, with interferer in first adjacent channel resulting in 3 dB degradation at BER = 10^{-3}	BPSK: < -12 dB QPSK: < -9 dB 16-QAM: < -2 dB 64-QAM: < +5 dB 256-QAM: < +12 dB
C/I, with interferer in first adjacent channel resulting in 1 dB degradation at BER = 10^{-3}	BPSK: < -8 dB QPSK: < -5 dB 16-QAM: < +2 dB 64-QAM: < +9 dB 256-QAM: < +16 dB
C/I, with interferer in second adjacent channel resulting in 3 dB degradation at BER = 10^{-3}	BPSK: < -37 dB QPSK: < -34 dB 16-QAM: < -27 dB 64-QAM: < -20 dB 256-QAM: < -13 dB
C/I, with interferer in second adjacent channel resulting in 1 dB degradation at BER = 10^{-3}	BPSK: < -33 dB QPSK: < -30 dB 16-QAM: < -22 dB 64-QAM: < -16 dB 256-QAM: < -9 dB

Table 396—BS minimum Tx performance requirements

Capability	Minimum performance
RF frequency	A frequency band (but not necessarily all bands) below 11 GHz
RF frequency accuracy	$\pm 8 * 10^{-6}$
Tx dynamic range	≥ 20 dB ± 3 dB
RMS power level at maximum power level setting	≥ 15 dBm
Power level minimum adjustment step	1 dB
Power level adjustment step relative accuracy	Monotonic, $\pm 25\%$ adjustment step, but ≤ 4 dB

Table 396—BS minimum Tx performance requirements (continued)

Capability	Minimum performance
Power level absolute accuracy	± 6 dB
Peak-to-peak symbol jitter, referenced to the previous symbol zero-crossing of the transmitted waveform, as percentage of nominal symbol duration when measured over a period of 2 seconds	2%
Spectral mask (OOB)	Local regulation
Spurious	Local regulation
Ramp up/ramp down time	< 5 μ s
Transmitter minimum SNR at antenna feed point	40 dB
Modulation accuracy when measured with an ideal receiver without an equalizer	BPSK: $< 12\%$ QPSK: $< 12\%$ 16-QAM: $< 6\%$ 64-QAM: < 3.1 256-QAM: $< 1.5\%$
Transition time from Tx to Rx and from Rx to Tx	TDD: 2 μ s H-FDD: 20 μ s FDD: n/a

Table 397—BS minimum Rx performance requirements

Capability	Minimum performance
Maximum on-channel input level	-40 dBm
Maximum on-channel input level without receiver damage	0 dBm
Uncoded sensitivity at BER = 10^{-3}	BPSK: $-96.2 + 10\log(\text{BW in MHz})$ dBm QPSK: $-93.2 + 10\log(\text{BW in MHz})$ dBm 16-QAM: $-86.2 + 10\log(\text{BW in MHz})$ dBm 64-QAM: $-80.0 + 10\log(\text{BW in MHz})$ dBm 256-QAM: $-73.8 + 10\log(\text{BW in MHz})$ dBm
C/I, with interferer in first adjacent channel resulting in 3 dB degradation at BER = 10^{-3}	BPSK: < -12 dB QPSK: < -9 dB 16-QAM: < -2 dB 64-QAM: $< +5$ dB 256-QAM: $< +12$ dB
C/I, with interferer in first adjacent channel resulting in 1 dB degradation at BER = 10^{-3}	BPSK: < -8 dB QPSK: < -5 dB 16-QAM: $< +2$ dB 64-QAM: $< +9$ dB 256-QAM: $< +16$ dB
C/I, with interferer in second adjacent channel resulting in 3 dB degradation at BER = 10^{-3}	BPSK: < -37 dB QPSK: < -34 dB 16-QAM: < -27 dB 64-QAM: < -20 dB 256-QAM: < -13 dB

Table 397—BS minimum Rx performance requirements (continued)

Capability	Minimum performance
C/I, with interferer in second adjacent channel resulting in 1 dB degradation at BER = 10^{-3}	BPSK: < -33 dB QPSK: < -30 dB 16-QAM: < -22 dB 64-QAM: < -16 dB 256-QAM: < -9 dB

All PHY profiles shall share the common characteristics in 12.2.3.1, while individual profiles shall be differentiated by the specific characteristics listed in 12.2.3.2. All Baseline profiles nominally support the mandatory concatenated FEC, and, through the inclusion of additional descriptors, are capable of specifying the use of BTC or CTC FEC options.

12.2.3.1 Common features of PHY profiles

All PHY profiles shall share characteristics listed in the ensuing descendent clauses.

For WirelessHUMAN operation, the channel BW shall be 10 MHz. For WirelessMAN operation, allowed channel bandwidths shall be limited to the regulatory provisioned bandwidth divided by any power of 2, but no less than 1.25 MHz.

12.2.3.1.1 Common Mandatory features

The following features shall be supported by all PHY profiles:

- Spread BPSK, QPSK, 16-QAM, 64-QAM downlink and UL
- Roll-off Factor = 0.25
- Symbol Rate (Mbd/s) = (BW in MHz - 0.088)/1.25
- RS code word length $N = 255$ bytes (with exception of shortened last RS code word)
- RS code words with $R = 16$ bytes
- Downlink Preamble composed of 3 UWs and 4 ramp-up symbols
- Uplink Preamble composed of 1–5 UWs and 4 ramp-up symbols
- No Pilot Words
- Block interleaver, $N_R = 10$
- Frame Duration 4 ms

The following features may be supported, but when supported, must conform to the parameters specified:

- 256-QAM downlink and uplink
- Downlink Pilot words with length 1 UW and interval 1024 symbols
- STC where
 - Downlink preamble composed of 3 UWs per half-dual block (6 UWs total) and 4 ramp-up symbols
 - Downlink STC blocks of length 1024 symbols with block burst profile “0”
 - Downlink Pilot word distribution, determined by Pilot Word DCD burst profile TLV
- Subchannel framing where
 - Preamble composed of 2 UWs,
 - Subchannel framing parameters $\{k,d\} = \{1,1\}$,
 - $r = 1024$ for 16 symbol UWs and $r = 4096$ for 64-symbol UWs

12.2.3.1.2 Conventions for MAC management messages for profiles

The following rules shall be followed when reporting parameters in MAC Management messages:

- Roll-off Factor shall be reported in UCD message.
- RS Information Byte and RS Parity Bytes shall be reported in UCD message.
- Burst Set Type and STC Parameters shall be reported in UCD message.

12.2.3.1.3 UCD and DCD parameters

12.2.3.1.3.1 and 12.2.3.1.3.2 specify the TLV-encoded parameters which shall be transmitted in the respective DCD and UCD messages by systems meeting a PHY profile. Systems implementing the profile shall only include the parameters listed under the respective message in its transmission of said messages. Parameters with defined default values should be omitted if the desired value coincides with the default one.

12.2.3.1.3.1 DCD

- BS EIRP
- TTG (omitted for FDD)
- RTG (omitted for FDD)
- Power Adjustment Rule
- $RSS_{IR,max}$
- MAC version
- Downlink Burst Profile(s)
- Modulation Type
- Exit Threshold
- Entry Threshold
- CC/CTC-specific Parameters
- Block Interleaver Depth (omitted if Modulation Type does not specify use of a block interleaver)
- BTC Code Selector (omitted if Modulation type does not specify use of a BTC)
- Spreading Parameters (omitted if Modulation type does not reference a spread BPSK type)

12.2.3.1.3.2 UCD

- Symbol Rate (omitted for TDD)
- Frequency (omitted for TDD)
- SSTG
- Power Adjustment Rule
- Contention-based Reservation Timeout
- Initial Ranging SSTG (if omitted, value is same as SSTG)
- Uplink Burst Profile(s)
- Modulation Type
- Preamble Length
- CC/CTC-specific Parameters
- Unique Word Length
- Pilot Word Parameters
- Burst set type
- Block Interleaver Depth (omitted if Modulation Type does not specify use of a block interleaver)
- BTC Code Selector (omitted if Modulation type does not specify use of a BTC)
- STC parameters (omitted if Burst set type is not STC)
- Spreading Parameters (omitted if Modulation type does not reference a spread BPSK type)
- Subchannel framing parameters (omitted if Burst set type does not specify subchannel usage)

12.2.3.2 Specific PHY profiles

12.2.3.2.1 FDD-specific PHY profile features

Mandatory features:

- FDD operation
- BS must respect half-duplex nature of half-duplex SSs
- Center Frequency and symbol rate for uplink must be reported in UCD channel encoding

12.2.3.2.2 TDD-specific PHY profile features

Mandatory features:

- TDD operation
- Center Frequency and symbol rate for uplink are not reported in UCD channel encoding

12.2.3.2.3 WirelessHUMAN-specific PHY profile features

Mandatory features:

- TDD operation
- Center Frequency and symbol rate for uplink are not reported in UCD channel encoding
- Channel Nr is reported in DCD channel encoding
- UW length 16, 64, and 256 symbols
- DFS capability
 - Detection of primary users with received signal strength in excess of -64 dBm
 - Channel switching within $300 \mu\text{s}$

12.2.3.2.4 ProfP6: WirelessMAN-SCa PHY profile A

Profile Identifier: profP6

Mandatory features:

- Symbol rate $SR \leq 1.25$ MBd/s
- UW length 16 symbols

12.2.3.2.5 ProfP7: WirelessMAN-SCa PHY profile B

Profile Identifier: profP7

Mandatory features:

- Symbol rate $1.25 \geq SR \geq 20$ MBd/s
- UW length 16, 64, and 256 symbols

12.2.3.2.6 ProfP8: WirelessMAN-SCa PHY profile C

Profile Identifier: profP8

Mandatory features:

- Symbol rate $SR > 20$ MBd/s
- UW length 256 symbols

12.2.4 WirelessMAN-SCa RF profiles**12.2.4.1 RF profiles for 3.5 MHz channelization****12.2.4.1.1 profR1**

Mandatory features:

- RF channels: (Uplink for FDD) $2524.75 + n \cdot 0.25$ MHz, $\forall n \in \{0, 1, \dots, 266\}$
 (Downlink for FDD) $2598.75 + n \cdot 0.25$ MHz, $\forall n \in \{0, 1, \dots, 266\}$
 Using FDD, n shall be identical for uplink and downlink.

12.2.4.1.2 profR2

Mandatory features:

- RF channels: (Uplink for FDD) $3411.75 + n \cdot 0.25$ MHz, $\forall n \in \{0, 1, \dots, 126\}$
 (Downlink for FDD) $3461.75 + n \cdot 0.25$ MHz, $\forall n \in \{0, 1, \dots, 126\}$
 Using FDD, n shall be identical for uplink and downlink.

12.2.4.1.3 profR3

Mandatory features:

- RF channels: (Uplink for FDD) $3501.75 + n \cdot 0.25$ MHz, $\forall n \in \{0, 1, \dots, 182\}$
 (Downlink for FDD) $3551.75 + n \cdot 0.25$ MHz, $\forall n \in \{0, 1, \dots, 182\}$
 Using FDD, n shall be identical for uplink and downlink.

12.2.4.1.4 profR4

Mandatory features:

- RF channels: (Uplink for FDD) $3601.75 + n \cdot 0.25$ MHz, $\forall n \in \{0, 1, \dots, 182\}$
 (Downlink for FDD) $3651.75 + n \cdot 0.25$ MHz, $\forall n \in \{0, 1, \dots, 182\}$
 Using FDD, n shall be identical for uplink and downlink.

12.2.4.1.5 profR5

Mandatory features:

- RF channels: (Uplink for FDD) $3701.75 + n \cdot 0.25$ MHz, $\forall n \in \{0, 1, \dots, 182\}$
 (Downlink for FDD) $3751.75 + n \cdot 0.25$ MHz, $\forall n \in \{0, 1, \dots, 182\}$
 Using FDD, n shall be identical for uplink and downlink.

12.2.4.2 RF profiles for 7 MHz channelization**12.2.4.2.1 profR6**

Mandatory features:

- RF channels: (Uplink for FDD) $2526.5 + n \cdot 0.25$ MHz, $\forall n \in \{0, 1, \dots, 252\}$
 (Downlink for FDD) $2600.5 + n \cdot 0.25$ MHz, $\forall n \in \{0, 1, \dots, 252\}$
 Using FDD, n shall be identical for uplink and downlink.

12.2.4.2.2 profR7

Mandatory features:

- RF channels: (Uplink for FDD) $3413.5 + n \cdot 0.25$ MHz, $\forall n \in \{0, 1, \dots, 112\}$
(Downlink for FDD) $3463.5 + n \cdot 0.25$ MHz, $\forall n \in \{0, 1, \dots, 112\}$
Using FDD, n shall be identical for uplink and downlink.

12.2.4.2.3 profR8

Mandatory features:

- RF channels: (Uplink for FDD) $3503.5 + n \cdot 0.25$ MHz, $\forall n \in \{0, 1, \dots, 168\}$
(Downlink for FDD) $3553.5 + n \cdot 0.25$ MHz, $\forall n \in \{0, 1, \dots, 168\}$
Using FDD, n shall be identical for uplink and downlink.

12.2.4.2.4 profR9

Mandatory features:

- RF channels: (Uplink for FDD) $3603.5 + n \cdot 0.25$ MHz, $\forall n \in \{0, 1, \dots, 168\}$
(Downlink for FDD) $3653.5 + n \cdot 0.25$ MHz, $\forall n \in \{0, 1, \dots, 168\}$
Using FDD, n shall be identical for uplink and downlink.

12.2.4.2.5 profR10

Mandatory features:

- RF channels: (Uplink for FDD) $3703.5 + n \cdot 0.25$ MHz, $\forall n \in \{0, 1, \dots, 168\}$
(Downlink for FDD) $3753.5 + n \cdot 0.25$ MHz, $\forall n \in \{0, 1, \dots, 168\}$
Using FDD, n shall be identical for uplink and downlink.

12.2.4.3 RF profiles for 10 MHz channelization**12.2.4.3.1 profR11**

Mandatory features:

- RF channels: $5000 + n \cdot 5$ MHz, $\forall n \in \{55, 57, 59, 61, 63, 65, 67\}$
- Spectral mask: See 8.6.2

12.2.4.3.2 profR12

Mandatory features:

- RF channels: $5000 + n \cdot 5$ MHz, $\forall n \in \{148, 150, 152, 154, 156, 158, 160, 162, 164, 166\}$
- Spectral mask: See 8.6.2

12.2.4.3.3 profR13

Mandatory features:

- RF channels: $5000 + n \cdot 5$ MHz, $\forall n \in \{147, 149, 151, 153, 155, 157, 159, 161, 163, 165, 167, 169\}$
- Spectral mask: See 8.6.2

12.2.4.4 RF profiles for 20 MHz channelization

12.2.4.4.1 profR14

Mandatory features:

- RF channels: $5000 + n \cdot 5$ MHz, $\forall n \in \{56, 60, 64\}$
- Spectral mask: See 8.6.2

12.2.4.4.2 profR15

Mandatory features:

- RF channels: $5000 + n \cdot 5$ MHz, $\forall n \in \{149, 153, 157, 161, 165\}$
- Spectral mask: See 8.6.2

12.2.4.4.3 profR16

Mandatory features:

- RF channels: $5000 + n \cdot 5$ MHz, $\forall n \in \{148, 152, 156, 160, 164, 168\}$
- Spectral mask: See 8.6.2

12.3 WirelessMAN-OFDM and WirelessHUMAN(-OFDM) System Profiles

This subclause defines system profiles for systems operating with the WirelessMAN-OFDM air interface and with the WirelessHUMAN interface where it uses the OFDM PHY.

A system profile consists of five components: a MAC profile, a PHY profile, a RF profile, a duplexing selection, and a power class. The defined PHY and MAC profiles are listed in Table 398.

Table 398—Profile definitions

Identifier	Description
profM3_PMP	WirelessMAN-OFDM Basic packet PMP MAC profile
profM3_Mesh	WirelessMAN-OFDM Basic packet Mesh MAC profile
profP3_1.75	WirelessMAN-OFDM 1.75 MHz channel basic PHY profile
profP3_3.5	WirelessMAN-OFDM 3.5 MHz channel basic PHY profile
profP3_7	WirelessMAN-OFDM 7 MHz channel basic PHY profile
profP3_3	WirelessMAN-OFDM 3 MHz channel basic PHY profile
profP3_5.5	WirelessMAN-OFDM 5.5 MHz channel basic PHY profile
profP3_10	WirelessHUMAN(-OFDM) 10 MHz channel basic PHY profile

The transmit power class profiles, as shown in Table 399, are based on the maximum mean transmit power $P_{Tx,max}$ using all non-guard subcarriers, for which the transmitter requirements as defined in 8.3.10 are met.

Table 399—Power classes profiles

Identifier	Transmit power performance
profC3_0	$P_{Tx,max} < 14$ dBm
profC3_14	$14 \leq P_{Tx,max} < 17$ dBm
profC3_17	$17 \leq P_{Tx,max} < 20$ dBm
profC3_20	$20 \leq P_{Tx,max} < 23$ dBm
profC3_23	$P_{Tx,max} \geq 23$ dBm

The duplexing shall be selected as follows: A system shall implement TDD and/or FDD. A FDD SS system may be implemented either as half-duplex or as full-duplex. A FDD BS system must respect the half-duplex nature of half-duplex SSs.

Using these conventions, a sample system profile is shown in Table 400. This sample system profile may also be represented by a concatenation of the profile components:

profM3_PMP.profP3_10.profR10_1.TDD.profC3_17.

Table 400—Sample system profile

Sample system profile
{
profM3_PMP
profP3_10
profR10_1
TDD
profC3_17
}

12.3.1 WirelessMAN-OFDM and WirelessHUMAN(-OFDM) MAC Profiles

This subclause defines MAC profiles for systems operating with the WirelessMAN-OFDM air interface and with the WirelessHUMAN interface where it uses the OFDM PHY.

12.3.1.1 ProfM3_PMP: Basic Packet PMP MAC System Profile

This profile specifies a set of capability requirements when a system is operating in the mandatory PMP mode. Table 401 lists the optional MAC features and designates whether they shall or may be implemented to comply with this profile.

Table 401—Optional feature requirements profM3_PMP

Optional Feature	Required?	Conditions/Notes
Packet convergence sublayer Payload header suppression Ipv4 over 802.3/Ethernet 802.3/Ethernet	Yes No Yes Yes	
ATM convergence sublayer	No	
Multicast polling groups Multicast polling	Yes	
CRC functionality	Yes	Elective per connection.
Unsolicited grant service functionality	No	
Real-Time Polling services	No	
Best effort services	Yes	
Non-Real-Time Polling services	Yes	
Cryptographic suites: No data encryption, no data authentication and 3-DES,128 CBC-Mode 56-bit DES, no data authentication and 3-DES,128 No data encryption, no data authentication and RSA, 1024 CBC-Mode 56-bit DES, no data authentication and RSA, 1024 AES, CCM mode, no data authentication and AES with 128-bit key	No Yes No No No	
Undecodable initial ranging feature	Conditional	Required for SS. Not required for BS.
ARQ	No	
Mesh	No	If used, apply profM3_Mesh
AAS	No	
DFS	Conditional	Required when intended for license exempt bands. Not required when intended for licensed bands.
BS capability for support of manageable SSs (creating secondary management connections, DHCP, TFTP, SNMP etc.)	Yes	

- Support of IPv4 capabilities at the Packet Convergence Sublayer means capability of classification and IPv4 datagrams encapsulation into MAC SDUs as specified in 5.2.6. It is relevant to both DL and UL.
- Support of IEEE 802.3/Ethernet capabilities at the Packet Convergence Sublayer means capability of classification and IEEE 802.3/Ethernet frames encapsulation into MAC SDUs as specified in 5.2.4. It is relevant to both DL and UL.
- Support of ARQ is defined as the minimum capability to support eight simultaneous ARQ connections.
- Support of CRC means ability to add CRC at Tx and ability to check CRC at Rx in the case when CRC presence is signaled by CI.

12.3.1.1.1 Conventions for MAC Management Messages

The following rules shall be followed when reporting parameters in MAC Management messages:

- Service Class Names should not be used.
- DSC-REQ messages shall not contain Request/Transmission Policy, Fixed vs. Variable Length SDU Indicator, SDU Size, ATM Switching, or Convergence Sublayer Specification TLVs.

12.3.1.1.2 MAC Management Message Parameter Transmission Order

TLVs within MAC Management messages shall be ordered as follows. Parameters for optional features shall occur after those listed for support of mandatory features. Features that are defined as optional, but are mandated by the implemented Profile, if any, shall be ordered as optional. Both mandatory and optional TLVs shall subsequently be sequenced in order of increasing Type value. Parameters with defined default values should be omitted if the desired value coincides with the default one.

12.3.1.2 ProfM3_Mesh: Basic Packet Mesh MAC System Profile

This profile specifies a set of capability requirements when a mesh enabled system is operating in the optional mesh mode. Table 402 lists the optional MAC features and designates whether they shall or may be implemented to comply with this profile.

Table 402—Optional feature requirements profM3_mesh

Optional Feature	Required?	Conditions/Notes
Packet convergence sublayer	Yes	
Payload header suppression	No	
Ipv4	Yes	
802.3/Ethernet	Yes	
ATM convergence sublayer	No	
Provisioned connections	No	
Classification of packets on incoming physical port	No	
Multicast polling groups	N/A	
Multicast polling		
CRC functionality	Yes	
Dynamic services	Yes	
Unsolicited grant service functionality	N/A	
Real-Time Polling services	N/A	
Best effort services	Yes	
Non-Real-Time Polling services	N/A	
Cryptographic suites:		
No data encryption, no data authentication and 3-DES,128	No	
CBC-Mode 56-bit DES, no data authentication and 3-DES,128	No	
No data encryption, no data authentication and RSA, 1024	No	
CBC-Mode 56-bit DES, no data authentication and RSA, 1024	Yes	
AES, CCM mode, no data authentication and AES with 128-bit key	No	
Undecodable initial ranging feature	N/A	
ARQ	Yes	
AAS	No	
DFS	Conditional	Required when intended for license exempt bands. Not required when intended for licensed bands.

- Support of ARQ functionality is mandatory as a capability, but may be turned on or off on a per packet basis. ARQ shall be used when the reliability bit in the Mesh CID is set to 1, and shall not be used otherwise. ARQ parameters shall be set to:

ARQ Window Size = 64_{DEC}

ARQ Retry Timeout = $\lceil 2 \cdot T_F \rceil_{\text{DEC}}$, with T_F the PHY dependent frame duration in μs .

ARQ Block Lifetime = $\lceil T_F/2 \rceil_{\text{DEC}}$, with T_F the PHY dependent frame duration in μs .

ARQ RX Purge Time Timeout = $\lceil 2 \cdot T_F \rceil_{\text{DEC}}$, with T_F the PHY dependent frame duration in μs .

ARQ Sync Loss Timeout = 0

ARQ Deliver in Order = 0

12.3.1.2.1 MAC Management message applicability

For a mesh-enabled system, the messages below and the corresponding functionality are always mandatory to implement:

MSH-NCFG
 MSH-NENT
 MSH-DSCH
 MSH-CSCH
 MSH-CSCF
 REG-REQ
 REG-RSP
 PKM-REQ
 PKM-RSP
 SBC-REQ
 SBC-RSP
 TFTP-CPLT
 TFTP-RSP
 RES-CMD

For a mesh enabled system, the following messages and the corresponding functionality are mandatory/optional whenever they are correspondingly optional/mandatory for a PMP system:

ARQ-Feedback

When operating in the mesh mode, the messages below and the corresponding functionality are not used (they are, however, implemented to support the mandatory PMP mode).

DL-MAP
 DCD
 DSA-ACK
 DSA-REQ
 DSA-RSP
 DSC-ACK
 DSC-REQ
 DSC-RSP
 DSD-RSP
 DSX-RVD
 UCD
 UL-MAP
 CLK-CMP
 DBPC-REQ
 DBPC-RSP
 DREG-CMD
 MCA-REQ
 MCA-RSP

RNG-REQ
RNG-RSP

Generally, the following procedures are different for a mesh node and a PMP node:

Synchronization
Network entry
Scheduling
Power control
Ranging

12.3.1.2.2 MAC Management Message Parameter Transmission Order

TLVs within MAC Management messages shall be ordered as follows. Parameters for optional features shall occur after those listed for support of mandatory features. Features that are defined as optional, but are mandated by the implemented Profile, if any, shall be ordered as optional. Both mandatory and optional TLVs shall subsequently be sequenced in order of increasing Type value. Parameters with defined default values should be omitted if the desired value coincides with the default one.

12.3.2 WirelessMAN-OFDM and WirelessHUMAN(-OFDM) Physical Layer Profiles

This subclause defines PHY profiles for systems operating with the WirelessMAN-OFDM and WirelessHUMAN(-OFDM) air interface.

The following set of parameters are common to all defined PHY profiles and shall be complied with in order to comply with each individual profile.

Table 403 lists the optional PHY features and designates whether they shall or may be implemented.

Table 403—Optional PHY feature requirements

Optional feature	Required?	Conditions/Notes
64-QAM	Yes	Required for license bands, but not required for license-exempt bands.
BTC	No	
CTC	No	
subchannelization	No	
STC	No	
Focused contention BW requesting	No	
T_g/T_b	Conditional	BS shall be capable of using at least one value. SS shall be capable of using entire set.

Table 404 lists minimum performance basic requirements for all defined profiles.

Table 404—Minimum Performance basic requirements

Capability	Minimum performance
Tx Dynamic range SS SS (if subchannelization supported) BS	≥ 30 dB ≥ 50 dB ≥ 10 dB
Tx Power Level minimum adjustment step	≤ 1 dB
Tx Power Level minimum relative step accuracy	$\leq \pm 50\%$ of step size, but not more than 4dB
Tx Spectral flatness Absolute difference between adjacent subcarriers: Deviation of average energy in each subcarrier from the measured energy averaged over all 200 active tones: Subcarriers -50 to -1 and $+1$ to $+50$: Subcarriers -100 to -50 and $+50$ to $+100$:	≤ 0.1 dB $\leq \pm 2$ dB $\leq +2/-4$ dB
Spectral mask (OOB)	Local regulation
Tx relative constellation error: BPSK-1/2 QPSK-1/2 QPSK-3/4 16-QAM-1/2 16-QAM-3/4 64-QAM-2/3 64-QAM-3/4	≤ -13.0 dB ≤ -16.0 dB ≤ -18.5 dB ≤ -21.5 dB ≤ -25.0 dB ≤ -28.5 dB ≤ -31.0 dB
Rx max. input level on-channel reception tolerance	≥ -30 dBm
Rx max. input level on-channel damage tolerance	≥ 0 dBm
1 st adjacent channel rejection at BER= 10^{-6} for 3 dB degradation C/I 16QAM-3/4 64QAM-3/4	≥ 11 dB ≥ 4 dB
2 nd adjacent channel rejection at BER= 10^{-6} for 3 dB degradation C/I 16QAM-3/4 64QAM-3/4	≥ 30 dB ≥ 23 dB
SSTTG and SSRTG: TDD and H-FDD	≤ 100 μ s
Reference frequency tolerance BS Mesh system	$\leq \pm 8 \cdot 10^{-6}$ $\leq \pm 20 \cdot 10^{-6}$

12.3.2.1 ProfP3_1.75: WirelessMAN-OFDM PHY profile for 1.75MHz channelization

Mandatory features:

- Licensed band usage only
- Channel bandwidth $BW = 1.75$ MHz
- BS shall select Frame duration from code set PMP:{2,4,6}. SSs shall be capable of operating with any of the Frame Durations indicated in the code set.

Systems implementing profP3_1.75 shall meet the minimum performance requirements listed in Table 405.

Table 405—Minimum Performance requirements for profP3_1.75

Capability	Minimum performance
T_b	= 128 μ s
BER performance threshold, BER= 10^{-6}	
BPSK-1/2	≤ -94 dBm
QPSK-1/2	≤ -91 dBm
QPSK-3/4	≤ -89 dBm
16QAM-1/2	≤ -84 dBm
16QAM-3/4	≤ -82 dBm
64QAM-2/3	≤ -77 dBm
64QAM-3/4	≤ -76 dBm
Threshold change if subchannelization used	$10 \cdot \log(N_{subchannels}/16)$
Reference frequency tolerance SS to BS synchronization tolerance	156.25 Hz
Reference time tolerance	$\pm (T_b/32)/2$

12.3.2.2 ProfP3_3.5: WirelessMAN-OFDM PHY profile for 3.5 MHz channelization

Mandatory features:

- Licensed band usage only
- Channel bandwidth $BW = 3.5$ MHz
- BS shall select Frame duration from code set PMP:{2,4,6}, Mesh:{1}. SSs shall be capable of operating with any of the Frame Durations indicated in the code set.

Systems implementing profP3_3.5 shall meet the minimum performance requirements listed in Table 406:

Table 406—Minimum Performance requirements for profP3_3.5

Capability	Minimum performance
T_b	= 64 μ s
BER performance threshold, BER= 10^{-6} BPSK-1/2 QPSK-1/2 QPSK-3/4 16QAM-1/2 16QAM-3/4 64QAM-2/3 64QAM-3/4	≤ -91 dBm ≤ -88 dBm ≤ -86 dBm ≤ -81 dBm ≤ -79 dBm ≤ -74 dBm ≤ -73 dBm
Threshold change if subchannelization used	$10 \cdot \log(N_{subchannels}/16)$
Reference frequency tolerance SS to BS synchronization tolerance Mesh to Mesh synchronization tolerance	≤ 312.5 Hz ≤ 468.75 Hz
Reference time tolerance	$\pm (T_b/32)/2$

12.3.2.3 ProfP3_7: WirelessMAN-OFDM PHY profile for 7 MHz channelization

Mandatory features:

- Licensed band usage only
- Channel bandwidth $BW = 7$ MHz
- BS shall select Frame duration from code set PMP:{2,4,6}, Mesh:{1}. SSs shall be capable of operating with any of the Frame Durations indicated in the code set.

Systems implementing profP3_7 shall meet the minimum performance requirements listed in Table 407:

Table 407—Minimum Performance requirements for profP3_7

Capability	Minimum performance
T_b	$= 32 \mu\text{s}$
BER performance threshold, $\text{BER}=10^{-6}$ BPSK-1/2 QPSK-1/2 QPSK-3/4 16QAM-1/2 16QAM-3/4 64QAM-2/3 64QAM-3/4	$\leq -88 \text{ dBm}$ $\leq -85 \text{ dBm}$ $\leq -83 \text{ dBm}$ $\leq -78 \text{ dBm}$ $\leq -76 \text{ dBm}$ $\leq -71 \text{ dBm}$ $\leq -70 \text{ dBm}$
Threshold change if subchannelization used	$10 \cdot \log(N_{\text{subchannels}}/16)$
Reference frequency tolerance SS to BS synchronization tolerance Mesh to Mesh synchronization tolerance	$\leq 625 \text{ Hz}$ $\leq 937.5 \text{ Hz}$
Reference time tolerance	$\pm (T_b/32)/2$

12.3.2.4 ProfP3_3: WirelessMAN-OFDM PHY profile for 3 MHz channelization

Mandatory features:

- Licensed band usage only
- Channel bandwidth $BW = 3.0 \text{ MHz}$
- BS shall select Frame duration from code set PMP:{2,4,6}, Mesh:{4}. SSS shall be capable of operating with any of the Frame Durations indicated in the code set.

Systems implementing profP3_3 shall meet the minimum performance requirements listed in Table 409:

Table 408—Minimum Performance requirements for profP3_3

Capability	Minimum performance
T_b	$= 73 \frac{99}{437} \mu\text{s}$
BER performance threshold, BER= 10^{-6} BPSK-1/2 QPSK-1/2 QPSK-3/4 16-QAM-1/2 16-QAM-3/4 64-QAM-2/3 64-QAM-3/4	≤ -91 dBm ≤ -88 dBm ≤ -87 dBm ≤ -81 dBm ≤ -80 dBm ≤ -75 dBm ≤ -73 dBm
Threshold change if subchannelization used	$10 \cdot \log(N_{subchannels}/16)$
Reference frequency tolerance SS to BS synchronization tolerance Mesh to Mesh synchronization tolerance	≤ 273.13 Hz ≤ 409.67 Hz
Reference time tolerance	$\pm (T_b/32)/2$

12.3.2.5 ProfP3_5.5: WirelessMAN-OFDM PHY profile for 5.5 MHz channelization

Mandatory features:

- Licensed band usage only
- Channel bandwidth $BW = 5.5$ MHz
- BS shall select Frame duration from code set PMP:{2,4,6}, Mesh:{4}. SSS shall be capable of operating with any of the Frame Durations indicated in the code set.

Systems implementing profP3_5.5 shall meet the minimum performance requirements listed in Table 409:

Table 409—Minimum Performance requirements for profP3_5.5

Capability	Minimum performance
T_b	$= 40 \frac{120}{157} \mu\text{s}$
BER performance threshold, BER= 10^{-6} BPSK-1/2 QPSK-1/2 QPSK-3/4 16-QAM-1/2 16-QAM-3/4 64-QAM-2/3 64-QAM-3/4	≤ -89 dBm ≤ -86 dBm ≤ -84 dBm ≤ -79 dBm ≤ -77 dBm ≤ -72 dBm ≤ -71 dBm
Threshold change if subchannelization used	$10 \cdot \log(N_{subchannels}/16)$
Reference frequency tolerance SS to BS synchronization tolerance Mesh to Mesh synchronization tolerance	≤ 490.63 Hz ≤ 735.94 Hz
Reference time tolerance	$\pm (T_b/32)/2$

12.3.2.6 profP3_10: WirelessHUMAN(-OFDM) PHY profile for 10 MHz channelization

Mandatory features:

- License-exempt band usage only
- Channel bandwidth $BW = 10$ MHz
- TDD operation
- BS shall select Frame duration from code set PMP:{2,4,6}, Mesh:{1}. SSs shall be capable of operating with any of the Frame Durations indicated in the code set.
- DFS capability
 - Ability to detect primary users with received signal strength in excess of -67 dBm
 - Ability to switch channel within $300 \mu\text{s}$

Systems implementing profP3_10 shall meet the minimum performance requirements listed in Table 410:

Table 410—Minimum Performance requirements for profP3_10

Capability	Minimum performance
T_b	$= 22 \frac{146}{357} \mu\text{s}$
Spectral mask (IB): $f_0 \pm 0$ MHz $f_0 \pm 4.75$ MHz $f_0 \pm 5.45$ MHz $f_0 \pm 9.75$ MHz $f_0 \pm 14.75$ MHz	Linear interpolation between points: 0 dBr 0 dBr -25 dBr -32 dBr -50 dBr
BER performance threshold, BER= 10^{-6} BPSK-1/2 QPSK-1/2 QPSK-3/4 16QAM-1/2 16QAM-3/4 64QAM-2/3 64QAM-3/4	≤ -86 dBm ≤ -83 dBm ≤ -81 dBm ≤ -76 dBm ≤ -74 dBm ≤ -69 dBm ≤ -68 dBm
Threshold change if subchannelization used	$10 \cdot \log(N_{subchannels}/16)$
Reference frequency tolerance SS to BS synchronization tolerance Mesh to Mesh synchronization tolerance	≤ 892.5 Hz ≤ 1339 Hz
Reference time tolerance	$\pm (T_b/32)/2$

12.3.3 WirelessMAN-OFDM RF profiles

For licensed bands, no explicit RF profiles are defined. A compliant system shall adhere to the requirements of 8.3.10.2 for the specified supported bands.

12.3.3.1 RF profiles for 10 MHz channelization

12.3.3.1.1 ProfR10_1

Mandatory features:

- RF channels: : $5000 + n \cdot 5$ MHz, $\forall n \in \{55, 57, 59, 61, 63, 65, 67\}$
- Spectral mask: See 8.5.2

12.3.3.1.2 profR10_2

Mandatory features:

- RF channels: : $5000 + n \cdot 5$ MHz, $\forall n \in \{148, 150, 152, 154, 156, 158, 160, 162, 164, 166\}$
- Spectral mask: See 8.5.2

12.3.3.1.3 profR10_3

Mandatory features:

- RF channels: $:5000 + n \cdot 5$ MHz, $\forall n \in \{147, 149, 151, 153, 155, 157, 159, 161, 163, 165, 167\}$
- Spectral mask: See 8.5.2

12.4 WirelessMAN-OFDMA and WirelessHUMAN(-OFDMA) system profiles

This subclause defines system profiles for systems operating with the WirelessMAN-OFDMA and WirelessHUMAN-OFDMA air interfaces.

Any feature not mandatory or conditionally mandatory for a profile is optional for the profile except where otherwise forbidden by the standard. Optional features shall be implemented as specified in the standard.

Table 411—Profile definitions

Identifier	Description
OFDMA_profM1	WirelessMAN-OFDMA basic packet PMP MAC Profile
OFDMA_profP1	WirelessMAN-OFDMA 1.25 MHz channel basic PHY Profile
OFDMA_profP2	WirelessMAN-OFDMA 3.5 MHz channel basic PHY Profile
OFDMA_profP3	WirelessMAN-OFDMA 7 MHz channel basic PHY Profile
OFDMA_profP4	WirelessMAN-OFDMA 14 MHz channel basic PHY Profile
OFDMA_profP5	WirelessMAN-OFDMA 28 MHz channel basic PHY Profile
OFDMA_profP6	WirelessHUMAN(-OFDMA) 10 MHz channel basic PHY Profile
OFDMA_profP7	WirelessHUMAN(-OFDMA) 20 MHz channel basic PHY Profile

12.4.1 WirelessMAN-OFDMA Power class profiles

A power class profile contains the class(es) of BS and SS transmitters used in a system. A power class profile may contain transmitters from more than one class, with the profile indicating the highest power level class permitted

The power classes for BS and SS transmitters in a system are listed in Table 412.

The power ratings, $P_{Tx,max}$, associated with these classes are the maximum average output power ratings at which the appropriate transmitter requirements in 8.4.12 are met.

Table 412—Power classes

Class identifier	Transmit power (dBm)
Class 1	$17 \leq P_{Tx,max} < 20$
Class 2	$20 \leq P_{Tx,max} < 23$
Class 3	$23 \leq P_{Tx,max} < 30$
Class 4	$30 \leq P_{Tx,max}$

12.4.2 WirelessMAN-OFDMA and WirelessHUMAN(-OFDMA) MAC Profiles

This subclause defines MAC profiles for systems operating with the WirelessMAN-OFDMA and WirelessHUMAN-OFDMA air interfaces.

12.4.2.1 Basic Packet PMP MAC Profile

Profile identifier: OFDMA_ProfM1.

Mandatory Features:

- Support of Packet convergence sublayer.
- Support of Internet Protocol Ipv4.
- Support IEEE 802.3/Ethernet specific part.
- CRC functionality shall be supported for all connections.
- Support of dynamic services.
- Support of Best effort services.
- Support of Non-Real-Time Polling services.
- Support of CDMA based Initial and Periodic Ranging.
- Support of Contention based CDMA bandwidth requests.
- DFS shall be required for the license exempt bands only.

12.4.2.1.1 Conventions for MAC Management Messages

The following rules shall be followed when reporting parameters in MAC Management messages:

- Service Class Names should not be used.
- No TLVs besides Error Encodings and HMAC Tuples shall be reported back in DSA-RSP and DSC-RSP messages.
- No TLVs besides HMAC Tuples shall be reported back in DSA-ACK messages.
- DSC-REQ messages shall not contain Request/Transmission Policy, Fixed vs. Variable Length SDU Indicator, SDU Size, ATM Switching, or Convergence Sublayer Specification TLVs.

12.4.2.1.2 MAC Management Message Parameter Transmission Order

Systems implementing the profile OFDMA_ProfM1 shall transmit the TLV encoded parameters for mandatory features in the respective messages. Those systems only include the parameters listed under the respective message in its transmission of these messages plus any parameters necessary for optional features. Parameters for optional features shall occur after those listed for support of mandatory features. For the required features, the relevant parameters shall be transmitted in order of increasing Type value of the parameter's TLV key. Parameters with defined default values should be omitted if the desired value coincides with the default one.

12.4.3 WirelessMAN-OFDMA and WirelessHUMAN(-OFDMA) System PHY Profiles

This subclause defines PHY profiles for systems operating with the WirelessMAN-OFDMA air interface and WirelessHUMAN-OFDMA air interfaces.

12.4.3.1 Common Features of PHY Profiles

All PHY profile shall share the common characteristics as defined in Table 413 while individual profiles shall be differentiated by the specific characteristics listed for each profile.

If one of the PHY profiles has a parameter, which is different from the parameter defined by the common parameters section, then the values stated in the PHY profile override the value stated in the common parameters section.

12.4.3.1.1 General implementation requirements

The following optional features are not required for implementation of any PHY profiles:

- BTC
- CTC
- 64-QAM
- STC

The following features must be supported by all PHY profiles:

Guard Time

- BS shall be capable of using at least one allowed value.
- SS shall be capable of detecting and using entire set of allowed values

Frame Duration

- SSs shall be capable of operating with any of the Frame Durations as defined at 8.4.5.2.

12.4.3.1.2 FDD-Specific PHY Profiles Features

Mandatory features:

- FDD Operation
- BS must respect half-duplex nature of half duplex SS
- Center Frequency for uplink must be reported in the UCD channel encoding

12.4.3.1.3 TDD-Specific PHY Profiles Features

Mandatory features:

- TDD Operation
- Center Frequency for uplink is not reported in the UCD channel encoding

12.4.3.1.4 WirelessHUMAN PHY Profiles Features

Mandatory features:

- TDD Operation

- Ability to detect primary users with received signal strength in excess of -61 dBm
- Center Frequency for uplink is not reported in the UCD channel encoding.
- Channel Nr is reported in DCD channel encoding
- Ability to switch channel within $300 \mu\text{s}$

12.4.3.1.5 Minimum performance requirements

Table 413 lists the minimum performance requirements needed for all profiles.

Table 413—Minimum performance requirements for all profiles

Capability	Minimum performance
Tx Dynamic range SS BS	≥ 30 dB ≥ 10 dB
Tx Power Level minimum adjustment step	≤ 1 dB
Tx Power Level minimum relative step accuracy	$\leq \pm 0.5$ dB
BS Spectral flatness, when using all subchannels. Absolute difference between adjacent subcarriers: (2.5dB should be added for Pilot carriers within the symbol due to their boosting). Deviation of average energy in each carrier from the measured energy averaged over all 1702 active tones: Carriers -425 to -1 and $+1$ to $+425$: Carriers -851 to -425 and $+425$ to $+851$:	≤ 0.1 dB $\leq \pm 2$ dB $\leq +2/-4$ dB
SS Spectral flatness, when using all subchannels. Absolute difference between adjacent subcarriers: (2.5 dB should be added for Pilot carriers within the symbol due to their boosting). Deviation of average energy in each carrier from the measured energy averaged over all 1696 active tones: Carriers -424 to -1 and $+1$ to $+424$: Carriers -848 to -424 and $+424$ to $+848$:	≤ 0.1 dB $\leq \pm 2$ dB $\leq +2/-4$ dB
Spectral mask (OOB)	Local regulation
Tx relative constellation error: QPSK-1/2 QPSK-3/4 16-QAM-1/2 16-QAM-3/4 64-QAM-2/3 (if 64-QAM supported) 64-QAM-3/4 (if 64-QAM supported)	≤ -19.4 dB ≤ -21.2 dB ≤ -26.4 dB ≤ -28.2 dB ≤ -32.7 dB ≤ -34.4 dB
Rx max. input level on-channel reception tolerance	≥ -30 dBm
Rx max. input level on-channel damage tolerance	≥ 0 dBm

Table 413—Minimum performance requirements for all profiles (continued)

Capability	Minimum performance
Number Of Subchannels Supported when receiving/ transmitting SS BS	1-32 1-32
1 st adjacent channel rejection at BER= 10^{-6} for 3 dB degradation C/I 16-QAM-3/4 64-QAM-3/4 (if 64-QAM supported)	≥ 11 dB ≥ 4 dB
2 nd adjacent channel rejection at BER= 10^{-6} for 3 dB degradation C/I 16-QAM-3/4 64-QAM-3/4 (if 64-QAM supported)	≥ 30 dB ≥ 23 dB
SSTG and SSRTG: TDD H-FDD	$\leq 50 \mu$ s $\leq 100 \mu$ s
Reference time tolerance	$\pm (T_b/32)/10$

12.4.3.2 WirelessMAN-OFDMA 1.25 MHz channel basic PHY Profile

Profile identifier: OFDMA_ProfP1.

Systems implementing OFDMA_ProfP1 shall meet the minimum performance requirements listed in Table 414:

Table 414—Minimum performance requirements for OFDMA_ProfP1

Capability	Minimum performance
Channel bandwidth	1.25 MHz
Operation mode	Licensed bands only
Tx Dynamic range SS BS	≥ 40 dB ≥ 10 dB
Tx relative constellation error: QPSK-1/2 16-QAM-3/4	≤ -22.4 dB ≤ -28.2 dB
1 st adjacent channel rejection at BER= 10^{-6} for 3 dB degradation C/I 16-QAM-3/4	≥ 30 dB
2 nd adjacent channel rejection at BER= 10^{-6} for 3 dB degradation C/I 16-QAM-3/4	≥ 80 dB

Table 414—Minimum performance requirements for OFDMA_ProfP1 (continued)

Capability	Minimum performance
BER performance threshold, BER=10 ⁻⁶ (using all subchannels BS/SS) QPSK-1/2 16-QAM-3/4 [Add to sensitivity 10*log ₁₀ (NumberOfSub-ChannelsUsed/32) when using less subchannels in the BS Rx]	≤ -90 dBm ≤ -80 dBm
Reference frequency tolerance BS SS to BS synchronization tolerance	≤ ± 1*10 ⁻⁶ ≤ 2 Hz
TTG (TDD only)	≥ 200 μs
RTG (TDD only)	≥ 5 μs
Frame duration code set	{4,7}

12.4.3.3 WirelessMAN-OFDMA 3.5 MHz channel basic PHY Profile

Profile identifier: OFDMA_ProfP2.

Systems implementing OFDMA_ProfP2 shall meet the minimum performance requirements listed in Table 415:

Table 415—Minimum Performance requirements for OFDMA_ProfP2

Capability	Minimum performance
Channel bandwidth	3.5 MHz
Operation mode	Licensed bands only
BER performance threshold, BER=10 ⁻⁶ (using all subchannels BS/SS) QPSK-1/2 QPSK-3/4 16QAM-1/2 16QAM-3/4 64QAM-2/3 (if 64-QAM supported) 64QAM-3/4 (if 64-QAM supported) [Add to sensitivity 10*log ₁₀ (NumberOfSub-ChannelsUsed/32) when using less subchannels in the BS Rx]	≤ -87 dBm ≤ -84 dBm ≤ -80 dBm ≤ -77 dBm ≤ -73 dBm ≤ -71 dBm
Reference frequency tolerance BS SS to BS synchronization tolerance	≤ ± 4*10 ⁻⁶ ≤ 20 Hz
Frame duration code set	{4,7}

12.4.3.4 WirelessMAN-OFDMA 7 MHz channel basic PHY Profile

Profile identifier: OFDMA_ProfP3.

Systems implementing OFDMA_ProfP3 shall meet the minimum performance requirements listed in Table 416:

Table 416—Minimum Performance requirements for OFDMA_ProfP3

Capability	Minimum performance
Channel bandwidth	7 MHz
Operation mode	Licensed bands only
BER performance threshold, BER= 10^{-6} (using all subchannels BS/SS) QPSK-1/2 QPSK-3/4 16QAM-1/2 16QAM-3/4 64QAM-2/3 (if 64-QAM supported) 64QAM-3/4 (if 64-QAM supported) [Add to sensitivity $10 \cdot \log_{10}(\text{NumberOfSubChannelsUsed}/32)$ when using less subchannels in the BS Rx]	≤ -84 dBm ≤ -81 dBm ≤ -77 dBm ≤ -74 dBm ≤ -71 dBm ≤ -68 dBm
Reference frequency tolerance BS SS to BS synchronization tolerance	$\leq \pm 4 \cdot 10^{-6}$ ≤ 40 Hz
Frame duration code set	{2,3,5}

12.4.3.5 WirelessMAN-OFDMA 8.75 MHz channel basic PHY Profile

Profile identifier: OFDMA_ProfP4.

Systems implementing OFDMA_ProfP4 shall meet the minimum performance requirements listed in Table 417:

Table 417—Minimum Performance requirements for OFDMA_ProfP4

Capability	Minimum performance
Channel bandwidth	8.75 MHz
Operation mode	Licensed bands only
BER performance threshold, BER= 10^{-6} (using all subchannels BS/SS) QPSK-1/2 QPSK-3/4 16QAM-1/2 16QAM-3/4 64QAM-2/3 (if 64-QAM supported) 64QAM-3/4 (if 64-QAM supported) [Add to sensitivity $10 \cdot \log_{10}(\text{NumberOfSubChannelsUsed}/32)$ when using less subchannels in the BS Rx]	≤ -82.5 dBm ≤ -79.5 dBm ≤ -75.5 dBm ≤ -72.5 dBm ≤ -68.5 dBm ≤ -66.6 dBm
Reference frequency tolerance BS SS to BS synchronization tolerance	$\leq \pm 4 \cdot 10^{-6}$ ≤ 48 Hz
Frame duration code set	{2, 4, 6, 8}
Spectrum mask	Local regulation

NOTE—When using this profile, the sampling frequency (see 8.4.2.4) shall be: $F_s = \text{floor}(n \times BW/2000) \times 2000$

12.4.3.6 WirelessMAN-OFDMA 14 MHz channel basic PHY Profile

Profile identifier: OFDMA_ProfP5.

Systems implementing OFDMA_ProfP4 shall meet the minimum performance requirements listed in Table 418:

Table 418—Minimum Performance requirements for OFDMA_ProfP5

Capability	Minimum performance
Channel bandwidth	14 MHz
Operation mode	Licensed bands only
BER performance threshold, $BER=10^{-6}$ (using all subchannels BS/SS) QPSK-1/2 QPSK-3/4 16-QAM-1/2 16-QAM-3/4 64-QAM-2/3 (if 64-QAM supported) 64-QAM-3/4 (if 64-QAM supported) [Add to sensitivity $10*\log_{10}(\text{NumberOfSubChannelsUsed}/32)$ when using less subchannels in the BS Rx]	≤ -81 dBm ≤ -78 dBm ≤ -74 dBm ≤ -71 dBm ≤ -67 dBm ≤ -65 dBm
Reference frequency tolerance BS SS to BS synchronization tolerance	$\leq \pm 4*10^{-6}$ ≤ 80 Hz
Frame duration code set	{2,3,5}

12.4.3.7 WirelessMAN-OFDMA 17.5 MHz channel basic PHY Profile

Profile identifier: OFDMA_ProfP6.

Systems implementing OFDMA_ProfP6 shall meet the minimum performance requirements listed in Table 419:

Table 419—Minimum Performance requirements for OFDMA_ProfP6

Capability	Minimum performance
Channel bandwidth	17.5 MHz
Operation mode	Licensed bands only
BER performance threshold, BER= 10^{-6} (using all subchannels BS/SS) QPSK-1/2 QPSK-3/4 16-QAM-1/2 16-QAM-3/4 64-QAM-2/3 (if 64-QAM supported) 64-QAM-3/4 (if 64-QAM supported) [Add to sensitivity $10 \cdot \log_{10}(\text{NumberOfSubChannelsUsed}/32)$ when using less subchannels in the BS Rx]	 ≤ -79.5 dBm ≤ -76.5 dBm ≤ -72.5 dBm ≤ -69.5 dBm ≤ -65.5 dBm ≤ -63.6 dBm
Reference frequency tolerance BS SS to BS synchronization tolerance	 $\leq \pm 4 \cdot 10^{-6}$ ≤ 97 Hz
Frame duration code set	{2, 4, 6, 8}
Spectrum mask	Local regulation

NOTE—When using this profile, the sampling frequency (see 8.4.2.4) shall be: $F_s = \text{floor}(n \times BW/2000) \times 2000$

12.4.3.8 WirelessMAN-OFDMA 28 MHz channel basic PHY Profile

Profile identifier: OFDMA_ProfP7.

Systems implementing OFDMA_ProfP7 shall meet the minimum performance requirements listed in Table 420:

Table 420—Minimum Performance requirements for OFDMA_ProfP7

Capability	Minimum performance
Channel bandwidth	28 MHz
Operation mode	Licensed bands only
BER performance threshold, $BER=10^{-6}$ (using all subchannels BS/SS) QPSK-1/2 QPSK-3/4 16-QAM-1/2 16QAM-3/4 64QAM-2/3 (if 64-QAM supported) 64QAM-3/4 (if 64-QAM supported) [Add to sensitivity $10*\log_{10}(\text{NumberOfSubChannelsUsed}/32)$ when using less subchannels in the BS Rx]	 ≤ -78 dBm ≤ -75 dBm ≤ -71 dBm ≤ -68 dBm ≤ -64 dBm ≤ -62 dBm
Reference frequency tolerance BS SS to BS synchronization tolerance	 $\leq \pm 4*10^{-6}$ ≤ 160 Hz
Frame duration code set	{2,3,5}

12.4.3.9 WirelessHUMAN(-OFDMA) 10 MHz channel basic PHY Profile

Profile identifier: OFDMA_ProfP8.

Systems implementing OFDMA_ProfP8 shall meet the minimum performance requirements listed in Table 421:

Table 421—Minimum Performance requirements for OFDMA_ProfP8

Capability	Minimum performance
Channel bandwidth	10 MHz
Operation mode	Licensed-exempt band usage only
BER performance threshold, BER= 10^{-6} (using all subchannels BS/SS) QPSK-1/2 QPSK-3/4 16QAM-1/2 16QAM-3/4 64QAM-2/3 (if 64-QAM supported) 64QAM-3/4 (if 64-QAM supported) [Add to sensitivity $10 \cdot \log_{10}(\text{NumberOfSubChannelsUsed}/32)$ when using less subchannels in the BS Rx]	≤ -82 dBm ≤ -79 dBm ≤ -75 dBm ≤ -72 dBm ≤ -68 dBm ≤ -66 dBm
Reference frequency tolerance BS SS to BS synchronization tolerance	$\leq \pm 4 \cdot 10^{-6}$ ≤ 55 Hz
Frame duration code set	{2,4,5}

12.4.3.10 WirelessHUMAN(-OFDMA) 20 MHz channel basic PHY Profile

Profile identifier: OFDMA_ProfP9.

Systems implementing OFDMA_ProfP9 shall meet the minimum performance requirements listed in Table 422:

Table 422—Minimum Performance requirements for OFDMA_ProfP9

Capability	Minimum performance
Channel bandwidth	20 MHz
Operation mode	Licensed-exempt band usage only
BER performance threshold, BER=10 ⁻⁶ (using all subchannels BS/SS) QPSK-1/2 QPSK-3/4 16QAM-1/2 16QAM-3/4 64QAM-2/3 (if 64-QAM supported) 64QAM-3/4 (if 64-QAM supported) [Add to sensitivity 10*log ₁₀ (NumberOfSub-ChannelsUsed/32) when using less subchannels in the BS Rx]	≤ -79 dBm ≤ -76 dBm ≤ -72 dBm ≤ -69 dBm ≤ -65 dBm ≤ -63 dBm
Reference frequency tolerance BS SS to BS synchronization tolerance	≤ ± 4*10 ⁻⁶ ≤ 110 Hz
Frame duration code set	{2,4,5}

12.4.4 WirelessMAN-OFDMA RF profiles

This subclause defined RF profiles for the WirelessMAN-OFDMA and WirelessHUMAN(-OFDMA) air interfaces.

Table 423 defines the RF channels for the license bands, the channels shall be calculated using the following formula: $F_{start} + n \cdot \Delta F_c, \forall n \in N_{range}$

where:

F_{start} is the start frequency for the specific band,

ΔF_c is the center frequency step,

N_{range} is the range values for the n parameter.

Table 423—License bands RF Profiles List

RF profile name	Channel bandwidth	Center frequency step ΔF_c	Uplink F_{start}	Downlink F_{start}	N_{range}
OFDMA_ProfR1	1.25	1.25	2150.625	N/A	{0,1,...,7}
OFDMA_ProfR2	1.25	1.25	2305.625	N/A	{0,1,...,12}
OFDMA_ProfR3	1.25	1.25	2345.625	N/A	{13,14,...,24}
OFDMA_ProfR4	1.25	1.25	2500.625	N/A	{0,1,...,150}
OFDMA_ProfR5	1.25	1.25	3400.625	N/A	{0,1,...,240}
OFDMA_ProfR6	3.5	1.75	2524.75	2598.75	{0,1,...,38}
OFDMA_ProfR7	3.5	1.75	3411.75	3461.75	{0,1,...,18}
OFDMA_ProfR8	3.5	1.75	3501.75	3551.75	{0,1,...,55}
OFDMA_ProfR9	3.5	1.75	3601.75	3651.75	{0,1,...,55}
OFDMA_ProfR10	3.5	1.75	3701.75	3751.75	{0,1,...,55}
OFDMA_ProfR11	7	1.75	2526.5	2600.5	{0,1,...,36}
OFDMA_ProfR12	7	1.75	3413.5	3463.5	{0,1,...,16}
OFDMA_ProfR13	7	1.75	3503.5	3553.5	{0,1,...,53}
OFDMA_ProfR14	7	1.75	3603.5	3653.5	{0,1,...,53}
OFDMA_ProfR15	7	1.75	3703.5	3753.5	{0,1,...,53}
OFDMA_ProfR16	14	1.75	2530	2604	{0,1,...,32}
OFDMA_ProfR17	14	1.75	3417	3467	{0,1,...,12}
OFDMA_ProfR18	14	1.75	3507	3550	{0,1,...,49}
OFDMA_ProfR19	14	1.75	3607	3650	{0,1,...,49}
OFDMA_ProfR20	14	1.75	3707	3750	{0,1,...,49}
OFDMA_ProfR21	28	1.75	2537	2611	{0,1,...,24}
OFDMA_ProfR22	28	1.75	3424	3467	{0,1,...,4}
OFDMA_ProfR23	28	1.75	3514	3557	{0,1,...,41}

Table 423—License bands RF Profiles List (continued)

RF profile name	Channel bandwidth	Center frequency step ΔF_c	Uplink F_{start}	Downlink F_{start}	N_{range}
OFDMA_ProfR24	28	1.75	3614	3657	{0,1,...,41}
OFDMA_ProfR25	28	1.75	3714	3757	{0,1,...,41}
OFDMA_ProfR26	10	5	5000	N/A	{55,57,59,61,63,65,67}
OFDMA_ProfR27	10	5	5000	N/A	{148, 150, 152, 154, 156, 158, 160, 162, 164, 166}
OFDMA_ProfR28	10	5	5000	N/A	{147, 149, 151, 153, 155, 157, 159, 161, 163, 165, 167, 169}
OFDMA_ProfR26	20	5	5000	N/A	{56,60,64}{149, 153, 157, 161, 165}
OFDMA_ProfR27	20	5	5000	N/A	{149, 153, 157, 161, 165}
OFDMA_ProfR28	20	5	5000	N/A	{148, 152, 156, 160, 164, 168}
OFDMA_ProfR29	8.75	0.125	2304.375	N/A	{0,...,730}
OFDMA_ProfR30	17.5	0.125	2308.75	N/A	{0,...,660}

NOTES:

- 1—For 10,20 MHz channels, a spectral mask as defined in 8.6.2 should be applied.
- 2—For FDD and H-FDD cases, both uplink and downlink shall have the same n value.

Annex A

(informative)

Bibliography

[B1] Alamouti, S. M., "A Simple Transmit Diversity Technique for Wireless Communications," *IEEE Journal on Select Areas in Communications*, vol. 16, no. 8, pp. 1451–1458, Oct. 1998.

[B2] ATM Forum Specification af-pnni-0055.000, Private Network-Network Interface Specification, Version 1.0, March 1996.

[B3] Branlund, D., "Stacked Carrier OFDM: Providing High Spectral Efficiency with Greater Coverage," Wireless Communications Association International 7th annual Technical Symposium, San Jose, CA, Jan. 17–19, 2001.¹⁸

[B4] Cantoni A., and Godara, L. C., "Fast Algorithm for Time Domain Broad Band Adaptive Array Processing," *IEEE Trans. Aerops. Electr. Syst.*, AES-18, 682, Sept. 1982.

[B5] CEN/TC 278 prEN 12253: *Road Transport and Traffic Telematics (RTTT) - Dedicated Short Range Communication (DSRC) - Physical Layer using Microwave at 5.8 GHz.*

[B6] CEPT/ERC/REC 70-03 Relating to the use of short range devices (SRD), <http://www.ero.dk/doc98/official/pdf/REC7003E.PDF>.

[B7] Chu, D. C., "Polyphase codes with good periodic correlation properties," *IEEE Transactions on Information Theory*, July 1972, pp. 531–532.

[B8] Craig, K. H., (Editor), *Propagation planning procedures for LMDS*, ACTS Project 215, CRABS, January 1999.

[B9] Drury G., Markarian G., and Pickavance K. "Coding and Modulation in Digital Television," KLUWER ACADEMIC Publishers, 2000, USA.

[B10] ERC/DEC/(99)23, *ERC Decision on the harmonised frequency bands to be designated for the introduction of HIPERLANs, 29-11-1999*, <http://www.ero.dk/doc98/official/pdf/DEC9923E.PDF>.

[B11] *ERC Report 15: Compatibility Studies Between Radar and WLANs Operating at Frequencies Around 5.5 GHz*, <http://www.ero.dk/doc98/Official/pdf/REP015.pdf>.

[B12] *ERC Report 72: Compatibility Studies Related to the possible Extension Band for HIPERLAN at 5 GHz*, <http://www.ero.dk/doc98/Official/pdf/REP072.pdf>.

[B13] Erceg, V., et al., "Channel models for fixed wireless access applications," http://www.wirelessman.org/tg3/contrib/802163c-01_29r4.pdf.

[B14] ETSI EN 300 674 v1.1.1 (1999-2) ERM RTTT; *Technical characteristics and test methods for Dedicated Short Range Communication (DSRC) transmission equipment (500 kbit/s / 250 kbit/s) operating in the 5,8 GHz Industrial, Scientific and Medical (ISM) band.*

¹⁸Contact WCAI at +1(202)452 7823 or sahar@wcai.com to obtain copy.

- [B15] ETSI EN 301 021 v1.4.1 (2001/03) Fixed Radio Systems; Point-to-multipoint equipment; Time division Multiple access (TDMA); Point-to-Multipoint digital radio systems bands in the range 3 GHz to 11 GHz.
- [B16] ETSI Technical Report TR 101 177 V1.1.1, Broadband Radio Access Networks (BRAN); Requirements and architectures for broadband fixed radio access networks (HIPERACCESS), May 1998.
- [B17] ETSI TS 101 475 v1.1.1 (2000-4) *BRAN HIPERLAN Type 2; Physical Layer*.
- [B18] Falconer, D. and Ariyavisitakul, S. L., “*Frequency Domain Equalization for 2–11 GHz Fixed Broadband Wireless systems*,” Tutorial, presented during Session #11 of IEEE 802.16 in Ottawa, Canada, Jan. 22, 2001.
- [B19] FCC CFR Title 47, part 15, http://www.fcc.gov/Bureaus/Engineering_Technology/Documents/cfr, Federal Communications Commission.
- [B20] FIPS 140-2, Security Requirements for Cryptographic Modules, May 2001.
- [B21] Frank R. L., and Zadoff, S. A., “*Phase shift pulse codes with good periodic correlation properties*,” IRE Transactions on Information Theory, Oct. 1962, pp. 381–382.
- [B22] Hagenauer J., “*The Turbo principle: Tutorial introduction and state of the art*,” in Proceedings of the International Symposium on Turbo Codes, Brest, France, Sept. 1997, pp. 1–11.
- [B23] IEEE 100™, *The Authoritative Dictionary of IEEE Standards Terms*, Seventh Edition.
- [B24] IEEE Std 802.1F™-1993, IEEE Standards for Local and Metropolitan Area Networks: Common Definitions and Procedures for IEEE 802 Management Information.
- [B25] IEEE Std 802.5™-1998, Information technology—Telecommunications and information exchange between systems—Local and metropolitan area networks—Specific requirements—Part 5: Token ring access method and physical layer specifications.
- [B26] IEEE Std 802.10™-1998, IEEE Standards for Local and Metropolitan Area Networks: Standard for Interoperable LAN/MAN Security (SILS).
- [B27] IEEE Std 802.10c™-1998, Interoperable LAN/MAN Security (SILS)—Key Management (Clause 3).
- [B28] IEEE Std 802.11™-1997, Information technology—Telecommunications and information exchange between systems—Local and metropolitan area networks—Specific requirements—Part 11: Wireless LAN Medium Access Control (MAC) and Physical Layer (PHY) specifications.
- [B29] IEEE Std 802.11a™-1999: *Wireless LAN Medium Access Control (MAC) and Physical Layer (PHY) specifications: High Speed Physical Layer in the 5 GHz Band*, http://standards.ieee.org/reading/ieee/std/lanman_select_802.11a-1999.pdf.
- [B30] IETF RFC 1750, “Randomness Recommendations for Security,” D. Eastlake, S. Crocker, J. Schiller, December 1994.
- [B31] ISO/IEC 7498-1, Information technology—Open Systems Interconnection—Basic Reference Model: The Basic Model, 1994.
- [B32] ITU, *ITU Radio Regulations*, Appendix S8, 1998 Edition.

- [B33] ITU-R Recommendation P.452, Prediction procedure for the evaluation of microwave interference between stations on the surface of the Earth at frequencies above about 0.7 GHz.
- [B34] ITU-R Recommendation P.530-8, Propagation data and prediction methods required for the design of terrestrial line-of-sight systems.
- [B35] ITU-R Recommendation F.1499, Radio transmission systems for fixed broadband wireless access (BWA) based on cable modem standards.
- [B36] Johnson, D. and Dudgeon, D., “*Array Signal Processing*,” Prentice-Hall, Englewood Cliffs, NJ, 1993.
- [B37] Liberti, J. C. and Rappaport, T. S., “*Smart Antenna for Wireless Communications*,” Prentice-Hall, Englewood Cliffs, NJ, 1999.
- [B38] Milewski, A., “Periodic Sequences with Optimal Properties for Channel Estimation and Fast Start-Up Equalization,” *IBM J. Res. Develop.*, Vol. 37, No.5, Sept. 1983, pp. 426-431.
- [B39] Sari H., and Karam, G., “*Orthogonal Frequency-Division Multiple Access and its Application to CATV Networks*,” European Transactions on Telecommunications (ETT), vol. 9, no. 6, pp. 507–516, Nov.–Dec. 1998.
- [B40] SCTE DSS 00-05 [DOCSIS SP-RFIV1.1-I05-000714], Radio Frequency Interface 1.1 Specification, July 2000.
- [B41] SCTE DSS 00-09, Baseline Privacy Plus Interface Specification, December 2000.
- [B42] Schneier, Bruce, *Applied Cryptography: Protocols, Algorithms, and Source Code in C*, 2nd Edition, John Wiley & Sons, 1994.
- [B43] Sydor J., *A proposed High Data Rate 5.2/5.8GHz Point to Multipoint MAN system*, IEEE 802.16hc-00/12, October 2000.
- [B44] U. K. Dept. of the Environment, Transport and the Regions, *Digest of environmental Statistics*, 15/3/2001, <http://www.environment.detr.gov.uk/des>.
- [B45] USA ITU-R WP7C/24, 8A-9B/3 (2000-2003) “*Analysis of potential interference between spaceborne SARS and U-NII devices around 5.3 GHz*,” <http://www.itu.int/itudoc/itu-r/sg7/docs/wp7c/2000-03/contrib/024e.html>.
- [B46] Viterbi, A. J., Wolf, J. K., Zehavi, E., and Padovani, R., “*A pragmatic approach to trellis-coded modulation*,” IEEE Communications Magazine, July 1989, pp. 11–19.
- [B47] Wolf, J. K., and Zehavi, E., “*P2 codes: Pragmatic trellis codes utilizing punctured convolutional codes*,” IEEE Communications Magazine, February 1995, pp. 94–99.

Annex B

(informative)

Supporting material for frequencies below 11 GHz

B.1 Targeted frequency bands

Table B.1 indicates frequency bands, and their allowed channel spacings, where WirelessMAN-SCa, WirelessMAN-OFDM or WirelessMAN-OFDMA may be applicable.

Table B.1—Frequency bands and channel allocation

Frequency bands (GHz) (licensed unless noted)		Allowed channel spacing	Reference
2.305–2.320 2.345–2.360		1 or $2 \times (5 + 5 \text{ MHz})$ or $1 \times 5 \text{ MHz}$ (Can be aggregated in any combinations) Interference Protection to digital audio radio satellite (DARS)	USA CFR 47 part 27 (WCS) See FCC Docket IB95-91 for potential (increased) interference from DARS repeaters.
2.150–2.162 2.500–2.690		125 kHz to $(n \times 6) \text{ MHz}$ Single or multiple, contiguous or non-contiguous and combinations. Interference Protection to video and ITFS users	USA CFR 47 part 21.901 (MDS) USA CFR 47 part 74.902 [ITFS, multichannel multipoint distribution service (MMDS)]
2.150–2.160 2.500–2.596 2.686–2.688		$1 \text{ MHz} - (n \times 6) \text{ MHz}$ (1 or 2-way) $25 \text{ kHz} - (n \times 25 \text{ kHz})$ “return” Contiguous channels preferred	Canada SRSP-302.5 (MCS) MDS service allocated to adjacent sub-bands (incl. separate “return” channels)
2.400–2.483.5 (license-exempt)		Frequency Hopping or Direct Sequence Spread Spectrum etc.	CEPT/ERC/REC 70-03 USA CFR 47 Part 15, subpart E [B19]
3.400–4.990	3.410–4.200	1.75–30 MHz paired with 1.75–30 MHz Symmetric only. (50 MHz or 100 MHz separation)	Rec. ITU-R F.1488 Annex II ETSI EN 301 021[B15], CEPT/ERC Rec. 14-03 E, CEPT/ERC Rec. 12-08 E
	3.400–3.700	$n \times 25 \text{ MHz}$ (single or paired) (50 MHz or 100 MHz separation if paired)	Rec. ITU-R F.1488 Annex I CITEL PCC.III/REC.47 (XII-99) Canada SRSP-303.4 (BWA)
	3.650–3.700	Rulemaking in progress	USA FCC Docket WT00-32
	4.940–4.990	Rulemaking in progress	USA FCC Dockets WT00-32 and ET-98-237

Table B.1—Frequency bands and channel allocation (continued)

Frequency bands (GHz) (licensed unless noted)		Allowed channel spacing	Reference
5.150–5.850 (license-exempt)	5.150–5.350	$n \times 20$ MHz (HIPERLAN) Restricted to Indoor Use	CEPT/ERC/REC 70-03
	5.470–5.725	$n \times 20$ MHz (HIPERLAN)	
	5.250–5.350	100 MHz maximum Restricted to Indoor Use	USA CFR 47 Part 15, subpart E [B19] USA CFR 47 Part 15, subpart C [B19]
	5.250–5.350	100 MHz maximum	
	5.725–5.850	125 MHz maximum	
10.000–10.680	3.5–28 MHz paired with 3.5–28 MHz. Symmetric only 350 MHz separation	CEPT/ERC/REC. 12-05 ETSI EN 301 021 [B15]	

B.2 License-exempt co-existence and interference analyses

B.2.1 Interference mitigation and sharing mechanisms

A number of license-exempt interference mitigation and sharing mechanisms are identified. Two categories are considered—mechanisms that fall within the scope of this standard and methods that fall outside that scope.

Within the scope of this standard, two methods are identified: DFS and transmit power control, both are mandated in this document (see 6.3.15 and 8.3.7.4, respectively) as well as by some regulatory regions (ERC/DEC/(99)23, [B10]).

Two methods outside the scope of this standard are identified—antenna directivity and antenna polarization.

B.2.1.1 DFS

As frequency planning is not practical in licensed-exempt bands, DFS can be used to avoid assigning a channel to a channel occupied by another system. DFS is generally based on comparison of a C/I threshold against idle time RSSI measurements. DFS is predominantly effective to combat interference from and to ground-based systems, such as RLANS, RTTT, radar and other WirelessHUMAN-compliant systems. It is generally ineffective to combat interference from and to airborne systems, such as airborne radars and satellites.

B.2.1.2 Transmit power control

With power control, the transmitter EIRP is reduced according to the link margin. Shorter link ranges result in lower transmitted power levels. For PMP systems, the average EIRP will typically be several decibels below the legal limit assuming that Ss are spread throughout the coverage area. For Mesh systems, this means that EIRP values decrease rapidly as customer deployment density increases. As power control is also influenced by C/I levels, the use of adaptive power control with DFS, where possible, tends to result in the most effective interference mitigation.

B.2.1.3 Antenna directivity

Antenna directivity, in horizontal but especially in vertical direction, can significantly reduce a BWA system's interference potential and resilience. Vertical directivity especially reduces the interference caused to satellite systems, which are designated primary users of part of the addressed bands. It also can significantly help reduce interference to and from indoor RLAN systems. Horizontal directivity significantly reduces the probability of interference to other systems (assuming interference is mainly caused in the main lobe), but tends to increase the severity of the interference, as the energy in the main lobe is generally higher.

B.2.1.4 Antenna polarization

Antenna cross-polarization in the 5-GHz band can achieve an isolation of up to 15 dB in LOS, but reduces significantly in near-LOS and NLOS environments. Most deployments use both horizontal and vertical polarization (circular polarization is not as common in currently known systems) to maximize spectral reuse. Polarization hence has the potential to provide some isolation between differently polarized systems, especially in LOS, but given the operational needs and implementation of most systems in the targeted spectrum, the effectiveness will be mostly marginal.

B.2.2 Services in the 5 GHz band

To enable co-existence studies, a short description of the systems and services in the 5-GHz bands is provided together with the necessary parameters for the subsequent interference analysis. This includes assumptions on parameters of WirelessHUMAN-compliant systems that are beyond the scope of this standard.

B.2.2.1 WirelessHUMAN PMP system

PMP are based upon the use of a central BS with distributed SSs.

Parameters shown in Table B.2 for sample BWA systems BWA1 and BWA2 are assumed.

Table B.2—Single U-NII BWA to synthetic aperture radar 4 (SAR-4) Interference

Parameter	BWA ₁	BWA ₂	units
Transmitted power (antenna port)	0		dBW
Antenna high elevation gain	0	-4	dB
Building loss (dB)	0		dB
Polarization	H/V	H/V	

B.2.2.2 WirelessHUMAN Mesh system

The Mesh deployment scenario is abstracted into a regular hexagonal shape as shown in Figure B.1. On each corner of each hexagon, one Mesh node is located. By parameterizing the distance between a set of neighboring nodes, different Mesh deployment density scenarios can relatively easily be analyzed.

If the distance between two nodes is denoted r , then from each node, there are 3 neighbors at distance r ; 6 nodes at distance $2r\sqrt{3}/2$; 3 nodes at distance $2r$; 6 nodes at distance $3r\sqrt{3}/2$; 6 nodes at distance $3r$; 12 nodes at distance $\sim 4r\sqrt{3}/2$; 3 nodes at distance $4r$; 12 nodes at distance $\sim 5r\sqrt{3}/2$ etc.

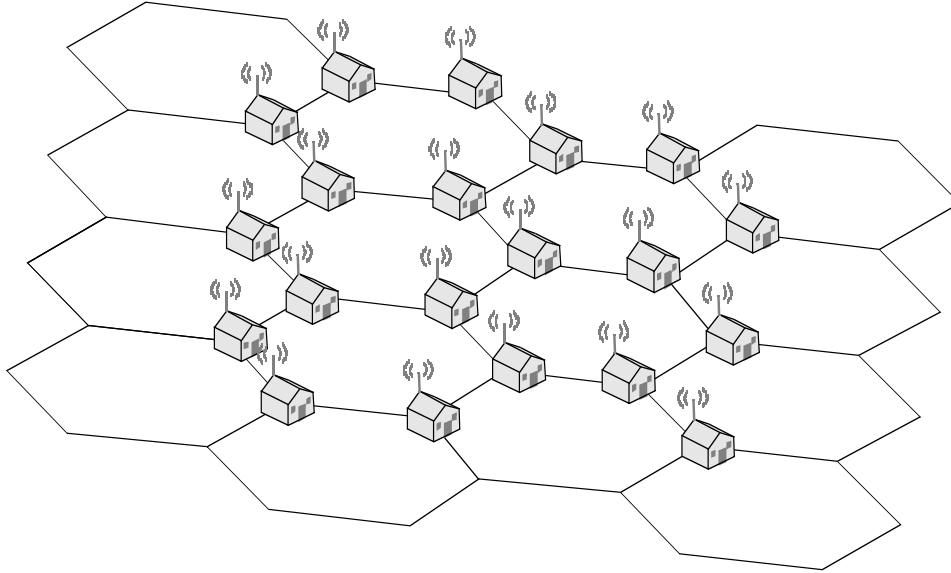

Figure B.1—WirelessHUMAN Mesh deployment model

Mesh devices that are close to each other cannot transmit at the same time on the same channel. This is normally defined in terms of extended neighborhoods, which comprises all nodes within two hops from the transmitting node. For modeling purposes, it is assumed that if a node is transmitting, all other nodes on the three hexagons that intersect on that node are silent. This translates into all nodes within a distance of $2r$ being silent.

In Table B.3, the topology and traffic assumptions are shown. The Tx activity of a node depends heavily on its position in the network, i.e., the amount of traffic that has to be forwarded from or to other nodes; and the activity of neighboring nodes. To keep the analysis simple, an average of 5% is assumed (This is based on the current average household internet usage of 30 minutes per day, as well as the activity probability during this on-time).

Table B.3—Tx activity parameters

Parameter	Value
Typical hops/packet	2
Total Tx activity	5%

Based on this model, the background interference at any node can be computed, which can be added to the interference from the node in question, resulting in the overall system interference.

B.2.2.2.1 Antenna parameters

The Mesh device is assumed to be using omni-directional antennas at all times, which is a worst-case assumption, as nonbroadcast communications between nodes could be performed with multiple antennas to reduce overall interference.

It is extremely important to notice that the Mesh device is by necessity a roof-mounted device, as it has to extend coverage in all directions. In contrast to PMP SSs, which are typically installed under the eaves, the amount of vertical scattering, which is harmful to both ground-based RLAN devices and satellites, is significantly less despite the lack of horizontal directivity. This is due to the relatively good probability of clear LOS of the nodes to each other due to their individual mounting location as well as the significantly shorter distances to each other than a PMP SS typically enjoys to its BS.

For these reasons, no extra scattering in the vertical direction is assumed for this evaluation besides the antenna pattern.

As shown in Table B.4, the antenna is an 8 dBi gain omni-directional antenna with a -22 dBi vertical gain and worst-case -15 dBi between 30° and 50° from vertical.

Table B.4—Antenna parameters

Parameter	Value
Mounting	Outdoors/rooftop
Gain (Horizontal omni-directional)	8 dBi @ 90° -22 dBi @ $0-30^\circ$ -15 dBi @ $30-50^\circ$
Polarization	Vertical

B.2.2.2.2 Radio parameters

Although 10 MHz channelization is also defined, the focus here is on the mandatory 20 MHz channelization, which gives the worst-case scenarios.

It is important to note that, throughout this study, the use of 6 dBW maximum EIRP is assumed for all parts of the spectrum with a backoff of only 3 dB for RLAN type devices. It should be understood that this study errs on the side of caution when considering the amount of interference that can be tolerated; as an example, in a practical OFDM system, the backoff is in the order of at least 6 dB minimum, whereas the rules commonly specify at most 0 dBW maximum mean EIRP (ERC/DEC/(99)23 [B10]) or 6 dBW maximum peak EIRP (FCC CFR Title 47 [B19]) for fractions of the band. The relevant assumed ratio parameters are shown in Table B.5.

Table B.5—Relevant radio parameters

Parameter	Value
Transmit power	28 dBm (i.e., 36 dBm maximum EIRP) with dynamic power control
20 dB bandwidth	21 MHz
Peak-to-Average power ratio	3 dB

The Rx sensitivity and C/I parameters are obtained from Equation (98) (NF = 7 dB, margin = 5 dB).

For the purpose of analytical full network interference analysis, the receiver sensitivity of the Mesh system is chosen to be -75 dBm, an average of the modulation and coding mode sensitivities up to rate 1/2, 16-QAM, which will be the most likely used in practical deployments.

B.2.2.3 Earth exploratory satellite system (EESS) and fixed satellite service (FSS)

Two types of satellite services are deployed in the 5 GHz—FSS and EESS services. EESS services are provided by two distinct types of satellite—Altimeter satellites and SAR satellites.

B.2.2.3.1 Altimeter satellites

The characteristics of altimeter satellites, as shown in Table B.6, have been derived from ERC *Report 72* [B12].

Table B.6—Altimeter satellite characteristics

Parameter	Value
Bandwidth	320 MHz
Rx sensitivity	-88 dBm
On-axis antenna gain	32.5 dBi
Off-axis antenna gain	$10^{3.25(\sin(\varphi)/\varphi)^2}$ ^a
Antenna size	1.2 m
Height	1344 km
Input loss = Output loss	1 dB
Coverage	$\varphi \in [-60^\circ, 60^\circ]$
Bandwidth	320 MHz

^a φ is the angle between the vertical and the direction of the ground-based device.

B.2.2.3.2 SAR satellites

The characteristics of SAR-1 through SAR-4 satellites, as shown in Table B.7, have been derived from ERC *Report 72* [B12].

Table B.7—Typical space borne imaging radar characteristics

Parameter	Value			
	SAR1	SAR2	SAR3	SAR4
Orbital altitude	426 km (circular)	600 km (circular)	400 km (circular)	400 km (circular)
Orbital inclination	57°	57°	57°	57°
RF Centre frequency	5305 MHz	5305 MHz	5305 MHz	5300 MHz

Table B.7—Typical space borne imaging radar characteristics (continued)

Parameter	Value			
	SAR1	SAR2	SAR3	SAR4
Peak radiated power	4.8 Watts	4800 Watts	1700 Watts	1700 Watts
Polarization	Horizontal (HH)	Horizontal and Vertical (HH,HV,VH,VV)	Horizontal and Vertical (HH,HV,VH,VV)	Horizontal and Vertical (HH,HV,VH,VV)
Pulse modulation	Linear FM chirp	Linear FM chirp	Linear FM chirp	Linear FM chirp
Pulse bandwidth	8.5 MHz	310 MHz	310 MHz	40 MHz
Pulse duration	100 μ s	31 μ s	33 μ s	33 μ s
Pulse repetition rate	650 pps	4492 pps	1395 pps	1395 pps
Duty cycle	6.5%	13.9%	5.9%	5.9%
Range compression ratio	850	9610	10230	1320
Antenna type	Planar phased array 0.5 m \times 16.0 m	Planar phased array 1.8 m \times 3.8 m	Planar phased array 0.7 m \times 12.0 m	Planar phased array 0.7 m \times 12.0 m
Antenna peak gain	42.2 dBi	42.9 dBi	42.7/38 dBi (full focus/beam-spoiling)	42.7/38 dBi (full focus/beam-spoiling)
Antenna median sidelobe gain	-5 dBi	-5 dBi	-5 dBi	-5 dBi
Antenna orientation	30° from nadir	20–38° from nadir	20–55° from nadir	20–55° from nadir
Antenna half-power beamwidth	8.5° (El), 0.25° (Az)	1.7° (El), 0.78° (Az)	4.9/18.0° (El), 0.25° (Az)	4.9/18.0° (El), 0.25° (Az)
Antenna polarization	Linear horizontal/ vertical	Linear horizontal/ vertical	Linear horizontal/ vertical	Linear horizontal/ vertical
System noise temperature	550 K	550 K	550 K	550 K
Image swath width	50 km	20 km	16 km/ 320 km	16 km/ 320 km

For both the SAR imaging missions and the topographic missions, a minimum SNR is defined, below which the radar image pixels, and/or differential phase measurements are unacceptably degraded. Studies suggest that:

- The degradation of the normalized standard deviation of power received from a pixel should be less than 10% in the presence of interference;
- The aggregate interference power-to-noise power ratio (corresponding to a pixel SNR of 0 dB) should be less than -6 dB;
- These levels may be exceeded upon consideration of the interference mitigation effect of SAR processing discrimination and the modulation characteristics of the radiolocation/ radio-navigation systems operating in the band;

- The maximum allowable interference level should not be exceeded for more than 1% of the images in the sensor service area for systematic occurrences of interference and should not be exceeded for more than 5% of the images in the sensor service area for random occurrences of interference.

The data loss criteria have been fully utilized to achieve sharing with the radio determination service. This study therefore uses the degradation interference criteria to derive the sharing constraints on BWA devices. Assuming that the interfering signal distribution is white Gaussian noise, the maximum acceptable interference signal is indicated in Table B.8.

Table B.8—Typical space borne imaging radar characteristics

Parameter	Value			
	Noise (dBW)	−129.5	−113.8	−113.8
Min. desired signal (dBW)	−189.7	−198.6	−187.1	−187.0
Max. acceptable interfering signal (dBW)	−135.5	−119.8	−119.8	−128.7
Receiver bandwidth (MHz)	9.8	356.5	356.5	46
Max. acceptable interfering spectral power density (dBW/Hz)	−205.4	−205.4	−205.4	−205.4
Antenna polarization	Linear horizontal/ vertical	Linear horizontal/ vertical	Linear horizontal/ vertical	Linear horizontal/ vertical
System noise temperature	550 K	550 K	550 K	550 K
Receiver front end 1 dB compression point ref to receiver input	−62 dBW input	−62 dBW input	−62 dBW input	−62 dBW input
Ground illumination area	93 km (elevation), 2.2 km (azimuth)	At 20° from nadir: 20 km (elevation), 8.7 km (azimuth)	At 20° from nadir: 40 km (elevation) 2 km (azimuth)	At 20° from nadir: 40 km (elevation) 2 km (azimuth)

B.2.2.3.3 FSS satellites

The characteristics of FSS satellites have been derived from ERC *Report 72* [B12].

The maximum allowable interference power spectral density tolerated by FSS satellites is given by

$$p = -42 + (G/T) - \gamma \quad \text{dBW/Hz} \quad (155)$$

where G is the gain of the satellite antenna, T the noise temperature (G/T is termed the merit factor), and γ the link gain. FSS satellites are geo-stationary and located at 36 000 km, resulting in 199 dB pathloss. In the case of the Telecom 3 network (ERC *Report 72* [B12]), which is used as an example, γ is 0 dB, the total link equivalent noise temperature is 870 K, the gain for the “Metropole” spot is 34 dBi and the coverage area of this spot is all of Europe. G/T then becomes 4.6 dB.

B.2.2.4 RLANs

The RLAN deployments considered here are the ETSI BRAN HIPERLAN/2 [B17] and IEEE 802.11a devices. Only indoor deployments are considered in detail. It is clear that outdoor RLAN devices cannot generally co-exist in the same channel with BWA devices in the same geographical area. However, the use of DFS, as well as the fact that the hotspot locations envisioned for outdoor RLAN deployments (such as airports and school campuses) do not generally coincide with the residential areas Mesh devices are targeted towards, easily resolve this type of RLAN deployments. The relevant RLAN assumptions are shown in Table B.9 and Table B.10.

Table B.9—RLAN Parameters I

Parameter	Value
Antenna type	Isotropical
Tx probability RLAN device	5%
Tx power	30 dBm maximum EIRP with dynamic power control
Radio access	TDD/TDMA

Table B.10—RLAN parameters II^a

Modulation	Coding rate	Rx sensitivity (dBm @ 10% PER)	C/I (dB @ 10% PER)
BPSK	1/2	-82	6
	3/4	-81	11
QPSK	1/2	-79	9
	3/4	-77	14
16-QAM	1/2	-74	16
	3/4	-70	20
64-QAM	1/2	-66	25
	3/4	-65	30

^aCopied from IEEE Std 802.11aTM-1999 [B29], Table 91.

B.2.2.5 Road transport and traffic telematics (RTTT)

Road transport and traffic telematics (RTTT) devices (ETSI EN 300 674 [B14]) are allocated in the band 5795-5805 MHz (2×5 or 1×10), with an extension band 5805-5815 MHz (2×5 or 1×10), which may be used on a national basis at multi-lane road junctions. These devices are split into the Road Side Unit (RSU) and the onboard unit (OBU), the parameters for which are shown in Table B.11 and Table B.12.

Table B.11—RTTT RSU parameters

Parameter	Value
Tx power (maximum EIRP)	3 dBW
Rx sensitivity	−105 to −130 dBW ^a
Antenna gain	20 dB
C/I: 2 / 4 / 8 - PSK	6 / 9 / 12 dB
Polarization	circular

^aThis range is merely informative. The device shall merely meet the manufacturer's claim.

Table B.12—RTTT OBU Parameters (−35° to +35°)

Parameter	Value	
Class	A,B,C,D	E
Re-radiated carrier power (maximum EIRP)	−54 dBW	−44 dBW
Antenna gain	1 dB	
Rx sensitivity	−73 dBW	−70 dBW
C/I: 2 / 4 / 8 -PSK	6 / 9 / 12 dB	C/I: 2 / 4 / 8 - PSK
Polarization	Circular	Polarization

In analyzing the compatibility between WirelessHUMAN systems and RTTT the basic approach taken is to use the Minimum Coupling Loss (MCL) technique to determine the necessary separation distances between the two systems.

$$\text{Minimum coupling loss: } L = P_t - \max \left\{ 10 \log \left(\frac{B_i}{B_{Rx}} \right), 0 \right\} - I_{Rx} \quad (156)$$

where

- P_t is the transmitter power,
- B_{Rx} is the receiver bandwidth (MHz),
- B_i is the interferer bandwidth (MHz),
- I_{Rx} is the tolerable interference at receiver (dBW).

Required separation distance: $d = \frac{\lambda}{4\pi} 10^{\text{pathloss}/23}$ where $\text{pathloss} = L + \text{Antenna and feeder gains and losses}$.

B.2.2.6 Radar

The radar parameters used in the radar analysis are taken from and ERC *Report 15* [B11] and ERC *Report 72* [B12]. In the analysis, the MCL technique described in B.2.2.5 will be used, with the exception that for the airborne radar (radar type B), a propagation exponent 2.0 instead of 2.3 is used.

Table B.13—Relevant radar parameters

Parameter	Value				
	A	B	C	D	E
Radar type	A	B	C	D	E
Peak EIRP (dBW)	98.6	26	60	93	97
Bandwidth _{radar} (MHz)	3	15	30	14	3
Antenna gain (dBi)	40	0	46	43	43
Tuning range (GHz)	5.30–5.60	5.70–5.80	5.40–5.82	5.25–5.85	5.60–5.65
Use	Transportable long range	Airborne	Fixed long range	Transportable multi-function	Fixed long range

B.2.3 WirelessHUMAN PMP interference analyses

B.2.3.1 Coexistence with SAR satellites in middle UNII

SAR-4 is used because the SAR-4 system is more interference sensitive than SAR-3, and the SAR-4 center frequency is 5.3 GHz. The SAR-4 scans a path from 20° to 55° from Nadir. This corresponds to Earth incident angles of 21° and 60°, which can be translated to angles of 69° and 30° with respect to the horizon. That is, any radiation from U-NII devices within that angular range could cause/contribute to satellite interference.

An approach that can be used in analyzing the interference potential from Middle U-NII BWA systems into space-borne SAR-4 receiver is to determine the worst-case signal power received from a single BWA transmitter at the space borne SAR. Then, the single interferer margin can be calculated by comparing the single BWA interferer level with the SAR-4 interference threshold. Knowing the SAR-4 footprint, the allowable density of active BWA transmitters can then be calculated, if a positive margin, as calculated from Table B.14, results from a single BWA interferer.

Table B.14—Single U-NII BWA to SAR-4 interference

Parameter	BWA ₁	BWA ₂	Units
Tx Power	0		dBW
Building loss	0		dB
Interference gain due to SS antenna directivity [B45]	-6		dB
Antenna high elevation gain	0	-4	dB
Pathloss (425.67 km)	-160.3		dB
Polarization gain (V/H → H/V)	-3		dB

Table B.14—Single U-NII BWA to SAR-4 interference (continued)

Parameter	BWA ₁	BWA ₂	Units
Noise figure	-4.62		dB
Noise power (46 MHz Rx bandwidth)	-122.73		dB
SAR-4 Interference threshold (I/N=-6dB)	128.71		dB
Margin (dB)	-4.71	-0.71	dB

Note that real-world antennas do not exhibit unity gain at high elevation look angles, and this feature can be used to mitigate interference.

A conclusion that can be drawn is that antenna directivity, if properly utilized, will provide interference margin for multiple transmitters. However, it should be noted that the satellite footprint is large (53 sq. km at 20° from Nadir and 208 sq. km at 55° from Nadir). Therefore, given the potential variables associated with the design, installation and maintenance of the various unlicensed transmitters, antenna directivity alone may not be sufficient to assure non-interference.

The margin calculation in Table B.14 includes 3 dB polarization loss. The fact that most PMP systems rely on polarization for maximizing channelization, as many as half of the U-NII transmitters in a given area could be transmitting on each polarization. If so, the 3 dB polarization loss may not be fully realizable.

If the satellite were restricted to one linear polarization and the U-NII transmitters were restricted to the other linear polarization, greater polarization isolation could be achieved. Given the operational needs of both services, this is unlikely to happen.

B.2.4 WirelessHUMAN Mesh interference analyses

B.2.4.1 Interference to EESS and FSS

B.2.4.1.1 Altimeter satellites

The interference from one Mesh node into the boresight of the SAR can be described by Equation (157)(see *ERC Report 72* [B12]).

$$P_r = \frac{P_m G_m G_a \lambda^2}{(4\pi)^2 R^2} L \quad (157)$$

where $P_m G_m = 6$ dBm (28 dBm Output power -22 dBi top lobe) is the EIRP of the Mesh antenna in the vertical direction, $G_a = 32.5$ dBi the gain of the altimeter antenna, $\lambda = 5.66$ cm the wavelength, $L = -1$ dB the input loss of the altimeter, and $R = 1344$ km the lowest orbit.

From this a value for $P_r = -132$ dBm can be obtained.

The altimeter interference threshold is -88 dBm; thus, it can be deduced that the altimeter can withstand the operation of huge numbers of Mesh devices simultaneously, since there is a 44 dB margin. Furthermore, the altimeter is built to provide measurements mainly over oceans and is not able to provide accurate data when a significant amount of land is in view of its antenna beam. From this analysis, it is clear that the altimeter will not suffer from the operation of Mesh networks; however, for completeness, the number of Mesh devices per square kilometer tolerable by the altimeter can be calculated.

The distance between the satellite and a Mesh node under angle φ is $R \tan(\varphi)$ km. Only freespace attenuation, which ignores atmospheric properties (which further attenuate the signal, especially when $\varphi \gg 0$) has been considered.

For simplicity, the three Mesh nodes that on average exist in one hexagon, are assumed to be in the centre point of the hexagon. The hexagon grid then reduces to a square grid with 3 nodes every 2 times the distance of a single set of nodes.

The value for P_r is then obtained as follows:

$$P_r = \sum_{r_1} \sum_{r_2} \frac{3P_m G_m G_a \lambda^2}{(4\pi)^2 R^2} L \left(1 + 4A \sum_{r_1} \sum_{r_2} \sin^2[2\varphi(r_1, r_2)] \right) \quad \forall \sqrt{r_1^2 + r_2^2} < \frac{R\sqrt{3}}{2} \quad \varphi = \arctan \left[\frac{2\sqrt{r_1^2 + r_2^2}}{R} \right] \quad (158)$$

where r_1 and r_2 enumerate over the square grid, and A is the activity factor.

This derivation is easily computed numerically. According to *Digest of environmental Statistics* [B44], significantly less than 15%^s of land is used for residential areas and normally a significant fraction of the footprint covers water as well. Hence a Residential fraction of 0.05 is introduced, to simulate clusters of nodes spread out over the whole satellite footprint. The receiver sensitivity is, as discussed in B.2.2.2.2, chosen to be -75 dBm.

^s Number includes land used for urban and other purposes, e.g., transport and recreation, and nonagricultural, semi-natural environments, e.g., sand dunes, grouse moors and non agricultural grasslands, and inland waters.

```

%Satellite specifications
Ga = 32.5;           % dBi Antenna gain
lambda = 0.0566;    % m Wavelength
L = -1;             % dB Insertion Loss
R = 1344;           % km Height
Int_limit = 88;     % dBm Interference limit
% Mesh specifications
Rbase = 0.5;        % km Distance between two Mesh nodes
AntGain = 8         % dBi Mesh antenna gain (max)
AntTop = -22        % dBi Mesh antenna gain (top-lobe)
RxSens = -105       % dBW Rx sensitivity Mesh
Pout = 28;          % dBm Max. output power Mesh
Backoff = 3;        % dB Average Backoff
Activity = 0.05;
pi = 3.1415;
pathloss = -20*log10(3E8/(4*pi*5.3E9))+2.3*10*log10(Rbase*1000);
PmGm = (pathloss - AntGain + FadingMargin + RxSens) + (AntTop-AntGain) -Backoff+ 30; %
dBm
Residential = 0.15; % fraction residential landuse
Pr1 = 0;nodes=0;
for r1 = Rbase : Rbase/sqrt(Residential): R*sqrt(3)/2
  for r2 = Rbase : Rbase/sqrt(Residential): R*sqrt(3)/2
    if( sqrt(r1*r1+r2*r2) < R*sqrt(3)/2)
      nodes = nodes+3;
      phi = atan( 2*sqrt(r1*r1+r2*r2)/R );
      Pr1 = Pr1 + sinc(2*phi/pi)*sinc(2*phi/pi);
    end;
  end;
end;

```

Figure B.2—Mesh interference code sample

The result of the simulation, as shown in Figure B.2, is that over 30 million nodes can be supported under the footprint, with 6 dB in interference margin. In many cases, shorter distances between the nodes will result in lower used power due to power control. Hence, in practice many more nodes could be supported without violating the interference limit.

B.2.4.1.2 SAR satellites

In analogy with ERC *Report 72* [B12], only the case for SAR-1 satellites is examined, since this provides the worst-case analysis. However, contrary to this report, it will show that, using Mesh technology, an increase in network density actually reduces the interference into the SAR satellite, since the dynamic power-control reduces the power for shorter links. The receiver sensitivity is, as discussed in B.2.2.2.2, chosen to be -75 dBm.

As can be seen from Table B.15, a Mesh network has limitations both on the maximum distance and maximum density of the network. The maximum distance that can be achieved by the Mesh network using 4 W EIRP is about 1 km, which retains a margin of 10 dB to the interference threshold.

Deployments with distances between nodes of one km are however exceedingly sparse and not practical except in the very early stages of service rollout (i.e., when seeding the service area).

Reducing the distance increases the number of nodes, but reduces the necessary power levels, hence reducing the overall interference into the satellite. Increasing the density, and hence the number of nodes to very high levels, up to about one device per 92 m would still obtain tolerable interference levels. Deployment densities of this nature, especially in the areas of major interest to the satellite community (oceanic and agrarian), are extremely unlikely.

To allow an easier comparison with the RLAN results in ERC *Report 72* [B12], Table B.15 computes the number of Mesh devices that can be situated in the SAR footprint without exceeding the interference limit.

Table B.15—WirelessHUMAN Mesh devices in the SAR footprint

Parameter	Value				
	1	0.5	0.25	0.1	km
Node distance	1	0.5	0.25	0.1	km
Tx antenna gain	8				dBi
Rx sensitivity	-105				dBW
path loss	115.93	109.00	10.08	92.93	dB
P_{out} required (EIRP)	2.93	-4.00	-10.92	-20.07	dBW
P_{out} required (conducted)	-5.07	-12.00	-18.92	-28.07	dBW
Freespace distance	-160.8				dB
Building attenuation	0				dB
Tx antenna gain (top lobe)	-22				dBi
Polarization loss	-3				dB
Peak-to-Average ratio	-3				dB
Rx antenna gain (main lobe)	42.4				dBi
Rx Power	-224.90	-231.82	-238.74	-247.90	dBW/Hz
SAR threshold	-205				dBW/Hz
Margin	19.54	26.46	33.38	42.54	dB/Hz
SAR footprint	22.59				dB
Tx activity	-13.01				dB
Permissible density/km ² /ch	9.91	498.78	240.22	1976.39	nodes
Nodes within SAR footprint (CEPT region)	26967	132804	654001	5380723	nodes

In Table B.15, it is assumed that all Mesh devices are located in the boresight of the SAR satellite, which provides the worst-case scenario.

B.2.4.1.3 FSS satellites

The bandwidth of the Mesh device is 21 MHz (73.2 dBHz). The maximum allowable interference power spectral density tolerated by the Telecom 3 network (see B.2.2.3.3) then becomes 27 dBW/Hz.

Appendix S8 of the ITU Radio Regulations [B32] gives the method to calculate the maximum interference power produced by an earth station to a satellite receiver. When calculating the maximum interference power from Mesh devices into a satellite receiver, consider all the Mesh devices under the satellite footprint as a single source. This means that the source is not specifically located, and only the direct top lobe of the Mesh antenna is taken into account.

Table B.16—Tolerable Mesh nodes for FSS operation

Parameter	Value				
	−6	0	3	6	
Tx EIRP	−6	0	3	6	dBW
Tx antenna gain (main lobe)	8				dB
Tx antenna gain (top lobe)	−22				dB
Peak-to-Average Ratio	3				dB
Shielding effect	0				dB
Acceptable interference	27				dBW
Active users	1000	251	126	63	nodes (thousands)
Average Tx ratio	5				%
Tolerable nodes	300	75.4	37.8	18.9	nodes (millions)

From Table B.16, it shows that by using 4 W (6 dBW) EIRP, an enormous amount of Mesh nodes can be in operation within the FSS footprint.

B.2.4.2 Interference to RLANs

B.2.4.2.1 Immediate neighborhood analysis

B.2.4.2.1.1 “Same building” analysis (1)

In the immediate neighborhood scenario, the interference from a Mesh node to a RLAN device in the same building is analyzed (link 1 in Figure B.3).

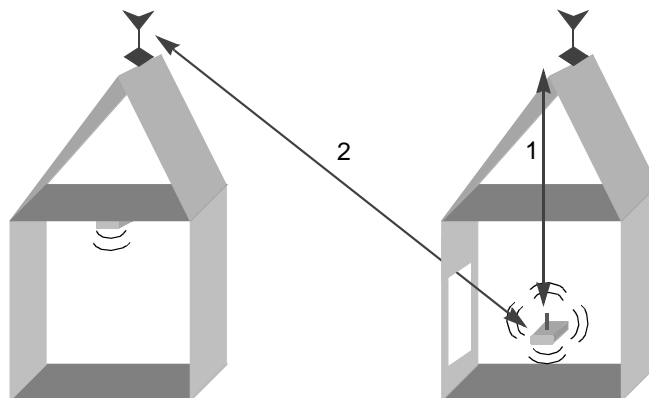

Figure B.3—Immediate neighborhood scenario

It is assumed for this scenario, that the distance between the Mesh node and the RLAN device in the same building is 5 m. The structural isolation plus attenuation due to multipath/scattering is assumed to be 25 dB over that distance, based to Annex 2 of *ERC Report 72* [B12]. Note that this is not the same as the average 13.4 dB assumed in *ERC Report 72* [B12], since only placement of Mesh devices on the roof are considered, and not placement outside in general as in the outside RLAN case. This is likely to be a very modest value for a typical (European) home with concrete ceiling and stone tile roofing. The total attenuation is then $25 + 20 \cdot \log_{10}(4 \cdot \pi \cdot d \cdot f_0 / c) = 86$ dB. Given the radiation pattern of a Mesh node transmitting at full 28 dBm (i.e., 36 dBm EIRP), the interference level at the RLAN = $28 - 22 - 86 = -80$ dBm. Taking into account the backoff, 3 dB, and the effect of the Mesh activity factor, an additional 13 dB, brings the average interference level, -97 dBm, far below receiver sensitivity values. Operation of a Mesh device on the roof, while running an RLAN network inside is hence feasible, even in the same channel.

In this scenario, to operate the RLAN at its highest modulation and coding rate (64-QAM, 3/4 coding) while the Mesh device is transmitting, would require the separation to be at least 20 m (instead of the 5 m used). For 16-QAM, 1/2 coding, the separation would be 10 m.

B.2.4.2.1.2 “Across the street” analysis (2)

Another critical consideration is the analysis of illumination of indoor RLANs in adjacent buildings. This is due to the fact that despite the larger distance, normally only one isolating building layer (which may also be a window) is situated in-between, and the Mesh antenna gain increases with the angle from the vertical axis.

It is assumed for this scenario that the street is 10 m wide, which gives an antenna gain of -15 dBi and an outdoor distance of $\sqrt{125} = 11.2$ m. The structural isolation plus attenuation due to multipath/scattering is assumed to be 10 dB (window plus some indoor scattering). The total attenuation is then $10 + 20 \cdot \log_{10}(4 \cdot \pi \cdot d \cdot f_0 / c) = 78$ dB. Taking into account the antenna gain, the backoff and the Mesh activity factor of the Mesh node reduces the average level at the RLAN to -78 dBm.

Of course, the numbers in the above analysis fluctuate by a number of decibels for individual deployments. The average structural attenuation was quoted to be 13.4 dB in *ERC Report 72* [B12], but there may be variations in building height or terrain sloping that increase the antenna gain in the direction of the RLAN by a few dBs. Typically the above results of this subclause are broadly applicable as conservative estimates to a wide range of deployment scenarios.

Power-control and DFS can assist in further reducing these interference levels. Note that the transmit probability of the RLAN device, (13 dB), has not been taken into consideration.

B.2.4.2.2 Outdoor RLAN analysis

An argument often used against the use of BWA devices in the 5-GHz bands is that it will interfere with outdoor deployments of RLAN devices. It is quite obvious that co-location of these two types of devices on a roof (or neighboring roofs) will cause severe interference when operating in the same channel; however, it should be realized that exactly the same issue exists when two RLAN APs on a roof (or neighboring roofs) are competing for the same channel. (To be specific, this is mostly the case for HIPERLAN/2, which is schedule based). Attempting to avoid this type of interference, which works well for low duty cycles, IEEE 802.11a uses CSMA/CD. In both cases, the requirement for a DFS mechanism can gracefully resolve the problem. In addition, outdoor RLAN deployments are predominantly used for hot-spot coverage and bridging, which implies the use of down-tilted antennas and oftentimes geographical isolation for hot-spot coverage and very directive antennas for bridging, each of which reduces the interference potential. In the cases where RLANs are currently used for access provisioning, WirelessHUMAN-compliant systems will likely not be deployed or be used as more efficient substitutes.

BWA deployments require broad coverage and reasonable frequency reuse numbers to maintain sufficient SNR plus limited DFS flexibility to avoid local interference sources. Therefore, the likelihood of roof-mounted RLAN devices unable to find a sufficient noise-free channel for proper operation are rather small.

B.2.4.2.3 Network analysis

To illustrate the interference analysis further, a typical scenario consisting of a 4-node indoor RLAN network and a nearby 4-node Mesh network, is examined.

From Annex 2 of ERC *Report 72* [B12], it can be extracted that the typical indoor attenuation on top of free-space attenuation at 5 m is 4 dB for a mixture of LOS through NLOS scenarios. The additional attenuation through one wall is 7.1 dB and the additional attenuation through two walls is 12.5 dB (the walls in these cases were breeze blocks and the rooms contained both wooden and metal furniture). The attenuation through a double-glazed window was found to be 7 dB.

In the case under study, a SU is assumed from each of these cases in a Small Office setting. The SU in the same room is assumed at 10 m; the SU in the adjacent room at 30 m; and the SU behind two walls at 50 m.

The Small Office is assumed to be a single-floor building with a flat roof. The attenuation through the roof is 22 dB. A typical indoor cross-floor attenuation according to Annex 2 of ERC *Report 72* [B12] is 19 dB, which is probably a fairly pessimistic value. The Mesh #4 node is situated on the roof directly atop AP #1 and provides the “Internet access” for the RLAN service within the building. The cabling distance between the data gathering point, the AP, and the access service, Mesh #4 node, is shortest. The distance between AP #1 and Mesh #4 is assumed to be 5 m.

The nearest neighboring node, Mesh #1, is 50 m away on an adjacent building. The building attenuation is 10 dB (a window plus indoor scattering, as in B.2.4.2.1.2). It is assumed that this building is lower than the building with the RLANs, resulting in an antenna gain of -10 dBi in the direction of the RLANs, rather than the -15 dBi specified in Table B.4). Two other nodes are each 200 m away as shown in Figure B.4. All Mesh nodes are on the roof and hence only have free-space (FS) attenuation to each other. Mesh #3 is assumed to have an additional 15 dB obstruction to the RLANs in the form of a building (basically the building on which Mesh #2 is located).

Note that in the Path Losses in Figure B.4, the antenna gain of the Mesh nodes (see Table B.4) in the direction of the RLANs has been included.

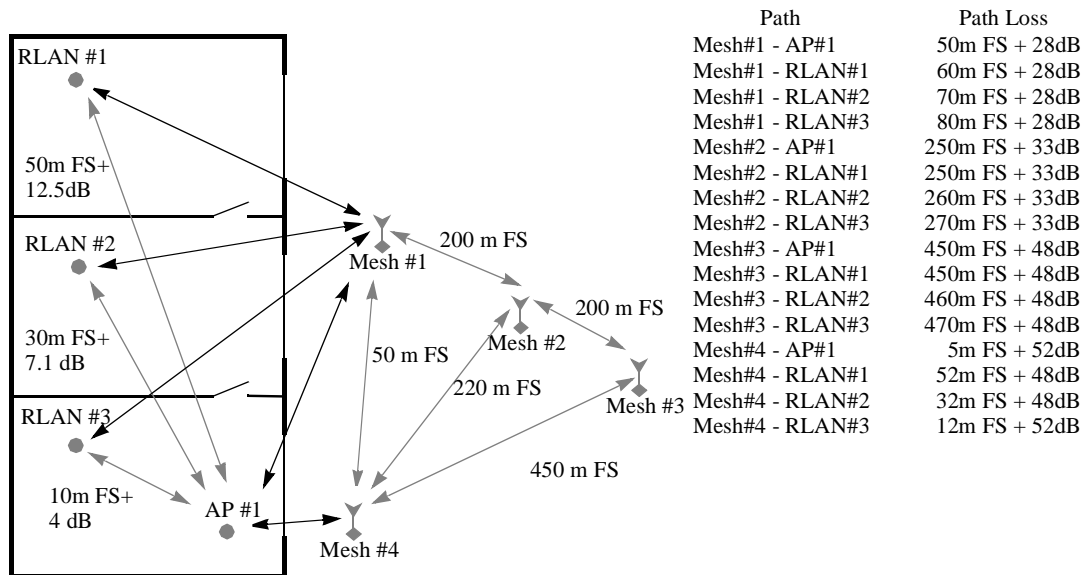

Figure B.4—Example network scenario

In Table B.17, the ranges and corresponding total link attenuations, which are assumed to be symmetrical, are gathered. In general, it can be observed that only nodes that are really close or in LOS through little attenuation (particularly windows) result in significant interference.

Table B.17—Link attenuations and ranges

	Link attenuation/Range							
	Mesh #1	Mesh #2	Mesh #3	Mesh #4	AP #1	RLAN #1	RLAN #2	RLAN #3
Mesh#1	-----	200 m	400 m	50 m	50 m	60 m	60 m	60 m
Mesh#2	94 dB	-----	200 m	220 m	220 m	230 m	230 m	230 m
Mesh#3	100 dB	94 dB	-----	450 m	450 m	460 m	460 m	460 m
Mesh#4	82 dB	94 dB	101 dB	-----	5 m	52 m	32 m	12 m
AP#1	110 dB	127 dB	149 dB	106 dB	-----	50 m	30 m	10 m
RLAN#1	111 dB	128 dB	149 dB	130 dB	94 dB	-----	50 m	20 m
RLAN#2	111 dB	128 dB	149 dB	126 dB	84 dB	132 dB	-----	30 m
RLAN#3	111 dB	128 dB	149 dB	121 dB	72 dB	94 dB	107 dB	-----

In Table B.18, the maximum power and EIRP values for each of the devices is shown. For the RLAN devices and their AP, values are chosen that reflect implementations that are currently available in the market.

Table B.18— Tx Power, conducted and EIRP (regulatory limited)

	AP	RLAN	Mesh
Tx Power (mW)	200	200	500
Antenna (dBi)	2	0	8
EIRP (dBm)	25	23	35

In Table B.19, the resulting received signal strengths are shown assuming transmission with EIRP values as shown in Table B.18. Note that especially between the Mesh nodes, the Rx values are extremely high, which would automatically be reduced by the AGC. For simplicity of computation, this is however ignored. This table is not symmetric since different antenna gains at each end can affect the perceived signal level.

Table B.19—Received Signal Levels (dBm)

	Mesh #1	Mesh #2	Mesh #3	Mesh #4	AP #1	RLAN #1	RLAN #2	RLAN #3
Mesh #1	-----	-54	-60	-42	-80	-83	-83	-83
Mesh #2	-54	-----	-54	-54	-97	-100	-100	-100
Mesh #3	-60	-54	-----	-61	-119	-121	-121	-121
Mesh #4	-42	-54	-61	-----	-84	-102	-98	-93
AP #1	-76	-93	-115	-80	-----	-72	-62	-50
RLAN#1	-79	-96	-117	-98	-72	-----	-112	-74
RLAN#2	-79	-96	-117	-94	-62	-112	-----	-87
RLAN#3	-79	-96	-117	-89	-50	-74	-87	-----

Table B.20 shows resulting sustainable modulations. The top row in each box shows the actual communication direction, the used modulation and the Noise threshold. The next four rows illustrate the effect of interference from each source (using maximum allowed EIRP). If the modulation differs from the top box, then switch to a more robust modulation scheme was mandatory to maintain 3% PER. The last column defines the interference margin. A positive value means the threshold has been exceeded and is shown in bold.

Table B.20—Sustainable modulation during interference

RLAN#1 =>AP#1	3/4 QPSK	-90	RLAN#2 =>AP#1	2/3 64-QAM	-95	RLAN#3 =>AP#1	3/4 64-QAM	-95
Mesh #1	PER>3%	4	Mesh #1	1/2 QPSK	-5	Mesh #1	1/2 QPSK	-5
Mesh #2	3/4 QPSK	-13	Mesh #2	2/3 64-QAM	-22	Mesh #2	2/3 64-QAM	-22
Mesh #3	3/4 QPSK	-35	Mesh #3	2/3 64-QAM	-44	Mesh #3	3/4 64-QAM	-44
Mesh #4	PER>3%	0	Mesh #4	3/4 QPSK	-9	Mesh #4	3/4 QPSK	-9
AP#1 => RLAN#1	3/4 QPSK	-90	AP#1 => RLAN#2	2/3 64-QAM	-95	AP#1 => RLAN#3	3/4 64-QAM	-95
Mesh #1	PER>3%	1	Mesh #1	3/4 QPSK	-8	Mesh #1	3/4 QPSK	-8
Mesh #2	3/4 QPSK	-16	Mesh #2	3/4 64-QAM	-25	Mesh #2	3/4 64-QAM	-25
Mesh #3	3/4 QPSK	-37	Mesh #3	3/4 64-QAM	-46	Mesh #3	3/4 64-QAM	-46
Mesh #4	3/4 QPSK	-18	Mesh #4	2/3 64-QAM	-23	Mesh #4	3/4 16-QAM	-18

From Table B.20, two observations can be generalized. The first is that in certain scenarios interference is unavoidable if DFS is not used. The second is that interference only occurs when nodes are really close (such as Mesh #4) or have relatively good LOS properties (such as Mesh #1, which only has a window in-between and a reduced height antenna) to the RLAN network. The later generalization means that very few nodes in a Mesh network will cause degradation of a RLAN network. Realizing that the interference excess is relatively low, and the Mesh network uses power-control to reduce the EIRP where possible, interference from a transmitting Mesh device will be very limited. Combined with the activity factors for both devices (on average 13 dB each) and DFS mechanisms, the likelihood of interference becomes so small that it is easily handled with Automatic Repeat Request (ARQ) causing minimal degradation of performance.

B.2.4.2.4 Adjacent channel issues

A feature of the OFDM technology used in both RLANs and Mesh technology at 5 GHz, is that the adjacent channel rejection is very high, at least 35 dB (see 8.3.11.2). Since the interference levels between RLANs and Mesh devices are relatively low compared to this, it is reasonable to assume that adjacent channels using RLAN and Mesh technology will not cause any noticeable interference to each other; therefore, this requires no further consideration.

B.2.4.3 Interference to RTTT

In accordance with CEN/TC 278 prEN 12253 [B5] and ERC *Report 72* [B12], the cross-polarization is assumed to be 10–15 dB to the RSU and 6–10 dB to the OBU (Table B.21 uses the lower numbers).

Table B.21—Needed separation distance Mesh to RSU and OBU

Parameter	RSU		OBU
P_t	6		6
B_{Rx}	10	5	10
B_i	22		22

Table B.21—Needed separation distance Mesh to RSU and OBU (continued)

Parameter	RSU		OBU
$I_{Rx}=R_{x_{sens}}-C/I_{8PSK}$	-117		-90
L	119.6	116.6	92.6
Cross-polarization	10		6
Antenna and feeder gain	8		8
Separation distance	553	394	53

It should be noted that in the above calculations of Table B.21, the duty cycle of the Mesh devices, which significantly reduces the interference scenario, has not been taken into consideration.

Especially for the RSU case, where the separation distance is fairly significant, it can be shown that the interference to the Mesh device is significantly larger than the other way around. Since RTTT devices normally have a fairly high duty cycle, a close Mesh device would not be able to operate properly in this channel and would need to use the DFS mechanisms to switch to another channel. Therefore, for RSUs, proper operation is virtually guaranteed by virtue of its own interference potential.

B.2.4.4 Interference to radar

For radars, a somewhat similar situation exists as with RTTT RSUs. To show this, the interference distance from radars into Mesh devices is derived, followed by the derivation of the interference distance from Mesh devices into radars. Comparing Table B.22 and Table B.23, the interference distance from radars to Mesh is much larger than the interference distance from Mesh to radars.

For analysis of the minimum distance at which an Mesh device still operates, shown in Table B.22, the most robust modulation and coding mode is used.

Table B.22—Minimum separation distance of radar to Mesh

Radar type	A	B	C	D	E	
Peak EIRP	98.6	26	60	93	97	dBW
Antenna gain	40	0	46	43	43	dBi
P_t	58.6	26	14	50	54	dBW
Bandwidth _{radar}	3	15	30	14	3	MHz
$I_{mesh}=R_{x_{sens}}-C/I_{BPSK1/2}$	-116					dBW
L	174.6	142.0	131.3	166.0	170.0	dB
Gain and feeder loss	48	8	54	51	51	dB
Propagation loss	222.6	150	185.3	217	221	dB
Distance at 5.5 GHz	20693	137	497	11813	17630	km
Radio horizon	51.4	346.6	51.4	51.4	51.4	km (see [B11])
Separation distance	51.4	137	51.4	51.4	51.4	km

In Table B.23, the thermal noise level has been assumed -204 dBW/Hz whereas the Rx noise factor is assumed to be 5 dB. The maximum I/N is -6 dB as specified by NATO (see ERC *Report 72* [B12], ERC *Report 15* [B11]).

Table B.23—Minimum separation distance of Mesh to radar

Radar type	A	B	C	D	E	
P_t mesh	-2					dBW
Bandwidth _{radar}	3	15	30	14	3	MHz
Noise (dBW)	-134.2	-127.2	-124.2	-127.5	-134.2	dBW
On-tune rejection	-8.9	-1.9	0.0	-2.2	-8.9	dB (see [B12])
Max. Interference	-131.3	-131.3	-130.2	-131.3	-131.3	dBW
L	129.3					dB
Gain + feeder loss	48	8	54	51	51	dB
Propagation loss	177.3	145.3	191.6	188.3	188.3	dB
Distance at 5.5 GHz	220.1	79.4	916.3	662.7	662.0	km

Comparing the required distances at 5.5 GHz from Table B.22 and Table B.23, it is shown that in all cases, the separation distance is larger for the BWA system, forcing it effectively out of the channel used by the radar. In all cases, the separation distance is effectively limited by the radio horizon.

In the case of radar type B, which is airborne, depending on the exact location of the radar, the gain+feeder loss will reduce from +8 to -22 dB, significantly reducing the necessary separation distance. Since the angle of detection (if any) is not known, this factor has not been used in the previous tables. For the other types, the distance is limited by the radio horizon, but in practice likely much lower due to obstructions and clutter.

From Table B.22 and Table B.23, similar conclusions to the RLAN analysis in ERC *Report 72* [B12] can be drawn. Sharing with maritime radars (which are not likely operating anywhere near residential areas) and S5.452 meteorological radars in band B, and radiolocation radars in both band B and C is feasible when an effective DFS mechanism is employed by the Mesh system and the radar density is not too high.

B.3 Performance characteristics

B.3.1 WirelessMAN-SCa PHY throughput

Table B.24 indicates the raw bit rates delivered by the WirelessMAN-SCa PHY for typical bandwidths and a roll-off of 0.25, while Table B.25 indicates the raw bit rates for a roll-off of 0.15.

The raw bite rate (in Mb/s) is defined as shown in Equation (159).

$$\frac{(BW - 0.088) \cdot Bpm \cdot R_{outer} \cdot R_{inner}}{(1 + \alpha)} \quad (159)$$

where

BW is the bandwidth in MHz,

α is the roll-off,

Bpm is the number of bits per modulation symbol,

$R_{outer} = 239/255$ is the outer (Reed-Solomon) code rate,

R_{inner} is the inner (TCM) code rate that specified in the first column of each table.

Table B.24—WirelessMAN-SCa raw bit rates (Mb/s) for 0.25 roll-off

Modulation and inner code rate	6 MHz (MMDS)	7 MHz (ETSI)	20 MHz (UNII)
BPSK 1/2	2.22	2.59	7.47
BPSK 3/4	3.32	3.89	11.20
QPSK 1/2	4.43	5.18	14.93
QPSK 2/3	5.91	6.91	19.91
QPSK 3/4	6.65	7.77	22.40
QPSK 5/6	7.39	8.64	24.88
QPSK 7/8	7.76	9.07	26.13
16-QAM 1/2	8.87	10.37	29.86
16-QAM 3/4	13.30	15.55	44.79
64-QAM 2/3	17.73	20.73	59.72
64-QAM 5/6	22.16	25.91	74.65
256-QAM 3/4	26.60	31.10	89.58
256-QAM 7/8	31.03	36.28	104.51

Table B.25—WirelessMAN-SCa raw bit rates (Mb/s) for 0.15 roll-off

Modulation and inner code rate	6 MHz (MMDS)	7 MHz (ETSI)	20 MHz (UNII)
BPSK 1/2	2.41	2.82	8.11
BPSK 3/4	3.61	4.22	12.17
QPSK 1/2	4.82	5.63	16.23
QPSK 2/3	6.42	7.51	21.64
QPSK 3/4	7.23	8.45	24.34
QPSK 5/6	8.03	9.39	27.05
QPSK 7/8	8.43	9.86	28.40
16-QAM 1/2	9.64	11.27	32.46
16-QAM 3/4	14.45	16.90	48.69
64-QAM 2/3	19.27	22.53	64.91

Table B.25—WirelessMAN-SCa raw bit rates (Mb/s) for 0.15 roll-off (continued)

Modulation and inner code rate	6 MHz (MMDS)	7 MHz (ETSI)	20 MHz (UNII)
64-QAM 5/6	24.09	28.17	81.14
256-QAM 3/4	28.91	33.80	97.37
256-QAM 7/8	33.73	39.43	113.60

B.3.2 WirelessMAN-OFDM/OFDMA PHY symbol and performance parameters

The effective bandwidth of the transmitted signal is related to the subcarrier spacing and the number of subcarriers.

In order to calculate the sampling frequency for any bandwidth, the bandwidth efficiency is defined as shown in Equation (160).

$$BW_{Efficiency} = \frac{F_s}{BW} \cdot \frac{(N_{used} + 1)}{N_{FFT}} = \frac{\Delta f \cdot (N_{used} + 1)}{BW} \quad (160)$$

where

- BW is the Channel bandwidth (Hz),
- F_s is the Sampling frequency (Hz),
- Δf is the Subcarrier spacing (Hz),
- $N_{used} + 1$ is the Number of active subcarriers used in the FFT (pilot and data subcarriers) + DC subcarrier,
- N_{FFT} is the FFT size.

The bandwidth efficiency is designed to be in the range of 83–95%, depending mainly on the FFT size, in order to occupy the maximum usable bandwidth but still allow adequate RF filtering.

The following tables give some calculations of the subcarrier spacing, symbol duration and CP duration for different masks. The sampling rate is defined as $F_s = BW \cdot 8/7$, except for 256-OFDM (see 8.3.2.4) in licensed bandwidths, which are not a multiple of 1.75 MHz. In those cases, the sampling rate is $F_s = BW \cdot 7/6$.

Table B.26—OFDM channelization parameters for licensed bands

Bandwidth (MHz)		OFDM ($N_{FFT} = 256$)					
		Δf (kHz)	T_b (μ s)	T_g (μ s)			
				$T_b/32$	$T_b/16$	$T_b/8$	$T_b/4$
MMDS ($n = 86/75$)	1.5	$6\frac{23}{32}$	$148\frac{36}{43}$	$4\frac{28}{43}$	$9\frac{13}{43}$	$18\frac{26}{43}$	$36\frac{9}{43}$
	3.0	$13\frac{7}{16}$	$74\frac{18}{43}$	$2\frac{14}{43}$	$4\frac{28}{43}$	$9\frac{13}{43}$	$18\frac{26}{43}$
	6.0	$26\frac{7}{8}$	$37\frac{9}{43}$	$1\frac{7}{43}$	$2\frac{14}{43}$	$4\frac{28}{43}$	$9\frac{13}{43}$
	12.0	$53\frac{3}{4}$	$18\frac{26}{43}$	$\frac{25}{43}$	$1\frac{7}{43}$	$2\frac{14}{43}$	$4\frac{28}{43}$
	24.0	$107\frac{1}{2}$	$9\frac{13}{43}$	$\frac{25}{86}$	$\frac{25}{43}$	$1\frac{7}{43}$	$2\frac{14}{43}$
ETSI ($n = 8/7$)	1.75	$7\frac{13}{16}$	128	4	8	16	32
	3.5	$15\frac{5}{8}$	64	2	4	8	16
	7.0	$31\frac{1}{4}$	32	1	2	4	8
	14.0	$62\frac{1}{2}$	16	$\frac{1}{2}$	1	2	4
	28.0	125	8	$\frac{1}{4}$	$\frac{1}{2}$	1	2
WCS ($n = 144/145$)	2.5	$11\frac{1}{4}$	$88\frac{8}{9}$	$2\frac{7}{9}$	$5\frac{5}{9}$	$11\frac{1}{9}$	$22\frac{2}{9}$
	5.0	$22\frac{1}{2}$	$44\frac{4}{9}$	$1\frac{7}{18}$	$2\frac{7}{9}$	$5\frac{5}{9}$	$11\frac{1}{9}$
	10.0	45	$22\frac{2}{9}$	$\frac{25}{36}$	$1\frac{7}{18}$	$2\frac{7}{9}$	$5\frac{5}{9}$
	15.0	$67\frac{3}{16}$	$14\frac{38}{43}$	$\frac{20}{43}$	$\frac{40}{43}$	$1\frac{37}{43}$	$3\frac{31}{43}$

Table B.27—OFDMA channelization parameters for licensed bands

Bandwidth (MHz)		OFDMA ($N_{FFT} = 2048$)					
		Δf (kHz)	T_b (μ s)	T_s (μ s)			
				$T_b/32$	$T_b/16$	$T_b/8$	$T_b/4$
MMDS ($f_s/BW = 8/7$)	1.5	$\frac{36}{43}$	$1194\frac{2}{3}$	$37\frac{1}{3}$	$74\frac{2}{3}$	$149\frac{1}{3}$	$298\frac{2}{3}$
	3.0	$1\frac{60}{89}$	$597\frac{1}{3}$	$18\frac{2}{3}$	$37\frac{1}{3}$	$74\frac{2}{3}$	$149\frac{1}{3}$
	6.0	$3\frac{8}{23}$	$298\frac{2}{3}$	$9\frac{1}{3}$	$18\frac{2}{3}$	$37\frac{1}{3}$	$74\frac{2}{3}$
	12.0	$6\frac{39}{56}$	$149\frac{1}{3}$	$4\frac{2}{3}$	$9\frac{1}{3}$	$18\frac{2}{3}$	$37\frac{1}{3}$
	24.0	$13\frac{11}{28}$	$74\frac{2}{3}$	$2\frac{1}{3}$	$4\frac{2}{3}$	$9\frac{1}{3}$	$18\frac{2}{3}$
ETSI ($f_s/BW = 8/7$)	1.75	$\frac{83}{85}$	1024	32	64	128	256
	3.5	$1\frac{61}{64}$	512	16	32	64	128
	7.0	$3\frac{29}{32}$	256	8	16	32	64
	14.0	$7\frac{13}{16}$	128	4	8	16	32
	28.0	$15\frac{5}{8}$	64	2	4	8	16
WCS ($f_s/BW = 8/7$)	2.5	$1\frac{32}{81}$	$714\frac{4}{5}$	$22\frac{2}{5}$	$44\frac{4}{5}$	$89\frac{3}{5}$	$179\frac{1}{5}$
	5.0	$2\frac{64}{81}$	$358\frac{2}{5}$	$11\frac{1}{5}$	$22\frac{2}{5}$	$44\frac{4}{5}$	$89\frac{3}{5}$
	10.0	$5\frac{47}{81}$	$179\frac{1}{5}$	$5\frac{3}{5}$	$11\frac{1}{5}$	$22\frac{2}{5}$	$44\frac{4}{5}$
	15.0	$8\frac{10}{27}$	$119\frac{7}{15}$	$3\frac{11}{15}$	$7\frac{7}{15}$	$14\frac{14}{15}$	$29\frac{13}{15}$

Table B.28—OFDM/OFDMA channelization parameters for license-exempt bands

		OFDM	OFDMA	
	n	144/25	8/7	
Bandwidth (MHz)	N_{FFT}	256	2048	
10	Δf (kHz)	45	$5\frac{47}{81}$	
	T_b (μ s)	$22\frac{2}{9}$	$179\frac{1}{5}$	
	T_g (μ s)	$\frac{T_b}{32}$	$\frac{25}{36}$	$5\frac{3}{5}$
		$\frac{T_b}{16}$	$1\frac{17}{18}$	$11\frac{1}{5}$
		$\frac{T_b}{8}$	$2\frac{7}{9}$	$22\frac{2}{5}$
		$\frac{T_b}{4}$	$5\frac{5}{9}$	
20	Δf (kHz)	90	$11\frac{9}{56}$	
	T_b (μ s)	$11\frac{1}{9}$	$89\frac{3}{5}$	
	T_g (μ s)	$\frac{T_b}{32}$		$2\frac{4}{5}$
		$\frac{T_b}{16}$	$\frac{25}{36}$	$5\frac{3}{5}$
		$\frac{T_b}{8}$	$1\frac{7}{18}$	$11\frac{1}{5}$
		$\frac{T_b}{4}$	$2\frac{7}{9}$	$22\frac{2}{5}$

In Table B.29, raw bit rates are shown for typical bandwidths. The raw bite rate is defined as $N_{used} \cdot b_m \cdot c_r / T_s$, where b_m is the number of bits per modulation symbol and c_r is the coding rate.

Table B.29—OFDM/OFDMA raw bitrates (Mb/s)

Bandwidth (MHz)	T_g	BPSK 1/2	QPSK 1/2	QPSK 3/4	16-QAM 1/2	16-QAM 3/4	64-QAM 2/3	64-QAM 3/4
OFDM 256-FFT								
6 MHz (MMDS)	$T_b/32$	2.50	5.00	7.51	10.01	15.01	20.01	22.52
	$T_b/16$	2.43	4.86	7.28	9.71	14.57	19.43	21.85
	$T_b/8$	2.29	4.59	6.88	9.17	13.76	18.35	20.64
	$T_b/4$	2.06	4.13	6.19	8.26	12.38	16.51	18.58

Table B.29—OFDM/OFDMA raw bitrates (Mb/s)

7 MHz (ETSI)	$T_b/32$	2.92	5.82	8.73	11.64	17.45	23.27	26.18
	$T_b/16$	2.82	5.65	8.47	11.29	16.94	22.59	25.41
	$T_b/8$	2.67	5.33	8.00	10.67	16.00	21.33	24.00
	$T_b/4$	2.40	4.80	7.20	9.60	14.40	19.20	21.60
20 MHz (U-NII)	$T_b/16$	8.13	16.26	24.40	32.53	48.79	65.05	73.19
	$T_b/8$	7.68	15.36	23.04	30.72	46.08	61.44	69.12
	$T_b/4$	6.91	13.82	20.74	27.65	41.47	55.30	62.21
OFDMA 2048-FFT								
6 MHz (MMDS)	$T_b/32$		4.99	7.48	9.97	14.96	19.95	22.44
	$T_b/16$		4.84	7.26	9.68	14.52	19.36	21.78
	$T_b/8$		4.57	6.86	9.14	13.71	18.29	20.57
	$T_b/4$		4.11	6.17	8.23	12.34	16.46	18.51
7 MHz (ETSI)	$T_b/32$		5.82	8.73	11.64	17.45	23.27	26.18
	$T_b/16$		5.65	8.47	11.29	16.94	22.59	25.41
	$T_b/8$		5.33	8.00	10.67	16.00	21.33	24.00
	$T_b/4$		4.80	7.20	9.60	14.40	19.20	21.60

B.4 Frequency reuse of 1 for OFDMA

This subclause defines extensions of OFDMA system for working in deployment scenarios with frequency reuse of 1.

B.4.1 Introduction

The definition of an OFDMA system as defined in 8.4 is well suited to work with deployment scenarios with frequency reuse factor >1 , but in order to satisfy requirement of reliability, coverage, capacity, spectral efficiency, and location base service. The system can be configured to work in a reuse of 1, which means the same RF frequency is allocated to all sectors in the cell. In this case, a new scheme of work must be introduced in order to achieve the needed performance. A scenario using a reuse of 1 is given in Figure B.5:

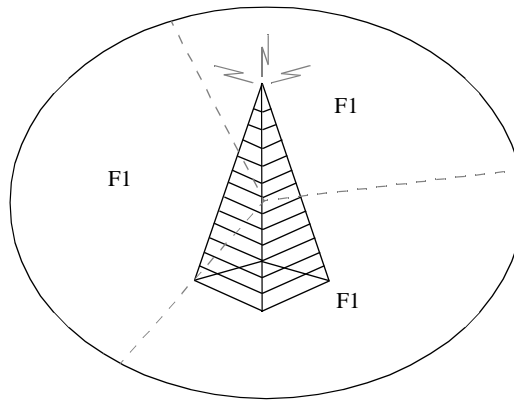

Figure B.5—Reuse of 1 configuration, 3 sectors per cell

There are three options of operation in the reuse of 1 scenario:

- **Asynchronous configuration**—In this configuration, every base-station uses its own permutation, the frame lengths and starting times are not synchronized among the base-stations. Therefore, orthogonality is kept within the base-station but not between base-stations. In this scenario, the base-stations could be synchronized or not to the same reference clock. This mode will introduce interference between base-station (subcarriers from different subchannels collide in a controlled way, determined by the different permutations). This configuration could be easily used as an independent low-cost hot spot deployment (as an example).
- **Synchronous configuration**—In this configuration, all base-stations use the same reference clock (for example, by using GPS), the frame durations and starting times are also synchronized among the base-stations but still each base station uses different permutations. Therefore, the time/frequency orthogonality is kept between and within the base-stations operation but still interference between the same subchannels of different base-station occurs. Due to the time synchronization in this scenario and the long symbol duration of the OFDMA symbol, fast handoff as well as soft handoff is possible. This configuration could be used as an independent base-stations deployment with a controlled interference level (as an example).
- **Coordinated Synchronous configuration**—In this configuration, all base-stations work in the synchronous mode but use also the same permutations. An upper layer is responsible for the handling of subchannels allocations within the sectors of the base-station, making sure that better handling of the bandwidth is achieved and the system could handle and balance load between the sectors and within the system. This mode is identical in performance as the regular coverage scenarios, beside the fact that the bandwidth allocated to each sector is only a portion of the overall bandwidth, but when using the load balancing additional system gain is achieved. This configuration could be used as a full scale system deployment, with a common backbone (as an example).

The preferred scenario is the Coordinated Synchronous mode (when using this configuration with different permutations per base-station we get the synchronous mode, and do not use a synchronized clock between the base stations as well we end up with the asynchronous mode of operation); the configuration of the base-station sectors are presented in Figure B.6

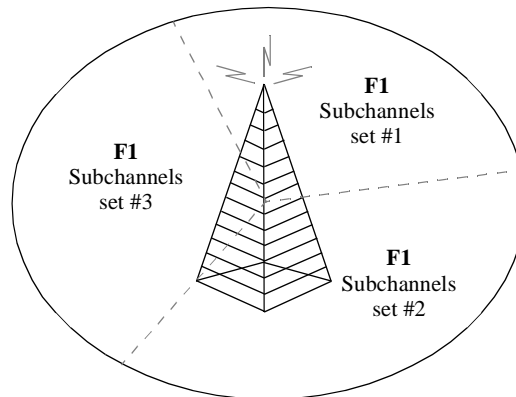

Figure B.6—Reuse of 1 configuration, 3 sectors per cell

B.5 FLI modulation codeword sequences for AAS Direct Signaling Method

The following list contains 8064*2 FLI modulation codeword sequences, first codeword representing in-phase and second codeword representing quadrature-phase.

FLI Codeword sequence =

0x5bbf,0x47cc,0x66b7,0x5e1f,0x2787,0x2256,0x1f04,0x2b03,0x5cfa,0x0443,0x0443,0x659a,0x20fe,0x2a91,0x7a89,0x6cd8,0x035c,0x1a8f,0x6300,0x5776,0x4f1c,0x7112e,0x3e7f,0x36af,0x6922,0x23b5,0x658d,0x4781,0x4ee8,0x0955,0x594d,0x328a,0x19a2,0x034b,0x0454,0x7148,0x74d4,0x5d43,0x343b,0x677f,0x1239,0x2de8,0x1165,0x1ddd,0x2863,0x760d,0x1799,0x1086,0x6978,0x7386,0x5a2d,0x282e,0x7edd,0x1165,0x4f6d,0x35f3,0x180c,0x17c3,0x4247,0x7537,0x786c,0x40ef,0x52c1,0x5971,0x23ef,0x20e9,0x724e,0x7c62,0x4564,0x6423,0x35e4,0x1239,0x6e16,0x61d9,0x61e5,0x3bae,0x7f29,0x0734,0x4490,0x66bf,0x2575,0x4ea5,0x2dd4,0x0ce2,0x5e34,0x2230,0x7ac4,0x35a9,0x01ae,0x5e6e,0x088a,0x5024,0x208f,0x3e25,0x14b4,0x27dd,0x4da3,0x5f8d,0x27ac,0x5ba8,0x0ba7,0x3fc6,0x77a3,0x7b41,0x715f,0x6b9d,0x3a00,0x438f,0x097e,0x5900,0x1159,0x2241,0x1856,0x2b72,0x4156,0x4604,0x2da5,0x3cb1,0x375b,0x1c29,0x5bf2,0x7174,0x071f,0x2121,0x7aa2,0x44bb,0x79d5,0x757a,0x337e,0x06fc,0x178e,0x4a97,0x301e,0x529b,0x5d0e,0x3bf4,0x3e32,0x1263,0x4ec3,0x724e,0x06eb,0x1f49,0x7c38,0x4b2e,0x1eaa,0x31a7,0x1df6,0x43a4,0x5d25,0x43c2,0x5593,0x52ea,0x1989,0x186a,0x4828,0x38e5,0x3693,0x0e4a,0x4abc,0x3701,0x395c,0x2790,0x08ec,0x7b27,0x6d61,0x55de,0x5467,0x77ee,0x0708,0x761a,0x7097,0x602d,0x3c8d,0x6a33,0x7b1b,0x7d81,0x1ddd,0x003c,0x166d,0x51fb,0x23f8,0x55b8,0x780a,0x08c7,0x757a,0x5a77,0x6a33,0x7080,0x543d,0x32ec,0x602d,0x1651,0x4c0d,0x2b3f,0x13cd,0x342c,0x36e2,0x40b5,0x1531,0x66a0,0x462f,0x069a,0x4675,0x20fe,0x632b,0x5042,0x0caf,0x5416,0x4f7a,0x0d67,0x712e,0x7ddb,0x5b94,0x47aa,0x6fde,0x0fbee,0x6e4c,0x29da,0x43b3,0x7c75,0x44ca,0x3cd7,0x3333,0x5707,0x7c5e,0x7a89,0x08ec,0x605c,0x715f,0x74d4,0x7080,0x4247,0x575d,0x2a86,0x19a2,0x47f0,0x65a6,0x44e1,0x669c,0x1afe,0x3d6e,0x79c2,0x38bf,0x4675,0x70ab,0x40a2,0x3bae,0x14c5,0x38a8,0x5feb,0x4247,0x0d01,0x3078,0x36c9,0x2acb,0x2c1c,0x0311,0x089d,0x4662,0x05a0,0x3e68,0x6d07,0x3324,0x0933,0x4991,0x2504,0x7ef6,0x2c0b,0x27e1,0x7386,0x4af1,0x5a3a,0x7b30,0x49dc,0x5be5,0x0e4a,0x7c13,0x2acb,0x002b,0x1dca,0x2af7,0x767c,0x6fc9,0x1637,0x2eb4,0x4b48,0x3b92,0x2562,

0x10e0,0x7c13,0x49ba,0x70da,0x0294,0x6a0f,0x61d9,0x6183,0x6e70,0x0caf,0x0e5d,0x6e67,0x1799,0x4df9,0x0942,0x13ab,0x32c7,0x7eac,0x5a3a,0x77b4,0x20a4,0x0cde,0x7e87,0x24cc,0x6944,0x4828,0x4d9f,0x2098,0x7148,0x220c,0x221b,0x1531,0x6d10,0x74ff,0x68a7,0x3a00,0x14f9,0x36f5,0x2b14,0x49ad,0x44bb,0x4b48,0x1540,0x180c,0x5885,0x4859,0x7499,0x113f,0x43d5,0x2136,0x1646,0x5682,0x51ec,0x0734,0x2787,0x5d32,0x47cc,0x3bb9,0x3d1f,0x0942,0x4564,0x3d79,0x6b9d,0x125f,0x5353,0x10cb,0x4250,0x52d6,0x076e,0x65fc,0x6317,0x5bf2,0x56d8,0x6ca9,0x6faf,0x2c6d,0x113f,0x239e,0x3369,0x40c4,0x1b21,0x4ae6,0x1d90,0x1c3e,0x24aa,0x77ee,0x2504,0x20c2,0x2c51,0x1f5e,0x74e8,0x0708,0x7163,0x6e67,0x766b,0x0942,0x1f75,0x0a78,0x5055,0x7821,0x3bae,0x6d3b,0x7de7,0x6366,0x0f82,0x4604,0x7265,0x0d5b,0x38d9,0x3bf4,0x74b2,0x227d,0x150d,0x58f4,0x7d96,0x4eb2,0x282e,0x7ac4,0x40d3,0x7f58,0x6cf3,0x7631,0x10e0,0x5fa6,0x6e2a,0x6e67,0x06d7,0x394b,0x7998,0x0e10,0x4ea5,0x1128,0x1ac2,0x2230,0x08c7,0x4221,0x5a4b,0x49ad,0x5bf2,0x1091,0x43fe,0x7112,0x6909,0x2f1a,0x6935,0x1d90,0x1e81,0x0294,0x5a3a,0x3977,0x2f26,0x35be,0x4487,0x1b7b,0x032d,0x5b94,0x47db,0x51a1,0x328a,0x1c15,0x73cb,0x24f0,0x79d5,0x2839,0x536f,0x0a22,0x51a1,0x70cd,0x724e,0x5584,0x7203,0x17b2,0x097e,0x330f,0x696f,0x1380,0x3318,0x40d3,0x2504,0x6a18,0x1a98,0x3894,0x1dac,0x635a,0x01f4,0x44bb,0x2658,0x7ac4,0x0bb0,0x5a5c,0x7eac,0x2241,0x2ea3,0x05c6,0x65fc,0x374c,0x6479,0x7657,0x08d0,0x4573,0x2790,0x4f51,0x5a60,0x13e6,0x05d1,0x2e88,0x55de,0x7537,0x4573,0x7af8,0x2839,0x74a5,0x0c93,0x1ebd,0x5e1f,0x6a69,0x38d9,0x7ebb,0x2997,0x20b3,0x634d,0x6743,0x5593,0x01b9,0x6a24,0x4c40,0x1ddd,0x31ea,0x7c49,0x31a7,0x4ed4,0x2496,0x5f8d,0x5d19,0x77c5,0x646e,0x23b5,0x3318,0x1f04,0x2575,0x62e3,0x1afe,0x1212,0x7551,0x6a55,0x0ba7,0x670e,0x05fa,0x2147,0x3342,0x3f8b,0x6fde,0x004d,0x06eb,0x3d45,0x641f,0x74e8,0x7df0,0x52fd,0x0cde,0x593c,0x5fb1,0x7259,0x0017,0x27ca,0x3369,0x097e,0x3e54,0x3fd1,0x7520,0x17ff,0x29f1,0x6d2c,0x1ef0,0x1ee7,0x55b8,0x3e68,0x1ebd,0x0d2a,0x0ff3,0x4613,0x6fc9,0x226a,0x4872,0x5ced,0x4803,0x79b3,0x5a4b,

0x2dff,0x633c,0x3b85,0x5bce,0x4089,0x77b4,0x688c,0x373d,0x0918,0x55c9,0x32b6,0x65eb,0x29da,0x0734,0x542a,0x06c0,0x5033,0x181b,0x5344,0x02e5,0x2602,0x2af7,0x454f,0x6faf,0x6292,0x0c84,0x5b83,0x3906,0x748e,0x3716,0x4f7a,0x7f02,0x47f0,0x0723,0x5761,0x6452,0x3035,0x6bd0,0x1128,0x29bc,0x0432,0x7e87,0x36e2,0x7f58,0x1c29,0x2c0b,0x6077,0x02bf,0x51d0,0x79fe,0x7520,0x187d,0x7edd,0x01c02,0x47bd,0x1526,0x6978,0x151a,0x24bd,0x20a4,0x31d6,0x43c2,0x2549,0x7499,0x5467,0x6371,0x677f,0x161c,0x3ca6,0x787b,0x7836,0x669c,0x7f64,0x17e8,0x51ec,0x19d3,0x51b6,0x688c,0x0752,0x7f4f,0x1830,0x0708,0x68b0,0x3911,0x3053,0x3911,0x226a,0x6ba1,0x2b65,0x52c1,0x5c9c,0x4814,0x3d6e,0x5bbf,0x484e,0x6fb8,0x4aab,0x1ad5,0x1c58,0x1274,0x31c1,0x2549,0x1f13,0x004d,0x465e,0x6ff5,0x3977,0x1827,0x519d,0x44e1,0x4b5f,0x3693,0x29ab,0x36de,0x3d45,0x1f04,0x14f9,0x544c,0x73e0,0x2256,0x2dd4,0x3e19,0x3693,0x3bae,0x0a22,0x507e,0x0a1e,0x4490,0x2b03,0x4638,0x2f40,0x6292,0x641f,0x55af,0x6445,0x55b8,0x3324,0x6c95,0x0071,0x6006,0x4649,0x0e10,0x1531,0x01e3,0x0969,0x06b1,0x2f0d,0x5707,0x4c0d,0x7c75,0x6725,0x7c62,0x4c6b,0x6d61,0x1c3e,0x2848,0x4b05,0x5e08,0x7b30,0x7c49,0x61ce,0x3d1f,0x122e,0x06bc7,0x58df,0x65eb,0x1eaa,0x3bc8,0x56e4,0x531e,0x77d2,0x06eb,0x0d5b,0x3e25,0x52ea,0x090f,0x688c,0x4127,0x6060,0x395c,0x7080,0x1b0a,0x528c,0x35d8,0x38a8,0x7c5e,0x74d4,0x033a,0x1c15,0x032d,0x0017,0x7c38,0x6e3d,0x7eca,0x6935,0x61f2,0x44ac,0x2f6b,0x52a7,0x575d,0x5695,0x410c,0x7e90,0x2848,0x66a0,0x156b,0x7c04,0x097e,0x6434,0x167a,0x1e81,0x6909,0x6fb8,0x748e,0x1205,0x2c7a,0x4986,0x5344,0x06c0,0x5309,0x7631,0x2ef9,0x0745,0x4acd,0x306f,0x595a,0x4f7a,0x74e8,0x2513,0x49cb,0x3e7f,0x6719,0x5d32,0x6f84,0x0f82,0x329d,0x1239,0x73ba,0x5f9a,0x6006,0x47bd,0x20d5,0x068d,0x3bf4,0x633c,0x1c64,0x4c40,0x51a1,0x1f75,0x14ee,0x1f62,0x4c6b,0x49f7,0x58e3,0x2ec5,0x5c8b,0x0cde,0x10e0,0x2db2,0x059c,0x2629,0x2874,0x2e9f,0x61ce,0x1ae9,0x3ca6,0x4af1,0x01c8,0x2150,0x410c,0x5470,0x6ba1,0x003c,0x0bd6,0x4b12,0x282e,0x24e7,0x0a35,0x23f8,0x536f,0x465e,0x4d88,0x507e,0x0ce2,0x2513,0x1114,0x52fd,0x4f6d,

0x6a42,0x1f2f,0x1ac2,0x6e67,0x7ee1,0x6732,0x2aba,0x0185,0x7b27,0x29cd,0x0b9b,0x4eff,0x23d3,0x43fe,0x285f,0x374c,0x35e4,0x61e5,0x1114,0x7df0,0x10cb,0x65d7,0x17ff,0x7626,0x0745,0x7203,0x17c3,0x4db4,0x3883,0x61a8,0x5885,0x7d81,0x0e2c,0x4c31,0x7b1b,0x4c1a,0x6a42,0x7ad3,0x3fed,0x1a8f,0x49cb,0x3a71,0x19b5,0x4f0b,0x4dee,0x7b1b,0x35f3,0x5bce,0x7b56,0x2f26,0x1989,0x7e90,0x217b,0x3407,0x603a,0x6ccf,0x4f37,0x02e5,0x543d,0x27bb,0x4986,0x02d9,0x6006,0x089d,0x125f,0x221b,0x3582,0x0b0ea,0x344a,0x420a,0x20e9,0x1f2f,0x2256,0x27ca,0x6944,0x0d67,0x4529,0x5d32,0x1c02,0x2b59,0x35be,0x1540,0x5018,0x23f8,0x2adc,0x58b9,0x6e4c,0x779f,0x1b6c,0x61bf,0x5069,0x73f7,0x750b,0x0e5d,0x0d67,0x780a,0x68c1,0x4814,0x220c,0x2b65,0x17d4,0x0bfd,0x7228,0x4db4,0x6bb6,0x3333,0x4130,0x5ced,0x31fd,0x2481,0x199e,0x3a3c,0x38d9,0x2812,0x7272,0x5710,0x62b9,0x1620,0x518a,0x0377,0x264f,0x3a71,0x4c57,0x2e9f,0x6c82,0x3324,0x7105,0x4e8e,0x01b9,0x51b6,0x29bc,0x1397,0x760d,0x5e79,0x20fe,0x4f20,0x3cd7,0x4872,0x6953,0x4d88,0x13f1,0x2389,0x0360,0x2790,0x1c64,0x3410,0x3bc8,0x2f7c,0x32c7,0x05fa,0x4558,0x4221,0x211d,0x1e81,0x4236,0x7105,0x7b1b,0x1ac2,0x4c31,0x08c7,0x51fb,0x5018,0x0e76,0x002b,0x6768,0x005a,0x3be3,0x3cd7,0x08a1,0x5055,0x2997,0x6d76,0x5917,0x19ef,0x5b83,0x604b,0x4c26,0x5378,0x0ff3,0x032d,0x20c2,0x3d52,0x7b41,0x74e8,0x2f1a,0x6cd8,0x0b9b,0x5d54,0x263e,0x3cc0,0x255e,0x7ef6,0x4e99,0x1540,0x5695,0x05b7,0x4f1c,0x1aa4,0x4398,0x392d,0x2aba,0x1edb,0x1d87,0x211d,0x7af8,0x575d,0x7c75,0x43d5,0x1f49,0x2664,0x3960,0x2496,0x3d45,0x32ec,0x2615,0x3977,0x1c15,0x7259,0x0283,0x35be,0x20b3,0x38ce,0x77f9,0x1856,0x658d,0x1557,0x2f31,0x3ceb,0x186a,0x7dbd,0x427b,0x779f,0x3410,0x2dd4,0x0a22,0x3d1f,0x417d,0x1c58,0x034b,0x343b,0x2c46,0x2db2,0x7f29,0x73dc,0x6285,0x114e,0x069a,0x5d19,0x3684,0x2e9f,0x05ed,0x4f51,0x4638,0x62df,0x79c2,0x5e45,0x779f,0x6e2a,0x4f46,0x691e,0x181b,0x4250,0x06a6,0x2f7c,0x55e2,0x2121,0x5fa6,0x160b,0x20e9,0x0bc1,0x6d76,0x6317,0x1159,0x4991,0x604b,0x0185,0x5e6e,0x4acd,0x0d3d,0x5c8b,0x1827,0x5e79,0x4236,0x58f4,0x0071,0x08d0,0x6a55,0x3035,

0x29bc,0x0924,0x52b0,0x2aba,0x5d0e,0x05c6,0x0f82,0x6d4a,0x605c,0x7aef,0x2b59,0x454f,0x01c8,0x2673,0x5378,0x6ce4,0x712e,0x0a35,0x149f,0x6fe2,0x56be,0x2b72,0x3476,0x076e,0x454f,0x7ac4,0x77ee,0x3461,0x52d6,0x49e0,0x3894,0x040e,0x7391,0x68c1,0x17e8,0x5e45,0x55f5,0x1ad5,0x24cc,0x604b,0x77d2,0x73ba,0x712e,0x56be,0x545b,0x65a6,0x36de,0x2389,0x6754,0x49ba,0x4796,0x7080,0x7836,0x3ceb,0x6d4a,0x1263,0x5322,0x70e6,0x125f,0x4dc5,0x40f8,0x7de7,0x7631,0x5d7f,0x1b0a,0x4b05,0x4b63,0x7f73,0x748e,0x2adc,0x2c20,0x7f73,0x40c4,0x36f5,0x61ce,0x6452,0x77ee,0x632b,0x6953,0x56f3,0x4502,0x66d1,0x1637,0x66c6,0x4986,0x6e70,0x6ff5,0x483f,0x5309,0x2ed2,0x2adc,0x17d4,0x0bfd,0x7998,0x1248,0x3c9a,0x01c8,0x4c1a,0x6d76,0x2980,0x08b6,0x14d2,0x2c6d,0x4abc,0x5cfa,0x62b9,0x61f2,0x411b,

0x7c2f,0x0e2c,0x49e0,0x1086,0x5bce,0x5cb7,0x7b56,0x47bd,0x35f3,0x669c,0x5d19,0x0fcf,0x4eff,0x421d,0x17c3,0x1165,0x40b5,0x5042,0x5a06,0x10ad,0x0e07,0x13bc,0x3770,0x484e,0x2e88,0x14f9,0x068d,0x74ff,0x5d54,0x0a53,0x6faf,0x5fd7,0x6b8a,0x27e1,0x1b1d,0x3770,0x38f2,0x071f,0x2ef9,0x62ae,0x32a1,0x6a7e,0x1165,0x56a9,0x3684,0x372a,0x40c4,0x150d,0x6a69,0x02ce,0x0caf,0x0e5d,0x329d,0x7b0c,0x2513,0x02a8,0x35a9,0x51ec,0x38a8,0x10ba,0x5682,0x594d,0x70bc,0x723f,0x5892,0x395c,0x7259,0x1dbb,0x7f29,0x4da3,0x7d81,0x19b5,0x13e6,0x27e1,0x3f9c,0x74b2,0x7214,0x0425,0x5401,0x58b9,0x6479,0x6fb8,0x7ddb,0x40b5,0x6011,0x5761,0x4529,0x6725,0x7174,0x1f49,0x6d2c,0x4604,0x58f4,0x6725,0x3009,0x62df,0x27e1,0x4dd2,0x392d,0x7eac,0x7b7d,0x3324,0x1de1,0x0779,0x1dbb,0x40f8,0x73ad,0x4ea5,0x2c1c,0x069a,0x6d10,0x181b,0x7998,0x462f,0x3009,0x47aa,0x2241,0x0fcf,0x6ca9,0x318c,0x0734,0x1f38,0x6a7e,0x2664,0x4b2e,0x668b,0x6d2c,0x1d87,0x0734,0x519d,0x342c,0x2980,0x0017,0x66b7,0x1ecc,0x4e99,0x033a,0x2db2,0x4236,0x059c,0x2dc3,0x4487,0x5e08,0x4b12,0x344a,0x29e6,0x6e16,0x0bea,0x7f73,0x3022,0x70e6,0x5ba8,0x0bfd,0x0e61,0x7228,0x1b50,0x7ac4,0x4c31,0x0e61,0x29e6,0x2805,0x5e6e,0x1b47,0x531e,0x05ed,0x766b,0x17c3,0x1ab3,0x002b,0x6452,0x6e70,0x65fc,0x5467,0x7847,0x7105,0x2150,0x49ad,0x0a53,0x3fb7,0x1488,

0x5309,0x55b8,0x544c,0x52c1,0x31fd,0x4398,0x0066,0x3f9c,0x122e,0x17d4,0x32d0,0x097e,0x1c73,0x2c20,0x5416,0x0468,0x090f,0x3d6e,0x3bb9,0x7af8,0x1a8f,0x4b39,0x68b0,0x4c6b,0x27bb,0x2dff,0x43fe,0x2c51,0x5cb7,0x7b0c,0x01ae,0x73cb,0x2c0b,0x0ce2,0x6d10,0x4236,0x211d,0x3bdf,0x1ef0,0x5024,0x1540,0x36b8,0x2b28,0x1b7b,0x4662,0x6e2a,0x24cc,0x06d7,0x5cd1,0x5a06,0x453e,0x3009,0x6479,0x2562,0x5e52,0x77f9,0x1086,0x61bf,0x1b50,0x43b3,0x58c8,0x4eb2,0x156b,0x0e76,0x410c,0x161c,0x1540,0x40a2,0x4b2e,0x0468,0x13bc,0x2b28,0x1edb,0x6434,0x49ba,0x24e7,0x10ad,0x6e67,0x1ecc,0x4662,0x1c4f,0x7c5e,0x0779,0x24e7,0x3cc0,0x62c8,0x318c,0x61d9,0x35cf,0x3cc0,0x6e5b,0x3ffa,0x7640,0x0bb0,0x2839,0x1b6c,0x5ca0,0x1ae9,0x345d,0x0432,0x58c8,0x306f,0x3a5a,0x31d6,0x20d5,0x545b,0x4e8e,0x7097,0x74ff,0x06b1,0x3ceb,0x4f1c,0x6452,0x5966,0x20a4,0x2aad,0x05b7,0x61d9,0x13da,0x6011,0x3333,0x1830,0x4130,0x529b,0x17ff,0x62c8,0x7b7d,0x6423,0x375b,0x4b63,0x52d6,0x5353,0x6f84,0x14b4,0x3ca6,0x47cc,0x7b7d,0x0bea,0x7537,0x19c4,0x3022,0x1ef0,0x06b1,0x3078,0x6754,0x5e52,0x2629,0x32c7,0x1397,0x2980,0x3767,0x02d9,0x0017,0x7163,0x4487,0x6ba1,0x669c,0x1103,0x58e3,0x2ec5,0x4515,0x635a,0x592b,0x02f2,0x7ee1,0x0425,0x23f8,0x38f2,0x06a6,0x4b12,0x761a,0x73cb,0x56a9,0x6bec,0x6ccf,0x4573,0x4b39,0x6b9d,0x2839,0x604b,0x4638,0x4b05,0x217b,0x0e10,0x1f2f,0x0ba7,0x090f,0x51c7,0x301e,0x35f3,0x5b94,0x61e5,0x31b0,0x005a,0x19f8,0x20a4,0x6300,0x1ecc,0x5d0e,0x113f,0x66fa,0x23f8,0x5018,0x748e,0x593c,0x6922,0x239e,0x5c9c,0x5885,0x2b65,0x394b,0x66d1,0x4991,0x4b39,0x0e61,0x167a,0x2eb4,0x4613,0x4828,0x4ec3,0x6194,0x19f8,0x2eee,0x43b3,0x6743,0x3bf4,0x787b,0x2eb4,0x1ee7,0x4127,0x0e4a,0x199e,0x7139,0x767c,0x6452,0x632b,0x7c38,0x5467,0x2b4e,0x14d2,0x074c,0x6a69,0x239e,0x51fb,0x56cf,0x3767,0x51c7,0x2863,0x31a7,0x2e88,0x5707,0x13ab,0x2673,0x0bd6,0x633c,0x0192,0x528c,0x677f,0x392d,0x2538,0x6725,0x2098,0x6935,0x3461,0x2227,0x3701,0x6183,0x113f,0x23a2,0x7f64,0x3a00,0x5033,0x40ef,0x5c9c,0x372a,0x798f,0x4aab,0x3fa0,0x239e,0x6a7e,0x760d,0x2d99,0x5d68,0x35cf,0x786c,0x157c,0x4130,0x3716,

0x5fc0,0x0752,0x29e6,0x285f,0x20e9,0x7097,0x6bc7,0x068d,0x1ad5,0x7c2f,0x47f0,0x2874,0x4141,0x66ed,0x1f62,0x55f5,0x40c4,0x2b03,0x2db2,0x5e08,0x1d90,0x7112,0x62f4,0x36de,0x7f3e,0x2eee,0x6fde,0x751c,0x3e19,0x5966,0x23b5,0x6d5d,0x3a17,0x0fa9,0x1ad5,0x0ff3,0x5cb7,0x1086,0x2c37,0x17a5,0x4221,0x02d9,0x1d90,0x3701,0x77a3,0x3716,0x3d79,0x7ab5,0x7aa2,0x1c73,0x40d3,0x0942,0x1b50,0x2504,0x2c37,0x4dc5,0x5776,0x6c95,0x659a,0x1ad5,0x3f8b,0x756d,0x5e6e,0x7203,0x5feb,0x208f,0x3a17,0x1ad5,0x5d68,0x2812,0x227d,0x3009,0x6953,0x0745,0x3078,0x059c,0x43b3,0x55e2,0x3cd7,0x3f8b,0x0a1e,0x2f26,0x1274,0x0cf5,0x227d,0x4aab,0x1ecc,0x7821,0x4ee8,0x79b3,0x2de8,0x689b,0x05b7,0x484e,0x670e,0x342c,0x17c3,0x005a,0x4db4,0x27bb,0x7b41,0x66c6,0x1ab3,0x4d9f,0x2658,0x342c,0x149f,0x0d01,0x531e,0x3e0e,0x08ec,0x2d8e,0x58df,0x3d52,0x43e9,0x56be,0x2c0b,0x5a5c,0x52b0,0x760d,0x3a00,0x4b74,0x02a8,0x6366,0x7dbd,0x1e96,0x13cd,0x5b83,0x17a5,0x798f,0x3e19,0x150d,0x7eca,0x61a8,0x4d88,0x52b0,0x19a2,0x2dff,0x61f2,0x70ab,0x47db,0x0a78,0x0d2a,0x1248,0x1e81,0x65c0,0x453e,0x3977,0x7546,0x62df,0x7dbd,0x4558,0x2ef9,0x166d,0x02d9,0x0caf,0x08c7,0x1c29,0x7d96,0x7626,0x0185,0x3333,0x5bd9,0x113f,0x604b,0x1c29,0x27dd,0x5d0e,0x3333,0x6fe2,0x7105,0x1b6c,0x6ba1,0x6a55,0x01df,0x79fe,0x32d0,0x5055,0x4564,0x4f37,0x2f1a,0x31ea,0x4221,0x1f13,0x7df0,0x5be5,0x2874,0x68c1,0x483f,0x0454,0x0a6f,0x4564,0x14a3,0x572c,0x6423,0x7551,0x79e9,0x31d6,0x6bec,0x5d68,0x55c9,0x2c51,0x0454,0x0f95,0x19c4,0x781d,0x047f,0x4ae6,0x1488,0x2f31,0x411b,0x4a97,0x6a0f,0x52ea,0x040e,0x23ef,0x

542a,0x1103,0x0a1e,0x6a42,0x3333,0x1b0a,0x5470,0x3582,0x536f,0x4515,0x5a2d,0x7ad3,0x70cd,0x1128,0x1e81,0x264f,0x02ce,0x6300,0x6ff5,0x52a7,0x034b,0x410c,0x7dbd,0x5a77,0x0a22,0x01f4,0x035c,0x4865,0x6c82,0x7998,0x0d01,0x345d,0x6e2a,0x7850,0x040e,0x6c95,0x0c84,0x3883,0x5042,0x6e4c,0x1b7b,0x7163,0x38bf,0x47db,0x35e4,0x574a,0x4acd,0x27ac,0x7850,0x1380,0x2136,0x1b6c,0x6e67,0x301e,0x7148,0x40b5,0x5a5c,0x6bd0,0x1ebd,0x66d1,0x24f0,0x6a69,0x2f6b,0x2787,0x4b12,0x52ea,0x68ea,0x2790,0x1f62,0x263e,0x3883,0x149f,

0x7847,0x70da,0x220c,0x4c57,0x0f95,0x4abc,0x033a,0x4558,0x787b,0x61a8,0x4f51,0x31fd,0x3fd1,0x24e7,0x4247,0x08b6,0x4f0b,0x0185,0x1380,0x24aa,0x1212,0x3a3c,0x1aa4,0x536f,0x29cd,0x3461,0x0745,0x36e2,0x4f20,0x47db,0x3701,0x4ec3,0x3e54,0x1ab3,0x4490,0x2790,0x2aba,0x3bf4,0x2f31,0x44e1,0x65fc,0x7f73,0x5776,0x216c,0x1ddd,0x27f6,0x2538,0x058b,0x634d,0x0468,0x4865,0x542a,0x52d6,0x36b8,0x2602,0x689b,0x2098,0x35e4,0x1b47,0x2c6d,0x7c75,0x2c7a,0x58b9,0x36de,0x1248,0x2839,0x0000,0x634d,0x5a3a,0x70f1,0x56be,0x66a0,0x70f1,0x047f,0x7105,0x43e9,0x20a4,0x20b3,0x4859,0x14d2,0x767c,0x35be,0x3fed,0x1f5e,0x4515,0x5024,0x38e5,0x3ffa,0x1841,0x44bb,0x1b7b,0x003c,0x4ec3,0x411b,0x3324,0x3078,0x0a22,0x66fa,0x02d9,0x4ae6,0x08a1,0x0377,0x29cd,0x35be,0x5695,0x7b1b,0x01e3,0x49f7,0x0a78,0x417d,0x36f5,0x0d3d,0x3355,0x65c0,0x761a,0x5ced,0x0e76,0x2513,0x01e3,0x3693,0x507e,0x0969,0x7631,0x56e4,0x1c64,0x217b,0x08b6,0x5033,0x0d67,0x1f49,0x724e,0x545b,0x6a18,0x040e,0x77d2,0x0924,0x7f64,0x6bd0,0x7c62,0x090f,0x4dd2,0x2f31,0x5d43,0x3d08,0x5be5,0x5a11,0x4c31,0x43e9,0x31fd,0x3fa0,0x6c95,0x4662,0x544c,0x5cb7,0x6d4a,0x6e2a,0x0b9b,0x61f2,0x52c1,0x49cb,0x08b6,0x0306,0x5d25,0x659a,0x6292,0x5fa6,0x6ba1,0x56f3,0x1205,0x5401,0x65b1,0x751c,0x01c8,0x5682,0x1b7b,0x19a2,0x62ae,0x2d8e,0x79fe,0x1c58,0x2615,0x602d,0x3053,0x7dcc,0x36c9,0x7850,0x2997,0x4796,0x691e,0x6faf,0x77ee,0x01ae,0x409e,0x0419,0x29bc,0x3a5a,0x5d19,0x49e0,0x10f7,0x0a09,0x62e3,0x5bd9,0x6e2a,0x2121,0x1b50,0x5fa6,0x0969,0x4b12,0x1b7b,0x7c04,0x756d,0x6b8a,0x4156,0x7d81,0x31d6,0x4e99,0x79a4,0x4d88,0x3e43,0x2241,0x7265,0x68c1,0x040e,0x5335,0x0bc1,0x0723,0x3770,0x2aad,0x5e1f,0x748e,0x7788,0x1f75,0x3fc6,0x5e23,0x6e3d,0x0b8c,0x38ce,0x0377,0x160b,0x5055,0x723f,0x10dc,0x02d9,0x161c,0x70bc,0x4f51,0x1c58,0x7520,0x670e,0x55c9,0x5e34,0x3fa0,0x1172,0x6c82,0x500f,0x5b94,0x20d5,0x438f,0x65a6,0x149f,0x4221,0x7b0c,0x7b6a,0x4b39,0x3410,0x0734,0x29da,0x4c40,0x47bd,0x51d0,0x0e76,0x5695,0x319b,0x4ada,0x5966,0x7ee1,0x1ac2,0x519d,0x4db4,0x500f,0x7f4f,0x4991,0x3318,0x7b7d,0x004d,0x1488,0x7139,0x7daa,

0x3d6e,0x02ce,0x5fc0,0x2eb4,0x5d43,0x7259,0x6bc7,0x6909,0x1488,0x61f2,0x5e08,0x7998,0x0bb0,0x4e8e,0x1856,0x3e43,0x4221,0x2980,0x2848,0x668b,0x545b,0x1b50,0x068d,0x5710,0x4398,0x56f3,0x55cc6,0x49f7,0x62ae,0x49ad,0x27ac,0x344a,0x7847,0x43b3,0x68d6,0x4b63,0x167a,0x5761,0x5e52,0x6e3d,0x79d5,0x6c82,0x6445,0x2481,0x2997,0x6408,0x756d,0x0779,0x1ab3,0x74d4,0x6317,0x343b,0x6fc9,0x1ac2,0x0443,0x1ef0,0x3fc6,0x6732,0x2c7a,0x13f1,0x4859,0x02a8,0x337e,0x5d7f,0x157c,0x1b21,0x56a9,0x1159,0x29f1,0x05c6,0x6719,0x337e,0x328a,0x31c1,0x306f,0x14f9,0x4515,0x0071,0x536f,0x31ea,0x3c9a,0x1212,0x1128,0x166d,0x3e43,0x3d79,0x6bc7,0x2c7a,0x4250,0x2c20,0x6bfb,0x5776,0x484e,0x3894,0x1827,0x43fe,0x1c3e,0x01b9,0x187d,0x6366,0x5416,0x2b14,0x74e8,0x6a18,0x31a7,0x55c9,0x1841,0x426c,0x688c,0x2dc3,0x4221,0x6d07,0x4649,0x3fc6,0x4564,0x0b8c,0x1239,0x1103,0x6bfb,0x4c7c,0x5584,0x2805,0x6d2c,0x32a1,0x6011,0x3a17,0x634d,0x1ab3,0x3fed,0x02e5,0x0d67,0x0bea,0x3595,0x2658,0x1c3e,0x35cf,0x3369,0x227d,0x4c26,0x65c0,0x090f,0x2a86,0x5917,0x033a,0x421d,0x0c93,0x4a80,0x0933,0x0a09,0x688c,0x1637,0x5b83,0x760d,0x38f2,0x0ff3,0x1380,0x5033,0x5d25,0x7f58,0x3461,0x3cfc,0x1557,0x05ed,0x005a,0x29f1,0x4ada,0x1ee7,0x7546,0x2f1a,0x1a98,0x572c,0x31b0,0x2602,0x52b0,0x17a5,0x4564,0x781d,0x02d9,0x4b63,0x3e0e,0x6445,0x3bc8,0x56be,0x0311,0x6ce4,0x2389,0x3044,0x36de,0x6935,0x2787,0x593c,0x1c4f,0x3d6e,0x417d,0x1651,0x0066,0x44dd,0x4a97,0x6a69,0x6f93,0x49f7,0x0294,0x29cd,0x483f,0x1620,0x7788,0x6cf3,0x4490,0x5069,0x1086,0x13f1,0x0425,0x3cfc,0x6423,0x6a0f,0x4eb2,0x032d,0x0d67,0x1f49,0x5892,0x5a4b,0x6452,0x543d,0x005a,0x090f,0x178e,0x3be3,0x44e1,0x157c,0x602d,0x483f,0x0d01,0x0283,0x02f2,0x4b39,0x5feb,0x32d0,0x6cd8,0x3fed,0x7de7,0x696f,0x343b,0x7c49,0x4eff,0x0443,0x5a11,0x5761,0x4b5f,0x374c,0x6fde,0x1205,0x0bd6,0x392d,0x6183,0x6006,0x2230,0x157c,0x55e2,0x6292,0x3693,0x6a42,0x2839,0x465e,0x3b92,0x5d25,0x3a00,0x38e5,0x65fc,0x7c2f,0x1557,0x14c5,0x0360,0x32d0,0x62b9,0x6a0f,0x1397,0x4141,0x68d6,0x1827,0x1526,0x1b47,0x2b28,0x2812,0x31b0,0x3c9a,0x17e8,0x181b,0x3be3,

0x1c64,0x6bc7,0x1c73,0x55e2,0x4613,0x3342,0x392d,0x44f6,0x150d,0x318c,0x4f0b,0x3318,0x181b,0x10e0,0x3d6e,0x44ac,0x6a18,0x343b,0x4c26,0x221b,0x6408,0x4613,0x47bd,0x3d45,0x4127,0x27bb,0x306f,0x23d3,0x17e8,0x4ae6,0x3e68,0x44e1,0x373d,0x0bc1,0x4127,0x2812,0x24db,0x595a,0x6ccf,0x7174,0x4502,0x7f15,0x36af,0x2f26,0x38bf,0x7228,0x4b74,0x5bd9,0x0192,0x7ddb,0x0d5b,0x605c,0x7ddb,0x239e,0x239e,0x52a7,0x7112,0x5e1f,0x4c6b,0x7836,0x4df9,0x7499,0x02e5,0x3911,0x0cb8,0x70f1,0x3e32,0x4e8e,0x7aef,0x6768,0x17e8,0x7daa,0x6ce4,0x3770,0x4a97,0x05fa,0x68fd,0x70da,0x2f0d,0x5470,0x7259,0x3b85,0x318c,0x3022,0x5c9c,0x210a,0x033a,0x7203,0x77a3,0x4a97,0x7272,0x56be,0x7daa,0x0e3b,0x43c2,0x62f4,0x70ab,0x43d5,0x2256,0x73dc,0x0d16,0x52c1,0x5335,0x4f1c,0x252f,0x58e3,0x6fe2,0x6bfb,0x3410,0x4c40,0x7c04,0x5ba8,0x306f,0x0e07,0x36b8,0x2f40,0x395c,0x465e,0x55af,0x2dc3,0x44bb,0x0723,0x4b05,0x4aab,0x6ccf,0x1b6c,0x5593,0x0d5b,0x0cb8,0x181b,0x3fc6,0x7ab5,0x68fd,0x79e9,0x2ec5,0x5900,0x6060,0x575d,0x47cc,0x5e6e,0x02e5,0x7c75,0x2256,0x20d5,0x2d99,0x518a,0x4db4,0x6a42,0x330f,0x641f,0x0454,0x3bf4,0x375b,0x77a3,0x08ec,0x27dd,0x7aef,0x712e,0x6fde,0x0955,0x7b1b,0x2f0d,0x55b8,0x285f,0x6194,0x5e45,0x2f40,0x0d16,0x51ec,0x13ab,0x06c0,0x7f15,0x65c0,0x5707,0x3b85,0x0306,0x3770,0x3693,0x6ce4,0x7836,0x2ef9,0x6e4c,0x70ab,0x5fb1,0x43fe,0x70e6,0x372a,0x2812,0x1c58,0x575d,0x7d96,0x05fa,0x58e3,0x5ffc,0x43c2,0x27ac,0x19f8,0x0cc9,0x1afe,0x2147,0x7ddb,0x36c9,0x1488,0x392d,0x6d5d,0x20d5,0x7daa,0x484e,0x27bb,0x3767,0x595a,0x410c,0x2538,0x4b74,0x5593,0x210a,0x0d2a,0x1799,0x6fe2,0x38f2,0x757a,0x0caf,0x4df9,0x7520,0x3fc6,0x076e,0x1f75,0x1edb,0x149f,0x20e9,0x10ba,0x7f58,0x798f,0x2f26,0x7272,0x4c40,0x55af,0x2ef9,0x0cf5,0x2b65,0x70f1,0x7112,0x0d16,0x5ba8,0x0c93,0x0b8c,0x2227,0x7228,0x01df,0x6434,0x7daa,0x2af7,0x319b,0x306f,0x2615,0x6e4c,0x55af,0x58df,0x3035,0x7f3e,0x3bf4,0x5e52,0x519d,0x4aab,0x79b3,0x3e32,0x3324,0x465e,0x1eaa,0x1df6,0x595a,0x44bb,0x3333,0x2256,0x2147,0x4da3,0x0cc9,0x239e,0x02f2,0x2b03,0x2f40,0x79b3,0x1de1,0x5335,0x6d2c,0x5966,0x7203,0x748e,

0x06b1,0x6732,0x06d7,0x574a,0x1274,0x2f0d,0x3022,0x4ae6,0x3d52,0x68c1,0x4573,0x3fd1,0x0377,0x56be,0x0d4c,0x52ea,0x5c9c,0x40f8,0x5353,0x4c0d,0x4156,0x3c9a,0x4a97,0x1248,0x438f,0x7203,0x5018,0x4141,0x66fa,0x4573,0x3b85,0x1c02,0x24db,0x0bea,0x5e52,0x20fe,0x2227,0x395c,0x47f0,0x1b50,0x55e2,0x040e,0x52c1,0x040e,0x0468,0x757a,0x6bfb,0x2f26,0x1830,0x7163,0x1989,0x5401,0x226a,0x5a06,0x0e07,0x426c,0x43d5,0x3595,0x32ec,0x3e7f,0x17b2,0x3f9c,0x3f8b,0x61d9,0x2c51,0x787b,0x6b8a,0x5917,0x6300,0x61e5,0x6445,0x373d,0x1aa4,0x2c20,0x1128,0x0c93,0x36af,0x536f,0x31d6,0x4dee,0x56cf,0x7c75,0x0a35,0x5ced,0x3a00,0x4649,0x2af7,0x2839,0x47db,0x3a4d,0x2b65,0x70ab,0x034b,0x097e,0x6d07,0x17d4,0x6c95,0x544c,0x6194,0x27dd,0x05d1,0x1aa4,0x62e3,0x01ae,0x7af8,0x5069,0x2acb,0x7b7d,0x49e0,0x6a69,0x23a2,0x1114,0x1aa4,0x2b72,0x574a,0x282e,0x3d08,0x1397,0x7626,0x08c7,0x06c0,0x7097,0x217b,0x58c8,0x4abc,0x0ff3,0x62df,0x4c26,0x5900,0x3cc0,0x20e9,0x688c,0x6452,0x6ce4,0x7f73,0x0a1e,0x2acb,0x1830,0x1c4f,0x3977,0x44e1,0x779f,0x7f4f,0x3bb9,0x4638,0x49f7,0x19b5,0x2ea3,0x114e,0x7f58,0x6faf,0x05a0,0x5353,0x06a6,0x6754,0x68c1,0x0a78,0x32ec,0x2549,0x6a24,0x1159,0x2eb4,0x05c6,0x3e43,0x0933,0x52d6,0x74a5,0x08b6,0x4558,0x7c62,0x301e,0x781d,0x4c57,0x0066,0x27e1,0x3c9a,0x2673,0x32b6,0x4e99,0x760d,0x4b63,0x4675,0x2575,0x658d,0x0933,0x4acd,0x4c0d,0x7214,0x7daa,0x5584,0x2e88,0x217b,0x1540,0x393a,0x1aa4,0x1d87,0x4ae6,0x1b1d,0x65fc,0x089d,0x20a4,0x5c8b,0x3e68,0x7b30,0x61a8,0x66ed,0x1620,0x5695,0x56cf,0x4b48,0x3324,0x13ab,0x66a0,0x01df,0x56e4,0x70e6,0x7af8,0x5593,0x3009,0x5695,0x5fa6,0x3684,0x73e0,0x19c4,0x7836,0x1e81,0x31d6,0x02e5,0x2b72,0x427b,0x40ef,0x35f3,0x151a,0x345d,0x1114,0x01ae,0x4558,0x6909,0x781d,0x66c6,0x6011,0x3022,0x14d2,0x438f,0x3d34,0x7de7,0x6194,0x0a35,0x3bb9,0x1841,0x3a66,0x2c37,0x1ae9,0x0a1e,0x27e1,0x394b,0x61a8,0x531e,0x17d4,0x65fc,0x161c,0x047f,0x1526,0x7e90,0x059c,0x4573,0x1380,0x5a2d,0x5e45,0x252f,0x6e3d,0x374c,0x6a18,0x65eb,0x1c3e,0x3342,0x5707,0x74e8,0x6e3d,0x06c0,0x7631,0x38e5,0x31c1,0x1830,0x5024,0x3bdf,0x5470,0x4abc,

0x2ec5,0x6a69,0x528c,0x06d7,0x3bae,0x0066,0x49e0,0x4b2e,0x1165,0x5707,0x2eee,0x27ca,0x68b0,0x089d,0x594d,0x3d34,0x52b0,0x1b36,0x65eb,0x4acd,0x3fed,0x10dc,0x122e,0x38e5,0x7f3e,0x65c0,0x65b1,0x4604,0x1248,0x5a11,0x5707,0x5344,0x62b9,0x14ee,0x7499,0x7551,0x4515,0x14d2,0x3e0e,0x38ce,0x2c20,0x034b,0x2863,0x1e81,0x337e,0x217b,0x2496,0x0443,0x24e7,0x0432,0x375b,0x38e5,0x36de,0x5467,0x216c,0x1091,0x3bc8,0x7ef6,0x36de,0x06c0,0x65c0,0x6a0f,0x633c,0x24e7,0x4781,0x13cd,0x74c3,0x5353,0x4c31,0x61bf,0x3f9c,0x0cb8,0x3767,0x282e,0x7850,0x2664,0x5feb,0x2c7a,0x484e,0x1ac2,0x20fe,0x1c02,0x65fc,0x1d90,0x17a5,0x6300,0x0294,0x7e90,0x519d,0x43fe,0x5892,0x7631,0x4b74,0x20b3,0x3369,0x3022,0x47bd,0x0bb0,0x1488,0x6bc7,0x44dd,0x40a2,0x4da3,0x61a8,0x166d,0x5d54,0x5bce,0x4

859,0x003c,0x5069,0x4f20,0x61f2,0x62b9,0x3e7f,0x1c29,0x6a69,0x49cb,0x1e81,0x5917,0x5042,0x2098,0x3a3c,0x1b47,0x5d32,0x70da,0x4613,0x5c8b,0x2673,0x3e43,0x6e4c,0x595a,0x3684,0x0933,0x73cb,0x70cd,0x7b7d,0x7788,0x2664,0x7ee1,0x0b9b,0x7e90,0x3f9c,0x27ac,0x6f84,0x5ced,0x3fa0,0x32fb,0x5416,0x61f2,0x43a4,0x1b21,0x40f8,0x068d,0x43b3,0x35d8,0x3d6e,0x79d5,0x1dbb,0x1128,0x5042,0x090f,0x65a6,0x5d0e,0x2c51,0x426c,0x4130,0x43e9,0x7788,0x003c,0x4991,0x2790,0x6fe2,0x47f0,0x31b0,0x70cd,0x05ed,0x344a,0x337e,0x1de1,0x7163,0x3b85,0x7998,0x52b0,0x1ad5,0x2227,0x23a2,0x43b3,0x19ef,0x3bc8,0x3960,0x1c4f,0x058b,0x5d0e,0x29ab,0x0ba7,0x2c1c,0x4c7c,0x5d25,0x6292,0x5a2d,0x5055,0x29da,0x5e79,0x3078,0x239e,0x2ef9,0x0e3b,0x342c,0x66d1,0x5e79,0x7de7,0x1c73,0x3977,0x2f1a,0x36de,0x7174,0x3cb1,0x0ff3,0x751c,0x52b0,0x6cd8,0x49f7,0x605c,0x56be,0x7105,0x61bf,0x5be5,0x6408,0x4675,0x13cd,0x227d,0x187d,0x13cd,0x65a6,0x688c,0x1091,0x23a2,0x73f7,0x6434,0x5fb1,0x263e,0x27dd,0x4991,0x5f9a,0x411b,0x5a3a,0x32c7,0x0bfd,0x5055,0x4f46,0x23b5,0x01b9,0x2848,0x65a6,0x2790,0x02f2,0x14f9,0x23f8,0x02e5,0x73e0,0x0933,0x670e,0x239e,0x13cd,0x427b,0x27e1,0x3078,0x2c20,0x6d61,0x1ab3,0x180c,0x0360,0x6a7e,0x2496,0x31fd,0x68ea,0x4859,0x0f82,0x454f,0x5bf2,0x29cd,0x65be,0x779f,0x1de1,0x6011,0x263e,0x691e,0x5033,

0x756d,0x2664,0x658d,0x0bea,0x5d19,0x5a4b,0x02d9,0x74d4,0x4b48,0x32d0,0x66ed,0x417d,0x6408,0x345d,0x4b5f,0x10ba,0x77ee,0x47e7,0x4d9f,0x5e08,0x543d,0x1dca,0x040e,0x374c,0x27dd,0x19ef,0x453e,0x1263,0x0468,0x6bd0,0x594d,0x633c,0x0ff3,0x0a22,0x6a69,0x2098,0x52c1,0x3fa0,0x2d8e,0x66fa,0x004d,0x6ba1,0x4af1,0x49ad,0x4ada,0x52b0,0x0d2a,0x27ca,0x23f8,0x5fd7,0x4ada,0x669c,0x0071,0x61f2,0x7265,0x49ad,0x187d,0x47aa,0x6a18,0x14b4,0x20e9,0x62f4,0x500f,0x1212,0x49cb,0x2602,0x575d,0x3d6e,0x3bf4,0x4d9f,0x2538,0x52c1,0x6909,0x70da,0x1de1,0x2b72,0x4c0d,0x420a,0x2602,0x669c,0x186a,0x24f0,0x150d,0x0a53,0x1841,0x66fb,0x1b21,0x23a2,0x5d7f,0x2562,0x3d52,0x0fa9,0x19c4,0x5966,0x0fcf,0x3883,0x4c57,0x10cb,0x4f20,0x090f,0x3355,0x0b9b,0x411b,0x2389,0x328a,0x2c0b,0x0942,0x395c,0x0f82,0x5966,0x10cb,0x1989,0x7f15,0x5b94,0x1afe,0x5a5c,0x0e4a,0x0fa9,0x3355,0x330f,0x68d6,0x372a,0x17ff,0x1dbb,0x2f1a,0x6d3b,0x2a86,0x7d81,0x2ed2,0x7105,0x0fcf,0x2ec5,0x337e,0x4f0b,0x58df,0x2389,0x090f,0x36f5,0x1edb,0x4796,0x3e25,0x0e61,0x19ef,0x1b1d,0x7f02,0x6183,0x7148,0x574a,0x62c8,0x034b,0x4abc,0x4ae6,0x73cb,0x7080,0x61ce,0x1f75,0x40b5,0x4abc,0x58e3,0x373d,0x4f7a,0x6a7e,0x14d2,0x1dca,0x4c1a,0x0caf,0x0432,0x0ce2,0x0cde,0x44bb,0x1f62,0x059c,0x1e96,0x5e52,0x0cf5,0x7de7,0x6317,0x7b27,0x6ca9,0x5344,0x6d76,0x2b72,0x47aa,0x38e5,0x2c0b,0x29ab,0x7eca,0x0311,0x7f15,0x3fb7,0x0066,0x3e68,0x0a35,0x5e34,0x7836,0x780a,0x3407,0x343b,0x1212,0x2812,0x2f7c,0x3e68,0x6f84,0x7386,0x49ad,0x767c,0x5bce,0x3f9c,0x114e,0x5344,0x7b1b,0x70e6,0x0a09,0x5d32,0x0468,0x19f8,0x79d5,0x0955,0x79b3,0x5bf2,0x1b36,0x7626,0x3333,0x4865,0x097e,0x6285,0x255e,0x3d52,0x31a7,0x7de7,0x7c75,0x781d,0x210a,0x518a,0x4df9,0x05d1,0x7d96,0x319b,0x5d68,0x1a98,0x1afe,0x4130,0x0fe4,0x669c,0x2504,0x35e4,0x6c95,0x02a8,0x394b,0x5e34,0x3a2b,0x5e6e,0x4487,0x3d52,0x14d2,0x1159,0x5322,0x7112,0x13ab,0x32a1,0x4564,0x1526,0x68ea,0x6faf,0x2eee,0x7eac,0x35be,0x318c,0x0425,0x7b1b,0x1397,0x6d61,0x2c20,0x51fb,0x3e19,0x3c9a,0x227d,0x226a,0x3ca6,0x646e,0x518a,0x2098,0x4c40,0x5e08,0x1557,0x06d7,0x55b8,0x02d9,

0x7a89,0x528c,0x7836,0x0a22,0x2c37,0x1a98,0x7b30,0x047f,0x392d,0x3911,0x35cf,0x27dd,0x35f3,0x1557,0x6bb6,0x1557,0x2ae0,0x06c0,0x6371,0x6a69,0x4df9,0x68b0,0x4c26,0x047f,0x5353,0x417d,0x5971,0x5d19,0x2aad,0x4558,0x0a35,0x4b05,0x5cb7,0x1637,0x1103,0x0443,0x23b5,0x157c,0x7eac,0x6ca9,0x1de1,0x3fd1,0x4828,0x5ca0,0x62f4,0x071f,0x66ed,0x20b3,0x5d54,0x5900,0x3e19,0x01df,0x7821,0x7c62,0x6ba1,0x43c2,0x3e25,0x595a,0x033a,0x372a,0x5042,0x6077,0x2504,0x0ff3,0x6ca9,0x55b8,0x604b,0x005a,0x0443,0x2863,0x5710,0x1ae9,0x38f2,0x4b12,0x766b,0x01f4,0x3684,0x0454,0x1172,0x29da,0x0bea,0x2e88,0x14c5,0x7b30,0x4991,0x375b,0x4c31,0x2839,0x2664,0x06fc,0x7c49,0x1dca,0x2658,0x035c,0x5d19,0x7aa2,0x40f8,0x24f0,0x2acb,0x4acd,0x786c,0x32ec,0x56f3,0x1263,0x6a69,0x3582,0x4ec3,0x4aab,0x7c38,0x1c58,0x4ec3,0x06a6,0x0a22,0x3324,0x7d81,0x7c49,0x13da,0x595a,0x342c,0x786c,0x4859,0x5055,0x1de1,0x6a24,0x6909,0x0ff3,0x4f20,0x301e,0x1841,0x285f,0x670e,0x1651,0x166d,0x36c9,0x592b,0x1c73,0x4828,0x2787,0x484e,0x44ac,0x23a2,0x70bc,0x6d07,0x167a,0x167a,0x43d5,0x1ae9,0x58e3,0x17e8,0x3bf4,0x3d79,0x20e9,0x282e,0x040e,0x4127,0x2658,0x5d25,0x2aba,0x2c6d,0x24e7,0x74e8,0x56e4,0x187d,0x05b7,0x3318,0x38d9,0x483f,0x44bb,0x2b03,0x05fa,0x7ebb,0x2629,0x178e,0x285f,0x6f93,0x4f1c,0x6445,0x4127,0x1dca,0x5f9a,0x0d3d,0x4529,0x36c9,0x4649,0x43fe,0x6faf,0x4f7a,0x4f1c,0x7f3e,0x0306,0x4649,0x462f,0x19a2,0x3407,0x3894,0x4529,0x3f8b,0x122e,0x3693,0x1e81,0x0a09,0x0311,0x760d,0x453e,0x766b,0x62e3,0x47f0,0x5892,0x409e,0x5cd1,0x3342,0x13da,0x66d1,0x3b92,0x7c75,0x6

434,0x68fd,0x17c3,0x5a2d,0x05d1,0x227d,0x36f5,0x5f9a,0x7ebb,0x208f,0x285f,0x36f5,0x7e87,0x1856,0x632b,0x6445,0x6944,0x1b1d,0x1397,0x08a1,0x05d1,0x6f93,0x180c,0x5900,0x36f5,0x43fe,0x3e25,0x426c,0x08ec,0x2b03,0x034b,0x4236,0x0a35,0x3fb7,0x3fa0,0x7640,0x6445,0x4b63,0x1263,0x392d,0x56d8,0x1380,0x4dc5,0x2eb4,0x392d,0x4af1,0x77d2,0x0e3b,0x3cd7,0x24db,0x62e3,0x14a3,0x1274,0x13da,0x1b36,0x1f62,0x38a8,0x2f40,0x1651,0x2b59,0x58f4,0x4c57,0x5892,0x411b,0x6768,0x3d23,0x0d4c,0x5feb,0x4221,0x409e,0x5917,0x2602,0x7c49,

0x08a1,0x3a2b,0x7f4f,0x6c82,0x0d67,0x3d1f,0x05b7,0x2c51,0x7386,0x1f13,0x35a9,0x3d52,0x4c31,0x0752,0x1c4f,0x6768,0x646e,0x4675,0x7265,0x3fed,0x62f4,0x688c,0x20fe,0x51a1,0x5966,0x6b8a,0x31d6,0x1ef0,0x7eca,0x2b3f,0x4247,0x4df9,0x7520,0x0ce2,0x5a3a,0x7edd,0x2c37,0x097e,0x4ada,0x2ae0,0x1df6,0x545b,0x2f31,0x3906,0x47aa,0x4250,0x6292,0x5d7f,0x1091,0x68fd,0x1799,0x374c,0x4ae6,0x004d,0x6978,0x603a,0x329d,0x7c13,0x4ee8,0x178e,0x2513,0x23b5,0x0bfd,0x66fa,0x454f,0x712e,0x13da,0x149f,0x157c,0x2575,0x0caf,0x7af8,0x6d10,0x5fd7,0x1b1d,0x4236,0x73ad,0x4b48,0x79a4,0x7499,0x6b9d,0x217b,0x033a,0x19d3,0x2241,0x5e45,0x5d54,0x4529,0x2805,0x2504,0x3684,0x1ae9,0x0bc1,0x51a1,0x6317,0x0d2a,0x4e8e,0x58ae,0x7aa2,0x301e,0x2eee,0x4803,0x5710,0x31a7,0x3d52,0x659a,0x3be3,0x7265,0x4b5f,0x40d3,0x66ed,0x4db4,0x7f73,0x410c,0x77f9,0x1989,0x23ef,0x787b,0x49cb,0x4d9f,0x05fa,0x2eb4,0x1239,0x6944,0x14ee,0x0066,0x1dac,0x13bc,0x2da5,0x0fcf,0x0071,0x7ddb,0x6fe2,0x5b94,0x798f,0x0745,0x44e1,0x4872,0x06d7,0x7edd,0x0c84,0x417d,0x1ee7,0x3701,0x23c4,0x4b2e,0x0cc9,0x38e5,0x38bf,0x3684,0x3e19,0x65fc,0x7df0,0x0fd8,0x7105,0x1c58,0x29bc,0x5f9a,0x5917,0x605c,0x7a9e,0x40b5,0x059c,0x14f9,0x14c5,0x0d5b,0x0918,0x3960,0x1830,0x68a7,0x751c,0x5707,0x1b47,0x52b0,0x4490,0x31ea,0x6f84,0x6e4c,0x4613,0x1620,0x1248,0x4604,0x70f1,0x10ad,0x44bb,0x4247,0x65d7,0x51b6,0x24cc,0x6935,0x0734,0x7b56,0x43c2,0x4796,0x7640,0x5042,0x5bd9,0x2513,0x2ed2,0x2b59,0x0942,0x2629,0x635a,0x2b28,0x374c,0x36f5,0x2eb4,0x10dc,0x3bc8,0x1c73,0x210a,0x1a8f,0x032d,0x02a8,0x6a24,0x24aa,0x0bd6,0x36af,0x3a2b,0x51c7,0x79c2,0x4db4,0x5401,0x74a5,0x05fa,0x2c0b,0x6452,0x6e16,0x438f,0x151a,0x2af7,0x6bb6,0x0c93,0x507e,0x1488,0x0a1e,0x3e0e,0x7daa,0x6719,0x2658,0x1c64,0x0294,0x6e3d,0x3053,0x1526,0x61a8,0x180c,0x5fa6,0x0a1e,0x4da3,0x4c7c,0x7f4f,0x6719,0x43d5,0x7139,0x4f37,0x2980,0x08d0,0x79b3,0x4662,0x3cb1,0x0a22,0x3053,0x24db,0x56a9,0x500f,0x536f,0x58f4,0x1239,0x55e2,0x74ff,0x6ccf,0x2241,0x66fa,0x1531,0x5a5c,0x5344,0x1f75,0x2c6d,0x5584,0x5917,0x1a98,0x5d68,0x1de1,0x337e,0x3a2b,0x199e,0x7520,

0x544c,0x0377,0x757a,0x781d,0x23a2,0x6a0f,0x1b21,0x634d,0x3476,0x6d5d,0x4ec3,0x36c9,0x7f4f,0x3a5a,0x779f,0x32b6,0x52fd,0x1646,0x7e90,0x3a17,0x2147,0x3ceb,0x10cb,0x0a78,0x10ba,0x13f1,0x0d16,0x6c82,0x43fe,0x2980,0x2c46,0x113f,0x1b6c,0x5695,0x0a78,0x5416,0x0a53,0x7626,0x5fd7,0x6743,0x1aa4,0x36f5,0x0d3d,0x70cd,0x6fb8,0x2538,0x0e3b,0x2a86,0x1eaa,0x595a,0x52c1,0x0185,0x4a828,0x1989,0x05ed,0x14b4,0x05c6,0x40b5,0x0e10,0x79e9,0x5d32,0x161c,0x3bb9,0x77ee,0x7228,0x2549,0x7080,0x02db2,0x6077,0x29f1,0x0e5d,0x5d43,0x7499,0x4d88,0x10dc,0x6e5b,0x542a,0x19c4,0x756d,0x2839,0x641f,0x35d8,0x1c73,0x06eb,0x24e7,0x5a5c,0x23ef,0x3e0e,0x689b,0x5966,0x35cf,0x5024,0x23a2,0x7e90,0x79fe,0x2ef9,0x7391,0x7b56,0x097e,0x0017,0x32fb,0x1ee7,0x49dc,0x6ba1,0x5bd9,0x1c64,0x4ed4,0x1c73,0x27ac,0x7b41,0x0708,0x3bdf,0x5cd1,0x4487,0x595a,0x5f8d,0x68d6,0x19d3,0x047f,0x5e1f,0x635a,0x3a17,0x781d,0x49dc,0x149f,0x0bfd,0x4da3,0x7c2f,0x7537,0x374c,0x1ac2,0x6fc9,0x61bf,0x73f7,0x1dbb,0x6e70,0x19b5,0x6445,0x02ce,0x62ae,0x68c1,0x519d,0x7a89,0x0f95,0x6e70,0x0bfd,0x6cf3,0x62df,0x035c,0x66ed,0x1c02,0x2664,0x6a69,0x5be5,0x4dee,0x7aef,0x56cf,0x2481,0x24f0,0x79c2,0x7551,0x2b3f,0x7edd,0x5fa6,0x62ae,0x0fd8,0x65c0,0x6d2c,0x3f9c,0x345d,0x3bc8,0x05a0,0x0bea,0x750b,0x4c57,0x6d76,0x641f,0x4130,0x3461,0x24cc,0x6cbe,0x375b,0x573b,0x1ad5,0x3355,0x4db4,0x097e,0x05a0,0x575d,0x483f,0x4aab,0x70cd,0x65a6,0x595a,0x1ac2,0x1651,0x6e70,0x5761,0x003c,0x1540,0x2c37,0x2b03,0x1f2f,0x2acb,0x668b,0x3476,0x5a3a,0x6d3b,0x1dbb,0x31d6,0x3ffa,0x7228,0x3333,0x2f31,0x7998,0x604b,0x6e01,0x3693,0x52ea,0x1c3e,0x4604,0x573b,0x572c,0x2b65,0x4dd2,0x3078,0x20d5,0x0e3b,0x2aba,0x4564,0x0969,0x73ba,0x3d34,0x5892,0x0723,0x5bf2,0x7c5e,0x36b8,0x7163,0x47aa,0x7b7d,0x210a,0x4803,0x3ca6,0x4865,0x7112,0x7850,0x573b,0x4613,0x4af1,0x6371,0x5fb1,0x1aa4,0x01b9,0x4c6b,0x003c,0x6d07,0x5e23,0x2d8e,0x4814,0x5309,0x38ce,0x40c4,0x1a8f,0x1557,0x5885,0x4398,0x31d6,0x20a4,0x1646,0x0d4c,0x66c6,0x13ab,0x0468,0x4f20,0x20d5,0x3fed,0x7e90,0x421d,0x0734,0x543d,0x7f73,0x7537,0x6ca9,0x2ef9,0x47e7,0x02f2,0x5a11,

0x1edb,0x5a4b,0x420a,0x2a91,0x301e,0x2863,0x035c,0x1c29,0x62df,0x55c9,0x5322,0x766b,0x0d01,0x151a,0x518a,0x6922,0x58f4,0x14f9,0x2848,0x0e5d,0x1ab3,0x2f7c,0x4c0d,0x395c,0x31b0,0x14b4,0x0bd6,0x6754,0x7214,0x52fd,0x1ef0,0x01ae,0x0ff3,0x1c15,0x20b3,0x4b74,0x6011,0x7b6a,0x5a77,0x66b7,0x5cc6,0x4089,0x058b,0x73ad,0x1086,0x2da5,0x4eff,0x2b4e,0x0fd8,0x6f93,0x32ec,0x52a7,0x6006,0x5e08,0x05d1,0x1b0a,0x4662,0x6434,0x3a5a,0x518a,0x17d4,0x0283,0x3595,0x6194,0x77d2,0x420a,0x43e9,0x602d,0x7f58,0x5bf2,0x5776,0x2812,0x1b21,0x19ef,0x4b48,0x2aba,0x0e3b,0x5033,0x696f,0x255e,0x409e,0x52ea,0x13cd,0x2b14,0x7520,0x337e,0x1651,0x1f49,0x669c,0x5776,0x7e87,0x51a1,0x3cb1,0x3767,0x6732,0x4b5f,0x076e,0x36b8,0x2575,0x7f64,0x1dac,0x08c7,0x035c,0x70da,0x531e,0x7788,0x4b63,0x0969,0x6408,0x688c,0x08fb,0x08ec,0x24aa,0x5ced,0x5e34,0x4865,0x394b,0x23c4,0x6c95,0x61e5,0x4c26,0x70da,0x6d4a,0x3c8d,0x31ea,0x5bd9,0x58df,0x5bf2,0x0924,0x29da,0x5a11,0x0454,0x7a89,0x6d61,0x5ca0,0x10f7,0x787b,0x68c1,0x090f,0x70ab,0x3324,0x2787,0x2787,0x5f8d,0x49dc,0x7a9e,0x51b6,0x343b,0x43a4,0x0caf,0x2f6b,0x6c95,0x0ce2,0x1488,0x27bb,0x0ce2,0x73dc,0x01b9,0x2481,0x528c,0x06b1,0x1de1,0x5a60,0x1ddd,0x7b0c,0x51ec,0x08ec,0x2c51,0x7b0c,0x1646,0x4f6d,0x0443,0x0071,0x1212,0x3a66,0x5378,0x3d08,0x4828,0x6371,0x06c0,0x426c,0x3960,0x49dc,0x6479,0x2848,0x3318,0x17ff,0x40a2,0x4e99,0x0419,0x27e1,0x2f57,0x2230,0x44ca,0x6a0f,0x4f0b,0x1c02,0x071f,0x23d3,0x1c3e,0x2997,0x3cfc,0x36e2,0x3a66,0x2b28,0x43b3,0x2dff,0x0311,0x5f8d,0x034b,0x4c1a,0x2147,0x344a,0x0918,0x5a06,0x3767,0x2dc3,0x4df9,0x27bb,0x113f,0x4675,0x3a66,0x2de8,0x6922,0x156b,0x518a,0x23b5,0x779f,0x3c8d,0x0e10,0x4781,0x62c8,0x2227,0x40f8,0x113f,0x6935,0x7df0,0x7105,0x7b30,0x221b,0x301e,0x4796,0x47aa,0x2f26,0x3fa0,0x5593,0x29e6,0x462f,0x1646,0x7272,0x7850,0x003c,0x68ea,0x2136,0x344a,0x4f46,0x4529,0x4a80,0x31c1,0x2227,0x44ca,0x668b,0x6292,0x1540,0x7640,0x32fb,0x5d43,0x0e10,0x760d,0x604b,0x7daa,0x210a,0x1f2f,0x77d2,0x5069,0x3716,0x4564,0x2241,0x0bc1,0x635a,0x454f,0x7ddb,0x4a97,0x2230,0x1091,0x31b0,0x36af,0x17b2,

0x5024,0x6cd8,0x7f64,0x3009,0x66d1,0x6faf,0x3582,0x3fc6,0x5e79,0x2787,0x6060,0x002b,0x17c3,0x4398,0x1d90,0x3fed,0x5d7f,0x74b2,0x10ad,0x7a9e,0x3a3c,0x2adc,0x29bc,0x4859,0x32fb,0x0752,0x6922,0x033a,0x6d5d,0x3407,0x5885,0x35f3,0x73f7,0x6e3d,0x7c38,0x7148,0x4b05,0x7163,0x2389,0x14c5,0x4089,0x4ee8,0x23d3,0x7f15,0x3044,0x3e25,0x264f,0x5761,0x7546,0x58e3,0x55de,0x2790,0x4236,0x220c,0x3bdf,0x0d4c,0x090f,0x47db,0x2147,0x1128,0x199e,0x090f,0x79fe,0x3035,0x5335,0x43b3,0x14ee,0x5b83,0x6434,0x1ee7,0x2b03,0x3770,0x5069,0x4ea5,0x2b03,0x6ce4,0x56e4,0x0e3b,0x767c,0x032d,0x417d,0x3f9c,0x3b85,0x6e67,0x4e8e,0x161c,0x56be,0x51b6,0x0779,0x426c,0x0a53,0x5cfa,0x1b21,0x7c75,0x7821,0x4b39,0x06b1,0x4558,0x5a4b,0x3e25,0x3770,0x3be3,0x1ac2,0x342c,0x4eff,0x38a8,0x6cf3,0x31a7,0x01df,0x0b8c,0x4487,0x19a2,0x3c9a,0x74ff,0x49e0,0x069a,0x0017,0x226a,0x6423,0x7ee1,0x5378,0x5d25,0x2ed2,0x3883,0x1488,0x4db4,0x417d,0x4acd,0x0933,0x6953,0x14d2,0x602d,0x2121,0x677f,0x1274,0x52ea,0x395c,0x0066,0x1114,0x5c8b,0x0e4a,0x2790,0x5e6e,0x3476,0x780a,0x4f70,0x4dee,0x5055,0x66c6,0x264f,0x330f,0x7850,0x2aad,0x10e0,0x5a11,0x7097,0x5e52,0x1f38,0x0d01,0x7ebb,0x7386,0x658d,0x44ac,0x2ae0,0x0fbe,0x2af7,0x27ca,0x004d,0x1c29,0x1b0a,0x374c,0x7998,0x61f2,0x52d6,0x0a44,0x6faf,0x2874,0x186a,0x7214,0x2256,0x781d,0x1637,0x2f26,0x7139,0x6194,0x31c1,0x7f15,0x0cc9,0x40b5,0x3d1f,0x2adc,0x1f38,0x529b,0x2b59,0x6371,0x10ba,0x6183,0x5584,0x6743,0x181b,0x6ccf,0x0cf5,0x3410,0x5a11,0x4781,0x723f,0x65d7,0x3cd7,0x7c49,0x635a,0x20fe,0x7c49,0x35d8,0x0419,0x6fc9,0x23ef,0x691e,0x77f9,0x6935,0x5885,0x2d99,0x1ae9,0x264f,0x61d9,0x572c,0x70ab,0x227d,0x40b5,0x5d25,0x1c3e,0x61a8,0x7551,0x02f2,0x167a,0x6f84,0x5be5,0x70e6,0x32a1,0x6452,0x02e5,0x574a,0x6bec,0x750b,0x344a,0x4b5f,0x5b94,0x6b8a,0x5ffc,0x3960,0x4c1a,0x0306,0x17ff,0x5cfa,0x05b7,0x411b,0x2b72,0x1ab3,0x6b8a,0x77c5,0x6bf0,0x089d,0x220c,0x6292,0x02ce,0x38f2,0x73ba,0x669c,0x29cd,0x10e0,0x6978,0x3d34,0x282e,0x6e2a,0x65a6,0x73ad,0x5892,0x1f62,0x06b1,0x605c,0x2c1c,0x44ca,0x6366,0x1e96,0x1557,0x32ec,0x544c,0x421d,0x7c62,

0x2dd4,0x4f20,0x17a5,0x2db2,0x2c20,0x1557,0x5a06,0x4b48,0x4d9f,0x5b83,0x52c1,0x3cd7,0x0708,0x66a0,0x31c1,0x2ed2,0x70ab,0x7836,0x7c62,0x6a24,0x2602,0x484e,0x51ec,0x696f,0x3a17,0x421d,0x55f5,0x6a69,0x38f2,0x5584,0x2874,0x748e,0x1526,0x122e,0x1ad5,0x23ef,0x5e23,0x0000,0x2ae0,0x659a,0x19ef,0x1ab3,0x3894,0x5bbf,0x2812,0x3bae,0x17d4,0x0cde,0x5682,0x4c26,0x069a,0x0454,0x40a2,0x56e4,0x77a3,0x0e76,0x7b41,0x2615,0x004d,0x6953,0x3022,0x19b5,0x10cb,0x32c7,0x2ec5,0x4f46,0x5a60,0x6922,0x58df,0x0e07,0x29cd,0x7657,0x3cfc,0x780a,0x20fe,0x6fde,0x1b0a,0x56f3,0x5a4b,0x47e7,0x2629,0x780a,0x2e88,0x7080,0x3e32,0x3035,0x7de7,0x24bd,0x44dd,0x3318,0x659a,0x2562,0x0d5b,0x29f1,0x5710,0x7c38,0x31d6,0x751c,0x3333,0x4986,0x2b14,0x1b47,0x7788,0x23f8,0x7148,0x2d8e,0x6725,0x1dd

d,0x79e9,0x5378,0x51c7,0x6cbe,0x4df9,0x4c40,0x6479,0x438f,0x0caf,0x49f7,0x4796,0x1212,0x1172,0x0ba7,0x3d08,0x0fe4,0x0e61,0x35a9,0x19c4,0x7788,0x2da5,0x77a3,0x4ed4,0x761a,0x151a,0x5c9c,0x2549,0x5966,0x43b3,0x0071,0x65a6,0x0000,0x6a33,0x3d79,0x2eb4,0x73e0,0x4c6b,0x7e87,0x374c,0x0306,0x62f4,0x572c,0x3d79,0x0d01,0x40f8,0x3e54,0x1b7b,0x0bc1,0x0d67,0x3461,0x7097,0x77c5,0x416a,0x6060,0x77b4,0x61ce,0x49f7,0x002b,0x453e,0x7eca,0x4db4,0x7a89,0x1239,0x02bf,0x0942,0x1c64,0x2b3f,0x3a00,0x44dd,0x13e6,0x3cd7,0x70bc,0x4502,0x4c57,0x1f38,0x6d4a,0x7c04,0x7ac4,0x5378,0x17e8,0x427b,0x453e,0x5e79,0x13da,0x372a,0x0d67,0x076e,0x1ac2,0x32d0,0x0a53,0x40ef,0x483f,0x1651,0x43c2,0x2230,0x632b,0x3355,0x1dca,0x43a4,0x1f5e,0x6d3b,0x047f,0x5971,0x0cde,0x3d79,0x167a,0x6183,0x7a89,0x6909,0x56a9,0x2f7c,0x034b,0x528c,0x5470,0x0a6f,0x73f7,0x0377,0x65a6,0x32c7,0x211d,0x7c13,0x01c8,0x529b,0x01ae,0x5d19,0x689b,0x2ef9,0x3355,0x0e07,0x3d45,0x7537,0x5593,0x6317,0x10e0,0x427b,0x6300,0x3ceb,0x1159,0x40f8,0x68ea,0x20c2,0x4558,0x6366,0x47db,0x02a8,0x0a44,0x5335,0x3977,0x52fd,0x65fc,0x4c57,0x4141,0x528c,0x226a,0x0a6f,0x088a,0x7c62,0x1165,0x160b,0x14d2,0x3a17,0x6fde,0x3906,0x27dd,0x5042,0x255e,0x786c,0x65d7,0x62f4,0x6cf3,0x208f,0x7b1b,0x1526,0x6452,0x68a7,0x5fa6,0x74b2,0x5d32,0x3582,0x5322,

0x23f8,0x4613,0x56f3,0x4da3,0x10ad,0x1df6,0x1a98,0x6423,0x3078,0x66b7,0x19c4,0x0071,0x2c51,0x4638,0x2f0d,0x01ae,0x465e,0x0779,0x1a98,0x5971,0x252f,0x4dd2,0x330f,0x01e3,0x3883,0x6b9d,0x51d0,0x2af7,0x65d7,0x4649,0x68ea,0x44e1,0x2f7c,0x58c8,0x3894,0x2673,0x4156,0x77b4,0x2481,0x4859,0x62e3,0x06d7,0x0425,0x392d,0x3911,0x4156,0x68d6,0x6944,0x3ca6,0x3333,0x180c,0x221b,0x5ba8,0x421d,0x0a09,0x5cd1,0x29cd,0x033a,0x1f5e,0x65d7,0x70e6,0x14d2,0x4c40,0x035c,0x05b7,0x7ef6,0x31ea,0x02bf,0x24f0,0x3cb1,0x5e79,0x4564,0x3d23,0x5900,0x0425,0x3476,0x484e,0x55e2,0x06a6,0x5e79,0x5682,0x345d,0x24aa,0x2615,0x2230,0x1637,0x2389,0x44bb,0x2ea3,0x3410,0x10f7,0x6d07,0x4859,0x4127,0x2136,0x38e5,0x1263,0x1c58,0x0fbc,0x5bce,0x2f26,0x66b7,0x36e2,0x453e,0x2150,0x0f82,0x44ca,0x1f04,0x1ab3,0x462f,0x01f4,0x4515,0x329d,0x216c,0x19f8,0x2a91,0x6f93,0x58b9,0x56f3,0x6bd0,0x186a,0x4a80,0x076e,0x0425,0x2c7a,0x4eb2,0x0b8c,0x410c,0x65c0,0x08b6,0x285f,0x32fb,0x61a8,0x3fb7,0x5ffc,0x77a3,0x7d96,0x2e88,0x5353,0x5f9a,0x0fd8,0x1ebd,0x670e,0x0924,0x125f,0x409e,0x0e4a,0x7b41,0x416a,0x7b0c,0x4236,0x3fd1,0x43fe,0x3355,0x6bec,0x3f8b,0x23d3,0x35e4,0x6732,0x6922,0x3701,0x1afe,0x122e,0x5322,0x282e,0x181b,0x5024,0x7de7,0x634d,0x3d52,0x06a6,0x74c3,0x4490,0x58f4,0x20a4,0x51ec,0x393a,0x5cfa,0x4f1c,0x6a0f,0x43d5,0x02bf,0x3e43,0x5bce,0x0752,0x5be5,0x2acb,0x19c4,0x4ada,0x536f,0x14ee,0x32fb,0x74e8,0x1ab3,0x2f0d,0x2805,0x0ff3,0x70e6,0x6fde,0x602d,0x4dc5,0x36b8,0x6ff5,0x668b,0x1b7b,0x0caf,0x1eaa,0x02ce,0x507e,0x6732,0x5322,0x395c,0x4eb2,0x70bc,0x2874,0x2147,0x6754,0x3fc6,0x0fe4,0x5d25,0x4b5f,0x2c46,0x6300,0x3a2b,0x507e,0x4eff,0x10ba,0x0e10,0x5d0e,0x1eaa,0x2805,0x1b1d,0x74a5,0x3c9a,0x5fa6,0x2aad,0x542a,0x68fd,0x6b8a,0x7821,0x43c2,0x3b85,0x6ce4,0x7228,0x7dce,0x5018,0x5bce,0x36e2,0x55af,0x4c1a,0x3e32,0x58df,0x1c58,0x3bc8,0x5cfa,0x3bf4,0x4da3,0x10ba,0x3a5a,0x29cd,0x08fb,0x6bc7,0x66ed,0x55de,0x43b3,0x7228,0x4eb2,0x2e9f,0x2b3f,0x658d,0x453e,0x4490,0x79c2,0x61ce,0x465e,0x7520,0x4f37,0x2c0b,0x6c82,0x5a3a,0x0723,0x3022,0x17b2,0x543d,0x4dd2,0x6194,0x0bb0,0x40c4,

0x0bb0,0x1103,0x150d,0x6285,0x3342,0x760d,0x2b28,0x7f3e,0x61bf,0x08c7,0x6e2a,0x6479,0x5a5c,0x3883,0x0ff3,0x217b,0x5a77,0x786c,0x373d,0x6768,0x6fc9,0x465e,0x4a80,0x4986,0x166d,0x1b47,0x0443,0x29cd,0x73ba,0x3e43,0x7ddb,0x226a,0x7f02,0x3977,0x2790,0x1248,0x2227,0x2ed2,0x6944,0x344a,0x2f57,0x4247,0x7b27,0x1b7b,0x1ebd,0x3f9c,0x166d,0x0e2c,0x4814,0x5593,0x35cf,0x6479,0x7b30,0x4a80,0x79b3,0x17a5,0x528c,0x0f82,0x3d6e,0x3a3c,0x724e,0x068d,0x7e87,0x4247,0x0192,0x36de,0x5c8b,0x0924,0x3684,0x6bd0,0x787b,0x1526,0x6a7e,0x1212,0x1b0a,0x2549,0x2997,0x0bc1,0x7f64,0x0fbc,0x7f02,0x6768,0x68c1,0x29bc,0x040e,0x059c,0x79e9,0x4f46,0x6ca9,0x462f,0x3a17,0x5a60,0x0fa9,0x7f02,0x66ed,0x5fc0,0x5cd1,0x27ca,0x1397,0x7836,0x3e54,0x7f3e,0x06c0,0x2812,0x3ceb,0x076e,0x17a5,0x62e3,0x19d3,0x68b0,0x0a1e,0x2538,0x7b56,0x0a35,0x7c5e,0x4c0d,0x4250,0x5b83,0x6bec,0x4872,0x462f,0x7f29,0x2790,0x301e,0x6a24,0x4b63,0x2e9f,0x4db4,0x1ef0,0x31c1,0x2d99,0x543d,0x301e,0x6d76,0x66a0,0x6d4a,0x51fb,0x157c,0x36e2,0x13ab,0x13ab,0x2b72,0x3a4d,0x2ed2,0x2b72,0x56d8,0x7f3e,0x5d0e,0x55b8,0x77d2,0x1f13,0x0734,0x1989,0x40d3,0x0192,0x0f95,0x3044,0x2acb,0x2496,0x5885,0x0bb0,0x071f,0x4b74,0x780a,0x10e0,0x4127,0x1637,0x2538,0x410c,0x77c5,0x29e6,0x5fd7,0x760d,0x14b4,0x5e23,0x4e99,0x6371,0x1557,0x1103,0x5fa6,0x4515,0x0a6f,0x319b,0x66c6,0x19a2,0x712e,0x7214,0x3c9a,0x1646,0x24aa,0x13cd,0x7139,0x3f9c,0x7c04,0x55f5,0x31fd,0x0918,0x62b9,0x3009,0x3d6e,0x3461,0x7ef6,0x6fc9,0x3d1f,0x1989,0x6a0f,0x4127,0x6bec,0x0918,0x06c0,0x35be,0x36f5,0x5344,0x4ee8,0x7c13,0x07

23,0x787b,0x7f15,0x66d1,0x49dc,0x13bc,0x1f49,0x0969,0x3a00,0x70bc,0x0468,0x047f,0x1103,0x3355,
0x0000,0x5fb1,0x4803,0x2d8e,0x0d2a,0x6a7e,0x114e,0x392d,0x089d,0x5be5,0x3cc0,0x2121,0x4abc,0x0
a1e,0x3911,0x58b9,0x2c6d,0x059c,0x6fde,0x62df,0x79b3,0x7c49,0x7631,0x3ceb,0x7f64,0x1c15,0x668b,
0x0752,0x62df,0x7f73,0x7391,0x52fd,0x7097,0x5e6e,0x7b7d,0x5710,0x4b39,0x2ae0,0x20e9,0x4f51,0x0f
a9,0x38ce,0x5d43,0x594d,0x20fe,0x1205,0x73cb,0x40a2,0x1159,0x1d90,0x68ea,0x1ebd,0x1aa4,0x003c,0
x01e3,0x3461,0x1aa4,0x05c6,0x08fb,

0x3d45,0x4649,0x2241,0x0a35,0x4156,0x5a11,0x7b7d,0x748e,0x3a4d,0x6e3d,0x5e6e,0x543d,0x6f93,0x1
3f1,0x161c,0x0fcf,0x160b,0x1ecc,0x08ec,0x35a9,0x7eac,0x6317,0x756d,0x79b3,0x4f6d,0x6194,0x7546,0
x27e1,0x2538,0x5cb7,0x544c,0x35a9,0x0d4c,0x7174,0x6423,0x08a1,0x24db,0x17c3,0x4250,0x519d,0x1
7a5,0x4613,0x328a,0x6ce4,0x199e,0x328a,0x779f,0x0b9b,0x47cc,0x7b56,0x01f4,0x1c73,0x2aba,0x3d08,
0x06c0,0x3fed,0x1274,0x4872,0x0e61,0x6060,0x239e,0x1128,0x2227,0x545b,0x594d,0x3e19,0x02e5,0x4
b48,0x2db2,0x0cc9,0x58ae,0x6408,0x6a55,0x2602,0x2664,0x421d,0x438f,0x52fd,0x3d52,0x7203,0x2acb
,0x3fb7,0x5ced,0x6f93,0x10ad,0x3bc8,0x659a,0x1dbb,0x1799,0x38a8,0x2549,0x1eaa,0x2c0b,0x1540,0x6
b9d,0x74a5,0x1841,0x6285,0x0311,0x306f,0x56d8,0x1e96,0x1d87,0x6d10,0x329d,0x0e07,0x6e4c,0x640
8,0x1856,0x1128,0x2664,0x1ad5,0x73cb,0x393a,0x6479,0x6a42,0x632b,0x7eac,0x06fc,0x4141,0x29ab,0
x7b6a,0x74c3,0x3977,0x40f8,0x1c4f,0x7b30,0x5344,0x4b12,0x27ca,0x3d45,0x58ae,0x7b30,0x0fcf,0x5e2
3,0x761a,0x4abc,0x19b5,0x4d88,0x6317,0x6935,0x3bc8,0x7272,0x66a0,0x0d70,0x3a5a,0x6ba1,0x1c64,0
x4803,0x2874,0x1f38,0x677f,0x0071,0x1b21,0x2c7a,0x68d6,0x4130,0x6fe2,0x5584,0x757a,0x2389,0x7e
87,0x3476,0x1eaa,0x06eb,0x3324,0x6c95,0x36f5,0x635a,0x5892,0x35be,0x6909,0x0d3d,0x62f4,0x1c15,0
x6922,0x2de8,0x06fc,0x0c84,0x301e,0x1841,0x3767,0x61d9,0x0fe4,0x4b05,0x05c6,0x454f,0x0306,0x03
77,0x1540,0x4dee,0x4662,0x73e0,0x0918,0x73cb,0x1a98,0x1827,0x1f13,0x35cf,0x2147,0x2d99,0x0017,
0x5055,0x157c,0x7163,0x2230,0x2481,0x1e96,0x7f4f,0x7df0,0x047f,0x52b0,0x68b0,0x74b2,0x65eb,0x2
496,0x0e5d,0x337e,0x32fb,0x114e,0x5033,0x35be,0x73e0,0x5401,0x0000,0x097e,0x285f,0x5467,0x4e8e,
0x3b85,0x4ed4,0x62b9,0x5309,0x4156,0x7dcc,0x51a1,0x6006,0x0f82,0x543d,0x74c3,0x6e2a,0x1620,0x5
cb7,0x2136,0x56e4,0x2da5,0x4dc5,0x282e,0x6922,0x543d,0x393a,0x633c,0x3906,0x5a4b,0x24bd,0x696f
,0x1b7b,0x4f7a,0x2549,0x2f0d,0x5f9a,0x73e0,0x55b8,0x7174,0x483f,0x47e7,0x32fb,0x44ac,0x20d5,0x6
725,0x29e6,0x0b8c,0x4b63,0x7ac4,0x0d70,0x227d,0x6e5b,0x2dd4,0x034b,0x6ca9,0x4d9f,0x2241,0x3cd7
,0x2549,0x5707,0x394b,0x5042,0x2c51,

0x08b6,0x2acb,0x0306,0x0e07,0x1856,0x211d,0x40a2,0x751c,0x420a,0x7ebb,0x4a80,0x17d4,0x44f6,0x6
fb8,0x3bdf,0x4ed4,0x4490,0x2664,0x13da,0x2dd4,0x6faf,0x40c4,0x0e07,0x5fd7,0x4828,0x3a3c,0x2256,
0x0734,0x5ba8,0x7203,0x58b9,0x40c4,0x5be5,0x5024,0x44dd,0x2c46,0x66c6,0x1c58,0x5470,0x373d,0x
7821,0x375b,0x3fc6,0x5d19,0x02ce,0x0c84,0x7520,0x1f13,0x420a,0x0e61,0x7080,0x7f58,0x7c62,0x4c5
7,0x68c1,0x5bce,0x076e,0x40ef,0x36c9,0x5033,0x62c8,0x6fe2,0x4eff,0x5feb,0x31ea,0x3e68,0x10e0,0x0f
f3,0x282e,0x7c62,0x2136,0x43fe,0x4c26,0x35f3,0x6d10,0x6944,0x059c,0x32c7,0x3bdf,0x2615,0x20e9,0
x3977,0x416a,0x10ad,0x3369,0x6754,0x2ed2,0x047f,0x1114,0x4eb2,0x5966,0x05b7,0x2513,0x74d4,0x7f
3e,0x0a53,0x6366,0x2513,0x5bf2,0x542a,0x6e70,0x4796,0x3d52,0x24f0,0x603a,0x786c,0x035c,0x52c1,0
x4acd,0x632b,0x1380,0x0734,0x32d0,0x1526,0x6d07,0x79d5,0x1b50,0x74b2,0x27dd,0x7ad3,0x1f5e,0x1
7b2,0x1c3e,0x3cfc,0x0a44,0x318c,0x10dc,0x6371,0x6bd0,0x7626,0x7b1b,0x06eb,0x7ebb,0x5971,0x7386
,0x221b,0x0e61,0x5c9c,0x7af8,0x0d3d,0x5593,0x70bc,0x5c8b,0x7546,0x167a,0x4c1a,0x36b8,0x417d,0x
6719,0x55e2,0x3333,0x604b,0x58df,0x70f1,0x5776,0x62ae,0x27ac,0x0a22,0x51ec,0x3a17,0x55e2,0x66b
7,0x7631,0x4250,0x4f0b,0x5ba8,0x1ddd,0x688c,0x6a18,0x5bce,0x7f02,0x7edd,0x55de,0x6bc7,0x0caf,0x
1841,0x6e16,0x7537,0x0e2c,0x252f,0x748e,0x51ec,0x31c1,0x0454,0x343b,0x13da,0x38a8,0x58c8,0x1c3
e,0x61f2,0x19ef,0x3d23,0x3ceb,0x7998,0x6a33,0x4502,0x0d4c,0x2f31,0x5e23,0x79fe,0x10f7,0x3be3,0x2
f1a,0x0000,0x3cc0,0x7f02,0x14a3,0x0cde,0x255e,0x208f,0x6e5b,0x5593,0x7c13,0x6077,0x2b3f,0x10cb,
0x74d4,0x02d9,0x2dff,0x779f,0x6366,0x5bbf,0x1f13,0x7546,0x4573,0x7386,0x748e,0x427b,0x5d54,0x1
e96,0x519d,0x74b2,0x2504,0x5b94,0x0a53,0x3582,0x14a3,0x68b0,0x3770,0x06a6,0x06fc,0x2673,0x334
2,0x4aab,0x56f3,0x74e8,0x7537,0x6bbf,0x761a,0x416a,0x5fc0,0x4e8e,0x6060,0x4dee,0x01f4,0x3022,0x
4490,0x0a22,0x0734,0x29ab,0x0454,0x4ada,0x0e3b,0x4649,0x343b,0x43b3,0x0745,0x1086,0x2496,0x42
50,0x5d68,0x6c95,0x70da,0x4b74,0x52ea,0x1248,0x02a8,0x0969,0x670e,0x0283,0x3d6e,0x4e99,0x0924,
0x6d5d,0x2c1c,0x5e1f,0x0a6f,0x392d,

0x4221,0x592b,0x483f,0x51ec,0x641f,0x23d3,0x4c26,0x3c8d,0x1263,0x0955,0x2496,0x7ad3,0x6944,0x7dbd,0x0071,0x0745,0x06b1,0x0a53,0x0066,0x0d3d,0x7dcc,0x2496,0x7eca,0x5f8d,0x529b,0x7537,0x4236,0x19a2,0x44ac,0x2227,0x4a80,0x3a4d,0x595a,0x0454,0x43fe,0x6423,0x6a42,0x5335,0x7998,0x17d4,0x24aa,0x08c7,0x677f,0x2d8e,0x6953,0x2b4e,0x2602,0x70e6,0x7ddb,0x68d6,0x5710,0x06d7,0x1ac2,0x52a7,0x1f49,0x1526,0x1172,0x27dd,0x7148,0x2b72,0x27f6,0x0c93,0x5682,0x32b6,0x157c,0x4236,0x2de8,0x4b5f,0x0b8c,0x05b7,0x5378,0x2b4e,0x74d4,0x1637,0x5d32,0x40a2,0x4c40,0x5b94,0x542a,0x4b74,0x0a09,0x500f,0x7f58,0x7d96,0x0bd6,0x4a80,0x1830,0x7b56,0x02bf,0x5467,0x4aab,0x1086,0x4acd,0x0017,0x5593,0x79c2,0x62c8,0x52fd,0x73ad,0x1637,0x4f0b,0x4613,0x394b,0x5682,0x7080,0x3cfc,0x1c73,0x7d96,0x6d76,0x0e5d,0x2874,0x4f37,0x27ca,0x14a3,0x4872,0x2dd4,0x2562,0x6bc7,0x0cde,0x43d5,0x2e9f,0x5682,0x2f7c,0x4a97,0x4991,0x1c29,0x1397,0x767c,0x0c84,0x0708,0x3318,0x2da5,0x7ab5,0x6d2c,0x7eac,0x058b,0x6e67,0x3b92,0x750b,0x4b05,0x2f40,0x01e3,0x19b5,0x77f9,0x6a7e,0x05d1,0x43e9,0x2adc,0x055c9,0x677f,0x66d1,0x17ff,0x005a,0x2ef9,0x2b28,0x2562,0x6754,0x217b,0x1ee7,0x4675,0x55c9,0x0f82,0x47e7,0x634d,0x5a77,0x0d70,0x77f9,0x5e1f,0x44bb,0x4d9f,0x4872,0x1239,0x7112,0x65b1,0x66b7,0x3894,0x4c31,0x0294,0x19d3,0x6ff5,0x32ec,0x0d70,0x4eb2,0x01e3,0x7daa,0x7ee1,0x519d,0x7546,0x68d6,0x68a7,0x19b5,0x1ef0,0x2f0d,0x2de8,0x29f1,0x23f8,0x151a,0x3e43,0x5e34,0x4df9,0x3e54,0x10cb,0x08d0,0x595a,0x5e6e,0x10e0,0x7c2f,0x43e9,0x1a8f,0x0708,0x01e3,0x536f,0x2863,0x62ae,0x7847,0x4b05,0x1f04,0x6a24,0x373d,0x3035,0x05ed,0x01b9,0x79a4,0x49f7,0x2227,0x05d1,0x7259,0x58df,0x756d,0x7850,0x1c29,0x17e8,0x68a7,0x0419,0x01f4,0x5761,0x51c7,0x5a77,0x781d,0x10ad,0x6909,0x4c31,0x5707,0x06c0,0x208f,0x6732,0x55c9,0x7b27,0x411b,0x6ff5,0x748e,0x4d9f,0x221b,0x2997,0x5b83,0x1c4f,0x0cc9,0x4558,0x438f,0x0e10,0x4f20,0x3b92,0x1b1d,0x5055,0x3e7f,0x3fd1,0x217b,0x35a9,0x74c3,0x3009,0x23ef,0x4675,0x7ee1,0x0a6f,0x6479,0x1239,0x691e,0x4649,0x13ab,0x0f82,0x7499,0x3894,0x4156,0x3318,0x1f13,0x6a7e,0x7ab5,0x7546,

0x7eac,0x1086,0x52fd,0x7a89,0x2b28,0x574a,0x1f49,0x0918,0x0bea,0x1397,0x7112,0x3d79,0x66b7,0x1dca,0x32ec,0x05c6,0x6c82,0x47e7,0x634d,0x2230,0x005a,0x44dd,0x329d,0x17ff,0x77f9,0x4f51,0x70f1,0x7b0c,0x6909,0x3906,0x3894,0x6ff5,0x7228,0x4398,0x23c4,0x49e0,0x1f62,0x1172,0x17d4,0x635a,0x5e45,0x1b36,0x4141,0x3e43,0x40a2,0x076e,0x32c7,0x3883,0x4814,0x1b0a,0x6408,0x372a,0x7b56,0x166d,0x161c,0x1eaa,0x2496,0x7499,0x51a1,0x0b0c,0x31b0,0x43b3,0x393a,0x4781,0x27bb,0x691e,0x19ef,0x5ced,0x5e34,0x05c6,0x52b0,0x61d9,0x7c75,0x330f,0x1856,0x1091,0x6183,0x4156,0x392d,0x605c,0x180c,0x2f0d,0x1f04,0x3e54,0x3410,0x73ad,0x5bbf,0x7f73,0x23f8,0x1dca,0x0924,0x0bc1,0x06c0,0x059c,0x5b94,0x29ab,0x2664,0x10e0,0x3a5a,0x689b,0x62e3,0x646e,0x2150,0x2121,0x1c73,0x0969,0x4f1c,0x5d7f,0x23b5,0x0a78,0x394b,0x544c,0x0fa9,0x003c,0x6e4c,0x4f20,0x3e0e,0x1165,0x0e61,0x2adc,0x49ba,0x6cbe,0x08a1,0x2241,0x66ed,0x4c1a,0x19f8,0x5d68,0x6953,0x38f2,0x6ca9,0x761a,0x3d45,0x0ba7,0x5c8b,0x2997,0x5344,0x5cd1,0x1263,0x264f,0x1799,0x160b,0x2980,0x3582,0x2de8,0x337e,0x1ddd,0x646e,0x6006,0x6743,0x4e8e,0x7f64,0x56d8,0x7788,0x5344,0x786c,0x7e87,0x6011,0x344a,0x3a17,0x5a11,0x62f4,0x3ceb,0x069a,0x61e5,0x6cd8,0x712e,0x4b63,0x0bc1,0x2863,0x2658,0x2aba,0x73ad,0x68fd,0x14ee,0x5a3a,0x17a5,0x345d,0x0419,0x4ec3,0x3e54,0x3770,0x6fc9,0x3ceb,0x6faf,0x19b5,0x7640,0x7daa,0x0bb0,0x4c57,0x7eac,0x38e5,0x1dac,0x7f64,0x1f13,0x1128,0x6d61,0x73ad,0x3fa0,0x74a5,0x7203,0x7631,0x3bf4,0x2874,0x2c6d,0x4859,0x2c7a,0x306f,0x58f4,0x52b0,0x4e99,0x79fe,0x4127,0x4613,0x36de,0x4ada,0x5d25,0x4db4,0x2f0d,0x49dc,0x3cd7,0x52ea,0x1d90,0x2c0b,0x73dc,0x5a5c,0x38f2,0x23d3,0x5e1f,0x35a9,0x2dc3,0x2790,0x24aa,0x3b85,0x1841,0x6e16,0x3044,0x2d99,0x1eaa,0x77f9,0x670e,0x7105,0x4f20,0x51c7,0x4acd,0x1dbb,0x05fa,0x2227,0x4c26,0x373d,0x6d61,0x3767,0x58ae,0x7f29,0x7998,0x4986,0x68fd,0x181b,0x1dac,0x4e8e,0x19f8,0x3770,0x4b05,0x10cb,0x0e76,0x1afe,0x5353,0x1397,0x0f82,0x52b0,0x5584,0x306f,0x6ff5,0x3582,0x77f9,0x5344,0x3a66,0x0f95,0x602d,0x51c7,0x5042,0x2790,0x49dc,0x0cb8,0x6cd8,0x0468,0x77f9,0x409e,

0x7c75,0x2997,0x6371,0x2496,0x2d99,0x4c1a,0x6953,0x1103,0x01ae,0x4acd,0x1856,0x3ca6,0x6317,0x519d,0x66c6,0x7847,0x68a7,0x70bc,0x2ec5,0x2b3f,0x7af8,0x3044,0x5ca0,0x24db,0x2f31,0x252f,0x79a4,0x593c,0x1df6,0x264f,0x4e99,0x2af7,0x2575,0x13e6,0x2b65,0x35e4,0x23a2,0x1ad5,0x4af1,0x1637,0x6d2c,0x01df,0x66a0,0x2c1c,0x6e70,0x4814,0x02a8,0x6d2c,0x7b6a,0x55af,0x1ef0,0x2863,0x2adc,0x1248,0x0468,0x7f64,0x6b8a,0x32ec,0x426c,0x2dd4,0x06fc,0x1856,0x5cfa,0x2f40,0x2241,0x1165,0x27dd,0x221b,0x1c64,0x7097,0x1856,0x483f,0x51fb,0x2ed2,0x7657,0x7b56,0x372a,0x5378,0x1ee7,0x3cb1,0x306f,0x5710,0x1540,0x543d,0x06d7,0x4c7c,0x211d,0x7174,0x6953,0x6978,0x6725,0x1620,0x0cf5,0x5707,0x6719,0x0e3b,0x454f,0x65b1,0x6c95,0x43b3,0x5d7f,0x4c57,0x61e5,0x58f4,0x787b,0x55f5,0x5fa6,0x2863,0

x55b8,0x7f15,0x2805,0x6371,0x3c8d,0x0425,0x17d4,0x20e9,0x68b0,0x438f,0x0c84,0x438f,0x3770,0x7a
 f8,0x3022,0x7b27,0x0185,0x1114,0x14c5,0x49dc,0x1ecc,0x61ce,0x462f,0x416a,0x2a91,0x4803,0x1a8f,0
 x2513,0x3ffa,0x7386,0x255e,0x1531,0x55c9,0x06b1,0x70ab,0x38a8,0x6909,0x0e07,0x779f,0x178e,0x4a
 ab,0x3d52,0x0d67,0x3324,0x5d19,0x70f1,0x4803,0x79b3,0x3bf4,0x633c,0x3693,0x44e1,0x688c,0x2874,
 0x032d,0x3d1f,0x1263,0x7f3e,0x01f4,0x5ffc,0x68c1,0x6e4c,0x0d2a,0x4d88,0x7c38,0x1114,0x2e9f,0x572
 c,0x0468,0x4490,0x1b6c,0x1540,0x3582,0x49dc,0x712e,0x06d7,0x0708,0x36af,0x4db4,0x5682,0x05c6,0
 x416a,0x097e,0x0a09,0x62c8,0x2e88,0x2812,0x20c2,0x20b3,0x0969,0x17ff,0x6cbe,0x02bf,0x70f1,0x0cc
 9,0x0cb8,0x4c6b,0x4f37,0x3e19,0x7ad3,0x252f,0x0969,0x06a6,0x071f,0x4b39,0x52b0,0x3fd1,0x56f3,0x
 3e7f,0x4487,0x0cc9,0x4a80,0x0ce2,0x6479,0x1ab3,0x4ec3,0x2549,0x79d5,0x5ca0,0x4f1c,0x27ca,0x7626
 ,0x1086,0x6cf3,0x0708,0x5971,0x0752,0x7ebb,0x5d7f,0x61e5,0x1e96,0x2dd4,0x3ffa,0x5cb7,0x3fed,0x4
 4bb,0x0a53,0x035c,0x6cf3,0x77c5,0x2dff,0x2812,0x318c,0x113f,0x06eb,0x6754,0x62df,0x696f,0x6d4a,0
 x4529,0x1637,0x0306,0x178e,0x5776,0x7c62,0x74e8,0x51ec,0x2f1a,0x61bf,0x6a42,0x7b6a,0x1531,0x7f
 73,0x05c6,0x36af,0x2121,0x5892,0x38f2,0x6d4a,0x13cd,0x0071,0x5776,0x344a,0x51a1,0x55b8,0x6285,
 0x004d,0x3770,0x4ed4,0x47e7,

0x542a,0x23b5,0x02ce,0x29e6,0x68d6,0x724e,0x507e,0x4564,0x097e,0x7f29,0x6944,0x5c8b,0x6371,0x7
 3cb,0x669c,0x2787,0x0a6f,0x1b36,0x0a1e,0x1205,0x5f8d,0x17d4,0x49dc,0x5710,0x01c8,0x1ae9,0x088a,
 0x3333,0x2241,0x1ac2,0x2dc3,0x3022,0x076e,0x7b30,0x2b3f,0x0432,0x06a6,0x1b21,0x156b,0x7b7d,0x
 7174,0x61a8,0x65fc,0x2230,0x7386,0x003c,0x1ebd,0x6bc7,0x6b8a,0x5309,0x1f04,0x1830,0x13bc,0x08b
 6,0x01ae,0x61e5,0x6d5d,0x7b0c,0x0cc9,0x2121,0x7b6a,0x6e16,0x1eaa,0x4502,0x06eb,0x5a60,0x1086,0
 x1c3e,0x73dc,0x0ba7,0x4ec3,0x7c62,0x160b,0x79e9,0x032d,0x3355,0x5bce,0x0d3d,0x2d8e,0x2136,0x01
 c8,0x6ff5,0x1b7b,0x7b56,0x5bce,0x5322,0x0e3b,0x1646,0x1856,0x0d4c,0x08c7,0x6935,0x62df,0x0745,0
 x3bc8,0x4ea5,0x5cb7,0x3355,0x0924,0x5917,0x5695,0x3476,0x14d2,0x2c46,0x0cde,0x114e,0x2acb,0x54
 01,0x160b,0x114e,0x70e6,0x2147,0x77ee,0x0432,0x1e81,0x157c,0x6faf,0x1103,0x6944,0x2adc,0x1526,0
 x51d0,0x0bfd,0x0306,0x7ad3,0x14ee,0x14a3,0x74ff,0x2b4e,0x1c15,0x0734,0x5033,0x040e,0x1128,0x21
 6c,0x2b14,0x0918,0x7b27,0x635a,0x1e81,0x4796,0x047f,0x531e,0x43a4,0x2dff,0x20fe,0x2c20,0x2a86,0
 x55de,0x6e70,0x7080,0x1827,0x0d01,0x74c3,0x70da,0x55e2,0x7e87,0x73f7,0x2602,0x17c3,0x4250,0x2b
 14,0x0fe4,0x1205,0x594d,0x4564,0x594d,0x4f51,0x6d4a,0x5a11,0x0cde,0x68fd,0x19c4,0x2c7a,0x6c82,0
 x38e5,0x40a2,0x7df0,0x7148,0x74b2,0x1a8f,0x10f7,0x0e4a,0x5e23,0x61f2,0x0f8e,0x543d,0x760d,0x73b
 a,0x345d,0x7ee1,0x3be3,0x342c,0x3c8d,0x4515,0x4089,0x756d,0x544c,0x32fb,0x36de,0x1989,0x199e,0
 x0c84,0x4f7a,0x19d3,0x5917,0x0a22,0x0bea,0x1557,0x3a3c,0x65d7,0x5a2d,0x3fed,0x38a8,0x32d0,0x76
 40,0x531e,0x2664,0x4991,0x4141,0x1f38,0x5e08,0x575d,0x29ab,0x4865,0x0e61,0x373d,0x4f46,0x5018,
 0x1091,0x7de7,0x0918,0x4141,0x2513,0x781d,0x6011,0x19d3,0x786c,0x1239,0x7499,0x125f,0x4a80,0x
 65b1,0x7df0,0x3fc6,0x217b,0x02e5,0x06b1,0x4c6b,0x1eaa,0x06fc,0x05fa,0x7214,0x058b,0x74a5,0x1f5e,
 0x594d,0x01b9,0x633c,0x14f9,0x677f,0x646e,0x1b21,0x3701,0x0192,0x05a0,0x5042,0x6faf,0x4eb2,0x0
 bb0,0x7836,0x02ce,0x62c8,0x66d1,0x748e,0x65eb,0x3a5a,0x635a,0x394b,0x19d3,0x4af1,0x13f1,0x2f26,
 0x52d6,0x5761,0x5378,0x17b2,0x49ba,

0x2c20,0x13e6,0x3d45,0x02f2,0x2a91,0x6bd0,0x3906,0x4eff,0x635a,0x691e,0x0443,0x7a9e,0x395c,0x3
 d45,0x44ca,0x05fa,0x51c7,0x44ca,0x55f5,0x56e4,0x5a3a,0x2562,0x252f,0x4564,0x51d0,0x7080,0x2227,
 0x6006,0x24db,0x58f4,0x4c40,0x2c7a,0x6194,0x1f2f,0x6719,0x1165,0x427b,0x002b,0x1159,0x79e9,0x3
 407,0x74c3,0x05fa,0x0752,0x421d,0x5309,0x4250,0x65d7,0x6bb6,0x161c,0x20a4,0x23c4,0x4dee,0x3369
 ,0x5695,0x2812,0x51c7,0x5bce,0x5d7f,0x7f3e,0x6a33,0x14c5,0x076e,0x2a91,0x3476,0x0b9b,0x2f40,0x5
 19d,0x66fa,0x069a,0x544c,0x17d4,0x2c6d,0x227d,0x4acd,0x6285,0x0bc1,0x0e10,0x594d,0x0e76,0x5a06
 ,0x2dff,0x688c,0x7e87,0x5a06,0x2150,0x3461,0x5bbf,0x208f,0x712e,0x0933,0x5322,0x187d,0x5971,0x0
 d70,0x0fe4,0x438f,0x06eb,0x44bb,0x1114,0x4649,0x10f7,0x0a78,0x2b28,0x4aab,0x6a0f,0x282e,0x2b28,
 0x0e2c,0x2602,0x0d5b,0x2f6b,0x32d0,0x4eff,0x4a97,0x2549,0x344a,0x6b9d,0x49cb,0x5707,0x5fc0,0x7f
 64,0x0734,0x3767,0x10f7,0x35e4,0x52c1,0x77c5,0x5cd1,0x263e,0x47bd,0x032d,0x40a2,0x58ae,0x2b14,
 0x373d,0x55f5,0x49f7,0x0e07,0x285f,0x06b1,0x62f4,0x62f4,0x6754,0x0443,0x0723,0x5bce,0x4d88,0x0
 6b1,0x7b7d,0x65b1,0x66b7,0x31fd,0x2dff,0x6e70,0x1205,0x114e,0x691e,0x6300,0x5a11,0x68d6,0x4ada,
 0x0d5b,0x4da3,0x7ddb,0x06a6,0x14a3,0x1dbb,0x55e2,0x1620,0x0cb8,0x0e61,0x4f46,0x5fa6,0x113f,0x6
 8d6,0x6b9d,0x7391,0x4ada,0x484e,0x6fc9,0x74b2,0x68c1,0x6ff5,0x3022,0x74b2,0x6e16,0x122e,0x0e07,
 0x6317,0x2adc,0x6b8a,0x6c82,0x1f75,0x0bd6,0x0e4a,0x0a22,0x1827,0x5d43,0x1dbb,0x2dff,0x3bf4,0x71
 12,0x0e61,0x7aa2,0x5ca0,0x6b8a,0x5470,0x047f,0x343b,0x1557,0x7c2f,0x5e79,0x427b,0x5e45,0x31b0,0

x438f,0x5e45,0x7112,0x4b12,0x2af7,0x56cf,0x7aa2,0x4515,0x79a4,0x0779,0x2256,0x2f57,0x6060,0x6bb6,0x5d68,0x5470,0x5d7f,0x1b7b,0x4573,0x220c,0x592b,0x7b27,0x5d43,0x29bc,0x0708,0x1f49,0x4eb2,0x6e70,0x5892,0x2de8,0x17d4,0x282e,0x66b7,0x6944,0x0bfd,0x047f,0x3960,0x73e0,0x047f,0x2dff,0x2de8,0x55c9,0x0bfd,0x3044,0x1263,0x61bf,0x3c8d,0x4ae6,0x7f3e,0x306f,0x74ff,0x27f6,0x4141,0x0e2c,0x3e54,0x089d,0x05c6,0x7f29,0x575d,0x2098,0x4f1c,0x6ce4,0x79d5,0x3b85,0x2c0b,0x3fd1,0x0283,0x7148,0x56be,0x5fc0,0x592b,0x4865,

0x160b,0x4f7a,0x5707,0x47bd,0x68d6,0x781d,0x715f,0x7eca,0x0a1e,0x56e4,0x0a6f,0x0752,0x7b0c,0x6ff5,0x49f7,0x4eff,0x395c,0x318c,0x2f6b,0x712e,0x44f6,0x35cf,0x51d0,0x669c,0x7ef6,0x1827,0x7af8,0x43fe,0x7788,0x088a,0x61e5,0x2538,0x7f64,0x3d34,0x786c,0x2a86,0x1ee7,0x23a2,0x1397,0x6317,0x7ebb,0x658d,0x0283,0x36f5,0x0a44,0x003c,0x668b,0x529b,0x306f,0x634d,0x68ea,0x4ed4,0x6e3d,0x10ba,0x5966,0x1248,0x1f2f,0x6423,0x08d0,0x77a3,0x40b5,0x6423,0x1620,0x2673,0x79c2,0x545b,0x3f8b,0x047f,0x635a,0x40c4,0x5033,0x4991,0x2de8,0x5fb1,0x227d,0x2c51,0x6ca9,0x3461,0x5971,0x5ba8,0x0e07,0x5a06,0x4dc5,0x0377,0x02d9,0x344a,0x2b72,0x2a91,0x4f51,0x7640,0x02bf,0x49e0,0x4da3,0x06c0,0x08a1,0x319b,0x3e25,0x77ee,0x01e3,0x4089,0x4573,0x6719,0x10e0,0x1afe,0x3cfc,0x02a8,0x31ea,0x3476,0x6434,0x2b65,0x602d,0x5bbf,0x47aa,0x74b2,0x7080,0x1114,0x51ec,0x3fed,0x3bdf,0x51c7,0x465e,0x20e9,0x06eb,0x29bc,0x43c2,0x13e6,0x6077,0x47f0,0x2839,0x7f58,0x6ce4,0x199e,0x06fc,0x1091,0x3f9c,0x7a9e,0x49ba,0x49cb,0x4c7c,0x5309,0x2e9f,0x766b,0x49dc,0x3342,0x6a18,0x0d5b,0x3d23,0x1c15,0x23ef,0x0cde,0x1ac2,0x29da,0x1d90,0x420a,0x5335,0x0ce2,0x2db2,0x0a35,0x226a,0x462f,0x17c3,0x1b50,0x0e10,0x2121,0x5018,0x375b,0x545b,0x208f,0x603a,0x2e88,0x035c,0x5776,0x32b6,0x3324,0x7c49,0x3b92,0x14f9,0x05c6,0x6d07,0x5d19,0x3d1f,0x6d61,0x61d9,0x4b05,0x1a8f,0x2ef9,0x55de,0x0a22,0x542a,0x4c6b,0x2997,0x1830,0x0c93,0x1526,0x4487,0x4ada,0x7631,0x5bd9,0x7c04,0x6719,0x7c49,0x2c6d,0x7640,0x465e,0x74b2,0x1488,0x65d7,0x417d,0x17e8,0x40f8,0x7b6a,0x1a8f,0x44ca,0x5971,0x2848,0x7c75,0x1f75,0x6f93,0x6452,0x0a09,0x3e68,0x5018,0x24bd,0x1f75,0x0d70,0x7c38,0x62c8,0x65fc,0x004d,0x2602,0x0d67,0x0c93,0x7ad3,0x1f04,0x3716,0x3053,0x6300,0x3035,0x6ba1,0x2136,0x301e,0x32d0,0x5d0e,0x14b4,0x7214,0x4986,0x0d4c,0x5cd1,0x0752,0x2787,0x5ffc,0x634d,0x4eb2,0x3d45,0x1f04,0x2848,0x08c7,0x73ad,0x14a3,0x5e45,0x097e,0x31c1,0x2f31,0x434a,0x318c,0x5a3a,0x6006,0x7b56,0x0d5b,0x462f,0x5bbf,0x6c95,0x0bfd,0x484e,0x2121,0x2664,0x543d,0x0c84,0x17d4,0x787b,0x5055,0x1ef0,0x1239,0x6ccf,0x217b,0x17d4,0x7daa,0x0360,

0x7788,0x58f4,0x23b5,0x1ab3,0x2098,0x0294,0x58e3,0x38bf,0x6423,0x1c3e,0x1dac,0x0d3d,0x3053,0x0708,0x0779,0x38ce,0x6ff5,0x3e43,0x1edb,0x2b65,0x6ba1,0x13ab,0x7551,0x52fd,0x3b92,0x7d96,0x178e,0x7b6a,0x6944,0x2b3f,0x0283,0x5d25,0x531e,0x453e,0x14ee,0x7520,0x3a17,0x20fe,0x4398,0x572c,0x5917,0x330f,0x3bae,0x23c4,0x594d,0x2980,0x5a2d,0x6725,0x40c4,0x74b2,0x0918,0x7dbd,0x4ee8,0x345d,0x2389,0x0918,0x19d3,0x7daa,0x6fde,0x36de,0x4b63,0x4dee,0x0752,0x0933,0x1ee7,0x05d1,0x217b,0x7265,0x32fb,0x786c,0x6e5b,0x66d1,0x3461,0x416a,0x66b7,0x4a80,0x4a80,0x0e76,0x5a5c,0x5682,0x73e0,0x40a2,0x1557,0x2ae0,0x31b0,0x2d8e,0x5917,0x31b0,0x4f20,0x7f4f,0x6d76,0x14c5,0x2f40,0x5cc6,0x5e34,0x52d6,0x52a7,0x79e9,0x161c,0x3b85,0x071f,0x2b14,0x6bec,0x2b28,0x5309,0x603a,0x0e76,0x73ba,0x19c4,0x0a6f,0x13cd,0x0cb8,0x227d,0x751c,0x0a78,0x77f9,0x2150,0x5467,0x0306,0x2b59,0x24f0,0x255e,0x7391,0x0fbc,0x47cc,0x5900,0x3cc0,0x13f1,0x6e16,0x08b6,0x1620,0x688c,0x166d,0x089d,0x2ea3,0x208f,0x7821,0x55af,0x2c0b,0x5be5,0x1128,0x6e16,0x5892,0x0745,0x4d88,0x3bae,0x4c6b,0x31ea,0x1086,0x7850,0x417d,0x61bf,0x2812,0x4515,0x36e2,0x4b74,0x4c1a,0x6408,0x0a09,0x7eca,0x10e0,0x3044,0x0185,0x3684,0x2b03,0x4ada,0x1b36,0x7eca,0x6c82,0x49ad,0x757a,0x0bfd,0x3b85,0x52a7,0x1ab3,0x17e8,0x345d,0x20c2,0x1d87,0x1531,0x0924,0x6300,0x125f,0x7b30,0x337e,0x61e5,0x393a,0x3595,0x40f8,0x1b0a,0x3906,0x393a,0x1ecc,0x2549,0x1b7b,0x3e32,0x416a,0x5e34,0x7626,0x3fb7,0x3a3c,0x211d,0x58ae,0x6d76,0x1ee7,0x1c3e,0x6a0f,0x08fb,0x2504,0x6445,0x4d88,0x2f40,0x2f7c,0x6bfb,0x4247,0x1380,0x034b,0x3bae,0x5710,0x5ffc,0x1ac2,0x1f62,0x7af8,0x29ab,0x7f3e,0x767c,0x62ae,0x0723,0x6faf,0x0d5b,0x05c6,0x5bbf,0x0306,0x3cd7,0x4a97,0x44ac,0x27dd,0x0443,0x7ab5,0x47bd,0x4221,0x4573,0x7ad3,0x4865,0x27bb,0x5309,0x7b56,0x1c02,0x4236,0x1841,0x4796,0x7139,0x7272,0x1159,0x7c49,0x4502,0x0294,0x55c9,0x44ac,0x781d,0x19ef,0x6ba1,0x7847,0x66ed,0x003c,0x4e8e,0x7c5e,0x5e23,0x0192,0x06eb,0x160b,0x252f,0x68c1,0x6452,0x7edd,0x55b8,0x3595,0x27bb,0x5c8b,0x005a,0x47cc,0x689b,0x20d5,0x1827,0x500f,0x70bc,0x1165,0x24f0,

0x2f26,0x4573,0x285f,0x0fd8,0x65b1,0x17b2,0x3476,0x3d08,0x7391,0x36c9,0x52c1,0x6366,0x6fe2,0x3693,0x4da3,0x23ef,0x2c51,0x38a8,0x646e,0x122e,0x79d5,0x410c,0x79fe,0x62c8,0x2b4e,0x1ae9,0x5695,0x2227,0x426c,0x761a,0x7c38,0x4af1,0x02a8,0x306f,0x263e,0x1114,0x7546,0x1df6,0x6f84,0x4089,0x7df0,0x544c,0x1830,0x4859,0x6719,0x7ee1,0x5c9c,0x0e3b,0x0e76,0x6d4a,0x724e,0x4ae6,0x2980,0x6a24,0x7b6a,0x375b,0x7b41,0x19f8,0x4d88,0x1c15,0x3369,0x1ef0,0x6c95,0x0fe4,0x3bc8,0x5761,0x5cfa,0x7c13,0x01ae,0x7546,0x31a7,0x44ac,0x0468,0x61e5,0x4638,0x2812,0x211d,0x31ea,0x3684,0x411b,0x23c4,0x2da5,0x23d3,0x090f,0x0942,0x0432,0x7dbd,0x31c1,0x150d,0x097e,0x4141,0x5fd7,0x0bd6,0x5e45,0x004d,0x5f8d,0x4ea5,0x1b47,0x2adc,0x61f2,0x2997,0x1f5e,0x5a5c,0x0955,0x49f7,0x29da,0x149f,0x156b,0x01df,0x06d3b,0x3ceb,0x757a,0x1aa4,0x5710,0x6bec,0x70bc,0x3461,0x38d9,0x605c,0x5322,0x6a18,0x51d0,0x4781,0x1dbb,0x1c64,0x2aad,0x4398,0x6bb6,0x61bf,0x5710,0x32fb,0x0cc9,0x4c1a,0x4f46,0x3fed,0x29cd,0x2c7a,0x180c,0x38f2,0x1a98,0x14d2,0x0caf,0x6479,0x4c7c,0x5467,0x20b3,0x5ca0,0x36b8,0x1637,0x6faf,0x5c8b,0x3bb9,0x27ca,0x6408,0x4986,0x5695,0x6a42,0x40ef,0x2f57,0x7b7d,0x7c62,0x2e9f,0x70cd,0x0311,0x199e,0x0f82,0x167a,0x6a69,0x748e,0x17a5,0x0b9b,0x27bb,0x1dca,0x06d7,0x7499,0x2ea3,0x6a33,0x66c6,0x5d19,0x3716,0x592b,0x65d7,0x113f,0x40ef,0x7272,0x7f4f,0x4529,0x56f3,0x20c2,0x6e5b,0x2adc,0x3a66,0x058b,0x35d8,0x56e4,0x66fa,0x6d2c,0x002b,0x798f,0x62df,0x6922,0x0fa9,0x3d79,0x5707,0x748e,0x79c2,0x62f4,0x3767,0x70e6,0x635a,0x4156,0x70cd,0x5fb1,0x7b30,0x27f6,0x4af1,0x0d70,0x40ef,0x071f,0x3582,0x069a,0x23b5,0x5353,0x23f8,0x1159,0x7b1b,0x5e45,0x2f31,0x0e2c,0x7e90,0x77b4,0x5a11,0x6194,0x6ce4,0x7265,0x1856,0x3a2b,0x7e87,0x5966,0x2874,0x4db4,0x3d08,0x7b41,0x751c,0x2230,0x27ac,0x35a9,0x0caf,0x2ef9,0x5bf2,0x4c40,0x20a4,0x55f5,0x4c31,0x55e2,0x7214,0x0cf5,0x40d3,0x781d,0x6e70,0x632b,0x1128,0x1274,0x3407,0x1b0a,0x08a1,0x2673,0x531e,0x3fed,0x51b6,0x40b5,0x465e,0x3009,0x7ddb,0x1128,0x5bce,0x034b,0x068d,0x5069,0x3d45,0x7edd,0x691e,0x0779,0x6743,0x0a09,0x0443,0x4d9f,0x187d,

0x5069,0x4247,0x1540,0x529b,0x56d8,0x31fd,0x6f93,0x0a6f,0x3d52,0x4130,0x658d,0x1f49,0x2805,0x4dd2,0x3cd7,0x5d25,0x6bc7,0x575d,0x20b3,0x4c57,0x4ee8,0x5d43,0x1172,0x7aef,0x2a91,0x5ffc,0x392d,0x5d68,0x02d9,0x2790,0x1f04,0x0f95,0x518a,0x35a9,0x7391,0x2c20,0x38ce,0x715f,0x3f8b,0x2602,0x35be,0x161c,0x55e2,0x2aba,0x08b6,0x5bf2,0x7f73,0x2da5,0x58e3,0x2f26,0x345d,0x47db,0x3d34,0x114e,0x32b6,0x17c3,0x345d,0x1ebd,0x7d81,0x7b6a,0x1ebd,0x7080,0x68ea,0x3cb1,0x06eb,0x5d0e,0x5593,0x668b,0x2481,0x632b,0x483f,0x3e0e,0x0d2a,0x641f,0x7626,0x5401,0x1a8f,0x7272,0x5e1f,0x417d,0x216c,0x13da,0x68fd,0x10f7,0x7537,0x0066,0x0fd8,0x767c,0x7c2f,0x7821,0x6ce4,0x7b41,0x7ebb,0x3a00,0x1646,0x0924,0x1651,0x5a3a,0x0bc1,0x5a4b,0x05fa,0x44e1,0x1a98,0x05d1,0x32c7,0x06a6,0x6d61,0x5ced,0x2db2,0x3684,0x0955,0x3fc6,0x7998,0x0d67,0x0ba7,0x1e81,0x779f,0x70ab,0x2b4e,0x411b,0x2eee,0x6bd0,0x604b,0x0a44,0x6a69,0x483f,0x1637,0x186a,0x0b9b,0x1263,0x5a11,0x1e96,0x5900,0x372a,0x2b3f,0x51a1,0x4dee,0x4a80,0x3d08,0x74e8,0x186a,0x0723,0x2c0b,0x1f38,0x7551,0x6cd8,0x2f31,0x6452,0x4814,0x2c46,0x43b3,0x68b0,0x420a,0x3d79,0x1091,0x06fc,0x73f7,0x2658,0x1c29,0x51a1,0x6285,0x3053,0x2147,0x3d34,0x059c,0x0192,0x47cc,0x05c6,0x0fa9,0x4490,0x4acd,0x4675,0x5776,0x77c5,0x4f6d,0x27ca,0x7ad3,0x181b,0x3324,0x3a66,0x62e3,0x4638,0x5a5c,0x2673,0x2562,0x5f9a,0x3355,0x3e68,0x6317,0x0306,0x2b4e,0x68d6,0x5024,0x62e3,0x4f51,0x2997,0x421d,0x2ec5,0x2549,0x23f8,0x55de,0x5761,0x36f5,0x6fe2,0x47e7,0x0d16,0x77d2,0x1ac2,0x47bd,0x6e4c,0x4c1a,0x51b6,0x17c3,0x36de,0x2c0b,0x02ce,0x4eff,0x1172,0x0360,0x7537,0x0fe4,0x68a7,0x7139,0x454f,0x6423,0x4649,0x4247,0x4c1a,0x1830,0x19a2,0x1c29,0x2dff,0x5885,0x43a4,0x4c7c,0x2863,0x62ae,0x2c7a,0x61bf,0x605c,0x20b3,0x7386,0x420a,0x4814,0x0000,0x531e,0x766b,0x2a91,0x3a71,0x51ec,0x6953,0x426c,0x6bb6,0x20e9,0x24aa,0x4da3,0x5d54,0x24cc,0x36b8,0x1f2f,0x2874,0x52fd,0x7de7,0x01f4,0x7228,0x31d6,0x58c8,0x29f1,0x1989,0x2256,0x6e16,0x595a,0x35a9,0x1b36,0x10f7,0x58df,0x35e4,0x0955,0x40f8,0x38d9,0x4f0b,0x5335,0x19ef,0x3009,0x19d3,0x5344,0x161c,0x7112,

0x1ddd,0x592b,0x17e8,0x19ef,0x29bc,0x24cc,0x70ab,0x5d7f,0x13bc,0x1c15,0x2c1c,0x4a80,0x44f6,0x2adc,0x1c73,0x6944,0x5470,0x6194,0x7df0,0x51fb,0x49ad,0x149f,0x7850,0x7228,0x0734,0x47aa,0x58ae,0x56d8,0x24e7,0x4b63,0x0454,0x426c,0x56cf,0x10dc,0x35d8,0x17ff,0x06a6,0x5584,0x36f5,0x19c4,0x2c20,0x6725,0x7105,0x58df,0x3355,0x06b1,0x0419,0x750b,0x44ca,0x77c5,0x0969,0x7259,0x5a4b,0x2f40,0x6a69,0x32a1,0x0425,0x52c1,0x2f0d,0x4141,0x2b65,0x6719,0x1dbb,0x1f13,0x4515,0x65c0,0x1114,0x2c1c,0x5feb,0x0708,0x0066,0x17a5,0x5917,0x4df9,0x5feb,0x3b85,0x14ee,0x068d,0x1ad5,0x6953,0x2615,0x74e8,0x7097,0x0ba7,0x6a55,0x61a8,0x723f,0x7847,0x330f,0x1540,0x0c84,0x7d96,0x73f7,0x4ec3,0x29da,0x38e5,0x069a,0x5ba8,0x1ecc,0x603a,0x1b21,0x2d99,0x7f3e,0x5ca0,0x1f62,0x285f,0x4db4,0x6ccf,0x

528c,0x4b05,0x3bb9,0x4aab,0x6a0f,0x264f,0x6a7e,0x1b7b,0x0bea,0x3035,0x4dc5,0x19c4,0x6d4a,0x3e7f,0x5e52,0x0bd6,0x252f,0x3ca6,0x0e10,0x0e5d,0x3e25,0x14a3,0x5682,0x0fd8,0x393a,0x1f49,0x14a3,0x2513,0x0cde,0x7265,0x3b92,0x5bd9,0x252f,0x3bc8,0x1de1,0x5cfa,0x1dca,0x55af,0x7386,0x66b7,0x4865,0x68b0,0x7836,0x6d07,0x2150,0x3a4d,0x23d3,0x2629,0x7ac4,0x421d,0x691e,0x593c,0x1c73,0x1ac2,0x032d,0x5a60,0x73cb,0x2ec5,0x47db,0x44bb,0x51a1,0x6e2a,0x4130,0x0311,0x573b,0x4089,0x29da,0x56be,0x3bc8,0x6b9d,0x6fb8,0x08c7,0x73e0,0x7c2f,0x1ad5,0x1086,0x3407,0x166d,0x3476,0x6cf3,0x5033,0x3fa0,0x2538,0x06b1,0x6e67,0x0a78,0x635a,0x1c4f,0x5900,0x6434,0x4573,0x4aab,0x7e90,0x0185,0x3ca6,0x4db4,0x06b1,0x004d,0x047f,0x033a,0x0468,0x2256,0x6ccf,0x252f,0x6bd0,0x3369,0x0734,0x1651,0x411b,0x32ec,0x7af8,0x5c9c,0x4f7a,0x0419,0x51fb,0x0bb0,0x5fa6,0x1ef0,0x5e6e,0x23d3,0x416a,0x2dc3,0x1d87,0x68fd,0x2a91,0x1651,0x4529,0x1856,0x6d76,0x7520,0x5042,0x4dc5,0x17c3,0x6060,0x6366,0x51c7,0x65fc,0x7daa,0x47e7,0x7174,0x0d4c,0x3f8b,0x31a7,0x4b5f,0x6fb8,0x56e4,0x4872,0x4662,0x3d23,0x6ff5,0x44e1,0x0bfd,0x0283,0x6f93,0x035c,0x49cb,0x779f,0x3044,0x3318,0x2af7,0x3e68,0x0a53,0x0b8c,0x7ddb,0x7228,0x392d,0x5a60,0x097e,0x27ac,0x180c,0x6e4c,0x27e1,0x51b6,0x74d4,0x3cb1,0x7c75,0x24e7,0x55f5,0x6743,0x779f,

0x7f02,0x7b1b,0x44dd,0x6768,0x4130,0x79a4,0x208f,0x0e76,0x0942,0x4247,0x02ce,0x2658,0x4f46,0x43fe,0x2ea3,0x29f1,0x3595,0x395c,0x5e6e,0x6d2c,0x2d99,0x0752,0x6e16,0x2f7c,0x5cfa,0x416a,0x220c,0x090f,0x7aef,0x4156,0x1263,0x574a,0x7203,0x29ab,0x40d3,0x2dff,0x076e,0x79d5,0x2ed2,0x216c,0x01b9,0x343b,0x01f4,0x08ec,0x66a0,0x2b3f,0x3e19,0x2863,0x1b0a,0x4398,0x08ec,0x5d54,0x0cf5,0x2dd4,0x6b9d,0x35d8,0x3d1f,0x0419,0x3fb7,0x7214,0x61ce,0x29bc,0x2a86,0x3a17,0x62b9,0x29da,0x47f0,0x7dbd,0x02ce,0x779f,0x79b3,0x5055,0x5b83,0x62b9,0x2af7,0x47aa,0x7520,0x29da,0x4398,0x2549,0x1397,0x14c5,0x7aef,0x7b1b,0x1b6c,0x55b8,0x36f5,0x4828,0x2664,0x73cb,0x7640,0x01c8,0x4f1c,0x65b1,0x3693,0x4f37,0x2af7,0x3b85,0x36e2,0x1edb,0x604b,0x328a,0x2c7a,0x7546,0x689b,0x7626,0x410c,0x6e67,0x409e,0x2136,0x3a71,0x08fb,0x0185,0x6fe2,0x5bd9,0x38f2,0x7080,0x2481,0x13bc,0x573b,0x43d5,0x2ee,0x5b94,0x1f38,0x167a,0x1dac,0x1159,0x7ac4,0x5ced,0x032d,0x74c3,0x2615,0x5344,0x210a,0x113f,0x0d2a,0x70da,0x2496,0x7163,0x5b83,0x2629,0x071f,0x5bce,0x2227,0x32a1,0x79a4,0x0e3b,0x6e3d,0x05ed,0x6909,0x1091,0x328a,0x0a35,0x68d6,0x217b,0x5d19,0x1397,0x70da,0x0924,0x5feb,0x1d90,0x10dc,0x3bc8,0x7112,0x7f29,0x6909,0x02f2,0x3bb9,0x519d,0x56cf,0x5cb7,0x1c64,0x5fc0,0x7657,0x122e,0x2b3f,0x6d3b,0x3035,0x090f,0x3fa0,0x31b0,0x3e19,0x3a5a,0x3cc0,0x7c62,0x2848,0x0cc9,0x52a7,0x5593,0x0a1e,0x5322,0x071f,0x221b,0x3cfc,0x1799,0x6922,0x0a44,0x58c8,0x7850,0x74d4,0x6452,0x1de1,0x7b30,0x35f3,0x47db,0x58c8,0x3bf4,0x766b,0x49cb,0x122e,0x5593,0x696f,0x31d6,0x19a2,0x3d52,0x17c3,0x0b9b,0x7f4f,0x0192,0x373d,0x5695,0x61f2,0x10f7,0x61a8,0x0cb8,0x61a8,0x595a,0x0e4a,0x1ddd,0x1e81,0x0419,0x1d90,0x29ab,0x0a09,0x05ed,0x0a44,0x3324,0x1d90,0x10cb,0x2664,0x10ba,0x0fa9,0x68ea,0x160b,0x1a98,0x282e,0x38d9,0x1488,0x2eb4,0x2dff,0x1380,0x6935,0x5fd7,0x20d5,0x0fa9,0x4b2e,0x7657,0x1091,0x32d0,0x31ea,0x4df9,0x0918,0x01df,0x1ee7,0x2d99,0x2ec5,0x1989,0x7b7d,0x4127,0x44dd,0x05b7,0x3a4d,0x0d67,0x507e,0x2aad,0x6922,0x24f0,0x1b6c,0x55e2,0x6fc9,0x4398,0x3a00,0x77a3,0x058b,0x0294,0x3770,0x29e6,0x1526,

0x033a,0x55af,0x5e1f,0x6cd8,0x52c1,0x2848,0x7847,0x3693,0x2980,0x156b,0x1799,0x23ef,0x3fd1,0x08d0,0x7520,0x2ec5,0x536f,0x329d,0x1de1,0x66ed,0x178e,0x3d34,0x17c3,0x573b,0x0d01,0x6a55,0x17a5,0x5e6e,0x4859,0x1ecc,0x1827,0x32fb,0x3e0e,0x3078,0x239e,0x4803,0x263e,0x0f82,0x1c15,0x0d16,0x40ef,0x5353,0x187d,0x3e7f,0x61f2,0x4865,0x77c5,0x47f0,0x392d,0x1239,0x2602,0x0419,0x575d,0x02f2,0x199e,0x658d,0x7f58,0x393a,0x2147,0x798f,0x0d16,0x3d23,0x61ce,0x528c,0x68a7,0x5cd1,0x4c31,0x7edd,0x4c7c,0x35e4,0x5a3a,0x5900,0x696f,0x1e96,0x4781,0x5a5c,0x62ae,0x40d3,0x36c9,0x748e,0x0071,0x6c95,0x255e,0x761a,0x6e01,0x1b7b,0x4f6d,0x1827,0x767c,0x0d16,0x4803,0x5a2d,0x5e08,0x507e,0x3d45,0x65a6,0x6d61,0x2504,0x3c9a,0x6a55,0x4a80,0x5ced,0x7b30,0x1827,0x767c,0x668b,0x7e87,0x38a8,0x31ea,0x6d5d,0x14f9,0x7105,0x4af1,0x3324,0x798f,0x65c0,0x756d,0x43fe,0x3d23,0x70bc,0x2098,0x575d,0x220c,0x0779,0x3fc6,0x0e10,0x6423,0x1212,0x187d,0x4613,0x3369,0x2aba,0x5a3a,0x574a,0x208f,0x7dbd,0x6a42,0x4c7c,0x068d,0x1c02,0x2e88,0x0ff3,0x4e99,0x55af,0x6732,0x2504,0x1841,0x6d61,0x2513,0x723f,0x2562,0x688c,0x6a33,0x329d,0x3977,0x6011,0x0caf,0x6d4a,0x122e,0x5ca0,0x5c8b,0x1e96,0x5ba8,0x23b5,0x3476,0x005a,0x3d79,0x2adc,0x545b,0x6292,0x23b5,0x0066,0x7b27,0x7788,0x635a,0x5761,0x24cc,0x7c38,0x35be,0x4b12,0x38bf,0x61e5,0x6a55,0x4dc5,0x2c1c,0x1086,0x3a2b,0x61f2,0x761a,0x5d43,0x342c,0x62f4,0x263e,0x4221,0x409e,0x4872,0x6434,0x208f,0x0933,0x221b,0x5cb7,0x77a3,0x150d,0x0000,0x3044,0x7551,0x5a06,0x6006,0x3d52,0x6d07,0x68c1,0x780a,0x68fd,0x7c04,0x4b12,0x0

b8c,0x3fc6,0x6a0f,0x43d5,0x79c2,0x659a,0x70f1,0x0360,0x74d4,0x1172,0x4796,0x44ac,0x2e9f,0x1df6,0x4487,0x66d1,0x343b,0x4814,0x715f,0x66fa,0x7e87,0x6e4c,0x4865,0x125f,0x10ad,0x05d1,0x7174,0x542a,0x36af,0x0e61,0x5467,0x74b2,0x7b6a,0x6285,0x1b36,0x66a0,0x1ef0,0x7788,0x5feb,0x27dd,0x2c37,0x7dcc,0x2acb,0x1830,0x239e,0x4c0d,0x3e43,0x27f6,0x02a8,0x5416,0x29e6,0x798f,0x002b,0x77b4,0x4ef f,0x4f0b,0x6366,0x3a3c,0x3369,0x14d2,0x465e,0x61a8,0x4ae6,0x6d10,0x7daa,0x7821,0x3883,0x40c4,0x24db,0x02f2,0x4f1c,0x4f1c,0x36b8,

0x6725,0x02f2,0x427b,0x3e43,0x076e,0x529b,0x70da,0x5bbf,0x5bf2,0x0f95,0x7139,0x2b59,0x0f82,0x3cfc,0x7c04,0x4991,0x1afe,0x7ab5,0x6479,0x3911,0x5707,0x55de,0x7139,0x5a06,0x0752,0x14b4,0x4abc,0x23a2,0x2adc,0x5335,0x51d0,0x4872,0x7259,0x4ee8,0x13f1,0x35d8,0x032d,0x507e,0x68b0,0x32a1,0x058b,0x4221,0x1c4f,0x68c1,0x3a71,0x4490,0x6408,0x24f0,0x3d1f,0x13bc,0x7f3e,0x62e3,0x3c9a,0x6060,0x3355,0x4859,0x715f,0x1c15,0x1f5e,0x239e,0x373d,0x264f,0x2575,0x1ef0,0x5ca0,0x6bb6,0x65a6,0x4515,0x3595,0x5917,0x3f9c,0x5309,0x4db4,0x31a7,0x14b4,0x4638,0x51d0,0x3461,0x5069,0x6011,0x5c9c,0x633c,0x1f5e,0x52d6,0x23ef,0x0d3d,0x6978,0x2241,0x5cc6,0x0fbc,0x0fcf,0x32d0,0x3407,0x3e54,0x36de,0x199e,0x14f9,0x4ada,0x5416,0x5a5c,0x79b3,0x2b28,0x6077,0x2629,0x761a,0x2b4e,0x528c,0x7c04,0x0bb0,0x5695,0x7c2f,0x1f62,0x089d,0x5378,0x677f,0x6e5b,0x0933,0x2b65,0x7a89,0x01c8,0x5776,0x3342,0x01e3,0x6d4a,0x10cb,0x6a55,0x2513,0x5fb1,0x13e6,0x4f20,0x6ba1,0x4f7a,0x10dc,0x3fd1,0x1103,0x2839,0x3bb9,0x3693,0x2812,0x4f0b,0x5353,0x3035,0x2af7,0x7ddb,0x7b0c,0x3e32,0x344a,0x4df9,0x0e3b,0x151a,0x62e3,0x3e68,0x7c2f,0x65fc,0x483f,0x5bd9,0x6a33,0x0066,0x02bf,0x0e3b,0x1128,0x23d3,0x216c,0x4d88,0x1b47,0x79fe,0x114e,0x0942,0x780a,0x4f6d,0x4ea5,0x36de,0x7080,0x5e6e,0x5344,0x059c,0x4ec3,0x677f,0x593c,0x1172,0x2de8,0x43c2,0x7a9e,0x05c6,0x5344,0x51a1,0x4f1c,0x27f6,0x01df,0x634d,0x2c6d,0x1989,0x65eb,0x19f8,0x29cd,0x6fde,0x0708,0x01f4,0x40ef,0x17e8,0x0f82,0x5a11,0x1103,0x3fed,0x58ae,0x5a11,0x70ab,0x05b7,0x3e54,0x4b63,0x0caf,0x167a,0x23ef,0x4986,0x27ac,0x0d01,0x6fc9,0x5a3a,0x574a,0x02a8,0x14ee,0x1c58,0x3342,0x6978,0x7f73,0x5467,0x5be5,0x7f29,0x06d7,0x3e32,0x3894,0x52d6,0x77ee,0x7a89,0x7b0c,0x0fd8,0x372a,0x10ad,0x5353,0x73ad,0x3bdf,0x1620,0x49cb,0x2150,0x0bfd,0x65b1,0x318c,0x1c4f,0x1ae9,0x4eff,0x7ebb,0x4dee,0x167a,0x08b6,0x23c4,0x7265,0x4aab,0x6434,0x52a7,0x2b4e,0x069a,0x05ed,0x3883,0x4dc5,0x3022,0x4156,0x1212,0x157c,0x5be5,0x01df,0x2adc,0x74ff,0x4d9f,0x2c20,0x74ff,0x51d0,0x0fd8,0x14c5,0x342c,0x1620,0x05fa,0x36e2,0x4b74,0x3410,0x151a,0x483f,0x5335,0x7edd,

0x05ed,0x328a,0x003c,0x2241,0x0000,0x1ddd,0x73ba,0x20fe,0x10cb,0x43c2,0x6ba1,0x5a2d,0x73dc,0x151a,0x5d7f,0x47f0,0x7998,0x10e0,0x2b14,0x5e79,0x56a9,0x2b14,0x05fa,0x186a,0x65c0,0x1989,0x7657,0x7163,0x65eb,0x543d,0x6b9d,0x5e52,0x0000,0x32c7,0x7112,0x342c,0x31b0,0x0a44,0x4df9,0x068d,0x6d10,0x7631,0x7b1b,0x7c75,0x01f4,0x6bc7,0x61a8,0x0419,0x08b6,0x3fb7,0x49f7,0x1488,0x3d52,0x715f,0x5d54,0x62f4,0x77d2,0x113f,0x3bdf,0x02ce,0x216c,0x4649,0x5cfa,0x55c9,0x3977,0x6a0f,0x4dee,0x2997,0x29e6,0x5a3a,0x6d76,0x786c,0x35e4,0x6a42,0x6183,0x74ff,0x712e,0x24aa,0x1c15,0x55af,0x4564,0x31ea,0x519d,0x7af8,0x605c,0x3ffa,0x3960,0x035c,0x2c37,0x7097,0x282e,0x79b3,0x0752,0x2848,0x3cfc,0x1f49,0x1526,0x2f40,0x0d70,0x0b9b,0x0e5d,0x3fa0,0x3960,0x757a,0x4872,0x2389,0x186a,0x2f1a,0x5f9a,0x1b21,0x2848,0x4130,0x73cb,0x0723,0x6cf3,0x2538,0x36c9,0x2b72,0x211d,0x592b,0x6d3b,0x0e61,0x20b3,0x4e99,0x5069,0x410c,0x0311,0x751c,0x3fb7,0x0071,0x1eaa,0x2538,0x2aad,0x3333,0x7b27,0x5cb7,0x0723,0x4d9f,0x2839,0x4236,0x68fd,0x0d4c,0x2805,0x6909,0x79c2,0x0fcf,0x02d9,0x6d07,0x167a,0x2602,0x1165,0x427b,0x3d6e,0x5885,0x2256,0x1b1d,0x38d9,0x3035,0x0cc9,0x3d6e,0x3d23,0x724e,0x531e,0x14a3,0x5761,0x23b5,0x7836,0x27f6,0x58f4,0x604b,0x02f2,0x4529,0x2538,0x3bae,0x51fb,0x3cb1,0x14f9,0x0fbc,0x2a86,0x29bc,0x44e1,0x372a,0x7c49,0x58e3,0x2b59,0x6317,0x150d,0x3e68,0x411b,0x199e,0x61a8,0x216c,0x750b,0x2863,0x4649,0x605c,0x2b65,0x7a9e,0x32d0,0x3d45,0x3e0e,0x6944,0x1c64,0x0d67,0x5cd1,0x0d3d,0x3bf4,0x31d6,0x32b6,0x51d0,0x08fb,0x125f,0x66d1,0x0cf5,0x216c,0x27bb,0x217b,0x7c5e,0x6732,0x319b,0x1f49,0x3a4d,0x0ce2,0x483f,0x0723,0x19b5,0x4c40,0x2a91,0x35a9,0x6e5b,0x395c,0x44e1,0x005a,0x5707,0x417d,0x574a,0x77f9,0x2ae0,0x7d81,0x4127,0x602d,0x20fe,0x4ada,0x2c6d,0x3e19,0x3324,0x0e61,0x6953,0x4859,0x7c2f,0x4b39,0x6011,0x787b,0x723f,0x186a,0x1114,0x7821,0x2b4e,0x56d8,0x004d,0x574a,0x604b,0x56a9,0x29ab,0x3b85,0x65b1,0x62f4,0x2997,0x65eb,0x0066,0x56d8,0x781d,0x52ea,0x2504,0x3d1f,0x58c8,0x1de1,0x187d,0x5018,0x2629,0x2575,0x757a,0x2c51,0x19b5,0x3fb7,0x594d,0x7163,0x125f,

0x7112,0x38bf,0x58c8,0x68a7,0x29f1,0x7b27,0x70f1,0x13da,0x167a,0x3cb1,0x38d9,0x08a1,0x757a,0x20b3,0x4b2e,0x2b14,0x416a,0x6a55,0x7ee1,0x2839,0x2b3f,0x7836,0x151a,0x5d25,0x4529,0x24bd,0x089d,0x05a0,0x3318,0x4acd,0x3911,0x2dff,0x5971,0x61d9,0x6cd8,0x01b9,0x3333,0x79d5,0x2b3f,0x166d,0x2790,0x3e43,0x3318,0x7080,0x01f4,0x2549,0x43b3,0x3c8d,0x167a,0x3960,0x17a5,0x23f8,0x319b,0x1397,0x31d6,0x1248,0x592b,0x059c,0x79fe,0x05ed,0x285f,0x3c8d,0x3333,0x52c1,0x0fe4,0x2538,0x7c13,0x1ddd,0x2230,0x29f1,0x5a3a,0x089d,0x38e5,0x518a,0x343b,0x1841,0x73e0,0x0fa9,0x51fb,0x4781,0x47db,0x3fb7,0x70da,0x2f0d,0x1397,0x1ebd,0x61e5,0x27ca,0x32a1,0x089d,0x210a,0x7847,0x426c,0x06c0,0x6a18,0x1799,0x7148,0x1799,0x3770,0x1dbb,0x05d1,0x38d9,0x61d9,0x372a,0x29ab,0x3d34,0x36b8,0x0000,0x211d,0x7640,0x13da,0x3022,0x3f9c,0x35e4,0x2da5,0x79fe,0x5e1f,0x5470,0x2098,0x7821,0x1799,0x06c0,0x1172,0x01b9,0x43c2,0x319b,0x2d99,0x38bf,0x01c8,0x0708,0x6f84,0x1a98,0x3cfc,0x6e16,0x66b7,0x633c,0x5416,0x4675,0x36b8,0x73f7,0x3342,0x4236,0x74c3,0x4dd2,0x06d7,0x6183,0x2d99,0x670e,0x6754,0x66fa,0x149f,0x0283,0x641f,0x3f8b,0x7f15,0x35cf,0x0017,0x5cc6,0x002b,0x4487,0x31a7,0x3770,0x4b05,0x55af,0x3e7f,0x420a,0x35cf,0x635a,0x7259,0x3d34,0x1f38,0x5584,0x3476,0x32ec,0x2241,0x7c13,0x3476,0x74a5,0x484e,0x5fd7,0x603a,0x3770,0x0fe4,0x49cb,0x06c0,0x5d32,0x14b4,0x319b,0x3318,0x5e23,0x6754,0x4675,0x43a4,0x5a06,0x4b12,0x0942,0x43d5,0x5d32,0x6cbe,0x6ff5,0x5584,0x6c82,0x2f26,0x0e2c,0x7dcc,0x5fd7,0x5a2d,0x35cf,0x572c,0x3bae,0x4b2e,0x0f82,0x7ee1,0x7788,0x66c6,0x3035,0x5bf2,0x6e01,0x5bbf,0x4eb2,0x3582,0x670e,0x0017,0x3883,0x6f93,0x4ee8,0x5d43,0x3342,0x641f,0x6909,0x4f46,0x06eb,0x2eee,0x4490,0x0a1e,0x2e88,0x5a77,0x2863,0x20c2,0x7228,0x70bc,0x7f4f,0x603a,0x6bfb,0x2c51,0x0311,0x0cb8,0x4487,0x2c46,0x0779,0x7626,0x35cf,0x3770,0x5d54,0x5ba8,0x5467,0x24cc,0x4dd2,0x6cbe,0x5c9c,0x0443,0x6f84,0x6e67,0x5ca0,0x74a5,0x0283,0x3476,0x633c,0x5c9c,0x545b,0x3407,0x10dc,0x70ab,0x7265,0x6183,0x68ea,0x157c,0x47bd,0x6e16,0x1380,0x3e25,0x409e,0x5e23,0x454f,0x3cd7,0x6e3d,0x5682,0x779f,

0x3bae,0x31fd,0x5401,0x7e90,0x0924,0x14b4,0x2241,0x5ca0,0x5584,0x1d87,0x409e,0x7259,0x0fe4,0x19a2,0x0d4c,0x5d32,0x1f2f,0x6371,0x420a,0x438f,0x4649,0x5ced,0x529b,0x77f9,0x7aef,0x2c46,0x1a8f,0x55af,0x4ee8,0x20fe,0x7f73,0x5e52,0x5fd7,0x301e,0x7ac4,0x7148,0x7eac,0x1b36,0x5966,0x3fc6,0x2f7c,0x1c73,0x0d67,0x6e16,0x6bc7,0x4127,0x77d2,0x44ac,0x646e,0x17ff,0x633c,0x4573,0x6e01,0x49cb,0x5335,0x2615,0x696f,0x3cc0,0x58c8,0x77ee,0x002b,0x1172,0x0bc1,0x3d52,0x2c20,0x27bb,0x7daa,0x7b0c,0x7ee1,0x593c,0x5971,0x3369,0x0cf5,0x0e10,0x79d5,0x0425,0x417d,0x08fb,0x2602,0x033a,0x77c5,0x781d,0x5018,0x06a6,0x226a,0x7ddb,0x58b9,0x1b21,0x1646,0x38bf,0x24aa,0x01ae,0x38f2,0x5e79,0x076e,0x6fe2,0x7a9e,0x1ab3,0x55f5,0x2f40,0x4b2e,0x032d,0x454f,0x1f5e,0x4ee8,0x65d7,0x4aab,0x47f0,0x6292,0x79e9,0x58f4,0x32c7,0x3a3c,0x6a0f,0x1841,0x0192,0x7eca,0x02e5,0x0a44,0x3a71,0x4564,0x767c,0x186a,0x2eee,0x02f2,0x4ea5,0x6d3b,0x4ae6,0x2eee,0x394b,0x688c,0x6194,0x3960,0x2673,0x3d45,0x2f6b,0x1e81,0x0432,0x4675,0x545b,0x4781,0x0955,0x7d81,0x6fb8,0x6d07,0x6732,0x1f49,0x62e3,0x1b6c,0x5be5,0x4e99,0x4872,0x56cf,0x4c0d,0x0e76,0x6bec,0x3a3c,0x344a,0x1651,0x3bdf,0x7391,0x5e34,0x3d52,0x199e,0x17d4,0x66a0,0x1f38,0x36c9,0x0a09,0x0e3b,0x3333,0x65fc,0x65b1,0x5e23,0x3b92,0x2e9f,0x2c51,0x0a44,0x0caf,0x724e,0x6cd8,0x6e3d,0x3b92,0x4f7a,0x3595,0x1212,0x2481,0x167a,0x77ee,0x2c1c,0x4da3,0x68c1,0x14b4,0x44f6,0x318c,0x08ec,0x6d4a,0x6ba1,0x4dee,0x3e0e,0x6077,0x5a3a,0x032d,0x36de,0x519d,0x2f31,0x32b6,0x6452,0x40d3,0x756d,0x4859,0x7af8,0x3906,0x62f4,0x65eb,0x40d3,0x5353,0x724e,0x6371,0x416a,0x5ba8,0x689b,0x0e2c,0x79fe,0x47f0,0x73f7,0x79a4,0x4ec3,0x6e2a,0x02f2,0x0311,0x2562,0x4828,0x7631,0x255e,0x4662,0x3693,0x4ed4,0x4156,0x4f7a,0x4872,0x2615,0x6366,0x79e9,0x3d08,0x536f,0x65d7,0x641f,0x4b39,0x4c0d,0x23b5,0x500f,0x4991,0x2acb,0x19ef,0x751c,0x5776,0x1dca,0x23ef,0x2b03,0x4ae6,0x2ef9,0x1ae9,0x43e9,0x5ba8,0x4af1,0x5467,0x52fd,0x1103,0x5069,0x2b28,0x4ed4,0x10dc,0x7847,0x2eb4,0x5fd7,0x08b6,0x0cf5,0x0443,0x4b2e,0x003c,0x5a5c,0x3684,0x19d3,0x02d9,0x01f4,0x2980,0x7259,

0x2aba,0x1172,0x2d99,0x7dcc,0x157c,0x6944,0x1841,0x58f4,0x7f02,0x0071,0x31c1,0x70f1,0x44bb,0x29e6,0x29cd,0x79c2,0x29f1,0x36f5,0x1f75,0x01b9,0x5a3a,0x4156,0x55af,0x1128,0x0969,0x68ea,0x68ea,0x47db,0x4a80,0x7ab5,0x32c7,0x483f,0x4af1,0x2629,0x3053,0x10f7,0x7105,0x7ebb,0x44e1,0x306f,0x6183,0x73ba,0x3894,0x2b14,0x2f6b,0x3a66,0x1159,0x38bf,0x4dd2,0x0969,0x0bfd,0x2f0d,0x08fb,0x2658,0x19d3,0x49dc,0x7657,0x1ae9,0x08fb,0x2980,0x19ef,0x574a,0x27bb,0x2848,0x2389,0x7537,0x156b,0x4828,0x5bbf,0x62ae,0x23a2,0x2f1a,0x0d16,0x2b3f,0x3476,0x5353,0x65b1,0x239e,0x2af7,0x10ad,0x20c2,0x5e23,0x65b1,0x5cc6,0x122e,0x0d01,0x23f8,0x4b48,0x68d6,0x7c62,0x2b4e,0x61a8,0x0f82,0x6077,0x301e,0x5024,0x14b4,0x6d10,0x2812,0x409e,0x47aa,0x56a9,0x3be3,0x2c20,0x5ba8,0x06c0,0x2c7a,0x1d87

,0x2db2,0x372a,0x44bb,0x7ac4,0x4649,0x2b65,0x285f,0x0723,0x3cfc,0x0caf,0x7821,0x3410,0x3bf4,0x3911,0x02ce,0x395c,0x343b,0x605c,0x36b8,0x604b,0x2562,0x7174,0x47bd,0x32fb,0x0419,0x2787,0x4865,0x5344,0x0ce2,0x4f20,0x157c,0x73ba,0x7f15,0x29e6,0x125f,0x24f0,0x3369,0x56cf,0x32fb,0x7e90,0x114e,0x13bc,0x392d,0x23ef,0x2f0d,0x7d96,0x62df,0x5be5,0x6faf,0x6a33,0x2147,0x329d,0x712e,0x73dc,0x2b4e,0x724e,0x1de1,0x3d34,0x0a35,0x7df0,0x05a0,0x5d54,0x27f6,0x160b,0x4c1a,0x781d,0x2e9f,0x58e3,0x68a7,0x4872,0x689b,0x0cde,0x3716,0x3d6e,0x6bc7,0x3767,0x1165,0x7520,0x70da,0x19f8,0x1f38,0x40b5,0x409e,0x4a80,0x3078,0x0fe4,0x529b,0x6bc7,0x696f,0x4f7a,0x3461,0x10ba,0x160b,0x0a6f,0x421d,0x5fc0,0x4529,0x0f95,0x7537,0x069a,0x2f0d,0x7265,0x14d2,0x3d23,0x186a,0x5e1f,0x071f,0x3078,0x2c20,0x6c95,0x3cfc,0x1ac2,0x02a8,0x14b4,0x4b63,0x7520,0x6a0f,0x5900,0x605c,0x0fa9,0x167a,0x29ab,0x4814,0x24f0,0x3a17,0x40c4,0x17b2,0x6cf3,0x5bce,0x2a91,0x51a1,0x1531,0x35e4,0x438f,0x23ef,0x318c,0x61d9,0x52c1,0x62c8,0x17a5,0x2b3f,0x20a4,0x06d7,0x7f64,0x6060,0x1488,0x689b,0x73ad,0x2389,0x1380,0x2615,0x6d61,0x2863,0x13da,0x3693,0x58c8,0x0e76,0x3d34,0x68ea,0x220c,0x0a6f,0x5707,0x0066,0x034b,0x05b7,0x750b,0x3fa0,0x10e0,0x2db2,0x49f7,0x17ff,0x27ac,0x677f,0x3369,0x08c7,0x2f0d,0x0294,0x7dbd,0x519d,0x32a1,

0x31a7,0x10e0,0x677f,0x36e2,0x7836,0x149f,0x2230,0x3d23,0x7e90,0x7821,0x2538,0x5d43,0x0fcf,0x6a42,0x17c3,0x5e08,0x2629,0x3cb1,0x4a97,0x6194,0x08fb,0x0360,0x35d8,0x43e9,0x157c,0x1248,0x5069,0x069a,0x409e,0x17c3,0x55f5,0x5feb,0x7b30,0x55b8,0x77f9,0x36af,0x1380,0x4529,0x1397,0x77a3,0x0a6f,0x1799,0x06eb,0x4781,0x696f,0x77b4,0x6d3b,0x766b,0x20b3,0x40ef,0x01b9,0x17c3,0x3bdf,0x7a89,0x2150,0x5593,0x7163,0x0468,0x3770,0x0468,0x529b,0x1380,0x409e,0x3595,0x2e9f,0x7f15,0x1799,0x6a69,0x483f,0x62df,0x01df,0x1f49,0x529b,0x5695,0x1f13,0x1b1d,0x20fe,0x227d,0x6978,0x7ebb,0x3035,0x3cc0,0x0425,0x40a2,0x43a4,0x0bfd,0x677f,0x4c31,0x760d,0x7e87,0x7228,0x5416,0x6183,0x6d5d,0x4e8e,0x6c82,0x760d,0x5917,0x180c,0x1c02,0x748e,0x5bd9,0x7788,0x43a4,0x2b72,0x4487,0x14ee,0x677f,0x5fa6,0x77ee,0x7ebb,0x0745,0x1c4f,0x40a2,0x3cc0,0x1ecc,0x1086,0x1620,0x208f,0x058b,0x6d5d,0x3d79,0x0d5b,0x01df,0x0e61,0x723f,0x2af7,0x5710,0x7228,0x7520,0x6978,0x7163,0x4c57,0x23f8,0x6e5b,0x7ab5,0x1b1d,0x79a4,0x20fe,0x47bd,0x462f,0x3e54,0x47f0,0x1827,0x0d16,0x0e76,0x3355,0x5353,0x5d7f,0x1d87,0x2812,0x0a53,0x5470,0x7626,0x4b74,0x5a60,0x0955,0x3e32,0x1dca,0x3d52,0x220c,0x426c,0x2b14,0x06f84,0x1c29,0x73cb,0x58f4,0x5d32,0x7b41,0x7f02,0x4dc5,0x44bb,0x3bb9,0x4796,0x4b74,0x0377,0x0cc9,0x24cc,0x4dd2,0x6a24,0x5a77,0x3c8d,0x2ec5,0x62f4,0x1205,0x329d,0x4ee8,0x52ea,0x3e0e,0x7551,0x150d,0x6bfb,0x6408,0x32b6,0x7163,0x2a86,0x0306,0x301e,0x1df6,0x1ee7,0x1212,0x6bec,0x0d5b,0x1c73,0x634d,0x73dc,0x766b,0x3053,0x0311,0x7eac,0x65c0,0x4dc5,0x7174,0x7265,0x66ed,0x66a0,0x68b0,0x1b7b,0x6cbe,0x068d,0x6bd0,0x62c8,0x4604,0x3a17,0x4df9,0x1103,0x3cc0,0x462f,0x65fc,0x3a66,0x10f7,0x62f4,0x088a,0x3476,0x7ac4,0x0723,0x5a3a,0x1de1,0x4502,0x32fb,0x602d,0x0ce2,0x1380,0x52c1,0x1dca,0x2de8,0x465e,0x74ff,0x5d43,0x58c8,0x6d4a,0x3d23,0x7b0c,0x20b3,0x1f38,0x0b0fd,0x01c8,0x7dcc,0x6d3b,0x6d5d,0x1a98,0x0a78,0x36de,0x35cf,0x6011,0x0192,0x3883,0x44ca,0x08b6,0x4814,0x602d,0x70ab,0x66ed,0x2ef9,0x786c,0x7c38,0x70f1,0x0f82,0x3fc6,0x3ffa,0x4f46,0x24bd,0x798f,0x0d70,0x0fcf,0x1128,0x2150,0x24cc,

0x0000,0x0017,0x723f,0x4b5f,0x2c20,0x0cb8,0x688c,0x68ea,0x6cf3,0x61f2,0x4b48,0x2848,0x29f1,0x5416,0x31ea,0x659a,0x6768,0x4ee8,0x6434,0x646e,0x5d25,0x7551,0x4b05,0x417d,0x670e,0x239e,0x20c2,0x3be3,0x3716,0x263e,0x10ba,0x670e,0x40d3,0x70e6,0x2d99,0x40c4,0x5e1f,0x4f1c,0x4250,0x1651,0x3cd7,0x3595,0x216c,0x05ed,0x4abc,0x5584,0x0419,0x0969,0x49ad,0x592b,0x2098,0x70cd,0x5353,0x375b,0x3a5a,0x167a,0x0723,0x6a33,0x4127,0x602d,0x38a8,0x1aa4,0x409e,0x2b28,0x62f4,0x0969,0x13cd,0x3693,0x3e25,0x373d,0x4156,0x32a1,0x6d10,0x2513,0x62ae,0x36e2,0x4a97,0x7e87,0x4c0d,0x43fe,0x0b9b,0x0933,0x23d3,0x20c2,0x2098,0x43fe,0x4abc,0x68b0,0x7dbd,0x3bb9,0x2863,0x38e5,0x343b,0x7139,0x574a,0x43c2,0x08a1,0x14a3,0x4781,0x2787,0x35f3,0x4a80,0x069a,0x7847,0x02ce,0x7df0,0x255e,0x677f,0x3461,0x1c73,0x14b4,0x157c,0x798f,0x58e3,0x226a,0x1526,0x1afe,0x13e6,0x2acb,0x0e4a,0x1edb,0x79a4,0x20c2,0x6909,0x167a,0x723f,0x3770,0x49f7,0x5917,0x06fc,0x19ef,0x01e3,0x2ae0,0x787b,0x7ee1,0x49e0,0x4991,0x4da3,0x3582,0x7537,0x6366,0x337e,0x2a91,0x19d3,0x40b5,0x01f4,0x003c,0x2098,0x08a1,0x4529,0x2aad,0x2eb4,0x6bfb,0x438f,0x0f95,0x3fd1,0x5885,0x416a,0x0e4a,0x3e54,0x089d,0x1989,0x20e9,0x574a,0x43fe,0x0bea,0x51fb,0x6e4c,0x17ff,0x08ec,0x4991,0x79e9,0x2136,0x1172,0x43e9,0x2615,0x411b,0x071f,0x01b9,0x29ab,0x263e,0x38bf,0x0360,0x3cb1,0x319b,0x798f,0x2538,0x217b,0x14a3,0x10ad,0x1ef0,0x3e32,0x3595,0x2575,0x6e5b,0x6a0f,0x6e01,0x059c,0x43fe,0x465e,0x1ae9,0x6479,0x7626,0x7148,0x73f7,0x65d7,0x74ff,0x0306,0x3e32,0x7f02,0x7b30,0x3a3c,0x2562,0x5584,0x10ad,0x5a2

d,0x65fc,0x5f8d,0x5033,0x5416,0x2575,0x2673,0x2658,0x6e5b,0x0fcf,0x77a3,0x3bdf,0x337e,0x2481,0x3c8d,0x3cb1,0x1dca,0x4398,0x43c2,0x3369,0x4c7c,0x5fa6,0x62c8,0x6e01,0x6f84,0x0311,0x3b92,0x264f,0x27f6,0x1ecc,0x035c,0x208f,0x1086,0x43c2,0x0443,0x465e,0x2615,0x6a0f,0x7a9e,0x49f7,0x766b,0x1799,0x4c0d,0x4acd,0x13cd,0x3022,0x05a0,0x4d9f,0x35be,0x7ab5,0x79b3,0x2658,0x51fb,0x3767,0x32c7,0x5378,0x2150,0x670e,0x1b1d,0x5322,0x7ad3,0x6768,0x0969,0x2eb4,0x6006,0x5401,0x2496,0x05d1,0x6a33,0x3894,0x3d6e,0x24bd,0x6b8a,

0x5e1f,0x19d3,0x410c,0x3d08,0x7c04,0x5cfa,0x6a42,0x23c4,0x3582,0x5401,0x0bb0,0x2ed2,0x56be,0x3e68,0x36c9,0x6e67,0x43d5,0x0360,0x1b7b,0x61ce,0x786c,0x519d,0x0d5b,0x5bd9,0x05d1,0x604b,0x125f,0x0e61,0x4c40,0x0cf5,0x373d,0x1c58,0x7259,0x6cbe,0x4ada,0x05a0,0x7657,0x5e08,0x74b2,0x5344,0x5776,0x58b9,0x4b12,0x6bfb,0x6479,0x29cd,0x1aa4,0x181b,0x3906,0x0017,0x373d,0x6292,0x2a86,0x4df9,0x5a5c,0x372a,0x17a5,0x31d6,0x35d8,0x70bc,0x2f26,0x36e2,0x484e,0x4b74,0x6317,0x17c3,0x4221,0x5018,0x264f,0x0000,0x23f8,0x7c75,0x2805,0x32d0,0x4986,0x786c,0x156b,0x6fb8,0x43e9,0x1b47,0x4613,0x0017,0x0454,0x1c02,0x2863,0x2812,0x7e87,0x2eb4,0x14c5,0x2b4e,0x3d79,0x56e4,0x757a,0x3c9a,0x79d5,0x44f6,0x2150,0x2f7c,0x1c3e,0x32b6,0x70cd,0x79a4,0x0bea,0x4638,0x0294,0x24cc,0x1248,0x0b9b,0x55e2,0x20c2,0x6743,0x40f8,0x3d23,0x0a6f,0x1ebd,0x605c,0x02bf,0x1830,0x3a2b,0x6d2c,0x6a7e,0x1ad5,0x1172,0x1f62,0x1ab3,0x7f15,0x20b3,0x2ea3,0x2227,0x068d,0x3a5a,0x5d19,0x4a97,0x7499,0x62df,0x2513,0x7ad3,0x798f,0x5900,0x1159,0x7aef,0x19f8,0x49cb,0x6077,0x66a0,0x77b4,0x20e9,0x74e8,0x5f9a,0x7551,0x5fd7,0x0d2a,0x3461,0x3770,0x7f4f,0x35be,0x634d,0x5467,0x0a09,0x1c64,0x160b,0x5cb7,0x2256,0x74b2,0x4acd,0x4828,0x36e2,0x0933,0x74c3,0x751c,0x7dcc,0x1f2f,0x1103,0x4872,0x73f7,0x3ca6,0x3e7f,0x7105,0x2f1a,0x1827,0x4865,0x2d99,0x65eb,0x0fa9,0x1f75,0x6935,0x0d4c,0x531e,0x4f20,0x44ac,0x2d8e,0x507e,0x5e34,0x2b4e,0x10f7,0x0fd8,0x52ea,0x5885,0x02ce,0x572c,0x43b3,0x4b12,0x7f29,0x5fc0,0x5761,0x05ed,0x1d90,0x08a1,0x1540,0x330f,0x1dac,0x4dd2,0x6719,0x6fde,0x420a,0x79c2,0x658d,0x227d,0x3960,0x4865,0x604b,0x2f57,0x70e6,0x4796,0x6c82,0x2c37,0x2c37,0x6cd8,0x1b50,0x4250,0x49dc,0x51c7,0x7de7,0x13da,0x7b56,0x7259,0x6b9d,0x2c1c,0x3cd7,0x2ed2,0x77c5,0x3410,0x0ce2,0x7821,0x5917,0x7537,0x2f1a,0x7640,0x4221,0x3ceb,0x44bb,0x7d81,0x0432,0x2f31,0x573b,0x0d70,0x0e76,0x1248,0x787b,0x1c4f,0x3c8d,0x3d1f,0x23a2,0x3bae,0x0071,0x113f,0x01df,0x5a06,0x0fe4,0x6d76,0x4564,0x592b,0x79c2,0x01b9,0x592b,0x114e,0x1380,0x55de,0x0306,0x216c,0x51ec,0x1e81,0x5c9c,0x3e25,0x3bf4,0x3bc8,0x55b8,0x632b,

0x342c,0x4573,0x0cb8,0x66fa,0x150d,0x27ca,0x4dd2,0x56cf,0x3d23,0x668b,0x573b,0x040e,0x5e6e,0x465e,0x29bc,0x0fa9,0x4eff,0x603a,0x51b6,0x6d4a,0x217b,0x6732,0x2481,0x31fd,0x6a24,0x5682,0x2980,0x0745,0x2549,0x17a5,0x27f6,0x29e6,0x4c1a,0x0bfd,0x7b7d,0x3cb1,0x047f,0x2acb,0x2aba,0x500f,0x4828,0x6bec,0x2f57,0x13ab,0x13ab,0x08c7,0x180c,0x7080,0x10dc,0x17a5,0x7391,0x40ef,0x10cb,0x56f3,0x32d0,0x658d,0x58b9,0x5e1f,0x4f6d,0x55c9,0x7998,0x2adc,0x6e4c,0x0a1e,0x62e3,0x32d0,0x426c,0x4b2e,0x2b59,0x595a,0x7edd,0x06eb,0x19f8,0x301e,0x6bec,0x24f0,0x7e87,0x7f29,0x221b,0x330f,0x0d70,0x7214,0x35cf,0x7788,0x5776,0x4649,0x3a3c,0x38f2,0x3d52,0x05b7,0x0c84,0x5fc0,0x757a,0x47cc,0x0192,0x2c6d,0x7c62,0x603a,0x3be3,0x6183,0x35cf,0x5a4b,0x0723,0x7de7,0x1afe,0x4986,0x3022,0x7eac,0x6434,0x2dc3,0x6a55,0x3960,0x7163,0x0d01,0x36b8,0x1799,0x1f04,0x0419,0x3977,0x73f7,0x7e90,0x1f62,0x4db4,0x156b,0x691e,0x1f04,0x6768,0x7f15,0x20a4,0x6a55,0x263e,0x7f73,0x4ec3,0x2c51,0x43fe,0x01f4,0x19f8,0x6faf,0x2673,0x157c,0x61ce,0x3324,0x3883,0x0066,0x5055,0x5bd9,0x208f,0x186a,0x6060,0x1841,0x3cfc,0x7dbd,0x343b,0x2230,0x2c20,0x4803,0x4649,0x7b1b,0x2b28,0x1205,0x7dbd,0x7c5e,0x2c46,0x220c,0x24bd,0x3407,0x24e7,0x2150,0x27ca,0x593c,0x5e45,0x56d8,0x2b72,0x43d5,0x06a6,0x4662,0x7174,0x23ef,0x1b6c,0x3ceb,0x2f6b,0x4ec3,0x500f,0x0cc9,0x2da5,0x5a60,0x4af1,0x544c,0x3894,0x4c7c,0x2adc,0x7ee1,0x1c29,0x2150,0x4859,0x6d4a,0x3d34,0x38d9,0x1ab3,0x6077,0x4f46,0x3582,0x6e5b,0x3684,0x3701,0x7f73,0x5033,0x2e9f,0x5024,0x1557,0x77d2,0x6d10,0x56f3,0x5900,0x4814,0x0fd8,0x1274,0x51c7,0x5344,0x2db2,0x13e6,0x002b,0x3fa0,0x4130,0x1263,0x70f1,0x5d32,0x208f,0x7f15,0x3d52,0x29f1,0x6f84,0x6d07,0x5bbf,0x632b,0x076e,0x0ba7,0x65fc,0x4089,0x13f1,0x4502,0x4398,0x1e96,0x780a,0x0294,0x6922,0x4089,0x44f6,0x150d,0x6ca9,0x19d3,0x32b6,0x328a,0x6953,0x68fd,0x4865,0x0bea,0x264f,0x518a,0x5e23,0x2513,0x5e52,0x0cc9,0x1620,0x2121,0x149f,0x14f9,0x6ce4,0x2150,0x4af1,0x1c02,0x4ea5,0x10dc,0x1f5e,0x076e,0x0377,0x52ea,0x27bb,0x4781,0x2839,0x7c2f,0x0294,0x3fed,0x5bd9,0x5cfa,0x779f,0x417d,0x3053,

0x1b0a,0x20c2,0x2f57,0x689b,0x2e9f,0x090f,0x1841,0x4515,0x1edb,0x3333,0x5966,0x7f15,0x65a6,0x3a71,0x780a,0x1239,0x7847,0x226a,0x227d,0x6a18,0x7b7d,0x7640,0x453e,0x6bd0,0x0283,0x465e,0x5f8d,0x4986,0x1531,0x6366,0x2997,0x7ab5,0x342c,0x0bea,0x7097,0x5033,0x1248,0x3906,0x632b,0x6c82,0x6d3b,0x1989,0x4236,0x748e,0x0918,0x74d4,0x77d2,0x5695,0x6e16,0x1c4f,0x2562,0x542a,0x4ea5,0x2504,0x6452,0x7b41,0x4f7a,0x5024,0x0cb8,0x3a4d,0x089d,0x4c0d,0x06fc,0x3a2b,0x2aad,0x421d,0x0a6f,0x2f7c,0x181b,0x43e9,0x4c6b,0x2629,0x73f7,0x1274,0x5761,0x4af1,0x58f4,0x0b8c,0x4529,0x1ecc,0x5bfb,0x3a66,0x531e,0x2805,0x3906,0x4f1c,0x73dc,0x5971,0x4d88,0x255e,0x3d45,0x2874,0x38a8,0x0d2a,0x6ff5,0x5cfa,0x51fb,0x01c8,0x36de,0x2c7a,0x454f,0x02d9,0x38bf,0x005a,0x572c,0x01c8,0x5018,0x1c73,0x034b,0x5e79,0x51a1,0x1f2f,0x73ba,0x4da3,0x3fb7,0x1df6,0x0b8c,0x19f8,0x545b,0x7f4f,0x5584,0x5ced,0x0000,0x462f,0x438f,0x670e,0x55af,0x5ffc,0x536f,0x6cd8,0x55af,0x7657,0x19b5,0x29e6,0x77f9,0x35f3,0x6ccf,0x2eee,0x4df9,0x2dff,0x73ba,0x74e8,0x0955,0x2b14,0x1c02,0x3053,0x6423,0x4db4,0x1380,0x3883,0x1128,0x6423,0x0e5d,0x44ac,0x393a,0x52b0,0x5d68,0x216c,0x6953,0x08a1,0x6c82,0x23d3,0x1e96,0x7de7,0x43c2,0x2b3f,0x1ebd,0x2389,0x24bd,0x4b39,0x5900,0x6ba1,0x047f,0x19b5,0x1114,0x1646,0x7b0c,0x715f,0x2673,0x0185,0x23b5,0x4649,0x1397,0x592b,0x2e9f,0x08d0,0x5682,0x633c,0x70cd,0x40d3,0x3bb9,0x6719,0x2658,0x483f,0x161c,0x7aef,0x05d1,0x7391,0x345d,0x2121,0x0f95,0x4127,0x08c7,0x55de,0x0745,0x1c15,0x0933,0x36b8,0x2ed2,0x05d1,0x4eb2,0x5a06,0x51b6,0x3701,0x2b28,0x239e,0x01e3,0x1a8f,0x696f,0x150d,0x1f75,0x0708,0x5b94,0x6f93,0x4e99,0x5ca0,0x6d3b,0x5378,0x02e5,0x68ea,0x55c9,0x1274,0x4dc5,0x1830,0x79a4,0x32b6,0x3369,0x7148,0x4dee,0x6434,0x7139,0x4490,0x5710,0x10ba,0x6bfb,0x319b,0x2575,0x306f,0x3ffa,0x65fc,0x43a4,0x61a8,0x5a06,0x06b1,0x5bf2,0x3716,0x17d4,0x6e3d,0x0311,0x6a42,0x2098,0x047f,0x7203,0x2ae0,0x32a1,0x7626,0x4ea5,0x74b2,0x38ce,0x670e,0x6a18,0x0360,0x05c6,0x47db,0x1d87,0x7a89,0x344a,0x1086,0x766b,0x0fbc,0x23c4,0x0e76,0x484e,0x2ea3,0x79fe,0x1b47,0x77a3,0x199e,

0x2c46,0x73e0,0x602d,0x65a6,0x3a17,0x199e,0x4d88,0x7eca,0x1488,0x6d5d,0x421d,0x24aa,0x4502,0x1b21,0x2874,0x0425,0x766b,0x3a4d,0x691e,0x3cd7,0x216c,0x1df6,0x5e08,0x4781,0x3a4d,0x79b3,0x35d8,0x2b59,0x3a5a,0x646e,0x6011,0x2f0d,0x2496,0x73ba,0x7c04,0x02bf,0x10dc,0x29cd,0x767c,0x2eb4,0x66ed,0x4250,0x68ea,0x13e6,0x6a0f,0x0955,0x5018,0x1a8f,0x68fd,0x66b7,0x31c1,0x6944,0x13ab,0x35e4,0x5e52,0x4236,0x6292,0x1f38,0x696f,0x0b9b,0x2aad,0x0c93,0x5f9a,0x4b2e,0x35be,0x4127,0x1f5e,0x79e9,0x62b9,0x0933,0x02bf,0x715f,0x0745,0x35cf,0x2ae0,0x36af,0x6a24,0x1ae9,0x4236,0x7272,0x58f4,0x1165,0x35a9,0x529b,0x1637,0x20a4,0x0e61,0x453e,0x7ad3,0x3342,0x2f40,0x750b,0x74d4,0x20a4,0x40d3,0x5feb,0x65fc,0x6bec,0x659a,0x7214,0x0bea,0x5f8d,0x6011,0x7ef6,0x2a91,0x7163,0x337e,0x44ca,0x02f2,0x68c1,0x1f38,0x23c4,0x44e1,0x1c64,0x6d61,0x06d7,0x5917,0x6bc7,0x7ddb,0x4aab,0x4c6b,0x149f,0x4c40,0x5776,0x6ca9,0x02e5,0x56cf,0x7386,0x0969,0x071f,0x4c31,0x27ac,0x0d3d,0x536f,0x4d9f,0x1f62,0x1c4f,0x282e,0x7a89,0x58b9,0x27dd,0x5e45,0x31b0,0x1eaa,0x7259,0x27dd,0x38ce,0x35d8,0x74e8,0x10cb,0x575d,0x6719,0x52a7,0x3e19,0x1dac,0x66a0,0x372a,0x4a80,0x602d,0x221b,0x760d,0x73e0,0x2ef9,0x3f8b,0x3be3,0x68fd,0x06d7,0x0071,0x06fc,0x7c04,0x724e,0x0ff3,0x65d7,0x059c,0x2f31,0x7e90,0x3767,0x4f6d,0x329d,0x0419,0x2848,0x5b83,0x005a,0x0d16,0x65b1,0x2121,0x4e8e,0x24db,0x5be5,0x3333,0x1989,0x2b28,0x49dc,0x157c,0x1557,0x61f2,0x0c84,0x688c,0x6f93,0x7657,0x426c,0x10ba,0x3a71,0x374c,0x40f8,0x27ca,0x462f,0x318c,0x7228,0x56f3,0x3883,0x3a4d,0x1620,0x43e9,0x393a,0x3e25,0x252f,0x77c5,0x1aa4,0x5e45,0x0d2a,0x19ef,0x4b48,0x3ca6,0x0ba7,0x3e32,0x0a6f,0x6011,0x3d52,0x528c,0x27bb,0x6479,0x55b8,0x1ee7,0x2f6b,0x3078,0x3369,0x0f95,0x47cc,0x7163,0x40ef,0x035c,0x4ed4,0x0918,0x0933,0x49e0,0x0a35,0x1a8f,0x5055,0x2da5,0x74ff,0x4f37,0x40ef,0x5470,0x3b92,0x417d,0x13da,0x2eee,0x6434,0x51b6,0x06a6,0x7daa,0x73ad,0x033a,0x285f,0x58df,0x0752,0x6bb6,0x36f5,0x35a9,0x31ea,0x097e,0x531e,0x3cfc,0x7d81,0x4b12,0x2241,0x79fe,0x5a06,0x1afe,0x6f93,0x211d,0x5d43,0x438f,0x32ec,0x68d6,0x0185,0x4638,

0x3cc0,0x0a09,0x542a,0x7c5e,0x5ffc,0x7836,0x1488,0x6300,0x5c8b,0x6bd0,0x6bd0,0x58df,0x14c5,0x3078,0x3693,0x575d,0x7f58,0x122e,0x677f,0x518a,0x6006,0x7139,0x4f0b,0x14ee,0x417d,0x4dd2,0x5a5c,0x411b,0x392d,0x5322,0x787b,0x10ba,0x7214,0x23b5,0x1212,0x7ee1,0x7ac4,0x0cc9,0x66c6,0x7f3e,0x6bb6,0x5fb1,0x38bf,0x5917,0x2997,0x01df,0x7f64,0x19d3,0x1086,0x574a,0x27f6,0x1f75,0x3035,0x1397,0x2136,0x5cd1,0x4156,0x2839,0x3009,0x5971,0x040e,0x787b,0x6f84,0x1dca,0x1d87,0x593c,0x635a,0x6bc7,0x02bf,0x2227,0x6366,0x5d25,0x255e,0x5a5c,0x5707,0x1c02,0x2230,0x58ae,0x6ca9,0x097e,0x0779,0x7272,0x6725,0x593c,0x6317,0x427b,0x1799,0x5bf2,0x6ba1,0x6060,0x646e,0x66c6,0x255e,0x4781,0x282e,0x17e8,0x7499,0x24bd,0x4d88,0x573b,0x1091,0x3e7f,0x1ebd,0x0377,0x2b14,0x2d99,0x3e25,0x6

8b0,0x5a77,0x3a5a,0x55f5,0x1114,0x43c2,0x5ba8,0x24f0,0x088a,0x4ed4,0x5042,0x31b0,0x4564,0x2b14,0x0443,0x4662,0x0283,0x3716,0x77b4,0x2787,0x40a2,0x1de1,0x5584,0x0723,0x0752,0x5ffc,0x6d61,0x0a22,0x658d,0x4db4,0x220c,0x7de7,0x0a22,0x4487,0x05c6,0x0185,0x5cb7,0x712e,0x3e54,0x4638,0x7a89,0x7aa2,0x4f0b,0x6743,0x0d4c,0x5ba8,0x318c,0x7631,0x2c46,0x79fe,0x2504,0x781d,0x786c,0x5a3a,0x43b3,0x1b47,0x66fa,0x20d5,0x35f3,0x6ca9,0x6011,0x0185,0x29f1,0x2eee,0x2f57,0x79d5,0x7f64,0x4cd0,0x1165,0x27dd,0x70e6,0x2629,0x49ad,0x68a7,0x239e,0x20d5,0x5344,0x13ab,0x7214,0x0d3d,0x1de1,0x1ef0,0x6292,0x19a2,0x5d19,0x7386,0x1165,0x1b6c,0x1f13,0x51ec,0x4c7c,0x4a80,0x2147,0x68d6,0x5e34,0x543d,0x6d2c,0x56d8,0x14a3,0x5d25,0x6e5b,0x0d2a,0x7386,0x7821,0x0e76,0x44e1,0x090f,0x13da,0x55c9,0x005a,0x58b9,0x5a2d,0x0e5d,0x3e7f,0x5e34,0x2f7c,0x0e10,0x7097,0x0d4c,0x08ec,0x4089,0x38ce,0x49ba,0x4ed4,0x3bae,0x416a,0x2c37,0x01ae,0x6292,0x4872,0x31fd,0x3cc0,0x6cbe,0x5cd1,0x125f,0x1856,0x62c8,0x56be,0x659a,0x40c4,0x0d70,0x4ee8,0x7105,0x4b39,0x55f5,0x7dcc,0x6ce4,0x394b,0x68a7,0x1ae9,0x633c,0x633c,0x329d,0x47f0,0x6953,0x004d,0x5e23,0x4c7c,0x7ac4,0x1856,0x5335,0x2147,0x7821,0x0e4a,0x715f,0x0955,0x208f,0x2ed2,0x19ef,0x0d4c,0x0e07,0x3ceb,0x6e2a,0x73dc,0x32ec,0x08d0,0x329d,0x7c13,0x1b6c,0x058b,0x3911,

0x35a9,0x27f6,0x2f1a,0x29bc,0x659a,0x68a7,0x6d61,0x417d,0x31c1,0x1ebd,0x7d96,0x13cd,0x420a,0x20a4,0x1b50,0x38e5,0x13bc,0x4487,0x35a9,0x7847,0x3407,0x0cf5,0x56cf,0x29da,0x6bec,0x113f,0x56a9,0x08d0,0x0745,0x40d3,0x2dd4,0x5c9c,0x0fe4,0x7af8,0x0bb0,0x6978,0x62b9,0x7c38,0x1d87,0x47e7,0x3fc6,0x779f,0x0454,0x68b0,0x210a,0x1de1,0x5fc0,0x49ba,0x0c93,0x691e,0x595a,0x4abc,0x5042,0x088a,0x01f4,0x125f,0x35cf,0x13f1,0x74a5,0x0071,0x125f,0x1856,0x51d0,0x5cc6,0x3ca6,0x0ba7,0x1159,0x52a7,0x187d,0x500f,0x4130,0x38f2,0x328a,0x3bb9,0x55c9,0x4b39,0x2c7a,0x7f3e,0x2805,0x31a7,0x0955,0x5a77,0x6faf,0x531e,0x73ad,0x756d,0x668b,0x7112,0x73cb,0x7dbd,0x1856,0x178e,0x70da,0x31a7,0x7daa,0x70e6,0x160b,0x77ee,0x5bf2,0x7ddb,0x543d,0x3b92,0x6e70,0x5a77,0x6944,0x20e9,0x4dc5,0x1ee7,0x4dd2,0x151a,0x7d81,0x05d1,0x7112,0x5bce,0x38ce,0x543d,0x7112,0x2a91,0x723f,0x0283,0x2af7,0x1ac2,0x5900,0x7272,0x2c1c,0x410c,0x01f4,0x79e9,0x6fc9,0x7998,0x0bfd,0x7aa2,0x1212,0x3044,0x3a66,0x227d,0x2575,0x4f1c,0x2549,0x1212,0x61bf,0x56e4,0x4502,0x3894,0x32ec,0x1ddd,0x6fe2,0x003c,0x24db,0x210a,0x6d3b,0x409e,0x7ab5,0x6fc9,0x6d5d,0x51d0,0x748e,0x4828,0x1ad5,0x38d9,0x1f38,0x79b3,0x544c,0x4859,0x5b83,0x32c7,0x5695,0x19f8,0x2ea3,0x51b6,0x70bc,0x68c1,0x3911,0x52ea,0x6e3d,0x73f7,0x178e,0x68c1,0x23ef,0x669c,0x1274,0x3d79,0x05fa,0x3b92,0x3fed,0x156b,0x226a,0x32fb,0x5b94,0x1540,0x5ca0,0x6d07,0x5a77,0x5fc0,0x1165,0x2eee,0x56e4,0x7499,0x4c6b,0x27f6,0x27ac,0x52fd,0x114e,0x3a71,0x2f31,0x1172,0x40ef,0x6ff5,0x10ad,0x08fb,0x6c95,0x0a53,0x032d,0x47bd,0x62f4,0x7b30,0x180c,0x66ed,0x2ec5,0x004d,0x7ebb,0x6922,0x5892,0x113f,0x1f04,0x5d68,0x49e0,0x723f,0x2dc3,0x4abc,0x44ca,0x6a33,0x1b36,0x3b85,0x0cf5,0x5d19,0x08fb,0x573b,0x507e,0x13da,0x426c,0x7ef6,0x2ef9,0x2136,0x002b,0x427b,0x2504,0x5069,0x40f8,0x6d3b,0x507e,0x70ab,0x0bd6,0x5378,0x6194,0x5900,0x6935,0x4e99,0x6f93,0x069a,0x7626,0x52ea,0x211d,0x0a22,0x0fcf,0x24aa,0x5d68,0x7228,0x7b56,0x14b4,0x1f49,0x1380,0x7df0,0x2615,0x7c62,0x2f6b,0x4e99,0x3e54,0x24e7,0x5309,0x68c1,0x1ef0,0x7c5e,0x2f1a,0x2c51,0x4a97,0x417d,0x2b65,

0x2848,0x02f2,0x2c1c,0x6077,0x4675,0x5584,0x5d68,0x5344,0x1172,0x7850,0x4ae6,0x38e5,0x7c13,0x255e,0x779f,0x56d8,0x6cf3,0x3a3c,0x3410,0x7657,0x372a,0x5e1f,0x6754,0x05b7,0x4573,0x35e4,0x6060,0x43c2,0x3716,0x6e5b,0x3a00,0x5f9a,0x4b12,0x1c73,0x35be,0x5fd7,0x61bf,0x394b,0x161c,0x6725,0x033a,0x24db,0x088a,0x1ef0,0x6a42,0x5416,0x29f1,0x6743,0x5d32,0x7640,0x6cbe,0x0432,0x4b48,0x0d01,0x0a35,0x696f,0x65d7,0x77f9,0x0432,0x73e0,0x3a3c,0x2f1a,0x1651,0x255e,0x5d7f,0x3701,0x1827,0x7998,0x36e2,0x14ee,0x4487,0x7c04,0x0e3b,0x08a1,0x3d08,0x4ada,0x0bd6,0x3701,0x1dbb,0x0cf5,0x61ce,0x6e4c,0x0bc1,0x77b4,0x1b6c,0x6a55,0x345d,0x4564,0x2389,0x786c,0x724e,0x4127,0x43e9,0x4f1c,0x5fd7,0x2acb,0x4604,0x1488,0x668b,0x1ae9,0x47e7,0x5a4b,0x40c4,0x239e,0x6e01,0x7b27,0x29da,0x5c8b,0x5885,0x059c,0x263e,0x0a6f,0x3684,0x7546,0x3cb1,0x068d,0x4ae6,0x282e,0x6e2a,0x0fcf,0x20a4,0x47f0,0x44bb,0x56d8,0x2e88,0x4a97,0x66fa,0x14c5,0x40b5,0x6faf,0x798f,0x0a1e,0x3d23,0x10cb,0x5d0e,0x6fc9,0x529b,0x27ca,0x4acd,0x781d,0x65d7,0x2aba,0x7112,0x167a,0x5ced,0x1651,0x13e6,0x3053,0x6754,0x2227,0x66fa,0x0b8c,0x7f4f,0x5309,0x6f93,0x6cbe,0x51d0,0x0d2a,0x06fc,0x0fe4,0x2664,0x1b0a,0x0a35,0x393a,0x5018,0x696f,0x2e88,0x2256,0x5d68,0x49ad,0x6ce4,0x715f,0x2241,0x1799,0x7a89,0x20a4,0x7631,0x1b47,0x44e1,0x6300,0x5042,0x0360,0x6371,0x3770,0x0e10,0x66b7,0x787b,0x7499,0x330f,0x1f38,0x5a11,0x3bc8,0x29da,0x4221,0x3e0e,0x6e01,0x1f62,0x421d,0x0432,0x2b4e,0x2b65,0x24bd,0x6423,0x13ab,0x0bb0,0x43fe,0x3318,0x3716,0x0955,0x66d1,0x14a3,0x7631,0x211d,0x6cd8,0x0a53,0x0468,0

x454f,0x1637,0x51fb,0x6371,0x7640,0x7386,0x58b9,0x2602,0x6768,0x74c3,0x5885,0x3e68,0x156b,0x211d,0x0ba7,0x4c40,0x31fd,0x02f2,0x426c,0x374c,0x4b2e,0x4ada,0x058b,0x7edd,0x3cd7,0x6ba1,0x1526,0x0723,0x7b27,0x3e43,0x3a5a,0x4814,0x1c64,0x47f0,0x1c15,0x35e4,0x0311,0x5917,0x44ac,0x79e9,0x2787,0x3461,0x38ce,0x4a97,0x02a8,0x3e25,0x239e,0x0d16,0x06eb,0x0419,0x3bdf,0x43b3,0x373d,0x14c5,0x0360,0x604b,0x7f58,0x2c37,0x5e34,0x38bf,0x2b3f,0x6e4c,0x4f46,0x1620,0x3e25,0x7174,0x5322,0x6754,0x7228,0x0a09,0x4828,0x44dd,

0x31fd,0x691e,0x2c46,0x7ddb,0x2b59,0x1ddd,0x7d81,0x2ae0,0x62df,0x01e3,0x31b0,0x7c04,0x0745,0x7b6a,0x0000,0x1e81,0x58f4,0x0192,0x5a77,0x4089,0x62c8,0x712e,0x0e3b,0x49ba,0x6a24,0x4529,0x3355,0x77ee,0x49cb,0x43a4,0x17a5,0x10ba,0x342c,0x5a06,0x217b,0x0d67,0x4130,0x2eb4,0x156b,0x079a,0x5fd7,0x3e25,0x2b72,0x55e2,0x306f,0x77a3,0x5042,0x5593,0x5cd1,0x14b4,0x2dff,0x1eaa,0x14ee,0x1aa4,0x7657,0x0955,0x0419,0x13ab,0x393a,0x1856,0x5322,0x2241,0x7a9e,0x6183,0x08d0,0x5fd7,0x0000,0x780a,0x7ef6,0x0e61,0x62c8,0x5c8b,0x2812,0x5d68,0x2dd4,0x7537,0x7df0,0x178e,0x7ef6,0x373d,0x3d23,0x2b14,0x5069,0x1d90,0x6bb6,0x4828,0x79e9,0x5ca0,0x5e34,0x2c51,0x3078,0x19d3,0x1637,0x528c,0x14f9,0x19a2,0x1239,0x6f93,0x6e01,0x23f8,0x3333,0x4eff,0x088a,0x150d,0x0d70,0x24db,0x2b28,0x49e0,0x19ef,0x2673,0x24f0,0x4502,0x1ab3,0x6a69,0x7203,0x0a1e,0x4991,0x1ab3,0x1f38,0x186a,0x4da3,0x1b0a,0x7f58,0x6a69,0x5055,0x0294,0x634d,0x0e5d,0x2dff,0x7551,0x31fd,0x7259,0x0f95,0x7148,0x2230,0x13cd,0x35f3,0x29bc,0x5bf2,0x40f8,0x3d6e,0x2615,0x3e19,0x4604,0x7203,0x4564,0x3f9c,0x483f,0x6183,0x06b1,0x77ee,0x1eccc,0x0283,0x3977,0x0a6f,0x7d96,0x2acb,0x7c2f,0x0745,0x2389,0x5cfa,0x4b5f,0x2e88,0x6732,0x4675,0x7eac,0x3595,0x766b,0x4558,0x5f9a,0x44dd,0x5d7f,0x10dc,0x3009,0x7788,0x4573,0x52d6,0x712e,0x7f02,0x1f49,0x1488,0x52fd,0x77d2,0x5470,0x151a,0x74b2,0x059c,0x4f6d,0x3009,0x6006,0x6371,0x421d,0x6d07,0x6a69,0x2241,0x7214,0x4c26,0x4abc,0x4130,0x20e9,0x0caf,0x0fbe,0x4e8e,0x0a6f,0x44ca,0x2874,0x2acb,0x36b8,0x4247,0x7eca,0x27e1,0x08c7,0x36c9,0x06fc,0x6e2a,0x4991,0x4f1c,0x5761,0x05c6,0x3595,0x5e6e,0x38d9,0x0311,0x1b7b,0x0fa9,0x751c,0x6b9d,0x2b65,0x27bb,0x2aad,0x7080,0x47bd,0x17b2,0x7ab5,0x500f,0x51a1,0x2575,0x44ca,0x1df6,0x4df9,0x4f6d,0x0e3b,0x780a,0x4604,0x20b3,0x519d,0x13cd,0x20c2,0x2b4e,0x0708,0x40d3,0x6317,0x374c,0x0c84,0x32fb,0x427b,0x02f2,0x2de8,0x4b2e,0x5710,0x004d,0x19c4,0x6fe2,0x5971,0x750b,0x034b,0x4558,0x0734,0x62b9,0x4ec3,0x0192,0x40f8,0x2504,0x0432,0x178e,0x2aba,0x65fc,0x58e3,0x574a,0x7174,0x3bdf,0x2098,0x641f,0x670e,0x2a91,0x0ce2,0x573b,0x2f57,

0x2673,0x52fd,0x3044,0x70bc,0x572c,0x0066,0x2dc3,0x1c4f,0x4638,0x2ea3,0x0fcf,0x417d,0x62ae,0x19c4,0x3cb1,0x453e,0x6935,0x0a1e,0x5c8b,0x5a77,0x0779,0x6a55,0x221b,0x4662,0x748e,0x6fb8,0x6719,0x08ec,0x4b39,0x4247,0x427b,0x6cf3,0x1159,0x668b,0x7546,0x4f20,0x301e,0x4638,0x2dc3,0x761a,0x7499,0x4c26,0x20d5,0x4236,0x65c0,0x4c31,0x7b41,0x27ac,0x2c37,0x3e68,0x73ba,0x1b1d,0x6006,0x36c9,0x781d,0x0cf5,0x633c,0x77a3,0x2658,0x178e,0x7836,0x20d5,0x208f,0x4141,0x6922,0x2eee,0x3cfc,0x01f4,0x20a4,0x767c,0x2d8e,0x5bf2,0x5bbf,0x760d,0x2241,0x210a,0x6cf3,0x3044,0x68ea,0x1dac,0x08b6,0x0d2a,0x3e7f,0x7af8,0x2c7a,0x73cb,0x3960,0x52d6,0x0e5d,0x5a11,0x29ab,0x7c13,0x73e0,0x6285,0x49cb,0x08b6,0x6a24,0x2e9f,0x6953,0x24e7,0x216c,0x6366,0x484e,0x071f,0x4c57,0x5710,0x0bd6,0x409e,0x74e8,0x7272,0x7af8,0x3b92,0x2b14,0x5d0e,0x35f3,0x3324,0x2ea3,0x1f13,0x166d,0x5335,0x2f57,0x543d,0x4c6b,0x4ada,0x4c7c,0x56f3,0x2acb,0x5353,0x13e6,0x0a1e,0x2863,0x156b,0x24db,0x6d61,0x572c,0x545b,0x7b30,0x66ed,0x3e54,0x221b,0x3a5a,0x02bf,0x337e,0x4eb2,0x1dbb,0x5b94,0x3906,0x4662,0x3fc6,0x0425,0x2b59,0x13e6,0x5e79,0x3bb9,0x4814,0x7386,0x5b83,0x097e,0x4986,0x2c0b,0x5033,0x66ed,0x4c57,0x375b,0x1103,0x0ff3,0x097e,0x689b,0x5966,0x301e,0x02e5,0x61d9,0x059c,0x595a,0x47aa,0x4c31,0x77c5,0x0d01,0x373d,0x0924,0x61f2,0x2b14,0x3044,0x5bf2,0x31d6,0x2f6b,0x0d5b,0x2538,0x7391,0x19a2,0x5d32,0x51ec,0x3342,0x38f2,0x4604,0x6a69,0x181b,0x2f57,0x6a24,0x2673,0x70da,0x216c,0x114e,0x0fcf,0x13e6,0x5917,0x7ddb,0x19a2,0x36f5,0x529b,0x73dc,0x500f,0x52a7,0x19d3,0x01f4,0x263e,0x7265,0x0360,0x58ae,0x02e5,0x668b,0x7f58,0x52b0,0x003c,0x7c49,0x0d70,0x2c37,0x66a0,0x5b83,0x2dc3,0x528c,0x187d,0x2980,0x500f,0x595a,0x3ffa,0x43a4,0x0283,0x70bc,0x1274,0x199e,0x7f15,0x3883,0x595a,0x2db2,0x602d,0x2629,0x77d2,0x689b,0x301e,0x5344,0x160b,0x6445,0x52d6,0x2136,0x766b,0x4250,0x337e,0x787b,0x23ef,0x4c7c,0x0e2c,0x51fb,0x3d1f,0x2c20,0x593c,0x3bf4,0x0294,0x0a35,0x411b,0x66ed,0x1205,0x7499,0x6978,0x6e5b,0x5322,0x5ca0,0x4221,0x2af7,0x27e1,0x2787,0x5353,0x0066,0x62b9,0x0e2c,0x114e,0x7386,0x5378,

0x6a69,0x337e,0x4247,0x125f,0x49e0,0x1172,0x285f,0x23b5,0x0fe4,0x5f9a,0x0caf,0x6719,0x51b6,0x5e79,0x285f,0x05ed,0x2ec5,0x0fa9,0x68c1,0x507e,0x518a,0x7097,0x6922,0x7b41,0x2ef9,0x0d5b,0x0e07,0x47aa,0x3911,0x0933,0x211d,0x27f6,0x2256,0x4089,0x6732,0x7265,0x2eee,0x723f,0x6011,0x13bc,0x157c,0x7ee1,0x7386,0x0a44,0x0e2c,0x4247,0x6935,0x3a66,0x6ff5,0x7272,0x0fa9,0x5776,0x4c0d,0x0a78,0x4649,0x217b,0x36c9,0x058b,0x2eb4,0x06eb,0x62f4,0x420a,0x7148,0x181b,0x2c51,0x5024,0x19b5,0x4b74,0x6ccf,0x4638,0x73ba,0x6ff5,0x62c8,0x49ba,0x40c4,0x593c,0x689b,0x2f31,0x0e07,0x44e1,0x0d3d,0x7b30,0x003c,0x4675,0x0a35,0x076e,0x24e7,0x4ee8,0x31ea,0x51b6,0x1a98,0x465e,0x5cb7,0x6fde,0x24aa,0x3a5a,0x06c0,0x0e07,0x13f1,0x5ced,0x49f7,0x4502,0x4558,0x27dd,0x43d5,0x74ff,0x345d,0x798f,0x1263,0x2aad,0x0708,0x3d6e,0x6909,0x252f,0x2ae0,0x1f04,0x4502,0x62ae,0x1651,0x27e1,0x3fa0,0x4f37,0x3ffa,0x7c49,0x6fe2,0x756d,0x4c40,0x7aa2,0x723f,0x0caf,0x0d70,0x4141,0x31c1,0x73dc,0x77c5,0x5cb7,0x66c6,0x1263,0x1091,0x4b2e,0x1f2f,0x3d79,0x7ac4,0x5feb,0x3ffa,0x68ea,0x40d3,0x318c,0x2575,0x31c1,0x5d54,0x73cb,0x395c,0x1ee7,0x74ff,0x507e,0x7ee1,0x4558,0x36af,0x4865,0x56a9,0x7ee1,0x6b51,0x1091,0x51ec,0x3410,0x3a00,0x696f,0x6fde,0x1a8f,0x35a9,0x1ac2,0x0708,0x6e4c,0x319b,0x1651,0x344a,0x1c4f,0x0c93,0x14c5,0x7b27,0x4558,0x1f2f,0x786c,0x01c8,0x4f46,0x2e88,0x36e2,0x5ca0,0x7d9c,0x646e,0x24bd,0x373d,0x65d7,0x1b47,0x3911,0x6909,0x7de7,0x1263,0x4e8e,0x4e8e,0x44f6,0x3a2b,0x6300,0x1ebd,0x19ef,0x167a,0x74d4,0x43e9,0x6ba1,0x1e96,0x32c7,0x1f38,0x05fa,0x4502,0x2549,0x3410,0x6935,0x1620,0x3977,0x798f,0x3b92,0x034b,0x3a5a,0x0fd8,0x1f04,0x4b5f,0x56a9,0x17b2,0x5d43,0x1a98,0x27f6,0x750b,0x0432,0x56be,0x49dc,0x24aa,0x62c8,0x4127,0x1c64,0x7c04,0x5d25,0x5be5,0x6fe2,0x5353,0x6732,0x43d5,0x0e07,0x74ff,0x31ea,0x66b7,0x409e,0x6922,0x199e,0x5ba8,0x05ed,0x411b,0x7b41,0x40d3,0x47cc,0x5d54,0x6fe2,0x0e4a,0x05b7,0x66c6,0x6423,0x7daa,0x4398,0x3582,0x2c7a,0x6bec,0x5cd1,0x7259,0x4f1c,0x20d5,0x3bb9,0x3fd1,0x27dd,0x5e08,0x0c93,0x395c,0x1651,0x088a,0x47cc,0x3476,0x4865,0x31c1,0x7aef,

0x7ac4,0x43c2,0x1a98,0x4f37,0x47bd,0x5ced,0x77b4,0x7551,0x4dc5,0x756d,0x5cb7,0x6d3b,0x44f6,0x79a4,0x723f,0x3bae,0x3767,0x5971,0x2eb4,0x7c49,0x2dd4,0x342c,0x5cfa,0x7aa2,0x0d70,0x1263,0x3e43,0x4089,0x0a09,0x17ff,0x20e9,0x3369,0x7a89,0x77d2,0x4613,0x0cb8,0x58df,0x7c49,0x6060,0x74ff,0x61d9,0x1a8f,0x5fb1,0x691e,0x38f2,0x7df0,0x08d0,0x47bd,0x6b8a,0x766b,0x187d,0x6d5d,0x438f,0x61d9,0x7dbd,0x1620,0x4ed4,0x3a00,0x5917,0x4487,0x7847,0x1646,0x52b0,0x10e0,0x1b47,0x05a0,0x438f,0x3ffa,0x02f2,0x3e0e,0x4662,0x1f5e,0x0468,0x0a09,0x6060,0x2575,0x0723,0x2481,0x2b03,0x79e9,0x6d07,0x0311,0x5a2d,0x66fa,0x61f2,0x08d0,0x10ba,0x0425,0x0bfd,0x542a,0x6d4a,0x61bf,0x3bdf,0x2121,0x2121,0x5d25,0x3767,0x1ebd,0x0a78,0x6e01,0x6fb8,0x73cb,0x528c,0x23c4,0x1a8f,0x646e,0x409e,0x66c6,0x0283,0x2adc,0x3e32,0x5776,0x73ba,0x696f,0x282e,0x0d70,0x114e,0x4c57,0x0e10,0x3716,0x2da5,0x0192,0x156b,0x65c0,0x3701,0x6d2c,0x1531,0x4649,0x1159,0x040e,0x4c1a,0x7f58,0x7ebb,0x0ba7,0x3fa0,0x5f8d,0x2a86,0x5892,0x5bd9,0x6978,0x13e6,0x2098,0x32a1,0x6c82,0x1ae9,0x394b,0x069a,0x208f,0x2874,0x3476,0x0b8c,0x5fb1,0x187d,0x020d5,0x2389,0x3fd1,0x31b0,0x641f,0x166d,0x35e4,0x2c46,0x6a55,0x372a,0x6bb6,0x3894,0x40ef,0x7391,0x4e99,0x68ea,0x5a60,0x19b5,0x24bd,0x4f51,0x161c,0x32fb,0x160b,0x2c0b,0x3407,0x1651,0x767c,0x0454,0x05a0,0x149f,0x6e16,0x0caf,0x3693,0x2980,0x1b21,0x4acd,0x757a,0x0918,0x10ba,0x216c,0x68b0,0x659a,0x5682,0x3461,0x55c9,0x420a,0x3701,0x1f49,0x3053,0x221b,0x5a4b,0x01ae,0x3bb9,0x1d87,0x1aa4,0x1637,0x0cc9,0x1ddd,0x3324,0x5761,0x2e88,0x6434,0x6e5b,0x5d68,0x5d0e,0x0bea,0x08fb,0x05c6,0x2c1c,0x4502,0x2ea3,0x040e,0x40d3,0x255e,0x0bb0,0x5b94,0x0bd6,0x2c1c,0x393a,0x2f31,0x2f1a,0x3a3c,0x4127,0x4c40,0x786c,0x4d9f,0x427b,0x1248,0x32a1,0x3b92,0x0708,0x161c,0x4613,0x55e2,0x3e19,0x56a9,0x44ac,0x0ce2,0x32b6,0x7eca,0x20b3,0x74c3,0x27ac,0x220c,0x7499,0x6e01,0x35e4,0x52d6,0x0e76,0x453e,0x58ae,0x5e52,0x7850,0x5470,0x19b5,0x20d5,0x0752,0x670e,0x7af8,0x1dbb,0x0306,0x178e,0x6e67,0x55af,0x5682,0x61e5,0x6a24,0x5a60,0x27ca,0x5024,0x7640,0x035c,0x2b72,0x3684,0x7214,

0x669c,0x1b50,0x416a,0x545b,0x329d,0x574a,0x7499,0x420a,0x227d,0x2b3f,0x2f40,0x2481,0x19c4,0x6a33,0x40c4,0x7214,0x3fc6,0x180c,0x7c2f,0x7272,0x6285,0x161c,0x4781,0x5cd1,0x0377,0x5069,0x0377,0x6e01,0x2db2,0x1a8f,0x6479,0x4529,0x29ab,0x47e7,0x5024,0x484e,0x29ab,0x2d8e,0x5322,0x2c0b,0x125f,0x31c1,0x4089,0x02bf,0x05a0,0x0fbc,0x0360,0x1dac,0x06a6,0x44dd,0x1b36,0x1e96,0x61f2,0x1ab3,0x574a,0x56d8,0x2e9f,0x2658,0x2dd4,0x032d,0x51ec,0x62f4,0x264f,0x1dac,0x2aad,0x6e01,0x4b74,0x02ce,0x5971,0x47cc,0x216c,0x7631,0x6a7e,0x5f8d,0x13bc,0x27ca,0x66fa,0x282e,0x24db,0x536f,0x6754,0x35d8,0x47e7,0x178e,0x6fc9,0x0779,0x79a4,0x35e4,0x4991,0x06d7,0x1531,0x77c5,0x73cb,0x6a0f,0x58ae,0x29cd,0x1c3e,0x1f04,0x0fbc,0x47e7,0x263e,0x465e,0x44f6,0x3684,0x3a3c,0x19c4,0x4c31,0x186a,0

x252f,0x4eff,0x31a7,0x416a,0x5f8d,0x79d5,0x6194,0x4f1c,0x0cb8,0x756d,0x7174,0x761a,0x6d07,0x2da5,0x05c6,0x51c7,0x5f8d,0x0d67,0x635a,0x4f37,0x51b6,0x1de1,0x73dc,0x6366,0x7c5e,0x79a4,0x0311,0x2f57,0x6e4c,0x1df6,0x38bf,0x0a44,0x14b4,0x5322,0x77d2,0x3fd1,0x4f37,0x2673,0x14c5,0x51b6,0x40a2,0x7edd,0x0443,0x150d,0x5be5,0x2150,0x2de8,0x4573,0x3977,0x58f4,0x40b5,0x4781,0x4814,0x19c4,0x4c31,0x7f3e,0x3a4d,0x1103,0x4130,0x65fc,0x375b,0x74e8,0x7998,0x6732,0x2839,0x3d1f,0x7174,0x2dd4,0x01df,0x77d2,0x7551,0x3684,0x13f1,0x66d1,0x32c7,0x5f9a,0x7eac,0x216c,0x4613,0x3d34,0x3a17,0x05b7,0x58e3,0x427b,0x05ed,0x0ce2,0x2790,0x77c5,0x394b,0x264f,0x47cc,0x2de8,0x426c,0x23ef,0x715f,0x4872,0x73ad,0x29e6,0x49cb,0x58b9,0x08fb,0x7ef6,0x1dca,0x58df,0x20c2,0x0a6f,0x595a,0x29e6,0x4ec3,0x5e34,0x1212,0x4c31,0x7139,0x20d5,0x4dc5,0x5d43,0x7e87,0x1ee7,0x5cfa,0x5fb1,0x411b,0x7e90,0x6a24,0x62c8,0x51fb,0x32fb,0x66fa,0x1ebd,0x2c1c,0x7203,0x641f,0x2227,0x0bea,0x58ae,0x08ec,0x0468,0x781d,0x5e45,0x6ff5,0x20a4,0x7163,0x51fb,0x4ec3,0x44ca,0x20c2,0x01df,0x5971,0x2dc3,0x36f5,0x13bc,0x1841,0x5018,0x31ea,0x180c,0x7850,0x3053,0x6f93,0x3b85,0x604b,0x52a7,0x689b,0x1de1,0x6cbe,0x7105,0x151a,0x66ed,0x2513,0x156b,0x6bd0,0x1de1,0x6445,0x08c7,0x6953,0x4c26,0x6d5d,0x47e7,0x531e,0x632b,0x61bf,0x2673,

0x5ffc,0x595a,0x767c,0x79e9,0x3b85,0x0a09,0x4675,0x3701,0x593c,0x6bfb,0x49ba,0x7139,0x0419,0x65b1,0x393a,0x01f4,0x0c93,0x4f6d,0x7de7,0x1dac,0x62df,0x2ed2,0x1114,0x47cc,0x68c1,0x0360,0x2997,0x77ee,0x65b1,0x0d4c,0x6754,0x180c,0x6ce4,0x1e81,0x6d5d,0x113f,0x6d61,0x29f1,0x19a2,0x52fd,0x6d10,0x73e0,0x77c5,0x0a53,0x73ad,0x6371,0x24e7,0x181b,0x1646,0x592b,0x7f15,0x4f6d,0x0924,0x150d,0x605c,0x0e76,0x004d,0x421d,0x7ab5,0x2ae0,0x1103,0x10ba,0x6d10,0x330f,0x181b,0x2d99,0x24f0,0x1172,0x0066,0x319b,0x7214,0x7d81,0x2805,0x2f57,0x29ab,0x426c,0x005a,0x798f,0x6d76,0x5042,0x68c1,0x1557,0x220c,0x56cf,0x603a,0x4c31,0x2dc3,0x0942,0x221b,0x6434,0x6317,0x0cf5,0x7391,0x05c6,0x7f15,0x3355,0x6ce4,0x410c,0x604b,0x6d3b,0x6c95,0x4b05,0x0377,0x4ee8,0x62b9,0x6c95,0x7203,0x6ff5,0x4b74,0x51ec,0x05fa,0x712e,0x2256,0x1d87,0x6978,0x6754,0x2673,0x19a2,0x603a,0x7391,0x4662,0x518a,0x0360,0x114e,0x593c,0x73ad,0x65c0,0x114e,0x1f38,0x0311,0x5feb,0x7d96,0x167a,0x6f84,0x35d8,0x090f,0x047f,0x166d,0x033a,0x0fe4,0x6a55,0x1dac,0x29f1,0x3009,0x23c4,0x715f,0x61f2,0x3e7f,0x4156,0x156b,0x66a0,0x0745,0x500f,0x3355,0x0432,0x4236,0x5584,0x7203,0x375b,0x2673,0x7b27,0x6434,0x20a4,0x3410,0x58df,0x38ce,0x1ef0,0x632b,0x3894,0x2098,0x7499,0x05fa,0x5fb1,0x5cb7,0x44ac,0x35be,0x2121,0x3fa0,0x24bd,0x0cc9,0x1557,0x090f,0x4b5f,0x7b1b,0x166d,0x646e,0x1841,0x14c5,0x1557,0x3044,0x5e34,0x7c62,0x1ae9,0x226a,0x52c1,0x6d2c,0x696f,0x484e,0x3d08,0x3883,0x5f8d,0x1ebd,0x239e,0x3b92,0x1ecc,0x0bea,0x069a,0x0c93,0x7c38,0x06fc,0x757a,0x156b,0x7aef,0x7ef6,0x43d5,0x395c,0x7a89,0x1526,0x4f0b,0x1edb,0x38ce,0x7aef,0x7520,0x27ac,0x634d,0x3cfc,0x44dd,0x3960,0x61e5,0x62b9,0x7f02,0x5710,0x4398,0x1646,0x4f51,0x4b2e,0x38bf,0x7c2f,0x5d54,0x4f1c,0x1637,0x3e25,0x29bc,0x36e2,0x5885,0x10e0,0x7105,0x7626,0x5a2d,0x7b6a,0x4ed4,0x6d3b,0x0ba7,0x344a,0x5900,0x5d54,0x519d,0x1d90,0x7ad3,0x52d6,0x44f6,0x5bd9,0x7546,0x0a78,0x1f49,0x5feb,0x6743,0x6300,0x4573,0x0432,0x500f,0x3407,0x7aa2,0x1380,0x17ff,0x13cd,0x1091,0x4796,0x1f5e,0x5e1f,0x715f,0x395c,0x3078,0x372a,0x0b8c,0x58e3,0x6a24,0x10f7,

0x696f,0x7b7d,0x02a8,0x1eaa,0x49cb,0x6bfb,0x1c58,0x6bb6,0x10ba,0x2b65,0x4247,0x4487,0x7e87,0x6d07,0x31a7,0x70ab,0x6fb8,0x1159,0x6452,0x40d3,0x375b,0x4250,0x19d3,0x05d1,0x17b2,0x70cd,0x7f73,0x7aef,0x427b,0x0a1e,0x2863,0x3e7f,0x035c,0x5cc6,0x4d88,0x6ca9,0x7139,0x51a1,0x74b2,0x4c7c,0x5584,0x2673,0x51c7,0x3a5a,0x2ed2,0x6c95,0x5892,0x0294,0x4859,0x7788,0x5761,0x374c,0x61f2,0x3582,0x069a,0x65a6,0x24bd,0x14f9,0x0443,0x7640,0x462f,0x19f8,0x2af7,0x5c9c,0x13bc,0x43d5,0x6452,0x3bb9,0x594d,0x1557,0x2673,0x594d,0x1b0a,0x1212,0x2658,0x52a7,0x4f51,0x328a,0x005a,0x3078,0x3be3,0x31ea,0x7112,0x51d0,0x47cc,0x55af,0x68a7,0x090f,0x0fe4,0x5416,0x5018,0x4c1a,0x08a1,0x757a,0x5fa6,0x5a77,0x5e45,0x1e81,0x572c,0x462f,0x4b12,0x1b36,0x77d2,0x74c3,0x77b4,0x6bb6,0x122e,0x167a,0x210a,0x635a,0x08b6,0x5ca0,0x44f6,0x44ac,0x2af7,0x1103,0x6ba1,0x1248,0x068d,0x4e8e,0x5e08,0x160b,0x0017,0x040e,0x2f0d,0x23c4,0x1086,0x02ce,0x529b,0x2f26,0x760d,0x3701,0x6300,0x4604,0x5d54,0x19f8,0x7aef,0x32c7,0x761a,0x221b,0x66ed,0x786c,0x6183,0x5e79,0x6bd0,0x004d,0x0d2a,0x56cf,0x417d,0x593c,0x5710,0x5682,0x3009,0x2513,0x2f57,0x2dc3,0x319b,0x076e,0x29f1,0x2c51,0x4abc,0x5e79,0x3701,0x0745,0x761a,0x6732,0x2256,0x0a44,0x344a,0x319b,0x2da5,0x5018,0x5378,0x5309,0x6e70,0x13ab,0x29bc,0x58ae,0x01f4,0x318c,0x6743,0x766b,0x0d70,0x13cd,0x3d34,0x4247,0x2b65,0x0d70,0x2db2,0x536f,0x51b6,0x10ad,0x47bd,0x604b,0x10cb,0x1c02,0x088a,0x0779,0x5e23,0x0e07,0x2b4e,0x4f46,0x766b,0x756d,0x23c4,0x6194,0x0360,0x43a4,0x52fd,0x02e5,0x5e23,0x239e,0x161c,0x40c4,0x3770,0

x3476,0x330f,0x2b4e,0x1380,0x5900,0x5cd1,0x4f20,0x3595,0x2a86,0x58c8,0x058b,0x52fd,0x0d01,0x756d,0x1165,0x3a17,0x3716,0x2481,0x66a0,0x32c7,0x23c4,0x6d4a,0x757a,0x6f84,0x62e3,0x2b72,0x0360,0x23a2,0x2121,0x4c40,0x3fb7,0x1c02,0x3e32,0x47bd,0x658d,0x088a,0x0b9b,0x3e7f,0x7657,0x6bb6,0x51b6,0x70e6,0x6e70,0x7139,0x2136,0x0caf,0x4aab,0x7b0c,0x6285,0x3fd1,0x1b36,0x161c,0x5378,0x7ab5,0x178e,0x6935,0x0969,0x6b8a,0x1eaa,0x761a,0x462f,0x4991,0x6e01,0x32a1,0x5d43,0x1103,0x3595,0x4662,0x2d8e,0x44f6,0x7097,0x4db4,0x77c5

Annex C

(informative)

Example MAC common part sublayer service definition

C.1 MAC service definition

This annex describes the services between the MAC and the CSs. This is a logical interface. As such, the primitives described are informative. Their purpose is to describe the information that must necessarily be exchanged between the MAC and the CSs to enable each to perform its requirements as specified in the remainder of this document. This subclause does not impose message formats or state machines for the use of these primitives.

In a layered protocol system, the information flow across the boundaries between the layers can be defined in terms of primitives that represent different items of information and cause actions to take place. These primitives do not appear as such on the medium (the air interface) but serve to define more clearly the relations of the different layers. The semantics are expressed in the parameters that are conveyed with the primitives.

C.1.1 MAC service definition for PMP

C.1.1.1 Primitives

The IEEE 802.16 MAC supports the following primitives at the MAC SAP, to support services between the MAC and the CSs in PMP mode.

MAC_CREATE_SERVICE_FLOW.request
MAC_CREATE_SERVICE_FLOW.indication
MAC_CREATE_SERVICE_FLOW.response
MAC_CREATE_SERVICE_FLOW.confirmation

MAC_CHANGE_SERVICE_FLOW.request
MAC_CHANGE_SERVICE_FLOW.indication
MAC_CHANGE_SERVICE_FLOW.response
MAC_CHANGE_SERVICE_FLOW.confirmation

MAC_TERMINATE_SERVICE_FLOW.request
MAC_TERMINATE_SERVICE_FLOW.indication
MAC_TERMINATE_SERVICE_FLOW.response
MAC_TERMINATE_SERVICE_FLOW.confirmation

MAC_DATA.request
MAC_DATA.indication

The use of these primitives to provide peer communication is shown in Figure C.1. The initial request for service from a higher layer is provided by the “request” primitive. When this request is sent across the air link to the peer MAC, it generates an “indicate” primitive to inform the peer CS of the request; the convergence entity responds with a “response” to the MAC. Again this is sent across the air link to the MAC on the originating side, which sends a “confirm” primitive to the original requesting entity.

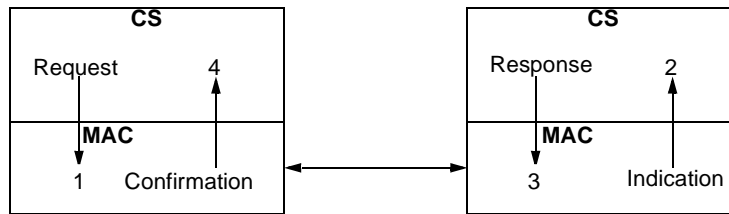

Figure C.1—Use of primitives to request service of MAC and generate response

In some cases, it is not necessary to send information to the peer station and the “confirm” primitive is issued directly by the MAC on the originating side. Such cases may occur, for example, when the request is rejected by the MAC on the requesting side. In cases where it is necessary to keep the other side of the link informed, an unsolicited “response” may be sent, in turn leading to the generation of an unsolicited “confirmation” for benefit of the CS.

For actions other than DATA.request and DATA.indication, the initiating CS sends a REQUEST primitive to its MAC. The initiating side MAC sends the appropriate Dynamic Service Addition, Change, or Deletion (DSx) Request message (see 6.3.14.7.1 and 6.3.14.8) to the receiving MAC. The noninitiating side MAC sends an INDICATION primitive to its CS. The noninitiating CS responds with a RESPONSE primitive, stimulating its MAC to respond to the initiating side MAC with the appropriate DSx Response message. The initiating side MAC responds to its CS with a CONFIRMATION primitive and, if appropriate, with the appropriate DSx Acknowledge message. At any point along the way, the request may be rejected (for lack of resources, etc.), terminating the protocol.

C.1.1.1.1 MAC_CREATE_SERVICE_FLOW.request

C.1.1.1.1.1 Function

This primitive is issued by a CS entity in a BS or SS unit to request the dynamic addition of a connection.

C.1.1.1.1.2 Semantics of the service primitive

The parameters of the primitive are as follows:

```

MAC_CREATE_SERVICE_FLOW.request
(
  MAC Address
  scheduling service type,
  convergence sublayer,
  service flow parameters,
  payload header suppression indicator,
  encryption indicator,
  Packing on/off indicator,
  Fixed-length or variable-length SDU indicator,
  SDU length (only needed for fixed-length SDU connections),
  CRC request,
  ARQ parameters,
  sequence number
)
  
```

For connection requests initiated from a BS, the 48-bit MAC Address value identifies the SS with which the connection is to be established. The parameter has no significance for connection requests initiated from an SS.

The scheduling service type (see 6.3.5) is one of the following: Unsolicited grant service (UGS), real-time polling service (rtPS), non-real-time polling service (nrtPS), and Best Effort (BE) service.

The convergence sublayer parameter indicates which CS handles data received on this connection. If the value is zero, then no CS is used; other values for specific CSs are given in 11.13.19.

The service flow parameters include details on such issues as peak and average rate, or reference to a service class. These parameters are the same as those in the DSC Request MAC Management message.

The payload header suppression indicator specifies whether the SDUs on the service flow are to have their headers suppressed.

The encryption indicator specifies that the data sent over this connection is to be encrypted, if ON. If OFF, then no encryption is used.

The packing on/off indicator specifies whether packing may be applied to the MAC SDUs on this connection. A value of ON means that packing is allowed for the connection.

The fixed-length or variable-length SDU indicator specifies whether the SDUs on the service flow are fixed-length or variable-length.

The SDU length specifies the length of the SDU for a fixed-length SDU service flow. The parameter has no significance for a variable length SDU service flow.

Cyclic redundancy check (CRC) request, if ON, requests that the MAC SDUs delivered over this connection are transported in MAC PDUs with a CRC added to them.

The ARQ parameters are: whether or not ARQ is used for the connection, maximum retransmission limit, and acknowledgment window size.

The sequence number is used to correlate this primitive with its response from the BS via the MAC.

C.1.1.1.1.3 When generated

This primitive is generated by a CS of a BS or SS unit to request the BS to set up a new connection.

C.1.1.1.1.4 Effect of receipt

If the primitive is generated on the SS side, the receipt of this primitive causes the MAC to pass the request (in the form of a DSA-REQ message) to the MAC entity in the BS. The SS MAC remembers the correlation between sequence number and the requesting convergence entity.

If the primitive is generated on the BS side, the BS checks the validity of the request and, if valid, chooses a CID and includes it in the DSA-REQ message (6.3.14.9.3) sent to the SS. This CID shall be returned to the requesting CS via the CONFIRM primitive. If the primitive originated at the SS, the actions of generating a CID and authenticating the request are deferred to the INDICATION/RESPONSE portion of the protocol.

C.1.1.1.2 MAC_CREATE_SERVICE_FLOW.indication

C.1.1.1.2.1 Function

This primitive is sent by the noninitiating MAC entity to the CS, to request the dynamic addition of a connection in response to the MAC receiving a DSA-REQ message. If the noninitiating MAC entity is at the BS, an SFID and possibly CID are generated and the request is authenticated.

C.1.1.1.2.2 Semantics of the service primitive

The parameters of the primitive are as follows:

```
MAC_CREATE_SERVICE_FLOW.indication
(
  service type,
  convergence sublayer,
  service flow parameters,
  sequence number
)
```

Parameters: see MAC_CREATE_SERVICE_FLOW.request. The encryption and CRC flags are not delivered with the indication primitive since they will have already been acted on by lower layers, to decrypt the data or to check a CRC, before the MAC SDU is passed up to the CS.

C.1.1.1.2.3 When generated

This primitive is generated by the MAC of the noninitiating side of the protocol when it receives a DSA-REQ message from the initiating side of the connection.

C.1.1.1.2.4 Effect of receipt

When the CS receives this primitive, it checks the validity of the request from the point of view of its own resources. It accepts or rejects the request via the MAC_CREATE_SERVICE_FLOW.response primitive.

If the connection request was originated on the SS side, the BS sends the CID to the SS side in this RESPONSE primitive. Otherwise, if the origin was the BS, the RESPONSE contains the CID contained in the DSA header bearing the indication.

C.1.1.1.3 MAC_CREATE_SERVICE_FLOW.response

C.1.1.1.3.1 Function

This primitive is issued by a noninitiating MAC entity in response to a MAC_CREATE_SERVICE_FLOW.indication requesting the creation of a new connection.

C.1.1.1.3.2 Semantics of the service primitive

The parameters of the primitive are as follows:

```
MAC_CREATE_SERVICE_FLOW.response
(
  Connection ID,
  response code,
  response message,
  sequence number,
  ARQ parameters
)
```

The Connection ID is returned to the requester for use with the traffic specified in the request. If the request is rejected, then this value shall be ignored.

The response code indicates success or the reason for rejecting the request.

The response message provides additional information to the requester, in type/length/value (TLV) format.

The sequence number is returned to the requesting entity to correlate this response with the original request.

The ARQ parameters are: whether or not ARQ is used for the connection, maximum retransmission limit and acknowledgment window size.

C.1.1.1.3.3 When generated

This primitive is generated by the noninitiating CS entity when it has received a MAC_CREATE_SERVICE_FLOW.indication.

C.1.1.1.3.4 Effect of receipt

The receipt of this primitive causes the MAC to send the DSA Response (DSA-RSP) message to the requesting MAC entity. Once the DSA Acknowledgment (DSA-ACK) is received, the MAC is prepared to pass data for this connection on to the air link.

C.1.1.1.4 MAC_CREATE_SERVICE_FLOW.confirmation

C.1.1.1.4.1 Function

This primitive confirms to a convergence entity that a requested connection has been provided. It informs the CS of the status of its request and provides a CID for the success case.

C.1.1.1.4.2 Semantics of the service primitive

The parameters of the primitive are as follows:

```
MAC_CREATE_SERVICE_FLOW.confirmation
(
  Connection ID,
  response code,
  response message,
  sequence number
)
```

Parameters: see MAC_CREATE_SERVICE_FLOW.response.

C.1.1.1.4.3 When generated

This primitive is generated by the initiating side MAC entity when it has received a DSA-RSP message.

C.1.1.1.4.4 Effect of receipt

The receipt of this primitive informs the convergence entity that the requested connection is available for transmission requests.

C.1.1.1.5 Changing an existing connection

Existing connections may be changed in their characteristics on a dynamic basis to, for example, reflect changing bandwidth requirements. The following primitives are used:

```
MAC_CHANGE_SERVICE_FLOW.request
MAC_CHANGE_SERVICE_FLOW.indication
MAC_CHANGE_SERVICE_FLOW.response
MAC_CHANGE_SERVICE_FLOW.confirmation
```

The semantics and effect of receipt of these primitives are the same as for the corresponding CREATE primitives. A new CID shall be generated in the case of changing a service flow type from provisioned to admitted or active.

C.1.1.1.6 MAC_TERMINATE_SERVICE_FLOW.request

C.1.1.1.6.1 Function

This primitive is issued by a CS entity in a BS or SS unit to request the termination of a connection.

C.1.1.1.6.2 Semantics of the service primitive

The parameters of the primitive are as follows:

```
MAC_TERMINATE_SERVICE_FLOW.request
(
  SFID
)
```

The SFID parameter specifies which service flow is to be terminated.

C.1.1.1.6.3 When generated

This primitive is generated by a CS of a BS or SS unit to request the termination of an existing connection.

C.1.1.1.6.4 Effect of receipt

If the primitive is generated on the SS side, the receipt of this primitive causes the MAC to pass the request to the MAC entity in the BS via the DSD Request (DSD-REQ) message. The BS checks the validity of the request, and if it is valid it terminates the connection.

If the primitive is generated on the BS side, it has already been validated and the BS MAC informs the SS by issuing a DSD-REQ message.

C.1.1.1.7 MAC_TERMINATE_SERVICE FLOW.indication**C.1.1.1.7.1 Function**

This primitive is issued by a the MAC entity on the noninitiating side to request the termination of a connection in response to the receipt of a DSD-REQ message.

C.1.1.1.7.2 Semantics of the service primitive

The parameters of the primitive are as follows:

```
MAC_TERMINATE_SERVICE FLOW.indication
(
  SFID
)
```

The SFID parameter specifies which service flow is to be terminated.

C.1.1.1.7.3 When generated

This primitive is generated by the MAC when it receives a DSD-REQ message to terminate a connection, or when it finds it necessary for any reason to terminate a connection.

C.1.1.1.7.4 Effect of receipt

If the protocol was initiated by the SS, when it receives this primitive, the BS checks the validity of the request. In any case, the receiving CS returns the MAC_TERMINATE_SERVICE FLOW.response primitive and deletes the SFID from the appropriate polling and scheduling lists.

C.1.1.1.8 MAC_TERMINATE_SERVICE FLOW.response**C.1.1.1.8.1 Function**

This primitive is issued by a CS entity in response to a request for the termination of a connection.

C.1.1.1.8.2 Semantics of the service primitive

The parameters of the primitive are as follows:

```
MAC_TERMINATE_SERVICE FLOW.response
(
  SFID,
  response code,
  response message
)
```

The SFID is returned to the requesting entity.

The response code indicates success or the reason for rejecting the request.

The response message provides additional information to the requester, in TLV format.

C.1.1.1.8.3 When generated

This primitive is generated by the CS entity when it has received a MAC_TERMINATE_SERVICE_FLOW.indication from its MAC.

C.1.1.1.8.4 Effect of receipt

The receipt of this primitive causes the MAC to pass the message to the initiating side via the DSD Response (DSD-RSP) message. The initiating MAC in turn passes the CONFIRM primitive to the requesting convergence entity. The convergence entity shall no longer use this CID for data transmission.

C.1.1.1.9 MAC_TERMINATE_SERVICE_FLOW.confirmation**C.1.1.1.9.1 Function**

This primitive confirms to a convergence entity that a requested connection has been terminated.

C.1.1.1.9.2 Semantics of the service primitive

The parameters of the primitive are as follows:

```
MAC_TERMINATE_SERVICE_FLOW.confirmation
(
  SFID,
  response code,
  response message
)
```

Parameters: see MAC_TERMINATE_SERVICE_FLOW.response.

C.1.1.1.9.3 When generated

This primitive is generated by the MAC entity when it has received a DSD-RSP message.

C.1.1.1.9.4 Effect of receipt

The receipt of this primitive informs the convergence entity that a connection has been terminated. The convergence entity shall no longer use this CID for data transmission.

C.1.1.1.10 MAC_DATA.request**C.1.1.1.10.1 Function**

This primitive defines the transfer of data to the MAC entity from a CS SAP.

C.1.1.1.11 Semantics of the service primitive

The parameters of the primitive are as follows:

```
MAC_DATA.request
(
  Connection ID,
  length,
  data,
  discard-eligible flag
)
```

The Connection ID parameter specifies the connection over which the data is to be sent; the service class is implicit in the Connection ID.

The length parameter specifies the length of the MAC SDU in bytes.

The data parameter specifies the MAC SDU as received by the local MAC entity.

The discard-eligible flag specifies whether the MAC SDU is to be preferentially discarded by the scheduler in the event of link congestion and consequent buffer overflow.

The encryption flag specifies that the data sent over this connection is to be encrypted, if ON. If OFF, then no encryption is used.

C.1.1.1.11.1 When generated

This primitive is generated by a CS whenever a MAC SDU is to be transferred to a peer entity or entities.

C.1.1.1.11.2 Effect of receipt

The receipt of this primitive causes the MAC entity to process the MAC SDU through the MAC and to pass the appropriately formatted PDUs to the PHY Transmission Convergence sublayer for transfer to peer MAC entities, using the CID specified.

C.1.1.1.12 MAC_DATA.indication

C.1.1.1.12.1 Function

This primitive defines the transfer of data from the MAC to the CS. The specific CS to receive the indicate message is implicit in the CID.

C.1.1.1.12.2 Semantics of the service primitive

The parameters of the primitive are as follows:

```
MAC_DATA.indication
(
  Connection ID,
  length,
  data,
  reception status,
)
```

The Connection ID parameter specifies the connection over which the data was sent.

The length parameter specifies the length of the data unit in bytes.

The data parameter specifies the MAC SDU as received by the local MAC entity.

The reception status parameter indicates transmission success or failure for those PDUs received via the MAC_DATA.indication.

C.1.1.1.12.3 When generated

This primitive is generated whenever an MAC SDU is to be transferred to a peer convergence entity or entities.

C.1.1.1.12.4 Effect of receipt

The effect of receipt of this primitive by a convergence entity is dependent on the validity and content of the MAC SDU. The choice of CS is determined by the CID over which the MAC SDU was sent.

C.1.1.2 MAC service stimulation of DSx messages

This subclause describes the logical interaction between the MAC Service primitives and the DSx messages.

The sequence of logical MAC SAP events and the associated actual MAC events effecting a CS-stimulated connection creation are shown in Figure C.2.

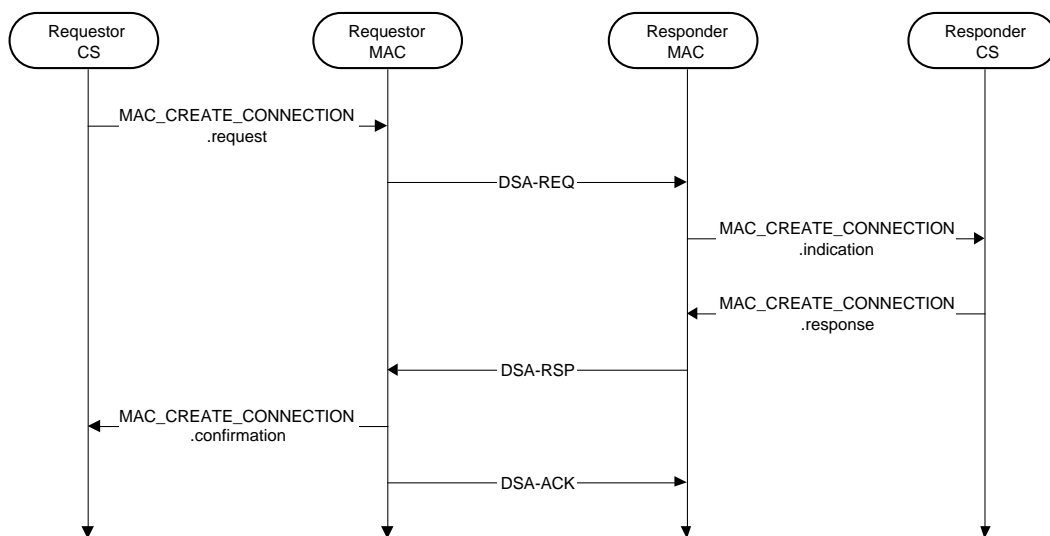

Figure C.2—MAC SAP event and MAC event sequence for connection creation stimulated by CS

The sequence of logical MAC SAP events and the associated actual MAC events effecting a CS stimulated connection change are shown in Figure C.3.

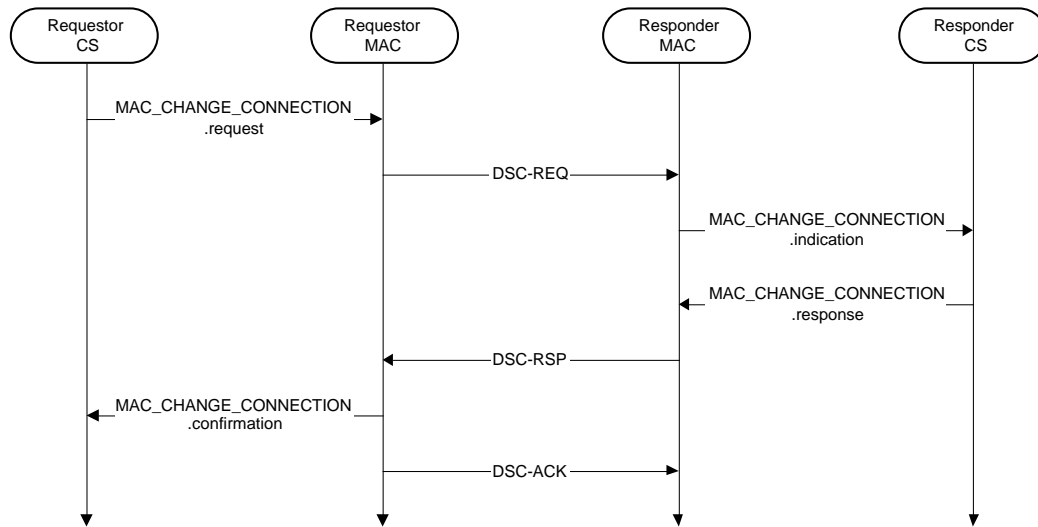

Figure C.3—MAC SAP event and MAC event sequence for connection change stimulated by CS

The sequence of logical MAC SAP events and the associated actual MAC events effecting a CS stimulated connection deletion are shown in Figure C.4.

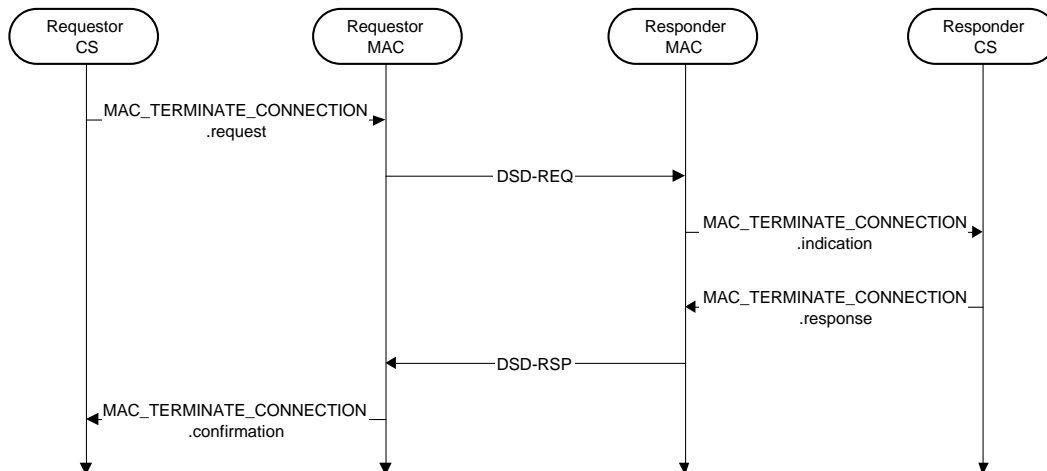

Figure C.4—MAC SAP event and MAC event sequence for connection deletion stimulated by CS

C.1.2 MAC service definition for Mesh

C.1.2.1 Primitives

The IEEE 802.16 MAC supports the following primitives at the MAC SAP in Mesh mode:

```
MAC_CREATE_SERVICE_FLOW.indication

MAC_CHANGE_SERVICE_FLOW.indication

MAC_TERMINATE_SERVICE_FLOW.request
MAC_TERMINATE_SERVICE_FLOW.indication

MAC_DATA.request
MAC_DATA.indication

MAC_FORWARDING_UPDATE.request
MAC_FORWARDING_UPDATE.indication
```

In Mesh mode none of the actions cause the initiating CS to send a REQUEST primitive to its MAC. They are either indications of the results from the processes handled by the MAC CPS management entity, or data delivery actions needed to convey information to the peer CS.

C.1.2.1.1 MAC_CREATE_SERVICE_FLOW.indication

C.1.2.1.1.1 Function

This primitive is issued by a MAC entity to the CS, to report a new link established to a neighbor node.

C.1.2.1.1.2 Semantics of the service primitive

The parameters of the primitive are as follows:

```
MAC_CREATE_SERVICE_FLOW.indication
{
  CID
  max length,
  service flow parameters,
  encryption flag
}
```

The CID is the Connection ID in Mesh as conveyed in the generic MAC header.

The max length parameter specifies the maximum length of SDUs that are allowed over the link.

The service flow parameters include information on

- Data rate (Mb/s)
Data rate associated with the profile for the physical link over which the connection is created.
- Transmit power (dBm)
Transmit power at the antenna port for the physical link over which the connection is created.
- Estimate of packet error rate for 256-byte packets
Estimate of PER for the physical link over which the connection is created.

The encryption flag specifies that the data carried over this link is encrypted, if ON, If OFF, then no encryption is used.

C.1.2.1.1.3 When generated

This primitive is generated whenever a new link has been established to a neighbor node.

C.1.2.1.1.4 Effect of receipt

The receipt of the primitive is an indication to the CS that a link to the given neighbor node is up and can be used for data delivery.

C.1.2.1.2 MAC_CHANGE_SERVICE_FLOW.indication

C.1.2.1.2.1 Function

This primitive is issued by a MAC entity to the CS, to report new parameters of an existing link to a neighbor node.

C.1.2.1.2.2 Semantics of the service primitive

The parameters of the primitive are as follows:

```
MAC_CHANGE_SERVICE_FLOW.indication
{
  CID,
  max length,
  service parameters,
  encryption flag
}
```

The CID is the Connection ID in Mesh as conveyed in the generic MAC header.

The max length parameter specifies the maximum length of SDUs that are allowed over the link.

The service parameters include information on

- Target data rate for the link in Mb/s
- Transmit energy for the link
- Estimate of packet error rate for 256 byte packets

The encryption flag specifies that over this link encryption is possible, if ON, If OFF, then no encryption is possible.

C.1.2.1.2.3 When generated

This primitive is generated whenever parameters of an existing link has changed.

C.1.2.1.2.4 Effect of receipt

The CS shall take into account new link parameters in the use of the link.

C.1.2.1.3 MAC_TERMINATE_SERVICE_FLOW.request**C.1.2.1.3.1 Function**

This primitive is issued by a CS, to terminate an existing link to a neighbor node.

C.1.2.1.3.2 Semantics of the service primitive

The parameters of the primitive are as follows:

```
MAC_TERMINATE_SERVICE_FLOW.request
{
  CID
}
```

The CID is the Connection ID in Mesh as conveyed in the generic MAC header.

C.1.2.1.3.3 When generated

This primitive is generated to bring down an existing link to a neighbor node.

C.1.2.1.3.4 Effect of receipt

The receipt of the primitive causes the MAC to terminate the connection and report that to the MAC entity in the neighbor the link was to.

C.1.2.1.4 MAC_TERMINATE_SERVICE_FLOW.indication**C.1.2.1.4.1 Function**

This primitive is issued by the MAC entity of the noninitiating side to indicate termination of the link to a neighbor node.

C.1.2.1.4.2 Semantics of the service primitive

The parameters of the primitive are as follows:

```
MAC_TERMINATE_SERVICE_FLOW.indication
{
  CID,
}
```

The CID is the Connection ID in Mesh as conveyed in the generic MAC header.

C.1.2.1.4.3 When generated

This primitive is generated by the MAC when it receives an indication in a Mesh Network Configuration (MSH-NCFG) message.

C.1.2.1.4.4 Effect of receipt

The receipt of the primitive is an indication to the CS that the link to the given neighbor node is down and cannot be used for data delivery.

C.1.2.1.5 MAC_DATA.request

C.1.2.1.5.1 Function

This primitive defines the transfer of data to the MAC entity from a CS SAP.

C.1.2.1.5.2 Semantics of the service primitive

The parameters of the primitive are as follows:

```
MAC_DATA.request
{
  CID,
  length,
  data,
  encryption flag
}
```

The CID is the Connection ID in Mesh as conveyed in the generic MAC header.

The length parameter specifies the length of the MAC SDU in bytes.

The data parameter specifies the MAC SDU as received by the local MAC entity.

The priority/class parameter embedded in the CID specifies priority class of the MAC SDU.

The reliability parameter embedded in the CID specifies maximum number of transmission attempts at each link.

The drop precedence parameter embedded indicates relative MSDU dropping likelihood.

The encryption flag specifies that the data sent over this link is to be encrypted, if ON. If OFF, then no encryption is used.

C.1.2.1.5.3 When generated

This primitive is generated by a CS whenever an MAC SDU is to be transferred to a peer entity.

C.1.2.1.5.4 Effect of receipt

The receipt of the primitive causes the MAC entity to process the MAC SDU through the MAC and pass the appropriately formatted PDUs to the PHY for transfer to the peer MAC entity, using the Node ID specified.

C.1.2.1.6 MAC_DATA.indication

C.1.2.1.6.1 Function

This primitive defines the transfer of data from the MAC to the CS.

C.1.2.1.6.2 Semantics of the service primitive

The parameters of the primitive are as follows:

```
MAC_DATA.request
{
  CID
  length,
  data,
  reception status,
  encryption flag
}
```

The CID is the Connection ID in Mesh as conveyed in the generic MAC header.

The length parameter specifies the length of the MAC SDU in bytes.

The data parameter specifies the MAC SDU as received by the local MAC entity.

The reception status parameter indicates transmission success or failure for those PDUs received via the MAC_DATA.indication.

C.1.2.1.6.3 When generated

This primitive is generated whenever an MAC SDU is to be transferred to a peer convergence entity.

C.1.2.1.6.4 Effect of receipt

The effect of receipt of this primitive by a convergence entity is dependent on the validity and content of the MAC SDU.

C.1.2.1.7 MAC_FORWARDING_UPDATE.request**C.1.2.1.7.1 Function**

This primitive defines the transfer of the centralized scheduling configuration to the MAC entity from a CS SAP in the Mesh BS.

C.1.2.1.7.2 Semantics of the service primitive

The parameters of the primitive are as follows:

```
MAC_FORWARDING_UPDATE.request
{
  number of nodes,
  node parameters[number of nodes]
}
```

The number of nodes parameter indicates number of nodes in the scheduling tree of this Mesh BS.

The node parameters entry shall contain the following information:

- Node ID: The Node ID parameter indicates the node.
- Number of children: The number of nodes parameter indicates number of children the given node.
- Child parameters[number of children]

Each child parameters entry shall contain the following information:

- Child index: The child index indicates index into the list of Node IDs
- Uplink burst profile: The uplink burst profile indicates burst profile of link to child node
- Downlink burst profile: The downlink burst profile indicates burst profile of link from child node

C.1.2.1.7.3 When generated

This primitive is generated in the Mesh BS whenever it has changed the schedule tree.

C.1.2.1.7.4 Effect of receipt

The receipt of this primitive causes the MAC to generate a MSH-CSCF message with the given information. The message shall be distributed to all the nodes listed in the tree.

C.1.2.1.8 MAC_FORWARDING_UPDATE.indication

C.1.2.1.8.1 Function

This primitive defines the transfer of the centralized scheduling configuration from the MAC to the CS.

C.1.2.1.8.2 Semantics of the service primitive

The parameters of the primitive are as follows:

```
MAC_FORWARDING_UPDATE.indication
{
  Node ID self
  number of nodes,
  node parameters[number of nodes]
}
```

The Node ID self indicates the Node ID of the node itself.

The number of nodes parameter indicates number of nodes in the scheduling tree of this Mesh BS.

The node parameters entry shall contain the following information:

- Node ID: The Node ID parameter indicates the node.
- Number of children: The number of nodes parameter indicates number of children the given node.
- Child parameters[number of children]

Each child parameters entry shall contain the following information:

- Child index: The child index indicates index into the list of Node IDs
- Uplink burst profile: The uplink burst profile indicates burst profile of link to child node
- Downlink burst profile: The downlink burst profile indicates burst profile of link from child node

C.1.2.1.8.3 When generated

This primitive is generated by the MAC at all the nodes, which have received the MSH-CSCF message, when new centralized schedule with revised schedule tree takes effect.

C.1.2.1.8.4 Effect of receipt

The receipt of this primitive synchronizes the forwarder and MAC scheduler to routing changes.