

(12) **United States Patent**
Archer

(10) **Patent No.:** **US 6,683,870 B1**
(45) **Date of Patent:** **Jan. 27, 2004**

(54) **METHOD AND SYSTEM FOR MULTICASTING CALL NOTIFICATIONS**

- (75) Inventor: **Michael Archer**, Dallas, TX (US)
(73) Assignee: **MCI Communications Corporation**, Washington, DC (US)
(*) Notice: Subject to any disclaimer, the term of this patent is extended or adjusted under 35 U.S.C. 154(b) by 0 days.
(21) Appl. No.: **09/104,570**
(22) Filed: **Jun. 25, 1998**

Related U.S. Application Data

- (62) Division of application No. 08/751,023, filed on Nov. 18, 1996, now abandoned, which is a division of application No. 08/798,350, filed on Feb. 10, 1997, now abandoned.
(51) **Int. Cl.**⁷ **H04L 12/66**
(52) **U.S. Cl.** **370/356; 370/390; 370/432**
(58) **Field of Search** 370/259, 260, 370/261, 270, 351, 352, 353, 354, 355, 356, 390, 432; 379/201, 202, 205, 209, 211, 212, 219, 220

(56) **References Cited**

U.S. PATENT DOCUMENTS

4,100,377 A	7/1978	Flanagan	179/15
4,771,425 A	9/1988	Baran et al.	370/85
4,969,184 A	11/1990	Gordon et al.	379/100
5,029,196 A	7/1991	Morganstein	379/67
5,333,173 A	* 7/1994	Seazholtz et al.	379/45
5,361,256 A	* 11/1994	Doeringer et al.	370/390
5,436,957 A	7/1995	McConnell	379/88
5,440,620 A	8/1995	Slusky	379/100
5,481,600 A	1/1996	Alesio	379/114
5,497,411 A	3/1996	Pellerin	379/59
5,511,114 A	4/1996	Stimson et al.	379/114
5,526,353 A	6/1996	Henley et al.	370/60.1
5,553,135 A	* 9/1996	Xing	379/399
5,590,181 A	12/1996	Hogan et al.	379/114

(List continued on next page.)

FOREIGN PATENT DOCUMENTS

EP	0549126	6/1993
EP	0583135 A	2/1994
EP	0740480 A	10/1996
EP	0767568 A	4/1997
EP	0802690 A	10/1997
JP	09168033 A	6/1997
JP	09168051 A	6/1997
JP	09168063 A	6/1997
JP	09168064 A	6/1997
JP	09168065 A	6/1997
JP	09172459 A	6/1997
JP	09172462 A	6/1997
WO	9501691 A	1/1995
WO	9522221 A	8/1995

(List continued on next page.)

OTHER PUBLICATIONS

- “Follow Me 800 Service”, *Newton’s Telecom Dictionary*, p. 304; Mar. 1998.
“Telephony Over the Internet How to Make This Into a Public Service”, Rinde, et al., pp. 1–18.
PC Week, Stephanie Lapolla, “Net Call Centers, Voice to Merge”, Mar. 31, 1997, p. 10.
Reuters, Nick Louth, “MCI Communications Corporation vaults phone–data divide”, Jan. 29, 1997, web page attached.

(List continued on next page.)

Primary Examiner—Kwang Bin Yao

(57) **ABSTRACT**

A method for communication over a network, which can be both analog and digital includes simultaneously transmitting a call notification to a plurality of communication devices. These communication devices include devices such as telephones, pagers, computers, and voice mail systems. The addresses (e.g., telephone numbers) are stored in a database which is queried based on the call notification. For example, this method can be used in a find-me/follow-me system or to initiate a conference call.

24 Claims, 6 Drawing Sheets

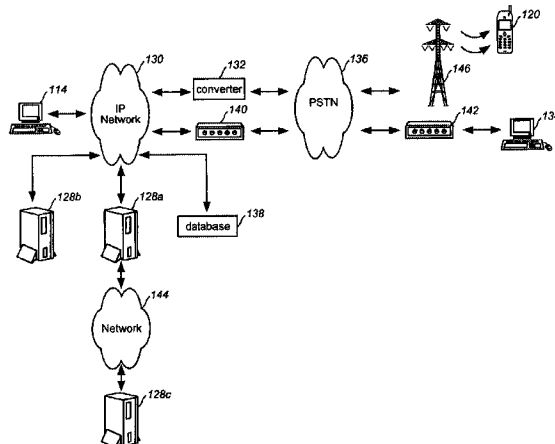

U.S. PATENT DOCUMENTS

5,600,704	A	2/1997	Ahlberg et al.	
5,604,737	A	2/1997	Iwami et al.	370/352
5,608,786	A	3/1997	Gordon	379/100
5,610,910	A	3/1997	Focsaneanu et al.	370/351
5,636,216	A	6/1997	Fox et al.	370/402
5,654,957	A	8/1997	Koyama	370/355
5,712,907	A	1/1998	Wegner et al.	379/112
5,724,355	A	3/1998	Bruno et al.	370/401
5,724,412	A	3/1998	Srinivasan	
5,742,596	A *	4/1998	Baratz et al.	370/356
5,742,905	A *	4/1998	Pepe et al.	455/461
5,751,706	A	5/1998	Land et al.	370/352
5,802,160	A *	9/1998	Kugell et al.	379/211
5,838,665	A *	11/1998	Kahn et al.	370/260
5,915,008	A *	6/1999	Dulman	379/201
5,995,597	A *	11/1999	Woltz et al.	379/93.24
6,069,890	A *	5/2000	White et al.	370/352
6,072,780	A *	6/2000	Johnson, Jr. et al.	370/260
6,104,799	A *	8/2000	Jain et al.	379/210
6,205,139	B1 *	3/2001	Voit	370/389
6,483,832	B1 *	11/2002	Civanlar et al.	370/390

FOREIGN PATENT DOCUMENTS

WO	9619068	A	6/1996
WO	9625720	A	8/1996
WO	9634341	A	10/1996
WO	9638799	A	12/1996
WO	9710668	A	3/1997
WO	9722211	A	6/1997
WO	9723078	A	6/1997
WO	9726748		7/1997
WO	9728628	A	8/1997
WO	9806201		2/1998
WO	9823080	A	5/1998

OTHER PUBLICATIONS

The Wall Street Journal, "MCI's New Service for Corporate Use Sets 1 Line for Net, Phone", Jan. 30, 1997, web page attached.

Yang, C.: INETPhone: Telephone Services and Servers on the Internet; Apr. 1995; Network Working Group; Request for Comments: 1789; Category: Informational.

Low C: "The Internet Telephony Red Herring", HP Laboratories Technical Report, May 15, 1997, pp. 1-15.

Low C, et al.: "Webin—An Architecture For Fast Deployment of In-Based Personal Services" Workshop Record. Intelligent Network. Freedom and Flexibility: Realising the Promise of Intelligent Network Services, Apr. 21, 1996, pp. 1-12.

Plamen L. Simeonov, et al.: "Ingate: A Distributed Intelligent Network Approach to Bridge Switching and Packet Networks" Proceedings of Sixth International Conference on Computer Communications and Networks, Sep. 22-25, 1997, pp. 358-363.

L. Gys, et al.: "Intelligence in the Network" Alcatel Telecommunications Review, No. 1, 1998, pp. 13-22.

Gareiss R: "Voice Over the Internet" Data Communications, vol. 25, No. 12, Sep. 1996, pp. 93, 94, 96, 98, 100.

Bolot, et al.: "Scalable Feedback Control For Multicast Video Distribution In The Internet" Computer Communications Review, vol. 24, No. 4, Oct. 1, 1994, pp. 58-67.

Davis A.W.: "Videoconferencing Via POTS Now: Proprietary Codecs & Emerging Standards" Advanced Imaging, Jan. 1, 1995, p. 32, 34, 36, 38 and 88.

Estrin, et al.: "Multimedia Over IP: Specs Show The Way" Data Communications, vol. 25, No. 10, Aug. 1, 1996, pp. 93-96 and 98.

Francois Fluckiger: "Multimedia Over The Internet" Proceedings of the European Conference on Multimedia Applications, Services and Techniques, vol. 1, May 28-30, 1996, pp. 3-8.

Gronert, et al.: "Van Gateway Services: Easy Does It For E-Mail" Data Communications, vol. 23, No. 6, Apr. 1, 1994, pp. 63/64, 64B and 64D.

Halton K. C.: "The Group 3 Facsimile Protocol" BT Technology Journal, vol. 12, No. 1, Jan. 1, 1994, pp. 61-69.

Jacobs, et al.: "Filling HTML Forms Simultaneously: Coweb-Architecture and Functionality" Computer Networks and ISDN Systems, vol. 28, 1996, pp. 1385-1395.

Katz, et al.: "MMCX Server Delivers Multimedia Here and Now" AT&T Technology, vol. 10, No. 4, Dec. 1, 1995, pp. 2-6.

Koch, et al.: "'Gruppe 3" Brachte Den Schneeballeffekt" Funkschau, No. 2, Jan. 15, 1988, pp. 48-50.

Low C: "The Internet Telephony Red Herring" HP Laboratories Technical Report, May 15, 1996, pp. 1-15.

Dr. Hannes P. Lubich: "Videoconferencing For MAC and PC—Initial Experiences With "CU-SEEME"" Switch Journal, No. 1, 1995, pp. 4-9.

Maeno, et al.: "Distributed Desktop Conferencing System (Mermaid) Based On Group Communication Architecture" Communications—Rising to the Heights, Denver, Jun. 23-26, 1991, vol. 1, Jun. 23, 1991, pp. 520-525.

Matsuo, et al.: "Personal Telephone Services Using IC-Cards" IEEE Communications Magazine, vol. 27, No. 7, Jul. 1989, pp. 41-48.

Patel, et al.: "The Multimedia Fax-Mime Gateway" IEEE Multimedia, vol. 1, No. 4, Dec. 21, 1994, pp. 64-70.

Henning Schulzrinne: "A Comprehensive Multimedia Control Architecture For The Internet" Proceedings of the IEEE 7th International Workshop on Network and Operating System Support for Digital Audio and Video, May 19-21, 1997, pp. 65-76.

Simeonov, et al.: "Ingate: A Distributed Intelligent Network Approach To Bridge Switching and Packet Networks" Proceedings of the International Conference on Computer Communications and Networks, 1997, pp. 358-363.

Tagg E.: "Automating Operator-Assisted Calls Using Voice Recognition" Speech Technology, Man-Machine Voice Communications, vol. 4, No. 2, Mar. 1988, pp. 22-25.

Turletti T: "The Inria Videoconferencing System (IVS)" Connexions, Oct. 1, 1994, pp. 20-24.

"Interactive Media: An Internet Reality" IEEE Spectrum, vol. 33, No. 4, Apr. 1, 1996, pp. 29-32.

"Workstation Communications System" IBM Technical Disclosure Bulletin, vol. 37, No. 9, Sep. 1, 1994, pp. 101-104.

MCI One—Life just got simpler Apr. 25, 1997.

WebPhone Gateway eXchange Server (WGX) May 12, 1998

* cited by examiner

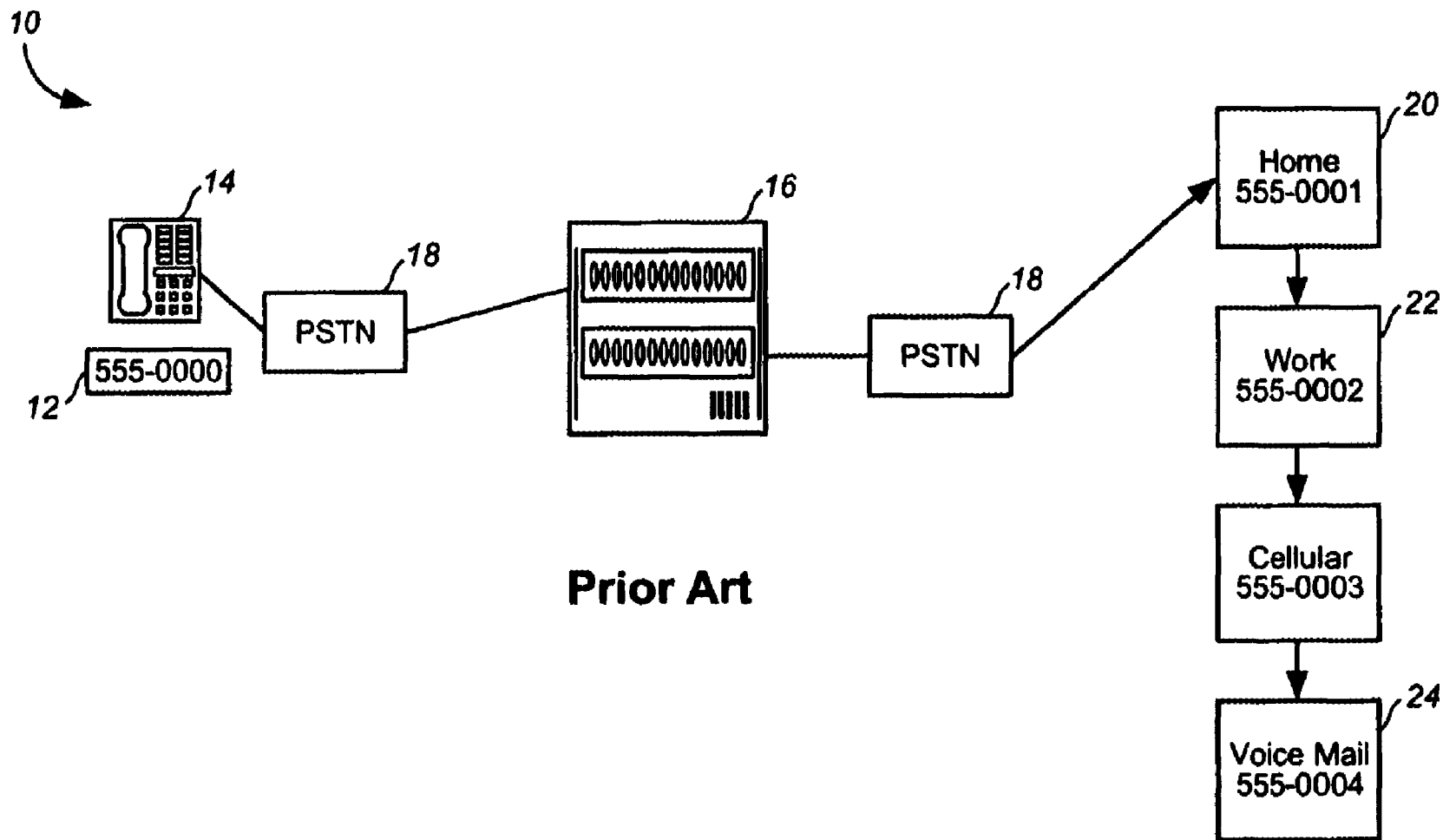

FIG. 1

YMAX CORPORATION v. FOCAL IP, LLC
FOCAL IP, LLC EX2048 - 3
U.S. Patent No. 6,683,870
IPR2016-01260

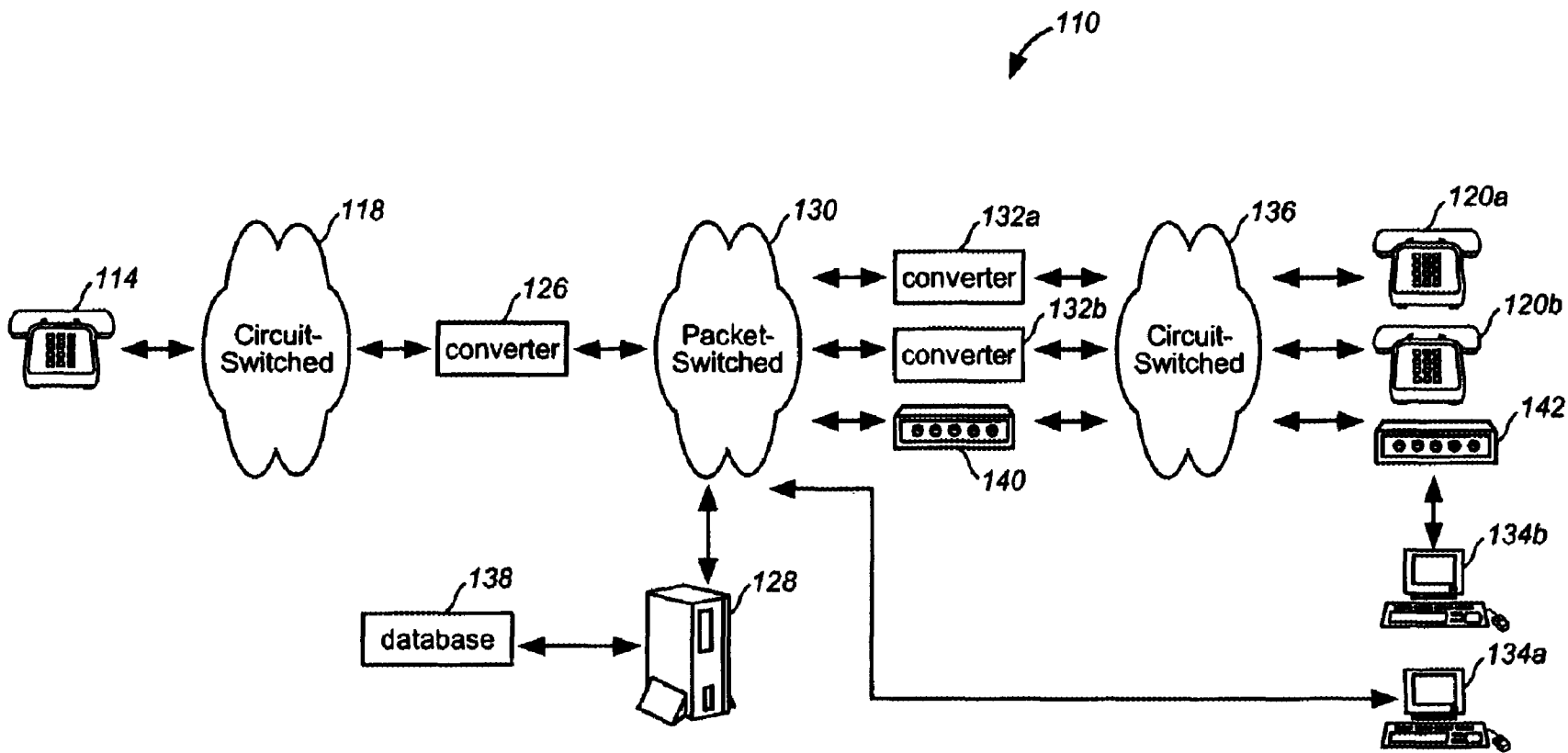

FIG. 2

YMAX CORPORATION v. FOCAL IP, LLC
FOCAL IP, LLC EX2048 - 4
U.S. Patent No. 6,683,870
IPR2016-01260

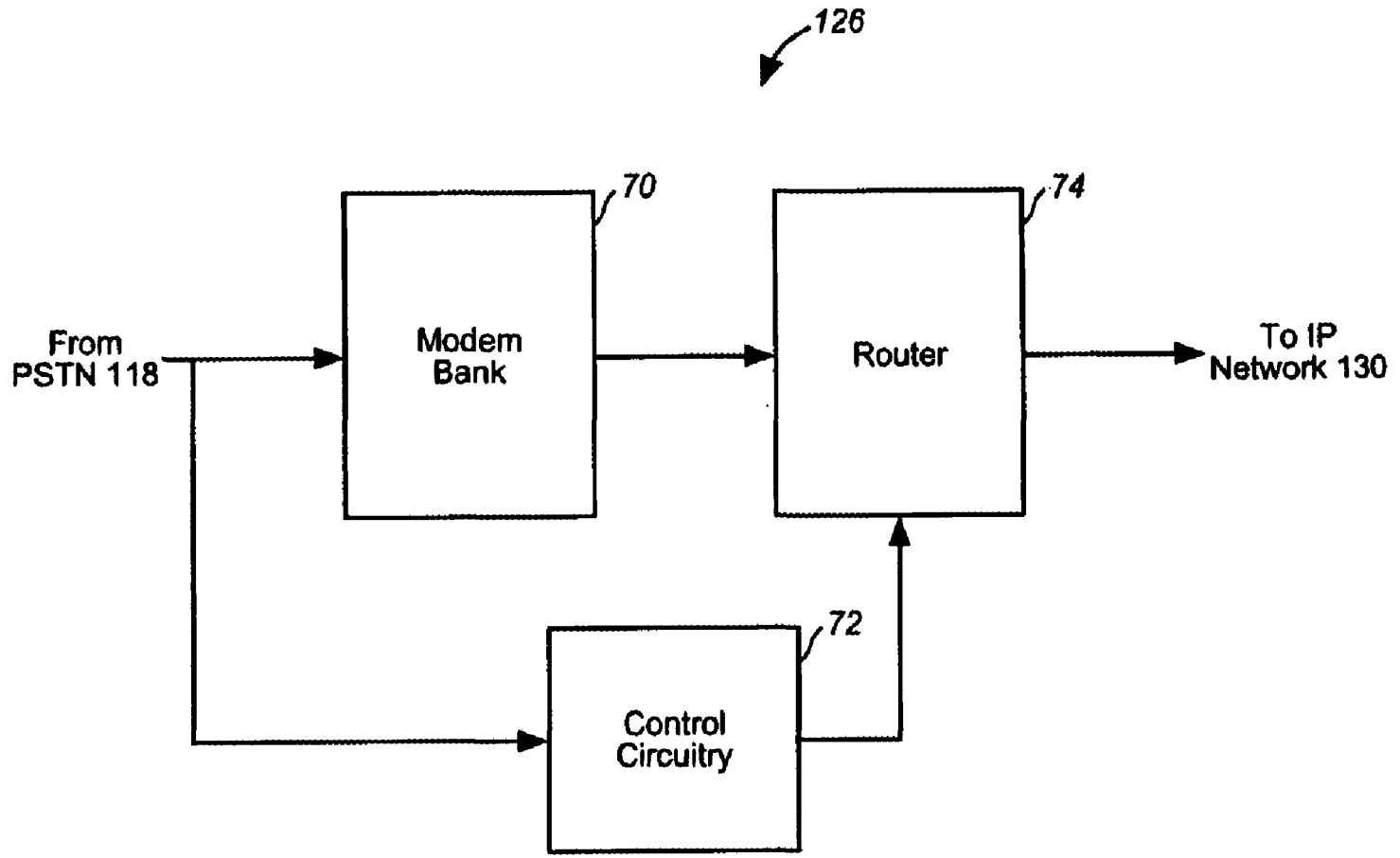

FIG. 3

YMAX CORPORATION v. FOCAL IP, LLC
FOCAL IP, LLC EX2048 - 5
U.S. Patent No. 6,683,870
IPR2016-01260

Explore Litigation Insights

Docket Alarm provides insights to develop a more informed litigation strategy and the peace of mind of knowing you're on top of things.

Real-Time Litigation Alerts



Keep your litigation team up-to-date with **real-time alerts** and advanced team management tools built for the enterprise, all while greatly reducing PACER spend.

Our comprehensive service means we can handle Federal, State, and Administrative courts across the country.

Advanced Docket Research



With over 230 million records, Docket Alarm's cloud-native docket research platform finds what other services can't. Coverage includes Federal, State, plus PTAB, TTAB, ITC and NLRB decisions, all in one place.

Identify arguments that have been successful in the past with full text, pinpoint searching. Link to case law cited within any court document via Fastcase.

Analytics At Your Fingertips



Learn what happened the last time a particular judge, opposing counsel or company faced cases similar to yours.

Advanced out-of-the-box PTAB and TTAB analytics are always at your fingertips.

API

Docket Alarm offers a powerful API (application programming interface) to developers that want to integrate case filings into their apps.

LAW FIRMS

Build custom dashboards for your attorneys and clients with live data direct from the court.

Automate many repetitive legal tasks like conflict checks, document management, and marketing.

FINANCIAL INSTITUTIONS

Litigation and bankruptcy checks for companies and debtors.

E-DISCOVERY AND LEGAL VENDORS

Sync your system to PACER to automate legal marketing.