

# ENGINEERING AND OPERATIONS IN THE BELL SYSTEM

Second Edition  
Reorganized and Rewritten  
Telecommunications in the  
Bell System in 1982–1983

**E**NGINEERING  
**O** and  
**O**PERATIONS  
**B** in the  
**B**ELL  
**S**YSTEM



# **E**NGINEERING **O** and OPERATIONS in the **B**ELL **S**YSTEM

**Second Edition  
Reorganized and Rewritten  
Telecommunications in the  
Bell System in 1982 - 1983**

Prepared by Members of the Technical Staff  
and the Technical Publication Department  
AT&T Bell Laboratories

R.F. Rey, Technical Editor

AT&T Bell Laboratories  
Murray Hill, N.J.

*Copyright© 1977, 1983 by Bell Telephone Laboratories, Incorporated  
All rights reserved*

*This second edition differs significantly from that of 1977. It contains revised and updated information, new entries and illustrations, and a different organization and format.*

*Second Printing 1984*

*International Standard Book Number 0-932764-04-5*

*Library of Congress Catalog Card Number 83-72956*

*AT&T Customer Information Center Select Code 500-478*

*No part of this publication may be reproduced or transmitted in any form or by any means, electronic or mechanical - including photocopy, recording, or any information storage and retrieval system - without permission in writing from the publisher.*

*Printed in the United States of America*

# 1

---

## Structure and Activities

### 1.1 INTRODUCTION

The Bell System led the development and use of communications equipment and techniques in the United States throughout most of this century. It became the nation's major supplier of telecommunications products and services ranging from basic residence telephones to increasingly sophisticated information services.

From its beginnings, the Bell System matched its organizational structure to the environment in which it operated. Early in the century, universal service—providing basic telephone service at an affordable price anywhere in the nation—became the Bell System goal. The Bell System approached this goal by creating a functional organization: Each of the local telephone companies and the American Telephone and Telegraph Company (AT&T) itself were organized along the lines of the job that had to be done. Tasks in each functional area were performed by specialists in that area to maximize efficiency. The local companies were responsible for responding to the particular needs of the communities they served, but they all used standard technology and operating methods. Thus, AT&T and the telephone companies achieved coordination on a national scale, while responding to local needs. As a result, the goal of universal service has been met—nearly everyone in the United States has a telephone that is connected to a single nationwide network. This **public switched telephone network**<sup>1</sup> is available to the general public and to other carriers and networks.

The functional organization that made providing universal service efficient and practical was possible because, for most of its history, the

<sup>1</sup> Sections 3.3.1 and 4.2.1 discuss the public switched telephone network in detail.

Bell System was almost the sole source of telecommunications service—although under terms and conditions approved by federal and state regulators. AT&T and the telephone companies have changed their organizational structure to match environmental changes such as new and diverse customer needs and, more recently, new markets.

Now, in the 1980s, the way in which telecommunications services are provided is changing entirely. The 1982 Modification of Final Judgment (MFJ), which terminated a 1974 Department of Justice antitrust suit against AT&T, ordered the breakup (divestiture) of the integrated Bell System. AT&T set January 1, 1984, as the target date for completion of the massive job of restructuring a business involving about 1 million employees and about \$160 billion in assets.

Subsequent sections of Chapter 1 describe the organization of the Bell System in 1982, the major provisions of the MFJ, and the postdivestiture structure. The chapter was revised late in 1983 to provide an introductory account of the impact of divestiture. The rest of the book describes the engineering and operations of the Bell System at the end of 1982 and in early 1983 and does not reflect divestiture because much of the material was prepared before the antitrust suit was settled in 1982.<sup>2</sup> However, the primary effects of divestiture are on the structure of the corporate units and the allocation of the roles in providing telecommunications services. The technology in the network, the considerations involved in its design, and the nature of functions required to operate the network and to provide service to customers remain essentially unchanged. Thus, this book constitutes a valid description of telecommunications engineering and operations and meets a growing need for an update to the previous book (Bell Laboratories 1977).

## 1.2 THE BELL SYSTEM IN 1982

### 1.2.1 AMERICAN TELEPHONE AND TELEGRAPH COMPANY

In 1982, the Bell System, serving more than 80 percent of the nation's telephones, had long been the largest of hundreds of companies providing communications services in the United States. Before divestiture, the Bell System operated as a partnership among AT&T; a number of Bell-owned telephone companies (known as *operating companies*); the Western Electric Company, Incorporated; and Bell Telephone Laboratories, Incorporated. The product of this partnership was service, provided through a dynamic and dependable communications network designed, built, and operated as a single system.

<sup>2</sup> Because the text describes the Bell System in 1982 and early 1983 and was written in that time frame and earlier, the reader will find the Bell System referred to extensively in the present tense.

Figure 1-1 shows the structure of the Bell System as it was in 1982. AT&T, the parent company, was publicly owned by 3.1 million stockholders. In turn, AT&T owned Western Electric and—totally or partially—each of the Bell operating companies.<sup>3</sup> AT&T and Western Electric jointly owned Bell Laboratories. Both AT&T and Western Electric also had subsidiary companies (shown on the figure); some of which supported Bell System operations, others that provided domestic and international communications services.

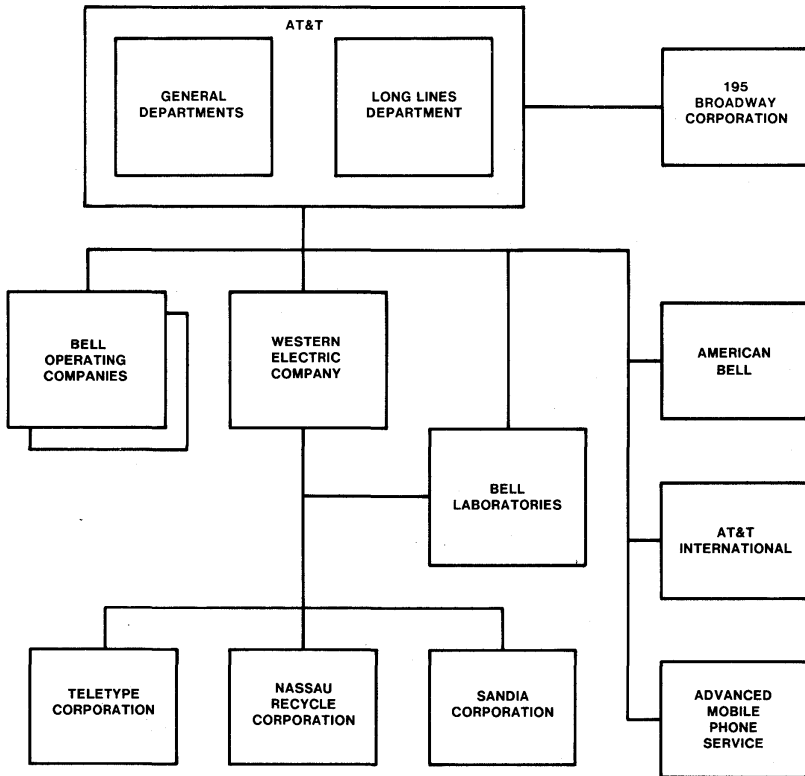

Figure 1-1. Structure of the Bell System (1982).

<sup>3</sup> AT&T was sole stockholder in twenty-one operating companies and a minority stockholder in two: the Southern New England Telephone Company and Cincinnati Bell, Inc. Bell Telephone Company of Nevada is wholly owned by the Pacific Telephone and Telegraph Company. Four Chesapeake and Potomac Telephone Companies offer service in Washington, D.C.; Maryland; Virginia; and West Virginia.



AT&T, the parent company of the Bell System, had its headquarters in New York City.<sup>4</sup>

### Corporate Functions

**General Departments.** The General Departments of AT&T set the major goals and large-scale programs for the Bell System. They advised and assisted the Bell operating companies on such matters as finance, operations, personnel, legal, accounting, marketing, planning, public relations, and employee information, thereby providing continuity of direction and consolidating the particular specialities of each Bell System partner. AT&T, through its General Departments, coordinated pricing activity and represented the Bell System before federal regulatory agencies. It determined price structures and recommended costing and pricing matters through federal agencies.

The General Departments ensured that new developments, solutions to existing problems, and provisions for the future needs of customers became part of the entire Bell System. This involved directing the work of Bell Laboratories and Western Electric and coordinating the integration of new technology into the network.

The General Departments established and maintained standards and procedures for the Bell System and for the interconnection of non-Bell System equipment and facilities with the Bell System network. They served as an information clearinghouse for associations of independent telephone companies (such as the United States Independent Telephone Association) and for general-trade (that is, other than Western Electric) suppliers.

**Long Lines Department.** The Long Lines Department, with headquarters in Bedminster, New Jersey, operated the long-distance network. Many of its activities were similar to those of the Bell operating telephone companies. Long Lines built, operated, and maintained most of the interstate network of long-distance lines, thereby providing interstate and international communications services for people throughout the United States. It directed the overall design and management of the network and coordinated the teamwork among the various Bell and independent companies who jointly own and operate this complex, widespread system of microwave radio, coaxial cable, optical fibers, satellites, and intricate switching systems.

To handle the network efficiently, Long Lines was divided into six territorial regions (see Figure 1-2). Each region took care of engineering, sales, and network operations in its territory.

<sup>4</sup> A new headquarters building at 550 Madison Avenue has replaced the building at 195 Broadway, which was the headquarters location for many years.



Figure 1-2. Long Lines regions and regional headquarters locations.

### Corporate Structure

Figure 1-3 is a block diagram of the AT&T organization as it existed in 1982. The office of the assistant to the president reviewed all aspects of the organization and ensured that each unit's plans, budgets, and operations were consistent with system requirements. It also maintained liaison with Bell Laboratories and with Western Electric. The figure shows the network function and how AT&T's customer-related operations and marketing functions were structured to reflect the Bell System's market segments: business, residence, directory, and public services.

- **Business** organizations coordinated the response of the Bell System to the needs of business customers; assisted telephone companies in the areas of marketing, pricing, costing, forecasting, training, and budget matters related to serving business customers; and supported telephone companies with installations, repairs, maintenance, customer contacts, engineering, and measurements required for customer services.
  - *Business Marketing* provided leadership and support for Bell System business marketing efforts.
  - *Business Services* combined under common management all the closely related delivery functions that flow from marketing and sales.

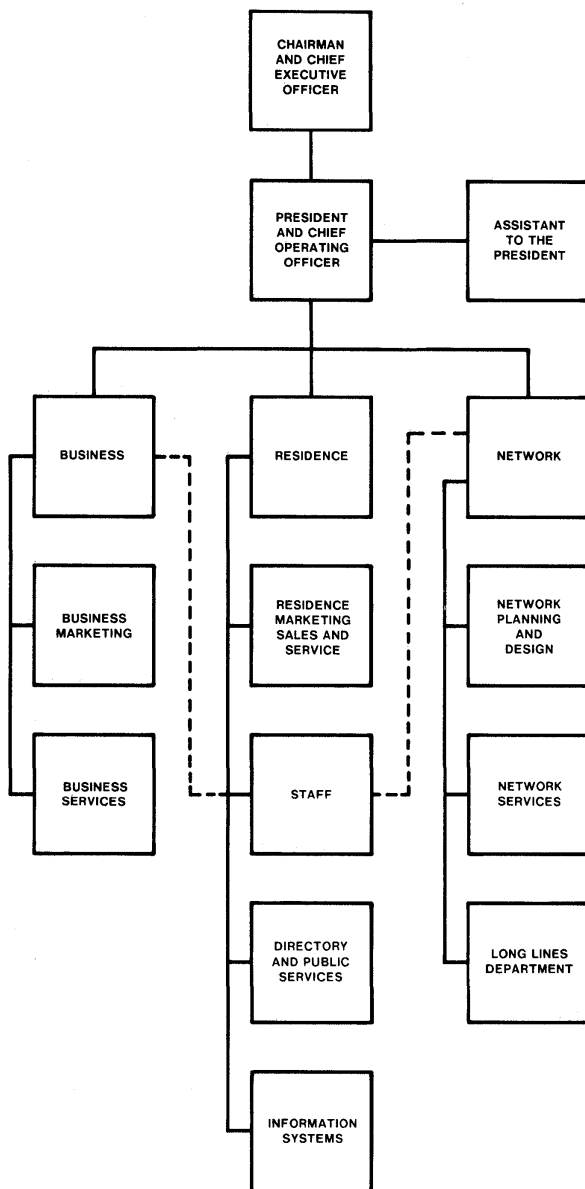

Figure 1-3. Corporate structure of AT&T (1982).

- **Residence** organizations coordinated the response of the Bell System to the needs of residential customers for telecommunications products and services.
  - *Residence Marketing Sales and Service* offered telephone companies help in marketing, pricing, costing, forecasting, training, and budget matters related to serving residence customers. It also supported telephone companies with installations, repairs, maintenance, customer contacts, engineering, and measurements required for customer service.

In addition, for organizational purposes, several other units reported to the executive vice-president-residence.

- *Staff* supplied support services within AT&T itself and coordinated support services such as inventory management, automotive operations, building planning, real-estate management, energy conservation, and environmental protection offered by other Bell System companies.
- The *Directory* organization assisted telephone companies with marketing, costing, pricing, forecasting, training, and budget matters for both white pages and Yellow Pages as well as with producing and distributing directories.
- *Public services* coordinated Bell System activities involved in providing communications services for users who are away from home or office. Public services comprised public and semipublic telephone service, including Charge-a-Call and *DIAL-IT*<sup>5</sup> network communications services such as Public Announcement Service and Media Stimulated Calling (see Section 2.5.1).
- *Information Systems* provided planning, design, and development of functional accounting and information systems for use by the operating companies.
- **Network** organizations supported the business, residence, directory, and public-service markets by guiding and coordinating the operation of the network and the activities that provide telecommunications services between customers' locations.
  - *Network Planning and Design* oversaw the provision of reliable and innovative interpremises communications services, ensured that existing Bell System services were continually improved, coordinated the development of the national and international network, guided the efforts of Bell Laboratories in the area of interpremises

<sup>5</sup> Service mark of AT&T Co.

services, guided the technical planning of the operating companies, and maintained technical liaison with both independent telephone companies and international and other domestic carriers.

- *Network Services* provided methods and guidance to operating telephone company network organizations. Supported functions included the administration and maintenance of network switching systems and transmission facilities; operator services; and the engineering, construction, maintenance, and administration of distribution facilities and services.
- The *Long Lines Department* was included in the network segment. This integration made it easier to combine the planning, design, and management of the interstate network with the intrastate networks for improved overall network service.

### Subsidiary Companies

AT&T owned several subsidiary companies that supported Bell System operations or provided domestic and international services. The primary subsidiaries were:

- **195 Broadway Corporation**, which provided real-estate management services for AT&T corporate locations. These services included constructing, owning, and leasing buildings; administering office space, facilities, and equipment; and providing related building and house-keeping support services such as transportation, maintenance, and cafeterias for corporate buildings.
- **AT&T International Inc.**, which was formed in August 1980 to sell Bell System products worldwide and apply Bell System technology, products, and experience to the needs of telephone administrations overseas and international business customers. It also provides technical and advisory services and directory and information systems.
- **American Bell Inc.**, which was formed in June 1982 in response to Computer Inquiry II (see Section 17.4.3). As a "separate" subsidiary, American Bell could sell its products and services to customers without government approval and had certain limitations in the way it dealt with other Bell System companies.
- **Advanced Mobile Phone Service, Inc.**, which was responsible for planning and developing a nationwide cellular radio system to provide communications from moving customers to the land-line telecommunications system. Section 11.4.1 discusses cellular radio.

## 1.2.2 BELL OPERATING COMPANIES

Before divestiture, the Bell operating companies built, operated, and maintained the local and intrastate networks and provided most of the day-to-day service for customers in their individual communities. Chapter 13 discusses the many functional activities performed by the operating companies. Long-distance calls also traveled over individual company facilities, but those that went from the territory of one company to that of another were carried by Long Lines or another common carrier. (Figure 1-4 shows the Bell operating companies as they existed in 1982 and the territories they served.) The operating companies also joined with Long Lines to furnish certain interstate services such as carrying radio and television network programs to broadcasting stations throughout the country. They also cooperated with the hundreds of independent telephone companies so that the public had access to a unified national telephone network.

The operating companies differed from one another in size and organization. Geographically, the smallest was that part of the Chesapeake and Potomac Telephone Companies that offered service in the 61 square miles of the District of Columbia. The largest was the Mountain States Telephone and Telegraph Company, which operated in seven states and had a service area of more than 300,000 square miles.

The difference in size was one reason for differences in organization. For example, a function that might have been centralized in a single-state company might have had separate organizations for each state in a multi-state company. There were other reasons for differences as well. For example, the operating problems and priorities of rural areas differ from those of urban areas. Traditionally, each company worked out operational methods most suited to its own needs, within guidelines and standards provided by AT&T.

As sole or part owner of the operating companies, AT&T derived a large portion of its earnings from those companies. The relationship between AT&T and an operating company was traditionally governed by an agreement called the *license contract* (which terminated with divestiture). Each license contract described the reciprocal services, licenses, and privileges that existed between the parties. The operating company was charged a fee for the services supplied by the AT&T General Departments. The fee was based on services the company received, but it could not exceed 2.5 percent of the company's annual revenues. The licensed company agreed to certain policies and procedures defined by the parent company.

The term *license contract* goes back to the early days of the business when local companies were first licensed to use Bell telephones. For many years, the contract guaranteed that the operating companies would

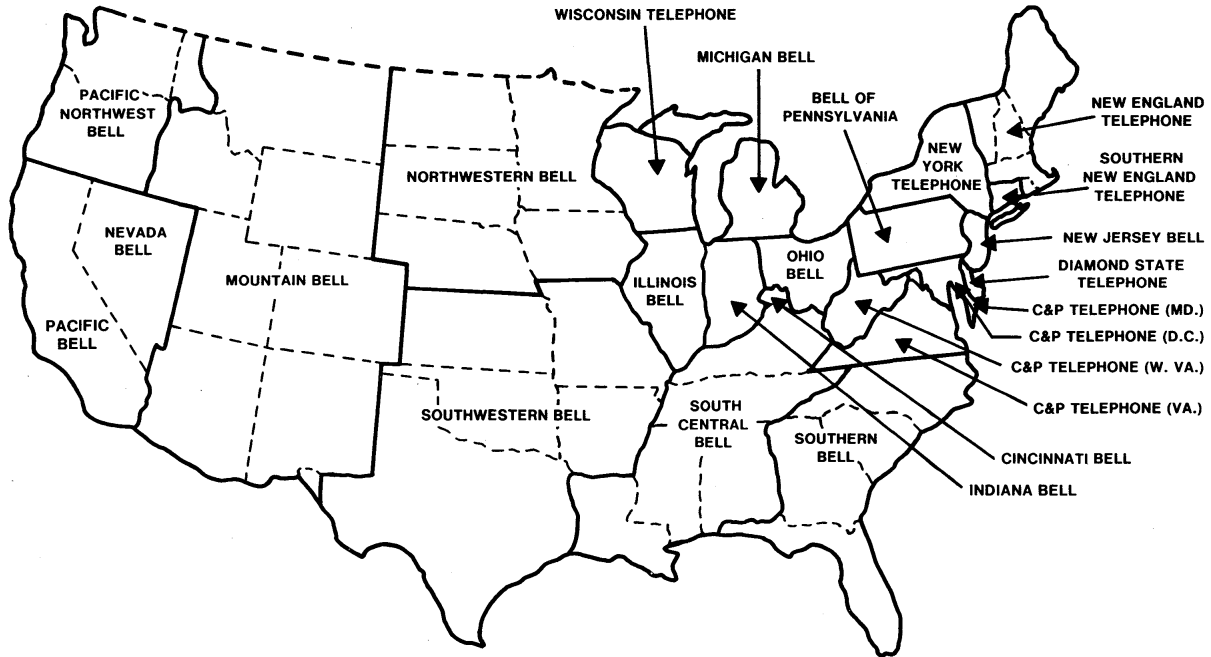
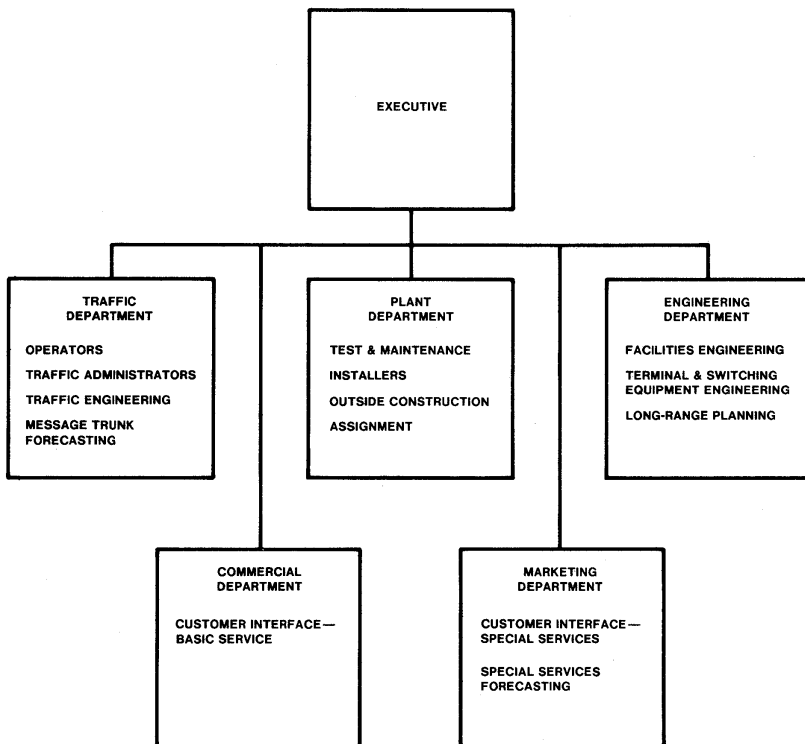

Figure 1-4. Bell operating companies and their territories (1982).

benefit from research, financing, engineering, and other important services offered by the parent company. It assured the manufacture of telephones and other devices and apparatus needed by the licensees for their business. AT&T accomplished this through Western Electric.

**Corporate Structure**

As with AT&T, the original organizational structure of the operating companies was defined by the jobs that needed to be done. This functional organization, shown in Figure 1-5,<sup>6</sup> later evolved into a network orientation. Still later, marketing became the driving force in shaping the Bell System and its operations. When AT&T reorganized around market segments, it recommended that the operating companies do the same by



**Figure 1-5. Traditional functional organization of the Bell operating companies.**

<sup>6</sup> Chapter 13 describes functional activities such as those shown in Figure 1-5.



forming business, residence, directory, public service, and network organizations.

The business, residence, directory, and public services organizations were to be responsible for marketing, sales, and delivery of products directly to customers. The network organization was to provide services between customer locations. It did the planning and engineering, provided the facilities and equipment, and operated the network. This restructuring of traditional lines of managerial authority did not reflect a difference in overall goals, however. Rather, it was done to keep pace with the emerging technological, business, and regulatory environment.

### 1.2.3 WESTERN ELECTRIC

Western Electric, with headquarters at 222 Broadway in New York City,<sup>7</sup> was the manufacturing and supply unit of the Bell System. In 1982, with about \$12.6 billion in sales, Western Electric ranked 22nd on *Fortune* magazine's list of the nation's 500 largest industrial corporations. The company's almost 150,000 employees worked in nearly every state.

Before divestiture, Western Electric made a variety of customer-premises equipment, including millions of telephones each year. It also manufactured much of the other equipment that made up the telephone network. These products were designed by Bell Laboratories, manufactured by one of Western Electric's manufacturing divisions, and distributed to the telephone companies by Western Electric's Bell Sales division. Table 1-1 lists Western Electric's manufacturing divisions and their locations. Figure 1-6 shows the twenty-two manufacturing plants. The structure of Western Electric included a number of divisions responsible for major functional areas.

The **Corporate Engineering Division** coordinated the work of the manufacturing divisions to ensure that the products were compatible with the network. The division also provided research and development support for all Western Electric's engineering activities including manufacturing, equipment engineering, distribution, installation, and repair of products. In addition, it coordinated the company's quality assurance program, which required that inspectors check products to ensure that they met Bell Laboratories standards. Engineering also assisted in planning for the acquisition, leasing, and development of company facilities. It evaluated and verified company-wide cost reductions and monitored energy use at all company locations.

Western Electric's Engineering Research Center near Princeton, New Jersey, developed and improved manufacturing processes. Examples of

<sup>7</sup> In October 1983, plans were announced for the sale of 222 Broadway and the establishment of a new headquarters facility in Berkeley Heights, New Jersey.

innovations that emerged from the Research Center include industrial applications of the laser and a technique for sensing minute abnormalities in ceramics.

**TABLE 1-1**  
**WESTERN ELECTRIC MANUFACTURING (1982)**

Products by Manufacturing Division	Locations
Cable and Wire Products	Atlanta Works (Norcross, GA) Baltimore Works Omaha Works Phoenix Works
Electronic Components	Allentown Works Kansas City Works (Lee's Summit, MO) Reading Works New River Valley Plant (Fairlawn, VA)
Business and Residence Products	Denver Works Indianapolis Works Kearney Works Montgomery Works (Aurora, IL) Shreveport Works
Switching Equipment	Columbus Works Dallas Works (Mesquite, TX) Hawthorne Works (Chicago) Lisle Plant (Lisle, IL) Oklahoma City Works
Transmission Equipment	Merrimack Valley Works (North Andover, MA) North Carolina Works (Winston-Salem) Burlington Works Richmond Works

The **Network Systems and Product Planning Division** ensured that products from the different manufacturing divisions were compatible with the network and met the needs of customers.

The principal points of contact between Western Electric and its Bell System customers were the Material and Account Management Division and two Bell Sales divisions. These organizations were responsible for the delivery of products and services to the customer. To facilitate this, seven Bell Sales regions were established (see Figure 1-6). Regional account management teams assisted operating companies in planning applications for Western Electric products and services and helped Western Electric identify emerging telephone company needs and develop marketing strategies to meet those needs.

- The **Material and Account Management Division** developed plans and support for the regional account management teams. It also forecast the demand for products, placed orders with the factories, and controlled stock supplies in all seven regions. The division established prices and administered the *standard supply contracts* (see below). It prepared brochures, handbooks, and customer instruction booklets on products.
- Two **Bell Sales Divisions** (East and West) provided regional account management. Their responsibilities also included systems equipment engineering, installation and repair of switching and transmission equipment, warehousing, and distribution for the Bell System. Systems equipment engineers tailored complicated Western Electric equipment to the exact needs of the customer and ensured its compatibility with existing equipment. The Bell Sales divisions operated a distribution network consisting of material management centers (huge warehouses) in each of the seven regions; thirty-one smaller service centers, which usually combined stocks of the most frequently needed items and repair facilities; and strategically located local distribution centers (see Figure 1-6).

Through its **Purchasing and Transportation Division**, Western Electric coordinated the purchase of over \$4.5 billion in supplies and services from other manufacturers both for its own manufacturing needs and for resale to Bell System companies. Western Electric used more than 47,000 suppliers and transportation carriers and delivered raw materials, parts, and finished products to more than 100 company locations and to Bell customers around the country. Purchases included telecommunications equipment, computers, power equipment, telephone booths, telephone poles, office machines, maintenance items, and stationery supplies. An important part of this work, the engineering and inspection of purchased products to ensure their compatibility and quality, was the responsibility



Figure 1-6. Western Electric's principal locations and regions (1982).



of Purchased Products Engineering and Purchased Products Inspection, which were located in Springfield, New Jersey.

Western Electric's responsibilities in this area were defined by the *standard supply contract*, an agreement it had with the Bell operating companies. The supply contract, which terminated at divestiture, required Western Electric either to manufacture or to purchase materials that the operating companies might reasonably require, which they then might order from Western Electric. However, the supply contract did not *oblige* the operating companies to purchase these materials from Western Electric. They were free to buy from anyone.

The **Government and Commercial Sales Division** was responsible for the sale of Western Electric products and services to the United States government and other non-Bell System customers.

In addition to its role as the Bell System manufacturing and supply unit, Western Electric responded to the government's needs for both specific design projects and telecommunications systems. During World War II, Western Electric provided communications and radar equipment to the armed forces. After the war, the company did pioneering work in early-warning defense systems such as the Distant Early Warning (DEW) Line, extending from Iceland to the Aleutians. Later, Western Electric and Bell Laboratories developed the Nike-Ajax and Nike-Hercules ground-to-air missile defense systems. More recently, in the early 1970s, Western Electric was prime contractor for the Safeguard antiballistic missile system.

Western Electric has been a major technological contributor to the space program. The company provided the tracking and communications system for the United States' first manned space flight, Project Mercury, and headed the industrial team that designed and built tracking and communications systems for the Gemini and Apollo programs. Bellcomm, a subsidiary of Western Electric, was formed to carry out the systems engineering work on these programs under contract to the National Aeronautics and Space Administration. The United States Air Force and the National Aeronautics and Space Administration use a Western Electric command guidance system and missile-borne guidance equipment to support satellite launches.<sup>8</sup>

Western Electric has also provided complete telecommunications facilities for various government agencies both in the United States and at military bases and embassies abroad. Western Electric recently modified the Nike-Hercules air defense system for the North Atlantic Treaty Organization. The company has been engaged, with Bell Laboratories, in United States Navy submarine sonar and underwater surveillance projects

<sup>8</sup> For further details on Bell System contributions to military and space programs, see Fagen 1975/1978, vol. 2.

involving the application of acoustic technology and oceanography. These designs include underwater sensor components, cable systems, associated data-processing equipment, displays, data transmission, and communications links.

### **Subsidiary Companies**

Western Electric owns several subsidiary companies that have supported Bell System operations or provided services. The subsidiaries include:

- **Teletype Corporation**, which develops and manufactures data terminals for the Bell operating companies, other companies, and the United States government. This equipment is used in news and wire-service operations, in data communications, and in computer systems. Teletype Corporation, with headquarters and engineering operations in Skokie, Illinois, maintains two manufacturing plants and a nationwide network of service centers.
- **Nassau Recycle Corporation**, which reclaims and recycles nonferrous metals such as copper and zinc from scrap equipment and cable. About one-third of the copper Western Electric uses in manufacturing is provided by Nassau Recycle. The company has plants in South Carolina and New York.
- **Sandia Corporation**, which is managed by Western Electric for the United States Department of Energy under a no-profit, no-fee contract. Sandia's principal functions are research and development of nuclear ordnance, research on energy projects, and various other programs in the national interest. Sandia has laboratories in Albuquerque, New Mexico, and Livermore, California.

#### **1.2.4 BELL LABORATORIES**

Before divestiture, Bell Laboratories was the Bell System's research and development organization. Recognized worldwide as a prestigious scientific and technical institution, it was the driving influence behind the Bell System's contributions to telecommunications science and technology. The broad scope of these contributions is reflected in Table 1-2. In 1982, engineers and scientists at Bell Laboratories received 310 patents, bringing the total number of patents issued to the company since its founding in 1925 to 19,833. In 1982, they also originated 3823 technical talks to outside organizations and 2087 papers and received more than 87 scientific and engineering awards. Seven scientists from Bell Laboratories have been awarded the Nobel Prize in physics (see Table 1-3).

TABLE 1-2

A SAMPLING OF BELL LABORATORIES  
CONTRIBUTIONS TO TELECOMMUNICATIONS  
SCIENCE AND TECHNOLOGY\*

---

<b>Microelectronics</b>	<b>Photonics</b>
Transistor effect†	Lasers
Silicon gate technology	Lightwave communications systems
Molecular beam epitaxy	Ultra-transparent glass fibers
Charge-coupled devices	Light-emitting diode
Microprocessors and microcomputers	
<b>Software Systems</b>	<b>General Science and Engineering</b>
Error-correcting code	Single-sideband transmission
Computer languages	Network theory
Computer graphics	Quality control
Computer operating systems	Systems engineering concept
Operations systems	Negative feedback
Centralized maintenance systems	Wave nature of matter†
Stored-program control network	Thermal noise
	Speech synthesis
<b>Digital Technology</b>	Radio astronomy
Electrical digital computer	Traveling-wave tube
Digital switching system	Microwave technology
Digital transmission	Information theory
Packet switching	Solar cell
Echo canceler chip	Cellular radio concept
	Communications satellite
	Supercurrent junctions†
	Cosmic background noise†

---

\*For a more complete list and discussion of Bell Laboratories' contributions, see Bell Laboratories 1982, Lustig 1981, and Mueser 1979.

†Nobel Prize.



**TABLE 1-3**  
**BELL LABORATORIES**  
**NOBEL LAUREATES IN PHYSICS**

1937	C. J. Davisson	Demonstration of wave nature of matter
1956	John Bardeen Walter Brattain William Shockley	Discovery of transistor effect
1977	Philip Anderson	Study of electronic structure of magnetic and disordered materials
1978	Arno Penzias Robert Wilson	Detection of cosmic microwave background radiation

NOTE: Arthur Schawlow, co-inventor (with C. H. Townes) of the laser while at Bell Laboratories from 1951 to 1962, shared the 1981 prize for work done later at Stanford on Doppler-free spectroscopy.

### Purpose

Before divestiture, the purpose of Bell Laboratories was to provide the knowledge and technology essential to meeting the current and future communications needs of Bell System customers. Its activities were divided into two categories: **Research and Systems Engineering (R&SE)** and **Specific Development and Design (SD&D)**.

In undertaking research, Bell Laboratories sought new knowledge relevant to communications, explored the potential usefulness of that knowledge, and looked for new modes of communication based on that knowledge. The aim of Bell Laboratories research was to improve the services provided by the Bell operating companies and to reduce the cost of providing those services. Fields of research included the physical and mathematical sciences, computer science, economics, communications principles, communications technology, engineering, and the behavioral sciences. To maintain its leadership in telecommunications, Bell Laboratories has, in recent years, devoted ever more of its efforts and resources to certain fundamental information-age technologies, especially microelectronics, software systems, digital systems, and photonics.

Systems engineers planned the nationwide telephone network and its operations. They considered the entire network rather than just one part

of the *plant*<sup>9</sup> or one phase of operations. This included studying performance objectives, evaluating service quality, planning network configurations, generating operations plans and methods, forming requirements for equipment to provide service, and defining plans and procedures for introducing new equipment and services into the network. Systems engineering at Bell Laboratories ensured that the entire telecommunications network worked efficiently to provide continuous service while new technologies, operations, equipment, and services were introduced as they became available. Research and Systems Engineering at Bell Laboratories was funded by AT&T, primarily as a part of the service the parent company provided to the operating companies under the license contracts.

Specific Development and Design was funded by Western Electric. It was directed toward components, devices, and specific products (often involving both hardware and software) to be manufactured and furnished by Western Electric. It was concerned with designing new telecommunications applications using existing types of devices, designing completely new circuits and equipment arrangements, and preparing manufacturing information and test specifications. It involved building and testing equipment designs both in the laboratory and under field conditions, dealing with the problems of early manufacture and use of a product, and making changes as indicated by experience.

The operating companies directly funded certain other work that Bell Laboratories undertook at their specific request, for example, developing computerized operations systems (see Chapter 14) for use in telephone company business operations.

### Corporate Structure

Figure 1-7 shows the corporate structure of Bell Laboratories as it existed in January 1983 following the transfer of certain customer products and services organizations to American Bell Inc.

- **Research** included divisions devoted to physics, the information sciences, the communications sciences, and materials science and engineering.
- **Legal** comprised general law, patents, regulatory matters, and corporate studies.
- **Research and Development Planning** was concerned with the organizational structure of Bell Laboratories as it was affected by the changing regulatory and business environment of the Bell System.

<sup>9</sup> All of the facilities (such as land, buildings, machinery, apparatus, instruments, and fixtures) needed to provide telecommunications services. Plant is usually divided into outside plant and inside plant.

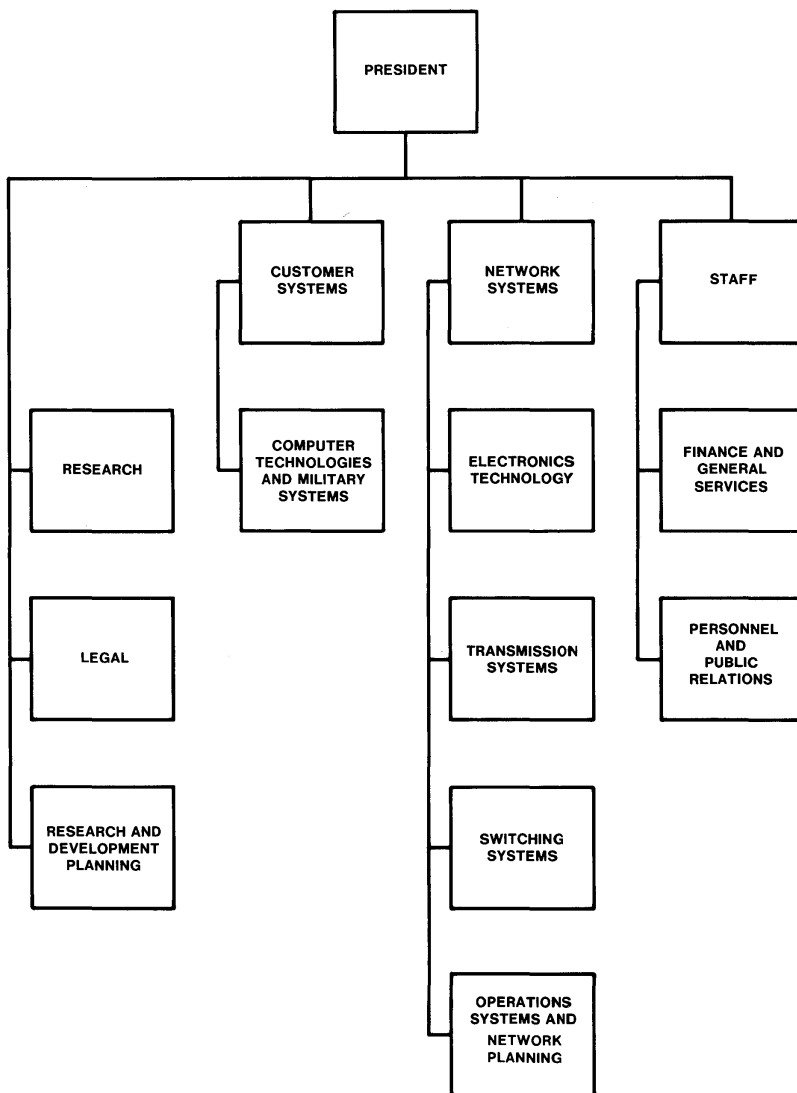

Figure 1-7. Corporate structure of Bell Laboratories (January 1983).

- **Computer Technologies and Military Systems** concentrated on research and development of computer software and hardware and on military systems work. Software development recently became an ever increasing part of the work at Bell Laboratories, and varying

amounts were done in other organizational areas as well. The efforts of the Military Systems Division were devoted exclusively to Western Electric's government contracts.

- **Electronics Technology** developed electronic components for systems of all kinds. It was involved in broad areas of research and development ranging from the design and processing of integrated circuits to lightwave communications subsystems to interconnection hardware and power-conversion systems.
- **Transmission Systems** provided the systems engineering, design, and development of systems to meet needs ranging from loop transmission to long-haul land, satellite, and undersea transmission. Research and development of digital transmission was an important aspect of work in this area.
- **Switching Systems** performed research, planning, and development to maintain, improve, and offer new services on existing switching systems and for planning and developing future switching systems.
- **Operations Systems and Network Planning** developed and designed computer-based systems to support telephone company operations and formulated plans for the effective integration of these systems with each other and with the people these systems support. Network planning encompassed functions involved in the evolution and implementation of the network, determining its configuration to best meet future service needs. The Bell Laboratories' Quality Assurance Center was part of this area. Bell Laboratories set the quality standards for products, and it worked with Western Electric quality assurance organizations to monitor manufacturing operations.<sup>10</sup>
- **Finance and General Services** had a wide range of company responsibilities including corporate auditing and finance, internal communications services, security, and managing buildings and grounds.
- **Personnel and Public Relations** included salary administration, personnel matters, affirmative action, public and employee communications, education, and medicine and environmental health.

In 1982, Bell Laboratories' main facilities for research and development were in New Jersey and Naperville (Indian Hill), Illinois (see Table 1-4). In addition, about 15 percent of the staff of nearly 26,000 people was located at seven Western Electric manufacturing plants. These *branch laboratories* (see Table 1-5) helped coordinate and implement Bell Laboratories' specific development and design functions that resulted in drawings and specifications for the telecommunications and software products

<sup>10</sup> Section 18.7 discusses quality assurance.

**TABLE 1-4**  
**BELL LABORATORIES LOCATIONS (1982)**

Location	Activities
Murray Hill, NJ	Administrative headquarters, electronics technology, basic research in various fields
Holmdel, NJ	Systems planning, network planning, operations systems planning, operations research, quality assurance, switching, transmission, customer equipment, research in communications sciences
Whippany, NJ	Loop transmission, mobile radio systems, interconnection, computing technology, engineering information, electronic power systems, military systems
Indian Hill, IL	Electronic switching, computer technology
Piscataway, NJ	Operations and network systems
Chester, NJ	Field laboratory for outside plant equipment and materials and constructed equipment
Crawford Hill, NJ	Radio and guided wave research
Freehold, NJ*	Business services operations and communications systems engineering
Neptune, NJ*	Engineering for facility networking operations and residence systems, <i>DATAPHONE</i> † digital service field support and exploratory development
Short Hills, NJ	Personnel, public relations, legal, finance and general services
South Plainfield, NJ	Computer program development, new services planning, quality assurance, network performance planning, education
Warren, NJ	Service center for New Jersey locations, stock supply center for all Bell Laboratories locations
West Long Branch, NJ	Switching and transmission engineering, network planning, operations research, quality assurance administration

\* Location became part of American Bell Inc. in 1983.

† Registered service mark of AT&T Co.

**TABLE 1-5**  
**BELL LABORATORIES**  
**BRANCH LABORATORIES (1982)**

Location	Activities
Allentown, PA	Electronic devices, integrated circuits
Atlanta, GA	Wire, cable, glass lightguides, systems for joining media
Columbus, OH	Switching systems
Denver, CO*	Customer switching systems for PBX services
Indianapolis, IN	Telephones, residential terminals and home communications systems
Merrimack Valley, MA	Microwave radio, carrier transmission
Reading, PA	Electronic devices, integrated circuits

\*Location became part of American Bell Inc. in 1983.

that Western Electric manufactures. Bell Laboratories also had field representatives at the headquarters locations of the Bell operating companies. They provided designers with rapid feedback on the quality and performance of new and existing telecommunications equipment.

### 1.2.5 RELATIONSHIPS WITH NON-BELL SYSTEM COMPANIES

Before divestiture, the Bell System served over 80 percent of the 180 million telephones in the United States, encompassing 30 percent of its geographical area. The remaining 36 million telephones were served by more than 1400 telephone companies that were not part of the Bell System. These *independents*, as they are called, worked with each other and interfaced with the Bell System through the United States Independent Telephone Association (USITA).

Through committees representing different aspects of the telecommunications business, USITA served as a focal point for agreements with the Bell System on issues such as routing the long-distance network and sharing revenues. On technical issues, the Bell System prepared network planning information and equipment compatibility specifications and released them to the independent telephone companies through USITA's Equipment Compatibility Committee and Subcommittee on Network

Planning. These releases, called *technical advisories*, ensured that the equipment and systems installed by the independents were compatible with the Bell System network.

Overseas and other international services use high-frequency radio, undersea cable, and satellite links. AT&T, other United States carriers, and foreign carriers share the ownership of some transmission facilities such as undersea cable; and they lease overseas voice circuits from satellite channels provided by the Communications Satellite Corporation (COMSAT). Service agreements with each foreign agency set up the type and extent of service and procedures for dividing revenues, and they establish the criteria for operations such as circuit engineering and quality of service.

The Bell System has participated in technical planning for international coordination through the Comité Consultatif International Télégraphique et Téléphonique (CCITT) and the Comité Consultatif International des Radio-communications (CCIR). These are the technical organs of the United Nations' specialized agency for telecommunications, the International Telecommunication Union (ITU). They function through international committees of telephone administrations and private operating agencies. Their recommendations, although not carrying the force of regulations, are generally observed, and more and more, they are becoming a consideration in system design, particularly for digital transmission and switching.

The Bell System has also worked with manufacturers other than Western Electric (general trade) who sell their products to Bell System companies. Information essential to general-trade manufacturers, specialized carriers, and other communications companies was made available in various documents. These include technical descriptions, technical manuals for Western Electric products, technical references containing interface information and technical standards for all aspects of the network and its operation, and textbooks and manuals used by Bell System designers. The public has also been able to subscribe to periodicals such as *The Bell System Technical Journal*, the *Bell Laboratories Record*, and the *Bell Journal of Economics*.

### 1.2.6 RESOURCES AND VOLUME OF SERVICE

After decades of growth, the goal of universal service has been achieved, and telecommunications services have become an increasingly important part of personal and business activities. Almost 1-½ billion miles of wire and radio paths interconnect almost every home and office in the United States. Over 180 million telephones have immediate, real-time access to each other and to 98 percent of another 315 million telephones in other countries.

As a result of such growth, the Bell System became a very large enterprise. Its size can be viewed from several perspectives: financial measures

such as its revenues and the amount of capital investment or plant, service measures such as the number of telephones and number of calls handled, and a measure of the vast amount of effort required to build and operate the network and deliver its services—the number of employees. Table 1-6 summarizes Bell System resources and volume of service at the end of 1982. To complete the picture, the corresponding figures for the independent telephone companies are also shown.

**TABLE 1-6**  
**RESOURCES AND VOLUME OF SERVICE (1982)**

	Bell System	Independents	Total
Operating companies	22*	1,432	1,454
Employees	1,009,817	192,100	1,201,917
Plant (\$ billions)	158.0	41.5	199.5
Construction (\$ billions)	16.8	4.7	21.5
Access lines (millions)	84.7	21.7	106.4
Central office codes	19,660	11,742	31,402
Local calls (billions)	178.9	67.1	246.0
Long-distance calls (billions)	25.9	6.6	32.5
Average calls/day (millions)	561.1	201.8	762.9
Revenues (billions)	65.1	13.9	79.0

SOURCES: AT&T 1983 and USITA 1983.

\*Excluding Southern New England Telephone Company and Cincinnati Bell, Inc.

### 1.3 THE POSTDIVESTITURE VIEW

#### 1.3.1 SUMMARY OF MODIFICATION OF FINAL JUDGMENT PROVISIONS

The 1982 Modification of Final Judgment (MFJ) requires AT&T to divest itself of the twenty-two Bell operating companies (BOCs). The major provisions of the MFJ are summarized in Table 1-7. Those provisions that significantly affect the conduct of engineering and operations are explained in more detail in the following paragraphs.

The nationwide Bell System network, which was designed, built, and operated as a single unit prior to divestiture, is now divided into two



TABLE 1-7

MAJOR PROVISIONS OF THE  
MODIFICATION OF FINAL JUDGMENT

1. Sufficient facilities, personnel, systems, and rights to technical information must be transferred from AT&T to the BOCs, or to a new entity owned by the BOCs, to allow the BOCs to provide exchange and exchange access services independent of AT&T.
2. Facilities, personnel, and accounts used to provide interexchange services or customer-premises equipment (CPE) must be transferred from the BOCs to AT&T.
3. License contracts between AT&T and the BOCs and the standard supply contracts between the BOCs and Western Electric must be terminated.
4. BOCs may create and support a centralized organization for the provision of those services that can be most efficiently provided on a centralized basis. The BOCs shall provide, through a centralized organization, a single point of contact for coordination of the BOCs for national security and emergency preparedness.
5. BOCs must provide all interexchange carriers with exchange access services equal in type, quality, and price to those provided to AT&T. This "equal access" must be provided on a gradual basis over a 2-year period beginning September 1, 1984. By September 1, 1986, all BOC switching systems must provide equal access, although exceptions may be made for electromechanical switches or switches serving fewer than 10,000 access lines where costs of providing equal access are prohibitive. Any such exceptions shall be for the minimum divergence in access and minimum time necessary.
6. BOC procedures for procurement of products and services, dissemination of technical information and standards, interconnection and use of BOC facilities and services, and planning and implementation of new services or facilities must not discriminate between AT&T and its affiliates and their competitors.
7. BOCs may provide, but not manufacture, CPE after divestiture.
8. BOCs may produce and distribute printed directories after divestiture.
9. With the permission of the court, the BOCs may provide products or services in addition to exchange and exchange access services upon showing that there is no substantial possibility they could use their monopoly power to impede competition in the additional markets.

components: an exchange and exchange access portion provided by the divested BOCs and an interexchange portion provided by AT&T. This division does not correspond to the predivestiture distinctions between AT&T Long Lines and BOC operations, between intrastate and interstate jurisdictions, or between toll and local services. It is based instead on a definition of an exchange used in the MFJ.

Prior to divestiture, the term *exchange area* was used to describe an area in which there was a single, uniform set of charges for telephone service. Calls between points in an exchange area were *local* calls. The MFJ defines an exchange area or exchange to be generally equivalent to a Standard Metropolitan Statistical Area (SMSA), which is a geographic area defined by the United States government for statistical purposes. The MFJ concept is to group large segments of population with common social and economic interests within an exchange.

The territory served by the Bell System has been divided into approximately 160 of these exchanges, which are also referred to as *local access and transport areas* (LATAs). Depending on population densities and other factors, most LATAs serve territories ranging from major metropolitan areas to entire states. Accordingly, LATAs generally contain a number of predivestiture exchange areas.

The predivestiture BOCs performed functions that now represent both inter-LATA and intra-LATA functions. The MFJ specifies that, after divestiture, BOCs offer regulated telecommunications services within LATAs, while AT&T and other interexchange carriers (ICs) offer services between LATAs. Some examples of exchange services offered by BOCs are basic local telephone service for residence and business customers, public telephone services, and intra-LATA operator services. In addition, BOCs offer exchange access services that allow inter-LATA networks provided by ICs to access customers within a LATA and allow end-users to access inter-LATA services. Examples of IC services include inter-LATA and international telephone service and inter-LATA operator services.

In addition to reconfiguring their operations to accommodate the transfer of inter-LATA functions to AT&T, the BOCs must modify the intra-LATA networks to provide all other ICs, at their option, with exchange access equal in type, quality, and price to that provided to AT&T. The quality of exchange access is measured in terms of traffic blocking criteria (see Chapter 5) and transmission performance (see Chapter 6). In addition, BOCs must implement a new national numbering plan that provides exchange access to every IC through a uniform number of digits.

The MFJ prohibits joint ownership of switching systems, transmission facilities, and operations systems (see Chapter 14) by the BOCs and AT&T. All Bell System assets are assigned to one or the other. The MFJ does, however, allow sharing, "through leasing or otherwise," of facilities that support both BOC and AT&T services. Sharing of such multifunctional facilities for a period after divestiture is necessary because of the

impracticality and enormous cost associated with the immediate reconfiguration and separation of the predivestiture Bell System network. After this transition period, BOC and AT&T facilities will be completely separated.

In its Computer Inquiry II decision (see Section 17.4.3), the Federal Communications Commission (FCC) required that all new customer-premises equipment (CPE) be provided by a separate subsidiary on a detariffed basis effective January 1, 1983. Installed CPE and remaining BOC inventories of CPE as of that date were sold or leased by the BOCs during 1983. The MFJ requires that leased CPE be transferred to AT&T at divestiture. After divestiture, BOCs are allowed to provide, but not manufacture, new CPE.

The provisions of Computer Inquiry II and the MFJ have a major impact on the BOC organizations that directly interface with customers for the provision of service and equipment, billing and collections, trouble referral, and other matters. Prior to divestiture, the BOCs provided a single point of customer contact for local and toll services as well as CPE. Under the MFJ, the BOC personnel and associated customer support responsibilities for these services are divided between the AT&T and BOC units responsible for regulated network services or CPE.

Figure 1-1, presented earlier, depicts the predivestiture relationship of the components of the Bell System. Figure 1-8 shows the new corporate structures resulting from divestiture. Sections 1.3.2 and 1.3.3 provide additional information on the organization and functions of the post-divestiture AT&T and BOCs, respectively.

### 1.3.2 THE NEW AT&T

The structure of the new AT&T is shown in Figure 1-8. AT&T Corporate Headquarters sets overall corporate policy and strategy for the other six entities shown. Five of these entities are divided into two sectors: **AT&T Communications** and **AT&T Technologies**, which are responsible for essentially regulated and unregulated activities, respectively. As AT&T gains experience in the new telecommunications environment, organizational structures and activities will be evolving to improve operating effectiveness. Therefore, only a brief summary of each entity is provided in this section.

#### **AT&T Communications**

The business of AT&T Communications is moving information electronically, from customer premises to customer premises, domestically and internationally. Initially, employees were drawn from BOCs, the AT&T General Departments, and Long Lines. At its inception, the company served sixty million residence customers and nearly six million

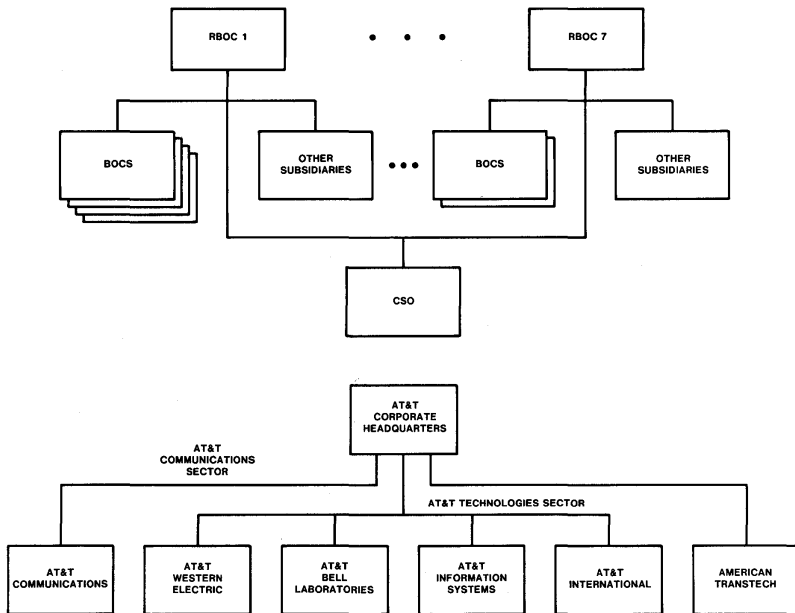

**Figure 1-8. Corporate structures after divestiture.** *Top*, structure of the divested operating companies (the RBOCs and their associated BOCS are identified in Figure 1-9); *bottom*, structures of AT&T.

businesses. As a result of the new regulatory environment, AT&T Communications will provide inter-LATA long-distance services, which include the interstate services previously provided by AT&T Long Lines and intrastate, inter-LATA services. Its goals, highlighted at the beginning of its mission statement, are: "To provide high-quality, innovative, widely available communications services that satisfy customers' needs to move information electronically throughout the United States and the world."

#### AT&T Western Electric

AT&T Western Electric continues in its leadership role as a provider of technologically advanced, high-quality products and services in the telecommunications and information systems markets. These include equipment and systems for telephone companies, consumer products, electronic components, and processors. Further, according to its mission statement, "within this role, AT&T Western Electric has a responsibility to expand its telecommunications business and address new market opportunities...."

### **AT&T Information Systems**

AT&T Information Systems, derived initially from American Bell Inc., develops, sells, and services leading-edge communications products, information management systems, and enhanced services to business customers. It also distributes products for residential and small business customers. Its products, services, and systems reflect the rapid convergence of what were three distinct industries: telecommunications, office equipment, and data processing.

### **AT&T International**

AT&T International, as before divestiture, markets, sells, and services current and future products and services of the AT&T Technologies sector outside the United States.

### **AT&T Bell Laboratories**

AT&T Bell Laboratories provides the technology base for AT&T's future and designs and develops the systems and services needed by AT&T enterprises. This includes basic research and the engineering and design of components, devices, and information and operations systems and services. It also conducts systems engineering work to help identify the best solution to customers' needs. It aids the national defense by making its special capabilities and expertise available to the government.

### **American Transtech**

American Transtech provides and/or packages quality stock transfer and related services for AT&T and regional company shareowners and customers at the lowest reasonable cost. Its mission statement further states: "American Transtech will enter new business opportunities that maximize existing functions and capacity to produce an attractive rate of return and growth."

## **1.3.3 THE DIVESTED OPERATING COMPANIES**

The MFJ allows the BOCs considerable latitude regarding their choice of corporate structure and organization after divestiture. It explicitly states that "nothing in this Modification of Final Judgment shall require or prohibit the consolidation of ownership of the BOCs into any particular number of entities."

After study by a committee of AT&T and BOC officers, the structure adopted (see Figure 1-8) organizes the postdivestiture BOCs into seven regional BOCs (RBOCs). These seven independent corporations wholly own and are supported by a separate central services organization (CSO). These organizational units are described in the following paragraphs. They have no corporate connection with the new AT&T or its affiliates.

### **Regional Bell Operating Companies**

RBOCs were designed to form corporate units with roughly equivalent assets and financial strength. Each RBOC contains from one to seven BOCs that serve the same general region of the country. Figure 1-9 is a map showing postdivestiture RBOC boundaries. The table below the map presents statistics that demonstrate the relative equivalence in size of the seven new corporate units.

The RBOCs operate as holding companies that hold the stock of the BOCs in their respective regions. The RBOCs are free to enter other, unregulated lines of business through the creation of separate subsidiaries. For example, each region has already formed a subsidiary to provide cellular mobile telephone services. Finally, the RBOCs jointly direct the work of the CSO.

### **Bell Operating Companies**

The BOCs offer regulated intra-LATA telecommunications services and exchange access services within their predivestiture operating territories. While the BOCs within each region remain as separate corporations with their own boards of directors and officers, they cooperate to achieve economies of scale possible within the larger, regional framework.

The BOCs in each region have already consolidated certain functions, such as procurement and staff services. In most cases, this has been accomplished through the formation of a Regional Services Company, staffed and managed by the BOCs in the region. The BOCs within a region may also cooperate in financial, strategic, and network planning to meet their obligations to the RBOC that is their parent company.

BOC operations are modified considerably as a result of divestiture. Personnel and organizations that support the provision and maintenance of CPE, inter-LATA telecommunications services, and directory services move to AT&T entities or to other subsidiaries of the RBOCs. While most of the operations functions and organizations described in Chapters 13 through 16 are still present in the BOCs, the details of operations change considerably. The creation of LATAs defines a new set of boundaries for the operation and engineering of the network. Similarly, management and administration of the network are no longer centrally directed by AT&T. Massive transfers of assets and personnel, changes to records and support systems, and modifications to operating procedures were required to accommodate the physical rearrangement of the Bell System and the breakup of its corporate structure.

### **Central Services Organization**

While the MFJ ends the centralized ownership and management of the Bell System and breaks up the vertically integrated structure that combined operations, research, and manufacturing, it recognizes the possibility that the BOCs might still choose to provide certain support functions

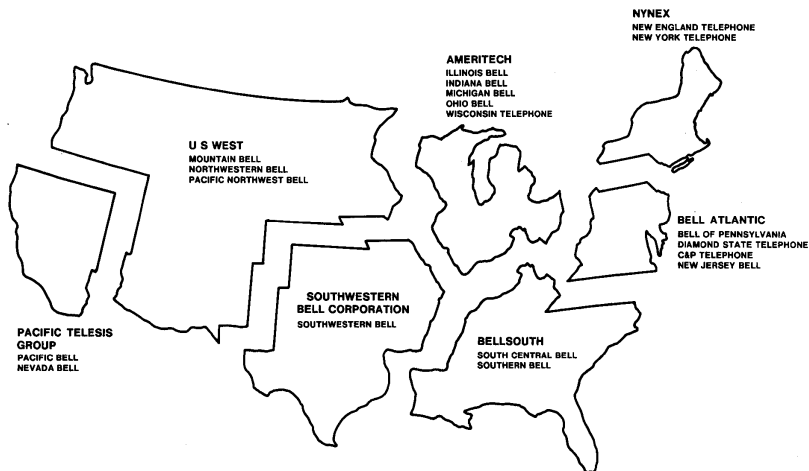

	Estimated Population Served (Millions)	Estimated Number of Employees (Thousands) 1/1/84	Total Assets (\$ Billions) 6/30/83	Estimated Total Access Lines (Millions) 1/1/84	Total Number of Telephones (Millions)
NYNEX Corporation	25	98.2	17.4	12.8	17.4
Bell Atlantic Corporation	27	80.0	16.3	14.2	23.2
BellSouth Corporation	30	99.1	20.8	13.6	23.1
American Information Technologies Corporation (Ameritech)	30	79.0	16.3	14.0	23.6
Southwestern Bell Corporation	21	74.7	15.5	10.3	16.9
U S WEST, Inc.	22	75.0	15.1	10.6	16.7
Pacific Telesis Group	20	82.0	16.2	10.9	15.1

NOTE: Based on Bell System figures for December 1982 except as noted.

Figure 1-9. Regional Bell operating companies.

on a centralized basis. The CSO provides this support. The economies realized by not duplicating certain technical and support functions in each RBOC enhance the financial position of the new companies and reduce the requirements for staffing these highly technical activities. Also, the centralization of certain activities in support of the BOC networks promotes technical compatibility and supports high-quality, nationwide telecommunications service. These activities also facilitate the introduction of new technology into a national network managed by a number of totally independent corporations.

Consistent with the intent of the MFJ, the work of the CSO is directed by the RBOCs. The CSO is owned equally by each of the seven RBOCs, and its board of directors is composed of BOC and RBOC officers. CSO work plans and budgets are determined by a committee structure that includes RBOC representatives at all levels of management.

During 1982, the BOCs determined the initial set of functions to be performed by the CSO. The vast majority of these functions are technical in nature. These technical support functions include:

- *network planning*, which includes analysis and planning for new technologies and services, participation in the development of network standards, and operations systems planning
- *engineering and operations support* related to procedures and standards for network operations and quality assurance implementation
- *information systems development* for the many current operations systems whose development is assigned to the CSO and for future systems
- *technology systems*, which includes generation of generic requirements for equipment, technical analysis of products for the network, and quality assurance methods
- *applied research* in the physical sciences, mathematics, computer science, network technology, and new services.

The CSO also provides support for the BOCs in areas such as market research, regulatory matters, and other financial and administrative matters. The initial staff of the CSO is drawn primarily from Bell Laboratories, AT&T, Western Electric, and the BOCs.

#### AUTHORS

J. A. Civarra  
B. R. Eichenbaum  
J. A. McCarthy  
J. A. Schelke





# 2

---

## Services

### 2.1 INTRODUCTION

Like other aspects of the Bell System, services are dynamic: New services are introduced frequently in response to evolving customer needs and the capabilities of new technology. Consequently, at any given time, there are many new services in various stages of planning and development. This chapter covers only services currently available and some services with an announced availability date. The next few paragraphs discuss some general concepts and terminology related to services, followed by descriptions of specific services.

#### 2.1.1 BASIC AND VERTICAL SERVICES

The concept of basic and vertical services has been central to the Bell System's role as a regulated monopoly providing telecommunications services. For several decades, **basic service** has been coupled to the Bell System's goal of universal service (see Section 17.4.1), that is, that telephone services should be available to every home in America at an affordable price. Basic service represents that universally available and affordable service.

Basic residence service, for example, generally implies that, for a fixed monthly charge, a customer receives the following:

- a standard, rotary-dial telephone set
- on-premises wiring
- a network access line—the connection to a local switching system for local calling and for access to the network
- a listing in the white pages of a directory.

All other services have been classified as **vertical services** for which customers pay a charge that is additional to the cost of basic service. Vertical services may provide greater convenience, more attractive telephone sets, or additional functions or features beyond basic service. Traditionally, revenues from vertical services have helped to maintain an affordable price for basic service. However, as competition replaces regulation in the telecommunications business, the price of a particular service will become more closely related to the cost of providing that service.

Section 2.2 describes vertical services related to station equipment. Section 2.3 describes customer switching services, vertical services used almost entirely by business customers. Sections 2.4 and 2.5 describe vertical services available through access to the network.

### 2.1.2 ORDINARY AND SPECIAL SERVICES

From the telephone company viewpoint, services are classified as **ordinary** or **special**. *Ordinary services* usually include residence service, public telephone service, mobile telephone service, and basic individual-line business services. All other services are considered *special services* (often called *specials*). Special services require special treatment with respect to transmission, signaling, switching, billing, or customer use and are used mostly by business customers. The overall demand for special services is growing twice as fast as the demand for ordinary telephone service.

Examples of special services described in this chapter include foreign exchange service, Wide Area Telecommunications Services, private branch exchange, and centrex services, and private-line and private network services. There are about twenty-five major categories of special services.

Facilities provided by the Bell System for other communications firms form an important and rapidly growing class of special services. These offerings include local distribution capability, interoffice facility sections, and access to the Bell System network for resale carriers and other common carriers (OCCs), including domestic satellite carriers, international record carriers,<sup>1</sup> and local radio common carriers. To provide communication services to their customers, these competing firms use Bell System facilities in conjunction with their own facilities or with facilities rented from independent telephone companies. Facilities offered to other carriers parallel the wide variety of general special services that the Bell System provides to its own customers: voice, data, telegraph, and television.

<sup>1</sup> *International record carriers*, such as International Telephone and Telegraph, RCA Global Communications, and Western Union, offer data and message services (like telex) internationally.

## 2.2 TERMINAL PRODUCTS

Terminal equipment is the principal interface between the customer and the nationwide telephone network. It ranges from the basic telephone set, which provides voice services, to the more versatile and specialized equipment that can link with computers and provide additional services such as data and graphics transmission.

This section describes terminal equipment available from the Bell System. In the past, all Bell System terminal equipment was leased to customers, but now, as the result of an order issued by the Federal Communications Commission (FCC) in 1975, customers have the option of purchasing it (see Section 2.7). Customers may purchase and install equipment from any manufacturer, provided the sets meet certain registration requirements (see Sections 8.7 and 11.1.2).

### 2.2.1 TELEPHONE SETS AND VERTICAL SERVICES

The telephone set is an important element of the communications network and provides access to a variety of services. The traditional rotary-dial set is available in desk and wall models and in various colors. It represented approximately 50 percent of all residential sets in service in 1980.

A number of premium telephone sets and decorator telephones are also available. (Figure 2-1 shows a group of *DESIGN LINE*<sup>2</sup> and other decorator telephones.) Premium sets have special features that make the use of the telephone more convenient or pleasant and provide the same access to the network as standard sets. There is an additional charge for premium sets, an example of a vertical service. The *PRINCESS*<sup>2</sup> telephone, a premium telephone introduced in 1959 as the "bedroom set," offers special features such as a lighted dial and a night light. The *TRIMLINE*<sup>2</sup> telephone features the dial in the handset and a "recall" button that allows the user to make consecutive calls without hanging up the handset.

*DESIGN LINE* decorator telephones use the same internal components as standard rotary or *TOUCH-TONE*<sup>3</sup> telephones but have distinctive housings. These sets are sold outright to the customer—there is no monthly service charge—and are covered for a limited warranty period. After this period, customers can purchase a maintenance contract for the internal mechanism.

<sup>2</sup> Registered trademark of AT&T Co.

<sup>3</sup> Trademark of AT&T Co.



Figure 2-1. Some *DESIGN LINE* and other decorator telephones, including designs from non-Bell manufacturers.

Other vertical services related to telephone sets are *TOUCH-TONE*<sup>4</sup> dialing and extension phones. *TOUCH-TONE* dialing is faster and more convenient for the customer. Faster dialing also offers advantages to the Bell System, because switching equipment is more quickly available for other calls. *TOUCH-TONE* dialing will be required for many telephone

<sup>4</sup> Registered service mark of AT&T Co.

services that are expected to grow in the future, for instance, banking by telephone and other services that require access to a computer.

Extension phones make single-line telephone service in the home more convenient. In addition, the use of a second telephone line is becoming more prevalent. A series of 2-line sets that provide hold and signaling features is now available. A customer can place one call on "hold" and answer a second call, or the customer can signal another person in the house that there is an incoming call on the second line.

### 2.2.2 MODULAR TELEPHONES AND RETAIL SALES

The telephone sets now available from the Bell System are *modular*. A modular set has plug-ended cords that connect the telephone base to the handset and wall connector, permitting installation and removal by the customer. Modular sets provide the customer with faster and more convenient service because customers can pick up these sets at retail sales locations and do not need to schedule installation (see Section 2.7.1). This also avoids the cost of a home visit.

### 2.2.3 DATA PRODUCTS

As computers and other sophisticated business machines become more commonplace, data transmission is becoming an increasingly larger part of almost all business communications. For many years, the Bell System has offered a wide variety of data products to satisfy the needs of customers. This section describes two general categories of data products: **data sets** and **data terminals**.

#### Data Sets

Digital computers and various types of data terminal equipment produce data in digital form, that is, as a sequence of discrete electrical pulses. While digital transmission facilities, which transport data in digital form, are rapidly being deployed in the telecommunications network, analog transmission facilities, which transport data as continuous electrical waves,<sup>5</sup> still represent a greater share of the total network. *Data sets* (also called *modems*) provide the conversion and control functions required to transmit digital data over analog facilities. The Bell System has a number of *DATAPHONE*<sup>6</sup> data sets available with different capabilities and

<sup>5</sup> Chapters 6 and 9 discuss digital and analog transmission.

<sup>6</sup> Registered trademark of AT&T Co.

features suitable for a wide range of applications. Section 11.1.2 contains a functional description of data sets and some of the specific types and characteristics.

In general terms, the *DATAPHONE* data communications service categories associated with *DATAPHONE* data sets are based on the type of analog facilities used: narrowband, voiceband, or broadband;<sup>7</sup> private line or switched. Data sets are primarily categorized by the data transfer rates they provide:

- low speed — up to 300 bits per second (bps)
- medium speed — 300 bps to 9600 bps (9.6 kbps)
- high speed — over 9.6 kbps.

In the case of the public switched telephone network (PSTN), including Wide Area Telecommunications Services and foreign exchange lines (see Section 2.5.1), *DATAPHONE* data sets permit customers to send data between any two locations served by the network at speeds up to 4.8 kbps. A telephone set is used for setting up the channel and for alternate voice communications. The calling and answering can also be controlled automatically by the customer's computer or data terminal. Automatic calling and answering take place through appropriate interaction with the data sets and associated *automatic calling units*. These units dial, connect, and terminate calls.

*DATAPHONE* data communications service is also provided on voiceband private lines. In this service, as with *DATAPHONE* data communications service for PSTN applications, a *DATAPHONE* data set is used on the customer's premises. Arrangements can be added to permit voice communications on the private lines and to permit access to the PSTN for service backup in case of a private-line outage. Voiceband private-line configurations can be point to point or multipoint; the latter is more prevalent. Speeds up to 9.6 kbps are offered.

*DATAPHONE* II data communications service, the most recent offering on voiceband private lines, employs a series of advanced microprocessor-based data sets. These sets provide considerable built-in diagnostic, testing, and on-line monitoring capabilities for a data network using diagnostic control devices at a customer's central computer site. (See Figure 2-2.) This capability is particularly important to customers such as airlines and banks who have data networks with real-time applications. These customers purchase terminals, computers, etc., from many suppliers, and they must quickly identify the vendor responsible for fixing a trouble.

<sup>7</sup> See Section 6.2.1.

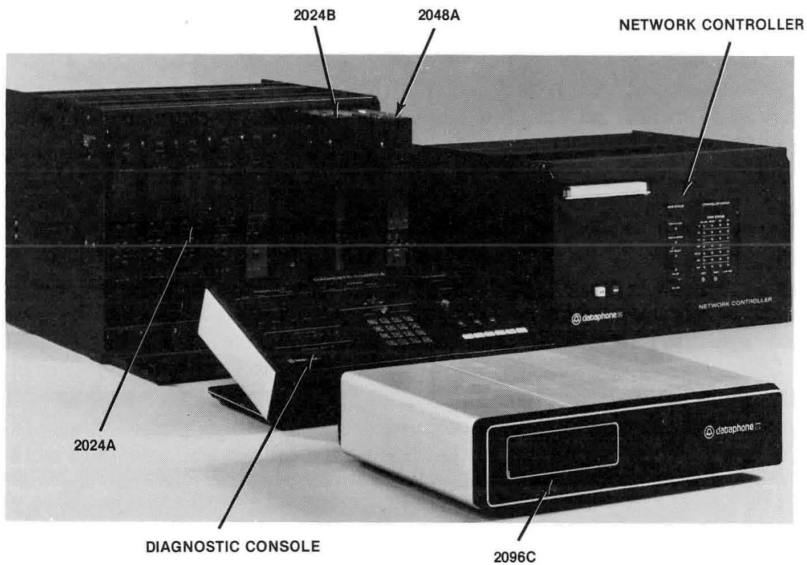

Figure 2-2. The DATAPHONE II data communications service new family of data products includes data sets, a diagnostic console, and a network controller.

High-speed data sets are used with analog broadband services. Both point-to-point private-line and switched offerings are provided. Speeds on broadband private-line channels range from 19.2 to 230.4 kbps. Broadband services find the greatest use in applications involving computer-to-computer transmission of large amounts of information.

The Bell System also provides several auxiliary sets for use as adjuncts to data sets. The automatic calling unit mentioned earlier is a commonly used auxiliary set. Other data auxiliary sets perform functions such as signal conversion and testing.

### Data Terminals

Data terminals are the end points in data communications. They originate and/or receive data transfers. Teletypewriter, telegraph, and remote metering terminals can be used with low-speed data sets to transmit data on narrow-bandwidth analog circuits. Cathode-ray tube (CRT) terminals, certain teletypewriters, and line printers along with medium-speed data sets use voiceband private lines or the PSTN for data transfer. Some



facsimile terminals, CRT terminals, and high-speed line printers are connected to high-speed data sets to transmit and/or receive data over broadband analog channels.<sup>8</sup>

The outputs from a number of terminals, each connected to a *data service unit*, may be multiplexed (combined) for transmission over the **Digital Data System (DDS)** network, which is described in Section 11.6.1. The data service units perform functions similar to those performed by data sets, except that conversion between analog and digital formats is not required since the DDS provides end-to-end (terminal-to-terminal) digital transmission. Computers may also appear as high-speed data terminals connected to the DDS network via an appropriate data service unit. The service provided the DDS network is called *DATAPHONE digital service* (see Section 2.5.4).

The Bell System offers many different types of terminals. Some of the more recent offerings are in the *DATASPEED*<sup>9</sup> terminal set line (shown in Figure 2-3), a collection of high-speed data communications terminals that includes CRT terminals, line printers, and intelligent interactive input/output terminals. (Intelligent terminals typically contain logic and memory capability.) New disk storage devices, offered with certain



**Figure 2-3.** *DATASPEED 4540 line of data terminals.*  
(Courtesy of Teletype Corporation)

<sup>8</sup> Table 2-1 in Section 2.5.2 lists narrowband, voiceband, and broadband offerings.

<sup>9</sup> Registered trademark of AT&T Co.

teleprinter and CRT terminals, permit message preparation and storage to improve interaction with a remote host computer. Section 11.1.3 provides more details on these data terminals.

#### 2.2.4 SPECIAL-PURPOSE TERMINALS

Special telephone sets and auxiliary equipment make other services available to both residential and business customers. One such service is automatic dialing from a directory of stored numbers. Some telephones use punch-coded cards (card dialers). Others, like the *TOUCH-A-MATIC*<sup>10</sup> S repertory dialer, automatically dial a number at the touch of one button. The repertory of numbers is stored in electronic memory (see Figure 2-4). Many of these telephones automatically store the last

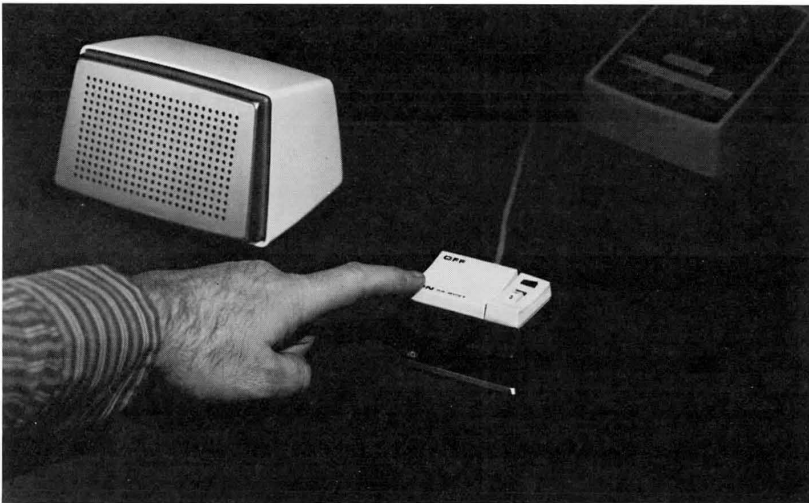

**Figure 2-4.** *TOUCH-A-MATIC S* series telephone, the Bell System's first microprocessor-based telephone for the home. Important or frequently called numbers can be dialed at the touch of a button. Red and green buttons at the top of the panel identify emergency numbers.

<sup>10</sup> Registered trademark of AT&T Co.

manually dialed number and redial it when the user pushes a button. Some designs have lights on their panels to help locate emergency numbers.

Auxiliary equipment, including hands-free telephone equipment together with electronic graphics, is also available for teleconferencing between two or more groups. The **4A speakerphone**, which is used by both residence and business customers, has an omnidirectional microphone and an adjustable loudspeaker to permit hands-free conversation and allow a group of people to participate in a conversation (see Figure 2-5). Portable conference telephone units are available for conferences or for communication between a student confined at home and a classroom.



**Figure 2-5. 4A speakerphone.** The loudspeaker is at the left. The transmitter unit has a volume control, an ON/QUIET-OFF switch, and a solid-state ON/OFF indicator light. The microphone is located under the switches.

The *GEMINI*<sup>11</sup> 100 electronic blackboard system uses a graphics transmission terminal that can send handwriting over conventional voice-grade telephone lines. It can be used for remote teaching and teleconferencing at a number of different locations simultaneously. (See Figure 2-6.)

<sup>11</sup> Registered trademark of AT&T Co.

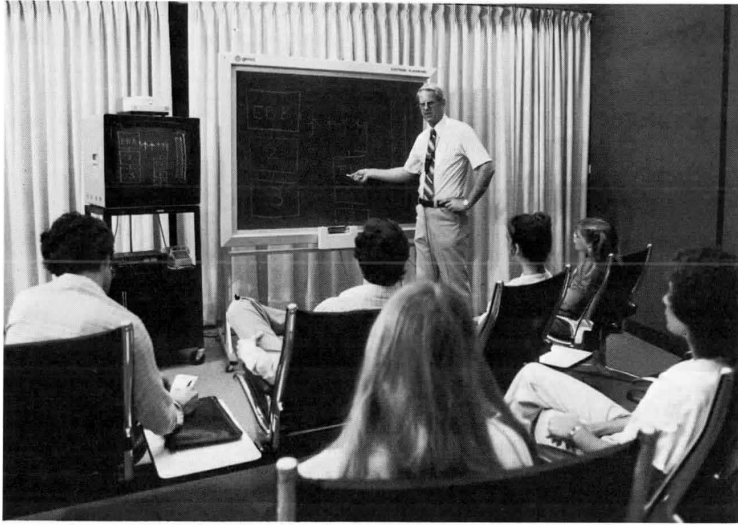

Figure 2-6. A demonstration of the *GEMINI 100* electronic blackboard.

Special-purpose terminals for business customers, like the **Transaction** telephone, can automatically dial a non-Bell System credit service center or data base for credit authorization or check verification. In a typical transaction, a cashier slides two cards (the merchant's identification card and the customer's credit card) through a magnetic strip reader in the telephone set (see Figure 2-7) and then keys in the sale price on a *TOUCH-TONE* telephone dial pad. The terminal automatically dials a computer in a bank or credit agency and obtains a purchase authorization as an audio response, a light, or a visual display.

### 2.2.5 AIDS FOR THE HANDICAPPED

Special Bell System equipment gives disabled persons access to basic telephone service. Someone with impaired mobility may find automatic dialing telephones and speakerphones easier to use than standard sets (see Section 2.2.4). For people who have lost the use of their larynx, or voice box, there is the **artificial larynx** (invented at Bell Laboratories in 1929), which replaces the vibrations of normal vocal cords with electronically controlled vibrations that can be formed into words (see Figure 2-8).

Several different aids are available to persons with impaired hearing. Among these are amplifying handsets, sets with tone ringers, and sets



Figure 2-7. The Transaction III terminal with a Transaction printer.



Figure 2-8. The artificial larynx in use.

that can be equipped with loud bells. The *CODE-COM*<sup>12</sup> set converts sound into either visual signals—a flashing light—or tactile signals—a vibrating disk (see Figure 2-9). To alert a deaf person to an incoming call, an ordinary household lamp may be plugged into the *SIGNALMAN*<sup>12</sup> relay switch, which causes the lamp to flash on and off. Alternatively, an electric fan can be plugged into the unit to signal someone who is both deaf and blind by blowing air on the person.



**Figure 2-9. COM-CODE set for the handicapped.** When connected to conventional telephones, this device allows a deaf person to receive messages via flashes of light or vibrations. The circular vibrating pad is shown on the left of the device, the sending key, which is used like a telegraph key, on the right. Light flashes come from a recess (the black rectangle) to the left of the bell symbol.

<sup>12</sup> Trademark of AT&T Co.

## 2.3 CUSTOMER SWITCHING SERVICES

The term *customer switching service* describes an arrangement that permits flexibility in the connections between one or more telephone lines and one or more station instruments.<sup>13</sup> Services can be tailored to the individual needs of the customer and may involve additional equipment either on the customer's premises or in a central office.

### 2.3.1 CUSTOMER NEEDS

Customer switching services are provided primarily for business customers, although the communications needs of some very large residences may overlap those of a small business. This section discusses only business applications.

While the specific communications needs of business customers depend on the size and nature of their businesses, for discussion purposes, these requirements may be divided into four broad categories: **intralocation calling, incoming calls, outgoing calls, and communications management.**

The first requirement is *intralocation calling*. Many businesses need to communicate between stations on the same premises. This is known as *intercom calling*. For voice communication, intercom calling may mean calls between people in different offices, access to an on-premises paging system, or dial access to a customer-owned recorded dictation system. For data communication, it may involve communications between a terminal and a computer or another terminal on the same premises.

The second category involves varying requirements for handling *incoming calls*. For business customers, incoming calls are important since they often represent new or additional business. Most customers, therefore, want to present a good telephone image to calling parties. This usually means having enough lines and attendants to ensure that incoming calls are promptly answered and efficiently passed to someone who can help the calling party.

The third requirements category concerns *outgoing calls*. The importance and nature of outgoing communications are, of course, a function of the customer's business. When employees spend a significant part of their workday making telephone calls, it is important to make those communications as convenient and friendly as possible. Station equipment with button-operated features and switching systems with automatic call-processing routines meet these needs. Control of outgoing call possibilities from selected lines may also be important to avoid abuses.

<sup>13</sup> Two or more telephone instruments permanently connected to a single telephone line is *not* a customer switching system.

The fourth category concerns the different needs of businesses in *managing communications*. Since communications can be a major expense, many customers have one or more managers in charge of communications facilities. To help these people do an effective job, modern equipment furnishes them with management information (data) about the use and performance of the communications service it provides.

The rest of Section 2.3 discusses the service needs of small-, medium-, and large-size business customers as well as the needs of some special customers.

### 2.3.2 SMALL-SIZE BUSINESS CUSTOMERS

The small business customer may be a doctor, a realtor, or a car dealer, for example. The needs of these customers are relatively simple. For incoming service, they need one or a few incoming lines. Depending on the nature of the business, these lines may be in one group accessed by a single listed directory number, or they may be individually listed so that the calling party can dial a specific number to reach a specific line. On the customer's premises, calls will be either answered at a central location and then passed to the desired person or answered at the specific dialed locations. In the latter case, there will be less need for call passing.

Call passing can be done in several ways. The desired person may be paged and requested to pick up a specific line. Another method uses switching system features that permit the transfer of the call to a telephone near the person.

In very small customer applications, where face-to-face communication is usually quite convenient, station-to-station intercom calls are often not required. These applications, however, may need paging or intercom calling to accomplish call passing. Some means may be required to hold an ongoing call temporarily so that a person may talk privately to someone else or answer another call.

The small business customer's outgoing call requirements are also simple. Like residence customers, most small business customers use their line(s) for both incoming and outgoing calls and are billed for each toll call they originate. Control of outgoing calls is also of minimal concern to the small customer because the person responsible for telephone charges can personally discuss problems with the individuals involved.

The needs of small business customers are often met by *key telephone systems*, which allow the station user to originate or answer a call on one of several lines by operating a button (*key*), and provide features such as hold, intercom calling, and message-waiting lights. Modern small communications systems (see Section 11.2.2) using integrated circuit technology, multibutton electronic telephones, and microcomputer control provide numerous additional features under software control.



### 2.3.3 MEDIUM-SIZE BUSINESS CUSTOMERS

The medium-size customer may be a business occupying a small office building, a manufacturer, or a municipal office such as a police station. An attendant at a central answering position most often handles incoming calls to the 20 to 200 on-premises lines representative of a medium-size customer. The physical size of this customer's organization makes convenient intralocation station-to-station calling more important, and outgoing traffic can range from a modest communications activity to a major one. Typically, management of communications services for this size customer is a part-time assignment for one person.

The customer switching service most often provided for medium-size business customers is known as a *private branch exchange* (PBX) service.<sup>14</sup> A PBX is a relatively small telephone switching system (*exchange*) located on the customer's premises (*private*) and connected to a central office (as a *branch*). The basic features of a PBX provide for the central answering position, convenient station-to-station intercom calling, and whatever special incoming and outgoing call features are necessary.

Customers in this size category often make and/or receive a substantial volume of calls to or from one or more distant areas of the country. To meet the needs of these customers, the Bell System offers **Wide Area Telecommunications Services** (WATS), which are described in Section 2.5.1. With WATS, calls to relatively large geographic areas are billed on a bulk basis rather than individually. The actual cost of a given call can therefore vary considerably depending on both the area called and the type of outgoing line—WATS or regular direct distance dialing (DDD)—selected.

In most cases, a medium-size customer will have a small number of different outgoing lines to access various geographic areas. Station users can then usually select the most economical line (that is, the most economical route or service) for their calls, depending primarily on the call's destination. Station users can be provided with a map or a list of area codes as the basis for selection. Other factors that may influence route selection include the time of day and whether any outgoing lines, such as WATS lines, are already busy.

In more complex installations, route selection by the individual station user is often not practical. Installations like these with calls to many geographic locations and with a greater number of different outgoing lines usually require outgoing calls to be placed through attendants. The attendants are specially trained to select the optimal route. In the most modern PBXs, this function can be performed by a computer within the PBX using software programs to provide a feature known as *automatic route selection* (see Section 2.3.4).

<sup>14</sup> To distinguish from early manual cord boards, current automatic systems are sometimes called *private automatic branch exchanges* (PABXs).

PBX service also meets other needs of the medium-size business customer. For example, it is usually possible to transfer a call from one station to another or to have a secretary pick up a telephone that is ringing in another office. As an alternative to PBX service, which is a customer switching service, a medium-size customer may select an exchange service (see Section 2.4), known as *centrex* service, that provides a PBX-type service.

### 2.3.4 LARGE-SIZE BUSINESS CUSTOMERS

Large customers have from about 200 to 10,000 or more lines. Typical locations are headquarters buildings, large banks, and combined design and manufacturing locations. At this size, centralized answering becomes less attractive, and a means of direct inward dialing<sup>15</sup> (DID) to station lines is often provided. Intercom calling is more important, and outgoing calls become a major concern. Most large customers also have some requirement for digital data communications on the same premises. All of these needs are satisfied by large PBXs.

The number of outgoing calls from a large system usually justifies the purchase of special long-distance facilities such as WATS lines and **foreign exchange** (FX) lines (see Section 2.5.1) that go directly to frequently called areas served by a distant central office. To use these special facilities in the most efficient way, modern PBX systems provide *automatic route selection*, a service that automatically analyzes a dialed number and selects the least-cost type of line (that is, type service) available for the call. Special arrangements are also available to distribute a relatively large number of incoming calls efficiently to a special group of lines (such as a customer service department).

In large companies, millions of dollars per year may be spent on communications. For this reason, large companies assign a small staff to manage communications services. The PBX system must provide management information for use by this staff. Modern systems not only can collect general data on system traffic (calls) but also can make a detailed record of each outgoing call, so that the costs of the communications facilities can be allocated to users.

### 2.3.5 SPECIAL CUSTOMERS

An airline reservation center is an example of a special customer. This type of business has a large number of incoming calls that must be evenly distributed among the reservations agents. *Automatic call distributors* (ACDs) provide this service. The operating costs and performance of an ACD greatly depend on having the correct number of agents on hand

<sup>15</sup> With *direct inward dialing*, the telephone number of the called party can be dialed directly; the call need not be passed by an attendant.

at all times. For this reason, modern ACDs also provide the customer with traffic data (in either raw or processed form) that can be used to manage the work force.

Another special customer is the telephone answering bureau, which answers other people's (clients') telephone calls. Historically, these customers have been served by providing the bureau with an extension of the client's phone. However, the service can now be implemented by means of a *Call Forwarding* feature available in modern electronic switching systems. With this feature, calls can be redirected (or "forwarded") from the original number to a special line at the answering bureau, where messages are taken for relay to the client. (See Section 11.2.7.)

## 2.4 EXCHANGE SERVICES

The term *exchange services* describes those services provided through the local or exchange area network. Access to the network and its services is obtained by one or more lines that connect the customer's station set(s) to the central office. Customers can choose from exchange services that range from basic local calling with standard rotary-dial telephones to PBX-like business services.

### 2.4.1 EXCHANGE LINES AND LOCAL CALLING

A single business or residence line connected to a rotary-dial telephone provides basic exchange services such as **local calling** and the **911 Emergency Service** described in the next section. *Local calls* are calls to any customer in the local calling area of the calling customer's central office. A *local calling area*, or *exchange area*,<sup>16</sup> is a geographic area within which a strong community of interest exists (that is, heavy calling volume among customers within the area). It may be served by several central offices. Basic exchange service also includes operator assistance on local calls and directory assistance<sup>17</sup> (see Section 2.5.1). This basic service is typically provided under a tariff<sup>18</sup> that allows the customer either flat-rate or measured-rate billing. With flat-rate billing, the customer can make an unlimited number of local calls for a fixed monthly charge. With measured-rate billing (also called *measured service*), the customer pays a lower fixed rate plus an additional charge for all local calls in excess of a

<sup>16</sup> This discussion is based on the traditional definition of exchange areas. The term was used with a different meaning in the 1982 Modification of Final Judgment.

<sup>17</sup> Some companies now charge for directory assistance calls when they exceed a fixed monthly allowance.

<sup>18</sup> *Tariffs* are rates and conditions for various telephone services (see Section 17.3).

specified monthly allotment. The trend in the Bell System is toward measured service.

In some locations, a customer may have the option of subscribing to single-party or multiparty service. With multiparty service, the line is shared by two or more customers; however, only one party may use the line at a time except when a call is between two customers on the line. Various ringing combinations are provided to indicate the destination of incoming calls. In 1981, about 97 percent of the Bell System was single party, with the trend toward total single-party service.

#### **2.4.2 CUSTOM CALLING SERVICES I**

Custom Calling Services I is a group of four features that take advantage of the stored-program control of electronic switching systems (see Section 10.3.1): **Call Waiting**, **Call Forwarding**, **Three-Way Calling**, and **Speed Calling**.

##### **Call Waiting**

This feature allows a customer engaged in a call to be reached by another caller. A short tone informs the customer that another call is waiting to be accepted. The tone is heard only by the Call Waiting customer; the caller hears the regular audible ringing. The customer can place the first call on "hold" and answer the second call by momentarily depressing the switchhook ("flashing"). By subsequent flashes of the switchhook, the customer can alternate between the two calls.<sup>19</sup>

##### **Call Forwarding**

This feature allows customers to "forward" their calls to another telephone number, which they designate by dialing a special code sequence. While Call Forwarding is activated, all incoming calls to a customer's telephone line are automatically transferred to the designated telephone.

##### **Three-Way Calling**

This feature allows a customer involved in an existing 2-way connection to place the other party on hold and dial a third party for a 3-way connection. When the third party answers, a 2-way conversation can be held before the earlier connection is re-established for the 3-way conference.

<sup>19</sup> In some business services provided by electronic switching systems, the procedures related to Call Waiting may be different.

## Speed Calling

This feature allows a customer to use abbreviated codes to dial frequently called numbers. Repertories of eight (using a 1-digit abbreviated code) and thirty (using a 2-digit abbreviated code) stored numbers are available.<sup>20</sup> Speed Calling customers who also have the Customer Changeable Speed Calling option can assign their own Speed Calling codes to telephone numbers directly and immediately from their own telephones.

### 2.4.3 TOUCH-TONE SERVICE

*TOUCH-TONE* service replaces the customary dial pulses with tones for network signaling. As a pushbutton is depressed, two tones are generated simultaneously and the combined signal, which is clearly audible to the caller, is transmitted to the central office. Special receivers located in the central office convert the signals into a form that can be used by the switching system. *TOUCH-TONE* service provides customers with improved speed and convenience in dialing, reduces the number of digit receivers required by the central office because faster dialing uses the digit receivers for a shorter time per call, and provides the capability for end-to-end signaling once a call is established. End-to-end signaling (a capability that does not exist with rotary-dial service) allows a customer at one end of a connection to control dictation units and access data bases at the other end of the connection. The use of *TOUCH-TONE* service is increasing and will be the dominant method of customer signaling in the future.

### 2.4.4 EXCHANGE BUSINESS SERVICES

Business services offered from the exchange network satisfy many of the same business customer communication needs served by the PBX and automatic call distributor (ACD) services described in Section 2.3. With PBX and ACD services, individual customer lines connect to switching equipment on the customer's premises, and the switching equipment connects to a switching system in a local central office. With the corresponding exchange services, all of the customer's subscriber lines are directly connected to the central office, thus reducing the amount of equipment required at the customer's premises. At the central office, software or wired logic indicates which subscriber lines are part of the customer's group. By providing special features in the central office for this group of lines, both PBX-type and ACD-type services can be emulated.

<sup>20</sup> These numbers may be different in some electronic switching system business services.

The primary business services offered from the exchange network are centrex, *ESS*<sup>21</sup>X-1, and *ESS-ACD*.<sup>22</sup> Centrex and *ESSX-1* provide the same basic service elements:

- A member of a centrex or *ESSX-1* group can dial another telephone number within the same group using only one to five digits.
- A member can dial calls outside the group directly, typically after dialing an access code, such as the digit 9.
- A member can receive calls that originate outside the group directly. No attendant is needed.
- Attendant positions can also be provided to allow central answering positions on the customer's premises to answer, hold, and route incoming calls to the group when the main centrex or *ESSX-1* telephone number has been called.

With *ESSX-1* service, the number of simultaneous incoming and outgoing calls and the number of simultaneous intragroup calls are limited by software to sizes specified by the customer. For centrex, however, the only limit is the call-handling capacity of the switching system.

The exchange service counterpart to ACD service (see Section 2.3.5) is called *ESS-ACD*. It is a specialized form of centrex service in which central office equipment, specifically an electronic switching system, distributes incoming calls to attendant lines. Typically, ACD attendants work full time receiving and servicing incoming calls (for example, making airline reservations). Therefore, in order to keep attendant positions efficiently loaded, there are generally fewer active attendants than the maximum number of simultaneous incoming calls.

With *ESS-ACD*, the central office distributes calls uniformly to the attendants, thus spreading the workload to minimize caller delay and maintain attendant efficiency. If no attendant is available, the central office will queue calls in order of arrival (see Section 5.2) and distribute them as attendants become available.

Additionally, specially designed customer-premises equipment and data links between the central office and the customer location make a large variety of management information, control, and status display features available. A customer can use statistical performance information and control capabilities to adjust the number of active positions and thus the average time a caller waits before reaching an attendant.

<sup>21</sup> Trademark of Western Electric Co.

<sup>22</sup> *ESSX-1* and *ESS-ACD* are services provided by the 1ESS switching equipment.

### 2.4.5 911 EMERGENCY SERVICE

911 Emergency Service is designed to provide free emergency calling capability to the general public and is used in conjunction with dial-tone-first service.<sup>23</sup> The cost of implementing and maintaining the service is typically paid by county and state governments. With 911 Emergency Service, a single, easily remembered telephone number accesses a variety of emergency agencies. The service was established by the Bell System in 1968 in response to a recommendation by a Presidential Commission on Law Enforcement and Justice. The Commission had recommended that "wherever practical, a single (police emergency) number should be established."

Originally, 911 systems simply routed emergency calls to a centralized answering point. Later, features were added to this **Basic 911** (B911) service to provide for forced disconnect of the calling line (to prevent tying up the emergency center with nonemergency calls); holding the connection regardless of the calling party's action; emergency ringback to the calling station; and a visual and audible indication of the switchhook status of an established 911 call.

The major difficulty in implementing B911 systems is that, in many places, the boundaries of emergency agencies do not coincide with the boundaries of the local areas served by a telephone company. In some places, one local area may have twenty or more different combinations of emergency jurisdictions. When this happens, emergency calls must be selectively routed to the correct emergency agency based on the location of the calling party. The **Enhanced 911** (E911) provides the routing logic required to solve this problem (see Figure 2-10). Other features available with E911 include the ability to display the telephone number and the address of the calling party at the public safety answering point (PSAP), generally, a police station.

Approximately 800 B911 systems covering 25 percent of the population of the United States were in service by 1980, along with a total of 8 E911 systems covering a population of nine million. The potential exists for over 100 E911 systems to be in service by 1986. More efficient handling of emergency calls with these 911 systems will undoubtedly result in significant savings in life and property.

## 2.5 NETWORK SERVICES

In addition to exchange services, which are limited to the capabilities and resources of the exchange area network, the Bell System offers network services that make use of the broad capabilities of the PSTN, including

<sup>23</sup> Section 2.6 describes public telephones and dial-tone-first service.

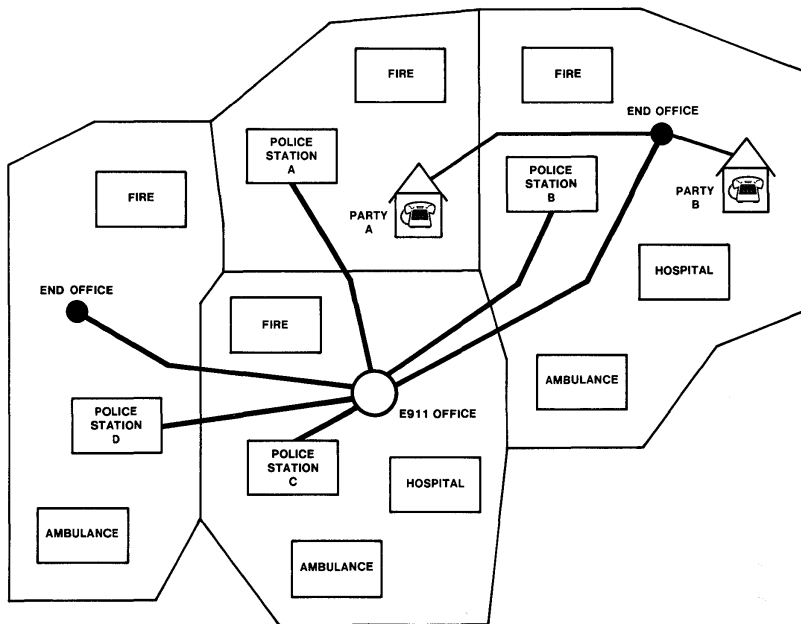

**Figure 2-10. Role of an E911 office in routing calls directly to public safety answering points (PSAPs), police stations in this figure.** The area shown above has four emergency agency jurisdictions. A 911 call from Party A would be routed to police station A, while a call from Party B would be routed to police station B, even though both callers are served by the same end office.

the stored-program control network (see Section 11.3.1); **private networks**; and **data networks**. The following sections describe these three types of network services.

### 2.5.1 PUBLIC SWITCHED TELEPHONE NETWORK SERVICES

A PSTN service, **toll service**, is used whenever calls are placed to points outside the local calling area. These calls are referred to as *toll calls*, and customers are ordinarily charged for each call. Other major PSTN services include **operator services**, **foreign exchange service**, **Wide Area Telecommunications Services**, services provided by the **direct services dialing capability**, **Automated Calling Card Service**, **DIAL-IT network communications service**, and services provided by the **circuit-switched digital capability**.



## Operator Services

Telephone company operators provide a variety of services to PSTN customers.<sup>24</sup>

- **Toll-and-assistance operators** directly assist in the completion of calls.
  - **Toll-and-assistance operators** interact with customers making calling card, collect, and person-to-person calls. They may also assess charges and control the collection and return of coins for some coin calls, and place calls to points that cannot be directly dialed, such as certain mobile radios, marine stations, and certain foreign countries. These operators provide special services such as conference and call-back calls and perform manual switching, where needed. (Very few calls are switched manually because the use of direct distance dialing is widespread.) Toll-and-assistance operators assist customers who require emergency help or who are having trouble with the network. They also verify the busy-idle status of lines, accept requests for credits, provide dialing instructions, and complete calls when the customer cannot or when a customer experiences transmission problems. In today's environment, many of the operator functions on a toll call have been automated.<sup>25</sup>
  - **Centralized automatic message accounting—operator number identification operators** (CAMA-ONI operators) obtain the calling customer's number where the switching system does not include automatic number identification (ANI) equipment. The calling number is supplied to CAMA equipment (see Section 10.5.4) for billing purposes. The ONI function, while included for completeness, is not an actual service to the customer.
- **Number-service operators** provide information necessary for the completion of calls.
  - **Directory assistance operators** respond to customers dialing 411 for the local area code and 555-1212 for nonlocal area codes.
  - **Intercept operators** handle calls to unassigned or changed numbers.
  - **Rate-and-route operators** assist toll operators.

<sup>24</sup> Section 4.2.2 describes how operator services are integrated into the network.

<sup>25</sup> Section 10.4 discusses automated systems in greater detail.

### Foreign Exchange Service

Foreign exchange (FX) service enables a customer to be served by a distant or "foreign" central office rather than by the nearby central office. Calls to other customers in the distant exchange area are then treated as local calls instead of toll calls. For customers who make enough calls to a particular distant exchange area, the monthly charge for FX service is less than the sum of the toll charges they would otherwise pay. Customers who find FX service economical include residence customers who often call friends or relatives in towns outside their local calling area and businesses such as firms in New Jersey who often call companies in New York City.

### Wide Area Telecommunications Services

There are two types of Wide Area Telecommunications Services (WATS): **inward WATS (INWATS)**, also called *800 Service*, and **outward WATS (OUTWATS)**. They permit a customer, respectively, to receive from or originate to selected service areas long-distance calls that are billed to the customer on a bulk basis rather than on an individual basis. Both of these services are available on an intrastate or interstate basis. Subscribers are predominantly businesses with a substantial volume of long-distance calls to or from a wide geographical area.

For an interstate WATS customer, the United States is divided into six service areas, or bands, that extend outward from, but do not include, the customer's home state. Service Area One contains the states contiguous to the home state (but not including it) and sometimes one or two nearby states. Service Area Two includes Service Area One plus certain other states. Each successive service area includes the previous service area plus additional states. Service Area Six encompasses the entire United States (including Alaska, Hawaii, and Puerto Rico) but not the home state. Intrastate WATS is also available in most states. Under present tariff provisions, customers must purchase separate dedicated access lines to terminate interstate and intrastate WATS calls.

**Expanded 800 Service**, an improvement over 800 Service, uses common-channel interoffice signaling,<sup>26</sup> to provide three features that give customers greater flexibility in defining service areas and determining the treatment an incoming call receives. *Single-Number Service* provides subscribers with one nationwide 800 number for both interstate and intrastate calls at one or more customer locations. With *Customized Call Routing*, customers can control their call distribution based on callers' area

<sup>26</sup> Sections 8.4.2 and 8.5.5 discuss common-channel interoffice signaling.

codes. *Variable Call Routing* allows the customer to specify call distribution based on the time of day and day of week. Customers with 800 Service can add any or all of these features to meet their needs.

### Services Using the Direct Services Dialing Capability

Traditionally, the Bell System has designed services to meet specific customer needs. Recently, however, there has been a trend to meet customer demand for new network services by providing a collection of service-independent network capabilities called the *direct services dialing capability*. This approach has many advantages. Customers can modify and control their services to a degree not previously possible. These capabilities are in the form of *primitives* in switching systems that can be summoned into use for various service applications. Some useful primitives might be "route the call" and "play an announcement." Services that would use the "route the call" primitive include:

- routing calls to different locations specified by the customer based on the location of the calling party, the time of day, the day of the week, the digits dialed by the caller (in response to a verbal prompt), and the busy-idle status of the customer's destination numbers. One application routes calls to the nearest retail store when there are several located in a city or town.
- routing incoming calls to different locations specified by the customer. One application has calls follow a salesperson who is moving from location to location, based on input from the salesperson.

### Automated Calling Card Service

Automated Calling Card Service offers customers the ability to charge telephone calls to a number other than that of the originating station without operator assistance. This service, available to business and residence customers, automates calling card, bill-to-third-number, and collect calls. Automated Calling Card Service uses the direct services dialing capability of the stored-program control network.

A feature that accompanies Automated Calling Card Service, but which is not strictly part of it, is *Billed Number Screening*. This feature is active on any bill-to-third-number call or collect call attempt and identifies numbers that do not accept any bill-to-third-number or collect calls. This applies to business or residence customers who have requested such screening and also prevents those types of billing to public telephones.

### **DIAL-IT Network Communications Service**

*DIAL-IT* service is a name for any of several services in which callers dial advertised telephone numbers to reach an announcement, a live answer, or both. The services fall into two categories: **Public Announcement Service (PAS)** and **Media Stimulated Calling (MSC)**.

PAS plays up-to-date recorded announcements for such services as Sports-Phone, Dial-a-Joke, and Horoscope. For these services, the Bell System provides access to the announcement; the announcements themselves are provided by other companies.

Services provided by MSC include media promotion, telethons, and telephone voting service. Media promotion and telethon services give the customer the ability to connect selected callers to a live answer. Typically, callers not selected for a live answer receive a recorded announcement thanking them for their participation. The telephone voting service allows callers to respond to questions presented to them by radio or television. A caller dials one of two telephone numbers corresponding to the caller's choice or opinion and is connected to a brief acknowledgement. The calls to each telephone number are tallied, and the result is provided to the sponsor.

*DIAL-IT* service is available nationwide on a standard basis through the use of area code 900.

### **Services Provided by the Circuit-Switched Digital Capability**

The circuit-switched digital capability (CSDC) will provide end-to-end digital connectivity. The CSDC, which is expected to be available as a tariffed service around the end of 1983, is an important step toward an **integrated services digital network (ISDN)**, a public end-to-end digital telecommunications network capable of supporting a wide spectrum of present and emerging user needs. Like the ISDN, the CSDC will be service independent. The CSDC will provide a 56-kbps digital path over the PSTN to customers whose lines are terminated on electronic switching systems with the CSDC feature.

One of the first applications of the CSDC will be the transport of bulk data. Since the CSDC will operate at a speed of 56 kbps, it will have ten times the capacity of the 4.8-kbps data sets that are currently used on the switched network. This feature can be useful to customers like banks who must transfer large quantities (for example, tens of megabytes) of information during a limited period, perhaps overnight.

New technologies and new capabilities will help make the integrated services digital network a reality. Applications of new technology will provide terminal equipment capable of integrating voice and data into a single information flow. New service-independent capabilities, such as

those to be provided by the CSDC, will route this flow over the PSTN and make many new services widely available.

### 2.5.2 PRIVATE-LINE SERVICES

Private-line services provide point-to-point and multipoint communication channels that are separate from channels of the PSTN. Private-line circuits are usually used for talking and signaling, but other offerings are available. These include teletypewriter services, telemetry,<sup>27</sup> wired music, video and television transmission, the connection of computers to other computers or input/output devices for data transmission, the extension of alarm or power control circuits from unattended to attended locations, and the connection of radio or television studios to remote transmitters.

While many private-line services can be approximated using services available on the PSTN, private lines offer the following advantages:

- Where the traffic is heavy enough and the geographic pattern lends itself to such use, private lines may be more economical.
- A private line incurs a specified charge that is independent of the amount of use.
- The time needed to establish a connection can be shorter with a private line than with the PSTN.
- Private-line services are dedicated to the customer and not shared, as in the PSTN, thereby ensuring a through (nonblocking) connection at all times (see Section 5.2).

Private lines are offered in several designated series, which serve as a basis for service negotiations between marketing representatives and customers. Different series lines have different uses and electrical characteristics. Table 2-1 lists the series numbers and types of service.

### 2.5.3 PRIVATE NETWORK SERVICES

Large business customers with geographically dispersed locations subscribe to private network services. Each of the customer locations is usually served by a PBX, centrex, or ESSX-1. As long as the calling volume over the private facility is such that the toll charges for equivalent PSTN calls are higher than the monthly charge for the dedicated facility, a private network is cost effective.

<sup>27</sup> Low-speed transmission of measured quantities. Generally, *telemetry* (or *telemetering*) refers to an arrangement in which measurements taken in one place are recorded in another place.

**TABLE 2-1**  
**PRIVATE-LINE OFFERINGS**

Series	Examples of Service
1000	Low-speed (narrowband*) data, for example, private-line telegraph, teletypewriter, teletypesetter, and remote metering (telemetry)
2000	Voice
3000	Medium-speed (voiceband*) data
4000	Telephoto/facsimile
6000	Audio (music transmission)
7000	Television
8000	High-speed (broadband*) data

\*Section 6.2.1 discusses voiceband, narrowband, and broadband channels.

The simplest kind of private network would be a transmission facility dedicated to a customer and interconnecting two geographically separated customer PBXs or centrex/ESSX-1 locations (in Los Angeles and New York, for example). One PBX/centrex location calls the other by dialing a code to access the other location and then dialing the extension number of the station at the distant location. This example is often not considered to be a true network and is usually referred to as *tie-line service*—the transmission facility ties together the customer locations.

If there are three customer PBXs located in Los Angeles, Chicago, and New York, the customer might acquire tie lines between Los Angeles and Chicago and Chicago and New York. A caller at the Los Angeles PBX who wishes to call the New York PBX first dials an access code to reach the Chicago PBX and then dials another access code to instruct the Chicago PBX to connect the Los Angeles tie line to the New York tie line. After the Chicago PBX makes the connection, the Los Angeles customer dials the called person's extension number to complete the call through the New York PBX. This type of service is known as *Tandem Tie-Line Service* because the Chicago PBX must be able to connect or "tandem" the call between the two tie lines. With this type of service arrangement, a different access code is required from each originating location to reach a particular location. In addition, the customer must not only pay for the

dedicated transmission facilities but must also pay for PBX or centrex switching capabilities to make direct or tandem connection to tie lines (see Section 3.3.2).

To establish a network of tie lines with a uniform numbering plan similar to that which exists in the PSTN, the customer must subscribe to private network services like **common-control switching arrangement (CCSA)**, **Enhanced Private Switched Communication Service (EPSCS)**, or **electronic tandem switching (ETS)**. These services are described in the next few paragraphs. Each of them allows interlocation dialing on a 7-digit basis, where the first three digits uniquely identify each location and the last four digits identify that location's PBX or centrex stations. The first three digits do not correspond to the station's normal telephone number and are only used for private network calls. The result is that the private network customer has a unique 7-digit dialing plan that is uniform for all locations on the network.

All of these services—tie lines, tandem tie lines, CCSA, EPSCS, and ETS—allow the private network the option of carrying calls that go off the network, that is, calls that do not terminate at one of the customer's PBX or centrex systems. To enter the public network to complete a call, tie-line customers dial "9" plus a PSTN number. The CCSA, EPSCS, and ETS networks recognize 10-digit calls as off-network calls (where the ten digits are PSTN numbers). The CCSA service, EPSCS, and ETS carry the call over the dedicated facilities of the private network to a point close to the desired location where the call enters the PSTN. (Chapter 4 contains more information about private network configurations and various call-routing arrangements.)

### **Common-Control Switching Arrangement**

CCSA service was the first private network service to offer a customer with geographically dispersed locations uniform dialing over dedicated private facilities. The CCSA is primarily an interstate service regulated by the FCC. Any station within a CCSA network may directly dial any other station by using a uniform 7-digit dialing plan. The first three digits identify the location, and the last four digits identify a location's PBX stations or centrex stations. The network switching systems that perform the routing function are selected by the Bell System or an independent telephone company, depending on the location, and are never on the customer's premises; that is, CCSA routing switches cannot be PBXs. Dedicated access lines from the PBX or centrex provide access to the private network and to the selected network switches.

To use a CCSA private network, the customer dials an access digit at the PBX or centrex and, after being connected to the Bell System CCSA switch, dials the 7-digit on-network number or a 10-digit off-network number.

Customers with extensive tie-line networks find that the costs of adding CCSA switches are justified by the convenience of the uniform dialing plan. Costs are still lower than they would be using the PSTN.

### Enhanced Private Switched Communication Service

EPSCS is an improved CCSA-like service introduced in 1978. Like CCSA, EPSCS is an interstate service regulated by the FCC and uses uniform 7-digit dialing. It, too, utilizes switching systems selected by the Bell System with dedicated access lines to customer PBXs and centrex switching systems to accomplish network routing functions. However, EPSCS offers features in addition to those available in CCSA both as part of the standard EPSCS offering and as options at extra cost.

Two unique standard features of EPSCS are 4-wire transmission (to improve transmission quality)<sup>28</sup> within the private network and a Customer Network Control Center, which customers can use to control some network operations and to obtain private network usage and status information automatically and on demand. Other features include:

- automatic route selection of FX and WATS facilities for off-network calling
- automatic alternate routing
- time-varying routing to accommodate expected changes in traffic loads
- call queuing when a network, FX, or WATS facility is busy
- authorization code entry when placing a call to provide controlled use of expensive facilities
- special recorded announcements
- "meet me" conferencing with 6-station capability<sup>29</sup>
- automatic dialing.

### Electronic Tandem Switching

ETS is another recently introduced (in 1979) private network service. ETS is regulated by state commissions and is not in itself an interstate service. It is a collection of features offered by the same switching equipment that provides PBX and centrex service. There are no special Bell System

<sup>28</sup> See Section 6.2.2.

<sup>29</sup> "Meet-me" conferencing allows a maximum of six people to participate in a conference call. The participants dial a special network number (called a *conference dial code*) at a prearranged time. Only those people who dial the assigned code have access to the conference.



switches. To obtain ETS, the customer must be served by PBXs and centrex switches that are capable of being equipped with ETS features. Once equipped, these PBX and centrex switches offer the basic uniform dialing plan for dedicated private facilities characteristic of private networks.

Many of the features available to EPSCS customers are also available to ETS customers, including automatic route selection, call queuing, and authorization codes. ETS also offers a Customer Administration and Control Center, which is similar to the Customer Network Control Center used with EPSCS but less sophisticated. ETS offers the customer less sophistication than EPSCS, but generally costs less.

#### 2.5.4 DATA SERVICES

Section 2.2.3 discussed data products for use on customer premises and described some data services derived from the use of *DATAPHONE* data sets and their inherent capabilities. In *DATAPHONE* II data communications service, for example, monitoring and control of a data network is accomplished through the capabilities of *DATAPHONE* II data communications service equipment; the telecommunications network provides only transport functions; that is, it serves only as a communications path or channel.

This section describes data services that require specific network implementations or functions, such as synchronization, multiplexing, and switching. These network services have evolved from the differing needs of users. *DATAPHONE* digital service, for example, responds to the need for very high-quality data transmission. *DATAPHONE* Select-a-station satisfies a special class of applications involving the interconnection of a large number of low-speed data stations on analog private-line facilities. The other services described in this section are emerging to meet rapidly growing, diverse needs and are expected to be available in 1983 or 1984.

##### *DATAPHONE* Digital Service

*DATAPHONE* digital service offers data communications over point-to-point or multipoint private lines at data rates of 2.4, 4.8, 9.6, and 56 kbps. The objectives of this service are high performance and excellent availability. Availability is provided by a network with high reliability and rapid restoration of service when failures do occur. It is attractive to customers such as on-line reservation services for airlines, who require low error rates and high network availability. In general, error rates and network availability are substantially better with *DATAPHONE* digital service than with other private-line services or on the PSTN.

The service is provided by the **Digital Data System (DDS)**, a synchronized data network (see Section 11.6.1). Data transmission is full

duplex (that is, 2-way simultaneous transmission) and remains digital end to end (terminal to terminal). There are no restrictions on the data format; that is, the service is transparent to any data sequence. The DDS is designed for data only—there is no provision for voice transmission.

In 1982, *DATAPHONE* digital service was available in about 100 metropolitan areas; it is expected to be available in over 125 areas in the next several years.

### *DATAPHONE* Select-A-Station

*DATAPHONE* Select-a-station service allows customers to establish a series of point-to-point connections rapidly between a master location and a large number of remote locations. It is suitable for users who need remote telemetry from a large number of remote locations. A typical customer might be a central station alarm company that would use the service to provide security and fire protection by monitoring business and residential premises. The service is provided over voiceband private lines and is supported by high-speed switching equipment designed especially for this application. The equipment is located in central offices but is controlled by the customer's master station equipment. Section 11.6.3 provides more information on the operation of the system.

### Basic Packet-Switching Service<sup>30</sup>

The Basic Packet-Switching Service (BPSS) is a private-line switching arrangement for switching data packets among a customer's various locations.<sup>31</sup> BPSS is particularly suited for customers with the following requirements:

- large numbers of data calls
- large quantities of data that must be transmitted between various locations
- data flow occurring in bursts, with a peak data rate that is high compared to the average data rate. (The higher the peak-to-average ratio, the more efficient the transport of data over BPSS.)

<sup>30</sup> Basic Packet-Switching Service has been renamed *ACCUNET* Packet Service. (*ACCUNET* is a service mark of AT&T Co.) Shortly before publication of this book, the names of several services were changed. Time did not permit changing the names throughout the book; however, the new names are indicated in footnotes the first time an applicable service is mentioned.

<sup>31</sup> With packet switching, the data are divided into *packets*, each of which includes destination and control information (see Section 5.8.1) in addition to data. Section 11.6.2 discusses packet-switching systems.

An airline company, which might use BPSS for reservations and other operations, is an example of this type of customer.

BPSS is furnished at a telephone company central office. It is accessed through ports that operate at transmission speeds of 9.6 and 56 kbps.<sup>32</sup> Each port is dedicated to a single customer, and a customer may combine ports from more than one BPSS packet switch with access lines and trunks to form private packet-switching networks. The design of BPSS permits different customers to obtain ports on the same switching arrangement and therefore share its common switching capability. Although a switching arrangement may be shared by many customers, its inherent design ensures privacy of communication between different customer networks. When the access lines to BPSS ports and the trunks between ports on different switching arrangements are provided by the Digital Data System, BPSS offers high availability and reliability.

BPSS provides two types of fundamental capabilities: **virtual call** and **permanent virtual circuit** capabilities. *Virtual call capability* allows setup and clearing on a per-call basis. Once a call is set up, it appears to have a dedicated connection for its duration, that is, until cleared. *Permanent virtual circuit capability* provides the same functions as virtual call capability, except that call-related procedures (setup and clearing) are eliminated. Permanent virtual circuits are permanently defined in tables in the switching arrangement(s) when service is established. Data terminals connected by a permanent virtual circuit appear to have a full-time, dedicated connection. A customer must place an order with the telephone company to establish, change, or discontinue a permanent virtual circuit.

Customers for the virtual call capability of BPSS may include retailers who need access to several different data bases periodically during business hours. An automotive parts or plumbing supply outlet may have to place orders with several different distributors. Customers for the permanent virtual circuit capability of BPSS may include retail stores whose checkout clerks routinely obtain clearances for credit-card purchases by customers.

The switching arrangement available with BPSS has a nominal switching capacity<sup>33</sup> of up to 500 data packets per second. It supports maximum packet sizes of either 128 or 256 data octets (8-bit characters) as specified by the customer. Various software functions are available, with which, for example, customers may create their own logical subnetworks.<sup>34</sup>

<sup>32</sup> BPSS supports the 1980 access protocol Comité Consultatif International Télégraphique et Téléphonique (CCITT) Recommendation X.25 (see Section 8.8).

<sup>33</sup> Actual switching capacity depends on traffic characteristics (see Section 5.8).

<sup>34</sup> The capabilities available in BPSS are described in detail in AT&T Long Lines 1982.

### High-Speed Switched Digital Service<sup>35</sup>

High-Speed Switched Digital Service (HSSDS) provides a 1.544-megabits-per-second (Mbps) network for transmission of voice, data, or video within or between HSSDS switching nodes. Customers call an 800 number to reserve HSSDS facilities between nodes. Access between customer premises and an HSSDS switching node is provided through **High-Capacity Terrestrial Digital Service**.<sup>36</sup> The network, which is composed of terrestrial and satellite digital facilities, is planned to have nodes in forty-two cities by the end of 1983. It will support 2-point, multipoint, and broadcast connections.

### High-Capacity Digital Transport Services

These services, first available in 1983, provide customers with 1.544-Mbps digital circuits on a full-time (24 hours a day) basis. Two services are included, one using terrestrial facilities, the other satellite facilities.

**High-Capacity Terrestrial Digital Service** (HCTDS) can be used to connect two customer locations or to connect a customer location to a telephone company central office. Equipment may be provided at the central office that enables the digital circuit to carry twenty-four voiceband channels, each of which can be terminated on the switching system.

**High-Capacity Satellite Digital Service** (HCSDS)<sup>37</sup> use dedicated earth stations at the customer's location or shared earth stations at four locations in the United States. Customers using shared earth stations obtain dedicated terrestrial links via HCTDS to one of the four shared stations. Point-to-point and multipoint communications among shared and dedicated earth stations are permitted. Features such as echo cancellation, elastic stores,<sup>38</sup> and earth station control are also available.

## 2.5.5 MOBILE TELEPHONE SERVICES

Mobile telephone services utilize radio transmission to provide telephone service to customers on the move. Until recently, development of these services has been constrained by limited radio-frequency assignments and

<sup>35</sup> High-Speed Switched Digital Service has been renamed *ACCUNET* Reserved 1.5 Service.

<sup>36</sup> High-Capacity Terrestrial Digital Service has been renamed *ACCUNET* T1.5 Service.

<sup>37</sup> High-Capacity Satellite Digital Service has been renamed *SKYNET* 1.5 Service. (*SKYNET* is a service mark of AT&T Co.)

<sup>38</sup> A buffer memory that can hold a variable amount of data. The length of time that specific data items remain in the store depends on the amount of data it contains.

technological complications. Mobile telephone services include: **land mobile telephone service**, *BELLBOY*<sup>39</sup> **personal signaling set paging service**, **air/ground service**, **marine radiotelephone services**, and **high-speed train telephone service**.

### **Land Mobile Telephone Service**

Land mobile telephone service provides 2-way voice communications, through designated central offices, between mobile units and land telephones or between two mobile units. Users in the mobile serving area have full access to the PSTN either on a manual (operator-handled) or a direct-dial basis. In 1981, the FCC approved a new type of system, called *cellular*. Beginning in 1983, the Bell companies will serve a much larger number of customers through this new design, which makes more efficient use of frequency assignments. Section 11.4.1 discusses this system and other land mobile telephone systems, present and future.

### ***BELLBOY* Personal Signaling Set Paging Service**

The *BELLBOY* personal paging service notifies customers when someone wants to talk with them. Customers carry a cigarette-pack-sized radio receiver that emits an audible tone when the number assigned to that unit is called. (A new receiver being offered by some telephone companies also incorporates a visual display of the calling number.) The receiver is activated by an array of radio transmitters that provide coverage for an urban area. In 1980, *BELLBOY* personal signaling set paging service had about one hundred thousand customers nationwide (see Section 11.4.2).

### **Air/Ground Service**

Air/ground service provides 2-way telephone service between customers flying in private aircraft and customers on the PSTN. The service uses radio base stations connected to control terminals and mobile service switchboards that interconnect with the PSTN. All radio equipment mounted on aircraft is customer owned and customer maintained. In 1980, approximately two thousand aircraft were equipped with this service, and sixty thousand calls were placed during the year.

### **Marine Radiotelephone Services**

Marine radio telephone services include **very high frequency (VHF) maritime service**, **coastal-harbor service**, and **high-seas maritime radiotelephone service**. These services provide 2-way telephone service to water

<sup>39</sup> Registered service mark of AT&T Co.

craft. The three services differ in the range of distances over which they operate. VHF maritime service offers reliable communications up to 50 miles offshore and on inland waterways. Coastal-harbor service communications can range up to 200 miles offshore, and high-seas service is intended for ships engaged in oceanic operations and transoceanic passages. The radio equipment for all three services mounted on board ships is customer owned and maintained.

### High-Speed Train Telephone Service

High-speed train telephone service provides telephone service between a passenger train and the PSTN. Operator-handled train telephone service was inaugurated in 1947, and by 1952, service was provided to nineteen trains on five railroads. These installations are now out of service, in most cases because of the demise of the equipped trains. More recently, in 1968, train telephone service was installed aboard the Metroliner trains operating between New York and Washington, D.C. The service provides the public with coinless *TOUCH-TONE* telephones. Approximately forty-five thousand calls were handled yearly during the 1970s. This service is being phased out in anticipation of the new cellular service.

### 2.5.6 VIDEO TELECONFERENCING SERVICE

In 1964, AT&T offered *PICTUREPHONE*<sup>40</sup> visual telephone service using small desktop units that contained both a special camera tube and a small black and white receiver. Public booths were also established, and service was offered between locations in Chicago, New York, and Washington, D.C. The offering was continued until 1975 as a market trial.

The experience gained in the trial led to a reorientation of the service. In 1975, *PICTUREPHONE meeting service* was introduced (also on a trial basis), using rooms equipped for conferences of various sizes. The trial of the reoriented service continued until 1981, when AT&T announced its plans to offer video teleconferencing as a standard service in forty-two cities. Long-distance transmission for the standard service is provided by the High-Speed Switched Digital Service (see Section 2.5.4). Access from conference rooms to the nodes is offered under full-period High-Capacity Terrestrial Digital Service (see Section 2.5.4) tariffs. Customers may have private conference rooms on their own premises or may use public rooms offered by AT&T.

The objective of the video teleconferencing service is to make conferences both effective and pleasant. As shown in Figure 2-11, six people

<sup>40</sup> Registered service mark of AT&T Co.



Figure 2-11. Conference room equipped for PICTUREPHONE meeting service.

are accommodated at a conference table. Each person is within range of one of three cameras. The picture selected for transmission depends on which person is speaking; thus the speaker is on camera. Other cameras are provided for overviews, various graphic displays, and for a speaker at an easel. Monitors show both the incoming and outgoing video.

Video teleconferencing service will prove to be economical when measured against the rising cost of travel and the time lost in travel that could be applied to other business or personal responsibilities.

## 2.6 PUBLIC COMMUNICATIONS SERVICES

By the end of 1981, there were approximately 1.6 million telephones providing Public Communications Services and generating about \$3 billion in annual revenues. Most public telephones are installed at locations where a public need exists such as airports, bus depots, train stations, hotel lobbies, large office buildings, and on public streets and highways. They provide the general public with access to all United States and international telephones, generally on a customer-dialed basis.

About 30 percent of the telephones that provide Public Communications Services are called *semipublic* because they are not always available to the public. Semipublic telephones are most often found in service stations, delicatessens, self-service laundries, and similar businesses. The

proprietor can use the line for business purposes and make a coin telephone available to the public during business hours. Many businesses also install semipublic telephones to control outgoing calls by employees. The semipublic station can also be equipped with a noncoin, answer-only extension to allow the proprietor to answer incoming calls without having to pick up the coin telephone. While most of these have a nondial telephone bridged across the line without any privacy protection for the user of either station set, arrangements can be made to provide privacy to users of the coin telephone. A business with a semipublic telephone can be listed in both the white pages and the Yellow Pages of telephone directories.

Revenues from public telephones are generally shared with the owners of the premises where the sets are located. For telephones located on public property, most state regulatory agencies have set up some formula to provide a commission to the political unit that grants the franchise. For example, urban sidewalk installations usually yield a commission to the city. Similarly, commissions on airport locations are paid to the government agency operating the airport.

Charging arrangements for semipublic telephones vary considerably from state to state. Some states require a minimum amount of revenue to be generated. If that amount is not achieved, the proprietor is billed for the amount needed to reach the minimum. Other states require a flat monthly fee with no guarantee. Rarely are any commissions paid on semipublic telephone service.

There are two types of public telephones—coin and Charge-a-Call, or coinless (see Figure 2-12). With a coin telephone, a customer may place either sent-paid calls (paid for at the time the call is made by depositing one or more coins) or non-sent-paid calls (where payment is not made at the time of the call). The latter include collect calls, calls charged to a third number, and calling card calls (that is, calls billed to another telephone). Charge-a-Call stations can complete only non-sent-paid calls.

Coin telephones can provide either coin-first or dial-tone-first service. Coin-first telephones require a specific deposit (ten, fifteen, twenty, or twenty-five cents) before the receipt of dial tone. Dial-tone-first telephones allow the completion of service calls (for example, directory assistance, 911, and repair service) and access to Traffic Service Position System (TSPS) operators or TSPS/Automated Coin Toll Service (ACTS) equipment without coin deposits. In addition to providing coin-free emergency access, the dial-tone-first station gives the customer some assurance that it is working before any coins are deposited.

For toll calls, a toll-and-assistance operator informs the caller of the charges and confirms the correct deposit of coins. Most toll service operators are supported by TSPS (see Section 10.4.1). Where TSPS has been enhanced by ACTS equipment, the operator function is automated, and synthesized voice messages are used for interaction with the caller.



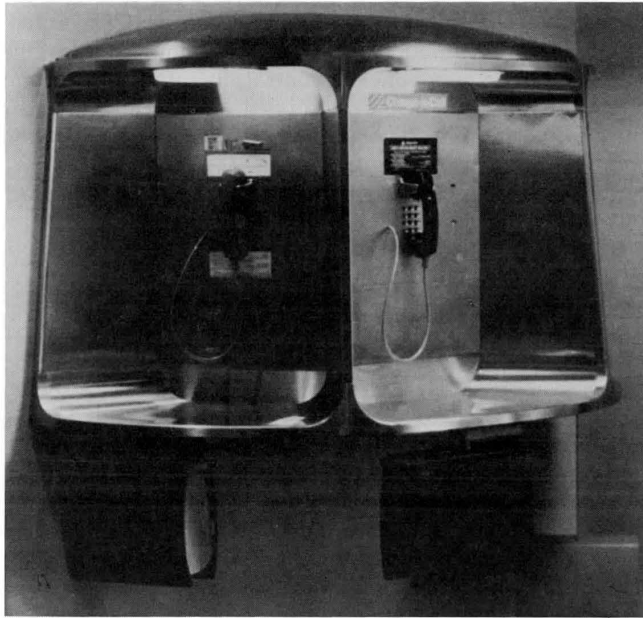

**Figure 2-12. Public telephones.** *Left, a coin set; right, a Charge-a-Call set.*

About two-thirds of the public telephone revenues are from non-sent-paid calls. At locations such as airports and railroad terminals, a substantial percentage of the calls are non-sent-paid. These locations are attractive candidates for the installation of Charge-a-Call telephones, which can handle such calls, and for the provision of Automated Calling Card Service (see Section 2.5.1), which automatically bills them.

## **2.7 CUSTOMER SUPPORT SERVICES**

The preceding sections describe many of the telecommunications services available to Bell System customers. These services are provided through various types of terminal equipment and the capabilities of the network. This section discusses a different class of services—those provided by an operating company to support customer needs in the areas of acquisition, use, and maintenance of telecommunications services.

### 2.7.1 RETAIL SALES AND SERVICE

In 1980, over 20 million requests for telephone service (for example, to initiate, terminate, or change service), representing more than half of the Bell System activity, were handled through the 1700 Bell PhoneCenters<sup>41</sup> then maintained by Bell operating companies. Before the introduction of Bell PhoneCenters, residential customers had to contact a telephone company business office to order service and then wait for an installer to bring the telephone set(s) to the home.

Until recently, telephones and other terminal equipment were leased from the local operating company. On January 1, 1983, under provisions of the FCC's Computer Inquiry II decision, sale of new terminal equipment at Bell PhoneCenters was transferred to AT&T.<sup>42</sup> Operating companies may sell terminal equipment that was in their inventory on that date, and they continue to operate service centers where customers may conveniently order service and replace faulty equipment bought or leased from the operating company.

Customers can select from a variety of basic and *DESIGN LINE* decorator telephones. They can also obtain the lengths of handset and mounting cords they desire and the particular adapters they need to make their inside wiring compatible with modular telephone technology (see Section 2.2.2). Once the wiring inside a residence has been adapted, station sets may be plugged in or removed quite conveniently.

### 2.7.2 BUSINESS OFFICE SERVICES

Where telephone company customer service centers exist, service representatives in business offices refer requests for new residential service to them. Business offices continue to initiate service orders for new phone installations in some cases, for example, when inside wiring records indicate that customers will be unable to install the phones they desire. In addition, they answer customers' questions about billing for residential services.

### 2.7.3 INSTALLATION AND MAINTENANCE SERVICES

Installation and maintenance services include the inside wiring and connection of station equipment. This may be required by business customers and by those residence customers who either cannot or do not wish to

<sup>41</sup> Also called PhoneCenter Stores.

<sup>42</sup> Terminal equipment from several manufacturers may be purchased at many retail stores.

install their own equipment. The installer may perform the inside wiring job for new installations and make changes to existing wiring, as required.

Service problems are handled by a call to Repair Service. The nature of the customer's complaint is recorded, and after the probable cause is determined by testing, repair action is initiated. Section 13.2.3 further discusses maintenance operations.

#### 2.7.4 DIRECTORY SERVICES

Customers are entitled to have their names, addresses, and telephone numbers listed in white pages directories, but listings will be withheld if a subscriber so desires. Subscribers not listed in the white pages may also specify that their addresses and telephone numbers not be published in Information Services directories for public disclosure. Arrangements may be made to print listings in bold-face type or in association with special instructions, such as, "After 5 o'clock, call 555-5555."

An additional fee is required for some white pages services. All Yellow Pages listings require additional fees. Costs depend on the details of the special listing, in particular, the size of the listing and whether or not it is accompanied by an advertisement.

To make Directory Services more helpful to users, innovations are being introduced. For example, in some white pages directories, federal, state, and county governmental listings are printed on blue paper in a special section. Upon request, partial addresses or no addresses may be listed with names and telephone numbers. Four-color advertisements are being introduced in Yellow Pages directories. New Yellow Pages books specialize in user-market needs such as Medical Directories, Tourist Directories, etc. White and Yellow Pages data bases have been developed for user access via the emerging electronic information technology.

#### AUTHORS

*C. E. Betta  
H. J. Bouma  
P. S. Browning  
W. R. Byrne  
R. Carlsen*

*D. C. Franke  
W. G. Heffron  
T. B. Morawski  
K. J. Pfeffer  
P. T. Porter*

*S. H. Richman  
J. F. Ritchey  
A. T. Vitenas  
C. H. Zima*

# 3

---

---

## Introduction to the Network

### 3.1 WHAT IS A TELECOMMUNICATIONS NETWORK?

As a starting point in defining a telecommunications network, a general definition of a network may be helpful. In a broad sense, a *network* is a system of interconnected elements. Topologically, it can be represented by a set of nodes and a set of links that interconnect pairs of nodes. A network is needed when certain types of services must be provided to many, widely dispersed customers. Depending on the types of services, the characteristics of the network elements may differ greatly.

Another concept necessary for the definition of a telecommunications network is the notion of telecommunications traffic or, simply, traffic. *Traffic* is the flow of information or messages through the network. Traffic may be generated by simple telephone conversations, or it may be the result of complex data, video, and audio services. (Chapter 5 deals with traffic theory and its application to engineering the network.)

A *telecommunications network*, then, is a system of interconnected facilities designed to carry the traffic that results from a variety of telecommunications services. (Chapter 2 discusses the various telecommunications services available.) The telecommunications network as a whole has two different but interrelated aspects. In terms of its physical components, it is a **facilities network**. In terms of the variety of telecommunications services that it provides, it is a set of many **traffic networks**, each representing a particular interconnection of facilities. The distinction between traffic networks and the facilities network is discussed in more detail later in this chapter.

As stated earlier, a network can be represented by nodes and links. In the telecommunications network, the nodes represent switching offices and facility junction points, and the links represent transmission facilities. Traffic is the flow of information in the network.

Telecommunications has three characteristics that dictate the basic nature of the network. First, traffic must be carried among customers dispersed over large geographic areas. Second, traffic may be generated between any pair of customers at virtually any time, although the duration of each call may be fairly short. Third, the ability to exchange information between any pair of customers is expected to be available with relatively short delay.

Figure 3-1 illustrates some key concepts in the design of a telecommunications network.<sup>1</sup> Figure 3-1A shows a highly oversimplified situation in which no switching is used and telephones at all four end points (customer locations) are directly interconnected in pairs by transmission paths. A telecommunications network designed in this way would be inefficient and prohibitively expensive because it would require many telephones at each end point and many transmission paths as well.

The design depicted in Figure 3-1A can be improved considerably by the introduction of switching. For example, the use of a switch at each location would eliminate the need for all but one telephone at each location. This situation is shown in Figure 3-1B. In this case, although the total number of telephones has decreased, the number of required transmission paths remains the same, and the implementation of switching at each end point would be expensive.

Figure 3-1C shows that a much more efficient use of network elements results from the introduction of switching at a central location to interconnect transmission paths emanating from the end points. Both the number of switches and the number of transmission paths are substantially reduced. In a network with no switching (as in Figure 3-1A), if there are  $n$  end points ( $n=4$  in Figure 3-1A),  $n(n-1)$  telephones and  $n(n-1)/2$  transmission paths are needed. However, the network design shown in Figure 3-1C requires only  $n$  telephones,  $n$  transmission paths, and one central switch.

More efficient network design and lower cost to the customer are achieved at a certain price: The number of simultaneous connections through the network is limited. Thus, while the network depicted in Figure 3-1A would allow the simultaneous connection of all pairs of end points, thereby supporting six calls at the same time, the centrally switched network configuration of Figure 3-1C can support only two simultaneous connections. This limited potential for simultaneous calls is not a serious drawback, however, because the concurrent use of the network by all or even most users is unlikely. Chapter 5 includes a further discussion of topics related to network usage.

<sup>1</sup> For an in-depth analysis of the design and cost characteristics of telecommunications networks, see Skoog 1980.

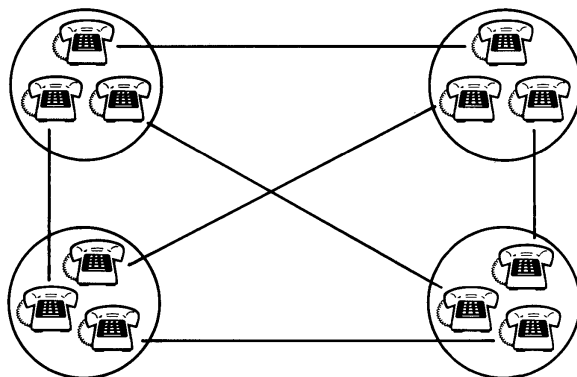

A

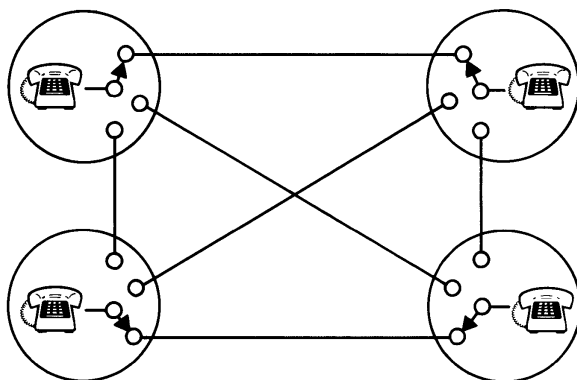

B

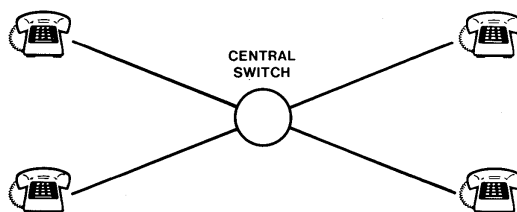

C

Figure 3-1. Networking and the tradeoff between transmission and switching. A, direct interconnection of telephones; B, interconnection through switches at end points; C, interconnection through a centralized switch.

## 3.2 THE FACILITIES NETWORK

The telecommunications network was defined in Section 3.1 as a system of interconnected facilities designed to carry traffic that results from a variety of telecommunications services. When viewed from the perspective of its physical components, or facilities, the network may be referred to as the *facilities network*.

The components of the facilities network may be divided into three broad categories.

- **Station equipment** is generally located on the customer's premises.<sup>2</sup> Its primary functions are to transmit and receive the information flow and required control signals between customers and the network.
- **Transmission facilities** provide the communications paths that "carry" the information between customers. In general, transmission facilities consist of some sort of transmission medium (for example, the atmosphere, paired cable,<sup>3</sup> coaxial cable, lightguide cable)<sup>4</sup> and various types of electronic equipment located at different points along the transmission medium. This equipment amplifies and, sometimes, regenerates the transmitted signals. In addition, various types of facility terminal equipment provide functions needed where transmission facilities connect to switching systems and at facility junction points.<sup>5</sup>
- **Switching systems** interconnect the transmission facilities at various key locations and route traffic through the network. As mentioned in Section 3.1, the introduction of central switching into the network yields cost savings in station equipment and transmission facilities.

In addition to the functions just described, transmission facilities and switching systems provide for **signaling** in the network. (Chapter 8 describes signaling, a major network function.)

The Bell System provides a large percentage of the telecommunications facilities in the United States nationwide network. However, numerous independent telephone companies and other common carriers also own both transmission facilities and switching systems.

The following sections give an overview of the three basic categories of facilities, which are discussed in detail in subsequent chapters.

<sup>2</sup> *Customer-premises equipment* (CPE), a broader term, includes more than station or terminal equipment. For example, private branch exchange equipment located on a customer's premises performs customer switching functions.

<sup>3</sup> Paired or multipair cable contains a number of twisted pairs of wires.

<sup>4</sup> Section 6.3 describes these transmission media.

<sup>5</sup> Chapters 6 and 9, respectively, describe some of the functions and equipment.

### 3.2.1 STATION EQUIPMENT

Station equipment is the user's interface with the rest of the network and the available services. The most common station equipment is the ordinary single-line telephone set. The functional components of a telephone set include a transmitter and a receiver (most often combined in a handset), a rotary or pushbutton dial, a switchhook mechanism, and a bell or other alerting device. The telephone converts an acoustic signal (which may be generated by a human voice or by a device that transforms data into a series of tones) into an electrical signal, which it sends over a transmission facility. For reception, the telephone converts an incoming electrical signal back into an acoustic signal.

In addition to transmitting and receiving information in the form of electrical signals, the telephone also provides for two kinds of signaling functions: **supervision** and **addressing**. *Supervision* includes the constant monitoring by the local switching system or by a private branch exchange (PBX) of the status (idle or busy) of the telephone and alerting the user that a call is being made by providing an audio (or visual) signal. *Addressing* refers to the task of specifying to the network the destination of a call.

The telephone switchhook is used to signal idle or busy status. When the telephone is idle, or "on-hook," the switchhook contacts are open. When the telephone is busy, or "off-hook," the switchhook contacts are closed. These supervisory signals allow certain equipment at the central office (or PBX) to recognize origination, answer, and termination of a call. A customer is alerted to an incoming call by a bell or tone ringer (or, in some cases, a light).

Addressing is done by either a rotary dial or a set of pushbuttons, producing a signal that corresponds to the called number. With a rotary dial, a series of pulses, equivalent to alternate on-hook, off-hook conditions, represents each digit dialed. With a pushbutton set, a different pair of tones represents each digit.<sup>6</sup>

Many other kinds of station equipment convey various types of information. Some enable computers to communicate directly with one another over the telecommunications network. Others are used for visual information such as video, facsimile, and graphics. (Section 11.1 discusses station equipment in detail.)

### 3.2.2 TRANSMISSION FACILITIES

Transmission facilities provide the communications paths that carry the traffic between any two points in the network. These communications

<sup>6</sup> There are also telephone sets with pushbuttons that produce dial pulses.



paths are referred to as *channels* or *circuits*<sup>7</sup> and may be classified as follows into three broad categories.

- Ordinary channels (circuits) that connect customers' station equipment to a switching system are called *lines* or *loops*.<sup>7</sup> *Loop* is derived historically from the pair of wires that form a loop between the customer's location and the switching system. Originally, all loops were wire pairs. Today, however, many loops do not have an associated physical pair of wires for the entire path. Instead, loop carrier systems<sup>8</sup> are used.
- Ordinary channels (circuits) that connect two switching systems are called *trunks*. There may be several switching nodes with trunks connecting them between the calling customer's telephone and the called customer's telephone. The trunks and switching systems carry traffic generated by many customers, while loops are dedicated to individual customers.<sup>9</sup>
- Finally, channels (circuits) dedicated to a specific customer to provide special services are called *special-services circuits*. They encompass both circuits to a customer's equipment and circuits between network switching systems.

Based on the above classification of channels, it is possible to divide the transmission facilities into two general categories.

- **Loop transmission systems, subscriber loop systems, or, simply, loop systems** carry loops and special-services circuits to a customer's premises. Typically, loop transmission systems are paired cable (also called *multipair cable*) that is suspended from telephone poles, buried directly in the ground, or placed in underground cable ducts (often called *conduit*). The average length of customer loops is about two miles.
- **Interoffice transmission facilities** carry trunks and special-services circuits between network switching systems. These facilities vary greatly, but the majority are carrier systems. Interoffice transmission facilities range in length from less than a mile to several thousand miles.

<sup>7</sup> For the most part, the terms *channel* and *circuit* are used interchangeably, as are the terms *loop* and *line*. Where differences are perceived, it is likely to be the result of traditional usage in a particular technology area.

<sup>8</sup> Carrier systems combine a number of circuits on two physical pairs of wires using a technique called *multiplexing* (discussed in Section 6.5).

<sup>9</sup> Except in the case of party-line service, where loops are shared by two or more customers.

### 3.2.3 SWITCHING SYSTEMS

This section provides a broad characterization of switching systems as elements of the facilities network. (Chapter 7 discusses switching functions and concepts, and Chapter 10 describes a number of systems.)

The primary function of switching systems is to interconnect circuits. Depending on the types of circuits involved, switching systems fall into two functional categories: **local** and **tandem**. *Local* switching systems connect customer loops directly to other customer loops or customer loops to trunks. Local switching systems, which may serve many thousands of customer loops, are also referred to as *central offices*. The central office building contains one or more switching systems (central offices),<sup>10</sup> certain transmission and signaling equipment, and other equipment necessary to provide telephone service to customers in the nearby geographic area. A central office may be divided into two or more 3-digit central office codes.<sup>11</sup> The last four digits of a telephone number provide up to 10,000 line numbers within each central office code.

The term *tandem* is used generically for any switching system that connects trunks to trunks. In a more limited sense, it is often used to denote systems typically found in metropolitan networks within the public switched telephone network (PSTN). These *local tandem* switching systems connect local switching systems to each other or to other systems in the PSTN or interconnect other metropolitan tandem systems. Generic tandem (that is, trunk-to-trunk) systems that perform class 1 through class 4 functions in the toll switching hierarchy (described in Section 4.2) are called *toll* systems. The terms *local* and *toll* reflect the tariff distinction between local and toll traffic.

In addition, some switching systems perform both local and tandem switching functions. (Chapter 4 discusses the implications of combined local/tandem switching systems.)

A recent development in local switching is the use of **remote switching systems** that serve small population centers typical of rural areas. Customer loops are connected to these systems, which, in turn, are connected to central offices in larger population centers. The remote systems are essentially extensions of the host central office. (Section 10.3 discusses these systems.)

In addition to network switching systems located in telephone company buildings, another type of switching system, the **PBX**, is typically located on a customer's premises. As described in Section 2.3, a PBX connects a localized community of users to each other and, through special-

<sup>10</sup> The term *central office* is sometimes applied loosely to a central office building and its equipment.

<sup>11</sup> Also called *exchanges*.

services circuits, to a network switching system. An attendant may handle calls involving an off-premises party. The circuits connecting a PBX to a central office are called *PBX trunks* since they interconnect two switching systems. In most cases, the circuits appear as lines to the central office. PBXs and associated PBX trunks are part of the total facilities network.

Finally, operator services (such as directory assistance, special charging on toll calls, and intercept of calls to nonworking numbers) are provided by arrangements of equipment that are considered to be switching systems. (Section 4.2.2 describes how operator services are provided within the network, and Section 10.4 describes the related equipment.)

### 3.3 TRAFFIC NETWORKS

The description of the telecommunications network in the previous section emphasized the physical components of the network, namely, station equipment, transmission facilities, and switching systems. In that context, the network was referred to as the facilities network. It is also important to consider the manner in which this network provides the various telecommunications services. From this perspective, the network may be thought of as a set of traffic networks sharing common facilities. For example, the PSTN, which provides public switched telephone network services, is the largest and best-known traffic network. Many other traffic networks provide a variety of special services such as private-line voice and data and audio and video program services. Each traffic network is designed to meet a particular set of requirements related to transmission performance, reliability, maintenance, and the ability to handle the expected traffic volume. The following sections describe some of these traffic networks and show how they use common elements and, in some cases, share them.

#### 3.3.1 PUBLIC SWITCHED TELEPHONE NETWORK

Because of the large volume of business and residential telephone traffic that it carries, the PSTN is probably the most familiar of the traffic networks. This network provides the public switched telephone network services described previously in Section 2.5.1.

The various types of traffic in the PSTN represent communications between any two end points in the network. Traffic is switched through each switching office, or node, it encounters and travels between nodes on trunk groups. The offices and trunk groups are arranged in a hierarchical routing structure, as described in Section 4.2. Circuits 1 and 2 in Figure 3-2 carry this type of traffic. The foreign exchange (FX) line shown as circuit 5 is noteworthy because it appears as a line at distant

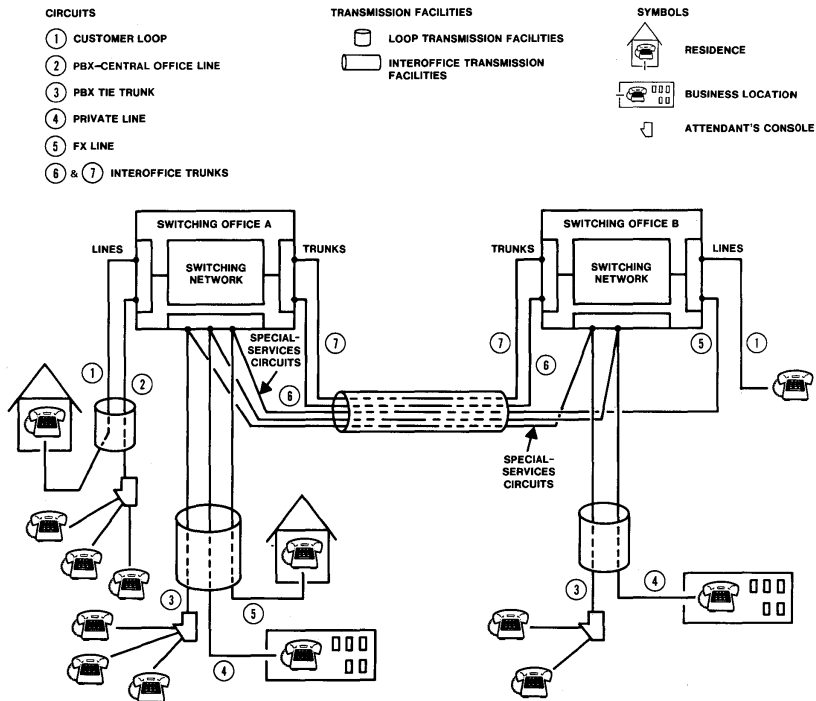

Figure 3-2. The use of transmission facilities by various types of services.

switching office B. It is generally used primarily for traffic to and from other lines in the local calling area of office B. It can also use office B as the access point for the entire PSTN.

The PSTN is, by far, the largest traffic network in terms of both equipment utilization and traffic volume. In 1981, it handled about 270 billion calls, and at the end of that year, it served about 180 million telephones in the United States. (These figures include both Bell System and non-Bell System calls and telephones.)

### 3.3.2 PRIVATE-LINE VOICE NETWORKS

As described in Section 2.5.3, large businesses with many dispersed locations often use private-line voice networks—dedicated facilities that connect a company's various locations. The circuits used for private networks are special-services circuits.

Some of these circuits are switched; others are nonswitched. Among nonswitched private networks, many serve only two stations and are called *point-to-point networks*. Others, called *multipoint networks*, interconnect a number of stations at dispersed locations and may have signaling arrangements to alert appropriate stations when communication is desired. Private-line nonswitched networks may be interconnected at telephone company switching offices, although they are not switched through the switching systems. The PBX tie trunk, circuit 3, and the private line, circuit 4, in Figure 3-2 are examples.

In addition to the nonswitched private networks, several thousand private switched voice networks serve government organizations and large business customers. The trunks and access lines in these networks are private-line circuits that interconnect switching systems either at customer locations (for example, PBXs) or in telephone company switching offices. A typical private switched network sharing switching systems with the PSTN is shown in Figure 3-3. The switching systems are partitioned so that only private network access lines may access the private network trunks. Private switched networks range in size from large nationwide networks that serve hundreds of locations to small networks in metropolitan areas that serve fewer than ten locations.

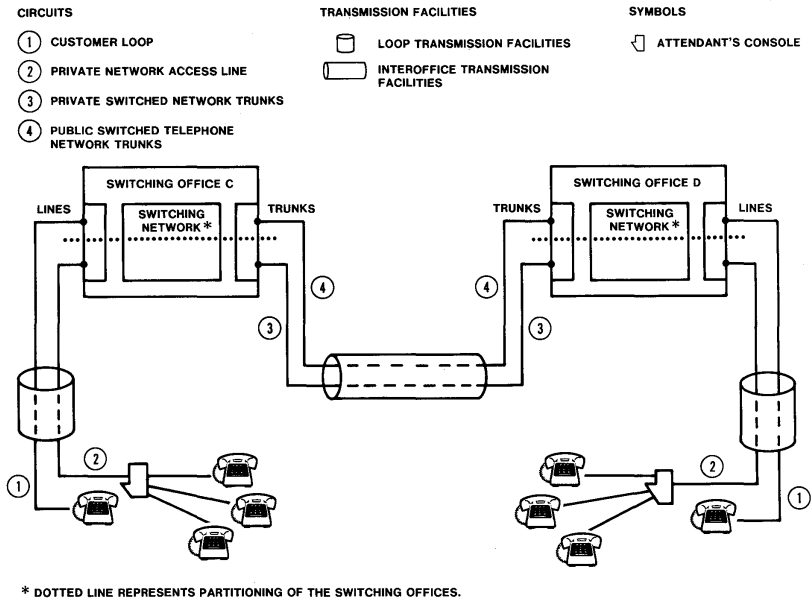

Figure 3-3. Example of a private switched network.

Examples of private switched networks are CORNET (the corporate network used in the Bell System), FTS (the Federal Telecommunications Service network serving the civil organization of the Federal Government), and AUTOVON (the automatic voice network of the United States military).

A key point illustrated by Figures 3-2 and 3-3 is that private networks, both switched and nonswitched, may share many elements of the facilities network with the PSTN. Specifically, the various circuits for the PSTN and private networks are provided by common transmission facilities. Furthermore, in switched private networks, even the switching systems can be shared, as shown in Figure 3-3; although certain private switched networks (for example, AUTOVON) have dedicated switching systems.

### 3.3.3 PRIVATE-LINE DATA NETWORKS

Section 2.2 describes private-line data services over analog facilities. Section 2.5.4 describes *DATAPHONE* digital service, and Section 11.6 describes the system aspects of the Digital Data System (DDS) that support the service.

Another example of private-line data networks involves telegraph channels. These channels employ a fraction of the voice bandwidth<sup>12</sup> and are used for services such as teletypewriter, remote metering, and burglar alarms. There are about 8000 interstate private teletypewriter networks. About half are simple 2-point networks; the rest are multipoint networks, most of them nonswitched.

In addition to private data networks provided by the telephone companies, customers may form their own switched data networks by leasing private-line circuits and interconnecting them with computers operating as data switches. Both the National Aeronautics and Space Administration and the Advanced Research Projects Agency have such private data networks. In a certain sense, the structure of private data networks is generically similar to that of private voice networks. The channels involved are dedicated to the customer, are usually not switched by network switching systems, and typically share transmission facilities with the PSTN.

Private voice and data channels differ primarily in their transmission requirements, particularly where high-speed data is involved. Furthermore, because of the current advances in both switching and transmission technologies, the distinction between voice and data networks is becoming less and less significant.

<sup>12</sup> The *voice bandwidth* is the range of frequencies necessary to transmit and receive acceptable quality speech signals. See Section 6.1.

### 3.3.4 PROGRAM NETWORKS

Radio and television broadcasters use program networks extensively to distribute program material simultaneously to a number of their affiliated stations. Because of different transmission requirements (see Chapter 6), both audio and video program networks exist. A key difference between program networks and private switched voice networks is the directional nature of the communications. While voice networks support simultaneous 2-way communications, the program networks provide 1-way transmission of audio and video programs from one source to many destinations. Another difference concerns the typical transmission capacities required. In a private voice network, two customer locations may be connected by a single voiceband channel; the transmission of audio and video programs, on the other hand, requires much larger bandwidths for the video information, typically, equivalent to hundreds of voice circuits. Except for these two distinguishing features, the structure of program networks is similar to that of private voice networks; hence, program networks share the transmission facilities with other private networks and the PSTN.

## 3.4 A TYPICAL TELEPHONE CALL

To introduce the rudimentary operation of the network, this section presents a functional description of a typical telephone call, the most familiar service provided by the PSTN. The description illustrates some of the terms defined in previous sections and introduces some new terms and concepts.

### 3.4.1 SETTING THE STAGE (FIGURE 3-4)

Mrs. Cooper, a local realtor, is calling Mrs. Mahon, a prospective buyer, at her home in a neighboring town. Mrs. Cooper's telephone is served by central office A, and her central office code is 747. Mrs. Mahon's telephone is served by central office code 951 in central office B. Since many calls are placed between central offices A and B, a number of trunks provide a direct route between the two offices. An alternate route through tandem office C is also available. (Chapter 5 describes traffic engineering aspects, including alternate routing.)

### 3.4.2 INITIATING THE CALL (FIGURE 3-5)

When Mrs. Cooper picks up her handset, the switchhook contacts of the telephone set close, signaling its off-hook status. Control equipment in the switching system at office A detects a change from on-hook to off-hook status and interprets the change as a request for service. At this time, dial tone is connected to Mrs. Cooper's telephone, assuming that a

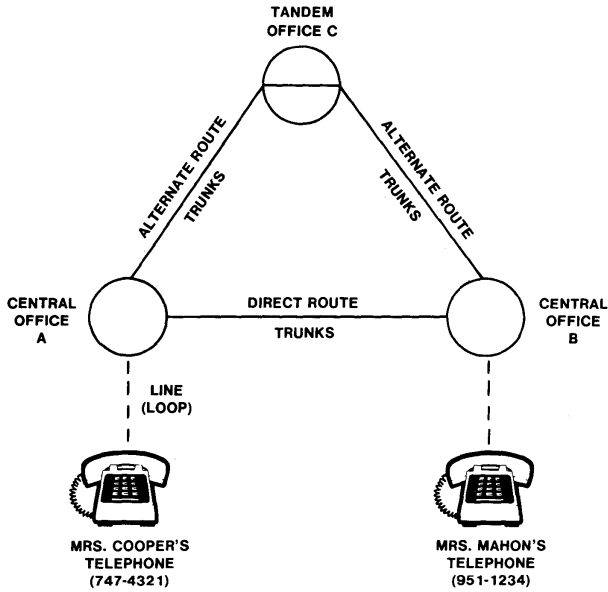

Figure 3-4. Direct and alternate routes for a call from Mrs. Cooper to Mrs. Mahon.

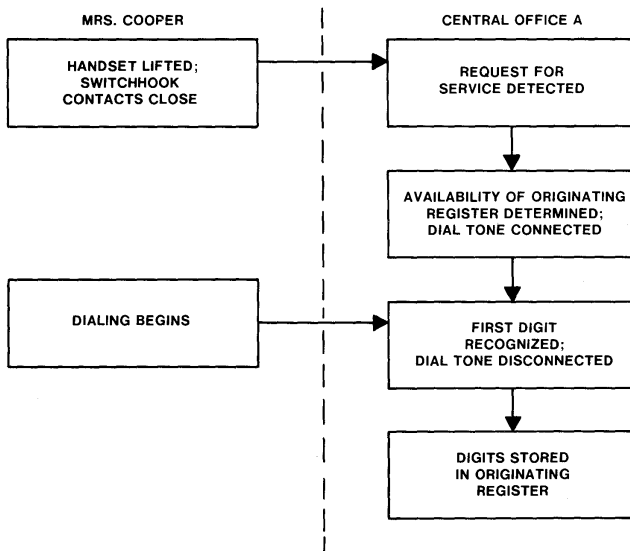

Figure 3-5. Initiating the call.



register, usually called an *originating register*,<sup>13</sup> is available to accept and store the digits she will dial.

After Mrs. Cooper dials the first digit, the dial tone is disconnected. The digits dialed by Mrs. Cooper (951-1234) are received and stored in the originating register.

### 3.4.3 CALL PROCESSING AT THE ORIGINATING CENTRAL OFFICE (FIGURE 3-6)

Next, the control equipment in central office A translates the dialed number. By examining the leading digits, usually the first three,<sup>14</sup> it determines that Mrs. Cooper's call is to another central office code; that is, it is not an *intraoffice* call. Her call is an *interoffice* call and must be connected to a trunk going to another office. Routing information stored in the system indicates which paths (trunk groups) are appropriate and translates the desired paths to representations of physical locations or terminations of trunks. If the call is billable, an automatic message accounting (AMA) register is requested (see Section 3.4.5). At this time, control equipment transfers the call information to a register in another storage area (the outpulsing register shown in Figure 3-7), releasing the originating register from the call. The control equipment begins scanning the outgoing trunks to find an idle trunk to office B. An idle trunk is found directly between offices A and B.

The control equipment could have found that all trunks in the trunk group(s) to office B were busy. In this case, it would have begun to scan the outgoing trunks to tandem switching office C, since the call could be routed on a trunk from office A to office C and from there to office B (as shown in Figure 3-4). If all trunks to tandem office C had also been busy, it would have been impossible to complete the call. In that case, Mrs. Cooper would have heard a reorder tone, often called a *fast busy tone* since it has 120 interruptions per minute (ipm), compared to the 60 ipm of the busy tone.

### 3.4.4 CALL ADVANCEMENT TO THE TERMINATING CENTRAL OFFICE (FIGURE 3-7)

The first event shown in Figure 3-7 is the seizing of an idle trunk to office B. When a trunk is seized for a particular call, it appears busy to the switching system and becomes unavailable for other calls. A 2-way

<sup>13</sup> To illustrate the functional operations involved in the call, this discussion uses generic terms for equipment. Because of the variety of switching systems in the network, the generic term may not fit all cases. For example, step-by-step switching systems, the oldest systems used (see Section 10.2.2), may not have originating registers and may complete the switching functions differently. Likewise, stored-program control systems (see Sections 10.3.1 and 11.3.1) are computer-like in their operation.

<sup>14</sup> In some cases, an access code, such as the digit 1, is used as a prefix to the address digits on calls outside the local area. (See Section 4.3.)

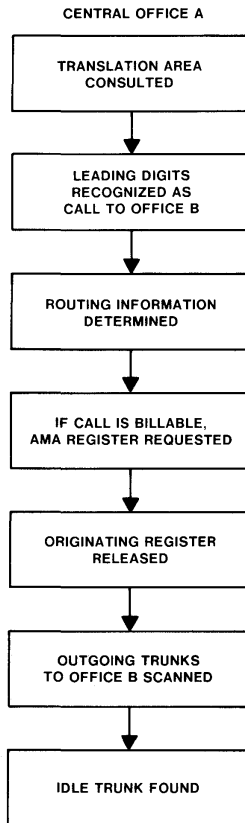

**Figure 3-6. Processing the call at the originating central office.**

trunk may be seized by the switching system at either end to originate a call, while a 1-way trunk may only be seized from one end. Transmission occurs in both directions on either type of trunk.

Mrs. Cooper's line is connected to the outgoing trunk through a path in the switching network within the switching system. The identity of this trunk, the number of digits to be transmitted, and additional information that may be necessary for call setup are recorded in an outpulsing register.

In central office B, an incoming register of the switch will be seized<sup>15</sup> and will signal readiness to receive address information. The control

<sup>15</sup> Seizing the register makes it unavailable for other incoming calls until it is released.

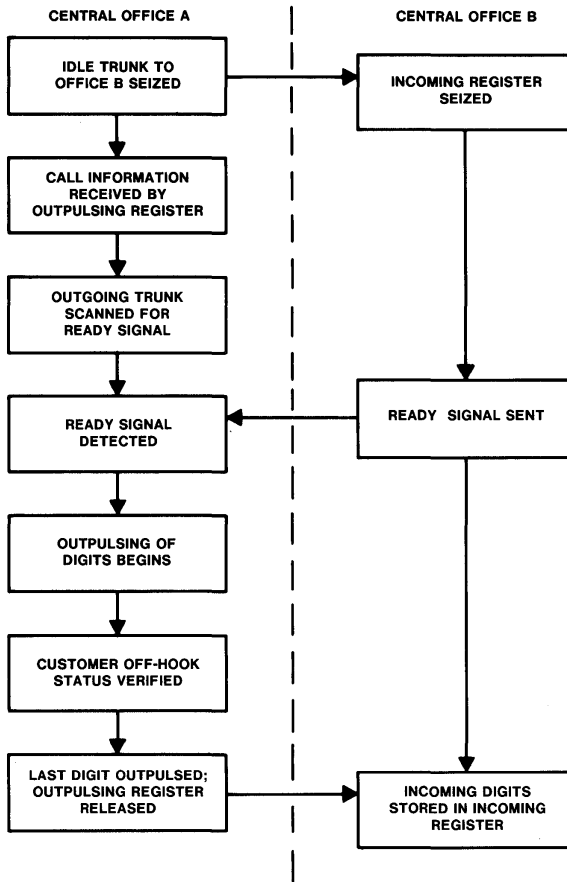

Figure 3-7. Call advancement to the terminating central office.

equipment in Mrs. Cooper's central office will periodically scan for this "ready" signal. When this "ready" signal is detected, outpulsing of digits begins. If central office B contains a single central office code, only the last four digits of Mrs. Mahon's number will be transferred. This is because all calls on the direct trunk group will terminate at central office B. However, if office B contains more than one central office code, additional digits must be transmitted to identify the particular central office code serving Mrs. Mahon.

Before the last digit is sent, the control equipment checks to see that the calling customer's line is still off-hook. If the calling customer has hung up (abandoned the call), the control equipment will terminate the call-processing sequence and release associated equipment and circuits.

When the last digit is outpulsed, the outpulsing register is released. The digits are now stored in the incoming register at central office B. (Sections 8.4 and 8.5 discuss several techniques for sending the digits between central offices.)

### 3.4.5 CALL COMPLETION (FIGURE 3-8)

Once the digits are stored in an incoming register at the terminating office, many functions are initiated and supervised by the control equipment. The 4-digit line number is translated to Mrs. Mahon's physical line termination. The status of Mrs. Mahon's line is interpreted and signifies that the line is idle. (If Mrs. Mahon's line were busy, a busy signal would be returned to Mrs. Cooper.)

The incoming trunk is connected through the switching network to Mrs. Mahon's line. A ringing register is seized, the incoming register is released from this call, and Mrs. Mahon's telephone rings. An *audible ring*, a tone that has the timing of a ringing signal and that indicates that a ringing signal is being applied to Mrs. Mahon's telephone, is sent back to Mrs. Cooper at this time.<sup>16</sup> The control equipment at the terminating office will scan Mrs. Mahon's line status for an answer (off-hook) indication and, when it is detected, will terminate the ringing signal and return answer supervision to office A. This will be used to record answer or connect time for billable calls.

Mrs. Mahon answers the phone, and the conversation begins. As Mrs. Cooper talks into her handset, the acoustic speech signal is converted into an electrical signal by the transmitter in the handset. The signal generated by conventional transmitters is an electrical analog of the acoustic signal. This electrical analog of the speech may proceed through the switching systems and transmission facilities to Mrs. Mahon's telephone in that form, or it may proceed through part of its path in digital form. The latter would then require analog-to-digital and digital-to-analog conversions.

With conventional technology, the signal reaching Mrs. Mahon's telephone will be analog, and the receiver will convert the analog signal back to an acoustic signal. The acoustic signal from the receiver is not an exact reproduction of that at the transmitter. One reason for this is that the frequency content is limited by the transmission path (see Section 6.2). Also, impairments such as noise and loss occur, and if the call

<sup>16</sup> Although initiated at the same time, the audible ring is separate from the ringing signal that activates the ringer in the called party's telephone.

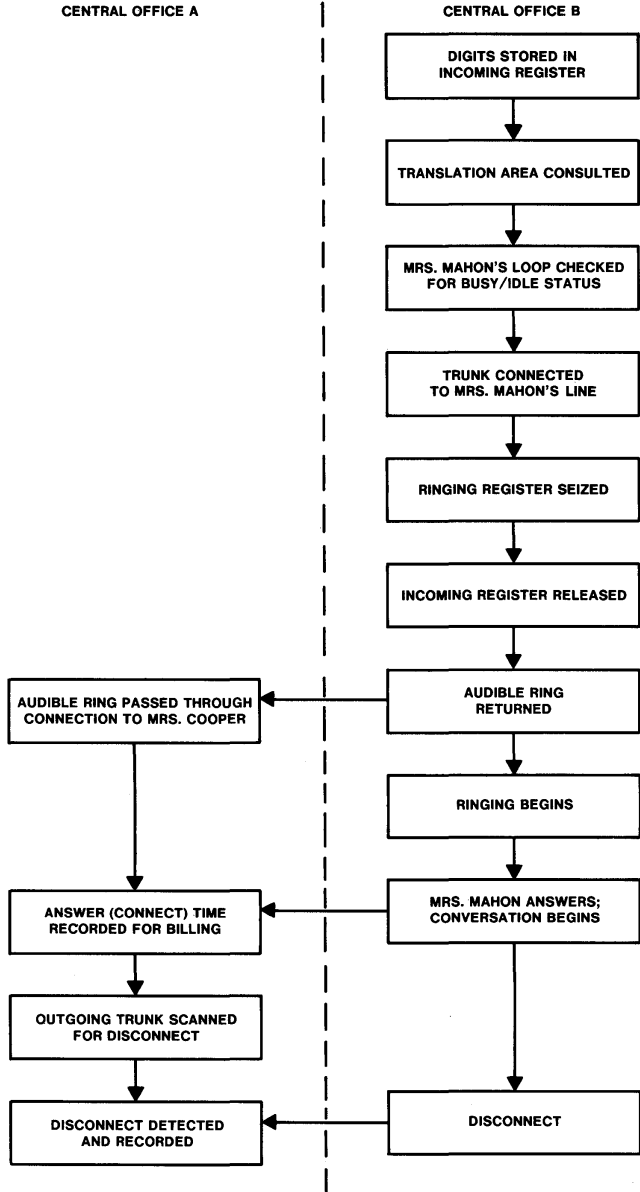

Figure 3-8. Completion of the call.

travels a long distance, an echo effect could occur. (These impairments and ways of controlling them are discussed in Section 6.6.)

During the conversation, the originating office, office A, monitors the outgoing trunk to office B for disconnect. If the calling party hangs up first, the connection is released, and disconnect supervision is sent to the terminating office. The trunk is idled when the terminating office returns on-hook supervision.

If the called party (Mrs. Mahon, in this example) hangs up first, a timed-release period of 10 to 11 seconds is initiated. The connection is released after this time—or earlier if the calling party hangs up.

Completion of the call is detected and recorded at central office A for accounting purposes if there is a charge for the call; that is, if it is not covered by a fixed monthly charge or a flat rate. When the call is first dialed, the control equipment in central office A determines whether the call is billable by the routing information associated with the first three digits (see Figure 3-6). If the call is billable, a register is requested from an automatic message accounting system to receive information that is to be recorded about the call. For Mrs. Cooper's call, the information recorded includes the number of Mrs. Cooper's telephone, the number dialed, the time Mrs. Mahon answered, and the time the connection was released. Data on this call and other billed calls from central office A are forwarded to a data-processing accounting center where they are periodically processed to compute customer charges. If the call is billable, Mrs. Cooper's next monthly telephone bill will include a charge for the call. (Section 10.5 describes how the data are processed to determine the charge, and Section 13.2.2 discusses operations at the accounting center.)

Thus, a basic telecommunications service—the simple telephone call—requires a relatively complex sequence of events.

#### *AUTHORS*

*J. L. Bazley*  
*T. Pecsvaradi*



# PART TWO

---

## NETWORK AND SYSTEMS CONSIDERATIONS

The five chapters in this second part present the basics of network structure and planning and explain engineering considerations applicable to network and customer-services systems. Network functions such as transmission, switching, and signaling are discussed, and a background of telecommunications concepts, principles, and technology is presented with emphasis on relevance to the related network and system topics. This should provide a general foundation for the description of specific network and customer-services systems in Part Three.

Chapter 4 expands on the introductory material in Chapter 3 and describes the structure of traffic and facilities networks. It explains the difference between local and toll networks, discusses the role of network planning, and describes the unified numbering plan. Chapter 5 presents basic traffic concepts through a discussion of topics such as traffic theory and its application to the engineering of switching systems and trunk groups. Interrelated traffic considerations that affect network engineering, the management of traffic networks, and considerations in the design of data networks are also discussed.

Chapter 6 presents fundamental transmission principles and technology. Concepts such as signals, channels, media, modulation, and multiplexing are examined, and transmission impairments and objectives are discussed. Beginning with a discussion of the basic role of switching, Chapter 7 explains switching functions, networks, and control. In addition to a description of the basic switching functions involved in establishing a connection, the various auxiliary functions are also discussed. Part Two concludes with Chapter 8, which explains the fundamentals of signaling and interfaces in terms of the basic functions they provide in the network and some of the methods and concepts involved in fulfilling their roles.





# 4

---

---

## Network Structures and Planning

### 4.1 INTRODUCTION

The telecommunications network, as defined in the last chapter, has two interrelated aspects. In terms of its physical components—station equipment, transmission facilities, and switching systems—the telecommunications network is a facilities network. To provide various services, those facilities are interconnected in many ways; in this sense, the telecommunications network is a set of traffic networks that share the facilities.

This chapter continues the discussion of the telecommunications network with descriptions of the structures of the facilities and traffic networks. For traffic networks, the emphasis is on the largest and most complex—the public switched telephone network (PSTN)—although private networks are covered briefly.<sup>1</sup> The discussion also includes a description of the PSTN worldwide numbering plan. The last section of the chapter discusses considerations and approaches used in planning the configuration of the telecommunications network so that it continuously meets constantly growing and changing demands.

### 4.2 STRUCTURE OF TRAFFIC NETWORKS

#### 4.2.1 THE PUBLIC SWITCHED TELEPHONE NETWORK

The PSTN actually consists of two strongly interdependent networks: the **local network** (sometimes called the *exchange area network*) and the **toll network**. The interdependence results from extensive integration and

<sup>1</sup> As noted in Section 2.1.2, special services (which include private networks) have been growing rapidly. One result of this growth is that about 5.2 million (43 percent) of the approximately 12 million interbuilding circuits in service in the Bell System in 1982 were special-services circuits.

sharing of functions to reduce overall network costs. The following discussion, which is designed to convey basic concepts, presents a simplified view of the local and toll network structures. The actual structure is far more complex due to the variety of ways in which network functions are integrated to meet diverse needs in particular segments of the network.

### Local Network Structure

The structure of the local network begins with customer station equipment connected by loops to local switching systems. All customers connected to a local switching system (central office) in a particular central office building<sup>2</sup> are said to be located in a *wire center area*, and the location of the building is called the *wire center*. These concepts are illustrated in Figure 4-1. Customers located within a wire center area communicate with each other through the local switching system, or systems, at the wire center. As indicated in Section 3.1, this arrangement reduces network costs by adding some switching costs in return for a large reduction in transmission costs.

Figure 4-2 illustrates the concept of judiciously combining switching and transmission to minimize overall costs in the local network. In the 2-level switching hierarchy shown, which is typical of most metropolitan areas, the switching systems at adjacent or nearby wire centers are connected by trunks, either directly or through one or two tandem switching systems. Thus, customers in adjacent or nearby wire center areas communicate with each other using their dedicated loops and the trunks interconnecting their local and tandem switching systems.

Whether it is more economical to provide direct trunks between two adjacent wire centers, to interconnect them indirectly using tandem trunks and tandem switching systems, or to use a combination of both depends on the traffic volumes, the distances involved, and the opportunities for sharing the facilities among many customers.

In Figure 4-2, there is a strong community of interest (high traffic volume) between offices at wire centers A and B, justifying a direct trunk group (represented by the dashed line). Traffic between wire center C and the other two wire centers does not warrant direct trunk groups and is carried by tandem groups (represented by solid lines) through tandem office T. Using tandem trunk groups and switching systems to provide service in a local area usually involves longer transmission paths and more switching but proves to be more economical when the traffic volumes between pairs of local switching systems are very low.

For intermediate traffic volumes, the most economical solution may be a combination of direct and tandem trunks. The routing technique that

<sup>2</sup> As noted in Chapter 3, a central office building may contain one or more switching systems.

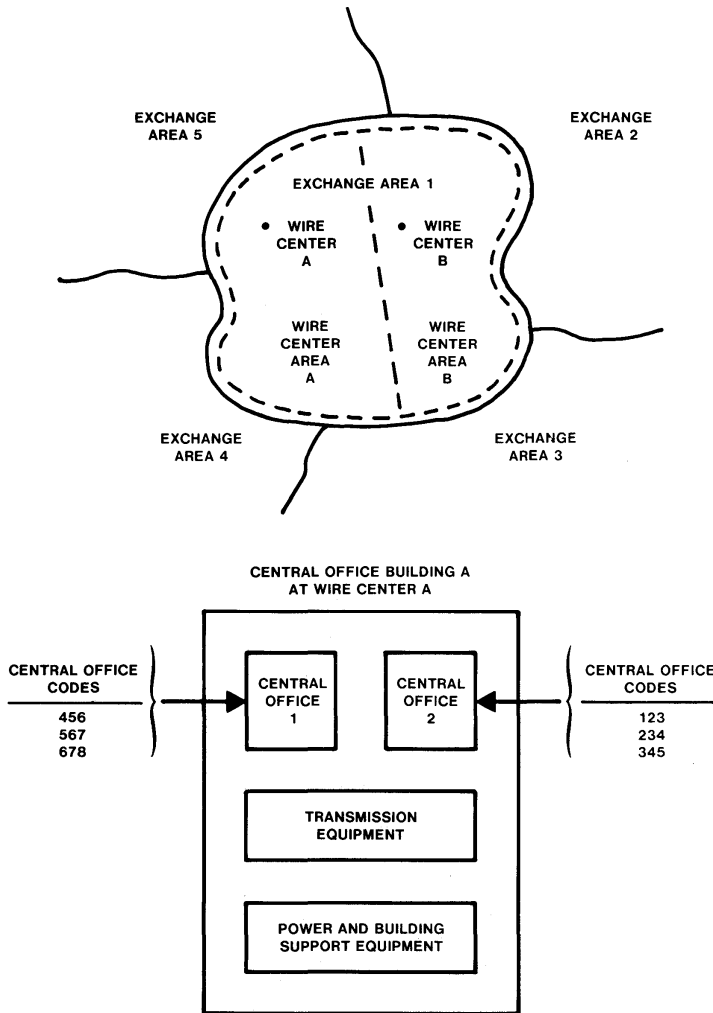

**Figure 4-1. Local network topology.** *Top*, wire center areas and exchange areas. Traditionally, a single, uniform set of charges exists for telephone service in an exchange area, and a call between any two points in the area is a local call. (Different meanings will apply after divestiture.) *Bottom*, central office building terminology.

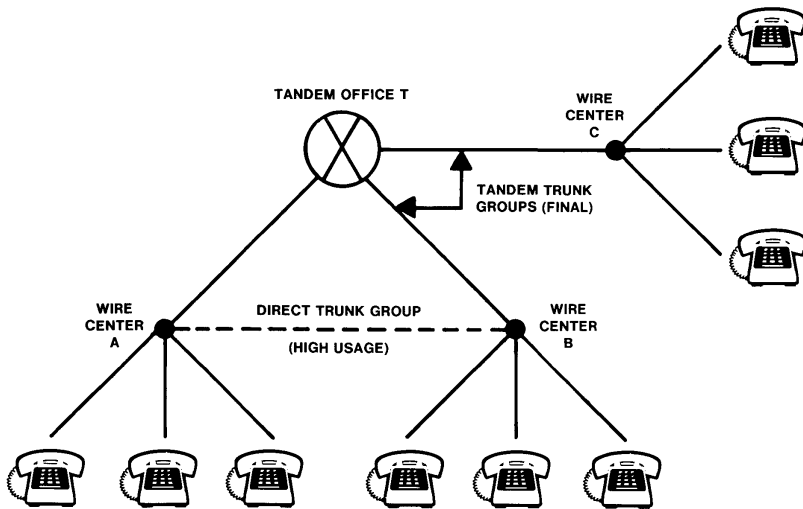

Figure 4-2. A typical local network configuration.

takes advantage of this network structure is called *automatic alternate routing*. With automatic alternate routing, a switching office first offers a call to a *high-usage (HU) trunk group* (a primary direct office route between two switching systems). If all trunks in the HU group are busy, the call is routed via a tandem office using a *final trunk group*. Final trunk groups are the final routes traffic can take. When all transmission paths on a final trunk group are busy, the calling customer is sent a reorder tone and must try again later.

It is important to note that the terms *direct trunk group* and *tandem trunk group* describe the topological structure of the network, while *high-usage trunk group* and *final trunk group* refer to the manner in which the trunk groups are used when routing traffic on them. Consequently, a direct trunk group is not necessarily an HU trunk group. If, for example, the traffic between offices A and B in Figure 4-2 were not allowed to overflow to the tandem trunk groups, then the direct trunk group would not be an HU group. HU and final groups are traffic-engineered differently, as described in Section 5.4.

Section 5.5 describes the method of determining the most economical apportionment of HU and final trunks. As discussed there, an important factor in the determination is trunk group *efficiency*—the concept that average traffic carried per trunk increases with trunk group size. This concept is the basis for efforts to concentrate traffic into larger parcels, a major consideration in the design of traffic networks.

When the number of central offices in a metropolitan area is large, it may be advantageous, in terms of trunking arrangements, to group central offices in sectors that reflect communities of interest. Each sector is served by a tandem office located near the traffic-weighted center of the sector. This reduces the total length of tandem trunking. The attendant penalty is that some calls may require three consecutive tandem trunks<sup>3</sup> and, consequently, may have a slightly longer set-up time. A more complicated structure with more routing choices may also result if certain office pairs, such as A and D in Figure 4-3, reside in different sectors but have enough traffic between them to justify a direct trunk group.

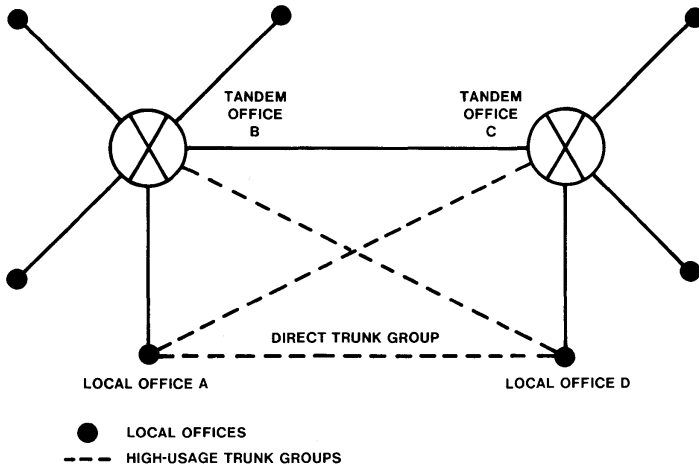

Figure 4-3. A 2-tandem-office local network.

### Toll Network Structure

As mentioned earlier, the switching configuration shown in Figure 4-2 is a 2-level hierarchy. While it provides an economical tradeoff between switching and transmission costs within most local metropolitan areas, it is not the most economical structure for interconnecting all switching offices in the nationwide network. The volume of traffic between widely spaced local offices is usually small, and direct trunks to serve this traffic would be too expensive. Therefore, the switching hierarchy now used in the United States has five levels (illustrated in Figure 4-4), in which successively higher level offices (also called *classes*) concentrate traffic from increasingly larger geographical areas.

<sup>3</sup> Trunks interconnecting tandem offices are sometimes called *intertandem trunks*.

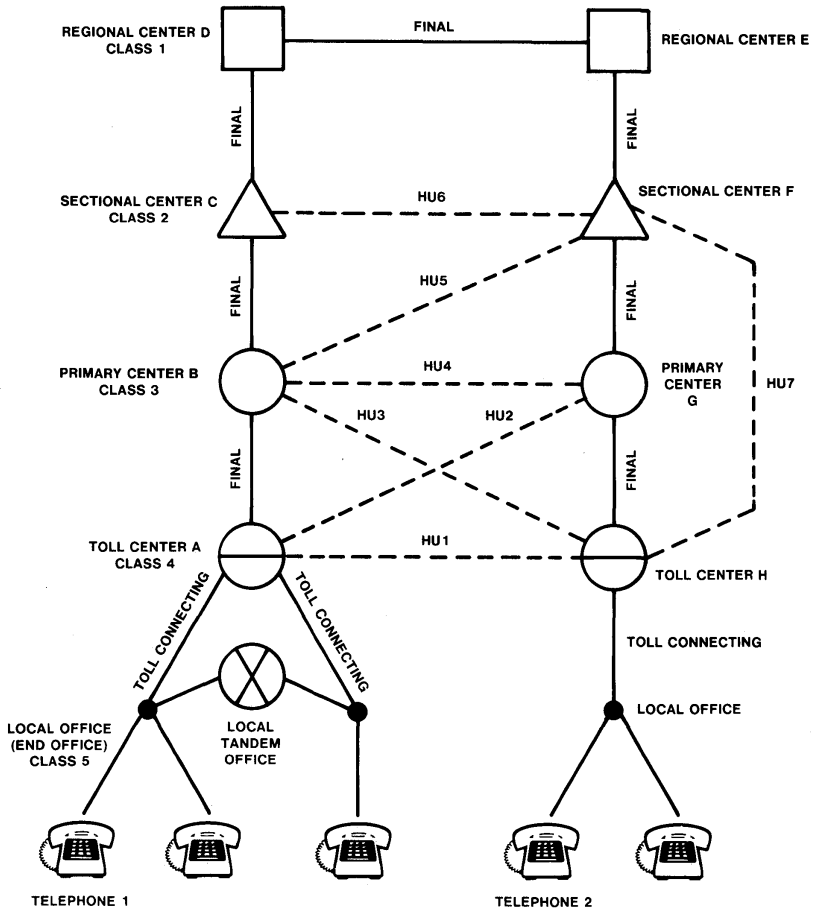

Figure 4-4. The switching hierarchy.

Class 5 offices (also called *local switching offices* and *end offices*) are part of the local network. The toll network consists of the class 4 and higher switching offices (toll centers, primary centers, sectional centers, and regional centers as shown in Figure 4-4) and the trunks interconnecting them. Table 4-1 gives the number of offices at each level of the PSTN hierarchy. All trunks within the toll network are called *intertoll trunks*. Class 5 end offices are connected to the class 4 toll centers by *toll connecting trunks*.

**TABLE 4-1**  
**DISTRIBUTION OF OFFICES IN**  
**THE PSTN HIERARCHY (1982)**

	Class				
	1	2	3	4	5
Bell operating companies	10	52	148	508	9803
Independent telephone companies			20	425	9000

An office connected by a final trunk group to a higher class office is said to "home" on that office, although it should be noted that offices do not always home on the next higher class office. For example, while most class 5 offices (end offices) home on class 4 offices (toll centers), some class 5 offices home on class 3, 2, or 1 offices.

Typically, offices in the same homing chain are located relatively near each other. Consequently, many final trunk groups are only a few miles long. The final and HU trunk groups that interconnect two different regions (that is, two different homing chains) are the *long-haul trunks* of the toll network. If the volume of traffic between offices of the same class or differing in class by one is high enough, it is more economical to connect them directly by HU trunks (HU1 through HU6 on Figure 4-4) than to send traffic by some indirect path. Sometimes traffic between offices in the same homing chain justifies interconnection by an HU group, as illustrated by HU7 in Figure 4-4.

The basic rule for routing a toll call is to complete the connection at the lowest possible level of the hierarchy, thus using the fewest trunks in tandem. In Figure 4-4, a call from telephone 1 to telephone 2 first goes to the local office (a class 5, or end office). That office recognizes the call as a toll call and sends it over toll connecting trunks to toll center A. Toll center A searches for an idle HU trunk, first in the HU1 group, then in the HU2 group. If all trunks in those groups are busy, the call overflows to the final trunk group connecting toll center A and primary center B. If all trunks in this final group are busy, the call is blocked and the customer receives a reorder tone. Otherwise, the call reaches primary center B, and the sequential search procedure continues up through the hierarchy, searching HU3 through HU6 and related final groups until either an idle path (sequence of trunks in tandem) between the two end offices is found or all possible routing alternatives are exhausted. The average toll call uses slightly over three trunks, including toll connecting trunks. The maximum number of trunks that may be used in a connection is nine.



The actual structure of the network is far more integrated and complex than the simplified local and toll network structures just described. For example, advances in switching technology allow the introduction of local switching systems that can record billing information and perform alternate routing, thus combining local, local tandem, and toll functions. Figure 4-5 shows the distribution of the different switching functions over the Bell System switching systems. The net effect of sharing among switching systems is a reduction in switching and transmission costs.

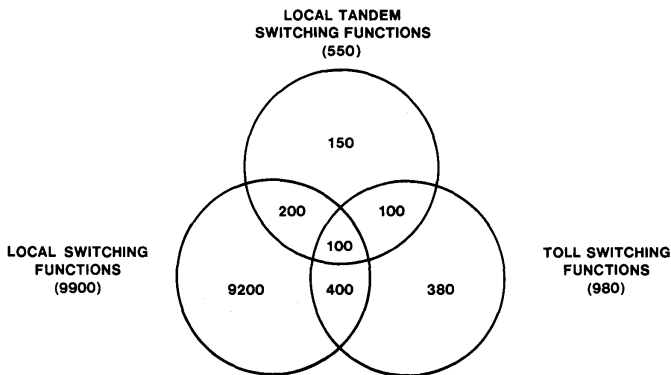

**Figure 4-5. Distribution of switching functions over Bell System switching systems.** The numbers represent the number of switching systems performing the indicated functions at the end of 1978. The union of any two (or all three) circles represents systems providing a combination of functions. For example, 400 systems provide a combination of local and toll functions.

One manifestation of the ability to combine or integrate local and toll functions in one switching system is that toll calls between certain pairs of end offices are not carried on toll connecting trunks up to the class 4 toll center on which the end office homes. Rather, they are carried on *end office toll trunks*. Many of these are direct trunk groups that carry toll traffic only between two end offices. Other end office toll trunks may carry toll traffic from one end office to the class 4 toll office on which a distant end office homes. These trunk groups are HU groups, so that any overflow from them would be routed through the toll hierarchy in the usual manner. Because they save on toll switching costs, end office toll trunks are economical when there is a sufficiently high community of interest between two end offices that are a considerable distance apart. In this arrangement, the switching systems involved must be able to record billing information and perform alternate routing. This type of trunking is prevalent in certain areas of the country. In New Jersey, for example, nearly 36,000 of the approximately 168,000 trunks carrying toll traffic at the end of 1982 were end office toll trunks.

**TABLE 4-4**  
**WORLD ZONE ASSIGNMENTS**

World Zone	Principal Areas Covered
1	Canada, United States
2	Africa
3, 4	Europe
5	South and Central America, Mexico
6	South Pacific
7	U.S.S.R.
8	North Pacific
9	Far and Middle East
0	Spare

NOTE: Specific country code assignments (see AT&T Long Lines 1982, p. 122) tend to be stable but may be changed by mutual agreement.

world zone 3; 50 and 59 for world zone 5) are selected in forming 3-digit codes. The other pairs are assigned as 2-digit country codes. Thus, from the initial two digits, switching systems can determine whether the country code is two or three digits long.

The dialing sequence for an IDDD call is illustrated by the following call from England to the United States. The customer in England dials 010-1-NXX-NXX-XXXX, where 010 is the international subscriber dialing prefix used in England; 1 identifies North America as the world zone (and, in this case, is the country code); and the remaining digits are the familiar 10-digit address or national number used in North America.

The Bell System has authorized two prefixes for outwardbound IDDD. The prefix 011 indicates simple coin or noncoin automatic calls. The prefix 01 indicates a desire for operator assistance.

#### 4.3.6 OTHER SPECIAL NUMBERING

International dialing, of course, is only one of a number of services dependent on numbering. A selection of representative formats for other services indicates that numbering is not static and that new services invariably require some adaptation of numbering.

- *Custom Calling Services* — for Call Forwarding: \*72 with TOUCH-TONE dialing or 1172 with rotary dialing (followed after dial tone by the 7-digit number of the telephone to which calls will be sent)

- *Toll-free service* (area code 800) — for directory assistance: 1+800-555-1212
- **DIAL-IT** *network communications service* (area code 900) — for Sports-Phone: 1+900-976-1313
- *Calling card service* — 0 followed by a 10-digit destination address, followed after signal by a 14-digit calling card number.

## 4.4 STRUCTURE OF THE FACILITIES NETWORK

Section 3.2 introduced the three major elements of the facilities network—station equipment, transmission facilities, and switching systems. From that discussion, it is evident that station equipment is dedicated to particular customers; and therefore, the quantity, type, and configuration are dictated by the services a customer chooses. Transmission and switching facilities, on the other hand, are shared. For this reason, station equipment is omitted from the following discussion, and the term *facilities network* refers only to transmission and switching facilities.

Many factors determine the structure of the facilities network. Some of the more important ones are customer location, telecommunications services desired, performance objectives, available communications technologies and their costs and performance characteristics, and the need for redundancy in the network to protect against major service interruptions.

For discussion purposes, it is convenient to divide the facilities network into the **local facilities network** and the **interoffice facilities network**, according to the two major classes of transmission facilities: loop and interoffice. No physical dividing lines separate these facilities; the distinction is merely an aid in describing the characteristics of the overall facilities network.

### 4.4.1 LOCAL FACILITIES NETWORK

The local facilities network consists of the local switching systems located at wire centers and the loop transmission facilities through which customers are connected to local switching systems. The local switching systems are located at what can be considered the conceptual boundary between the local facilities network and the interoffice facilities network. In this sense, they belong to both networks.

A wire center area is divided into several (usually four) distinct geographical areas called *feeder route areas*. Feeder route areas are further divided into *allocation areas*, and each allocation area is divided into one to five *distribution areas*. Figure 4-8 shows a portion of the structure of the local facilities network in a typical suburban area, including a wire center building and one feeder route area. The inset shows the structure of a distribution area in detail.

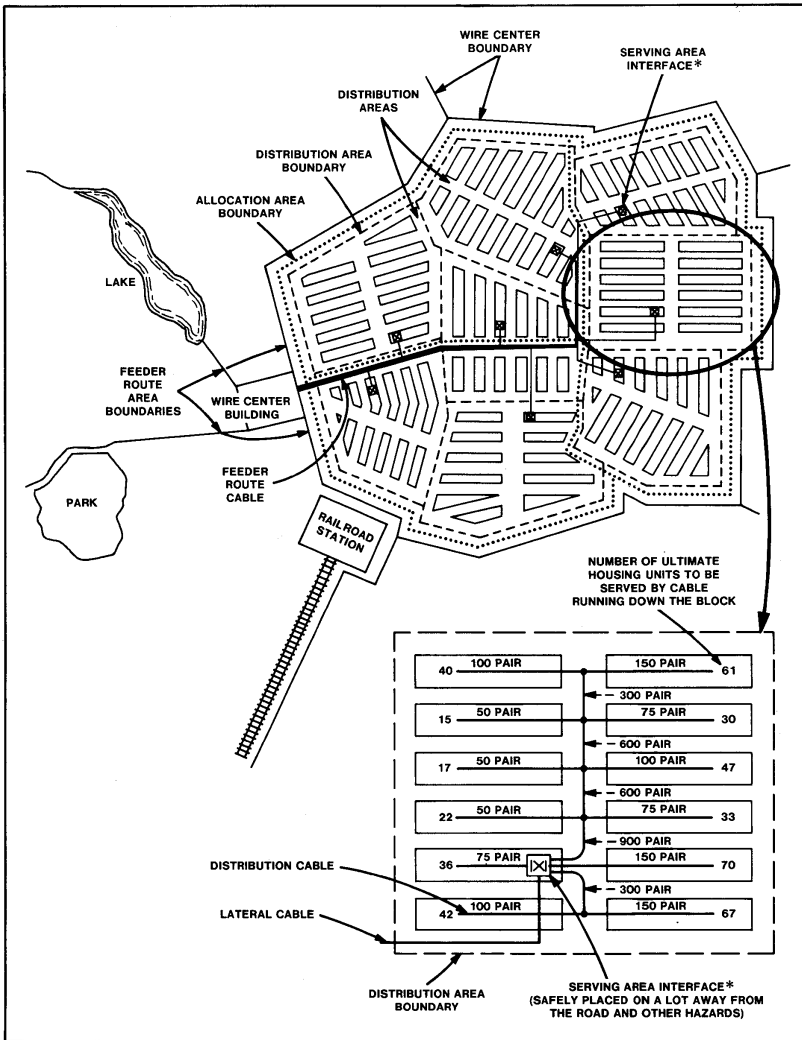

\* A rearrangeable cross-connect point between feeder and distribution cables in the loop plant.

Figure 4-8. A suburban feeder route area.

Loop transmission facilities have a tree-like structure: A feeder route (typically, a large paired cable<sup>13</sup>) extends out from the wire center into each feeder route area; lateral cables are spliced to the feeder cables at various points along the route; distribution cables are joined to the lateral cables; and, finally, customers' station equipment is connected to the distribution cable. The feeder cables near the wire center are generally quite large (containing 1200 to 3600 wire pairs). At each lateral cable splice, feeder cables become progressively smaller as the distance along the route from the wire center increases (indicated by the progressively narrow feeder route line in Figure 4-8).

The primary transmission facility in the loop network is paired cable suspended on telephone poles, placed in underground conduit, or buried directly in the ground. In recent years, the application of pair-gain systems has become an important consideration in the design of the loop network. To reduce the number of cables required, subscriber pair-gain systems use carrier and concentrator techniques (see Chapter 9), thereby enabling a number of customer loops to share the same wire pair and electronics.

Local switching systems may be either electromechanical or electronic.<sup>14</sup> Switching system size depends on the number of customers in the area served and the area's growth rate. System type depends on area characteristics and the switching technology available at the time of installation. Table 4-5 lists the average values of some parameters of the facilities network in urban, suburban, and rural environments. Trunks are provided on interoffice transmission facilities, and thus, they are a part of the interoffice facilities network discussed in the next section. However, trunks are relevant to wire center parameters because, as stated earlier, they terminate at local offices.

A number of observations may be made about Table 4-5. The average area served by a wire center in suburban and rural areas is about an order of magnitude larger than the average urban area served. Although greater switching economy might be achieved by serving even larger rural areas, the savings would be more than offset by the additional cost of the loop electronics necessary to maintain service quality. While about 85 percent of the customers served by small, unattended switching offices in rural areas are located within 2 miles of the wire center, the average length of those rural loops that extend beyond 2 miles greatly exceeds the global average. Thus, a relatively small percentage of the customers

<sup>13</sup> Paired (or multipair) cable consists of pairs of wires twisted together to form the core of a communications cable. Section 6.3 discusses transmission media, including paired cable.

<sup>14</sup> Chapter 7 describes the concept of switching, and Chapter 10 describes switching systems.

have very little built-in slack, blocking on them increases dramatically when an overload is present. Reattempts cause a departure from the random arrival assumption used in the traditional models and, if they are not accounted for, cause an overestimate of offered load based on measurements. In practice, the accounting has been done by assuming that only 35 percent of blocked calls are lost (do not return to the system).

The potential problem caused by reattempts is minimized because the trunking tables use the models (originally, the Poisson, now, the Neal-Wilkinson  $\bar{B}$ ) only for groups of fewer than 250 trunks. When the  $\bar{B}$  model calls for more than 250 trunks (that is, for the higher occupancy groups), the group is engineered to the same (lower) occupancy that a 250-trunk group provides.

#### 5.4.4 NONRANDOM LOAD

Both the Erlang B and the Poisson models assume that calls arrive in accordance with the Poisson distribution. For final groups serving overflow from HU groups, however, the Poisson arrival assumption is demonstrably false. Poisson load has a variance-to-mean ratio equal to 1; overflow load has a variance-to-mean ratio significantly greater than 1. The variance-to-mean ratio of the offered load is called the *peakedness* and is denoted by  $z$ . More trunks are required to provide an equivalent GOS for peaked ( $z > 1$ ) load than for Poisson ( $z = 1$ ) load.

The effect of peaked (non-Poisson offered) traffic is modeled using a technique known as the *equivalent random method*. It assumes that all peaked traffic will behave the same way as traffic overflowing a single trunk group that meets the same assumptions as the Erlang B Loss Formula. The model is constructed by calculating a load,  $A$ , and a number of trunks,  $C$ , that will have an overflow traffic with mean,  $a$ , and variance,  $v$ , ( $v > a$ ), equal to the traffic to be modeled. The desired overflow from a group of trunks to serve the peaked traffic is expressed as *overflow load*,  $\alpha$ . For example, the objective may be 1-percent blocking, or  $\alpha/A = 0.01$ . If  $A$  erlangs offered to  $C+c$  trunks produce  $\alpha$  erlangs of overflow, then the  $a$  erlangs of peaked traffic offered to  $c$  trunks will also produce  $\alpha$  erlangs of overflow.

Calculated values of  $C$  and  $A$  for a wide range of overflow loads and peakedness are tabulated. Calculation of  $c$ , then, involves iteration of the equation:

$$\left(\frac{\alpha}{A}\right) = B(C+c, A). \quad (19)$$

The disadvantage of the equivalent random method is that it presumes that the group of  $c$  trunks is engineered using the Erlang B model. But, as mentioned previously, engineering final groups using the Erlang B

model fails to account for day-to-day variations. Nor can inserting the Poisson blocking probability in equation (19) compensate for day-to-day variations, since  $A$  and  $C$  are estimated by assuming blocked calls are cleared on the  $C$  trunks.

The development of alternate-route networks, in which non-Poisson offered traffic reaches the final groups, spurred the effort to produce models that accurately account for peakedness. This effort, in turn, generated a need for models (for example, Neal-Wilkinson) that properly account for both day-to-day variation effects and non-Poisson offered traffic. The next section discusses the advantages of alternate-route networks and some factors complicating their design.

## 5.5 TRAFFIC NETWORK DESIGN

The previous two sections described the problems of engineering switching systems and engineering trunk groups as if they were independent activities. However, when the nodes (switching systems) and the links (trunks) are combined to form a network, optimizing overall network design becomes the key problem. This optimization involves providing satisfactory (from the customer's viewpoint) end-to-end service at the lowest possible cost. Because the telephone network is so large and complex and must be flexible enough to respond to increasing demands, new services, and changing technology, a precise formulation of the design problem is impossible. However, alternate routing has proven to be a key factor in optimizing the network. The next few sections describe one of the simple models developed to produce cost-optimal (in the static sense) alternate-route networks and how this model is used as part of a process to provide the required number of trunks in the network—a process that captures dynamic (year-to-year) effects too complex to include directly in a single optimization model.<sup>17</sup>

### 5.5.1 THE ECONOMICS OF ALTERNATE ROUTING

Every central office (CO) in the PSTN is connected by a final trunk group to some tandem<sup>18</sup> switching office, so that routing between COs is always possible over these "backbone" final groups (see Section 4.2). Figure 5-8, in which COs 1 and 2 have final groups to the same tandem office  $A$ , illustrates this construction. Traffic between COs 1 and 2 can always be

<sup>17</sup> Section 13.3.1 describes the process for providing trunks and special-services circuits in the network (*provisioning*).

<sup>18</sup> *Tandem* is used in this discussion in the generic or functional sense, that is, an office that switches trunks to trunks. In the switching hierarchy, this office may be a toll office or a local tandem office.

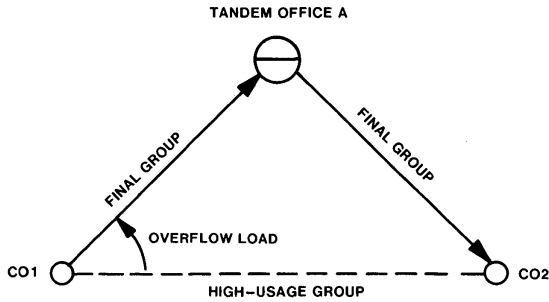

Figure 5-8. Alternate-route triangle.

routed on groups 1-A and A-2 and would encounter (roughly) 0.02 blocking on the average during the busy season, assuming 0.01 blocking on each final group.

Where enough traffic exists, there are significant advantages in also building a direct group between COs 1 and 2 and allowing calls blocked on the 1-2 group to overflow to the alternate route 1-A-2. This routing strategy effectively balances the conflicting forces of cost and service. Trunks in the direct group, being shorter, tend to be cheaper than trunks in the alternate route, which seems to suggest that all traffic between the offices should be carried on a direct group. If this were done, however, the group would have to be engineered for objective blocking, requiring a larger number of trunks. In addition, there would be no service protection if a serious failure in the trunk group occurred. The alternate-route network in Figure 5-8 provides better service at lower cost than either the alternate-route-only or the direct-route-only strategies, provided the correct number of trunks is determined for the direct group.<sup>19</sup>

The model for determining the correct number of HU trunks is based on the simple triangle network of Figure 5-8. The following discussion assumes that there is a cost per alternate-route trunk,  $C_A$  (which includes the cost of switching through tandem office A plus the transmission cost of trunks 1-A and A-2), and a cost per direct trunk,  $C_D$ . The *marginal capacity*,  $\gamma$ , of a trunk group engineered to 0.01 blocking can be defined as the additional load that can be offered to the group, without changing the blocking, when one trunk is added. (Mathematically,

$$\gamma = \left. \frac{\partial a}{\partial c} \right|_{B=0.01}$$

<sup>19</sup> An exception occurs when the traffic between COs 1 and 2 is small. Because small trunk groups are inefficient compared to larger trunk groups (that is, small groups operate at low average occupancies), there are cases when no direct group can be justified economically.



where  $a$  is the offered load and  $c$  is the number of trunks in the group.) Since the 1-A and A-2 groups are carrying other traffic (group 1-A carries traffic from CO1 to other COs; group A-2 carries traffic from other COs to CO2), they tend to be reasonably large and efficient; that is, they have a high marginal capacity. The following discussion assumes both groups have the same marginal capacity, denoted by  $\gamma_A$ . (In practice,  $\gamma_A$  is usually between 26 and 28 CCS.)<sup>20</sup>

If  $n$  trunks are put into the CO1-CO2 group, the cost of these trunks will be  $nC_D$ . Moreover, the overflow from this  $n$ -trunk HU group,  $\alpha(n)$ , will be offered to the alternate route, which will require the addition of  $\alpha(n)/\gamma_A$  trunks to group 1-A and to group A-2 to maintain 0.01 blocking. The incremental<sup>21</sup> cost, then, of putting  $n$  trunks in the CO1-CO2 HU group, denoted by  $C(n)$ , is given by

$$C(n) = nC_D + \frac{\alpha(n)}{\gamma_A} C_A. \tag{20}$$

Figure 5-9 shows  $C(n)$  and its two components in graph form, treating  $n$  as a continuous variable. As shown,  $C(n)$  has a unique minimum, which occurs at the value of  $n$  such that

$$-\frac{\partial \alpha(n)}{\partial n} = \gamma_A \frac{C_D}{C_A} = \frac{\gamma_A}{C_R} \tag{21}$$

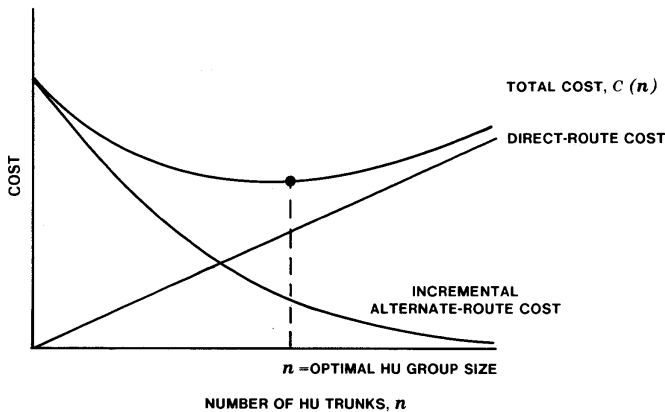

Figure 5-9. Cost function for alternate routing.

<sup>20</sup> Hundred call seconds per hour (see footnote 3).

<sup>21</sup> The background traffic on trunk groups 1-A and A-2 requires trunks too, of course, but the cost of those trunks is assumed to be independent of  $n$ . Thus, only the additional cost of routing the CO1-CO2 overflow via 1-A-2 must be considered.

where  $C_R = C_A/C_D$ .  $C_R$  is referred to as the *cost ratio* of the HU group. (If there is no  $n$  such that equation (21) holds, then the minimum occurs at  $n=0$ ; that is, tandem route only is the optimal strategy.)

The quantity  $-\partial\alpha(n)/\partial n$  has a practical interpretation: It is the load on the last trunk of an  $n$ -trunk group, assuming the Erlang B model applies to the HU group. Thus, the quantity  $\gamma_A/C_R$  is the most economical load on the last trunk, and the optimal group size is such that the last trunk carries  $\gamma_A/C_R$  load. Since the telephone companies measure load in CCS, the quantity  $\gamma_A/C_R$  is referred to as the *economic CCS (ECCS)*. The technique of sizing HU groups such that the last-trunk load is  $\gamma_A/C_R$  is commonly called *ECCS engineering*.

### 5.5.2 MODIFICATIONS TO THE ECCS ENGINEERING TECHNIQUE

The cost function in equation (20) represents an approximation to the actual incremental cost of providing  $n$  trunks in the HU group. The marginal capacity, for example, is not truly a constant but depends on both the peakedness (variance-to-mean ratio) of the background traffic on the alternate route and the peakedness of the overflow from the HU group. Nevertheless, the ECCS technique yields a good approximation to the optimum HU group size. This approximation can be improved by recognizing certain cost realities that the ECCS model ignores. These realities are discussed in the following paragraphs.

#### Minimum Group Sizes

There is an administrative cost associated with an HU group that is not reflected in equation (20). This cost applies when  $n>0$  but not when  $n=0$ . When this administrative cost is added to the total cost for the optimal group size as determined by the ECCS method, it may well be that  $n=0$  is a cheaper solution. Empirical studies have determined that this happens when the ECCS method suggests small HU groups and can be corrected effectively by using the ECCS method in conjunction with a minimum HU group size. The recommended minimum, determined empirically, is typically three trunks per group for local networks and six trunks per group for toll networks; smaller HU groups are not built. The difference between the two minimum values is explained by the fact that cost ratios ( $C_A/C_D$ ) in local networks tend to be higher than in toll networks, so that smaller groups are economical.

#### Modular Engineering

The cost function of equation (20) assumes that there is a unit cost,  $C_D$ , for each trunk added to the direct group. However, many of the transmission components that implement trunk groups have the capacity to handle multiple trunk circuits. For example, trunks can be added to a

## 7.1 INTRODUCTION

The primary function of switching in a telecommunications network is to interconnect the telephones or other telecommunications terminals of a large number of customers as economically as possible. As shown in Section 3.1, centralized switching requires only one telephone and one telephone line per customer; the interconnection of  $n$  customers without switching requires  $n-1$  telephones per customer and a total of  $[n(n-1)]/2$  wire pairs. Even with centralized switching, as  $n$  and the area served continue to grow, points are reached where using two or more switching systems interconnected by transmission facilities becomes the most economic way to provide telecommunications access for all  $n$  customers. The public switched telephone network (PSTN) extends the concept of a network of centralized switching systems to a very large geographic area through a hierarchical network of switching offices (see Section 4.2.1).

Although connection is the primary function of switching, other functions must also be provided, as discussed in Section 7.2. Some of these functions are associated with the operation of the telecommunications network and others are associated with customer services.

Interest in improved customer services has strongly influenced the design of modern switching systems that use *stored-program control*, a concept that enables new features to be implemented through changes in software rather than hardware. Section 7.4.3 describes stored-program control. Chapter 10 describes the various switching systems, including those that use stored-program control.

Traditionally, Bell Laboratories has been responsible for systems engineering of switching systems for both network and customer applications on behalf of AT&T and the Bell operating companies. These include systems developed by Bell Laboratories and manufactured by Western Electric, as well as systems from other suppliers.

The rest of this chapter provides a basic understanding of some of the concepts and considerations involved in the design of switching systems.

## 7.2 BASIC SWITCHING FUNCTIONS

Connection can best be understood by considering the two essential parts of a switching system: the **switching network** and the **control mechanism**. The *switching network* consists of the individual switching devices used to connect the communication paths. The *control mechanism* provides the intelligence to operate the appropriate switching devices at the proper time. (Sections 7.3 and 7.4 discuss switching networks and control mechanisms, respectively.)

In addition to the basic function of connecting communication paths, a switching system must be capable of receiving and sending network control signals between itself and customer terminals and other switching systems, performing functions required to administer and maintain the system, and providing customer services. Each of these switching functions is described below. These additional functions are many and complex and must interact properly, compounding the work of switching system designers.

### 7.2.1 CONTROL

Control is the technique by which a switching system interprets and responds to signals and directs the switching network. In the past, control was accomplished by logic circuits using relays and other electromechanical devices. Today, virtually all new switching systems employ stored-program computer control. By changing and adding to the stored program, the operation of the switching system can be modified and extended.

### 7.2.2 SIGNALING

All modern switching involves the transfer of information (for example, dialing and ringing) between users and the switching system and between two switching systems. This is known as *signaling* and can be thought of as a special form of data communication.

In early automatic switching systems, most signaling between systems involved dc electrical signals. Later, as signaling distances increased, single- and multiple-frequency tones were used. Recently, faster and more versatile digital signaling over dedicated networks separate from the voice network has been introduced. (Chapter 8 discusses the signals required in the network and the various signaling techniques.)

### 7.2.3 ADMINISTRATION AND MAINTENANCE

Today's switching systems provide separate features to ensure that the switch operates reliably and efficiently. These features monitor, test, record, and permit human control of service-affecting conditions of the switching system. Examples include:

- *network management*, which enables traffic to be rerouted to avoid congested portions of the PSTN (see Section 5.6)
- *traffic measurement*, which provides indications of the traffic loads being carried by various components of the switching system (see Section 5.7)
- *billing*, which allows recording of call-related information required to charge properly for service (see Section 10.5)
- *maintenance*, which involves features that automatically detect, isolate, and often locate system and component troubles to within several plug-in circuit packs (see Section 13.3.3).

Today, much of the operating data are reported by the switching system to operations systems that collect, analyze, filter, and summarize the data for human use. Chapter 14 describes some related operations systems.

### 7.2.4 CUSTOMER SERVICES

In addition to connecting communication paths, modern switching systems also provide a variety of customer services. As described in Chapter 2, customer services are enhancements to basic interconnection. They include operator services, coin services, Custom Calling Services, and special business features such as centrex service. Some examples of switching system functions related to these services are:

- routing a call for a nonworking number to an intercept operator
- returning deposited coins at a coin telephone when the called party does not answer
- routing a call to a line other than the one dialed (Call Forwarding)
- identifying the calling line for billing purposes on outgoing calls.

## 7.3 SWITCHING NETWORKS

The *network* is the portion of a switch that provides the connection between communication channels (lines or trunks) terminated on the system. Traditionally, switching networks are made up of connective devices or circuits arranged in a structure that allows the simultaneous

connection of many pairs of communication channels. This mode of switching is known as *circuit switching*, denoting the dedication of circuits to each connection for the duration of the call. Other forms of switching are currently in use for data communications (see Section 11.6), but the telephone networks of today are virtually all circuit switching.

### 7.3.1 CIRCUIT-SWITCHING NETWORK TYPES, APPLICATIONS, AND TECHNOLOGIES

Two types of circuit-switching networks in use today are distinguished by the manner in which the information passes through the network. In **space-division networks**, the message paths are separated in space, as described in Section 7.3.2. In **time-division networks**, the message paths are separated in time, as described in Section 7.3.3.

As discussed in Chapter 4, switching systems are used in a variety of applications throughout the network. For **local service** (class 5 operation), 2-wire switching is sufficient. In 2-wire switching, one message path (the equivalent of two wires in a space-division switching network) simultaneously carries the transmitted and received information. For **toll operation** (classes 1, 2, 3, and 4), however, the need for more stringent control of transmission impairments (such as echo) due to the longer distances involved generally requires 4-wire switching. In space-division switching networks, 4-wire switching is provided over two message paths, one for each direction of transmission. As will be seen in Section 7.3.3, time-division switching systems are inherently 4-wire since the information flow in each direction is switched separately.

Three basic types of technology have been used to implement switching networks:

- The **manually-operated** switch where an operator places plug-ended wires (*cords*) in jacks is the oldest.
- **Electromechanical** switches are either motor-driven, gross-motion devices (such as rotary and panel switches), gross-motion devices driven by electrical impulses (such as step-by-step switches), or electromagnetically operated, fine-motion switches (such as crossbar and dry reed matrix switches). Gross-motion switches have inherent limitations in their operating speed; and they use common metal (for example, copper) contacts to withstand the wear of the sliding or wiping motions, which may, in time, result in noisy transmission paths. Also, the considerable wear on the contacts causes maintenance costs to be high. In fine-motion switches, contact motion is essentially perpendicular to the contact surfaces, resulting in much less wear. Therefore, precious metal (for example, gold) can be used to improve transmission quality. (Section 10.2 describes electromechanical switches in detail.)

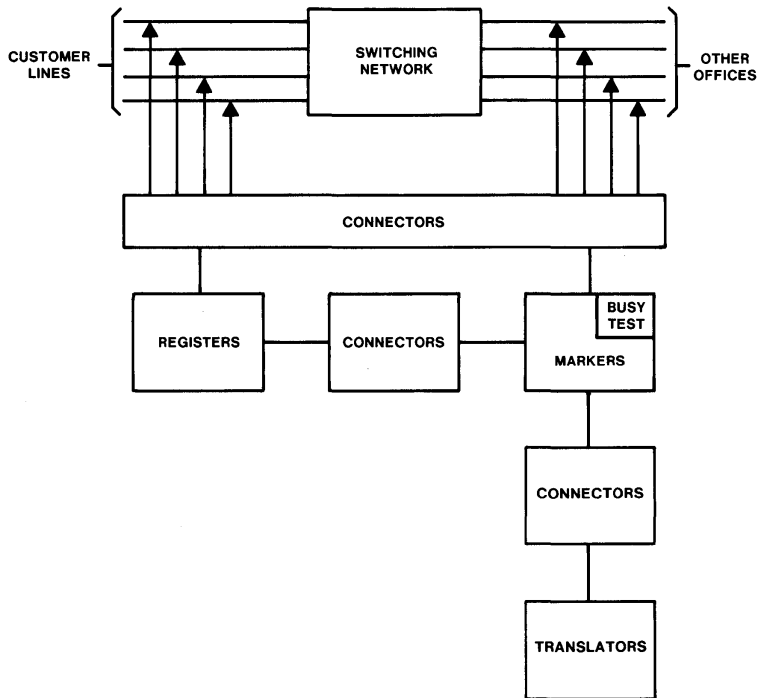

Figure 7-14. Marker-type common-control system.

Common-control functions originally used electromechanical switches and relays. With the advent of solid-state electronics, some or all of the common-control functions were implemented with electronic wired logic. This allowed a further reduction in the number of control elements, saving floor space and money. Whereas a large switching system carrying heavy traffic might require a dozen or more relay markers to control its network, one electronic marker may handle that same workload, although a second such marker might be included primarily to serve as a backup.

### 7.4.3 STORED-PROGRAM CONTROL

With stored-program control (SPC), specially designed processors that execute software programs replace the wired-logic common control. Since the addition of new customer services and special features, changes in translations, and other modifications can be implemented as changes in the program rather than as more complex changes in hardware, SPC greatly enhances flexibility. Figure 7-15 illustrates the basic components

of a typical SPC system with centralized control. Besides the switching network, they include:

- one or more high-speed processors (central control) that interpret and execute the instructions of the program
- a memory (for example, program store) that stores the program
- a memory (for example, call store) that is used as an erasable scratch pad to record and accumulate data during call processing
- input signal devices (for example, scanners) through which the central control receives information such as customer on-hook, off-hook, and dialed digits
- output signal devices (for example, signal distributors) through which the central control causes network switches to operate.

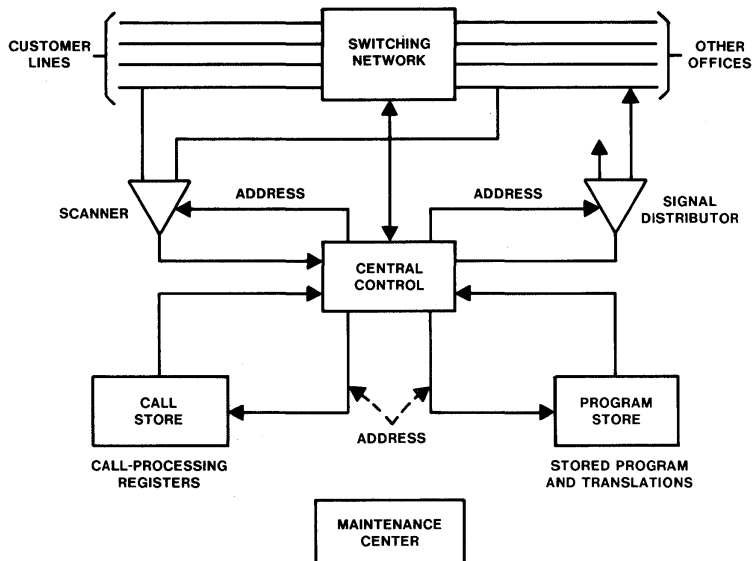

Figure 7-15. A centralized stored-program control system.

In the particular system shown in Figure 7-15, the principle of common control is fully applied. Processors perform all the functions necessary to switch calls. Through time sharing, processors simultaneously handle many calls in various stages of completion. The central control executes



one function per call and then progresses to the same function on a different call or to another function on the same or on a different call. The processors are sufficiently faster than the network they control, so that they are able to interleave the control functions for many different calls without creating any delays noticeable by the customer.

Of the several types of SPC processor arrangements, the most common are a full **centralized control, independent multiprocessors** that perform load sharing, and **functional multiprocessing** arrangements in which different processing functions are allocated to different processors.

### Centralized Processing

The application of electronics allows a large system to be fully controlled by a single high-speed processor. This has the advantage of greatly simplifying the interface circuits between the controller and the rest of the switching system. It also presents a single point (the processor's software) for introducing new features and services. It has the disadvantage that a complete control complex must be provided even for small office sizes, and complete redundancy is often required to allow the system to operate in the presence of a processor fault or while changes are made to the controller.

### Independent Multiprocessing

By using more than one processor, the central controls may be designed to operate independently and share the workload. Load sharing allows two (or more) central controls to handle more calls per unit time than would be possible with a single (usually duplicated) unit. However, in the event of a failure of one unit, the remaining units must carry on with reduced system capacity. Under normal conditions, the two (or more) processors work independently, each performing the full range of functions required for call processing. At least part of the memory (for example, the busy-idle status of lines) must be accessible by all processors in order to avoid conflicting actions among the processors.

A major advantage of multiprocessing is that small offices require less than the maximum number of processors, lowering the cost of control. Increased capacity can be provided by adding processors. However, as more processors are added, the call capacity of each processor decreases. Conflicts on processor access to memory and peripheral equipment increase with the number of processors. Unless the amount of sharing of memory and peripheral equipment is carefully controlled, independent multiprocessing rapidly reaches a practical limit with respect to office size and would not be an economical approach for large switching offices.

### Functional Multiprocessing

The advent of low-cost microprocessors has encouraged the distribution of the call-processing functions to a number of processors within a single switching system. Functional multiprocessing involves the allocation of different call-processing functions to different processors. As in load sharing, the processors frequently communicate with one another either directly or through common memory.

Functional multiprocessors may be arranged in a sequential, hierarchical, or hybrid structure. In sequential structures, as on an assembly line, each processor is responsible for a portion of a call and hands the next step to a succeeding processor. In hierarchical structures, as in a master-slave relationship, a master processor assigns tasks to subsidiary processors and maintains control of the system. Frequently, the subsidiary processors are dedicated to segments of the switching or signaling circuits. As network and peripheral equipment modules are added, this control capability is correspondingly enlarged. This enables processing capacity to be added as the system size increases and avoids incurring the cost of excess processor capacity. Most recent switching systems, such as the 5ESS switching equipment (discussed in Section 10.3.4), use functional multiprocessing.

#### AUTHORS

*C. E. Betta*  
*W. R. Byrne*  
*W. S. Hayward*  
*L. G. Raymer*  
*F. F. Taylor*

# 8

---

---

## Signaling and Interfaces

### 8.1 INTRODUCTION

#### 8.1.1 SIGNALING

*Signaling* is the process of transferring information between two parts of a communications network to control the establishment of connections and related operations. For example, a customer originating a simple call usually has three signals to send: call origination (receiver off-hook), call address (dialing), and call termination (receiver on-hook). The signaling considered here is normally carried on over a distance and is of two traditional application-related realms: **customer-line signaling** and **interoffice trunk signaling**. *Customer-line signaling* refers to the interaction between the customer and the switching system that serves the customer. *Interoffice trunk signaling* refers to the exchange of call-handling information between switching offices within the network. Certain applications, such as foreign exchange lines, may have some characteristics of each of these signaling realms and therefore are discussed as a third realm called **special-services signaling**. Alerting stations on a nonswitched private-line configuration is another signaling process in this realm. A fourth signaling realm has been created by the need to communicate directly among the computer-based systems that have been introduced to support telephone company operations. These signals are often not directly associated with a specific line or trunk but are carried by dedicated data links. The operations systems are linked by the operations system network (see Section 15.5), which also links some operations systems to switching and transmission systems.

The term *signaling*, as it is used in this chapter, does not include the many and varied call-handling interactions between components within a switching system or within the more complex forms of station equipment.

The amount of information sent in signaling is normally much less than in the associated communications. As a result, network control signals have generally been carried by the same transmission channel as message signals. Use of the voice channel when it is not occupied by conversation, as in *TOUCH-TONE* dialing, or use of frequencies not occupied by voice are typical examples of how this is done.

In considering signaling, then, it is necessary to describe interfaces between terminal equipment and transmission system, between transmission system and switching system, and between transmission system and transmission system.

### 8.1.2 INTERFACES

An *interface* can be thought of as the common boundary or set of points where two systems or pieces of equipment are joined. *Interface specifications* are the technical requirements for mating equipments. An *interface device* is any equipment used on one side of an interface to ensure that the interface specification will be met.

The set of boundary requirements at an interface, to a degree, separate responsibilities on the two sides of the interface. This allows each side the flexibility of rearrangement and evolutionary introduction of new equipment and services. The interface specification should be defined so as not to impede technological progress and to minimize the need for changes in the interface specification itself as new products and services evolve.

Interfaces also provide a demarcation point from which testing can be performed on the individual units being mated. If the interface is well defined, the units can be designed and tested independently, ensuring that they will work together as a total system. The interface specification also makes it possible to conduct tests at the interface to locate the sources of service impairment after equipment is put into service. Ideal interfaces are not always achievable, and, as will become apparent, the term *interface* sometimes is used in a broader sense than defined above.

The first five sections of this chapter discuss signaling as a principal component of a telephone interface specification, including descriptions of the **signaling functions, applications, interfaces, and techniques**. The rest of the chapter discusses other forms of interfaces as they apply to the telecommunications network.

## 8.2 SIGNALING FUNCTIONS

A typical telephone connection sequence from one line to another in the same central office illustrates the primary functions of signaling. These functions (and the corresponding actions by the customer where applicable) are listed below. Figure 8-1 is a schematic of this sequence including

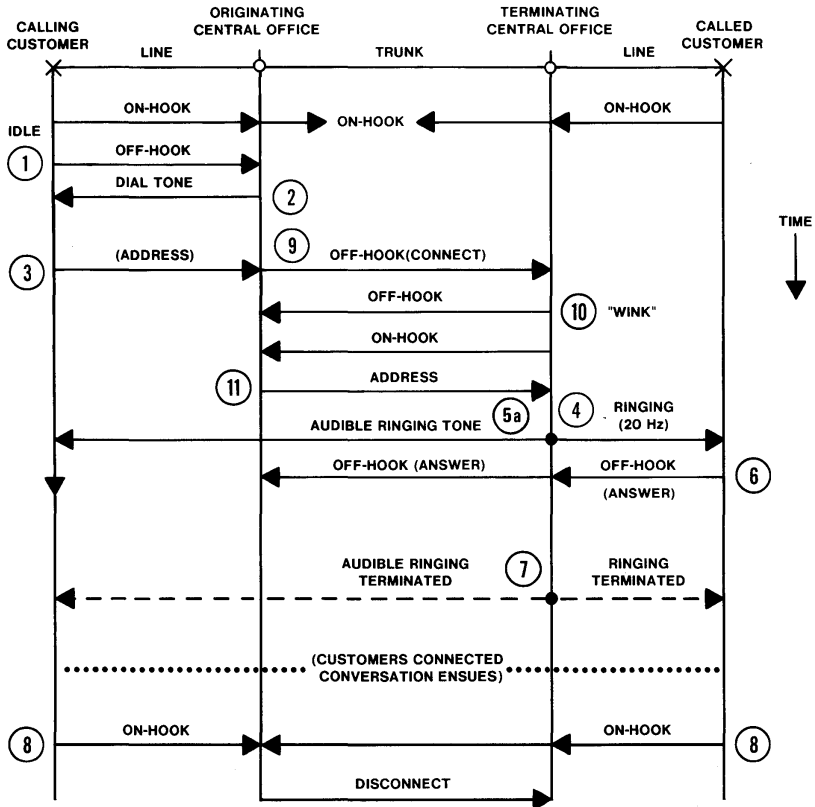

Figure 8-1. Signaling on a typical completed call.

the associated switchhook states.<sup>1</sup> The circled numbers in the figure correspond to the steps in the list.

- 1) A request for service is initiated when the caller lifts the telephone handset off the cradle or switchhook.
- 2) The central office sends a dial tone to the caller to indicate that the caller may begin dialing.

<sup>1</sup> When both customers are served by the same central office, that office handles both the originating and terminating central office functions shown in Figure 8-1 (steps 1 through 8 in the text).

- 3) The address of the called station is transmitted when the caller dials the called number.
- 4) If the called station is not busy, the central office alerts the called party by sending a *ringing signal* to the called station.
- 5) Feedback is provided to the originating station by the central office:
  - a) if the called station is not busy, the central office returns an *audible ringing tone* to the caller; or,
  - b) if the called station is busy, the central office sends a busy signal to the caller (not shown on Figure 8-1); or,
  - c) if the call cannot be completed through the central office, the office sends a "reorder" message to the caller (not shown on Figure 8-1).
- 6) The called party indicates acceptance of the incoming call by lifting the telephone handset.
- 7) The central office recognizes the acceptance and terminates the ringing signal, removes the audible ringing signal, and establishes a connection between calling and called stations.
- 8) The connection is released when either party hangs up.

When the called customer is in a different central office, the following interoffice trunk signaling functions are required:

- 9) The originating office seizes an idle interoffice trunk, sends an off-hook indication on the trunk, and requests a digit register at the far end.
- 10) The terminating office sends a "wink" (an off-hook followed by an on-hook signal); this indicates a register-ready or start-dial status to the originating central office to initiate the output of address digits.
- 11) The originating office sends the address digits to the terminating office.

In Figure 8-1, the terms *on-hook* and *off-hook* have been extended to the interoffice trunk signaling junctions even though the switchhook does not exist as a part of the trunk. The "wink" signal is needed because the receiving register for the address signals is not permanently associated with a trunk; it is called for and switched to the trunk in response to the connect signal. Also, in interoffice calls, the originating office generates dial tone while the terminating office generates the ringing signal and the audible ringing tone.

The term *supervisory* is often used to refer to control functions that are basically on-off, such as request for service, answer, alerting, and return to idle. The term *address* refers to the telephone number of the called party. The term *information* refers to audible tones and announcements used to convey call-progress information to customers or operators.

The ways in which these signals are generated, transmitted, and detected differ for each realm of signaling (for example, customer line, interoffice trunk) and transmission facility used (for example, analog carrier, digital carrier).<sup>2</sup> Sections 8.4 and 8.5 describe, respectively, signaling interfaces and techniques used to implement signaling functions.

Most of the above signaling functions have been provided in some form since the initiation of telephone service and are apparent to the customer. Other signaling functions have been introduced more recently and are not apparent to the customer. Network management signals, for instance, are sent from one office to another to control the gross flow of traffic under unusual load situations, as described in Section 5.6. Other signals may interrogate a remote data base to access special billing or routing information for more flexible call handling. Also, a set of functional signals is provided for many electronic offices that are remotely monitored and administered by computer-based operations systems.<sup>3</sup> In general, with the widespread introduction of computer control and operation of the network, the list of functional signals can be expected to grow rapidly.

### 8.3 FUNDAMENTAL CONSIDERATIONS

A fundamental objective of the telephone industry is to make operation of the telephone as simple and universal as is practical. This has resulted in a relatively small number of arrangements for customer-line signaling, which are usually seen by the customer as highly standardized procedures. On the other hand, interoffice signaling is essentially a machine-to-machine interaction and is, therefore, less constrained by consideration of human factors. Rather, the emphasis is on overall efficiency and flexibility. Consequently, over the years, interoffice signaling has been extensively affected by new transmission techniques and advances in switching system design. This is reflected in the large variety of signaling arrangements in service.

To satisfy the objectives of uniformity for customer signaling and flexibility for interoffice signaling, a high degree of independence has been maintained between these two signaling realms. Facilitated by the

<sup>2</sup> Sections 9.3 and 9.4 describe analog and digital carrier systems.

<sup>3</sup> Section 14.3.2 describes one such operations system—the Switching Control Center System.

widespread use of common-control, switching systems in local central offices provide an effective signaling buffer between lines and trunks.

Another basic signaling consideration is promptness or its inverse, delay. The calling customer may experience three components of delay in completing a call: **dialing time**, **postdialing delay**, and **answer delay**; all involve signaling to some degree.

*Dialing time* is the time it takes for the calling customer to dial the desired number: from the time the customer lifts the handset (or goes off-hook) until the last digit is dialed. This delay is determined by the central office delay (called *dial-tone delay*) in recognizing the customer's request for service by providing the dial tone, the customer's reaction time, and the speed with which the customer operates the rotary dial or pushbuttons.

*Postdialing delay* is the elapsed time from the end of dialing to the start of ringing (or other feedback such as a busy signal) at the called end. Postdialing delay depends on many factors, including the number of switched links in the connection, the types of interoffice signaling used, switching system work times, and the traffic load.

*Answer delay* is the time from the beginning of ringing until the called station answers. It is determined primarily by the called customer's promptness in answering and, to a lesser degree, by the alerting method used.

The ability to interconnect with systems designed by a number of manufacturers has become more important recently. This requires greater attention and effort with respect to national and international signaling standards organizations, such as the Comité Consultatif International Télégraphique et Téléphonique (CCITT), so that interfaces are kept simple and few in number.

## 8.4 SIGNALING SYSTEM APPLICATIONS AND INTERFACES

For any signaling carried by a transmission facility, interfaces must be provided for the interchange of signaling information between the facility and the source and between the facility and the destination. In some cases, the interface is a well-defined demarcation point with specified impedances and voltages. (The E&M lead interface described in Section 8.4.2 is an example of this type.) In other cases, the interface may be so integrated into the circuit design that it is hard to define. In such cases, the signaling information interchange requires careful coordination in design and, to some degree, in engineering between the source, destination,<sup>4</sup> and intervening facility.

<sup>4</sup> *Source and destination* are used here to mean station equipment or a switching office.



# 10

---

---

## Network Switching Systems

### 10.1 INTRODUCTION

Switching systems used in the Bell System can be divided into two broad functional categories: those designed for **local** switching and those designed for **tandem** switching. Local offices connect customer lines to each other for local calls and connect lines to trunks for interoffice calls. Tandem switching has two applications. Offices that connect trunks to trunks within a metropolitan area are referred to as *local tandem offices*. Offices that connect trunks to trunks to form the toll network portion (class 1 to class 4) of the hierarchical public switched telephone network (PSTN) are called *toll offices* (see Chapter 4).

There are significant differences in requirements for these areas of application. Consequently, systems designed primarily for local switching applications (often called *local switching systems*) are different in architecture and function from those designed primarily for local tandem or toll switching. As discussed in Section 4.2 and shown in Figure 4-4, many switching systems serve more than one role in the PSTN, and in particular, they may provide both local and tandem switching functions.

Because lines and trunks connecting nearby offices usually generate a load per termination that is less than the link capacity within a switching network, local switching systems generally employ *concentration* of lines and *expansion* to trunks (see Section 7.3). In tandem and toll applications, however, trunks are more heavily used, so expansion of trunks to the network is frequently used.

Because lines and short-distance trunks generally use 2-wire transmission, the telephone connections within local and local tandem offices have generally been 2-wire. Time-division digital systems, however, usually switch on a 4-wire basis (that is, separate paths for each direction of

transmission). Toll facilities are usually also 4-wire, so toll switching systems switch on a 4-wire basis.

Functions needed to provide exchange services<sup>1</sup> are built into the local switching system because of the convenience resulting from the direct interface with customer lines. The geographic centralization of the tandem office, however, offers efficiency in providing centralized billing and operator and network services.

The Bell System formally began installing automatic switching in 1919. Since that time, the market for switching systems has expanded continuously in terms of both the number of systems and their applications. The growth of cities, establishment of new population centers in the suburbs, increased use of the telephone, and demand for new services all contribute to the expanding market.

The evolution of switching systems has been marked by a flow of new technology. As new technology is developed, new capabilities become available at lower cost for the basic switching functions and new customer services. Switching networks have evolved from progressive switching to coordinate switching to the current technology of time-division switching. Switching control has evolved from direct progressive control through common control by electromagnetic registers and markers to the current technology of stored-program control.

Because of the large base of existing systems and the cost and effort associated with replacement, older systems that still provide satisfactory service may remain in service for a considerable time after introduction of a new system. As a result, several systems of various vintages exist in the PSTN.

## 10.2 ELECTROMECHANICAL SWITCHING SYSTEMS

### 10.2.1 EVOLUTION

#### Local Switching

The earliest automatic switching system was the **step-by-step** (SXS) system, known around the world as the Strowger system. Although it was invented in 1889 by A. B. Strowger and first installed in 1892, the Bell System did not begin using the step-by-step system extensively until 1919, and even then, the equipment was installed by the Automatic Electric Company. One reason for the delay in applying step-by-step systems was the high percentage of Bell System customers who were located in large cities where step-by-step systems were not economically attractive. However, by 1921, Western Electric did begin installing them in the smaller cities. Western Electric acquired licensing agreements with Automatic Electric in 1916 and began many design improvements leading

<sup>1</sup> Section 2.4 describes exchange services.

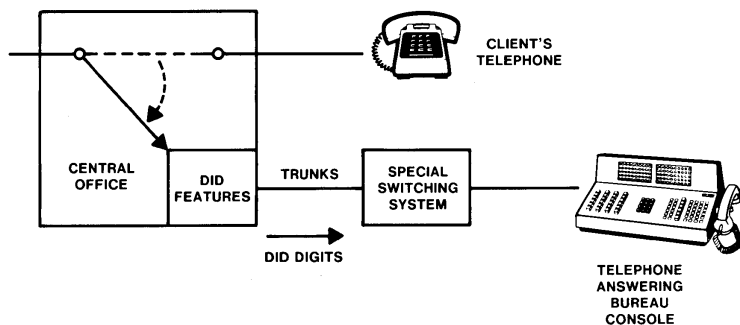

**Figure 11-26. Telephone answering systems: use of Call Forwarding and direct inward dialing to telephone answering bureaus.** *Note:* The number of clients' telephones is greater than the number of trunks.

sends DID digits over that trunk to the switching system at the answering bureau. Complete call identification can therefore be provided at the answering console.

This arrangement provides complete privacy, requires few cable pairs, and is suitable for occasional service. A lingering disadvantage, however, is the inability of a client to join a conversation between a calling party and the answering bureau. This is because Call Forwarding actually switches the call from the client's line and redirects it to the answering bureau.

## 11.3 PUBLIC SWITCHED NETWORK SERVICE SYSTEMS

The services available from the nationwide PSTN were described from the customer's point of view in Section 2.5. The following sections examine the systems and equipment that provide these network services. The discussion emphasizes the configuration, functional operation, and customer service features provided by systems associated with direct service dialing capability and *DIAL-IT* network communications service.

### 11.3.1 THE STORED-PROGRAM CONTROL NETWORK

The PSTN has thousands of switching nodes that employ the variety of switching systems described in Chapter 10. As indicated in Chapter 10, older systems are rapidly being replaced by more advanced stored-program control (SPC) systems. The collection of SPC systems in the PSTN that are interconnected by the common-channel interoffice signaling (CCIS) network (see Sections 8.4 and 8.5) is called the *SPC network*.

The SPC network enables the Bell System to offer the network services described in Section 2.5.1. This section describes the elements of the SPC network and its architecture as it pertains to providing these services.

Figure 11-27 is a schematic of the SPC network. The solid lines represent communication channels (trunks) that interconnect the major SPC network nodes: toll switching systems and operator-services systems such as the Traffic Service Position System (TSPS). The broken lines represent the CCIS channels (data links). A simplified version of the nationwide signaling network is also included. For convenience, nodes called *network control points* (NCPs) and their associated data bases are shown inside the signaling network, but the architecture of the SPC network does not actually restrict them to the CCIS network. They may also be integrated into existing SPC network nodes or associated directly with them. The network control points and data bases are used to store customer service data and are accessed by signals routed over the CCIS network. Figure 11-27 can be viewed as two networks: one for basic call transport and the other for signaling and information exchange among the SPC network nodes. The integration of these two networks forms the basis of the SPC network.

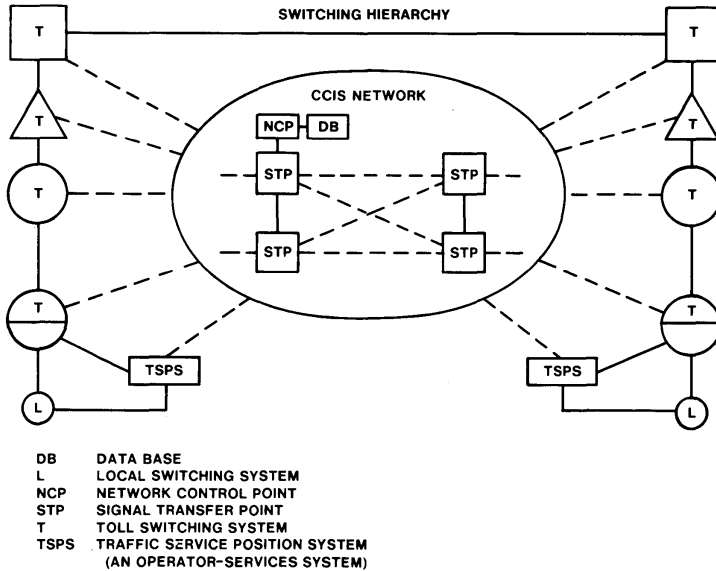

Figure 11-27. Stored-program control network.

By 1981, the CCIS network had been extended nationwide, with twelve pairs of signal transfer points (STPs)<sup>22</sup> handling about 38 million signaling messages per average busy hour over 2700 signaling links. As new SPC switching nodes with CCIS capability are added to the network, CCIS links are connected to their two regional signal transfer points and become members of the SPC network. There are 197 toll switching systems in the SPC network, and CCIS is routinely used on 400,000 trunks (about 35 percent of the intertoll trunks). It is projected that, by 1985, 80 percent of the intertoll trunks will be using CCIS. TSPs are now being equipped with CCIS capability, and 40 percent of these operator-services systems are expected to belong to the SPC network by the end of 1983.

The architecture of the SPC network has been designed to meet two network service needs: the need to customize services and the need for ubiquitous access.

- The need to customize services to fit the particular requirements of individual customers results in three service objectives:
  - Customer control over service options should be quick, easy, and direct. Customers prefer to invoke, use, and cancel them as they wish.
  - A variety of services should be available. While many of their basic service needs are similar, different customers may want significant variations in how their overall service is put together.
  - As new services are defined, they should be introduced quickly, without major changes in the entire network.
- Many of the new service applications have great value when they can be invoked from any telephone. These services are obvious candidates for network solutions rather than specialized arrangements outside the network. On the other hand, the universal deployment of new service capabilities in every node of the network is clearly impractical, too slow, and too costly. The solution is a carefully planned network architecture.

The architecture of the stored-program control network has been designed with these service needs in mind (see Figure 11-28). Calls from customers requesting special SPC services are routed to certain nodes called *action points* (ACPs). Two observations can be made here. First, an extended, open-ended dialing plan has been worked out for service requests from customers. Second, the routing of calls requiring special

<sup>22</sup> A pair of signal transfer points is associated with each region of the PSTN in the United States and Canada.

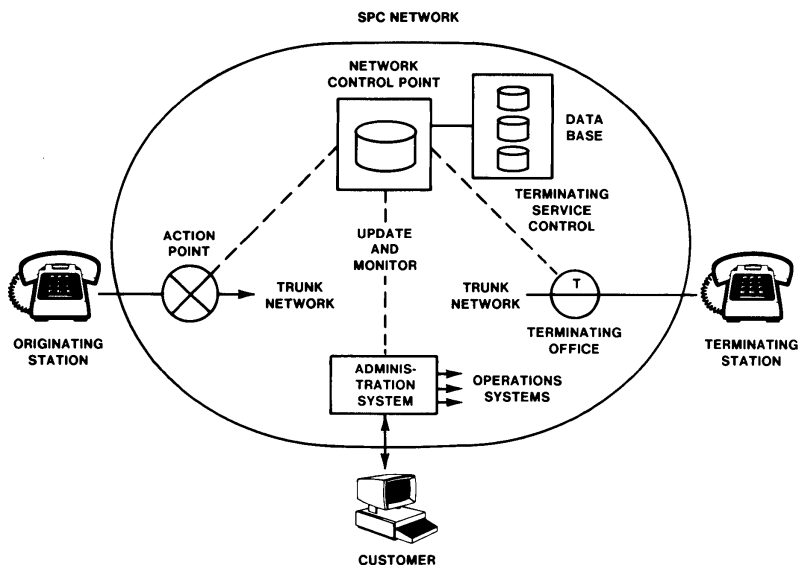

Figure 11-28. Generic architecture of the stored-program control network.

actions from any local switch to a special ACP node provides a mechanism for ubiquitous access to new service capabilities. Ordinary local offices need not have any new service capabilities themselves. They need only apply their regular routing functions to send special calls to "more intelligent" nodes in the network for handling. They must also pass along the automatic number identification of the calling line. (This function is already widely available in Bell System local offices.)

The action point has the ability to recognize special calls by the dialed digits and to send messages requesting instructions to an appropriate network control point. The ACP itself has no knowledge of the customer service but responds as directed by the NCP. The NCP is the repository for all customer network service information. The ACP is equipped with basic capabilities, called *switching primitives*, that it applies as instructed by the NCP. This functional split is an important characteristic of the SPC architecture.

The NCP can query any SPC network node for information or action. When lines at one business location are busy, a customer may prefer to have calls routed to another location. "Hubbing" all service logic in NCPs also assists in making changes in customer services since changes can be made rapidly in data stored there. If a rich set of ACP capabilities has

been deployed, nothing new may be needed in the network control nodes themselves.

A necessary part of the architecture is the methods and administration system for entering customer service information into the data bases associated with the network control points, for monitoring the service to ensure performance, and for interacting as needed with operations systems to maintain service quality.<sup>23</sup> Ultimately, the customer will want to interact directly with the service management process.

The architecture of the stored-program control network has provided a set of direct services dialing capabilities (DSDC) that are used both to improve current services and to offer new services. Automated Calling Card Service and Expanded 800 Service are the first two services to use DSDC.

Automated Calling Card Service permits customers to charge calls to a number other than that of the originating station without the assistance of an operator. As shown in Figure 11-29, the network control point is

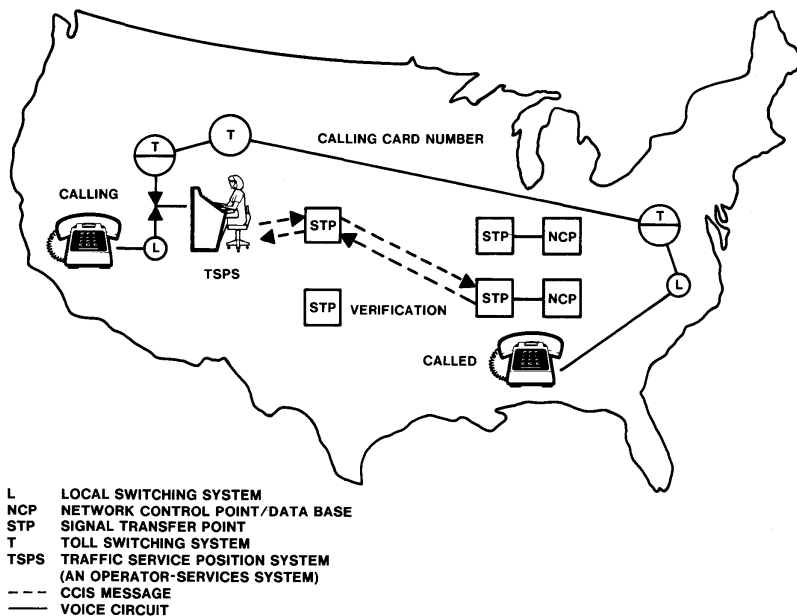
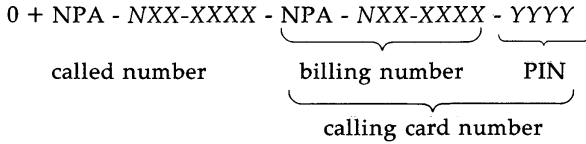

Figure 11-29. Stored-program control network—Automated Calling Card Service.

<sup>23</sup> Chapter 14 discusses operations systems.

accessed by a TSPS serving as an action point. The calling customer, with appropriate prompting from the ACP, keys in the number being called (including the numbering plan area,<sup>24</sup> if needed), the number to be billed, and a private personal identification number (PIN):



After validating this information, the NCP either authorizes the call, allowing it to be completed, or denies the call, requesting that the customer take appropriate action.

Expanded 800 Service, shown in Figure 11-30, is an improved method of handling inward Wide Area Telecommunications Services (INWATS) traffic. When a call is originated toll free to a customer of Expanded 800 Service, the 800 plus the 7-digit dialing sequence is received by the local

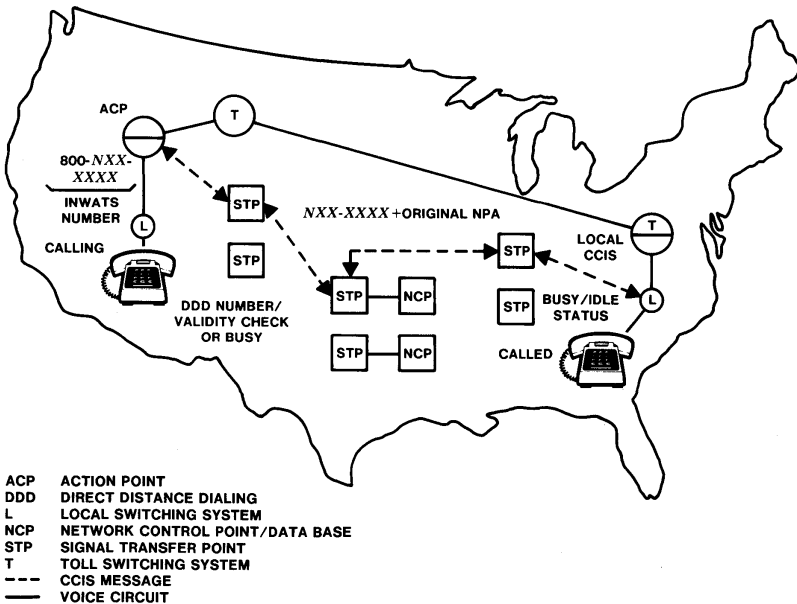

Figure 11-30. Stored-program control network—Expanded 800 Service.

<sup>24</sup> Also called the *area code*.



office, and the call is routed to the nearest action point. Initially, the ACPs for Expanded 800 Service will be large SPC switching systems such as the 4ESS electronic switch. In order to determine how to handle the call, the ACP sends a message over the common-channel interoffice signaling network to an appropriate network control point. The NCP data contain the routing instructions as requested by the customer of Expanded 800 Service. When the NCP extracts the proper call-handling instructions from the data base, it sends an answering message to the ACP telling it how to route the call. The ACP then forwards the call. When the Expanded 800 Service customer lines terminate on a local office in the SPC network, busy/idle status messages keep the NCP informed when all the lines are busy. Consequently, when all lines are busy, the NCP tells the ACP either to turn back the call or to route it to a different location (which has been predetermined by the customer of the service). This increases completions when multiple terminating locations are available and also reduces ineffective network attempts to busy lines.

The NCP is one of the first applications of the 3B20 computer. The computer is configured with a CCIS network interface to communicate with action points, an administration and maintenance interface, and a disk storage system to hold the customer data. For reliability, NCPs are provided in geographically separated pairs. Each member of the pair has the processing capacity and information necessary to provide uninterrupted service to all users of the pair should the other member not be in service.

Other components of the stored-program control network such as electronic switching systems, TSPs, and the CCIS network are discussed in Sections 10.3, 10.4.1, and 8.5.5, respectively.

### 11.3.2 MASS ANNOUNCEMENT SYSTEM

The Mass Announcement System (MAS) provides the announcement capability that supports selected *DIAL-IT* service (see Section 2.5.1). This capability allows various sponsors to provide services in which a large number of calling customers can dial advertised numbers to listen to Public Announcement Service announcements, register their opinions via telephone calls (call counting), or talk to a celebrity—if they are one of the randomly selected callers who are connected (cut through).

The Mass Announcement System consists of a MAS frame connected to a 4ESS electronic switch. The MAS frame provides announcements to the 4ESS switch; the 4ESS switch then distributes them to the *DIAL-IT* service calls. Two MAS units are located on the MAS frame, each unit containing a disk on which the announcements are stored. The frame (see Figure 11-31) provides disk storage and control for eighty audio segments, each 30 seconds in duration. Announcements up to 300 seconds in length can be produced by linking a number of segments together.

although it may be found in maintenance of customer loops. The procedure is an important factor in achieving guaranteed performance. A variety of operations centers and operations systems are involved in ensuring high-quality performance and rapid restoration of service.

A number of emerging services and capabilities such as circuit-switched digital capability and Basic Packet-Switching Service will use DDS network elements for connectivity for initial growth, expansion into new geographic areas, and/or data transport on an ongoing basis.

### 11.6.2 PACKET-SWITCHING SYSTEMS

In many data communications applications, data occur in bursts separated by idle periods, and the average data rate may be much lower than the peak rate. This type of "bursty" data can often be transmitted more economically by assembling the data into packets and interspersing packets from several channels on one physical communication path. A header is added to each packet to identify it. The contents of the header depend on the system used, but in general, the header must at least indicate the call of which it is a part and where it fits into the sequence of packets in a call.

A network can be formed to interconnect a number of users of packet switching. A packet switch sorts packets coming in on one circuit and switches them out to another circuit according to the header information in each packet. Potential savings from using a packet-switching network rather than direct connection of users are similar to those described in Section 3.1. The switch network trades the cost of the packet switch(es) against the reduced cost of transmission facilities and equipment for interfacing with the facilities. The packet-switching network becomes more economical as the number of user nodes and the distances between them increase.

Any type of traffic that has a sufficient peak-to-average information transfer rate is a candidate for packet switching. In the future, even voice messages may be assembled into packets. The immediate application of packet switching, however, is in data communications—primarily in the interconnections among computers. The first Bell System service designed for packet switching is the Basic Packet-Switching Service (BPSS) described in Section 2.5.4.

#### The No. 1 PSS Packet Switch

The packet-switching network supporting BPSS will use the No. 1 PSS packet switch. The architecture of the packet switch reflects the service objectives: high reliability and responsiveness at high capacity. One important characteristic of the architecture is that it is based or centered

upon a Western Electric 3B20D computer. The 3B20D computer is designed to be out of service no more than 2 hours in 40 years. The reliability of this system is achieved by redundancy in hardware (duplex processor and disk, for example) and by diligence in software (the bulk of the operating system is devoted to maintaining the integrity of the system). All centralized functions associated with providing a packet-switching system are performed on this computer. For example, one function, routing, associates a physical path through the switch with lines to customers or trunks to other packet switches. Other functions include billing, traffic measurement and reporting, and system maintenance.

The capacity of the system to switch packets responsively is a function of the processing capacity available for packet switching. The architecture of the No. 1 PSS packet switch provides duplex processors as shown in Figure 11-40. Access lines to customers and trunks to other switches are connected to facility interface processors (FIPs), microprocessors especially designed for the system. The FIPs are connected to the duplex central processor (DCP). Technicians interact with the switch through CRT terminals connected to the DCP.

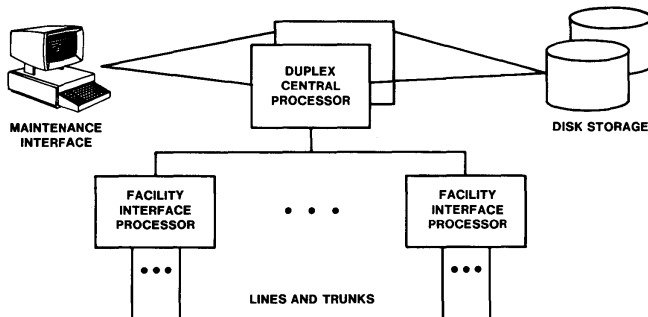

Figure 11-40. Architecture of No. 1 PSS packet switch.

An important characteristic of a packet-switching system is the protocol it implements. The No. 1 PSS packet switch implements the X.25—the packet-switching protocol<sup>33</sup> agreed to by the international standards organization of the Comité Consultatif International Télégraphique et Téléphonique (CCITT).

The X.25 protocol defines standards for three levels of communication between the data terminating equipment (the customer's terminal equipment) and the data communications equipment (the packet switch).

<sup>33</sup> Section 8.8 discusses data communications protocols and X.25.

- Level 1 (*physical* level) defines the electrical interface and is implemented in hardware.
- Level 2 (*link* level) processing for both trunks and access lines is done by firmware (code permanently placed in read-only memory) and special-purpose integrated circuits that are part of the FIP. The microprocessors that control the level 2 processing for each line or trunk operate asynchronously with respect to the level 3 processing on the FIP.
- Level 3 (*packet* level) processing for multiple lines and/or trunks is done by FIPs. The actual number supported depends on the traffic. The microprocessor chosen for the FIP does all the processing on data packets; packets associated with setting up calls are also processed by the DCP, where there is enough memory to store the routing tables.

The call setup rate of the No. 1 PSS packet switch is determined by the processing power of the 3B20D computer and is roughly 200 call set-ups per second. The capacity to handle data packets is primarily determined by the number of FIPs used and is about 1200 packets per second.

To achieve responsiveness for the large number of logical channels (simultaneous calls) that are supported on each line, the FIPs must have large amounts of memory to buffer packets. The 3B20D computer must also have large amounts of memory to store the routing information necessary to describe potential networks of users.

A characteristic that the system shares with other highly reliable systems is the amount of software devoted to maintaining the system. Of slightly more than one megabyte of object code for No. 1 PSS, only 200 kilobytes are transport (that is, X.25-related) functions. Administration and maintenance programs account for the other 80 percent.

An essential contributor to the high availability of the packet switch is the recovery strategy implemented by the software. When a failure is detected, the smallest portion of the system necessary for restoring service is reinitialized. The goal of the strategy is to minimize the effects of system recovery on customers. For the No. 1 PSS, levels of reinitialization result in:

- 1) clearing the call associated with the logical channel that was active when the error occurred
- 2) clearing all calls on the line that was active when the error occurred
- 3) clearing all calls on the switch
- 4) at the highest No. 1 PSS level, going through analogous levels of initialization provided by the operating system of the 3B20D computer.

## Service Capabilities

To foster open interconnection of customer equipment, the No. 1 PSS packet switch is designed to adhere to international standards. It supports, for example, all essential services and facilities of the 1980 version of the CCITT X.25 protocol. It supports access line speeds of 9.6 and 56 kbps. Subscribers can interconnect their terminals, hosts, and office equipment effectively without large start-up costs or network management expenses. Key design goals include high availability, rapid data transfer (low end-to-end delay), high throughput (high average packet rate per channel), and high capacity (large number of packets per unit time over the switch as a whole). Operations centers and associated operations systems (see Chapter 15) provide both centralized and distributed support to respond to customer trouble reports most effectively.

The No. 1 PSS packet switch can support a common user network to provide a highly reliable, full-time computer communications network for users in need of basic data transport. A common user network allows intercorporate communications and facilitates resource sharing of value-added vendors who wish to market information services.

### 11.6.3 DATAPHONE SELECT-A-STATION SERVICE IMPLEMENTATION

*DATAPHONE* Select-a-station service is a voiceband private-line data service that is designed for applications—such as alarm service bureaus—in which a master station exchanges data with a number of remote stations, one at a time, usually in rapid sequence. The service allows 2-way transmission between the master and remote stations, but no direct transmission is possible between remote stations. Nor is broadcast communication possible between the master station and all remote stations. The security of this service makes it particularly well suited for alarm service bureaus. Connection control can only come from the master station, and all remote stations, other than the one connected at a particular time, are isolated from the connected path and from each other. This ensures that trouble in any leg cannot affect proper operation of the remainder of the circuit. This isolation of each point-to-point connection also ensures the privacy of communication between the master station and each remote station.

To implement *DATAPHONE* Select-a-station service, high-speed switches called *data station selectors* (DSSs) are located in the telephone company's central office building to connect the customer's master station with various remote stations (see Figure 11-41). Connection is established by the DSS stepping automatically in a fixed sequence or by the customer at the master station. The master station terminal is a minicomputer or a specially designed controller owned and operated by the alarm service

is developed and modified to fit the overall Bell System plan, planning is required at several levels. These levels include:

- defining design requirements for individual operations systems and allocating functions between operations systems and telecommunications systems
- grouping operations systems into specific operations centers, including defining the roles of proposed or existing systems in order to provide efficient support for the operation of a center
- specifying the interactions between groupings of related centers and the operations systems with which they interact
- integrating the entire family of operations centers and systems into the Bell System operations plans.

## 15.5 OPERATIONS SYSTEMS NETWORK PLANNING

The number of operations system computers (including minicomputers and large mainframe computers) in use throughout the Bell System in 1981 was estimated at about 4500. These computers are accessed by about 114,000 computer terminals dispersed among the operations centers. These numbers are expected to increase to about 6300 computers and 180,000 terminals by 1985 as implementation of operations plans matures.

To provide more efficient transfer of information among operations systems and between operations systems and terminals in operations centers, Bell Laboratories is planning the operations systems network illustrated in Figure 15-6. When fully deployed in the mid-1980s, this network will provide a flexible, cost-effective national network of operations systems, computer terminals, and data communications capabilities. It will carry the over 2.5 trillion characters of information required each month to operate the nationwide telecommunications network. In fact, it can be viewed as a "second network," parallel to the telecommunications network whose operation it supports.

The operations systems network will provide many new benefits to nationwide network operations. For example, network operations tasks often require Bell System technicians to access several computer systems. To repair a circuit, a technician may first need to access a record of the circuit from TIRKS, the Trunks Integrated Records Keeping System (see Section 14.2.1), and then perform a test using the CAROT system mentioned earlier in this chapter. With the operations systems network, the technician will be able to access these systems and others, as needed, from a single computer terminal. Bell Laboratories is in the process of deploying this capability using a data communications system called the *Bell Administrative Network Communications System*, designed as part of the operations systems network plan.

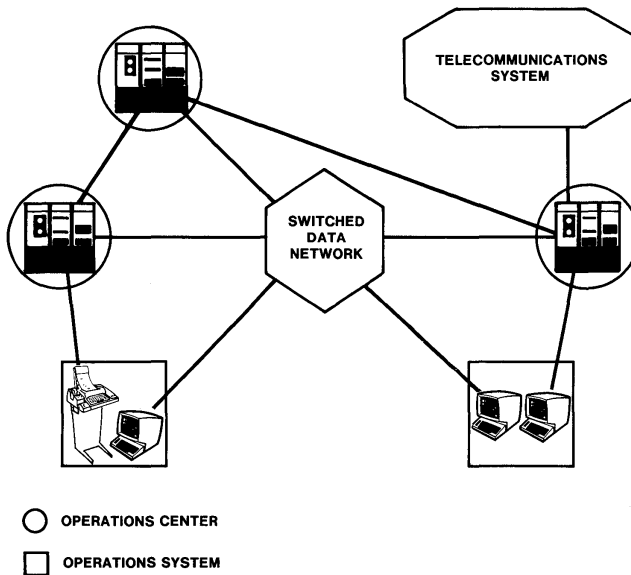

**Figure 15-6. Operations systems network.** The operations systems network includes the collection of operations systems, communications terminals at operations centers, and the switched and direct communications links interconnecting them and connecting them to a variety of telecommunications systems, such as an electronic switching system.

In the future, the flexibility afforded by the operations systems network in rapidly switching data between operations systems computers and terminals will permit the Bell System to take advantage of advances in distributed-processing technology. It will be possible for many different operations systems to share data bases to a much greater extent than is possible today. The result will be even more economical computer support, using more timely and accurate data.

Planning is also underway to incorporate "intelligent terminals" (computer terminals with self-contained processing capabilities) into the operations systems network. With the integration of this technology, it will be possible to shift much of the processing done today in centralized computer systems to a technician's terminal. This will make more efficient use of computer resources and the computer communications network and will provide even more rapid response to a technician's inquiries. This new technology will also allow individual technicians to customize computer displays into a form that they find personally convenient, both increasing the technicians' effectiveness and making the human-machine interface more personal.

## 15.6 SUMMARY

Operations in the Bell System are becoming more sophisticated through the increasing use of advanced computer technology. Operations must respond to a rapidly changing environment as the result of the evolution of the telecommunications network as it embraces new technologies, the development and marketing of new network services and customer products, and competitive and regulatory forces. All these factors change the way operations are performed.

Operations planning is a relatively new and expanding cooperative effort among Bell Laboratories, AT&T, and the Bell operating companies to guide the evolution of operations in the Bell System. Centralized planning for the entire Bell System ensures a consistent, high standard of telecommunications services throughout the nation and the rapid introduction of new services and technologies into the network. The operations systems network will allow an even more effective use of operations systems in the mid-1980s and beyond.

### *AUTHOR*

*B. A. Newman*