

(19) World Intellectual Property Organization
International Bureau



(43) International Publication Date
5 April 2001 (05.04.2001)

(10) International Publication Number
WO 01/24501 A1

- (51) International Patent Classification⁷: H04M 7/00, 3/42
- (21) International Application Number: PCT/US00/26618
- (22) International Filing Date:
27 September 2000 (27.09.2000)
- (25) Filing Language: English
- (26) Publication Language: English
- (30) Priority Data:
09/406,321 27 September 1999 (27.09.1999) US
- (63) Related by continuation (CON) or continuation-in-part (CIP) to earlier application:
US 09/406,321 (CON)
Filed on 27 September 1999 (27.09.1999)
- (71) Applicant (for all designated States except US): **3COM CORPORATION** [US/US]; 3800 Golf Road, Rolling Meadows, IL 60008 (US).

Guido, M. [CH/US]; Apartment 408, 1433 Perry Street, Des Plaines, IL 60016 (US). **DEAN, Frederick, D.** [US/US]; 2311 N. Greenview Avenue, Chicago, IL 60614 (US). **MAHLER, Jerry, J.** [US/US]; 20 Country Club Drive, #B, Prospect Heights, IL 60070 (US). **GRABIEC, Jacek, A.** [PL/US]; 5903 W. Wilson, Chicago, IL 60630 (US). **SIDHU, Ikhtlaq, S.** [US/US]; 403 River Grove Lane, Vernon Hills, IL 60061 (US).

(74) Agent: **PEREZ, Enrique**; McDonnell Boehnen Hulbert & Berghoff, 32nd Floor, 300 South Wacker Drive, Chicago, IL 60606 (US).

(81) Designated States (*national*): AE, AG, AL, AM, AT, AU, AZ, BA, BB, BG, BR, BY, BZ, CA, CH, CN, CR, CU, CZ, DE, DK, DM, DZ, EE, ES, FI, GB, GD, GE, GH, GM, HR, HU, ID, IL, IN, IS, JP, KE, KG, KP, KR, KZ, LC, LK, LR, LS, LT, LU, LV, MA, MD, MG, MK, MN, MW, MX, MZ, NO, NZ, PL, PT, RO, RU, SD, SE, SG, SI, SK, SL, TJ, TM, TR, TT, TZ, UA, UG, US, UZ, VN, YU, ZA, ZW.

(84) Designated States (*regional*): ARIPO patent (GH, GM, KE, LS, MW, MZ, SD, SL, SZ, TZ, UG, ZW), Eurasian patent (AM, AZ, BY, KG, KZ, MD, RU, TJ, TM), European

[Continued on next page]

(54) Title: SYSTEM AND METHOD FOR CONTROLLING TELEPHONE SERVICE USING A WIRELESS PERSONAL INFORMATION DEVICE

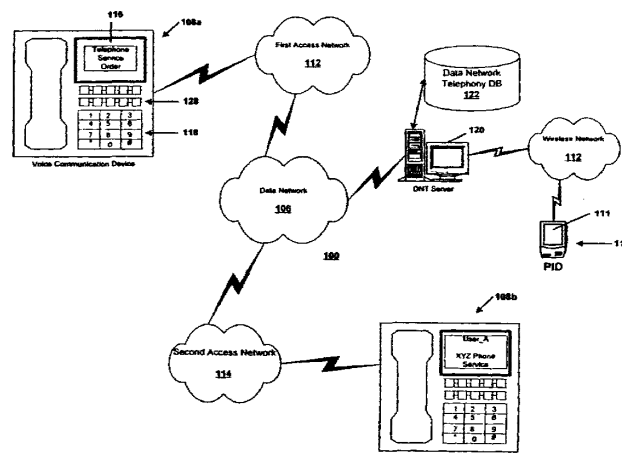

(57) Abstract: A system and method for controlling telephony service to a user with a wireless personal information device (PID). The user may connect to a telephony control server via a data network. The telephony control server has access to the user's telephony account which indicates the user's telephone number in a telephone number entry. The user connection is by a wireless PID that uses the wireless cellular infrastructure to connect to a data network gateway or server. Once the connection is made, the user issues a command to set the telephone number entry in the user's data network telephony account to a specific telephone number. The user may then invoke a contacts application in the wireless PID and select a person from the contacts list to call. The user selects the entry in the contact application to send a command to initiate a telephone connection between the party selected and the user at the telephone set at the telephony control server.



WO 01/24501 A1



patent (AT, BE, CH, CY, DE, DK, ES, FI, FR, GB, GR, IE, IT, LU, MC, NL, PT, SE), OAPI patent (BF, BJ, CF, CG, CI, CM, GA, GN, GW, ML, MR, NE, SN, TD, TG).

— *Before the expiration of the time limit for amending the claims and to be republished in the event of receipt of amendments.*

Published:

— *With international search report.*

For two-letter codes and other abbreviations, refer to the "Guidance Notes on Codes and Abbreviations" appearing at the beginning of each regular issue of the PCT Gazette.

**SYSTEM AND METHOD FOR CONTROLLING TELEPHONE SERVICE
USING A WIRELESS PERSONAL INFORMATION DEVICE**

BACKGROUND OF THE INVENTION

A. Field of the Invention

This invention relates generally to the field of telecommunication, and more particularly to methods by which a personal information device ("PID") can be used to control a telephone system.

B. Description of Related Art and Advantages of the Present Invention

For many years, telephone service providers on the Public Switched Telephone Network (PSTN) provided their customers nothing more than a telephone line to use to communicate with other subscribers. Over time, telephone service providers have enhanced their service by providing Custom Local Area Signaling Service (CLASS) features to their customers. Similar communication services are provided by a Private Branch Exchange (PBX), which is typically implemented in a nonresidential setting.

The CLASS features permit customer subscribers of the features to tailor their telephone service according to individual needs. Some of the more well-known CLASS features are:

- Call blocking: The customer may specify one or more numbers from which he or she does not want to receive calls. A blocked caller will hear a rejection message, while the callee will not receive any indication of the call.
- Call return: Returns a call to the most recent caller. If the most recent caller is busy, the returned call may be queued until it can be completed.
- Call trace: Allows a customer to trigger a trace of the number of the most recent caller.
- Caller ID: The caller's number is automatically displayed during the silence period after the first ring. This feature requires the customer's line to be equipped with a device to read and display the out-of-band signal containing the number.
- Caller ID blocking: Allows a caller to block the display of their number in a callee's caller ID device.

- Priority ringing: Allows a customer to specify a list of numbers for which, when the customer is called by one of the numbers, the customer will hear a distinctive ring.
- Call forwarding: A customer may cause incoming calls to be automatically forwarded to another number for a period of time.

A customer subscriber to a CLASS feature may typically activate and/or deactivate a CLASS feature using "*" directives (e.g., *69 to automatically return a call to the most recent caller). CLASS features may also be implemented with the use of out-of-band data. CLASS feature data is typically transmitted between local Class-5 switches using the Signaling System 7 (SS7).

Local Exchange Carriers (LECs) and other similar organizations maintain CLASS offices that typically contain a database entry for each customer. The database allows specification of the CLASS features a customer has subscribed to, as well as information, such as lists of phone numbers, associated with those features. In some cases, customers may edit these lists on-line via a touch-tone interface. A list of all phone numbers that have originated or terminated a call with each customer is often included in the CLASS office database. For each customer, usually only the most recent number on this list is stored by the local Class-5 switch.

A Private Branch Exchange (PBX), is a stored program switch similar to a Class-5 switch. It is usually used within a medium-to-large-sized business for employee telephony service. Since a PBX is typically operated by a single private organization, there exists a wide variety of PBX services and features. Custom configurations are common, such as integration with intercom and voice mail systems. PBX's typically support their own versions of the CLASS features, as well as other features in addition to those of CLASS. Most PBX features are designed to facilitate business and group communications.

A summary of typical PBX features includes:

- Call transfer: An established call may be transferred from one number to another number on the same PBX.
- Call forwarding: In addition to CLASS call forwarding, a PBX number can be programmed to automatically transfer a call to another number when the first number does not answer or is busy.

- Camp-on queuing: Similar to PSTN call return, a call to a busy number can be queued until the callee can accept it. The caller can hang up their phone and the PBX will ring them when the callee answers.
- Conference calling: Two or more parties can be connected to one another by dialing into a conference bridge number.
- Call parking: An established call at one number can be put on hold and then reestablished from another number. This is useful when call transfer is not warranted.
- Executive override: A privileged individual can break into an established call. After a warning tone to the two participants, the call becomes a three-way call.

While the CLASS and PBX features have enhanced the offerings of service providers that use the PSTN, the features are nevertheless limited in their flexibility and scope. The effect to the user is that the features become clumsy and difficult to use. For example, in order to use the Call Forwarding function, the user must perform the steps at the user's own phone prior to moving to the location of the telephone to which calls will be forwarded. A more desirable approach, from the standpoint of usefulness to the user, would be to perform the steps at the telephone to which calls will be forwarded.

Much of the lack of flexibility of the PSTN features is due to the lack of flexibility in the PSTN system itself. One problem with the PSTN is that the terminal devices (e.g. telephones) lack intelligence and operate as "dumb" terminals on a network having the intelligence in central offices. Most PSTN telephones are limited in functional capability to converting the analog signals they receive to sound and converting the sound from the handset to analog signals.

Some PSTN telephones have a display device and a display function to display specific information communicated from intelligent agents in the PSTN network using the PSTN signaling architecture. For example, some PSTN telephones have a display function to enable the Caller ID feature. Even such PSTN telephones are limited however by the closed PSTN signaling architecture, which prohibits access by the PSTN telephones to the network signaling protocols. The display functions are effectively limited to displaying text, again, as a "dumb" terminal.

The Internet presents a possible solution for distributing intelligence to telephony terminal devices. In Internet telephony, digitized voice is treated as data and transmitted across a digital data network between a telephone calls' participants. One form of Internet telephony uses a telephony gateway/terminal where IP telephony calls are terminated on the network. PSTN telephones are connected by a subscriber line to the gateway/terminal at the local exchange, or at the nearest central office. This form of Internet telephony provides substantial cost savings for users. Because the PSTN portion used in Internet telephony calls is limited to the local lines on each end of the call, long distance calls may be made for essentially the cost of a local call.

It is presently contemplated that Internet service providers with a Point of Presence on the Internet will be suitable entities to offer Internet telephony services. The devices that are used by most Internet service providers for Internet access are known as Network Access Servers or Remote Access Servers. These products are commercially available from 3Com Corporation and other telecommunications equipment manufacturers such as Ascend Communications, Lucent Technologies (successor to Livingston Enterprises), and Multitech.

A representative Network Access Server is the Total Control Enterprise Network Hub from 3Com Corporation, described in the patent of Dale M. Walsh, et al., U.S. No. 5,597,595, which is fully incorporated by reference herein. This device further includes a plurality of digital modems to perform signal conversions on the data from the telephone line channels and a bus network connecting the modems to a network interface card or module. The network interface couples the device to a local or wide area network, such as the Internet service provider backbone network of the Internet, network Access Servers are particularly suited for use in Internet telephony, as they can be configured with software to perform the functions of a Gateway or terminal, as defined by the relevant ITU-T H.323 and H.225 specifications. This is particularly so if the device is configured with a general purpose computing platform (such as the EdgeServer card of the Total Control Network Access Server), as described in the pending patent application of William Verthein, Daniel L. Schoo and Todd Landry, Serial No. 08/813,173, also incorporated by reference herein.

Notwithstanding the costs savings provided by this form of Internet telephony, it is no more flexible than the PSTN with respect to providing enhancements and features to the basic telephone service.

In another form of Internet telephony, telephones are connected to access networks that access the Internet using a router. The telephones in this form of Internet telephony may be substantially more intelligent than typical PSTN telephones. For example, such a telephone may include substantially the computer resources of a typical personal computer.

It would be desirable to incorporate CLASS and PBX features into a data network telephony system that uses a data network such as the Internet.

It would be desirable to provide new features and enhancements to telephony service that accommodates and conforms to users' needs.

It would also be desirable to provide features and capabilities to telephone service that create new opportunities for users and for service providers.

The present invention addresses the above needs by providing a system in a data network telephony system, such as for example, the Internet, that uses a wireless personal information device (PID) to control the telephony system. A user may configure his or her telephone service by connecting to a telephony control server using the wireless PID. The wireless PID connection to the telephony control server may provide a user with the power to control the behavior of the telephone system to meet the user's needs.

SUMMARY OF THE INVENTION

In a first aspect of the present invention, a personal information device (PID) is provided for controlling telephone service. The PID includes a user interface having a display and a user input device. A user profile includes a telephone number entered by a user. A communications function in the PID establishes a data communications channel over a wireless network to a telephony control server. The telephony control server contains the user's telephony account. An account update function in the PID sends a message over the data communication channel to the telephony control server. The message contains the user profile telephone number and a request to set the user's telephony account telephone number the user profile telephone number.

In a second aspect of the present invention, a contacts application is added to the PID to display a plurality of contact entries. Each entry includes a contact telephone number. The contacts application includes a function to send the contact telephone number to the telephony control server over the data communications channel with a message to call the contact telephone number.

In a third aspect of the present invention, a telephony control server includes a network interface operable to provide data connectivity with a user accessible over a wireless network. An accounts program accesses a plurality of user accounts. The accounts program may receive a message to set a user telephone number. Each user account contains a telephone number entry, which the accounts program can set to the telephone number entry in response to the message. A connection signaling function in the telephony control server may receive a call message from the user to establish a telephone connection between the user telephone number and a callee telephone number contained in the call message. The connection signaling function initiates a telephone call having at least a portion of the telephone call connected via the data network.

In a fourth aspect of the present invention, a gateway locator is included in the telephony control server to locate a user gateway closest to the user telephone number and to locate a callee gateway closest to the callee telephone number. The telephony control server initiates the portion of the call connected via the data network between the user gateway and the callee gateway.

In a fifth aspect of the present invention, a method is provided for initiating a data network telephone call using a wireless PID with a display. A contacts application is started to display a plurality of contact entries on the display of the PID. One of the contact entries identifying a callee is selected. A data communications channel is initiated to a telephony control server having a user telephone number. A message is sent to the telephony control server to establish the telephone call between the callee and the user by sending a message to call the callee, connecting a telephone call to the user, and connecting the telephone call to the callee.

These and other features and advantages of the present invention will become more apparent from the following detailed description of preferred embodiments of the present invention.

BRIEF DESCRIPTION OF THE DRAWINGS

Presently preferred embodiments of the invention are described below in conjunction with the appended drawing figures, wherein like reference numerals refer to like elements in the various figures, and wherein:

FIG. 1 is block diagram of a data network telephony system for providing advertising services in accordance with embodiments of the present invention;

FIG. 2A shows one embodiment of the system of FIG. 1;

FIG. 2B shows one example of one of the personal information device (PID) in FIG. 2A;

FIG. 3 is a pictorial and block diagram showing one example of a user controlling a telephone system using a wireless PID;

FIG. 4 is a pictorial and block diagram showing another example of a user controlling a telephone system using a wireless PID;

FIG. 5 is a pictorial and block diagram showing another example of a user controlling a telephone system using a wireless PID;

FIG. 6 is a pictorial and block diagram showing another example of a user controlling a telephone system using a wireless PID;

FIG. 7 is a pictorial and block diagram showing another example of a user controlling a telephone system using a wireless PID;

FIG. 8 is a flowchart showing one example of a method for controlling a telephone system with a wireless PID; and

FIG. 9 is a flowchart showing another example of a method for controlling a telephone system with a wireless PID.

DETAILED DESCRIPTION OF THE PREFERRED EMBODIMENT

The following references to patent applications filed concurrently herewith are incorporated by reference:

- * “System and Method for Advertising Using Data Network Telephone Connections” to Schuster, et al.
 - * “System and Method for Providing User-Configured Telephone Service in a Data Network Telephony System” to Sidhu, et al.
 - * “System and Method for Accessing a Network Server Using a Portable Information Device Through a Network Based Telecommunication System” to Schuster, et al.
 - * “System and Method for Interconnecting Portable Information Devices Through a Network Based Telecommunication System” to Schuster, et al.
 - * “System and Method for Enabling Encryption on a Telephony Network” to Schuster, et al.
 - * “System and Method for Using a Portable Information Device to Establish a Conference Call on a Telephony Network” to Schuster, et al.
 - * “System and Method for Associating Notes with a Portable Information Device on a Network Telephony Call” to Schuster, et al.
 - * “System and Method for Providing Shared Workspace Services Over a Telephony Network” to Schuster, et al.
 - * “System and Method for Providing Service Provider Configurations for Telephones in a Data Network Telephony System” to Schuster, et al.
- The following additional references are also incorporated by reference herein:
- * “Multiple ISP Support for Data Over Cable Networks” to Ali Akgun, et al.
 - * “Method and System for Provisioning Network Addresses in a Data-Over-Cable System” to Ali Akgun, et al., Serial No. 09/218,793.
 - * “Network Access Methods, Including Direct Wireless to Internet Access” to Yingchun Xu, et al., Serial No. 08/887,313

A. Data Network Telephony System

FIG. 1 is a block diagram showing an example of a system 100 for controlling a telephony system using a wireless personal information device (PID) 110 according to one embodiment of the present invention. The system includes a data network 106. A first voice communication device 108a may communicate by a voice connection over the data network 106 by establishing the connection via first access network 112. The voice connection may be linked to a second voice communication device 108b which is accessed via a second access network 114.

The data network 106 in the system 100 typically includes one or more Local Area Networks (LANs) connected to one another or to a Wide-Area Network (WAN), such as an Internet Protocol (IP) network, to provide wide-scale data connectivity. The data network 106 may use Voice Over Packet (VOP) schemes in which voice signals are carried in data packets. In one embodiment, the data network 106 may include one or more LANs such as Ethernet LANs and support data transport protocols for performing Voice-over-Internet-Protocol (VoIP) techniques on the Internet. For further details regarding VoIP, see the information available through the Internet Engineering Task Force (IETF) at www.ietf.org. In addition, an Internet Telephony gateway may be included within the system 100 to allow for voice connections to users connected by subscriber lines at a PSTN Central Office.

The first and second voice communication devices 108a and 108b may include a direct interface to a data-switched network, such as a LAN. Such voice communications devices 108a,b typically include a voice input, a voice output and a voice processing system. The voice processing system converts voice sound from the voice input to digital data signals that are communicated on a voice connection over the data network. The voice processing system also converts digital data signals received from the voice connection to voice sound at the voice output. The voice communication devices 108a and 108b typically include a central processing unit and memory to store and process computer programs. Each voice communication device 108a and 108b typically includes a unique network address, such as an IP address, in memory to uniquely identify it to data network 106 and permit data packets to be routed to the device.

In one embodiment, the voice communication device 108a includes a handset with a receiver and transmitter similar or identical to handsets of traditional circuit-switched telephones. A console on which the handset sits may include the voice processing system, a display 116 and a keypad 118. The voice communication device 108a may also include a speed dial key set 128 programmed, or assigned to initiate connections to other voice communication devices that may be connected to the data network 106. In a preferred embodiment, the keys on the speed dial key set 128 may be programmed remotely by a message carried on a voice connection using a selected data transport protocol .

One example of the voice communication device 108a in a preferred embodiment is the NBX 100™ communication system phones offered by 3Com® Corporation, that has been modified, as described herein, to perform speed dial programming. In alternative embodiments, the voice communication device 108a may include any device having voice communications capabilities. For example, a personal computer having a microphone input and speaker output may also be used as the voice communication device 108a. Other configurations for the user interface are also intended to be within the scope of the present invention.

The voice communication devices 108a, 108b may also include a typical plain-old telephone set (POTS) currently used for circuit-switched telephony in the Public Switched Telephone Network (PSTN).

The details relating to operation of the voice communication devices 108a and 108b depend on the nature of the data network 106 and the nature of the access networks 112, 114 connecting the voice communication devices 108a and 108b to each other and/or to other network entities. The access networks 112, 114 typically include any high bandwidth network adapted for data communications, i.e. a network having a bandwidth greater than 64,000 bits-per-second (bps). The access networks 112, 114 may link to the voice communication device 108a using an Ethernet LAN, a token ring LAN, a coaxial cable links (*e.g.* CATV adapted for digital communication), a digital subscriber line (DSL), twisted pair cable, fiberoptic cable, an integrated services digital network (ISDN) link, and wireless links. In embodiments that may not require bandwidth greater than 64,000 bps, the access networks 112, 114 may also include the PSTN and link the voice communications device 108a by a subscriber line.

The system 100 in FIG. 1 shows a telephony control server 120 and an accounts database 122. The telephony control server 120 includes an interface to the data network 106. The purpose of the telephony control server is to provide users of the telephony system with control over their telephony service. Users may subscribe for telephony service from a telephony service provider (*e.g.* an Internet Service Provider, or ISP). The service provider configures the users' accounts and maintains the accounts in the accounts database 122. The users' account may include information about the user and the user's service provisions. A typical account may include the information shown in Table A.

User Account Information
<ul style="list-style-type: none"> • User identifier: a sequence of alphanumeric elements that uniquely identifies the user. The user identifier may be formatted as an E.164 telephone number, or as a name. • Telephone Number/Identifier: a sequence of alphanumeric elements that uniquely identifies the telephone used by the user. The user identifier may be formatted as an E.164 telephone number, or as a number, such as a MAC address. • The user's name, address and other information that may be used primarily for billing purposes. For example, the user's checking account number, credit card number or other financial information may be provided for automatic billing and payment capabilities. • User's telephony service features. The user may subscribe, permanently or temporarily, to one or more telephony service features offered by the service provider. For example: <ul style="list-style-type: none"> ◆ Voice mail ◆ Caller ID ◆ Call Forwarding with true number portability ◆ Teleconferencing • Menu of functions displayed at the telephone • Help menu displayed at the telephone • Speed dial key programming (<i>e.g.</i> speed dial to customer service) • Features as standard offerings – to compete, a provider may offer features that normally cost extra (<i>e.g.</i> caller ID, etc.) as standard features • Packaged configurations – Features and offerings may be grouped as distinctly priced packages • Functions using PDA connectivity (<i>e.g.</i> Remote Whiteboard communication, control of telephone use through PDA)

TABLE A

The telephony control server 120 is connected to the data network 106 and configured to allow access by users. For example, users may access the telephony control server 120 by connecting to a web page. The telephony control server 120 may also include functions to initiate telephone calls using a call management protocol and one or more data communications channels. In a preferred embodiment, the user connects to the telephony control server 120 from a wireless personal information device (PID) 110. The preferred wireless PID 110 is the Palm 7 from 3Com.

The wireless PID 110 includes wireless communications capabilities to permit connections to be made over a wireless network 112. The wireless network 112 preferably includes any cellular telephone network, although other technologies (*e.g.* infrared, microwave, non-cellular radio, etc.) may be used. The advantage of using cellular radio is that it is widely available.

One advantage of the system 100 in FIG. 1 is that a user may use the wireless PDA 110 to control telephony service provided to voice communications devices 108a,b that interface directly to data connections (*i.e.* data network telephones) as well as to voice communications devices 108a,b connected to the PSTN. FIG. 2A shows one embodiment of the system 100 in FIG. 1 that provides a user with the capability of controlling telephone service with a wireless PDA, such as the wireless PDA 110.

The system 200 shown in FIG. 2A shows a data network telephony system that provides voice over data communication for both PSTN telephones and data network telephones. The system 200 includes a data network telephony system that includes a first data network telephone 208 connected to a first local area network 212. The first local area network provides the data network telephone 208 with access to a data network 206 via a router 218. The first local area network 212 also includes a first connection server 250, which uses a call management protocol to provide data network telephony service to the first data network telephone 208 (and other telephones connected to the local area network 212).

The system 200 in FIG. 2A also includes a second local area network 214 to provide data network access to a second data network telephone 218 via a router 215. A second connection server 238 provides call management services for the second data network telephone 218.

In one embodiment, the system shown in FIG. 2A uses the Session Initiation Protocol (SIP) as a call management protocol to establish, maintain and teardown sessions, or telephone calls between users. There are two major architectural elements to SIP: the user agent (UA) and the network server. The UA resides at the SIP end stations, (e.g. the data network telephones), and contains two parts: a user agent client (UAC), which is responsible for issuing SIP requests, and a user agent server (UAS), which responds to such requests. There are three different network server types: a redirect server, a proxy server, and a registrar. The various network server types may be combined into a single server, such as the telephony connection server 250, 238. Not all server types are required to implement the embodiments of the present invention. The communication services to be provided will determine which servers are present in the communication system. Preferred embodiments of the present invention may be carried out using proxy servers.

One example of a SIP operation involves a SIP UAC issuing a request, a SIP proxy server acting as end-user location discovery agent, and a SIP UAS accepting the call. A successful SIP invitation consists of two requests: INVITE followed by ACK. The INVITE message contains a user identifier to identify the callee, a caller user identifier to identify the caller, and a session description that informs the called party what type of media the caller can accept and where it wishes the media data to be sent. User identifiers in SIP requests are known as SIP addresses. SIP addresses are referred to as SIP Uniform Resource Locators (SIP-URLs), which are of the form *sip:user@host.domain*. Other addressing conventions may also be used.

Redirect servers process an INVITE message by sending back the SIP-URL where the callee is reachable. Proxy servers perform application layer routing of the SIP requests and responses. A proxy server can either be stateful or stateless. A stateful proxy holds information about the call during the entire time the call is up, while a stateless proxy processes a message without saving information contained in the message. Furthermore, proxies can either be forking or non-forking. A forking proxy can, for example, ring several phones at once until somebody takes the call. Registrar servers are used to record the SIP address (called a SIP URL) and the associated IP address. The most common use of a registrar server is for the UAC to notify the registrar where the UAC can be reached for a specified amount of time.

When an INVITE request arrives for the SIP URL used in a REGISTER message, the proxy or redirect server forwards the request correctly.

At the first local area network 212, the central registrar/proxy server, such as the telephony connection server 250 is the primary destination of all SIP messages trying to establish a connection with users on the local area network 212. Preferably, the telephony connection server 250 is also the only destination advertised to the SIP clients outside the LAN 212 on behalf of all the SIP clients residing on the LAN 212. The network telephony server 250 relays all SIP INVITE messages to the appropriate final destination (or another SIP proxy), based on a database lookup using a user database (not shown). It allows all mobile clients to register with their current locations.

Similarly, the second telephony connection server 238 is the primary destination of all SIP messages trying to establish a connection with the data network telephone 218 connected to the second local area network 214. Preferably, the second telephony connection server 238 is also the only destination advertised to the SIP clients outside the LAN 214 on behalf of all the SIP clients (*e.g.* data network telephones) residing on the LAN 214. The second telephony connection server 238 relays all SIP INVITE messages to the appropriate final destination (or another SIP proxy), based on a database lookup using the user database (not shown).

The data network telephones 208 and 218 in the system 200 preferably have pre-programmed device identifiers (*e.g.* phone numbers), represented as SIP-URL's that are of the form *sip:8475551212@3com.com*. After power-up, each data network telephones 208, 218 sends a SIP REGISTER message to the default registrar, such as the telephony connection servers 250, 238. When a call arrives at one of the telephony connection servers 250, 238 for any of the registered SIP URLs, the server will forward the call to the appropriate destination. If a data network telephone is moved to a new location, all calls to the associated SIP URL will still be properly routed to that device. The system in FIG. 2A, therefore, provides device mobility in the sense that calls will "follow" the data network telephone according to its SIP URL. This is especially useful if the data network telephone 208, 218 is running the DHCP (Dynamic Host Configuration Protocol) so that when the location is changed, the IP address is also automatically changed.

In one preferred embodiment of the present invention, the wireless PID 210 may send a third party register request directly to the telephony connection server 250, 238. Alternatively, the wireless PID 210 may connect to an application in the telephony control server 120 that may issue a request to one of the data network telephones 208, 218 to register as belonging to the user. The capability to re-register the user's telephone may correspond to a feature offered by a telephony service provider to give a user control over his/her telephone service. When the user is not at his/her telephone, the user may modify a profile of personal information stored in the wireless PID 210 with a telephone number that is nearby. The user may then connect to the telephony control server 120 to change the user's telephone number to that of the nearby telephone.

One advantage of using the telephony control server 120 with the wireless PID 210 is that the user may modify his/her account with the telephone number of any type of telephone.

System 200 in FIG. 2A also shows an alternative arrangement of telecommunications devices that can be used to conduct an IP telephony call. The system 200 includes a first gateway 233, a first central office 235 and a PSTN telephone 237 belonging to a user USER A. A second user, USER B, has a second PSTN telephone 226 connected to a second gateway 222 via a second central office 224. A third PSTN telephone 227 is connected to a third gateway 223 via a third central office 225. This alternative arrangement permits telephone service over the data network 206 using PSTN telephones.

An Internet telephony call from USER A's telephone 237 is transmitted over the Public Switched Provider (ISP) Gateway/Terminal 233. The ITU-T H.225 and H.323 specifications may be used for call management, one of the functions of the Gateway/Terminal 233. The gateway/Terminal 233 may be implemented in a Network Access Server, as described in more detail below.

The Gateway/Terminal 233 provides an interface between the PSTN (typically a time division multiplexed line such as a T1 line) and the data network 206, which is typically a packet switched network such as the Internet or the local ISP backbone network. The Gateway/Terminal 233 routes the call onto the Internet 206, where it is forwarded to a gatekeeper 219 in accordance with the H.323 and H.225 standards.

The Gatekeeper 219 may be embodied as a general purpose computer, or as one function performed by an existing piece of telecommunications equipment such as a network access server. The gatekeeper 219 determines where to send the call over the Internet 206 to the proper terminating ISP Gateway/Terminal 222, for example, for the called party. The terminating Gateway/Terminal 222 calls the called party over the PSTN via the central office 224 to USER B's telephone 226. The gateway/terminal 222 facilitates communication between the telephone 226 at the near end with the telephone 237 at the far end.

The wireless PID 210 may be used to control telephone service to the PSTN telephones 226, 227, 237. FIG. 2B shows a pictorial and block diagram of one embodiment of the wireless PDA 210 and the telephony control server 120.

The wireless PDA 210 includes (in 210') a user interface circuitry 291, a wireless interface 304, a processor 293 and alternative input/output configurations 295, 297, 299. The user interface circuitry 291 controls the user interface of the wireless PID 210. The user interface of the Wireless PID 210 may include a stylus, buttons, touch sensitive display buttons, the display, etc.

The wireless network interface 304 performs the functions needed to establish a data connection over the wireless network 216. The processor 293 includes a contacts application 300, a user profile 302 and a communications application 304. The contacts application 300 includes any application for a PID (*e.g.* PDAs) that allows a user to enter information about personal and business contacts.

The user profile 302 stores personal information about the owner of the PID 210. The user profile 302 may include account information about the user's telephone service as well. In one embodiment, the user may enter personal information as a contact in the contacts application 300 and designate the entry as the user profile 302.

The communications function 304 allows a user to initiate a connection to the telephony control server 120 to modify the user's account, or to initiate a telephone call. The communications function 304 may include a program that senses a designated key activation. Upon activation of the designated key, the communications function 304 composes a message to transmit to the telephony control server 120. For example, to initiate a telephone call to a person identified by an entry in the contacts

application, the user selects the entry and presses a 'send' screen button to send the request to the telephony control server 120.

The telephony control server 120 in FIG. 2B includes (at 120') a network interface 121, an accounts program 127, a server/gateway locator 125 and a telephone connection signaling function 123. The network interface 121 performs communications functions for communicating on data communications channels in accordance with selected data transport protocols. In a preferred embodiment, the network interface 121 in the telephony control server 120 communicates with the wireless network interface 304 in the PID 210 using a TCP/IP connection. Other protocols and protocol combinations as required by the wireless network infrastructure selected may also be used.

The accounts program 127 performs requests on selected user accounts in the accounts database 122. For example, when the telephony control server 120 receives a request to set a telephone number for selected user, the accounts program 127 retrieves the selected user's account and performs the requested modification.

The telephone connection signaling function 123 performs call management functions to initiate a telephone call between users as requested by the PID 210 user. The telephone connection signaling function 123 may include a signaling stack in accordance with SIP, H.323, MEGACO, MGCP, etc. The signaling stack may support multiple protocols as well.

The server/gateway locator 125 performs location functions for requests to initiate a telephone call. For example, if a PSTN telephone requests to initiate a call to a second PSTN telephone, the server/gateway locator 125 locates the gateway closest to the second PSTN, and if necessary the gateway closest to the first PSTN. The server/gateway locator 125 may include a gatekeeper function, or it may include a function that seeks the gatekeeper 219 shown in FIG. 2A.

FIG. 3 is an example of how the wireless PID 210 may advantageously control user A's telephone service in accordance with one embodiment to the present invention. User A may enter and maintain a profile of personal information in the wireless PID 210, as shown on the display 111. In one embodiment of the present invention, user A may also maintain a similar or identical profile in the telephony control server 120. The telephony control server 120 stores the profile of user A's

personal information in the accounts database 122. The profile of user A's personal information may include any type of personal information that user A may wish to store in the wireless PID 210. Preferably, however, user A's profile information includes information about user A's telephone service, such as user A's telephone number. As shown on the display 111, user A has entered *A_Number* as his phone number. The number *A_Number* corresponds with the telephone number addressed or identifying user A's telephone 237.

FIG. 3 shows how user A may update his profile of information in the account database 122. User A may update his profile of information in the account database 122 by establishing a data connection 250 with the telephony control server 120. The data connection 250 includes a wireless connection via the wireless network 216 and on the data network 206. In a preferred embodiment, the data connection 250 includes a cellular call over the wireless connection with a TCP/IP channel established between the PID 210 and the telephony control server 120.

Once the data connection 250 is established, the user may use the PID 210 to send a message to set user A's profile in the telephony control server 120 on the data connection 250. As shown in FIG. 3, user A's account in the accounts database 122 shows A's phone number as being *A_Number*.

One advantage of having user A's profile of personal information in the accounts database 122 is that the telephony control server 120 may initiate telephone connections involving user A. Referring to FIG. 4, user A may display a list of user A's contacts on the display 111 using a contacts application (shown in FIG. 2B) in the PID 210. User A's contact list includes an entry for user B. After selecting the entry, the PID 210 may use a data connection that is the same or similar to the data connection 250 of FIG. 3 to send a message to call user B to the telephony control server 120. The telephony control server 120 receives the message and hardware and software components in the server 120 attempt to establish the telephone connection.

Referring to FIG. 5, the network telephony server 120 sends a signal over a second data connection 252 to user B's gateway 222 and to user A's gateway 233. The two gateways, 222, 233 signal the respective user telephones 227, 226 the respective central offices 224, 225 using well known PSTN signaling methods. The data network telephony server 120 also establishes a third data channel 253 between

user A's Gateway 223 and user B's Gateway 222. The third data connection 253 is used to carry digitized voice signals in data packets in accordance with selected network data transport protocols.

The third data channel 253 in FIG. 5 uses UDP over IP to transport the data, and RTP to format voice signals represented as G.711 (but other protocols such as G.723.1) data samples. The specific protocols used, are not important as any suitable protocol may be used for transport and/or data formatting. When user A picks up his telephone 227 and when user B picks up his telephone 226, they may communicate by telephone.

One advantage of using the PID 210 to control the data network telephony server 120 is that the system and methods may be enhanced to provide personal mobility. Referring to FIG. 6, user A may be at a location that is away from user A's telephone 227. In addition, user A may be near a third telephone 237. User A may enter the telephone number for the telephone 237 into his profile of personal information on the wireless PID 210, as shown in the display 111. User A may then use the wireless PID 210 to send a message to set user A's phone number to *X_Number* to the telephony control server 120. The telephony control server 120 receives the message and modifies user A's account in the accounts database 122 to reflect that user A's phone number is now *X_Number*.

The telephony control server 120 may now divert telephone calls for user A from his original telephone *A_Number* to the telephone number for the telephone that is closest to him *X_Number*. Referring to FIG. 7, the user displays user A's contacts on the display 111 of the PID 210. By selecting the "user B" entry, the wireless PID 210 may send a message to caller user B to the telephony control server 120. The telephony control server 120 signals the gateway 223 to call the telephone 227 having the telephone number *X_Number*. The telephony control server 120 also signals the gateway 222 for user B to call user B's telephone 226. The telephony control server 120 may send a message to the gatekeeper 219 to determine which gateways are closest to user A's telephone 237 and user B's telephone 226. The telephony control server 120 may have prior knowledge as to the location of the gatekeeper 241, or may send out a gatekeeper request message over the data network 206 to seek a gatekeeper to handle a call.

The gatekeeper 223 places a PSTN telephone call to the telephone 227 closest to user A and having the telephone number *X_Number*. The gateway 222 places a PSTN telephone call to user B's telephone 226. The gateways 222, 223 also establish a data channel 257 to communicate voice over data packets between the two gateways 222, 223. User A may now speak with user B over the data channel 257.

FIG. 3 through 7 illustrates systems and methods for controlling telephony service using a wireless PID 210 in accordance with one embodiment of the present invention. The present invention however, is not limited to any system or method shown in FIGS. 3 through 7.

FIG. 8 shows a flow chart that illustrates how a user may modify his/her telephony user account in a telephony control server 120 using a wireless PID 210 (both shown in FIG. 2).

At step 400 user enters a telephone number into his/her profile of personal information in the PID 210. At step 402, the user initiates a wireless connection to the telephony control server. The PID 210 sends a message to the telephony control server 120 to set the PID user's telephone number in the user's account to the telephone number contained in the message, as shown in step 404. The telephony control server 120 receives the message at step 406 and retrieves user A's account from the accounts database 122 and modifies user A's telephone number contained in the message.

Once the telephony control server 120 modifies user A's account, telephone calls to user A will be directed to the telephone number in user A's account.

FIG. 9 shows an example of a method for initiating a telephone call between two PSTN telephones from the wireless PID 210. Starting at step 410, the user invokes a contacts application in the wireless PID 210 to select an entry for a person that the user wishes to call. At step 412, the user selects an entry and commands the wireless PID 210 to initiate a telephone call. At step 414, the wireless PID 210 initiates a wireless data connection to the telephony control server 120. At step 416, the wireless PID 210 sends a message to call the person whose telephone number is included in the message. At step 418, telephony control server 120 determines the gateway nearest to each party. Once the closest gateway is found, the data network telephony server 120 signals the gateways to make PSTN telephone calls to the

telephone identified by the telephone numbers. At step 422, the gateways establish a voice over data channel over the data network. When the users pick up their telephones, the gateways connect their telephones to the voice over data channel so that they may begin conversing as in a normal telephone call.

While the invention has been described in conjunction with presently preferred embodiments of the invention, persons of skill in the art will appreciate that variations may be made without departure from the scope and spirit of the invention. For example, the access networks shown in FIG. 2A may comprise any other suitable type of local area network or service infrastructure.

In addition, protocols of various types are referenced throughout. While preferred and alternative embodiments may implement selected protocols, any suitable replacement protocol not mentioned, or any function not part of a protocol used to replace a corresponding function from a protocol may be implemented without departing from the scope of the invention.

This true scope and spirit is defined by the appended claims, interpreted in light of the foregoing.

WE CLAIM:

1. A personal information device for controlling telephone service comprising:
 - a user interface comprising a display and a user input device;
 - a user profile having a telephone number entered by a user;
 - a communications function to establish a data communications channel over a wireless network to a telephony control server, the telephony control server containing the user's telephony account; and
 - an account update function to send a message over the data communication channel to the telephony control server, the message containing the user profile telephone number and a request to set the user's telephony account telephone number the user profile telephone number.

2. The PID of Claim 1 further comprising:
 - a contacts application operable to display a plurality of contact entries, each entry comprising a contact telephone number, the contacts application operable to send the contact telephone number over the data communications channel to the telephony control server with a message to call the contact telephone number.

3. A telephony control server comprising:
 - a network interface operable to provide data connectivity with a user accessible via a wireless network;
 - an accounts program to access a plurality of user accounts, the accounts program operable to receive a message to set a user telephone number, each user account containing a telephone number entry, the accounts program being operable to set the telephone number entry in response to the message;
 - a connection signaling function to receive a call message from the user and to establish a telephone connection between the user telephone number and a callee telephone number contained in the call message; and
 - the connection signaling function operable to initiate a telephone call having at least a portion of the telephone call connected via the data network.

4. The telephony control server of Claim 3 further comprising:
 - a gateway locator to locate a user gateway closest to the user telephone number and to locate a callee gateway closest to the callee telephone number; wherein the connection signaling function initiates the portion of the call connected via the data network between the user gateway and the callee gateway.

5. A method for modifying a user telephone account having a telephone number entry using a wireless personal information device (PID) connected over a data network, the method comprising the steps of:
 - updating a user profile in the wireless PID to a user telephone number;
 - and
 - sending a request to set the user telephone account to the user telephone number over a data communications channel to a telephony control server wherein the telephony control server updates the user telephone number entry to the user telephone number.

6. A method for initiating a data network telephone call using a wireless PID with a display comprising the steps of:
 - starting a contacts application to display a plurality of contact entries;
 - selecting one of the contact entries identifying a callee;
 - initiating a data communications channel to a telephony control server having a user telephone number;
 - sending a message to call the callee;
 - connecting a telephone call to the user; and
 - connecting the telephone call to the callee.

7. The method of Claim 6 wherein the step of connecting the telephone call to the callee includes the steps of locating a callee gateway closest to the user telephone number and sending a signal to call the callee by dialing via a callee's central office.

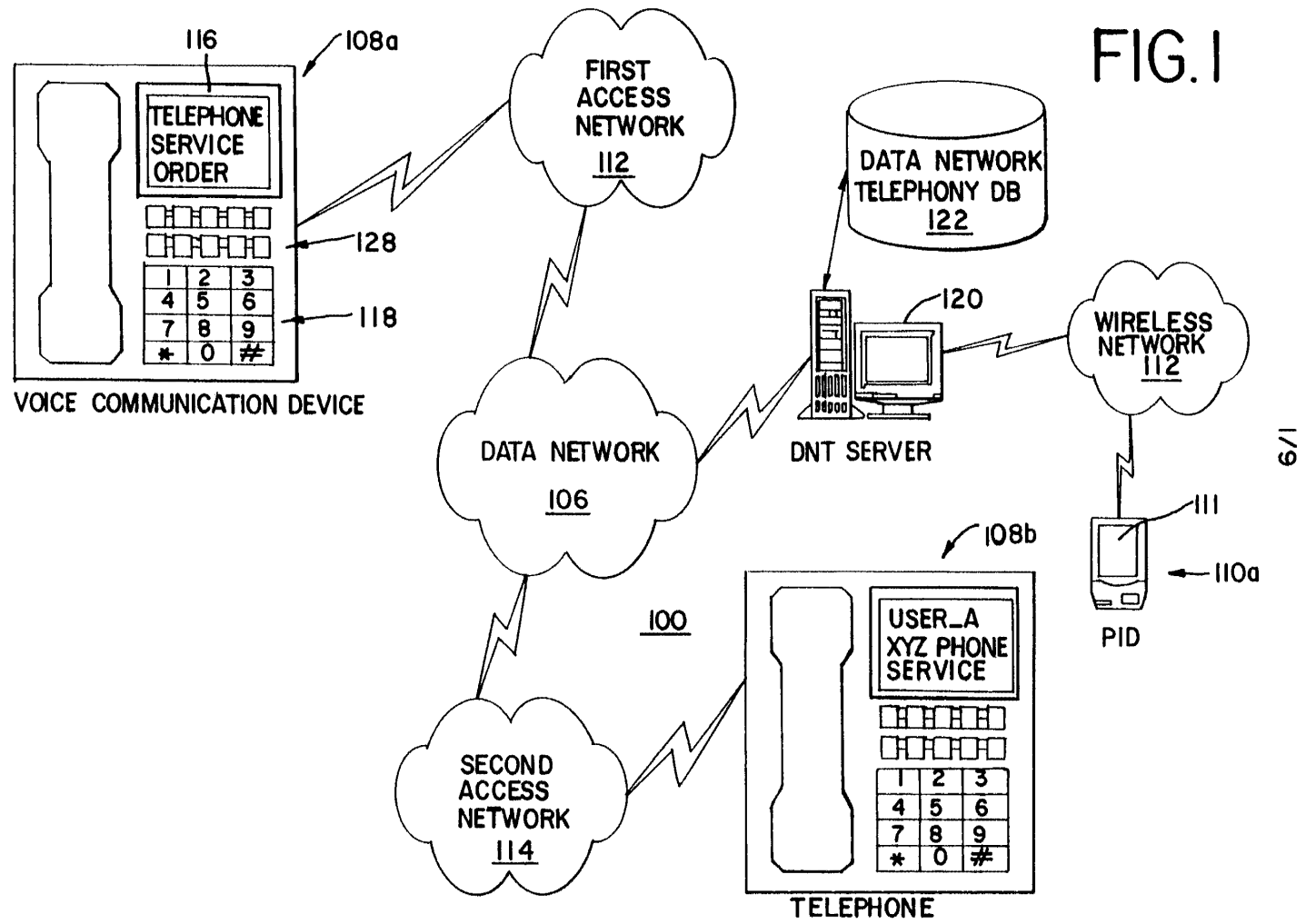
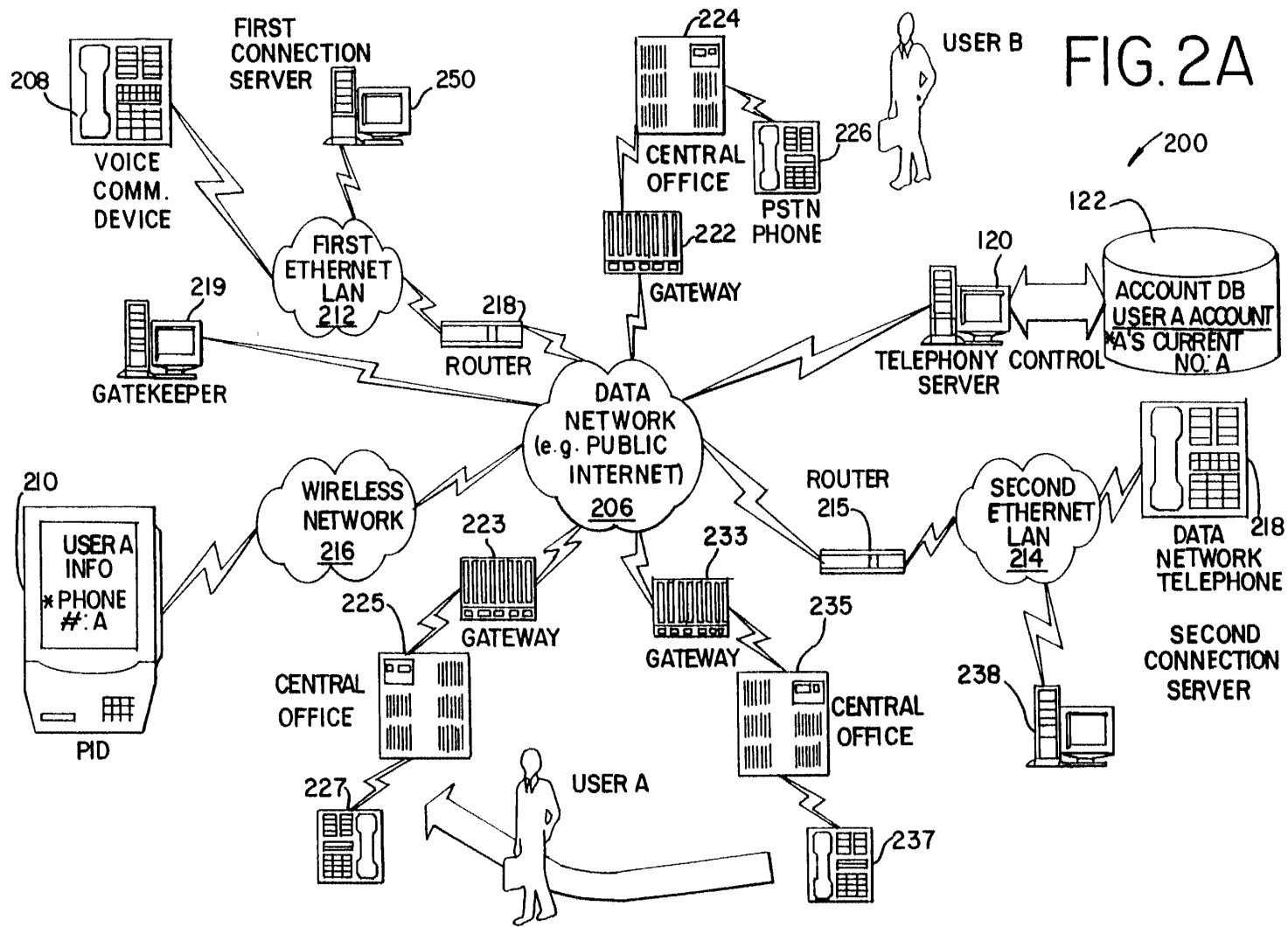

FIG. 1



2/9

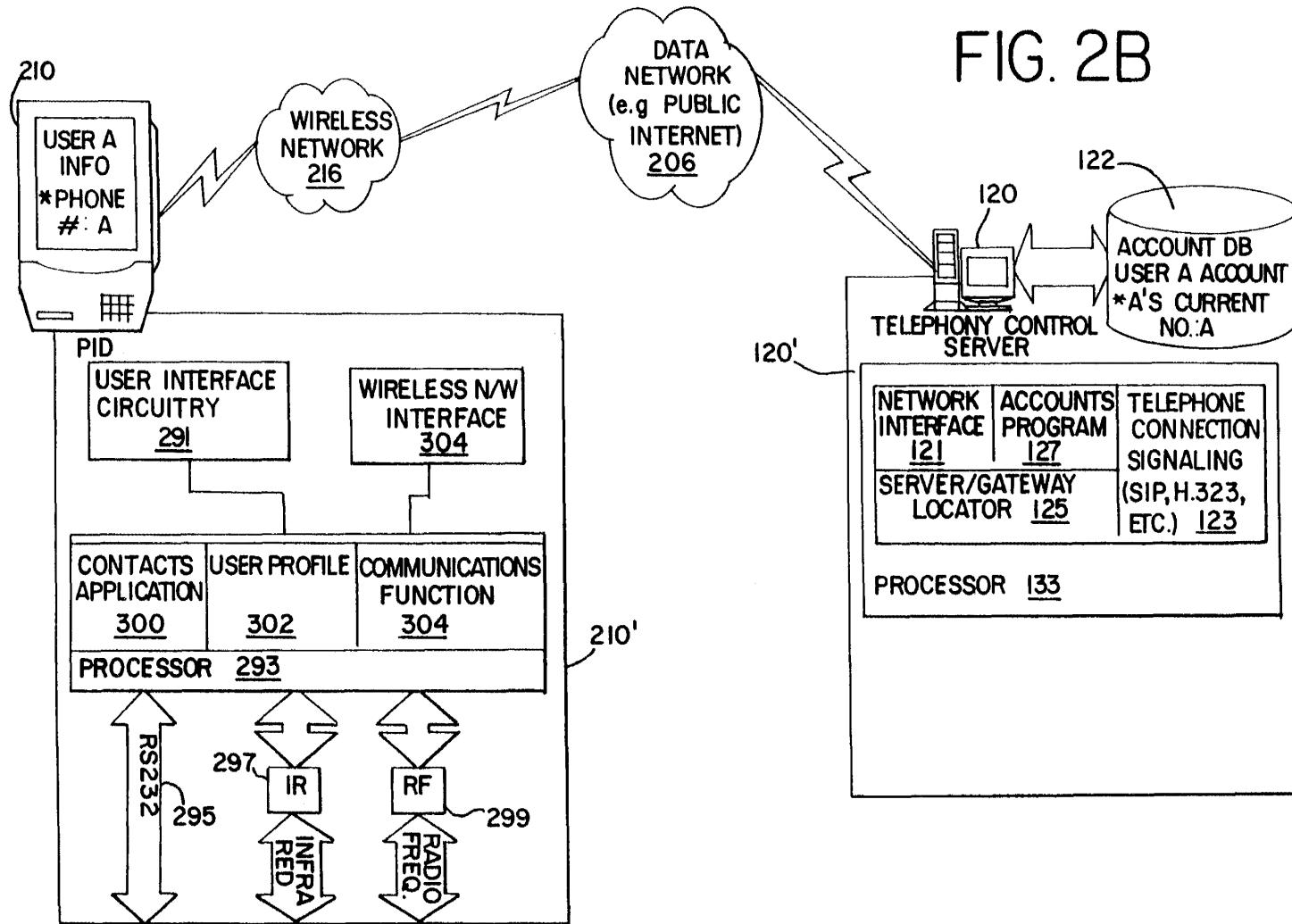
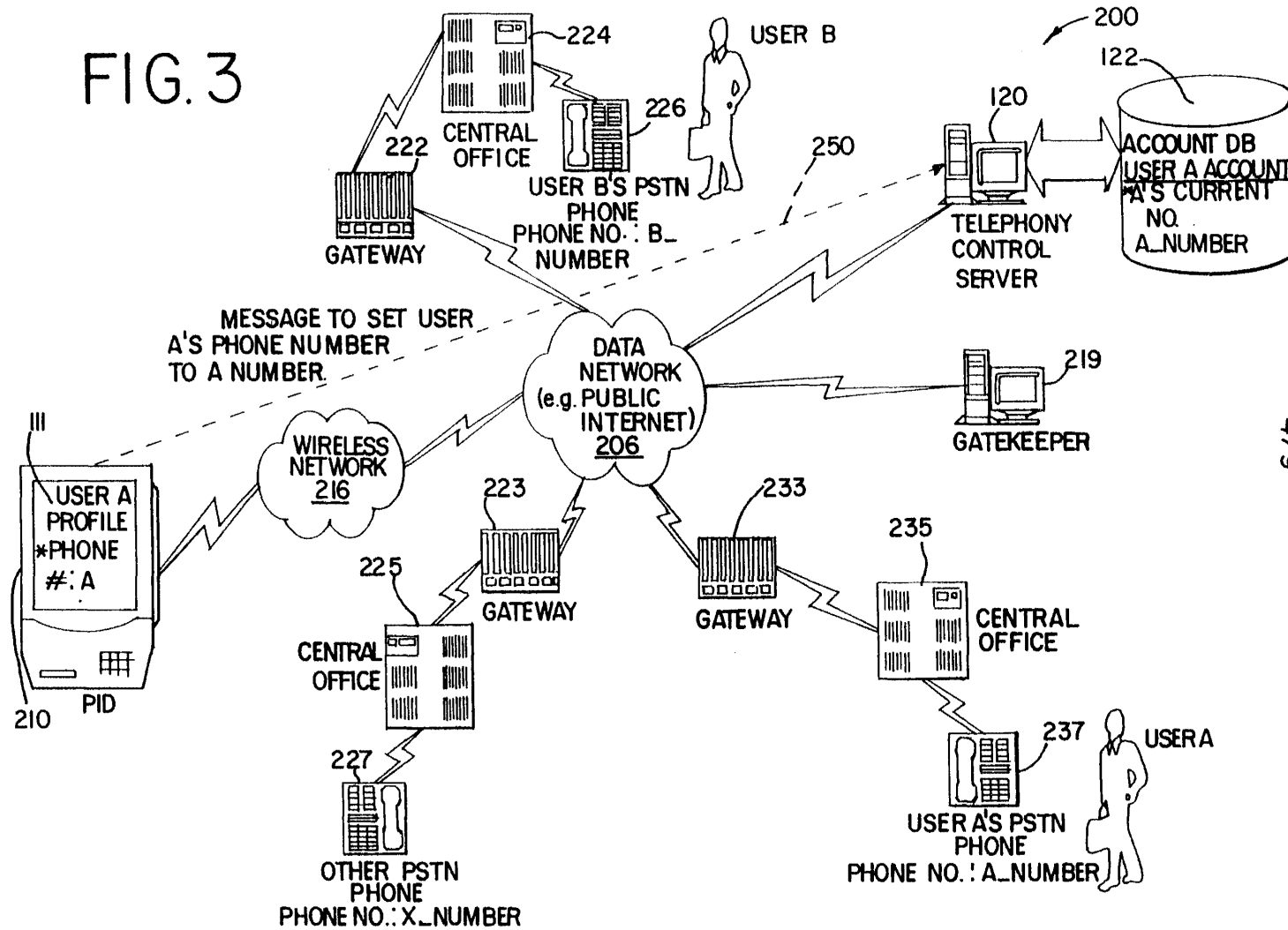
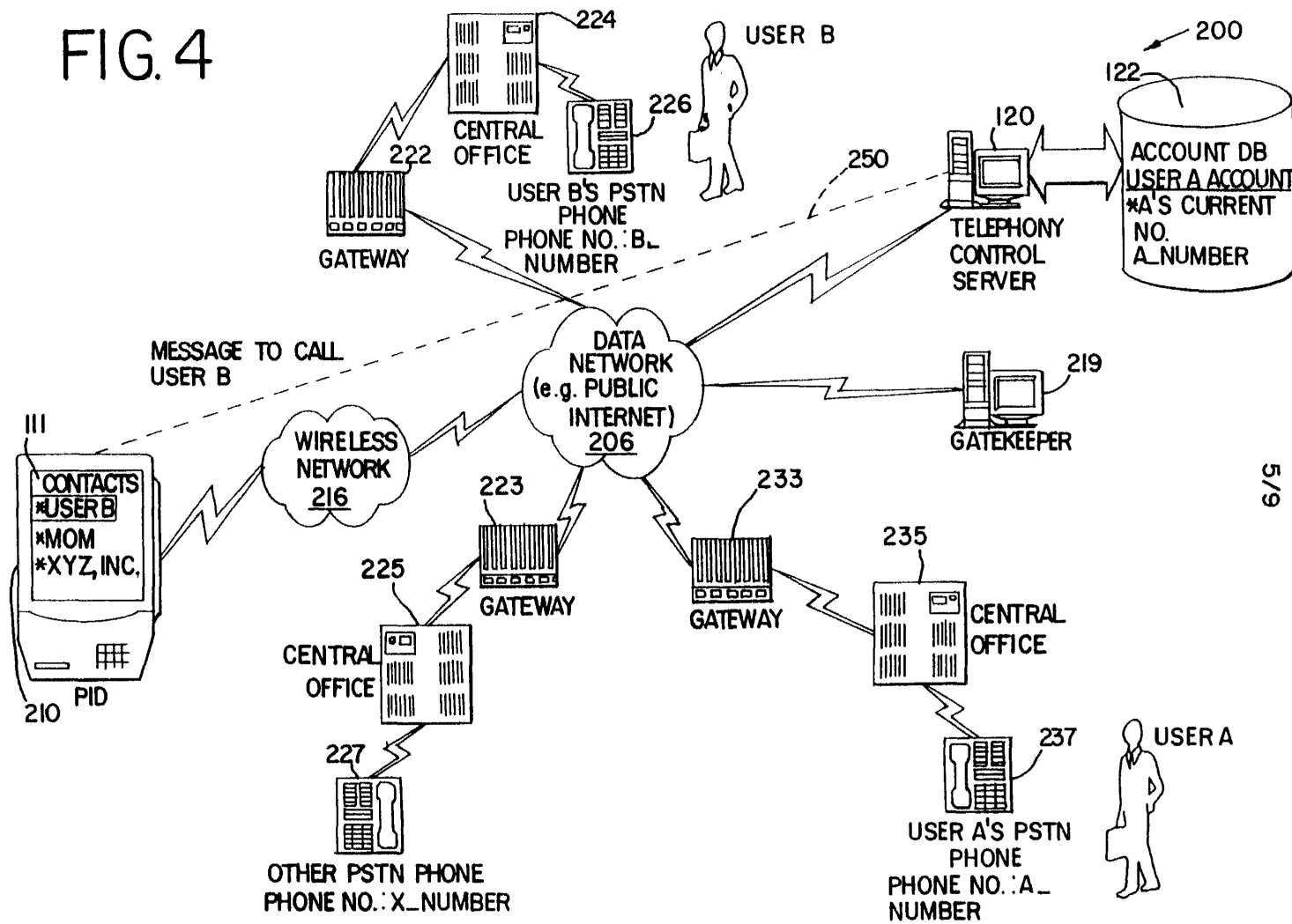

FIG. 3



SUBSTITUTE SHEET (RULE 26)

FIG. 4



SUBSTITUTE SHEET (RULE 26)

WO 01/24501

PCT/US00/26618

FIG.5

SUBSTITUTE SHEET (RULE 26)

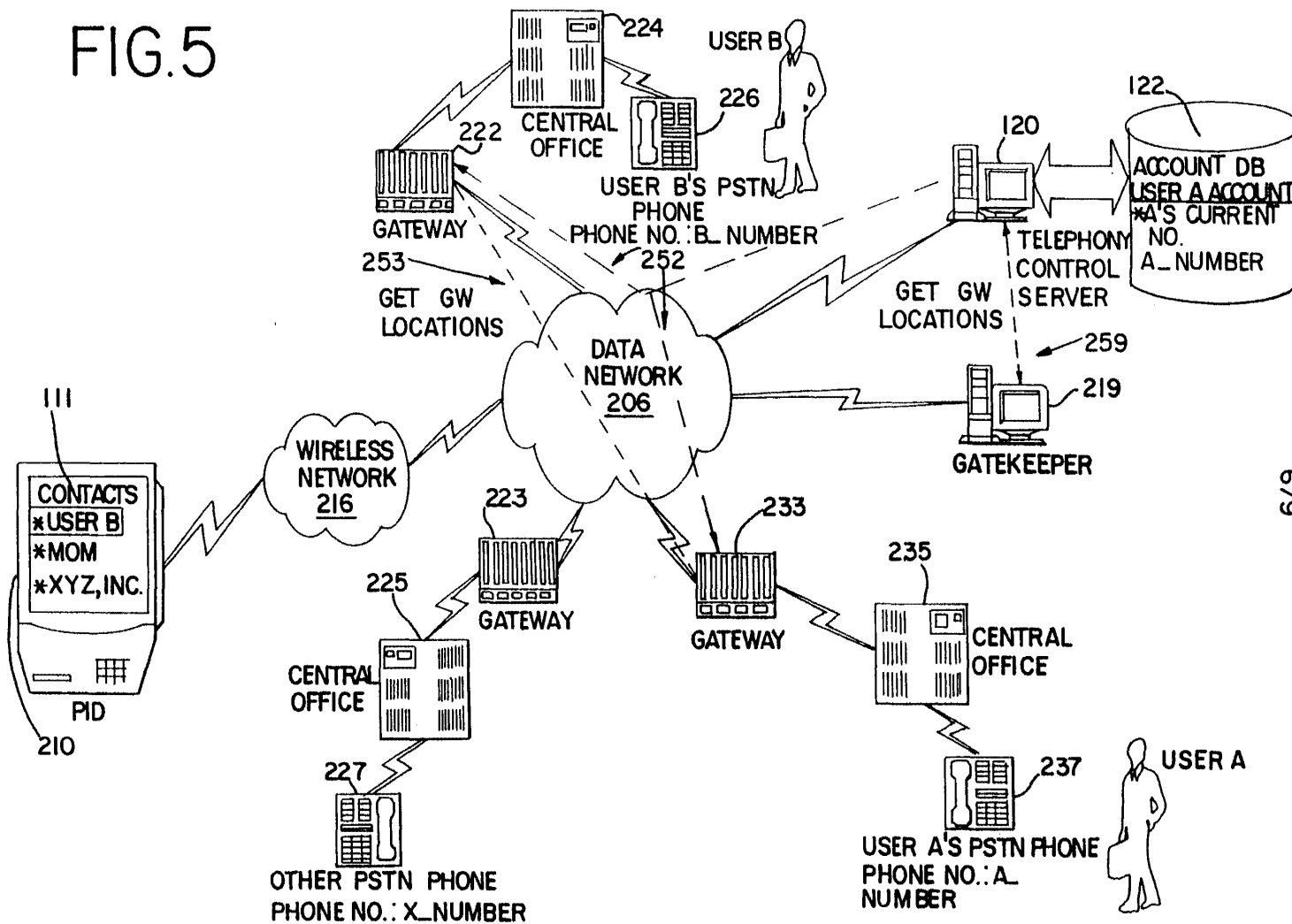

6/9

WO 01/24501

PCT/US00/26618

FIG. 6

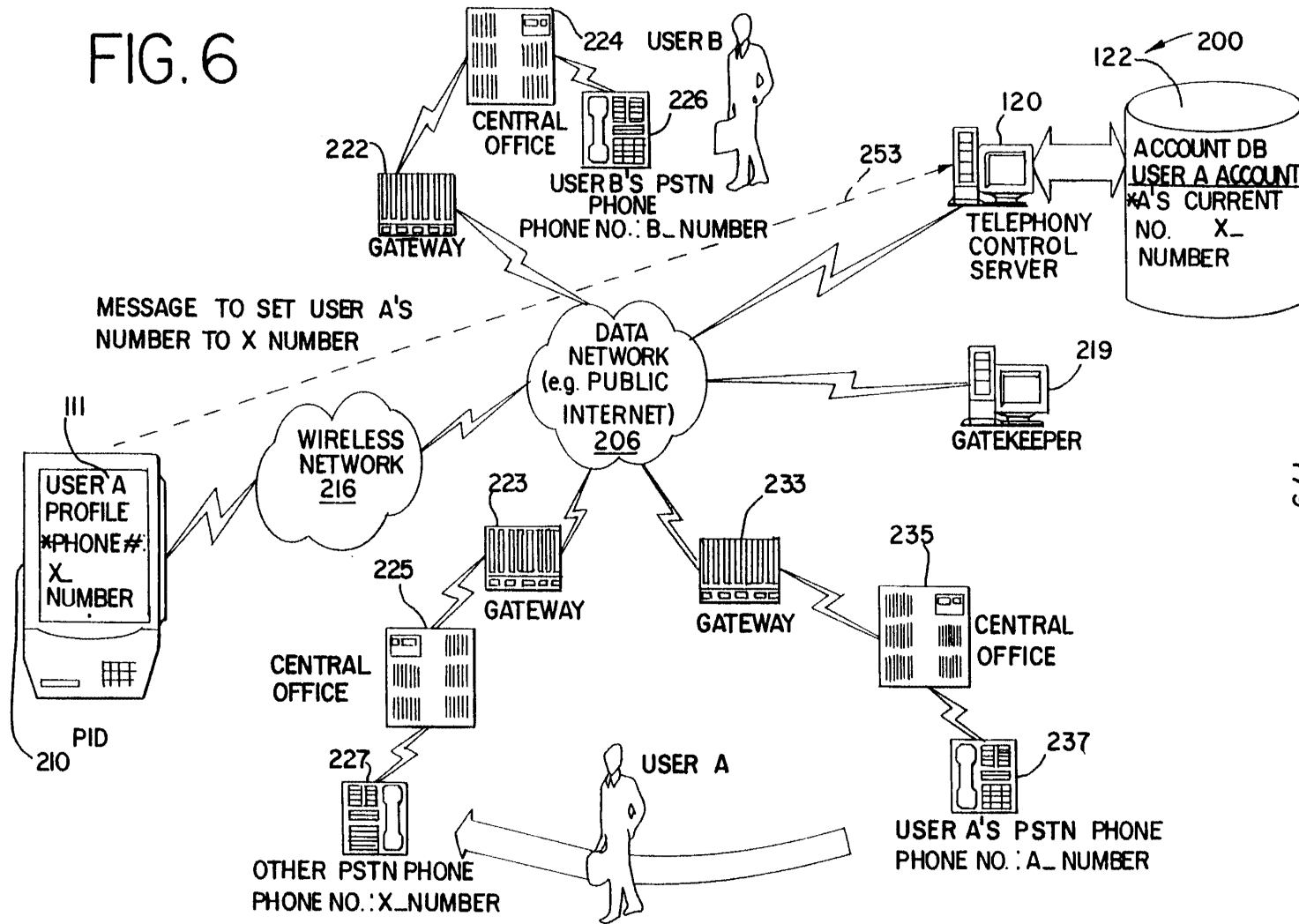

SUBSTITUTE SHEET (RULE 26)

7/9

W/O 01/24501

PCT/US00/26618

FIG. 7

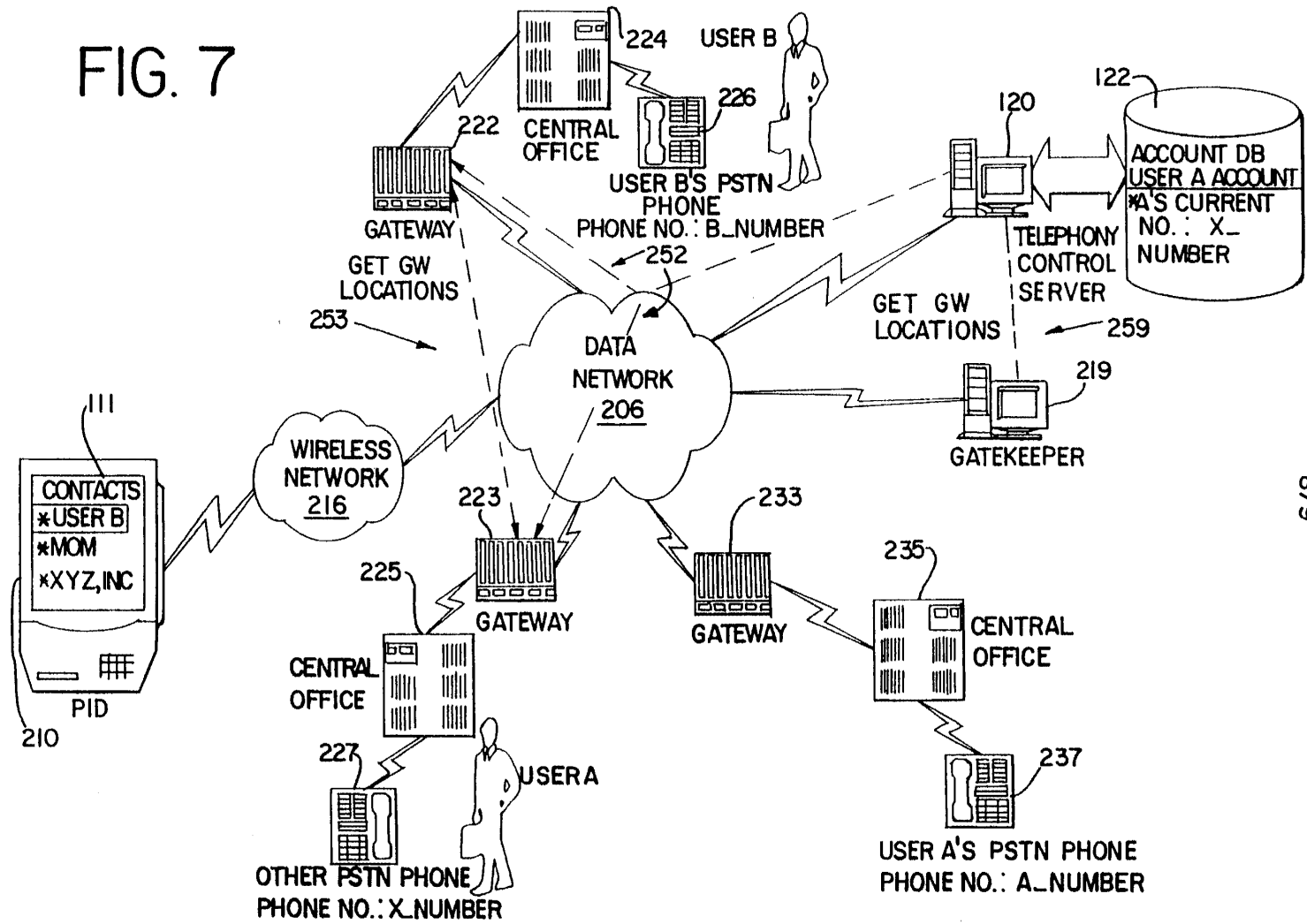

SUBSTITUTE SHEET (RULE 26)

8/9

WO 01/24501

PCT/US00/26618

FIG. 8

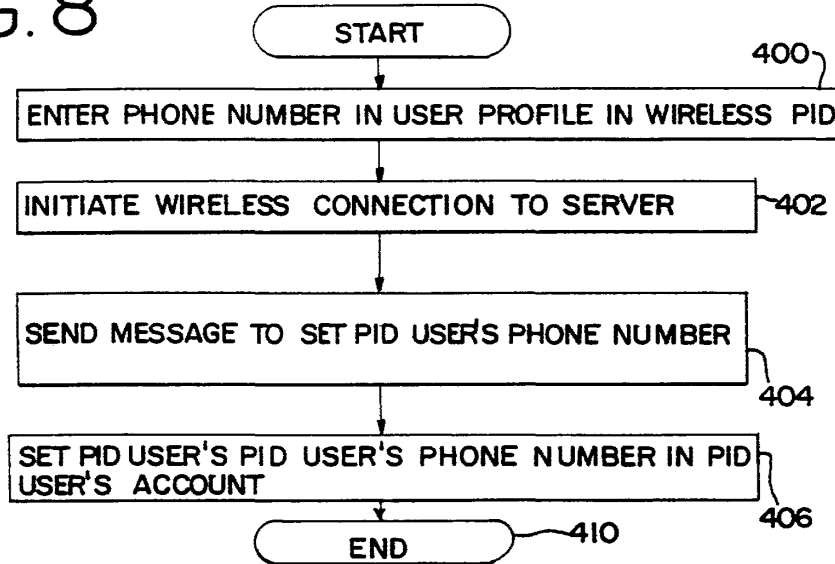
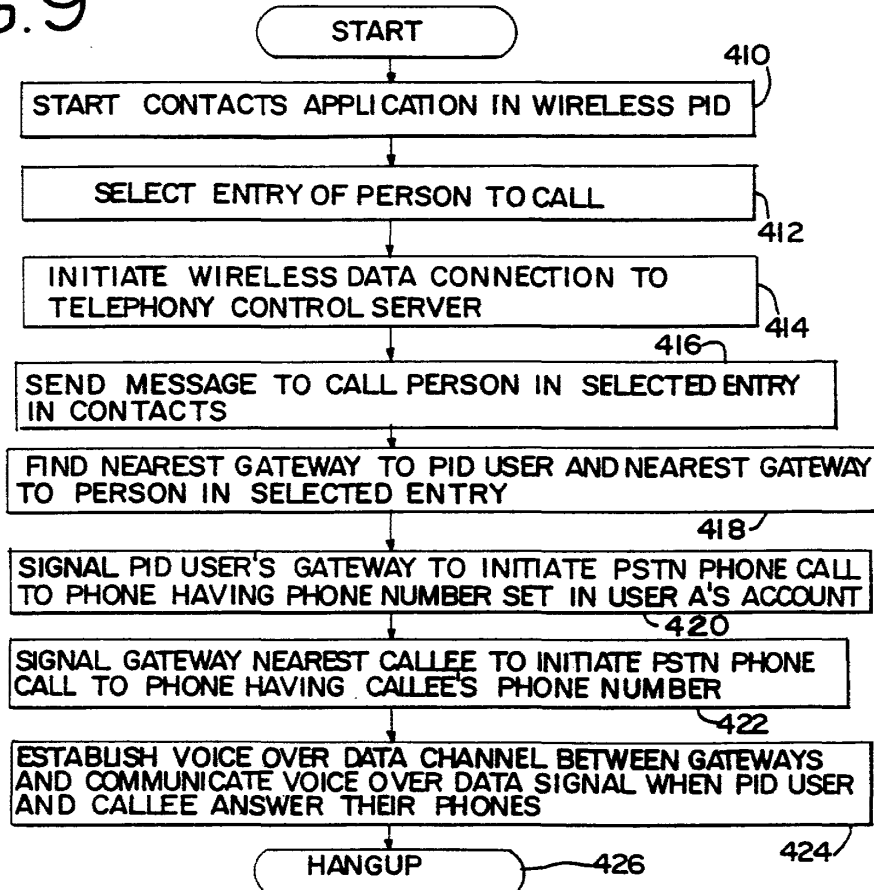

FIG. 9



INTERNATIONAL SEARCH REPORT

Int. Application No
PCT/US 00/26618

A. CLASSIFICATION OF SUBJECT MATTER IPC 7 H04M7/00 H04M3/42				
According to International Patent Classification (IPC) or to both national classification and IPC				
B. FIELDS SEARCHED				
Minimum documentation searched (classification system followed by classification symbols) IPC 7 H04M				
Documentation searched other than minimum documentation to the extent that such documents are included in the fields searched				
Electronic data base consulted during the international search (name of data base and, where practical, search terms used) EPO-Internal, WPI Data, PAJ, INSPEC, COMPENDEX, IBM-TDB				
C. DOCUMENTS CONSIDERED TO BE RELEVANT				
Category °	Citation of document, with indication, where appropriate, of the relevant passages	Relevant to claim No.		
X	WO 99 12365 A (WINROTH MATS OLOF ;HYLLANDER KLAS (SE); TELIA AB (SE)) 11 March 1999 (1999-03-11) page 11, line 31 -page 18, line 22 ---	1-7		
A	PEPPER D J ET AL: "The CallManager system: A platform for intelligent telecommunications services" SPEECH COMMUNICATION,NL,ELSEVIER SCIENCE PUBLISHERS, AMSTERDAM, vol. 23, no. 1-2, 1 October 1997 (1997-10-01), pages 129-139, XP004117214 ISSN: 0167-6393 the whole document --- -/--	1-7		
<input checked="" type="checkbox"/> Further documents are listed in the continuation of box C.				
<input checked="" type="checkbox"/> Patent family members are listed in annex.				
° Special categories of cited documents :				
<table style="width: 100%; border: none;"> <tr> <td style="width: 50%; border: none; vertical-align: top;"> *A* document defining the general state of the art which is not considered to be of particular relevance *E* earlier document but published on or after the international filing date *L* document which may throw doubts on priority claim(s) or which is cited to establish the publication date of another citation or other special reason (as specified) *O* document referring to an oral disclosure, use, exhibition or other means *P* document published prior to the international filing date but later than the priority date claimed </td> <td style="width: 50%; border: none; vertical-align: top;"> *T* later document published after the international filing date or priority date and not in conflict with the application but cited to understand the principle or theory underlying the invention *X* document of particular relevance; the claimed invention cannot be considered novel or cannot be considered to involve an inventive step when the document is taken alone *Y* document of particular relevance; the claimed invention cannot be considered to involve an inventive step when the document is combined with one or more other such documents, such combination being obvious to a person skilled in the art. *&* document member of the same patent family </td> </tr> </table>			*A* document defining the general state of the art which is not considered to be of particular relevance *E* earlier document but published on or after the international filing date *L* document which may throw doubts on priority claim(s) or which is cited to establish the publication date of another citation or other special reason (as specified) *O* document referring to an oral disclosure, use, exhibition or other means *P* document published prior to the international filing date but later than the priority date claimed	*T* later document published after the international filing date or priority date and not in conflict with the application but cited to understand the principle or theory underlying the invention *X* document of particular relevance; the claimed invention cannot be considered novel or cannot be considered to involve an inventive step when the document is taken alone *Y* document of particular relevance; the claimed invention cannot be considered to involve an inventive step when the document is combined with one or more other such documents, such combination being obvious to a person skilled in the art. *&* document member of the same patent family
A document defining the general state of the art which is not considered to be of particular relevance *E* earlier document but published on or after the international filing date *L* document which may throw doubts on priority claim(s) or which is cited to establish the publication date of another citation or other special reason (as specified) *O* document referring to an oral disclosure, use, exhibition or other means *P* document published prior to the international filing date but later than the priority date claimed	*T* later document published after the international filing date or priority date and not in conflict with the application but cited to understand the principle or theory underlying the invention *X* document of particular relevance; the claimed invention cannot be considered novel or cannot be considered to involve an inventive step when the document is taken alone *Y* document of particular relevance; the claimed invention cannot be considered to involve an inventive step when the document is combined with one or more other such documents, such combination being obvious to a person skilled in the art. *&* document member of the same patent family			
Date of the actual completion of the international search	Date of mailing of the international search report			
7 February 2001	19/02/2001			
Name and mailing address of the ISA	Authorized officer			
European Patent Office, P.B. 5818 Patentlaan 2 NL - 2280 HV Rijswijk Tel. (+31-70) 340-2040, Tx. 31 651 epo nl, Fax: (+31-70) 340-3016	Megalou, M			

1

INTERNATIONAL SEARCH REPORT

In. :tional Application No
PCT/US 00/26618

C.(Continuation) DOCUMENTS CONSIDERED TO BE RELEVANT		
Category °	Citation of document, with indication, where appropriate, of the relevant passages	Relevant to claim No.
A	DALGIC I ET AL: "TRUE NUMBER PORTABILITY AND ADVANCED CALL SCREENING IN A SIP-BASED IP TELEPHONY SYSTEM" IEEE COMMUNICATIONS MAGAZINE, IEEE SERVICE CENTER. PISCATAWAY, N.J, US, vol. 37, no. 7, July 1999 (1999-07), pages 96-101, XP000835310 ISSN: 0163-6804 the whole document -----	1-7
A	US 5 894 595 A (FOLADARE MARK JEFFREY ET AL) 13 April 1999 (1999-04-13) abstract -----	
A	WO 97 33421 A (BELL COMMUNICATIONS RES) 12 September 1997 (1997-09-12) page 23, line 12 -page 32, line 2 -----	

INTERNATIONAL SEARCH REPORT

Information on patent family members

International Application No PCT/US 00/26618

Patent document cited in search report	Publication date	Patent family member(s)	Publication date
WO 9912365 A	11-03-1999	SE 509926 C EP 1008266 A NO 20000902 A SE 9703121 A	22-03-1999 14-06-2000 27-04-2000 01-03-1999

US 5894595 A	13-04-1999	CN 1128477 A EP 0696152 A JP 8065749 A	07-08-1996 07-02-1996 08-03-1996

WO 9733421 A	12-09-1997	AU 706931 B AU 5184896 A	01-07-1999 22-09-1997

Form PCT/ISA/210 (patent family annex) (July 1992)

(19) World Intellectual Property Organization
International Bureau



(43) International Publication Date
5 April 2001 (05.04.2001)

PCT

(10) International Publication Number
WO 01/24502 A1

- (51) International Patent Classification⁷: H04M 7/00
- (21) International Application Number: PCT/US00/26649
- (22) International Filing Date:
27 September 2000 (27.09.2000)
- (25) Filing Language: English
- (26) Publication Language: English
- (30) Priority Data:
09/406,066 27 September 1999 (27.09.1999) US
- (63) Related by continuation (CON) or continuation-in-part (CIP) to earlier application:
US 09/406,066 (CON)
Filed on 27 September 1999 (27.09.1999)
- (71) Applicant (for all designated States except US): 3COM CORPORATION [US/US]; 3800 Golf read, Rolling Meadows, IL 60008 (US).
- (72) Inventors; and
(75) Inventors/Applicants (for US only): SCHUSTER, Guido, M. [CH/US]; Apartment 408, 1433 Perry Street, Des Plaines, IL 60016 (US). DEAN, Frederick, D. [US/US]; 2311 N. Greenview Avenue, Chicago, IL 60614 (US). SIDHU, Ikhlqa, S. [US/US]; 403 River Grove Lane, Vernon Hills, IL 60061 (US). MAHLER, Jerry, J. [US/US]; 20 Country Club Drive #B, Prospect Heights, IL 60070 (US). SIDHU, Sagan, S. [US/US]; 403 River Grove Lane, Vernon Hills, IL 60061 (US).
- (74) Agent: PEREZ, Enrique; McDonnell Boehnen Hulbert & Berghoff, 300 South Wacker Drive, 32nd floor, Chicago, IL 60606 (US).
- (81) Designated States (national): AE, AG, AL, AM, AT, AU, AZ, BA, BB, BG, BR, BY, BZ, CA, CH, CN, CR, CU, CZ, DE, DK, DM, DZ, EE, ES, FI, GB, GD, GE, GH, GM, HR, HU, ID, IL, IN, IS, JP, KE, KG, KP, KR, KZ, LC, LK, LR, LS, LT, LU, LV, MA, MD, MG, MK, MN, MW, MX, MZ, NO, NZ, PL, PT, RO, RU, SD, SE, SG, SI, SK, SL, TJ, TM, TR, TT, TZ, UA, UG, US, UZ, VN, YU, ZA, ZW.

[Continued on next page]

(54) Title: SYSTEM AND METHOD FOR SERVICE PROVIDER CONFIGURATION OF TELEPHONES IN A DATA NETWORK TELEPHONY SYSTEM

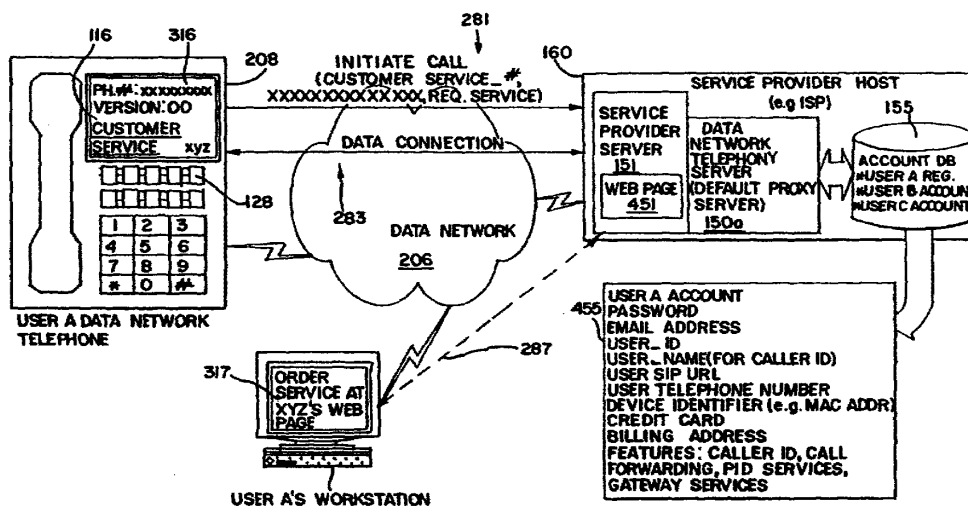

(57) Abstract: A system and method for providing service provider configured telephone service to a user of a data network telephone. The user connects a data network telephone to the data network. The data network telephone sends a request to register for service with a telephone connection server. The request includes a version identifier identifying the configuration version as having a particular set of functions and features for the data network telephone. The telephone connection server determines whether the version of the configuration is up to date. If it is not it may replace the configuration of the data network telephone. The telephony connection server may also query the user as to whether or not to update the configuration.



WO 01/24502 A1



(84) Designated States (regional): ARIPO patent (GH, GM, KE, LS, MW, MZ, SD, SL, SZ, TZ, UG, ZW), Eurasian patent (AM, AZ, BY, KG, KZ, MD, RU, TJ, TM), European patent (AT, BE, CH, CY, DE, DK, ES, FI, FR, GB, GR, IE, IT, LU, MC, NL, PT, SE), OAPI patent (BF, BJ, CF, CG, CI, CM, GA, GN, GW, ML, MR, NE, SN, TD, TG).

— *Before the expiration of the time limit for amending the claims and to be republished in the event of receipt of amendments.*

Published:

— *With international search report.*

For two-letter codes and other abbreviations, refer to the "Guidance Notes on Codes and Abbreviations" appearing at the beginning of each regular issue of the PCT Gazette.

**SYSTEM AND METHOD FOR SERVICE PROVIDER CONFIGURATION OF
TELEPHONES IN A DATA NETWORK TELEPHONY SYSTEM****BACKGROUND OF THE INVENTION****A. Field of the Invention**

The present invention is related to field of telecommunications, and more particularly to a system and method for providing communication services over a network. .

B. Description of the Related Art and Advantages of the Present Invention

For many years, telephone service providers on the Public Switched Telephone Network (PSTN) provided their customers nothing more than a telephone line to use to communicate with other subscribers. Over time, telephone service providers have enhanced their service by providing Custom Local Area Signaling Service (CLASS) features to their customers. Similar communication services are provided by a Private Branch Exchange (PBX), which is typically implemented in a nonresidential setting.

The CLASS features permit customer subscribers of the features to tailor their telephone service according to individual needs. Some of the well known CLASS features are:

- Call blocking: The customer may specify one or more numbers from which he or she does not want to receive calls. A blocked caller will hear a rejection message, while the callee will not receive any indication of the call.
- Call return: Returns a call to the most recent caller. If the most recent caller is busy, the returned call may be queued until it can be completed.
- Call trace: Allows a customer to trigger a trace of the number of the most recent caller.
- Caller ID: The caller's number is automatically displayed during the silence period after the first ring. This feature requires the customer's line to be equipped with a device to read and display the out-of-band signal containing the number.
- Caller ID blocking: Allows a caller to block the display of their number in a callee's caller ID device.

- Priority ringing: Allows a customer to specify a list of numbers for which, when the customer is called by one of the numbers, the customer will hear a distinctive ring.
- Call forwarding: A customer may cause incoming calls to be automatically forwarded to another number for a period of time.

A customer subscriber to a CLASS feature may typically activate and/or deactivate a CLASS feature using "*" directives (e.g., *69 to automatically return a call to the most recent caller). CLASS features may also be implemented with the use of out-of-band data. CLASS feature data is typically transmitted between local Class-5 switches using the Signaling System 7 (SS7).

Local Exchange Carriers (LECs) and other similar organizations maintain CLASS offices that typically contain a database entry for each customer. The database allows specification of the CLASS features a customer has subscribed to, as well as information, such as lists of phone numbers, associated with those features. In some cases, customers may edit these lists on-line via a touch-tone interface. A list of all phone numbers that have originated or terminated a call with each customer is often included in the CLASS office database. For each customer, usually only the most recent number on this list is stored by the local Class-5 switch.

A Private Branch Exchange (PBX), is a stored program switch similar to a Class-5 switch. It is usually used within a medium-to-large-sized business for employee telephony service. Since a PBX is typically operated by a single private organization, there exists a wide variety of PBX services and features. Custom configurations are common, such as integration with intercom and voice mail systems. PBX's typically support their own versions of the CLASS features, as well as other features in addition to those of CLASS. Most PBX features are designed to facilitate business and group communications.

A summary of typical PBX features includes:

- Call transfer: An established call may be transferred from one number to another number on the same PBX.
- Call forwarding: In addition to CLASS call forwarding, a PBX number can be programmed to automatically transfer a call to another number when the first number does not answer or is busy.

- Camp-on queuing: Similar to PSTN call return, a call to a busy number can be queued until the callee can accept it. The caller can hang up their phone and the PBX will ring them when the callee answers.
- Conference calling: Two or more parties can be connected to one another by dialing into a conference bridge number.
- Call parking: An established call at one number can be put on hold and then reestablished from another number. This is useful when call transfer is not warranted.
- Executive override: A privileged individual can break into an established call. After a warning tone to the two participants, the call becomes a three-way call.

While the CLASS and PBX features have enhanced the offerings of service providers that use the PSTN, the features are nevertheless limited in their flexibility and scope. The effect to the user is that the features become clumsy and difficult to use. For example, in order to use the Call Forwarding function, the user must perform the steps at the user's own phone prior to moving to the location of the telephone to which calls will be forwarded. A more desirable approach, from the standpoint of usefulness to the user, would be to perform the steps at the telephone to which calls will be forwarded.

Much of the lack of flexibility of the PSTN features is due to the lack of flexibility in the PSTN system itself. One problem with the PSTN is that the terminal devices (e.g. telephones) lack intelligence and operate as "dumb" terminals on a network having the intelligence in central offices. Most PSTN telephones are limited in functional capability to converting the analog signals they receive to sound and converting the sound from the handset to analog signals.

Some PSTN telephones have a display device and a display function to display specific information communicated from intelligent agents in the PSTN network using the PSTN signaling architecture. For example, some PSTN telephones have a display function to enable the Caller ID feature. Even such PSTN telephones are limited however by the closed PSTN signaling architecture, which prohibits access by the PSTN telephones to the network signaling protocols. The display functions are effectively limited to displaying text, again, as a "dumb" terminal.

The Internet presents a possible solution for distributing intelligence to telephony terminal devices. In Internet telephony, digitized voice is treated as data

and transmitted across a digital data network between a telephone calls' participants. One form of Internet telephony uses a telephony gateway/terminal where IP telephony calls are terminated on the network. PSTN telephones are connected by a subscriber line to the gateway/terminal at the local exchange, or at the nearest central office. This form of Internet telephony provides substantial cost savings for users. Because the PSTN portion used in Internet telephony calls is limited to the local lines on each end of the call, long distance calls may be made for essentially the cost of a local call. Notwithstanding the costs savings provided by this form of Internet telephony, it is no more flexible than the PSTN with respect to providing enhancements and features to the basic telephone service.

In another form of Internet telephony, telephones are connected to access networks that access the Internet using a router. The telephones in this form of Internet telephony may be substantially more intelligent than typical PSTN telephones. For example, such a telephone may include substantially the computer resources of a typical personal computer.

It would be desirable to incorporate CLASS and PBX features into a data network telephony system that uses a data network such as the Internet.

It would be desirable to provide new features and enhancements to telephony service that accommodates and conforms to users' needs.

It would also be desirable to provide features and capabilities to telephone service that create new opportunities for users and for service providers.

The present invention addresses the above needs by providing a system in a data network telephony system, such as for example, the Internet, that provides a way for users to make brand new telephones usable without having to wait for days while the telephone company programs an account. The embodiments of the present invention may also be used to modify existing telephone accounts to incorporate new features, or features that may be desired for a limited amount of time. Alternative embodiments are provided, some of which address systems and methods that are simple and some of which address systems and methods that are completely user configurable.

BRIEF DESCRIPTION OF THE DRAWINGS

Presently preferred embodiments of the invention are described below in conjunction with the appended drawing figures, wherein like reference numerals refer to like elements in the various figures, and wherein:

FIG. 1 is block diagram of a data network telephony system for providing telephony and enhanced telephony services in accordance with embodiments of the present invention;

FIG. 2A shows one embodiment of the system of FIG. 1 showing examples of access to data network telephony service providers;

FIG. 2B shows one example of one of the data network telephones in FIG. 2A;

FIG. 3A is a block diagram showing the interaction between components in accordance with one example of a system and method for configuring a data network telephone for service in the data network telephony system in FIG. 2A;

FIG. 3B is a block diagram showing one example of the interaction between components in the embodiment shown in FIG. 4A to update the data network telephone version;

FIG. 3C is a block diagram showing one example of the interaction between components in the embodiment shown in FIG. 4A when registration is complete;

FIG. 4A is a block diagram showing one example of the interaction between components in the embodiment shown in FIG. 4A to provision the data network telephone version with a voice account;

FIG. 4B is a depiction of a sample screen for ordering telephone service for the data network telephone of FIG. 5A;

FIG. 4C is a block diagram showing the interaction between components in the embodiment shown in FIG. 4A to confirm service;

FIG. 4D is a depiction of a sample screen for confirming telephone service for the data network telephone of FIG. 5A;

FIG. 5 is a block diagram showing the interaction between components in accordance with an example of a system and method for communicating by data network telephone in the data network telephony system in FIG. 2A;

FIG. 6 is a flowchart showing an example of a method for registering a data network telephone using the data network telephony system of FIG. 1;

FIG. 7 is a flowchart showing an example of a method for provisioning a data network telephone in the data network telephony system of FIG. 1; and

FIG. 8 is a flowchart showing an example of confirming the telephony service ordered using the method described in FIG. 7.

DETAILED DESCRIPTION OF THE PREFERRED EMBODIMENT

The following references to patent applications filed concurrently herewith are incorporated by reference:

- * “System and Method for Controlling Telephone Service Using a Wireless Personal Information Device” to Schuster, et al.
- * “System and Method for Advertising Using Data Network Telephone Connections” to Schuster, et al.
- * “System and Method for Providing User-Configured Telephone Service in a Data Network Telephony System” to Sidhu, et al.
- * “System and Method for Accessing a Network Server Using a Portable Information Device Through a Network Based Telecommunication System” to Schuster, et al.
- * “System and Method for Interconnecting Portable Information Devices Through a Network Based Telecommunication System” to Schuster, et al.
- * “System and Method for Enabling Encryption on a Telephony Network” to Schuster, et al.
- * “System and Method for Using a Portable Information Device to Establish a Conference Call on a Telephony Network” to Schuster, et al.
- * “System and Method for Associating Notes with a Portable Information Device on a Network Telephony Call” to Schuster, et al.
- * “System and Method for Providing Shared Workspace Services Over a Telephony Network” to Schuster, et al.

The following additional references are also incorporated by reference herein:

- * “Multiple ISP Support for Data Over Cable Networks” to Ali Akgun, et al.
- * “Method and System for Provisioning Network Addresses in a Data-Over-Cable System” to Ali Akgun, et al., Serial No. 09/218,793.
- * “Network Access Methods, Including Direct Wireless to Internet Access” to Yingchun Xu, et al., Serial No. 08/887,313

A. Data Network Telephony System

FIG. 1 is a block diagram showing an example of a system 100 for providing telephony services according to preferred embodiments of the present invention. The system includes a data network 106. A first voice communication device 108a communicates by a voice connection over the data network 106 by establishing the connection via first access network 112. The voice connection may be linked to a second voice communication device 108b which is accessed via a second access network 114.

The data network 106 in the system 100 typically includes one or more Local Area Networks (LANs) connected to one another or to a Wide-Area Network (WAN), such as an Internet Protocol (IP) network, to provide wide-scale data connectivity. The data network 106 may use Voice Over Packet (VOP) schemes in which voice signals are carried in data packets. The network 106 may also include a connection to the Public Switched Telephone Network (PSTN) to allow for voice connections using traditional circuit switching techniques. In one embodiment, the data network 106 may include one or more LANs such as Ethernet LANs and support data transport protocols for performing Voice-over-Internet-Protocol (VoIP) techniques on the Internet. For further details regarding VoIP, see the information available through the Internet Engineering Task Force (IETF) at www.ietf.org. In addition, an Internet Telephony gateway may be included within the system 100 to allow for voice connections to users connected by subscriber lines at a PSTN Central Office.

The first and second voice communication devices 108a and 108b typically include a voice input, a voice output and a voice processing system (described further below with reference to Figures 2B). The voice processing system converts voice sound from the voice input to digital data signals that are communicated on a voice connection over the data network. The voice processing system also converts digital data signals received from the voice connection to voice sound at the voice output. The voice communication devices 108a and 108b typically include a central processing unit and memory to store and process computer programs. Each voice communication device 108a and 108b typically includes a unique network address, such as an IP address, in memory to uniquely identify it to data network 106 and permit data packets to be routed to the device.

A first personal information device (PID) 110a may be connected to the first voice communication device 108a and may communicate over the data network 106 by connecting via the access network 112. The PID 110a may communicate with a second PID 110b connected to the second voice communications device 108b. Connections by the PIDs 110a,b may be made using the IrDA protocol or the Bluetooth system. Point to point links may include an RS232 port.

The PIDs 110a,b each contain user attributes stored in a user information database. The user attributes may contain such information as a user identifier, schedule information, and other information that is associated with a user of the PIDs 110a,b. The PIDs 110a,b each include a user interface allowing a user to easily enter and retrieve data. In a preferred embodiment, the user interface includes a pressure-sensitive display that allows a user to enter input with a stylus or other device. An example of a PID with such an interface is a PDA (Personal Digital Assistant), such as one of the Palm™ series of PDAs offered by 3Com Corporation. The PIDs 110a,b may include other functionality, such as wireless phone or two way radio functionality.

In one embodiment, the voice communication device 108a includes a handset with a receiver and transmitter similar or identical to handsets of traditional circuit-switched telephones. A console on which the handset sits may include the voice processing system, a display 116 and a keypad 118. The voice communication device 108a may also include a speed dial key set 128 programmed, or assigned to initiate connections to other voice communication devices that may be connected to the data network 106. In a preferred embodiment, the keys on the speed dial key set 128 may be programmed remotely by a message carried on a voice connection using a selected data transport protocol.

One example of the voice communication device 108a in a preferred embodiment is the NBX 100™ communication system phones offered by 3Com® Corporation, that has been modified, as described herein, to perform speed dial programming. In alternative embodiments, the voice communication device 108a may include any device having voice communications capabilities. For example, a personal computer having a microphone input and speaker output may also be used as

the voice communication device 108a. Other configurations for the user interface are also intended to be within the scope of the present invention.

The details relating to operation of the voice communication devices 108a and 108b depend on the nature of the data network 106 and the nature of the access networks 112, 114 connecting the voice communication devices 108a and 108b to each other and/or to other network entities. The access networks 112, 114 typically include any high bandwidth network adapted for data communications, i.e. a network having greater than 64,000 bits-per-second (bps) bandwidth. The access networks 112, 114 may link to the voice communication device 108a using an Ethernet LAN, a token ring LAN, a coaxial cable links (e.g. CATV adapted for digital communication), a digital subscriber line (DSL), twisted pair cable, fiberoptic cable, an integrated services digital network (ISDN) link, and wireless links. In embodiments that may not require a bandwidth greater than 64,000 bps, the access networks 112, 114 may also include the PSTN and link the voice communications device 108a by an analog modem. Further details regarding specific implementations are described below, with reference to FIGs. 2A and 2B.

B. System For Providing Provisioning and Configuration Services for a Telephone Using A Data Network Telephony System

One advantage of the data network telephony system 100 in FIG. 1 is that a user may begin making telephone calls by connecting the data network telephone to the access network. Alternatively, another advantage of the system 100 is that the user may plug the data network telephone to the access network to receive rudimental service, but obtain access to fully personalized, user-configured service account as well as to user-selected telephony enhancements and features.

A service provider server 120, connected to the data network 106, maintains user service accounts and manages the transport of data communications channels between voice communications devices 108a, 108b. A service provider database 122 stores the user accounts and other subscription information. In accordance with preferred embodiments, the service provider server 120 provides voice communications devices 108a, 108b with rudimentary service sufficient to connect to a service provider. The service provider server 120 then sets up user interactive connections to allow a user to configure a telephony user account. The user account is

then activated substantially contemporaneously with the user interactive connection once the user submits the information. By substantially contemporaneously, it is meant that no substantial waiting period is needed before the user account may be used. In alternative embodiments, the service provider server 120 configures voice communications devices 108a, 108b with a full, ready-to-use configuration. The service provider host 120 also makes modifications to the user accounts easy and immediate in effect. A user may select features for temporary use. For example, a user may set up call forwarding to use while at a meeting for a week, and then disable it for other times.

1. Local Area Network As
An Exemplary Access
Network

FIG. 2A is a block diagram showing one example of the system 100 of FIG. 1 for providing customized communication services according to the present invention. The system 200 in FIG. 2A includes a local area network 212, connected to a data network 206 by a first router 228 and a cable network 214 connected to the data network 206 by a second router 238. Those of ordinary skill in the art will appreciate that, while the local area network 212 and the cable network 214 are shown in FIG. 2A as access networks, any other type of network may be used. For example, the local area network 212 and/or the cable network 214 may be replaced by ISDN, DSL, or any other high-speed data link.

The local area network 212 provides data connectivity to its members, such as a first data network telephone 208a, a second data network telephone 208b, a gateway 222 and a network telephony connection server 150a. The local area network 212 in FIG. 2A is an Ethernet LAN operating according to the IEEE 802.3 specification, which is incorporated by reference herein, however, any other type of local area network may be used. The local area network 212 uses the router 228 to provide the data network telephone 208a,b, the gateway 222 and the network telephony connection server 150a with access to the data network 206. For example, the router 228 may perform routing functions using protocol stacks that include the Internet Protocol and other protocols for communicating on the Internet.

The network telephony connection server 150a (hereinafter “telephony connection server”) provides telephony registration, location and call initiation

services for voice connections in which its members are a party. A user may register for telephony service with an administrator of the telephony connection server 150a and receive a user identifier and a telephone identifier. The user identifier and telephone identifier may be sequences of unique alphanumeric elements that callers use to direct voice connections to the user. The telephony connection server 150a registers users by storing user records in a data network telephony user database (hereinafter "user database") 152a in response to registration requests made by the user.

The call setup process and the user and telephone identifiers preferably conform to requirements defined in a call management protocol. The call management is used to permit a caller anywhere on the data network to connect to the user identified by the user identifier in a data network telephone call. A data network telephone call includes a call setup process and a voice exchange process. The call setup process includes steps and message exchanges that a caller and callee perform to establish the telephone call. The actual exchange of voice signals is performed by a data communications channel. The data communications channel incorporates other data transport and data formatting protocols, and preferably includes well-known data communications channels typically established over the Internet.

The call management protocol used in FIG. 2A is the Session Initiation Protocol (SIP), which is described in M. Handley et al., "SIP: Session Initiation Protocol," IETF RFC 2543, Mar. 1999, incorporated by reference herein, however, any other such protocol may be used. Other protocols include H.323, the Media Gateway Control Protocol (MGCP), etc.

The local area network 206 is connected to a gateway 222. The gateway 322 communicates with a PSTN central office 224, which provides PSTN service to a PSTN phone 226. The PSTN phone 226 is likely to be one of many PSTN phones serviced by the central office 224. Additional portions of a PSTN network have been omitted from FIG. 2A to improve clarity. The PSTN network is well known by those having skill in the art of telecommunications.

The telephony connection server 150a provides telephony service for mobile users. A user may be registered to use the first network telephone 208a (which is identified by its telephone identifier), but move to a location near the second data

network telephone 208b. The user may re-register as the user of the second data network telephone 208b. Calls that identify the user by the user's user identifier may reach the user at the second network telephone 208b.

2. The Data Network Telephones

The data network telephones 208a, b are Ethernet phones which are telephones that include an Ethernet communications interface for connection to an Ethernet port. The Ethernet phones in FIG. 2A support the Internet Protocol (IP), using an IP address that is either statically configured or obtained by access to a Dynamic Host Configuration Protocol (DHCP) server.

FIG. 2B is a block diagram showing the data network telephone 208a connected to the local area network 212 in FIG. 2A. The data network telephone 208 in FIG. 2B is connected to the network 212 by a network interface 210. The network interface 210 may, for example, be a network interface card, and may be in the form of an integrated circuit. A bus 248 may be used to connect the network interface 210 with a processor 240 and a memory 242. Also connected to the processor are user interface circuitry 261 and three alternative (and all optional) interfaces to the Personal Information Device (PID) 110 (shown in FIG. 1).

A first interface 248 includes an RS-232 serial connection and associated coupling hardware and mechanisms. The first alternative interface 248 may, for example, be a docking cradle for a PDA, in which information can be transferred between the PDA and the data network telephone 208. The second alternative interface comprises a first connection 254, such as an RS-232 connection, along with infrared circuitry 250 for converting signals into infrared output and for accepting infrared input. An infrared interface 252 may also be included within the second alternative interface. The third alternative interface comprises a first connection 256, such as an RS-232 connection, along with radio-frequency circuitry 258 for converting signals into radio frequency output and for accepting radio frequency input. A radio frequency interface 259 may also be included as part of the third alternative interface.

The three alternative interfaces described above are merely examples, and additional means for implementing the interface between the data network telephone

208 and the PID may also be used. Although three interfaces are shown in FIG. 2B, there may be only one such interface in the data network telephone 208. More than one interface may be included to improve flexibility and to provide redundancy in case of failure of an interface.

The user interface circuitry 261 includes hardware and software components that access the functions of the handset, display, keypad and speed dial keypad to provide user input and output resources for functions in the processor 240. The user interface circuitry includes a display interface 262, a keypad interface 264, a speed dial interface 266, an audio output interface 265 and an audio input interface 267.

The audio input interface 267 may receive voice signals from a microphone or other audio input device and converts the signals to digital information. The conversion preferably conforms to the G.711 ITU Standard. Further processing of the digital signal may be performed in the audio input interface 267, such as to provide compression (e.g. using G.723.1 standard) or to provide noise reduction, although such processing may also be performed in the processor 240. Alternatively, the audio input interface 267 may communicate an analog voice signal to the processor 240 for conversion to digital information.

The audio output interface 265 receives digital information representing voice from the processor 240 and converts the information to sound. In one embodiment, the speaker interface receives information in the form of G.711 although other processing such as decompression may be performed in the speaker interface 265. Alternatively, the processor 240 may convert digital information to analog voice signals and communicate the analog voice signals to the speaker interface 265.

The speed dial interface 266, the keypad interface 264 and the display interface 262 include well-known device interfaces and respective signal processing techniques. The speed dial interface 266 may include an interface to buttons on a keypad, or to display buttons that the user activates by pressing designated areas on the screen.

The user interface circuitry 261 may support other hardware and software interfaces. For example, a videophone implementation might also include a camera and monitor. The fixed communication device of the present invention is not limited to telephones or videophones – additional user interface types, for example, such as

the ones needed for computer games, are also contemplated as being within the scope of the present invention.

The processor 240 may consist of one or more smaller processing units, including, for example, a programmable digital signal processing engine. In the preferred embodiment, the processor is implemented as a single ASIC (Application Specific Integrated Circuit) to improve speed and to economize space. The processor 240 also includes operating system, application and communications software to perform the functions of the data network telephone 208. The operating system may be any suitable commercially available embedded or disk-based operating system, or any proprietary operating system.

The processor 240 includes a media engine 241 and a signaling stack 243 to perform the primary communications and applications functions of the data network telephone 208. The purpose of the signaling stack in an exemplary data network telephone 208 is to set up, manage, and tear down a call. During the setup phase, a user may use the keypad to enter a user identifier to call. The signaling stack 243 receives the user entry and formats a request message to send to the user identified by the user identifier to initiate a telephone call. The request message is sent to discover the location of the user identified by the user identifier, exchange communication parameters, such as the supported voice CODEC types, and establish the voice channel.

During the management phase, communication proceeds over the voice over data channel. Other parties may be invited to the call if needed or the existing CODEC can be changed. During the teardown phase, the call is terminated.

The signaling protocol used in the data network telephone 208 in FIG. 2B is the SIP protocol. In particular, the signaling stack implements a User Agent Client 244 and a User Agent Server 242, in accordance with the SIP protocol. Alternative signaling protocols, such as the ITU-T H.323 protocol and others, may also be used to implement the present invention.

Once the call is setup, the media engine 241 manages the communication over a data communications channel using a network transport protocol and the network interface 210. The media engine 241 sends and receives data packets having a data payload for carrying data and an indication of the type of data is being transported.

The media engine 241 in the data network telephones 208 may sample the voice signals from the audio input 267 (or receive voice samples from the audio input 267), encode the samples, and build data packets on the sending side. On the receiver side, in addition to performing the reverse operations, the media engine also typically manages a receiver buffer to compensate for network jitter.

The media engine 241 includes hardware and software components for performing speed dial functions 246, registration functions 147, voice-over-data functions 249, display data function 251 and keypad output functions 253. The media engine 241 processes data that is received from the network 212, and data that is to be sent over the network 241.

For data that is received from the network 212, the media engine 241 may determine from the type of data in the packet whether packets contain sampled voice signals or data for performing other functions. Packets containing sampled voice signals are processed by voice over data function 249. The voice over data function 249 preferably conforms to a protocol for formatting voice signals as digital data streams. While any suitable protocol may be used, the media (voice signal) is preferably transported via the Real Time Protocol (RTP), which itself is carried inside of User Datagram Protocol (UDP). RTP is described in H. Schulzrinne et al., "RTP: A Transport Protocol for Real-Time Applications," IETF RFC 1889, Jan. 1996, which is incorporated herein by reference. UDP is described in J. Postel, "User Datagram Protocol," IETF RFC 768, Aug. 1980, and IP is described in J. Postel, ed., "Internet Protocol," IETF RFC 791, Sept. 1981, both of which are incorporated by reference herein.

Packets containing data for use in registering the data network telephone 208 with a network telephony service are processed by the registration/provisioning function 247. By registering the data network telephone 208, a user may establish with the network telephony service provider that calls addressed to the user's user identifier may be connected to the data network telephone 208. Provisioning configures the data network telephone 208 with features and other user account information that relate to the service provider.

Registration may occur when the data network telephone 208 sends a request to register to a service provider host, which may occur during power up, if the data

network telephone 208 is connected to the network 212, or when the user connects the data network telephone 208 to the network 212. The registration/provisioning function 247 may automatically send the Register request when the network is sensed. The service provider host may respond by setting the user's user identifier to correspond to the telephone identifier of the data network telephone 208, and by acknowledging the request with a status message to the data network telephone 208. In one embodiment, the service provider host communicates a response message to the data network telephone that includes a service provider logo and/or a configuration program that programs selected features into the telephone. The selected features may include a speed dial assignment to a customer server, a help menu, a user-friendly display, etc.

Other features may be added to the registration/provisioning functions 247, or implemented as extensions to the registration functions 247. For example, the data network telephone 208 may be provisioned to provide selected network telephony features by establishing a data connection with a service provider, requesting the selected services, and receiving data that ensures that the services have been successfully provisioned. Such features may include, for example, caller identification, call forwarding, voice mail, unified voice/email, gateway services, PID-based applications, call conferencing, advertisement enable/disable, and any other service offered by the network telephony service provider to enhance the capabilities of the data network telephone 208. The requests for features may be made contemporaneously with setting up a new account (as described below with reference to FIGs. 3A-8). The features may also be requested to modify the service. Users need not be locked into any service plan or feature set. One advantage of such provisioning functions is that services may be ordered for temporary use in a manner that is convenient to the user.

Packets containing data that is to be displayed on the display device are processed by the display data function 251. The display data function 251 may be used for displaying, for example, the name(s) and user identifier(s) of the other party(-ies) to the call, the status of the telephone call, billing information, and other information. The display data function 251 may also provide access to the display interface 262 for the display of commercial messages sent from the commercial

message server 120 (shown in FIG. 2A). The display data function 251 may process image data and text data that may be contained in and of the messages.

Packets containing data that programs or assigns speed dial keys are processed by the speed dial function 246. A speed dial key may be programmed during registration with the user identifier of the service provider's customer service department, or to a provisioning service. When a message, or one or more packets, is received, the data in the commercial message is examined for speed dial programming data. The speed dial programming data may include a speed dial key selector to identify the speed dial key being programmed, and a user identifier used to initiate a telephone call when the selected speed dial key is pressed. The speed dial programming data may also include directions to be displayed on the display screen that inform the user that a selected speed dial key has been programmed. In addition, the speed dial programming data may include an icon for display on a touch sensitive screen that describes the user or service to be reached when the icon on the display is touched.

The speed dial programming data may also include an indication of whether the speed dial key is to be programmed permanently, or temporarily. Temporarily programmed keys may be programmed for the duration of the present call only, or for a selected time period. Permanently programmed speed dial keys are programmed until re-programmed later.

For data that is to be sent over the data network 212, the media engine 241 formats the data as data packets in accordance with a selected protocol. The selected protocol is preferably the protocol that is supported by the data network telephone that will receive the data for the particular type of data being transported.

The voice over data function 249 formats voice samples according to the protocol used by the receiving data network telephone. In one preferred embodiment, the voice over data function 249 formats voice samples as RTP packets. The registration function 247 and the keypad output function 253 may use RTP or other protocols to transport data that does not represent voice signals.

3. Cable Network As An Exemplary Access Network

Referring back to FIG. 2A, the system 200 includes a cable network 214 connected to the data network 206 by a router 238. The cable network 214 provides data network access to its members, which in FIG. 2A include a third data network telephone 218a, a fourth data network telephone 218b, a fifth data network telephone 218c, a workstation 218d, a second data network connection telephony server 150b and a network telephony connection database 152b. The users of the data network telephones 218a-c connected to the cable network 214 may communicate by telephone over the data network 206 with the users of the data network telephones 208a,b connected to the local area network 214.

The cable network 214 includes any digital cable television system that provides data connectivity. In the cable network 214, data is communicated by radio frequency in a high-frequency coaxial cable. The cable network 214 may include a head-end, or a central termination system that permits management of the cable connections to the users.

The cable network 214 includes high-frequency coaxial cable connections for terminating the members, such as the data network telephones 218a-c and the workstation 218d. The third, fourth and fifth data network telephones 218a-c are preferably similar to the data network telephone 208 described with reference to FIG. 2B. One difference is that the third, fourth and fifth data network telephones 218a-c access telephone service over the cable network 214, and the first and second data network telephones 208a,b access telephone service over the Ethernet.

C. Providing Telephone Services By A Data Network Telephony Service Provider

1. Telephony Service Provider

FIG. 2A shows a service provider host 160 having a service provider server 120 and a service provider database 122. The service provider server 120 registers data network telephones and performs user interactive connections with users to configure users' telephone accounts. The host 160 is connected to the data network 206, however, the host 160 may also be connected to either access network 212, 214.

The host 160 may also include network telephony connection servers, such as server 150a,b. The host 160 may also communicate with separately located local network telephony connection servers 150, 152 for billing purposes, or for carrying out the features selected by users. The host 160 may be managed by a telephony service provider or by any entity for a telephony service provider.

The telephony connection server 150b is preferably a SIP-based server that performs call initiation, maintenance and teardown for the data network telephones 218a-c connected to the cable network 214. The telephony connection server 150b may be similar or identical to the telephony connection server 150a connected to the local area network 212. The ISP host 160 includes the service provider server 120 and the service provider database 122.

The system 200 shown in FIG. 2A includes a data network telephony system that permits the data network telephones 208a, b connected to the local area network 212 to communicate with the data network telephones 214 connected to the cable network 214. The system shown in FIG. 2A uses SIP in order to establish, maintain and teardown sessions, or telephone calls between users.

There are two major architectural elements to SIP: the user agent (UA) and the network server. The UA resides at the SIP end stations, (e.g. the data network telephones), and contains two parts: a user agent client (UAC), which is responsible for issuing SIP requests, and a user agent server (UAS), which responds to such requests. There are three different network server types: a redirect server, a proxy server, and a registrar. The various network server types may be combined into a single server, such as the telephony connection server 150a,b. Not all server types are required to implement the embodiments of the present invention. The communication services to be provided will determine which servers are present in the communication system. Preferred embodiments of the present invention may be carried out using proxy servers.

One example of a SIP operation involves a SIP UAC issuing a request, a SIP proxy server acting as end-user location discovery agent, and a SIP UAS accepting the call. A successful SIP invitation consists of two requests: INVITE followed by ACK. The INVITE message contains a user identifier to identify the callee, a caller user identifier to identify the caller, and a session description that informs the called party

what type of media the caller can accept and where it wishes the media data to be sent. User identifiers in SIP requests are known as SIP addresses. SIP addresses are referred to as SIP Uniform Resource Locators (SIP-URLs), which are of the form sip:user@host.domain. Other addressing conventions may also be used.

Redirect servers process an INVITE message by sending back the SIP-URL where the callee is reachable. Proxy servers perform application layer routing of the SIP requests and responses. A proxy server can either be stateful or stateless. A stateful proxy holds information about the call during the entire time the call is up, while a stateless proxy processes a message without saving information contained in the message. Furthermore, proxies can either be forking or non-forking. A forking proxy can, for example, ring several phones at once until somebody takes the call. Registrar servers are used to record the SIP address (called a SIP URL) and the associated IP address. The most common use of a registrar server is for the UAC to notify the registrar where the UAC can be reached for a specified amount of time. When an INVITE request arrives for the SIP URL used in a REGISTER message, the proxy or redirect server forwards the request correctly.

At the local area network 212, the central registrar/proxy server, such as the network telephony server 150a is the primary destination of all SIP messages trying to establish a connection with users on the local area network 212. Preferably, the network telephony server 150a is also the only destination advertised to the SIP clients outside the LAN 212 on behalf of all the SIP clients residing on the LAN 212. The network telephony server 150a relays all SIP INVITE messages to the appropriate final destination (or another SIP proxy), based on a database lookup using the user database 152a. It allows all mobile clients to register with their current locations.

Similarly, the network telephony server 150b is the primary destination of all SIP messages trying to establish a connection with the data network telephones 218a-c connected to the cable network 214. Preferably, the network telephony server 150b is also the only destination advertised to the SIP clients outside the LAN 212 on behalf of all the SIP clients (e.g. data network telephones) residing on the LAN 212. The network telephony server 150b relays all SIP INVITE messages to the appropriate final destination (or another SIP proxy), based on a database lookup using the user database 152b.

2. Registration of the Telephone

The data network telephones 208a,b and 218a-c in the system 200 preferably have pre-programmed device identifiers (e.g. MAC addresses or phone numbers), represented as SIP-URL's that are of the form sip:8475551212@3com.com. After power-up, each data network telephones 208a,b and 218a-c sends a SIP REGISTER message to the default registrar, such as the network telephony servers 150a,b. When a call arrives at one of the network telephony servers 150a,b for any of the registered SIP URLs, the server will forward the call to the appropriate destination. If a data network telephone is moved to a new location, all calls to the associated SIP URL will still be properly routed to that device. In other words, the system in FIG. 2A provides device mobility in the sense that calls will "follow" the data network telephone according to its SIP URL. This is especially useful if the data network telephone 208a,b or 218a-c is running the DHCP (Dynamic Host Configuration Protocol) so that when the location is changed, the IP address is also automatically changed.

An advantage of the system in FIG. 2A is that the network telephony connection server 150a,b may respond to REGISTER messages (for SIP and similar messages in other protocols) with a message that configures the data network telephone 208a,b or 218a-c to have a variety of ready-to-use features. The service provider may configure the telephony connection server 150a,b to enforce a particular configuration for operation, or offer the user choices of features that comprise the configuration. A data network telephone may be configured to include features such as:

- User identifier: a sequence of alphanumeric elements that uniquely identifies the user. The user identifier may be formatted as an E.164 telephone number, or as a name. The user identifier may be unique throughout the universe of users on the data network telephony system 200 (shown in FIG. 1), or it may acquire such uniqueness by association with a server identifier.
- Telephone Identifier: a sequence of alphanumeric elements that uniquely identifies the telephone. The telephone identifier may be formatted as an E.164 telephone number, or as a number, such as a MAC address. The telephone identifier may be unique throughout the universe of data network telephones on the data network telephony system 200, or it may acquire such uniqueness by association with a server identifier.
- The user's name, address and other information that may be used primarily for billing purposes. For example, the user's checking account number, credit card number or other financial information may be provided for automatic billing and payment capabilities.
- User's telephony service features. The user may subscribe, permanently or temporarily, to one or more telephony service features offered by the service provider:
 - ◆ Voice mail
 - ◆ Caller ID
 - ◆ Call Forwarding with true number portability
 - ◆ Teleconferencing
 - ◆ Commercial messaging – a service that may be made available in embodiments of the present invention. A user may subscribe to have the data network telephone 218 receive (or not to receive) advertisements for display on the display of the data network telephone 218.
- Commercial messaging with speed dial programming – a service that may be made available in embodiments of the present invention. A user may subscribe to have the data network telephone 218 receive (or not to receive) advertisements that program the speed dial keys of the data network telephone 218. The display of the service provider logo
 - Menu of functions
 - Help menu
 - Speed dial key programming (*e.g.* speed dial to customer service)
 - Features as standard offerings – to compete, a provider may offer features that normally cost extra (*e.g.* caller ID, etc.) as standard features
 - Packaged configurations – Features and offerings may be grouped as distinctly priced packages
 - Functions using PDA connectivity (*e.g.* Remote Whiteboard communication, control of telephone use through PDA)

TABLE A

FIG. 3A shows the data network telephone 208 for User A begin the registration process. User A's telephone 208 may be brand new, in which case, the process described with reference to FIGs. 3A-3D illustrates the ease with which the data network telephone 208 may be installed and used immediately. When User A connects the data network telephone 208 to the network 206 (NOTE: connection may be through an access network), the data network 208 uses its MAC address as an initial telephone identifier. The data network telephone 208 retrieves an IP address using a DHCP Discover message exchange, shown at 271, with a DHCP server 161.

The data network telephone 208 then sends a registration message as shown at 273. In a preferred embodiment, the registration message includes a temporary user identifier (xxxxxxxxxxxxxxx) and a version identifier that identifies the current version of the configuration of the telephone 208. FIG. 3B shows a sample registration request at 472 in a message flow diagram.

Referring back to FIG. 3A, the telephony connection server 150a may respond to the registration message at 273 with a response message as shown at 275. The message at 275 includes an auto-configuration command which forces the data network telephone 208 to implement a new configuration. The new configuration may be an update to the current version identified by the current version identifier. FIG. 3B shows a sample of the auto-configuration response at 474. In a preferred embodiment, the auto-configuration message is communicated in the message body of a SIP response message.

The response message at 275 in FIG. 3A may also comprise an exchange of messages using a data channel. FIG. 3B shows a first data channel message 480 having a query to the user in TCP transmitted as TCP/IP. It is to be understood that any other protocol may be used. The message may be formatted for display on the data network telephone 208, as voice over data in a voice mail session, or any other manner conforming to the user interface capabilities of the telephone 208. The user may respond by saying "Yes"/"No", selecting a menu item by touching the screen, pressing a yes/no button, or any other manner conforming to the user interface capabilities of the telephone 208.

The user's response is communicated in a second data channel 482 to the network telephony connection server 150a. If the response was a "Yes" such that the

user wants the configuration of the data network telephone 208 updated, the network telephony connection server 150a responds with the updated version at 484.

Referring to FIG. 3C, the data network telephone 208 is shown as having been registered. The data network telephone 208 is shown configured with a phone number (user identifier), a service provider logo (xyz) and a hotlink, or display button programmed to dial customer service at 116 for the service provider. The service provider host 160 may configure the data network telephone with a full set of features, such as from those listed above, to allow the user to make full use of the data network telephone 208.

In an alternative embodiment, the registration process leaves the data network telephone 208 with a rudimentary configuration barely able to make any telephone calls. For example, the process may leave the data network telephone 208 capable of making only one call, to customer service for a user controlled provisioning of the system. The user may also provision the telephone 208 using a connection to the service provider's web page.

As shown in FIG. 4A, the user at data network telephone 208 makes a call at 281 to the service provider server 120 with its user identifier (xxxxxxxxxxxxxx), and a command to request service provisioning. A provisioning function, in response to the telephone call at 281, establishes a data connection 283 to perform the transfer (which may be with voice over data signals) of information. The service provider server 120 may send a form, or present an order screen 316, at the telephone requesting information from the user. The user may also use a workstation and connect at 287 to a web page 451 at the service provider server 120 and enter the information at a web page order screen 317. The information requested in both the order screen 316 and the web page order screen 317 is illustrated in FIG. 4B. One of ordinary skill in the art will appreciate that the web page order screen 317 is illustrated as an example of the type of information requested during a provisioning session. More or less information may be requested.

Referring to FIG. 4C, when the user has entered the data requested in the order screen, the service provider server 120 leaves a ready display 416 at the data network telephone 208 indicative of the type of configuration provided by the provisioning process. The service provider server 120 may also leave a confirmatory message 417

on the workstation (or on the data network telephone, either on the display or by voice) indicating what happens next. FIG. 4D shows an example of such a confirmatory message. Once the user responds to the email, the data network telephone 208 is ready for use.

The service provider server 120 also builds and stores in the service provider database 122 a user account 455 for the user as shown in FIG. 4A.

3. A Telephone Call

FIG. 5 shows the interaction between the components in FIG. 2A in performing a telephone call. As shown in FIG. 5, a telephony service provider (e.g. ISP) provides telephone service using the host 160. The telephony service provider may also provide data connectivity services and other services relating to communication (e.g. advertising) on the data network 206. With User A and User B registered with network telephony connection servers 150a,b respectively, the telephony connection server 150b operates as a proxy server (e.g. as a SIP proxy server) for User B's data network telephone 218. When other users, such as User A, attempt to call User B, the call setup will be made through the telephony connection server 150b.

As shown in FIG. 5, User A initiates a telephone call from User A's data network telephone 208 to the data network telephone 218 belonging to User B. User A begins the telephone call by dialing User B's user identifier using the keypad 118 (or a PID, or a speed dial key, or using any other manner). The data network telephone 208 sends a request to initiate a call to User B at 280 to the data network telephony connection 150b providing service to User B. The request to initiate a call to User B at 280 includes User B's user identifier as the callee, User A's user identifier as the caller and the protocols supported by User A's data network telephone 208.

The telephony connection server 150b sends the request to the data network telephone 218 identified in the user database 152b as belonging to User B, preferably, in accordance with its role as a proxy server, and preferably as defined in the SIP protocol. The data network telephone 218 responds with a response message (not shown in FIG. 5) to the telephony connection server 150b. The telephony connection

server 150b receives the response message and sends the response message to User A's data network telephone 208 as shown at 282.

User A's data network telephone 208 receives the response message and may prepare an acknowledgement message if called for by the protocol (e.g. the SIP protocol).

User A's data network telephone 208 also establishes a voice over data channel 284 to permit communication between User A and User B. The voice over data channel 284 is preferably a data communications channel in which voice signals that have been converted to digital information are being carried as data messages in accordance with a selected protocol. The data messages include User B's message 286 and User A's messages 288 as shown in FIG. 5. User B's message 286 and User A's message 288 both include an IP protocol component, a UDP component, an RTP component and a G.72x component.

The IP protocol component permits routing of the messages 286, 288 in accordance with an Internet Protocol (e.g. Ipv4, IPV6, etc.). The UDP component permits transport as a User Datagram in a connection-less environment in accordance with the User Datagram Protocol (UDP). The RTP component is the chosen format for communicating the voice signals as data. The G.72x component indicates how the voice signals, once extracted from the RTP component are to be processed to produce audio. The G.72x indication represents that the voice signals may conform to ITU-T Recommendation G.721, ITU-T Recommendation G.722, ITU-T Recommendation G.723, ITU-T Recommendation G.723.1, ITU-T Recommendation G.728 or ITU-T Recommendation G.729. The voice signals may also conform to ITU-T Recommendation G.711 or to any other suitable protocol.

One of ordinary skill in the art will appreciate that the voice over data channel 284 may be implemented using different protocols than the ones shown in FIG. 5. Moreover, when the signaling protocol used to establish the telephone call permits negotiation of supported protocols as is done with the preferred SIP protocol, the voice over data channel 284 may be asymmetrical; that is, User A's messages 288 may be different from User B's messages 286.

The telephone call carried out over the voice over data channel 284 proceeds until one or both users terminate the call. During termination or teardown of the call,

the telephony connection server 150b performs in accordance with the selected session protocol such as the SIP protocol.

FIGs. 3A-5 show systems and methods for registering and auto-configuring a data network telephone 208 in accordance with embodiments of the present invention. Those of ordinary skill in the art will appreciate that the systems and methods described above are examples. Other embodiments may fall within the scope of the claims.

D. Methods For Providing Registration and Provisioning of a Data Network Telephone Using A Data Network Telephony System

FIGs. 6-8 illustrate methods for providing registration and provisioning for a data network telephone that may be performed using any suitable data network telephony system. FIG. 6 is a flowchart showing a method of configuring a data network telephone by registering for service with a service provider. As shown at step 500 in FIG. 6, a data network telephone starts by obtaining an IP address from a DHCP server. At step 502, a request to register message is sent to a service provider server. The service provider server may have a designated default proxy server to use, or may provide the appropriate server with a call management protocol and/or registration server. In the request to register message, the data network telephone includes a current version of the telephone configuration as shown at step 502. The version of the telephone configuration may include different combinations of the features listed above in Table A.

At step 506, the service provider server 120 (FIG. 1) checks the telephone version with the latest version available. An OR step 506 in the flowchart of FIG. 6 indicates that alternative steps may be taken. At step 507, the service provider server 120 may automatically re-configure the data network telephone. Alternatively, the service provider server may query the user to determine whether to upgrade to a new version at decision block 508. A yes response to the query leads to step 510 to re-configure the data network telephone.

One advantage of registering in the manner shown in FIG. 6 is that a full-function feature laden configuration of the data network telephone is possible using a register request.

FIG. 7 is a flowchart that shows a method for registering the data network telephone with partial or low-level service so that the user may provision the data network telephone as a completely personalized data network telephone. At step 600 in FIG. 7, the data network telephone requests an IP address from a DHCP server. The request to register is sent at step 602 to the default proxy server. At step 604, the user proceeds to a method for provisioning the data network telephone.

FIG. 8 shows a preferred method for provisioning the data network telephone. At step 700, the user connects to the service provider's web page for providing user account information. At step 702, the user enters billing information. At step 704, the user enters user-selectable user identifiers, passwords, email identifiers, etc. At step 706, the user selects features that the user would like to add, and at step 708, the account information is submitted. A confirmatory message and email is received at step 710. When the user responds to the email at step 712, the data network telephone may be used.

While the invention has been described in conjunction with presently preferred embodiments of the invention, persons of skill in the art will appreciate that variations may be made without departure from the scope and spirit of the invention. For example, the access networks shown in FIG. 2A may comprise any other suitable type of local area network or service infrastructure.

In addition, protocols of various types are referenced throughout. While preferred and alternative embodiments may implement selected protocols, any suitable replacement protocol not mentioned, or any function not part of a protocol used to replace a corresponding function from a protocol may be implemented without departing from the scope of the invention.

This true scope and spirit is defined by the appended claims, interpreted in light of the foregoing.

WE CLAIM:

1. A system for providing telephone service comprising:
 - a data network to provide data connectivity for a plurality of data communications channels using data transport protocols;
 - at least one data network telephone connected to the data network, the data network operable to communicate voice signals as data packets on a voice over data channel, the voice over data channel being one of the plurality of data communications channels on the data network containing packetized voice signals, the data network telephone being operable to convert data packets communicated on the voice over data channel to voice; and
 - a service provider server connected to the data network, the service provider server being operable to configure the data network telephone to perform voice communications functions and at least one enhanced telephony feature.
2. The system of Claim 1 wherein the service provider server includes a registration function to automatically configure the data network telephone with a first configuration.
3. The system of Claim 1 wherein the service provider server includes a registration function to query a user to determine whether to configure the data network telephone with a second configuration.
4. The system of Claim 1 wherein the service provider server includes a network telephony connection server operable to perform registration functions, the registration functions being operable to configure the data network telephone.
5. The system of Claim 4 wherein the network telephony connection server uses a call management protocol to perform registration functions.

6. The system of Claim 5 wherein the call management protocol is a protocol selected from the group consisting of: Session Initiation Protocol (SIP), H.323, MGCP and MEGACO.

7. A telephone for communicating voice signals on a data network telephony system, the telephone comprising:
 - a network interface to sense a network connection;
 - a signaling stack operable to perform call initiation functions;
 - a media engine operable to perform data communications functions, the media engine comprising a voice function operable to communicate digitized voice signals on data packets; and
 - a registration function to generate a request to register with a telephony connection server when the network connection is sensed.

8. The telephone of Claim 7 wherein the registration function receives a configuration from the telephony connection server.

9. The telephone of Claim 8 wherein:
 - the telephone includes a display device; wherein,
 - the configuration includes a service provider logo and the registration function displays the service provider logo on the display.

10. A method of providing service provider selected configurations of a data network telephone comprising the steps of:
 - detecting a request to register from the data network telephone, the request containing a current configuration version identifier;
 - comparing the current configuration version identifier with a service provider current configuration; and
 - if current configuration version identifier is not the service provider current configuration, determining whether to update the configuration of the data network telephone.

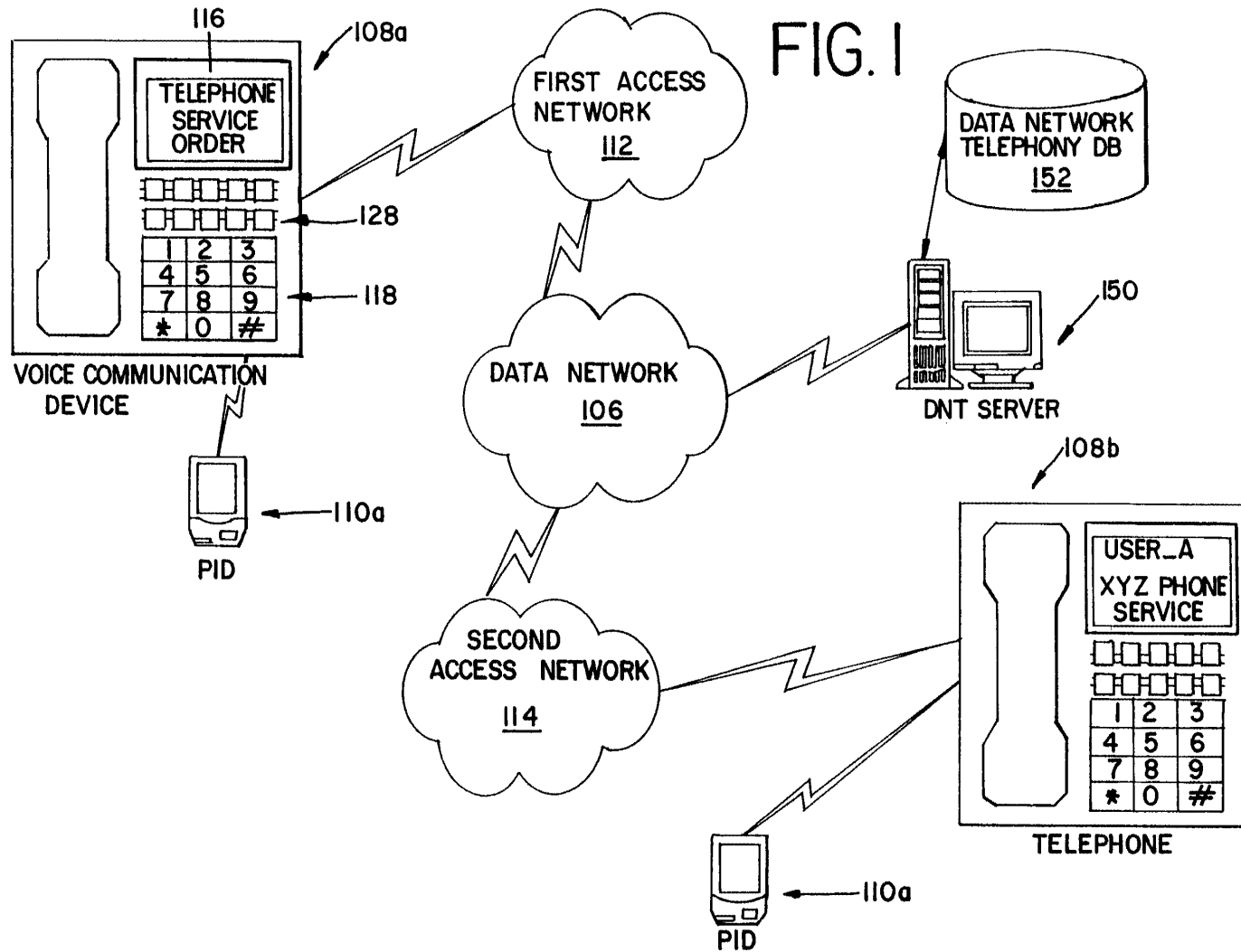
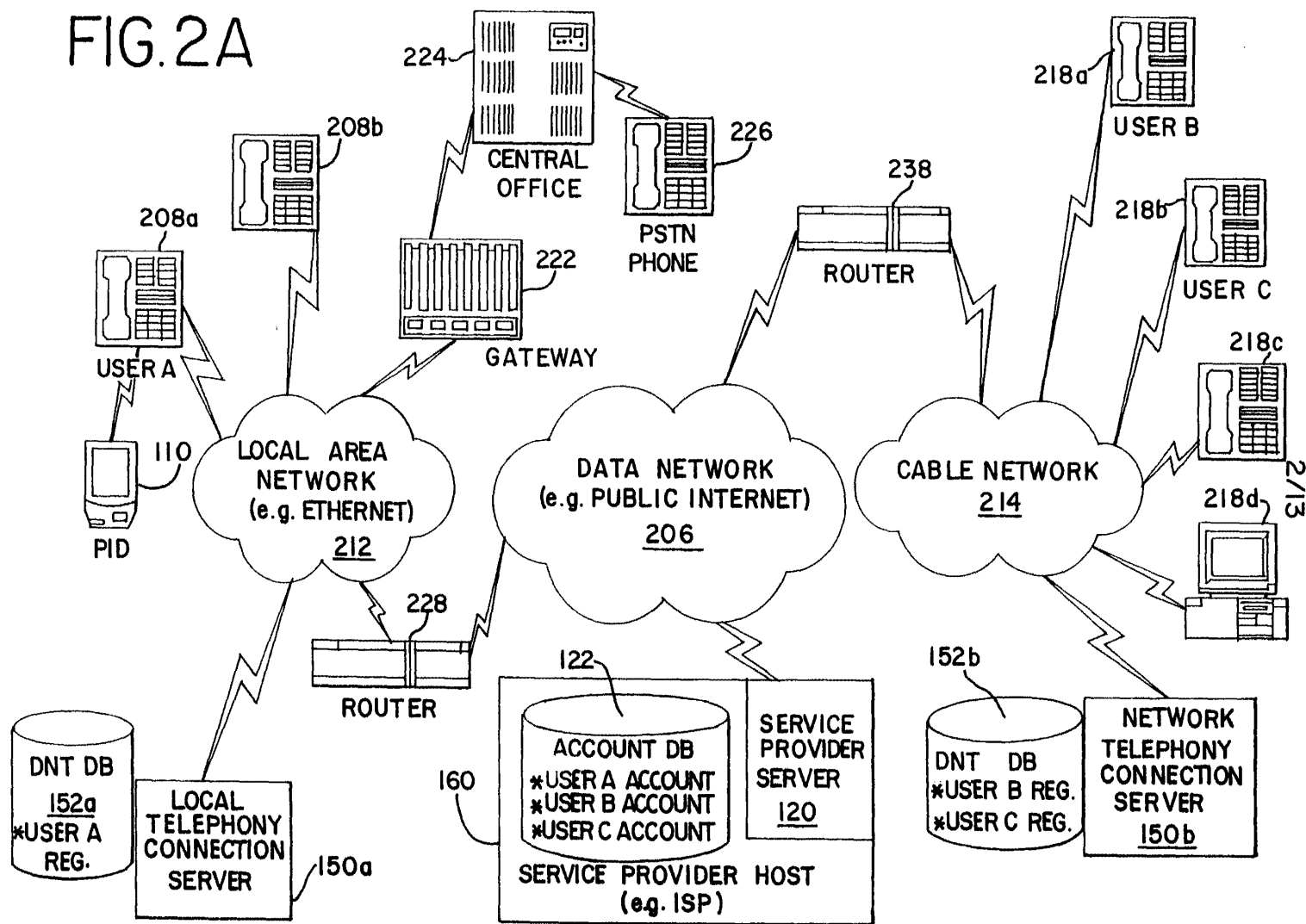

FIG. 1

FIG. 2A



SUBSTITUTE SHEET (RULE 26)

WO 01/24502

PCT/US00/26649

FIG. 2B

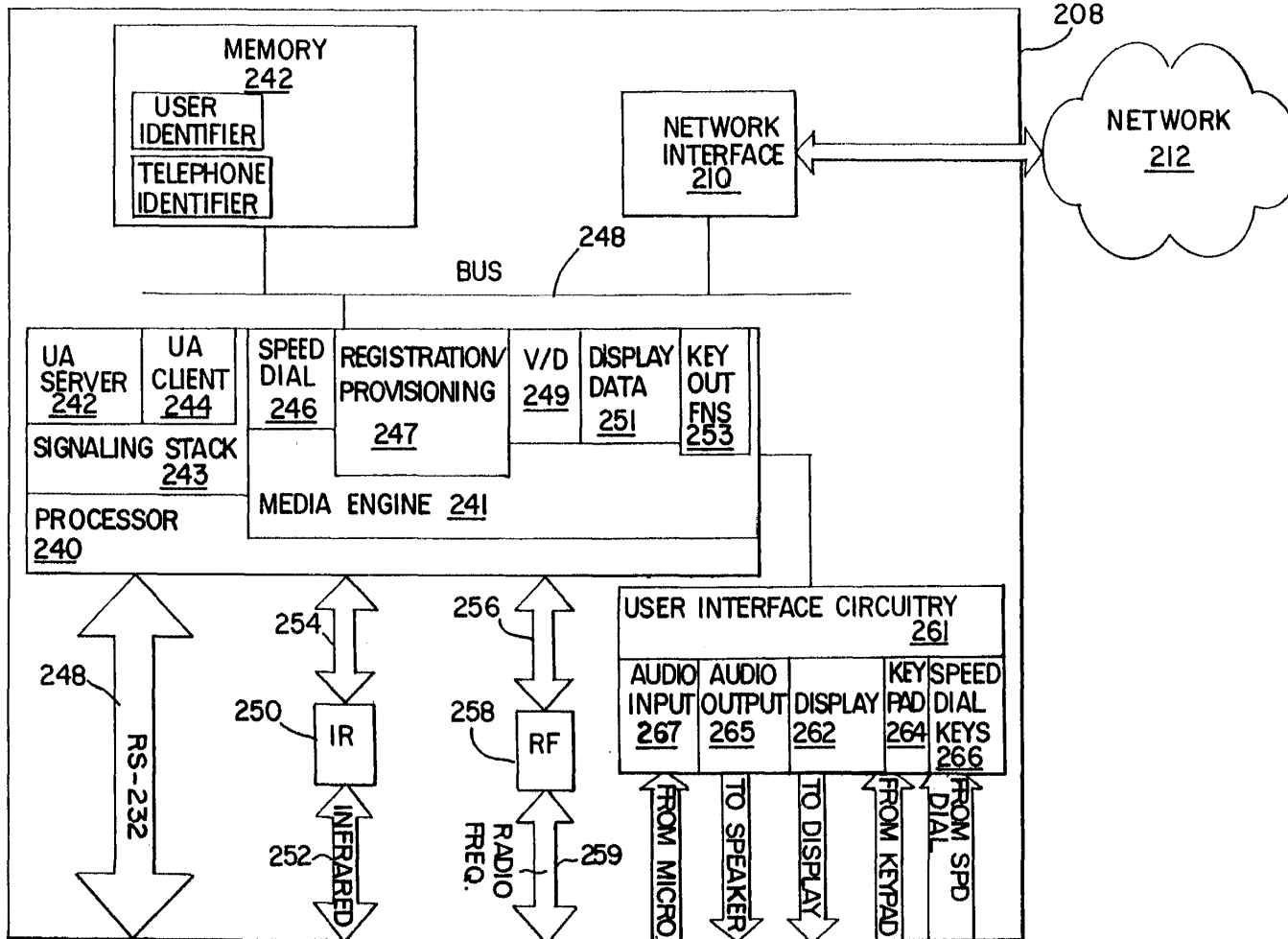

SUBSTITUTE SHEET (RULE 26)

3/13

WO 01/24502

PCT/US00/26649

FIG. 3A

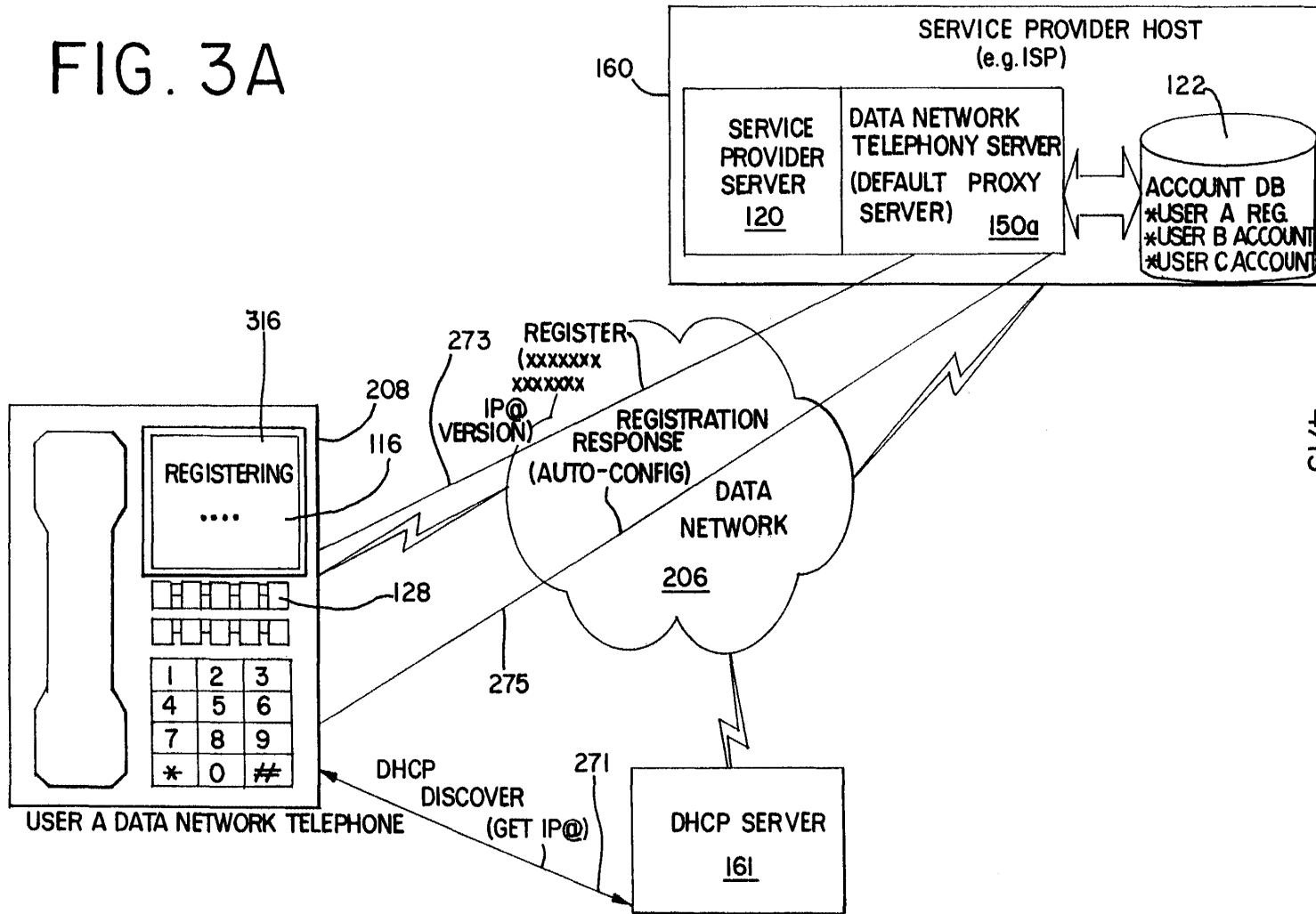

SUBSTITUTE SHEET (RULE 26)

4/13

W/O 01/24502

PCT/US00/26649

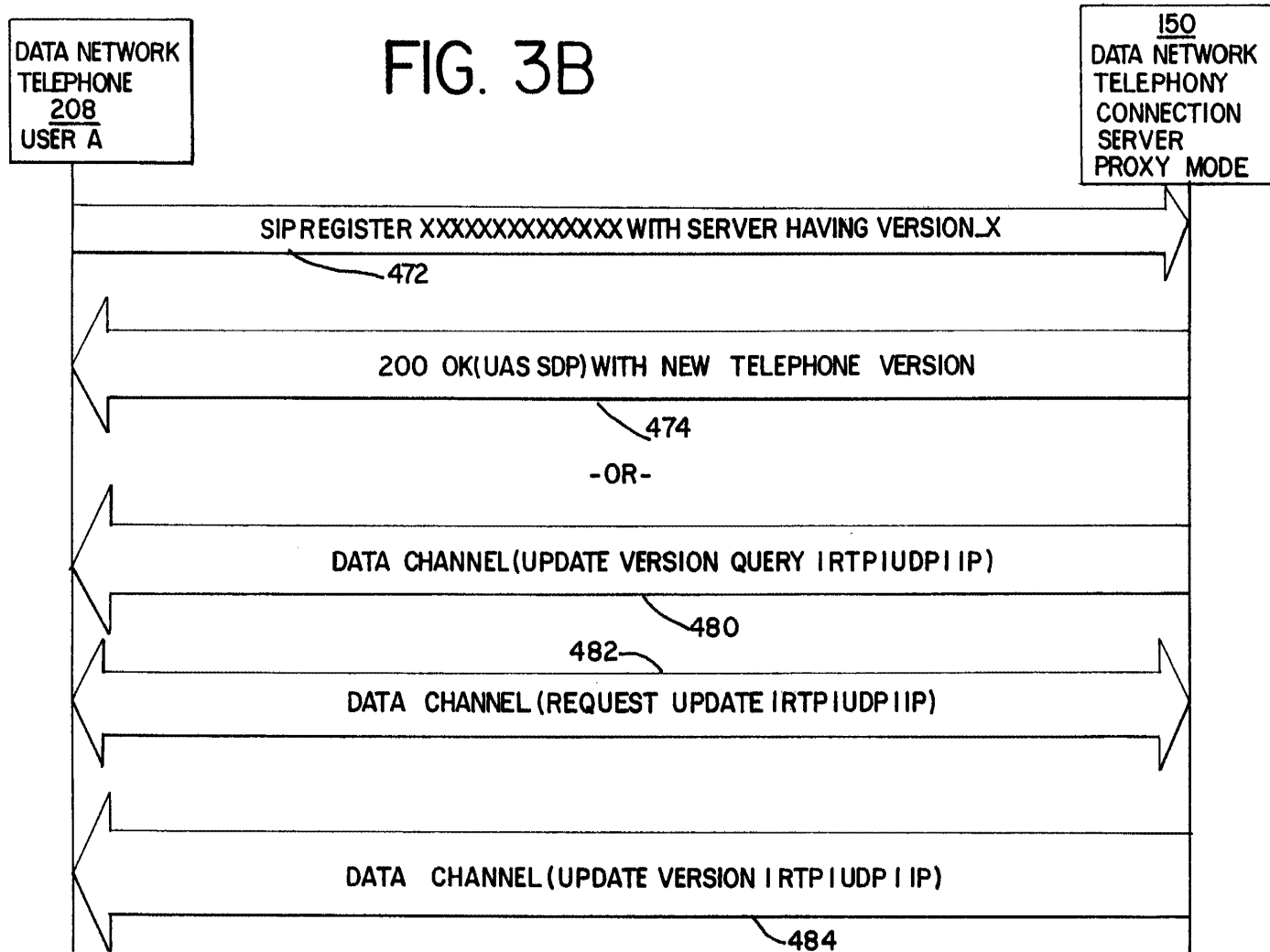

5/13

FIG. 3C

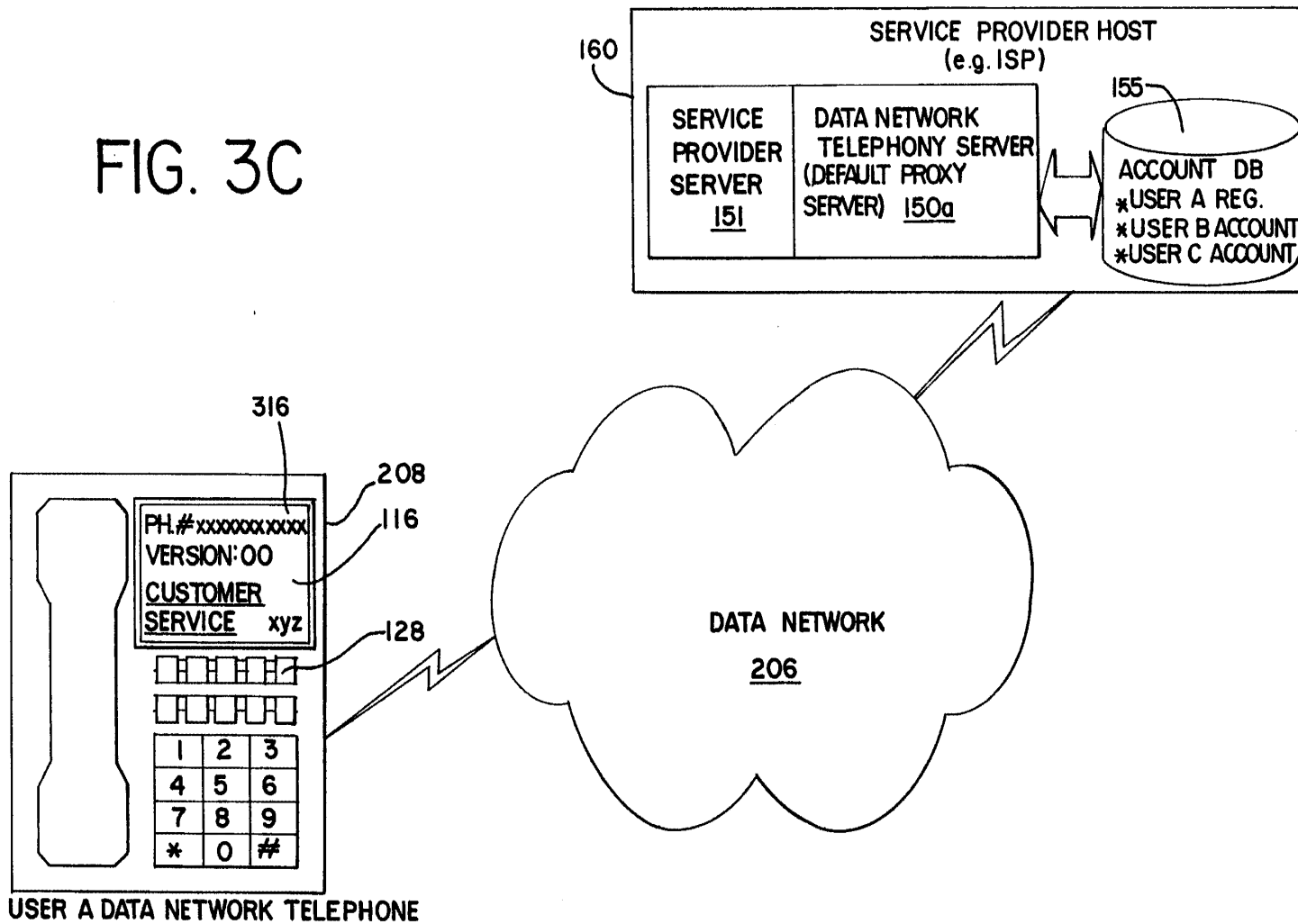

SUBSTITUTE SHEET (RULE 26)

WO 01/24502

6/13

PCT/US00/26649

FIG. 4A

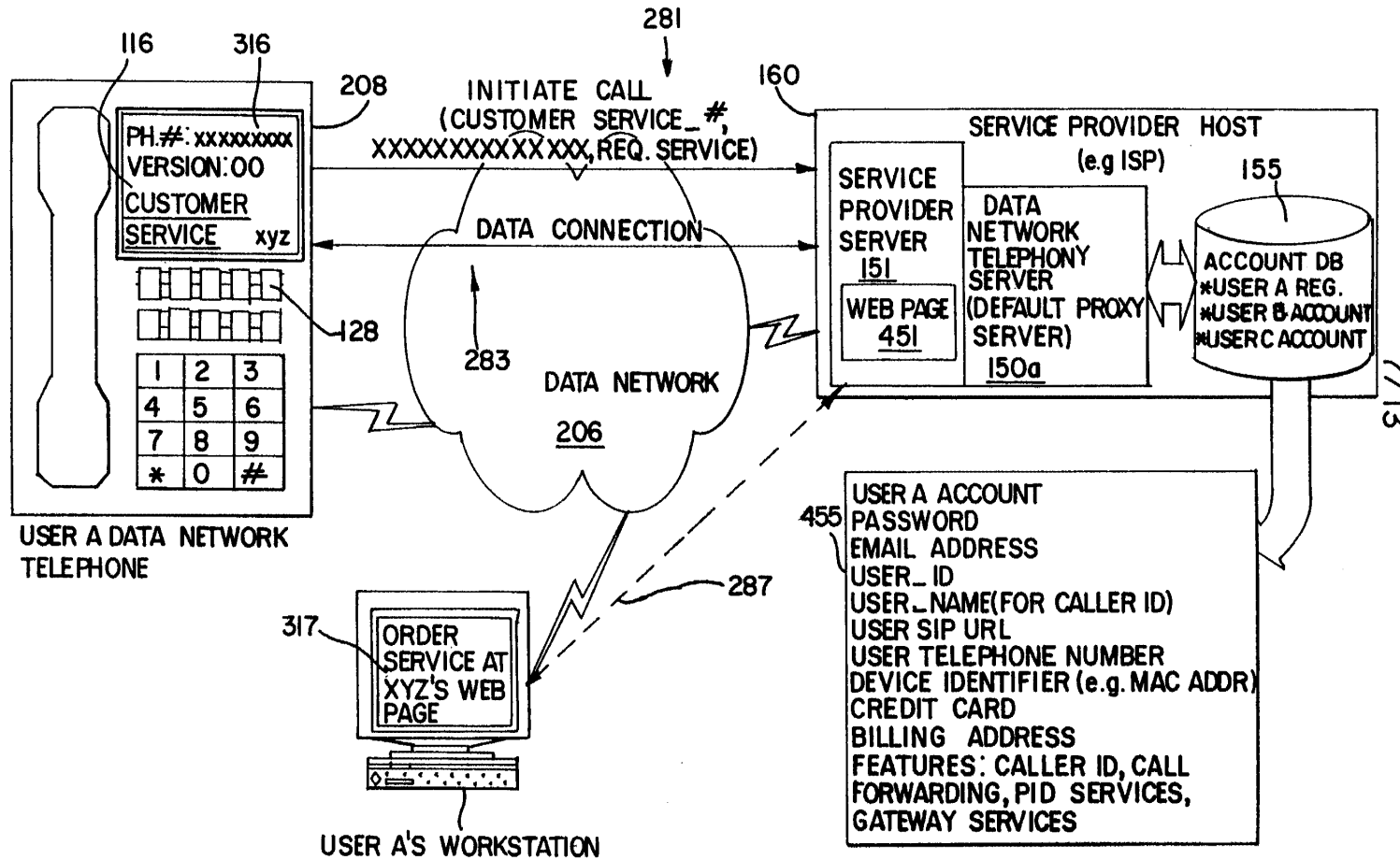

SUBSTITUTE SHEET (RULE 26)

W/O 01/24502

PCT/US00/26649

FIG. 4B

SUBSTITUTE SHEET (RULE 26)

317

NEW ACCOUNT

WELCOME TO 3COM/(YAHOO!,AOL,MSN,AT&T,MCI,LEVEL3) INTERNET VOICE SERVICES. ALL 3COM/XXX INTERNET VOICE SERVICES MEMBERS CAN BE REACHED AT 1-800-555-3COM EXT.(PROVIDER NUMBER) (PERSONAL NUMBER)

YOUR PERSONAL NUMBER CAN BE ANY NUMBER YOU CHOOSE WHICH IS NOT ALREADY TAKEN.

CHOOSE YOUR PERSONAL NUMBER(VARIABLE LENGTH)

A PASSWORD:

RE-ENTER:

A SHORT NAME FOR CALLER ID:

YOUR E-MAIL ADDRESS:

THE PHONE DEVICE ID:

A SIP URL:(OPTIONAL)

A CREDIT CARD AND EXPIRATION DATE:

8/13

FIG. 4C

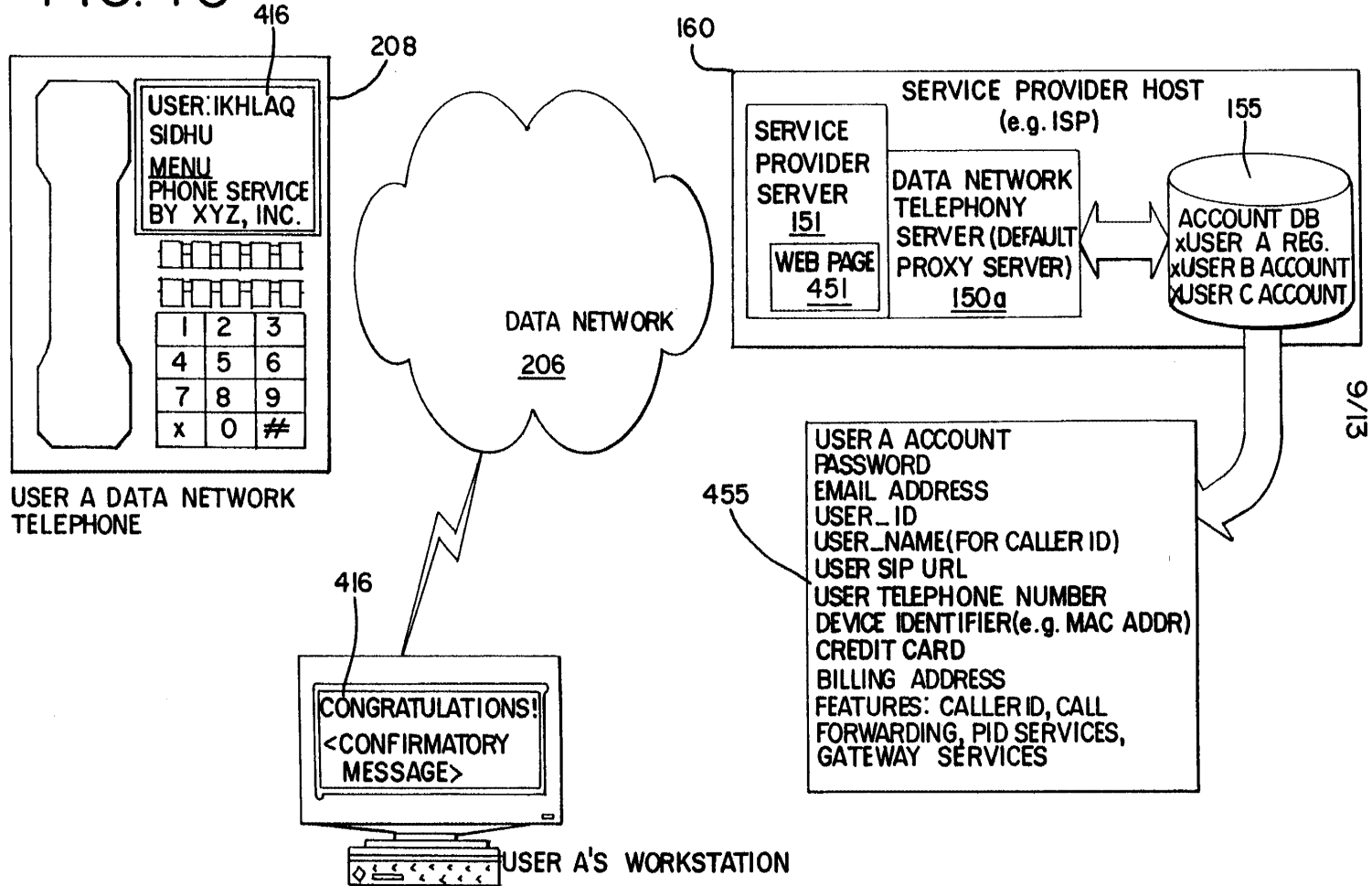

SUBSTITUTE SHEET (RULE 26)

9/13

FIG. 4D

SUBSTITUTE SHEET (RULE 26)

417

CONGRATULATIONS!
AN E-MAIL HAS BEEN SENT TO YOU. YOU MUST REPLY TO THAT E-MAIL TO ACTIVATE THIS ACCOUNT. YOU SHOULD PRINT THIS PAGE AND KEEP IT FOR FUTURE REFERENCE.
+ YOUR NEW "PERSONAL" PHONE NUMBER IS 1-800-5553COM EXT. 200 634-0610
+ YOUR SIP ADDRESS (FOR PALM PDA BASED DIALING) IS IKHLAQ_SIDHU.3COM.COM@
xxxCOM
SOME FREQUENTLY ASKED QUESTIONS:
Q: HOW DO I DIAL ANOTHER 3COM/XXX INTERNET PHONE USER?
A: YOU ONLY NEED TO DIAL THE EXTENSION NUMBER. FOR EXAMPLE OTHER 3COM/(...) USERS WITH THE SAME PROVIDER CODE (200) CAN CALL YOU AT 634-0610. TO CALL A USER WITH ANOTHER (SAY 202) PROVIDER NUMBER, YOU MUST DIAL 1-202-634-0610.
Q: HOW DO I DIAL TRADITIONAL PEOPLE PHONES?
A: DIAL 9 TO GET OUT OF THE SYSTEM. I.e. DIAL 9, 1800-ATT TO USE AT&T CALLING CARD.
Q: HOW ARE CALLS BILLED?
A: THERE IS NO EXTRA CHARGE FOR CALLS TO OTHER 3COM/XXX SUBSCRIBERS.
THERE IS NO EXTRA CHARGE TO MAKE DOMESTIC LONG DISTANCE CALLS OVER THE PUBLIC TELEPHONE NET. INTERNATIONAL CALLS OVER THE PUBLIC NETWORK ARE BILLED TO YOUR CREDIT CARD ON A PER CALL BASIS.
Q: HOW DO I SET SPEED DIALS AND OTHER ADVANCED FEATURES?
A: GOTO WWW.3COMVOICE.COM/IKHLAQ_SIDHU.3COM.COM@XYZ.COM AND ENTER YOUR PASSWORD ZZZ.
Q: HOW DO I USE SPEED DIALING FROM MY PALM PDA?
A: THE PROXY SERVER OPTION MUST BE SET TO PROXY@XXX.COM. ANY SUBSCRIBER WITH AN E-MAIL ADDRESS CAN BE AUTO DIALED BY...

10/13

WO 01/24502

PCT/US00/26649

FIG. 5

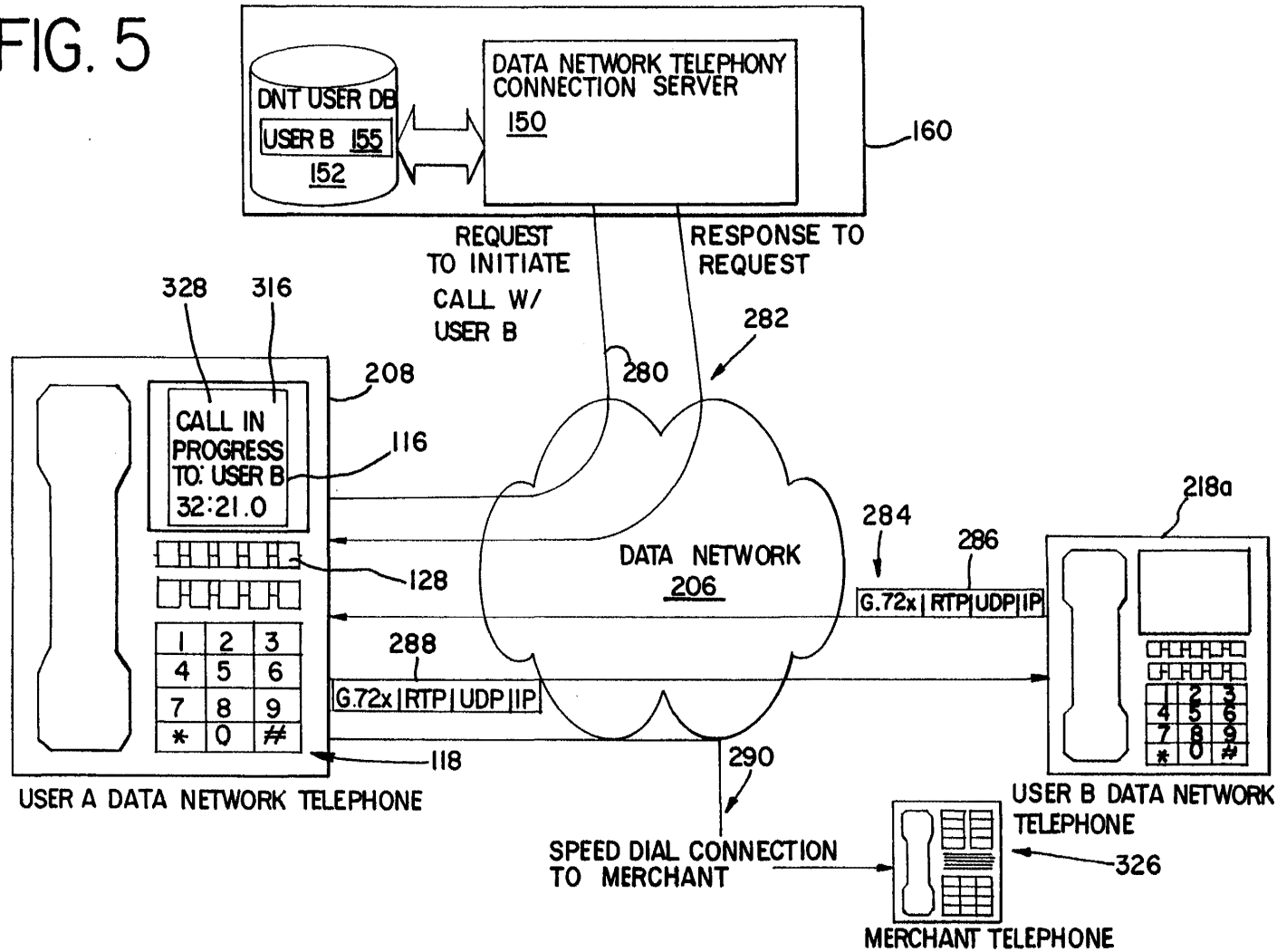

SUBSTITUTE SHEET (RULE 26)

11/13

WO 01/24502

PCT/US00/26649

FIG. 6

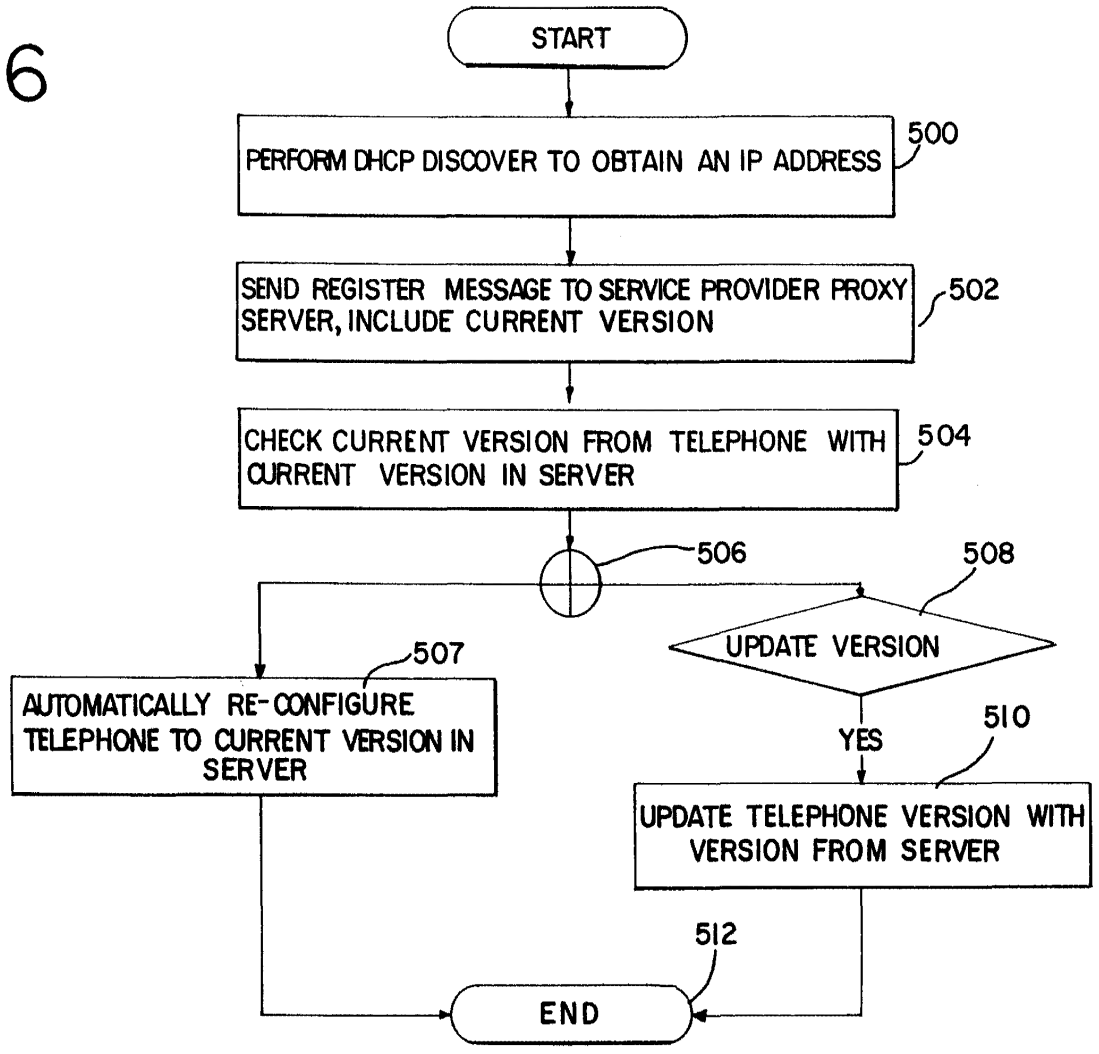

SUBSTITUTE SHEET (RULE 26)

12/13

WO 01/24502

PCT/US00/26649

FIG. 7

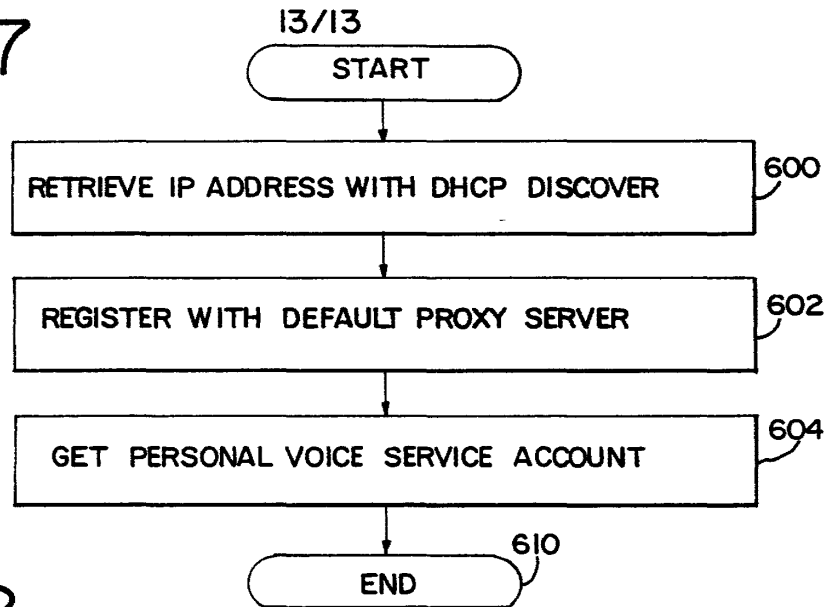
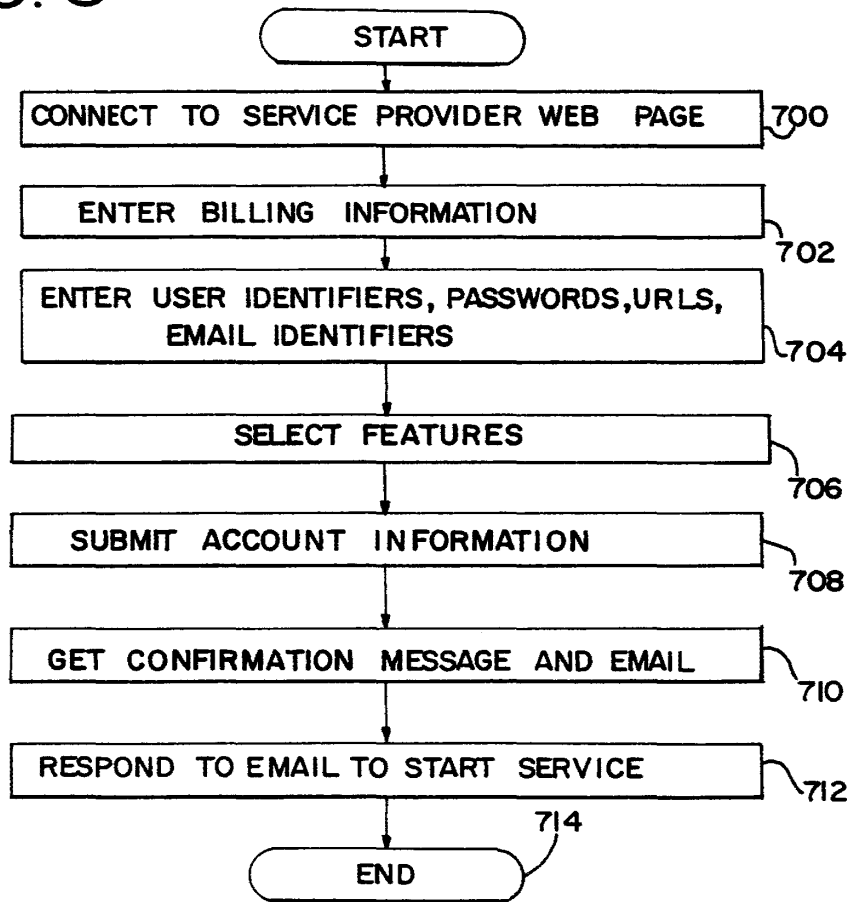

FIG. 8



INTERNATIONAL SEARCH REPORT

International Application No
PCT/US 00/26649

A. CLASSIFICATION OF SUBJECT MATTER IPC 7 H04M7/00				
According to International Patent Classification (IPC) or to both national classification and IPC				
B. FIELDS SEARCHED Minimum documentation searched (classification system followed by classification symbols) IPC 7 H04M				
Documentation searched other than minimum documentation to the extent that such documents are included in the fields searched				
Electronic data base consulted during the international search (name of data base and, where practical, search terms used) EPO-Internal, WPI Data, PAJ, INSPEC, COMPENDEX				
C. DOCUMENTS CONSIDERED TO BE RELEVANT				
Category °	Citation of document, with indication, where appropriate, of the relevant passages	Relevant to claim No.		
X	WO 99 19988 A (INFOGEAR TECHNOLOGY CORP) 22 April 1999 (1999-04-22) abstract page 4, line 30 -page 6, line 9 page 10, line 36 -page 12, line 4 page 14, line 10 -page 14 page 19, line 1 - line 7 claims 6,13; figures 3,6	1-10		
A	DALGIC I ET AL: "TRUE NUMBER PORTABILITY AND ADVANCED CALL SCREENING IN A SIP-BASED IP TELEPHONY SYSTEM" IEEE COMMUNICATIONS MAGAZINE, IEEE SERVICE CENTER. PISCATAWAY, N.J,US, vol. 37, no. 7, July 1999 (1999-07), pages 96-101, XP000835310 ISSN: 0163-6804 the whole document	1-10		
--- -/--				
<input checked="" type="checkbox"/> Further documents are listed in the continuation of box C.				
<input checked="" type="checkbox"/> Patent family members are listed in annex.				
° Special categories of cited documents :				
<table style="width: 100%; border: none;"> <tr> <td style="width: 50%; border: none; vertical-align: top;"> *A* document defining the general state of the art which is not considered to be of particular relevance *E* earlier document but published on or after the international filing date *L* document which may throw doubts on priority claim(s) or which is cited to establish the publication date of another citation or other special reason (as specified) *O* document referring to an oral disclosure, use, exhibition or other means *P* document published prior to the international filing date but later than the priority date claimed </td> <td style="width: 50%; border: none; vertical-align: top;"> *T* later document published after the international filing date or priority date and not in conflict with the application but cited to understand the principle or theory underlying the invention *X* document of particular relevance; the claimed invention cannot be considered novel or cannot be considered to involve an inventive step when the document is taken alone *Y* document of particular relevance; the claimed invention cannot be considered to involve an inventive step when the document is combined with one or more other such documents, such combination being obvious to a person skilled in the art. *&* document member of the same patent family </td> </tr> </table>			*A* document defining the general state of the art which is not considered to be of particular relevance *E* earlier document but published on or after the international filing date *L* document which may throw doubts on priority claim(s) or which is cited to establish the publication date of another citation or other special reason (as specified) *O* document referring to an oral disclosure, use, exhibition or other means *P* document published prior to the international filing date but later than the priority date claimed	*T* later document published after the international filing date or priority date and not in conflict with the application but cited to understand the principle or theory underlying the invention *X* document of particular relevance; the claimed invention cannot be considered novel or cannot be considered to involve an inventive step when the document is taken alone *Y* document of particular relevance; the claimed invention cannot be considered to involve an inventive step when the document is combined with one or more other such documents, such combination being obvious to a person skilled in the art. *&* document member of the same patent family
A document defining the general state of the art which is not considered to be of particular relevance *E* earlier document but published on or after the international filing date *L* document which may throw doubts on priority claim(s) or which is cited to establish the publication date of another citation or other special reason (as specified) *O* document referring to an oral disclosure, use, exhibition or other means *P* document published prior to the international filing date but later than the priority date claimed	*T* later document published after the international filing date or priority date and not in conflict with the application but cited to understand the principle or theory underlying the invention *X* document of particular relevance; the claimed invention cannot be considered novel or cannot be considered to involve an inventive step when the document is taken alone *Y* document of particular relevance; the claimed invention cannot be considered to involve an inventive step when the document is combined with one or more other such documents, such combination being obvious to a person skilled in the art. *&* document member of the same patent family			
Date of the actual completion of the international search <p style="text-align: center;">25 January 2001</p>		Date of mailing of the international search report <p style="text-align: center;">06/02/2001</p>		
Name and mailing address of the ISA European Patent Office, P.B. 5818 Patentlaan 2 NL - 2280 HV Rijswijk Tel. (+31-70) 340-2040, Tx. 31 651 epo nl, Fax: (+31-70) 340-3016		Authorized officer <p style="text-align: center;">Megalou, M</p>		

INTERNATIONAL SEARCH REPORT

International Application No
PCT/US 00/26649

C.(Continuation) DOCUMENTS CONSIDERED TO BE RELEVANT		
Category °	Citation of document, with indication, where appropriate, of the relevant passages	Relevant to claim No.
A	WO 98 16051 A (MITEL CORP) 16 April 1998 (1998-04-16) the whole document ---	1-10
A	WO 97 31492 A (TRUONG HONG LINH ;WONG JOHNNY WAI NANG (CH); IBM (US)) 28 August 1997 (1997-08-28) claims 1-13; figures 2,3 -----	1-10

1

INTERNATIONAL SEARCH REPORT

Information on patent family members

International Application No PCT/US 00/26649

Patent document cited in search report		Publication date		Patent family member(s)	Publication date
WO 9919988	A	22-04-1999		AU 9570598 A EP 1021902 A ZA 9808251 A	03-05-1999 26-07-2000 13-05-1999
WO 9816051	A	16-04-1998		CA 2187240 A	07-04-1998
WO 9731492	A	28-08-1997		EP 0885530 A JP 11504191 T	23-12-1998 06-04-1999

Form PCT/ISA/210 (patent family annex) (July 1992)

(12) INTERNATIONAL APPLICATION PUBLISHED UNDER THE PATENT COOPERATION TREATY (PCT)

(19) World Intellectual Property Organization
International Bureau



(43) International Publication Date
5 April 2001 (05.04.2001)

PCT

(10) International Publication Number
WO 01/24503 A1

(51) International Patent Classification⁷: H04M 7/00

(21) International Application Number: PCT/US00/26650

(22) International Filing Date:
27 September 2000 (27.09.2000)

(25) Filing Language: English

(26) Publication Language: English

(30) Priority Data:
09/406,152 27 September 1999 (27.09.1999) US

(63) Related by continuation (CON) or continuation-in-part (CIP) to earlier application:
US 09/406,152 (CON)
Filed on 27 September 1999 (27.09.1999)

(71) Applicant (for all designated States except US): 3COM CORPORATION [US/US]; 3800 Golf Road, Rolling Meadows, IL 60008 (US).

(72) Inventors; and

(75) Inventors/Applicants (for US only): SCHUSTER,

Guido, M. [CH/US]; Apartment 408, 1433 Perry Street, Des Plaines, IL 60016 (US). SIDHU, Ikhlaq, S. [US/US]; 403 River Grove Lane, Vernon Hills, IL 60061 (US). DEAN, Frederick, D. [US/US]; 2311 N. Greenview Avenue, Chicago, IL 60614 (US). BELKIND, Ronnen [US/US]; 1960 Lincoln Park West #2503, Chicago, IL 60614 (US).

(74) Agent: THYMIAN, Marcus, J.; McDonnell Boehnen Hulbert & Berghoff, 32nd Floor, 300 South Wacker Drive, Chicago, IL 60606 (US).

(81) Designated States (national): AE, AG, AL, AM, AT, AU, AZ, BA, BB, BG, BR, BY, BZ, CA, CH, CN, CR, CU, CZ, DE, DK, DM, DZ, EE, ES, FI, GB, GD, GE, GH, GM, HR, HU, ID, IL, IN, IS, JP, KE, KG, KP, KR, KZ, LC, LK, LR, LS, LT, LU, LV, MA, MD, MG, MK, MN, MW, MX, MZ, NO, NZ, PL, PT, RO, RU, SD, SE, SG, SI, SK, SL, TJ, TM, TR, TT, TZ, UA, UG, US, UZ, VN, YU, ZA, ZW.

(84) Designated States (regional): ARIPO patent (GH, GM, KE, LS, MW, MZ, SD, SL, SZ, TZ, UG, ZW), Eurasian patent (AM, AZ, BY, KG, KZ, MD, RU, TJ, TM), European patent (AT, BE, CH, CY, DE, DK, ES, FI, FR, GB, GR, IE, IT, LU, MC, NL, PT, SE), OAPI patent (BF, BJ, CF, CG, CI, CM, GA, GN, GW, ML, MR, NE, SN, TD, TG).

[Continued on next page]

(54) Title: SYSTEM AND METHOD FOR INTERCONNECTING PORTABLE INFORMATION DEVICES (PDAS) THROUGH A DAA TELEPHONY SYSTEM

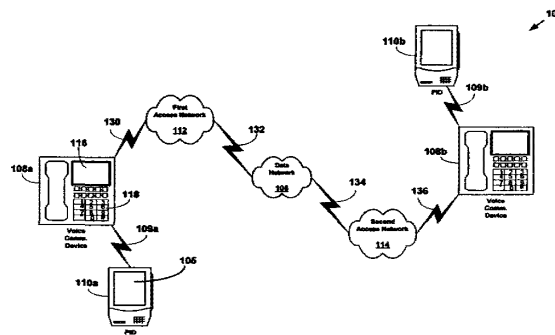

(57) Abstract: A personal information device (PID) is coupled to an IP Telephony phone in order to provide end-to-end connectivity to another PID through a network. The architecture disclosed includes a pair of internet-enabled phones that are able to establish a call session using a Session Initiation Protocol (SIP) and a Session Description Protocol (SDP). Each phone is also provided with an interface configured to communicate with a PID. Each PID is registered to a corresponding internet-enabled phone using each PID user's SIP URL. The user of a first PID connected to a first phone requests a call to a SIP URL corresponding to the user of the second PID that is connected to a second phone. The SIP URL for the user of the second PID is resolved to the network address of the second phone and connection is established between the first and second phones. The connection includes a media stream for transferring data between each of the PDAs. A data object transmitted by the first PID through its interface with the first phone is transmitted to the second phone through the media stream of the connection between the first and second phones. The data object received by the second phone is transmitted to the second PID through the interface between the second phone and the second PID.



WO 01/24503 A1



Published:

- *With international search report.*
- *Before the expiration of the time limit for amending the claims and to be republished in the event of receipt of amendments.*

For two-letter codes and other abbreviations, refer to the "Guidance Notes on Codes and Abbreviations" appearing at the beginning of each regular issue of the PCT Gazette.

SYSTEM AND METHOD FOR INTERCONNECTING PORTABLE INFORMATION DEVICES (PDAS)
THROUGH A DAA TELEPHONY SYSTEM

5

BACKGROUND OF THE INVENTION**A. Field of the Invention**

The present invention is related to a method and system for providing communication services over a network. In particular, the present invention relates to a system and method for exchanging data related to personal information device (PID) services over a telephony network.

B. Description of the Related Art

For many years, telephone service providers on the Public Switched Telephone Network (PSTN) provided their customers nothing more than a telephone line to use to communicate with other subscribers. Over time, telephone service providers have enhanced their service by providing Custom Local Area Signaling Service (CLASS) features to their customers. Similar communication services are provided by a Private Branch Exchange (PBX), which is typically implemented in a nonresidential setting.

The CLASS features permit customer subscribers of the features to tailor their telephone service according to individual needs. Some of the more popular CLASS features are:

- *Call blocking*: The customer may specify one or more numbers from which he or she does not want to receive calls. A blocked caller will hear a rejection message, while the callee will not receive any indication of the call.
- *Call return*: Returns a call to the most recent caller. If the most recent caller is busy, the returned call may be queued until it can be completed.
- *Call trace*: Allows a customer to trigger a trace of the number of the most recent caller.
- *Caller ID*: The caller's number is automatically displayed during the silence period after the first ring. This feature requires the customer's line to be equipped with a device to read and display the out-of-band signal containing the number.

- *Caller ID blocking:* Allows a caller to block the display of their number in a callee's caller ID device.
- *Priority ringing:* Allows a customer to specify a list of numbers for which, when the customer is called by one of the numbers, the customer will hear a distinctive ring.
- *Call forwarding:* A customer may cause incoming calls to be automatically forwarded to another number for a period of time.

A customer subscriber to a CLASS feature may typically activate and/or deactivate a CLASS feature using "*" directives (e.g., *69 to automatically return a call to the most recent caller). CLASS features may also be implemented with the use of out-of-band data. CLASS feature data is typically transmitted between local Class-5 switches using the Signaling System #7 (SS7).

Local Exchange Carriers (LECs) and other similar organizations maintain CLASS offices that typically contain a database entry for each customer. The database allows specification of the CLASS features a customer has subscribed to, as well as information, such as lists of phone numbers, associated with those features. In some cases, customers may edit these lists on-line via a touch-tone interface. A list of all phone numbers that have originated or terminated a call with each customer is often included in the CLASS office database. For each customer, usually only the most recent number on this list is stored by the local Class-5 switch.

A Private Branch Exchange (PBX), is a stored program switch similar to a Class-5 switch. It is usually used within a medium-to-large-sized business for employee telephony service. Since a PBX is typically operated by a single private organization, there exists a wide variety of PBX services and features. Custom configurations are common, such as integration with intercom and voice mail systems. PBX's typically support their own versions of the CLASS features, as well as other features in addition to those of CLASS. Most PBX features are designed to facilitate business and group communications.

A summary of typical PBX features includes:

- *Call transfer:* An established call may be transferred from one number to another number on the same PBX.

- *Call forwarding*: In addition to CLASS call forwarding, a PBX number can be programmed to automatically transfer a call to another number when the first number does not answer or is busy.
- *Camp-on queuing*: Similar to PSTN call return, a call to a busy number can be queued until the callee can accept it. The caller can hang up their phone and the PBX will ring them when the callee answers.
- *Conference calling*: Two or more parties can be connected to one another by dialing into a conference bridge number.
- *Call parking*: An established call at one number can be put on hold and then reestablished from another number. This is useful when call transfer is not warranted.
- *Executive override*: A privileged individual can break into an established call. After a warning tone to the two participants, the call becomes a three-way call.

While the CLASS and PBX features have enhanced the offerings of service providers that use the PSTN, the features are nevertheless limited in their flexibility and scope. The effect to the user is that the features become clumsy and difficult to use. For example, in order to use the Call Forwarding function, the user must perform the steps at the user's own phone prior to moving to the location of the telephone to which calls will be forwarded. A more desirable approach, from the standpoint of usefulness to the user, would be to perform the steps at the telephone to which calls will be forwarded.

Much of the lack of flexibility of the PSTN features is due to the lack of flexibility in the PSTN system itself. One problem with the PSTN is that the terminal devices (*e.g.* telephones) lack intelligence and operate as "dumb" terminals on a network having the intelligence in central offices. Most PSTN telephones are limited in functional capability to converting the analog signals they receive to sound and converting the sound from the handset to analog signals.

Some PSTN telephones have a display device and a display function to display specific information communicated from intelligent agents in the PSTN network using the PSTN signaling architecture. For example, some PSTN telephones have a display function to enable the Caller ID feature. Even such PSTN telephones are limited however by the closed PSTN signaling architecture, which prohibits access by the PSTN

telephones to the network signaling protocols. The display functions are effectively limited to displaying text, again, as a “dumb” terminal.

The Internet presents a possible solution for distributing intelligence to telephony terminal devices. In Internet telephony, digitized voice is treated as data and transmitted across a digital data network between a telephone calls’ participants. One form of Internet telephony uses a telephony gateway/terminal where IP telephony calls are terminated on the network. PSTN telephones are connected by a subscriber line to the gateway/terminal at the local exchange, or at the nearest central office. This form of Internet telephony provides substantial cost savings for users. Because the PSTN portion used in Internet telephony calls is limited to the local lines on each end of the call, long distance calls may be made for essentially the cost of a local call. Notwithstanding the costs savings provided by this form of Internet telephony, it is no more flexible than the PSTN with respect to providing enhancements and features to the basic telephone service.

In another form of Internet telephony, telephones are connected to access networks that access the Internet using a router. The telephones in this form of Internet telephony may be substantially more intelligent than typical PSTN telephones. For example, such a telephone may include substantially the computer resources of a typical personal computer.

Data network telephones and the data network (*e.g.* Internet) system in which they operate, however, lack a substantial infrastructure and service providers for providing telephone service.

It would be desirable to incorporate CLASS and PBX features into a data network telephony system that uses a data network such as the Internet.

It would be desirable to provide new features and enhancements to telephony service that accommodates and conforms to users’ needs.

It would also be desirable to provide features and capabilities to telephone service that create new opportunities for users and for service providers.

The present invention addresses the above needs by providing a system in a data network telephony system, such as for example, the Internet, that enables connected users to transmit user data, such as graphical data, or application-related data (*e.g.* email,

contacts data, calendar data, interactive game data, etc.), to each other across a telephony network using PIDs (Portable Information Devices) that may be linked to network communication devices. The system according to some embodiments of the present invention addresses concurrent voice and user data transmissions between users.

BRIEF DESCRIPTION OF THE DRAWINGS

Presently preferred embodiments of the invention are described below in conjunction with the appended drawing figures, wherein like reference numerals refer to like elements in the various figures, and wherein:

5 FIG. 1 is block diagram of a network telephony system according to one embodiment of the present invention;

 FIG. 2 is a block diagram showing a system for exchanging data related to portable information device (PID) services on a telephony system according to an exemplary embodiment of the present invention;

10 FIG. 3 is a block diagram of a data network telephone according to an exemplary embodiment of the present invention;

 FIG. 4 is a block diagram of a PID according to an exemplary embodiment of the present invention;

 FIG. 5 is a stack layer diagram showing the layers of an IrDA stack;

15 FIG. 6 is a block and stack layer diagram illustrating an embodiment of the protocol stacks in an exemplary embodiment of a PID linked to a data network telephone;

 FIG. 7 is block and stack layer diagram illustrating an embodiment of the present invention in which a SIP call may be established;

 FIG. 8 is a combined block and pictorial diagram showing a system for providing
20 PID data exchange according to a first embodiment of the present invention;

 FIG. 9 is a combined block and pictorial diagram showing a system for providing PID data exchange according to a second embodiment of the present invention; and

 FIG. 10 is a combined block and pictorial diagram showing a system for providing PID data exchange according to a third embodiment of the present invention.

25

DETAILED DESCRIPTION OF THE PREFERRED EMBODIMENT

The following references to patent applications filed concurrently herewith are incorporated by reference:

- 5 * "System and Method for Controlling Telephone Service Using a Wireless Personal Information Device" to Schuster, et al.
 - * "System and Method for Advertising Using Data Network Telephone Connections" to Schuster, et al.
 - * "System and Method for Providing User-Configured Telephone Service in a Data Network Telephony System" to Sidhu, et al.
 - 10 * "System and Method for Accessing a Network Server Using a Portable Information Device Through a Network Based Telecommunication System" to Schuster, et al.
 - * "System and Method for Enabling Encryption on a Telephony Network" to Schuster, et al.
 - 15 * "System and Method for Using a Portable Information Device to Establish a Conference Call on a Telephony Network" to Schuster, et al.
 - * "System and Method for Associating Notes with a Portable Information Device on a Network Telephony Call" to Schuster, et al.
 - * "System and Method for Providing Shared Workspace Services Over a Telephony
20 Network" to Schuster, et al.
 - * "System and Method for Providing Service Provider Configurations for Telephones in a Data Network Telephony System" to Schuster, et al.
- The following additional references are also incorporated by reference herein:
- * "Multiple ISP Support for Data Over Cable Networks" to Ali Akgun, et al.
 - 25 * "Method and System for Provisioning Network Addresses in a Data-Over-Cable System" to Ali Akgun, et al., Serial No. 09/218,793.
 - * "Network Access Methods, Including Direct Wireless to Internet Access" to Yingchun Xu, et al., Serial No. 08/887,313

30

A. PID-Enabled Data Network Telephony System

FIG. 1 is a block diagram showing an exemplary embodiment of a system 100 for exchanging mixed media messages according to one embodiment of the present invention. The system includes a data network 106. A first voice communication device 108a linked to a first access network 112 via connection 130 may communicate over the data network 106 by connecting via the first access network 112. A second voice communication device 108b is linked to a second access network 114 through connection 136 and may communicate over the data network 106 by connecting via the second access network 114

The data network 106 in the system 100 typically includes one or more Local Area Networks (LANs) connected to one another or to a Wide-Area Network (WAN), such as an Internet Protocol (IP) network, to provide wide-scale data connectivity. The data network 106 may use Voice Over Packet (VOP) schemes in which voice signals are carried in data packets. The network 106 may also include a connection to the Public Switched Telephone Network (PSTN) to allow for voice connections using traditional circuit switching techniques. In one embodiment, the data network 106 may include one or more LANs such as Ethernet LANs and support data transport protocols for performing Voice-over-Internet-Protocol (VoIP) techniques on the Internet. For further details regarding VoIP, see the information available through the Internet Engineering Task Force (IETF) at www.ietf.org. In addition, an Internet Telephony gateway may be included within the system 100 to allow for voice connections to users connected by subscriber lines at a PSTN Central Office.

The voice communication devices 108a-b (described further below with reference to FIG. 3) typically include a voice input, a voice output and a voice processing system.

The voice processing system converts voice sound to digital data signals that are communicated on a voice connection over the data network. The voice processing system also converts digital data signals received from the voice connection to voice sound. The voice communication devices 108a-b typically include a central processing unit and memory to store and process computer programs. Additionally, each voice communication device 108a-b typically includes a unique network address, such as an IP

address, in memory to uniquely identify it to the data network 106 and to permit data packets to be routed to the device.

A first PID 110a linked to the first voice communication device 108a via connection 109a may communicate over the data network 106 by connecting via the first access network 112. A second PID 110b linked to the second voice communication device 108b via connection 109b may communicate over the data network 106 by connecting via the second access network 114. The PIDs 110a-b each contain user attributes stored in a user information data base. The user attributes may contain such information as a user identifier, schedule information, and other information that is associated with a user of the PID 110a or 110b. The PIDS 110a-b each include a user interface allowing a user to easily enter and retrieve data. In a preferred embodiment, the user interface includes a pressure-sensitive display that allows a user to enter input with a stylus or other device. An example of a PID with such an interace is a PDA (Personal Digital Assistant), such as one of the Palm™ series of PDAs offered by 3Com® Corporation. The PIDs 110a-b may include other functionality, such as wireless phone or two-way radio functionality.

Links 109a-b are point-to-point links, and may entirely or partially wireless, or they may be hard-wired connections. Each of the links 109a-b is preferably a wireless link, such as an infrared link specified by the Infrared Data Association (IrDA) (see irda.org for further information) or a radio frequency (RF) link such as the Bluetooth system (see www.bluetooth.com for further information). However, the point-to-point link can also be a hardwired connection, such as an RS-232 serial port.

In one embodiment, the voice communication device 108a includes a handset with a receiver and transmitter similar or identical to handsets of traditional circuit-switched telephones. A console on which the handset sits may include the voice processing system, a display 116, and a keypad 118.

In a preferred embodiment, a portion of the voice communication device 108a utilizes an NBX 100™ communication system phone offered by 3Com® Corporation. In alternative embodiments, the voice communication device 108a may include any device having voice communications capabilities. For example, a personal computer having a microphone input and speaker output may also be used to implement the voice

communication device 108a. Other configurations are also intended to be within the scope of the present invention.

The details relating to operation of the voice communication devices 108a and 108b depend on the nature of the data network 106 and the nature of the access networks 112, 114 connecting the voice communication devices 108a and 108b to each other and/or to other network entities. The access networks 112, 114 typically include any high bandwidth network adapted for data communications, i.e. a network having greater than 64,000 bits-per-second (bps) bandwidth. The access networks 112, 114 may link to the voice communication devices 108a-b using an Ethernet LAN, a token ring LAN, a coaxial cable link (*e.g.* CATV adapted for digital communication), a digital subscriber line (DSL), twisted pair cable, fiberoptic cable, an integrated services digital network (ISDN) link, and wireless links. In embodiments that may not require bandwidth greater than 64,000 bps, the access networks 112, 114 may also include the PSTN and link the voice communications devices 108a-b by an analog modem. Further details regarding specific implementations are described below, with reference to FIGs. 2 through 10.

B. System for Providing PID Data Exchange Using a Data Network Telephony System

One advantage of the PDA-Enabled Data Network Telephony System 100 in FIG. 1 is that it may be used to exchange PID data. In one embodiment, the PIDs 110a is able to accept and process PID data from a user through a user interface on the PID 110a. The PID data may include any data used by the PID, such as graphical data, email, calendar data, contacts data (*e.g.* business card data), interactive game data. The PID data can be communicated across the link 109a to the voice communication devices 108a for transport across the first access network 112, the data network 106, and the second access network 114 to the voice communication device 108b. The PID 110b can receive the PID data across the link 109b for display on the PID 110b. A voice-over-data channel for communicating voice-over-data can concurrently exist with this communication of PID data over a graphical data channel. In this way, a user of the PID 110a can communicate PID data to a user of the PID 110b while voice signals are communicated between the voice communication device 108a and the voice communication device 108b.

1. Local Area Network As An Exemplary Access Network

FIG. 2 is a block diagram showing one example of the system 100 of FIG. 1 for providing PID data exchange according to the present invention. The system 200 in FIG. 2 includes a local area network 212, connected to a data network 206 by a first router 228. A cable network 214 is connected to the data network 206 by a second router 238. Those of ordinary skill in the art will appreciate that while FIG. 2 illustrates the access networks as the local area network 212 and the cable network 214, any other type of network may be used. For example, the local area network 212 and/or the cable network 214 may be replaced by ISDN, DSL, or any other high-speed data link.

The local area network 212 provides data connectivity to its network elements, such as a first data network telephone 208a, a second data network telephone 208b, and a first network telephony connection server 150. The local area network 212 in FIG. 2 is an Ethernet LAN operating according to the IEEE 802.3 specification, which is incorporated by reference herein, however, any other type of local area network may be used. The local area network 212 uses the router 228 to provide the data network telephone 208a and the first network telephony connection server 150 with access to the data network 206. For example, the router 228 may perform routing functions using protocol stacks that include the Internet Protocol and other protocols for communicating on the Internet.

The first network telephony connection server 150 provides telephony registration, location and session initiation services for voice connections in which its members are a party. A user may register for telephony service with an administrator of the first network telephony connection server 150 and receive a user identifier and a telephone identifier. The user identifier and telephone identifier may be sequences of unique alphanumeric elements that callers use to direct voice connections to the user. The first network telephony connection server 150 registers users by storing user records in a first registration database 152 in response to registration requests made by the user.

The call setup process and the user and telephone identifiers preferably conform to requirements defined in a call management protocol. The call management protocol is used to permit a caller anywhere on the data network to connect to the user identified by the user identifier in a data network telephone call. A data network telephone call

includes a call setup process and a voice exchange process. The call setup process includes steps and message exchanges that a caller and callee perform to establish the telephone call. The actual exchange of voice signals is performed by a data communications channel. The data communications channel incorporates other data transport and data formatting protocols, and preferably includes well-known data communications channels typically established over the Internet.

The call management protocol used in FIG. 2 is the Session Initiation Protocol (SIP), which is described in M. Handley et al., "SIP: Session Initiation Protocol," IETF RFC 2543, Mar. 1999, incorporated by reference herein, however, any other such protocol may be used. Other protocols include H.323, the Media Gateway Control Protocol (MGCP), MEGACO, etc.

The network telephony connection server 150 may be used to provide telephony service for mobile users. A user may be registered to use the first network telephone 208a (which is identified by its telephone identifier), but move to a location near the second network telephone 208b. The user may re-register as the user of the second network telephone 208b. Calls that identify the user by the user's user identifier may reach the user at the second network telephone 208b.

2. Cable Network As An Exemplary Access Network

The system 200 in FIG. 2 also shows a cable network 214 connected to the data network 206 by a router 238. The cable network 214 provides data network access to its network elements, which in FIG. 2 include a third data network telephone 218a and a second network telephony connection server 162. The users of the data network telephone 218a connected to the cable network 214 may communicate over the data network 206 with the users of the data network telephones 208a-b connected to the local area network 212.

The cable network 214 includes any digital cable television system that provides data connectivity. In the cable network 214, data is communicated by radio frequency in a high-frequency coaxial cable. The cable network 214 may include a head-end, or a central termination system that permits management of the cable connections to the users.

3. Providing Telephony Services

The second network telephony connection server 162 is preferably a SIP-based server that performs call initiation, maintenance and teardown for the data network telephone 218a connected to the cable network 214. The second network telephony
5 connection server 162 may be similar or identical to the first network telephony connection server 150 connected to the local area network 212.

The system 200 shown in FIG. 2 permits the data network telephones 208a-b connected to the local area network 212 to communicate with the data network telephone 218a connected to the cable network 214. The system shown in FIG. 2 uses SIP in order
10 to establish, maintain, and teardown telephone calls between users.

There are two major architectural elements to SIP: the user agent (UA) and the network server. The UA resides at the SIP end stations, (e.g. the data network telephones), and contains two parts: a user agent client (UAC), which is responsible for issuing SIP requests, and a user agent server (UAS), which responds to such requests.
15 There are three different network server types: a redirect server, a proxy server, and a registrar. The various network server types may be combined into a single server, such as the network telephony connection server 150 and 162. Not all server types are required to implement the embodiments of the present invention. The communication services to be provided will determine which servers are present in the communication
20 system. Preferred embodiments of the present invention may be carried out using proxy servers.

One example of a SIP operation involves a SIP UAC issuing a request, a SIP proxy server acting as end-user location discovery agent, and a SIP UAS accepting the call. A successful SIP invitation consists of two requests: INVITE followed by ACK.
25 The INVITE message contains a user identifier to identify the callee, a caller user identifier to identify the caller, and a session description that informs the called party what type of media the caller can accept and where it wishes the media data to be sent. User identifiers in SIP requests are known as SIP addresses. SIP addresses are referred to as SIP Uniform Resource Locators (SIP-URLs), which are of the form
30 *sip:user@host.domain*. Other addressing conventions may also be used.

Redirect servers process an INVITE message by sending back the SIP-URL where the callee is reachable. Proxy servers perform application layer routing of the SIP requests and responses. A proxy server can either be stateful or stateless. A stateful proxy holds information about the call during the entire time the call is up, while a
5 stateless proxy processes a message without saving information contained in the message. Furthermore, proxies can be either forking or non-forking. A forking proxy can, for example, ring several data network telephones at once until somebody takes the call. Registrar servers are used to record the SIP address (the SIP URL) and the associated IP address. The most common use of a registrar server is for the UAC to notify the registrar
10 where a particular SIP URL can be reached for a specified amount of time. When an INVITE request arrives for the SIP URL used in a REGISTER message, the proxy or redirect server forwards the request correctly.

At the local area network 212, the central registrar/proxy server, such as the first network telephony server 150, is the primary destination of all SIP messages trying to
15 establish a connection with users on the local area network 212. Preferably, the first network telephony server 150 is also the only destination advertised to the SIP clients outside the LAN 212 on behalf of all the SIP clients residing on the LAN 212. The network telephony server 150 relays all SIP INVITE messages to the appropriate final destination (or another SIP proxy), based on a database lookup using the first SIP
20 database 152. It allows all mobile clients to register with their current locations.

Similarly, the second network telephony server 162 is the primary destination of all SIP messages trying to establish a connection with the data network telephone 218a connected to the cable network 214. Preferably, the second network telephony server
25 162 is also the only destination advertised to the SIP clients outside the cable network 214 on behalf of all the SIP clients (*e.g.* data network telephones) residing on the cable network 214. The second network telephony server 162 relays all SIP INVITE messages to the appropriate final destination (or another SIP proxy), based on a database lookup using the second SIP database 164.

The data network telephones 208a-b and 218a in the system 200 preferably have
30 pre-programmed device identifiers (*e.g.* phone numbers), represented as SIP-URL's that are of the form *sip: user@domain*. An example is *sip: 8475551212@3Com.com..* After

power-up, each of the data network telephones 208a-b and 218a sends a SIP REGISTER message to the default registrar, such as the network telephony servers 150 and 162.

When a call arrives at one of the network telephony servers 150 or 162 for any of the registered SIP URLs, the server will forward the call to the appropriate destination. If a data network telephone is moved to a new location, all calls to the associated SIP URL will still be properly routed to that device. In other words, the system in FIG. 2 provides device mobility in the sense that calls will "follow" the data network telephone according to its SIP URL. This is especially useful if the data network telephone 208a-b or 218a is running the DHCP (Dynamic Host Configuration Protocol) so that when the location is changed, the IP address is also automatically changed.

An advantage of the system in FIG. 2 is that once the call is established between data network telephones, the data network 206 provides data connectivity for a plurality of data communications channels. For example, the data network telephones 208a and 218a can communicate voice signals as voice-over-data packets on a voice-over-data channel. The data network telephones 208a and 218a can also communicate graphical data (or other PID data) as graphical data packets on a graphic data channel. For example, the graphical data may be communicated to and from the PIDs 210a and 220a across links 209a and 219a to the data network telephones 208a and 218a, where graphical data is packetized and depacketized as part of the process for communicating the graphical data packets across the data network 206 and any access networks, such as the Ethernet LAN 212 and the cable network 214.

4. The Data Network Telephones

The data network telephones 208a-b are preferably telephones that include an Ethernet communications interface for connection to an Ethernet port. The Ethernet phones in FIG. 2 support the Internet Protocol (IP), using an IP address that is either statically configured or obtained by access to a Dynamic Host Configuration Protocol (DHCP) server.

FIG. 3 is a block diagram showing the data network telephone 208a connected to the local area network 212 in FIG. 2. The data network telephone 208a in FIG. 3 is connected to the network 212 by a network interface 270. The network interface 270

may, for example, be a network interface card, and may be in the form of an integrated circuit. A bus 248 may be used to connect the network interface 270 with a processor 240 and a memory 242. Also connected to the processor are user interface circuitry 260 and three alternative link interfaces to a PID, such as the PID 210a.

5 A first link interface 248 includes an RS-232 serial connection and associated coupling hardware and mechanisms. The first alternative link interface 248 may, for example, be a docking cradle for a PDA (Personal Digital Assistant), in which information can be transferred between the PDA and the data network telephone 208a. The second alternative link interface comprises a first connection 254, such as an RS-232
10 connection, along with infrared circuitry 250 for converting signals into infrared output and for accepting infrared input. An infrared interface 252 may also be included within the second alternative link interface. The third alternative link interface comprises a first connection 256, such as an RS-232 connection, along with radio-frequency circuitry 258
15 input. A radio frequency interface 259 may also be included as part of the third alternative link interface.

The three alternative link interfaces described above are merely examples, and additional means for implementing the link interface between the data network telephone 208a and the PID 210a may also be used. Although three link interfaces are shown in
20 FIG. 3, there may be only one such interface in the data network telephone 208a. More than one link interface may be included to improve flexibility and to provide redundancy in case of failure of one of the link interfaces.

The user interface circuitry 260 includes hardware and software components that access the functions of the handset, display, and keypad to provide user input and output
25 resources for functions in the processor 240. The user interface circuitry includes a display interface 262, a keypad interface 264, an audio output interface 265, and an audio input interface 267.

The audio input interface 267 may receive voice signals from a microphone or other audio input device and convert the signals to digital voice information. The
30 conversion preferably conforms to the *G.711 ITU Standard*. Further processing of the digital signal may be performed in the audio input interface 267, such as providing

compression (*e.g.* using G.723.1 standard) or providing noise reduction, although such processing may also be performed in the processor 240. Alternatively, the audio input interface 267 may communicate an analog voice signal to the processor 240 for conversion to digital information within the processor 240.

5 The audio output interface 265 receives digital information representing voice from the processor 240 and converts the information to audible sound, such as through a magnetic speaker. In one embodiment, the audio output interface 265 receives information in the form of G.711, although other processing such as decompression may be performed in the audio output interface 265. Alternatively, the processor 240 may
10 convert digital information to analog voice signals and communicate the analog voice signals to the audio output interface 265.

 The keypad interface 264 and the display interface 262 include well-known device interfaces and respective signal processing techniques. The user interface circuitry 260 may support other hardware and software interfaces. For example, a videophone
15 implementation might also include a camera and monitor. The data network telephones of the present invention are not limited to telephones or videophones – additional user interface types, for example, such as the ones needed for computer games, are also contemplated as being within the scope of the present invention. In addition, some of the features described here, such as the display interface 262, are optional and serve to
20 enhance the functionality of the first data network telephone 208a.

 The processor 240 may consist of one or more smaller processing units, including, for example, a programmable digital signal processing engine. In the preferred embodiment, the processor is implemented as a single ASIC (Application Specific Integrated Circuit) to improve speed and to economize space. The processor 240 also
25 may include an operating system, and application and communications software to implement the functions of the data network telephone 208a. The operating system may be any suitable commercially available embedded or disk-based operating system, or any proprietary operating system.

 The processor 240 includes a media engine 241 and a signaling stack 243 to
30 perform the primary communications and application functions of the data network telephone 208a. The purpose of the signaling stack in the exemplary data network

telephone 208a is to set up, manage, and tear down a call. During the setup phase, a user may use the keypad to enter a user identifier to call. Alternatively, a PID such as PID 210a may transmit the user identifier of the party across the first link 209a. The signaling stack 243 receives the user entry and formats a request message to send to the user
5 identified by the user identifier to initiate a telephone call. When the request message is sent, the location of the user identified by the user identifier is discovered, communication parameters, such as the supported voice CODEC types are exchanged, and a voice-over-data channel is established. During the management phase, for example, other parties may be invited to the call if needed. During the tear down phase,
10 the call is terminated.

The signaling protocol used in the data network telephone 208a in FIG. 3 is the SIP protocol. In particular, the signaling stack implements a User Agent Client 244 and a User Agent Server 242, in accordance with the SIP protocol. Alternative signaling protocols, such as the ITU-T H.323 protocol, MGCP, MEGACO, and others, may also be
15 used to implement the present invention.

Once the call is set up, the media engine 241 manages the communication over one or more data communications channels using network transport protocols and the network interface 270. The media engine 241 sends and receives data packets having a data payload for carrying data and an indication of the type of data is being transported.
20 The media engine 241 in the data network telephones 208a may sample the voice signals from the audio input 267 (or receive voice samples from the audio input 267), encode the samples, and build data packets on the sending side. On the receiver side, in addition to performing the reverse operations, the media engine also typically manages a receiver buffer to compensate for network jitter. Similar procedures may be performed for other
25 types of data, such as graphical data, or for data used in PID applications such as email, contacts data, calendar data, other non-voice sound data, interactive game data, etc.

The media engine 241 may also include hardware and software components for performing registration functions 247, voice-over-data functions 249, display data functions 251, and keypad output functions 253. The media engine 241 processes data
30 that is received from the network 212, and data to be sent over the network 241.

For data that is received from the network 212, the media engine 241 may determine from the type of data in the packet (such as by examining a packet header) whether packets contain sampled voice signals or other data types. Packets containing sampled voice signals are processed by the voice-over-data function 249. The voice-over-data function 249 preferably conforms to a protocol for formatting voice signals as digital data streams. While any suitable protocol may be used, the media (i.e. the voice signal) is preferably transported via the Real Time Protocol (RTP), which itself is carried inside of UDP (User Datagram Protocol). RTP is described in H. Schulzrinne et al., "RTP: A Transport Protocol for Real-Time Applications," IETF RFC 1889, Jan. 1996, which is incorporated herein by reference. UDP is described in J. Postel, "User Datagram Protocol," IETF RFC 768, Aug. 1980, and IP is described in J. Postel, ed., "Internet Protocol," IETF RFC 791, Sept. 1981, both of which are incorporated by reference herein.

Packets containing data for use in registering the data network telephone 208a with a network telephony service are processed by the registration function 247. By registering the data network telephone 208a, a user may establish with the network telephony connection server 150 that calls addressed to the user's user identifier may be connected to the data network telephone 208a. Registration may occur when the data network telephone 208a sends a request to register to a service provider host, such as the network telephony connection server 150. The service provider host may respond by setting the user's user identifier to correspond to the telephone identifier of the data network telephone 208a, and by acknowledging the request with a status message to the data network telephone 208a. In one embodiment, a request to register the data network telephone 208a to a default user is automatically sent during power-up of the data network telephone 208a.

Other features may be added to the registration functions 247, or implemented as extensions to the registration functions 247. For example, the first data network telephone 208a may be provisioned to provide selected network telephony services by establishing a data connection with a service provider, requesting the selected services, and receiving data that ensures that the services have been successfully provisioned. Such services may include, for example, caller identification, call forwarding, voice mail

and any other services offered by the network telephony service provider to enhance the capabilities of the first data network telephone 208a. One advantage of provisioning functions is that services may be ordered for temporary use in a manner convenient to the user.

5 Packets containing data for display on a display device of the data network telephone 208a are processed by the display data function 251. The display data function 251 may be used for displaying, for example, the names and user identifiers of other parties to the call, the status of the telephone call, billing information, and other information.

10 For data to be sent over the data network 212, the media engine 241 formats the data as data packets in accordance with a selected protocol. The selected protocol is preferably a protocol that is supported by data network telephones that will receive the data being transported.

15 The voice-over-data function 249 formats voice samples according to the protocol used by the receiving data network telephone. In one preferred embodiment, the voice over data function 249 formats voice samples as RTP packets. The registration function 247 and the keypad output function 253 may control the transport of data that does not represent voice signals.

20 The data network telephones 208b and 218a are preferably similar or identical to the data network telephone 208a. For each of the data network telephones 208a-b and 218a, many of the features described in FIG. 3 are optional and their inclusion depends on the services to be offered.

5. The Portable Information Devices (PIDs)

25 FIG. 4 is a block diagram showing the exemplary PID 210a that can communicate via the link 209a with the data network telephone 208a connected to the LAN 212. The PID 210a may be linked to the data network telephone 208a through a link interface 545. A bus 580 may be used to connect the point-to-point interface 545 with a processor 540, a memory 542, data storage 543, and user interface circuitry 544.

The link interface 545 shown in FIG. 4 illustrates three alternative link interfaces for establishing a link to a data network telephone, such as the data network telephone 208a.

A first link interface 546 includes an RS-232 serial connection and associated
5 coupling hardware mechanisms. The first alternative link interface 546 may, for example, be for coupling with a PDA docking cradle, in which information can be transferred between the PDA and the data network telephone 208a. The second alternative link interface comprises a first connection 548, such as an RS-232 serial connection, along with infrared circuitry 250 for converting signals into infrared output
10 and for accepting infrared input. An infrared interface 552 may also be included within the second alternative link interface. The third alternative link interface comprises a first connection 554, such as an RS-232 connection, along with radio-frequency circuitry 556 for converting signals into radio frequency output and for accepting radio frequency input. A radio frequency interface 558 may also be included as part of the third
15 alternative interface. The radio interface 554/556/558 may be implemented according to the Bluetooth specifications, described at www.bluetooth.com.

The three alternative link interfaces described above are merely exemplary, and additional means for implementing the interface between the PID 210a and the data network telephone 208a may also be utilized. Although three link interfaces are shown in
20 FIG. 4, there may be only one such interface in the PID 210a. More than one link interface may be included to improve flexibility and to provide redundancy in case of failure of one of the link interfaces.

The user interface circuitry 544 includes hardware and software components that provide user input and output resources for functions in the processor 540. The user
25 interface circuitry includes a display output 562, a display input 565, and an additional input/output interface 567.

The display output 562 preferably receives digital information representing graphical data from the processor 540 and converts the information to a graphical display, such as text and/or images, for display on a display screen, for example.

30 The display input 565 may receive data inputs, such as graphical data inputs, from a user of the PID 210a. The graphical data inputs are preferably entered by the user with

a stylus on a pressure-sensitive display screen, and may include text, drawings, or other objects that are capable of being graphically presented.

The additional input/output interface 567 allows the user to enter other types of data besides graphical data into the PID 210a. For example, audio data, additional graphical data, or additional input, such as video camera input for example, may be entered through the additional input/output interface 567. The data may also include data formatted for operation with particular applications on the PID. For example, email data, calendar data, contacts data, database data, spreadsheets, notes, game data, etc. may also be entered. Touch-sensitive screen buttons are an exemplary method for a user to enter control data into the PID 210a.

The processor 540 may include an operating system, as well as application and communication software, to implement the functions of the PID 210a. The operating system may be any suitable commercially available operating system, or any proprietary operating system. The operating system and software may be stored on data storage 543, in the memory 542, or the may be embedded in the processor 540. Although the processor 540 is shown connected to the data storage 543 through a bus 580, other configurations may also be used. Similarly, the memory 542 may be configured other than as shown in FIG. 4, and may be embedded within the processor 540.

The PID 210a is able to send data to and receive data from the data network telephone 208a across a point-to-point link, such as the point-to-point link 209a shown in FIG. 1. A user enters PID data at the display input 565. The graphical data may be processed in the user interface circuitry 544 or it may go directly to the processor 540 or the memory 542. The processor 540 may also perform processing functions, such as compression.

A PID data application may be used to perform functions that may implement the display input, the display output, and the processing functions. For example, a contacts application may be used to accept and maintain user input consisting of information about the user's personal or business contact. The information, or contacts data is provided by the user at the display input 565 with a stylus on the display screen of a PDA. The contacts application could then display the contacts data through the display output 562 to enable the user to see a visual representation of the user input.

If the user desires to share the contacts data with a second user on the system 200, where the second user is using a second PID such as PID 220a, the contacts data from the contacts application can be transmitted through one of the point-to-point interfaces 545, allowing the data to be received by the data network telephone 208a. An application in
5 the data network telephone 208a receives the contacts data across the point-to-point link, and the contacts data is prepared for transmission across the data network 206, such as by the media engine 241 shown in FIG. 3. Preferably the contacts data is converted to data packets and is communicated on a data channel across the LAN 212 through the router 228 across the data network 206 through the second router 238 across the cable network
10 214 to the third data network telephone 218a. The third data network telephone 218a converts the data packets received on the data channel into the contacts data. The contacts data is then transmitted across a point-to-point link to the second PID 220a, where it may be displayed on a display screen on the PID 220a. The PID 220a may contain a similar contacts program as that which was referenced to the PID 210a,
15 allowing the user of the PID 220a to modify the information and transmit the modifications back across the point-to-point link to the third data network telephone 218a across the cable network 214 through the second router 238 across the data network 206 through the first router 228 across the LAN 212 to the first data network telephone 208a across the point-to-point link and back to the first PID 210a.

20 The point-to-point link 209a may be a serial bit stream between an application in the first PID 210a and an application in the first data network telephone 208a. For example, the link 209a could be an infrared link that is implemented with minimal stack interpretation. However, the link 209a between PID 210a and the first data network telephone 208a can alternatively be implemented as an infrared link using all or parts of a
25 specialized protocol, such as the Infrared Data Association (IrDA) protocol stack, where data is interpreted through the stack between application-layer processes at each end of the link.

FIG. 5 is a protocol diagram illustrating the layers of the IrDA protocol stack. An IrDA stack is implemented at each of the connection endpoints of an IrDA link. For
30 example, the first PID 210a and the first data network telephone 208a could each implement an IrDA protocol stack to enable the link 209a. As a second alternative, two

PIDs, such as the first PID 210a and the third PID 218a, may each contain an IrDA stack. In the second alternative, the communications between the PIDs and the data network telephones might take place without the assistance of IrDA. For example, IrDa data from the first PID 210a might be transmitted across the link 209a as a serial stream of data to
5 the first data network telephone 208a, which might treat the IrDA data like any other data received from the first PID 210a. The first data network telephone 208a could then assemble the IrDA data into packets, such as TCP/IP packets for transport across the access and data networks to the third data network telephone 218a. The third data network telephone 218a may disassemble the packets and forward the IrDA data (without
10 interpreting the IrDA portions) across the link 219a to the third PID 220a. The third PID 220a could then process the IrDA information received across the networks.

The required layers of an IrDA protocol stack are the physical layer 602, the IrLAP layer 604, the IRLMP layer 606 and the IAS layer 608. The physical layer 602 specifies optical characteristics of the link, encoding of data, and framing for various
15 speeds. The IrLAP (Link Access Protocol) layer 604 establishes the basic reliable connection between the two ends of the link. The IrLMP (Link Management Protocol) layer 606 multiplexes services and applications on the IrLAP connection. The IAS (Information Access Service) layer 608 provides a directory or "yellow pages" of services on an IrDA device.

The IrDA protocol also specifies a number of optional protocol layers, these
20 protocol layers being TinyTP 610, IrOBEX 612, IrCOMM 614 and IrLAN 616. TinyTP (Tiny Transport Protocol) 610 adds per-channel flow control to keep traffic over the IrDA link moving smoothly. This important function is required in many cases. IrOBEX (Infrared Object Exchange protocol) 612 provides for the easy transfer of files and other
25 data objects between the IrDA devices at each end of the link. IrCOMM 614 is a serial and parallel port emulation that enables existing applications that use serial and parallel communications to use IrDA without change. IrLAN (Infrared Local Area Network) 616 enables walk-up infrared LAN access for laptops and other devices. The use of the optional layers depends upon the particular application in the IrDA device. The IrDA
30 protocol stack is defined by such standards documents as "IrDA Serial Infrared Physical Layer Link Specification", "IrDA 'IrCOMM': Serial and Parallel Port Emulation over IR

(Wire Replacement)", "IrDA Serial Infrared Link Access Protocol (IrLAP)", "IrDA Infrared Link Management Protocol (IrLMP)", and "IrDA 'Tiny TP': A Flow-Control Mechanism for use with IrLMP", and related specifications published by the IrDA and available at <http://www.irda.org/standards/specifications.asp> and is incorporated by
5 reference herein.

The IrDA protocol stack can be implemented at just the PID devices at the endpoints with the intermediate phones and networks simply providing a tunnel for the media stream attendant to the infrared links. Since PIDs, such as the Palm PDA, already have an IrDA stack implemented in them to support their infrared link to other devices
10 and the benefits of the IrDA stack are already available. By using the layers of the IrDA protocol stack, the PID applications and the base applications in the phones can be simplified as the IrDA protocol layers take over certain functionalities. For example, the IrOBEX layer in each IrDA protocol stack can be used to transfer text and graphics object files, such as electronic business cards or whiteboard graphics, end-to-end between
15 PID devices connected via data connected data network telephones..

With the IrDA stack being implemented only in the PIDs and not in the phones, only a small level of delay is introduced for stack interpretation by each PID and the connection provided is largely transparent to the applications in the PID devices, i.e. little or no modification to existing user applications in the PIDs is required. This approach
20 may be more suitable for delay sensitive applications, such as interactive games involving the transfer of data between user applications in each PID.

It should be noted that the IrDA stack is written for a single infrared point-to-point interface and not for an infrared-to-network-to-infrared interface. As a result, the timers and retransmission schemes implemented in view of the single infrared point-to-
25 point interface may not function properly for the extended network interface.

Alternatively, IrDA stacks can be implemented in the phones as well. By implementing IrDA stacks in the phones, the timing of the infrared interface is unaffected by a network delay. Also, additional functions and features can be implemented in the phones. For example, the phones can implement challenge and authentication where the
30 phone requires the user, through the PID, to enter a password or other information to authenticate an authorized user. Similarly, the PID may also be used to transmit

commands to the phone and receive status information via the IrDA stack. The approach taken will depend upon the requirements of the design and the particular application.

6. Providing Telephony and PID Data Exchange

FIG. 6 is a functional block diagram and protocol stack diagram illustrating an embodiment of the protocol stacks in the first PID 210a and the first data network telephone 208a that support link 209a. In the infrared RS-232 embodiment, the link interface circuitry 545 in the first PID 210a provides the physical layer 656, such as that specified by the Infrared Data Association (IrDA), that connects via link 209a to the link interface circuitry 260 implementing a physical layer 664 in the first data network telephone 208a. The data link layer 654 in the first PID 210a provides data link control for link 209a in transferring data to and from a PID application client 652. Similarly, the first data network telephone 208a includes a data link layer 662 and a base application server 600 that is configured to synchronize connection and other functions with the PID application 652 in the first PID 210a.

When PID 210a is activated, either through power-up or through a user input at the user interface 650, the synchronization application client 652 in the PID 210a may send the user's SIP URL across the link 209a to the first data network telephone 208a, where it is received by the synchronization application server 600. The synchronization application server 600 sends the SIP URL received from the PID 210a across connection 230 and the Ethernet LAN 212 through connection 243 to the network telephony connection server 150. The network telephony connection server 150 may store the SIP URL and the IP address of the associated data network telephone 208a in the SIP database 152 so that the SIP URL is listed as being resident at the IP address of the data network telephone 208a. (If the network telephony connection server 150 uses a location server for registration/location tasks, the registration information might instead be stored with such a location server). SQL (Structured Query Language) is preferred for querying the database. Once the PID 210a is registered with the network telephony connection server 150, calls to the SIP URL for PID 210a (or the user of the PID 210a) will be directed to the data network telephone 208a.

FIG. 7 is a functional block and protocol stack diagram illustrating an embodiment of the present invention where a SIP connection is established from the first data network phone 208a to the third data network phone 218a through network connection 230, first access network 212, data network 206, second access network 214 and network connection 236. The routers 228 and 238, and associated connections 232a-b and 234a-b, are not shown to simplify the block diagram representation.

The diagram of FIG. 7 shows how PID data from a PID application can be passed from one PID to another PID in one aspect of the present invention. The PID application 652 in PID 210a is configured to send PID data input through the user interface 650 through link 209a to base application 660 in the first data network phone 208a. In this embodiment, base application 660 is configured to define data channels for transport to the third data network telephone 218a.

Multiple data channels in SIP may be defined through the Session Description Protocol described in RFC 2327, herein incorporated by reference. Included in a SIP INVITE request for a connection are options for the requested connection that describe the number and type of media streams. Each media stream is described by a "m=" line in the INVITE request. For example, a request for a connection that includes an audio stream and a bidirectional video stream using H.261 might look like this:

```

20          v=0
           o=alice 2890844526 2890844526 IN IP4 host.anywhere.com
           c=IN IP4 host.anywhere.com
           m=audio 49170 RTP/AVP 0
           a=rtpmap:0 PCMU/8000
25          m=video 51372 RTP/AVP 31
           a=rtpmap:31 H261/90000

```

TABLE 1.

If the called device includes functionality to receive the connection as described in Table 1, then the called device will respond to the INVITE request with a 200 OK response that includes the same option values. If the called device or party is unable or

unwilling to receive such a connection, then it will respond with alternative option values for the connection. See RFC 2543 for further details regarding the negotiation of connection parameters in SIP.

In FIG. 7, a first data channel for voice data and a second data channel for PID data have been negotiated by the base applications 660 in the first data network telephone 208a and the base application 674 in the second data network telephone 218a. The base applications 660 and 674 transfer voice data between the AUDIO applications, such as applications including G.711 encoders, in each phone via the first data channel. The base application 660 in phone 208a is also configured to send the PID data received via link 10 209a from PID 210a to the base application 674 in phone 218a via the second data channel. The base application in phone 218a is configured to forward the PID data received via the second data channel to PID 220a via link 219a. The PID application 688 in PID 220a then outputs the user data received from phone 218a to the user interface 686 for output to the user of PID 220a. Depending on the particular application being used in 15 the PID 220a, the PID data may also be used in application functions.

The PID data in FIG. 7 can take a variety of forms. For example, the PID data can be a text file containing information about the user of PID 210a, such as an electronic business card. The PID data can also be drawing data generated by graphical applications in the PIDs 210a and 220a whereby a user drawing on a touchscreen of the 20 user interface 650 in PID 210a generates corresponding PID data that is transmitted via the second data channel to PID 220a for display on the user interface 686 of PID 220a. The media description for the media stream can be defined during connection setup to establish a connection appropriate to the type of data being transferred. These examples represent just a few of the applications for this aspect of the present invention and should 25 not be viewed as limiting the present invention.

In one embodiment, RTP data packets for two or more types of data are exchanged between the first data network telephone 208a and the second data network telephone 218a according to one of three possible methods. In the first method, one RTP data channel (or RTP stream) on UDP carries data packets in which both data types are 30 present in a single split packets. Each such split packet contains (1) a source port number and a destination port number in the UDP portion, and (2) a special payload sequentially

including each of the data types in the RTP portion. The special payload type can be defined in the SDP described with reference to FIG. 6. Other information is also contained in each packet as well. In the second method for transmitting two or more data types, a separate RTP over UDP data channel is created for each of the different data types, and the RTP header indicates which type of data is contained in each packet. For example, voice data coded as G.711 might be assigned a payload type code of 0, while PID data is assigned a payload type code of 190. In the third method for transmitting two or more data types, a single RTP/UDP data channel (RTP/UDP stream) is created that contains data packets of two or more different types. In this method, the data types are identified in a payload type field in the RTP header of each packet, enabling an underlying application to identify which data packets are voice data packets and which data packets are PID data packets, for example.

C. Providing PID Data Exchange Concurrent with Voice Services

FIGs. 8-10 are block diagrams illustrating exemplary embodiments of the present invention. Various elements within FIGs. 8-10 are similar to or identical to elements in FIG. 2, and accordingly share common reference numerals. Although only two PIDs 210a and 220a are shown in FIGs. 8-10, this is not intended to be limiting. More than two PIDs may be involved in a session. The quantity of PIDs is limited by the bandwidth of the access and data networks, and the characteristics of the data to be utilized in the shared environment. To communicate with additional PIDs, additional data channels are created by the data network telephones.

1. Non-Continuous PID Data Transmission with Separate Data Channels for PID Data and Voice Data

FIG. 8 shows an exemplary embodiment of the present invention in which separate data channels are used for PID data and voice data, and in which PID data may be transmitted on a non-continuous basis. The first PID 210a includes a display screen 702, a stylus 700 that a user can use to enter PID data into the first PID 210a, and an SYNC button 718.

The display screen 702 is shown as a pressure-sensitive display screen in which the stylus 700 can be used to enter PID data 714 into the first PID 210a. In the example shown in FIG. 8, the PID data 714 consists of a drawing 704 that is a tic/tac/toe game. The stylus is being used to draw a modification 706 (an "O") as part of a tic/tac/toe game with a user of the second PID 220a. The second PID 220a also contains a display screen 708, a SYNC button 720, and a stylus, which is not shown in FIG. 8. The display screen 708 on the second PID 220a also displays the drawing of the tic/tac/toe game between the user of the first PID 210a and the user of the second PID 220a.

In the embodiment shown in FIG. 8, the modification 706 to the drawing 704 is not transmitted continuously as the modification is being made by the stylus 700. Instead, the PID data 714, including the modification 706, is only transmitted when the user of the first PID 210a synchronizes the first PID 210a with the first data network telephone 208a. For example, the user may synchronize the first PID 210a by pressing the SYNC button 718 to cause the PID data 714 to be transmitted across the link 209a to the first data network telephone 208a. As a second example, a predefined stylus-stroke may be executed by the user of the stylus 700 to the display screen 702 to cause the PID data 714 to be transmitted to the first data network telephone 208a. An example of a stylus-stroke is a long stroke from the bottom to the top of the display screen 702. In an alternative aspect of this embodiment of the invention, a PID application 652, such as a drawing application, may periodically transmit the PID data 714 at predefined time intervals to the first data network telephone 208a. If the predefined time intervals are short, the transmission of the PID data 714 will approach the appearance of a continuous transmission of the PID data from the first PID 210a to the first data network telephone 208a.

When the first data network telephone 208a receives the PID data 714, an application within the first data network telephone 208a will place the PID data 714 into PID data packets for transmission to the second data network telephone 218a across the access and data networks 212, 206 and 214 (and any associated connections and routers). The second data network telephone 218a then removes the received PID data 716, the PID data packets and transmits the PID data 716 across the second link 219a to the second PID 220a for display on the display screen 708. The PID data packets

communicated between the first and second data network telephones 208a and 218a are on a PID data channel 724. In the exemplary embodiment of FIG. 8, the PID data channel 724 is the second of two data channels. A voice-over-data channel 722 is the first data channel between the first data network telephone 208a and the second data network telephone 218a. The voice-over-data channel 722 carries voice-over-data packets assembled by the data network telephones 208a and 218a that contain voice signals 726 and 728 spoken by the users of the PIDs 210a and 220a. As a result of the dual data channels, the users of the PIDs 210a and 220a may participate in a conversation while they are playing their tic/tac/toe game in the example shown.

One advantage of the examples described herein of the present invention is that the PID data is not limited to graphical or image data. The type of data transmitted conforms to the application being used. For example, in the example described above with reference to FIG. 8, the tic-tac-toe game may be played with a tic-tac-toe game application as opposed to simply a drawing program. The tic-tac-toe game may determine the winner and draw the line through the winning row or column. The game may also keep a record of games won v. games lost for each user.

The PID data channel 724 is shown as being transported by using TCP over IP. This is merely one method for transporting the graphical data packets. Other transport protocols may also be used. A TCP/IP implementation may be particularly advantageous for non-continuous graphical data transmission embodiments of the present invention. This is due to TCP's congestion avoidance mechanisms. Therefore, if PID data packets are being lost (which may be the result of a congested network), TCP may reduce the transmission packet size (the window) to alleviate some of the congestion and to provide better performance. By reducing the quantity of PID data on such a congested network, the other network traffic (such as the voice data) should also experience better performance (fewer lost packets, etc.), which can be important for voice data applications. The voice-over-data channel 722 is shown as an RTP/UDP/IP channel. Such a channel will be described in more detail with reference to FIG. 9.

Note that with the non-continuous PID data transmission embodiment of the present invention, when a user inputs PID data into the first PID 210a, the PID data does not appear on the display screen of the second PID 220a until the PID data 714 is

transmitted to the first data network telephone 208a. Therefore, in FIG. 8, the user has begun making a modification 706 to the drawing 704, but has not synchronized the PID 210a with the first data network telephone 208a. As a result, the drawing 710 on the display screen 708 of the second PID 220a does not yet contain the modification 706 (see the open box 734). When the user of the first PID 210a has completed the modification 706 and has synchronized the PID 210a with the first data network telephone 208a, the PID data will be transmitted through the data network telephone 208a through the access and data networks 212, 206 and 214, through the second data network telephone 218a and to the second PID 220a in the box 734 on the display screen 708 of the second PID 220a.

2. Continuous PID Data Transmission with Separate Data Channels for PID Data and Voice Data

FIG. 9 is a block diagram showing a second exemplary embodiment of the present invention. This embodiment differs from the embodiment illustrated by the example of FIG. 8 because PID data is continuously transmitted from the PID 210a across the first link 209a to the first data network telephone 208a, where it is packetized and transported across the access and data networks to the second data network telephone 218a. At the second data network telephone 218a, the PID data packets are disassembled, and PID data 716 is sent to the second PID 220a for display on the display screen 708 of the second PID 220a. Therefore, the user of the second PID 220a is able to see the modification 712 as the modification 706 is being drawn by the user using the stylus 700 on the first PID 210a, although there may be some network delay and delay due to the packet assembly and disassembly operations.

To accomplish the continuous transmission of PID data 714 from the first PID 210a to the first network communication device 208a, the PID application 652 continuously transmits PID data, such as pixel information, to the data network telephone 208a as the PID data is received by the PID 210a through the user interface 650. The base application 660 in the first data network telephone 208a receives the PID data transmitted by the PID 210a and converts the PID data into PID data packets for transmission on a PID data channel 730. The PID data channel 730 is shown as being

transported across the access and data network 212, 206, and 214 using the RTP protocol over UDP which is on top of IP. Other protocol implementations may also be used, but the continuous nature of the PID data transmission in the example of FIG. 9 lends itself well to the use of RTP/UDP/IP. Similarly, the voice-over-data channel 722 is also shown as an RTP/UDP/IP channel, to take advantage of the real-time properties of voice data 726 and 728.

3. Continuous PID data Transmission with a Mixed-Media Data Channel for PID data and Voice Data

FIG. 10 is a block diagram showing a third exemplary embodiment for providing PID data exchange concurrently with voice services in which PID data 714 is continuously transmitted from the first PID 210a to the first data network telephone 208a for transport across the access and data networks 212, 206, and 214 to the second data network telephone 218a, where PID data 716 is then transmitted to the second PID 220a for display on the display screen 708 of the second PID 220a. As in the exemplary embodiment shown in FIG. 9, a graphical modification 706 on the first PID 210a is continuously transmitted as the modification is being made so that similar representation of the modification 712 appears on the second display screen 708 on the second PID 220a, after processing and propagation delays.

The main difference between the embodiment of FIG. 9 and the embodiment of FIG. 10 is that in FIG. 10 PID data 714 and the voice data 726 are transported across a single data channel. The first data network telephone 208a receives the voice data 726 and the PID data 209a through the user interface circuitry 260 and one of the link interfaces, such as the infrared link interface 252/250/254 as shown in FIG. 3. The processor 240 (or a portion of the processor 240, such as media engine 241) assembles a data packet, such as an RTP packet, in which the payload consists of a portion that represents the voice data 726 and a second portion that represents the PID data 714. The header of the RTP packet contains a "payload type" field, which is a 7-bit field identifying the format of the RTP payload and which determines the payload's interpretation by an application. RTP allows a profile to specify a default static mapping of payload type codes to payload formats. Additional payload type codes may be defined

dynamically through non-RTP means. All that is required is that the receiving device, such as the second data network telephone 218a, be able to disassemble the mixed media packet into voice data 728 and PID data 716. Although RTP has been described for implementing the mixed media, data packets, other similar protocols may also be used.

5 While the invention has been described in conjunction with presently preferred embodiments of the invention, persons of skill in the art will appreciate that variations may be made without departure from the scope and spirit of the invention. For example, the access networks shown in FIG. 2 may comprise any other suitable type of local area network or service infrastructure.

10 In addition, protocols of various types are referenced throughout. While preferred and alternative embodiments may implement selected protocols, any suitable replacement protocol not mentioned, or any function not part of a protocol used to replace a corresponding function from a protocol may be implemented without departing from the scope of the invention.

15 This true scope and spirit is defined by the appended claims, interpreted in light of the foregoing.

WE CLAIM:

1. A system for exchanging data on a data network telephony system comprising:
a data network to provide data connectivity for a plurality of data communications channels using data transport protocols;

5 first and second data network telephones connected to the data network, each data network telephone operable to communicate a voice signal as voice-over-data packets on a voice-over-data channel, the voice over data channel being one of the plurality of data communications channels on the data network, the data network telephones operable to convert voice-over-data packets communicated on the voice-over-data channel to voice signals;

10 a first portable information device comprising a first graphical user interface and a first data network telephone interface, the first graphical user interface operable to accept and display PID data, the first data network telephone interface operable to communicate PID data to and from the first data network telephone; and

15 a second portable information device comprising a second graphical user interface and a second data network telephone interface, the second graphical user interface operable to accept and display PID data, the second data network telephone interface operable to communicate PID data to and from the second data network telephone,

20 wherein the first PID communicates PID data to the first data network telephone, the first data network telephone communicates the PID data to the second data network telephone, and the second data network telephone communicates the PID data to the second PID..

2. The system of Claim 1 wherein:

at least a first and second user communicate on the voice-over-data channel and the PID data channel, each user identified by a user identifier that includes a unique sequence of alpha numeric elements

5
3. The system of Claim 2 wherein each data network telephone includes a device identifier that corresponds to the user identifier.

4. The system of Claim 3 wherein the device identifiers include Internet Protocol (IP) addresses.
5. The system of Claim 3 wherein the user identifiers include Session Initiation Protocol (SIP) addresses.
6. The system of Claim 3 wherein the user identifiers include E.164 telephone numbers.
7. The system of Claim 1 further comprising:
 - a network telephony user database connected to the data network to store a user identifier and a telephone identifier corresponding to the user identifier for each of a plurality of users, wherein:
 - 5 the user identifier includes a first sequence of alphanumeric elements that identify a corresponding user;
 - the telephone identifier includes a second sequence of alphanumeric elements that identifies a corresponding data network telephone; and
 - 10 a network telephony connection server operable to receive a request message from the first data network telephone to initiate the voice over data channel and the PID data channel with the second data network telephone, and to send a response message in response to the request message.
8. The system of Claim 7, wherein the response and request messages are communicated by the network telephony connection server in accordance with the Session Initiation Protocol (SIP).
9. The system of Claim 7, wherein the response and request messages are communicated by the network telephony connection server in accordance with the H.323 Protocol.

10. The system of Claim 7 wherein the response and request messages are communicated by the network telephony connection server in accordance with the MGCP protocol.
11. The system of Claim 7 wherein the response and request messages are communicated by the network telephony connection server in accordance with the MEGACO protocol.
12. The system of Claim 7 wherein:
the request message includes a callee user identifier; and
wherein the network telephony connection server determines the telephone identifier for the callee user identifier and includes the telephone identifier in the response message.
- 5
13. The system of Claim 7 wherein:
the request message includes a callee user identifier; and
wherein the network telephony connection server determines the telephone identifier for the callee identified in the callee user identifier and sends the response message to the callee at the telephone identifier.
- 5
14. A method for transferring data between first and second personal information devices (PIDs) across a network, the method comprising the steps of:
providing a first communication link between the first PID and a first network communication device coupled to the network;
providing a second communication link between the second PID and a second network communication device coupled to the network;
establishing a connection through the network between the first and second network communication devices, where the connection includes at least one media stream for transfer of data between the first and second PIDs;
selecting a data object in the first PID;

transmitting the selected data object from the first PID to the first network communication device over the first communication link;

transferring the selected data object from the first network communication device over the media stream to the second network communication device; and

transmitting the selected data object from the second network communication device to the second PID over the second communication link.

15. The method of claim 14, the method further including the step of providing a location server accessible via the network and where the step of establishing a connection through the network further comprises:

sending a connection request from the first PID to the first network communication device, where the connection request includes a user identifier value corresponding to the second PID;

responsive to the connection request, sending a query including the user identifier value to the location server;

searching in the location server for an entry matching the user identifier value, where the matching entry includes a network address value corresponding to the second network communication device;

when the matching entry is found, sending a response message with the network address value corresponding to the second network communication device from the location server to the first network communication device; and

setting up the connection from the first network communication device to the second network communication device using the network address value corresponding to the second network communication device.

16. The method of claim 15, the method further including the steps of:

sending a registration request including the user identifier value from the second PID to the second network communication device via the second communication link;

responsive to the registration request, sending a registration update message including the user identifier value from the second network communication device to the location server via the network; and

responsive to the registration update message, storing the matching entry having the user identifier value and the network address of the second network device in the location server.

17. The method of claim 16, where the location server further comprises a redirect server according to an Session Initiation Protocol (SIP).

18. The method of claim 14, the method further including the step of providing a location server accessible via the network and where the step of establishing a connection through the network further comprises:

 sending a connection request from the first PID to the first network communication device, where the connection request includes a user identifier value corresponding to the second PID;

 responsive to the connection request, sending a query including the user identifier value to the location server;

 searching in the location server for an entry matching the user identifier value, where the matching entry includes a network address value corresponding to the second network communication device;

 when the matching entry is found, sending a connection set-up message to the network address value corresponding to the second network communication device from the location server; and

 setting up the connection between the first network communication device to the second network communication device responsive to the connection set-up message.

19. The method of claim 18, the method further including the steps of:

 sending a registration request including the user identifier value from the second PID to the second network communication device via the second communication link;

 responsive to the registration request, sending a registration update message including the user identifier value from the second network communication device to the location server via the network; and

 responsive to the registration update message, storing the matching entry having the user identifier value and the network address of the second network device in the location server.

20. The method of claim 19, where the location server further comprises a proxy server according to an Session Initiation Protocol (SIP).

21. The method of claim 19, including the step of defining the connection through the network between the first and second network devices using a Session Description Protocol (SDP).

22. The method of claim 14, where the first and second communication links are infrared links.

23. The method of claim 22, further including the steps of:
providing a predetermined protocol stack in the first and second PIDs; and
transferring the selected data object between peer layers of the predetermined protocol stack.

24. A data network telephone for transferring data between a personal information device (PID) and a network, the device comprising:
means for communicating with the PID;
means for communicating with the network;
means for setting up a connection to another network communication device responsive to receiving a connection request command from the PID through the PID communication means, where the connection request command includes a user identifier value corresponding to the another network communication device and where the connection is defined to have at least one media stream for transferring data from the PID to another PID; and
means for receiving a selected data object from the PID and transmitting the selected data object through the media stream of the connection to the another network communication device.

25. The network communication device of claim 24, where the means for setting up a connection to another network communication device includes:
means for sending a query for the user identifier value to a location server;

means for receiving a response from the location server, where the response includes a network address for the another network communication device; and

means for connecting to the another network communication device using the network address from the response.

26. The network communication device of claim 25, where the means for connecting to the another network communication device further comprises Session Initiation Protocol (SIP) means for setting up the connection.

27. The network communication device of claim 26, where the means for connecting to the another network communication device includes means for defining the one media stream using a Session Description Protocol (SDP).

28. The network communication device of claim 25, further including means for receiving a registration request having another user identifier value from the PID and, responsive thereto, sending a registration update message, having the another user identifier value and another network address corresponding to the network communications device, to the location server.

29. The network communication device of claim 24 further including protocol means for communicating with a peer protocol means in the another PID.

30. The network communication device of claim 29, where the means for communicating with the PID further comprises an infrared communications link and where the protocol means further comprises an IrDA protocol stack.

31. The network communication device of claim 24, where the means for setting up a connection to another network communication device is further configured to set up another media stream for transferring data between the network communication device and the another network communication device simultaneous to the transfer of data between the PID and the another PID through the one media stream.

32. A system for transferring data between personal information devices (PIDs) across a network, the system comprising:

a first personal information device (PID) having a communication port, where the first PID is configured to transmit a connection request having a user identifier value through the communication port and where the first PID is configured to transmit a selected data object via the communication port;

a first network communication device having a communication port and a network interface connection coupled to the network, where the first network device is configured to receive the connection request and establish a connection with a second network communication device corresponding to the user identifier value from the connection request, where the connection includes a first media stream for transferring data between PIDs, and where the first network communication device is further configured to receive the selected data object via the communication port of the first network device and send the selected data object through the first media stream.

33. The system of claim 32, where:

the first network communication device is further configured to transmit a query message onto the network that includes the user identification value from the connection request and the first network communication device is configured to receive a response message through the network that includes a network address corresponding to the user identification value and establish the connection using the network address; and

the system further includes a location server having a network connection coupled to the network and a data store for storing entries that relate user identifier values to network addresses, where the location server is configured to receive the query message from the first network communication device that includes the user identifier value and, responsive thereto, search the data store for an entry corresponding to the user identifier value and, when a corresponding entry is found, send a response over the network to the first network communication device that includes the network address value from the corresponding entry.

34. The system of claim 33, where:
the user identifier value is a Session Initiation Protocol (SIP) Universal Resource Locator (URL);
the location server is a SIP location server operating in redirect mode; and
the first network device is configured to define the first media stream using a Session Definition Protocol (SDP).

35. The system of claim 32, where:
the first network communication device is further configured to transmit a query message onto the network that includes the user identification value from the connection request; and
the system further includes a location server having a network connection coupled to the network and a data store for storing entries that relate user identifier values to network addresses, where the location server is configured to receive the query message from the first network communication device that includes the user identifier value and, responsive thereto, search the data store for an entry corresponding to the user identifier value and, when a corresponding entry is found, establish the connection between the first network communication device and a network communication device corresponding to the network address value from the corresponding entry.

36. The system of claim 33, where:
the user identifier value is a Session Initiation Protocol (SIP) Universal Resource Locator (URL);
the location server is a SIP location server operating in proxy mode; and
the first network device is configured to define the first media stream using a Session Definition Protocol (SDP).

37. The system of claim 32, where the system includes a second PID coupled to the second network communications device, and where the first network communications device is further configured to establish a second media stream for transferring data between the first and second network communications

devices while data is simultaneously transferring between the first and second PIDs via the first media stream.

FIG. 1

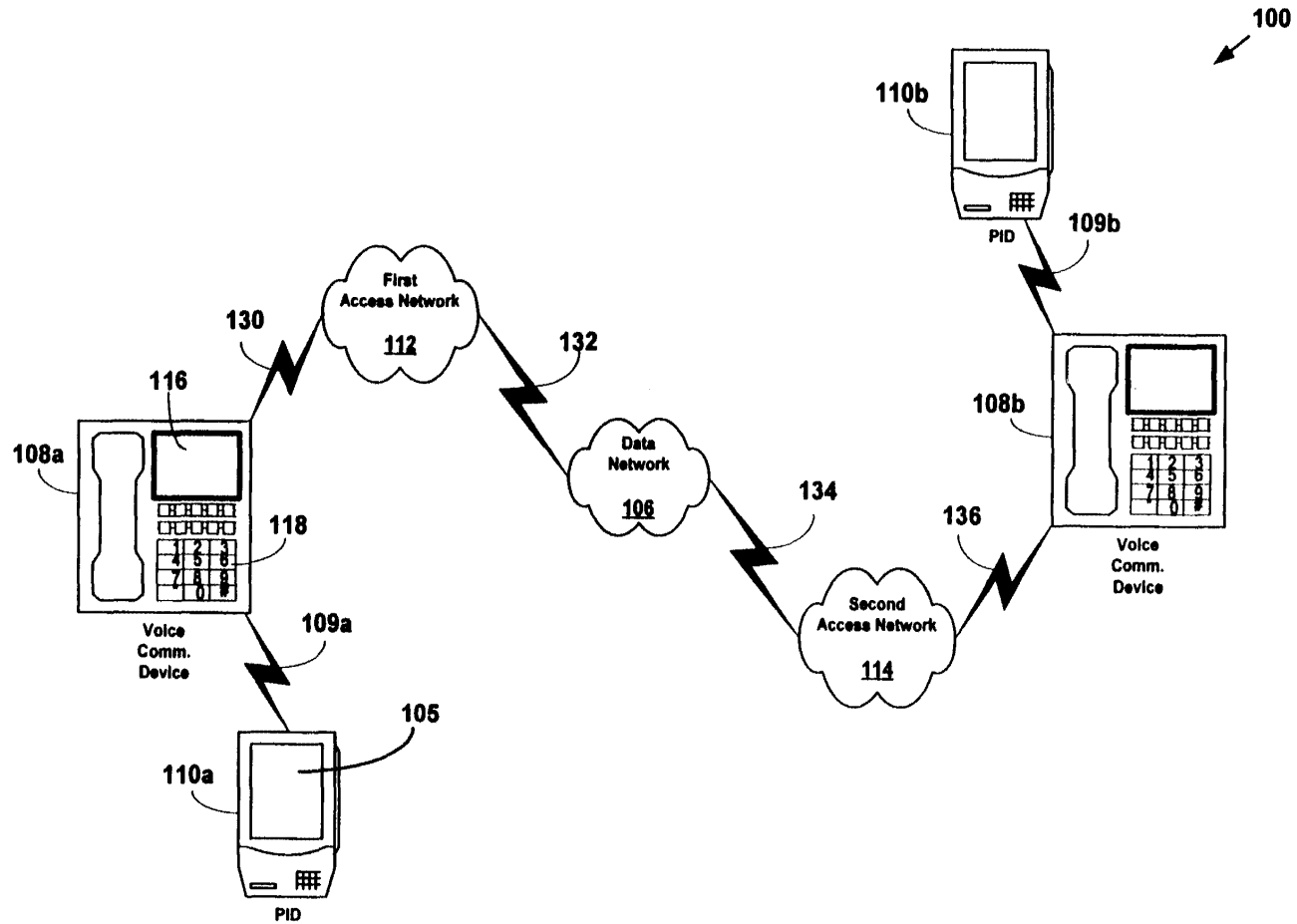
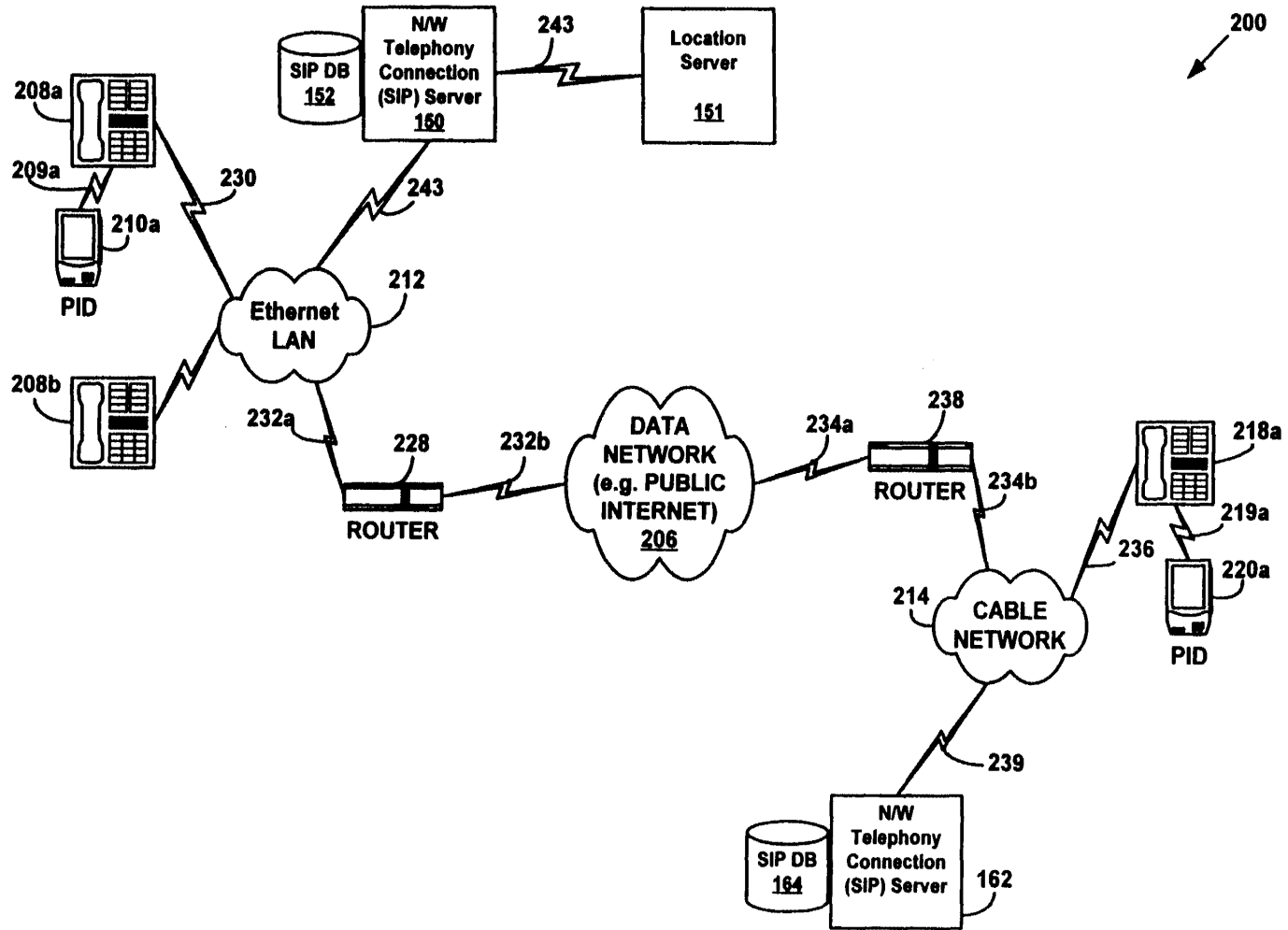

FIG. 2



WO 01/24503

2 / 10

PCT/US00/26650

FIG. 3

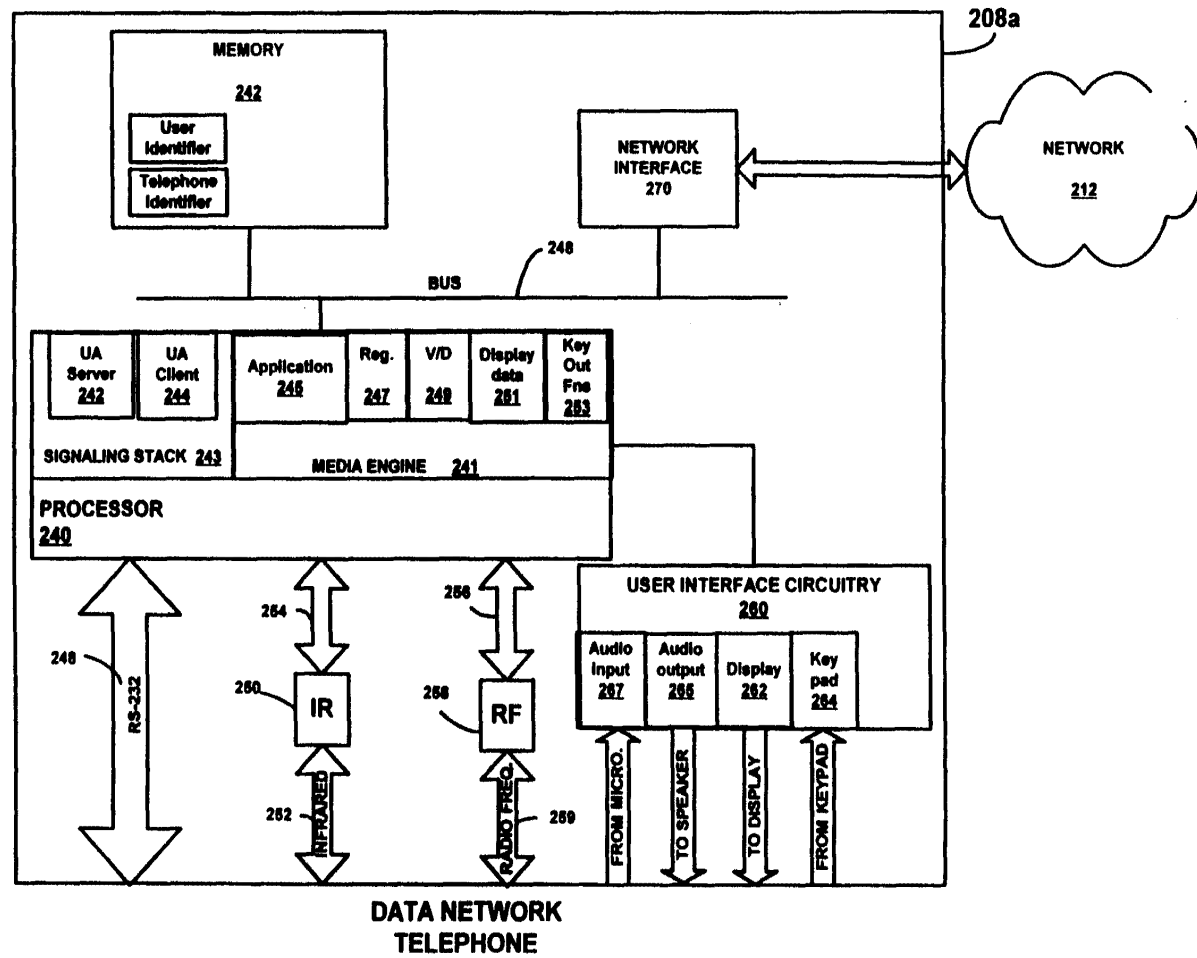
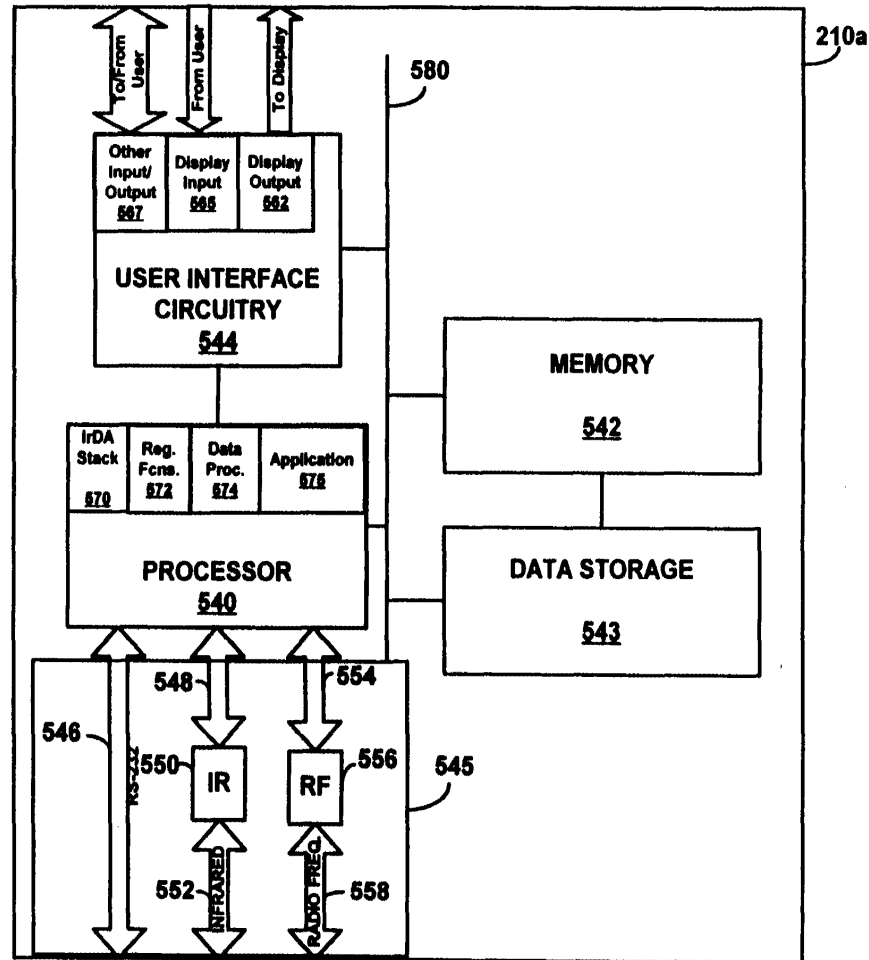

FIG. 4



PID

FIG. 5

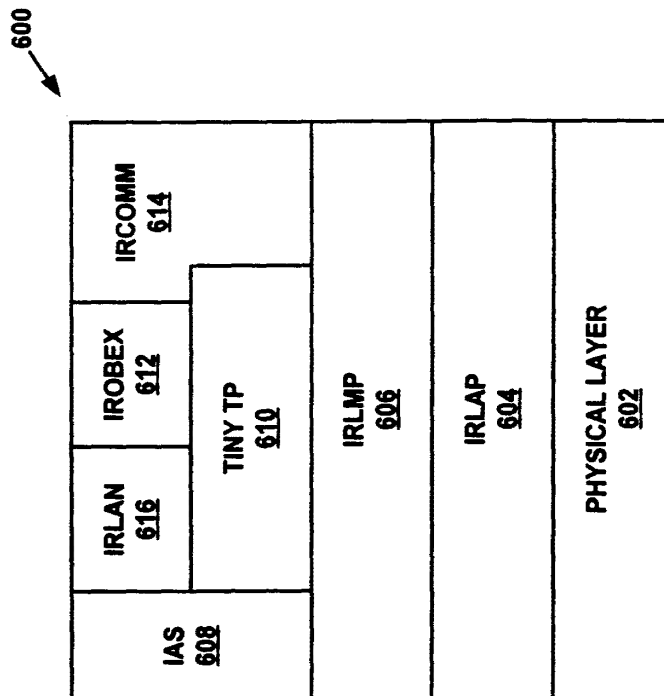

FIG. 6

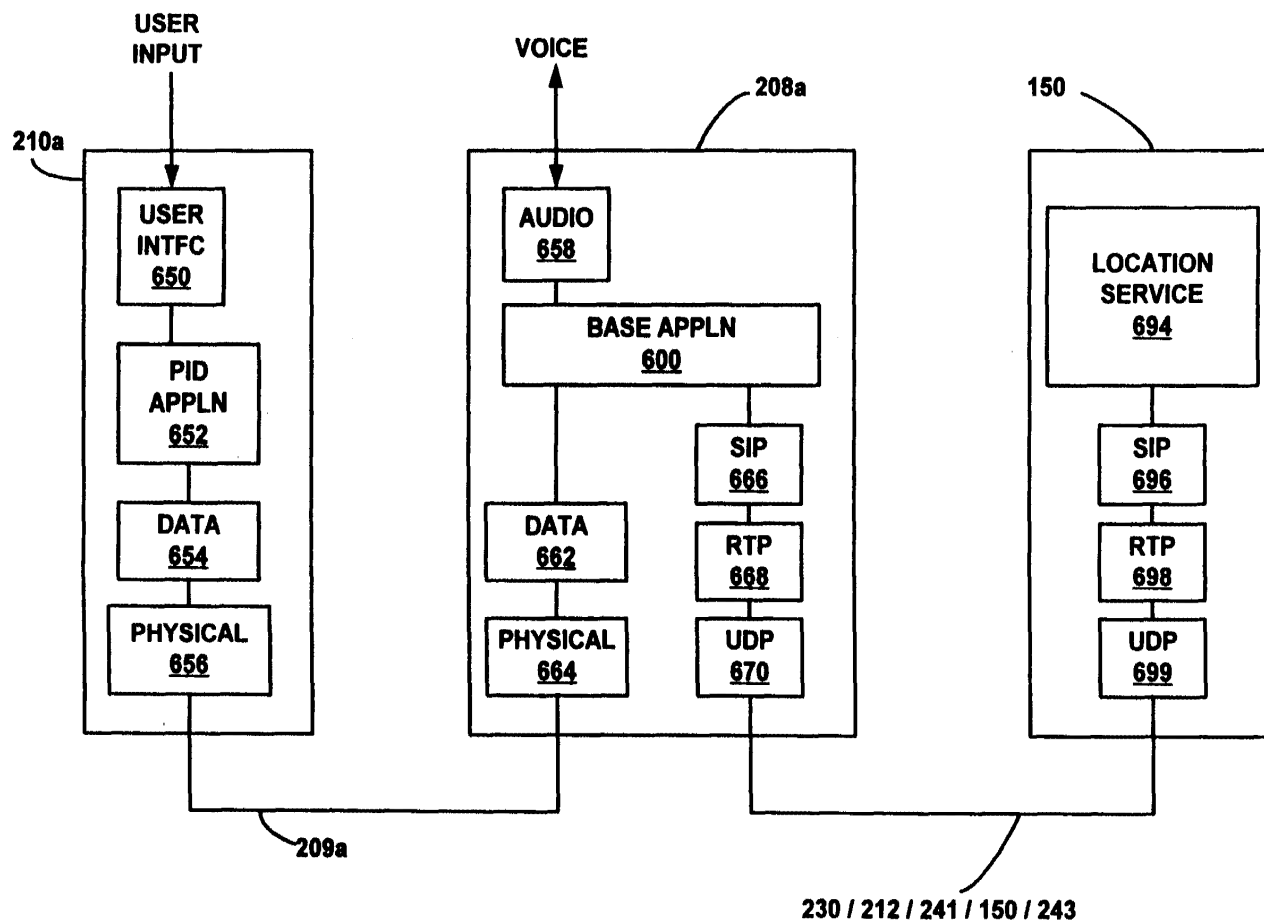

FIG. 7

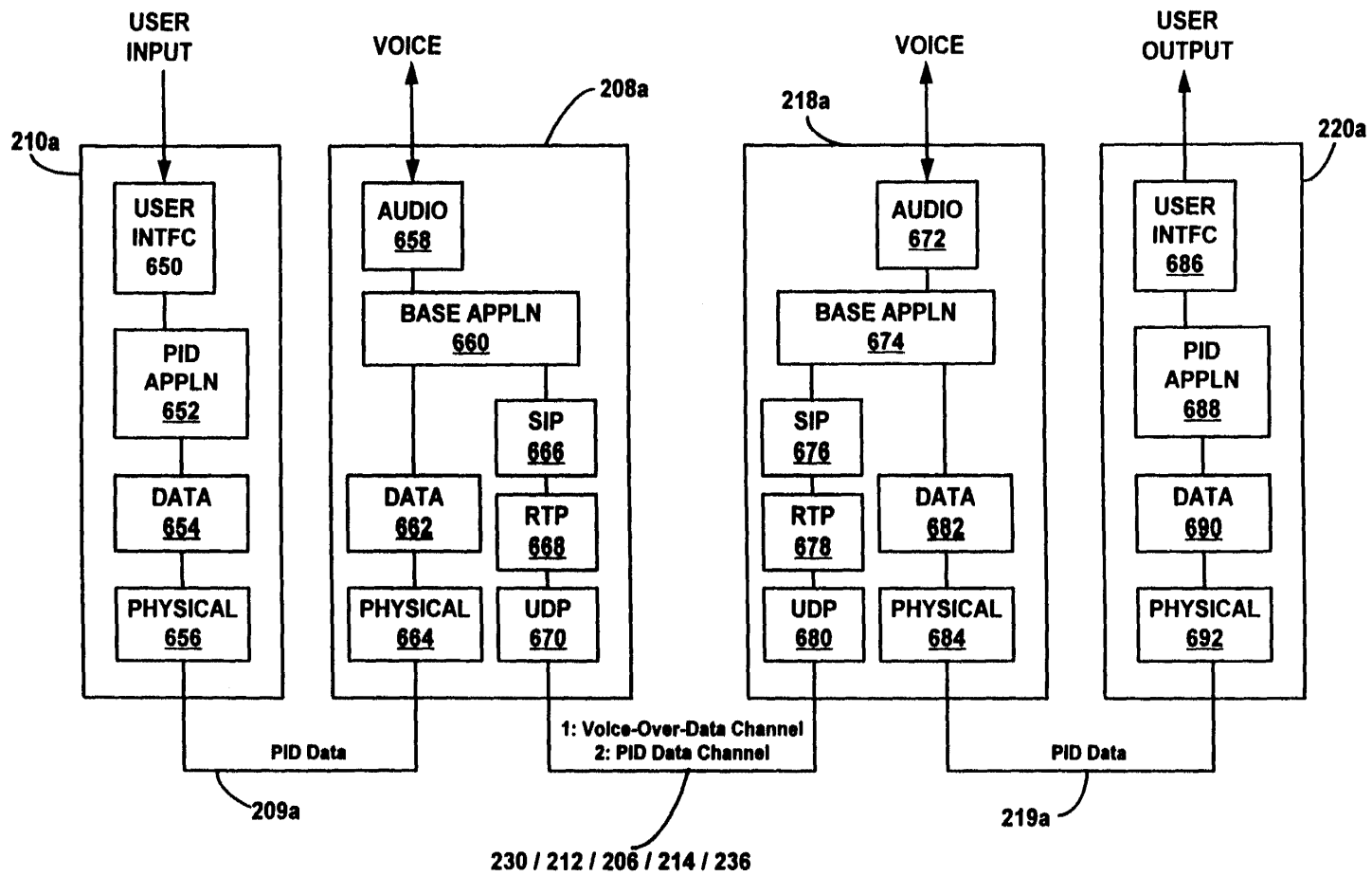

FIG. 8

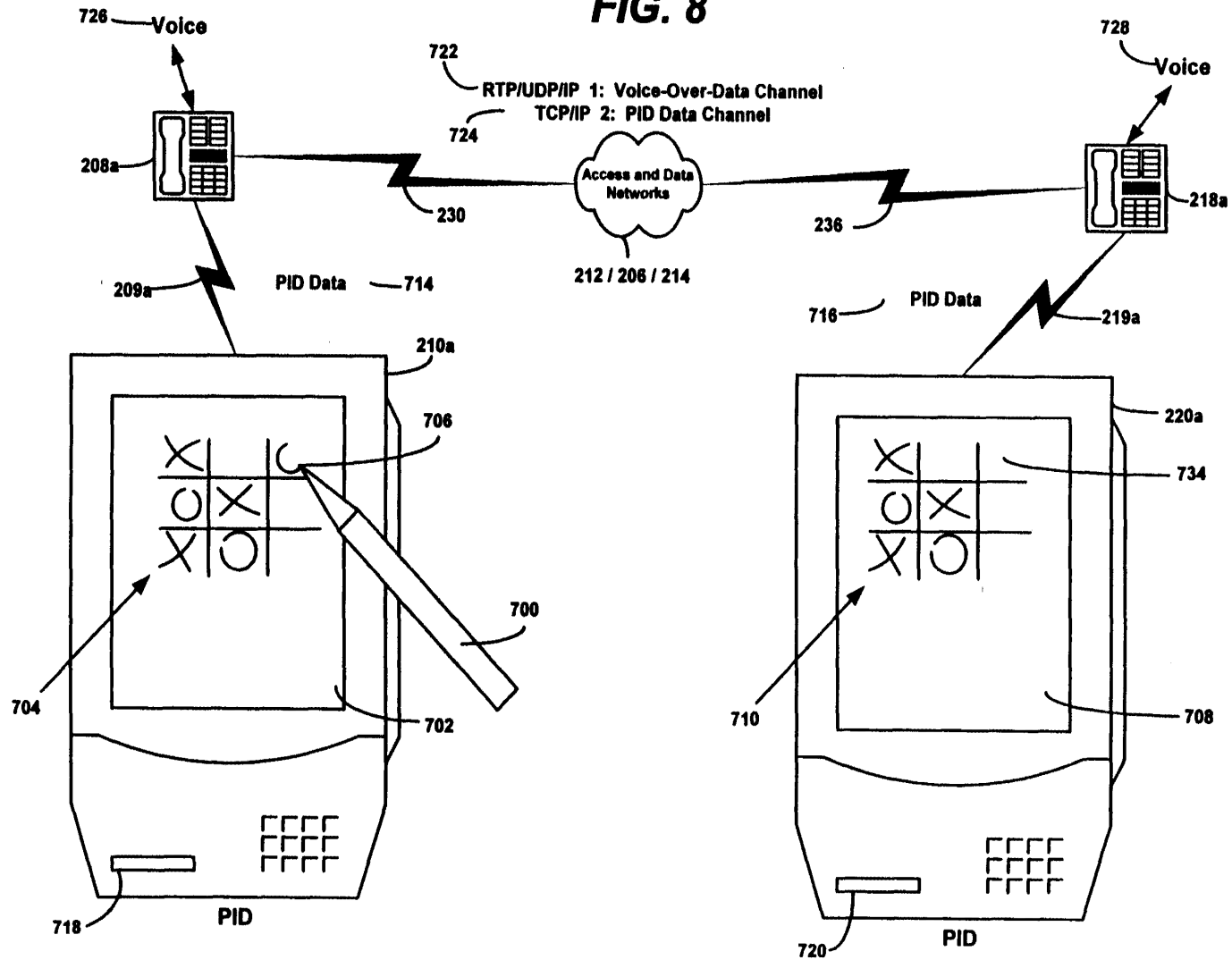

FIG. 9

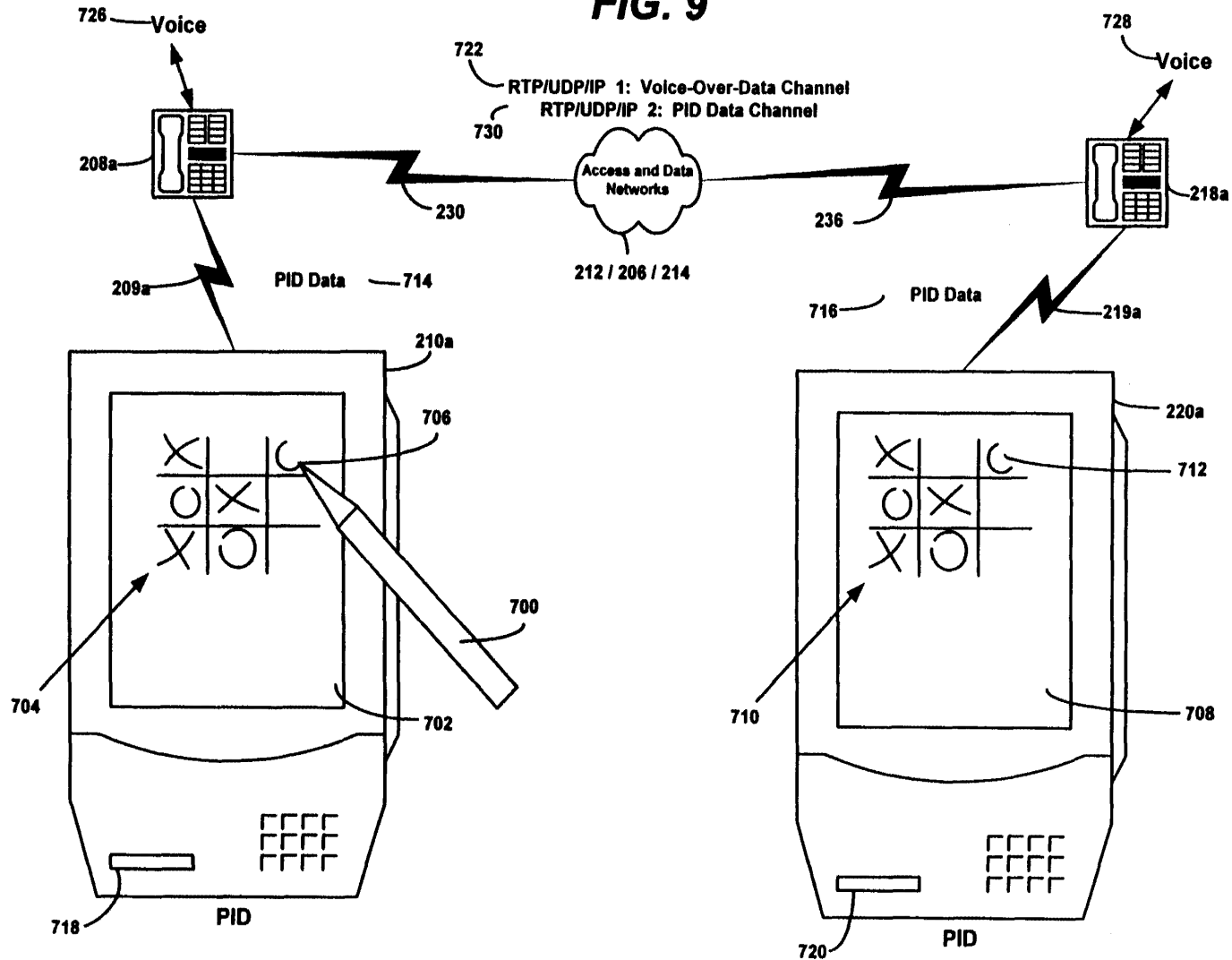
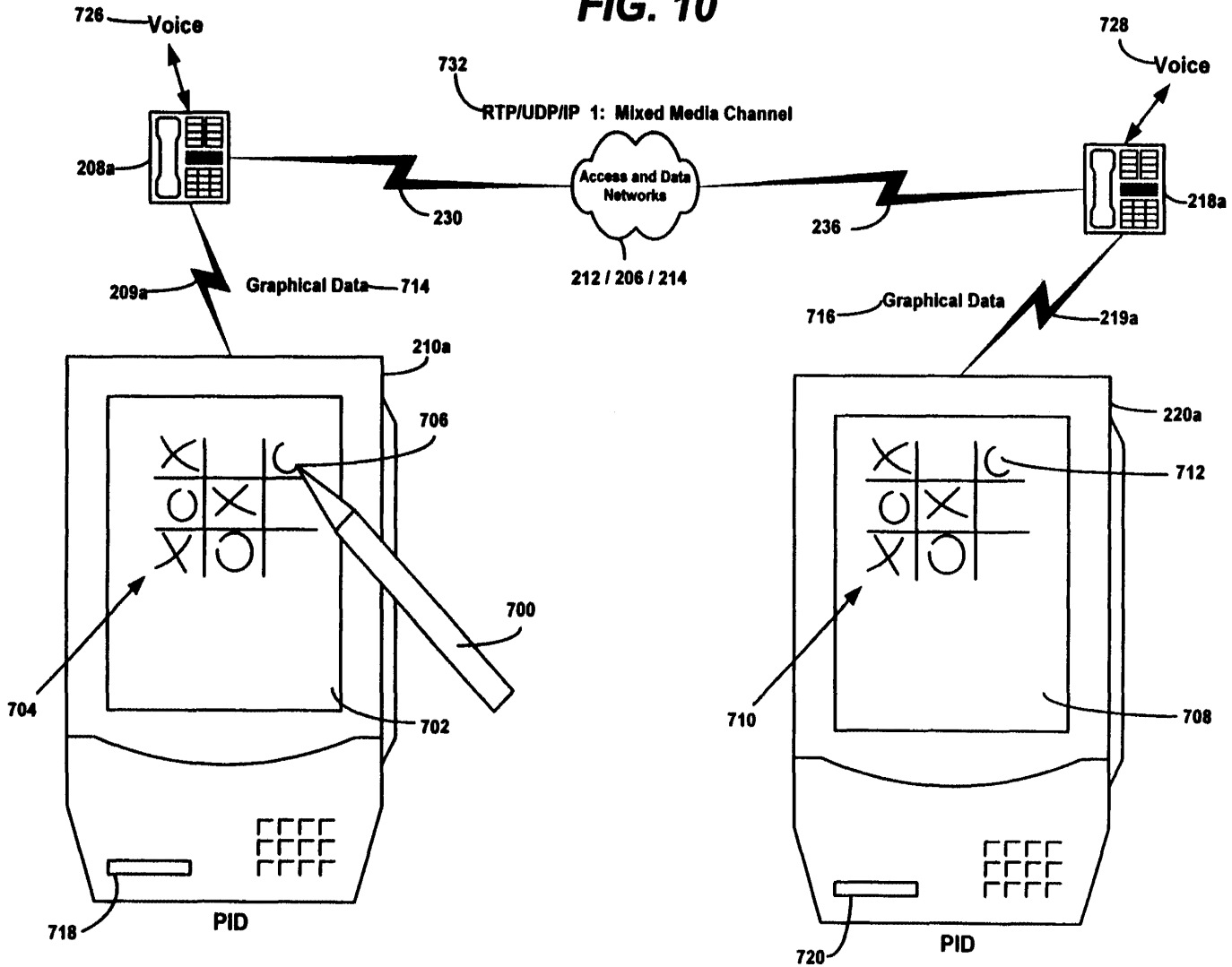

FIG. 10



INTERNATIONAL SEARCH REPORT

I. National Application No PCT/US 00/26650
--

A. CLASSIFICATION OF SUBJECT MATTER IPC 7 H04M7/00				
According to International Patent Classification (IPC) or to both national classification and IPC				
B. FIELDS SEARCHED				
Minimum documentation searched (classification system followed by classification symbols) IPC 7 H04M H04L				
Documentation searched other than minimum documentation to the extent that such documents are included in the fields searched				
Electronic data base consulted during the international search (name of data base and, where practical, search terms used) EPO-Internal, WPI Data, PAJ, INSPEC, IBM-TDB				
C. DOCUMENTS CONSIDERED TO BE RELEVANT				
Category °	Citation of document, with indication, where appropriate, of the relevant passages	Relevant to claim No.		
X	DALGIC I ET AL: "TRUE NUMBER PORTABILITY AND ADVANCED CALL SCREENING IN A SIP-BASED IP TELEPHONY SYSTEM" IEEE COMMUNICATIONS MAGAZINE, IEEE SERVICE CENTER. PISCATAWAY, N.J,US, vol. 37, no. 7, July 1999 (1999-07), pages 96-101, XP000835310 ISSN: 0163-6804 the whole document	1-37		
X	EP 0 881 848 A (CASIO COMPUTER CO LTD) 2 December 1998 (1998-12-02) column 4, line 40 -column 6, line 7	1,14,24,32		
A	EP 0 704 788 A (AT & T CORP) 3 April 1996 (1996-04-03)	---		
--- -/--				
<table style="width: 100%; border: none;"> <tr> <td style="width: 50%; border: none;"> <input checked="" type="checkbox"/> Further documents are listed in the continuation of box C. </td> <td style="width: 50%; border: none;"> <input checked="" type="checkbox"/> Patent family members are listed in annex. </td> </tr> </table>			<input checked="" type="checkbox"/> Further documents are listed in the continuation of box C.	<input checked="" type="checkbox"/> Patent family members are listed in annex.
<input checked="" type="checkbox"/> Further documents are listed in the continuation of box C.	<input checked="" type="checkbox"/> Patent family members are listed in annex.			
° Special categories of cited documents :				
<table style="width: 100%; border: none;"> <tr> <td style="width: 50%; border: none;"> *A* document defining the general state of the art which is not considered to be of particular relevance *E* earlier document but published on or after the international filing date *L* document which may throw doubts on priority claim(s) or which is cited to establish the publication date of another citation or other special reason (as specified) *O* document referring to an oral disclosure, use, exhibition or other means *P* document published prior to the international filing date but later than the priority date claimed </td> <td style="width: 50%; border: none;"> *T* later document published after the international filing date or priority date and not in conflict with the application but cited to understand the principle or theory underlying the invention *X* document of particular relevance; the claimed invention cannot be considered novel or cannot be considered to involve an inventive step when the document is taken alone *Y* document of particular relevance; the claimed invention cannot be considered to involve an inventive step when the document is combined with one or more other such documents, such combination being obvious to a person skilled in the art. *&* document member of the same patent family </td> </tr> </table>			*A* document defining the general state of the art which is not considered to be of particular relevance *E* earlier document but published on or after the international filing date *L* document which may throw doubts on priority claim(s) or which is cited to establish the publication date of another citation or other special reason (as specified) *O* document referring to an oral disclosure, use, exhibition or other means *P* document published prior to the international filing date but later than the priority date claimed	*T* later document published after the international filing date or priority date and not in conflict with the application but cited to understand the principle or theory underlying the invention *X* document of particular relevance; the claimed invention cannot be considered novel or cannot be considered to involve an inventive step when the document is taken alone *Y* document of particular relevance; the claimed invention cannot be considered to involve an inventive step when the document is combined with one or more other such documents, such combination being obvious to a person skilled in the art. *&* document member of the same patent family
A document defining the general state of the art which is not considered to be of particular relevance *E* earlier document but published on or after the international filing date *L* document which may throw doubts on priority claim(s) or which is cited to establish the publication date of another citation or other special reason (as specified) *O* document referring to an oral disclosure, use, exhibition or other means *P* document published prior to the international filing date but later than the priority date claimed	*T* later document published after the international filing date or priority date and not in conflict with the application but cited to understand the principle or theory underlying the invention *X* document of particular relevance; the claimed invention cannot be considered novel or cannot be considered to involve an inventive step when the document is taken alone *Y* document of particular relevance; the claimed invention cannot be considered to involve an inventive step when the document is combined with one or more other such documents, such combination being obvious to a person skilled in the art. *&* document member of the same patent family			
Date of the actual completion of the international search	Date of mailing of the international search report			
1 February 2001	19/02/2001			
Name and mailing address of the ISA European Patent Office, P.B. 5818 Patentlaan 2 NL - 2280 HV Rijswijk Tel. (+31-70) 340-2040, Tx. 31 651 epo nl, Fax: (+31-70) 340-3016	Authorized officer Megalou, M			

2

INTERNATIONAL SEARCH REPORT

I. International Application No
PCT/US 00/26650

C.(Continuation) DOCUMENTS CONSIDERED TO BE RELEVANT		
Category °	Citation of document, with indication, where appropriate, of the relevant passages	Relevant to claim No.
A	US 5 894 595 A (FOLADARE MARK JEFFREY ET AL) 13 April 1999 (1999-04-13) abstract -----	1-37

INTERNATIONAL SEARCH REPORT

Information on patent family members

International Application No PCT/US 00/26650

Patent document cited in search report	Publication date	Patent family member(s)	Publication date
EP 0881848 A	02-12-1998	JP 10336326 A CN 1201346 A	18-12-1998 09-12-1998
EP 0704788 A	03-04-1996	US 5625673 A CA 2156208 A JP 8129530 A	29-04-1997 23-03-1996 21-05-1996
US 5894595 A	13-04-1999	CN 1128477 A EP 0696152 A JP 8065749 A	07-08-1996 07-02-1996 08-03-1996

Form PCT/ISA/210 (patent family annex) (July 1992)



INTERNATIONAL APPLICATION PUBLISHED UNDER THE PATENT COOPERATION TREATY (PCT)

<p>(51) International Patent Classification : H04M 11/00, 15/00, 3/42 H04M 7/00</p>	<p>A1</p>	<p>(11) International Publication Number: WO 94/05111 (43) International Publication Date: 3 March 1994 (03.03.94)</p>
<p>(21) International Application Number: PCT/US93/07835 (22) International Filing Date: 20 August 1993 (20.08.93) (30) Priority data: 934,240 25 August 1992 (25.08.92) US 972,501 6 November 1992 (06.11.92) US 972,502 6 November 1992 (06.11.92) US 972,503 6 November 1992 (06.11.92) US 972,504 6 November 1992 (06.11.92) US 972,813 6 November 1992 (06.11.92) US 972,817 6 November 1992 (06.11.92) US (71) Applicant: BELL COMMUNICATIONS RESEARCH, INC. [US/US]; 290 West Mount Pleasant Avenue, Livingston, NJ 07039-2729 (US). (72) Inventors: MAN, Susan, Kuo-Kung ; 5 Old Farm Road, Holmdel, NJ 07733 (US). CEBULKA, Kathleen, Dickens ; 75 Evans Avenue, Piscataway, NJ 08854 (US). FISHER, Gregory, Michael ; 2704 North Oak Boulevard, North Brunswick, NJ 08902 (US). LANCASTER, Jill, Ellen ; 1029 Old York Road, Hightstown, NJ 08520 (US). NAZIF, Zaher, Amin ; 7 Jane Lane, High Bridge, NJ 08829 (US). VINCIGUERRA, Lori, Jean ; 75 Evans</p>	<p>Avenue, Piscataway, NJ 08854 (US). SHASTRY, Subramanya, Kolpe ; 66 Green Meadow Boulevard, Middletown, NJ 07748 (US). CHU, Francis, Yiu-keung ; 123 Forest Glen Drive, Highland Park, NJ 08904 (US). WANG, Lei-Lei, Chu ; 37 Brians Circle, Princeton Junction, NJ 08550 (US). (74) Agents: WINTER, Richard, C.; PCT International, Inc., Post Office Box 573, New Vernon, NJ 07976 (US) et al. (81) Designated States: CA, JP, European patent (AT, BE, CH, DE, DK, ES, FR, GB, GR, IE, IT, LU, MC, NL, PT, SE). Published <i>With international search report. Before the expiration of the time limit for amending the claims and to be republished in the event of the receipt of amendments.</i></p>	

(54) Title: AN APPARATUS AND METHOD FOR CREATING, TESTING, VALIDATING, AND PROVISIONING TELECOMMUNICATION SERVICES

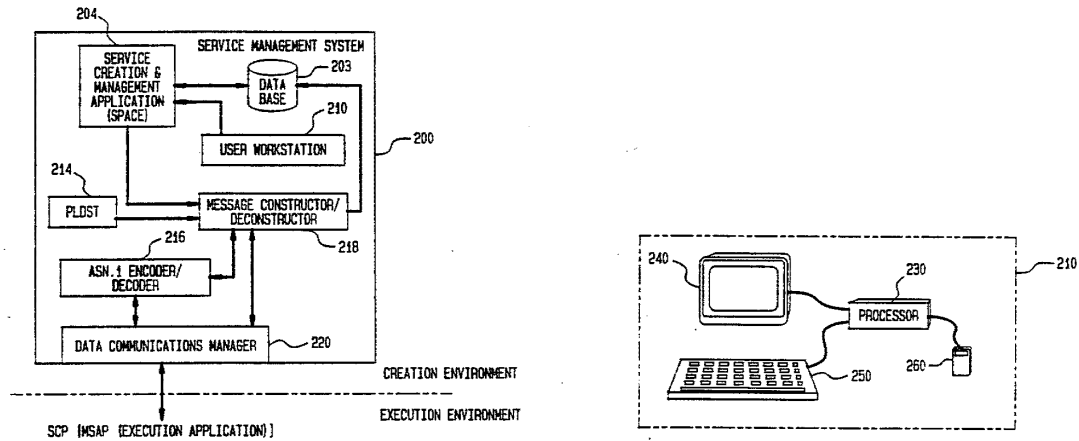

(57) Abstract

In a method of creating a general service specification for a call processing record in a telephone network, a processor [230] in the record creation system [200] prompts the operator to identify at least one optional node [128c], at least one required node [126c], and at least one restricted node from a node set presented to the operator. Also, in a method of creating a template for the creation of call processing services, a processor [230] in the record creation system [200] displays a selected call processing record [925] to the operator. The operator then identifies which nodes in the call processing record will be made customizable. Data tables [1220] can be created and accessed by one or more call processing records for executing telephone services. Also, call processing sample nodes [734] and measurement nodes [733] can be created and used for call processing.

FOR THE PURPOSES OF INFORMATION ONLY

Codes used to identify States party to the PCT on the front pages of pamphlets publishing international applications under the PCT.

AT	Austria	FR	France	MR	Mauritania
AU	Australia	GA	Gabon	MW	Malawi
BB	Barbados	GB	United Kingdom	NE	Niger
BE	Belgium	GN	Guinea	NL	Netherlands
BF	Burkina Faso	GR	Greece	NO	Norway
BG	Bulgaria	HU	Hungary	NZ	New Zealand
BJ	Benin	IE	Ireland	PL	Poland
BR	Brazil	IT	Italy	PT	Portugal
BY	Belarus	JP	Japan	RO	Romania
CA	Canada	KP	Democratic People's Republic of Korea	RU	Russian Federation
CF	Central African Republic	KR	Republic of Korea	SD	Sudan
CG	Congo	KZ	Kazakhstan	SE	Sweden
CH	Switzerland	LI	Liechtenstein	SI	Slovenia
CI	Côte d'Ivoire	LK	Sri Lanka	SK	Slovak Republic
CM	Cameroon	LJ	Luxembourg	SN	Senegal
CN	China	LV	Latvia	TD	Chad
CS	Czechoslovakia	MC	Monaco	TG	Togo
CZ	Czech Republic	MG	Madagascar	UA	Ukraine
DE	Germany	ML	Mali	US	United States of America
DK	Denmark	MN	Mongolia	UZ	Uzbekistan
ES	Spain			VN	Viet Nam
FI	Finland				

-1-

AN APPARATUS AND METHOD FOR CREATING, TESTING, VALIDATING,
AND PROVISIONING TELECOMMUNICATION SERVICESBackground of the Invention

The present invention relates generally to the field of customized services, and more specifically to the problems of creating, testing, validating, and provisioning customized telecommunication services.

Existing telephone systems can include a service creation environment for creating customized telephone services and a service execution environment for executing the telephone services. The service creation environment can include a graphical user interface, which permits a user to build and/or change a displayed graphical representation of a desired service using "nodes," "decision boxes," and "branches." Each node represents a high level instruction for the execution of the service. The displayed graphical representation of the service is translated to a binary representation and stored as a call processing record (CPR). CPRs are transmitted from a creation environment to an execution environment where they are executed during call processing operations to send call processing instructions to inquiring switches.

These systems and methods for creating and executing customized telephone services can be implemented in the Advanced Intelligent Telephone Network (AIN).

Fig. 1 illustrates an exemplary AIN comprising System Service Points (SSPs) 30, 35, 40, and 45, Signal Transfer Points (STPs) 48 and 50, Service Control Points (SCPs) 10 and 20, and Service Management Systems (SMS) 60 (only one shown). SSPs are central office switching systems which receive telephone calls from telephones 12. Each SSP recognizes a variety of "triggers" within customer telephone call signals and generates queries to SCPs based on the triggers. The SSPs then process customer calls in response to commands received from the SCPs.

The SCPs communicate with the SSPs over a common-channel-signalling (CCS) network 67 that includes STPs 48 and

- 2 -

50. The CCS network 67 employs communication channels separate from channels used to transport customer voice signals and includes a packet-switching system. The CCS network 67 switches data in packets instead of allocating circuits for the duration of a call. The STPs 48 and 50 provide the packet-switching functions.

Each SCP is fault tolerant because each SCP includes processors connected through dual local-area networks (not shown). If one processor of an SCP fails, another processor of the SCP can ensure that the SCP continues to function. Further, SCPs are configured as a mutually mated pair in different locations. If an SCP, such as SCP 10, is disabled, its mate, SCP 20, can ensure that telephone service continues without interruption.

Associated with each SCP or each pair of SCPs is an SMS 60. An SMS 60 provides a support interface through which customer data and service logic can be added or managed.

Techniques also exist for testing and validating CPRs that have been created at a creation environment. Testing of a CPR for example can provide a visual indication on a displayed graphical representation (graph) of the CPR of the execution path taken through the CPR during a call processing operation. The visual indication may be a red line trace of the paths connecting the nodes of a displayed graph. Validating a CPR involves detecting logical infractions in the processing routine of the CPR and identifying these infractions to an operator based on a set of rules and a knowledge base understood by an expert system.

Some service providers may wish to maintain a high degree of control over services that they make available. For example, they may wish to restrict the use of certain nodes to their customers or to offer only certain types of services to certain types of customers.

Moreover, an operating company may offer a substantially similar service to numerous customers. It is expensive and inefficient to build substantially the same graph to provide

- 3 -

each customer with substantially the same service. Hence, it would be beneficial to an operating company to be able to provide a specification for a service from which numerous similar graphs could be generated, but with enough flexibility to cater to each customer's individual needs. For example, an operating company may determine that many of its customers are interested in a service that permits the customer to specify the carrier for long distance calls associated with the customer's "800" number. This service would be similar for each customer and would require certain nodes (such as carrier nodes) in each customer's CPR. However, larger businesses may want additional features from such a service. For example, they may want to provide for different carriers during different times of the day. It would therefore be beneficial to the operating company to be able to offer a basic 800 service and an enhanced 800 service wherein each service is partially predefined, yet flexible enough to permit some customization by the individual customers.

Accordingly, it is desirable to provide a general service specification that allows a service creator to define a service, but permits a user enough flexibility to customize the service to some degree.

It is also desirable to permit a service creator to define a service specification in which certain predetermined nodes are mandatory, certain predetermined nodes are optional, and certain predetermined nodes are restricted.

In addition, many customers may want the same service, or they may want services with only minor differences. For example, an operating company may determine that most of its customers desire a service that permits them to specify the carrier for their long distance calls. This service would be similar for each customer, and each customer's graph for this service would be almost identical. It may be impractical or costly for the service creator to generate essentially the same CPR numerous times, once for each customer, particularly when only slight differences need exist in the CPRs. In the

- 4 -

example of the long distance carrier, it would be beneficial to the operating company to be able to create a long distance carrier service only once and make only minor changes to it to accommodate each customer. In addition, this allows for consistent service deployment within an operating company.

Accordingly, it is desirable to provide for the creation of a service template that specifies most of a desired service, but permits some tailoring to meet the needs of individual customers.

It is also desirable to permit an operator to create a service CPR template that is readily adaptable for any number of customers.

Some existing service creation systems suffer from a disadvantage because they do not efficiently scale up to provide services to a large number of customers.

For example, a company with several employees may wish to prevent long distance calls from certain phone extensions in its building. To offer such a service to the company, one existing service creation system would require a CPR specifying a branch node for each phone extension of the company for which it sought to permit such long distance calls, and provide different routing requirements therefor. It would take an extraordinary amount of time to create such a CPR and its different branch conditions. Moreover, the service logic corresponding to this CPR would be very complicated and make the overall service implementation very inefficient.

Accordingly, it is desirable to provide an efficient and effective means to create services on a large scale.

It is further desirable to provide CPR nodes which permit the efficient and effective accessing and updating of data tables during call processing.

In general, CPRs, after being created, are transmitted to an execution environment where a service provider has little control over the CPR. However, for many services, a service provider may desire to monitor the service or to

- 5 -

obtain useful information concerning the execution of the service. Accordingly, it is desirable to permit a service provider to administer the execution of a service.

In the system referred to, services can be created using only fixed or predefined nodes. Although these nodes provide a great deal of service creation flexibility, because only certain nodes are available, service creation flexibility is limited.

It is desirable to provide for the design, layout, and instantiation of user-defined nodes that are indistinguishable from other predefined nodes from the perspective of the service creation and execution environments.

The CPRs discussed above comprise a "key" and a plurality of nodes, decision boxes, and branches. The "key" includes a telephone number and a suffix. The suffix .e04 means that the CPR controls calls made from the corresponding telephone number, and the .e05 suffix means that the CPR controls calls made to the corresponding telephone number. Hence, to provide separate services for calls made to or from a subscriber's telephone number, existing service creation systems require separate CPRs.

Requiring multiple CPRs per customer in a system having many customers strains the storage and execution environments with tremendous amounts of service logic. Moreover, it complicates and hinders efficient service execution and management.

Accordingly, it is desirable to provide a CPR structure that permits efficient use of CPRs on a large scale in an execution environment.

It is also desirable to provide a CPR structure that permits quick and efficient storage, access, management, and execution of CPRs.

Additional desires of the invention will be set forth in the description which follows, and in part will be apparent from the description, or may be learned by practice of the

- 6 -

invention. The advantages of the invention may be realized and obtained by means of the instrumentalities and combinations particularly pointed out in the appended claims.

Disclosure of the Invention

To achieve the foregoing desires and objects, and in accordance with the purposes of the invention as embodied and broadly described herein, the present invention provides a method of creating a general service specification for a call processing record comprising logically related nodes and branches, the method comprises the steps, executed by a processor, of: prompting an operator to identify at least one optional node which may appear in a call processing record associated with the general service specification; receiving from an operator, an identification of at least one optional node which may appear in a call processing record associated with the general service specification; prompting an operator to identify at least one required node which must appear in a call processing record associated with the general service specification; receiving from an operator, an identification of at least one required node which must appear in a call processing record associated with the general service specification; and enabling the optional and required nodes as a general service specification.

To achieve the foregoing desires and objects, and in accordance with the purposes of the invention as embodied and broadly described herein, the present invention also provides a method of creating a template for the creation of call processing services, each call processing service being represented by a call processing record comprising logically related call processing nodes and branches, the method comprises the steps, executed by a processor, of: displaying a selected call processing record to an operator; receiving from an operator a selection of a node in the call processing record to be made customizable, a customizable node being a node for which subsequent template users can specify

- 7 -

predetermined expressions; displaying all expressions of the selected node; prompting the operator to specify which of the selected node expressions will be customizable; designating the specified node expressions as customizable; and enabling the selected call processing record and the designation of customizable node expressions for the selected node as a service template.

To achieve the foregoing desires and objects, and in accordance with the purposes of the invention as embodied and broadly described herein, the present invention also provides in a telecommunication service creation environment providing for call processing records and value tables, the value tables comprising one or more columns and one or more rows of values, a method of creating a call processing procedure to determine whether a particular value exists in a particular value table, the method comprises the steps, executed by a data processor, of: prompting an operator to name a value table to be searched; receiving from the operator a name of the value table to be searched; prompting an operator to identify one or more columns in the value table to be searched; receiving from the operator an identification of one or more values in the value table to be searched; prompting an operator to specify a value to be searched for in the one or more columns to be searched; receiving from the operator a value to be searched for in the one or more columns to be searched; prompting an operator to specify comparison criteria for the value specified and values in the column to be searched; receiving from the operator a comparison criteria for the value specified and values in the column to be searched; and instantiating the table name, one or more columns, value to be searched for, and comparison criteria as part of the call processing procedure.

To achieve the foregoing desires and objects, and in accordance with the purposes of the invention as embodied and broadly described herein, the present invention also provides a method of providing a call processing sample node to determine an amount of call processing activity, the method

- 8 -

comprises the steps, executed by a processor, of: prompting an operator to input values for parameters to be used with the sample node; receiving from an operator a sampling rate identifying a percentage of calls to be sampled; receiving from an operator a sample name for data collected; receiving from an operator a sampling type defining whether a sample activity should be determined based on attempted or completed call processing operations; receiving from an operator a collection type defining whether results of a sample activity should be collected presently or deferred; receiving from an operator an identification of call variables to be sampled; and instantiating the sampling rate, sample name, sampling type, collection type, and call variables as a call processing sample node.

The present invention also provides a method of providing a call processing measurement node to count call processing events, the method comprises the steps, executed by a processor, of: prompting an operator to input values for parameters to be used with the measurement node; receiving from an operator a call variable naming a measurement vector; receiving from an operator a component name identifying a component in the measurement vector; receiving from an operator information specifying whether the component should be incremented or decremented; and instantiating the call variable name, component name, and increment or decrement information as a measurement node.

To achieve the foregoing desires and objects, and in accordance with the purposes of the invention as embodied and broadly described herein, the present invention also provides a method of creating a user-defined call processing node for a call processing record, the call processing record comprising logically related nodes and branches, the method comprising the steps, executed by a processor, of: receiving an instruction from an operator to construct a user-defined call processing node; presenting to the customer a screen in which to construct the user-defined call processing node; constructing an underlying representation of call processing

- 9 -

procedures selected by the operator; and enabling the underlying representation of call processing procedures as a single node for use in creating call processing records.

Finally, to achieve the foregoing desires and objects, and in accordance with the purposes of the invention as embodied and broadly described herein, the present invention provides a call processing record for execution in a telephone service execution environment, comprising: a record header associating the call processing record with a corresponding telephone service subscriber; at least one call processing logic section including call processing procedures executable by a processor in the telephone service execution environment; at least one first data section, each of the at least one first data sections being associated with one of the at least one call processing logic sections and storing data executable only by the call processing procedures included in the associated one of the at least one call processing sections; and at least one entry point, each of the at least one entry points being associated with one of the at least one call processing logic sections and an associated one of the at least one first data sections, the at least one entry point identifying the associated one of the at least one call processing sections.

Brief Description of the Drawings

The accompanying drawings, which are incorporated in and constitute a part of the specification, illustrate presently preferred implementations of this invention and, together with the general description given above and the detailed description of the preferred implementations given below, serve to explain the principles of the invention.

In the drawings:

Fig. 1 is a block diagram of the Advanced Intelligent Telephone Network (AIN);

- 10 -

Fig. 2A is a block diagram illustrating a service creation environment in accordance with one embodiment of the present invention;

Fig. 2B is a block diagram illustrating a workstation within the service creation environment shown in Fig 2A in accordance with one embodiment of the present invention;

Fig. 3 is a procedure diagram for a service creation environment in accordance with one embodiment of the present invention;

Fig. 4A is a schematic representation of software modules corresponding to display and editing procedures of the software in accordance with one embodiment of the present invention;

Fig. 4B is a schematic representation of software modules corresponding to data structure procedures of the software in accordance with one embodiment of the present invention;

Fig. 4C is a schematic representation of software modules corresponding to binary and other related procedures of the software in accordance with one embodiment of the present invention;

Fig 5 illustrates the structure of a CPR in accordance with one embodiment of the present invention;

Fig. 6A illustrates a Table in accordance with one embodiment of the present invention;

Fig. 6B illustrates a Table Specification in accordance with one embodiment of the present invention;

Fig. 6C illustrates a Table Record in accordance with one embodiment of the present invention;

Fig. 7 illustrates a system screen in accordance with one embodiment of the present invention;

Fig. 8 illustrates a New Record Information Box in accordance with one embodiment of the present invention;

Fig. 9 illustrates a CPR Editor screen in accordance with one embodiment of the present invention;

Fig. 10 illustrates a GSS Editor screen in accordance with one embodiment of the present invention;

- 11 -

Fig. 11 is a flow diagram illustrating a GSS creation operation in accordance with one embodiment of the present invention;

Fig. 12 illustrates a GSS Editor screen showing an exemplary GSS in accordance with one embodiment of the present invention;

Fig. 13A illustrates an example of a graph in accordance with one embodiment of the present invention;

Fig. 13B illustrates another example of a graph in accordance with one embodiment of the present invention;

Fig. 14 is a flow diagram illustrating an operation for validating a graph against an associated GSS in accordance with one embodiment of the present invention;

Fig. 15 illustrates a NODE Editor screen in accordance with one embodiment of the present invention;

Fig. 16 illustrates an example of a graph using Measurement and Sampling nodes in accordance with one embodiment of the present invention;

Fig. 17 illustrates an example of a graph using External System Interaction nodes in accordance with one embodiment of the present invention;

Fig. 18 illustrates a Custom Node Editor screen in accordance with one embodiment of the present invention;

Fig. 19A illustrates Parameter Editor screen in accordance with one embodiment of the present invention;

Fig. 19B illustrates a Selection List Editor screen in accordance with one embodiment of the present invention;

Fig. 20 illustrates a Custom Node Preview screen in accordance with one embodiment of the present invention;

Fig. 21 illustrates a Custom Node Layout Screen in accordance with one embodiment of the present invention;

Fig. 22 illustrates a Custom Node Category screen in accordance with one embodiment of the present invention;

Fig. 23 illustrates an example of a graph using an Intable node in accordance with one embodiment of the present invention;

- 12 -

Fig. 24 illustrates a table in accordance with one embodiment of the present invention;

Fig. 25 is an Intable Editor screen in accordance with one embodiment of the present invention;

Fig. 26 is a flow diagram illustrating an operation of an Intable node in accordance with one embodiment of the present invention;

Fig. 27 is a Table Node Editor screen in accordance with one embodiment of the present invention;

Fig. 28 is a flow diagram illustrating an operation of a Table node in accordance with one embodiment of the present invention;

Fig. 29A illustrates a Template Editor screen in accordance with one embodiment of the present invention;

Fig. 29B illustrates a Carrier Node Editor screen for templates in accordance with one embodiment of the present invention; and

Fig. 29C illustrates a Template Preview Editor screen in accordance with one embodiment of the present invention;

Fig. 29D illustrates a Template Layout Editor screen in accordance with one embodiment of the present invention; and

Fig. 30 illustrates a Template Find Editor screen in accordance with one embodiment of the present invention.

Best Mode for Carrying Out the Invention

Reference will now be made in detail to the construction and operation of the preferred implementations of the present invention which are illustrated in the accompanying drawings. In the drawings, like elements and operations are designated by like reference numbers. The following description of the preferred implementations is exemplary, and does not limit the invention to these specific implementations

- 13 -

A. System Configuration

In a preferred embodiment of the present invention, a service is created in the AIN. In particular, a service is created by a user at a workstation associated with the SMS 200.

Fig. 2A is a block diagram of a preferred embodiment of an SMS 200 in accordance with the present invention. The SMS 200 includes a service creation and management application 204 which preferably comprises the SPACE® application version 2.0. SPACE is a proprietary software application owned by Bellcore, the assignee of this application.

In addition to the service creation and management application 204, SMS 200 includes a user workstation 210. Preferably, user workstation 210 (also shown in Fig. 2B) includes an IBM RS-600 (Model 320) as well as related equipment, for example, processor 230, keyboard 250, mouse 260, and graphical display 240 which preferably runs AIX windows (IBM), version 3.2 or X-windows, version 11, release 4 or later .

The SMS 200 also includes database 203, Programming Language Data Structure Translator (PLDST) 214, ASN.1 Encoder/Decoder 216, Message Constructor/Deconstructor (Message C/D) 218, and Data Communications Manager 220. These elements, their relationships, and their relationship to the execution environment in an SCP 10, 20 are described in the incorporated interface application.

The service creation portion of the SPACE application is dedicated to the creation of CPRs and Tables (described below). CPRs are created using the SPACE application by generating a high level, displayed representation (graph) of the desired service on the display 240 of user workstation 210. The displayed graph of a CPR is extremely useful in that it permits an operator to create and understand the telephone service being created and to test and validate the service logic. However, the graph cannot be interpreted

- 14 -

efficiently directly by the execution environment. Accordingly, the CPR graph is translated into a binary representation which can be used to process calls in the execution environment.

B. Software Configuration

In a preferred embodiment, before a CPR graph is translated into a binary representation, it is first translated into an internal representation comprising data structures and pointers. These translations and representations are shown in Fig. 3, wherein display procedures 300 generate the display representation 302 of the CPR, data structure procedures 304 generate the internal representation 306, and binary procedures 308 generate the binary representation 310 of the CPR, which is stored in database 203.

Preferably, the display procedures 300 are designed according to an object-oriented design methodology using the C++ language. Accordingly, the data structure procedures 304 are also object-oriented. The data structure procedures 304 are less machine dependent than the display procedures 300 because the data structure procedures 304 can be used with many different display forms and many different types of hardware. The binary representation 310 of the CPR is the most machine independent.

Each of the foregoing display, data structure, and binary data procedures is established in the SPACE application by one or more software "modules." Modular programming allows individual procedures or functions to be distinctly represented during design, and individually exercised during execution. A defined module may interactively "call" or invoke another module.

- 15 -

1. Display and Editing Modules

In a preferred embodiment, the display procedures 300 of Fig. 3 include display and editing modules. The display and editing modules display various graphical objects on the display 240 of workstation 210 and allow manipulation of the graphical objects by the user. The display and editing modules, as shown in Fig. 4A, include Record Control module 321, Node Specification Editing module 322, CPR Editing module 323, GSS Editing module 324, Graph Editing module 325, Variable Editing module 326, Form Creation module 327, Provisioning module 328, Table Node Editing module 339, and Dialog module 329.

Record Control module 321 interfaces Database module 340 (Fig. 4C) with each of the editing modules (modules 322, 323, 324, 325, 326, and 339) to transfer data from database 203 to editor buffers (not shown) associated with the respective editing modules in the workstation 210 and to transfer (save) data from the editor buffers to database 203. Record Control module 321 also allows a user to prepare a template (described below in section G) for a mass market service.

CPR Editing module 323 allows a user to change the characteristics (i.e., headers, entry points, etc., as described below) of a CPR. To do so, CPR Editing module 323 invokes the Graph Editing module 324 and the Variable Editing module 326 to change corresponding portions of the CPR. The CPR Editing module 323 also allows editing of existing templates.

Graph Editing module 325 allows a user to manipulate the structure or relationship of nodes and branches in a graph. Thus, in conjunction with the Node Specification Editing module 322 and Variable Editing module 326, which allows manipulation of call variables within nodes, the Graph Editing module 325 also allows graphs to be edited and translates the corresponding internal data structures into graphical display representations for display on the display 240 of workstation 210. In addition, the Graph Editing

- 16 -

module 324 allows a user to graphically display and edit the structure or relationship of nodes and branches in a template.

Call Variable Editing module 326 allows a user to add, delete, and modify call variables. Call variables (also referred to as "CVs") identify data elements whose values are processed by CPRs. Before a call variable can be used, it must be defined. CVs can be predefined or user-defined. User-defined CVs can be defined for specific services being created. An example of a user-defined CV is a counter used to count the number of times a loop has been executed. To define a call variable, the following attributes are preferably specified: tag name, scope, extend, data type, and optional initial value. The tag name is a name which identifies the CV. For example, MTOD is the tag name for a time of day CV, MDOW is the tag name for a day of week CV, and QDIALEDNBR is the tag name for a dialed number CV. Scope determines the visibility, e.g. global or local. The extent determining how long the value lasts, e.g. persistent or non-persistent. The value of a global CV is available to all graphs interpreted during call processing of a call query. The value of a local CV is available only to the graph in which it is defined. A persistent CV maintains its value from one call to another. Data type refers to the type of data stored in the CV, which can be, for example, a string or an integer. An optional initial value can be any valid value of the data type indicated for the CV.

Preferred data types include:

- a. Signed Integer - This data type is a positive or negative number or zero.
- b. Bit String - This data type is a string of binary bits that represent logical values. To be recognized, the bit string preferably begins with the letter "B."
- c. Telephone Number - The telephone number data type represents values of telephone numbers. To be recognized, the telephone number preferably begins with a letter from the set T, S, I, and P, where, T = National

- 17 -

Telephone Numbering Plan, I = International Number, S = Special Number, and P = Private Number.

- d. String - This data type is a string of characters.
- e. Numeric String - This data type is a string of digits, "#," or "*," as can be entered from a telephone keypad.
- f. Date - This data type represents a date.
- g. Day of Week (DOW) - This data type is used to represent the days of the week.
- h. Time of Day (TOD) - This data type is used to represent the time of day.
- i. Carrier - The Carrier data type is used to represent an Inter- or Intra-LATA Telephone Carrier Company Designation. For example, LEC, ATX, or 222.
- j. Boolean - This data type is used to represent one of only two possible values such as true/false or yes/no.
- k. Float - This data type is used to represent a floating point number. The precision is determined by storage restrictions.
- l. Signaling Point Code - This data type represents information about network signaling.
- m. Measurement Vector - This data type represents a vector of counters.
- n. Table - This data type is a table of rows and columns where data is stored (see Section C.2 below).

The Variable Editing module 326 is also used to restrict input values, identify data for templates, and specify user prompt language. In addition, the Variable Editing Module 326 is used to define user input parameters when creating User Defined Nodes (described below in Section F.5).

General Service Specification (GSS) Editing module 324 is used to retrieve, display, and edit a GSS (described below in section E).

Node Specification Editing module 322 allows a user to change the characteristics of a node specification, and thereby define a custom or User-defined node. This module

- 18 -

invokes the Graph Editing module 324 and the Variable Editing module 326 as needed to change corresponding portions of the node specification.

Dialog module 329 provides a set of utilities and procedures called by other editing and display modules. The procedures defined in Dialog module 329 facilitate data entry and/or option selection by the user. These procedures include procedures for defining dialog boxes, which query the user regarding data required for particular inputs and accept the user's input data.

Form Creation module 327 allows a user to create a new user interface for a template. The user interface preferably comprises a displayed list of user prompts and input fields which allow a user to create a CPR from a template.

Provisioning module 328 translates internal data structures into a user interface form. The particular characteristics of the form depend on the data structures of the template created by Form Creation module 327. The Provisioning module 328 also presents available templates, verifies user permissions for templates, and monitors processes for activation of a template based CPR.

Table Node Editing module 339 allows a user to define, edit, and manipulate values in a table data structure. The Table Editing module 339 is invoked by the Variable Editing module 326. As with values appearing within nodes, table values may be expressed in a variety of data types as explained above, with the exception of measurement vector and table data types.

2. Data Structure Modules

As shown in Fig. 4B, the data structure procedures 304 in Fig. 3 preferably include the following data structure modules: CPR module 330, Graph module 331, Node module 332, Branch module 333, Expression module 334, Node Specification module 335, Variable module 336, and GSS module 337. Each of

- 19 -

these data structure modules is particularly related to one or more data structure types.

Upon creation of a graph, the Graph module 331 is invoked to define the data structure which results upon creation of the logical relation between branches and nodes in the graph. Within the Graph module 331, data structures representing individual branches within the graph are further defined by the Branch module 333. Thus, at points in the graph where a branch is required, the Graph module 331 invokes the Branch module 333. Data structures representing individual nodes within the graph are further defined by the Node module 332. Thus, at points in the graph where a node is required, the Graph module 331 invokes the Node module 332. Similarly, expressions within a node are defined by the Expression module 334, which is called as necessary by the Node Specification Editing module 332.

As previously described, preferred implementations of the present invention use object oriented-programming techniques. One aspect of object oriented-programming is that all functions operable upon a particular "object" are defined with the object. Thus, all functions operable upon a graph ("the object") are defined within the Graph module 331. Accordingly, each data structure module preferably represents the data structure (i.e., defines the structure) and allows manipulation (i.e., defines the operable functions) of that data structure. Data structure modules may also use subordinate data structure modules as described above.

CPR module 330 internally represents and allows manipulation of graphs and call variables which define a customer service. This module also handles the representation and manipulation of templates. The CPR module also includes administrative information such as, for example, record ownership and status information. The CPR module 330 invokes Graph module 331 and Variable module 336.

- 20 -

Graph module 331 represents and allows manipulation of the logic section of a graph or the graph section of a User-defined node. Graph module 331 invokes Node module 332 and Branch module 333. It also includes validation information.

Node module 332 represents and allows manipulation of objects corresponding to a single call processing instruction. The single call processing instruction may include complex nodes such as table nodes (described below in Section F.6) and administrative nodes (described below in Section F.3). Node module 332 also includes validation information for a particular node. Node module 331 invokes Node Specification module 335 and Expression module 334.

Branch module 333 represents and handles manipulation of branches within a graph. Branch module 333 invokes Expression module 334 to define conditional branches.

Expression module 334 represents and handles manipulation of data values in CPRs and tables. An expression is a construct that has a value when evaluated. The value that is returned preferably has a data type. The expression is the basic unit of data manipulation. For example, an assignment node (described below in Section F.1) consists of a left-hand part, which is an expression, an assignment operator, and a right-hand part, which is an expression. Expressions can be constants, call variables, or manipulators as defined in the incorporated interface application. In addition, the Expression module 334 includes information about the use of an expression in a template and the presentation of an expression.

Node Specification module 335 represents and handles manipulation of different node types. Node specifications determine for each respective node what type of information is needed by node and how each node will be interpreted by the call processor. The Node Specification module 335 also reads a set of predefined node specifications from a series of system files and typically invokes the Variable module 336 and Expression module 334.

- 21 -

Call Variable module 336 represents and handles manipulation of different types of call variables used in graphs and data sections of CPRs. This module reads a set of variable expressions from a series of files in the database 203. A preferred implementation provides for two types of variables: call variables used in CPRs and node specification parameters used in user-defined nodes.

Generic Service Specification (GSS) module 337 represents and handles manipulation of objects which specify the type of service a graph may represent.

3. Database and Related Processing Modules

As shown in Fig. 4C, the binary procedures 308 in Fig. 3 preferably include Database module 340, Binary module 341, Validation module 342, and Testing module 343. Binary module 341 converts various internal data structures into binary representations that can be transferred between different hardware configurations. This module also performs the reverse process of converting binary representations of CPRs and tables into internal data structures.

Database module 340 stores, retrieves, deletes, and searches on CPRs, templates, user-defined nodes, GSSs, and tables in database 203.

Validation module 342 facilitates CPR validation procedures.

Finally, Testing module 343 simulates call processing execution and produces a resulting "processed" binary representation.

C. System Records

The foregoing hardware and software components cooperate to allow a user to create customer services. Preferably, services are created by the formation of two types of system records: CPRs and tables.

- 22 -

1. CPR Structure

Fig. 5 illustrates a preferred structure or organization of a CPR. The CPR structure 400 includes a CPR record header 402, a global data section 404, entry points 406, local data sections 408, and logic sections 410.

a. CPR Record Header

Each CPR is assigned a unique record header 402 to identify the CPR and associate the CPR to a customer. The record header 402, (also referred to as the CPR key) can be, for example, a ten-digit telephone number. The record header 402 also includes data that characterizes the CPR. For example, the record header 402 may also include a code 412 indicating whether the CPR is "shared" or non-shared. Shared CPRs are used in performing services for multiple subscribers, while non-shared CPRs are used for only one subscriber. The designation of whether a CPR is shared is made by the user. Whether a CPR is shared or non-shared does not change its structure. Shared CPRs are labeled to allow an execution environment to improve performance capabilities by storing shared CPRs in a manner that provides faster access time. The record header 402 may also contain a code 414 indicating whether a CPR can update CPRs or tables in the execution environment and requesting a copy of these updates, and a code 416 indicating whether the CPR controls updating of CPRs and tables in the execution environment. The record header may include a test code 418 to label the CPR as a test CPR. The record header may also include a trace flag 420 which requests a trace of the execution path through the graph.

b. Global Data Section

The global data section 404 includes global data used by the logic of all logic sections 410 within the CPR 400. This

- 23 -

global data may include, for example, declarations and/or definitions of call variables, embedded tables, and measurement vectors.

c. Entry Points

An entry point in a CPR is a point at which call processing can be initiated. Each entry point corresponds to a previously defined graph and an associated local data section, the interpretation and execution of which establishes a customer service. As seen from Fig. 5, a CPR may have more than one entry point; hence, all of a customer's services may be provided on a single CPR.

A user may assign any name to an entry point. Entry points are preferably grouped as "trigger" and "non-trigger" entry points. For example, two entry points have special significance in the execution environment: (1) "ani" which is called to process an originating number query; and (2) "dln" which is called to process a called number query.

Non-trigger type entry points are preferably used by other entry points within the CPR or other CPRs.

d. Local Data Sections

As shown in Fig. 5, each entry point 406 is associated with a local data section 408. The local data section 408 includes local data used only by the corresponding logic section of the associated entry point. This local data includes definitions of call variables of local scope.

e. Logic Sections

Logic section 410 contains the actual call processing logic or call processing procedure corresponding to a particular graph or service.

When a SCP 202 processes a CPR in the execution environment, after having retrieved the CPR based on the CPR

- 24 -

record header 402, SCP 202 reads the global data section 404 and applies all call variable definitions found therein. The SCP 202 then selects an entry point based on a received trigger. The SCP 202 reads the local data from local data section 408 associated with the entry point 406. The call processing logic of the associated logic section 410 is then interpreted using all the data that has been applied.

2. Tables

In accordance with the present invention, tables may be used to store lists of values used in processing one or more CPRs. Tables (also referred to herein as value lists) can be created as stand-alone records or embedded within CPRs. As described below, stand-alone tables are identified by a user, embedded tables are identified using a "Table" call variable.

Tables are defined by a table specification and table data. The table data is laid out in one or more rows corresponding to predefined columns. The table specification defines these columns including data type, maximum size, and whether they are a key column.

Figs. 6A and 6B illustrate the table data and table specification for a table that associates telephone extensions of an office building with a selected telephone number having a maximum length of 15 digits.

The table 500 in Fig. 6A includes two columns: the first column 502 lists the number of extensions in the office building, and the second column 504 lists the telephone numbers associated with each of the three exemplary extensions.

Fig. 6B illustrates the table specification 506 for the table 500 shown in Fig. 6A. The table specification includes four rows: name 508, data type 510, maximum length 512, and key 514. The information defined by these four rows is specified for each of the columns of table data. Thus, as shown in Fig. 6B, the name of the first column is "EXTENSION," and the name of the second column is "TELEPHONE

- 25 -

NUMBER." The data type of the EXTENSION column is a numeric string, and the data type of the TELEPHONE NUMBER column is a telephone data type. The maximum length of the numeric string in the EXTENSION column is four digits, and the maximum length of the TELEPHONE NUMBER in the telephone column is 15 digits. The key specification 514 permits a user to specify which column uniquely identifies a row and allows for more efficient search.

Fig. 6C illustrates a table record structure 518 for a stand alone table. As shown, the structure includes a header section 516, the table specification 506 as shown in Fig. 6B, and the table data 500 as shown in Fig. 6A. For embedded tables, the table specification 506 and table data 500 are stored as part of the call variable that denotes the embedded table.

In a preferred implementation, six operations can be performed on table data: addRow, delRow, updtRow, findRow, selRow, and nextRow. These operations are executed using menu buttons (not shown) which are displayed in a Table Editor Screen (not shown) that is displayed when a user selects the Table Suboption 175d as shown in Fig. 7. The addRow operation adds (or inserts) a set of rows into a table. The delRow operation deletes a set of rows in a table. The updtRow operation updates a set of values in a table. The findRow operation searches a table for a specified row. The selRow operation selects a set of column values from a row of a table that matches a specified condition and returns the values from the first row found. The nextRow operation selects a set of column values from the next row of a table that match the specified condition in a previous selRow operation.

D. CPR Creation

A user creates a CPR by accessing a CPR Editor screen on display 240 of workstation 210. To call up the CPR Editor screen, a user logs onto the system (hereafter "system" is

- 26 -

used to describe a preferred implementation of the present invention running the SPACE application) which presents a system screen 170 as shown, for example, in Fig. 7.

The system screen 170 presents a menu line 172 having five user options: Record, View, Operations, MSAP, and Administration. The user selects an option using either the keyboard 250 or mouse 260 (Fig. 2B). This selection prompts the display of additional options. As shown, for example, in Fig. 7, if the user selects the "Record" option, a menu of Record options 174 is displayed. The user may then select an option from the displayed options by means of the keyboard 250 or mouse 260. The Record options menu 174 includes, for example, options to create a "New" record, "Find" an existing record, "Save" a record, or "Delete" a record. If a user selects the "New" option 177, the system displays associated options 175.

To create a new CPR and enter the CPR Editor, the user selects the CPR option 175a. This selection causes the display of a New Record Information Dialog Box, as shown for example in Fig. 8.

The New Record Information Dialog Box 180 contains five text entry fields: Name field 181, Account field 182, Service Order field 183, Due Date field 184, Supplemental Form field 185, and Service Rep field 186. Preferably, the Name field 181 may contain any user defined alphanumeric string of characters corresponding to a CPR header. The Account field 182 is optionally used to indicate a customer account for which the CPR should be associated. This allows a user to tie together a number of individual CPRs (and other records) under a single customer's account. The Service Order field 183 is optionally used to specify a service order number corresponding to the customer's request for this service. The service order number allows a user to refer to other operations systems, for example, an operations system that handles service orders. The Due Date field 184 is optionally used to indicate when the service being created must be active. The Supplemental Form field 185 is

- 27 -

optionally used to indicate whether the service being created has additional forms in other operations systems. The Service Rep field 186 is optionally used to maintain a record of a representative who may have taken a customer's order for the service being created. The New Record Information Dialog Box 180 also includes Controls DTMF Update field 187, which is used to indicate whether the service being created will be used to control the updating of other services or tables.

Once the respective fields in the New Record Information Dialog Box 180 have been filled-in and checked by the user, the user selects the "OK" button, and the system presents the CPR Editor screen 171, as shown, for example, in Fig. 9.

CPR Editor Screen 171 includes a Graph Window Screen 173, a CPR Information window 176, a Graphs In CPR window 178, a Nodes window 179, a Graph Manipulator window 188, a Provisioning Data window 189, Call Variables field 190, and an Entry Point Information dialog box 195.

The user specifies an initial entry point for the CPR using the Entry Point Information dialog box 195. The Entry Point Information dialog box 195 contains two text entry fields: Name field 195a and GSS field 195b. Preferably, a user enters the name of a trigger type entry point (e.g., "ani" or "dln") or a non-trigger type entry point into the Name field 195a. The GSS field 195b is preferably prepopulated with a "generic" GSS, which is a system supplied GSS that includes every node as optional. The user can optionally specify any enabled GSS in the GSS field 195b.

As shown in Fig. 9, some of the information entered in the New Record Information Dialog Box 180 is displayed in the CPR Information window 176 on the CPR Editor screen 171 (i.e., the Type 176a and the Name 176b). The CPR Information window 176 may also include a user's identification field 176c, a modification date(s) field 176d, and an activation or effective date field 176e for the CPR.

The Graphs In CPR window 178 includes "Add Graph" button 178a, "Delete Graph" button 178b, "Edit Graph" button 178c, "Browse Graph" button 178d, and Graph List 178e.

- 28 -

The Call Variables window 190 includes "Name" button 190a, "Data Type" button 190b, "Value" button 190c, "Defined In" button 190d, "Availability" button 190e, and Same Value After Call button 190f.

The Nodes window 179 includes Nodes List 191, Node Type buttons 192, and Node Function buttons 193, which include a "Change Value" button 193a, "Delete Item" button 193b, "Delete Subtree" button 193c, "Add Branches" button 193d, "Connect" button 193e, and "Hide Subtree" button 193f.

The Graph Manipulation window 188 includes Undo button 188a, Cut button 188b, Paste button 188c, and Copy button 188d.

The Provisioning Data window 189 includes Customer button 189a and Service Order button 189b.

The Graph window 173 also includes a root node 194 which displays the Name (or Key) entered in the Name Field 181 of the New Record Information Dialog Box 180, the "ani" trigger entered in the Name field 195a of the Entry Point Information Dialog Box 195, and the associated GSS entered in the GSS field 195b of the Entry Point Information Dialog Box 195.

In the Graph window screen 173, graph building is accomplished using Graphs In CPR window 178, Nodes window 179, and Call Variables window 190. As described above, CPRs may have one or more entry points; hence, one or more graphs. The Graphs In CPR window allows a user to "Add" a new graph to the CPR, "Delete" an existing graph, "Edit" an existing graph, or "Browse" (view without editing) an existing graph. The name of each entry point in the CPR, as well as an indication whether the entry point is a "trigger" entry point, is displayed in Graph List 178e.

A user creates (and similarly edits) a graph by selecting nodes and logically arranging the selected nodes to form a graph. To select a node, a user first selects the type of node to be added using node type buttons 192. In one embodiment, a set of available nodes is divided into "Assignment" nodes (button 192a), "Decision" nodes (button 192b), "Play Announcement and Get Digits (PAGD) nodes"

- 29 -

(button 192c), and "Other" nodes (button 192d). Assignment and Decision nodes are described below in Section F. PAGD nodes do just what their name suggests; during call processing, they play an announcement to the caller, prompting the caller to input information, and collect the information. Based on the node type button 192 selected by the user, the system displays the available node choices corresponding to that node type in Nodes List window 191.

The nodes of a graph are arranged in the Graph window 173 using the node function buttons presented in Node Function window 193. Preferable function buttons include "Change Value" button 193a for changing the value of a node, "Delete Item" 193b for deleting a node or branch from a graph, "Delete Subtree" button 193c for deleting a portion (subtree) of a graph, "Add Branches" button 193d for adding branches to a node, "Connect" button 193e for logically relating two nodes in a graph, and "Hide Subtree" button 193f for removing a graph portion from the CPR Editor screen in order to facilitate graph creation or editing.

The nodes of a graph are manipulated in the Graph window 173 using the graph function buttons presented in the Graph Manipulation window 188. Preferable function buttons include "Undo" button 188a for successively undoing graph actions, "Cut" button 188b for removing a subtree from a graph and placing it in an internal buffer, "Copy" button 188d for copying a subtree from a graph and placing in an internal buffer, and "Paste" button 188c for copying a subtree from the internal buffer and placing it in a graph.

Call variables of nodes in a graph are preferably defined using the Call Variables window 190. A user assigns a name to each call variable at "Name" field 190a, the data type of a call variable at the "Data type" field 190b, and the "Value" of a call variable at Value field 190c. The CALL VARIABLE window 190 also includes "Defined In" field 190d to identify the CPR, graph, or node in which the call variable is defined. The "Availability" field 190e defines the scope

- 30 -

of the call variable, and the "Same Value After Call" field 190f indicates whether the CV is persistent.

A user can view and modify certain customer account information using the buttons presented in Provisioning Data window 189. Preferable buttons include "Customer" 189a which allows the user to view the customer account record that was specified in the Account field 182 of the New Record Information Dialog Box 180, and "Service Order" 189b which allow the user to view and/or edit the service order information that was entered in the Service Order field 183, Due Date field 184, Supplemental Form field 185, and Service Rep field 186 of the New Record Information Dialog Box 180.

E. General Service Specifications

A General Service Specification (GSS) is a specification for a particular "generic" service which may be created in numerous specific forms to tailor the generic service to a particular customer's needs. For example, many residential telephone customers may wish to prevent "900" calls from being made from their home phones. A "900 Block" service would thus be generally offered to residential customers. However, customers may desire variations in the 900 Block service they receive, thus making some "900 Block" services slightly different from others. Additionally, a service provider may desire certain functionality to monitor or control the use of the "900 Block" service by its customers. Thus, the service provider may desire to specify certain permissible functions which may be included in each customer's "900 Block" service, certain mandatory functions which must be included in each customer's "900 Block" service, and certain restricted functions which cannot be included in a customer's "900 Block" service. The GSS permits the service provider to specify these limitations and requirements for services. It can also be a useful tool for billing and generating service-specific validation nodes.

- 31 -

A GSS contains information that specifies and describes a generic customer service.

1. GSS Creation

To create a GSS, a user accesses the system screen 170 and selects the "Record" option from menu line 172. When the Record option menu 174 is presented, the user selects the "New" option, and the "New" option suboptions window 175 is displayed. The user then selects the "GSS" suboption 175b. Upon selecting the GSS suboption 175b, a dialog box (not shown) is presented to the user. The dialog box simply requests the user to input a name for the GSS.

After the user inputs a name, the system presents the GSS editor screen 120, as shown, for example, in Fig. 10.

The GSS editor screen 120 preferably includes four sections: GSS Information window 122, GSS Description window 124, Required Nodes window 126, and Optional Nodes window 128. The GSS Information window 122 includes a Name field 122a for the name of the GSS entered by the user, a Creator field 122b for the name of the creator of the GSS, a Modified field 122c for dates on which the GSS has been modified, and an Enable field 122d for a date on which the GSS was enabled.

The GSS Description window 124 is used to enter information regarding the customer service related to the GSS. For instance, the GSS description might contain a detailed description of the service to which the GSS is related or an explanation of the reasons why certain nodes are required, optional, or prohibited within CPRs associated with the GSS. For the "900 Block" service described above, a user may provide the following description: "900 Block is a service directed to residential customers who wish to prevent calls beginning with a 900 area code from their home phones."

A user defines which functions are mandatory or optional within each CPR associated with the GSS by identifying (or listing) required nodes and optional nodes for the GSS in the Required Nodes window 126 and the Optional Node window 128,

- 32 -

respectively. Preferably, the Required Nodes window 126 includes a nodes palette 126a, node type buttons 126b, and a selected nodes window 126c. As with the nodes window 179 shown in Fig. 9, to identify required nodes, a user selects the type of node desired using node type buttons 126b. Each available node for that node type is listed in nodes palette 126a. The nodes presented in the required nodes palette 126a may be the same as the nodes appearing in the Nodes List 191 of the CPR Editor's Nodes window 179 (Fig. 9). The selected required nodes are listed in the required nodes section 126c. Each node listed in the required nodes section 126c must be used at least one time in the creation of any CPR associated with the GSS.

The optional nodes list is similarly established using the Optional Nodes window 128 which includes a nodes palette 128a, node type buttons 128b, and a selected nodes section 128c. The optional nodes list indicates which nodes may optionally be used in a CPR associated with the GSS. Any nodes not listed in either the required or optional nodes lists cannot be used in the creation of CPRs associated with the GSS being created.

In an alternative embodiment, the GSS Editor screen 120 further includes a Restricted Nodes window (not shown), which is similar to Required Nodes window 126 and Optional Nodes window 128, but wherein a user specifies nodes which cannot be used in a CPR associated with the GSS.

Once a user is satisfied that the required nodes list, optional nodes list, and restricted nodes list accurately reflect the requirements and limitations necessary to "specify" the service related to the GSS, the user saves the GSS in the database 203. To save the GSS (or any other record), the user selects the "Record" option from the menu line 172. (As shown in Figs. 9 and 10, the menu line 172 appears on the CPR Editor screen 171 and the GSS Editor screen 120.) Once the Record option menu 174 (Fig. 7) is presented, the user selects the "Save" option and the contents of the GSS are stored in the database 203.

- 33 -

Before a subsequent CPR may be associated with the GSS, the GSS must be enabled. To enable a GSS, a user selects the "Operation" option from the first menu line 172 and selects an "Enable" option (not shown) from the Operations options menu (not shown). Preferably, an enabled GSS may not be edited or deleted if other records depend on it, since changes to an enabled GSS could affect records previously associated therewith.

The foregoing description of a method for creating a GSS is summarized in the flowchart shown in Fig. 11. In Fig. 11, a user begins by naming the GSS (step 1000) and describing the GSS and the related service (step 1002). Next, the user defines at least one required node (step 1004), lists the at least one required node (step 1006), defines at least one optional node (step 1008), and lists the at least one optional node (step 1010). Finally, the user stores the GSS in the database (step 1012), enables the GSS (step 1014), and the creation procedure ends (step 1016). In an alternative embodiment, the step of defining at least one restricted node (not shown) would be added. In an alternative embodiment, the user may specify that the GSS has zero or more optional, required, or restricted nodes.

In like manner as described above, a GSS may be created for a template.

2. Validating a CPR in Accordance with an Associated GSS

In accordance with the embodiment of the invention, during a validation process, a graph is examined to determine whether the graph is consistent with the requirements of the associated GSS. If the CPR contains restricted nodes, which are not permitted by the GSS, or does not include the mandatory nodes, the CPR fails the validation process.

Fig. 12 is an example of a GSS Editor screen 120 containing a definition of a GSS named "800basic" for a service that designates a particular long distance carrier

- 34 -

for "800" calls made to the customer between 8:00 a.m. and 5:00 p.m. The 800basic GSS may be compared to another, more complex GSS named "800enhanced" (not shown) which might provide a greater range of potential features (at increased cost) such as, for example, Personal-Identification-Number (PIN) validation and call sampling.

In Fig. 12, the GSS description for the 800basic GSS describes some distinctions between the 800basic service and 800enhanced service. As shown in the Selected Nodes window 126c for the required nodes, the 800basic GSS requires a "Carrier" node which identifies the desired long distance carrier, and a "RouteTo" node which identifies the actual telephone number to which the "800" call should be routed. As shown in the Selected Nodes window 128c for the optional nodes, the optional nodes for the 800basic include the "Day" and "Time" nodes.

Assume for sake of example, that having established the foregoing GSS, a user is attempting to create a graph according to the GSS. Fig. 13A illustrates a portion of such a graph. In Fig. 13A, dialed number "8006993156" (header 701) will be routed according to a decision as to the time of day (node 703). If the time is between 08:00 and 17:00 hours (branch 705), the user wishes to validate a PIN (node 708), select a carrier (node 711), and route the call according to routing node 713. If the time is other than above (branch 707), the user wishes to route the call according to routing node 717. However, because the 800basic service does not allow PIN validation, the PINmatch node 708 must be removed from the graph. This error would be identified to the user during a validation process. A user could then edit the graph to conform to the specified parameters of the 800basic GSS. For example, a graph acceptable under the 800basic GSS is shown in Fig. 13B. The graph in Fig. 13B is the same as the graph in Fig. 13A except for the omission of PINmatch node 708. Note that the graphs of Figs. 13A and 13B include the required "Carrier" and "Route To" nodes.

- 35 -

A preferred method by which the present invention validates a CPR graph against its associated GSS is shown, for example, in Fig. 14. In Fig. 14, the system reads the first node in the graph (step 1052) and determines whether the node is a required node (step 1054). If the node is a required node, the system determines whether the node is the last node in the graph (step 1062). If the node is not the last node in the graph, the system goes to the next node in the graph (step 1064) and repeats the procedure. However, if the first node is not a required node, the system determines whether the node is an optional node (step 1056).

If the node is an optional node, the system repeats steps 1062 and 1064. If the node is not an optional node, the node violates the GSS and fails validation (step 1058). This failed validation is displayed to the user (step 1060).

After the final node in a graph is determined (step 1062), the system determines whether every required node of the GSS is present in the graph (step 1050). If not, the graph fails validation. If, however, every required node of the GSS is present in the graph; the system indicates a successful validation to the user (step 1063).

F. Nodes

As discussed in the set of incorporated patent applications, nodes are the basic units that define the logical operations to be performed during call processing. Each node is therefore a separate call processing procedure or a subprocedure of a graph. Nodes are logically connected to form a directed graph.

1. Action Nodes

Action nodes may be categorized as Assignment nodes, Network Action nodes, and Control nodes.

Assignment nodes are nodes which provide a function that sets a designated call variable to a particular value. The

- 36 -

value may be a constant, another call variable, or the result of a predefined manipulator. Each Assignment node includes a call variable to be assigned a value and an expression.

For example, one example of an Assignment node is a "CARRIER" node. The CARRIER node includes a call variable "RPCARRIER" and an expression. Call variable RPCARRIER is predefined to be a "carrier" data type. For purposes of this example, the RPCARRIER CV may be assigned one value from a set of values including AT&T, MCI, or SPRINT. Accordingly, during creation of a graph containing the CARRIER Assignment node, a user must specify (or assign to) call variable RPCARRIER one of the values defined within the carrier data type (i.e., AT&T, MCI, or SPRINT).

Preferably, Assignment nodes include billing nodes. Billing nodes are of particular importance because service providers must bill customers for the type and quantity of services used by the customer. Accordingly, billing nodes are often one of the required nodes in GSSs. Billing nodes preferably include a BillingInd node, BillingNum node, and BillingType node.

The BillingInd node allows a user to assign a value to one or more predefined "billing indicator" call variables. For example, a billing indicator call variable named RPBILL, may be assigned a 4-digit customer number (i.e., Mr. Jones may be customer 2045) and have a corresponding expression. Thus, a graph having the foregoing BillingInd node allows a user to define "RPBILL = 2045." With this assignment, services provided by the CPR having the graph containing the foregoing BillingInd node will be billed to customer 2045 (Mr. Jones') account.

The BillingNum node allows a user to assign a value to a call variable corresponding to a "billing number," such as a telephone number. For example, the billing number call variable may be named "RPBILLNBR," (i.e. Mr. Jones' telephone number may be 703-308-5555), may be of "telephone number" data type, and may have a corresponding expression. Thus, a graph having the foregoing BillingNum node allows a user to

- 37 -

assign "RPBILLNBR = 7033085555." With this assignment, services provided by the CPR having the graph containing the foregoing billingNum node will be billed to telephone number 703-308-5555.

The BillingType node allows a user to assign a value to one or more predefined "billing type" call variables. For example, a billing type call variable may be named RPMONTHLY, may be of signed integer data type, and may have a corresponding expression. Thus, a graph having the foregoing BillingType node allows a user to assign "RPMONTHLY = 15." With this assignment, services provided by the CPR having the graph containing the foregoing BillingType node will be calculated and billed on the fifteenth day of every month.

Control Nodes allow multiple CPR entry points to be traversed as part of a single call execution and include a Handover node and Transfer Control node. The Handover node allows a CPR to call and execute another graph before continuing with the current CPR graph. The graph may be located in another CPR, thus the Handover node requires that the CPR key, trigger, and entry point for the graph be specified within the Handover node. Once the other graph is processed, processing returns to the original CPR graph.

The Transfer Control node is like the Handover node in that another CPR is specified and executed. Unlike the Handover node, however, the processing does not return to the original graph, but remains at the transferred CPR.

2. Decision Nodes

Decision nodes are used to branch execution through the graph. Decisions as to which graph branch to traverse may be made on the basis of a call variable value and an expression within the decision node. For example, a Call Variable Decision node may include a call variable named "READY" of data type Boolean. This decision node branches one way or the other in a graph based on "READY = yes," or "READY = no." Compare nodes compare expressions. For example, a compare

- 38 -

node may compare the expressions: "\$TRYS<3" to determine whether a customer has made less than three attempts to input data to the system. The compare node takes a "yes" branch if the comparison is true and takes a "no" branch if the comparison is false.

Decisions as to which graph branch to traverse may also be made on the basis of a "percent" decision. The Percent Decision node is used to randomly choose one of a number of possible graph branches. The percentage each individual branch will be traversed in the long run is specified in a Percent Decision node at the head of each branch. The sum of all branch percentages will equal 100%.

3. Administrative Nodes

Administrative nodes are used to collect service or customer traffic data which can be used by a service provider to analyze and administrate service or customer usage. Administrative Nodes preferably include Sampling nodes and Measurement nodes.

a. Sampling Nodes

Sampling nodes collect values of selected call variables during call processing execution. Sampling nodes are defined by a sampling rate, a sampling type, and a sample data name. Additionally, a sample data retention period, a collection type, and/or a list of call variables to be collected may be specified for a sampling node.

The sampling rate identifies the percentage of calls to be sampled in order to obtain the specified data. The sample type may be, for example, an "attempt" sample, which captures data when a call is attempted, or a "completion" sample, which captures data when the call is actually completed.

To add a Sample node to a graph, a user selects the "Sample" node from the Nodes window 179 (Fig. 9). A Sample Node Editor Dialog Box 750, as shown for example in Fig. 15,

- 39 -

is then superimposed on the CPR editor screen 170. For a sample node, the Node Editor Dialog Box 750 requests a definition of a sampling rate (0-100%) (field 752), collection type (field 753), sampling type (attempted or completed) (field 754), sample node name (field 755), and the call variable to be sampled (field 756). Once the fields are completed and the user selects the "OK" button, the Sample node is instantiated in the graph. Use of a Sampling node in a graph is illustrated in Fig. 16 and described in more detail below.

b. Measurement Nodes

Measurement nodes count events. Events may be, for example, the number of times a graph or a portion of a graph is traversed, how many times a call variable is changed, etc. Measurement nodes may count up or down from a predetermined starting number. Thus, Measurement nodes are used to update a component of a measurement vector. A measurement vector is an "up count" or a "down count."

Measurement nodes are created during graph building by specifying which component of a measurement vector call variable is to be incremented or decremented. This designation is preferably made in the Call Variable window 190 of the CPR Editor Screen 170 (Fig. 9). Alternatively, the measurement vector call variable, the measurement vector component, and the increment/decrement designation are provided in response to prompts in a measurement node Editor Dialog Box (not shown) similar to the Sample Mode Editor Dialog Box 750 shown in Fig. 15.

The system uses a unique counter created when the measurement vector was defined. The counter is loaded with the starting point value and changes the value (up or down) on the basis of subsequent measurements.

Fig. 16 shows part of a graph incorporating a Sample node and Measurement nodes. In this graph, calls originating from a customer's number "3014447500" (header 720) are routed

- 40 -

based on a determination of the "900?" node (721). For this example, the 900? node is a User-defined node (described below) which accepts a telephone number, determines the area code of the telephone number, compares this area code to a constant call variable value of 900, and selects a graph branch on the basis of this comparison.

If the dialed telephone number does not have an area code of 900, the call is "counted" by a Measurement node named "Measureother" (node 723), assigned a carrier (node 724), and routed according to routing node 725. If, however, the dialed telephone number has a 900 area code, the call is counted by a Measurement node named "Measure900" (node 733), sampled by a Sampling node named "Sample 900," (node 734), and routed according to routing node 735.

Measureother node 723 and Measure900 node 733 each has an assigned counter which counts up from zero to measure the number of outgoing phone calls having non-900 and 900 area codes, respectively. Accordingly, the number of uses for each branch of the graph can be measured.

In the above example, the "Sample900" node 734 has been previously defined to sample a predetermined call variable. Assuming a sample rate of 20, the Sample900 node will sample the predetermined call variable once every five calls having a 900 area code.

Data measured or sampled is preferably stored in a database for review by the service provider and/or the customer.

4. Interaction Nodes

Interaction nodes preferably include two types of nodes: Network Interaction Nodes and External System Interaction Nodes.

- 41 -

a. Network Interaction Nodes

Network Interaction nodes preferably include a Connect node, a Terminate node, and a Play Announcement and Collect Digits Node. The Connect node allows a user to route a call to a designated number. The routing number is specified as a call in the Connect node. The Terminate node allows a user to block a call. Once a graph reaches a Terminate node, all call processing is halted. The Play Announcement and Collect Digits node, as discussed above, is used to play an announcement to the customer, and then collect digits (i.e., DTMF signals) from the user in response to the announcement.

b. External System Interaction Nodes

This node type preferably includes a GetData node, SendData node, and WaitForEvent node. The GetData node allows the user to send a message to an external system (outside the SCP) requesting certain data from that external systems data base to be placed in call variables that are specified in the node. The SendData node allows a user to send a message to an external system (outside the SCP) to store certain data as provided in call variables that are specified in the node, in the external system's data base. The WaitForEvent node allows the user to wait for the completion of an external event such as any GetData or SendData operation before call processing will continue.

Fig. 17 illustrates a graph using GetData, SendData, and WaitForEvent nodes. In the graph of Fig. 17, GetData node 1800a requires the SPACE system to get a value from a different system, return it to the SPACE system and put it into a call variable entitled Event 1. Call variable decision node 1800b may be, for example, a day of week decision node which compares the Event 1 call variable to value 1 in decision branch 1800c, which may be, for example, the values equal to Monday-Friday. If the call variable in Event 1 is equal to value 1, GetData node 1800d requires the

- 42 -

SCP to retrieve a value from a system outside the SCP and put it into a call variable entitled Event 2. Because the external system from which GetData node 1800d is retrieving a value may be located far away from the SCP or may be busy, it may require some time to return the value. Accordingly, WaitForEvent node 1800e tells the SCP to wait until the value is returned before further processing. If at node 1800b the event 1 call variable is something other than value 1, it will be processed through branch 1800f. SendData node 1800g causes the SCP to send a call variable specified in event 3 to an external system. WaitForEvent node 1800h awaits the completion of the SendData operation.

5. User-Defined Nodes

User-defined (or custom) nodes are single nodes having an underlying graph associated therewith. The underlying graph is defined by the user, hence the name. A displayed representation of a User-defined node will have the appearance of a single node even when that particular User-defined node contains multiple nodes.

To create a User-defined node, a user displays the system screen 170 and selects the "custom node" suboption 175c (Fig. 7). The system then displays a dialog box (not shown) requesting the user to input a name for the custom node. Once the name has been entered and the user selects the "OK" button, the Custom Node Editor screen 791 is displayed, as shown in Fig. 18.

Custom Node Editor screen includes a Custom Node Information window 798, which includes "Name," "Creator," "Modified," and "Effective" fields 798a-d, similar to these same fields for the CPR and GSS Editor screens (see Figs. 9 and 10).

The underlying graph of a custom node is built by the user in the Graph Editor portion 796 of the Custom Node Editor screen. Graph building on the Graph Editor portion 790 proceeds in a manner similar to the graph building

- 43 -

process described with respect to the CPR Editor screen 171 in Fig. 9.

The Custom Node Editor 791 also includes parameters window 797 which displays a list of parameters associated with the custom node being generated. These parameters define the relationship of the input fields for the custom node and the values within the graph. A parameter is a variable that will be filled in by the user of the custom node when it is inserted into a graph.

A Parameter Editor 1900, as shown for example in Fig. 19A, is used to create and modify parameters for a custom node. The Parameter Editor 1900 is displayed by "mouse clicking" on a preselected portion of the Parameters window 797. Parameter Editor 1900 prompts the user to complete a "parameter name" field 1900a, a "data type" field 1900b, an "allow" field 1900c, and an "interface" field 1900d. The parameter name is used when referring to this parameter as part of the value of a node. The "allow" field specifies permissible values for the parameter. For example, in Fig. 19A, the "allow" field 1900c permits only constants and call variables for the "Pin" parameter.

Using "Interface" field 1900d, the user can specify the type of interface to be displayed to a user of the customized node. Preferable interfaces include text fields, buttons, or selection lists. If a user designates the interface to be either buttons or selection lists, a Selection List Editor, as shown for example in Fig. 19B, is displayed.

The Selection List Editor 1902 allows the user to enter a list of labels which will be displayed when a custom node having the parameter being defined is used, as well as values associated with the labels.

The Selection List Editor 1902 includes a "Labels Defined In" field 1902a, a "Name" field 1902b, a "Label/Value" field 1902c, and a "Manipulators" field 1902d. Labels for a parameter may be defined in the Label/Value field 1902c or in another parameter. This allows a user to tie together the values of the parameters. Fields 1902a and

- 44 -

1902b permit the user to specify in which parameter the labels are defined. Label/Value field 1902c provides a list of labels that will be presented to user of the custom node. In Fig. 19B, for example, the labels for the personal identification number (PIN) are "Choice 1," "Choice 2," and "Choice 3." The actual values specified for these labels are "1221," "2212," and "1234," respectively. The labels for values provide for a more user-friendly interface. Manipulator buttons 1902d are used to manipulate labels and values in the Label/Value field 1902c.

Parameter Editor 1900 also includes Prompt field 1900e, which allows a user to designate the text of a prompt should the user select the interface to be a text field. For example, in Fig. 19A, a user has selected a text field interface and specified the text field to read "Enter a PIN number."

Returning to Fig. 18, the Custom Node Editor 791 also includes Edit Help option 792, Set Category option 793, Layout option 794, and Preview option 795, each of which allows the user to define a portion of the Custom node.

The Edit Help option 792 invokes an Edit Help Editor (not shown) which contains a written description of the custom node. Upon creation or modification of a custom node, the user may edit the written description regarding the custom node.

The Preview option 795 displays a Preview Editor 2000, as shown for example in Fig. 20. Preview Editor 2000 includes a Name field 2000a to identify the node for which information will be requested. Field 2000b displays the user interface that was specified in the prompt field 1900e and the interface field 1900d of the Parameter Editor 1900. For PIN nodes, the system permits the user to specify the number of PIN retries that will be permitted; hence, Fig. 20 includes "retries" field 2000c.

The layout of the fields presented in the Preview Editor can be changed using the Layout option 794. The Layout option 794 displays a Layout Editor 2100, as shown for

- 45 -

example in Fig. 21. As shown, the Layout Editor 2100 includes the same fields 2000a, 2000b, and 2000c, as displayed in the Preview Editor 2000. However, in the Layout Editor 2100, these fields can be manipulated by selecting a field (using select buttons 2100a) and clicking on one of the manipulator buttons 2100b.

The Set Category option 793 is used to establish a node category type for the custom node being created when a user selects the Set Category option 793, the system displays a Custom Node Category Editor 804, as shown for example in Fig. 22. Using the Custom Node Category Editor 804, a custom node may be assigned to any of the node types represented by the node type buttons 192 (Fig. 9).

When the custom node is fully defined and categorized, the user enables the node by selecting an "Enable" suboption (not shown) from the "Operations" menu (not shown) on the System screen 170 (Fig. 7). Preferably, the underlying graph is validated prior to being enabled. Once a User-defined node has been enabled, it will appear in the nodes list 191 of the CPR Editor screen 171 and the nodes lists 126a and 128a of the GSS Editor screen 120.

When a CPR containing a custom node is trace tested, the custom node will be displayed as a single node. In other words, the underlying graph is not displayed. However, individual nodes within the underlying graph of the custom node are tested in the same manner as other nodes in the graph. Each node of the underlying graph of a custom node is also considered during validation. Thus, errors and warnings generated by a testing or validation process can be specified to a particular node within the underlying graph of the custom node.

- 46 -

6. Table Nodes

a. Intable node

An Intable node determines whether a particular value exists in a particular table and selects between two branches of a graph depending on the determination.

An example of a graph using an Intable node is shown in Fig. 23. In this graph, calls originating from telephone number 703-308-5555 (see header 1200) are checked by Intable node 1201 to see if the dialed number is listed in a Table of prohibited telephone numbers. For this example, Intable node 1201 is named "Prohibited." If the Prohibited node finds the dialed number in the Table, an announcement is played (node 1203) informing the caller that the dialed call cannot be completed, and the call is terminated (node 1204). However, if the dialed number is not found in the table, the call is routed according to routing node 1202.

The table designated and searched by the "Prohibited" node might be a single column table listing all prohibited telephone numbers (1220) like the one shown, for example, in Fig. 24. Alternatively, the designated table might be a multiple column table such as that shown in Fig. 6A, in which case the Intable node which designates and searches the table must also designate the column to be searched.

The Intable node includes a search expression defining search criteria for locating a particular table row in a standalone table or a table call variable. The search criteria is a list of column value pairs. Preferable values for search columns are any valid column names within the specified Table. Preferable values for the search value are any valid values for the search column (e.g., a string if the search column contains string data type information) or the name of a call variable (preceded by a dollar sign) whose value is of the same data type as the search column.

A user specifies the foregoing criteria using an Intable Node Editor 2200, as shown for example in Fig. 25, which is

- 47 -

displayed when a user selects an Intable node from a nodes list.

Intable Node Editor 2200 includes Name field 2200a corresponding to this node type. The table search criteria is inserted in search fields 2200b-e. Table Name field 2200b specifies the table to be searched. Column field 2200c specifies the column or columns of the table to be searched. Value field 2200d specifies a value to be searched for in the specified column. Finally, Expression field 2200e permits a user to specify comparison criteria for the value specified in field 2200d and the values in the table. In a preferred embodiment, the comparison criteria in the Expression field 2200e includes "=", " <=", ">=", "<=", "≥," and "≤."

In a preferred implementation of the present invention, a method by which the system executing an Intable node searches a designated table and outputs a response is illustrated in the flowchart of Fig. 26. Initially, when executing a table node the system reads the Table name designated by the Intable node (step 1230) and determines whether such a table exists (step 1231). If not, an error is indicated (step 1235). If the table is found, however, the system reads the Column names to be searched (step 1232) and determines whether the Columns exist in the Table (step 1233). If not, an error is indicated (step 1235). Once the Table and Columns are found, the system reads the value(s) to be searched (step 1236), and searches the Table Columns using the expression contained in the Intable node to compare the specified values to values in the Table (step 1237). If the value(s) are found in the Table, the call is processed one way; if the value(s) are not found in the Table, the call is processed another way, as designated by the branches in the graph.

- 48 -

b. Table node

The Table node allows a user to determine whether a row exists in a designated Table that meets certain specified criteria, and, if a row exists, to retrieve a value from one or more of the columns in that row. The retrieved value is used by nodes of a graph which follow the Table node.

Like the Intable node, a Table node has an associated table name and a list of column value pairs. For each column from which values will be retrieved, a call variable is defined. Preferable values for retrieve and search columns are any valid column names within the specified Table. Preferable values for the search values are any valid values for the search column (e.g., a string if the search column contains string data type information) or the name of a call variable (preceded by a dollar sign) whose value is of the same data type as the search column.

When a user selects a Table node from a nodes list, the system displays

Table Node Editor 2300, as shown for example in Fig. 27. Unlike an Intable node which return a yes/no boolean value, a Table node retrieves and returns a value from a table. However, field 2300a of the Table Node Editor 2300 allows a user to specify a call variable to which an indication of whether the search was successful can be assigned. In this manner, the user gets "yes/no" search information, similar to an Intable node. Table Node Editor 2300 also includes a "name" field 2300b, which is used to specify the table to be searched, as well as "search matrix" field 2300c and "retrieve" matrix field 2300d. In search matrix field 2300c, a user specifies the column name, a value to be compared, and a comparison expression, in a manner similar to the Intable Node Editor 2200. Search criteria can be entered or deleted using manipulator button 2300e. Search matrix field 2300c also permits a user to specify whether a search of the table should be made with respect to "all" or "any" of the specified search criteria. In retrieve matrix field 2300d, a

- 49 -

user specifies the column name or names of a table from which to retrieve a value and the corresponding call variable name or names to which the retrieved value(s) should be assigned. Additional column names and call variable names can be added or deleted using manipulator buttons 2300f.

Upon execution of a graph having a Table node, the call variables designated by the TABLE node will have either values obtained from the table designated or null values.

A preferred method by which the system executing a graph having a TABLE node searches a designated table and outputs a response is illustrated in the flowchart of Fig. 28.

Initially, the system sequentially reads the call variables designated in the Table node (step 1250), the table name designated by the Table node (step 1252), and the Column names designated in the Table node (step 1254). After reading each of these designations, the system respectively determines whether each exists (steps 1251, 1253, and 1255). If one does not exist, an error is indicated (step 1256). Once the call variables, table, and column names have been read, the system reads the search values (step 1256) and searches the Table using the comparison expressions contained in the Table node (step 1257). If values are found in the columns which meet the requirements of the search values, the values are output (step 1259). If no such values are found, "null" values are output (step 1260).

G. Templates

Many customers may request the same telecommunication service for mass markets. For example, many customers may wish to designate a long distance carrier during certain times of the day (i.e., business hours). Each customer's graph would therefore be identical except for call variables and nodes and branches defining the carriers and nodes defining the time of day that specified carriers will service the call. All other nodes in the graph and the structure of the graph would be "generic" to the service.

- 50 -

It is impractical and inefficient to require a user to build the same graph for every customer requesting the same service. Accordingly, the present invention provides for templates. Once created and enabled, a template serves as a "form" for creating a customer specific version of a service. Customer specific versions of a service are established by providing values for "customizable" expressions in a node, branch, or call variable within a template. In this manner, the template allows the same service to be provided to more than one customer without having to rebuild the entire graph or redefine generic call variables in the CPR establishing the service. "Customizable" nodes in a template are different from User-defined or "custom" nodes described above. A User-defined or "custom" node is a single node representation having an underlying graph (including more than one node) which defines the "custom" node's functionality. A "customizable" node in a template is a partially defined, single node which is completed by a user during CPR building in accordance with customer specific data. In a like fashion branches and call variables can be made customizable.

Templates are preferably created from preexisting CPRs. To create a template, a user opens the CPR Editor screen 171 and displays a graph from which he or she desires to make a template. With the graph displayed, the user selects the "Operations" option on the menu line 172 of the CPR Editor screen 171 (Fig. 9). In response to this selection, the system displays the Operations menu of suboptions (not shown). One of these suboptions is a "Make Templates" suboption (not shown), which the user selects.

In response to selection of the Make Template suboption, the system displays a Make Template Information Dialog Box (not shown), which prompts the user to enter a name for the template. After the user names the template, a Template Editor screen 910, as shown for example in Fig. 29A, is displayed.

- 51 -

Template Editor screen 910 includes a Template Record Information window 911, a Call Variables window 913, a Graphs In Template window 912, and a Form Operations window 914. The Template Record Information window 911 includes "Name," "Creator," "Modified," and "Effective" fields 911a-d, similar to these same fields for the CPR, GSS, and Custom nodes screens (see Figs. 9, 10, and 18). The Graphs In Template window 912 and Call Variables window 913 of the Template Editor screen 910 operate in the same way as the Graphs in CPR window 178 and the Call Variables window 190, respectively, of the CPR Editor screen 171 (Fig. 9). Form Operations window buttons 914a and 914b are described below.

The graph 925 from which the template is being created is displayed in Graph window 920. The exemplary graph of Fig. 29A provides for a predetermined carrier for all calls made to a particular telephone number and routes the calls to one of two telephone numbers depending on whether the calls are made on a weekday or weekend. A user from which the template is being created can select which of the nodes of the graph he or she wishes to make customizable by clicking a mouse or similar device on the node.

Each expression in the selected node can be designated as customizable. For example, assume that the template creator selects the "Carrier" node 925a to be customizable. In response to this selection, the system displays a Template Carrier Node Editor 930. Template Node Editors in general differ from CPR Node Editors because Template Node Editors include customizable selection buttons 935, which allow a user to designate which node expressions will be customizable. For example, in Fig. 29B, the carrier type is not customizable, but is fixed as primary. However, the carrier value is customizable. Text fields 936a and 936b are provided to specify a prompt which will be displayed to a user to collect the customizable information for the node.

In like manner, to make a branch a call variable customizable, in response to a selection of the branch or call variable by the user, the system prompts the user to

- 52 -

identify the expressions to be made customizable using a Template branch or Template call variable Editor (not shown) similar to the template node editor described above. This prompt is used in both a form representation and a graph representation of any CPR based on this template.

Following customization of the node expressions, the user returns to the Template Editor screen 910 wherein node 925a of the displayed graph 925 is preferably indicated as a "customizable" node in the template by means of a different color or different colored border.

As described above, a user can display a CPR as either a graph or a form representation. A template creator can view the graph representation in the graph window 920, but can also browse and manipulate the form representation using Form Operators window 904.

Form Operations window 914 includes "Layout" and "Preview" options 914a and 914b, respectively. Selection of the "Preview" option 914b causes the system to display a Preview Editor 915 as shown for example in Fig. 29c. The Preview Editor 915 displays the CPR in its form representation to the template creator. When initially displayed, because the template is being created from an existing graph, the information fields 915b-915e of the Preview Editor 915 may contain information relating to the existing graph. Because the template creator is creating a template and not an external CPR based on the template, the creator cannot modify the information displayed in the form. In the example of Fig. 29C, the template form tells the template creator that a user using this template to create a CPR will specify a primary carrier (field 915b) and different routing numbers for selected weekdays and weekends (fields 915c-915e). The Preview Editor 915 also includes information field 915a to display the template name, creator, and modification dates.

The layout of the information viewed in the Preview Editor 915 can be modified using the "Layout" option 914a.

- 53 -

Selection of the "Layout" option 914a causes the system to display a Layout Editor 916, as shown for example in Fig. 29D. The Layout Editor 916 includes the same fields 915a-d as shown in the Preview Editor 915, and shows the layout of information that will be presented to a user creating a CPR based on a particular template. A set of manipulator buttons 916a is provided to allow the user to change the order of the fields. Preferably, only the order of the entry fields is changed in the Layout Editor 916.

After the user makes "customizable" all the nodes required to transform the CPR graph 925 into an appropriate template, the user enables the template by selecting an Enable suboption (not shown) from the main menu bar "Operations" Menu (not shown). The enabled template is then available for making template-based CPRs and can be stored in the database 203.

A user creates a template-based CPR by selecting the "Find Template" option 178 under the Record menu of the main menu bar 172. Selection of the "Find Template" option causes the system to display a Find Editor 950, as shown for example in Fig. 30, which displays in list window 950a a list of templates stored in database 203. For each template stored in database 203, the system displays the name, status, and creator of the status, as well as dates the template was enabled and modified. Find Editor 950 also includes search fields 950b, which allow a user to designate search criteria to search the template list. Menu buttons 950c permit a user to edit, browse, delete, customize, or cancel a selected template.

A user selects a template by selecting the template name (e.g., mouse click) in the template list 950a and selecting the customize button. In response to these selections, the system displays a New Record Information Dialog Box requesting the user to input a name of the template-based CPR. The user then has the option of viewing the template-based CPR in a graph representation (which looks like the graph 925 shown in Fig. 29A) or in a form representation.

- 54 -

(which looks very much like the information presented in the Preview Editor 915 (Fig. 29C)). The user can only input values for the expressions and call variables that the template creator indicated as customizable. After inputting the custom values, the user can test, validate, and activate this CPR just like any other CPR.

H. SUMMARY

While there has been illustrated and described what are at present considered to be preferred implementations and methods of the present invention, it will be understood by those skilled in the art that various changes and modifications may be made, and equivalents may be substituted for elements thereof without departing from the true scope of the invention.

In addition, many modifications may be made to adapt a particular element, technique or implementation to the teachings of the present invention without departing from the central scope of the invention. Therefore, it is intended that this invention not be limited to the particular embodiments and methods disclosed herein, but that the invention include all embodiments falling within the scope of the appended claims.

- 55 -

WHAT IS CLAIMED:

1. A method of creating, in response to inputs from an operator of a record creation system in a telecommunication network, a general service specification for a call processing record containing logically related nodes and branches, the method comprising the steps, executed by a processor in the record creation system, of:

prompting the operator to identify at least one optional node which may appear in a call processing record associated with the general service specification;

receiving from the operator an identification of at least one optional node which may appear in the call processing record associated with the general service specification;

prompting the operator to identify at least one required node which must appear in the call processing record associated with the general service specification;

receiving from the operator an identification of at least one required node, which must appear in call processing records associated with the general service specification; and

enabling said at least one optional node and said at least one required node as a general service specification.

2. A method according to claim 1, further comprising the steps of:

prompting the operator to identify at least one restricted node which cannot appear in the call processing record associated with the general service specification;

receiving from the operator an identification of at least one restricted node which cannot appear in the call processing record associated with the general service specification; and

enabling at least one restricted node as part of the general service specification.

3. A method of creating, in response to inputs from an operator of a record creation system, a call processing

- 56 -

record for execution in a telephone service execution environment, comprising the steps, executed by a processor in the record creation system, of:

comparing each node of said call processing record against a list of optional and required nodes included in a general service specification, optional nodes being nodes which may be used in the call processing record, and required nodes being nodes which must be used in the call processing record;

indicating to the operator a failed validation procedure if said call processing record does not contain the nodes listed in the required nodes list or contains nodes not listed in either the required nodes or the optional nodes list; and

indicating to the operator a successful validation procedure if said call processing record does not contain the nodes listed in the required nodes list and does not contain nodes that are not listed in either the required nodes or the optional nodes list.

4. A method according to claim 3, further comprising the steps of:

comparing each node of said call processing record against a list of restricted nodes, restricted nodes being nodes which cannot appear in a call processing record; and

indicating to the operator a failed validation procedure if said call processing record does contain a node listed in the restricted nodes list.

5. A method of creating, in response to inputs from an operator of a record creation system, a template for the creation of call processing services, each call processing service being represented by a call processing record containing logically related call processing nodes, branches, and call variables, the method comprising the steps, executed by a processor, of:

displaying to the operator a selected call processing record;

- 57 -

receiving from the operator an identification of a selected node in the call processing record to be made customizable, a customizable node being a node for which subsequent template users can specify predetermined expressions;

displaying to the operator all expressions of the selected node;

prompting the operator to identify which of the selected node expressions will be customizable;

receiving from the operator an identification of an expression of the selected node which will be customizable;
and

enabling the selected call processing record and the designation of customizable node expressions for the selected node as a service template.

6. The method according to claim 5, further comprising the step of displaying the service template as a graph representation or a form representation.

7. A method of creating, in response to inputs from an operator of a record creation system, a template for the creation of call processing services, each call processing service being represented by a call processing record containing logically related call processing nodes, branches, and call variables, the method comprising the steps, executed by a processor, of:

displaying to the operator a selected call processing record;

receiving from the operator an identification of a selected branch in the call processing record to be made customizable, a customizable branch being a branch for which subsequent template users can specify predetermined expressions;

displaying to the operator all expressions of the selected branch;

prompting the operator to identify which of the selected branch expressions will be customizable;

- 58 -

receiving from the operator an identification of an expression of the selected branch which will be customizable; and

enabling the selected call processing record and the designation of customizable branch expressions for the selected branch as a service template.

8. A method of creating, in response to inputs from an operator of a record creation system, a template for the creation of call processing services, each call processing service being represented by a call processing record containing logically related call processing nodes, branches, and call variables, the method comprising the steps, executed by a processor, of:

displaying to the operator a selected call processing record;

receiving from the operator an identification of a selected call variable in the call processing record to be made customizable, a customizable call variable being a call variable for which subsequent template users can specify predetermined expressions;

displaying to the operator all expressions of the selected call variable ;

prompting the operator to identify which of the selected call variable expressions will be customizable;

receiving from the operator an identification of an expression of the selected call variable which will be customizable; and

enabling the selected call processing record and the designation of customizable call variable expressions for the selected call variable as a service template.

9. A method of creating, in response to inputs from an operator of a record creation system, a call processing service from a service template stored in a database, a service template comprising a call processing record of logically related call processing nodes, branches, and call variables, at least one of said call processing nodes being customizable, a customizable node having at least one

- 59 -

variable expression, the method comprising the steps, executed by a processor, of:

- retrieving the service template from the database;
- displaying a representation of the retrieved service template;
- prompting the operator to provide information to specify at least one variable expression of the at least one customizable node;
- defining the variable expression of the at least one customizable node with the information provided by the operator; and
- enabling the displayed representation of the retrieved service template and defined expression as a call processing record.

10. A method of providing a requested service to one or more customers of a telecommunication network, the method comprising the steps, executed by a data processor of the telecommunication network, of:

- creating one or more call processing records each including a plurality of call processing procedures for execution by a call processing environment of the telecommunication network;
- creating a table of data associated with each of said one or more call processing records;
- storing said one or more call processing records and said table of data;
- executing one of said processing records in the call processing environment; and
- retrieving data from said table of data during the execution of said one of said call processing records.

11. In a telecommunication service creation environment in a telecommunication network providing for call processing records and value tables, each of the value tables comprising one or more columns and one or more rows of values, a method of creating a call processing procedure to determine whether a particular value exists in a particular value table comprising the steps, executed by a data processor, of:

- 60 -

prompting an operator to identify a value table to be searched;

receiving from the operator an identification of a value table to be searched;

prompting an operator to identify one or more columns in the value table to be searched;

receiving from the operator an identification of one or more values in the value table to be searched;

prompting an operator to specify a value to be searched for in the one or more identified;

receiving from the operator a specified value to be searched for in the one or more columns to be searched;

prompting an operator to specify comparison criteria for the specified value in the column to be searched;

receiving from the operator a comparison criteria for the value specified and values in the column to be searched; and

instantiating the table name, one or more columns, value to be searched for, and comparison criteria as part of the call processing procedure.

12. A method of providing call processing in a telecommunication network comprising the steps, executed by a processor, of:

retrieving a call processing record from storage in response to a request to process a call;

executing call processing procedures specified in the call processing record;

reading a table name specified in a predetermined call processing procedure;

accessing a value table corresponding to the table name;

reading one or more column names, a search value, and comparison criteria specified in the predetermined call processing procedure;

searching the specified one or more columns of the accessed value table;

- 61 -

comparing values in the one or more columns to the specified search value in accordance with the specified comparison criteria;

generating a first output if the comparison criteria is met during the comparing step; and

generating a second output if the comparison criteria is not met during the comparing step.

13. In a telecommunication service creation environment providing for call processing records and value tables, the value tables comprising one or more columns and one or more rows of values, a method of creating a call processing procedure to retrieve a value from the value table for call processing, the method comprising the steps, executed by a data processor, of:

prompting an operator to name a value table to be searched;

receiving from the operator a name of the value table to be searched;

prompting an operator to identify one or more columns in the value table to be searched;

receiving from the operator on identification of one or more values in the value table to be searched;

prompting an operator to specify a value to be searched for in the one or more columns to be searched;

receiving from the operator a value to be searched for in the one or more columns to be searched;

prompting an operator to specify comparison criteria for the value specified and values in the column to be searched;

receiving from the operator a comparison criteria for the value specified and values in the column to be searched;

prompting an operator to specify one or more call variable names to which one or more retrieved values should be assigned;

- 62 -

receiving from the operator one or more call variable names to which one or more retrieved values should be assigned; and

instantiating the table name, one or more columns, one or more values to be searched for, comparison criteria, and one or more call variables as part of the call processing procedure.

14. A method of designing a procedure to direct a telecommunication network to provide requested services to an individual customer of the network, the method comprising the steps, executed by a data processor in the network, of:

presenting the customer with a plurality of types of nodes, the nodes indicating the determinations and actions allowable for the procedure;

receiving from the customer selections of desired nodes;

receiving from the customer selections of desired relationships between the desired nodes;

receiving from the customer values for parameters to be used with the desired nodes; and

constructing a graphical representation of the desired nodes reflecting the customer values and the indicated relationships among the nodes, wherein one of said nodes comprises a sample node for determining the amount of activity that occurs in a portion of the graphical representation including the sample node.

15. A method according to claim 14, wherein said step of receiving from the customer values for parameters to be used with the desired nodes includes the steps of:

receiving a sampling rate for said sample node, said sampling rate identifying a percentage of the call processing executions to be sampled;

receiving a collection type for said sample node, said collection type defining whether results of the activity should be collected presently or deferred;

- 63 -

receiving a sampling type for said sample node, said sampling type defining whether the activity should be determined based on attempts or completions;

receiving a sample name for said sample node, said sample name defining a name for data collected; and

receiving a list of call variables to be collected.

16. A method of designing a procedure to direct a telecommunication network to provide requested services to an individual customer of the network, the method comprising the steps, executed by a data processor, of:

presenting the customer with a plurality of types of nodes, the nodes indicating the determinations and actions allowable for the procedure;

receiving from the customer indications of desired nodes;

receiving from the customer indications of desired relationships between the desired nodes;

receiving from the customer values for parameters to be used with the desired nodes; and

construction of a graphical representation of the desired nodes reflecting the customer values and the indicated relationships among the nodes, wherein one of said nodes comprises a measurement node for counting a predetermined call processing event.

17. A method according to claim 16, wherein said step of receiving from the customer values for parameters to be used with the desired nodes includes the steps of:

receiving a call variable naming a measurement vector;

receiving a component name identifying a component within the measurement vector which will be incremented or decremented; and

receiving information specifying when the measurement vector should be incremented or decremented.

18. A method of providing a call processing measurement node to count call processing events, the method comprising the steps, executed by a processor, of:

- 64 -

prompting an operator to input values for parameters to be used with the measurement node;
receiving from an operator a call variable naming a measurement vector;
receiving from an operator a component name identifying a component in the measurement vector;
receiving from an operator information specifying whether the component should be incremented or decremented;
and
instantiating said call variable name, component name, and increment or decrement information as a measurement node.

19. A method of creating, in response to inputs from an operator of a telecommunications system, a user-defined call processing node for a call processing record containing logically related nodes and branches, the method comprising the steps, executed by a processor of the system, of:
receiving an instruction from the operator to construct a user-defined call processing node;
presenting to said operator, in response to the instruction, a screen with which to construct the user-defined call processing node;
presenting the operator with a plurality of types of predefined nodes;
receiving from the operator selections of predefined nodes;
arranging said selected predefined nodes into an underlying representation of call processing procedures; and
enabling the underlying representation of call processing procedures as a single node for use in creating call processing records.

20. The method according to claim 19, wherein the underlying representation of call processing procedures is a graphical representation or a form representation.

21. The method according to claim 19, further comprising the step of requesting the operator to specify parameters for the underlying representation of call

- 65 -

processing procedures, said parameters defining call variables for which values can be provided at a later time.

22. The method according to claim 21, further comprising the step of receiving from the operator a parameter name, data type, allowed inputs, and interface type.

23. A call processing record for execution in a telephone service execution environment, comprising:
at least one call processing logic section including call processing procedures executable by a processor in said telephone service execution environment;
at least one first data section, each of said at least one first data sections being associated with one of said at least one call processing logic sections and storing data executable only by said call processing procedures included in the associated one of said at least one call processing sections; and

at least one entry point, each of said at least one entry points being associated with one of said at least one call processing logic sections and an associated one of said at least one first data sections, said at least one entry point identifying the associated one of said at least one call processing sections.

24. A call processing record according to claim 23, further comprising a second data section including data executable by call processing procedures in each of said at least one call processing logic sections.

25. A call processing record according to claim 23, further comprising a record header identifying said call processing record and including a telephone number for the corresponding telephone service subscriber.

26. A call processing record according to claim 23, wherein one of said at least one entry points comprises a trigger identifying a telephone call either originating from a called telephone number or being made to a called telephone number.

- 66 -

27. A method of executing a call processing record for execution in a telephone service execution environment, said call processing record including a plurality of call processing procedures corresponding to a plurality of different services, each of said call processing procedures including a plurality of call processing subprocedures said method comprising the steps, executed by a data processor, of:

receiving a query from a telephone switch, said query including a telephone number and a trigger;

selecting a call processing record from a storage area based on said telephone number;

selecting one of said plurality of call processing procedures based on said trigger;

executing said one of said plurality of call processing procedures to obtain call processing information; and

returning said call processing information to said telephone switch.

28. A method according to claim 27, further comprising the steps of:

reading first data from a first data section of said call processing record; and

applying said first data to appropriate subprocedures of said one of said plurality of call processing procedures.

1/31

FIG. 1
(PRIOR ART)

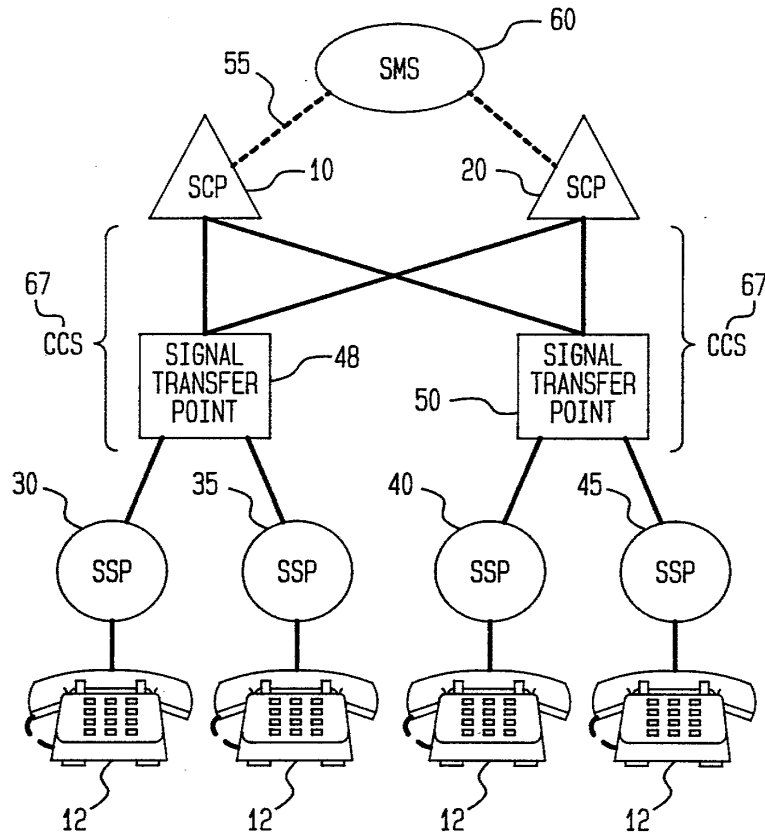

2/31

FIG. 2A

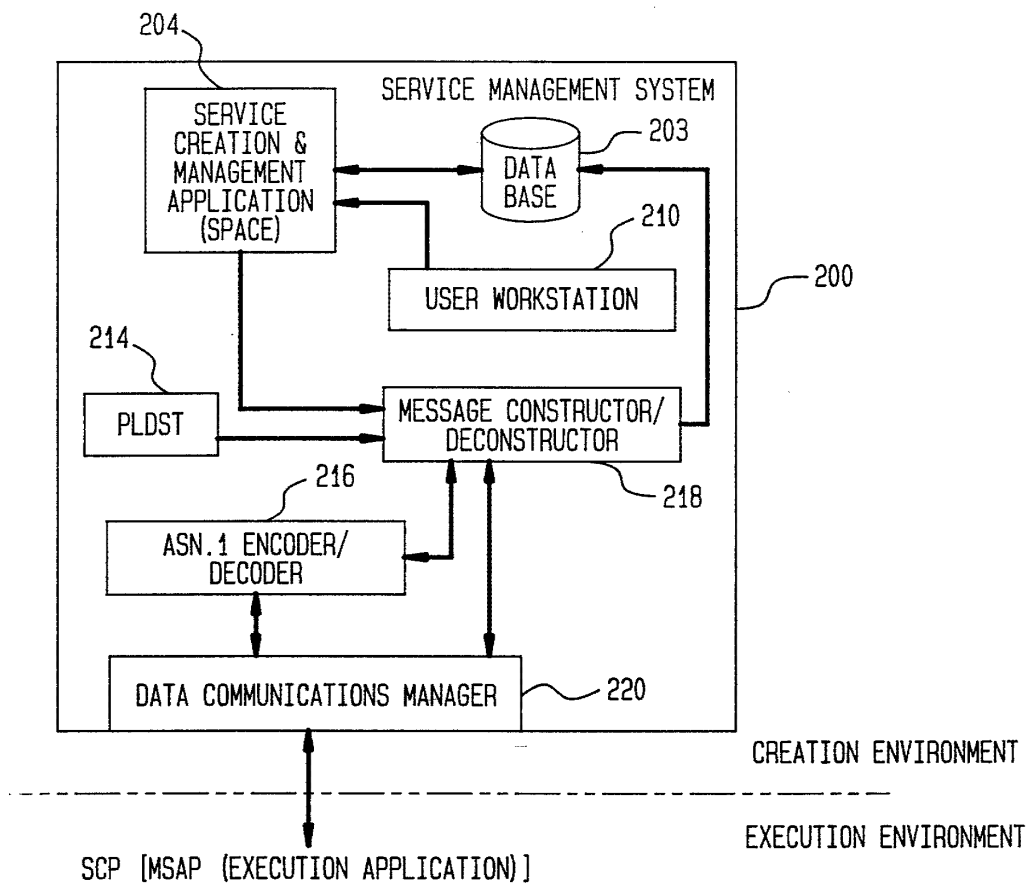

FIG. 2B

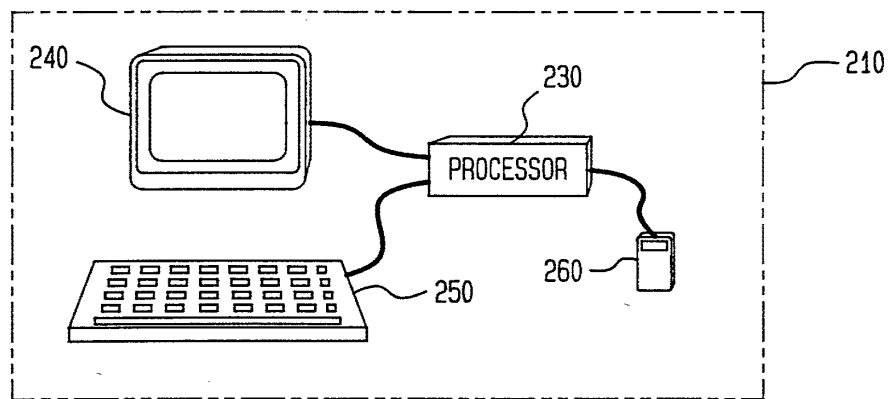
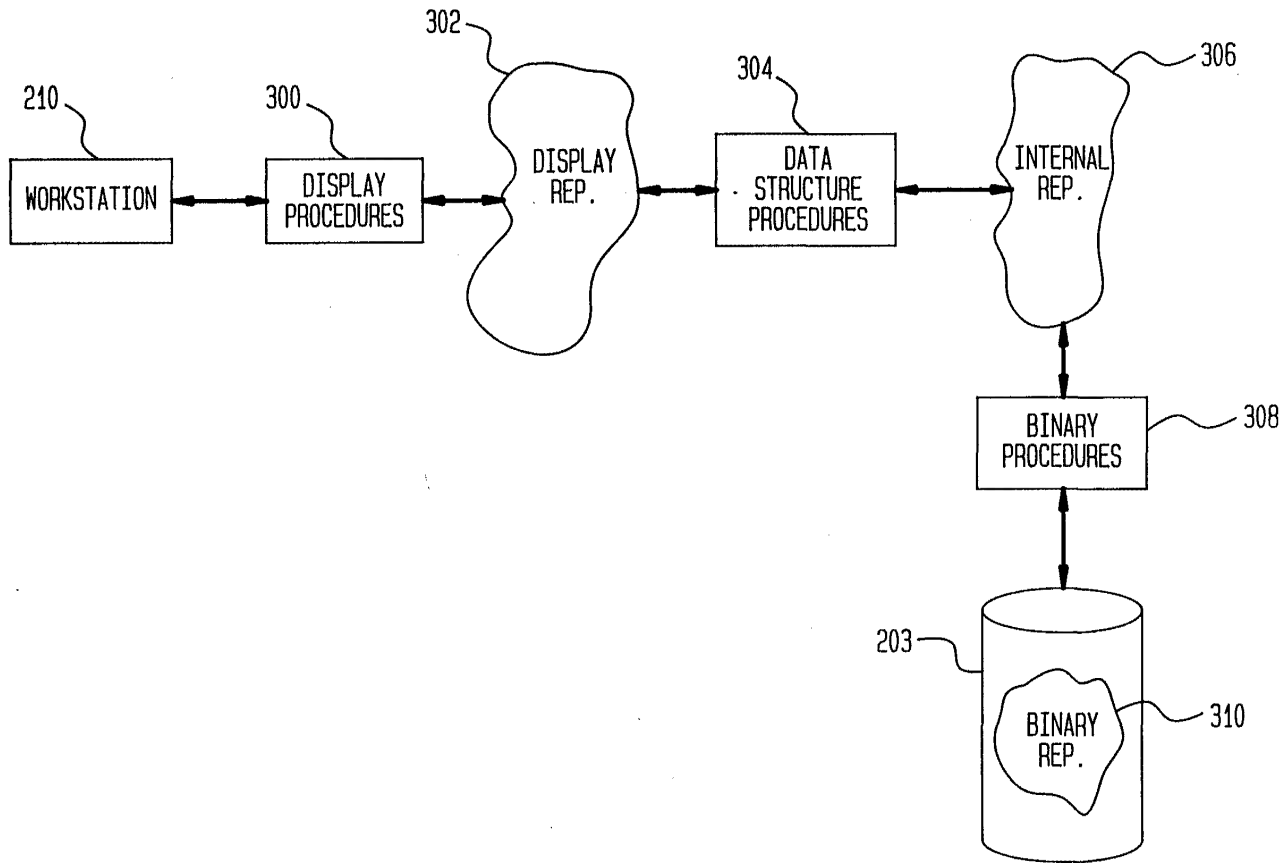
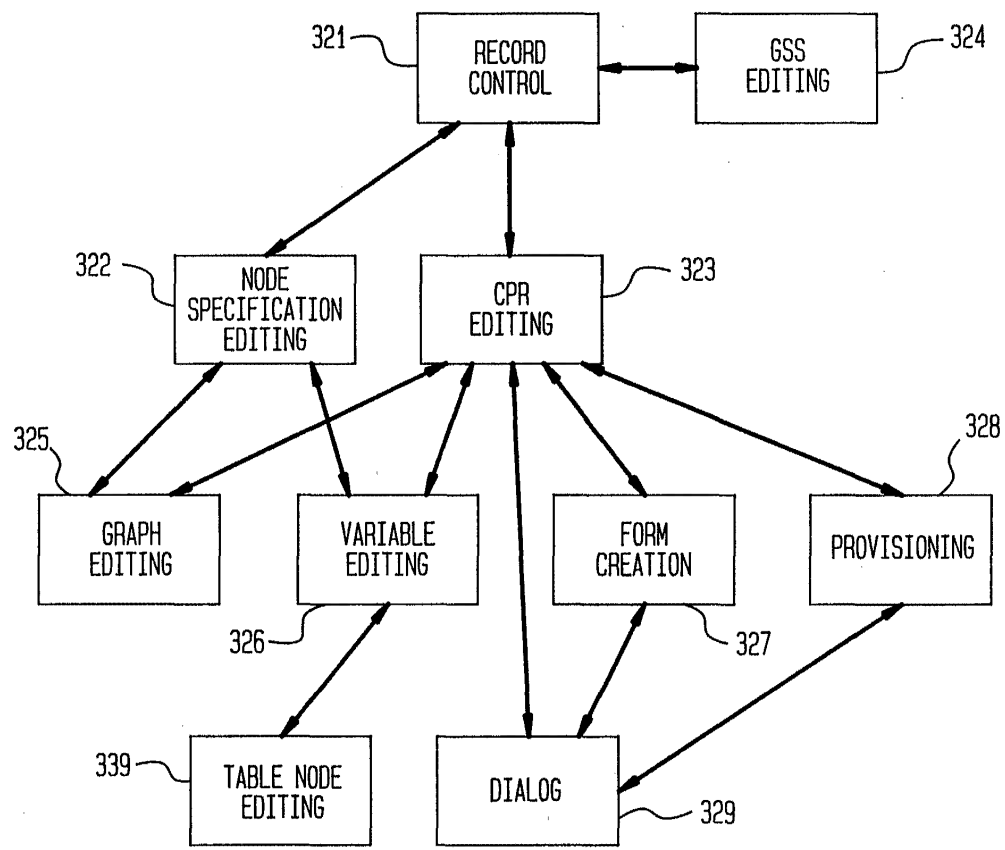

FIG. 3



3/31

FIG. 4A



4/31

FIG. 4B

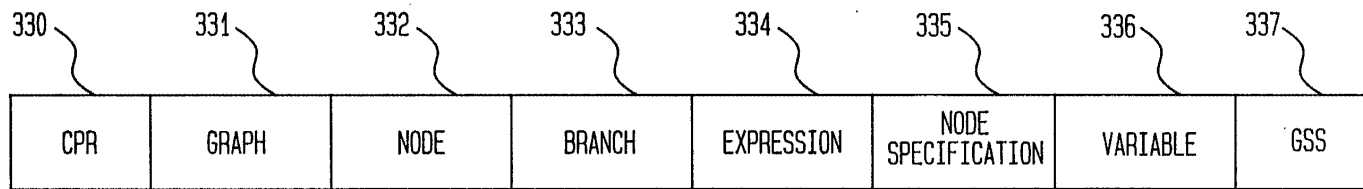
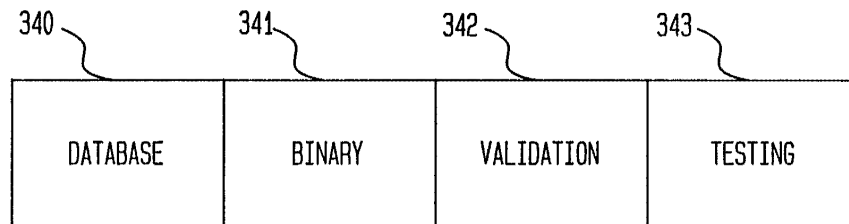

FIG. 4C



5/31

6/31

FIG. 5

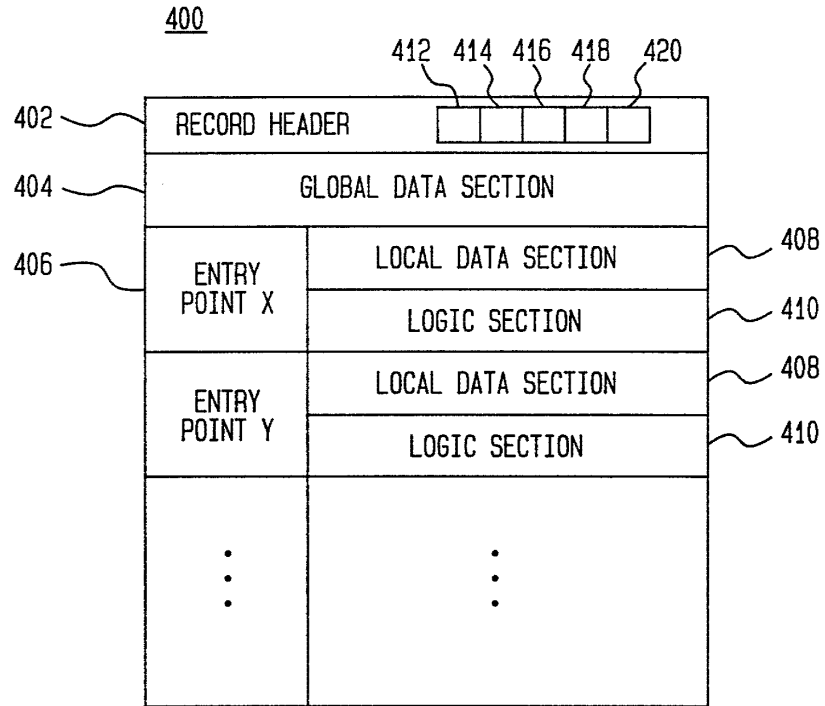

7/31

FIG. 6A

502	504	
EXTENSION	TELEPHONE NUMBER	
1002	(101) 555-1234	500
1004	(901) 555-5678	
4069	(901) 501-5555	

FIG. 6B

508	NAME	EXTENSION	TELEPHONE NUMBER	
510	DATATYPE	NUMERIC STRING	TELEPHONE	506
512	MAXIMUM LENGTH	4	15	
514	KEY	YES	NO	

FIG. 6C

516	HEADER	
506	TABLE SPECIFICATION	518
500	TABLE DATA	

8/31

FIG. 7

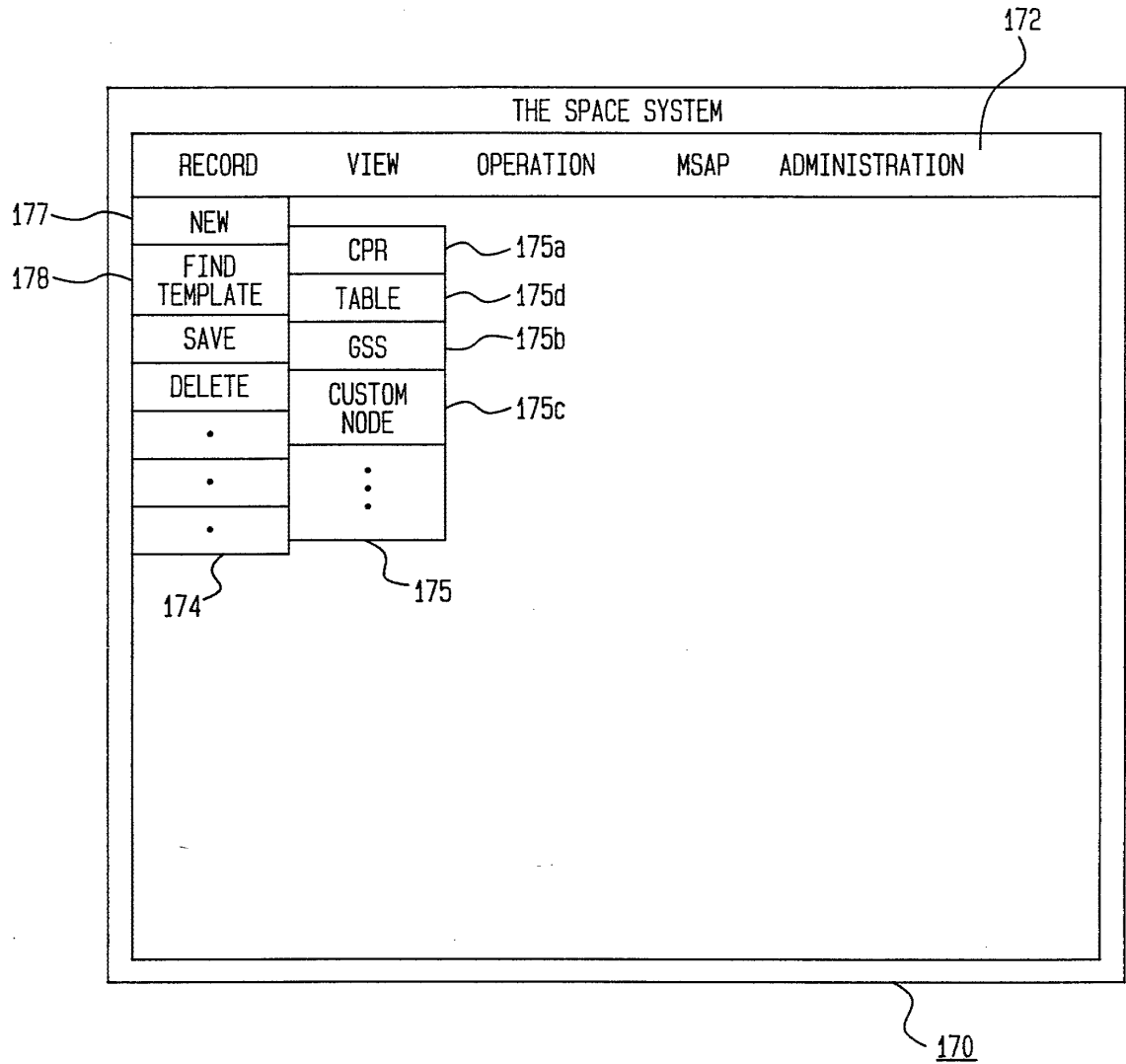

9/31

FIG. 8

A graphical user interface window (180) with a title bar in the top-left corner. The window contains the following elements:

- NAME: (181)
- ACCOUNT: (182)
- SERVICE ORDER: (183)
- DUE DATE: (184)
- SUPPLEMENTAL FORM: (185)
- SERVICE REP: (186)
- CONTROLS DTMF UPDATE? YES NO (187)
- OK button
- CANCEL button
- HELP button

FIG. 9

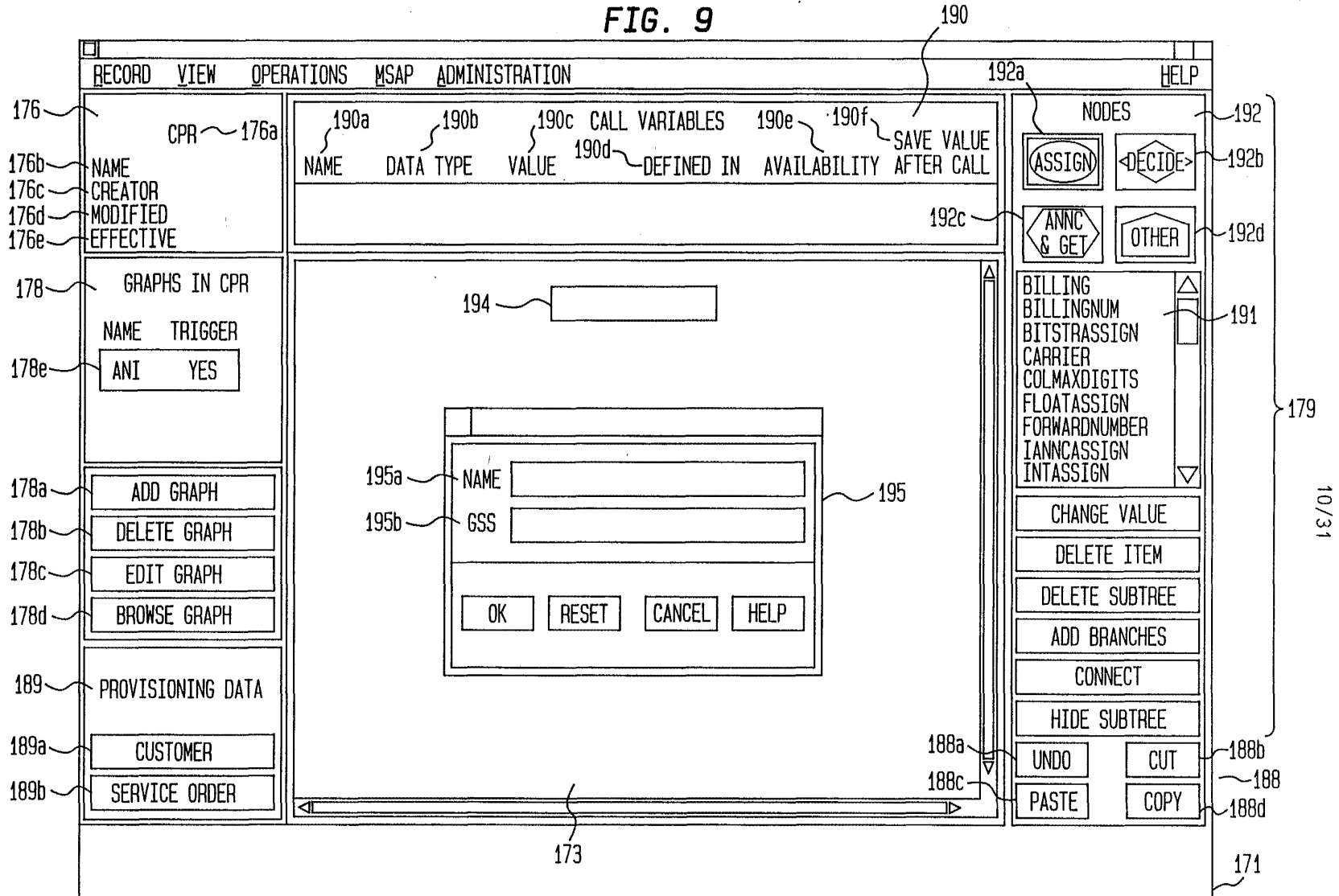
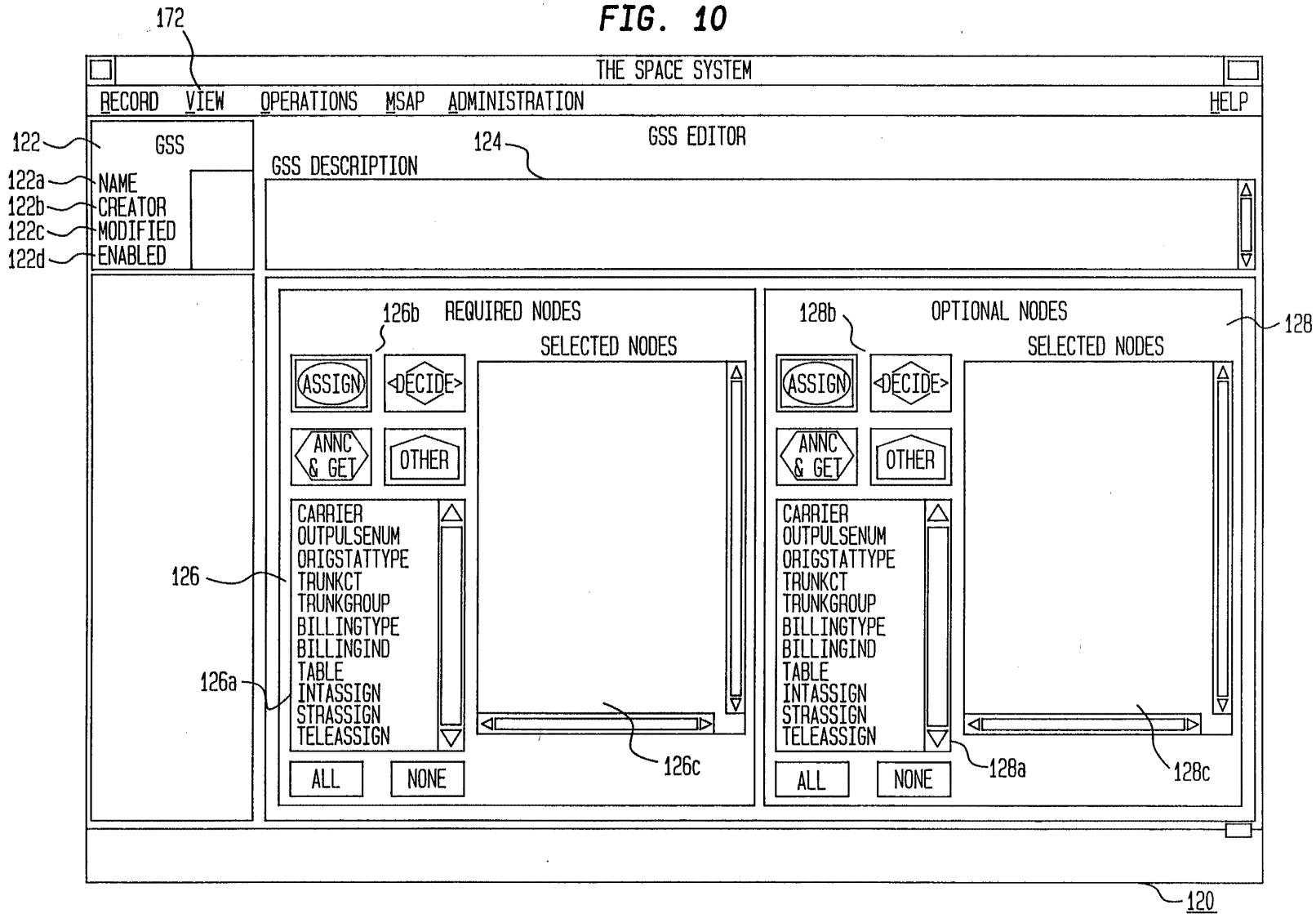

FIG. 10



12/31

FIG. 11

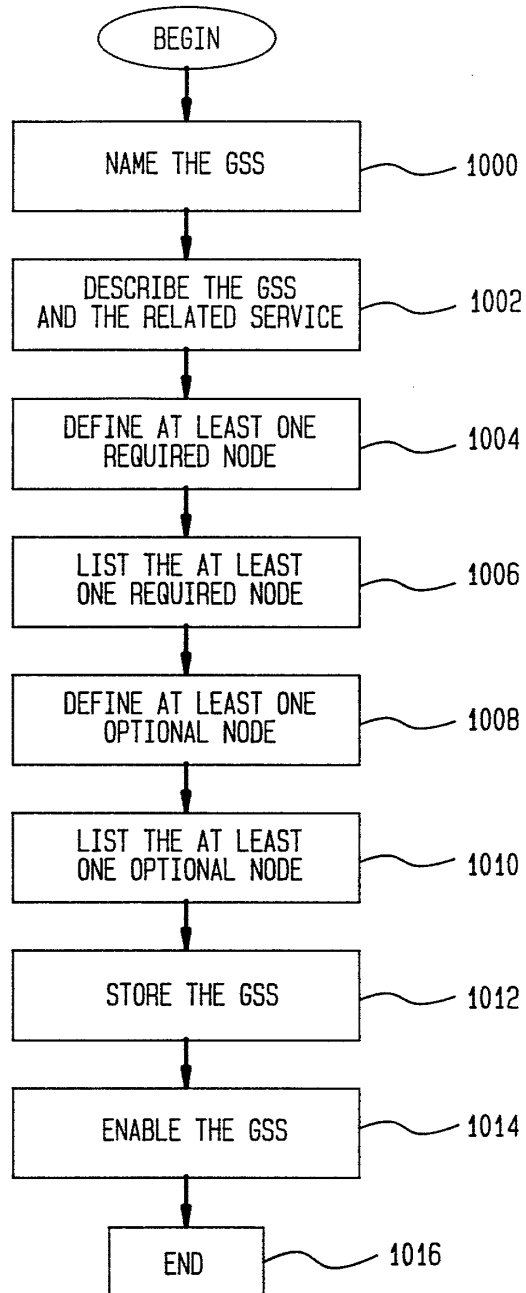

FIG. 12

120

WO 94/05111

RECORD VIEW OPERATIONS MSAP ADMINISTRATION		HELP	
GSS		GSS EDITOR	
NAME	800BASIC	GSS DESCRIPTION THIS GSS SPECIFIES THE BASIC FEATURES OF 800 SERVICE WITH DAY OF WEEK AND TIME OF DAY ROUTING. IT DISALLOWS PIN VALIDATION, SAMPLING, AND OTHER FEATURES IN THE 800ENHANCED GSS.	
CREATOR	skkm		
MODIFIED	05/13/92 11: 46: 48		
ENABLED	05/12/92		
		REQUIRED NODES	OPTIONAL NODES
		SELECTED NODES	SELECTED NODES
		<input type="checkbox"/> ASSIGN <input type="checkbox"/> DECIDE <input type="checkbox"/> ANNC & GET <input type="checkbox"/> OTHER	<input type="checkbox"/> ASSIGN <input type="checkbox"/> DECIDE <input type="checkbox"/> ANNC & GET <input type="checkbox"/> OTHER
		CARRIER ROUTE TO _____	DAY TIME _____
		126c	128c
		<input type="button" value="ALL"/> <input type="button" value="NONE"/>	<input type="button" value="ALL"/> <input type="button" value="NONE"/>
SUCCESS			

13/31

PCT/US93/07835

14/31

FIG. 13A

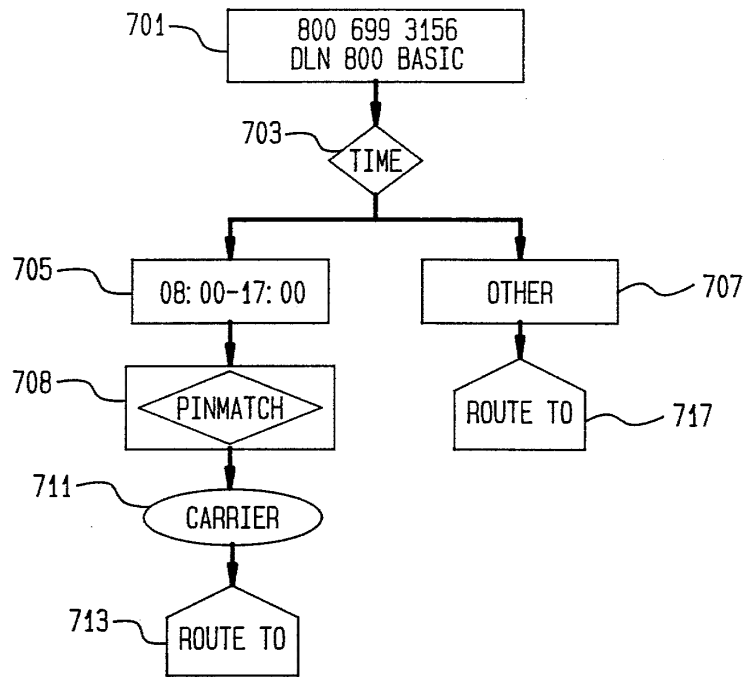

FIG. 13B

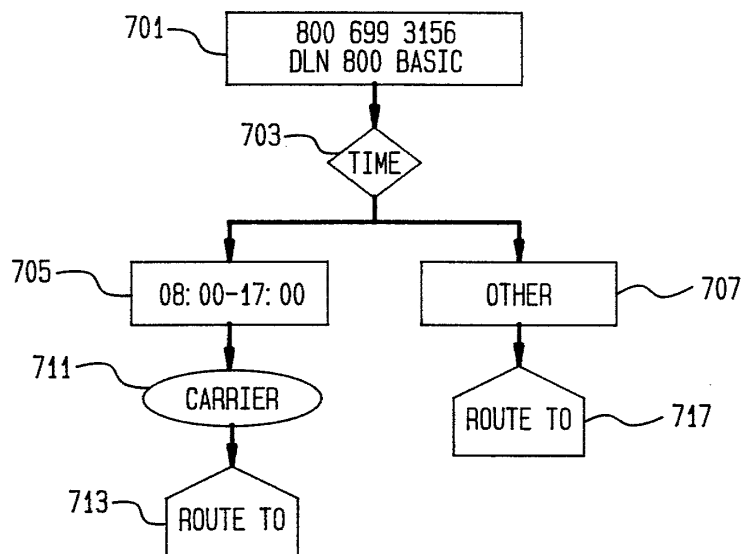
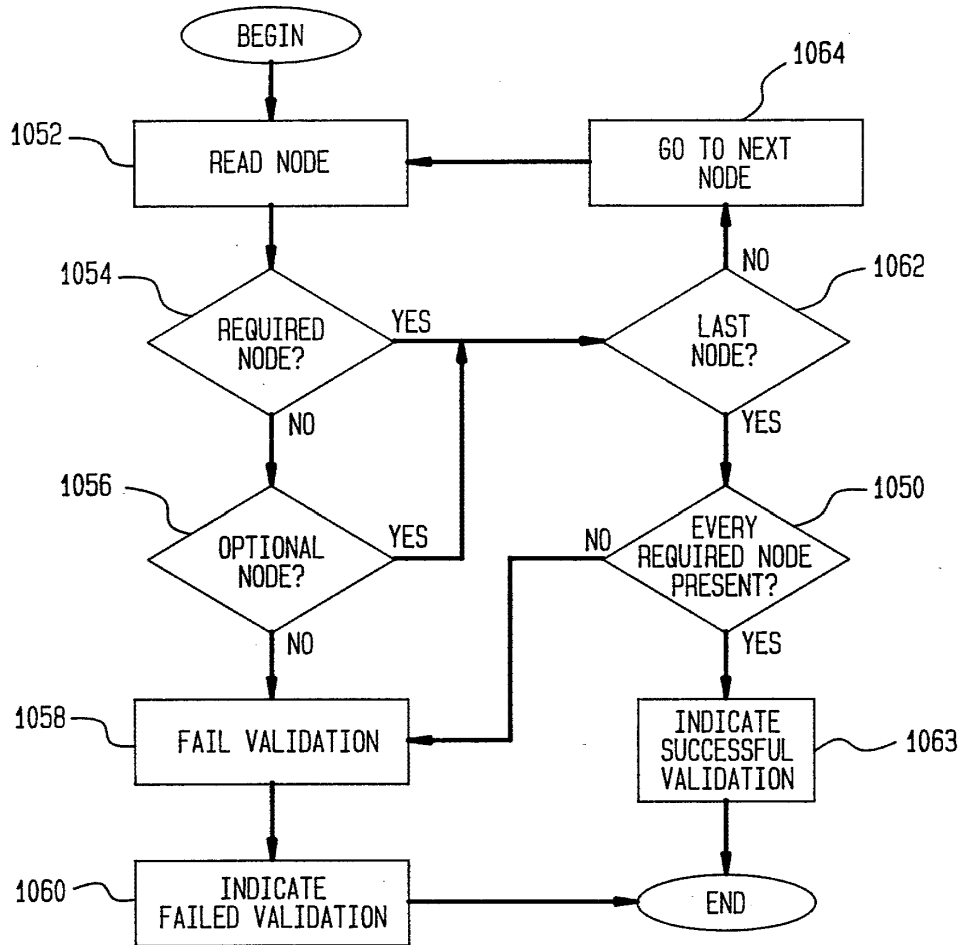

FIG. 14



16/31

FIG. 15

The image shows a graphical user interface window titled "NODE EDITOR". Inside the window, there is a header area with a house-shaped icon containing the word "SAMPLE" and the word "SAMPLE" to its right. Below this are five input fields, each with a label and a corresponding reference number:

- 752: ENTER THE SAMPLING RATE
- 753: ENTER THE COLLECTION TYPE (IMMEDIATE (0), DEFFERRED (1))
- 754: ENTER THE SAMPLING TYPE (ATTEMPT (0), COMPLETION (1))
- 755: ENTER THE SAMPLE NAME
- 756: ENTER THE NAMES OF THE CALL VARIABLES TO BE SAMPLED

At the bottom of the window, there are four buttons: "OK", "RESET", "DELETE", and "HELP". A reference number 750 points to the right side of the window frame.

17/31

FIG. 16

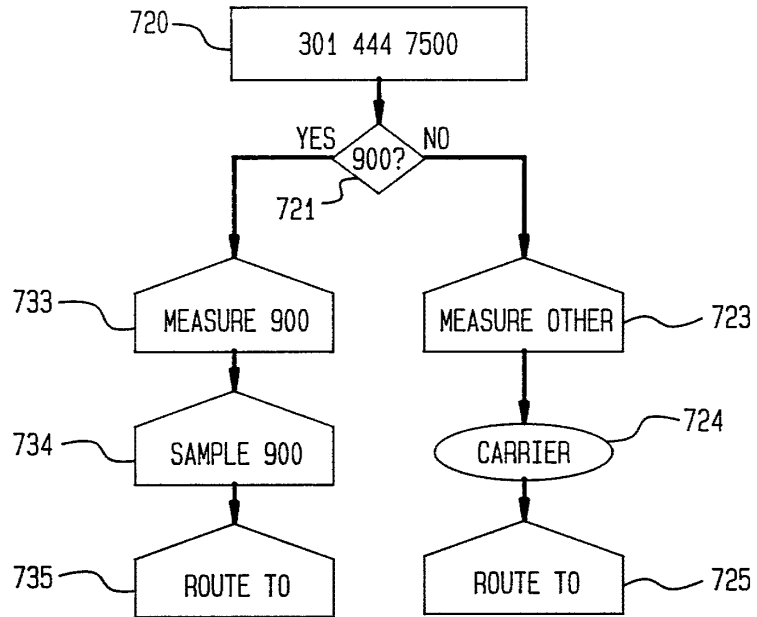

FIG. 17

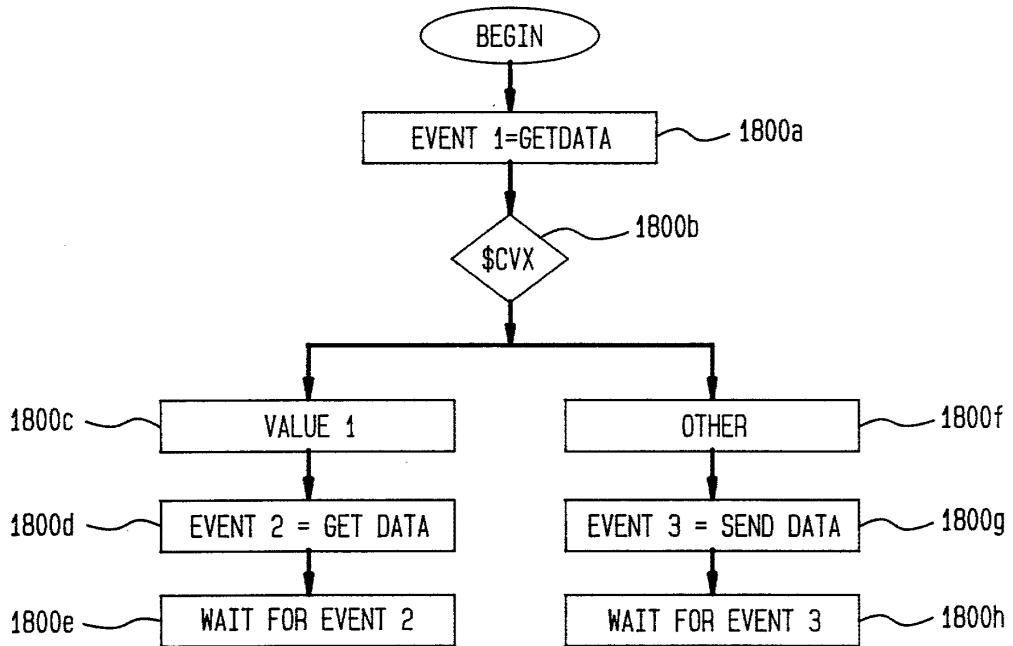
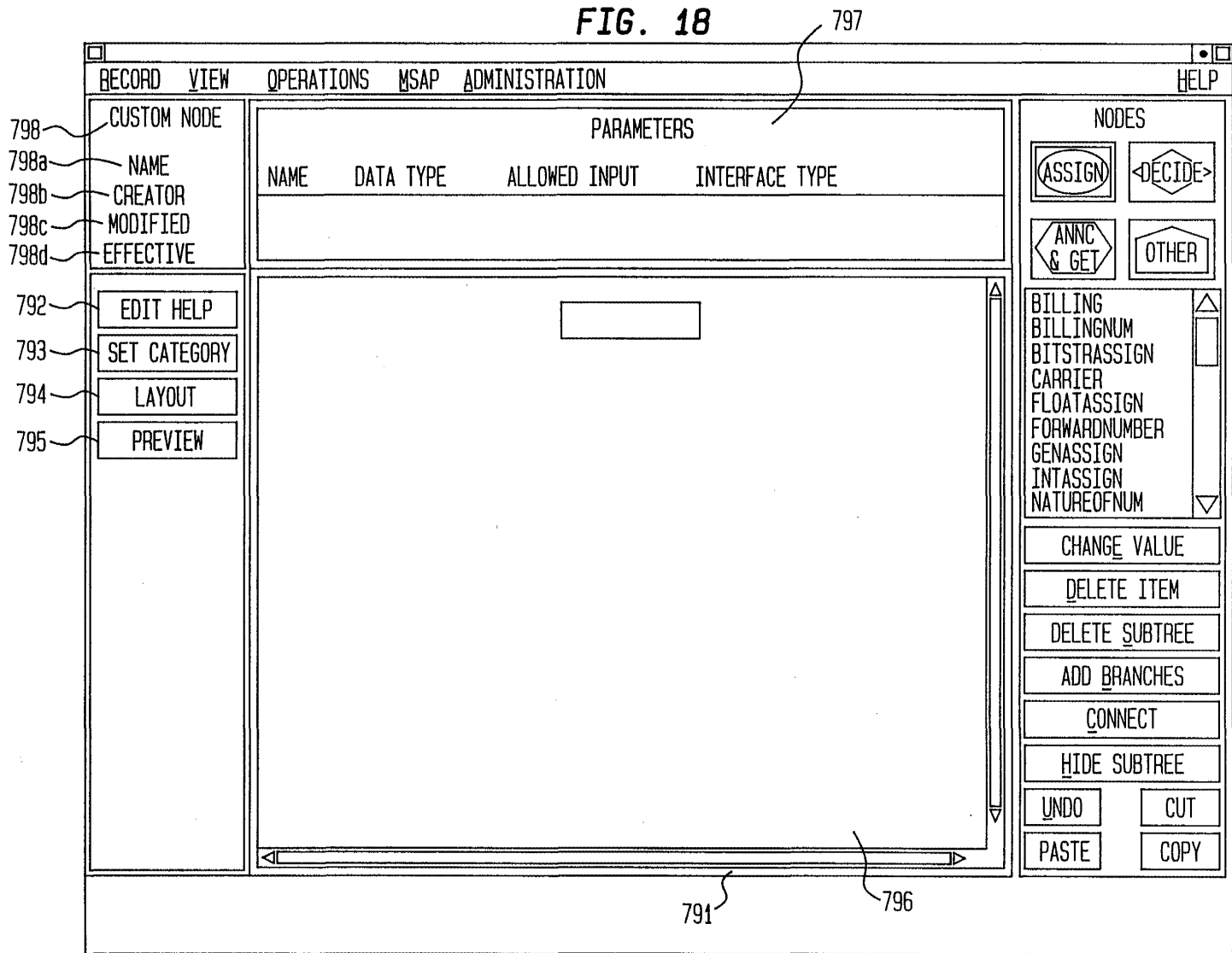

FIG. 18



18/31

FIG. 19A

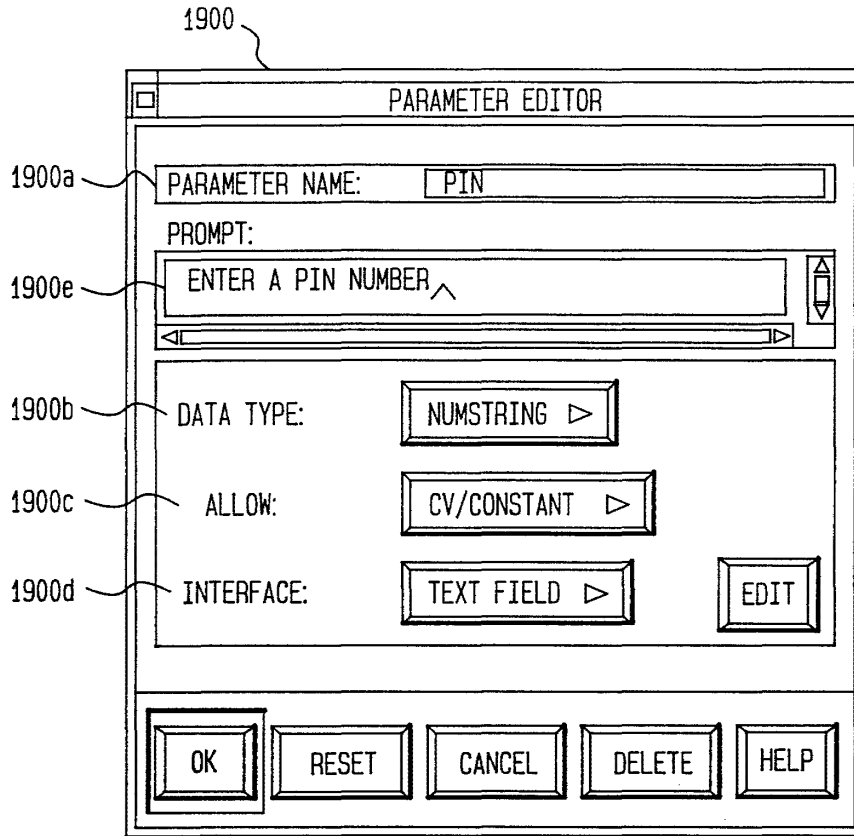
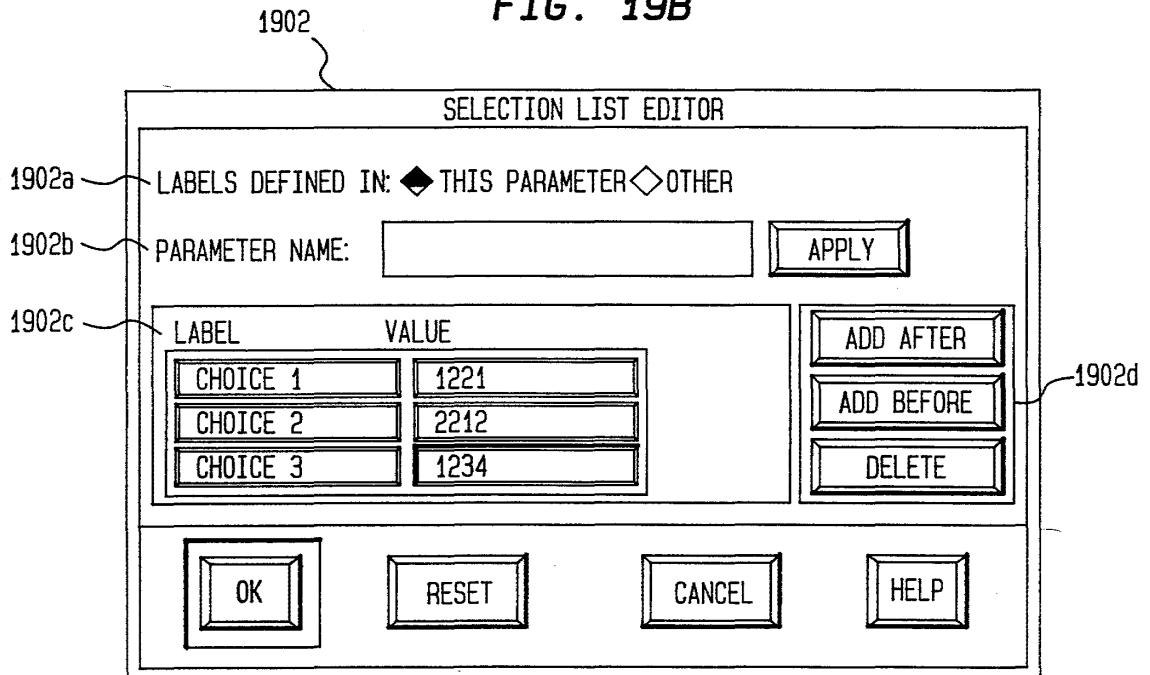

FIG. 19B



20/31

FIG. 20

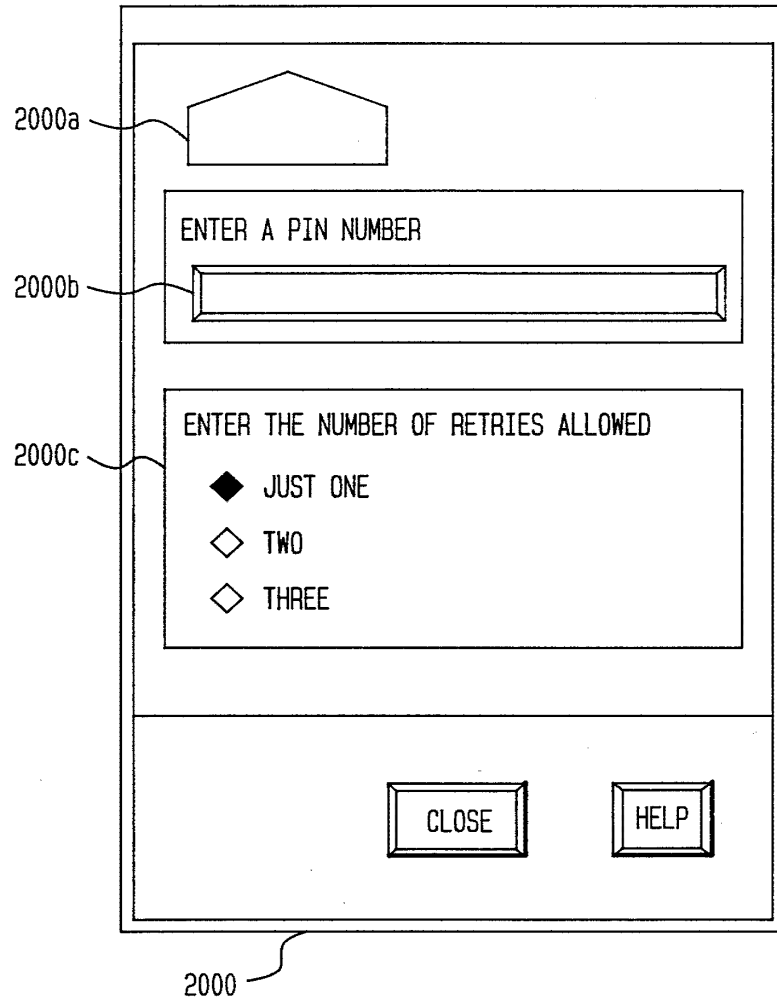

FIG. 21

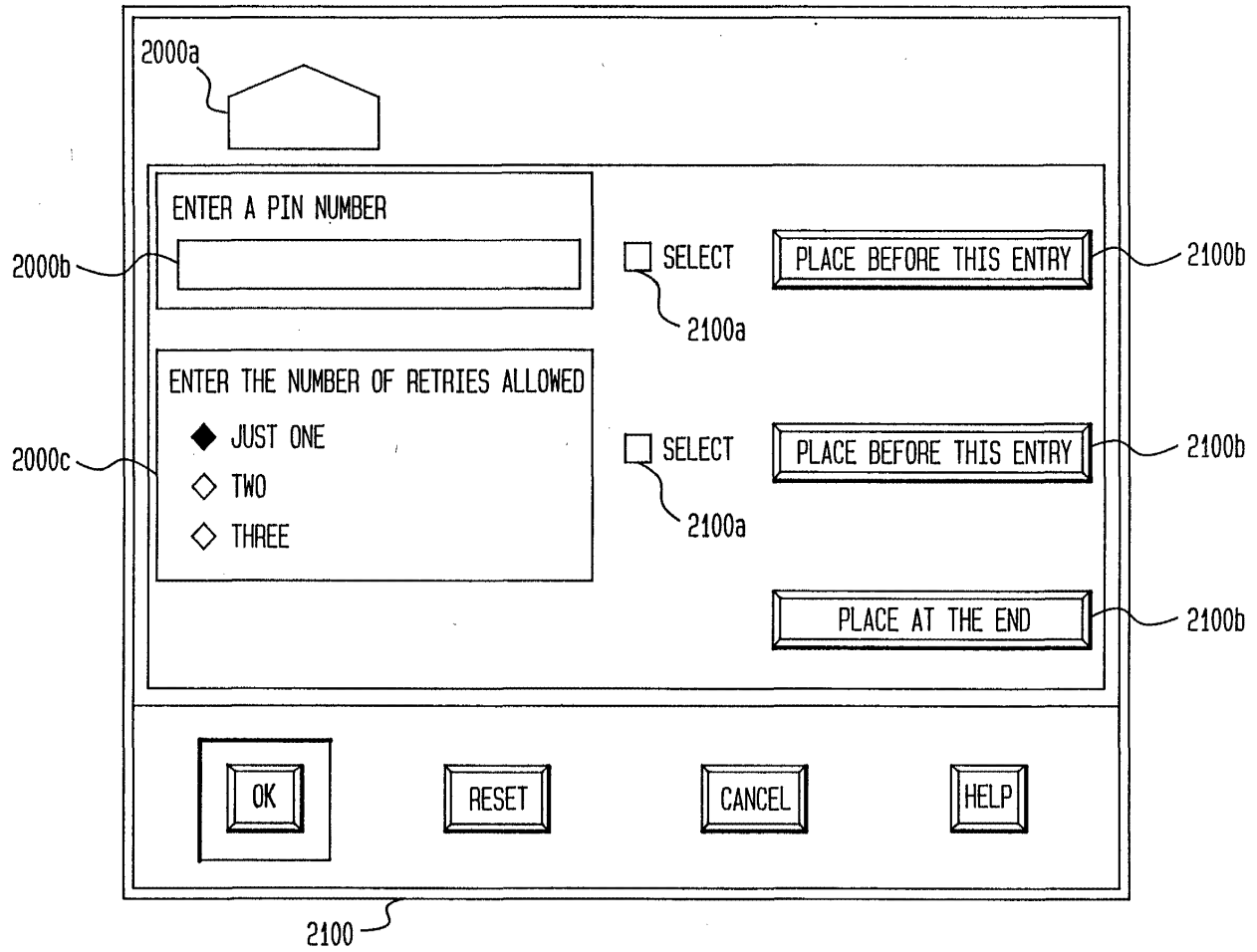

FIG. 22

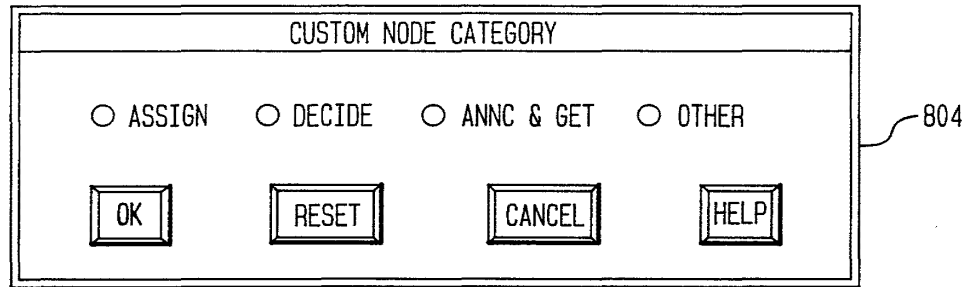

FIG. 23

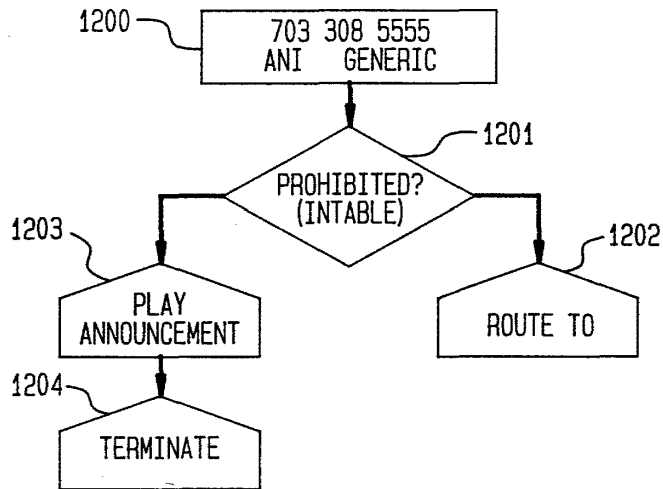

FIG. 24

TELEPHONE
NUMBERS
PROHIBITED

900-555-1212

900-721-1212

.

.

.

1220

FIG. 25

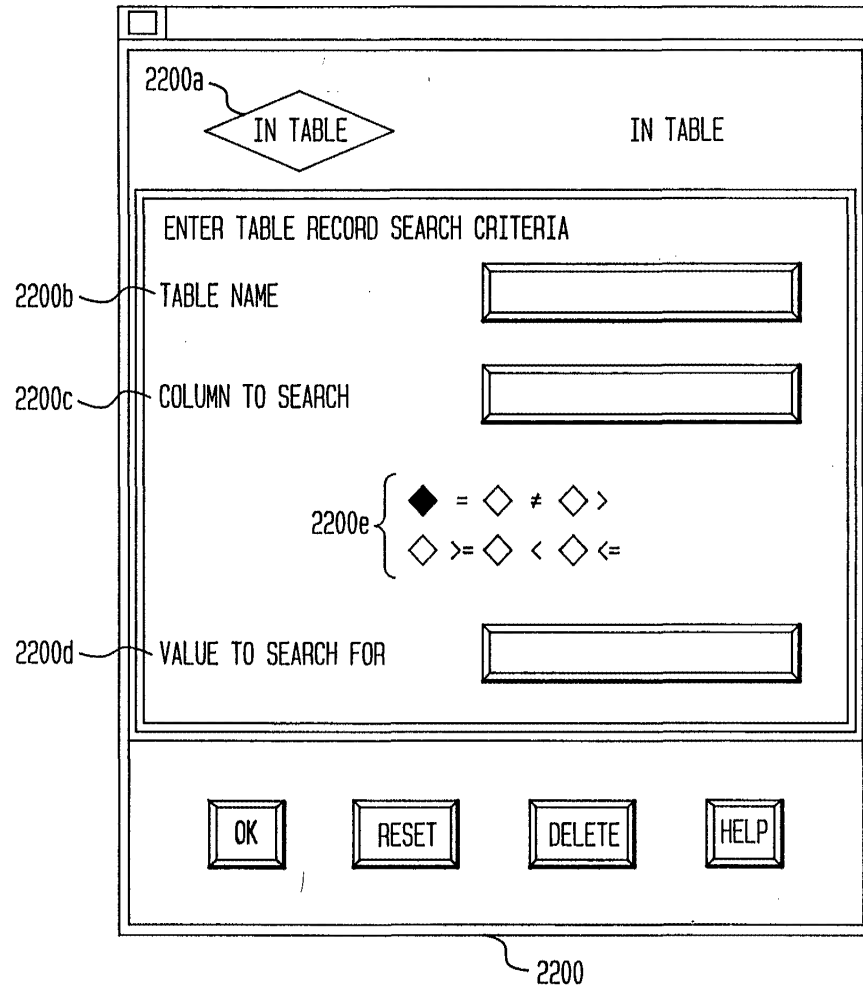

23/31

24/31

FIG. 26

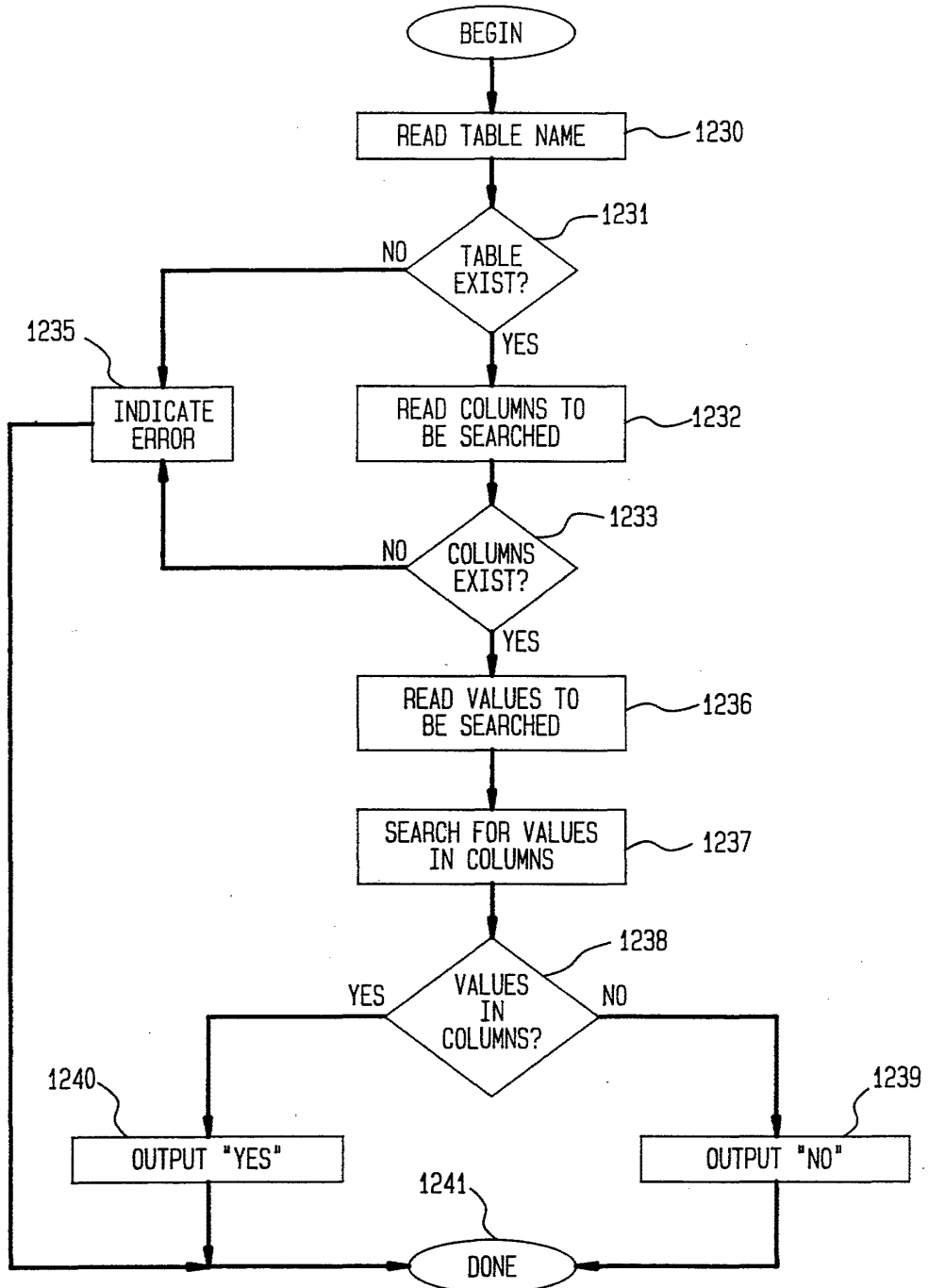

FIG. 27

TABLE

TABLE

2300a ENTER A YES/NO CALL VARIABLE TO INDICATE IF THE RETRIEVE WAS SUCCESSFUL

2300b ENTER TABLE RECORD SEARCH CRITERIA

TABLE NAME

2300c SEARCH MATRIX

◆ SEARCH FOR THE ROWS MEETING ALL OF THE CRITERIA

◇ SEARCH FOR THE ROWS MEETING ANY OF THE CRITERIA

COLUMN NAME COMPARISON VALUE TO BE COMPARED TO

2300e ADD ROW BEFORE

2300e ADD ROW AFTER

2300e DELETE ROW

2300d RETRIEVE MATRIX

SELECT THE COLUMNS TO RETRIEVE DATA FROM

COLUMN NAME CALL VARIABLE NAME

2300f ADD ROW BEFORE

2300f ADD ROW AFTER

2300f DELETE ROW

OK RESET DELETE HELP

2300

26/31

FIG. 28

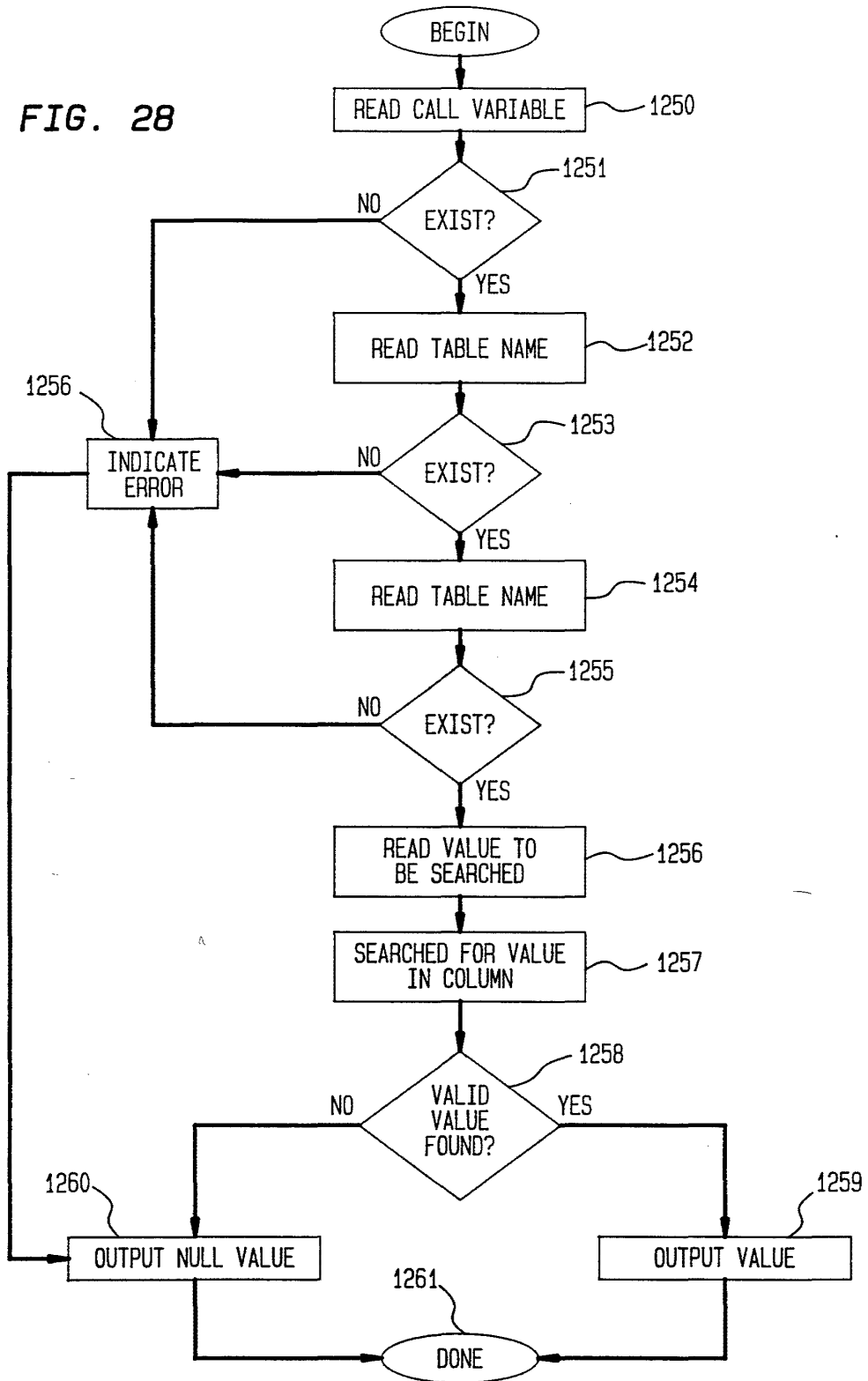
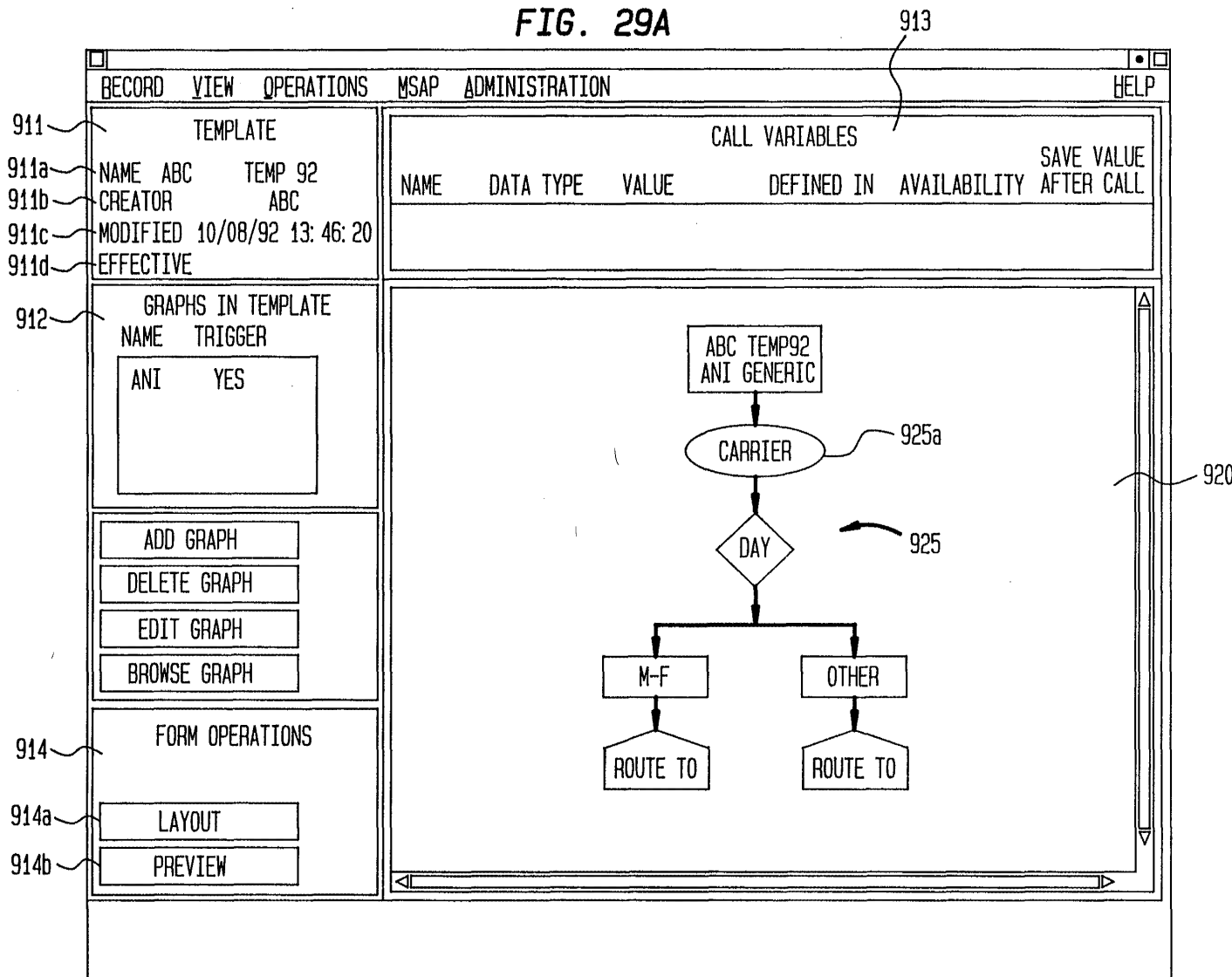

FIG. 29A



WO 94/05111

27/31

PCT/US93/07835

28/31

FIG. 29B

The figure shows a graphical user interface window titled "CARRIER". At the top left, there is a small square icon. The title "CARRIER" is centered at the top. Below the title, there is a section titled "SELECT A CARRIER TYPE" containing three radio button options: "PRIMARY" (selected), "ALTERNATE", and "SECOND ALTERNATE". Below these options is a checkbox labeled "CUSTOMIZABLE" with a reference number 935 pointing to it. Underneath is a text input field with a reference number 936a pointing to it. The next section is titled "ENTER A CARRIER VALUE" and contains another text input field with a reference number 935 pointing to it. Below this is a checkbox labeled "CUSTOMIZABLE" with a reference number 935 pointing to it. Underneath is a text input field with the text "PLEASE ENTER A PRIMARY CARRIER NAME" and a reference number 936b pointing to it. At the bottom of the window, there are four buttons: "OK", "RESET", "CANCEL", and "HELP". A reference number 930 points to the bottom of the window frame.

29/31

FIG. 29C

915a {

TEMPLATE NAME: ABC TEMP92
CREATOR: ABC
MODIFICATION DATE: 10/08/92 13: 50: 30

PLEASE ENTER A PRIMARY CARRIER NAME 915b

PLEASE ENTER THE WEEKDAYS 915c

M
TU
W
TH
F
SA
SU

SA-SU

915d

PLEASE ENTER THE WEEKDAY ROUTING NUMBER 915e

PLEASE ENTER THE WEEKEND ROUTING NUMBER

915

FIG. 29D

PLEASE ENTER A PRIMARY CARRIER NAME SELECT

915b

PLEASE ENTER THE WEEKDAYS

915c

M
TU
W
TH
F
SA
SU

SA-SU

SELECT

916a

SELECT

916a

915d

PLEASE ENTER THE WEEKDAY ROUTING NUMBER

SELECT

916a

915e

PLEASE ENTER THE WEEKEND ROUTING NUMBER

SELECT

916a

916

30/31

FIG. 30

TEMPLATE	STATUS	ENABLE DATE	CREATOR	MODIFICATION DATE
T1	ENABLED	04/24/1992 09: 16: 46	04/24/1992 09: 16: 46	
TEMP92	ENABLED	10/08/1992 14: 33: 51	10/08/1992 14: 33: 51	

COUNT = 2

Buttons: FIND, CLEAR, EDIT, BROWSE, DELETE, CUSTOMIZE, CANCEL, HELP

950

INTERNATIONAL SEARCH REPORT

International application No.
PCT/US93/07835

A. CLASSIFICATION OF SUBJECT MATTER
 IPC(5) :H04M 11/00, 15/00, 3/42, 7/00
 US CL :379/94, 112, 127, 142, 201, 207, 230
 According to International Patent Classification (IPC) or to both national classification and IPC

B. FIELDS SEARCHED
 Minimum documentation searched (classification system followed by classification symbols)
 U.S. : 379/94, 112, 127, 142, 201, 207, 230

Documentation searched other than minimum documentation to the extent that such documents are included in the fields searched

Electronic data base consulted during the international search (name of data base and, where practicable, search terms used)

C. DOCUMENTS CONSIDERED TO BE RELEVANT

Category*	Citation of document, with indication, where appropriate, of the relevant passages	Relevant to claim No.
X, E Y	US,A, 5,241,588 (Babson, III et al.) 31 August 1993, Entire Document	9,10 & 23-28 1-8 & 11-22
Y	US,A, 4,835,683 (Phillips et al.) 30 May 1989, Abstract	1-4, 12 and 14-22
Y	US,A, 4,611,094 (Asmuth et al.) 09 September 1986, See Fig 19 and 20	14 and 16
Y	US,A, 5,019,961 (Adesso et al.) 28 May 1991, Abstract	14-22
Y	ERICSSON REVIEW, No. 1, 1990, Fredrik Ljunblom, "A Service Management System for the Intelligent Network", pp 32-41	1-28

Further documents are listed in the continuation of Box C. See patent family annex.

* Special categories of cited documents:	"T" later document published after the international filing date or priority date and not in conflict with the application but cited to understand the principle or theory underlying the invention
"A" document defining the general state of the art which is not considered to be part of particular relevance	"X" document of particular relevance; the claimed invention cannot be considered novel or cannot be considered to involve an inventive step when the document is taken alone
"E" earlier document published on or after the international filing date	"Y" document of particular relevance; the claimed invention cannot be considered to involve an inventive step when the document is combined with one or more other such documents, such combination being obvious to a person skilled in the art
"L" document which may throw doubts on priority claim(s) or which is cited to establish the publication date of another citation or other special reason (as specified)	"g" document member of the same patent family
"O" document referring to an oral disclosure, use, exhibition or other means	
"P" document published prior to the international filing date but later than the priority date claimed	

Date of the actual completion of the international search 26 JANUARY 1994	Date of mailing of the international search report 28 JAN 1994
--	---

Name and mailing address of the ISA/US Commissioner of Patents and Trademarks Box PCT Washington, D.C. 20231 Facsimile No. NOT APPLICABLE	Authorized officer HARRY S. HONG Telephone No. (703) 305-4717
---	---

INTERNATIONAL SEARCH REPORT

International application No.
PCT/US93/07835

C (Continuation). DOCUMENTS CONSIDERED TO BE RELEVANT		
Category*	Citation of document, with indication, where appropriate, of the relevant passages	Relevant to claim No.
Y	IEEE Communications Magazine, January, 1991, Masanobu Fujioka et al., "Universal Service Creation and Provision Environment for Intelligent Network", pp 44-51, See pp 45-49 and Fig 4.	1-28

Form PCT/ISA/210 (continuation of second sheet)(July 1992)*



PCT

WELTORGANISATION FÜR GEISTIGES EIGENTUM
Internationales Büro

INTERNATIONALE ANMELDUNG VERÖFFENTLICHT NACH DEM VERTRAG ÜBER DIE
INTERNATIONALE ZUSAMMENARBEIT AUF DEM GEBIET DES PATENTWESENS (PCT)

<p>(51) Internationale Patentklassifikation ⁶ : H04M 3/42, H04Q 7/38</p>	<p>A1</p>	<p>(11) Internationale Veröffentlichungsnummer: WO 95/34985 (43) Internationales Veröffentlichungsdatum: 21. December 1995 (21.12.95)</p>
<p>(21) Internationales Aktenzeichen: PCT/EP95/02264 (22) Internationales Anmeldedatum: 12. Juni 1995 (12.06.95) (30) Prioritätsdaten: P 44 20 462.0 13. Juni 1994 (13.06.94) DE (71) Anmelder (nur für AT BE CH DE DK ES FR GB GR IE IT LU MC NL PT SE): ALCATEL SEL AKTIENGESELLSCHAFT [DE/DE]; Lorenzstrasse 10, D-70435 Stuttgart (DE). (71) Anmelder (nur für AU CA CN FI JP KR MX RÜ): ALCATEL N.V. [NL/NL]; Burgemeester Elsenlaan 170, NL-2288 BH Rijswijk (NL). (72) Erfinder; und (75) Erfinder/Anmelder (nur für US): WIZGALL, Manfred [DE/DE]; Eckartshaldenweg 41, D-70191 Stuttgart (DE). KUTTNER, Axel [DE/DE]; Odenwaldstrasse 16, D-70469 Stuttgart (DE). (74) Anwälte: BROSE, Gerhard usw.; Alcatel SEL AG, Zentralbereich Patente und Lizenzen, Postfach 300 929, D-70449 Stuttgart (DE).</p>		<p>(81) Bestimmungsstaaten: AU, CA, CN, FI, JP, KR, MX, RU, US, europäisches Patent (AT, BE, CH, DE, DK, ES, FR, GB, GR, IE, IT, LU, MC, NL, PT, SE). Veröffentlicht Mit internationalem Recherchenbericht.</p>
<p>(54) Title: METHOD OF SELECTING ONE OF AT LEAST TWO TELECOMMUNICATIONS TERMINALS AND A SUITABLE TELECOMMUNICATIONS TERMINAL</p>		
<p>(54) Bezeichnung: VERFAHREN ZUR AUSWAHL EINES VON MINDESTENS ZWEI FERNMELDEENDGERÄTEN UND FERNMELDEENDGERÄT DAFÜR</p>		
<p>(57) Abstract</p>		
<p>Telecommunications infrastructure allowing a call addressed to a particular subscriber to be picked up at one of at least two separate terminals. The aim of the invention is to allow calls to be switched between the terminals in question. The basic concept is that the subscriber (10) is identified to at least one terminal (11) by a subscriber identification card which can be remotely interrogated within a circumscribed area. The subscriber (10) registers all his terminal devices (11, 12) (at home, in the office, in the car, portable) with a service operator (3); each terminal device which recognizes, through remote interrogation, that the subscriber is nearby reports this fact to the service operator (3). Calls addressed to the subscriber are directed to the service operator and whence to whichever terminal device reported last. The invention provides automatic switching without any restriction on the subscriber's freedom of movement.</p>	<p>The diagram illustrates a telecommunications network. It is divided into three sections by a central vertical line. On the left, a subscriber (10) is shown with two terminal devices (11 and 12). In the center, a service operator (3) is shown with a database (31) and a computer (32). The network is represented by a series of interconnected diamond shapes, indicating a mesh or ring topology. The subscriber (10) is connected to both terminals (11 and 12), and both terminals are connected to the service operator (3). The service operator (3) is connected to the database (31) and the computer (32).</p>	

(57) Zusammenfassung

Stand der Technik: Fernmeldeinfrastruktur, die es erlaubt, einen an einen bestimmten Teilnehmer gerichteten Ruf gezielt an einer von mindestens zwei getrennten Endgeräten entgegenzunehmen. Technisches Problem: Gezieltes Umschalten zwischen den in Frage kommenden Endgeräten. Grundgedanke: Teilnehmer (10) identifiziert sich durch räumlich begrenzt fernabfragbare Teilnehmeridentifikationskarte gegenüber mindestens einem der Endgeräte (11). Beispiel: Teilnehmer (10) meldet alle seine Endgeräte (11, 12) (zuhause, im Büro, im Auto, Handheld) bei einem Service Operator (3) an. Jedes Endgerät, das durch Fernabfrage die räumliche Nähe des Teilnehmers erkennt, meldet dies an den Service Operator (3). An den Teilnehmer gerichtete Rufe werden an den Service Operator und von diesem an dasjenige Endgerät geleitet, das sich zuletzt gemeldet hat. Vorteil: Automatisches Umschalten ohne Behinderung der Freiheit des Teilnehmers.

LEDIGLICH ZUR INFORMATION

Codes zur Identifizierung von PCT-Vertragsstaaten auf den Kopfbögen der Schriften, die internationale Anmeldungen gemäss dem PCT veröffentlichen.

AT	Österreich	GA	Gabon	MR	Mauretanien
AU	Australien	GB	Vereinigtes Königreich	MW	Malawi
BB	Barbados	GE	Georgien	NE	Niger
BE	Belgien	GN	Guinea	NL	Niederlande
BF	Burkina Faso	GR	Griechenland	NO	Norwegen
BG	Bulgarien	HU	Ungarn	NZ	Neuseeland
BJ	Benin	IE	Irland	PL	Polen
BR	Brasilien	IT	Italien	PT	Portugal
BY	Belarus	JP	Japan	RO	Rumänien
CA	Kanada	KE	Kenya	RU	Russische Föderation
CF	Zentrale Afrikanische Republik	KG	Kirgisistan	SD	Sudan
CG	Kongo	KP	Demokratische Volksrepublik Korea	SE	Schweden
CH	Schweiz	KR	Republik Korea	SI	Slowenien
CI	Côte d'Ivoire	KZ	Kasachstan	SK	Slowakei
CM	Kamerun	LI	Liechtenstein	SN	Senegal
CN	China	LK	Sri Lanka	TD	Tschad
CS	Tschechoslowakei	LU	Luxemburg	TG	Togo
CZ	Tschechische Republik	LV	Lettland	TJ	Tadschikistan
DE	Deutschland	MC	Monaco	TT	Trinidad und Tobago
DK	Dänemark	MD	Republik Moldau	UA	Ukraine
ES	Spanien	MG	Madagaskar	US	Vereinigte Staaten von Amerika
FI	Finnland	ML	Mali	UZ	Usbekistan
FR	Frankreich	MN	Mongolei	VN	Vietnam

Verfahren zur Auswahl eines von mindestens zwei
Fernmeldeendgeräten und Fernmeldeendgerät dafür

Die Erfindung betrifft ein Verfahren zur Auswahl eines von mindestens zwei Fernmeldeendgeräten nach dem Oberbegriff des Anspruchs 1 und ein Fernmeldeendgerät, insbesondere ein Fernsprechgerät, zur Durchführung dieses Verfahrens.

Im konventionellen Fernsprechnetzt besitzt jeder Teilnehmer ein Fernsprechgerät, über das er an einem ganz bestimmten Ort unter einer ganz bestimmten Fernsprechnummer erreichbar ist. Damit ist die Fernsprechnummer letztlich nicht dem Teilnehmer, sondern dem Ort zugeordnet. Einerseits ist dieser Teilnehmer unter "seiner" Nummer nicht erreichbar, wenn er sich an einem anderen Ort aufhält, andererseits sind aber andere Personen, etwa Familienangehörige, unter dieser Nummer erreichbar, obwohl sie nicht im Teilnehmerverzeichnis stehen.

Im Mobilfunknetz dagegen ist unter einer bestimmten Fernsprechnummer immer der Ort erreichbar, an dem sich das Mobilfunkgerät des Teilnehmers und damit oft dieser selbst befindet. Allerdings haben die meisten Mobilfunkteilnehmer, nicht zuletzt aus Kostengründen, außer dem Mobilfunkgerät auch noch ein "Festnetzgerät" und damit eine zweite Fernsprechnummer. Ein Anrufer muß dann wissen, welche der beiden Nummern er wählen soll. In der

Praxis erfolgt dies häufig durch Probieren. Auch technische Lösungen für die Probiermethode sind bekannt. Dabei wird jeder nicht an einem ersten Endgerät angenommene Ruf nach einer vorgegebenen Zeit (z.B. nach dreimaligem Läuten) an ein zweites Endgerät umgeschaltet, vielleicht anschließend auch noch an ein drittes Endgerät oder wieder zurück an das erste.

Es sind auch Lösungen bekannt, bei denen der Teilnehmer jeweils einer irgendwie gearteten Zentrale melden muß, an welchem Endgerät er sich gerade befindet. Rufe an den Teilnehmer gehen dann an diese Zentrale und werden von dort an das ausgewählte Endgerät weitergeleitet. Die vorliegende Erfindung setzt eine solche Fernmeldeinfrastruktur voraus und baut darauf auf.

Das der vorliegenden Aufgabe zugrundeliegende Problem liegt darin, den seitens des Teilnehmers erforderlichen Aufwand zum Umschalten zwischen den in Frage kommenden Endgeräten zu verringern.

Die Aufgabe wird gelöst durch ein Verfahren nach der Lehre des Anspruchs 1 und ein Fernmeldeendgerät nach der Lehre des Anspruchs 4.

Der Grundgedanke der Erfindung liegt demnach darin, daß sich der Teilnehmer durch einen räumlich begrenzt fernabfragbaren Teilnehmeridentifikationsausweis gegenüber mindestens einem der Endgeräte ausweist, das dann eine Meldung an die Zentrale veranlaßt, wodurch dann jedes für den Teilnehmer bestimmte ankommende Gespräch zu diesem Endgerät geleitet wird.

Weitere Ausgestaltungen der Erfindung sind den Unteransprüchen zu entnehmen.

Im folgenden wird die Erfindung anhand eines Ausführungsbeispiels unter Zuhilfenahme der beiliegenden Zeichnung weiter erläutert.

Die Zeichnung zeigt einen Teilnehmerbereich 1, einen Netzbereich 2 und einen Diensteanbieterbereich 3. Im Teilnehmerbereich 1 sind der Teilnehmer 10, sein stationäres Fernsprengerät 11 und sein Handfunktelefon 12 gezeigt. Der Diensteanbieterbereich 3 ist durch eine Datenbank 31 und ein Datenterminal 32 symbolisiert. Das Datenterminal 32 wird im folgenden nicht weiter erwähnt. Es ist für den laufenden Betrieb nicht erforderlich.

Sowohl das Fernsprengerät 11, als auch das Handfunktelefon 12 und der Diensteanbieterbereich 3 sind über den Netzbereich 2, der letztlich das gesamte weltweite Fernmeldenetz umfaßt, miteinander verbindbar.

Das Fernsprengerät 11 und das Handfunktelefon 12 sind in bekannter Weise unter verschiedenen Nummern, die in der Regel durch unterschiedliche Ausscheidungskennziffern erreichbar sind, vom Netzbereich 2 aus erreichbar. Weiter ist dem Teilnehmer 10 im Diensteanbieterbereich 3 eine Nummer zugeordnet, während der Diensteanbieterbereich 3 selbst durch Wahl bestimmter Ausscheidungskennziffern erreichbar ist.

Der Teilnehmer 10 ist erreichbar durch Wahl der Ausscheidungskennziffern für den Diensteanbieterbereich 3 und der diesem Teilnehmer im Diensteanbieterbereich 3 zugeordneten Nummer. Unter Zuhilfenahme der in der Datenbank 31 enthaltenen, den Teilnehmer 10 betreffenden, Daten wird nun der Ruf entweder an das Fernsprengerät 11 oder an das Handfunktelefon 12 weitergeleitet. Diese Weiterleitung erfolgt durch Signalisierung der entsprechenden Daten an die aus dem Netzbereich 2 anfragende, den Verbindungsaufbau steuernde Vermittlungsstelle. Bis hierher unterscheidet sich die Erfindung noch nicht von Bekanntem. Details sind deshalb insoweit nicht nötig.

Der Einfachheit halber wird nun angenommen, und dies macht in der Praxis durchaus Sinn, sagt ein Eintrag in der Datenbank 31 aus, daß

von den beiden in Frage kommenden Endgeräten 11 und 12 immer dann das Handfunktelefon 12 ausgewählt wird, wenn vom Fernsprechgerät 11 keine Meldung vorliegt, daß sich der Teilnehmer 10 in dessen Nähe aufhält.

Das Fernsprechgerät 11 ist nun so ausgestaltet, daß es einen Sensor enthält, um aus seiner Umgebung Teilnehmeridentifikationssignale zu empfangen und daß es eine Schalteinrichtung aufweist, um beim Empfang eines Teilnehmeridentifikationssignals als Reaktion eine Meldung an den Diensteanbieterbereich 3 auszulösen. Meldungen an den Diensteanbieterbereich 3 können als Anmeldungen und Abmeldungen erfolgen; der augenblickliche Zustand ist dann sowohl im Fernsprechgerät 11 als auch in der Datenbank 31 festgehalten.

Sensoren, die auf Identifikationssignale ansprechen, sind für die verschiedensten Zwecke bekannt; viele der bekannten Lösungen sind auch hier anwendbar. Beispiele hierfür sind auf induktiver Basis arbeitende Warensicherungsanlagen, auf Funkbasis arbeitende Plakettenidentifikationssysteme für Frachtcontainer oder Eisenbahngüterwagen (wie z.B. in den US-Patenten 4,739,328, 4,864,158, 5,030,807 und 5,055,659 beschrieben) oder auch auf Infrarotbasis oder Ultraschallbasis arbeitende Erkennungssysteme.

Auch die Stimme des Teilnehmers könnte als dessen "Ausweis" verwendet als Teilnehmeridentifizierungssignal Verwendung finden. In Fernsprechgeräte eingebaute Mikrofone als Teil einer Freisprecheinrichtung sind ebenso bekannt wie eingebaute Spracherkennungseinrichtungen zur sprachgeführten Benutzung. Schon mit sehr wenig Zusatzaufwand im Teilnehmerbereich 1 (Ergänzung in der Software) könnte so die Erfindung durchgeführt werden.

Wenn nicht gerade der Teilnehmer selbst mit seiner Stimme oder im Zusammenhang mit einem Bildtelefongerät mit seinem Aussehen als Ausweis wirkt, sondern irgendeine fernabfragbare Einheit als Ausweiskarte trägt, dann muß das Fernsprechgerät 11 noch einen geeigneten Generator aufweisen, der ein Feld erzeugt, mit dessen

Hilf diese vom Teilnehmer 10 mitgeführte Einheit "Ausweiskarte" zum Senden von Teilnehmeridentifikationssignalen veranlaßt wird. Je nach verwendetem Erkennungssystem ist dies ein Magnetfeldgenerator, ein HF-Sender, ein Infrarot- oder Ultraschallsender oder auch der Lautsprecher einer Freisprecheinrichtung. Von Warensicherungsanlagen beispielsweise ist es bekannt, nur passiv ein angelegtes Magnetfeld zu verändern und dann diese Veränderung zu erkennen. Beim genannten Plakettenidentifizierungssystem wird die empfangene HF-Energie als Energiequelle zur Absendung einer Folge von HF-Impulsen verwendet. Wieder andere Systeme enthalten eigene Batterien als Energiequellen und werden durch äußere Signale oder Felder nur angeregt.

Diejenigen Schalteinrichtungen, die erforderlich sind, um Meldungen über Anwesenheit oder Abwesenheit des Teilnehmers vom Fernsprechgerät 11 an den Dienstbieterebereich 3 zu senden, sind letztlich Fernüberwachungseinrichtungen und als solche ausreichend bekannt.

Im folgenden werden noch einige Ergänzungs- und Abwandlungsmöglichkeiten angegeben:

Besitzt der Teilnehmer weitere Endgeräte, so müssen auch diese der Datenbank 31 bekannt sein. Auch von ihnen müssen Meldungen über Anwesenheit oder Abwesenheit des Teilnehmers an die Datenbank 31 gesendet werden.

Die Auslösung solcher Meldungen kann beim einen oder andern Endgerät auch anders erfolgen. Beispielsweise kann die Inbetriebnahme eines Kraftfahrzeugs des Teilnehmers 10 als dessen Anwesenheit im Kraftfahrzeug interpretiert und über ein eingebautes Mobilfunktelefon an die Datenbank 31 gemeldet werden. Ankommende Rufe gehen dann an dieses Mobilfunktelefon.

Es ist auch bekannt, daß sich ein Teilnehmer an einem beliebigen Telefon durch Meldung an eine Zentrale unter Zuhilfenahme einer Chipkarte oder eines Codewortes bei einem Diensteanbieter meldet, um von diesem Telefon aus auf seine Kosten zu telefonieren und um dort unter seiner Nummer angerufen werden zu können. Auch dies kann in das erfindungsgemäße Verfahren mit eingebunden werden.

Im oben genannten Beispiel ist das Handfunktelefon 12 dasjenige Endgerät, das ausgewählt wird, wenn kein anderes Endgerät die Anwesenheit des Teilnehmers 10 meldet. Als Alternativen hierzu käme etwa ein Anrufbeantworter in Frage oder auch die Meldung über einen Pager oder nur die Hinterlassung einer Nachricht in der Datenbank 31, die dann bei nächster Gelegenheit an den Teilnehmer 10 weitergegeben wird.

Die Funktion, die im oben genannten Beispiel der Diensteanbieterbereich 3 übernimmt, kann auch im Teilnehmerbereich 1 selbst ausgeführt werden. Die erforderlichen Einrichtungen können im Fernsprengerät 11 mit enthalten sein. Ist dieses ein ISDN-Gerät mit zwei Basis- oder B-Kanälen und einem Daten- oder D-Kanal, so können die auf einem B-Kanal ankommenden Rufe auf dem andern B-Kanal zu demjenigen Endgerät weitergeleitet werden, an dem der Teilnehmer erreichbar ist. Meldungen erfolgen dann über den D-Kanal.

Ein weiteres einfaches Beispiel der Erfindung liegt in einer automatischen Umschaltung zwischen zwei oder mehr Endgeräten im selben Haus. Dabei sind alle Endgeräte in Reihe geschaltet. Jedes Endgerät bis auf das letzte schaltet solange zum nächsten Endgerät weiter, solange es nicht die Anwesenheit des Teilnehmers 10 feststellt. Bei diesem Beispiel ist keine irgendwie geartete Zentrale erforderlich; auch Schalteinrichtungen zur Weitergabe von Meldungen sind nicht erforderlich.

Patentansprüche

1. Verfahren zur Auswahl eines von mindestens zwei demselben Teilnehmer zugeordneten oder zuordenbaren Fernmeldeendgeräten (11, 12); d a d u r c h g e k e n n z e i c h n e t , daß mindestens eines dieser Fernmeldeendgeräte (11) Teilnehmeridentifikationssignale aus seiner Umgebung zu empfangen in der Lage ist und daß beim Erkennen eines solchen Signals die Zuordnung dieses Fernmeldeendgerätes (11) an den Teilnehmer (10) veranlaßt wird.
2. Verfahren nach Anspruch 1, dadurch gekennzeichnet, daß mindestens ein Fernmeldeendgerät (11) ein Feld erzeugt, durch das eine vom Teilnehmer (10) mitgeführte Einheit veranlaßt wird, Teilnehmeridentifikationssignale zu senden.
3. Verfahren nach Anspruch 1, dadurch gekennzeichnet, daß das Fernmeldeendgerät (11) das Erkennen eines Teilnehmeridentifikationssignals an eine Zentrale (3) meldet, daß an den Teilnehmer (10) gerichtete Rufe an die Zentrale (3) gemeldet werden und daß die Zentrale (3) aufgrund der vorliegenden Meldungen ein Fernmeldeendgerät (11, 12) auswählt und die Weiterleitung an dieses Fernmeldeendgerät (11, 12) veranlaßt.

4. Fernmeldeendgerät (11), insbesondere Fernsprechendgerät, dadurch gekennzeichnet, daß es einen Sensor aufweist, um aus der Umgebung Teilnehmeridentifikationssignale zu empfangen und daß es eine Schalteinrichtung aufweist, um beim Empfang eines Teilnehmeridentifikationssignals eine Reaktion auszulösen.

5. Fernmeldeendgerät (11) nach Anspruch 4, dadurch gekennzeichnet, daß es einen Generator aufweist, um ein Feld zu erzeugen, durch das eine von einem Teilnehmer (10) mitgeführte Einheit veranlaßt wird, Teilnehmeridentifikationssignale zu senden.

6. Fernmeldeendgerät (11) nach Anspruch 4, dadurch gekennzeichnet, daß die Schalteinrichtung ein Mittel aufweist, um über das Fernmeldenetz (2) eine Meldung an eine Zentrale (3) zu senden.

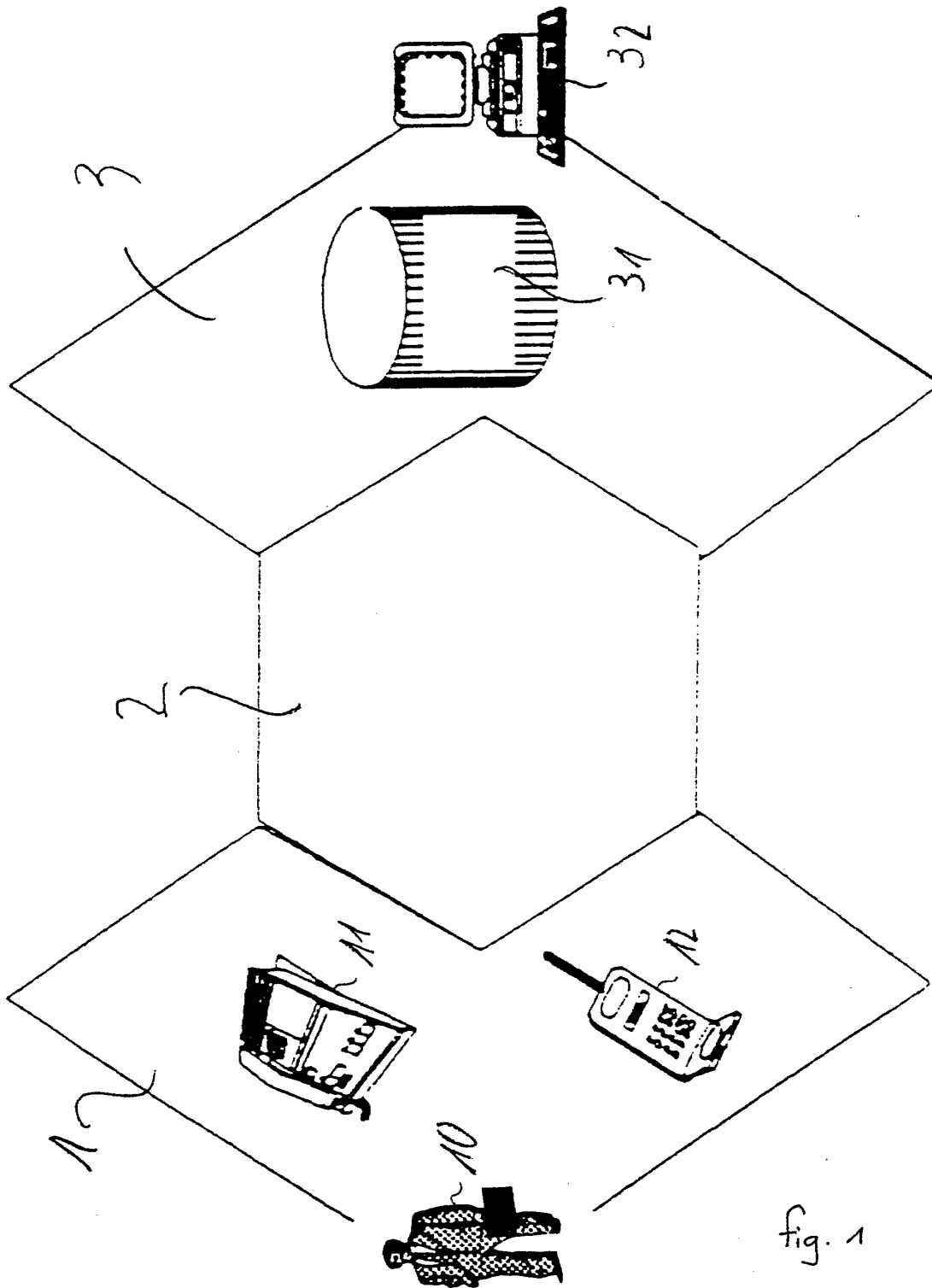

INTERNATIONAL SEARCH REPORT

Intern. Application No
PCT/EP 95/02264

A. CLASSIFICATION OF SUBJECT MATTER IPC 6 H04M3/42 H04Q7/38		
According to International Patent Classification (IPC) or to both national classification and IPC		
B. FIELDS SEARCHED Minimum documentation searched (classification system followed by classification symbols) IPC 6 H04M H04Q		
Documentation searched other than minimum documentation to the extent that such documents are included in the fields searched		
Electronic data base consulted during the international search (name of data base and, where practical, search terms used)		
C. DOCUMENTS CONSIDERED TO BE RELEVANT		
Category *	Citation of document, with indication, where appropriate, of the relevant passages	Relevant to claim No.
X	GB,A,2 254 755 (THE GENERAL ELECTRIC COMP.) 14 October 1992 see the whole document ---	1-6
X	EP,A,0 520 194 (NETWORK ACCESS CORP.) 30 December 1992 see column 2, line 38 - column 3, line 58 ---	1-6
X	WO,A,93 10616 (LIGHT IDEAS INC.) 27 May 1993 see page 14, line 20 - page 16, line 19 ---	1,3,4,6
X	GB,A,2 222 503 (CALLSCAN LIM.) 7 March 1990 see the whole document ---	1,3,4,6
-/--		
<input checked="" type="checkbox"/> Further documents are listed in the continuation of box C.		<input checked="" type="checkbox"/> Patent family members are listed in annex.
* Special categories of cited documents :		
"A" document defining the general state of the art which is not considered to be of particular relevance "E" earlier document but published on or after the international filing date "L" document which may throw doubts on priority claim(s) or which is cited to establish the publication date of another citation or other special reason (as specified) "O" document referring to an oral disclosure, use, exhibition or other means "P" document published prior to the international filing date but later than the priority date claimed	"T" later document published after the international filing date or priority date and not in conflict with the application but cited to understand the principle or theory underlying the invention "X" document of particular relevance; the claimed invention cannot be considered novel or cannot be considered to involve an inventive step when the document is taken alone "Y" document of particular relevance; the claimed invention cannot be considered to involve an inventive step when the document is combined with one or more other such documents, such combination being obvious to a person skilled in the art. "&" document member of the same patent family	
Date of the actual completion of the international search <div style="text-align: center; font-weight: bold;">25 September 1995</div>	Date of mailing of the international search report <div style="text-align: center; font-weight: bold;">06. 10. 95</div>	
Name and mailing address of the ISA European Patent Office, P.B. 5818 Patentlaan 2 NL - 2280 HV Rijswijk Tel. (+ 31-70) 340-2040, Tx. 31 651 epo nl, Fax: (+ 31-70) 340-3016	Authorized officer <div style="text-align: center; font-weight: bold;">Vandevenne, M</div>	

INTERNATIONAL SEARCH REPORT

Intern. Application No
PCT/EP 95/02264

C.(Continuation) DOCUMENTS CONSIDERED TO BE RELEVANT		
Category *	Citation of document, with indication, where appropriate, of the relevant passages	Relevant to claim No.
X	GB,A,2 198 910 (STANLEY ELECTRIC) 22 June 1988 see abstract	1,3,4,6
X	EP,A,0 536 949 (A.T.T.) 14 April 1993 see column 2, line 45 - column 3, line 20	1,3,4,6
A	EP,A,0 546 467 (ALCATEL SEL) 16 June 1993	

INTERNATIONAL SEARCH REPORT

Information on patent family members

International Application No

PCT/EP 95/02264

Patent document cited in search report	Publication date	Patent family member(s)	Publication date
GB-A-2254755	14-10-92	NONE	
EP-A-520194	30-12-92	US-A- 5315636 CA-A- 2069727 JP-A- 5191516 US-A- 5416780	24-05-94 29-12-92 30-07-93 16-05-95
WO-A-9310616	27-05-93	AU-A- 2378392	15-06-93
GB-A-2222503	07-03-90	NONE	
GB-A-2198910	22-06-88	JP-A- 63152255 JP-A- 63152256 JP-A- 63152257 DE-A- 3732109 FR-A- 2608877	24-06-88 24-06-88 24-06-88 30-06-88 24-06-88
EP-A-536949	14-04-93	CA-A- 2076434 JP-A- 7066875 US-A- 5428663	10-04-93 10-03-95 27-06-95
EP-A-546467	16-06-93	DE-A- 4140974 AU-A- 2991392	17-06-93 17-06-93

INTERNATIONALER RECHERCHENBERICHT

Intern: des Aktenzeichens
PCT/EP 95/02264

A. KLASSIFIZIERUNG DES ANMELDUNGSGEGENSTANDES IPK 6 H04M3/42 H04Q7/38		
Nach der Internationalen Patentklassifikation (IPK) oder nach der nationalen Klassifikation und der IPK		
B. RECHERCHIERTE GEBIETE		
Recherchiertes Mindestprüfstoff (Klassifikationssystem und Klassifikationssymbole) IPK 6 H04M H04Q		
Recherchierte aber nicht zum Mindestprüfstoff gehörende Veröffentlichungen, soweit diese unter die recherchierten Gebiete fallen		
Während der internationalen Recherche konsultierte elektronische Datenbank (Name der Datenbank und evtl. verwendete Suchbegriffe)		
C. ALS WESENTLICH ANGESEHENE UNTERLAGEN		
Kategorie*	Bezeichnung der Veröffentlichung, soweit erforderlich unter Angabe der in Betracht kommenden Teile	Betr. Anspruch Nr.
X	GB,A,2 254 755 (THE GENERAL ELECTRIC COMP.) 14.Oktober 1992 siehe das ganze Dokument ---	1-6
X	EP,A,0 520 194 (NETWORK ACCESS CORP.) 30.Dezember 1992 siehe Spalte 2, Zeile 38 - Spalte 3, Zeile 58 ---	1-6
X	WO,A,93 10616 (LIGHT IDEAS INC.) 27.Mai 1993 siehe Seite 14, Zeile 20 - Seite 16, Zeile 19 ---	1,3,4,6
X	GB,A,2 222 503 (CALLSCAN LIM.) 7.März 1990 siehe das ganze Dokument ---	1,3,4,6
	-/--	
<input checked="" type="checkbox"/>	Weitere Veröffentlichungen sind der Fortsetzung von Feld C zu entnehmen	<input checked="" type="checkbox"/> Siehe Anhang Patentfamilie
<p>* Besondere Kategorien von angegebenen Veröffentlichungen :</p> <p>"A" Veröffentlichung, die den allgemeinen Stand der Technik definiert, aber nicht als besonders bedeutsam anzusehen ist</p> <p>"E" älteres Dokument, das jedoch erst am oder nach dem internationalen Anmeldedatum veröffentlicht worden ist</p> <p>"L" Veröffentlichung, die geeignet ist, einen Prioritätsanspruch zweifelhaft erscheinen zu lassen, oder durch die das Veröffentlichungsdatum einer anderen im Recherchenbericht genannten Veröffentlichung belegt werden soll oder die aus einem anderen besonderen Grund angegeben ist (wie ausgeführt)</p> <p>"O" Veröffentlichung, die sich auf eine mündliche Offenbarung, eine Benutzung, eine Ausstellung oder andere Maßnahmen bezieht</p> <p>"P" Veröffentlichung, die vor dem internationalen Anmeldedatum, aber nach dem beanspruchten Prioritätsdatum veröffentlicht worden ist</p> <p>"T" Spätere Veröffentlichung, die nach dem internationalen Anmeldedatum oder dem Prioritätsdatum veröffentlicht worden ist und mit der Anmeldung nicht kollidiert, sondern nur zum Verständnis des der Erfindung zugrundeliegenden Prinzips oder der ihr zugrundeliegenden Theorie angegeben ist</p> <p>"X" Veröffentlichung von besonderer Bedeutung; die beanspruchte Erfindung kann allein aufgrund dieser Veröffentlichung nicht als neu oder auf erfinderischer Tätigkeit beruhend betrachtet werden</p> <p>"Y" Veröffentlichung von besonderer Bedeutung; die beanspruchte Erfindung kann nicht als auf erfinderischer Tätigkeit beruhend betrachtet werden, wenn die Veröffentlichung mit einer oder mehreren anderen Veröffentlichungen dieser Kategorie in Verbindung gebracht wird und diese Verbindung für einen Fachmann naheliegend ist</p> <p>"&" Veröffentlichung, die Mitglied derselben Patentfamilie ist</p>		
Datum des Abschlusses der internationalen Recherche		Absenddatum des internationalen Recherchenberichts
25. September 1995		06.10.95
Name und Postanschrift der Internationalen Recherchenbehörde Europäisches Patentamt, P.B. 5818 Patentaan 2 NL - 2280 HV Rijswijk Tel. (+31-70) 340-2040, Tx. 31 651 epo nl, Fax (+31-70) 340-3016		Bevollmächtigter Bediensteter Vandevenne, M

Formblatt PCT/ISA/210 (Blatt 2) (Juli 1992)

INTERNATIONALER RECHERCHENBERICHT

Internationales Aktenzeichen
PCT/EP 95/02264

C.(Fortsetzung) ALS WESENTLICH ANGESEHENE UNTERLAGEN		
Kategorie*	Bezeichnung der Veröffentlichung, soweit erforderlich unter Angabe der in Betracht kommenden Teile	Betr. Anspruch Nr.
X	GB,A,2 198 910 (STANLEY ELECTRIC) 22.Juni 1988 siehe Zusammenfassung ---	1,3,4,6
X	EP,A,0 536 949 (A.T.T.) 14.April 1993 siehe Spalte 2, Zeile 45 - Spalte 3, Zeile 20 ---	1,3,4,6
A	EP,A,0 546 467 (ALCATEL SEL) 16.Juni 1993 -----	

1

INTERNATIONALER RECHERCHENBERICHT

Angaben zu Veröffentlichungen, die zur selben Patentfamilie gehören

Internationales Aktenzeichen

PCT/EP 95/02264

Im Recherchenbericht angeführtes Patentdokument	Datum der Veröffentlichung	Mitglied(er) der Patentfamilie	Datum der Veröffentlichung
GB-A-2254755	14-10-92	KEINE	
EP-A-520194	30-12-92	US-A- 5315636 CA-A- 2069727 JP-A- 5191516 US-A- 5416780	24-05-94 29-12-92 30-07-93 16-05-95
WO-A-9310616	27-05-93	AU-A- 2378392	15-06-93
GB-A-2222503	07-03-90	KEINE	
GB-A-2198910	22-06-88	JP-A- 63152255 JP-A- 63152256 JP-A- 63152257 DE-A- 3732109 FR-A- 2608877	24-06-88 24-06-88 24-06-88 30-06-88 24-06-88
EP-A-536949	14-04-93	CA-A- 2076434 JP-A- 7066875 US-A- 5428663	10-04-93 10-03-95 27-06-95
EP-A-546467	16-06-93	DE-A- 4140974 AU-A- 2991392	17-06-93 17-06-93



INTERNATIONAL APPLICATION PUBLISHED UNDER THE PATENT COOPERATION TREATY (PCT)

<p>(51) International Patent Classification ⁶ : H04Q 3/00, H04L 29/06</p>	<p>A1</p>	<p>(11) International Publication Number: WO 97/31492 (43) International Publication Date: 28 August 1997 (28.08.97)</p>
<p>(21) International Application Number: PCT/IB96/00134 (22) International Filing Date: 21 February 1996 (21.02.96) (71) Applicant (for all designated States except US): INTERNATIONAL BUSINESS MACHINES CORPORATION [US/US]; Old Orchard Road, Armonk, NY 10504 (US). (72) Inventors; and (75) Inventors/Applicants (for US only): TRUONG, Hong, Linh [DE/CH]; Reidholzstrasse 37, CH-8805 Richterswil (CH). WONG, Johnny, Wai-Nang [CA/CH]; Leimbachstrasse 119, CH-8041 Zurich (CH). (74) Agent: BARTH, Carl, Otto; International Business Machines Corporation, Säumerstrasse 4, CH-8803 Rüschlikon (CH).</p>		<p>(81) Designated States: BR, CA, CN, JP, KR, US, European patent (AT, BE, CH, DE, DK, ES, FR, GB, GR, IE, IT, LU, MC, NL, PT, SE). Published <i>With international search report.</i></p>

(54) Title: DISTRIBUTED ARCHITECTURE FOR SERVICES IN A TELEPHONY SYSTEM

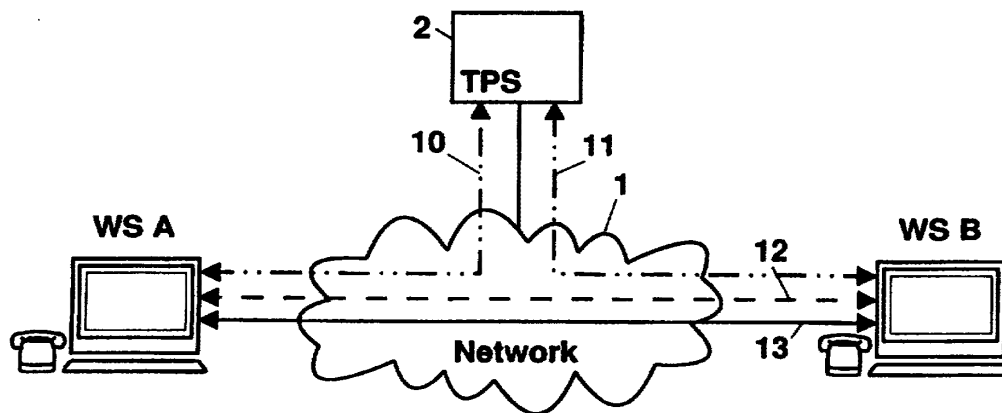

(57) Abstract

The invented method and system for enabling and controlling telephony over existing networks, e.g. ATM networks, the Internet or other data networks, uses essentially distributed control processing employing intelligence in the typical end-user devices, e.g. workstations or personal computers. Parallel use of a real-time channel (to provide the needed direct voice communication) and a control channel (for basic services like connection buildup and termination and for supplementary services) essentially established by and from the users's workstations (and in principle excluding the PBXs) allows implementation of practically any imaginable function.

FOR THE PURPOSES OF INFORMATION ONLY

Codes used to identify States party to the PCT on the front pages of pamphlets publishing international applications under the PCT.

AM	Armenia	GB	United Kingdom	MW	Malawi
AT	Austria	GE	Georgia	MX	Mexico
AU	Australia	GN	Guinea	NE	Niger
BB	Barbados	GR	Greece	NL	Netherlands
BE	Belgium	HU	Hungary	NO	Norway
BF	Burkina Faso	IE	Ireland	NZ	New Zealand
BG	Bulgaria	IT	Italy	PL	Poland
BJ	Benin	JP	Japan	PT	Portugal
BR	Brazil	KE	Kenya	RO	Romania
BY	Belarus	KG	Kyrgystan	RU	Russian Federation
CA	Canada	KP	Democratic People's Republic of Korea	SD	Sudan
CF	Central African Republic	KR	Republic of Korea	SE	Sweden
CG	Congo	KZ	Kazakhstan	SG	Singapore
CH	Switzerland	LI	Liechtenstein	SI	Slovenia
CI	Côte d'Ivoire	LK	Sri Lanka	SK	Slovakia
CM	Cameroon	LR	Liberia	SN	Senegal
CN	China	LT	Lithuania	SZ	Swaziland
CS	Czechoslovakia	LU	Luxembourg	TD	Chad
CZ	Czech Republic	LV	Latvia	TG	Togo
DE	Germany	MC	Monaco	TJ	Tajikistan
DK	Denmark	MD	Republic of Moldova	TT	Trinidad and Tobago
EE	Estonia	MG	Madagascar	UA	Ukraine
ES	Spain	ML	Mali	UG	Uganda
FI	Finland	MN	Mongolia	US	United States of America
FR	France	MR	Mauritania	UZ	Uzbekistan
GA	Gabon			VN	Viet Nam

1

DESCRIPTION

5

Distributed Architecture for Services in a Telephony System

10

FIELD OF THE INVENTION

15

This invention relates to telephony, in particular to a method and apparatus for enabling telephony over existing networks like the Internet or other data networks. Essentially, distributed call processing is employed using intelligence in the typical end-user devices, e.g. workstations or personal computers.

BACKGROUND AND PRIOR ART

20

Computer-telephony integration is quickly developing a wide variety of applications that use well known, existing networks, e.g. the telephone networks, as well as new, often quickly expanding data networks, e.g. the Internet.

25

Telephony requires a real-time channel to provide the needed direct and immediate voice communication which makes it so attractive. Today, it also must provide certain supplementary services. Such supplementary services are traditionally implemented in the telephone switches, the so-called PBXs (for Private Branch Exchanges), through which the users are connected.

30

Some examples for such services are:

- 2 -

- 1 — Alternate Call - this supplementary service enables a user A to put a currently active call to another user B on hold and place a call to, or activate a previously "on hold" call with, user C.
- Call Back - user A calls user B and finds that user B is busy; this
5 supplementary service enables user A to request a call back from user B.
- Camp on Call - user A calls user B and finds that user B is busy; this supplementary service enables the call to be placed again as soon as user B becomes free.
- 10 — Deflect Call - this supplementary service enables a user to re-direct (or forward) an incoming call to another user or phone.
- Call Transfer - this supplementary service enables user A to transform two of his calls (with users B and C) into a new call between users B and C.
- 15 — Directed Pickup Call - user A calls user B and the call is in the ringing state; this supplementary service enables a third user C to answer the call from a different destination.
- Multi-line Appearance - this supplementary service enables an
20 incoming call to ring at two or more users; the first user who answers gets the call.
- Call do not Disturb - this supplementary service enables a user to reject all incoming calls.

25 As said above, these supplementary services are traditionally implemented in the switches (or PBXs). Such PBXs are usually located at user's premises and connected to the public telephone network.

30 With the advent of new and versatile networks like the Internet or ATM (for Asynchronous Transfer Mode) networks that allow the exchange and transmission of digital data, including real time exchange of digitized voice which can be used for telephony, the traditional telephone systems are getting competition. However, when using such novel transmission tools,

1 those supplementary services that were usually implemented in the PBXs
are no more be available.

5 Further, computer-network telephony requires more complex transmission
management since voice transmission is much more susceptible than data
transmission to even minimal delays. Traditional call control in existing
telephone networks is not adapted to provide this service for a data
network.

10 Also, PBXs use a centralized approach to basic telephony services, i.e. call
placement and termination, and to supplementary services. Due to the
many functions that are performed, PBXs are generally complex and costly.
They also treat the end-user equipment (e.g. the telephone sets) as simple
15 devices that are specialized for telephony. With the wide availability of
powerful workstations, it becomes attractive to use their capabilities for
providing at least part of these telephony services and possibly integrate
computers and telephony.

20 Some approaches for integrating computers and phones are addressed by
James Burton in: "Standard Issue" in BYTE, September 1995, pp. 201-207.
Burton describes several CTI (for Computer-Telephone Integration)
architectures and their characteristic layout. The architectures listed by
Burton, however, provide for a combined transmission of voice and control
25 data over at least partially the same connections and are based on
connectivity to a telephone network or a PBX. The power of the end-user
workstations is not exploited for basic or supplementary telephony services.

30 US patent 4 634 812 by Hornburger et al discloses a method for transferring
information including voice between computers in a decentralized telephone
control system. This system provides a data, also voice, transmitting
multi-wire bus and two single wire control buses. A telephone system
according to the Hornberger patent consists of identical PBXs, all being
connected by two control buses and one data/voice multi-wire bus. Thus,

1 this system provides a distributed control in a telephone system through
multiple parallel channels and especially designed PBXs. It is a specially
designed, so-to-speak self-contained, system for PBXs and does not address
the idea of exploiting the power of end-user workstations for basic telephony
5 services and supplementary services.

US patent 4 313 036 to Jabara et al describes a distributed computerized
PBX, called CBX, system wherein the CBXs are connected by both a voice
and a packet-switched network. Two links or channels are provided between
10 the CBXs: a signalling data link and a voice link. The data link is part of a
virtual network which may be provided by a packet-switched network.
However, this system concerns communication between PBXs for call
control purposes and does not address the potential of end-user
workstations for basic telephony services and supplementary services.

15 Various systems that use the Internet for telephony have been proposed.
One such is advertised in the World Wide Web (WWW) under the Universal
Resource Locator (URL) <http://www.vocaltec.com>. An overview of some
other such systems with more references can be found under the URL
20 <http://www.northcoast.com/~savetz/voice-faq.html>. The systems described
there exploit the power of the users' workstations for limited basic telephony
services, but do neither address nor provide means for supplementary
services.

25 Thus, it is an object of this invention to provide, for a telephone system, a
distributed, i.e. workstation-oriented, architecture with more than one link
between the workstations and a method for providing not only basic
telephony services, such as call placement and termination, but also
complex supplementary service functions.

30 Another object is to provide a telephone system with a distributed, i.e. not
switch-centered, architecture that uses an existing network, preferably a

1 packet-switched network, to implement desired basic and/or supplementary
services.

The invention provides a solution to the need of using existing network
5 infrastructure for telephony, in particular for complex supplementary
services. By employing a workstation-oriented architecture, the invention
provides an effective and versatile tool for implementing any desired
supplementary services, that can be altered and adapted at any time with
minimal effort and practically without disturbing an existing network
10 architecture and/or protocols used.

SUMMARY OF THE INVENTION

15 In brief, the distributed, workstation-oriented architecture for basic and
supplementary telephony services according to the invention, which
services were traditionally implemented in the switches (PBXs), comprises
setting up a first communication channel for transmitting first signals and
setting up a second communication channel for second signals, whereby
20 both channels directly connect the end-user devices, e.g. workstations.
Preferably, the first signals are control signals and the second signals voice
signals. The two (or more) connections or channels can be established
directly and independently, the second or voice channel being preferably
set up subsequent to the first or control channel. The control channel, once
25 established, is preferably maintained permanently during a communication
session. A session in this context may include interruptions or pauses in the
voice connection as long as an intent to continue the telephone
communication is recognizable.

30 With the invention, telephony services can be implemented solely in
workstations; the use of a server for a limited number of functions, e.g.
address resolution or authentication, may however be required or
advantageous. The switches, PBXs, if used at all, only need to provide the

1 communication channels for voice and/or real-time data transport. They are
not involved in the implementation of the services.

5 Details of the invention may be extracted from the following general and
detailed description of preferred implementations.

BRIEF DESCRIPTION OF THE DRAWINGS

10

Fig. 1 is an overview of one possible configuration using the
invention;

Fig. 2 depicts the general function of the invention;

15

Fig. 3 exemplifies the call placement process executed by the
invention;

Fig. 4 exemplifies the call back process executed by the invention;

20

Fig. 5 exemplifies the call transfer process executed by the invention;

Fig. 6 references one architecture of an implementation, and

25

Fig. 7 references another architecture according to the invention.

30

1 DESCRIPTION OF THE PREFERRED EMBODIMENTS

A. General Description

5 A.I. Overview

Fig.1 shows an example for a general configuration in which the invention can be applied. A network 1, which may be an ATM network or an IP (Internet Protocol) network as examples for existing digital networks conventionally used for data transfer, links workstations (WS) 3a to 3d. Also connected to network 1 is a telephony server (TPS) 2. Further, to enable communication with a PBX 4, a first gateway (GW) 5 is also attached to network 1. A second gateway 7 links network 1 to an ISDN (Integrated Service Digital Network) 6. Each of PBX 4 and ISDN 6 have connected to it usual telephones 8 and 9 and/or appropriate workstations that allow telephony.

The gateways shown in Fig.1, which are not part of this invention, usually support interworking with an ISDN and/or with an existing PBX, respectively. Technically, a gateway is able provide signalling interworking (mapping of ISDN/PBX signalling and signalling used in a distributed, i.e. workstation-oriented, architecture), voice signal translation (between voice encoding scheme used in ISDN/PBX and that used in the distributed architecture), and/or proxy functions for ISDN/PBX users.

The dotted lines in Fig.1 shall illustrate the telephone calls between the users 3a to 3d, 8, and 9; the solid lines shall indicate the attachments to the network. This will be apparent in more detail from the following description of Fig.2.

Fig.2 shows an overview of the basic configuration and the essential data flow according to the invention. The invention uses a distributed,

1 workstation-oriented architecture which will be apparent from the detailed
description of embodiments of the invention below.

5 One key element of the novel architecture is the use of two separate
end-to-end channels between the workstations for each phone call. As
shown in Fig.2, a workstation-workstation control channel 12 is provided for
call control and a voice channel 13 for voice communication. Workstations
A and B exchange control messages over control channel 12. These
10 messages could contain name or phone number of the calling and called
users, qualify service parameters (e.g. voice encoding schemes supported
by the workstation or preferred by the user), status information regarding
the call (e.g. whether call is active or on hold), and specific requests by
users (e.g. put user on call-back list). All messages transported on control
15 channel 12 are handled by processes at the workstations; they are not
interpreted by the switches or routers (Figs.3 and 4) which provide the
means for these channels.

Another key element of the invention is that control channel 12 is
20 maintained for the duration of the call, whereas voice channel 13 need not
be sustained permanently, but is set up only when needed. For example,
voice channel 13 can be released when a call is put on hold, and
re-established when the call is activated again. The ability to exchange any
control signals or messages over the maintained workstation-workstation
control channel 12 allows the implementation of a wide variety of
25 supplementary telephony services without involvement of the switches or
routers.

Telephony server 2 may perform functions such as name/phone number
registration, address resolution, and authentication. Workstations request
30 service from server 2 over separate workstation-server control channels 10
and 11. These control channels are set up on a as-needed basis. So much
for the general layout.

1 Since any of the channels mentioned, control channels 10, 11, or 12, as well
as voice channel 13, respectively, can be provided by existing networks, e.g.
ATM or IP networks, the invention allows the implementation of basic
telephony services (i.e. call placement and termination) as well as
5 supplementary telephony services on practically any of the existing and
evolving data networks.

The following is a more general description of a set of functions
implemented according to the invention; for someone skilled in the art, it is
10 already sufficient for carrying out the invention. Still, a subset of these
functions will be addressed in much more detail further down.

A.II. Basic Telephony Services

15

1. Place and Receive a Call

The steps for this process are depicted in Fig.3. User A wishes to place a
call to user B; each is at one of the workstations 3a to 3d shown in Fig.1.

20

Step 1: User A's workstation (WS A) maps user B's name or phone number
address onto the network address of user B's workstation (WS B). This
"address mapping" function may be provided by an appropriate server
process running at telephony server 2.

25

Step 2: Workstation A sets up a control channel (12 in Fig.2) to workstation
B.

Step 3: Workstation A sends a "call request" message to workstation B over
30 the control channel.

1 Step 4: Workstation B returns a "call confirm" message to workstation A,
informing workstation A that workstation B is able to proceed with call
placement

5 Step 5: Workstation B indicates to user B that there is an incoming call.

Step 6: User B responds that he is answering the call.

10 Step 7: Workstation B sends a "connect" message to workstation A over the
control channel, informing workstation A that user B is answering the call,
and asking workstation A to set up a voice channel.

Step 8: Workstation A sets up a voice channel to workstation B.

15 Step 9: Workstation B indicates to user B that the call is now active.

Step 10: Workstation A indicates to user A that the call is now active.

20 Step 11: User A and user B talk over the voice channel.

2. Call Termination

25 At any time, user A or user B may request call termination. Suppose call
termination is initiated by user A. The steps are as follows:

Step 1: Workstation A sends a "terminate call" message to workstation B
over the control channel, and releases the voice channel of the call.

30 Step 2: Workstation B returns a "terminate call" message to workstation A,
and release voice channel also.

1 Step 3: Workstation A completes call termination by releasing the workstation-workstation control channel of the call.

5 A.III. Supplementary Services

1. Alternate Call

At some point in time, user A may have two or more calls in progress. One
10 of these calls (to user B) is active while the others are on hold. Suppose user A wishes to put the call to user B on hold and activate the call to user C. The steps are as follows:

Step 1: Workstation A sends a "hold" message to workstation B over the
15 control channel with workstation B, informing workstation B that the call is now on hold.

Step 2: Workstation A sends an "active" message to workstation C over the
20 control channel with workstation C, informing workstation C that the call is now active.

2. Call Back

25 During call placement, workstation A finds that user B is busy at the initial message exchange over the control channel. User A then requests a call back. The steps are illustrated in Fig.4.

Steps 1 to 3: Same as those for placing a call (see above: Place and Receive
30 a Call, described in connection with Fig.3).

Step 4: Workstation B responds with a "user busy" message, informing workstation A that user B is busy, but call back is possible.

1

Step 5: User A requests that he be put on user B's call back list.

5

Step 6: Workstation A sends a "call back request" message to workstation B over the control channel. This message contains user A's phone number.

Step 7: Workstation B enters user A's phone number onto user B's call-back record.

10

When user B subsequently checks the call-back record, he/she will learn that user A has requested a call back.

3. Camp on Call

15

This is similar to the above Call Back process, except that an attempt will be made to call user B again as soon as B becomes free.

20

Steps 1 to 3: Same as those for Place and Receive a Call.

Step 4: Workstation B responds with a "user busy" message, informing workstation A that user B is busy, but camp on busy is possible.

25

Step 5: User A requests camp on call.

Step 6: Workstation A sends a "camp on call" message to workstation B over the control channel.

30

Step 7: Workstation B returns a "camp on confirmed" message to workstation A.

1 Step 8: When user B becomes free and indicates that he is answering the
camp on call, workstation B resumes the call placement with workstation A,
at step 7 of Fig.3.

5

4. Deflect Call

User B may wish to forward an incoming call to another phone number
(phone number M) immediately, or if he/she is busy, or if the call is not
10 answered after a time-out interval. Suppose user A is placing a call to user
B, the steps for the case of deflect after time-out are:

Steps 1 to 5: Same as those for Place an Receive a Call.

15 Step 6: User B has not answered after a time-out.

Step 7: Workstation B sends a "deflect call" message to workstation A over
the control channel. This message contains the phone number to which the
call is to be forwarded (phone number M).

20

Step 8: Workstation B releases the control channel to workstation A.

Step 9: Workstation A places a call to phone number M.

25

5. Call Transfer

Suppose user A has two calls in progress: a call with user B which is on
hold and a call with user C which is active. User A requests to have user B
and user C connected, and his/her calls to these users terminated. This
30 process is shown in Fig.5. The steps are:

1 Step 1: Workstation A sends a "hold" message to workstation C over the control channel with workstation C.

5 Step 2: Workstation A sends a "receive transfer call" message to workstation C over the control channel with workstation C, requesting workstation C to accept a transfer call from workstation B.

10 Step 3: Workstation C returns a "transfer confirm" message to workstation A, and waits for a transfer call from workstation B.

Step 4: Workstation A sends a "place transfer call" message to workstation B over the control channel with workstation B, requesting workstation B to place a transfer call to workstation C.

15 Step 5: Workstation C returns a "transfer confirm" message to workstation A.

Step 6: Workstation B places a transfer call to workstation C.

20 Step 7: Workstation A initiates termination of his/her call to workstation B.

Step 8: Workstation A initiates termination of his/her call to workstation C.

25 6. Directed Pickup Call

Suppose user A calls user B and the call is in the ringing state. A third user C wishes to answer the call. The steps are as follows.

30 Step 1: Workstation C sets up a control channel to workstation B.

Step 2: Workstation C sends a "pickup query" message to workstation B to find out whether call pick-up is possible or not. User C's phone number is included in this message.

1

Step 3: Workstation B returns a "pickup allowed" message to workstation C.

5

Step 4: Workstation C sends a "pickup request" message to workstation B, requesting call pickup.

10

Step 5: Workstation B sends a "directed pickup" message to workstation A which contains user C's phone number, instructing workstation A to place a call to user C.

7. Multi-line Appearance

15

Suppose user A places a call to a phone number that has multi-line appearance. Workstation A maps the destination phone number onto a list of network addresses. This "address mapping" function is provided by a server process running at the telephony server. Workstation A then places separate calls to each of these addresses. Workstation A will proceed with the first destination that answers, and terminates the call placement to the other addresses.

20

8. Call do not Disturb

25

Suppose user B has requested call do not disturb. Any workstation A attempting to place a call to user B will get a "do not disturb" message over the control channel in return.

30

1 B. Detailed Description of Specific Functions

B.I. Reference Architecture

5 Figs.6 and 7 show the reference architecture of a communication system employing the invention. The basic telephony services (mainly call establishment, call termination) and supplementary services (e.g. call hold, call back, call transfer, call deflection) are implemented by an enabling layer at the workstation. Integrated are functions such as address resolution,
10 voice encoding, and authentication.

Until now, a user was identified by a name or a phone number. In the following, users will be identified by their respective e-mail address.

15 Fig.6 depicts an architecture according to the invention in an ATM (Asynchronous Transfer Mode) environment. Physical layer 18 and ATM layer 17 are standard design features. TCP (Transmission Control Protocol) connection is set up over IP, i.e. Internet Protocol 15, which runs on top of AAL5, i.e. ATM Adaptation Layer 16. The implementation of IP on an ATM
20 network is available off-the-shelf.

Voice communication requires QoS (Quality of Service) guarantee from transport services interface 14, e.g. acceptable end-to-end delay and delay jitter. The voice channel is established by a VCC (Virtual Channel
25 Connection) with QoS. Encoded voice samples are sent in ATM cells. Q.2931 and SAAL (Signalling ATM Adaptation Layer) are signalling protocols for VCC setup and release. Transport services interface 14 provides transport for voice and control channels.

30 Enabling layer 19 uses the services provided by transport services interface 14 for establishing control channels and voice channels. Specifically, both workstation-server and workstation-workstation control channel are realized by TCP connections as indicated by block 15. Enabling layer 19 supports an

1 API (Application Programming Interface) which can be used for the development of telephony applications.

5 Fig.7 depicts an architecture according to the invention in an IP (Internet Protocol) environment. The physical layer is an IP subnet technology 26 able to provide the required services. QoS for the voice channel can be provided by a pair of RSVP (Resource Reservation Protocol) flows because an RSVP flow is uni-directional. Encoded voice samples are sent in UDP (User Datagram Protocol) packets using TCP/UDP protocol 24 and transport services interface 23. In this case, RSVP is the signalling protocol used
10 between the workstations and the routers to establish the needed RSVP flows.

15 In such an IP subset, encoded voice packets can also be sent in UDP packets without RSVP. This is a best-effort service and no QoS guarantee is provided. Transport services interface 23 provides transport capacity for voice and control channels. Enabling layer 22 supports an API 21 which can be used for developing telephony applications.

20 So much for the functionality of the invention. Some selected functions will be described further below in extensive detail to clarify the invention.

25 The abbreviations already introduced above, e.g. WS for workstation, WS A for workstation of user A as shown in the drawings, will be exclusively used.

Control messages exchanged over WS-server and WS-WS control channels are used to implement the basic and supplementary services. These control channels are realized by TCP connections.

30 Each control message contains a code which indicates the name of the control message and optionally a list of parameters (this list may be empty). For convenience, a control message is denoted by:

1 message-name (parameter list)

This notation will be used in the description of how the basic and supplementary services are implemented. In addition, only the parameters relevant to the procedure being described are listed, in order not to include unnecessary details.

Several timers are used in the implementation descriptions. These timers operate as follows. A timer is stopped when an expected event occurs before it expires. If, for whatever reason, the timer expires, some recovery action will be taken. In the implementation descriptions, unless otherwise specified, the recovery action is to terminate the phone call, using the procedure described in Section B.II.2. below.

15

B.II. Basic Telephony Services

Basic telephony services include call placement and call termination.

20

1. Call Placement

Suppose user A at workstation A (WS A) wishes to place a call to user B at workstation B (WS B) and user B is free to accept the call. The basic steps are depicted in Fig.3, there using the generic terms of Section A.II. Details of the implementation at WS A and WS B are described below.

30

WS A procedure:

Upon receiving a request for call placement from user A, WS A sets up a TCP connection to the telephony server. This connection will be used as the WS-server control channel. The setting up of a TCP connection is a

1 well-known procedure. WS A then prepares a AdrQuery (user B's e-mail address) control message and sends this message to the telephony server.

5 The telephony server, upon receiving the AdrQuery control message, checks its address mapping database. If an entry for user B's e-mail address is found, the telephony server prepares an AdrRsp (WS B's TCP address) control message, and returns this message to WS A; otherwise, an AdrRsp (user B not registered) is prepared and returned. In both cases, the TCP connection between WS A and the telephony server is released. The
10 address mapping function performed by the telephony server can be implemented by available nameserver technologies, e.g. the Internet domain name system.

15 Upon receiving the AdrRsp control message from the telephony server, WS A interprets the content of this message. If WS B's TCP address is included as a parameter, WS A proceeds to step 2 of call placement. On the other hand, if "user B is not registered" is indicated, WS A informs user A about this indication, and the call placement is finished.

20 Step 2: WS A sets up a WS-WS control channel to WS B.

WS A procedure:

25 WS A sets up a TCP connection to WS B. This connection will be used as the WS-WS control channel between WS A and WS B. WS A then proceeds to step 3 of call placement.

WS B procedure:

30 As a result of WS A action to set up a TCP connection, WS B completes the connection setup, and starts timer TB1.

Step 3: WS A sends a "call request" control message to WS B.

1 WS A procedure:

WS A prepares a CallReq (user A's e-mail address, user B's e-mail address) control message, sends this message to WS B, and starts a timer TA2.

5 Step 4: WS B returns a "call confirm" control message to WS A, informing WS A that WS B is able to proceed with call placement.

WS B procedure:

10 Upon receiving the CallReq control message from WS A, WS B stops timer TB1, and checks whether user B's e-mail address matches that contained in the CallReq control message. If this check is positive and user B is free, WS B prepares a CallCnf (B free) control message, and returns this message to WS A. WS B then proceeds to step 5.

15 On the other hand, if the check is negative, WS B terminates call placement using the procedure described in Section B.II.2.

WS A procedure:

20 Upon receiving the CallCnf control message from WS B, WS A stops timer TA2 and starts another timer TA3.

Step 5: WS B indicates to user B that there is an incoming call.

WS B procedure:

25 WS B informs user B that there is an incoming call and starts a timer TB4.

Step 6: User B responds that he is answering the call.

WS B procedure:

30 WS B stops timer TB4 and proceeds to step 7.

Step 7: WS B informs WS A that user B is answering the call and asks WS A to set up a voice channel.

1

WS B procedure:

WS B prepares a Connect control message, sends this message to WS A and starts timer TB5.

5

Step 8: WS A sets up a voice channel to WS B.

WS A procedure:

10

Upon receiving the Connect control message from WS B, WS A stops timer TA3 and sets up a voice channel to WS B. This connection will be used for the phone conversation between user A and user B. The implementation of voice channel setup will be described in section B.II.1.1.

15

Step 9: WS B indicates to user B that the call is now active.

WS B procedure:

Upon receiving the voice call setup request from WS A, WS B completes the voice channel setup, stops timer TB5, and informs user B that the call is active.

20

Step 10: WS A indicates to user A that the call is now active.

WS A procedure:

WS A informs user A that the call is active.

25

Step 11: User A and user B talk over the voice channel.

WS A procedure:

30

During the phone conversation, WS A prepares voice messages which contain encoded voice samples from user A and sends these messages over the voice channel to WS B. WS A also decodes the voice samples contained in voice messages received from WS B.

1
WS B procedure:

During the phone conversation, WS B prepares voice messages which contain encoded voice samples from user B and sends these messages over the voice channel to WS A. WS B also decodes the voice samples contained in voice messages received from WS A.
5

10 1.1. Voice Channel Setup

The negotiation of the type of voice channels to be used is done during call setup. The voice channel types include ATM (Asynchronous Transfer Mode), RSVP (Resource Reservation Protocol), or best-effort UDP (User Datagram Protocol). ATM and RSVP support quality of service guarantees, but best-effort UDP does not. Best-effort UDP is the default type. The negotiation is implemented as follows.
15

At step 3 of call placement (Fig.3), WS A sends a CallReq control message to WS B. The parameters relevant to the negotiation are: WS A's preferred voice channel type, and the corresponding addressing information for voice channel setup. The addressing information for best-effort UDP is also included as a parameter if it is not the preferred type.
20

At step 4 of call placement, WS B confirms the voice channel preferred by WS A if it also has access to the same type, otherwise WS B confirms that best-effort UDP (the default) will be used. In the CallCnf control message sent by WS B to WS A, the relevant parameters are confirmed voice channel type, and the corresponding addressing information for voice channel setup.
25

At step 8 of call placement: WS A sets up a voice channel to WS B. For ATM and RSVP, standard protocols are specified, and the setup is therefore
30

1 implemented by known procedures. For best-effort UDP, there is no need to
implement voice channel set-up because UDP is a datagram protocol.

5 2. Call Termination

At any time, user A or user B can request call termination. Call termination
can also be initiated because a timer has expired. Suppose WS A initiates
call termination. The steps are as follows:

10

Step 1: WS A informs WS B of call termination.

WS A procedure:

15 WS A prepares a TermCall control message and sends this message to WS
B. WS A also stops any running timer, releases any existing voice channel
of the call, and starts timer TA6. Release of ATM and RSVP voice channel
types are implemented by known procedures. For best effort-UDP, there is
no need to implement voice channel release because UDP is a datagram
protocol.

20

If TA6 expires before a TermCall control message is received from WS B,
WS A completes call termination by releasing the WS-WS control channel to
WS B.

25 Step 2: WS B informs WS A of call termination.

WS B procedure:

30 Upon receiving a TermCall control message from WS A, WS B stops any
timer, releases any existing voice channel of the call, prepares a TermCall
control message, sends this message to WS A, and releases the WS-WS
control channel to WS A.

1 Step 3: WS A completes call termination.

WS A procedure:

Upon receiving a TermCall control message from WS B, WS A stops timer
5 TA6 and releases the WS-WS control channel to WS B.

B.III. Supplementary Services

10 In the following, some implementations of supplementary services are
described. As said above, one key to this invention is the ability to
exchange control messages over the WS-WS control channel which is
maintained for the duration of a call. Two types of control messages shall be
first defined. This is followed by a description of the implementation of three
15 exemplary supplementary services.

1. Control Message Definition

20 1.1. Status Control Message for Hold or Activate Call

When a call is in the "active" state, the users can carry out their
conversation over the voice channel. On the other hand, when the call is in
the "hold" state, conversation between the users is suspended. The Status
25 control message is defined to support state changes.

Status (hold): the remote WS is informed that the state of the call has been
changed to "hold".

30 Status (active): the remote WS is informed that the state of the call has been
changed to "active".

1 1.2. Supplementary Service Control Message

The following four control messages are defined to support the implementation of the various supplementary services:

5

- SSInfo: This message is used to inform the remote WS about the possibility of activating a certain SS (Supplementary Service).
- 10 – SSReq: This message is used to request the remote WS to perform actions relating to a certain SS.
- SSCnf: This message is sent in response to a SSReq message to confirm the processing of a SS that the remote WS has requested.
- 15 – SSReject: This message is sent in response to a SSReq to reject the processing of a SS that the remote WS has requested; the reason for the rejection is included.

20 The above SS messages can be sent any time after the CallCnf control message (see step 4 of call placement, Fig.3), and before a TermCall control message (see step 1 of call termination).

25 2. Workstation Procedures for Supplementary Services

In this section, the implementation details of three supplementary services are described. These examples illustrate how the invention is to be used. Other supplementary services can be easily implemented by someone
30 skilled in the art on the basis of these examples and the general description above.

1 2.1. Alternate Call

At any point in time, a user A may have two or more calls in progress. One of these calls (to user B) is active while the others are on hold. Suppose
5 user A requests to put the call to user B on hold and activate the call to user C. The alternate call supplementary service is implemented as follows:

Step 1: WS A informs WS B that the call has been put on hold.

10 WS A procedure:

Upon receiving the request from user A, WS A changes the state of the call with WS B to "hold", disconnects the voice channel of this call from its audio subsystem, prepares a Status (hold) control message, and sends this message to WS B.

15

WS B procedure:

Upon receiving the Status message from WS A, WS B changes the state of the call with WS A to "hold" and disconnects the voice channel of this call from its audio subsystem.

20

Step 2: WS A informs WS C that the call has been activated.

WS A procedure:

WS A changes the state of the call with WS C to "active", attaches the voice
25 channel of this call to its audio subsystem, prepares a Status (active) control message, and sends this message to WS C.

WS C procedure:

Upon receiving the Status message, WS C changes the state of the call with
30 WS A to "active" and attaches the voice channel of this call to its audio subsystem.

1 2.2. Call Back

This process is depicted in Fig.4, there using the generic terms of Section A.III. Suppose user B has a "call back" record which is maintained by WS B. Any calling user A may request to have his e-mail address entered into this record, thus asking user B to call back at his convenience. This request is made during call placement in case user B is busy or does not answer. The call back supplementary service for the case of user B busy is implemented as follows (see Fig.4).

10

Steps 1 to 3: The procedures for WS A and WS B are identical to those for call placement (see Section B.II.1.).

Step 4: WS B returns a "call confirm" control message to WS A, informing WS A that user B is busy, but call back is possible.

WS B procedure:

Upon receiving the CallReq control message from WS A, WS B stops timer TB1 and checks whether user B's e-mail address matches that contained in the CallReq control message. If this check is positive but user B is busy, WS B prepares a CallCnf (user B busy, call back record) control message, returns this message to WS A, and starts timer TB4.

WS A procedure:

Upon receiving the CallCnf control message from WS B, WS A stops timer TA2, informs user A that user B is busy, but call back is possible, and starts timer TA3.

Step 5: User A requests that he be put on user B's call back record.

30

WS A procedure:

WS A stops timer TA3 and proceeds to step 6.

1 Step 6: WS A sends a SSReq control message to WS B.

WS A procedure:

5 WS A prepares a SSReq (call back request, user A's e-mail address) control message, sends this message to WS B, and starts timer TA5.

Step 7: WS B enters user A's e-mail address onto user B's call-back record.

WS B procedure:

10 Upon receiving the SSReq message from WS A, WS B stops TB4, enters user A's e-mail address to user B's call back record, prepares a SSCnf (call back confirmed) and returns this message to WS A. WS B also starts timer TB6.

15 Timer TB6 is stopped as part of call termination initiated by WS A at step 8 (see Section B.II.2.).

Step 8: WS A terminates call placement

20 WS A procedure:

Upon receiving the SSCnf control message from WS B, WS A stops timer TA5 and initiates procedure for call termination as described in Section B.II.2.

25

2.3. Call Transfer

This process is shown in Fig.5, there using the generic terms of Section A.III. Suppose user A has two calls in progress: a call with user B which is on hold and a call with user C which is active. User A requests to have user B and user C connected and his calls to these two users terminated. The implementation details of the call transfer supplementary service are described below. For ease of exposition, any timers used are not

30

1 mentioned, but their usage is similar to that described in call placement
(Section B.II.1.) and call back (Section B.III.2.).

Step 1: WS A puts its call to WS C on hold.

5

WS A procedure:

Upon receiving the call transfer request from user A, WS A changes the
state of the call to WS C to "hold", disconnects the voice channel of this call
from its audio subsystem, prepares a Status (hold) control message and
10 sends this message to WS C.

WS C, upon receiving the Status control message, changes the state of the
call with WS A to "hold" and disconnects the voice channel of this call from
its audio subsystem.

15

Step 2: WS A requests WS C to receive a transfer call.

WS A procedure:

WS A prepares a SSReq (receive transfer call, user B's e-mail address) and
20 sends this message to WS C.

Step 3: WS C confirms the transfer request.

WS C procedure:

25 Upon receiving the SSReq control message from WS A, WS C prepares a
SSCnf (transfer confirmed) control message and sends this message to WS
A. WS C also saves user B's e-mail address and enters the "wait for
transfer" state.

30 While in the "wait for transfer" state, WS C only accepts calls initiated by a
CallReq (transfer call) control message from WS B. All other CallReq
control messages will be responded to by a CallCnf (user C busy).

1 Step 4: WS A requests WS B to place a transfer call.

WS A procedure:

5 Upon receiving the SSCnf control message from WS C, WS A prepares a
SSReq (place transfer call, user C's e-mail address) and sends this message
to WS B.

Step 5: WS B confirms the transfer request.

10 WS B procedure:

Upon receiving the SSReq control message from WS A, WS B prepares a
SSCnf (transfer confirmed) and sends this message to WS A.

Step 6: WS B places a transfer call to WS C.

15

WS B procedure:

WS B places a "transfer" call to WS C using the procedure described in
Section B.II.1.

20 Step 7: WS A terminates calls with WS B

WS A procedure:

25 Upon receiving the SSCnf control message from WS B, WS A initiates call
termination for its call with WS B using the procedure described in Section
B.II.2.

Step 8: WS A terminates calls with WS C

WS A procedure:

30 WS A initiates call termination for its call with WS C using the procedure
described in Section B.II.2.

1 The above description of implementations shows how an architecture for
services in a telephony system can be devised which integrates computer
and telephony in a novel way by taking advantage of the computing power
and versatility of today's workstations and personal computers as well as
5 the quickly developing digital networks that connect virtually the whole
globe. It is to be understood that the above description of embodiments
merely illustrates the principles of the invention and its various applications
in known, existing networks like the Internet and ATM networks, as well as
new data networks being developed, and that someone skilled in the art can
10 easily develop various modifications based on the above without departing
from the spirit of this invention.

15

20

25

30

1
CLAIMS

5
1. A method for effecting and/or controlling telephony between at least two users connected through a network (1, 4-6), comprising

- 10
- establishing a first communication channel (12) between end user devices (3a - 3d), each said device being associated with one of said users, for transmitting first signals,
 - establishing a second communication channel (13) between said end user devices (3a - 3d) for transmitting second signals,
 - said first and second communication channels being independent of each other.

15
2. The method according to claim 1, wherein

the first signals exchanged between the end user devices (3a-3d) are control signals and the second signals are voice signals, preferably encoded voice signals.

20
3. The method according to claim 2, wherein

the control signals exchanged between the end user devices (3a-3d) include signals providing and/or effecting basic telephony services and/or supplementary telephony services.

25
4. The method according to claim 3, wherein

30
the control signals exchanged between the end user devices (3a-3d) are generated essentially by or within said devices, thus effecting desired channel establishing and control functions from said end user devices.

- 1 5. The method according to any of the preceding claims, wherein
- in addition to the communication signals, a voice transmission function,
especially enciphering/deciphering, is implemented in the end user
5 devices (3a-3d).
6. The method according to claim 1, wherein
- each of the two channels (12, 13) transparently, independently, and
10 directly connects the end user devices (3c, 3d) of the users
communicating or desiring to communicate.
7. The method according to claim 1, wherein
- 15 the first communication channel (12) is maintained essentially
permanently through a telephony session, whereas the second
communication channel (13) is designed to enable intermittent
operation.
- 20 8. A distributed system for effecting and/or controlling telephony between
at least two end user devices (3a-3d) over a decentralized network (1),
wherein
- 25 - at least one of said end user devices (3a-3d) comprises means for
establishing a first communication channel (12) essentially directly
between said end user devices (3a-3d) for transmitting first signals,
and
 - at least one of said end user devices (3a-3d) comprises means for
30 establishing an independent second communication channel (13)
essentially directly between said end user devices (3a-3d) for
transmitting second signals.

1 9. The system according to claim 8, wherein

the means in the end user devices (3a-3d) is designed to enable
intermittent operation of one of the channels whereas the other channel
5 is essentially permanently maintained.

10. The system according to claim 8, wherein

the means in the end user devices (3a-3d) is designed to produce
and/or interpret control signals exchanged between said end user
10 devices over one of the established channels to effect basic and/or
supplementary telephony services.

15 11. The system according to claim 8, wherein

the means in the end user devices (3a-3d) is designed to process
and/or interpret voice signals exchanged between said end user
15 devices over one of the established channels to effect voice telephony
between said end user devices (3a-3d).

20

12. The system according to claim 8, further comprising

a telephony server (2) for effecting desired central functions, in
particular user and access control information, said telephony server
25 being designed to communicate essentially directly and independently
with each of the end user devices (3a-3d).

13. The system according to any of claim 8 to 12, wherein

30 the end user device (3a-3d) is a multi-purpose workstation or personal
computer.

1/5

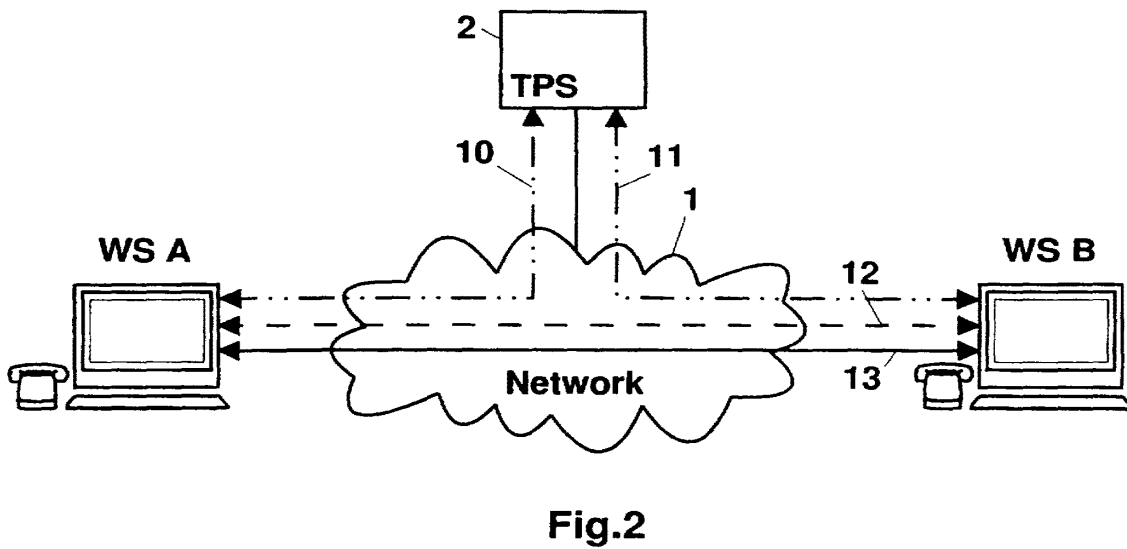
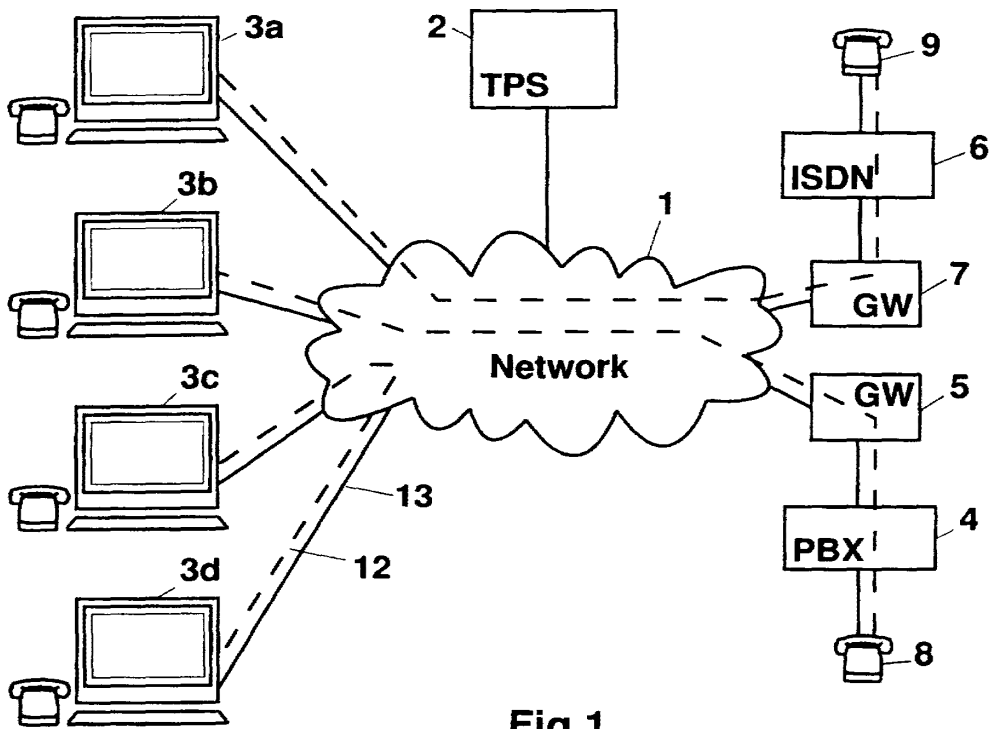

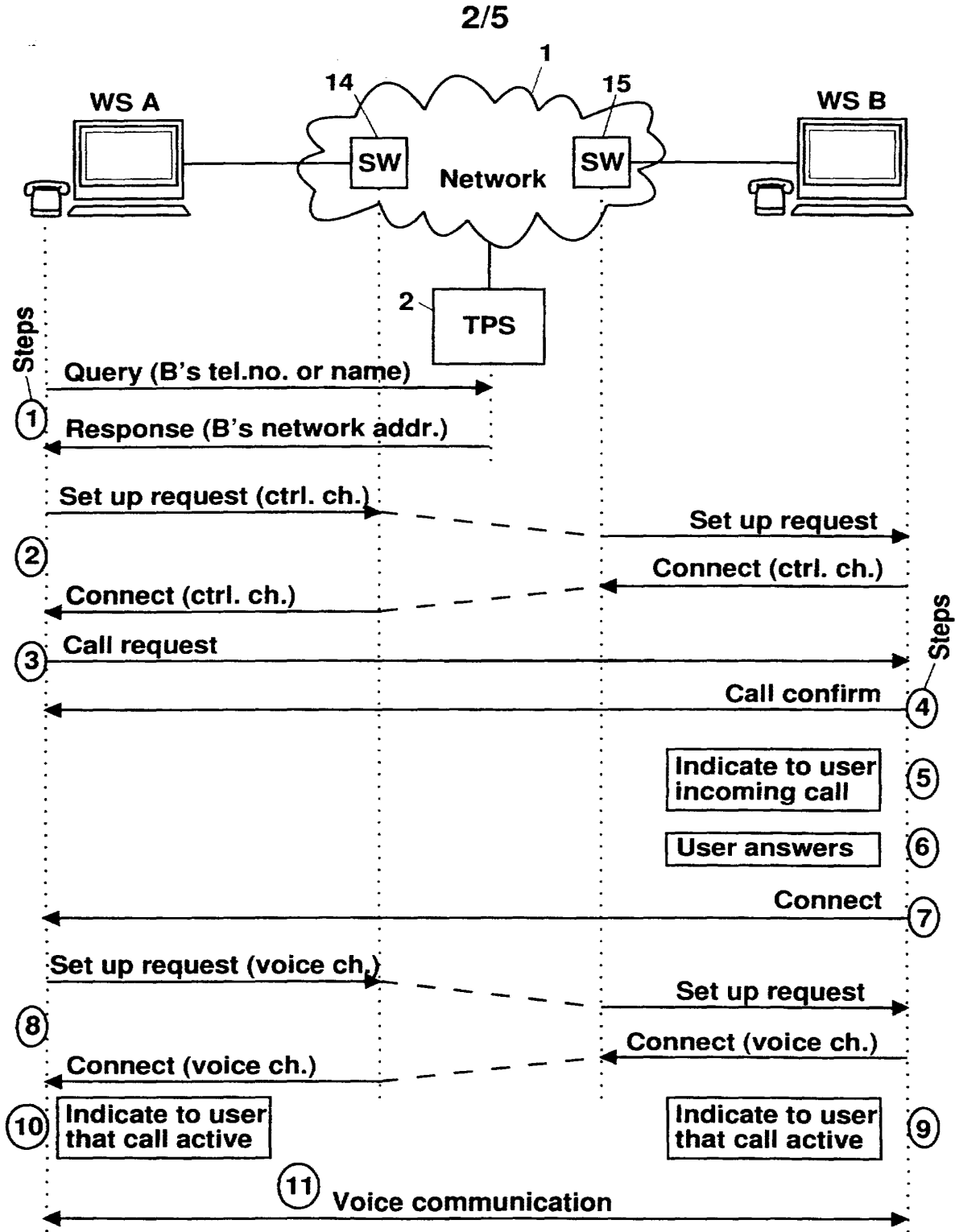
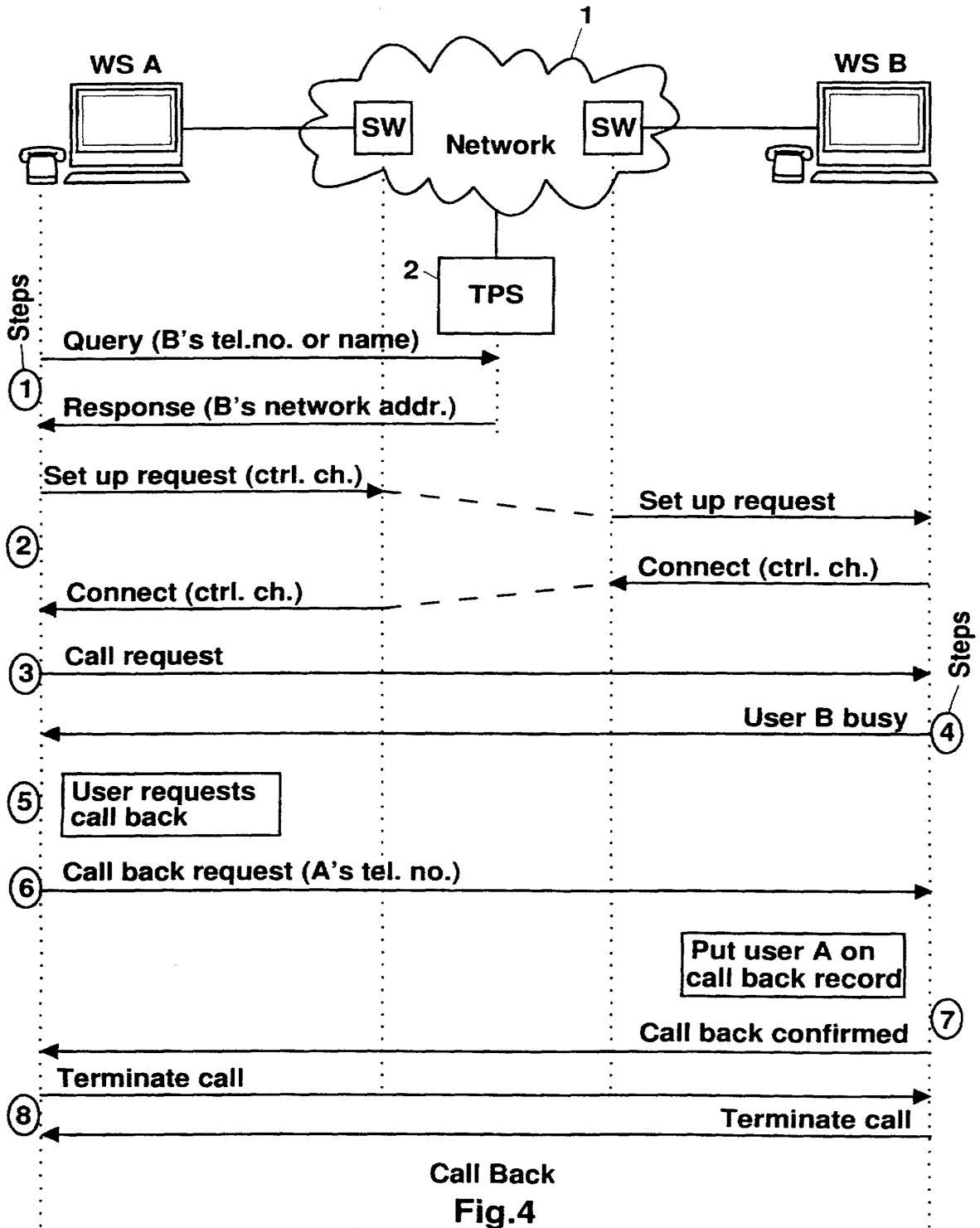

Fig.3



Call Back
Fig.4

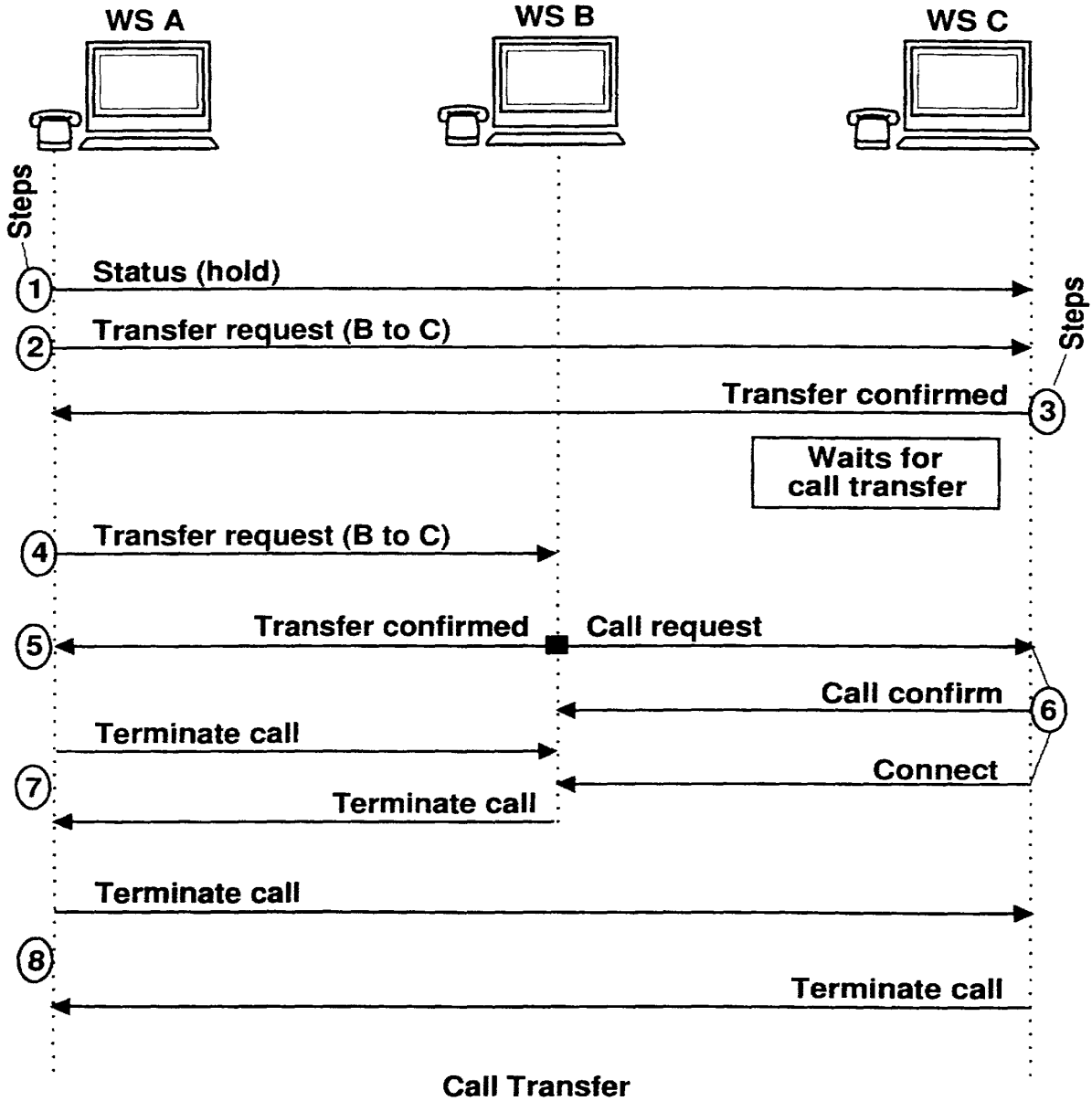

Fig.5

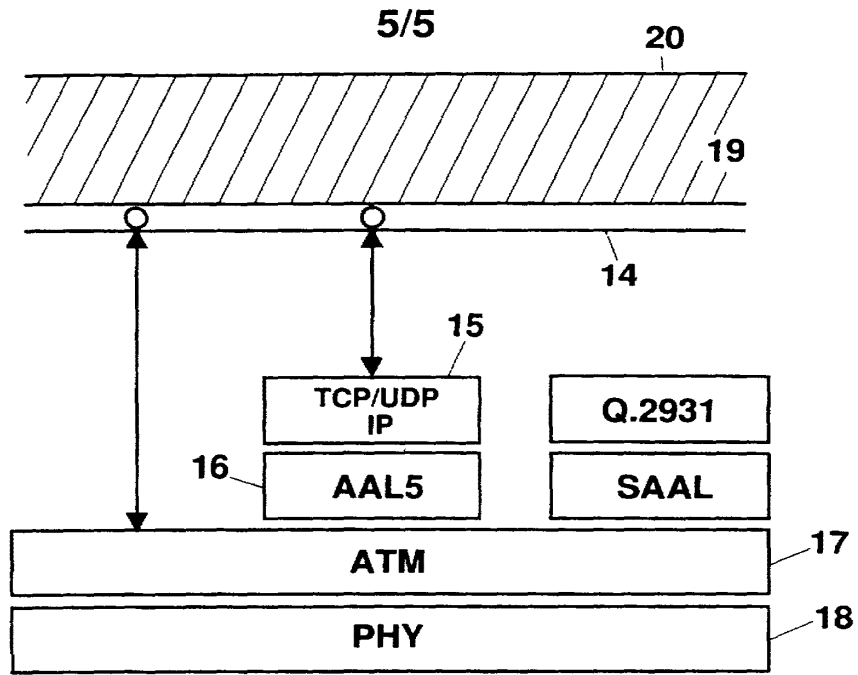

Fig.6

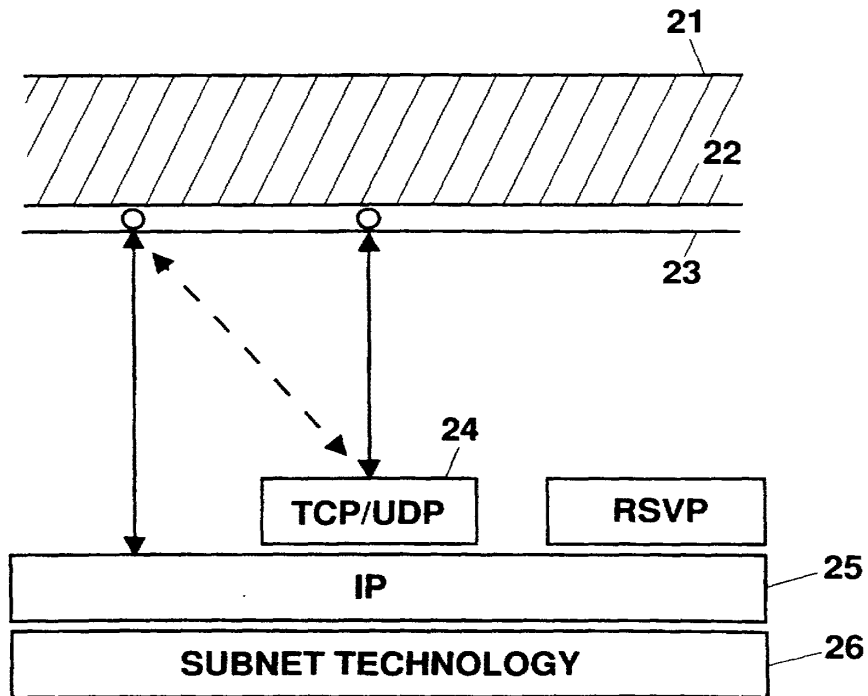

Fig.7

INTERNATIONAL SEARCH REPORT

International Application No
PC/IB 96/00134

<p>A. CLASSIFICATION OF SUBJECT MATTER IPC 6 H04Q3/00 H04L29/06</p>		
<p>According to International Patent Classification (IPC) or to both national classification and IPC</p>		
<p>B. FIELDS SEARCHED</p>		
<p>Minimum documentation searched (classification system followed by classification symbols) IPC 6 H04Q H04L</p>		
<p>Documentation searched other than minimum documentation to the extent that such documents are included in the fields searched</p>		
<p>Electronic data base consulted during the international search (name of data base and, where practical, search terms used)</p>		
<p>C. DOCUMENTS CONSIDERED TO BE RELEVANT</p>		
Category *	Citation of document, with indication, where appropriate, of the relevant passages	Relevant to claim No.
Y	<p>BYTE, vol. 21, no. 2, February 1996, PETERBOROUGH US, pages 83-88, XP000549779 MULLER: "Dial 1-800-INTERNET" see page 84, middle column, line 6 - page 86, right-hand column, line 11 ---</p>	<p>1-4,6,8, 10-13</p>
Y	<p>IEEE SPECTRUM, vol. 33, no. 1, January 1996, pages 30-41, XP000566101 BELL ET AL.: "Communications" see page 35, left-hand column, paragraph 4 - page 36, right-hand column, paragraph 3 see page 39, middle column, paragraph 3 - page 41, left-hand column, paragraph 1 ---</p> <p style="text-align: center;">-/--</p>	<p>5</p>
<p><input checked="" type="checkbox"/> Further documents are listed in the continuation of box C. <input checked="" type="checkbox"/> Patent family members are listed in annex.</p>		
<p>* Special categories of cited documents :</p>		
<p>"A" document defining the general state of the art which is not considered to be of particular relevance</p> <p>"E" earlier document but published on or after the international filing date</p> <p>"L" document which may throw doubts on priority claim(s) or which is cited to establish the publication date of another citation or other special reason (as specified)</p> <p>"O" document referring to an oral disclosure, use, exhibition or other means</p> <p>"P" document published prior to the international filing date but later than the priority date claimed</p>		<p>"T" later document published after the international filing date or priority date and not in conflict with the application but cited to understand the principle or theory underlying the invention</p> <p>"X" document of particular relevance; the claimed invention cannot be considered novel or cannot be considered to involve an inventive step when the document is taken alone</p> <p>"Y" document of particular relevance; the claimed invention cannot be considered to involve an inventive step when the document is combined with one or more other such documents, such combination being obvious to a person skilled in the art.</p> <p>"&" document member of the same patent family</p>
<p>Date of the actual completion of the international search</p> <p style="text-align: center;">5 November 1996</p>		<p>Date of mailing of the international search report</p> <p style="text-align: center;">27.11.96</p>
<p>Name and mailing address of the ISA European Patent Office, P.B. 5818 Patentlaan 2 NL - 2280 HV Rijswijk Tel. (+31-70) 340-2040, Tx. 31 651 epo nl, Fax (+31-70) 340-3016</p>		<p>Authorized officer</p> <p style="text-align: center;">Lambley, S</p>

Form PCT/ISA/210 (second sheet) (July 1992)

INTERNATIONAL SEARCH REPORT

International Application No
 PC1/IB 96/00134

C.(Continuation) DOCUMENTS CONSIDERED TO BE RELEVANT		
Category *	Citation of document, with indication, where appropriate, of the relevant passages	Relevant to claim No.
Y	EP,A,0 398 183 (NORTHERN TELECOM LTD) 22 November 1990 see column 2, line 11 - column 4, line 51 ---	1-6,8, 10-13
A	WO,A,95 23492 (HARRIS CORPORATION) 31 August 1995 see abstract; claims 1,2 -----	1,4,8,12

1

INTERNATIONAL SEARCH REPORT

Information on patent family members

International Application No

PCT/IB 96/00134

Patent document cited in search report	Publication date	Patent family member(s)	Publication date
EP-A-398183	22-11-90	US-A- 4924500	08-05-90
		AU-B- 620240	13-02-92
		AU-A- 5379390	22-11-90
		CA-A- 1312394	05-01-93
		CN-B- 1022788	17-11-93
		DE-D- 69024257	01-02-96
		DE-T- 69024257	10-10-96
		JP-A- 2311065	26-12-90
		JP-B- 7077402	16-08-95
WO-A-9523492	31-08-95	US-A- 5455827	03-10-95

Form PCT/ISA/210 (patent family annex) (July 1992)



INTERNATIONAL APPLICATION PUBLISHED UNDER THE PATENT COOPERATION TREATY (PCT)

<p>(51) International Patent Classification ⁶ : H04M 3/42</p>	<p>A1</p>	<p>(11) International Publication Number: WO 97/33421 (43) International Publication Date: 12 September 1997 (12.09.97)</p>
<p>(21) International Application Number: PCT/US96/03064 (22) International Filing Date: 6 March 1996 (06.03.96) (71) Applicant: BELL COMMUNICATIONS RESEARCH, INC. [US/US]; 445 South Street, Morristown, NJ 07960 (US). (72) Inventors: PEPE, David, Matthew; 51 Kings Highway, Middletown, NJ 07748 (US). BLITZER, Lisa, B.; 10 Gramercy Lane, Manalapan, NJ 07726 (US). BROCKMAN, James, Joseph; 15 Running Brook Drive, Perrineville, NJ 08535 (US). CRUZ, William; 9 Violante Court, Eatontown, NJ 07724 (US). HAKIM, Dwight, Omar; 20 Tina Place, Matawan, NJ 07747 (US). KRAMER, Michael; 6136 Fieldston Road, Bronx, NY 10471 (US). PETR, Dawn, Diane; 331 English Place, Basking Ridge, NJ 07920 (US). RAMAROSON, Josefa; 23 Terrance Terrace, Freehold, NJ 07728 (US). RAMIREZ, Gerardo; 3505 Sunny Slope Road, Bridgewater, NJ 08807 (US). WANG, Yang-Wei; 10 Cambridge Drive, Howell, NJ 07731 (US). WHITE, Robert, G.; 20 Knollwood Drive, Morristown, NJ 07960 (US). (74) Agents: YEADON, Loria, B. et al.; c/o International Coordinator, Room 1G112R, 445 South Street, Morristown, NJ 07960-6438 (US).</p>		<p>(81) Designated States: AU, CN, KR, MX, SG. Published <i>With international search report.</i></p>

(54) Title: PERSONAL COMMUNICATIONS INTERNETWORKING

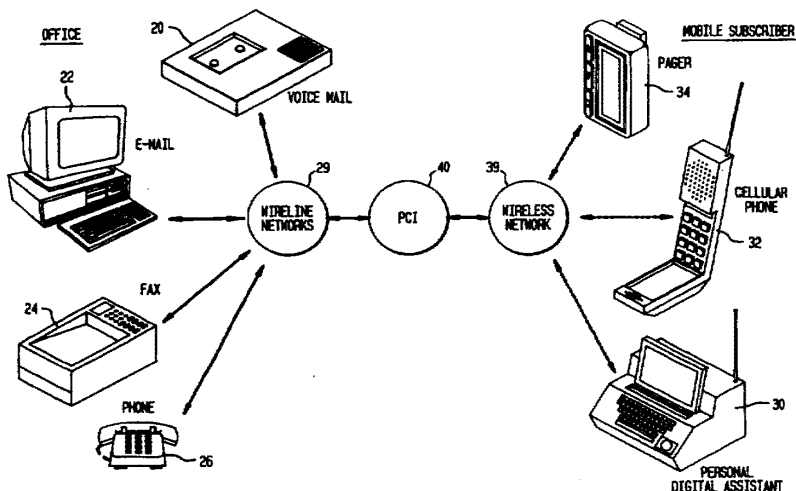

(57) Abstract

A personal communications internetworking (40) provides a network subscriber with the ability to remotely control the receipt and delivery of wireless and wireline voice and text messages. The network operates as an interface between various wireless (39) and wireline (29) networks, and also performs media translation, where necessary. The subscriber's message receipt and delivery options are maintained in a database which the subscriber may access by wireless or wireline communications to update the options programmed in the database. The subscriber may be provided with CallCommand service which provides real-time control of voice calls while using a wireless data terminal or PDA (30).

FOR THE PURPOSES OF INFORMATION ONLY

Codes used to identify States party to the PCT on the front pages of pamphlets publishing international applications under the PCT.

AM	Armenia	GB	United Kingdom	MW	Malawi
AT	Austria	GE	Georgia	MX	Mexico
AU	Australia	GN	Guinea	NE	Niger
BB	Barbados	GR	Greece	NL	Netherlands
BE	Belgium	HU	Hungary	NO	Norway
BF	Burkina Faso	IE	Ireland	NZ	New Zealand
BG	Bulgaria	IT	Italy	PL	Poland
BJ	Benin	JP	Japan	PT	Portugal
BR	Brazil	KE	Kenya	RO	Romania
BY	Belarus	KG	Kyrgystan	RU	Russian Federation
CA	Canada	KP	Democratic People's Republic of Korea	SD	Sudan
CF	Central African Republic	KR	Republic of Korea	SE	Sweden
CG	Congo	KZ	Kazakhstan	SG	Singapore
CH	Switzerland	LI	Liechtenstein	SI	Slovenia
CI	Côte d'Ivoire	LK	Sri Lanka	SK	Slovakia
CM	Cameroon	LR	Liberia	SN	Senegal
CN	China	LT	Lithuania	SZ	Swaziland
CS	Czechoslovakia	LU	Luxembourg	TD	Chad
CZ	Czech Republic	LV	Latvia	TG	Togo
DE	Germany	MC	Monaco	TJ	Tajikistan
DK	Denmark	MD	Republic of Moldova	TT	Trinidad and Tobago
EE	Estonia	MG	Madagascar	UA	Ukraine
ES	Spain	ML	Mali	UG	Uganda
FI	Finland	MN	Mongolia	US	United States of America
FR	France	MR	Mauritania	UZ	Uzbekistan
GA	Gabon			VN	Viet Nam

PERSONAL COMMUNICATIONS INTERNETWORKING

5 FIELD OF THE INVENTION

The present invention is directed to an internetwork for personal communications and, more particularly, to a network which allows a mobile communications subscriber to remotely control personal communications delivery options.

10 BACKGROUND OF THE INVENTION

The use of messaging as a means of day-to-day communications continues to grow and evolve, particularly in a business context. Messaging includes electronic mail (e-mail), facsimile transmissions (fax), paging, voice mail, and telephone communications. The introduction of the cellular phone and other wireless communications facilitated the advent of the "mobile office". The mobile office allows an employee, for example, to work away from the office on a portable computer and be in constant touch with the office via a cellular phone.

The messaging options described above are available to businesses of all sizes, as well as individual users, from a variety of service providers. Many offices have some or all of the messaging options described above. The office may have certain messaging equipment (referred to as "consumer premises equipment" or "CPE") connected to one or more wireline networks. That is, the office may have telephones, fax servers, and voice mail systems connected to phone lines, and computers having modems for e-mail connected to packet networks which are connected via phone lines. The mobile employee may have certain wireless messaging equipment, such as a pager, a cellular telephone, or a personal digital assistant ("PDA"), which is typically a notebook computer connected to a wireless communication network.

One important goal of personal communication services is to allow users to communicate from anywhere to anywhere at any time. Such personal communication services generally involve multiple service providers including local and long distance telephone companies and cellular telephone companies. An example of a personal communication service is as follows:

30 A personal communication service provider (e.g., a cellular telephone company) enables traveling users to rent a wireless portable phone from a rental phone company (e.g., from an airline or car rental company). Using the rental phone, the user is provided with basic mobile

phone service from the personal communication service provider. In addition, the user would like the following features:

- 1) The user wants calls directed to his/her office or home to be automatically forwarded to the rental portable phone, without informing anyone that he/she is traveling.
- 5 2) To avoid unimportant incoming calls (and corresponding incoming call charges), the user would like to restrict the number of people who can call the rented portable phone.
- 3) It is important to the user that the rental phone features be activated instantly, so that calls can be made immediately upon the user's arrival at the visiting location.

This kind of personal communication service involves a plurality of service providers. 10 These providers are (a) the local telephone company at the home location, (b) a long distance telephone company, (c) the local telephone company at the visiting location, and (d) the personal communication service provider (i.e., the cellular telephone company) at the visiting location. All of these are referred to herein as "service providers".

To enable this kind of personal communication service, involving multiple service 15 providers, interoperability problems among the different service providers must be resolved. The interoperability problems can be divided into two categories: (a) location tracking and (b) service management.

The interoperability problem for location tracking has been addressed by adopting 20 signaling protocols used by the mobile phone industry. Location tracking functions are implemented using two location registers. One of the registers, maintained by the local telephone company of the user's home location, is called the Home Location Register (HLR). The other register, maintained by the local telephone company of the visiting location, is called the Visiting Location Register (VLR). The HLR stores customer profile data and the location of the VLR of the user. The customer profile data contains important information such as the user's name, 25 address, preferred long distance carrier, service features (e.g., call forwarding and call restriction), billing, and other administrative related information. When the user travels to a new visiting location, a new VLR is created in the new location. A part of the profile data stored in the HLR is transmitted and loaded into the VLR such that the service provider at the visiting location can implement service features for the visiting user. When the user travels to a new visiting location 30 the location of the VLR stored in the HLR is changed to the new VLR location, and the VLR in the previously visited location is deleted. The process of creating a new VLR, loading profile data

to the VLR, and updating the visiting location of a user in the HLR is called "automatic roamer registration".

The interoperability problem for service management is much more complex than that for location tracking. Service management refers to a collection of functions required to enable a personal communication service user to subscribe to, modify, and activate service features anywhere and at any time. Examples of service management functions include phone number administration, customer profile data management, service activation, and security administration. The phone number administration function is important for maintaining the uniqueness of phone numbers. The customer profile data management function provides customer profile databases and user interfaces for creating, modifying, or transferring such databases. The service activation function extracts part of the data specifying service features from the profile data and loads this data into physical communication systems that process calls. The service activation function also controls the activation and deactivation of the service features. The security administration function prevents or detects unauthorized uses of services and service management functions.

Service management functions of this type are needed to provide personal communication services involving multiple service providers. Such service management functions generally require interactions between application software and various databases owned and operated by the different service providers. Consider an application which enables a nomadic user to subscribe to a personal communication service from any service provider at any location. An example of such a service is call forwarding to a temporarily rented portable phone. The application may, for example, need to perform the following database access operations at databases maintained by various different service providers:

- × check credit databases owned by credit card companies or phone companies to determine whether the user is able to pay for the service;
- × check the customer profile database in the user's HLR to determine whether the user is currently located in a place other than the visiting location currently stored in the HLR;
- × check the credit and network databases of long distance phone companies specified by the user to determine whether the user can use a particular long distance carrier in the visiting location;
- × load profile data into the VLR at the visiting location and update the HLR with the location of the VLR if necessary; and
- × load the profile data to the call processing systems and activate the service.

The user may need to send or receive messages from any or all of the messaging options described above at a visiting location. That is, the user may want to receive or receive notification of e-mail, faxes, phone calls, or voice mail at a visiting location or to send e-mail or faxes from a wireless terminal. The need to integrate these various types of messaging options and
5 to interconnect the many service providers has, until now, been largely unaddressed.

It is also desirable for the mobile employee to be able to limit the messages sent to the wireless messaging equipment, so that only urgent messages are received when away from the office and unwanted in-coming calls are avoided. The mobile employee may also wish to route certain incoming wireless messages and phone calls to other destinations, such as an office fax
10 machine or a colleague's telephone.

Therefore, it is an object of the present invention to provide a mobile service subscriber the ability to control and integrate a plurality of messaging options.

It is another object of the present invention to provide a mobile service subscriber with the ability to remotely control the addressability, routing, accessibility, and delivery of messaging
15 options.

It is yet a further object of the present invention to provide an internetwork which interconnects messaging services with both wireless and wireline networks.

It is yet a further object of the present invention to provide a subscriber with real-time control of voice calls while using a wireless data terminal or PDA.

It is yet a further object of the invention to provide a control over the messages routed
20 to wireless messaging options.

SUMMARY OF THE INVENTION

These objects are obtained by a personal communications internetwork providing a
25 network subscriber with the ability to remotely control the receipt and delivery of wireless and wireline voice and text messages. The network operates as an interface between various wireless and wireline networks, and also performs media translation, where necessary. The subscriber's message receipt and delivery options are maintained in a database which the subscriber may access by wireless or wireline communications to update the options programmed in the database. The
30 subscriber may be provided with CallCommand service which provides real-time control of voice calls while using a wireless data terminal or PDA.

BRIEF DESCRIPTION OF THE DRAWINGS

These and other objects and features of the invention will become apparent from the following drawings, wherein:

Fig. 1-3 are overviews of the PCI networks;

5 Fig. 4 is an overview of one node of the PCI network according to the present invention;

Fig. 5 is a block diagram of an exemplary PCI server according to the present invention;

10 Fig. 6 is a block diagram of an exemplary embodiment of a PCI database according to the present invention;

Fig. 7 is a block diagram of the logical connections between the PCI server and PCI database according to the present invention;

Figs. 8-11 illustrate exemplary message flows between a server and a database according to the present invention;

15 Fig. 12 is a block diagram of a personal digital assistant according to the present invention;

Figs. 13-20 illustrate exemplary message flows between a PDA and PCI server;

Fig. 21 is a block diagram of a text messaging portion of a PCI network;

Fig. 22 is a block diagram of a voice messaging portion of a PCI network;

20 Fig. 23 is a block diagram of a facsimile messaging portion of a PCI network;

Fig. 24 is a diagram illustrating an exemplary CallCommand service network;

Figs. 25-27 illustrate exemplary message flows in the PCI network; and Figs. 28-45 illustrate exemplary screens displayed to a PCI subscriber using a wireless PDA.

25 DETAILED DESCRIPTIONS OF PREFERRED EMBODIMENTS

For clarity of presentation, the detailed description is set out in the following subsections:

I. PCI Overview

30 The overall network is illustrated in Figs. 1-4. The network is an interface between a plurality of wireless and wireline networks, providing a subscriber with a variety of wireless and wireline message and voice delivery and receipt options.

II. The PCI Server

The PCI Server is illustrated in Fig. 5. The PCI server is a peripheral which performs messaging and call redirection functions and interfaces with the PCI database to update the subscriber profile.

5 III. The PCI Database

The PCI Database is illustrated in Fig. 6. The PCI database maintains the subscriber profile, controls CallCommand functions, and handles DTMF-based subscriber profile updates.

IV. The Server/Database Interface

10 The Server/Database interface is illustrated in Figs. 7 - 11. The PCI server/PCI database interface provides for the transfer of information regarding the subscriber profile and the CallCommand services.

V. The PDA/PCI Interface

The PDA/PCI interface is illustrated in Figs. 12 - 20. The PDA/PCI interface provides for the transfer of information between a remote wireless subscriber and the PCI.

15 VI. Services

A. E-Mail Messaging

E-Mail messaging in the PCI is illustrated in Fig. 21. The PCI network provides the subscriber with a variety of e-mail delivery, receipt, and notification options, including screening and selective destination delivery of incoming e-mail.

20 B. Voice Messaging

Voice messaging in the PCI is illustrated in Fig. 22. The PCI provides the subscriber with a variety of voice mail delivery, receipt, and notification options, including screening and selective destination delivery of incoming voice mail.

C. Facsimile Messaging

25 Facsimile messaging in the PCI is illustrated in Fig. 23. The PCI provides the subscriber with a variety of facsimile delivery, receipt, and notification options, including screening and selective destination delivery of incoming faxes.

D. CallCommand

30 The CallCommand service is illustrated in Fig. 24. CallCommand service provides real-time control of voice calls while using a wireless data terminal or PDA.

VII. Message Flows

Certain message flows for wireless messaging in the PCI are illustrated in Figs. 25 - 27. The three message flows illustrated are sending a message from one subscriber to another, receiving a message regardless of whether the subscriber is using a wireless or wireline terminal, and sending a message to a non-subscriber.

VIII. The PDA Application

The application residing in the PDA is described in Figs. 28 - 45, which illustrate exemplary screens displayed to a PCI subscriber using a wireless PDA.

IX. Billing

Billing procedures for a PCI network use is briefly described.

X. Conclusion

A glossary of acronyms used in this specification is attached as Appendix A.

I. PCI Overview

Fig. 1 is a simplified overview of a personal communications internetworking ("PCI") according to the present invention. A consumer, an office for example, has various messaging equipment, such as a voice mail system 20, an e-mail terminal 22, fax machines 24, and telephones 26. These are all connected to wireline networks 29. For example, the fax 24, phone 26, and voicemail system 20 may be connected to a Public Switched Telephone Network (PSTN), part of which belongs to a particular local phone service company, and part of which belongs to a particular long distance service provider. The e-mail terminal 22 may be connected to a data packet network, such as Internet, whose packets are carried over phone lines.

A mobile communications subscriber (for example an employee who works at the office described above and travels frequently) has various portable messaging equipment, such as a PDA 30, a cellular phone 32, and a pager 34. These are connected to wireless networks 39. These wireless messaging options may be provided by different service providers. That is, the cellular phone may be connected to a wireless network of a cellular phone service provider, the pager may be connected to a different wireless network maintained by a pager service provider, and the PDA may be connected to a third wireless communications network maintained by yet another service provider.

A Personal Communications Internetworking ("PCI") 40 according to the present invention is connected between the wireless 39 and wireline networks 29. The PCI 40 permits the

mobile communications subscriber to send and receive messages between disparate networks and messaging systems and a variety of service providers. The mobile communications subscriber can receive e-mail, fax, pages, and voice messages under a single phone number while using either a wireless or wireline network. The subscriber may also select the media format and serving network
5 used to receive messages. The subscriber may also select cross-media notification of incoming messages, (i.e., the subscriber may receive notification from a pager message that a voice mail message was received).

The subscriber selects the wireline or wireless network and media format to be used for delivering messages or notification of message receipt. The PCI 40 will perform a media
10 conversion to allow, for instance, an e-mail message to be delivered to a fax server. The PCI 40 may also include accessibility controls which allow the user to screen messages by selected criteria such as media type (e.g., e-mail, fax, etc.), message length (e.g., voice mail messages less than three minutes), or sender (e.g., only messages from the office and a certain client are to be forwarded):

For example, the subscriber may have notification of a voice mail or fax message
15 receipt directed to a wireless PDA in the form of e-mail messages. If the subscriber's wireless PDA is not turned on or otherwise not operating, the notification may be routed to an alternate wireless or wireline network. Notification to the subscriber that a voice mail message was received may be, for example, rerouted to the subscriber's pager, and notification that a fax has been received may be rerouted to the wireline e-mail.

Fig. 2 is a simplified version of the interconnections between various messaging
20 systems and a PCI. As shown in Fig. 2, a subscriber provides the network with message routing and delivery instructions. These instructions are received by a PCI database 44 and stored in a "subscriber profile" for that subscriber. This database controls the delivery of outgoing messages and the routing of incoming messages and message notification. (In Fig. 2, wireline
25 communications are indicated with solid line connections and wireless communications are indicated with dashed line connections. The instructions to the PCI are shown with a solid line, but as will be explained in greater detail below, the instructions may be sent either by a wireline or wireless network.)

The PCI database 44 supports access to information authenticating the subscriber's
30 identity and validating the types of services subscribed to, the subscriber's message delivery (incoming messages) options and origination (outgoing messages) options and voice (telephone call and voice mail) options. For origination, the subscriber may select message distribution lists

with specific media delivery options. The database 44 also supports access to the portions of the subscriber profile that the subscriber may control.

The subscriber may use a personal telephone number to register at alternate wireline and wireless terminals while maintaining use of the message screening and delivery options selected and stored in a subscriber's profile. This is called "personal mobility". Information about the location of a wireless or wireline network location to which the subscriber's terminal is connected automatically registers and deregisters a subscriber's terminal. This is called "terminal mobility."

Fig. 3 shows the PCI 40. The CPE (voice mail 20, e-mail 22, fax 24, and phone 26) are connected to wireline networks 29. The mobile subscriber equipment (PDA 30, cellular phone 32, and pager 34) are connected to wireless networks 39. Both the wireline and wireless networks 29, 39 are connected to a PCI 40 at a service provider. The networks 29, 39 are connected to a local exchange carrier (LEC) 42 for the personal communications internetworking.

A PCI database 44 is a physical communication system which provides call processing functions for a collection of central office switches. The PCI database 44 includes the mobile subscriber's profile, including message sending, message receiving, and service control options. The PCI database 44 may be a service control point or a network adjunct. The PCI database may be connected via a service management system (SMS) interface to a service integrator 46. The service integrator 46 allows the service provider to update subscriber data and create and modify subscriber profiles.

The PCI database 44 preferably stores and updates the subscriber profiles. The profiles contain service related information for mapping services to subscribers (e.g., screening, routing, terminal selection by subscriber selected parameters, custom calling features, and the like); subscriber authentication data (e.g., password and user I.D.); user status (registered or not registered); generic service profile for non-call associated service, such as subscriber address or social security number; specific profile for a non-call service (based on subscriber selected parameters); wireless data providers identification (e.g., what cellular phone provider is used); and specific profile for call associated services (e.g., call forwarding), based on user selected parameters.

Fig. 4 is a more detailed depiction of the one node 43 of the PCI. The PCI has a plurality of nodes and is preferably built on the Advanced Intelligent Network (AIN) architecture. Other network architectures may be used, but for illustrative purposes, the description is directed to an AIN-based network.

A PCI server 48 is a peripheral which performs messaging and call redirection functions and interfaces with the PCI database 44 to update the subscriber profile. The PCI server may be an AIN Intelligent Peripheral, such as a Bellcore Intelligent Services Peripheral, or a network adjunct. The PCI server is connected to a switch 50. In the AIN architecture, this switch is a Service Switching Point Access Tandem (SSP AT), but may be any suitable switch, depending on the architecture. The SSP AT 50 connects wireline networks to the CPE. The SSP AT 50 also connects the PCI server 48 with a central office (CO) 52. The SSP AT 50 also connects to the SCP 44. The PCI database 44 and the PCI server 48 are directly connected. The LEC of Fig. 3 is part of a large network and includes the PCI database 44, the PCI server 48, and the SSP AT 50. The PCI database may be connected to an SMS interface to a system integrator 46, as described above.

The PCI server 48 is also connected to various wireless and wireline networks 49 via signaling connections in these networks to transmit and receive information for all of the messaging options. Illustratively, the PCI server provides access to Public Packet Switched Networks (PPSN), Public Switched Telephone Network, (PSTN), Integrated Signaling Digital Networks (ISDN), X.25 networks and TCP/IP networks and may include access to asynchronous transfer mode (ATM), Switched Multimegabit Digital Service (SMDS), and Frame Relay networks.

The mobile subscriber may access his or her subscriber profile to change message sending, message receiving, and service control options. These option changes are sent to the PCI database 44 to be stored in the subscriber profile. Fig. 4 shows, for example, a PDA 30 connected to the PCI server 48 by a wireless network, but the subscriber may also use wireline e-mail, or wireless or wireline telephones (using DTMF signals) to access the subscriber profile. The messages from the PDA, for example, are sent by a wireless network 54 to the PCI server 48 using, for example, an X.25 transport.

Delivering PCI service to a subscriber who may be present on a number of different systems requires storage, movement and caching of the service profile associated with that subscriber. A mobility controller 49, located in the PCI server 48, is a controller and data store, which dynamically maintains service control information for a Message Transfer Agent (MTA), described below, in the PCI server 48, which connects the PCI server 48 to wireless data networks.

Data storage functions are handled by two tiered entities. The subscriber profile is preferably located in the PCI database 44 and is the top of the hierarchy where permanent records

such as service profile, authentication and validation information, and the like of the subscriber or device are maintained and performing status and location management and mapping are performed. A service profile cache 51 is preferably located in the PCI server 48 and is a local cache entity which stores on a "needs basis" information such as service profiles and validation status and maintains a local repository for the service recipient. It also administers information necessary to serve the wireless data network entity, as well as sending updates to the permanent storage entity PCI database. The service profile cache 51 maintains the personal data associated with the processing of the mobility controller 49. The mobility controller 49 interacts with the PCI database-based subscriber profile (or third party data base) on behalf of the cache to obtain service profiles and location information related to wireless terminals.

PCI may also provide directory services as a value-added component. The X.400 MTA can query a local directory serving agent in the PCI server 48 for addressing and routing information. If the information is not local, the PCI server 48 will need to get the addressing information from another PCI server 48 at another PCI node or an interconnected private directory serving agent which maintains a separate information base. By using the existing standard, the PCI network and mail PCI servers message handling can independently manage the networks without interfering with the PCI service.

II. The PCI Server

The PCI server is a peripheral which performs messaging and call redirection functions and interfaces with the PCI Database to update the subscriber profile. The PCI server performs a variety of functions. For example, an illustrative PCI server:

- × is an X.400 Gateway;
- × routes messages using the X.400 messaging protocol;
- × connects proprietary messaging protocols into X.400 protocol;
- × interfaces with wireless data networks;
- × interfaces with messaging systems;
- × interfaces with the PCI database to access subscriber profiles information;
- × processes messages as specified by the user in the service profile;
- × provides media conversion such as text to fax or fax to text;
- × provides access to an X.500 directory to determine addressing schemes for packet data;

- × supports signaling between wireless data networks for management functions such as registration; and
- × maintains a service profile cache.

5 Fig. 5 is a detailed illustration of a preferred embodiment of a PCI server 48 according to the present invention. The PCI server 48 includes three main elements: a call processor 110, a data messaging peripheral 112, and a shared disk memory 113.

The call processor 110 comprises a plurality of interconnected computers. The messaging peripheral 112 maybe implemented by a computer such as a DEC XAP system.

10 The call processor 110 includes a PCI applications server 114. The application server is the central decision making point of the wireless messaging service described below in Section VI. Thus, the server 114 controls message routing, screening, and notification for the wireless messaging service.

The application server 114 is connected to a PDA protocol handler 115. The protocol
15 handler is the interface to the wireless network 54, for example the RAM wireless network. This handles messages to be sent to and from the subscribers PDA 30. A plurality of personal digital assistants (PDA) 30 are connected to the wireless network 54.

The application server 114 also manages a PCI database protocol handler 126. The
20 protocol handler 126 is the interface between the call processor 110 and the PCI database 44. The application server 114 also manages a Service Profile Cache 51. The Service Profile Cache 51 is maintained in the memory of the application server 114. The cache 51 stores a subset of the data in the subscriber profile stored in the PCI database 44. This subset is subscriber profile information which currently needs to be accessed frequently by the PCI server 48.

The Service Profile Cache 51 stores and accesses data related to access systems such
25 as wireless data providers and messaging services, and subscriber location. The Service Profile Cache 51 may store and update data related to the subscriber location such as routing address for subscribers specific wireless terminals; store and updates services related data for a particular terminal type (such as uni- or bi- direction); maintain a list of the subscribers wireless data provides and message services; track the subscribers terminal status (registered or not registered); provide a
30 generic service profile for non-call messaging service; and provide a specific profile for a non-call associated service based on subscriber selected parameters.

The application server 114 also manages the registration status of each application on each PDA 30 and controls customer profile information via each PDA 30.

The call processor 110 also includes an IP Functions Server 130. The IP Function Server 130 manages CallCommand applications. This server is also connected to the PCI database protocol handler 126 for communication with the PCI database 44 and the PDA protocol handler 115 for communication with the wireless network 54. The PCI database protocol handler 126 handles both interfaces between the PCI database and the PCI server, as described below.

Thus, the two main application servers in the call processor 110 are the IP Function server 130 for CallCommand applications and the PCI applications server 114 for wireless messaging services.

The call processor 110 also includes a plurality of communication interfaces. The protocol handlers 115 and 126 have already been discussed. The alphanumeric paging server (APS) 132 gives the call processor 110 the ability to provide alphanumeric paging services. The APS 132 includes one or more modems to communicate with terminal equipment of a network 134 maintained by a paging service provider. The APS communicates with the paging service provider using, for example, the TAP protocol (Telocator Alphanumeric Protocol).

The call processor 110 also includes a plurality of control processes which control peripheral equipment external to the call processor 110. These controllers are as follows:

A message controller 136 controls the data messaging peripheral 112 and controls the sending of messages between the call processor 110 and the data peripheral 112.

The mobility controller 49 comprises the PCI database protocol handler 126, the IP function server 130, the service profile cache 51, and the PCI application server 114. The mobility manager provides control logic for user authentication, service request validation, location management, user access to service profile, access registration, and communication management such as routing to user-specified destinations. The mobility controller 49 contains the service logic and handles service related processing for personal data and service access such as service feature analysis; access system mapping relationship information; identity management; subscriber validation and authentication; billing information based on the subscriber; wireless data specific routing information for message delivery and subscriber paging; subscriber service validation; and subscriber review and modification of the subscriber's profile.

A transaction controller 150 controls a switch controller 152 and a voice peripheral controller 154. The switch controller 152 controls the digital switch 156 which connects to the

public switched telephone network 58. The voice peripheral controller 154 controls the voice peripherals 160, which are for example text-to-speech converters.

The switch 156 and the voice peripheral 160 are also connected by a T1 line 161. The digital switch 156 is connected to the public switched telephone network by a plurality of transmission media such as T1 lines 162, fax lines 163, and ADSI lines 164.

The data messaging peripheral 112, which is optional, is now discussed in greater detail. The data messaging peripheral is the gateway to the wireline electronic mail network, which network is designated 170. The data messaging peripheral has a message transfer agent 158 for transferring messages between the call processor 110 and the data networks 170, 54 either directly or through the PDA protocol handler 115. The messaging peripheral 112 also includes a POP (post office protocol) server 190 and associated memory 192 for providing a message storing capability. The message directory 194 is used for storing a subset of service profile cache 51 relating to the routing of e-mail messages.

The messaging peripheral 112 includes the message gateway 140. The message gateway 140 has the following capabilities:

- 1) Notifying the PCI application server 114 in the call processor that e-mail has arrived from the wireline e-mail network 170 for a subscriber.
- 2) Accept a request from the PCI application server 114 to send an e-mail message to a wireline address.
- 3) Accept a request from the application server 114 to provide all unread messages stored in the server 190 which would have been sent to a primary destination if the subscriber had been registered.
- 4) Accept a request from the application processor 114 to rewrite to the message store server 190 or back to the sender.

Using the call processor 110 and its associated peripherals, a wide variety of services may be performed. These have been discussed above briefly and are described in detail in Section VI below. However, to understand how the call processor 110 operates to provide these services, some exemplary descriptions for certain services is provided.

For example, when a wireline e-mail message arrives at the PCI server's Data Messaging Peripheral 112, the messaging gateway 140 and messaging Controller 136 send notification to the PCI application server 114 of the e-mail arrival. The PCI application server 114

will query the profile cache 51, or if necessary, the PCI database 44. Driven by data in the subscriber's profile, the PCI application server 114 executes service logic to determine where to forward the e-mail (i.e., forward to PDA 30 or to POP server 190 depending on screening outcome), and what media, if any, to use to send notification of the e-mail arrival.

5 For another example, when a CallCommand call arrives at the PCI server 48, the procedure is as follows. The switch controller 152 and transaction controller 150 forward the call to the IP Functions Server 130 based on the dialed number. The IP functions 130 sends a provide_instructions 1129+ message to the PCI database 44 to determine how to handle the call. The PCI database 44 and IP functions applications servers 130 begin a conversation of messages
10 which perform a sequence of functions which play an announcement to the caller, send notification to the PDA, etc. When a response arrives from the PDA 30, the IP functions server 130 forwards the response to the PCI database 44. The PCI database 44 will then direct IP functions server 130 to forward the call to a routing number and/or play a synthesized message to the caller.

If a subscriber wishes to update the subscriber profile by DTMF, the procedure is as
15 follows. A call arrives at the PCI server 48. The switch controller 152 and transaction controller 150 forward the call to the IP functions server 130 based on the dialed number. The IP functions server 130 sends a provide_instructions 1129+ message to the PCI database 44 to determine how to handle the call. The PCI database 44 sends a request to play an announcement and collect digits ("please enter PIN", collect PIN). The IP functions server 130 returns the result of this request to
20 the PCI database 44. Again the PCI database 44 sends a request to the IP functions server 130 to play an announcement and collect digits ("voice menu", menu selection). The IP functions server 130 returns the result of this request to the PCI database 44.

This process repeats as users are guided through menus and change profile elements. The PCI database 44 interprets the collected DTMF tones and updates the subscriber's profile
25 accordingly.

When a PDA 30 sends an e-mail message addressed to a wireline address the procedure is as follows. The PDA 30 sends a UDP send_mail message to the PCI application server 114. The PCI application server 114 detects the message is not destined for another PCI subscriber and forwards the request to the messaging controller 136, which forwards it to the
30 messaging gateway 140 which is in the Data and Messaging Peripheral 112. The messaging gateway 140 interfaces with the MTA 158 to send the e-mail to the wireline network 170, using, for example, the Simple Messaging Transfer Protocol (SMTP).

The PCI server 48 may be based, for example, on either an X.400 MTA or an SMTP router and can convert between both protocols. The PCI server 48 may receive text messages from a variety of different text messaging systems such as Internet mail, third party messaging systems, or proprietary messaging systems. In the example where PCI routes messages using an X.400 MTA, these messages must be converted to conform with X.400 protocol before they can be routed. Thus, an exemplary messaging gateway is an X.400 gateway, which can be designed and built by a person of ordinary skill in the art.

II. The PCI Database

A PCI Database 44 maintains the subscriber profile, controls the Call Command functions, and handles DTMF-based subscriber profile updates.

The PCI database architecture shown in Fig. 6 comprises several application and support components. The application components include Multiple Services Application Platform (MSAP) 202; Service Provisioning and Creation Environment (SPACE) 204; and Data and Report Subsystem (DRS) 206.

The service components include the Maintenance and Operation Console (MOC) 208; the Intelligence Peripheral Interface (IPI) 210; the Generic Data Interface (GDI) 212; the Service Network Interface (SNI) 214; and the Data and Report database (D&R) 218.

The service network interface (SNI) 214 provides a communication interface to external systems such as switch 50 and PCI server 48. These interfaces include the IPI 210 and GDI 212 which connect the PCI database to the PCI server via the TCP/IP network 213. The GDI 212 is used for uploading and downloading a subscriber profile to the PCI server 48. The IPI 210 is used for transmitting DTMF commands from a user via the PCI server 48. For redundancy, each intelligent peripheral interface (IPI) and generic data interface (GDI) processor preferably requires two logical connections to the PCI server.

The Multiple Services Application Platform (MSAP) 202 includes a call processor 220, a first call process request (CPR) database 222, an MSAP common 224, a shared memory 226, and a call contact database (CCDB) 228. The call processor 220 receives messages from and sends messages to a message distributor 219 in the SNI 214. The message distributor determines whether the message received from the call processor 220 is to be sent to the IPI 210 or the GDI 212. The call processor receives messages from the message distributor and sends them to the first CPR database, the CCDB 228, and/or the shared memory 226. The first CPR database 222 stores

the subscriber profiles. The MSAP 224 connects the first CPR database 222 with the second CPR 230, which resides in SPACE 204. MSAP common 224 updates one of the CPR databases 222, 230 when changes have been made to the other CPR database. The CCDB 228 is a temporary, dynamic storage for storing subscriber profiles, and related data during profile update procedures.

5 The shared memory 226 allows different processors to use the same data.

SPACE 204 is a service provider-operated module through which new PCI database applications are created and new subscriber profiles are initiated. SPACE 206 includes the second CPR database 230 which contains the identical information as the first CPR database 222 in MSAP 202. When a new subscriber profile is to be created, a service provider uses a display terminal 232 in SPACE to provision a new service profile including certain subscriber information. The subscriber profile is activated through MSAP when the user initially registers. Service provider changes made to the second CPR database 230 are transmitted to the first CPR database 222 in MSAP via the MSAP common 224. Changes made to the second CPR database 230 by a service provider are not transmitted to the service profile cache 51 in the PCI server 48 until a later time.

10 That is, the PCI database 44 does not send data to the PCI server 48 unless requested by the server 48. The server profile cache 51 will be updated with this new information the next time the PCI server 48 requests a profile download, for instance when the subscriber next registers. SPACE 204 provides a function parallel to the Service Management System described above.

The Data and Report Subsystem (DRS) 206 collects data about the PCI database 44 usage which may be helpful to the service provider. For example, errors made by the subscriber when updating the user profile are noted. The types of alterations made, times such alterations are made, and the like are also stored for future use by the service provider.

MOC 110 is a network maintenance support system which monitors the status of the network and checks for system failures and the like.

25 When a subscriber wishes to update the subscriber profile using a PDA 30, the procedure is as follows. The PDA 40 communicates with the PCI server 48. The PCI server 48 sends a GetData message having a "Service Key", which is a preferably a ten digit PCI subscriber number (e.g., a telephone number), to the PCI database 44 over the GDI 212. The GDI 212 translates the GetData message into a format understandable by the PCI database 44. The message

30 is sent through the message distributor 219 and call processor 220 to the first CPR database 222 where the subscriber profile resides. The Service Key is used to obtain the correct subscriber profile and the profile is sent through the call processor 220 to the message distributor 219. The

message distributor determines that this message is to be sent to the PCI server 48 via the GDI 212. (The reason for this is discussed below.) The GDI 212 translates the data into a format suitable for the TCP/IP network and is transmitted to the PCI server 48. The requested changes are performed in the PCI server 48 and the updated profile is sent back to the PCI database 44 through the TCP/IP network, the GDI 212, message distributor 219, call processor 220 and to the first CPR database 222. The call processor 220 also sends a message through the GDI 212 to the PCI server 48 which will be sent a wireless transmission to the PDA 30 acknowledging the subscriber profile update. The changes are also sent to the MSAP common 222 where they are sent to the second CPR database 230 in SPACE 204.

During this process, information may be temporarily stored in the Call Contact Database (CCDB) 228. The CCDB database 228 provides temporary storage for subscriber profile updates that are suspended because they are waiting for action by a subscriber or waiting for data from an external system, such as the PCI server 48. During the time intervals between action by the user or delays in receiving data from an external system, the call processor 220 stores the information in the CCDB database 228 and processes other calls.

When a subscriber desires to update his or her subscriber profile using a touch tone phone, the procedure is as follows. The subscriber calls, for example, a service number provided by the service provider. The call is routed to the PCI server 48. The PCI server 48 sends a message to the PCI database 44 via the IPI 210 that the DTMF commands are present. The message is sent through the message distributor 219 to the call processor 220. The appropriate subscriber profile is retrieved from the first CPR database 222 in the MSAP 202.

The call processor 220 instructs the PCI server 48 to play a voice announcement instructing the caller to enter the subscriber ID and password, by pressing the appropriate digits on the touch-tone phone. The information is entered by the caller, and the PCI database 44 validates this information. If the validation determines that the caller is an authorized subscriber, the PCI database 44 instructs the PCI server 48 to ask the subscriber to select which subscriber profile information is to be modified. Only two fields are modifiable using DTMF messaging: changing a wireline registration or recording a personalized greeting. The subscriber selects either registering at a wireline phone or recording a personalized greeting. If wireline registration is selected, the PCI database 44 instructs the PCI server 48 to prompt a ten digit telephone number to which all incoming calls will be routed. If the subscriber selects to record a personalized greeting, the PCI database 44 instructs the PCI server 48 to prompt the subscriber for a new greeting.

If invalid information is entered at any time, the PCI server 48 plays an error message to the subscriber and the subscriber retries the modification. If the retry fails, the call is terminated. Otherwise, the subscriber's profile is updated according to the modification, data synchronizing the messages are sent to the PCI server 48 and the call processor 220 instructs the PCI server 48 to
5 inform the subscriber that the PCI service profile was updated.

The call processor 220 also sends a message through the message distributor 219 to the GDI 212 and to the PCI server 48 which updates the service profile cache 51 in the PCI server 48. The changes stored back in the first CPR database 220 are sent to the MSAP common 224 where they are sent to the second CPR database 230. Note that DTMF function signals, which use
10 the 1129+ protocol, are routed through the IPI 210 and the subscriber profile data, which uses the GDI protocol, are routed through the GDI 212.

IV. The PCI Server/Database Interface

The interface between the PCI server 48 and the PCI database 44 is based on two
15 protocols. The first protocol is 1129+. This protocol will be used to support the PCI Call Command feature and for subscriber initiated profile manipulation using DTMF. The second protocol is Generic Data Interface. The GDI is used for subscriber profile management, specifically downloading a subscriber profile from the PCI database 44 to the PCI server 48 and for applying updates to the profile stored in the PCI database 44.

20 Fig. 7 shows the logical links from the PCI database 44 to the PCI server 48. The PCI database 44 consists of a mated pair of PCI databases 44a, 44b, each containing three call processors 220 which each share the load. The links 250 are TCP/IP links between Intelligent Peripheral Interface (IPI) 210 and the Generic Data Interface (GDI) 212 processors on the PCI database 44 to the PCI server call processor. Two logical connections are made from each IPI 210
25 and GDI 212 processors to the PCI server for redundancy. Thus, a full SCP configuration supporting PCI would preferably require 24 logical links, as shown in Fig. 7. The PCI database initiates the opening of the logical links.

In this illustrative embodiment the CallCommand feature employs the 1129+ protocol. For the wireless messaging feature, PCI uses the GDI protocol. The GDI tag IDs assigned for the
30 PCI subscriber profile elements are provided in Appendix B.

Appendix B also shows the PCI profile data, including the profile elements, their data types, maximum lengths, and GDI tag IDs. An * indicates elements which were shortened to 32

bytes because of GDI byte limitations. The description of the types and lengths of these elements is as follows:

- dN BCD-encoded digits. The number N represents the maximum number of BCD digits, not octets.
- 5 cN Up to N ASCII characters.
- cN Binary integer N bytes in length, in network byte order (highest order bit transmitted first).

Because the portion of the PCI subscriber profile downloaded to the PCI server is large (preferably approximately 1,000 bytes), and a maximum Transaction Capable Application Program (TCAP) message size is 256 bytes, the profile must be managed in segments. The service profile is divided into six segments as shown in Table 1. Each segment is assigned a unique numeric identifier.

PCI Profile Segment	Segment ID (decimal)
Personal data	1
CC service profile	2
E-mail routing	3
E-mail subject screening	4
E-mail from screening	5
Voice mail profile	6

15 Certain data in a subscriber profile provides a subscriber's preferred media for messages delivery and notification. The encoding for these types are given in Table 2.

Media Type	Code
Alphanumeric Pager	A
E-mail message store	S
Fax	F
PDA	P
Voice mail	V
Wireline e-mail	E
Null	Z

For example, if the subscriber prefers to receive e-mail which passes screening via the PDA 30, then the "primary destination one" profile element will contain a "P".

Fig. 8 illustrates a message flow for profile retrieval using the GDI protocol. A subscriber attempts to register with the PCI server either explicitly or implicitly (registration is discussed in detail below). The PCI server 48 send a GDI GetData query to the PCI database 44 over one of the GDI links (line 260). The PCI server 48 may send one GetData data query for each PCI profile segment. Each query will be processed by the PCI database 44 as an independent transaction with a unique TCAP transaction ID. Each GetData query sent by the PCI server 48 will include a "Service Key" parameter which is a ten-digit PCI subscriber number (e.g., a telephone number). This key should be used by the PCI database 44 to identify the subscriber. In each GetData is a list of tag IDs listed in the profile elements to be retrieved. The PCI database 44 responds to the GetData data query with a GetData response (line 262). The response contains a return code and data for each element requested in the GetData data query.

Fig. 9 provides a message flow between the PCI server 48 and the PCI database 44 for a profile update originating from a wireless PDA 30. This wireless profile update uses the GDI protocol. A subscriber performs a profile manipulation activity, and the PDA 30 sends a profile data message to the PCI server 48. The PCI server 48 sends a GDI SendData query to the PCI database 44 over one of the GDI links (line 264). The PCI server 48 may send one SendData query for each PCI profile segment for which a profile element was updated. Each query will be processed by the PCI database 44 as an independent transaction with a unique TCAP transaction ID.

Each Send Data query sent by the PCI server 48 will include a "Service Key" parameter which is the ten digit PCI subscriber number. This key should be used by the PCI database 44 to identify the subscriber. Each SendData query contains a list of tag IDs provided in Appendix B and data for the profile elements to be updated. Not all tags in this segment may be included in the SendData query; only those profile elements which are actually updated by the subscriber will be sent. The PCI database 44 should not update data for which no tag was included in the SendData query.

The PCI database 44 responds to the SendData query with a Send Data response (line 266). The response contains a return code for each element requested in the SendData query.

Fig. 10 is an illustrative example of one possible CallCommand message flow between the PCI server 48 and the PCI database 44. (CallCommand is discussed in more detail in section VI D.) The exact call flow for CallCommand depends upon the implementation of the service logic by the service designer, and upon options selected by the CallCommand subscriber. The CallCommand functions illustratively use the 1129+ protocol and the IPI 210 (see Figs. 6 and 7).

As illustrated in Fig. 10, a CallCommand call arrives in the PCI server 48. The PCI server 48 sends a provide_instructions query to the PCI database over one of the 1129+ links (line 268). A TCAP transaction ID is generated for the query. The dialed number digits parameter contains the personal numbers of the PCI subscriber (i.e., Service Key). The ANI digits contain the automatic number identification, if any, of the caller (ANI is a telephone network capability). The PCI database sends a 1129+ send_to_resource command to the PCI server 48 to play an announcement and collect digits (line 270). The PCI server 48 plays the announcement, collects the digits, and sends a response containing a return code and the digits collected (line 272).

PCI database 44 sends a 1129+ play_application command to the PCI server 48 to notify the PDA 40 of the incoming call (line 274). The PCI server 48 responds with a return code and a destination number (entered by the subscriber at the PDA 30) to which the call is routed (line 276). The PCI database 44 sends a 1129+ switch_to_resource command to the PCI server 48 instructing the PCI server 48 to route the call to a destination number (line 278). The PCI server responds with the return code executing that request (line 280).

Fig. 11 is an illustrative example of one possible message flow between the PCI server 48 and the PCI database 44 for a DTMF profile manipulation message. The DTMF profile manipulator uses the 1129+ protocol through the IPI 210. The exact call flow for DTMF profile

manipulation depends upon the implementation of service logic by the service designer, and upon options selected by the PCI subscriber.

As shown in this illustrative example, when a call arrives at the PCI server, the PCI server sends an 1129+ provide_instructions query to the PCI database (line 282). The called number contains a dialed number (i.e., the service number for a DTMF updates), while the ANI field contains the ANI, if . The PCI DTMF profile manipulations Call Process Request CPR is triggered by the dialed service number. The CPR 222 instructs the PCI server to play announcements and collect digits, guiding the subscriber through voice menus and prompts (lines 284, 288). The PCI server responds to each request with digits collected (lines 286, 290, 294).
10 The CPR updates subscriber's profile with data collected via DTMF.

V. PDA/PCI Interface

Communication between the PDA and PCI use, for example, an X.25 transport using the UDP IP protocol. A brief discussion of the PDA structure is provided. The PDA 30 is preferably a notebook or palm top computer having a wireless network interface. The PDA may be, for example a Hewlett Packard Omnibook 300 notebook computer running a PCI application. Fig. 12 illustrates an exemplary PDA. The PDA 30 has a central processing unit 295 connected to a bus B. The central processing unit ("CPU") 295 performs most of the computing and logic functions of the PDA 30. A memory 295 is connected to the bus B, which stores information to be provided to the CPU 295 or otherwise used by the PDA 30. An input/output device 297, such as a keyboard, is also connected to the bus B which allows a user to input data for storage in memory 296 or for use by CPU 295. A display 298 is connected to the bus B. The PDA 30 also has a wireless communication interface 299 for communication with a wireless communication network.
15
20

The PDA/PCI interface involves six types of message flow. These messages are: (1) registration/deregistration; (2) wireless messaging; (3) retrieving E-Mail; (4) cross-media notification; (5) CallCommand; and (6) profile management.
25

There are two types of registration and deregistration: explicit and implicit. Explicit registration occurs when a PCI subscriber starts the PCI application software on the PDA 30 (this is called start-up registration) or when the subscriber clicks a status check button or one of the service registration request buttons on the PDA 30 either for the CallCommand or wireless messaging service. Once successfully registered, if the subscriber's profile is not already present in the service profile cache 51 maintained by the PCI server 48, the PCI server 48 will request a
30

download of the subscriber's profile from the PCI database 44 to the service profile cache 51. The PCI server 48 sets the subscriber's registration status in the cache 51 to match those requested by the subscriber for the wireless messaging service for the call command service.

5 Fig. 13 illustrates one example of the message flow between the PDA 30 and PCI server 48 during explicit registration. This flow is also used by a subscriber to check registration of CallCommand or wireless messaging services. A subscriber starts the PCI application software on the PDA or clicks the service status check, CallCommand registration, or wireless messaging registration buttons on the PDA. The PDA sends a registration request to the PCI server 48 with the subscriber's validation information (subscriber ID and password (line 300)). The PDA 30 also
10 starts a timer during which the PDA 30 will wait for a response from the PCI server 48. The PCI server 48 server receives the registration request and checks if the subscriber is provisioned and if the subscriber ID and password are correct. The PCI server then sends a registration acknowledgement (line 302). If the subscriber is not provisioned, no service profile exists and the acknowledgement includes an "unrecognized subscriber" response. If the subscriber ID and
15 password are invalid, the acknowledgement includes an "incorrect password/PIN" response. Otherwise, the PCI server acknowledgement includes a "success" response. If the PDA 30 does not receive an acknowledgement from the PCI server within a predetermined time, it aborts the registration attempt and tells the subscriber to try again later.

Implicit registration automatically registers a subscriber for the wireless messaging
20 service when the subscriber is currently not registered and wishes to send or fetch E-Mail from or to a PDA 30. Implicit registration is done as follows. The PCI server receives a fetch or send request from a subscriber who is not registered for the wireless messaging service. The PCI server 48 retrieves a copy of the subscriber's service profile from the PCI database 44, if necessary, and validates the subscriber's ID and password. The PCI server 48 validates the profile contents to
25 make sure that subscriber may use the wireless messaging service. If wireless messaging is permitted, the PCI server 48 processes the request. Otherwise, it sends an acknowledgement indicating the reason why the subscriber is not permitted to use the wireless messaging service. The message flow is the same as illustrated in Fig. 13.

30 Once the subscriber is registered for either the CallCommand service or the wireless messaging service, the subscriber remains registered until the subscriber explicitly deregisters by either quitting the application or clicking the deregistration button on the PDA 30. The subscriber can also be implicitly deregistered for the wireless messaging service by the PCI server 48 provided

the PCI did not detect any wireless messaging activities to or from that subscriber for a given duration of time. Although the subscriber is deregistered, the subscriber's service profile will remain in the service profile cache 51. The profile remains in the cache as long as the PCI server has some activity for the subscriber, such as incoming e-mail messages within a predetermined time, such as four hours.

No PDA-to-PCI server messages may be sent by the subscriber to implicitly register for CallCommand, thus, a subscriber should not be implicitly deregistered from this service. Implicit registration and deregistration occurs only for the wireless messaging service, and not for CallCommand. A subscriber remains registered for CallCommand as long as he or she is running the CallCommand software application on the PDA.

Explicit deregistration occurs when a subscriber quits the PCI application software on the PDA (this is called exit deregistration) or when the subscriber clicks one of the service deregistration request buttons on the PDA for the CallCommand or wireless messaging services. Fig. 14 is an illustrative embodiment of a message flow between the PDA 30 and PCI server 48 for explicit deregistration. A subscriber quits the PCI application software on the PDA or clicks a deregistration button on the PDA. The PDA 30 sends a deregistration request to the PCI server 48 with the subscriber's validation information (the subscriber ID and password) (line 304). The PDA 30 also starts a timer during which the PDA will wait for a response from the PCI server 48. The PCI server 48 sends an acknowledgement (line 306). The PCI server 48 receives the deregistration request and checks if the subscriber ID and password are correct. If the subscriber ID and password are not correct, the acknowledgement includes an "incorrect password/PIN" response. Otherwise, the acknowledgement includes a "success" response. If the PDA 30 does not receive an acknowledgement from the PCI server 48 after a predetermined time, the PDA 30 assumes that it is out of radio coverage and informs the subscriber to retry later.

Implicit deregistration occurs when the PCI does not detect any wireless messaging activity from or to the subscriber for a given duration of time, for example four hours. The PCI will also try to implicitly deregister a subscriber from the wireless messaging service in the middle of the night in the event that the subscriber inadvertently left the PDA 30 turned on. The PCI server 48 keeps a time-stamp of the most recent wireless messaging activity for each registered subscriber in the subscriber's service profile maintained in the service profile cache 51. Whenever the PCI server 48 detects any wireless messaging activities to or from a particular subscriber, the time-stamp is updated to the current time. The stored time-stamp of a registered subscriber is

periodically compared to the current time. When a predetermined time elapses, the PCI server 48 assumes that the subscriber is out of radio coverage or has quit the PCI application.

For implicit (or automatic) deregistration, the message flow is the same as illustrated in Fig. 14. The PCI server 48 sends to the PDA 30 a deregistration request containing registration information about the subscriber. The PCI server 48 also sets a timer during which it will wait for a response from the PDA 30. When the PDA 30 receives the deregistration request, it responds with registration acknowledgement which contains the registration information currently known to PDA. When the PCI server 48 receives the registration acknowledgement, it updates the subscriber's registration status based on information in the acknowledgement. The PCI server 48 also updates the wireless messaging time-stamp associated with the subscriber to the current time. If the PCI server 48 does not receive an acknowledgement within a predetermined time as described above, the PCI server 48 assumes that the subscriber is no longer registered and removes all references to the subscriber from the service profile cache 51.

Sending and receiving e-mail wireless messages involves two types of message flows: sending messages from the PDA 30 to the PCI server 48 and from the PCI server 48 to the PDA 30.

Fig. 15 is an illustrative example of a message flow sending an E-mail from a PDA 30 to an PCI server 48. When a subscriber sends an E-Mail notification from the PDA 30, the PDA 30 forwards the E-Mail notification to the PCI server 48. The body of the E-mail contains, for example, "to;from;subject;cc" information (line 308). The PCI server acknowledges this notification (line 310). If the E-mail is longer than can be transmitted in a single message, the PDA 30 segments the E-mail into multiple, sequentially numbered messages and sends them to the PCI server (lines 312, 316, 320). Each message sent from the PDA is responded to with an acknowledgement containing the reception status of the message and the sequence number it is acknowledging (lines 314, 318, 322). The PDA 30 and PCI server 38 use the sequence number to maintain a sequential flow of packets. Out of sequence messages are discarded. Once all of the packets are received, the PCI server 48 puts them into their original order using the sequence number and forwards the now assembled E-mail to a message transfer agent, which then forwards the E-mail to its intended destination.

The PDA 30 starts a timer each time it sends out an E-mail. If the PDA 30 does not receive an acknowledgement after a predetermined time (for example ten seconds), the send operation is aborted and the E-mail is stored in a local outbound queue for redelivery in the future.

When an E-mail is being delivered from an PCI server 48 to a PDA 30, a similar message flow is used. The only difference is that the PCI server 48 initiates the flow and sends the initial messages instead of the PDA 30.

Retrieving E-mail involves two types of message flows: retrieving undelivered E-mail addressed to the PDA 30 and retrieving E-mail delivered a messaging system, such as a wireline e-mail system. When a subscriber is out of radio coverage or is not registered with PCI, the PCI sends E-mails addressed to be delivered to the PDA (PDA-bound E-mail) to an external mail storage system. The PCI server will also send certain E-mail directly to an external mail storage system (MS-bound E-mail), such as the subscriber's wireline E-mail connected to his or her personal computer, according to the subscriber profile stored in the PCI database 44.

A registered subscriber can retrieve PDA 30 bound E-mail at any time by starting "FETCH" operation. The PCI will send the PDA bound mail from the external mail storage and will also summarize MS-bound E-mail.

An illustrative example of the message flow between the PDA and the PCI server for retrieving undelivered PDA bound E-mail is shown in Figs. 16a and (b). If there are no MS-bound messages, an illustrative message flow is shown in Fig. 16(a). The PDA 30 sends a fetch request to the PCI server 48 (line 324) and starts a timer, which waits for an acknowledgement. If no acknowledgement is received within a predetermined time, for example twelve seconds, the PDA 30 assumes it is out of radio coverage and informs the subscriber to try again later. In response to the request, the PCI server 48 logs into an external mail storage system specified in the subscriber's profile. If any PDA-bound E-mail is stored in the external storage system, the PCI server 48 will (a) move the PDA bound E-mail from the external mail storage system into a pending area in the PCI server; (b) send an acknowledgement to the PDA indicating the number of PDA bound E-mail now residing in the pending area; and (c) initiate delivery of these PDA bound E-mail from the pending area to the PDA (line 326).

If there are MS-bound E-mail messages, an illustrative message flow is shown in Fig. 16(b). The PDA sends a fetch request (line 328) and starts a timer. Whenever the PCI server sends a summary message, it starts a timer. If the PCI server 48 does not receive an acknowledgement within a certain predetermined time, for example ten seconds, it will assume that the PDA 30 is out of radio coverage, abort the send operation and discard the summary information. In response to the request, the PCI server 48 will (a) send an acknowledgement to the PDA indicating the number of MS-bound E-mail present (line 300); (b) extract summary information from those messages; and

(c) send the summary to the subscriber's PDA (line 332). When the PDA receives an acknowledgement from the PCI server, it informs the subscriber based on the contents.

Summary information for the MS-bound E-mail is formatted into one ASCII text per E-mail and sent to the PDA. If the summary information, or the number of summarized E-mail
5 require more than one message, the PCI server 48 splits the summary information into multiple sequentially numbered segments and sends each segment in a separate message (lines 336, 340). Each message from the PCI server 48 is responded to by the PCI server with an acknowledgement containing the reception status of the message and the sequence number it is acknowledging (lines 334, 338, 342). Out of sequence messages are discarded. Once all of the packets are received, the
10 PDA 30 puts them into their original order using the sequence number.

Once the summary information describing the MS-bound E-mail messages is reviewed, the subscriber may start a FETCH operation to retrieve these MS-bound E-mail messages. Fig. 17 is an illustrative example of a message flow between the PDA 30 and the PCI server 48 retrieving MS-bound E-mail. The subscriber selects an MS-bound E-mail message to be received. The PDA
15 30 sends a retrieve request to the PCI server 48 containing the message selected by the subscriber (line 344). The PCI server 48 responds with an acknowledgement (line 346). The PCI server 48 logs into the external message storing system specified in the subscriber's service profile and moves the MS-bound E-mail specified in the request out of the storage system into a pending area in the PCI server 48. The PCI server 48 initiates a send operation which delivers the E-mail in the same
20 manner as discussed above.

Cross media notification (e.g., PDA notification of voice mail message receipt) is sent to the PDA 30 using the same delivery as a wireless E-mail message to the subscriber. The PCI server 48 originates the notification E-mail and the e-mail subject is "message notification". The body of the notification E-mail contains the message sender's address (i.e., the phone number for a
25 voice mail), the date and time the message arrived at the PCI; the type of media, (i.e., voice mail, FAX, E-mail or other); whether the message is marked urgent (if detectable); the length of the message (for example, in minutes for a voice mail message); and, if appropriate, the subject of the message.

CallCommand allows a PCI subscriber to reroute or direct calls in real time. The
30 subscriber may receive notification on the PDA 30 that a call is waiting. Using the PDA 30, the subscriber may instruct the PCI to route the call to specified destination number or have the PCI server play a message entered by the subscriber using synthesized speech.

When a call is made to a CallCommand subscriber's number, it is routed to an PCI server 48. The PCI server 48 queries the PCI database 44 to determine how the subscriber's profile has directed the call to be processed. If the subscriber is registered at a known telephone number, the PCI database 44 instructs the PCI server 48 to route the incoming call to the given telephone number (assuming that the call meets any screening requirements). If the subscriber is not registered at a known telephone number, the PCI database 44 will provide a default routing number and a timer value instructs the PCI to play an announcement customized by the subscriber to the caller and start collecting DTMF digits within that time period. The PCI plays the announcement and starts the timer provided by the PCI database 44 and then begins collecting DTMF digits entered by the caller. If no digits are collected within a predetermined time period, the PCI routes the call to a default number indicated by the subscriber's profile in the PCI database 44. If DTMF digits are collected, the PCI puts the caller on hold determines if the caller meets screening requirement, and handles the call accordingly. If the call is to be directed to the subscriber, the PCI attempts to contact the subscriber.

Fig. 18 is an illustrative example of the message flow between the PDA 30 and PCI server 48 for a CallCommand call. The PCI server 48 sends a notification message to the subscriber's PDA 30 to notify the subscriber that a call is waiting (line 348). The message contains the DTMF digits entered by the caller. The PCI server 48 starts two timers, which are the time interval the PCI server 48 expects to receive an acknowledgement from the PDA 30 and the time interval the PCI server 48 expects to receive a response from the PDA 30, respectively. The typical values for these timers are ten and forty seconds, respectively. The time to receive an acknowledgement should be less than the time for the response.

After receiving a notification message, the PDA sends an acknowledgement to the PCI (line 350). This informs the PCI server 48 that the PDA 30 is within radio coverage and that the subscriber has been notified about the incoming call. Once the acknowledgement is received, it cancels the acknowledgement timer, but leaves the response timer ticking, waiting for a response to come from the PDA 30. If the PCI server 48 does not receive an acknowledgement within the predetermined time, it assumes that the PDA is either out of radio range or is turned off and cancels the response timer and routes the call to a default number programmed into the user profile in the PCI database 44. The subscriber is notified of the incoming call by the CallCommand interface on the PDA 30. The DTMF digits entered by the caller provide the subscriber with the name and/or telephone number of the incoming caller.

The subscriber can decide to route the call to directory number or voicemail, enter a text message to be played to the caller, or both. The PDA will send a response to the PCI server 48, which carries the number to which the call should be routed, a short text message to be played to the caller through synthesized voice, or both (line 352). When the PCI server receives the response, it cancels the response timer and executes the subscriber's decision in the response and sends an acknowledgement which contains how the subscriber's decision is to be carried out (line 354).

If the response timer expires before the PCI server 48 receives a response, the PCI server 48 routes the call to a default number obtained from the PCI database 44 and send a status message to the PDA 30 to inform the subscriber that the caller is no longer waiting (line 356). Also, if the caller decided not to wait any longer (that is hangs up or presses "*", which allows the caller to go to the default number) the PCI sends a status message providing this information. The PDA acknowledges the status message (line 358).

Profile management allows the subscriber to modify wireless messaging and Call Command services by updating certain elements in the subscriber's service profile stored in the PCI database 44 and the service profile cache 51 in the PCI server 48. Profile information is not stored locally on a PDA 30. Updating the subscriber's profile using a PDA 30 always requires the subscriber to have a profile download from the PCI.

Profile management involves two types of message flows, profile download and profile upload. Fig. 19 is an illustrative example of the message flow between the PDA 30 and the PCI server 48 for a profile download. As indicated above, any profile change requires a profile download because the profile is never stored in the PDA 30. A subscriber starts a profile management application on a PDA 30 and requests a profile download. The PDA 30 sends a download request to the PCI server and requests a copy of the subscriber's modifiable profile elements to be downloaded to the PDA 30 (line 360). The PCI validates the identity of the subscriber through its subscriber ID and password. If the subscriber's identity is not validated, the PCI sends an acknowledgement and an error code and terminates the profile update session. If the subscriber's identity is validated, the PCI downloads the subscriber's modifiable profile elements (lines 362, 366, 370). Attached as Appendix C is a list of tags for modifiable profile elements. The PDA 30 acknowledges the received data (lines 364, 368, 372). The PDA starts a timer after sending the download request. If the PDA does not receive an acknowledgement or data from the PCI server within a predetermined amount of time, for example, ten seconds, it assumes that it is

out of radio coverage and informs the subscriber to try again later. The PCI server 48 starts a timer each time it sends out data to the PDA 30. If the PCI server 48 does not receive an acknowledgement from the PDA 30 within a predetermined time, for example ten seconds, it will abort the profile download operation.

5 Once the subscriber finishes editing the profile on the PDA, a profile upload request is issued. An illustrative example of the message flow between the PDA 30 and the PCI server 48 for a profile upload is shown in Figs. 20(a) and (b). After the subscriber issues a profile upload request, the PDA 30 sends an upload request to the PCI server 48 requesting permission to send the updated profile elements (step 374). The PCI server 48 validates the identity of the
10 subscriber, for example by checking the subscriber ID and password, and checks if there is an associated download request issued by the same subscriber. The check for an associated previous download request is necessary so that the PCI server 48 is sure that the profile the subscriber wants to change is the profile that the PCI server 48 has just sent. If the subscriber's identity is not validated, or there is no associated download request packet, the PCI server sends an error code to
15 the PDA 30 and terminates the profile update session. If the subscriber's identity is validated and there is an associated download request, the PCI server 48 honors the request by sending an acknowledgement and a status code of "OK" to the PDA 30 (line 376). When the PDA 30 receives the OK, it formats the updated profile elements and sends them to the PCI server 48 in the same way the profile was sent to the PDA 30 during the download phase (lines 378-386). If no
20 error is detected, the PCI server 48 sends the updated profile elements to the PCI database 44 to commit the change. After a confirmation is received from the PCI database 44, the PCI server 48 sends an acknowledgement with status code of "OK" to the PDA to confirm and conclude the profile update session (line 388), as shown in Fig. 20(a).

Fig. 20(b) is an illustrative message flow when the PCI server 48 detects errors in
25 an uploaded profile. The upload proceeds as above (lines 390-398). If the PCI server 48 detects errors in the updated profile elements it responds with an error message to notify the subscriber about the invalid profile element (line 400). The PDA acknowledges receipt of the error message (line 402). The PCI server 48 sends the invalid profile elements in a similar way as the profile was sent to the PDA 30 during the download phase (lines 404, 406).

30 The PDA 30 starts a timer when its sends out an upload request or sends out data. If the PDA 30 does not receive an acknowledgement from the PCI server 48 within a certain

predetermined time, it will abort the profile upload operation and inform the subscriber to retry at a later time.

VI. Services

5 A. Wireless E-mail Messaging

PCI includes several wireless text message sending, receiving, and service control features. PCI's wireless text messaging services are based on three network-based capabilities:

- × message integration combining voice message notification, voice mail, telephone calls, e-mail, and fax;
- 10 × message routing and delivery, i.e., the PCI is a wireless and wireline network gateway;
- × database access, i.e., subscriber profile, authentication, and validation.

The PCI uses personal communications service-integration capabilities to integrate the wireless service capabilities available to the subscriber. This is accomplished by providing the subscriber with control over the message routing and delivery by the subscriber accessible "subscriber profile" stored in the PCI. The subscriber profile contains subscriber programmed instructions on message receipt, origination, and notification. Thus, PCI operates as a messaging gateway for providing access to multiple wireline and wireless networks, while using subscriber profile information to control sending and receiving options. PCI allows wireless service providers to integrate the voice messaging, e-mail, and fax message services for one subscriber through a single telephone number. Thus, one phone number may provide a single link between the service provider and the subscriber's voice and data communications lines.

The message sending features include communications across disparate networks and broadcast communications. A subscriber may send voice mail, e-mail, and fax messages between different service providers and networks. A subscriber may also send broadcast e-mail and fax messages, which broadcasts may mix e-mail and fax messages within a single distribution list. For example, the subscriber may type a message on a PDA and send it to a distribution list over a wireless network. The distribution list may direct the PCI to deliver the message to the office as an e-mail and to a client as a fax.

30 The message receiving features include personal number addressing, selection of message receipt media format, selection of cross-media message notification, and selection of message screening and delivery options. A subscriber may receive voice (e.g., phone), voice mail

notification, e-mail, and fax communications under a single personal telephone number. A subscriber may direct e-mail and fax delivery based on selected parameters, such as time-of-day, day-of-week, etc. A subscriber's media message notification, voice mail notification of e-mail or fax messages, e-mail notification of voice mail or fax messages, and fax notification of e-mail or voice mail messages may be delivered to the subscriber based on selected options and parameters.

Alternatively, if the subscriber's wireless terminal is not activated, e-mail messages may be automatically routed to alternate destinations as defined by the subscriber's profile. For example, the subscriber may not want to receive all telephone calls at a visiting location to avoid unnecessary interruptions and unwanted incoming call charges. The subscriber directs the PCI to send notification of phone calls to the pager and to route the call to voice mail. Once notified, the user can determine from the phone number included in the pager notification whether to call the person directly, check voice mail, or ignore the call until a later time. The subscriber may also direct which messages are to be routed to the subscriber's current serving network, which are to be sent to another network, and what media is to be used to receive certain messages. The subscriber may also designate, for example, that if the wireless terminal is off, all text messages to be sent to e-mail and all voice messages are to be sent to voice mail.

The PCI service control features include supporting subscriber profile management, supporting personal mobility across wireless and wireline networks, and supporting wireless terminal mobility. A subscriber's profile may be updated by sending text messages from a PDA over a wireless network or DTMF (touch-tone) messages from either a wireline or wireless terminal. The subscriber may program the profile to select media for receiving and sending information; select cross media for message notification; select message screening and delivery options; select single voice mailbox storage (for subscriber's with more than one voice mailbox); and select a PCI service password. All of these options may be maintained over wireless or wireline terminals. The subscriber may automatically register and deregister a wireless terminal thus updating the subscriber's profile to receive or reroute messages as preprogrammed in the profile.

The wireless data network provides data transport between the PCI server 48 and the subscriber using a wireless data terminal, such as a PDA 48. The wireless data network may connect to the PCI server in a variety of ways, using a variety of protocols. For example, the wireless data network may connect to the PCI using a leased line and run a proprietary protocol to connect the PCI server via standardized protocols such as TCP/IP.

Text messaging systems may be connected to the PCI server through for example, Frame Relay, SMDS, ISDN, leased line interface, or other transport mechanism effective for supporting data communications may be used. An inter-message handling system protocol, such as X.400 (in which case X.400 gateway conversion is needed), or Internet SMTP or other protocols supported by an interworking unit terminating the data transport interface, may be used to forward messages between the PCI server 48 and the system accessing the PCI.

The PCI server will preferably support sending and receiving faxes in the T.434 format. The PCI server may also preferably support sending and receiving faxes using the simple mail transfer protocol (SMTP) supported by the TCP/IP transport protocol.

Fig. 21 shows an illustrative embodiment of a PCI service supporting text messaging systems. In this example, a subscriber has a personal computer 402 at the office connected to a local area network (LAN) 414 and an enterprise text messaging system (for example, a local network e-mail) 413, a personal computer at home 416, and a wireless terminal, such as PDA 30 that may send and receive messages. All of these devices are connected to the PCI. For example, the subscriber's home personal computer 416 may be connected to the PCI 40 via a modem and a wireline data network 418 over either a PSTN or ISDN.

Persons connected to the LAN may send text messages to the subscriber by using the local text messaging system without using the PCI. That is, the user of computer 420 can send an e-mail to the subscriber's office computer 412 without entering the PCI node 40. Because the enterprise text messaging system 413 is connected to PCI, all enterprise messaging users may send messages to and receive messages from all PCI subscribers (including those not connected to the local text messaging system 413) by using an appropriate PCI address.

A person connected to a different enterprise messaging system, such as text message handling system 2 422, can send messages to the subscriber on message handling system 1 413 by routing the message through the PCI Server 48.

PCI subscribers are assigned a single personal telephone for both voice and data communication. For example, an E.164 address (i.e., a telephone number) may be assigned to a PCI subscriber to use as the single PCI address. These phone numbers may be geographically based according to current PSTN architecture, but it is also possible to use portable universal numbers. Fifteen digit number formats may be desirable to permit sub-addressing. For example, a message destined for a PCI subscriber may be addressed to the subscriber's telephone number, e.g., 201-555-5555. If an originating mail system such as a LAN mail system or third party message

handling system requires a domain identifier, the originator may have to specify 201-555-5555 @ PCI, or on the Internet 201-555-5555 @ pci.net. When the PCI server 48 receives the message, it will look at the subscriber's profile stored in call process request database 222 stored in an PCI database 44 to determine how to handle the incoming message. An example of a few of the options that PCI may provide for the subscriber are to:

5

- × send the message to the subscriber's wireless PDA;
- × send the message to the subscriber's wireline computer at home;
- × send the message to the destination text messaging system at the office;
- × send a notification of an incoming message to the wireless data terminal

10 and the actual message to the text messaging system.

- × send the message to any or all of the above;

The subscriber may send text messages over the wireless data network or wireline data network to the PCI server 48. The PCI server 48 consults with the subscriber's profile at the PCI database 44 and forwards the message to the appropriate destination, depending on the routing destination found in the profile. Text messaging systems not connected to the PCI 40 may send text messages to PCI subscribers by using another network connected between the sender's text messaging system and the PCI subscriber's text messaging system, for example, the non-connected text message may be connected to a PCI over the Internet.

15

The flow for wireless messaging is now described.

20

The flow for a PCI subscriber receiving an e-mail message to a wireless PDA 30, for example, is as follows. An e-mail message is sent from a wireline or wireless sender to a PCI subscriber and arrives at the PCI server 48. The incoming e-mail contains a recipient address in the format of "201-555-5555 @ pci.net" where 201-555-5555 is the subscriber's ten-digit personal number and pci.net is the PCI server's domain name in the Internet.

25

The PCI server 48 checks the subscriber's service profile, either from the profile service cache 51 in the PCI server or by downloading the subscriber profile from the PCI database 44 into the cache 51 to determine how to process the e-mail message. The profile contains screening and routing information and cross media notification information. The PCI server 48 uses this information to send incoming e-mail to an actual destination address that can be a wireless, wireline, or paging address using, for instance, the UDP/IP protocol over a wireless data network; the Internet SMTP protocol over the Internet wireline network; or the Telocator Alpha Numeric Protocol (TAP), respectively. In this case, the subscriber has programmed into the

30

subscriber profile to have the e-mail sent to a PDA 30. The PCI server 48 receives the e-mail message and forwards it to the wireless data network programmed into the profile. The e-mail is transmitted over a wireless data network 39 for receipt by the PDA 30.

5 If the e-mail cannot be delivered, the PCI server returns the e-mail to the original sender with a short description of why the delivery was unsuccessful, using the SMTP protocol.

If an e-mail message is to be delivered to an alphanumeric paging address, the PCI server translates the e-mail message into a paging message and sends the paging message to the paging network specified in the subscriber profile. The protocol between the PCI server and the paging network is the Telocator Alpha Numeric Protocol (TAP). The PCI server formats the
10 paging message into a maximum page limit with a maximum number of characters per page. For example, the page limit may be two pages and a maximum of 256 characters per page. The PCI server does not verify whether a paging message is actually delivered by the paging service provider. It will, however, verify that the message was successfully sent to the paging service provider. Because the PCI server does not provide this verification, it is under the assumption that
15 messages sent to a pager arrive successfully at the pager.

If the subscriber profile contains an option for voice message notification of e-mail messages, the PCI server generates and sends a digitized prerecorded voice announcement to the address specified in the subscriber service profile. The protocol used to deliver the voice message notification is the AMIS-Analog Protocol.

20 In this illustrative embodiment, a preferred PCI server node functions as an X.400 message transport agent or SMTP router and routes messages destined for PCI subscribers and to those destined for users connected on other systems. In the case of an X.400 message transfer agent (MTA), X.400 addresses are used to internally represent subscriber addresses. The translation from the "user friendly" subscriber addresses such as E.164 numbering to the X.400
25 address would be done via a look-up table (ROM or other memory device) at the PCI access module or the X.400 gateway. Destination or source addresses from users on other networks are not converted to X.400 addresses, but are left in the native address format of the sending or receiving system. An X.400 gateway address may be added to the message header, however, to allow PCI to route the message to an appropriate gateway.

30 The PCI server 48 is responsible for delivering a message to the subscriber listed in the destination field of the message. In a simple case, the subscriber has an X.400 or Internet mailbox accessible to the PCI via one of its access connections. Alternatively, the subscriber

profile may contain forwarding addresses which route the message for delivery to unusual destinations. For example, the subscriber's mailbox may reside on another message handling system, a wireless data network, wireline data network, or PSTN destination associated with a fax machine. The delivery of such a message to a final destination is handled by an interworking unit
5 which is responsible for doing address translation and, if necessary, format translation as defined by the subscriber profile entry.

For subject e-mail screening, the subject field is analyzed to determine if a match exists before comparing the address field. If the subject field matches an entry on the screening list, the treatment for a matched entry will occur. That means, in this illustrative embodiment, that
10 subject screening takes precedence over address sender screening. That is, if e-mail originated from an address that is excluded from the e-mail screening address list, the e-mail will still be delivered according to the screening criteria.

If the PDA 30 is not registered for the wireless messaging service or if the PDA 30 is out of radio coverage at the time the message arrives at the PCI server 48, the message will be
15 sent to the subscriber's external message storage system, such as the text message system 413.

B. Voice Messaging

Fig. 22 shows an illustrative embodiment of a PCI service for voice mail system. The voice mail systems 430 may use the public telephone network 432 and Audio Messaging
20 Interface Specification (AMIS) - Analog Protocol to connect analog voice messages to the PCI. Alternatively, the voice mail system may use a modem 434, a private line 436, or an ISDN BRI AMIS - Digital Protocol 438 to connect digital voice mail signals to the PCI.

Voice messaging systems on the PCI must be able to send a message to the PCI server 48 providing notification that the subscriber has received a voice message. The voice mail
25 system may send this text message using, for example, by asynchronous interfaces with a modem; X.25; ISDN BRI, or TCP/IP interfaces. Preferably, the PCI server 48 supports the AMIS Analog and Digital interfaces.

The PCI voice messaging call flow is as follows. Using the AMIS-Analog Protocol the system originating the voice message sends message information to the PCI server 48
30 specifying the type of message to be delivered, the message length (in minutes), the originator's mailbox number, and the recipient's mailbox number. When the message arrives at the PCI server 48, the originator's mailbox is extracted from AMIS-Analog Protocol and is compared to the

subscriber's voice mailbox number stored in the subscriber profile. If the two values match, the voice message is already in the mailbox designated by the subscriber. In this case, the PCI server 48 sends a bogus error code to the originating voice messaging system using the AMIS-Analog protocol so that the voice message is rejected and is not forwarded to the PCI server 48. The PCI server 48, however, has header information needed to send a notification message to the subscriber, if such notification is required by the subscriber profile.

If the originator's mailbox does not match the subscriber's voice mailbox number, the PCI server 48 analyzes the message length parameter. If this parameter exceeds a certain predetermined length, for example three minutes, the PCI server 48 sends a response message to the originating voice messaging system with an error code specifying that the message is too long. No further processing of the voice message occurs. If the message length is not longer than the predetermined time, the PCI server 48 sends a response message to the originating voice messaging system accepting the message. The originating voice messaging system will then forward the voice message to the PCI server.

When the voice message arrives at the PCI server 48, the PCI server 48 attempts to route the voice message according to the screening, registration, and routing options contained in the subscriber profile. Using AMIS-Analog Protocol, the PCI server 48 sends message information to the subscriber's destination voice messaging system, specifying the type of message to be delivered, length of the message in minutes, the originator's mailbox number, and the recipient's mailbox number.

For voice messages that cannot be delivered to the destination, for example if the mailbox is full, the destination system sends a non-delivery notification message to the PCI server 48 specifying the reason why the message is undeliverable. The PCI server 48 retries delivering for up to a system defined time period. If all of the retries fail, the PCI server 48 uses the AMIS-Analog Protocol to return the voice message to the originating voice messaging system with an appropriate non-delivery notification. A pre-recorded non-delivery announcement is sent to notify the message originator that the message was undeliverable. No further processing occurs. If the destination system accepts the message, the PCI server 48 forwards the voice message to the destination system.

If the subscriber chooses e-mail notification of incoming voice messages, the notification is sent via wireless or wireline network to the subscriber as specified in the subscriber profile. If the subscriber selected page notification, the notification will be sent through the paging

network according to the profile. Either notification contains the mailbox number that originated the voice message, the date and time the message was received, and the length of the voice message in minutes.

5 In another example, a user having a digital voice mail system creates a voice mail message and addresses it to a user of analog voice mail system. The destination telephone number indicates that the message must be routed to the PCI server 48. The PCI server 48 checks the recipient's user profile and determines that the destination recipient has an analog voice mail system. The message is then passed into the analog voice mail system via the AMIS - Analog Protocol.

10 The subscriber will receive all of the voice mail messages at the voice mail system, if that is what is selected in the subscriber's profile. The subscriber may also set up the profile to receive at a wireless data terminal a text message that provides a notification of a voice mail message and envelope information of the message. Alternatively, a recipient voice mail system may send a text message containing a notification and envelope information of the message.

15 One feature of the AMIS-Digital Protocol is that if the original voice message is marked urgent by the sender, the AMIS-Digital Protocol includes as priority status information in the message sent from the voice messaging system to the PCI server. Using this information, the PCI can screen priority messages.

20 The voice messaging gateway converts vendor proprietary voicemail format to the X.400 format and vice versa, thus bridging different messaging formats. It is responsible for voice transcoding from proprietary to or from X.400 form. It also maps options to or from the X.400 protocol as specified in AMIS.

C. Facsimile Messaging

25 Fig. 23 illustrates a PCI service for fax messaging. The PCI server 48 is connected to public switch telephone networks 432 via analog lines 444 or a T1 trunk 445. Fax machines 440 and fax servers 442 are connected to the PSTN 432. The PCI server 48 may also be connected to fax machines 440 and fax servers 442 by private lines 446 or an ISDN 438. For a subscriber to receive faxes, the fax machine telephone number must be supplied to the subscriber profile. The
30 PCI will send a fax to the designated number and may send a text notification message or take other action as the user has selected in the profile. If the user has specified a wireless data terminal

to receive the fax, the PCI server 48 will perform the necessary wireless adaptation and send a fax through a wireless data terminal.

A fax may be sent to a PCI subscriber by routing the fax to the PCI node, the user must dial the telephone number of the PCI server 48 to send the fax to the subscriber. The PCI server 48 will send the fax to the subscriber's telephone number. The PCI server will check the subscriber's user profile to determine how the fax should be delivered. In this example, the fax message is sent to a fax machine at a designated telephone number.

Fax users having existing fax machines 440 must place a call over the PSTN network in order to access the PCI. This is because existing fax machines 420, unlike fax servers 422, are designed for point - to -point communication, not fax network communication. Users of the existing fax machine 420 can access the PCI in two ways. One way is by two stage dialing. The sender first dials the PCI 48 and then dials the recipient's number after receiving a prompt from the PCI. Alternatively, the user can dial *FX+destination address. The fax machine user can directly dial from the fax terminal the recipient telephone number proceeded by *FX, which signals the switch to automatically forward the fax call through the PCI server.

Fax servers that support X.400 messaging will include the personal number in the X.400 address field and there is no reason for the PCI to prompt the user for the personal number.

20 D. CallCommand

PCI CallCommand (CC) service provides subscribers real-time control of voice calls while using a wireless data terminal or PDA. CC is designed to enhance personal number services (i.e., HLR), by providing real time call management capabilities to nomadic users.

CC provides the subscriber with four call management options:

- 25 × *location independence* (supplementing personal number/HLR applications);
- × *real-time call screening* (using ANI and/or prompting the caller to enter a number);
- × *real-time call redirection* (routing calls to any telephone number based on the calling party); and
- 30 × *real-time short messaging* (inputting or selecting a short message to be played to the caller).

When a caller dials a PCI subscriber's telephone number, the caller's telephone number is entered for screening. After the caller's number is entered, the PDA 30 can map the calling number to a name and alert the subscriber of an incoming call. The PDA 30 visually displays the name and/or number of the caller. The subscriber can then use the PDA 30 to accept the call by entering the telephone number of a nearby telephone to which the call will be routed. The subscriber can alternatively have the call forwarded to another number, such as a colleague's phone or a voice mailbox. If the subscriber decides not to respond to the caller, the caller is played an announcement and forwarded to a pre-determined default telephone number, such as a voice mail box or secretary.

CC allows the subscriber to send a brief message to the caller. Upon being alerted to an incoming call, the subscriber can select from a pre-defined list of messages, or type a new message, on the PDA 30. The message is transmitted to the PCI server 48 which converts the text message into speech and plays the message to the waiting caller. The caller receives the message and can leave voice mail for the subscriber, or be forwarded by the subscriber to an alternate telephone number.

Call command enables nomadic subscribers to manage, in real time, incoming calls using screening, rerouting and messaging to the caller. Call command subscribers having a PDA 30 are visually informed of the name and or number of the caller. The subscriber can elect to either accept the call, routing it to a specified number, such as the number of a nearby telephone; route the call to an alternate number, such as a voice mailbox, colleague phone number or secretary phone number; or respond to the caller with a brief keyed in message, which is played back to the caller in synthesized speech. The service also provides a number of non-real time call management features including predetermined screening lists, day of week\time of day routing schedules; and location sequencing. Call command allows mobile subscribers to manage and receive telephone calls using a personal digital assistant.

Call command users pre-subscribe to a wireless data service such as Ardis or RAM mobile data for E-mail, call management, and other wireless data applications. The wireless data provider provides a radio interface to the subscriber's PDA 30. A local exchange carrier interfaces with the wireless data provider over a PCI interface. When a caller enters his or her number the local exchange carrier forwards a data message containing the caller party information. The wireless data provider locates the subscriber and forwards the calling party information to the

subscriber's PDA 30 where the subscriber is alerted of the call. The subscriber then forwards the data packet containing a routing number to the PCI. The PCI reroutes the call accordingly.

Fig. 24 is an illustrative example of a CallCommand service network. A caller, Joe 450, wishes to speak with Mary. Mary, who is away from the office, is a PCI subscriber having the
5 CallCommand service. She has a PDA 30, which is turned on and registered at a visiting location. Joe dials Mary's office phone number. This phone number connects Joe's call to the PCI server 48. The PCI server 48 network instructs Joe to type in his telephone number. The PCI server 48 puts Joe on hold and plays back a message using synthesized speech informing Joe that the network is trying to locate Mary. The network recognizes that Mary is registered at a visiting location and
10 sends a phone notification over a wireless data network 39. Mary is notified on a PDA 30 that a phone call is coming from a particular phone number. If Mary has already programmed a name corresponding to that phone number in a directory on her PDA 30, that name will also appear. Therefore, she is aware that she has a phone call from Joe Smith. Mary has several options. She may type or select a preselected message to be sent from the PDA 30 to the PCI network which
15 converts the message into synthesized speech and play it back to Joe; she may forward the call to a nearby telephone, such as a cellular phone or a nearby pay phone 452 or forward the call to her secretary or colleagues's phone number; she may send a message and forward the call; or she may direct the call to her voice mail. In this illustration, Mary selects that the call be routed to a local public pay telephone 452. The call is routed over public switched telephone networks 432 to the
20 selected telephone and Mary and Joe speak.

CallCommand has several advantageous features. Call command includes real time call screening which allows the subscriber to direct calls in a predetermined fashion based on the caller, the time or date, etc. Call command also has real time call rerouting which allows the
25 subscriber to reroute calls to any phone number on a per call basis. That is, when a call is received, the subscriber may enter a phone number to which she wishes the call to be routed. For example, it may be a phone in an office she is visiting, a rented cellular phone, or a public telephone. In the event that a subscriber cannot respond to a caller because PDA is out of range, the subscriber is preoccupied, the PDA is turned off, etc., the subscriber may select a default routing number. Such a default number could be a voice mailbox, secretary, colleague, or other phone number.

30 Call command also has a call messaging option. This allows the subscriber to send a brief message to a calling party. The message is typed on the PDA 30 and sent by wireless means to the PCI. The PCI converts the signal into synthesized speech and plays it to the caller. For

example, a subscriber may be on an important customer call when his supervisor calls, expecting a response. The call command subscriber can send a message to the manager ("Talking to customer, call you back"), while still communicating with the customer.

5 The call messaging feature has two aspects. The first is the wireless messaging from the PDA 30 to the PCI. The second is the text to speech translation. The subscriber may type in a message on the PDA 30. The message originates as a data message from the wireless data provider network and is forwarded to a local exchange carrier network over the PCI interface. The PCI server 48 translates the wireless text message into speech and plays it back to the caller.

10 Call command also has a predetermined call management option. This feature allows a subscriber to have unanswered calls sent to predetermined default telephone numbers. For example, in the event a call cannot be answered, it is first routed to, for example, a service hotline; if the service hotline does not answer, it is forwarded to a secretary; and if the secretary does not answer, then it is forwarded to voice mail. Each time the call is forwarded to the next number a message is played back to the caller. The routing numbers and sequence order may be altered by
15 updating the subscriber profile in the PCI database.

This feature also allows the subscriber to predetermine the management of certain numbers. For an example, a subscriber may want to be notified in real time only if a calling party number matches that of an immediate family member, supervisor, or important client. In other cases, the subscriber may wish to have calls automatically rerouted to a default number, such as a
20 voice mailbox or secretary. For a company which does business over a large geographic area, the subscriber may wish to have the phone call routed to different places based on the geographic origin of the call. For example, calls originating from New York or New Jersey may be routed to a sales representative for that area and calls originating from California are routed to a sales representative for that geographic area.

25 The call management feature allows the subscriber to predetermine call routing based on the time of day. For example, a subscriber may wish to have calls forwarded to a customer service staff during business hours and be personally notified of calls during non-business hours.

30 Wireless technologies make subscribers constantly available, therefore it is important to give them the ability to accept or decline communication attempts at their discretion. While delivering the calling number to the PDA 30 allows a subscriber to locally screen each attempt as they occur, the subscriber may be in an environment where distractions are unacceptable

such as an important meeting. Therefore, the subscriber is able to create lists against which callers are screened by the network delivering the service. These network resident lists reduce the number of call attempts to the subscriber's remote wireless device. The CallCommand service allows subscribers to turn screening on and off and add or remove numbers and names from these lists.

5 Like the wireless data services, CallCommand service profile management allows subscribers to modify or update their subscriber profiles which preferably reside in a PCI database 44. Profiles are created and deleted by the service integrator controlled by the service provider. A subscriber may modify the profile by either wireless or wireline messaging using DTMF tones or data.

10 The subscriber profile can be updated by a wireless device such as a PDA 30. A subscriber profile may be modified by wireline communications as well. A subscriber may use a telephone or wireline data terminal to contact an PCI database 44. The PCI server 48 acts as a mediation device between wireless terminals and an PCI database 44 for DTMF profile updates. It is preferable that the wireline network be supported by a service management operating system
15 capable of prompting subscribers using a DTMF telephone for a profile update that is completed when the service management operating system makes the appropriate changes in the subscriber's profile in the PCI database 44. When a service management operations system is used to modify the profile in the PCI database 44, the changes should also be reported to PCI server 48 so that the service profile cache 51 may be modified accordingly.

20 Call command has its locus of control in service logic in the PCI database 44. The PCI database 44 service logic provides (1) service status maintenance, which maintains the status of the subscriber as registered or deregistered; (2) call screening, which provides network based screening of incoming calls; (3) call routing, which provides routing destinations for each call; this information is based on information received from the subscriber in real time via the PCI server 48
25 or by preprogrammed instructions in the subscriber profile in the PCI database 44; (4) profile management support, which is service logic in the PCI database which permits "downloading" of the subscriber's profile to the PCI server 48 for presentation to an update by the subscriber through the PDA 30; (5) security, wherein subscriber authentication and validation must be supported to safeguard the subscriber's personal information and status such as location; and (6) accounting
30 management, the PCI database 44 collects accounting parameters to support service provider billing.

The subscriber profile in the PCI database 44 must contain certain information. This type of information includes a subscriber identifier; subscriber authentication information; wireless data provider parameters; registration status; service mode (default, override, or command); screening lists; and routing tables (including day of week and time of day parameters).

5 The application supporting the CallCommand server in the PCI server 48 includes a mobility management function. The mobility management function provides status location information to a database in the PCI database 44 and is responsible for delivering a Temporary Location Destination number on request from the PCI database 44. To do this, the PCI server 48 is responsible for (1) location registration, the PCI server 48 updates the PCI database 44 with the
10 subscriber's PDA 30 status (for example, registered on a wireless data network or registered on a wired telephone); (2) play announcements and digit collection for caller information and presentation to the subscriber; (3) remote alerting, such as formatting and sending call information through a wireless data network to the PDA 30 for presentation to the subscriber; (4) profile management support (the PCI server 48 must support the "downloading" of the subscriber's profile
15 and packaging for presentation to update by the subscriber through the PDA 30); (5) security (the subscriber authentication invalidation information must be supported to safeguard the subscriber's personal information and status such as location); and (6) account management, the PCI server should collect accounting parameters for presentation to the service provider for billing.

20 VII. Message Flows

PCI wireless messaging involves three types of message flow. The first is sending a message from one subscriber to another, the second is receiving a message regardless of whether the subscriber is using a wireless or wireline terminal, and the third is sending a message to a non-subscriber.

25 Fig. 25 is an illustrative example of the message flow of a PCI wireless subscriber sending a message. The PCI user submits a message 502. The message is received by a message transfer agent in the PCI server. The MTA copies and temporarily stores the originating and destination addresses 504. The MTA sends to the mobility manager function in the PCI server a request to validate the sending user as a PCI subscriber 506. The mobility manager sends this
30 validation request to the PCI database and waits for a response 508. Upon receipt of an affirmative validation from the PCI database, the mobility manager sends the validation response to the MTA 510, 512. The MTA then sends the mobility manager a request for the address of the user's home

MTA 514. The mobility manager routes this request to the PCI database 516. Upon receipt of a response from the PCI database, the mobility manager routes the home MTA address to the MTA 518, 520. The MTA then routes the message to the home MTA 522. If a third party PCI database must be consulted, the home MTA request will be directed from the PCI database to a third party
5 PCI database 524, 526.

Fig. 26 illustrates an example of the message flow of a wireless PCI user receiving a message. When the PCI receives a message from a subscriber, the MTA in the PCI server copies and temporarily stores the destination address and the message 530. The MTA sends to the mobility manager function in the PCI server a request for the PCI subscriber's user profile 532.
10 The mobility manager will retrieve this profile request from the PCI database 534 (If third party PCI database is involved, the local PCI database contacts the third party PCI database through a switch transfer point 536, 538.) Upon receipt of the subscriber's profile from the PCI database 540, the mobility manager requests the message from the MTA using a "message forward request" message 542. When the mobility manager receives the message from the MTA 544, the mobility
15 manager processes the message as indicated by the subscriber's profile, which may involve media conversion or screening 546. After processing the message, the mobility manager sends the message to the MTA for delivery 548, 550. Alternatively, the PCI server mobility manager function may directly deliver the message to the termination receiver 552.

Fig. 27 illustrates an example of a message flow from a PCI wireless subscriber to a
20 non-subscriber. When the MTA receives a message from a PCI subscriber 560, the MTA copies and temporarily stores the originating addresses and the message 562. The MTA sends the mobility manager a request to validate the originating address as a PCI subscriber 564. The mobility manager will send this validation request to the PCI database and wait for a response 566. When the mobility manager receives an affirmative validation response from the PCI database 568,
25 the mobility manager sends the validation response to the MTA 570. Next, the mobility manager sends to the PCI database a request for the PCI subscriber's profile 572. Upon receipt of the subscriber's profile from the PCI database 574, the mobility manager requests the message from the MTA using a "message forward request" 576. Upon receipt of the message from the MTA 578, the mobility manager processes the message as indicated by the user's profile, which may require
30 media conversion or obtaining the addresses for the distribution list for the message 580. After processing the message, the mobility manager sends the message to the MTA for delivery 582, 584. Alternatively, the MTA may directly deliver the message 586.

VIII The PDA Application

To better understand the capabilities of PCI and PDA/PCI server interface, a discussion of the PDA user interface is helpful. The user interface is application software residing
5 in the PDA. This software is described by describing the screens displayed on a PCI subscriber's PDA screen. The following discussion is for an illustrative embodiment of the PDA user interface. A person skilled in the art recognized that the interface may be implemented in a myriad of ways.

Fig. 28 is an illustrative example of a PDA user interface main menu. The menu allows the user to enter the CallCommand or wireless messaging services, update the user profile,
10 or check the status of the system by clicking on buttons 610, 612, 614, 616, respectively.

Fig. 29 shows a computer screen after "status request" 616 is selected. The status request screen shows that there are five local originating messages (waiting to be sent by the PDA) and three outgoing messages (waiting to be retrieved) in boxes 618, 620, respectively. The various services' status is also displayed. As seen in Fig. 29, this subscriber's wireline registration is on, as
15 seen in box 622. This registers the subscriber on a particular wireline telephone, seen in box 624. This registration will direct calls to this phone number. The status request also advises this subscriber about the status of the CallCommand and wireless messaging features, as seen in boxes 626, 628.

Fig. 30 illustrates an exemplary screen if the subscriber clicks "Call Command" 610
20 on the main menu (Fig. 28). If the subscriber clicks on "YES" 630, a screen such as Fig. 31 appears. The screen includes a window 632 which shows the status of various received telephone calls. The status indicates whether an incoming call was answered, forwarded to another number, was hung up before being answered; unanswered; or forwarded to voice mail. The phone number and receipt time and date of each call are displayed. The subscriber may save or delete any entry
25 the subscriber by clicking box 634 or 636, respectively. The subscriber may also connect or disconnect the CallCommand service by clicking box 638, 640, respectively.

Fig. 32 is an illustrative example of a screen if the subscriber selected "Wireless Messaging" 512 on the main menu (Fig 28). The subscriber will be connected to the wireless messaging service if "YES" 642 is clicked.

Fig. 33 is an example of a screen which may appear if the subscriber selected
30 "Profile" 614 from the main menu (Fig. 28). If the subscriber selects "Fax" 644 from this screen, a screen such as that shown in Figure 34 may appear, which allows the subscriber to enter a phone

number into box 646 to which faxes will be directed. Turning on e-mail screening activates both the subject and address screening. Subject screening takes priority over address screening parameters.

5 If the subscriber selected "e-mail" 648 on the screen Fig. 33, a screen such seen in Fig. 35 appears. The subscriber can select where e-mail messages should be delivered (destination screening) 650, where notification of e-mail receipt should be delivered (notification screening) 652, whether messages should be screened at all 654 and, if so, how they should be screened 656, 658.

10 The destination 650 allows the subscriber to select destinations for incoming e-mail. Messages that satisfy the screening requirement may be sent to two destinations (match A, match B). As shown in this illustrative example, e-mail received which match the subscriber's preprogrammed screening criteria are to be delivered only to a wireline e-mail, such as the subscriber's personal computer at the office, because match A 660 and match B 662 designate the same destination. All received e-mail messages which do not meet either criteria ("not matched")
15 are sent to a selected fax machine 664, for example, the fax machine at the subscriber's office.

The subscriber also indicates where notification of a received e-mail should be sent 652. Notification for all e-mail messages meeting the screening requirement should be sent to a selected fax machine 666. The PCI network will select information about the e-mail origination such as the author, recipient, and subject matter and convert it to a facsimile format and send the
20 message to a fax machine. Notification of all e-mail that does not meet the screening criteria are sent to a pager 668. The PCI network will take the originating message information and turn it into alphanumeric information according to the TAP protocol and send it to the subscriber's pager. If the screening option is turned off, notification of all incoming e-mail is sent to voicemail 670. The PCI network will convert the origination information from text to synthesized speech and send
25 the information to a selected voice mailbox.

The user may also select whether to screen incoming e-mail messages at all 654. If the screening is on, the user may screen e-mail based on the originating address 656 or subject matter 658.

30 Fig. 36 is an illustrative screen which the subscriber may use to edit e-mail screening according to address by clicking box 656 (Fig. 35). The subscriber may input new e-mail addressees into box 672 and add them to a list by clicking a box 674 or select addresses already entered to be included in a screening criteria as seen in box 676. For example, the user may want

e-mail messages originating from the following addresses to be routed according to the screening criteria: cc!stanp, cc!rizzo, and cc!rupin. E-mail messages originating from these addresses will be routed and notified according to the criteria selected on the screen illustrated in Fig. 35.

5 If the user selected to edit the "subject" a screening criteria based on "subjects" by clicking box 658 (Fig. 35), a screen such as that illustrated in Fig. 37 is presented. The user may type in to boxes 678 particular subjects which should be routed according to a screening criteria. The subject will search the incoming e-mail origination information to determine the subject of the e-mail. Subjects may include "urgent", "personal", the name of a client or project, etc.

10 If the subscriber viewing the "profile menu" (Fig. 33) clicked "voice mail" 680, a screen such as that illustrated in Fig. 38 is presented. The subscriber can type into a box 682 in the destination voice mail system phone number. The subscriber may also select notification based on certain screening criteria 684. If the incoming voice mail message matches the screening criteria, the subscriber has selected to be notified by a message sent to the PDA 686. If the voice mail message does not match a screening parameter, the subscriber has selected to not be notified 688.
15 If the screening option is turned off, the subscriber has decided to not be notified of any voice mail messages 690.

The user has the option of turning the screening on or off 692. If the screening is on, the messages are screened by caller 694. If the user decides to screen by caller by clicking box 694, a screen such as illustrated in Fig. 39 is displayed. The user may type into boxes 696 certain incoming phone number which meet the screening parameters.
20

If the subscriber viewing the "profile menu" (Fig. 33) clicked "Call Command", 698 a screen such as illustrated in Fig. 40 is displayed. The subscriber may type in a box 700 a wireline registration telephone number, which is a number to which incoming calls may be forwarded. The subscriber has the option to edit screening criteria phone numbers or to edit reply messages to be sent to the caller.
25

If the subscriber wishes to edit forwarding call numbers box 702 is clicked and a screen such as illustrated in Fig. 41 is displayed. The user may type into boxes 704 or select certain phone numbers which are to be forwarded to a preselected phone number if screening is on.

30 If the subscriber viewing the "Call Command" screen (Fig. 39) clicked "edit messages" 706, a screen such as illustrated in Fig. 42 is displayed. The user may compose a unique message in box 708 or edit one already on a list shown in box 710.

If the subscriber has connected the Call Command and an incoming call is received, a screen such as that illustrated in Fig. 43 is displayed. This screen displays in a box 712 the number from which the incoming call originates. The user has the option of sending a message and forwarding the call by clicking box 714, forwarding the call without a message by clicking box 716, 5 sending a message and not forwarding the call by clicking box 718, or routing the call to voice mail by clicking box 720.

If either the "message and forward" or "forward" 716 option is selected, a screen such as that illustrated in Fig. 44 is displayed. This allows the subscriber to select one of several the preselected phone numbers 722-728 to forward, or select another phone number, such as a 10 nearby telephone to which the call is to be forwarded. This phone number may be typed into a box 730.

If the user selected the "message and forward" 714 or "message only" 718 selections, a screen such as that shown in Fig. 45 is displayed. This allows the subscriber to type in a message into a box 732 or select a predetermined message shown in box 4134 to be sent to the 15 incoming caller. This message is sent by wireless communications to the PCI network where the ISP converts the message into synthesized speech and plays it for the caller. For example, if the subscriber desires to call back the incoming caller as soon as possible, the message "will call back ASAP" is selected. This message is transmitted from the PDA by wireless communications to the PCI network. The ISP will receive the message and convert it to synthesize speech and send the 20 synthesize speech message to the incoming caller.

IX. Billing

Billing operations is supported by an Automatic Message Accounting Network Function. The automatic network accounting measures, collects, formats and outputs network 25 usage information to upstream billing and other operation application and service purposes. Preferably, automatic message accounting data is collected at various stages of service flows across network equipment and services.

X. Conclusion

A system has been described which enables a wireless PDA user to remotely control a large number of messaging and call handling options.

5 While the invention has been described by the reference to specific embodiments, this was for purposes of illustration only and should not be construed to limit the spirit or the scope of the invention.

We claim:

1. A personal communication internetworking for sending and receiving wireless and wireline messages:
 - (1) a server, including:
 - 5 (a) a message transfer agent interfaced with at least one wireline data network;
 - (b) a wireless data network protocol handler connected to the message transfer agent and interfacing with at least one wireless data network;
 - (c) a mobility controller, including
 - 10 i. a subscriber profile cache;
 - ii. a message router responsive to message routing parameters in the subscriber profile;
 - iii. an interface connected to exchange message routing parameters between the subscriber profile and the at least one wireless network;
 - iv. an interface connected to exchange message routing parameters
15 between the subscriber profile and a personal communication control point; and
 - v. an interface with at least one of a telephone network, an alphanumeric pager network, and a voice peripheral; and
 - (2) the personal communication control point connected to the server, including:
 - 20 (a) a first interface connected to exchange DTMF message routing parameter signals with the server;
 - (b) a second interface connected to exchange generic data message routing parameter signals with the server;
 - (c) a subscriber profile connected to receive and maintain message routing parameters; and
 - 25 (d) a call processor connected between the subscriber profile and the first and second interfaces.
2. The personal communication internetworking of claim 1, wherein the internetworking is built on an Advanced Intelligent Network architecture, the server is an Intelligent Peripheral, and
30 the control point is a Service Control Point.

3. The personal communication internetworking of claim 1, further including a personal digital assistant having a wireless data network interface connected to exchange message routing parameters and an application designed to communicate with the interface to receive, update, and transmit the message routing parameters.
- 5
4. The personal communication internetworking of claim 1, wherein the server further comprises:
a message converter connected to receive from an interface a message in a first format and output to another interface the message in second format.
- 10
5. A method for personal communications internetworking, comprising the steps of:
(a) storing a subscriber profile containing message routing commands for a subscriber;
(b) receiving any of an electronic mail, a facsimile, and a voice mail message addressed to the subscriber from either of a wireless and a wireline network;
15 (c) consulting the subscriber profile for instructions for routing the received message;
and
(d) routing the received message to any of a wireless or wireline network according to the instructions in the subscriber profile.
- 20
6. The method of claim 5, further comprising the step of converting the received message into a different format if the subscriber profile instructs routing the received message in the different format.
7. The method of claim 5, further comprising the step of remotely updating the routing
25 commands in the subscriber profile via one of a wireless and a wireline data network.
8. The method of claim 5, wherein the received message is addressed to a single subscriber telephone number regardless of format.
- 30
9. The method of claim 5, further comprising the step of sending a message notifying the subscriber of the received message.

10. A method for routing incoming telephone calls, comprising the steps of:
- (a) storing a subscriber profile containing telephone, routing, and screening parameters including at least one of incoming telephone call origin, time of day, and day of week;
 - (b) receiving a telephone call directed to the subscriber;
 - 5 (c) consulting the subscriber profile to determine where to route the received telephone call; and
 - (d) routing the telephone call according to the subscriber profile.
11. The method of claim 10, further comprising the step of remotely updating the subscriber profile via a wireless data network.
12. The method of claim 10, further comprising the step of remotely updating the subscriber profile via either a wireless and a wireline telephone network.
13. The method of claim 10, further comprising the steps of:
- (a) if the subscriber profile so instructs, notifying the subscriber of the received telephone call via a wireless data network message; and
 - (b) the subscriber selecting one of:
 - (i) forwarding the call to a subscriber selected telephone number;
 - 20 (ii) selecting a text message to be transmitted over the wireless data network and converted into synthesized speech and played to the incoming telephone call; and
 - (iii) forwarding the call and selecting a text message.
14. A communication apparatus, comprising:
a personal communications internetworking:
- 25 (i) having a number of subscribers, each subscriber having a single address to which all incoming communications are addressed;
 - (ii) being connected to receive and transmit communications from a plurality of wireless and wireline communications networks;
 - (iii) having a profile configured to store communication forwarding options
 - 30 for each subscriber; and
 - (iv) having a communication router connected to receive the received communications from the plurality of wireless and wireline networks and being responsive to

the profile for transmitting the received communications according to the stored communication forwarding options.

15. The communications apparatus of claim 14, wherein the communication information includes incoming communication delivery and outgoing communication origination
5 information.
16. The communication apparatus of claim 14, wherein the profile is connected to receive and store revised communication forwarding options from a subscriber.
17. The communication apparatus of claim 16, wherein the profile is connected to receive the revised communication forwarding options from one of a wireless and a wireline network.
- 10 18. The communication apparatus of claim 17, wherein the profile is connected to receive revised communication forwarding options in the form of dual tone modulated frequency signals from a telephone.
19. The communication apparatus of claim 17, wherein the profile is connected to receive revised communication forwarding options in the form of generic data messages from a
15 generic data interface.
20. The communication apparatus of claim 14, wherein the single address is a telephone number.
21. The communication apparatus of claim 14, wherein the communications include at least one of telephone, pager, facsimile, voice mail, and electronic text communications.
- 20 22. The communication apparatus of claim 14, wherein the communication router further includes a media format translation device configured to translate a received communication into a different communication medium for transmission.
23. The communication apparatus of claim 14, wherein the profile further stores cross-media notification information and the personal communications internetworking further
25 includes a cross-media notification device responsive to the received communication received on one of the plurality of wireless and wireline communications networks, and to the profile, and being configured to transmit in a first preselected medium a notification signal indicating receipt of the received communication.
24. The communication apparatus of claim 23, wherein the cross-media notification
30 information includes a second preselected medium and, when the first preselected medium is not available, the cross-media notification device transmits in the second predetermined medium the notification signal indicating receipt of the received communication.

25. The communication apparatus of claim 14, wherein the profile further includes received communication screening information and the communication router is further responsive to the screening information.
26. The communication apparatus of claim 25, wherein the received communication
5 screening information includes information to screen communications based on at least one of a received communication's media type, time of day received, day of week received, origin, and sender.
27. The communication apparatus of claim 14, further including a server connected to the profile.
- 10 28. The communication apparatus of claim 27, wherein the server includes a call processor.
29. The communication apparatus of claim 28, wherein the call processor comprises a plurality of interconnected computers.
30. The communication apparatus of claim 28, wherein the call processor includes an
15 interface with at least one of the profile, a wireless data network, an alphanumeric paging network, a telephone network switch, and a voice peripheral.
31. The communication apparatus of claim 30, wherein the voice peripheral includes a text-to-speech converter.
32. The communication apparatus of claim 28, wherein the call processor further includes
20 a service profile cache which contains a subset of information stored in the profile, which subset of information is currently frequently needed.
33. The communication network of claim 27, wherein the server further includes a data messaging peripheral.
34. The communication device of claim 33, wherein the data messaging peripheral
25 includes an interface with at least one electronic messaging network.
35. The apparatus of claim 14, wherein the internetworking is built on an Advanced Intelligent Network architecture.
36. The apparatus of claim 14, wherein the internetworking is a network adjunct.
37. The communication device of claim 14, wherein the communication router further
30 comprises an audio messaging interface specification analog protocol connected to a public telephone network.

38. The communication device of claim 14, wherein the communication router further comprises an audio messaging interface specification digital protocol connected to at least one of a modem, a private line, and an integrated signalling digital network basic rate interface.
39. The communication device of claim 14, wherein the communication router further
5 comprises at least one of an analog line connected to a public switched telephone network, a private line, and an integrated signalling digital network.
40. The method of claim 7, wherein the step of updating is done via a wireless network and further includes:
- a. transmitting a data request from a terminal over a wireless network to the profile;
 - 10 b. transmitting the requested data from the profile over the wireless network to the terminal;
 - c. updating the routing commands at the terminal;
 - d. transmitting the updated routing commands over the wireless network to the profile; and
 - 15 e. storing the updated routing commands in the profile.
41. The method of claim 40, further including after the step of transmitting the updated routing commands:
- a. generating an update acknowledgement signal; and
 - 20 b. transmitting the update acknowledgement signal over the wireless network to the terminal.
42. The method of claim 9, wherein the step of sending a message further includes notifying the subscriber of a received telephone call.
43. The method of claim 42, further including after the step of notifying, the step of selecting any one of:
- 25 a. forwarding the telephone call to a selected telephone number;
 - b. selecting a text message to be transmitted over the wireless data network and converting the text message into synthesized speech and played to the incoming telephone call; and
 - c. forwarding the call and selecting a text message.
- 30 44. The method of claim 42, further including the step of remotely updating the subscriber profile via either one of a wireless and a wireline telephone network.

45. The method of claim 44, wherein the step of updating includes using DTMF signals to update the subscriber profile and storing the updated profile.
46. The method of claim 44, further including after the step of updating:
- a. generating an update acknowledgement signal; and
 - 5 b. transmitting the update acknowledgement signal over the telephone network.
47. The method of claim 5, further including delivering a single message according to a distribution list stored in the subscriber profile, the distribution list instructing the message to be delivered to a plurality of addresses via one of an electronic mail and a facsimile format.
48. The method of claim 5, wherein the step of receiving a voice mail message
- 10 addressed to the subscriber further includes the steps of:
- a. receiving from an originating voice mail system voice mail information including identification information;
 - b. extracting the identification information from the message to determine the origin of the voice mail message;
 - 15 c. the step of consulting further comprising determining if the identification of the originator indicates that the originator is also the subscriber;
 - d. if the originator is the subscriber, the step of routing further comprises the steps of:
 - i. not forwarding the voice mail message to the communication network; and
 - 20 ii. extracting header information from the identification information and transmitting a notification to the subscriber containing the header information;
 - e. if the originator is not the subscriber, the step of routing further includes the steps of:
 - i. if the message exceeds a predetermined length, rejecting the message; and
 - 25 ii. if the message is less than or equal to the predetermined length, the communication router accepting the message; and
 - f. the step of routing the received message further includes routing the voice mail message according to routing instructions in the profile.
49. The method of claim 48, wherein before the step of routing, the step of translating the voice mail message from analog format into a digital format.
- 30 50. The method of claim 48, wherein before the step of routing, the step of translating the voice mail message from a digital format into an analog format.

51. The personal communication internetworking of claim 1, wherein the internetworking is a network adjunct.

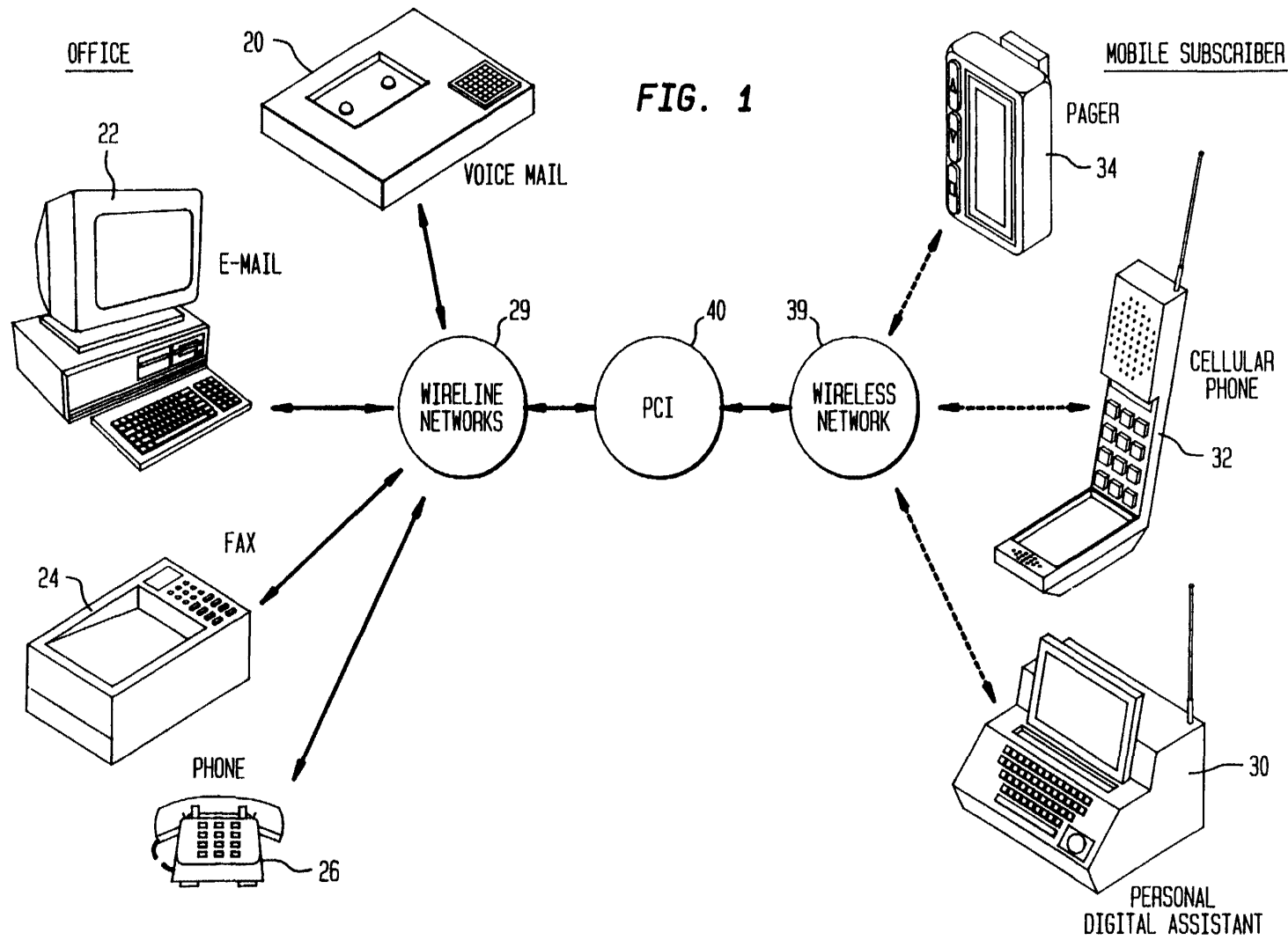

FIG. 1

FIG. 2

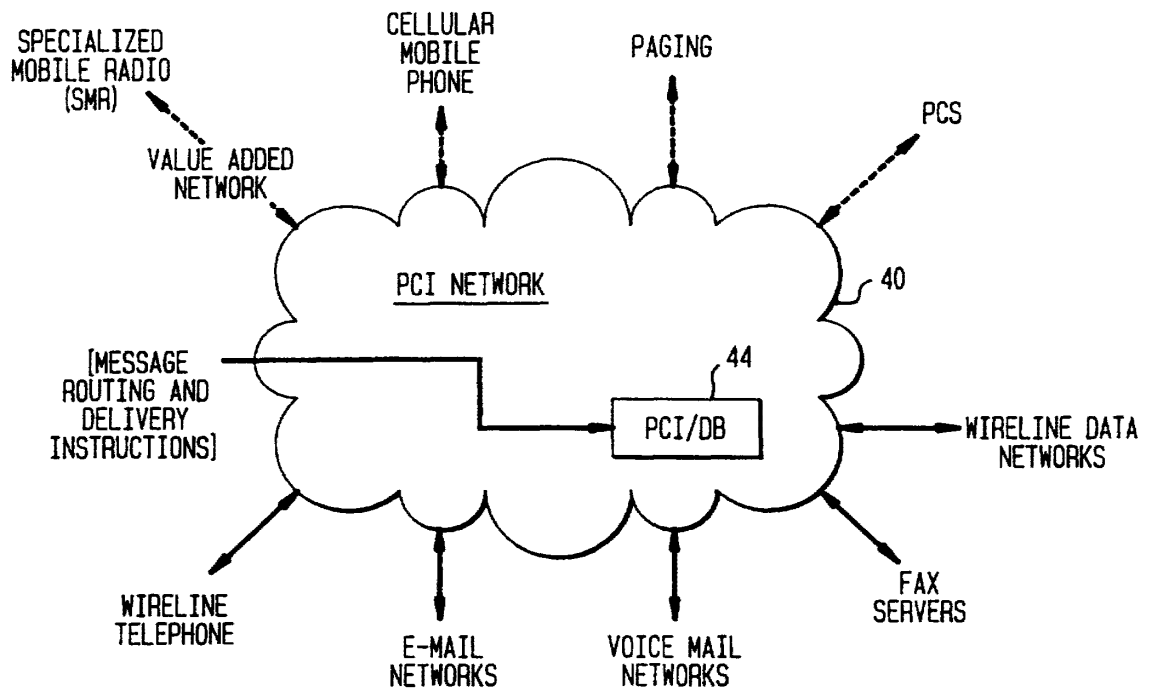
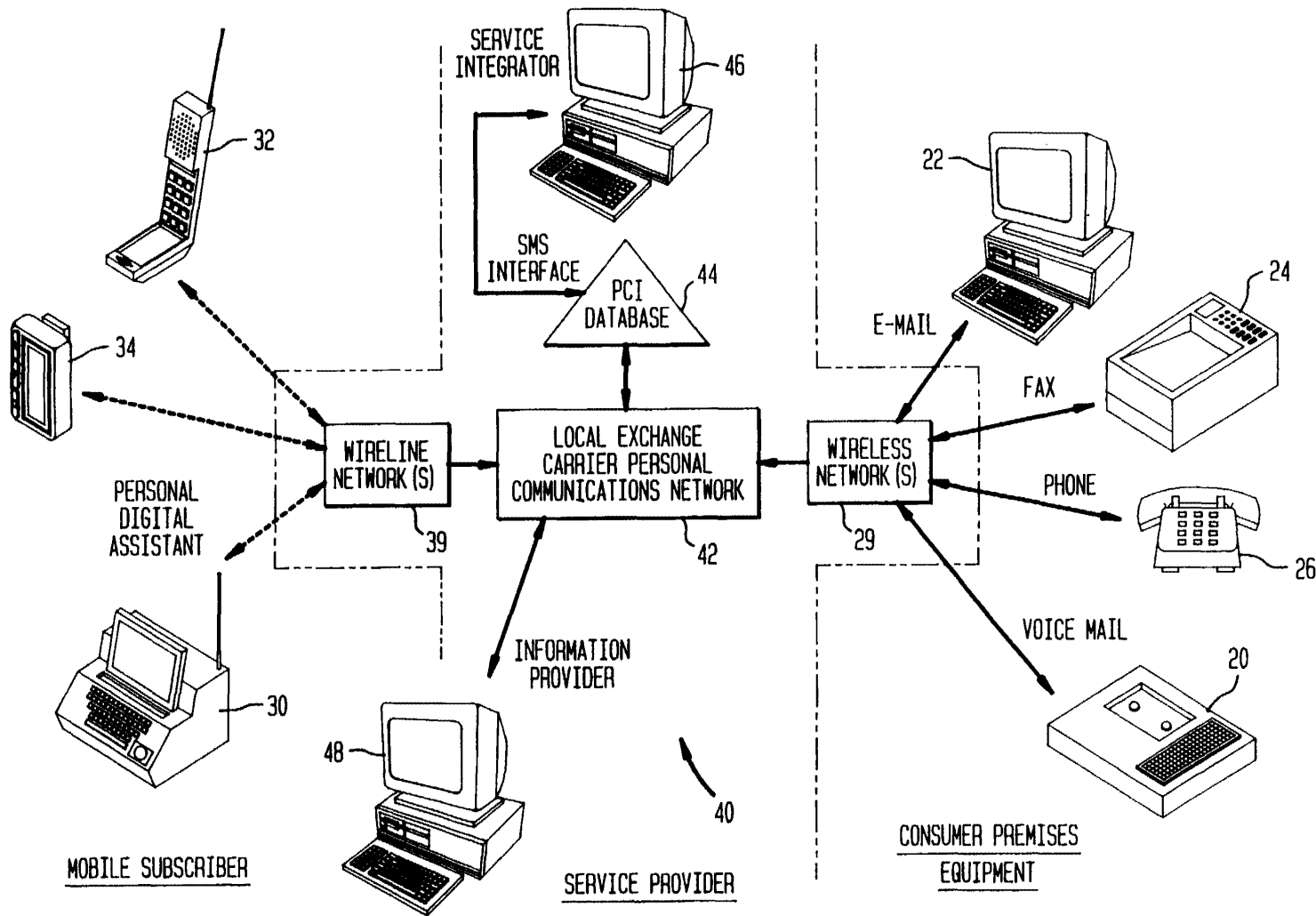

FIG. 3



3/26

WO 97/33421

PCT/US96/03064

FIG. 4

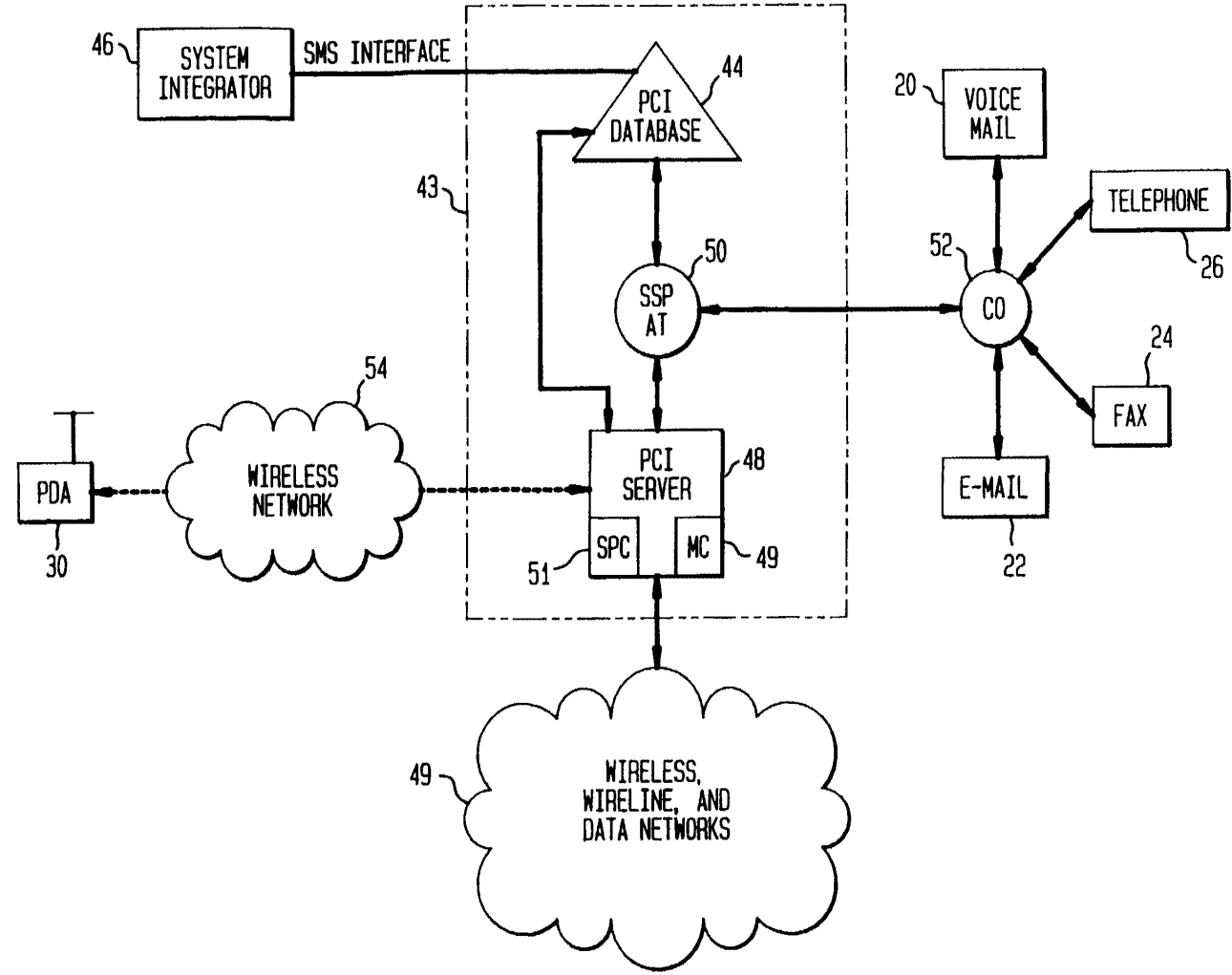
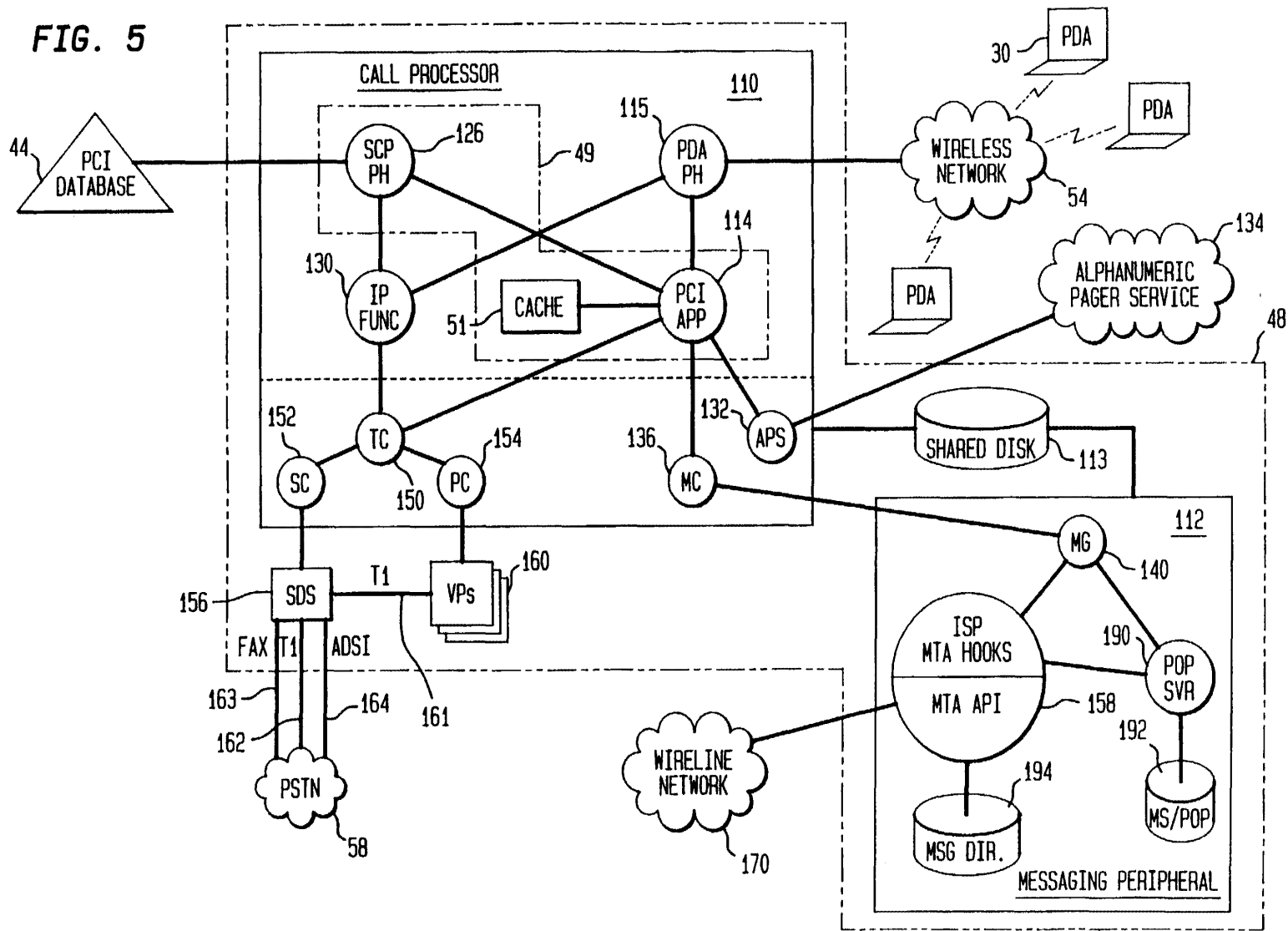

FIG. 5



5/26

FIG. 6

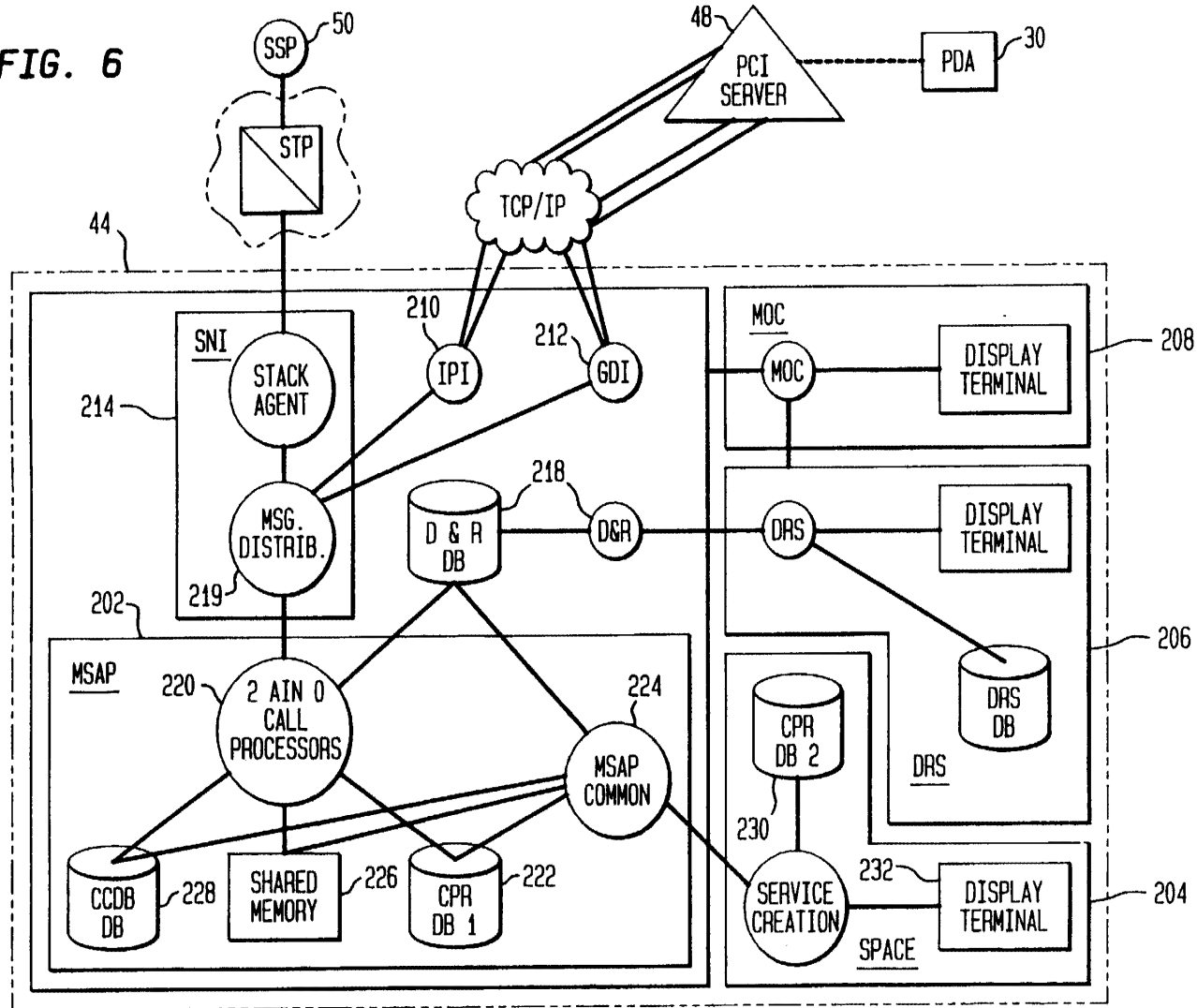
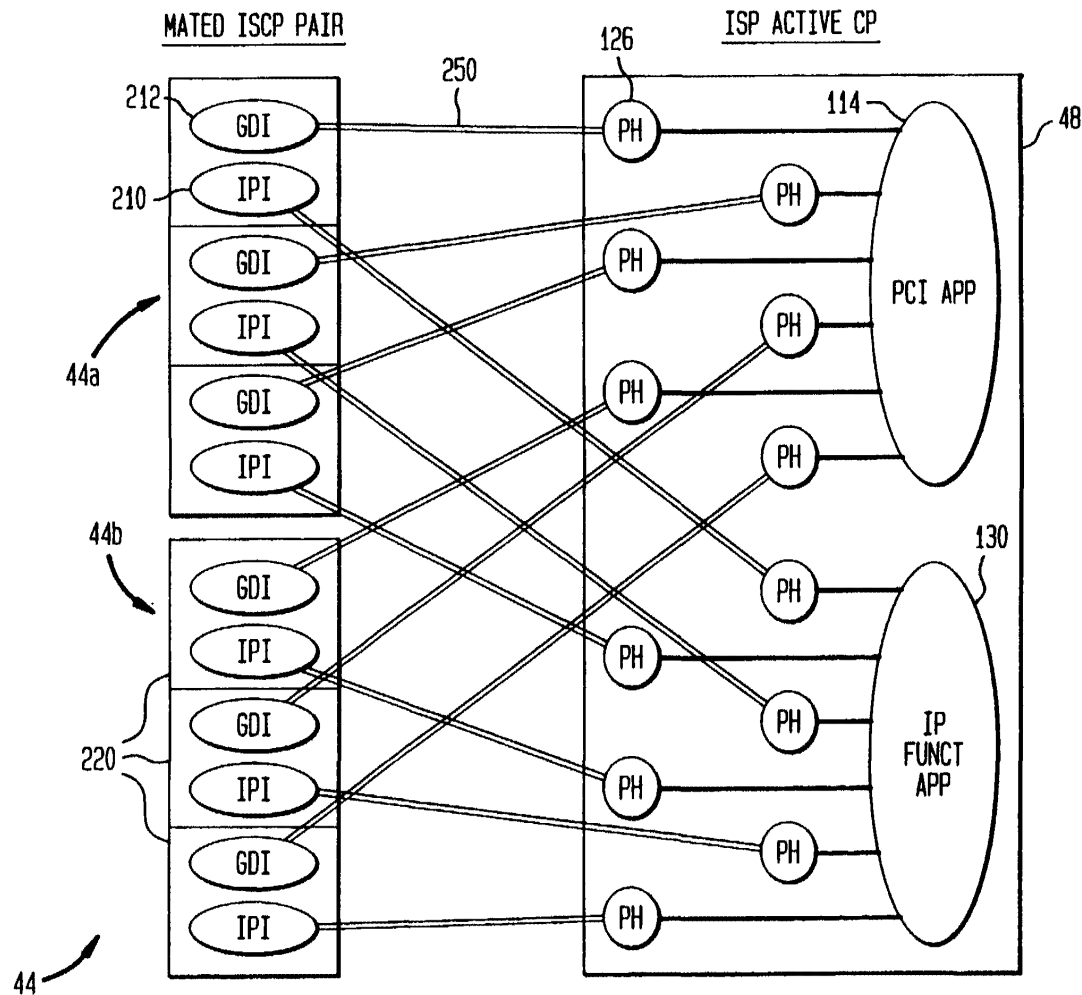

FIG. 7



8/26

FIG. 8

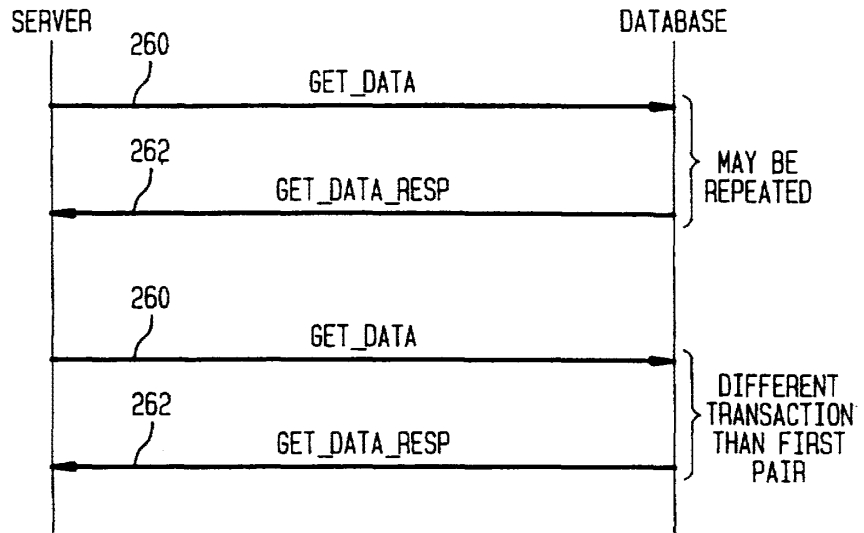
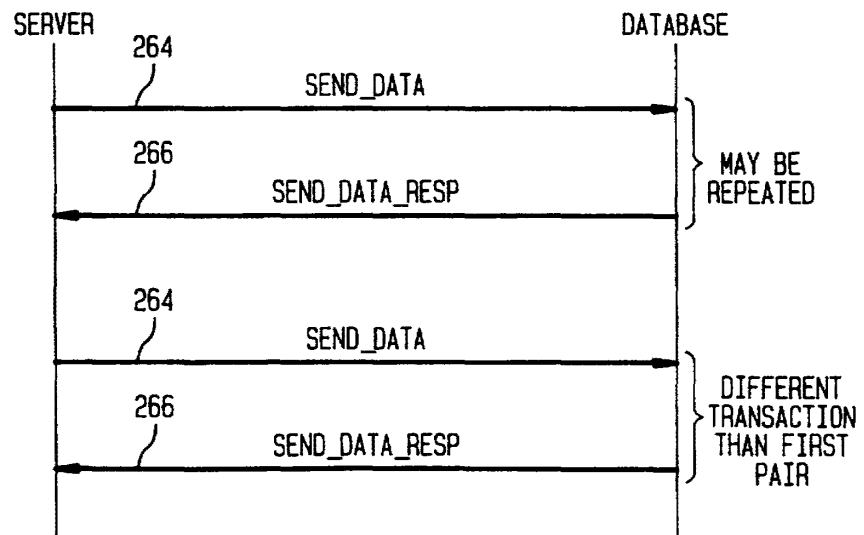

FIG. 9



9/26

FIG. 10

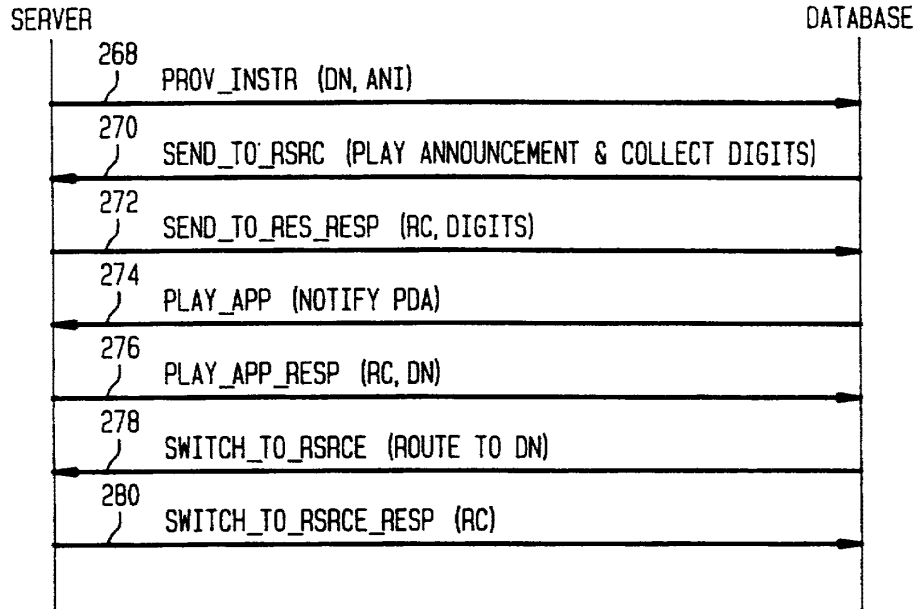
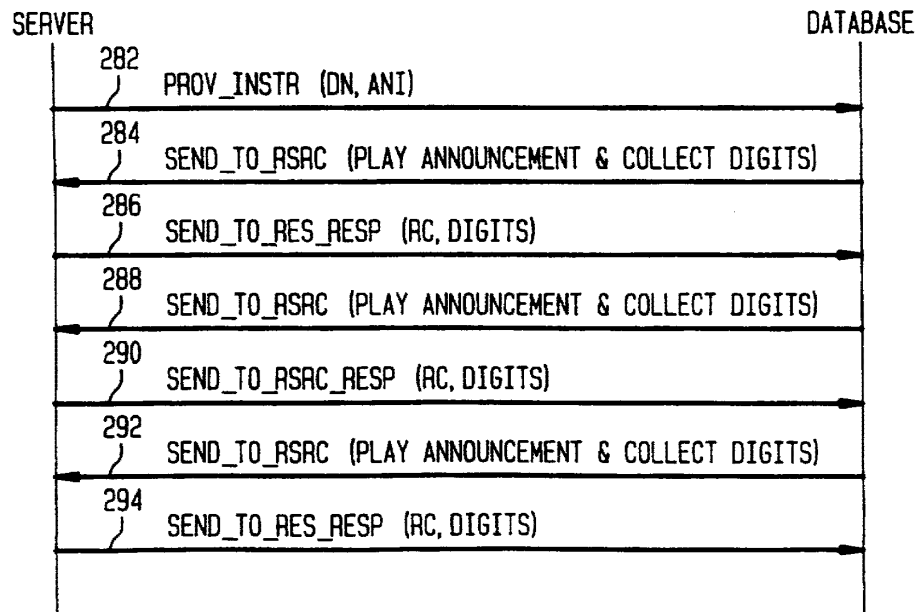

FIG. 11



10/26

FIG. 12

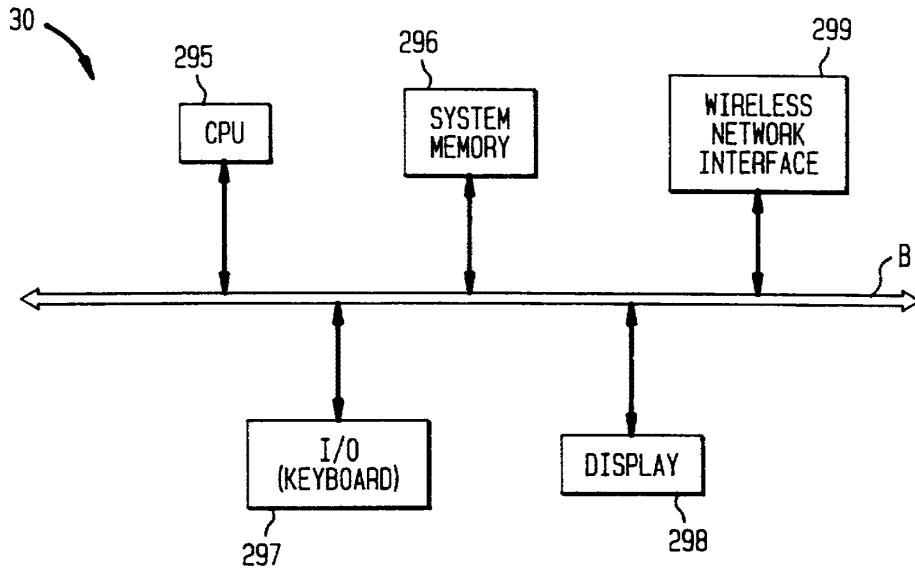

FIG. 13

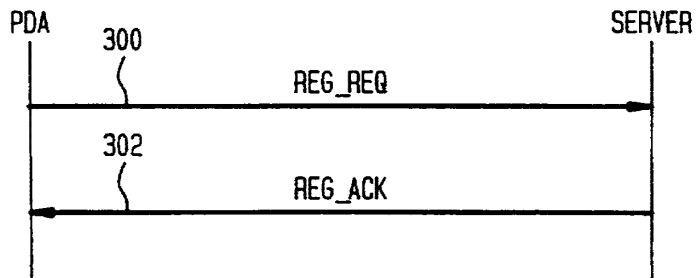
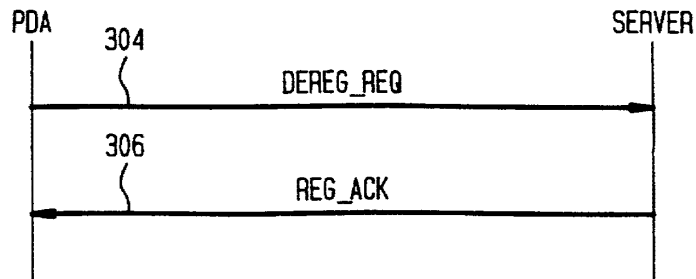

FIG. 14



11/26

FIG. 15

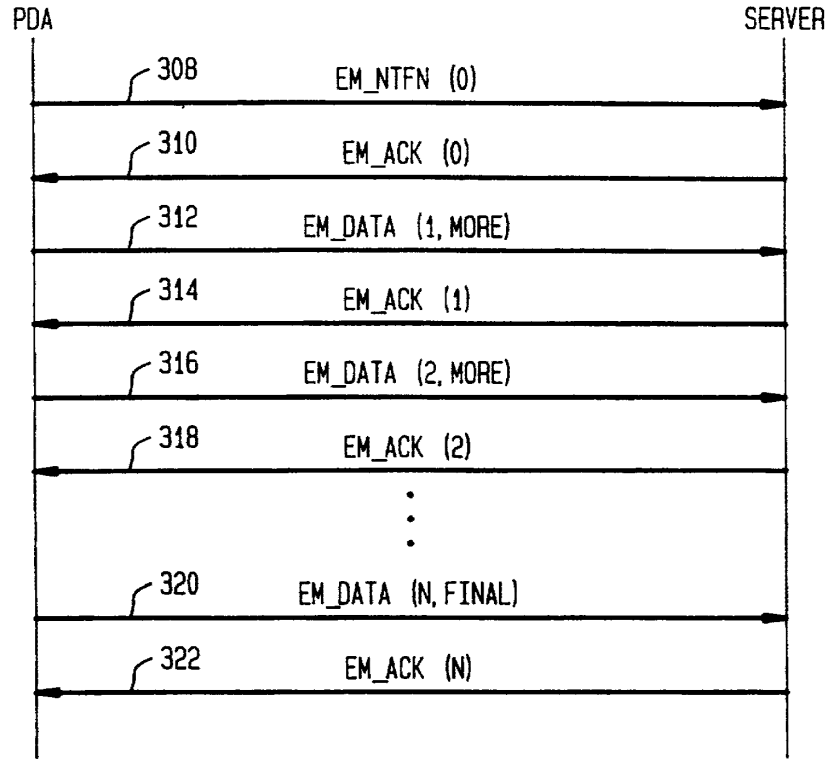
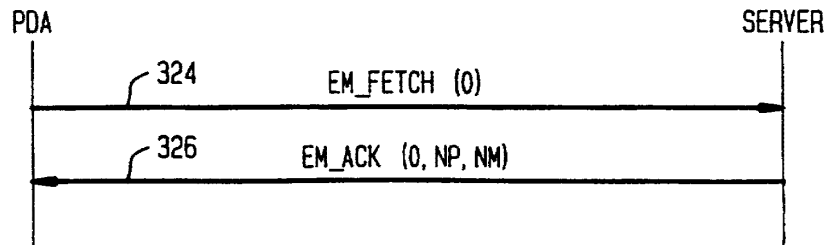

FIG. 16A



12/26

FIG. 16B

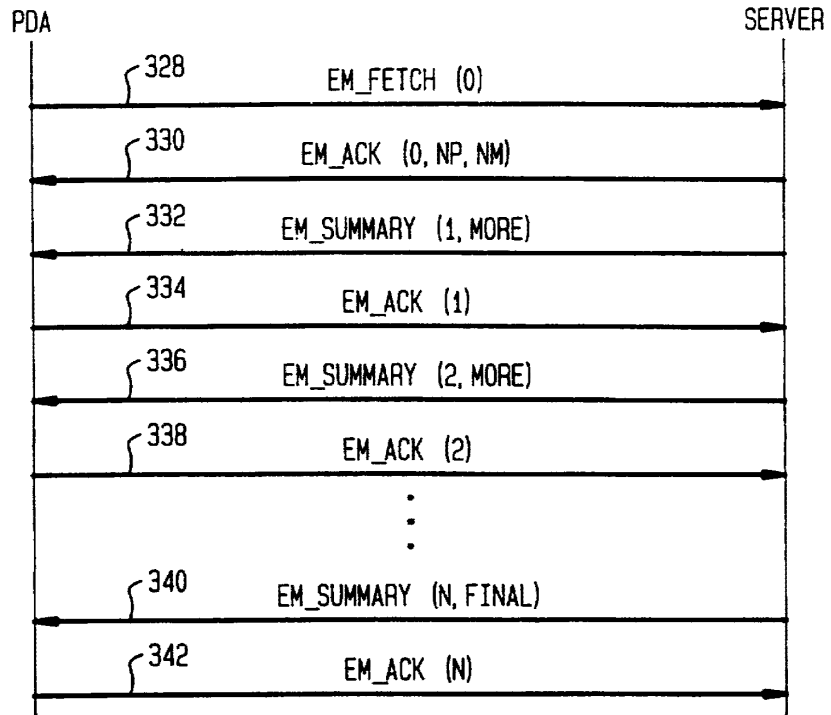

FIG. 17

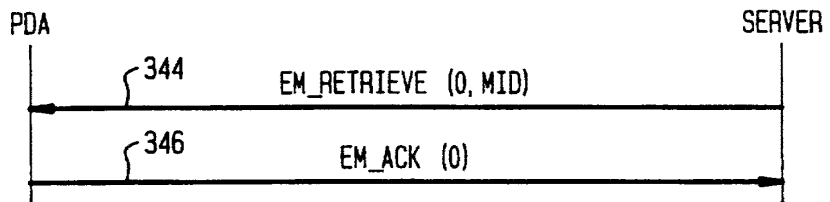
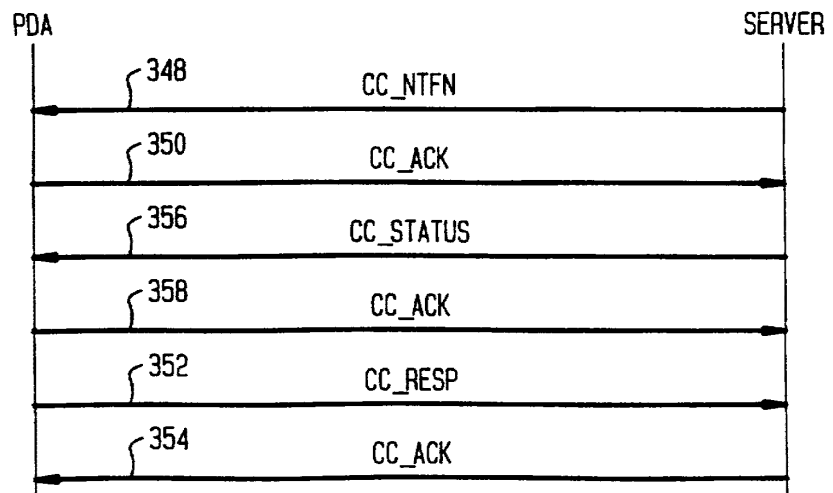

FIG. 18



13/26

FIG. 19

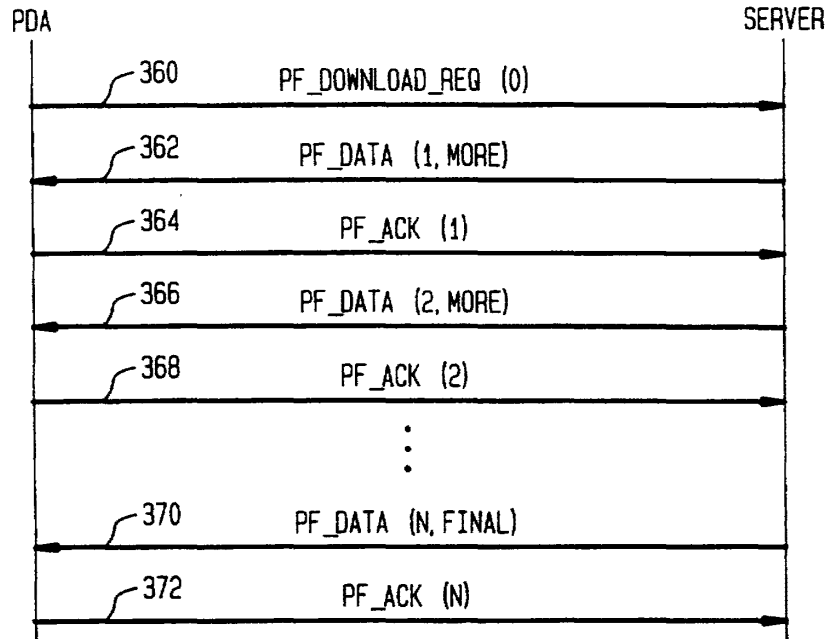
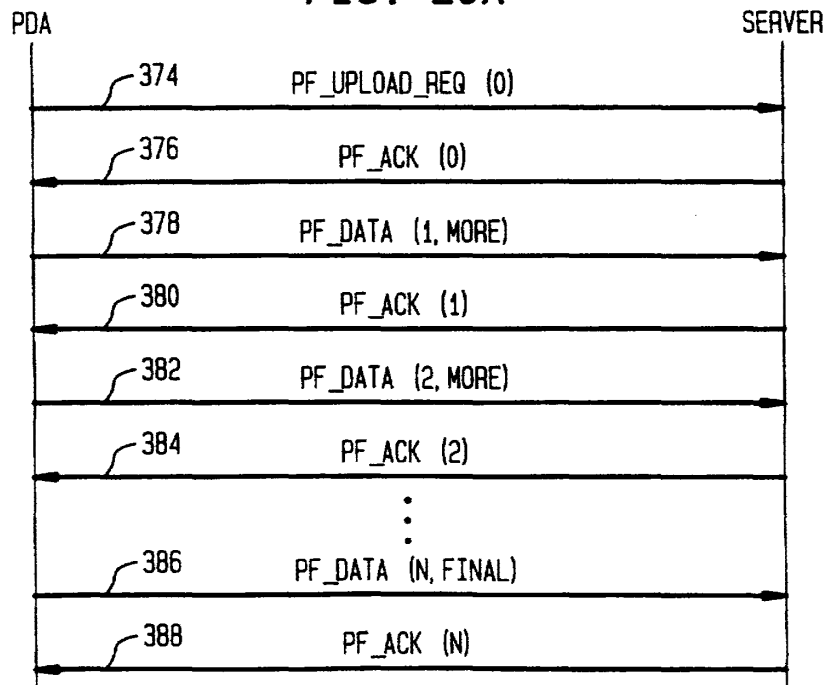

FIG. 20A



14/26

FIG. 20B

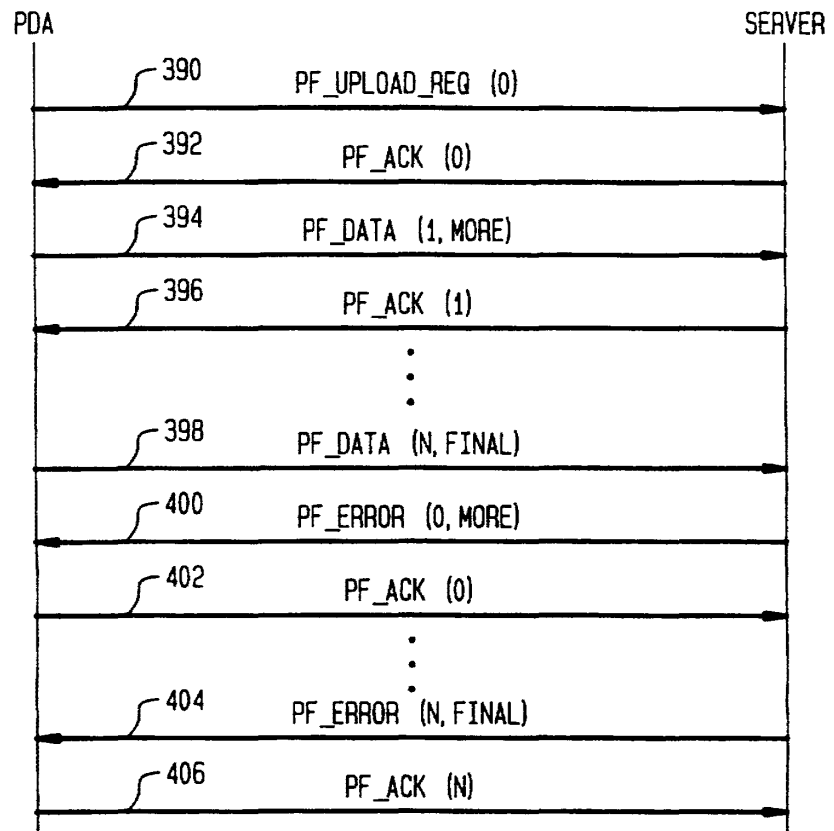

FIG. 21

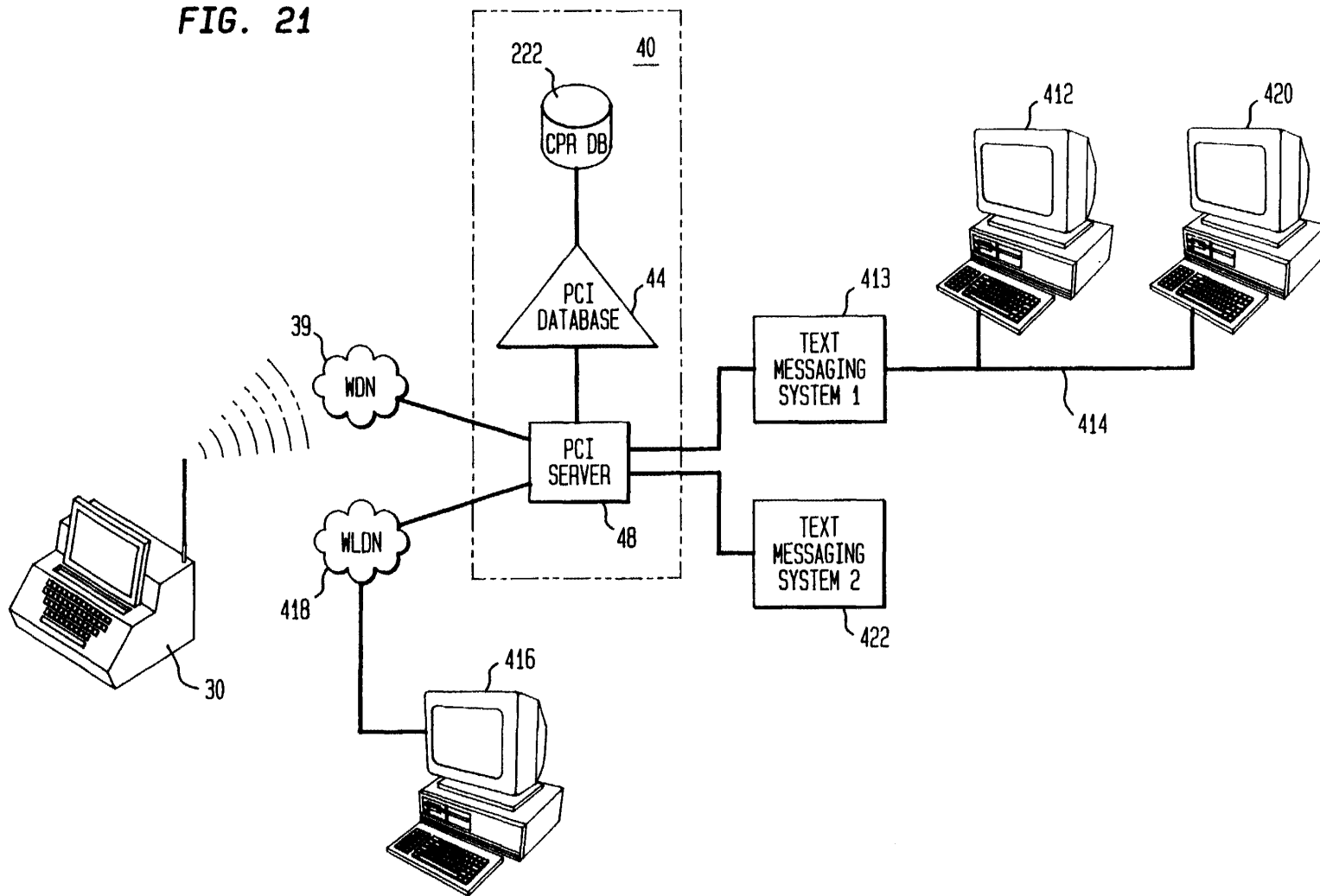

FIG. 22

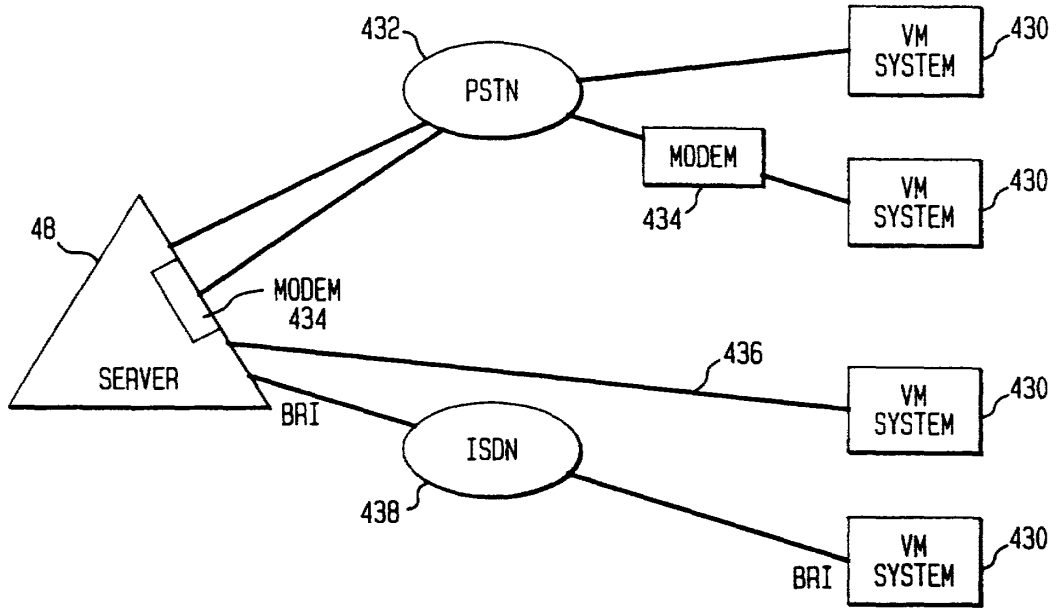
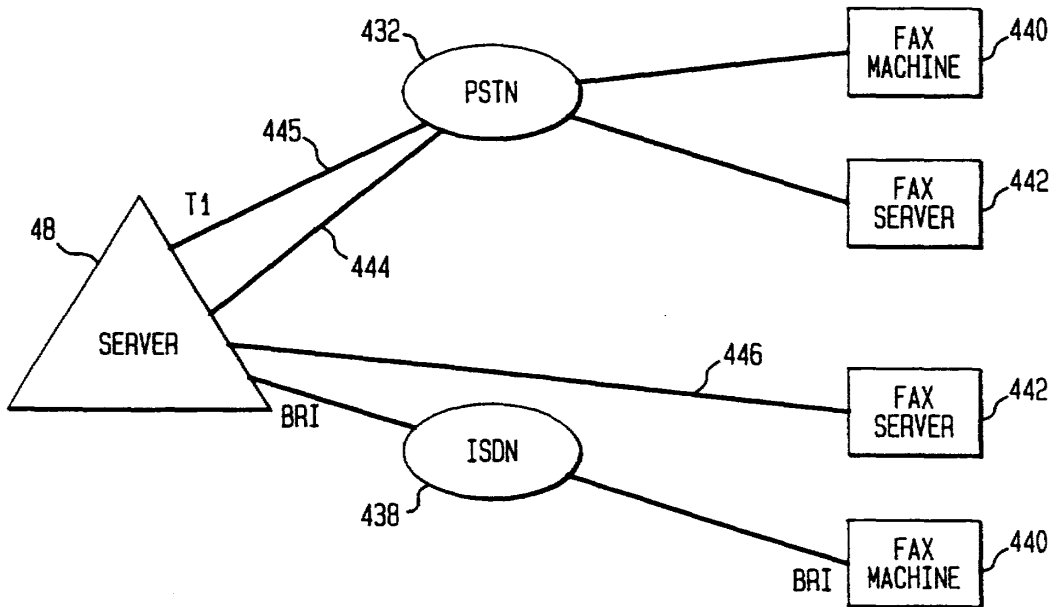

FIG. 23



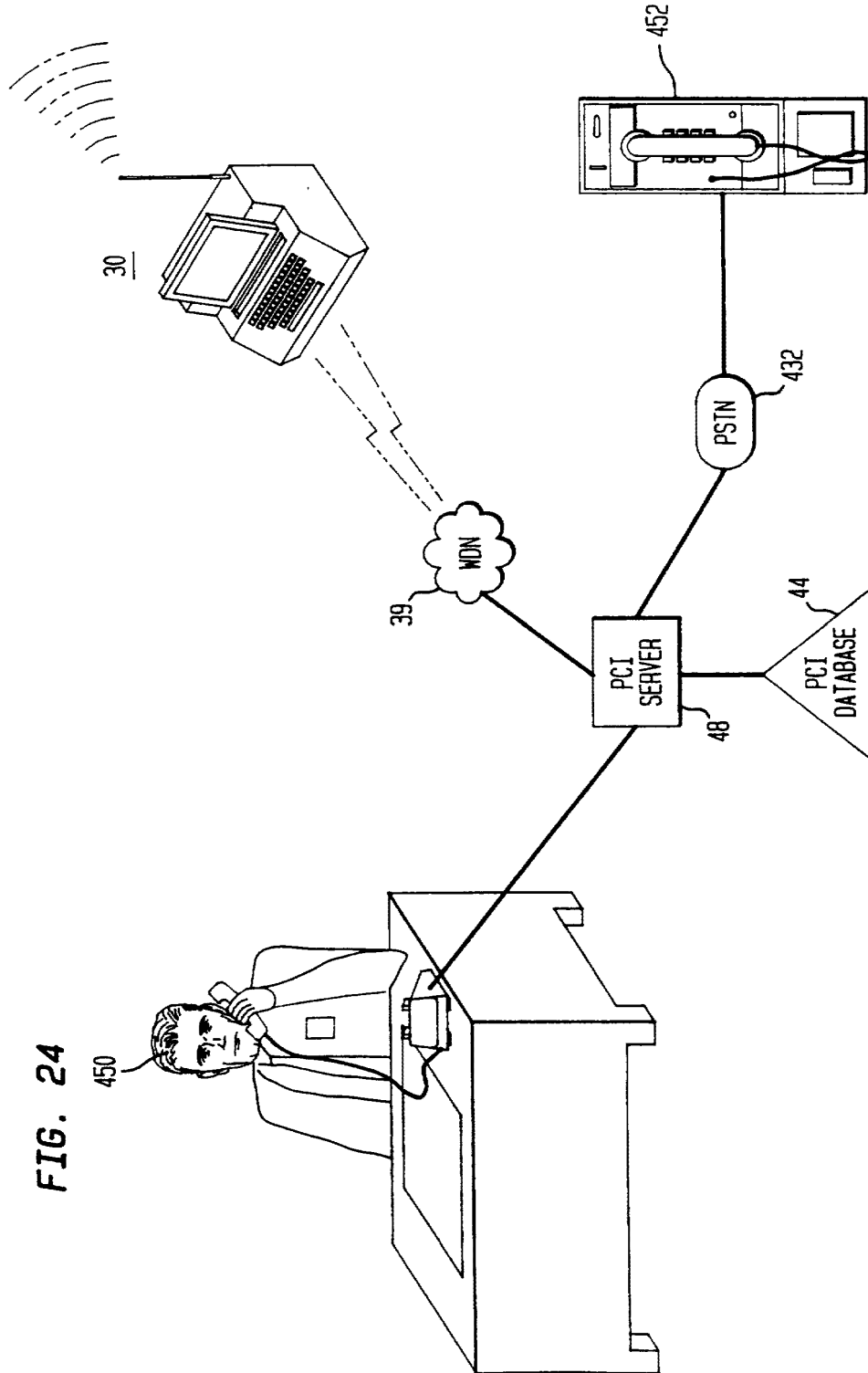
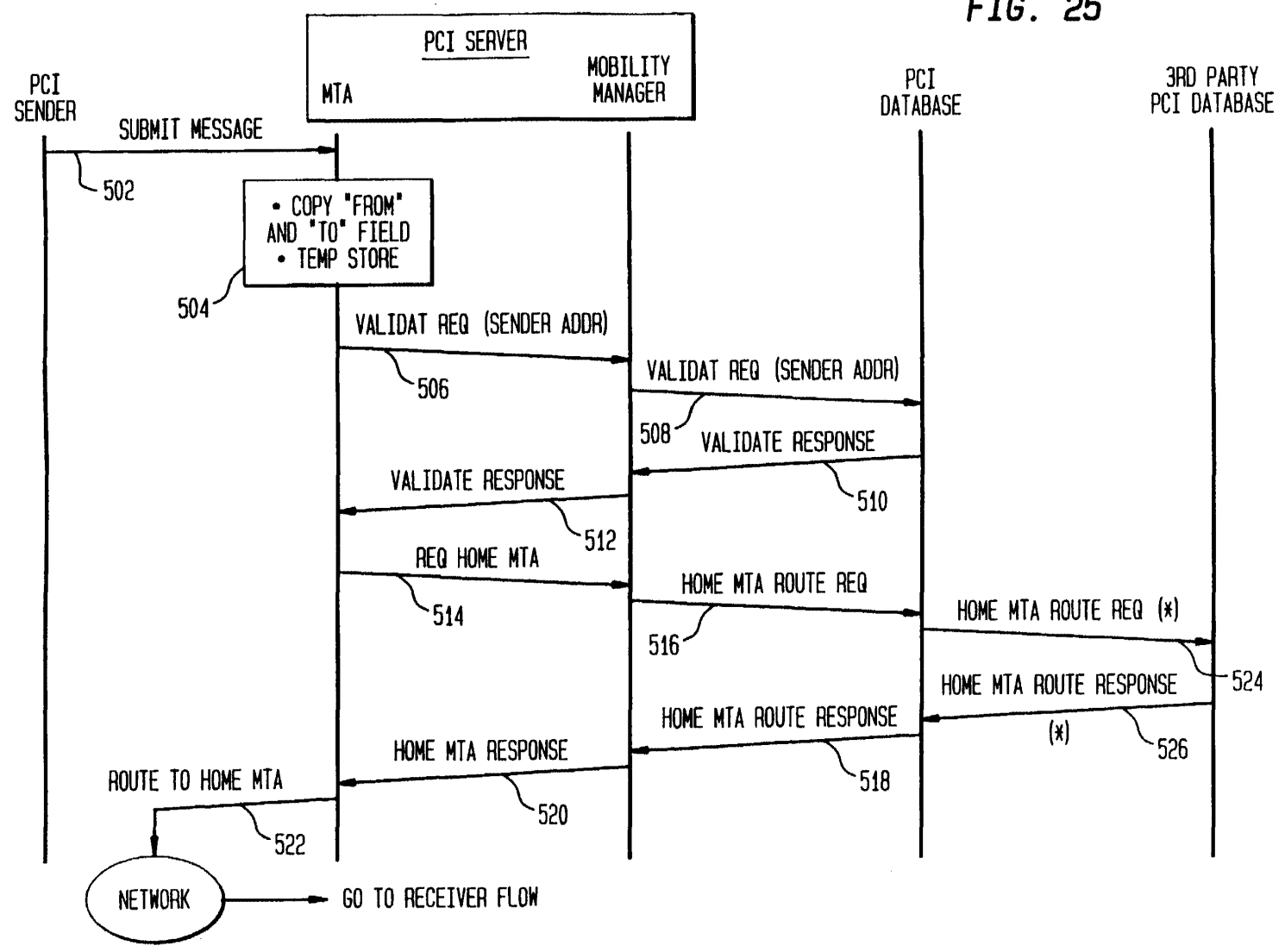

FIG. 24

FIG. 25



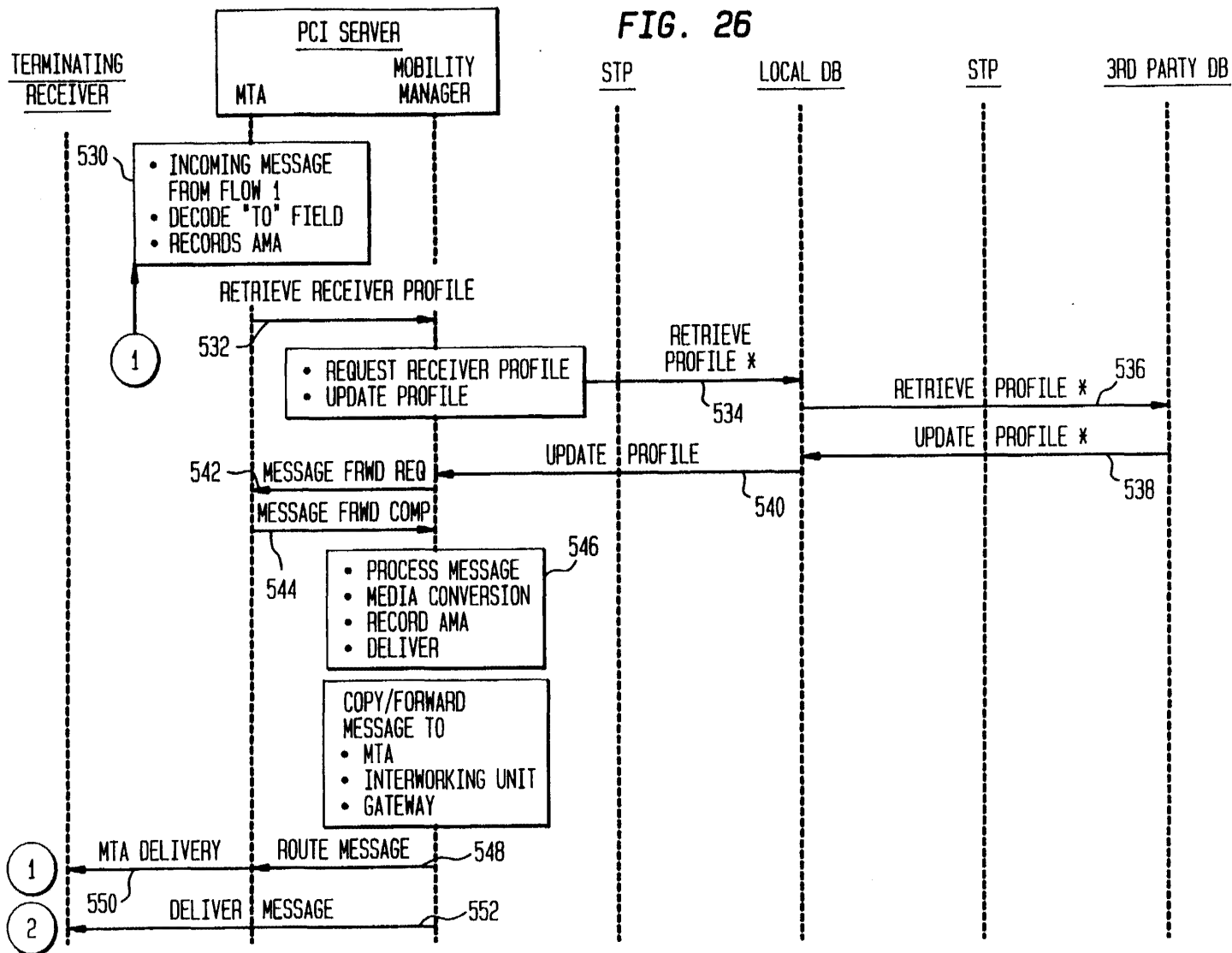
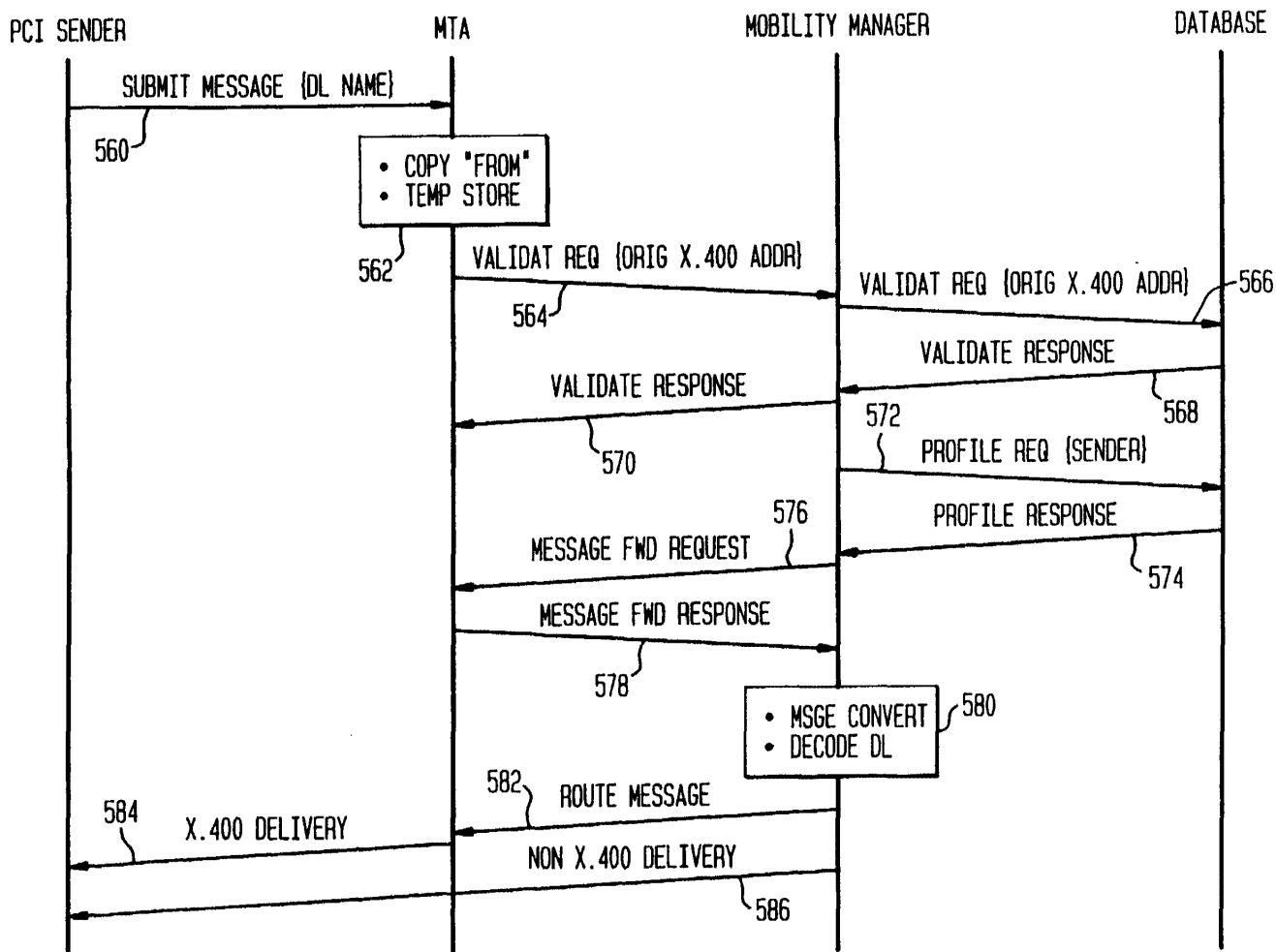

FIG. 27



WO 97/33421

20/26

PCT/US96/03064

21/26

FIG. 28

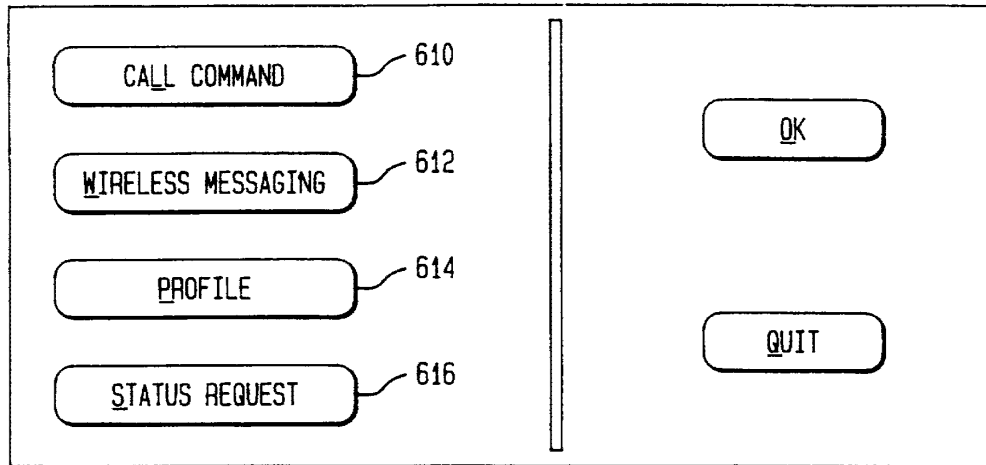

FIG. 29

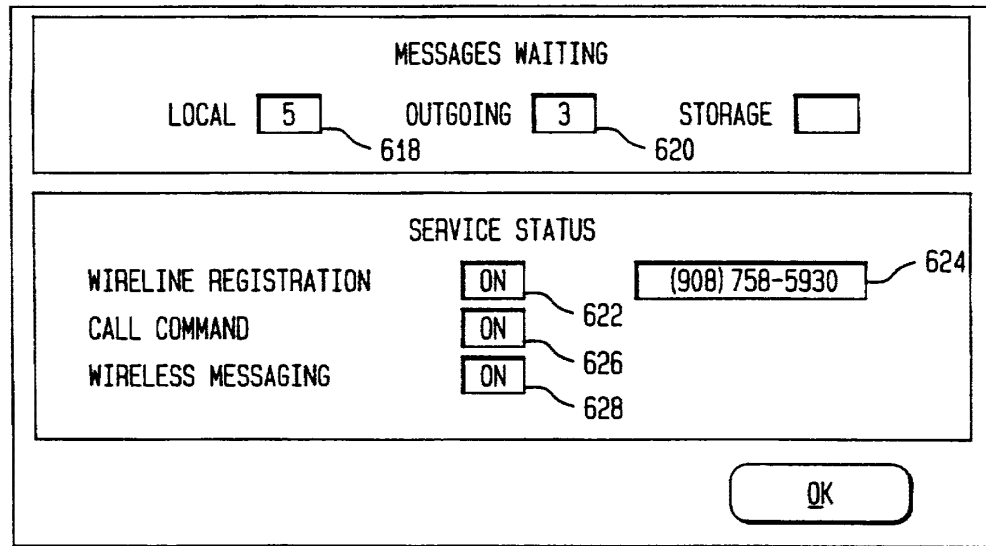
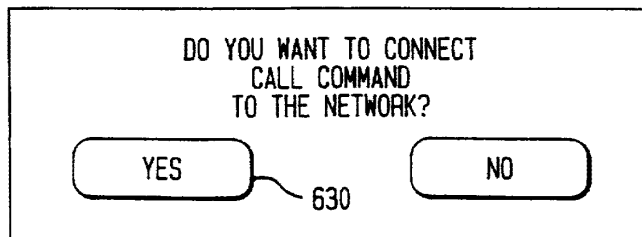

FIG. 30



22/26

FIG. 31

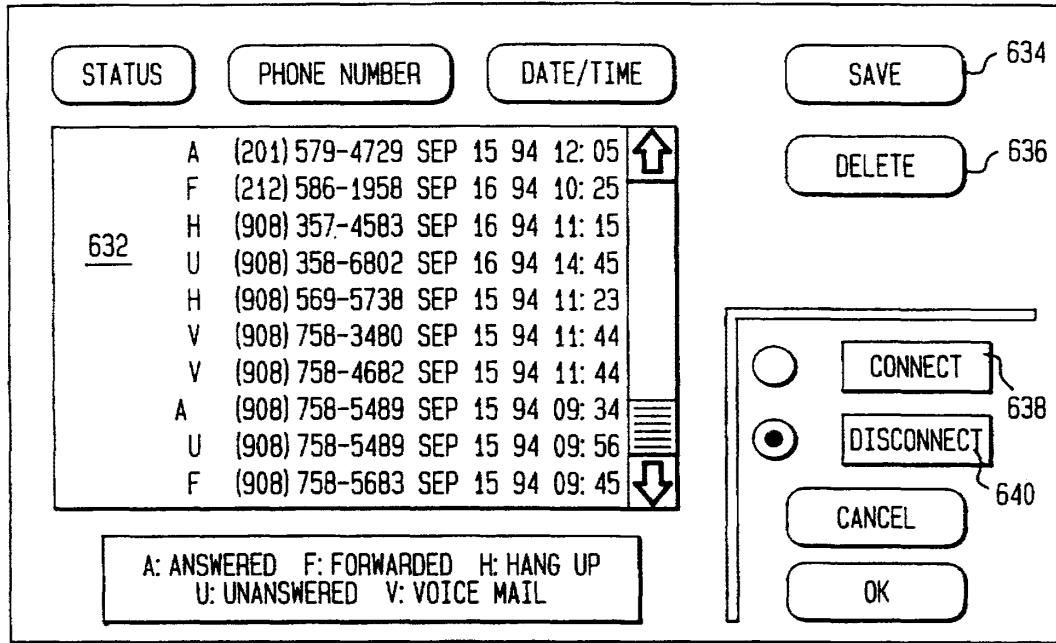

FIG. 33

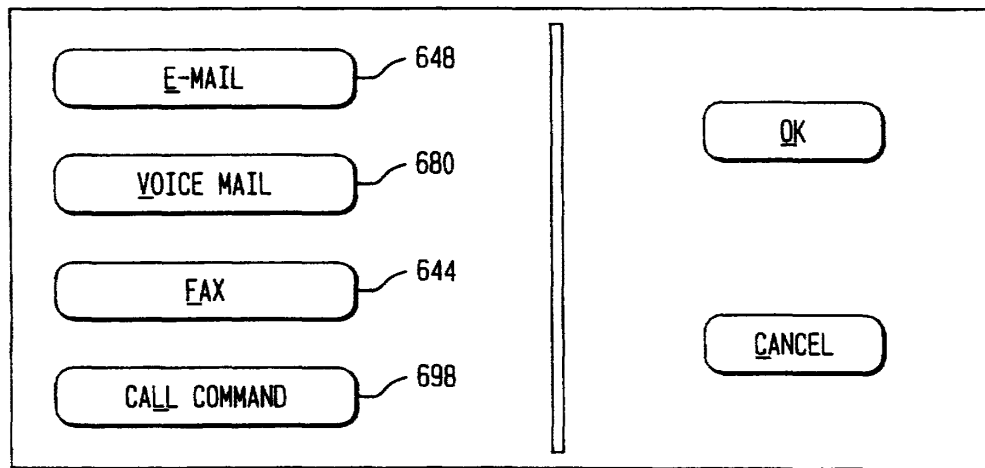

FIG. 32

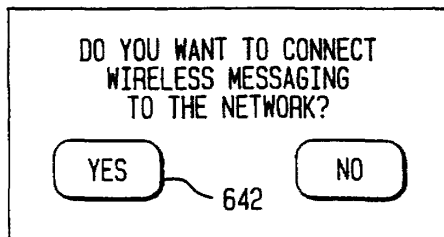

FIG. 34

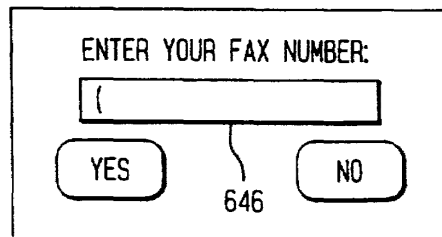

FIG. 35

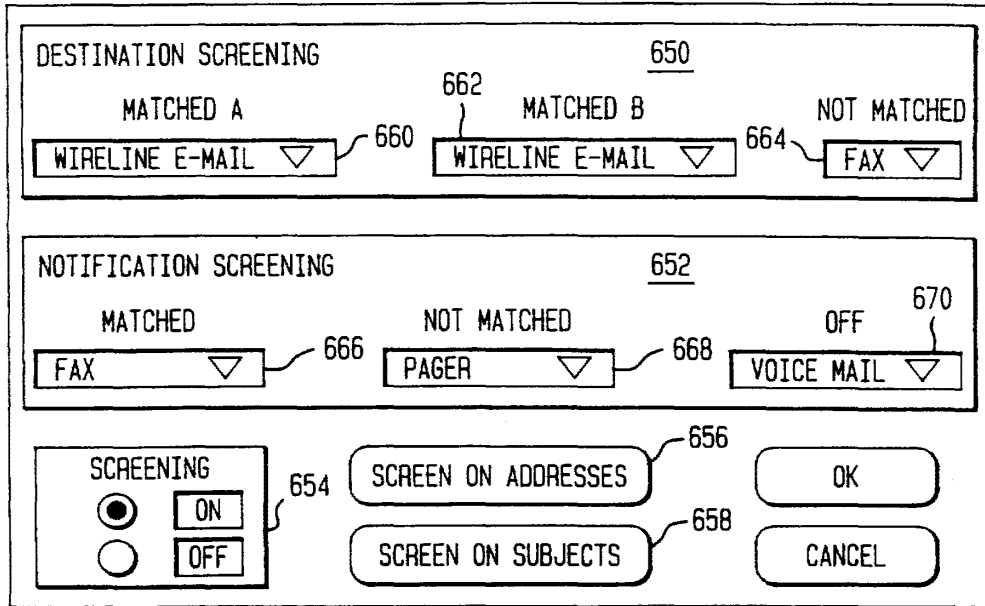

FIG. 36

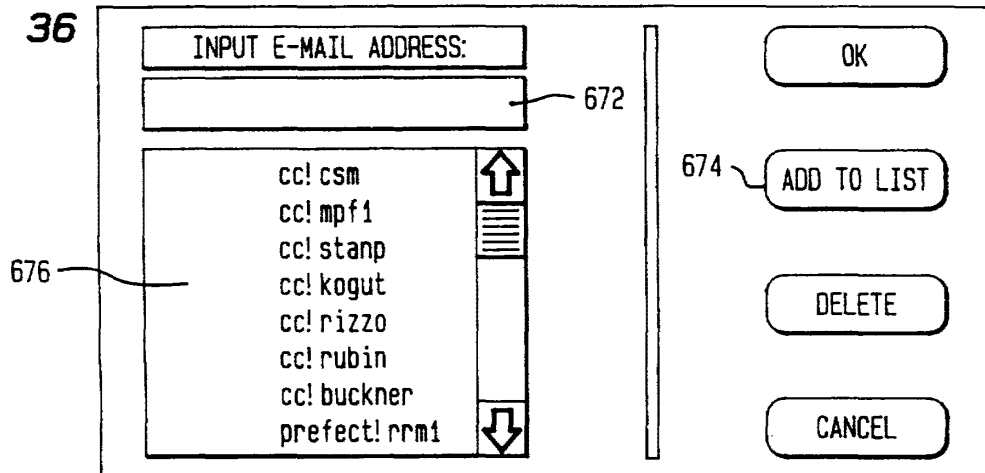
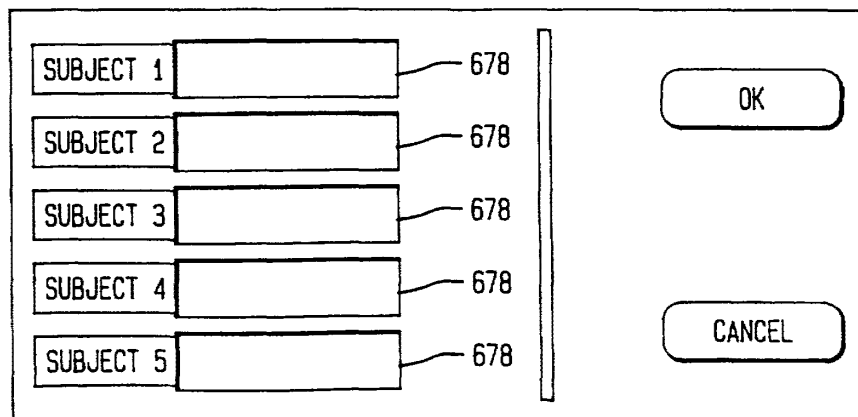

FIG. 37



24/26

FIG. 38

DESTINATION (908) 758-2715 682

NOTIFICATION SCREENING 684

MATCHED 686 PDA

NOT MATCHED 688 NULL

OFF 690 NULL

SCREENING 692

ON

OFF

SCREEN ON CALLER 694

OK

CANCEL

FIG. 39

FROM 1 696

FROM 2 (212) 589-5093 696

FROM 3 696

FROM 4 696

FROM 5 (212) 458-3849 696

OK

CANCEL

FIG. 40

WIRELINER REGISTRATION NUMBER:

(908) 487-9083 700

EDIT NUMBERS 706

EDIT MESSAGES 702

OK

CANCEL

25/26

FIG. 41

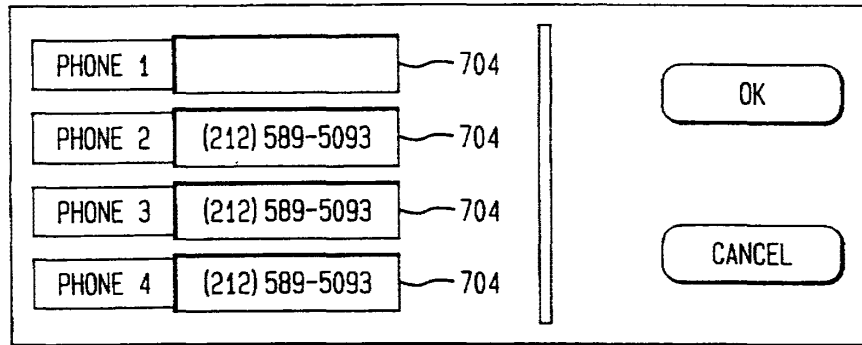

FIG. 42

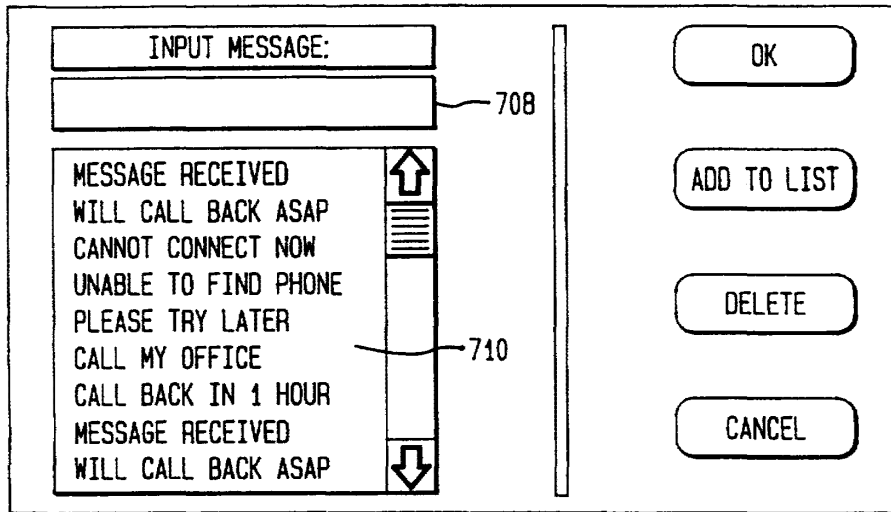

FIG. 43

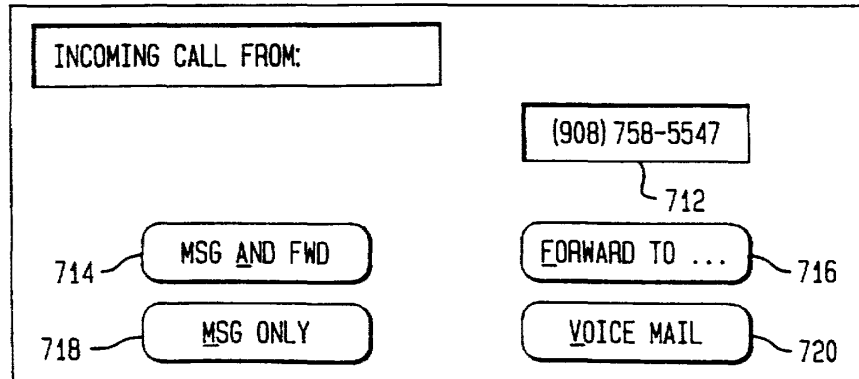

FIG. 44

FORWARD CALL TO:

730

PHONE 1	(201) 459-5902	722
PHONE 2	(908) 589-6739	724
PHONE 3	(212) 758-9803	726
PHONE 4	(908) 758-3901	728

OK

CANCEL

FIG. 45

INPUT MESSAGE TO SEND:

732

SELECT MESSAGE TO SEND:

734

MESSAGE RECEIVED
WILL CALL BACK ASAP
CANNOT CONNECT NOW
UNABLE TO FIND PHONE
PLEASE TRY LATER
CALL MY OFFICE
CALL BACK IN 1 HOUR
MESSAGE RECEIVED
WILL CALL BACK ASAP

OK

ADD TO LIST

DELETE

CANCEL

INTERNATIONAL SEARCH REPORT

International application No.
PCT/US96/03064

A. CLASSIFICATION OF SUBJECT MATTER
 IPC(6) :H04M 3/42
 US CL :379/58, 211, 210, 212
 According to International Patent Classification (IPC) or to both national classification and IPC

B. FIELDS SEARCHED
 Minimum documentation searched (classification system followed by classification symbols)
 U.S. : 379/58, 210, 211, 212

Documentation searched other than minimum documentation to the extent that such documents are included in the fields searched

Electronic data base consulted during the international search (name of data base and, where practicable, search terms used)

C. DOCUMENTS CONSIDERED TO BE RELEVANT

Category*	Citation of document, with indication, where appropriate, of the relevant passages	Relevant to claim No.
Y	US, A, 5,353,331, (EMERY ET AL) 04 OCTOBER 1994, ABSTRACT	1, 2, 35, 36, 38, 39
Y	US, A, 5,327,486, (WOLFF ET AL) 05 JULY 1994, col. 3, lines 38-40, col. 5, lines 1-6.	3, 4, 6, 22, 31 AND 34
Y	US, A, 5,479,472 (CAMPANA, Jr. ET AL) 26 DECEMBER 1995, ABSTRACT	47
Y	US, A, 5,329,578 (BRENNAN ET AL) 12 JULY 1994, Col. 4, Line 19- col. 13, line 56.	5, 7-21, 23-30, 33,37, 40-46, 48-52

Further documents are listed in the continuation of Box C. See patent family annex.

* Special categories of cited documents:	*T	later document published after the international filing date or priority date and not in conflict with the application but cited to understand the principle or theory underlying the invention
A document defining the general state of the art which is not considered to be part of particular relevance	*X*	document of particular relevance; the claimed invention cannot be considered novel or cannot be considered to involve an inventive step when the document is taken alone
E earlier document published on or after the international filing date	*Y*	document of particular relevance; the claimed invention cannot be considered to involve an inventive step when the document is combined with one or more other such documents, such combination being obvious to a person skilled in the art
L document which may throw doubts on priority claim(s) or which is cited to establish the publication date of another citation or other special reason (as specified)	*Z*	document member of the same patent family
O document referring to an oral disclosure, use, exhibition or other means		
P document published prior to the international filing date but later than the priority date claimed		

Date of the actual completion of the international search 17 MAY 1996	Date of mailing of the international search report 12 JUN 1996
--	--

Name and mailing address of the ISA/US Commissioner of Patents and Trademarks Box PCT Washington, D.C. 20231 Facsimile No. (703) 305-3230	Authorized officer <i>Lisa M. Coward</i> LISA M. COWARD Telephone No. (703) 305-4847
---	---