



[54] **METHOD FOR PLANARIZING A SEMICONDUCTOR DEVICE HAVING A AMORPHOUS LAYER**

[75] Inventors: **Masako Kodera**, Kawasaki, Japan;
Hiroyuki Yano, Wappingers Falls, N.Y.; **Atsushi Shigeta**, Yamato, Japan; **Riichirou Aoki**, Tokyo, Japan; **Hiromi Yajima**, Yokohama, Japan; **Haruo Okano**, Tokyo, Japan

4,735,679	4/1988	Laske	437/62
4,879,258	11/1989	Fisher	437/225
4,910,155	3/1990	Cote et al.	437/8
4,940,507	7/1990	Harbarger	156/636
5,036,015	7/1991	Sandhu et al.	437/8
5,064,683	11/1991	Poon et al.	427/39
5,078,801	1/1992	Malik	437/225
5,084,071	1/1992	Neuadic et al.	51/309
5,110,428	5/1992	Prigge et al.	204/129.3
5,166,096	11/1992	Cote et al.	437/195
5,236,861	8/1993	Otsu	437/67
5,246,884	9/1993	Jaso et al.	437/225
5,262,346	11/1993	Bindal et al.	156/636
5,272,117	12/1993	Roth et al.	437/228

[21] Appl. No.: 66,375

[22] Filed: May 25, 1993

[30] Foreign Application Priority Data

May 26, 1992	[JP]	Japan	4-132978
Sep. 25, 1992	[JP]	Japan	4-256889
Oct. 20, 1992	[JP]	Japan	4-281194
Nov. 30, 1992	[JP]	Japan	4-319175
Dec. 11, 1992	[JP]	Japan	4-331945

[51] Int. Cl.⁶ H01L 21/302; H01L 21/463

[52] U.S. Cl. 437/225; 437/101; 437/966; 437/235

[58] Field of Search 156/636; 437/228, 966, 437/960, 225, 101, 637

[56] References Cited

U.S. PATENT DOCUMENTS

3,715,842	2/1973	Tredinnick et al.	51/303
4,671,851	6/1987	Beyer et al.	156/645

FOREIGN PATENT DOCUMENTS

0272531A1	6/1988	European Pat. Off.	.
0403287A2	12/1990	European Pat. Off.	.
63-266830	11/1988	Japan	.

Primary Examiner—Olik Chaudhuri
 Assistant Examiner—H. Jey Tsai
 Attorney, Agent, or Firm—Finnegan, Henderson, Farabow, Garrett & Dunner

[57] ABSTRACT

To planarize an insulating film formed on a semiconductor substrate, a polishing slurry containing cerium oxide is used to polish the surface of the insulating film. Using the cerium oxide included slurry as a polishing agent, the insulating film is not contaminated by alkali metals during the polishing process. Furthermore, the insulating film is polished at an enhanced polishing rate.

1 Claim, 41 Drawing Sheets

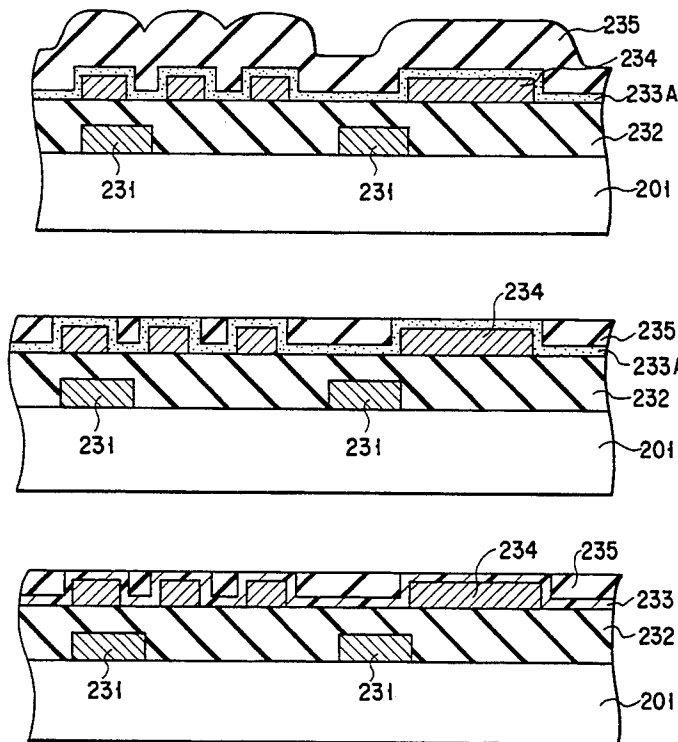

FIG. 1A
PRIOR
ART

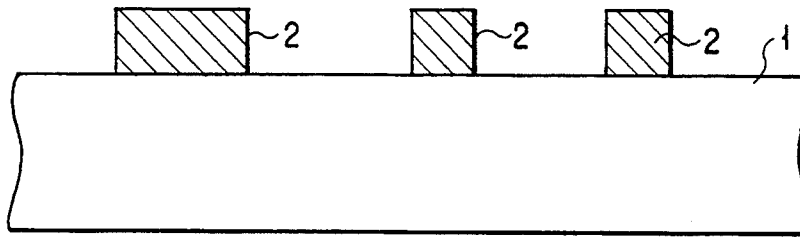

FIG. 1B
PRIOR
ART

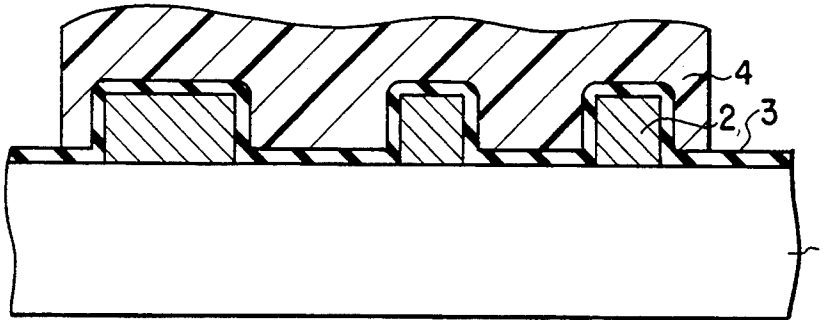

FIG. 1C
PRIOR
ART

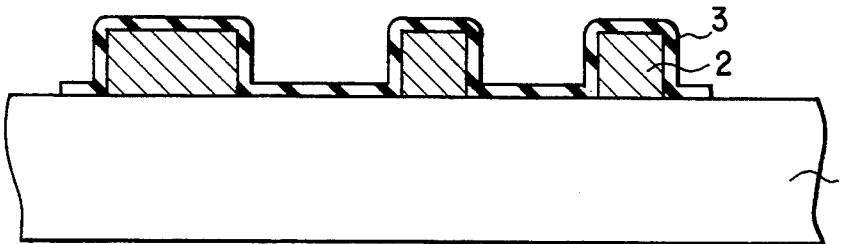

FIG. 1D
PRIOR
ART

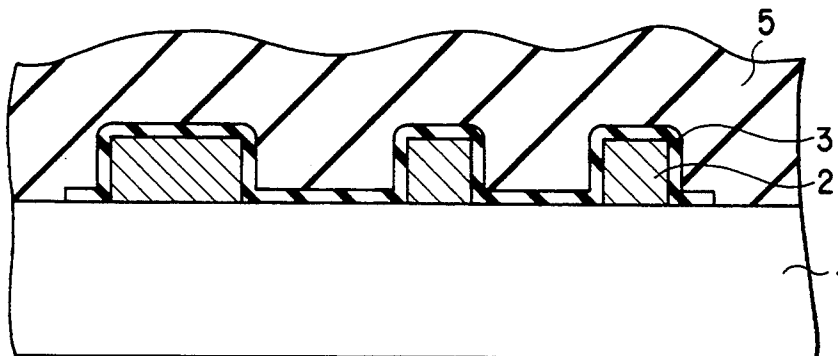

FIG. 1E
PRIOR
ART

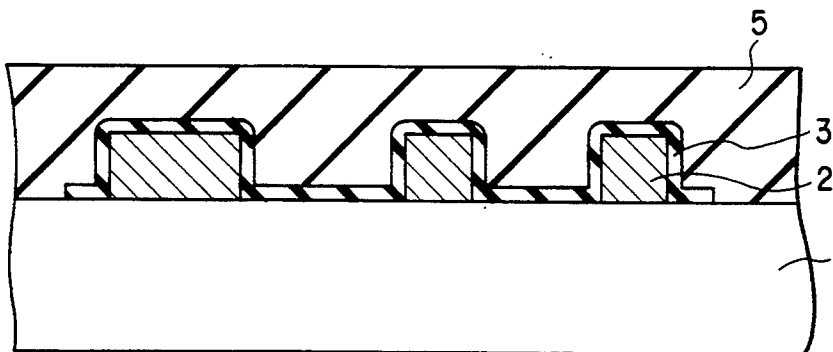

FIG. 2A
PRIOR ART

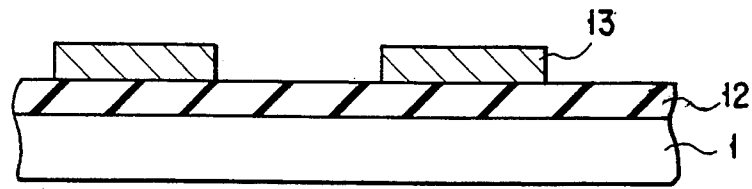

FIG. 2B
PRIOR ART

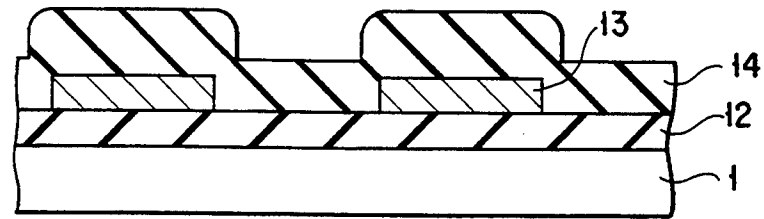

FIG. 2C
PRIOR ART

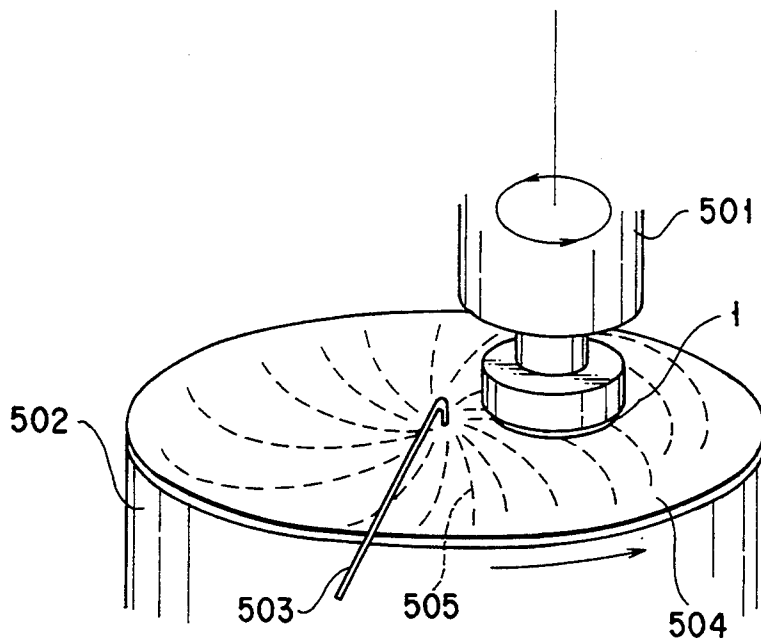
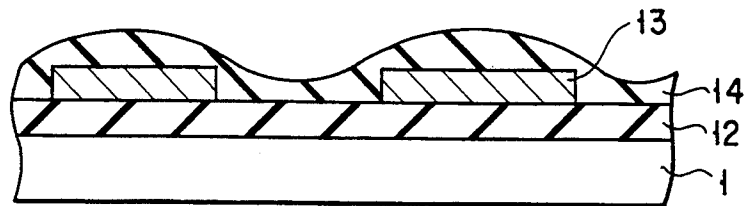

FIG. 3
PRIOR ART

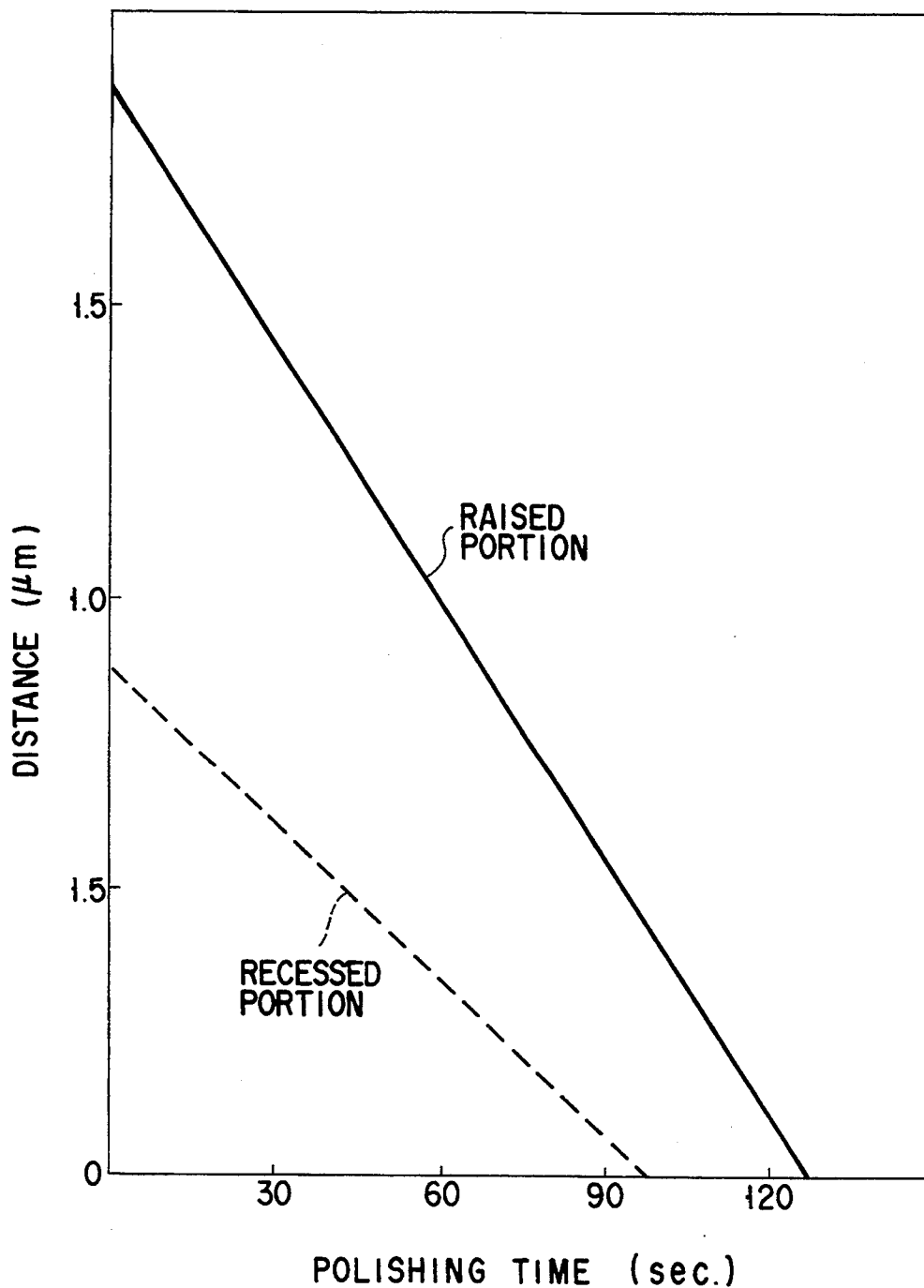

FIG. 4
PRIOR ART

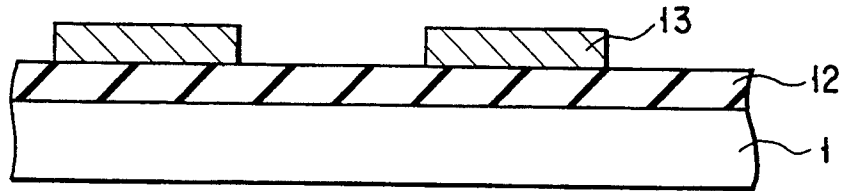

FIG. 5A
PRIOR ART

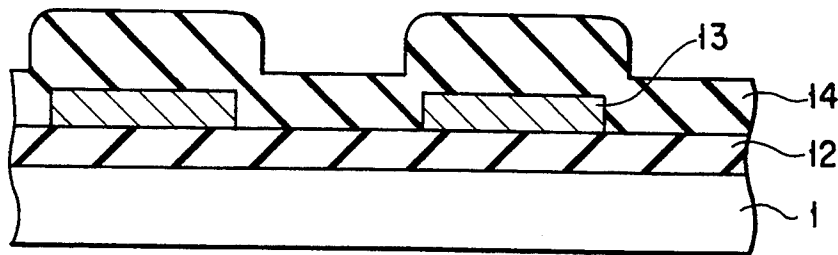

FIG. 5B
PRIOR ART

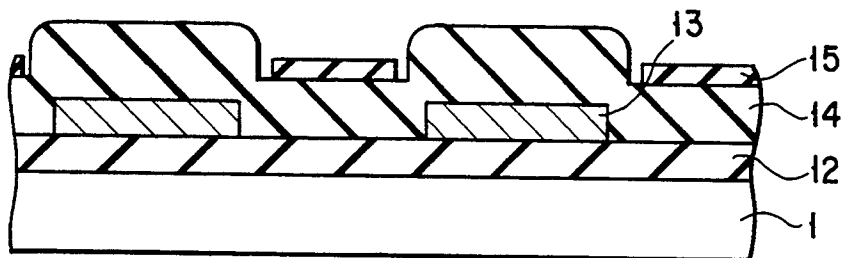

FIG. 5C
PRIOR ART

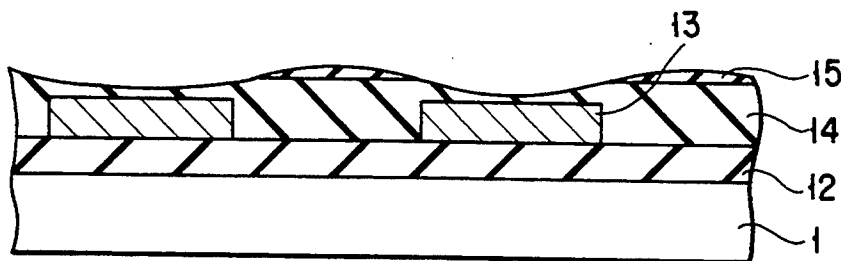

FIG. 5D
PRIOR ART

Explore Litigation Insights

Docket Alarm provides insights to develop a more informed litigation strategy and the peace of mind of knowing you're on top of things.

Real-Time Litigation Alerts



Keep your litigation team up-to-date with **real-time alerts** and advanced team management tools built for the enterprise, all while greatly reducing PACER spend.

Our comprehensive service means we can handle Federal, State, and Administrative courts across the country.

Advanced Docket Research



With over 230 million records, Docket Alarm's cloud-native docket research platform finds what other services can't. Coverage includes Federal, State, plus PTAB, TTAB, ITC and NLRB decisions, all in one place.

Identify arguments that have been successful in the past with full text, pinpoint searching. Link to case law cited within any court document via Fastcase.

Analytics At Your Fingertips



Learn what happened the last time a particular judge, opposing counsel or company faced cases similar to yours.

Advanced out-of-the-box PTAB and TTAB analytics are always at your fingertips.

API

Docket Alarm offers a powerful API (application programming interface) to developers that want to integrate case filings into their apps.

LAW FIRMS

Build custom dashboards for your attorneys and clients with live data direct from the court.

Automate many repetitive legal tasks like conflict checks, document management, and marketing.

FINANCIAL INSTITUTIONS

Litigation and bankruptcy checks for companies and debtors.

E-DISCOVERY AND LEGAL VENDORS

Sync your system to PACER to automate legal marketing.