

offset during error recovery. However, after any error recovery is completed the target shall return the head offset to the value specified in this field.

NOTE 131 The degree of offset for each incremental value and the number of valid values are device specific. It is recommended that the number of valid values be equal for the positive and negative head offset counts.

The target shall return CHECK CONDITION status and shall set the sense key to ILLEGAL REQUEST if an unsupported head offset value is specified. The valid bit shall be set to one and the information field shall be set to the positive value of the maximum head offset count that is supported. The target shall set the valid bit to zero if it cannot determine the maximum head offset count supported.

NOTE 132 If the target does not support this field, it returns a zero value in the MODE SENSE command.)

The data strobe offset count field specifies in two's-complement notation an incremental position to which the recovered data strobe shall be adjusted from its nominal setting. The effect of this field on write operations is unspecified. A value of zero indicates that no data strobe offset is specified. A positive value indicates movement in a positive direction as defined by the target. A negative value indicates movement in the negative direction as defined by the target. Any value specified in this field does not preclude the target from using positive or negative data strobe offset during error recovery. However, after any error recovery is completed the target shall return the data strobe offset to the value specified in this field.

NOTE 133 The degree of offset for each incremental value and the number of valid values are device specific. It is recommended that the number of valid values be equal for the positive and negative data strobe offset counts.

The target shall return CHECK CONDITION status and shall set the sense key to ILLEGAL REQUEST if an unsupported data strobe offset count value is specified. The valid bit shall be set to one and the information field shall be set to the positive value of the maximum data strobe offset count that is supported. The target shall set the valid bit to zero if it cannot determine the maximum data strobe offset supported.

NOTE 134 If the target does not support the data strobe offset count field, it returns a zero value in the MODE SENSE command.

The recovery time limit field specifies in increments of one ms the maximum time duration that the target shall use for data error recovery procedures. The target may round this value as described in 7.5.4. The limits in this field specifies the maximum error recovery time allowed for any individual logical block. A recovery time limit of zero specifies that the target shall use its default value.

If both retry count and recovery time limit are specified, the field that specifies the recovery action of least duration shall have priority.

ANSI X3.131-1994

9.3.3.7 Rigid disk drive geometry page

The rigid disk drive geometry page (see table 171) specifies parameters for direct-access devices employing a rigid disk drive.

Table 171 - Rigid disk drive geometry page

Bit Byte	7	6	5	4	3	2	1	0
0	PS	Reserved	Page code (04h)					
1	Page length (16h)							
2	(MSB)	Number of cylinders						(LSB)
4								
5	Number of heads							
6	(MSB)	Starting cylinder-write precompensation						(LSB)
8								
9	(MSB)	Starting cylinder-reduced write current						(LSB)
11								
12	(MSB)	Drive step rate						(LSB)
13								
14	(MSB)	Landing zone cylinder						(LSB)
16								
17	Reserved						RPL	
18	Rotational offset							
19	Reserved							
20	(MSB)	Medium rotation rate						(LSB)
21								
22	Reserved							
23	Reserved							

The parameters savable (PS) bit is only used with the MODE SENSE command. This bit is reserved with the MODE SELECT command. A PS bit of one indicates that the target is capable of saving the page in a non-volatile vendor-specific location.

NOTE 135 This page is intended to define drive geometry parameters of rigid disk drives. It may be used for other devices if applicable.

The number of cylinders field defines the number of physical cylinders used for data storage.

The number of heads field defines the physical number of heads used for data storage. Heads used exclusively for servo information are excluded.

The starting cylinder for write precompensation field is the physical cylinder at which write precompensation is to begin. The first cylinder is number zero. If the starting cylinder for write precompensation is equal to the value in the number of cylinders field, write precompensation shall be disabled by the target.

The starting cylinder for reduced write current field is the physical cylinder at which write current is reduced. The first cylinder is number zero. If the starting cylinder for reduced write current is equal to the value in the number of cylinders field, reduced write current shall be disabled by the target.

The drive step rate field indicates the step rate in 100 ns increments. The target shall use the drive step rate, greater than or equal to the drive step rate specified. If the target rounds this field it shall terminate the command as described in 7.5.4. A value of zero requests the target to set its default value.

The landing zone cylinder field indicates two's complement location where the target shall position the disk heads. A negative value indicates that the heads are positioned below cylinder zero by that number of cylinders. A positive value greater than the number of cylinders indicates that the heads are positioned beyond the cylinders used for data storage at the cylinder location specified. A zero indicates that the default should be used.

The rotational position locking (RPL) field is used for spindle synchronization as defined in table 172. See K of the ANSI X3.170A-1991 for further information on synchronized spindles.

Table 172 - Rotational position locking

RPL	Description
00b	Indicates that spindle synchronization is disabled or not supported
01b	The target operates as a synchronized-spindle slave
10b	The target operates as a synchronized-spindle master
11b	The target operates as a synchronized-spindle master control

NOTE 136 The signals and connectors used for rotational position locking are external to the SCSI bus and are not part of this standard.

If a target fails to achieve synchronization it shall create a unit attention condition to all initiators. The sense key shall be set to UNIT ATTENTION and the additional sense code set to RPL STATUS CHANGE.

If subsequent to achieving synchronization the target detects a change of synchronization:

- a) and, if the logical unit is not presently executing an I/O process for the initiator, the target shall create a unit attention condition. The sense key shall be set to UNIT ATTENTION and the additional sense code set to RPL STATUS CHANGE.
- b) and, if the logical unit is presently executing an I/O process and no other error occurs, then the target shall return CHECK CONDITION status. The sense key shall be set to RECOVERED ERROR if the target is able to complete the I/O process or HARDWARE ERROR if the target is unable to complete the I/O process. The additional sense code is set to RPL STATUS CHANGE.

The rotational offset indicates the amount of rotational skew that the target shall use when synchronized. The rotational skew is applied in the retarded direction (lagging the synchronized spindle master control). The value in the field is the numerator of a fractional multiplier that has 256 as its denominator (e.g. a value of 128 indicates a one-half revolution skew). A value of zero indicates that rotational offset shall not be used. This value may be rounded as defined in 7.5.4. The rotational offset is not used when a target is configured as synchronized-spindle master.

The medium rotation rate indicates the speed at which the medium rotates. The unit of measure is rotations per minute (e.g. 3 600 rpm).

9.3.3.8 Verify error recovery page

The verify error recovery page (see table 173) specifies the error recovery parameters the target shall use during the VERIFY command, the verify operation of the WRITE AND VERIFY command and the verify operation of the COPY AND VERIFY command.

Table 173 - Verify error recovery page

Bit Byte	7	6	5	4	3	2	1	0	
0	PS	Reserved	Page code (07h)						
1	Parameter length (0Ah)								
2	Reserved				EER	PER	DTE	DCR	
3	Verify retry count								
4	Verify correction span								
5	Reserved								
6	Reserved								
7	Reserved								
8	Reserved								
9	Reserved								
10	(MSB)	Verify recovery time limit							
11								(LSB)	

The parameters savable (PS) bit is only used with the MODE SENSE command. This bit is reserved with the MODE SELECT command. A PS bit of one indicates that the target is capable of saving the page in a non-volatile vendor-specific location.

The AWRE bit as defined in the read-write error recovery page (see 9.3.3.6) applies to the WRITE AND VERIFY command. The VERIFY and COMPARE commands shall not perform automatic reallocation. The COPY and COPY AND VERIFY commands might or might not perform automatic reallocation depending on the settings of the mode parameters.

The EER, PER, DTE and DCR bits are defined in 9.3.3.6. The combinations of these bits is defined in 9.3.3.6.

The verify retry count field specifies the number of times that the target shall attempt its recovery algorithm during a verify operation. If the verify retry count and the verify recovery time limit are both specified, the one that requires the least time for data error recovery actions shall have priority.

The verify correction span field specifies the size, in bits, of the largest burst data error for which data error correction may be attempted. If the target does not implement this field, a value of zero is returned in MODE SENSE data.

The verify recovery time limit field specifies in increments of one millisecond the maximum time duration that the target shall use error recovery procedures to recover data for an individual logical block. The target may round this value as described in 7.5.4. If the verify retry count and the verify recovery time limit are both specified, the one that requires the least time for data error recovery actions shall have priority.

NOTE 137 To disable all types of correction and retries the initiator should set the EER bit to zero, the PER, DTE and DCR bits to one and the number of retries and recovery time limit to zero.

9.4 Definitions specific to direct-access devices

9.4.1 cache memory: A temporary (and often volatile) data storage area outside the user-accessible area. A cache memory is usually faster to access than the medium and thus has the effect of increasing data throughput by reducing the number of accesses to the medium.

9.4.2 non-volatile medium: Physical storage medium that retains data written to it for a subsequent read operation through a power-on condition. An example of this is a disk device that stores data as magnetic fields that do not require device power to exist.

9.4.3 notch: A notch refers to all or part of the medium having a consistent set of geometry parameters. Notches are used to increase storage capacity by optimizing the number of sectors per track between the inner and outer tracks.

9.4.4 user-accessible: The area of the medium that can be read from or written to by READ and WRITE commands.

9.4.5 volatile medium: Medium that may not retain data written to it for a subsequent read operation through a power-on condition. An example of this is a silicon memory device that loses data written to it if device power is lost.

ANSI X3.131-1994

10 Sequential-access devices

10.1 Sequential-access device model

10.1.1 Physical elements

Sequential-access devices (called devices below) optimize their use in storing or retrieving user data in a sequential manner. Since access is sequential, position changes typically take a long time, when compared to direct-access devices.

Sequential-access devices are usually tape devices. The remainder of this description is from the point of view of a tape device; however, other implementations are not precluded.

The recording medium for tape devices consists of various widths and lengths of a flexible substrate coated with a semi-permanent magnetic material. The recording medium may be wound onto single reels or encapsulated into cartridges containing both a supply reel and a take-up reel. Several American National Standards exist covering the construction of reels and cartridges for interchange as well as recording techniques for many of the format or density combinations.

A complete unit composed of the recording medium and its physical carrier (e.g. reel, cartridge, cassette) is called a volume. Volumes have an attribute of being mounted or de-mounted on a suitable transport mechanism.

Mounted is the state of a volume when the device is physically capable of executing commands that cause the medium to be moved. A volume is de-mounted when it is being loaded, threaded, unloaded, unthreaded, or when not attached to the device.

Ready is the state of the device when medium access and non-medium access commands can be executed. The device is not ready when no volume is mounted or, from the initiator's perspective, whenever all medium access commands report CHECK CONDITION status and a NOT READY sense key. Some devices may have a separate switch function which places the device in a not ready state even when a volume is mounted.

The write enabled or write protected state determines when an initiator may write information on a volume. This attribute is usually controlled by the user of the volume through manual intervention (e.g. thumbwheel switch).

The recording medium has two physical attributes called beginning-of-medium (BOM) and end-of-medium (EOM). Beginning-of-medium is at the end of the medium that is attached to the take-up reel. End-of-medium is at the end of the medium that is attached to the supply reel. In some cases, the medium is permanently affixed to one or both of the reel hubs.

As shown in figure 18, the entire physical length of medium is not usable for recording data. For most volumes, a length of the medium is reserved before the beginning-of-medium and after the end-of-medium position. This is done to provide sufficient tape wraps onto the reel hub(s) and to ensure that recording starts in an undamaged section of the medium.

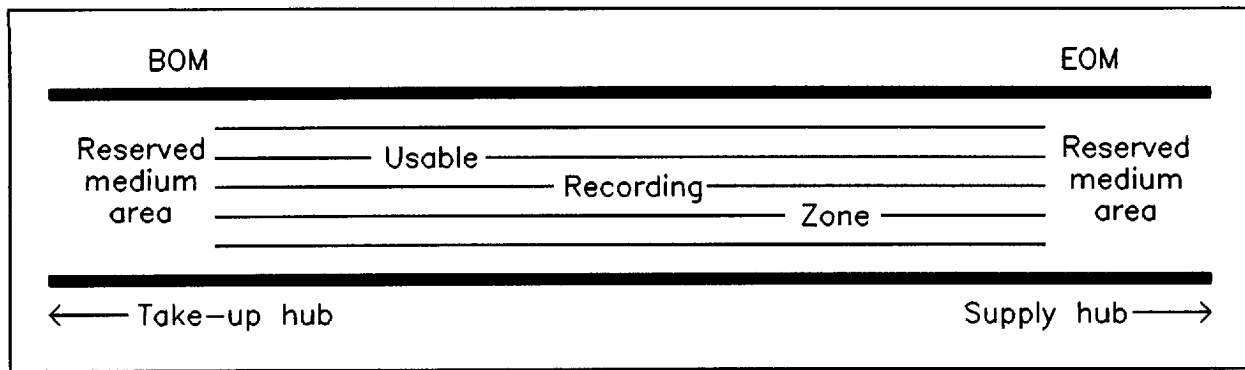

Figure 18 - Typical volume layout

10.1.2 Data storage characteristics

The position on the medium where a pattern of recorded signal may be written by one write component is called a track (see figure 19). A device may write or read from one or more tracks at a time, depending on the format.

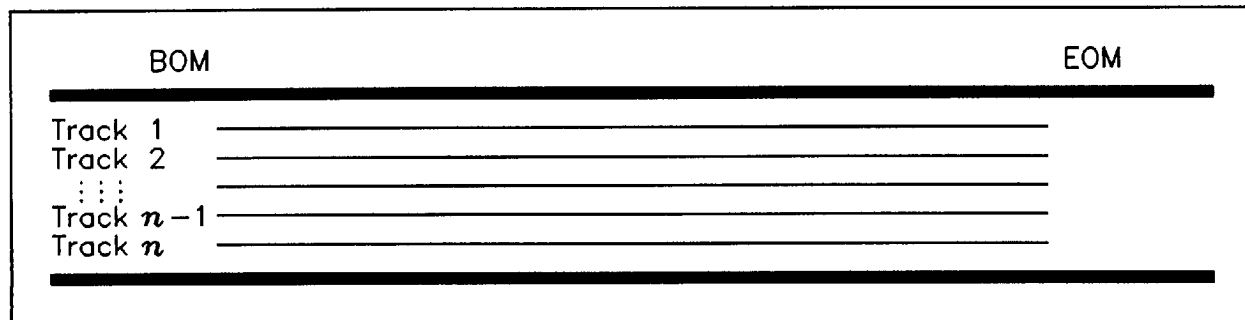

Figure 19 - Typical medium track layout

On a new volume, recording of one or more tracks begins after mounting the volume and moving from beginning-of-medium toward end-of-medium. The number of tracks written at one time is called a track group (TrkGrp). For recorded volumes, reading in the forward direction follows the same course of tracks as when writing.

If not all tracks are recorded at the same time, and the device reverses direction when approaching end-of-medium and begins writing on remaining tracks, the recording method is called serpentine. For serpentine devices that record only one track at a time, each physical track represents one track group (see figure 20).

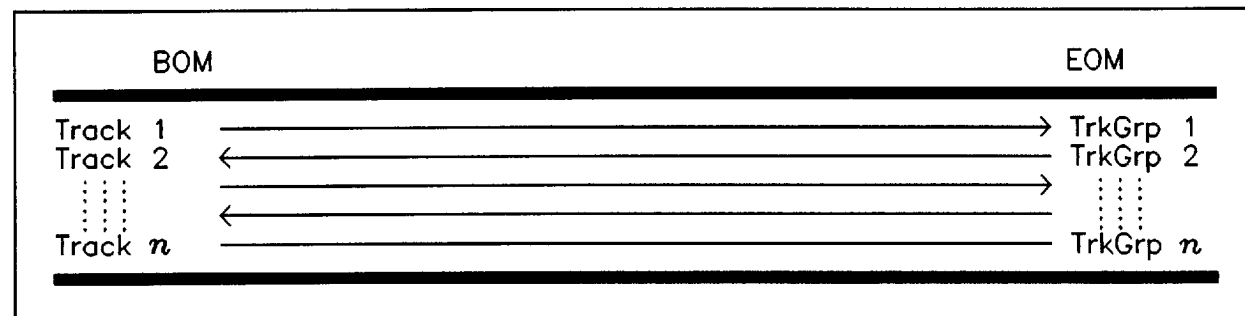

Figure 20 - Serpentine recording example

ANSI X3.131-1994

Some multi-track devices have only one track group, using a parallel storage format that supports the simultaneous recording of all available tracks (see figure 21).

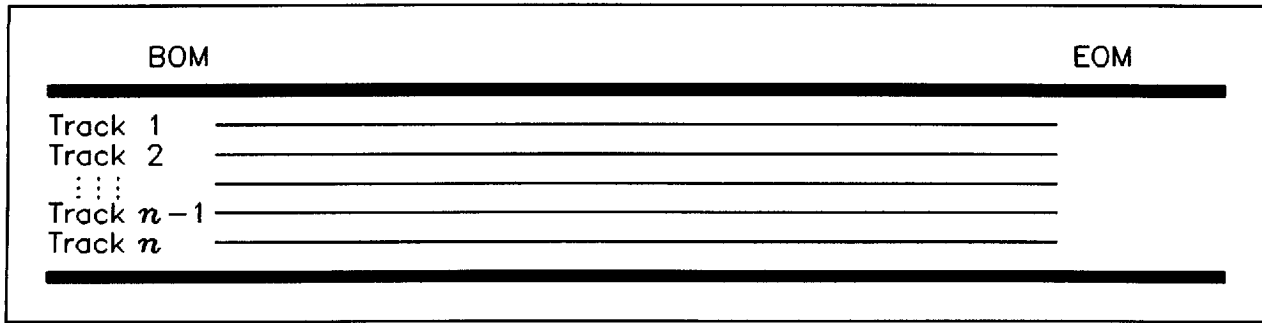

Figure 21 - Parallel recording example

The serpentine and parallel recording formats shown in the previous examples define tracks as longitudinal patterns of recorded information. One other storage format used by some devices records tracks diagonally across the medium. This recording technique is known as helical scan (see figure 22).

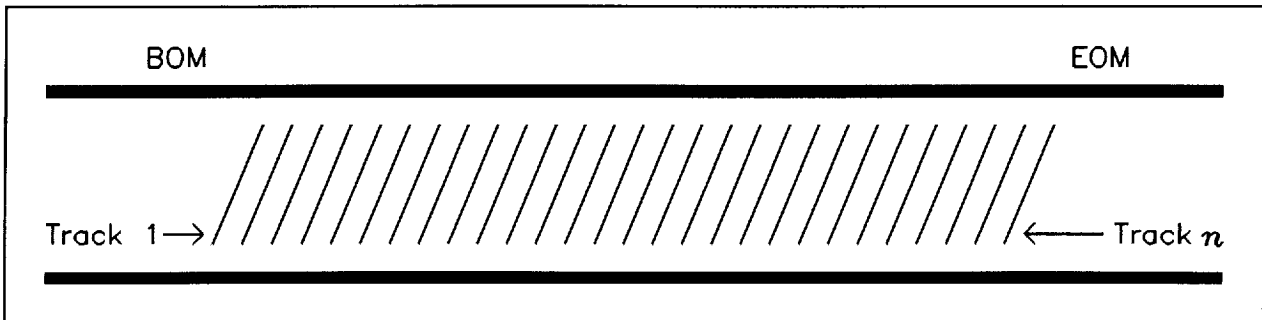

Figure 22 - Helical scan recording example

For most recording formats, an area at beginning-of-medium contains a format identification in the form of a tone burst or some other recognizable pattern. User data is not recorded in this area. The format identification is an attribute of a volume used for interchange purposes and is defined in applicable standards.

When writing, the initiator needs an indication that it is approaching the end of the permissible recording area. This position, called early-warning (EW), is typically reported to the initiator at a position early enough for the device to write any buffered data to the medium while still leaving enough room for additional recorded labels or filemarks. Some American National Standards include physical requirements for a marker placed on the medium to be detected by the device as early-warning (see figure 23).

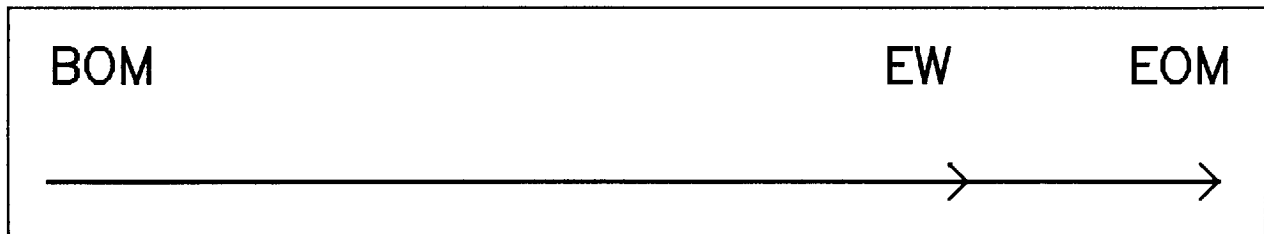

Figure 23 - Early-warning example

For devices which implement large data buffers, the early-warning position defined by a physical marker may be too close to the end of the recording region to permit emptying the data buffer(s). For these devices, a logical

concept of early-warning is often used to signal the initiator at an appropriate location prior to the physical marker.

10.1.3 Partitions within a volume

Another attribute of a volume is called a partition. Partitions consist of one or more non-overlapped mini-volumes, each with its own beginning and ending points, contained within single physical volume. Each partition (x) within a volume has a defined beginning-of-partition (BOP x), an early-warning position (EW x), and an end-of-partition (EOP x).

All volumes have a minimum of one partition called partition 0, the default data partition. For devices which support only one partition, the beginning-of-partition zero (BOP 0) may be equivalent to the beginning-of-medium and the end-of-partition zero (EOP 0) may be equivalent to the end-of-medium.

When a volume is mounted, it is logically positioned to beginning of the default data partition (BOP 0). When a REWIND command is received in any partition (x), the device positions to the beginning-of-partition (BOP x).

Partitions on a volume do not need to be recorded in any defined order, nor do all partition numbers in a sequence need to be present on a volume. It is sufficient for a device to be able to locate a partition, given its code value, or determine that it does or does not exist on the volume. For interchange, information about which partitions are present on a volume may be stored on the volume in a device-defined area (possibly unavailable to the initiator) or the information may be an intrinsic attribute of the device implementation.

Figure 24 shows a possible partition implementation for a four-track serpentine recording device, assuming that each track group defines a partition.

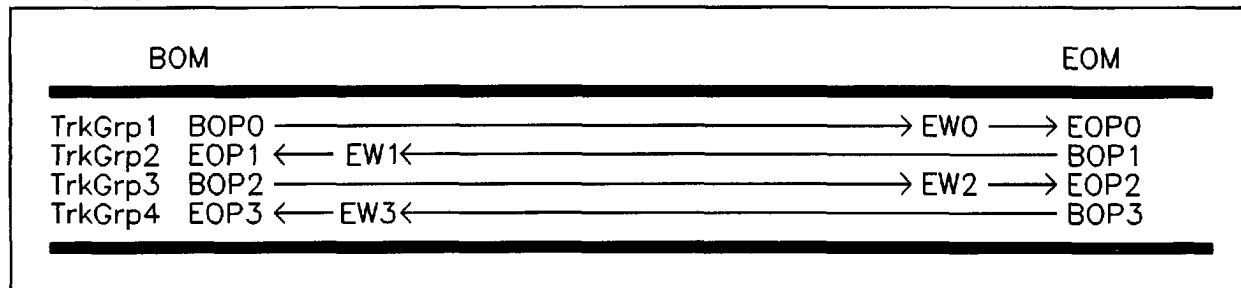

Figure 24 - Partitioning example - one partition per track group

Another possible partition implementation for this four-track serpentine recording device is shown in figure 25, using two track groups to define each partition.

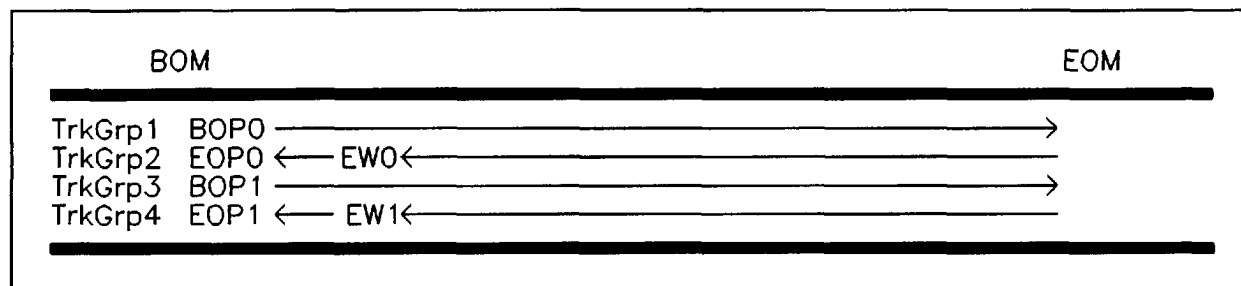

Figure 25 - Partitioning example - one partition per two track groups

The previous examples show the beginning and ending points for a partition aligned with physical bounds of the medium. This is not a mandatory requirement for partitioning; it is sufficient for a device to be able to locate to and stay in any partition bounded by a BOP x and EOP x . In this case, a recorded mark or some other device-

ANSI X3.131-1994

recognizable attribute could be used to delineate the partitions. Figure 26 shows a possible two-partition implementation for a device with only one track group.

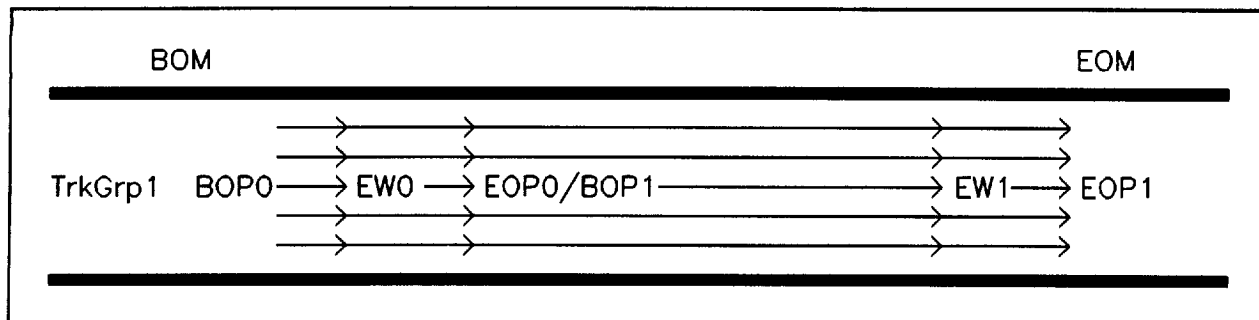

Figure 26 - Partitioning example - two partitions per track group

Three methods are defined in the MODE SENSE and MODE SELECT commands for managing partitions; each method is progressively more difficult to implement and manage:

- a) device-defined fixed locations;
- b) device-defined based on an initiator supplied number of partitions and a device specific allocation algorithm; and,
- c) definition by name and capacity by an initiator.

10.1.4 Logical elements within a partition

The area between BOP x and EOP x on a typical recorded volume contains at least two types of initiator accessible elements, data blocks and tape marks. These elements are controlled and transferred between the initiator and the medium using READ, READ REVERSE, WRITE, and WRITE FILEMARKS commands.

A unit of data supplied or requested by an initiator is called a logical block. Logical blocks are stored according to the specifications of the format for the volume and may be recorded as one or more physical blocks on the medium. When the physical block and the logical block are not recorded in a one-to-one relationship, it is the responsibility of the device to perform all blocking, de-blocking, padding, stripping, splitting or rebuilding of the logical data block(s) sent by an initiator.

Filemarks are special recorded elements containing no user data. The filemark format is defined in some American National Standards. Initiators traditionally use filemarks to separate user data from labels and logical groupings of data from each other. Since some format standards do not define an explicit end-of-data (EOD), host software has often used conventions with filemarks to represent an EOD indication. At least one American National Standard specifically defines filemark use for this purpose. In some implementations, the device's EOD definition may be specified the initiator using the MODE SELECT command.

A setmark is another type of special recorded element containing no user data, providing a segmentation scheme hierarchically superior to filemarks. This level of segmentation is useful for some high capacity storage devices to provide concise addressing and fast positioning to specific sets of data within a partition. In some implementations, the detection and reporting of setmarks may be controlled by the initiator using the MODE SELECT command.

Inter-block gaps, the gaps between blocks, filemarks, and setmarks, are introduced on the medium at the time a block or mark is written without explicit action by the initiator. Minimum and maximum lengths for inter-block gaps are defined in some American National Standards. In some devices, the length of inter-block gaps may be selected by the initiator using the MODE SELECT command while in other devices the gaps are fixed and non-changeable.

In addition to blocks, filemarks, and setmarks, erase gaps may be recorded on the medium through use of the ERASE command or device-initiated error recovery actions. Although explicitly recorded on the medium, there is normally no distinction between two contiguous erase gaps. An erase gap may be a length of erased medium or

a recorded pattern not distinguishable as a block or mark. Minimum and maximum lengths for erase gaps are defined in some American National Standards while some devices may have no implementation of an erase gap.

After writing data from BOP x , the medium is considered to be a contiguous grouping of blocks, filemarks, setmarks, and gaps. Certain American National Standards define gap lengths which, if exceeded, are to be considered as having reached blank medium. Depending on the format, this blank medium may be treated as an end-of-data indication, an error recovery area, or an unrecoverable medium error causing an interchange error. Unrecorded volumes (new or erased) may exhibit blank medium characteristics if an attempt is made to read or space the volume before data has been written.

A sequential-access device may be capable of supporting fixed or variable length blocks. The concept of fixed or variable mode for writing and reading blocks only indicates the method by which the initiator specifies the size of a logical block for transfer and not the method of recording physical blocks on the medium. However, a device that supports only fixed-length physical blocks may only be capable of supporting logical blocks of the same length. The length of a logical block is always described in bytes. The length of a physical block may or may not be recorded as an exact byte count, depending on the format.

10.1.5 Data buffering

A device may contain a temporary storage area capable of holding one or more logical blocks - a data buffer. A device data buffer may include any combination of blocks, filemarks, and setmarks in the process of being written to the medium, or it may contain read-ahead data blocks transferred from the medium.

A device with a data buffer may be capable of operating in either a buffered mode or an unbuffered mode. A device with no data buffer operates only in unbuffered mode. Either term is only applicable to the manner in which the device manages information to be written to the medium. Buffered mode is not applicable during read commands, regardless of whether read data passes through a data buffer.

A device operating in buffered mode may return GOOD status for write operations when all write data has been successfully transferred from the initiator into the device data buffer. For devices operating in unbuffered mode, GOOD status is not returned until all requested data, filemarks, or setmarks are successfully recorded on the medium.

When issuing a buffered WRITE FILEMARKS command with the immediate bit set to one, GOOD status is returned as soon as the command is validated. A WRITE FILEMARKS command with the immediate bit set to zero causes any buffered blocks, filemarks, and setmarks to be written to the medium. Upon successful completion of this process, which is called a synchronize operation, no blocks, filemarks, or setmarks remain in the data buffer which have not been written to the medium. A synchronize operation has no effect on a data buffer which contains only read-ahead data or write data which has already been successfully written to the medium.

Should an unrecoverable write error occur while in buffered mode, the device generates an error condition to the current active command. If no command is active, the error may be reported on the next applicable operation as a deferred error (see 8.2.14.2). For some implementations, asynchronous event notification or extended contingent allegiance may be required. Refer to 7.5.5 and 7.7 for descriptions of asynchronous event notification and extended contingent allegiance protocol.

The READ POSITION command may be used to determine the number and storage space of buffered blocks not written before the unrecoverable error was encountered.

A device with read-ahead data blocks in the data buffer does not report an unrecovered read error until the data block in error is requested by an initiator.

ANSI X3.131-1994

10.1.6 Recorded object descriptors (block identifiers)

Some recording formats specify that recorded objects (blocks, filemarks, and setmarks) have identifiers included in the recorded information to help determine write sequence and also to help detect device positioning errors. The identifier values are unique within a partition and may be unique within a volume.

The use of the term block identifier may imply some arithmetic sequence applied to the assignment of recorded objects. The block identifier assignment algorithm may be defined in an applicable format standard.

For some pre-formatted volumes, the identifiers are associated with physical blocks. In variable-length implementations, the identifier can be associated with a physical block when the logical block and the physical block have a one-to-one relationship on the medium.

Some formats may carry both physical and logical block identifiers recorded on the medium. When a logical block is split over more than one physical block, or multiple logical blocks are concatenated to form a physical block, the logical block identifier and the physical block identifier are not the same. Filemarks and setmarks may or may not have recorded identifiers, but if identifiers are used in the format, then each mark is assigned a value even if it is not explicitly recorded.

The READ POSITION and LOCATE commands use four-byte fields to hold these format dependent identifiers. For some implementations, this value may correspond to a real physical location; however, it is sufficient for the device to map the identifier to a value representing the unique recorded object. With this capability, the READ POSITION command may be used to report a device-defined block identifier and the initiator may use this value with a LOCATE command to position to the same location at some future time (provided the volume has not been rewritten in the interim).

10.1.7 Direction and position definitions

For sequential-access devices, positioning has the connotation of logically being in, at, before, or after some defined place within a volume. This definition means the position is capable of being repeated under the same circumstances. The orientation of usage for the four words (in, at, before, or after) is in one direction, from BOP x toward EOP x . All positioning defined below is worded from this perspective. Devices without buffers have some physical position which relates to these logical positions. However, these definitions do not require the medium to have a physical position equivalent to the logical position unless explicitly stated.

The forward direction is defined as logically progressing from BOP x toward EOP x . The reverse direction is defined as logically progressing from EOP x toward BOP x . In serpentine devices, the logical forward or reverse direction has an alternating relationship to the physical motion of the medium.

The concept of being in some position means not being outside a defined region. The definition allows the position to be on the boundary of a defined region. When a volume is first mounted, the logical position is always at the beginning of the default data partition (BOPO). Whenever a volume is mounted and the medium motion is stopped, the position is in some partition. While moving between partitions, there is no stable position.

The concept of being at some position indicates being positioned to a logical or physical extremity of a partition. A sequential-access device may be positioned at beginning-of-medium, at BOP x , at end-of-data (EOD), at EOP x , or at end-of-medium (EOM), since these are stable positions at extremities of a partition.

The concept of being before some position indicates that there is some element (data block, filemark, setmark, or other defined point) which may be encountered when moving toward EOP x , if the proper commands are issued. Being positioned before a particular data block means that if the device receives a valid READ command, the data block is transferred to the initiator. This position may also be before EW x and EOP x , since these are defined points within any partition. However, if data has not been written to the end-of-partition, these points may not be accessible by the initiator.

The concept of being after some position indicates that there is some element (data block, filemark, setmark, or other defined point) on the BOP x side of the current position which may be encountered if the proper commands are issued. When a READ command for a single data block has been successfully executed, the logical position is after the transferred data block.

10.1.8 Error reporting

If any of the following conditions occur during the execution of a command the target shall return CHECK CONDITION status. The appropriate sense key and additional sense code should be set. The following list illustrates some error conditions and the applicable sense keys. The list does not provide an exhaustive enumeration of all conditions that may cause the CHECK CONDITION status.

<u>Condition</u>	<u>Sense Key</u>
Invalid logical block address	ILLEGAL REQUEST
Unsupported option requested	ILLEGAL REQUEST
Target reset or medium change since last command from this initiator	UNIT ATTENTION
Self diagnostic failed	HARDWARE ERROR
Unrecovered read error	MEDIUM ERROR HARDWARE ERROR
Recovered read or write error	RECOVERED ERROR
Overrun or other error that might be resolved by repeating the command	ABORTED command
Attempt a WRITE, READ, READ REVERSE, VERIFY, or RECOVER BUFFERED DATA command with the fixed bit set to zero and variable block mode is not supported	ILLEGAL REQUEST
Attempt a WRITE, READ, READ REVERSE, VERIFY, or RECOVER BUFFERED DATA command with a fixed bit of zero and requested block length is not supported	ILLEGAL REQUEST
Attempt a WRITE, READ, READ REVERSE, VERIFY, or RECOVER BUFFERED DATA command with a fixed bit of one and MODE SENSE block length set to zero	ILLEGAL REQUEST
Attempt to execute an erase or write-type operation on write protected medium	DATA PROTECT
Deferred write error	MEDIUM ERROR VOLUME OVERFLOW

In the case of an unrecovered read or write error, if the read-write error recovery page (10.3.3.4) is implemented, the current values specify the target error recovery criteria. If this page is not implemented, the error recovery is vendor-specific.

In the case of an unrecovered read error, if the fixed bit is one, the valid bit shall be set to one and the information field shall be set to the requested transfer length minus the actual number of blocks read (not including the unrecovered block). If the fixed bit is zero, the valid bit shall be set to one and the information field shall be set to the requested transfer length. Upon termination, the logical position shall be after the unrecovered block.

ANSI X3.131-1994

In the case of an unrecovered write error, if unbuffered mode is selected and the fixed bit is set to one, the valid bit shall be set to one and the information field shall be set to the requested transfer length minus the actual number of blocks written. If unbuffered mode is selected and the fixed bit is set to zero, the information field shall be set to the requested transfer length.

In the case of an unrecovered write error or a deferred write error, if buffered mode is selected and the fixed bit is one, the valid bit shall be set to one and the information field shall be set to the total number of blocks, filemarks, and setmarks not written (the number of blocks not transferred from the initiator plus the number of blocks, filemarks, and setmarks remaining in the target's buffer). If buffered mode is selected and the fixed bit is zero, the information field shall be set to the total number of bytes, filemarks, and setmarks not written (the number of bytes not transferred from the initiator plus the number of bytes, filemarks, and setmarks remaining in the target's buffer). In both cases, the value in the information field may exceed the transfer length.

In the case of an unrecovered write error or a deferred write error, if buffered mode 1h is selected, the error shall be reported to the first initiator issuing a command (other than INQUIRY or REQUEST SENSE) or the first initiator responding to asynchronous event notification. If buffered mode 2h is selected, the error shall be reported to the initiator with unwritten data in the buffer.

10.2 Command descriptions for sequential-access devices

The commands for sequential-access devices shall be as shown in table 174.

Table 174 - Commands for sequential-access devices

Command name	Operation code	Type	Subclause
CHANGE DEFINITION	40h	O	8.2.1
COMPARE	39h	O	8.2.2
COPY	18h	O	8.2.3
COPY AND VERIFY	3Ah	O	8.2.4
ERASE	19h	M	10.2.1
INQUIRY	12h	M	8.2.5
LOAD UNLOAD	1Bh	O	10.2.2
LOCATE	2Bh	O	10.2.3
LOG SELECT	4Ch	O	8.2.6
LOG SENSE	4Dh	O	8.2.7
MODE SELECT(6)	15h	M	8.2.8
MODE SELECT(10)	55h	O	8.2.9
MODE SENSE(6)	1Ah	M	8.2.10
MODE SENSE(10)	5Ah	O	8.2.11
PREVENT ALLOW MEDIUM REMOVAL	1Eh	O	9.2.4
READ	08h	M	10.2.4
READ BLOCK LIMITS	05h	M	10.2.5
READ BUFFER	3Ch	O	8.2.12
READ POSITION	34h	O	10.2.6
READ REVERSE	0Fh	O	10.2.7
RECEIVE DIAGNOSTIC RESULTS	1Ch	O	8.2.13
RECOVER BUFFERED DATA	14h	O	10.2.8
RELEASE UNIT	17h	M	10.2.9
REQUEST SENSE	03h	M	8.2.14
RESERVE UNIT	16h	M	10.2.10
REWIND	01h	M	10.2.11
SEND DIAGNOSTIC	1Dh	M	8.2.15
SPACE	11h	M	10.2.12
TEST UNIT READY	00h	M	8.2.16
VERIFY	13h	O	10.2.13
WRITE	0Ah	M	10.2.14
WRITE BUFFER	3Bh	O	8.2.17
WRITE FILEMARKS	10h	M	10.2.15

Key: M = command implementation is mandatory.
O = command implementation is optional.

The following command codes are vendor-specific: 02h, 06h, 07h, 09h, 0Ch, and 0Eh. All other command codes for sequential-access devices are reserved for future standardization.

10.2.1 ERASE command

The ERASE command (see table 175) causes part or all of the medium to be erased beginning at the current position on the logical unit. As used here, erased means either the medium shall be erased or a pattern shall be written on the medium that appears as a gap to the target.

Table 175 - ERASE command

Bit Byte	7	6	5	4	3	2	1	0
0	Operation code (19h)							
1	Logical unit number			Reserved			Immed	Long
2	Reserved							
3	Reserved							
4	Reserved							
5	Control							

An immediate (Immed) bit of zero indicates that the target shall not return status until the erase operation has completed. An Immed bit of one indicates that the target shall return status as soon as the command has been validated. If CHECK CONDITION status is returned for an ERASE command with an Immed bit of one, the erase operation shall not be performed.

A long bit of one indicates that all remaining medium in the current partition shall be erased beginning at the current logical position. If the Immed bit is one, the target shall return status as soon as all buffered commands have completed execution and the command descriptor block of the ERASE command has been validated. The logical position following an ERASE command with a long bit of one is not specified by this standard.

NOTE 138 Some targets may reject an ERASE command with the long bit set to one if the logical unit is not at beginning-of-partition.

A long bit of zero specifies an erase gap defined by the gap size field in the device configuration page (10.3.3.1). If the gap size is zero or the field is not supported, a device defined erase gap operation shall be performed. If the Immed bit is one, the target shall return status as soon as the command descriptor block has been validated. Erase gaps may be used in initiator controlled error recovery or update in place applications.

If the logical unit encounters early-warning during an ERASE command, and any buffered data, filemarks, or setmarks remain to be written, the target action shall be as defined for the early-warning condition of the WRITE command (10.2.14). If the long bit is zero, the erase operation shall terminate with CHECK CONDITION status and return sense data as defined for the WRITE command. Any buffered erases are not reported as part of the information field.

ANSI X3.131-1994

10.2.2 LOAD UNLOAD command

The LOAD UNLOAD command (see table 176) requests that the target enable or disable the logical unit for further operations. This command may also be used to request a retension function. Prior to performing the load or unload operation, the target shall ensure that all buffered data, filemarks, and setmarks have been transferred to the medium.

Table 176 - LOAD UNLOAD command

Bit Byte	7	6	5	4	3	2	1	0
0	Operation code (1Bh)							
1	Logical unit number			Reserved				Immed
2	Reserved							
3	Reserved							
4	Reserved				EOT	Reten	Load	
5	Control							

An immediate (Immed) bit of zero indicates that the target shall not return status until the load or unload operation has completed. An Immed bit of one indicates that the target shall return status as soon as all buffered commands have completed execution and the command descriptor block of the LOAD UNLOAD command has been validated. If CHECK CONDITION status is returned for a LOAD UNLOAD command with an Immed bit of one, the load or unload operation shall not be performed.

NOTE 139 For compatibility with devices implemented prior to this version of the standard, a WRITE FILEMARKS command with an Immed bit of zero should be used to ensure that all buffered data, filemarks, or setmarks have been transferred to the medium prior to issuing a LOAD UNLOAD command with an Immed bit of one.

An end-of-tape (EOT) bit of one indicates that an unload operation (load bit set to zero) shall position the medium at end-of-medium for removal from the device. An EOT bit of zero indicates that an unload operation shall position the medium at beginning-of-medium for removal from the device.

An EOT bit of one and a load bit of one shall cause the target to return CHECK CONDITION status and the sense key shall be set to ILLEGAL REQUEST in the sense data.

A retension (ReTen) bit of one indicates that the medium on the logical unit shall have the correct tension applied. Implementation of the retension function is device specific.

If the load bit is set to one, the medium in the logical unit shall be loaded and positioned to the beginning-of-partition zero. If the load bit is zero, the medium in the logical unit shall be positioned for removal at the extreme position along the medium specified by the EOT bit. Following successful completion of an unload operation, the target shall return CHECK CONDITION status with the sense key set to NOT READY for all subsequent medium-access commands until a new volume is mounted or a load operation is successfully completed.

When operating in buffered mode 1h or 2h (see 10.3.3), the target shall discard any unwritten buffered data after the LOAD UNLOAD command is validated if the previous command was terminated with CHECK CONDITION status and the device is unable to continue successfully writing.

10.2.3 LOCATE command

LOCATE command (see table 177) causes the target to position the logical unit to the specified block address in a specified partition. Upon completion, the logical position shall be before the specified location. Prior to performing the locate operation, the target shall ensure that all buffered data, filemarks, and setmarks have been transferred to the medium.

Table 177 - LOCATE command

Bit Byte	7	6	5	4	3	2	1	0
0	Operation code (2Bh)							
1	Logical unit number			Reserved		BT	CP	Immed
2	Reserved							
3	(MSB)							
4	Block address							
5								
6								
7	Reserved							
8	Partition							
9	Control							

A block address type (BT) bit of one indicates the value in the block address field shall be interpreted as a device-specific value. A BT bit of zero indicates the value in the block address field shall be interpreted as an SCSI logical block address.

A change partition (CP) bit of one indicates that a change to the partition specified in the partition field is to occur prior to positioning to the block specified in the block address field. A CP bit of zero indicates no partition change is to be made and the partition field is to be ignored.

An immediate (Immed) bit of zero indicates that the target shall not return status until the locate operation has completed. An Immed bit of one indicates that the target shall return status as soon as all buffered commands have completed execution and the command descriptor block of the LOCATE command has been validated. If CHECK CONDITION status is returned for a LOCATE command with an Immed bit of one, the locate operation shall not be performed.

The block address field (see 10.1.6) specifies the block address to which the target shall position the medium based on the current setting of the BT bit.

The partition field specifies which partition to select if the CP bit is one. Refer to the sequential-access device model (see 10.1.3) and the medium partition pages (see 10.3.3.2 and 10.3.3.3) for additional information about partitioning.

ANSI X3.131-1994

10.2.4 READ command

The READ command (see table 178) requests that the target transfer one or more block(s) of data to the initiator beginning with the next block on the logical unit.

Table 178 - READ command

Bit Byte	7	6	5	4	3	2	1	0
0	Operation code (08h)							
1	Logical unit number			Reserved			SILI	Fixed
2	(MSB)							
3	Transfer length							
4	(LSB)							
5	Control							

The fixed bit specifies whether fixed-length or variable-length blocks are to be transferred. Refer to the READ BLOCK LIMITS command (see 10.2.5) for additional information about fixed and variable block mode.

If the fixed bit is one, the transfer length specifies the number of fixed-length blocks to be transferred, using the current block length reported in the mode parameters block descriptor (see 8.3.3). If the fixed bit is zero, a variable-length block is requested with the transfer length specifying the maximum number of bytes allocated for the returned data.

A successful READ command with a fixed bit of one shall transfer the requested transfer length times the current block length in bytes to the initiator. A successful READ command with a fixed bit of zero shall transfer the requested transfer length in bytes to the initiator. Upon completion, the logical position shall be after the last block transferred (end-of-partition side).

If the suppress incorrect length indicator (SILI) bit is one and the fixed bit is zero, the target shall:

- report CHECK CONDITION status for an incorrect length condition only if the overlength condition exists (see 10.1.8) and the block length field in the mode parameter block descriptor is nonzero (see 8.3.3).
- not report CHECK CONDITION status if the only error is the underlength condition (see 10.4), or if the only error is the overlength condition and the block length field of the mode parameters block descriptor is zero.

NOTE 140 Since the residue information normally provided in the information field of the sense data may not be available when the SILI bit is set, other methods for determining the actual block length should be used (e.g. including length information in the data block).

If the SILI bit is one and the fixed bit is one, the target shall terminate the command with CHECK CONDITION status and the sense key shall be set to ILLEGAL REQUEST with an additional sense code of INVALID FIELD IN CDB.

If the SILI bit is zero and an incorrect length block is read, CHECK CONDITION status shall be returned and the ILI and valid bits shall be set to one in the sense data. Upon termination, the logical position shall be after the incorrect length block (end-of-partition side). If the fixed bit is one, the information field shall be set to the requested transfer length minus the actual number of blocks read (not including the incorrect length block). If the fixed bit is zero, the information field shall be set to the requested transfer length minus the actual block length. Targets that do not support negative values shall set the information field to zero if the overlength condition exists (see 10.4).

NOTE 141 In the above case with the fixed bit of one, only the position of the incorrect-length logical block can be determined from the sense data. The actual length of the incorrect block is not reported. Other means may be used to determine its actual length (e.g. read it again with the fixed bit set to zero).

A transfer length of zero indicates that no data shall be transferred. This condition shall not be considered an error and the logical position shall not be changed.

If the logical unit encounters a filemark during a READ command, CHECK CONDITION status shall be returned and the filemark and valid bits shall be set to one in the sense data. The sense key shall be set to NO SENSE or RECOVERED ERROR, as appropriate. Upon termination, the logical position shall be after the filemark (end-of-partition side). If the fixed bit is one, the information field shall be set to the requested transfer length minus the actual number of blocks read (not including the filemark). If the fixed bit is zero, the information field shall be set to the requested transfer length.

If the logical unit encounters a setmark during a READ command and the RSmk bit is set to one in the device configuration page (see 10.3.3.1), CHECK CONDITION status shall be returned and the filemark and valid bits shall be set to one in the sense data. The sense key shall be set to NO SENSE or RECOVERED ERROR, as appropriate, and the additional sense code shall be set to SETMARK DETECTED. Upon termination, the logical position shall be after the setmark (end-of-partition side). If the fixed bit is one, the information field shall be set to the requested transfer length minus the actual number of blocks read (not including the setmark). If the fixed bit is zero, the information field shall be set to the requested transfer length. The target shall not return CHECK CONDITION when a setmark is encountered if the RSmk bit is set to zero or if this option is not supported.

If the logical unit encounters early-warning during a READ command and the REW bit is set to one in the device configuration page (see 10.3.3.1), CHECK CONDITION status shall be returned upon completion of the current block. The sense key shall be set to NO SENSE or RECOVERED ERROR, as appropriate. The EOM and valid bits shall be set to one in the sense data. Upon termination, the logical position shall be after the last block transferred (end-of-partition side). If the fixed bit is one, the information field shall be set to the requested transfer length minus the actual number of blocks read. If the fixed bit is zero, the information field shall be set to the requested transfer length minus the actual block length. The target shall not return CHECK CONDITION status when early-warning is encountered if the REW bit is zero or if the REW option is not supported.

NOTE 142 A REW bit of one is not recommended for most system applications since read data may be present after early-warning.

If the logical unit encounters end-of-data during a READ command, CHECK CONDITION status shall be returned, the sense key shall be set to BLANK CHECK, and the valid bit shall be set to one in the sense data. If end-of-data is encountered at or after early-warning, the EOM bit shall also be set to one. Upon termination, the logical position shall be after the last recorded logical block (end-of-partition side). If the fixed bit is one, the information field shall be set to the requested transfer length minus the actual number of blocks read. If the fixed bit is zero, the information field shall be set to the requested transfer length.

If the logical unit encounters end-of-partition during a READ command, CHECK CONDITION status shall be returned, the sense key shall be set to MEDIUM ERROR, and the EOM and valid bits shall be set to one in the sense data. The medium position following this condition is not defined. If the fixed bit is one, the information field shall be set to the requested transfer length minus the actual number of blocks read. If the fixed bit is zero, the information field shall be set to the requested transfer length.

ANSI X3.131-1994

10.2.5 READ BLOCK LIMITS command

The READ BLOCK LIMITS command (see table 179) requests that the logical unit's block length limits capability be returned. The READ BLOCK LIMITS data shown in table 180 shall be returned.

Table 179 - READ BLOCK LIMITS command

Bit Byte	7	6	5	4	3	2	1	0
0	Operation code (05h)							
1	Logical unit number				Reserved			
2	Reserved							
3	Reserved							
4	Reserved							
5	Control							

Table 180 - READ BLOCK LIMITS data

Bit Byte	7	6	5	4	3	2	1	0
0	Reserved							
1	(MSB)							
2	Maximum block length limit							
3	(LSB)							
4	(MSB)							
5	Minimum block length limit							
	(LSB)							

If the maximum block length limit value equals the minimum block length limit value, the logical unit supports the transfer of data in the fixed-block mode only, with the block length equal to the given value. In this case the fixed bit shall be set to one in the WRITE and READ commands.

If the maximum block length limit value is not equal to the minimum block length limit value, the logical unit supports the transfer of data in either fixed-block or variable-block modes, with the block length constrained between the given limits in either mode. The transfer mode is controlled by the fixed bit in the WRITE or READ commands. If the maximum block limit is zero a maximum block length is not specified.

10.2.6 READ POSITION command

The READ POSITION command (see table 181) reports the current position of the logical unit and any data blocks in the buffer. No medium movement shall occur as a result of the command.

Table 181 - READ POSITION command

Bit Byte	7	6	5	4	3	2	1	0
0	Operation code (34h)							
1	Logical unit number			Reserved				BT
2	Reserved							
3	Reserved							
4	Reserved							
5	Reserved							
6	Reserved							
7	Reserved							
8	Reserved							
9	Control							

A block address type (BT) bit of one requests the target to return its current first block location and last block location as a device-specific value. A BT bit of zero requests the target to return the first block location and the last block location as an SCSI logical block address (relative to a partition).

If the logical unit is not capable of reporting block locations, the BPU bit shall be set to one in the returned data. Support for this option of the READ POSITION command is indicated by a BIS bit set to one in the device configuration page (see 10.3.3.1).

The READ POSITION data shown in table 182 shall be returned.

Table 182 - READ POSITION data format

Bit Byte	7	6	5	4	3	2	1	0
0	BOP	EOP	Reserved			BPU	Reserved	
1	Partition number							
2	Reserved							
3	Reserved							
4	(MSB)	First block location						(LSB)
7								
8	(MSB)	Last block location						(LSB)
11								
12	Reserved							
13	(MSB)	Number of blocks in buffer						(LSB)
15								
16	(MSB)	Number of bytes in buffer						(LSB)
19								

A beginning of partition (BOP) bit of one indicates that the logical unit is at the beginning-of-partition in the current partition. A BOP bit of zero indicates that the current logical position is not at the beginning-of-partition.

An end of partition (EOP) bit of one indicates that the logical unit is positioned between early-warning and end-of-partition in the current partition. An EOP bit of zero indicates that the current logical position is not between early-warning and end-of-partition.

NOTE 143 The BOP and EOP indications are not necessarily a result of a physical tape marker (e.g. reflective marker).

A block position unknown (BPU) bit of one indicates that the first and last block locations are not known or cannot be obtained. A BPU bit of zero indicates that the first and last block location fields contain valid position information.

The partition number field reports the partition number for the current logical position. If the logical unit only supports one partition for the medium, this field shall be set to zero.

The first block location field indicates the block address associated with the current logical position. The value shall indicate the block address of the next data block to be transferred between the initiator and the target if a READ or WRITE command is issued.

The last block location field indicates the block address (see 10.1.6) associated with the next block to be transferred from the buffer to the medium. The value shall indicate the block address of the next data block to be transferred between the buffer and the medium. If the buffer does not contain a whole block of data or is empty, the value reported for the last block location shall be equal to the value reported for the first block location.

NOTE 144 The information provided by the first and last block location fields can be used in conjunction with the LOCATE command to position the medium at the appropriate logical block on another device in the case of unrecoverable errors on the first device.

The number of blocks in buffer field indicates the number of data blocks in the target's buffer that have not been written to the medium.

The number of bytes in buffer field indicates the total number of data bytes in the target's buffer that have not been written to the medium.

10.2.7 READ REVERSE command

The READ REVERSE command (see table 183) requests that the target transfer one or more block(s) of data to the initiator beginning at the current position on the logical unit.

Table 183 - READ REVERSE command

Bit Byte	7	6	5	4	3	2	1	0
0	Operation code (0Fh)							
1	Logical unit number			Reserved			SILI	Fixed
2	(MSB)							
3	Transfer length							
4	(LSB)							
5	Control							

The execution of this command is similar to the READ command except that medium motion is in the reverse direction. All block(s), and the byte(s) within the block(s), are transferred in the reverse order. The order of bits within each byte shall not be changed. Upon completion of a READ REVERSE command, the logical position shall be before the last block transferred (beginning-of-partition side).

Refer to the READ command (see 10.2.4) for a description of the fixed bit, the SILI bit, the transfer length field, and any associated error conditions.

Filemarks, setmarks, incorrect length blocks, and unrecovered read errors are handled the same as in the READ command, except that upon termination the logical position shall be before the filemark, setmark, incorrect length block, or unrecovered block (beginning-of-partition side).

If the logical unit encounters beginning-of-partition during a READ REVERSE command, CHECK CONDITION status shall be returned and the EOM and valid bits shall be set to one in the sense data. The sense key shall be set to NO SENSE or RECOVERED ERROR, as appropriate. If the fixed bit is one, the information field shall be set to the requested transfer length minus the actual number of blocks transferred. If the fixed bit is zero, the information field shall be set to the requested transfer length.

ANSI X3.131-1994

10.2.8 RECOVER BUFFERED DATA command

The RECOVER BUFFERED DATA command (see table 184) is used to recover data that has been transferred to the target's buffer but has not been successfully written to the medium. It is normally used to recover from error or exception conditions that make it impossible to write the buffered data to the medium. One or more RECOVER BUFFERED DATA commands may be required to recover all unwritten buffered data.

Table 184 - RECOVER BUFFERED DATA command

Bit Byte	7	6	5	4	3	2	1	0
0	Operation code (14h)							
1	Logical unit number			Reserved			SILI	Fixed
2	(MSB)							
3	Transfer length							
4	(LSB)							
5	Control							

The execution of this command is similar to the READ command except that the data is transferred from the target's buffer instead of the medium. The order in which block(s) are transferred is defined by the RBO bit in the device configuration page (see 10.3.3.1). If the RBO bit is not implemented, block(s) are transferred in the same order they would have been transferred to the medium.

Refer to the READ command (see 10.2.4) for a description of the fixed bit, the SILI bit, the transfer length field, and any associated error conditions.

If the fixed bit is zero, no more than the requested transfer length shall be transferred to the initiator. If the requested transfer length is smaller than the actual length of the logical block to be recovered, only the requested transfer length shall be transferred to the initiator and the remaining data for the current logical block shall be discarded.

NOTE 145 During recovery operations involving unknown block sizes, the initiator should select the maximum block length supported by the target to ensure that all buffered data will be transferred and set the fixed bit to zero.

If a buffered filemark is encountered during a RECOVER BUFFERED DATA command, CHECK CONDITION status shall be returned, the sense key shall be set to NO SENSE, and the filemark and valid bits shall be set to one in the sense data. Upon termination, the logical position shall be after the filemark. If the fixed bit is one, the information field shall be set to the requested transfer length minus the actual number of blocks transferred (not including the filemark).

If the fixed bit is zero, the information field shall be set to the requested transfer length.

If a buffered setmark is encountered during a RECOVER BUFFERED DATA command and the RSmk bit is set to one in the device configuration page (see 10.3.3.1), CHECK CONDITION status shall be returned and the filemark and valid bits shall be set to one in the sense data. The sense key shall be set to NO SENSE and the additional sense code shall be set to SETMARK DETECTED. Upon termination, the logical position shall be after the setmark. If the fixed bit is one, the information field shall be set to the requested transfer length minus the actual number of blocks transferred (not including the setmark). If the fixed bit is zero, the information field shall be set to the requested transfer length. The target shall not return CHECK CONDITION when a setmark is encountered if the RSmk bit is zero or if this option is not supported.

If an attempt is made to recover more logical blocks of data than are contained in the target's buffer, CHECK CONDITION status shall be returned, the sense key shall be set to NO SENSE, and the EOM and valid bits shall

be set to one in the sense data. If the fixed bit is one, the information field shall be set to the requested transfer length minus the actual number of blocks transferred. If the fixed bit is zero, the information field shall be set to the requested transfer length.

10.2.9 RELEASE UNIT command

The RELEASE UNIT command (see table 185) is used to release previously reserved logical units for the requesting initiator, or if it is a third-party release, to another specified SCSI device.

Table 185 - RELEASE UNIT command

Bit Byte	7	6	5	4	3	2	1	0
0	Operation code (17h)							
1	Logical unit number			3rdPty	Third party device ID			Reserved
2	Reserved							
3	Reserved							
4	Reserved							
5	Control							

The RESERVE UNIT and RELEASE UNIT commands provide the basic mechanism for contention resolution in multiple-initiator systems.

If a valid reservation exists for the I_T_L nexus, the target shall release the reservation and return GOOD status.

A reservation may only be released by the initiator that made it. It is not an error to attempt to release a reservation that is not currently valid or is held by another initiator. In this case, the target shall return GOOD status without altering any other reservation.

10.2.9.1 Third-party release

Third-party release allows an initiator to release a logical unit that was previously reserved using a third-party reservation (see 10.2.10.1).

If the third party (3rdPty) bit is zero, then a third-party release is not requested. If the 3rdPty bit is one, and if the reservation was made using a third-party reservation by the initiator that is requesting the release for the same SCSI device as specified in the third-party device ID, then the target shall release the reservation.

If the 3rdPty bit is one, the target shall not modify the mode parameters for commands received from the third-party device even if the target implements the transfer of mode parameters with a third-party RESERVE UNIT command.

NOTE 146 When a target implements independent storage of mode parameters for each initiator, a third-party RESERVE UNIT command effects a transfer of the current mode parameters. Those set up by the initiator of the RESERVE UNIT are to be set as the mode parameters used for commands from the third-party device (usually a copy master device). A unit attention condition notifies the third-party device of the changed mode parameters. A successful third-party RELEASE UNIT command leaves the transferred parameters intact. The third-party device can issue MODE SENSE and MODE SELECT commands to query and modify the mode parameters.

ANSI X3.131-1994

10.2.10 RESERVE UNIT command

The RESERVE UNIT command (see table 186) is used to reserve logical units for the exclusive use of the requesting initiator, or if it is a third-party reservation, to another specified SCSI device.

Table 186 - RESERVE UNIT command

Bit Byte	7	6	5	4	3	2	1	0
0	Operation code (16h)							
1	Logical unit number			3rdPty	Third party device ID			Reserved
2	Reserved							
3	Reserved							
4	Reserved							
5	Control							

The RESERVE UNIT and RELEASE UNIT commands provide the basic mechanism for contention resolution in multiple-initiator systems.

This command requests that the entire logical unit be reserved for the exclusive use of the initiator until the reservation is superseded by another valid RESERVE UNIT command from the initiator that made the reservation or until released by a RELEASE UNIT command from the same initiator that made the reservation, by a BUS DEVICE RESET message from any initiator, by a hard reset condition, or by a power on cycle. The reservation shall not be granted if the logical unit is reserved by another initiator. It shall be permissible for an initiator to reserve a logical unit that is currently reserved by that initiator.

If the logical unit is reserved for another initiator, the target shall return RESERVATION CONFLICT status.

If, after honouring the reservation, any other initiator attempts to perform any command on the reserved logical unit other than an INQUIRY, REQUEST SENSE, PREVENT ALLOW MEDIUM REMOVAL (with a prevent bit of zero), or a RELEASE UNIT command, the command shall be rejected with RESERVATION CONFLICT status.

10.2.10.1 Third-party reservation

Third-party reservation allows an initiator to reserve a logical unit for another SCSI device. This is intended for use in multiple-initiator systems that use the COPY command.

If the third-party (3rdPty) bit is zero, a third-party reservation is not requested. If the 3rdPty bit is one the target shall reserve the logical unit for the SCSI device specified in the third-party device ID field. The target shall preserve the reservation until it is superseded by another valid RESERVE UNIT command from the initiator that made the reservation or until it is released by the same initiator, by a BUS DEVICE RESET message from any initiator, or a hard reset condition. The target shall ignore any attempt to release the reservation made by any other initiator.

If independent sets of parameters are implemented, a third party reservation shall cause the target to transfer the set of parameters in effect for the initiator of the RESERVE command to the parameters used for commands from the third-party device. Any subsequent command issued by the third-party device is executed according to the mode parameters in effect for the initiator that sent the RESERVE command.

If independent sets of parameters are implemented, a third party reservation shall cause the target to transfer the set of parameters in effect for the initiator of the RESERVE command to the parameters used for commands from the third party device. Any subsequent command issued by the third-party device is executed according to the mode parameters in effect for the initiator that sent the RESERVE command.

NOTE 147 This transfer of the mode parameters is applicable to target devices which store mode information independently for different initiators. This mechanism allows an initiator to set the mode parameters of a target for the use of a copy master (i.e. the third-party device). The third-party copy master may subsequently issue a MODE SELECT command to modify the mode parameters.

10.2.10.2 Superseding reservations

An initiator that currently has a logical unit reserved may modify the current reservation by issuing another RESERVE UNIT command to the same logical unit. The superseding reservation shall release the current reservation if the superseding reservation request is granted. The current reservation shall not be modified if the superseding reservation request cannot be granted. If the superseding reservation cannot be granted because of conflicts with a previous reservation (other than the current reservation), then the target shall return RESERVATION CONFLICT status.

NOTE 148 Superseding reservations allow the third-party SCSI device ID to be changed during a reservation using the third-party reservation option. This capability is necessary for certain situations when using COMPARE, COPY, and COPY AND VERIFY commands.

10.2.11 REWIND command

The REWIND command (see table 187) causes the target to position the logical unit to the beginning-of-partition in the current partition. Prior to performing the rewind operation, the target shall ensure that all buffered data, filemarks, and setmarks have been transferred to the medium.

Table 187 - REWIND command

Bit Byte	7	6	5	4	3	2	1	0
0	Operation code (01h)							
1	Logical unit number			Reserved				Immed
2	Reserved							
3	Reserved							
4	Reserved							
5	Control							

An immediate (Immed) bit of zero indicates that the target shall not return status until the rewind operation has completed. An Immed bit of one indicates that the target shall return status as soon as all buffered commands have completed execution and the command descriptor block of the REWIND command has been validated. If CHECK CONDITION status is returned for a REWIND command with an Immed bit of one, the rewind operation shall not be performed.

NOTE 149 For compatibility with devices implemented prior to this standard, it is suggested that a WRITE FILEMARKS command with an Immed bit of zero be used to ensure that all buffered data, filemarks, or setmarks have been transferred to the medium before issuing a REWIND command with an Immed bit of one.

When operating in buffered mode 1h or 2h (see 10.3.3), the target shall discard any unwritten buffered data after the REWIND command is validated if the previous command was terminated with CHECK CONDITION status and the device is unable to continue successfully writing.

ANSI X3.131-1994

10.2.12 SPACE command

The SPACE command (see table 188) provides a variety of positioning functions that are determined by the code and count. Both forward and reverse positioning are provided, although some targets may only support a subset of this command. If an initiator requests an unsupported function, the command shall be terminated with CHECK CONDITION status and the sense key shall be set to ILLEGAL REQUEST.

Table 188 - SPACE command

Bit Byte	7	6	5	4	3	2	1	0
0	Operation (11h)							
1	Logical unit number			Reserved		Code		
2	(MSB)							
3	Count							
4	(LSB)							
5	Control							

The code field is defined in table 189.

Table 189 - Code field definition

Code	Description	Support
000b	Blocks	Mandatory
001b	Filemarks	Mandatory
010b	Sequential filemarks	Optional
011b	End-of-data	Optional
100b	Setmarks	Optional
101b	Sequential setmarks	Optional
110b - 111b	Reserved	

When spacing over blocks, filemarks, or setmarks, the count field specifies the number of blocks, filemarks, or setmarks to be spaced over in the current partition. A positive value N in the count field shall cause forward positioning (toward end-of-partition) over N blocks, filemarks, or setmarks ending on the end-of-partition side of the last block, filemark, or setmark. A zero value in the count field shall cause no change of logical position. A negative value $-N$ (two's complement notation) in the count field shall cause reverse positioning (toward beginning-of-partition) over N blocks, filemarks, or setmarks ending on the beginning-of-partition side of the last block, filemark, or setmark. Support of spacing in the reverse direction is optional.

If a filemark is encountered while spacing over blocks, the command shall be terminated. The logical position shall be on the end-of-partition side of the filemark if movement was in the forward direction and on the beginning-of-partition side of the filemark if movement was in the reverse direction. CHECK CONDITION status shall be returned to the initiator, the sense key shall be set to NO SENSE, and the filemark and valid bits shall be set to one in the sense data. The information field shall be set to the requested count minus the actual number of blocks spaced over (not including the filemark).

If a setmark is encountered while spacing over blocks or filemarks and the RSmk bit is set to one in the device configuration page (see 10.3.3.1), the command shall be terminated, CHECK CONDITION status shall be returned to the initiator, and the filemark and valid bits shall be set to one in the sense data. The sense key shall be set to NO SENSE and the additional sense code shall be set to SETMARK DETECTED. The information field shall be set to the requested count minus the actual number of blocks or filemarks spaced over (not including the setmark). The logical position shall be on the end-of-partition side of the setmark if movement was in the forward direction and on the beginning-of-partition side of the setmark if movement was in the reverse direction. The

target shall not return CHECK CONDITION status when a setmark is encountered if the RSmk bit is set to zero or if this option is not supported.

If early-warning is encountered while spacing over blocks, filemarks, or setmarks and the REW bit is set to one in the device configuration page (see 10.3.3.1), CHECK CONDITION status shall be returned, the sense key shall be set to NO SENSE, and the EOM and valid bits shall be set to one in the sense data. The information field shall be set to the requested count minus the actual number of blocks, filemarks, or setmarks spaced over as defined by the code value. If the REW bit is zero or the option is not supported by the target, the target shall not report CHECK CONDITION status at the early-warning point.

NOTE 150 Setting the REW bit is not recommended for most system applications since data may be present after early-warning.

If end-of-data is encountered while spacing over blocks, filemarks, or setmarks, CHECK CONDITION status shall be returned, the sense key shall be set to BLANK CHECK, and the valid bit shall be set to one in the sense data. Additionally, the EOM bit shall be set to one if end-of-data is encountered at or after early-warning. The information field shall be set to the requested count minus the actual number of blocks, filemarks, or setmarks spaced over as defined by the code value.

If the end-of-partition is encountered while spacing forward over blocks, filemarks, or setmarks, CHECK CONDITION status shall be returned, the sense key shall be set to MEDIUM ERROR, the EOM bit shall be set to one, and the valid bit shall be set to one. The information field shall be set to the requested count minus the actual number of blocks, filemarks, or setmarks spaced over as defined by the code value.

If beginning-of-partition is encountered while spacing over blocks, filemarks, or setmarks in the reverse direction, the target shall return CHECK CONDITION status and shall set the sense key to NO SENSE. The EOM and valid bits shall be set to one, and the information field set to the total number of blocks, filemarks, or setmarks not spaced over (the requested number of blocks, filemarks, or setmarks minus the actual number of blocks, filemarks, or setmarks spaced over).

When spacing over sequential filemarks (or setmarks), the count field is interpreted as follows:

- a) A positive value N shall cause forward movement to the first occurrence of N or more consecutive filemarks (or setmarks) being logically positioned after the N^{th} filemark (or setmark).
- b) A zero value shall cause no change in the logical position.
- c) A negative value $-N$ (2's complement notation) shall cause reverse movement to the first occurrence of N or more consecutive filemarks (or setmarks) being logically positioned on the beginning-of-partition side of the N^{th} filemark (or setmark).

If a setmark is encountered while spacing to sequential filemarks and the RSmk bit is set to one in the device configuration page (see 10.3.3.1), CHECK CONDITION status shall be returned, the filemark bit shall be set to one, and the valid bit shall be set to zero. The sense key shall be set to NO SENSE and the additional sense code shall be set to SETMARK DETECTED. The target shall not return CHECK CONDITION status when a setmark is encountered if the RSmk bit is set to zero or if this option is not supported.

If end-of-partition is encountered while spacing to sequential filemarks or setmarks, CHECK CONDITION status shall be returned, the sense key shall be set to MEDIUM ERROR, the EOM bit shall be set to one, and the valid bit shall be set to zero.

If end-of-data is encountered while spacing to sequential filemarks or setmarks, CHECK CONDITION status shall be returned, the sense key shall be set to BLANK CHECK, and the valid bit shall be set to zero. Additionally, the EOM bit shall be set to one if end-of-data is encountered at or after early-warning.

When spacing to end-of-data, the count field is ignored. Upon successful completion, the medium shall be positioned such that a subsequent write operation would append to the last logically recorded information.

ANSI X3.131-1994

If end-of-partition is encountered while spacing to end-of-data, CHECK CONDITION status shall be returned, the sense key shall be set to MEDIUM ERROR, the EOM bit shall be set to one, and the valid bit shall be set to zero.

10.2.13 VERIFY command

The VERIFY command (see table 190) requests that the target verify one or more block(s) beginning with the next block on the logical unit.

Table 190 - VERIFY command

Bit Byte	7	6	5	4	3	2	1	0
0	Operation code (13h)							
1	Logical unit number			Reserved		Immed	BytCmp	Fixed
2	(MSB)							
3	Verification length							
4	(LSB)							
5	Control							

An immediate (Immed) bit of zero indicates that the command shall not return status until the verify operation has completed. An Immed bit of one indicates that status shall be returned as soon as the command descriptor block has been validated (but after the data transfer from the initiator, if the BytCmp bit is one).

NOTE 151 In order to ensure that no errors are lost, the initiator should set the Immed bit to zero on the last VERIFY command when issuing a series of VERIFY commands.

A byte compare (BytCmp) bit of zero indicates that the verification shall be simply a medium verification (e.g. CRC, ECC). No data shall be transferred from the initiator to the target.

A BytCmp bit of one indicates that the target shall perform a byte-by-byte compare of the data on the medium and the data transferred from the initiator. Data shall be transferred from the initiator to the target as in a WRITE command. If the BytCmp bit is one and the byte compare option is not supported, the target shall terminate the command with CHECK CONDITION status and the sense key shall be set to ILLEGAL REQUEST.

The verification length specifies the amount of data to verify, in blocks or bytes, as indicated by the fixed bit. Refer to the READ command (see 10.2.4) for a description of the fixed bit and any associated error conditions. If the BytCmp bit is one and the verification length is zero, no data shall be verified and the current logical position shall not be changed. This condition shall not be considered as an error.

The VERIFY command shall terminate when the verification length has been satisfied, when an incorrect length block is encountered, when a filemark is encountered, when a setmark is encountered (if the RSmk bit is one in the device configuration page, see 10.3.3.1), when end-of-data is encountered, when the end-of-partition is encountered, when early-warning is encountered (if the REW bit is one in the device configuration page, see 10.3.3.1), or when an unrecoverable read error is encountered. The status and sense data for each of these conditions are handled in the same manner as in the READ command (see 10.2.4). Upon successful completion of a VERIFY command, the logical position shall be after the last block verified.

If the data does not compare (BytCmp bit of one), the command shall terminate with CHECK CONDITION status, the valid bit shall be set to one, and the sense key shall be set to MISCOMPARE. If the fixed bit is one, the information field shall be set to the requested verification length minus the actual number of blocks successfully verified. If the fixed bit is zero, the information field shall be set to the requested verification length minus the actual number of bytes successfully verified. This number may be larger than the requested verification length if

the error occurred on a previous VERIFY command with an Immed bit of one. Upon termination, the medium shall be positioned after the block containing the miscompare (end-of-partition side).

10.2.14 WRITE command

The WRITE command (see table 191) requests that the target write the data that is transferred from the initiator to the current position on the logical unit.

Table 191 - WRITE command

Bit Byte	7	6	5	4	3	2	1	0
0	Operation code (0Ah)							
1	Logical unit number			Reserved				Fixed
2	(MSB)							
3	Transfer length							
4	(LSB)							
5	Control							

The fixed bit specifies whether fixed-length or variable-length blocks are to be transferred. See the READ BLOCK LIMITS command (see 10.2.5) for additional information about fixed and variable block mode.

If the fixed bit is one, the transfer length specifies the number of fixed-length blocks to be transferred, using the current block length reported in the mode parameter block descriptor (see 8.3.3). If the fixed bit is zero, a single block is transferred with the transfer length specifying the block length in bytes.

If the transfer length is zero, no data shall be transferred and the current position on the logical unit shall not be changed. This condition shall not be considered an error.

A WRITE command may be buffered or unbuffered, as indicated by the buffered mode field of the mode parameter header (see 10.3.3). For unbuffered operation (buffered mode 0h), the target shall not return GOOD status until all data block(s) are successfully written to the medium. For buffered operation (buffered mode 1h or 2h), the target may return GOOD status as soon as all data block(s) are successfully transferred to the target's buffer.

NOTE 152 For compatibility with devices implemented prior to this version of this standard, a WRITE FILEMARKS command with the Immed bit set to zero should be issued when completing a buffered write operation to ensure that all buffered data, filemarks, and setmarks are written to the medium.

If the logical unit encounters early-warning during a WRITE command, an attempt to finish writing any data may be made, as determined by the current settings of the REW and SEW bits in the device configuration page (see 10.3.3.1). The command shall terminate with CHECK CONDITION status and the EOM and valid bits shall be set to one in the sense data. If all data that is to be written is successfully transferred to the medium, the sense key shall be set to NO SENSE or RECOVERED ERROR, as appropriate. If any data that is to be written cannot be transferred to the medium when early-warning is encountered, the sense key shall be set to VOLUME OVERFLOW.

The information field shall be defined as follows:

- a) If unbuffered mode is reported in the mode parameter header and the fixed bit is set to one, the information field shall be set to the requested transfer length minus the actual number of blocks written.
- b) If unbuffered mode is reported and the fixed bit is set to zero, the information field shall be set to the requested transfer length.

ANSI X3.131-1994

- c) If buffered mode is reported in the mode parameter header and the fixed bit is set to one, the information field shall be set to the total number of blocks, filemarks, and setmarks not written (the number of blocks not transferred from the initiator plus the number of blocks, filemarks, and setmarks remaining in the target's buffer). Note that the value in the information field may exceed the transfer length.
- d) If buffered mode is reported and the fixed bit is set to zero, the information field shall be set to the total number of bytes, filemarks, and setmarks not written (the number of bytes not transferred from the initiator plus the number of bytes, filemarks, and setmarks remaining in the target's buffer).

NOTES

153 The value in the information field may exceed the transfer length.

154 The target should ensure that some additional data can be written to the medium (e.g. labels, filemarks, or setmarks) after the first early-warning indication has been returned to the initiator.

If a WRITE command is received while the logical unit is positioned between early-warning and end-of-partition, the target shall return CHECK CONDITION status after attempting to perform the command. The EOM and valid bits shall be set to one in the sense data. If all data that is to be written is successfully transferred to the medium, the information field shall be set to zero. If any data that is to be written is not transferred to the medium prior to encountering end-of-partition, the sense key shall be set to VOLUME OVERFLOW and the information field shall be defined as follows:

- a) If the fixed bit is one, the information field shall be set to the requested transfer length minus the actual number of blocks written to the medium.
- b) If the fixed bit is zero, the information field shall be set to the requested transfer length.

NOTE 155 In some systems it is important to recognize an error if end-of-partition is encountered during execution of a WRITE command, without regard for whether all data that is to be written is successfully transferred to the medium. By its definition, the VOLUME OVERFLOW sense key may always validly be returned if end-of-partition is encountered while writing, and such usage is recommended. Reporting the MEDIUM ERROR sense key, as was done in some SCSI-1 implementations, may cause confusion as to whether there was really defective medium encountered during execution of the last write command.

10.2.15 WRITE FILEMARKS command

The WRITE FILEMARKS command (see table 192) requests that the target write the specified number of filemarks or setmarks to the current position on the logical unit.

Table 192 - WRITE FILEMARKS command

Bit Byte	7	6	5	4	3	2	1	0
0	Operation code (10h)							
1	Logical unit number			Reserved			WSmk	Immed
2	(MSB)							
3	Transfer length							
4	(LSB)							
5	Control							

If the Write Setmark (WSmk) bit is one, the transfer length specifies the number of setmarks to be written. If the WSmk bit is zero, the transfer length specifies the number of filemarks to be written.

An immediate (Immed) bit of one indicates that the target shall return status as soon as the command descriptor block has been validated. An Immed bit of one is only valid if buffered mode is reported in the mode parameter header (see 10.3.3).

An Immed bit of zero indicates that the target shall not return status until the write operation has completed. Any buffered data, filemarks, and setmarks shall be written to the medium prior to completing the command.

NOTE 156 Upon completion of any buffered write operation, the initiator can issue a WRITE FILEMARKS command with the Immed bit set to zero and the transfer length field set to zero to ensure that all buffered data, filemarks, and setmarks are successfully written to the medium.

If the logical unit encounters early-warning during a WRITE FILEMARKS command, an attempt to finish writing any buffered data, filemarks, or setmarks may be made, as determined by the current settings of the REW and SEW bits in the device configuration page (see 10.3.3.1). The command shall terminate with CHECK CONDITION status and the EOM and valid bits shall be set to one in the sense data. If all buffered data, filemarks, and setmarks are successfully transferred to the medium, the sense key shall be set to NO SENSE or RECOVERED ERROR, as appropriate. If any buffered data, filemarks, or setmarks to be written are not transferred to the medium when early-warning is encountered, the sense key shall be set to VOLUME OVERFLOW.

The information field shall be defined as follows:

- a) If unbuffered mode is reported in the mode parameter header, the information field shall be set to the requested transfer length minus the actual number of filemarks or setmarks written.
- b) If buffered mode is reported in the mode parameter header and the buffered data was written in variable block mode (see 10.2.14), the information field shall be set to the total number of bytes, filemarks, and setmarks not written (the number of filemarks or setmarks not transferred from the initiator plus the number of bytes, filemarks and setmarks remaining in the target's buffer). Note that it is possible for the value in the information field to exceed the transfer length.
- c) If buffered mode is reported and the buffered data was written in fixed block mode (see 10.2.14), the information field shall be set to the total number of blocks, filemarks, and setmarks not written (the number filemarks or setmarks not transferred from the initiator plus the number of blocks, filemarks, and setmarks remaining in the target's buffer). Note that it is possible for the value in the information field to exceed the transfer length.

NOTE 157 The target should ensure that some additional data can be written to the medium (e.g. labels, filemarks, or setmarks) after the first early-warning indication has been returned to the initiator.

If a WRITE FILEMARKS command is received while the logical unit is positioned between early-warning and end-of-partition, the target shall return CHECK CONDITION status after attempting to perform the command. The EOM and valid bits shall be set to one in the sense data. If all filemarks or setmarks to be written are successfully transferred to the medium, the information field shall be set to zero. If any filemarks or setmarks to be written are not transferred to the medium prior to encountering end-of-partition, the sense key shall be set to VOLUME OVERFLOW and the information field shall be set to the requested transfer length minus the actual number of filemarks or setmarks written to the medium.

ANSI X3.131-1994

10.3 Parameters for sequential-access devices

10.3.1 Diagnostic parameters

This subclause defines the descriptors and pages for diagnostic parameters used with sequential-access devices.

The diagnostic page codes for sequential-access devices are defined in table 193.

Table 193 - Diagnostic page codes

Page code	Description	Subclause
00h	Supported diagnostic pages	8.3.1.1
01h - 3Fh	Reserved (for all device type pages)	
40h - 7Fh	Reserved	
80h - FFh	Vendor-specific pages	

10.3.2 Log parameters

This subclause defines the descriptors and pages for log parameters used with sequential-access devices.

The log page codes for sequential-access devices are defined in table 194.

Table 194 - Log page codes

Page code	Description	Subclause
01h	Buffer over-run/under-run page	8.3.2.1
02h	Error counter page (write) page	8.3.2.2
03h	Error counter page (read) page	8.3.2.2
04h	Error counter page (read reverse) page	8.3.2.2
05h	Error counter page (verify) page	8.3.2.2
07h	Last <i>n</i> error events page	8.3.2.3
06h	Non-media error page	8.3.2.4
00h	Supported log pages	8.3.2.5
08h - 2Fh	Reserved	
3Fh	Reserved	
30h - 3Eh	Vendor-specific	

10.3.3 Mode parameters

This subclause defines the descriptors and pages for mode parameters used with sequential-access devices.

The mode parameter list, including the mode parameter header and mode block descriptor, are described in 8.3.3.

The medium-type code field in the mode parameter header is reserved for sequential-access devices.

The device-specific parameter byte of the mode parameter header (see 8.3.3) is defined in table 195 for sequential-access devices.

Table 195 - Device-specific parameter

Bit	7	6	5	4	3	2	1	0
	WP	Buffered mode			Speed			

When used with the MODE SENSE command, a write protect (WP) bit of zero indicates that medium is write enabled. A WP bit of one indicates that the medium is write protected. When used with the MODE SELECT command, this field is not defined.

Values for the buffered mode field are defined in table 196.

Table 196 - Buffered modes

Code	Description
0h	The target shall not report GOOD status on write commands until the data blocks are actually written on the medium.
1h	The target may report GOOD status on write commands as soon as as all the data specified in the write command has been transferred to the target's buffer. One or more blocks may be buffered prior to writing the block(s) to the medium.
2h	The target may report GOOD status on write commands as soon as: a) All the data specified in the write command has been successfully transferred to the target's buffer, and b) All buffered data from different initiators has been successfully written to the medium.
3h - 7h	Reserved

Values for the speed field shall be assigned as defined in table 197.

Table 197 - Speed field definition

Code	Description
0h	Default (Use the peripheral device's default speed).
1h	Use the peripheral device's lowest speed.
2h - Fh	Use increasing peripheral device speeds.

For the MODE SELECT command, the density code field of the sequential-access device block descriptor (8.3.3) indicates the density selected by the initiator for use in subsequent read and write operations. For devices capable of automatic density recognition, the density code selected by the initiator may be overridden by the target for a subsequent read operation if the selected value does not match the current recorded density of the medium. If the MODE SELECT command specifies the default density code the device selects the actual density code to be used in a vendor-specific manner. The value is expected to be the principal density code (or an optimal density code).

For the MODE SENSE command, the density code field reflects the current operating density of the device. If a current operating density has not been selected, either because no medium is installed or because the density of the installed medium has not been determined, the density code field should be set to the principal density code value. The principal density code is the highest density code supported, the optimal density code supported, or the most common density code supported. In some devices, the principal density code value returned in

ANSI X3.131-1994

response to a MODE SENSE command may change dynamically to match the most recently selected density. The density code value returned in response to a MODE SENSE command shall be as described below:

- a) Following a UNIT ATTENTION condition for a power on or hard reset condition, while not ready, the target shall report the principal density.
- b) Following a UNIT ATTENTION condition for a not-ready-to-ready transition, the target shall:
 - 1) report the principal density if no attempt has been made by the target to determine the density;
 - 2) report the principal density if the target cannot automatically determine the density from the medium;
 - 3) report the current medium density if the target has determined

the density from the medium.

- c) Following a successful read operation at or after beginning-of-medium, the target shall report a density code value reflecting the recorded density of the medium. For some implementations, the target may automatically determine this value from the medium. For devices not capable of automatic density determination, the principal density is reported if the density code value is not provided by the preceding MODE SELECT command.
- d) Following an unsuccessful read operation or a successful write operation, while at beginning-of-partition, the target shall:
 - 1) report a density code value as described for item b) if a previous MODE SELECT command has not established a density code for the currently mounted volume;
 - 2) report a density code value as provided by the last successful MODE SELECT command for the currently mounted volume.
- e) Following a successful unload operation the target shall report the most recent density code value as determined by items b) through d) above.

Table 198 lists the sequential-access device density codes

Table 198 - Sequential-access density codes

Code value	Description							Note	
00h	Default density (MODE SELECT command only)							7	
0Eh	Reserved for ECMA								
15h - 7Eh	Reserved								
7Fh	No change from previous density (NO-OP)								
80h - FFh	Vendor-specific								
Descriptions for magnetic tapes									
	Width	mm(in)	Tracks	Density	bpm(m bpi)	Code	Type	Reference	
01h	12,7	(0,5)	9	32	(800)	NRZI	R	X3.22-1983	2
02h	12,7	(0,5)	9	63	(1 600)	PE	R	X3.39-1986	2
03h	12,7	(0,5)	9	246	(6 250)	GCR	R	X3.54-1986	2
05h	6,3	(0,25)	4/9	315	(8 000)	GCR	C	X3.136-1986	1
06h	12,7	(0,5)	9	126	(3 200)	PE	R	X3.157-1987	2,4
07h	6,3	(0,25)	4	252	(6 400)	IMFM	C	X3.116-1986	1
08h	3,81	(0,15)	4	315	(8 000)	GCR	CS	X3.158-1987	1,4
09h	12,7	(0,5)	18	1 491	(37 871)	GCR	C	X3.180-1990	2,4
0Ah	12,7	(0,5)	22	262	(6 667)	MFM	C	X3.181-1990	1,4
0Bh	6,3	(0,25)	4	63	(1 600)	PE	C	X3.56-1986	1
0Ch	12,7	(0,5)	24	500	(12 690)	GCR	C		1,6
0Dh	12,7	(0,5)	24	999	(25 380)	GCR	C		1,6
0Fh	6,3	(0,25)	15	394	(10 000)	GCR	C		1,6
10h	6,3	(0,25)	18	394	(10 000)	GCR	C		1,6
11h	6,3	(0,25)	26	630	(16 000)	GCR	C		1,6
12h	6,3	(0,25)	30	2 034	(51 667)	RLL	C		1,6
13h	3,81	(0,15)	1	2 400	(61 000)	DDS	CS	11319-1992	5,8
14h	8,00	(0,315)	1	1 703	(43 245)	RLL	CS		5,6
15h	8,00	(0,315)	1	1 789	(45 434)	RLL	CS	ECMA TC17	5
16h	12,7	(0,5)	48	394	(10 000)	MFM	C	X3.197-1991	1,4
17h	12,7	(0,5)	48	1 673	(42 500)	MFM	C		1,4
Code	Description						Type	Description	
NRZI	Non return to zero, change on ones						R	Reel-to-reel	
GCR	Group code recording						C	Cartridge	
PE	Phase encoded						CS	Cassette	
IMFM	Inverted modified frequency modulation								
MFM	Modified frequency modulation								
DDS	DAT data storage								
RLL	Run length limited								
NOTES									
1 Serial recorded.									
2 Parallel recorded.									
3 Old format known as QIC-11.									
4 See annex D for additional standards information.									
5 Helical scan.									
6 This is not an American National Standard.									
7 This density code value is defined for the MODE SELECT command and shall not be returned by the MODE SENSE command.									
8 This is an ANSI/ISO/IEC document.									

The mode page codes for sequential-access devices are defined in table 199.

Table 199 - Mode page codes

Page code	Description	Subclause
0Ah	Control mode page	8.3.3.1
10h	Device configuration page	10.3.3.1
02h	Disconnect-reconnect page	8.3.3.2
11h	Medium partition page(1)	10.3.3.2
12h	Medium partition page(2)	10.3.3.3
13h	Medium partition page(3)	10.3.3.3
14h	Medium partition page(4)	10.3.3.3
09h	Peripheral device page	8.3.3.3
01h	Read-write error recovery page	10.3.3.4
00h	Vendor-specific (does not require page format)	
03h - 08h	Reserved	
0Bh - 0Fh	Reserved	
15h - 3Eh	Vendor-specific (page format required)	
3Fh	Return all pages (valid only for the MODE SENSE command)	

10.3.3.1 Device configuration page

The device configuration page (see table 200) is used to specify the appropriate sequential-access device configuration.

Table 200 - Device configuration page

Bit Byte	7	6	5	4	3	2	1	0
0	PS	Reserved	Page code (10h)					
1	Page length (0Eh)							
2	Reserved	CAP	CAF	Active format				
3	Active partition							
4	Write buffer full ratio							
5	Read buffer empty ratio							
6	(MSB) Write delay time							
7	(LSB)							
8	DBR	BIS	RSmk	AVC	SOCF		RBO	REW
9	Gap size							
10	EOD defined			EEG	SEW	Reserved		
11	(MSB) Buffer size at early warning							
12	(LSB)							
13	Select data compression algorithm							
14	Reserved							
15	Reserved							

A change active partition (CAP) bit of one indicates that the logical partition is to be changed to the one specified by the active partition field. A CAP bit of zero indicates no partition change is specified.

A change active format (CAF) bit of one indicates that the active format is to be changed to the value specified in the active format field. A CAF bit of zero indicates no active format change is specified. For some devices, the format may only be changed when the logical unit is at beginning-of-partition.

The active format field indicates which recording format is in use for the selected density code when reading or writing data on a logical unit. The value of the active format field is vendor-specific.

The active partition field indicates the current logical partition number in use on the medium.

The write buffer full ratio, on WRITE commands, indicates to the target how full the buffer shall be before writing data to the medium. A value of zero indicates that the value is not specified.

The read buffer empty ratio, on READ commands, indicates to the target how empty the buffer shall be before retrieving additional data from the medium. A value of zero indicates that the value is not specified.

The write delay time indicates the maximum time, in 100 ms increments, that the target should wait before any buffered data that is to be written, is forced to the medium after the last buffered WRITE command that did not cause the buffer to exceed the buffer full ratio. A value of zero indicates that the target shall never force buffered data to the medium under these conditions.

A data buffer recovery (DBR) bit of one indicates that the target supports data buffer recovery using the RECOVER BUFFERED DATA command. A DBR bit of zero indicates that the target does not support data buffer recovery. This bit is target-defined.

A block identifiers supported (BIS) bit of zero indicates that block IDs are not supported in the format written on the medium. A BIS bit of one indicates that the format on the medium has recorded information about the block IDs relative to a partition. This bit is target-defined.

A report setmarks (RSmk) bit of one indicates that the target shall recognize and report setmarks during appropriate read or space operations. A RSmk bit of zero indicates that the target shall not report setmarks.

The automatic velocity control (AVC) bit of one, indicates that the device shall select the speed (if the device supports more than one speed) based on the data transfer rate that should optimize streaming activity and minimize medium repositioning. An AVC bit of zero indicates the speed chosen should be the device's default speed.

A stop on consecutive filemarks (SOCF) field of 00b indicates that the device shall pre-read data from the medium in buffered mode to the limits of the buffer capacity without regard for filemarks. This implies that the device can differentiate between data blocks and filemarks in the buffer. Values 01b, 10b, and 11b specify that the device shall terminate the pre-read operation if one, two, or three consecutive filemarks are detected, respectively. If the RSmk bit is one, the target shall interpret this field as stop on consecutive setmarks.

A recover buffer order (RBO) bit of one indicates that data blocks shall be returned from the target's buffer on a RECOVERED BUFFERED DATA command in LIFO order (last-in-first-out) from which they were written to the buffer. A RBO bit of zero indicates data blocks shall be returned in FIFO (first-in-first-out) order.

A report early-warning (REW) bit of zero indicates that the target shall not report the early-warning condition for read operations and it shall report early-warning at or before any medium-defined early-warning position during write operations.

A REW bit of one indicates that the target shall return CHECK CONDITION status with the EOM bit set in the sense data when the early-warning position is encountered during read and write operations. If the REW bit is one and the SEW bit is zero, the target shall return CHECK CONDITION status with the sense key set to VOLUME OVERFLOW when early-warning is encountered during write operations.

ANSI X3.131-1994

NOTE 158 A REW bit of one is intended for compatibility with those systems using old tape formats that require an early-warning indication during read operations. Other systems should set this bit to zero to avoid potential data loss when interchanging tapes between peripheral devices.

The GapSize field value determines the size of the inter-block gap when writing data. A value of 00h specifies the device's defined gap size. A value of 01h specifies a device defined gap size sufficiently long to support update-in-place. Values of 02h through 0Fh are multipliers on the device's defined gap size. Values 10h through 7Fh are reserved. Values 80h through FFh are vendor-specific.

The end-of-data (EOD) defined field indicates which format type the logical unit shall use to detect and generate the EOD area. The types of EOD formats are specified in table 201.

Table 201 - EOD formats

Value	Description
000b	Logical unit's default EOD definition
001b	Format-defined erased area of medium
010b	As specified in the SOCF field
011b	EOD recognition and generation is not supported
100b - 111b	Reserved

An enable EOD generation (EEG) bit set to one indicates that the logical unit shall generate the appropriate EOD area, as determined by the EOD defined field. A value of zero indicates that EOD generation is disabled.

NOTE 159 Some logical units may not generate EOD at the completion of any write-type operation.

The synchronize at early-warning (SEW) bit set to one indicates that the target shall cause any buffered write data, filemarks, or setmarks to be transferred to the medium when early-warning is encountered. A value of zero indicates that the target shall retain any unwritten buffered data, filemarks, or setmarks in the buffer when early-warning is encountered (see the WRITE command, 10.2.14, and the WRITE FILEMARKS command, 10.2.15).

The buffer size at early-warning field indicates the value, in bytes, to which the target shall reduce its logical buffer size when writing. The target should reduce the buffer size only when the logical unit is positioned between its early-warning and end-of-partition. A value of zero indicates that the implementation of this function is device specific.

NOTE 160 The intent is to prevent the loss of data by limiting the size of the buffer when near the end-of-partition.

The select data compression algorithm field set to 00h indicates that the target shall not use a compression algorithm on any data sent to it prior to writing the data to the medium. A value of 01h indicates that the data to be written shall be compressed using the target's default compression algorithm. Values 02h through 7Fh are reserved. Values 80h through FFh are vendor-specific.

10.3.3.2 Medium partition page(1)

The medium partition page(1) (see table 202) is used to specify the first group of medium partitions. Additional groups are specified in medium partition pages(2-4) (see 10.3.3.3).

Table 202 - Medium partition page(1)

Bit Byte	7	6	5	4	3	2	1	0	
0	PS	Reserved	Page code (11h)						
1	Page length								
2	Maximum additional partitions								
3	Additional partitions defined								
4	FDP	SDP	IDP	PSUM		Reserved			
5	Medium format recognition								
6	Reserved								
7	Reserved								
Partition size descriptor(s)									
0	(MSB)	Partition size							
1							(LSB)		

The maximum additional partitions field is a target-defined value indicating the maximum number of additional partitions supported by the logical unit. A value of zero indicates that no value is specified.

The additional partitions defined field specifies the number of additional partitions to be defined for a volume when the SDP or IDP bit is set to one. The maximum value allowed is the value returned in the maximum additional partitions field.

A fixed data partitions (FDP) bit of one indicates that the device assigns partitions based on its fixed definition of partitions. Setting this bit to one may only be valid at beginning-of-partition and is mutually exclusive with the SDP and IDP bits.

A select data partitions (SDP) bit of one indicates that the device is to partition the medium into the number of partitions as specified by the additional partitions defined field using partition sizes defined by the device. Setting this bit to one may only be valid at beginning-of-partition and it is mutually exclusive with the FDP and IDP fields.

An initiator-defined partitions (IDP) bit of one indicates that the initiator is defining the number and size of the data partitions using the additional partitions defined field and the partition size descriptors. Setting this bit to one may only be valid at beginning-of-partition and is mutually exclusive with the FDP and SDP fields.

NOTE 161 Since defining partitions may require reformatting the medium for some implementations, an implicit write to the medium may occur as a result of a MODE SELECT command that supplies any of these parameters.

Partition size unit of measure (PSUM) field defines the units in which the partition size descriptors select the partition size. The values 00b, 01b, and 10b define the units as bytes, kilobytes, and megabytes, respectively. The value 11b is reserved.

The medium format recognition field is a target-defined value indicating the device's capability to automatically identify the medium format and partition information when reading an unknown volume.

ANSI X3.131-1994

Values for the medium format recognition field shall be assigned as follows:

- a) 00h Logical unit is incapable of format or partition recognition.
- b) 01h Logical unit is capable of format recognition only.
- c) 02h Logical unit is capable of partition recognition only.
- d) 03h Logical unit is capable of format and partition recognition.
- e) 04h - FFh Reserved.

NOTE 162 If a target indicates that it is not capable of medium format recognition, the initiator must supply all necessary parameters for the device to identify the specific format. The value in this field may be different following a medium change.

Partition size descriptors define the size of the respective partitions in the units specified in the PSUM field. Up to 64 partitions may be defined using this page. If additional partitions need to be defined, up to 64 partitions can be defined in each of the medium partition pages(2-4) defined in 10.3.3.3.

10.3.3.3 Medium partition page(2-4)

The medium partition page(2-4) (see table 203) is used to specify additional groups of medium partitions. The first group is specified in the medium partition page(1) (see 10.3.3.2).

Table 203 - Medium partition page(2-4)

Bit Byte	7	6	5	4	3	2	1	0	
0	PS	Reserved	Page code (12h, 13h, 14h)						
1	Page length								
	Partition size descriptor(s)								
0	(MSB)	Partition size							
1								(LSB)	

The additional page codes defined for partition size definition are 12h, 13h, and 14h. Up to a maximum of 64 partitions can be defined in each of these pages. The partition size is defined by the value of the partition size field. The units of size used by the partition size field is specified in the PSUM field of the medium partition page(1) (see 10.3.3.2).

NOTE 163 Since defining partitions may require reformatting the medium for some implementations, an implicit write to the medium may occur as a result of a MODE SELECT command that supplies these parameters.

10.3.3.4 Read-write error recovery page

The read-write error recovery page (see table 204) specifies the error recovery and reporting parameters that the target shall use when transferring data between the initiator and the medium. These parameters only apply to read-write errors and do not affect message system retries or positioning error recovery procedures.

Table 204 - Read-write error recovery page

Bit Byte	7	6	5	4	3	2	1	0
0	PS	Reserved	Page code (01h)					
1	Page length (0Ah)							
2	Reserved	Reserved	TB	Reserved	EER	PER	DTE	DCR
3	Read retry count							
4	Reserved							
5	Reserved							
6	Reserved							
7	Reserved							
8	Write retry count							
9	Reserved							
10	Reserved							
11	Reserved							
NOTE - The parameters in this page also apply to verify operations.								

A transfer block (TB) bit of one indicates that a data block that is not recoverable within the specified recovery limits shall be transferred to the initiator before CHECK CONDITION status is returned. A TB bit of zero indicates that the unrecoverable data block shall not be transferred to the initiator. Data blocks that can be recovered within the recovery limits are always transferred, regardless of the value of the TB bit.

An enable early recovery (EER) bit of one indicates that the target shall use the most expedient error recovery algorithm (e.g. attempt error correction prior to retries). An EER bit of zero indicates that the target shall use the most deliberate error recovery algorithm, within the limits established by the other error recovery parameters (e.g. attempt to recover the block error-free prior to using error correction).

A post error (PER) bit of one indicates that the target shall return CHECK CONDITION status to report recovered errors. A PER bit of zero indicates that the target shall not report errors recovered within the limits established by the error recovery parameters. If this bit is zero, the DTE bit must also be set to zero.

A disable transfer on error (DTE) bit of one indicates that the target shall terminate the data transfer after a recovered read-write error occurs. All data from the recovered block shall be transferred prior to terminating the read-write operation. A DTE bit of zero indicates that the target shall not terminate the transfer for errors recovered within the limits established by the read-write error recovery parameters.

A disable correction (DCR) bit of one indicates that the target shall not use error correction codes during error recovery. A DCR bit of zero allows the use of error correction codes for error recovery.

The read retry count specifies the number of times that the target should attempt its recovery algorithm during a read operation before an unrecoverable error is reported. A read retry count of zero indicates that the target shall not use its recovery algorithm during read operations.

The write retry count specifies the number of times that the target should attempt its recovery algorithm during a write operation before an unrecoverable error is reported. A write retry count of zero indicates that the target shall not use its recovery algorithm during write operations.

10.4 Definitions specific to sequential access devices

10.4.1 beginning-of-partition: The position at the beginning of the permissible recording region of a partition. If only one partition is defined, this position is typically equivalent to the beginning-of-medium.

10.4.2 beginning-of-medium: The extreme position along the medium in the direction away from the supply reel which can be accessed by the device.

10.4.3 buffered mode: A mode of data transfer in write operations which facilitates tape streaming (10.1.5), as reported in the mode parameter header device-specific parameter (10.3.3).

10.4.4 early-warning: A physical mark or device computed position near but logically before the end-of-partition (independent of physical direction). See the REW bit in the device configuration page in 10.3.3.1.

10.4.5 end-of-data: End of data in a partition is denoted in format-specific manner. See the EOD defined field in the device configuration page in 10.3.3.1.

10.4.6 end-of-medium: The extreme position along the medium in the direction away from the take-up reel which can be accessed by the device. This position may be accessed by devices that support the LOAD UNLOAD command with the EOT bit set to one.

10.4.7 end-of-partition: The position at the end of the permissible recording region of a partition.

10.4.8 filemark: A special recorded element within a partition, containing no user data, which provides a segmentation scheme.

10.4.9 overlength: The incorrect length condition that exists after executing a read command when the length of the actual block read exceeds the requested transfer length in the command descriptor block.

10.4.10 partition: The entire usable region of recording and reading paths in a volume or in a portion of a volume, defined in a device-specific manner. If there is more than one partition, they shall be numbered starting with zero (i.e. beginning-of-partition-zero).

10.4.11 setmark: A special recorded element within a partition, containing no user data, which provides a segmentation scheme hierarchically superior to filemarks for use in addressing or fast positioning on high capacity storage devices.

10.4.12 spacing: The act of positioning the medium on a sequential access device.

10.4.13 underlength: The incorrect length condition that exists after executing a read command when the requested transfer length in the command descriptor block exceeds the length of the actual block read.

10.4.14 volume: A recording medium together with its physical carrier.

11 Commands for printer devices

11.1 Model for printer devices

This command set includes capability for the printer-controlling device, that is an SCSI target to be is functionally separate from the physical printer device (see figure 27) as well as integrated with it. The physical printer device is connected to the SCSI target via one of several common device-level interfaces. There may be more than one physical printer device attached to the printer controlling device. In such a case, each physical printer device is assigned a separate logical unit number, beginning with zero. The printer-controlling device, printer device-level interface, and the physical printer device are referred to collectively as the printer device.

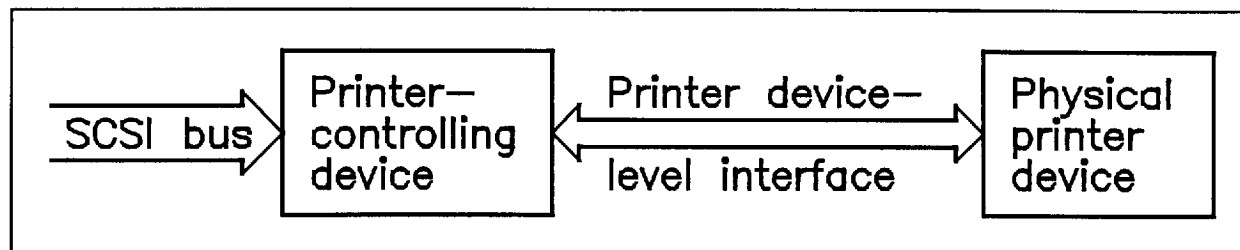

Figure 27 - SCSI printer model

Specific control mechanisms are defined in mode pages for two industry-standard interfaces known as the line printer interface (e.g. the Data Products interface or equivalent) and the EIA RS-232C interface. These mode pages are used to control optional features of these interfaces. No mode page was defined for the popular industry-standard parallel interface because the options requiring controls are embedded in the data.

The printer-controlling device may be integrated within the printer device; it is not required to use one of the industry-standard interfaces referenced above.

The printer device commands are structured on the assumption that specific printer control codes may be embedded in the data transferred by the FORMAT, PRINT, and SLEW AND PRINT commands. The transparent control codes may take the form of escape code sequences. commands for the operation of the target function and some printer controls, which are not convenient to handle in a transparent way, are specified in 11.2.

This standard does not specify which character set is used by the printer device; nor does it specify the meaning of the escape code sequences that may be used.

ANSI X3.131-1994

11.2 Commands for printer devices

The commands for printer devices shall be as shown in table 205.

Table 205 - Commands for printer devices

Command name	Operation code	Type	Subclause
CHANGE DEFINITION	40h	O	8.2.1
COMPARE	39h	O	8.2.2
COPY	18h	O	8.2.3
COPY AND VERIFY	3Ah	O	8.2.4
FORMAT	04h	O	11.2.1
INQUIRY	12h	M	8.2.5
LOG SELECT	4Ch	O	8.2.6
LOG SENSE	4Dh	O	8.2.7
MODE SELECT(6)	15h	O	8.2.8
MODE SELECT(10)	55h	O	8.2.9
MODE SENSE(6)	1Ah	O	8.2.10
MODE SENSE(10)	5Ah	O	8.2.11
PRINT	0Ah	M	11.2.2
READ BUFFER	3Ch	O	8.2.12
RECEIVE DIAGNOSTIC RESULTS	1Ch	O	8.2.13
RECOVER BUFFERED DATA	14h	O	11.2.3
RELEASE UNIT	17h	M	10.2.9
REQUEST SENSE	03h	M	8.2.14
RESERVE UNIT	16h	M	10.2.10
SEND DIAGNOSTIC	1Dh	M	8.2.15
SLEW AND PRINT	0Bh	O	11.2.4
STOP PRINT	1Bh	O	11.2.5
SYNCHRONIZE BUFFER	10h	O	11.2.6
TEST UNIT READY	00h	M	8.2.16
WRITE BUFFER	3Bh	O	8.2.17

Key: M = command implementation is mandatory.
O = command implementation is optional.

The following operation codes are vendor-specific: 01h, 02h, 05h, 06h, 07h, 08h, 09h, 0Ch, 0Dh, 0Eh, 0Fh, 11h, 13h, 19h, and C0h through FFh. All remaining operation codes for printer devices are reserved for future standardization.

11.2.1 FORMAT command

The FORMAT command (see table 206) provides a means for the initiator to specify forms or fonts to printers that support programmable forms or fonts. The format information is peripheral-device specific.

Table 206 - FORMAT command

Bit Byte	7	6	5	4	3	2	1	0
0	Operation code (04h)							
1	Logical unit number			Reserved			Format type	
2	(MSB)							
3	Transfer length							
4	(LSB)							
5	Control							

The format type field specifies the type of format information to be transferred from the initiator to the target. This field is defined in table 207.

Table 207 - Format type

Code	Format type
00b	Set form
01b	Set font
10b	Vendor-specific
11b	Reserved

The transfer length specifies the length in bytes of format information that shall be transferred during the DATA OUT phase. A transfer length of zero indicates that no format information shall be transferred. This condition shall not be considered as error.

ANSI X3.131-1994

11.2.2 PRINT command

The PRINT command (see table 208) transfers the specified number of bytes from the initiator to the target to be printed.

Table 208 - PRINT command

Bit Byte	7	6	5	4	3	2	1	0
0	Operation code (0Ah)							
1	Logical unit number			Reserved				
2	(MSB)							
3	Transfer length							
4	(LSB)							
5	Control							

The transfer length specifies the length in bytes of data that shall be transferred during the DATA OUT phase. A transfer length of zero indicates that no data shall be transferred. This condition shall not be considered as error.

11.2.3 RECOVER BUFFERED DATA command

The RECOVER BUFFERED DATA command (see table 209) returns to the initiator data that was transferred to the target, but not yet printed.

Table 209 - RECOVER BUFFERED DATA command

Bit Byte	7	6	5	4	3	2	1	0
0	Operation code (14h)							
1	Logical unit number			Reserved				
2	(MSB)							
3	Transfer length							
4	(LSB)							
5	Control							

This command is normally used only to recover from error or exception conditions that make it impossible to print the buffered data. The order in which data are transferred from the target to the initiator is the same as when the data were previously transferred using the PRINT command or SLEW AND PRINT command. Data transferred by this command are deleted from the target data buffer. One or more RECOVER BUFFERED DATA commands may be used to return the buffered data that is not printed.

If an attempt is made to recover more data than is contained in the buffer, the command shall be terminated with CHECK CONDITION status and the sense key shall be set to NO SENSE. In addition, the EOM, valid, and ILI bits shall be set to one. The information bytes shall be set to the difference (residue) between the transfer length and the actual number of bytes returned.

The transfer length specifies the maximum length in bytes of data that shall be transferred during the DATA IN phase. A transfer length of zero indicates that no data shall be transferred. This condition shall not be considered as error.

11.2.4 SLEW AND PRINT command

The SLEW AND PRINT command (see table 210) transfers the specified number of bytes from the initiator to the target to be printed. This command is provided for printer devices that do not support forms control information embedded within the print data.

Table 210 - SLEW AND PRINT command

Bit Byte	7	6	5	4	3	2	1	0
0	Operation code (0Bh)							
1	Logical unit number			Reserved				Channel
2	Slew value							
3	(MSB) Transfer length							
4	(LSB)							
5	Control							

The transfer length specifies the length in bytes of data that shall be transferred during the DATA OUT phase. A transfer length of zero indicates that no data shall be transferred. This condition shall not be considered as error.

If the channel bit is zero, the slew value specifies the number of lines the form shall be advanced before printing. A value of 255 indicates that the form shall be advanced to the first line of the next form before printing. If the channel bit is one, the slew value specifies the forms control channel number to which the form shall be advanced prior to printing the data. If implemented, the printer options page in the MODE SELECT command provides additional control over the usage of the slew value field.

If the channel bit is one, and the channel option is not implemented, the command shall be terminated with CHECK CONDITION status and the sense key shall be set to ILLEGAL REQUEST.

ANSI X3.131-1994

11.2.5 STOP PRINT command

The STOP PRINT command (see table 211) requests that the target halt printing on buffered devices in an orderly fashion.

Table 211 - STOP PRINT command

Bit Byte	7	6	5	4	3	2	1	0
0	Operation code (1Bh)							
1	Logical unit number			Reserved				Retain
2	Vendor-specific							
3	Reserved							
4	Reserved							
5	Control							

A retain bit of zero requests that the target data buffer be discarded; otherwise, the data not printed shall be retained. The data not printed may be recovered using the RECOVER BUFFERED DATA command, if implemented by the target. A subsequent SYNCHRONIZE BUFFER command, PRINT command, or SLEW AND PRINT command shall cause the remaining data not already printed to be printed, followed by the data transferred by the subsequent command, if any. The point at which printing is suspended by this command is vendor-specific.

11.2.6 SYNCHRONIZE BUFFER command

The SYNCHRONIZE BUFFER command (see table 212) provides a means for an initiator to ensure that the data have been printed successfully prior to releasing the peripheral device. This is useful for applications that handle any error or exception conditions (e.g. end-of-medium) prior to termination of the application.

Table 212 - SYNCHRONIZE BUFFER command

Bit Byte	7	6	5	4	3	2	1	0
0	Operation code (10h)							
1	Logical unit number			Reserved				
2	Reserved							
3	Reserved							
4	Reserved							
5	Control							

When all buffered data are actually printed, the command shall be terminated with a GOOD status. If it is not possible to finish printing all of the buffered data (due to an error or exception condition on the peripheral device), then this command shall be terminated with a CHECK CONDITION status and the appropriate sense key.

The printer options page in the MODE SELECT command, if implemented, provides additional control over termination sequences when using this command.

11.3 Parameters for printer devices

11.3.1 Diagnostic parameters

This subclause defines the descriptors and pages for diagnostic parameters used with printer devices.

The diagnostic page codes for printer devices are defined in table 213.

Table 213 - Diagnostic page codes

Page code	Description	Subclause
00h	Supported diagnostic pages	8.3.1.1
01h - 3Fh	Reserved (for all device type pages)	
40h - 7Fh	Reserved	
80h - FFh	Vendor-specific pages	

11.3.2 Log parameters

This subclause defines the descriptors and pages for log parameters used with printer devices.

The log page codes for printer devices are defined in table 214.

Table 214 - Log page codes

Page code	Description	Subclause
01h	Buffer over-run/under-run page	8.3.2.1
07h	Last n error events page	8.3.2.3
06h	Non-medium error page	8.3.2.4
00h	Supported log pages	8.3.2.5
02h - 05h	Reserved	
08h - 2Fh	Reserved	
3Fh	Reserved	
30h - 3Eh	Vendor-specific pages	

11.3.3 Mode parameters

This subclause defines the descriptors and pages for mode parameters used with printer devices.

The mode parameter list, including the mode parameter header and mode block descriptor, are described in 8.3.3.

The medium-type code field is contained in the mode parameter header (see 8.3.3). This field is reserved for printer devices.

The device-specific parameter field is contained in the mode parameter header (see 8.3.3). Table 215 defines the device-specific parameter used for printer devices.

Table 215 - Printer device-specific parameter

Bit	7	6	5	4	3	2	1	0
	WP	Buffered mode			Reserved			

ANSI X3.131-1994

When using the MODE SELECT command, a buffered mode of zero indicates that the target shall not report a GOOD status on PRINT commands or SLEW AND PRINT commands until the data are actually printed. A buffered mode of one indicates that the target may report a GOOD status on PRINT commands or SLEW AND PRINT commands as soon as the data have been transferred to the SCSI device buffer. The data from one or more commands may be buffered prior to printing. Buffered modes of 2h through 7h are reserved.

When using the MODE SENSE command, the buffered mode field returns the current value of this parameter.

The density code field is contained in the mode parameter block descriptor (see table 93). This field is reserved for printer devices.

The mode page codes for printer devices are shown in table 216.

Table 216 - Mode page codes

Page code	Description	Subclause
0Ah	Control mode page	8.3.3.1
02h	Disconnect-reconnect page	8.3.3.2
03h	Parallel printer interface page	11.3.3.1
09h	Peripheral device page	8.3.3.3
05h	Printer options page	11.3.3.2
04h	Serial printer interface page	11.3.3.3
01h	Reserved	
06h - 08h	Reserved	
0Bh - 1Fh	Reserved	
00h	Vendor-specific (does not require page format)	
20h - 3Eh	Vendor-specific (page format required)	
3Fh	Return all pages (valid only for the MODE SENSE command)	

11.3.3.1 Parallel printer interface page

The parallel printer interface page (see table 217) is intended to support printer devices that use the industry-standard line printer interface.

Table 217 - Parallel printer interface

Bit Byte	7	6	5	4	3	2	1	0
0	PS	Reserved	Page code (03h)					
1	Parameter length (03h)							
2	Parity select	PIPC	Reserved	VCBP	VCBS	VES	Autofd	
3	Reserved							

The parameters savable (PS) bit is only used with the MODE SENSE command. This bit is reserved with the MODE SELECT command. A PS bit of one indicates that the target is capable of saving the page in a non-volatile, vendor-specific location.

The parity select field specifies parity generation on the printer interface is defined in table 218.

Table 218 - Parity select

Code	Parity select
00b	No parity generation
01b	Even parity
10b	Odd parity
11b	Reserved

A paper instruction parity check (PIPC) bit of one indicates that the printer interface Paper Instruction signal is included in parity generation on the printer interface by the target. A PIPC bit of zero indicates that the Paper Instruction signal is not included in parity generation on the printer interface by the target.

NOTES

164 The format of the vertical forms unit (VFU) control byte is specified by the VCBP, VCBS, and VES bits. The VFU control byte is not part of this standard; however, a discussion of it is included here for a better understanding. This VFU control byte (see table, below) includes a control bit (C) to select whether to slew over a number of lines or to skip to a vertical forms unit (VFU) channel number. This bit may be located in two different bit positions and may have either polarity.

165 The number of lines to slew over may be coded as an unsigned four-bit number (NNNN) or an unsigned six-bit number (EENNNN). The upper two bits of the six-bit number (EE) may be positioned contiguously with the lower four bits (NNNN) or they may be separated from the lower four bits by the control bit (C). Furthermore, the upper two bits may or may not be supported.

166 The VFU channel to select is specified by an unsigned four-bit number (NNNN) in the VFU control byte.

167 Pictorially, the control byte is shown in table 219.

Table 219 - VFU control byte

VFU control byte	Description
Bits 7 6 5 4 3 2 1 0	
0 E E C N N N N	Advance (EE)NNNN lines (C = line skip)
0 0 0 C N N N N	Skip to VFU channel NNNN (C = VFU channel)
0 C E E N N N N	Advance (EE)NNNN lines (C = line skip)
0 C 0 0 N N N N	Skip to VFU channel NNNN (C = VFU channel)
Key: C = VFU control bit	

A VFU control bit polarity (VCBP) bit of one indicates that the VFU control bit (C) is true for a VFU channel command and false for a line skip command. A VCBP bit of zero indicates the opposite polarity.

A VFU control bit select (VCBS) bit of one indicates that the control bit (C) is in bit position 6 and the EE bits are in bit positions 5 and 4. A VCBS bit of zero indicates that the control bit (C) is in bit position 4 and the EE bits are in bit positions 6 and 5.

A VFU extended skip (VES) bit of one indicates that the EE bits are supported for line skip operations. A VES bit of zero indicates that the EE bits are not supported.

For MODE SELECT, an automatic line feed (Autofd) bit of one specifies that the target assert the printer interface Auto Line Feed signal. An Autofd bit of zero specifies that the target negate the printer interface Auto Line Feed signal. For MODE SENSE, the target shall return the current value of this bit.

ANSI X3.131-1994

11.3.3.2 Printer options page

The printer options page (see table 220) supports control and reporting of various target functions and features.

Table 220 - Printer options

Bit Byte	7	6	5	4	3	2	1	0
0	PS	Reserved	Page code (05h)					
1	Parameter length (0Ah)							
2	EVFU	Font identification						
3	Reserved		Slew mode		Reserved		SCTE	AFC
4	(MSB) Maximum line length							
5	(LSB)							
6	EVFU format start character							
7	EVFU format stop character							
8	Line slew options				Form slew options			
9	Data termination options				Reserved			
10	Reserved							
11	Reserved							

The parameters savable (PS) bit is only used with the MODE SENSE command. This bit is reserved with the MODE SELECT command. A PS bit of one indicates that the target is capable of saving the page in a non-volatile vendor-specific location.

An electronic vertical forms unit (EVFU) bit of one indicates that a tape or electronic vertical forms unit is present in the printer device. An EVFU bit of zero indicates that the electronic vertical forms unit should not be used or that the unit is not present in the printer device.

For the MODE SELECT command, the font identification field specifies which font is to be used. For the MODE SENSE command, this field identifies the currently selected font. The font identification codes are defined in table 221.

Table 221 - Font identification

Code	Font identification
00h	Default font
01h - 3Fh	Reserved
40h - 7Fh	Vendor-specific font

For the MODE SELECT command, the slew mode field controls the target's behavior when a SLEW AND PRINT command is received with a channel bit of zero (see 11.2.4). For the MODE SENSE command, this field reports the current slew mode. This slew mode is defined in table 222.

Table 222 - Slew mode

Code	Slew mode
00b	SLEW AND PRINT commands with a channel bit of zero are supported without any required setup.
01b	SLEW AND PRINT commands with a channel bit of zero are only accepted after the initiator issues a FORMAT command with a format type of set form (to initialize the electronic vertical forms unit).
10b	SLEW AND PRINT commands with a channel bit of zero are always accepted. The target shall use the electronic vertical forms unit if it has previously been initialized or it shall initialize the electronic vertical forms unit for line skipping by sending the EVFU start format character immediately followed by the EVFU stop format character (both are defined below) prior to executing the SLEW AND PRINT command.
11b	Reserved

For the MODE SELECT command, a step count truncate enable (SCTE) bit of one indicates that the target shall assume the printer truncates slew values in SLEW AND PRINT commands, so that the data prints on the first line of the next form. A SCTE bit of zero indicates that the target shall assume the printer continues to slew over forms boundaries in SLEW AND PRINT commands if the slew value exceeds the number of remaining lines on the current form. The target shall return the current value of this field in the MODE SENSE data.

An ASCII forms control (AFC) bit of one indicates that the printer supports ASCII forms control characters. An AFC bit of zero indicates that the printer does not support ASCII forms control characters.

The maximum line length field specifies the maximum transfer length (maximum number of bytes per line) to be accepted in the SLEW AND PRINT command. A value of 0000h in MODE SELECT specifies that the target shall use its default value. In any case, the target shall report its actual value in the MODE SENSE data (not 0000h).

The EVFU format start character field specifies the character code to be used by the target to start the initialization of the electronic vertical forms unit, if slew mode option 10b is selected.

The EVFU format stop character field specifies the character code to be used by the target to stop the initialization of the electronic vertical forms unit, if slew mode option 10b is selected.

The line slew options field specifies the implementation of the line slew (using ASCII forms control characters) in the SLEW AND PRINT command. Code values in this field are defined in table 223.

Table 223 - Line slew

Code	Line slew option
0h	Not implemented. (SLEW AND PRINT commands cause CHECK CONDITION status with ILLEGAL REQUEST sense key.)
1h	The target shall insert an ASCII carriage return character (0Dh) for each line to slew over.
2h	The target shall insert an ASCII line feed character (0Ah) for each line to slew over.
3h	The target shall insert an ASCII carriage return character (0Dh) and line feed character (0Ah) for each line to slew over.
4h - 7h	Reserved
8h - Fh	Vendor-specific

The form slew options field specifies the implementation of form slewing in the SLEW AND PRINT command. Code values in this field are defined in table 224.

Table 224 - Form slew

Code	Form slew option
0h	Not implemented. (SLEW AND PRINT commands cause CHECK CONDITION status with ILLEGAL REQUEST sense key.)
1h	The target shall insert an ASCII form feed character (0Ch) to move to the beginning of the next form.
2h	The target shall insert an ASCII carriage return character (0Dh) and form feed character (0Ch) to move to the beginning of the next form.
3h - 7h	Reserved
8h - Fh	Vendor-specific

The data termination options field specifies the termination sequence to be issued to the printer device when a SYNCHRONIZE BUFFER command is received. Code values for this field are defined in table 225.

Table 225 - Data termination option

Code	Line slew option
0h	Selects the target default implementation (MODE SELECT).
1h	No termination sequence. (The target sends any remaining data in its buffer to the printer device with no termination sequence.)
2h	The target shall print any buffered data followed by an ASCII carriage return character (0Dh).
3h	The target shall print any buffered data followed by an ASCII line feed character (0Ah).
4h	The target shall print any buffered data followed by an ASCII carriage return, line feed character sequence (0Dh, 0Ah).
5h	The target shall send any buffered data followed by an ASCII form feed character (0Ch).
6h	The target shall print any buffered data followed by an ASCII carriage return, form feed character sequence (0Dh, 0Ch).
7h	The target shall issue a zero line slew command to the printer device.
8h - Bh	Reserved
Ch - Fh	Vendor-specific

11.3.3.3 Serial printer interface page

The serial printer interface page (see table 226) is intended to support printer devices that use the industry-standard serial interface usually referred to as EIA RS-232C.

Table 226 - Serial printer interface

Bit Byte	7	6	5	4	3	2	1	0
0	PS	Reserved	Page code (04h)					
1	Parameter length (06h)							
2	Reserved		Stop bit length					
3	Parity selection			Reserved	Bits per character			
4	RTS	CTS	Reserved		Pacing protocol			
5	(MSB)							
6	Baud rate							
7	(LSB)							

The parameters savable (PS) bit is only used with the MODE SENSE command. This bit is reserved with the MODE SELECT command. A PS bit of one indicates that the target is capable of saving the page in a non-volatile vendor-specific location.

The stop bit length field specifies the length of the stop bit(s) in units of 1/16 bit. The target may round this field as described in 7.5.4. A stop bit length of zero in the MODE SELECT command indicates that the target shall use its default value.

ANSI X3.131-1994

The parity selection field specifies parity generation and checking as defined in table 227.

Table 227 - Parity selection

Code	Parity selection
000b	None
001b	Mark
010b	Space
011b	Odd
100b	Even
101b	Reserved
110b	Reserved
111b	Reserved

The bits per character field specifies the number of bits in each character. A value of zero in the MODE SELECT command indicates that the target shall use its default character size.

For the MODE SELECT command, a request to send (RTS) bit of one specifies that the target shall insure the Request to Send (RTS) signal in the serial interface follows the line state of the Data Terminal Ready (DTR) signal in the serial interface. A RTS bit of zero specifies that the target shall set the Request to Send (RTS) signal to high whenever the target power is on. For the MODE SENSE command, the target shall report the current value of this field.

For the MODE SELECT command, a clear to send (CTS) bit of one specifies that the target shall delay data transmission to the printer device until the printer device asserts the Clear to Send (CTS) signal in the serial interface. A CTS bit of zero indicates that the target shall ignore the Clear to Send signal. For the MODE SENSE command, the target shall report the current value of this field.

The code values for the pacing protocol field are defined in table 228.

Table 228 - Pacing protocol

Code	Pacing protocol
0h	None
1h	XON/XOFF
2h	ETX/ACK
3h	DTR
4h - 7h	Reserved
8h - Fh	Vendor-specific

The baud rate field specifies the baud rate in bits per second. The target may round this value as described in 7.5.4. A baud rate of zero in the MODE SELECT command specifies that the target shall use its default baud rate.

12 Processor devices

12.1 Model for processor devices

The SCSI processor device is a target with the characteristics of a primary computing device, typically a personal computer, minicomputer, mainframe computer, or auxiliary computing device or server. Such a primary computing device is often called a host. The processor device receives or provides packets of data as requested by the initiator.

In the SCSI processor device, the target accepts and provides the data packets transferred according to the commands of the initiator. The initiator and the processor device are both assumed to know the rules by which information is exchanged between them, how the information is interpreted by the processor device, and when it is allowable to exchange the information. These rules are not specified by this standard.

The initiator requests that the processor device accept a packet of data by transmitting a SEND command. The initiator requests that the processor device return a packet of data by transmitting a RECEIVE command. A COPY command can also be transmitted to the processor device to request that it serve as a copy manager. The actual data flow can be between the processor device and another SCSI device or can be between two SCSI devices under control of the processor device acting as a copy manager.

If a processor device temporarily has no resource available to manage a data packet from the initiator, has no data packet to provide to the initiator, or has no resources assigned to perform the operation, the device may then choose one of the following responses:

- a) Terminate the command with CHECK CONDITION status and the sense key NOT READY with the appropriate additional sense code for the condition. This is the appropriate response to a TEST UNIT READY command.
- b) Disconnect until the necessary resource or data packet becomes available, and then reconnect to the initiator and resume the operation.
- c) Terminate the command with BUSY status.

More than one logical unit can be implemented by a processor device. Logical units can serve as additional paths to a single resource, and/or each logical unit can serve as a path to different resources within the device. A single logical unit may also serve as a path to multiple resources if the processor device can interpret information within the data packet and route the packet to the appropriate resource. If the logical unit addressed by the initiator does not have an available resource or data packet associated with it, the processor device may choose to treat the logical unit as an invalid logical unit (see 7.5.3) or respond as described in the previous paragraph.

If the processor device determines that an error or unusual condition has occurred while performing an operation specified by the contents of a data packet, the information describing the condition is normally returned as a part of a data packet. If the processor device determines that an error or unusual condition has occurred while executing the SCSI command from the initiator, the command is terminated with a CHECK CONDITION and the failures are identified through a REQUEST SENSE command.

The SCSI processor device is distinguished from a SCSI communications device by the fact that the primary destination of the data packets is within the target device. A SCSI communications device, in contrast, passes the data on to an ultimate destination outside the target through a network. Many types of devices may find it convenient to function as processor devices if no other suitable SCSI device type exists and if the packet exchange protocol dictated by the processor device model meets their functional requirements. Devices requiring totally incompatible protocols and command sets should be examined carefully to ensure that the incompatibilities are based on functional requirements. If they are, they should be treated as vendor-unique device types.

ANSI X3.131-1994

Several examples of processor device implementations are provided to clarify the range of utility of the SCSI processor device.

12.1.1 Host-to-host communication, SEND only

A host system, (host A), takes the initiator role and selects a processor device (host B), transmitting a packet to host B using the SEND command. The SEND command contains an operating system call that requests data from the local storage devices attached to host B. After performing the functions required by the data packet, Host B assumes the initiator mode and selects host A as a processor device and uses a SEND command to transmit the requested data back to host A. Host A thus acts as a primary computer and host B acts as a specialized data server computer. Note that the SEND command is sufficient to perform a complete transaction if both host A and host B are capable of acting as initiators. This provides the capability of a high bandwidth inter-communication among nearby host processors.

12.1.2 Host-to-host communication, SEND and RECEIVE

A host system (host A) takes the initiator role and selects a processor device (host B), transmitting a packet using the SEND command to host B containing instructions about an operation to be performed. Host A again takes the initiator role and sends the data to be used by host B in the operation. Host A then assumes that a result will be obtained consistent with rules understood by both devices. Host A generates a RECEIVE command to obtain the result from host B. If the result is not yet ready, host B may disconnect until the calculation is complete and the requested data packet can be returned to host A.

NOTE 168 Host A need not support target mode and host B need not support initiator mode to successfully complete an exchange between the two devices.

12.1.3 Host-to-special-output peripheral

A special co-processor device which can use the processor device command set is a high-performance graphics display terminal. The initiator sends to the display terminal control and data packets that contain the image to be displayed. Only the SEND command is required. A peripheral failure should be indicated through the normal CHECK CONDITION / REQUEST SENSE protocol.

12.1.4 Host-to-special-input peripheral

A second special co-processor device that can use the processor device command set is a data acquisition subsystem. Such subsystems may multiplex and compact streams of data from many sources. A host could control the data acquisition modes and the selection of data streams by transmitting control packets to the processor device using the SEND command. The host could then obtain the acquired data by executing a series of RECEIVE commands. The data acquisition device could also serve as an initiator, selecting peripheral storage devices and storing the compacted acquired data there for later access directly by the host or through host to host communication protocols. A peripheral failure would be indicated through the normal CHECK CONDITION / REQUEST SENSE protocol.

12.2 Commands for processor devices

The commands for processor devices shall be as shown in table 229.

Table 229 - Commands for processor devices

Command name	Operation code	Type	Subclause
CHANGE DEFINITION	40h	O	8.2.1
COMPARE	39h	O	8.2.2
COPY	18h	O	8.2.3
COPY AND VERIFY	3Ah	O	8.2.4
INQUIRY	12h	M	8.2.5
LOG SELECT	4Ch	O	8.2.6
LOG SENSE	4Dh	O	8.2.7
READ BUFFER	3Ch	O	8.2.12
RECEIVE	08h	O	12.2.1
RECEIVE DIAGNOSTIC RESULTS	1Ch	O	8.2.13
REQUEST SENSE	03h	M	8.2.14
SEND	0Ah	M	12.2.2
SEND DIAGNOSTIC	1Dh	M	8.2.15
TEST UNIT READY	00h	M	8.2.16
WRITE BUFFER	3Bh	O	8.2.17

Key: M = command implementation is mandatory.
O = command implementation is optional.

The following operation codes are vendor-specific: 02h, 05h, 06h, 09h, 0Ch, 0Dh, 0Eh, 0Fh, 10h, 11h, 13h, 14h, 19h, C0h through FFh. All remaining operation codes for processor devices are reserved for future standardization.

12.2.1 RECEIVE command

The RECEIVE command (see table 230) requests that the target transfer data to the initiator. The contents of the data are not defined by this standard.

Table 230 - RECEIVE command

Bit Byte	7	6	5	4	3	2	1	0
0	Operation code (08h)							
1	Logical unit number			Reserved				
2	(MSB)							
3	Allocation length							
4	(LSB)							
5	Control							

ANSI X3.131-1994

12.2.2 SEND command

The SEND command (see table 231) requests that the target transfer data from the initiator.

Table 231 - SEND command

Bit Byte	7	6	5	4	3	2	1	0
0	Operation code (0Ah)							
1	Logical unit number			Reserved				AEN
2	(MSB)							
3	Transfer length							
4	(LSB)							
5	Control							

An asynchronous event notification (AEN) bit of one indicates that the data to be transferred conforms to AEN data format as defined in table 232. A SEND command with an AEN bit of one shall be only issued to logical unit zero.

Table 232 - SEND command - AEN data format

Bit Byte	7	6	5	4	3	2	1	0
0	Reserved		LUNTAR	Reserved		LUNTRN		
1	Reserved							
2	Reserved							
3	Reserved							
4	Sense data byte (0)							
n+4	Sense data byte (n)							

An AEN bit of zero indicates that the data to be transferred are vendor-specific.

The transfer length specifies the length in bytes of data that shall be sent during the DATA OUT phase. A transfer length of zero indicates that no data shall be sent. This condition shall not be considered an error.

A logical unit target (LUNTAR) bit of zero specifies that the asynchronous event occurred on a logical unit. A LUNTAR bit of one specifies that the asynchronous event occurred on a target routine.

If the LUNTAR bit is zero, the logical unit number target routine number (LUNTRN) field specifies the logical unit on which the asynchronous event occurred. If the LUNTAR bit is one, the LUNTRN field specifies on the routine on which the asynchronous event occurred.

The sense data bytes are defined in table 65.

12.3 Parameters for processor devices

12.3.1 Diagnostic parameters

This subclause defines the descriptors and pages for diagnostic parameters used with processor devices.

The diagnostic page codes for processor devices are defined in table 233.

Table 233 - Diagnostic page codes

Page code	Description	Subclause
00h	List of supported parameters page	8.3.1.1
01h - 3Fh	Reserved (for all device type pages)	
40h - 7Fh	Reserved	
80h - FFh	Vendor-specific pages	

12.3.2 Log parameters

This subclause defines the descriptors and pages for log parameters used with processor devices.

The log page codes for processor devices are defined in table 234.

Table 234 - Log page codes

Page code	Description	Subclause
01h	Buffer over-run/under-run page	8.3.2.1
07h	Last n error events page	8.3.2.3
00h	List of supported parameters page	8.3.2.5
06h	Non-medium error page	8.3.2.4
02h - 05h	Reserved	
08h - 2Fh	Reserved	
30h - 3Eh	Vendor-specific pages	
3Fh	Reserved	

12.4 Definitions specific to processor devices

12.4.1 host: A device with the characteristics of a primary computing device, typically a personal computer, workstation, minicomputer, mainframe computer, or auxiliary computing device or server.

12.4.2 data packet: The data transferred during the DATA IN phase of a RECEIVE command, or during the DATA OUT phase of a SEND command. A data packet often contains information at the beginning or end of the packet that describes the contents of the packet. A data packet might contain control or status information for the destination device.

12.4.3 resource: A part of the device required to operate on or store the data packet.

ANSI X3.131-1994

13 Write-once devices

13.1 Model for write-once devices

The model for the write-once device is a variation on the optical memory model. Most of the aspects of a write-once device are similar to optical memory devices. The differences are summarized in this clause.

13.1.1 Logical blocks

Data may be written to a logical block only once. A subsequent write to a logical block already written may or may not be corrupted, depending on the implementation. Write-once physical media is non-volatile.

The updating of blocks (see 16.1) is discouraged. SCSI write-once devices are intended to be archival in nature. Data at a logical block address is not expected to change once it is written. The update commands are not defined for this device type. Devices are not precluded from implementing the update function by this standard, though devices that require the update function should use the optical memory device type.

Devices may be able to determine the state of a logical block prior to access. These devices can determine whether a block is blank or written. This is useful in detecting previously written blocks, and preventing a destructive overwrite. This is also useful in finding blank areas for later writing. The MEDIUM SCAN command can be used to find blank and written areas prior to WRITE and READ access.

13.1.2 Initialization

The FORMAT UNIT command is not defined for write-once devices. Write-once media is shipped pre-formatted by the manufacturer and is ready for use when mounted.

13.1.3 Physical medium defects

The raw defect rate is typically higher for optical medium than for magnetic medium. Data is usually recovered through the use of sophisticated error correction algorithms. The level of error correction used for data recovery is often can be selected. However, many write-once devices have a minimum level that is always used and cannot be de-selected through the error recovery mode parameter. Control of the error correction algorithms and level of correction is vendor-specific.

Defect management on write-once devices is usually vendor-specific. However, there are standards for some types of write-once media that specify defect management techniques. These standards, where they exist, may supersede the implementation requirements pertaining to error and defect reporting in this standard.

13.1.4 Error reporting

If any of the following conditions occur during the execution of a command the target shall return CHECK CONDITION status. The appropriate sense key and additional sense code should be set. The following list illustrates some error conditions and the applicable sense keys. The list does not provide an exhaustive enumeration of all conditions that may cause the CHECK CONDITION status.

<u>Condition</u>	<u>Sense Key</u>
Invalid logical block address	ILLEGAL REQUEST
Unsupported option requested	ILLEGAL REQUEST
Target reset or medium change since last command from this initiator	UNIT ATTENTION
Self diagnostic failed	HARDWARE ERROR
Unrecovered read error	MEDIUM ERROR HARDWARE ERROR
Recovered read error	RECOVERED ERROR
Overrun or other error that might be resolved by repeating the command	ABORTED command
Attempt to write on write protected medium	DATA PROTECT
Attempt to read a blank or previously unwritten block	BLANK CHECK
Attempt to write a previously written block and blank checking is enabled	BLANK CHECK

In the case of an invalid logical block address, the sense data information field shall be set to the logical block address of the first invalid address.

In the case of an attempt to read a blank or previously unwritten block, the sense data information field shall be set to the logical block address of the first blank block encountered. The data read up to that block shall be transferred.

In the case of an attempt to write a previously written block and blank checking is enabled, the sense information field shall be set to the logical block address of the first non-blank block encountered.

13.2 Commands for write-once devices

The commands for write-once devices shall be as shown in table 235.

Table 235 - Commands for write-once devices

Command name	Operation code	Type	Subclause
CHANGE DEFINITION	40h	0	8.2.1
COMPARE	39h	0	8.2.2
COPY	18h	0	8.2.3
COPY AND VERIFY	3Ah	0	8.2.4
INQUIRY	12h	M	8.2.5
LOCK UNLOCK CACHE	36h	0	9.2.2
LOG SELECT	4Ch	0	8.2.6
LOG SENSE	4Dh	0	8.2.7
MEDIUM SCAN	38h	0	16.2.3
MODE SELECT(6)	15h	0	8.2.8
MODE SELECT(10)	55h	0	8.2.9
MODE SENSE(6)	1Ah	0	8.2.10
MODE SENSE(10)	5Ah	0	8.2.11
PRE-FETCH	34h	0	9.2.3
PREVENT ALLOW MEDIUM REMOVAL	1Eh	0	9.2.4
READ(6)	08h	0	9.2.5
READ(10)	28h	M	9.2.6
READ(12)	A8h	0	16.2.4
READ BUFFER	3Ch	0	8.2.12
READ CAPACITY	25h	M	9.2.7
READ LONG	3Eh	0	9.2.9
REASSIGN BLOCKS	07h	0	9.2.10
RECEIVE DIAGNOSTIC RESULTS	1Ch	0	8.2.13
RELEASE	17h	M	9.2.11
REQUEST SENSE	03h	M	8.2.14
RESERVE	16h	M	9.2.12
REZERO UNIT	01h	0	9.2.13
SEARCH DATA EQUAL(10)	31h	0	9.2.14.1
SEARCH DATA EQUAL(12)	B1h	0	16.2.8
SEARCH DATA HIGH(10)	30h	0	9.2.14.2
SEARCH DATA HIGH(12)	B0h	0	16.2.8
SEARCH DATA LOW(10)	32h	0	9.2.14.3
SEARCH DATA LOW(12)	B2h	0	16.2.8
SEEK(6)	0Bh	0	9.2.15
SEEK(10)	2Bh	0	9.2.15
SEND DIAGNOSTIC	1Dh	M	8.2.15
SET LIMITS(10)	33h	0	9.2.16
SET LIMITS(12)	B3h	0	16.2.9
START STOP UNIT	1Bh	0	9.2.17
SYNCHRONIZE CACHE	35h	0	9.2.18
TEST UNIT READY	00h	M	8.2.16
VERIFY(10)	2Fh	0	16.2.11
VERIFY(12)	AFh	0	16.2.12
WRITE(6)	0Ah	0	9.2.20
WRITE(10)	2Ah	M	9.2.21
WRITE(12)	AAh	0	16.2.14
WRITE AND VERIFY(10)	2Eh	0	9.2.22
WRITE AND VERIFY(12)	AEh	0	16.2.16
WRITE BUFFER	3Bh	0	8.2.17
WRITE LONG	3Fh	0	9.2.23

Key: M = command implementation is mandatory.
0 = command implementation is optional.

The following command codes are vendor-specific: 02h, 05h, 06h, 09h, 0Ch, 0Dh, 0Eh, 0Fh, 10h, 11h, 13h, 14h, 19h, 20h, 21h, 22h, 23h, 24h, 26h, 27h, 29h, and C0h through FFh. All remaining command codes for write-once devices are reserved for future standardization.

13.3 Parameters for write-once devices

Refer to the parameters for optical memory devices (see 16.3).

13.4 Definitions specific to write-once devices

See 16.4.

ANSI X3.131-1994

14 CD-ROM devices

14.1 Model for CD-ROM devices

CD-ROM devices permit reading data from a rotating media. Writing the media is not supported. Data transfer can begin with any of the consecutively numbered logical blocks. Data on CD-ROM devices are addressed the same as usual (magnetic) direct-access devices. Some CD-ROM devices support a separate information stream (e.g. audio and/or video but referred to as audio in this clause) transmitted via a connection other than the SCSI Bus. This device type defines commands for controlling these other information streams.

CD-ROM drives are designed to work with any disc that meets IEC. Many new drives read CD-ROM data discs, digital audio discs, and audio-combined discs (i.e. some tracks are audio, some tracks are data).

14.1.1 CD-ROM media organization

The formats written on the CD-ROM and CD-DA (Digital Audio) media require special interfacing considerations.

NOTE 169 This subclause contains a number of terms that have special meanings peculiar to CD-ROM technology or that may be unfamiliar to many readers of this standard. The glossary (see 14.4.) defines these terms.

Discs may contain either audio, data or a mixture of the two. Table 236 gives an example of a of a audio-combined disc to illustrate the relationship between the logical block addresses reported in SCSI and the MSF address encoded on the media. The logical addresses given in the table assume a block length of 2 048, 2 336 or 2 340 bytes. For block lengths of 1 024, 512 or 256 multiply all values given in the SCSI address columns by 2, 4 or 8 respectively.

NOTE 170 The term frame is used in two different ways in the CD-ROM media standard. The intended meaning can only be determined from the context. Whenever possible, this description replaces the larger data unit with the more familiar term sector. The primary exception to this policy is the use of frame when referring to the MSF address. In the MSF context, one frame (F field unit) equals one sector. On a typical two channel CD-DA media, each frame (F field unit) is played in 1/75th of a second.

Table 236 - Example mixed mode CD-ROM disc layout

Block description	SCSI address		/— Sub-channel information —\					CD-ROM data mode ²
	Logical address (decimal)	Track relative logical address	Absolute MSF address ¹	Track and index	Track relative MSF address	Sector is info or is pause	Mode audio or data	
Lead-in area ³⁾ Pre-gap ³⁾	—	—	00/00/00	0/- 1/0	— 00/02/00	— Pause	Audio Data	— Null
1st track data	0 000 ⁵⁾	0	00/02/00 ⁴⁾	1/1	00/00/00	Info	Data	L-EC
2nd track data	6 000 ⁵⁾ 7 500	0 1 500	01/22/00 ⁴⁾ 01/42/00	2/1 2/2	00/00/00 00/20/00	Info Info	Data Data	L-EC L-EC
Post-gap	9 000	3 000	02/02/00	2/3	00/40/00	Pause	Data	Null
Pause-silence	9 150	-150 ⁹⁾	02/04/00	3/0	00/02/00 ⁸⁾	Pause	Audio	—
3rd track audio	9 300 ⁷⁾	0	02/04/00 ⁶⁾	3/1	00/00/00	Info	Audio	—
4th track audio	11 400 ⁷⁾ 21 975 ⁷⁾	2 250 0	02/34/00 ⁶⁾ 04/53/00 ⁶⁾	3/2 4/1	00/30/00 00/00/00	Info Info	Audio Audio	— —
Pre-gap part 1	30 000	-225 ⁹⁾	06/40/00	5/0	00/03/00	Pause	Audio	—
Pre-gap part 2	30 075	-150	06/41/00	5/0	00/02/00	Pause	Data	Null
5th track data	30 225	0	06/43/00	5/1	00/00/00	Info	Data	L-EC
Last information	263 999 ¹⁰⁾	233 774	58/39/74	5/1	51/56/74	Info	Data	L-EC
Post-gap	—	233 775	58/40/00	5/2	51/57/00	Pause	Data	Null
Lead-out track	264 000 ¹¹⁾	0	58/42/00 ¹²⁾	AA/ ¹³	00/00/00	Pause	Audio	—

Notes

- 1 Absolute MSF address repeated in the header field of data blocks.
- 2 The CD-ROM data mode is stored in the header of data tracks. This indicates that the block is part of a data pre-gap or post-gap (null), that this is a data block using the auxiliary field for L-EC symbols (ECC - CD-ROM data mode one), or that this is a data block using the auxiliary field for user data (CD-ROM data mode two).
- 3 Table of contents information is stored in the sub-channel of lead-in area. The lead-in area is coded as track zero. Track zero and the initial 150 sector pre-gap (or audio pause) are not accessible with logical addressing.
- 4 Value stored in table of contents with zero tolerance.
- 5 Exact value returned by READ TOC command.
- 6 Value stored in table of contents plus or minus 75 sectors.
- 7 Value returned by READ TOC command plus or minus 75 blocks.
- 8 Track relative MSF value decreases to 0 in pre-gap areas.
- 9 Track relative logical addresses are negative in the pre-gap areas. Pre-gap areas have index values of zero.
- 10 Minimum value returned by READ CD-ROM CAPACITY - exact value depends on encoding of this track and the lead out track and whether this is derived from the TOC data.
- 11 Value returned by READ TOC command - exact if lead-out track is encoded as data, or plus or minus 75 blocks if encoded as audio.
- 12 Value stored in table of contents - exact if lead-out track is coded as data, or plus or minus 75 blocks if coded as audio.
- 13 Lead-out track number is defined as 0AAh.

The physical format defined by the CD-ROM media standards provides 2 352 bytes per sector. For usual computer data applications, 2 048 bytes are used for user data, 12 bytes for a synchronization field, 4 bytes for a sector address tag field and 288 bytes - the auxiliary field - for L-EC (CD-ROM data mode 1). In less critical applications, the auxiliary field may also be used for user data (CD-ROM data mode 2). A CD-ROM physical sector size is 2 048, 2 336 or 2 340 bytes per sector. These values correspond to user data field only, user data plus auxiliary data, the 4 byte address tag plus user data plus auxiliary data.

Selection among these options is made by setting the density code field of the MODE SELECT block descriptor. The usual selection is 2 048 bytes per physical sector via a density code setting of 1. See the table of CD-ROM density code values in 14.3.3.

This same area of the CD-ROM or CD audio media may store 1/75th of a second of two channel audio information formatted according to the CD-DA specification. (These audio channels are usually the left and right

ANSI X3.131-1994

components of a stereo pair.) An audio only density code value can be used to declare an area of the media to be invalid for data operations.

For data and mixed mode media (those conforming to ISO/IEC 10149), logical block address zero shall be assigned to the block at MSF address 00/02/00. For audio media (those conforming only to IEC 908), logical block address zero should be assigned to the actual starting address of track 1. This may be approximated by using the starting address of track 1 contained in the table of contents (TOC) or by assigning logical block address zero to the block at MSF address 00/02/00.

Logical addressing of CD-ROM information may use any logical block length. When the specified logical block length is an exact divisor or integral multiple of the selected number of bytes per CD-ROM sector, the device shall map (one to one) the bytes transferred from CD-ROM sectors to the bytes of logical blocks. For instance, if 2 048 bytes are transferred from each CD-ROM sector (specified by the CD-ROM density code value), and the logical block length is 512 bytes, then each CD-ROM sector shall map to exactly four logical blocks. This standard does not define the mapping of logical block lengths which do not evenly divide or are not exact multiples of the selected number of bytes per CD-ROM sector.

A track may be viewed as a partition of the CD-ROM address space. A CD-ROM media contains from one to ninety-nine tracks. All information sectors of a track are required to be of the same type (audio or data) and mode. Each change in the type of information on the disc requires a change in track number. A disc containing both audio and data would have at least two tracks, one for audio and one for data.

The tracks of a CD media are numbered consecutively with values between 1 and 99. However, the first information track may have a number greater than 1. Tracks have a minimum length of 300 sectors including any transition area that is part of a track.

The CD-ROM media standards require transition areas between tracks encoded with different types of information. In addition, transition areas may be used at the beginning or end of any track. For audio tracks the transition areas are called pause areas. For data tracks, transition areas are called pre-gap and post-gap areas. See table 236 for an example. The IEC 908 and ISO/IEC 10149 standards specify minimum time durations for these areas. Maximum time durations are not specified.

Transition areas are formatted and the logical address continues to increment through transition areas. Some media (i.e. discs with only one track) may not have transition areas. The means to determine the location of the transition areas is vendor or application-specific and is addressed by other standards (e.g. ISO 9660).

CD-ROM is a unique SCSI device in the respect that some logical blocks on a disc may not be accessible by all commands. SEEK commands may be issued to any logical block address within the reported capacity of the disc. READ commands cannot be issued to logical blocks that occur in some transition areas, or to logical blocks within an audio track. PLAY commands cannot be issued to logical blocks within a data track.

The blank verify (BlkVfy) option of the verify command (see 16.2.11), for CD-ROM devices, shall verify that the addressed blocks are transition area blocks.

CD-ROM media have lead-in and lead-out areas. These areas are outside of the user-accessible area as reported in the READ CD-ROM CAPACITY data. The lead-in area of the media is designated track zero. The lead-out area is designated track 0AAh. The sub-channel Q in the lead-in track contains a table of contents (TOC) of the disc.

NOTE 171 The READ CD-ROM CAPACITY command returns the logical block address of the last block prior to the lead-out area. This location may be in a transition area and therefore not a valid address for read operations.

The table of contents gives the absolute MSF location of the first information sector of each track. Control information (audio/data, method of audio encoding, etc.) for each track is also given in the TOC. However, the TOC does not distinguish between the different modes of data tracks (i.e. CD-ROM data mode one vs. CD-ROM data mode two).

The MSF locations of the beginning of data tracks in the TOC are required to be accurate, however, the TOC values for audio tracks have a tolerance of plus or minus 75 sectors. Information from the TOC can be used to reply to a READ CD-ROM CAPACITY command. When this is done, the drive implementor should consider the possible tolerances and return a value that allows access to all information sectors.

An index is a partition of a track. Pre-gap areas are encoded with an index value of zero. Pause areas at the beginning of audio tracks are also encoded with an index value of zero. The first information sector of a track has an index value of one. Consecutive values up to 99 are permitted. Index information is not contained in the TOC. Not all sectors are encoded with the index value in the Q-sub-channel data (the requirement is 9 out of 10). A sector without an index value is presumed to have the same index as the preceding sector.

Tracks and indexes are not defined to be any particular length, (except for a minimum track length of 300 sectors.) A CD disc may be created with a single information track that has a single index; or with 99 information tracks, each with 99 indexes.

The sub-channel information which is part of each sector includes a track relative MSF location value giving the distance from the first information sector of the track. On the media, this value decreases during the pre-gap area (sectors with index values of 0) and increases for the rest of the track. The data, returned by the READ SUB-CHANNEL command with MSF bit set to zero, converts this to a track relative logical block address (TRLBA). The TRLBA is continually increasing over the whole track, and pre-gap areas shall return negative values. When the MSF bit in the read sub-channel command is set to one, the MSF track relative location value from the media is reported without change.

14.1.2 CD-ROM physical data format

The physical format of CD-ROM and CD-DA media uses a smaller unit of synchronization than the more familiar magnetic or optical recording systems. The basic data stream synchronization unit is a small frame. This is not the same large frame (sector) as referred to in the MSF unit. Each small frame consists of 588 bits. A sector on CD-ROM media consists of 98 small frames.

A CD-ROM small frame consists of:

- | | | |
|-------------------------------|--------------------|------------------|
| a) 1 synchronization pattern | (24+3 bits) | |
| b) 1 byte of sub-channel data | (14+3 bits) | |
| c) 24 bytes of data | (24 x (14+3) bits) | |
| d) 8 bytes of CIRC code | (8 x (14+3) bits) | Total: 588 bits. |

Data, sub-channel and CIRC bytes are encoded with an eight-to-fourteen bit code; then three merging bits are added. The merging bits are chosen to provide minimum low-frequency signal content and optimize phase lock loop performance.

14.1.2.1 Frame format for audio

Each small frame of an audio track on a two-channel CD-DA or CD-ROM media consists of six digitized 16-bit samples of each audio channel. These 24 bytes of data are combined with a synchronization pattern, CIRC bytes and a sub-channel byte to make a frame. Each frame takes approximately 136.05 μ S to play. This gives a sampling rate of 44,1 khz for each channel. The sub-channel information creates the higher level sector grouping for audio tracks.

14.1.2.2 Sector format for data

The data bytes of 98 small frames comprise the physical unit of data referred to as a sector. (98 small frames times 24 bytes per small frame equal 2 352 bytes of data per sector.)

ANSI X3.131-1994

A sector that contains CD-ROM data mode one data has the following format:

- a) 12 bytes Synchronization field
- b) 4 bytes CD-ROM data header
 - Absolute M field in bcd format
 - Absolute S field in bcd format
 - Absolute F field in bcd format
 - CD-ROM data mode field
- c) 2048 bytes User data field
- d) 4 bytes Error detection code
- e) 8 bytes Zero
- f) 276 bytes Layered error correction code

A sector that contains CD-ROM Data Mode two data has the following format:

- a) 12 bytes Synchronization field
- b) 4 bytes CD-ROM data header
 - Absolute M field in bcd format
 - Absolute S field in bcd format
 - Absolute F field in bcd format
 - CD-ROM data mode field
- c) 2 336 bytes User data field (2048 bytes of mode 1 data plus 288 bytes of auxiliary data)

NOTE 172 Many drives are capable of returning CD-ROM data mode one data in a CD-ROM data mode two format. This allows the user to investigate the error detection and error correction codes. However data encoded as CD-ROM data mode two cannot be read as CD-ROM data mode one data.

14.1.2.3 Sub-channel information formats

The sub-channel byte of each frame is assigned one bit for each of the 8 sub-channels, designated P, Q, R, S, T, U, V, W. Only sub-channels P and Q are defined for CD-ROM media. The other sub-channel bits are zero.

Sub-channel P is a simple flag bit that may be used for audio muting control and track boundary determination.

Sub-channel Q has a higher level of structure. All the sub-channel Q bits of a sector define the sub-channel Q information block. (For audio tracks, decoding the Q sub-channel is the only way to distinguish sector boundaries.)

The sub-channel Q block consists of 98 bits, one bit from each small frame in a sector. Three formats are defined for the sub-channel Q information block. The first format provides location information and is defined as follows:

- a) 2 bits Sub-channel synchronization field
- b) 4 bits ADR field - defines the format
- c) 4 bits Control field - defines the type of information in this sector
- d) 8 bits Track number (in BCD)
- e) 8 bits Index number (in BCD)
- f) 24 bits Track relative MSF address
- g) 8 bits Reserved (0)
- h) 24 bits Absolute MSF address
- i) 16 bits CRC error detection code

This format is required to exist in at least nine out of ten consecutive sectors.

The second and third formats are optional. If used, they must exist in at least one out of 100 consecutive sectors. They include the absolute frame byte of the MSF address to provide location information continuity.

The second format gives the catalogue number of the disc (UPC/EAN bar code number). This information is constant over the whole media.

The third format gives the International Standard Recording Code (ISRC) for each track. The ISRC is defined in ISO 3901. This format is not present on lead-in or lead-out tracks and may change only after the track number changes.

14.1.3 CD Audio error reporting

PLAY AUDIO commands with the immediate bit set in the audio control mode return status as soon as the command has been validated (which may involve a seek to the starting address). The playback operation continues and may complete without notification to the initiator. Error termination of audio operations shall be reported to the initiator by returning immediate CHECK CONDITION status to the next command (except for REQUEST SENSE and INQUIRY.) The deferred error sense data (see 8.2.14.2.) is used to indicate that the error is not due to the current command.

The status of the play operation may be determined by issuing a REQUEST SENSE command. The sense key is set to NO SENSE and the audio status (see 14.2.10) is reported in the additional sense code qualifier field.

14.1.4 CD-ROM ready condition/not ready condition

The ready condition occurs after a cartridge is inserted and the drive has performed its initialization tasks. These may include reading the table of contents from the media.

A not ready condition may occur for the following reasons:

- a) There is no cartridge inserted.
- b) The drive is unable to load or unload the cartridge.
- c) The drive is unable to recover the table of contents.
- d) The controller cannot select the drive.

14.1.5 CD-ROM address reporting formats (MSF bit)

Several CD-ROM specific commands can report addresses either in logical or in MSF format (see table 237). The READ HEADER, READ SUB-CHANNEL and READ TABLE OF CONTENTS commands have this feature.

Table 237 - MSF address format

Bit Byte	7	6	5	4	3	2	1	0
0	Reserved							
1	M field							
2	S field							
3	F field							

An MSF bit of zero requests that the logical block address format be used for the CD-ROM absolute address field or for the offset from the beginning of the current track expressed as a number of logical blocks in a CD-ROM track relative address field. This track relative logical block address (TRLBA) value is reported as a negative value in twos-complement notation for transition areas that have decreasing MSF encoded relative addresses.

ANSI X3.131-1994

An MSF bit of one requests that the MSF format be used for these fields. In certain transition areas, the relative MSF addresses are decreasing positive values. The absolute MSF addresses are always increasing positive values (see entry in 14.4).

The M, S, and F fields are expressed as binary numbers. The values match those on the media, except for the encoding. The ratios of M field units to S field units and S field units to F field units are reported in the mode parameters page (see 14.3.3).

14.1.6 Sensing support for CD-audio commands.

If any commands related to audio operations are implemented, then the PLAY AUDIO command shall be implemented to allow a method for the initiator to determine if audio operations are supported. A target responding to a PLAY AUDIO command which has a transfer length of zero, with CHECK CONDITION status, and setting the sense key to ILLEGAL REQUEST does not support audio play operations.

NOTE 173 The PLAY AUDIO command may be implemented without support for any of the other audio operations commands.

14.1.7 Error reporting

If any of the following conditions occur during the execution of a command, the target shall return CHECK CONDITION status. The appropriate sense key and additional sense code should be set. The following list illustrates some error conditions and the applicable sense keys. The list does not provide an exhaustive enumeration of all conditions that may cause the CHECK CONDITION status.

<u>Condition</u>	<u>Sense Key</u>
Invalid logical block address	ILLEGAL REQUEST
Unsupported option requested	ILLEGAL REQUEST
Target reset or medium change since last command from this initiator	UNIT ATTENTION
Self diagnostic failed	HARDWARE ERROR
Unrecovered read error	MEDIUM ERROR HARDWARE ERROR
Recovered read error	RECOVERED ERROR
Overrun or other error that might be resolved by repeating the command	ABORTED command
Attempt to read a blank block	BLANK CHECK
Attempt to play a data block as audio	BLANK CHECK

In the case of an invalid logical block address, the sense data information field shall be set to the logical block address of the first invalid address.

In the case of an attempt to read a blank or previously unwritten block, the sense data information field shall be set to the logical block address of the first blank block encountered. The data read up to that block shall be transferred.

There are other special error situations for CD-ROM devices. In the following cases the sense key shall be set to BLANK CHECK and the additional sense code set to END OF USER AREA ENCOUNTERED ON THIS TRACK:

- a) a post-gap area is encountered (i.e. a block with CD-ROM Data Mode 0);

- b) a pre-gap area is encountered (i.e. a block with index equal to 0);
 c) The information type (data vs. audio) changes.

When not performing audio playback, if the logical block address requested is not within a data track, the command shall be terminated with CHECK CONDITION status. The sense key shall be set to BLANK CHECK and the additional sense code set to ILLEGAL MODE FOR THIS TRACK. This applies to audio-combined and audio media.

14.2 Commands for CD-ROM devices

The commands for CD-ROM devices shall be as shown in table 238.

Table 238 - Commands for CD-ROM device

Command name	Operation code	Type	Subclause
CHANGE DEFINITION	40h	O	8.2.1
COMPARE	39h	O	8.2.2
COPY	18h	O	8.2.3
COPY AND VERIFY	3Ah	O	8.2.4
INQUIRY	12h	M	8.2.5
LOCK/UNLOCK CACHE	36h	O	9.2.2
LOG SELECT	4Ch	O	8.2.6
LOG SENSE	4Dh	O	8.2.7
MODE SELECT(6)	15h	O	8.2.8
MODE SELECT(10)	55h	O	8.2.9
MODE SENSE(6)	1Ah	O	8.2.10
MODE SENSE(10)	5Ah	O	8.2.11
PAUSE/RESUME	48h	O	14.2.1
PLAY AUDIO(10)	45h	O*	14.2.2
PLAY AUDIO(12)	A5h	O*	14.2.3
PLAY AUDIO MSF	47h	O*	14.2.4
PLAY AUDIO TRACK/INDEX	48h	O*	14.2.5
PLAY TRACK RELATIVE(10)	49h	O*	14.2.6
PLAY TRACK RELATIVE(12)	A9h	O*	14.2.7
PRE-FETCH	34h	O	9.2.3
PREVENT/ALLOW MEDIUM REMOVAL	1Eh	O	9.2.4
READ(6)	08h	O	9.2.5
READ(10)	28h	M	9.2.6
READ(12)	A8h	O	16.2.4
READ BUFFER	3Ch	O	8.2.12
READ CD-ROM CAPACITY	25h	M	14.2.8
READ HEADER	44h	O	14.2.9
READ LONG	3Eh	O	9.2.9
READ SUB-CHANNEL	42h	O	14.2.10
READ TOC	43h	O	14.2.11
RECEIVE DIAGNOSTIC RESULTS	1Ch	O	8.2.13
RELEASE	17h	M	9.2.11
REQUEST SENSE	03h	M	8.2.14
RESERVE	16h	M	9.2.12
REZERO UNIT	01h	O	9.2.13
SEARCH DATA EQUAL(10)	31h	O	9.2.14.1
SEARCH DATA EQUAL(12)	B1h	O	16.2.8
SEARCH DATA HIGH(10)	30h	O	9.2.14.2
SEARCH DATA HIGH(12)	B0h	O	16.2.8
SEARCH DATA LOW(10)	32h	O	9.2.14.3
SEARCH DATA LOW(12)	B2h	O	16.2.8
SEEK(6)	0Bh	O	9.2.15
SEEK(10)	2Bh	O	9.2.15
SEND DIAGNOSTIC	1Dh	M	8.2.15
SET LIMITS(10)	33h	O	9.2.16
SET LIMITS(12)	B3h	O	16.2.9
START STOP UNIT	1Bh	O	9.2.17
SYNCHRONIZE CACHE	35h	O	9.2.18
TEST UNIT READY	00h	M	8.2.16
VERIFY(10)	2Fh	O	16.2.11
VERIFY(12)	Afh	O	16.2.12
WRITE BUFFER	3Bh	O	8.2.17

Key: M = command implementation is mandatory.
 O = command implementation is optional.
 * = indicates a PLAY AUDIO command

ANSI X3.131-1994

The following command codes are vendor-specific: 02h, 05h, 06h, 09h, 0Ch, 0Dh, 0Eh, 0Fh, 10h, 11h, 13h, 14h, 19h, 20h, 21h, 22h, 23h, 24h, 26h, 27h, 29h, and C0h through FFh. All remaining command codes for CD-ROM devices are reserved for future standardization.

If any of the PLAY AUDIO commands (indicated by an * in the type column) are implemented, the PLAY AUDIO command shall be implemented by the target.

14.2.1 PAUSE RESUME command

The PAUSE RESUME command (see table 239) requests that the device stop or start an audio play operation. This command is used with PLAY AUDIO commands issued while the immediate bit is set to one.

Table 239 - PAUSE RESUME command

Bit Byte	7	6	5	4	3	2	1	0
0	Operation code (4Bh)							
1	Logical unit number			Reserved				
2	Reserved							
3	Reserved							
4	Reserved							
5	Reserved							
6	Reserved							
7	Reserved							
8	Reserved							Resume
9	Control							

A resume bit of zero causes the drive to enter the hold track state with the audio output muted after the current block is played. A resume bit of one causes the drive to release the pause and begin play at the block following the last block played.

If an audio play operation cannot be resumed and the resume bit is one, the command is terminated with CHECK CONDITION status. If the resume bit is zero and an audio play operation cannot be paused, (no audio play operation has been requested, or the requested audio play operation has been completed), the command is terminated with CHECK CONDITION status.

It shall not be considered an error to request a pause when a pause is already in effect, or to request a resume when a play operation is in progress.

14.2.2 PLAY AUDIO(10) command

The PLAY AUDIO command (see table 240) requests that the target begin an audio playback operation. The command function (Immed and SOTC bits) and the output of audio signals shall be as specified by the settings of the mode parameters (see 14.3.3.1.).

Table 240 - PLAY AUDIO(10) command

Bit Byte	7	6	5	4	3	2	1	0
0	Operation code (45h)							
1	Logical unit number			Reserved				RelAdr
2	(MSB)							
3	Starting logical block address							
4								
5								
6	Reserved							
7	(MSB)							
8	Transfer length						(LSB)	
9	Control							

If any commands related to audio operations are implemented then the PLAY AUDIO command shall be implemented to allow a method for the initiator to determine if audio operations are supported. A target responding to a PLAY AUDIO command that has a transfer length of zero with CHECK CONDITION status and setting the sense key to ILLEGAL REQUEST does not support audio play operations.

The logical block address field specifies the logical block at which the audio playback operation shall begin.

The transfer length field specifies the number of contiguous logical blocks that shall be played. A transfer length field of zero indicates that no audio operation shall occur. This condition shall not be considered an error.

If the logical block length is not equal to the sector size, the target may adjust the starting logical block address and the transfer length. In such case, it is recommended that the target start the audio play operation with the beginning of a sector whenever the starting logical address falls within that sector (MSF unit). If the requested transfer length causes the end of an audio play operation to fall within a sector, the target may continue the play operation through the end of that sector.

If the starting address is not found, if the address is not within an audio track, or if a not ready condition exists, the command shall be terminated with CHECK CONDITION status.

If the CD-ROM information type (data vs. audio) changes, the sense key shall be set to BLANK CHECK and the additional sense code set to END OF USER AREA ENCOUNTERED ON THIS TRACK.

If the logical block address requested is not within an audio track, the command shall be terminated with CHECK CONDITION status. The sense key shall be set to BLANK CHECK and the additional sense code set to ILLEGAL MODE FOR THIS TRACK.

ANSI X3.131-1994

14.2.3 PLAY AUDIO(12) command

The PLAY AUDIO(12) command (see table 241) requests that the target to begin an audio playback operation. The command function (Immed and SOTC bits) and the output of audio signals shall be as specified by the settings of the mode parameters (see 14.3.3.1.). See the PLAY AUDIO(10) command for a description of the fields in this command.

Table 241 - PLAY AUDIO(12) command

Bit Byte	7	6	5	4	3	2	1	0
0	Operation code (A5h)							
1	Logical unit number			Reserved				RelAdr
2	(MSB)							
3	Logical block address							
4								
5								
6	(MSB)							
7	Transfer length							
8								
9								
10	Reserved							
11	Control							

14.2.4 PLAY AUDIO MSF command

The PLAY AUDIO MSF command (see table 242) requests that the target to begin an audio playback operation. The command function (Immed and SOTC bits) and the output of audio signals shall be as specified by the settings of the mode parameters (see 14.3.3.1.).

Table 242 - PLAY AUDIO MSF command

Bit Byte	6	5	4	3	2	1	0
0	Operation code (47h)						
1	Logical unit number			Reserved			
2	Reserved						
3	Starting M field						
4	Starting S field						
5	Starting F field						
6	Ending M field						
7	Ending S field						
8	Ending F field						
9	Control						

The starting M field, the starting S field, and the starting F field specify the absolute MSF address at which the audio play operation shall begin. The ending M field, the ending S field, and the ending F field specify the absolute MSF address where the audio play operation shall end. All contiguous audio sectors between the starting and the ending MSF address shall be played.

A starting MSF address equal to an ending MSF address causes no audio play operation to occur. This shall not be considered an error. If the starting MSF address is less than the ending MSF address, the command shall be terminated with CHECK CONDITION status. The sense key shall be set to ILLEGAL REQUEST.

If the starting address is not found, if the address is not within an audio track, or if a not ready condition exists, the command shall be terminated with CHECK CONDITION status. See 14.1.7 for a description of error reporting information.

ANSI X3.131-1994

14.2.5 PLAY AUDIO TRACK INDEX command

The PLAY AUDIO TRACK INDEX command (see table 243) requests the target to begin an audio play operation. The command function (Immed and SOTC bits) and the output of audio signals shall be as specified by the settings of the mode parameters (see 14.3.3.1.).

Table 243 - PLAY AUDIO TRACK INDEX command

Bit Byte	7	6	5	4	3	2	1	0
0	Operation code (48h)							
1	Logical unit number			Reserved				
2	Reserved							
3	Reserved							
4	Starting track							
5	Starting index							
6	Reserved							
7	Ending track							
8	Ending index							
9	Control							

The starting track field specifies the track number of the starting audio track. The starting index field specifies the index number within the track at which the audio play operation shall begin.

The ending track field specifies the track number of the ending audio track. The ending index field specifies the index number within the track after which the audio play operation shall stop. The audio play operation shall terminate at the last block with an index number equal to the ending index. All contiguous audio sectors between the starting and the ending address shall be played.

If the starting address is less than the ending address, the command shall be terminated with CHECK CONDITION status. The sense key shall be set to ILLEGAL REQUEST.

If the starting address is not found, or if the address is not within an audio track, or if a not ready condition exists, the command shall be terminated with CHECK CONDITION status. See 14.1.7 for a description of error reporting information.

NOTE 174 Valid values for the track and index fields are 1 to 99. A starting index value of one specifies that playback is to start with the first audio sector of the track following the (optional) pause. A last index value of 99 specifies that playback continues through the last sector of the track.

If the ending track is greater than the last information track on the media, the playback shall continue until the last track is complete. If the ending index is greater than the largest index value on the ending track, the playback shall continue until this track is complete; then terminate. These conditions shall not be considered errors.

If the starting index is greater than the largest index value on the starting track, and the stop on track crossing (SOTC) bit of the audio control MODE SELECT parameters page (see 14.3.3.1) is zero, the playback operation shall start at the beginning of the next track. This situation is not an error.

If the starting index is greater than the largest index value on the starting track, and the stop on track crossing (SOTC) bit of the audio control MODE SELECT parameters page (see 14.3.3.1) is one, the playback shall not begin. The target shall return CHECK CONDITION, and the sense key shall be set to ILLEGAL REQUEST.

NOTE 175 The operation of the SOTC bit described above comes about because the user may not be able to determine the largest index value on a track, either from the table of contents or by other means. The SOTC bit one case allows the user to determine the largest index. The SOTC bit zero case allows the user to set up play operations without complete knowledge of the media layout.

14.2.6 PLAY AUDIO TRACK RELATIVE(10) command

The PLAY AUDIO TRACK RELATIVE(10) command (see table 244) requests that the device begin an audio playback operation. The starting address is specified as a track relative logical block address within the specified starting track. The command function (Immed and SOTC bits) and the output of audio signals shall be as specified by the settings of the mode parameters (see 14.3.3.1.).

Table 244 - PLAY AUDIO TRACK RELATIVE(10) command

Bit Byte	7	6	5	4	3	2	1	0
0	Operation code (49h)							
1	Logical unit number				Reserved			
2	(MSB)							
3	Track relative logical block address							
4								
5								
6	Starting track							
7	(MSB)							
8	Transfer length							
	(LSB)							
9	Control							

The starting track field specifies the track number of the starting audio track.

The track relative logical block address (TRLBA) field specifies the two's complement starting logical block address relative to the beginning of the first sector on the track with an index value of one. Negative values indicate a starting location within the audio pause area at the beginning of the requested track.

The transfer length field specifies the number of contiguous logical blocks that shall be output as audio data. A transfer length field of zero indicates that no audio playback operation shall occur. This condition shall not be considered an error. Any other value indicates the number of logical blocks that shall be output.

If the logical block length is not equal to the sector size the target may adjust the starting logical block address and the transfer length. In such case, it is recommended that the target start the audio play operation with the beginning of a sector whenever the starting logical address falls within that sector (MSF unit). If the requested transfer length causes the end of an audio play operation to fall within a sector, the target may continue the play operation through the end of that sector.

If the starting address is not found, or if the address is not within an audio track, or if a not ready condition exists, the command is terminated with CHECK CONDITION status. See 14.1.7 for a description of error reporting information.

ANSI X3.131-1994

14.2.7 PLAY AUDIO TRACK RELATIVE(12) command

The PLAY AUDIO TRACK RELATIVE(12) command (see table 245) requests that the device begin an audio playback operation. The command function (Immed and SOTC bits) and the output of audio signals shall be as specified by the settings of the mode parameters (see 14.3.3.1.). See the PLAY AUDIO TRACK RELATIVE(10) command for a description of the fields in this command.

Table 245 - PLAY AUDIO TRACK RELATIVE(12) command

Bit Byte	7	6	5	4	3	2	1	0								
0	Operation code (A9h)															
1	Logical unit number			Reserved												
2	(MSB)															
3	Track relative logical block address															
4																
5									(LSB)							
6									(MSB)							
7	Transfer length															
8																
9									(LSB)							
10	Starting track															
11	Control															

14.2.8 READ CD-ROM CAPACITY command

The READ CD-ROM CAPACITY command (see table 246) provides a means for the initiator to request information regarding the capacity of the logical unit.

Table 246 - READ CD-ROM CAPACITY command

Bit Byte	7	6	5	4	3	2	1	0								
0	Operation code (25h)															
1	Logical unit number			Reserved				RelAdr								
2	(MSB)															
3	Logical block address															
4																
5									(LSB)							
6									Reserved							
7	Reserved															
8	Reserved						PMI									
9	Control															

NOTE 176 This command has the same operation code (25h) as the READ CAPACITY command (see 92.7). The general function is the same but the exact definitions of the returned logical block address is modified to allow returning a possibly inexact value (but one with a known error bound) based on CD-ROM table of contents data. For many CD-ROM devices, this implementation allows a quicker response.

A partial medium indicator (PMI) bit of zero indicates that the information returned in the READ CD-ROM CAPACITY data shall be the logical block address and block length (in bytes) of the last valid logical block of the logical unit for seek operations. The logical block address returned shall be greater than or equal to the last readable or playable block. If greater, this address may be in a transition area beyond the last valid logical block for read or audio play operations. The value returned shall not be more than 75 sectors (MSF units) greater than the logical block address of the last readable or playable block. (This value arises because the CD-ROM table of contents lead-out track location has a +/- 75 sector tolerance when the lead-out track is encoded as an audio track.) The logical block address in the command descriptor block shall be set to zero for this option.

A PMI bit of one indicates that the information returned shall be the logical block address and block length (in bytes) of the last logical block address after which a substantial delay in data transfer will be encountered. This logical block address shall be greater than or equal to the logical block address specified in the command descriptor block. On CD-ROM media, this is interpreted as being the last readable or playable logical block of the information area containing or immediately following the specified logical block address.

NOTE 177 This option may take several seconds to complete on CD-ROM media.

See 9.1.10 for a description of the relative address bit (RelAdr).

Eight bytes of READ CD-ROM CAPACITY data (see table 247) shall be sent during the DATA IN phase of the command.

Table 247 - READ CAPACITY data format

Bit Byte	7	6	5	4	3	2	1	0	
0	(MSB)							Logical block address	(LSB)
3									
4	(MSB)							Block length	(LSB)
7									

ANSI X3.131-1994

14.2.9 READ HEADER command

The READ HEADER command (see table 248) requests that the device return the CD-ROM data block address header of the requested logical block.

Table 248 - READ HEADER command

Bit Byte	7	6	5	4	3	2	1	0
0	Operation code (44h)							
1	Logical unit number			Reserved			MSF	Reserved
2	(MSB) _____							
3	_____							
4	Logical block address							
5	_____ (LSB)							
6	Reserved							
7	(MSB) _____							
8	Allocation length							
9	_____ (LSB)							
9	Control							

See 14.1.5. for a description of the MSF bit.

The logical block address field specifies the logical block at which the read header operation shall begin.

See the READ command for exception handling. If the logical block size is other than the physical block size, it shall be mapped into the appropriate physical block from which the data would have been read.

The READ HEADER data format (see table 249) defines the CD-ROM data block address header of the requested logical block.

Table 249 - READ HEADER data format

Bit Byte	7	6	5	4	3	2	1	0
0	CD-ROM data mode							
1	Reserved							
2	Reserved							
3	Reserved							
4	(MSB) _____							
7	Absolute CD-ROM address							
7	_____ (LSB)							

The CD-ROM data mode field specifies the CD-ROM data mode of the logical blocks in this sector of data. The values in this field are defined in table 250.

Table 250 - CD-ROM data mode codes

CD-ROM mode	User data field contents (2 048 bytes)	Auxiliary field contents (288 bytes)
00h 01h 02h 03h - FFh	All bytes zero User data User data Reserved	All bytes zero L-EC symbols User data Reserved

If the MSF bit is zero, the absolute address field gives the logical block address of the first logical block in the physical sector where the data for the requested logical block address is found. If the MSF bit is one, the absolute address field gives the MSF address of the sector where the data for the requested logical block address is found. (See 14.1.5.)

14.2.10 READ SUB-CHANNEL command

The READ SUB-CHANNEL command (see table 251) requests that the target return the requested sub-channel data plus the state of audio play operations.

Table 251 - READ SUB-CHANNEL command

Bit Byte	7	6	5	4	3	2	1	0	
0	Operation code (42h)								
1	Logical unit number			Reserved			MSF	Reserved	
2	Reserved	SubQ	Reserved						
3	Sub-channel data format								
4	Reserved								
5	Reserved								
6	Track number								
7	(MSB)	Allocation length							
8								(LSB)	
9	Control								

NOTE 178 Sub-channel data returned by this command may be from the last appropriate sector encountered by a current or previous media accessing operation. When there is no current audio play operation, the target may access the media to read the sub-channel data. The target is responsible that the data returned are current and consistent. For example with sub-channel data format 0, the International Standard Recording Code (ISRC) data reported must have been read from the same track as the reported current position data.

See 14.1.5. for a description of the MSF bit.

The sub Q bit set to one requests that the target return the Q sub-channel data. The sub Q bit set to zero requests that no sub-channel data be returned. This shall not be considered an error.

NOTE 179 The other bits in this byte are reserved for future standardization when they may be defined to request other sub-channel data.

The sub-channel data format field specifies the returned sub channel data (see table 252). If this field is 00h, sub-Q channel data is returned. If this field is 01h, 02h or 03h, the requested sub-Q data item is returned.

ANSI X3.131-1994

Table 252 - Sub-channel data format codes

Format Code	Returned data
00h	Sub-Q channel data
01h	CD-ROM current position
02h	Media catalogue number (UPC/bar code)
03h	Track international standard recording code (ISRC)
04h - EFh	Reserved
F0h - FFh	Vendor-specific

The track number field specifies the track from which ISRC data is read. This field must have a value between 01h and 63h (99bcd), and is valid only when the sub-channel data format field is 03h. In this case, the target returns ISRC data for this track.

14.2.10.1 Sub-Q channel data format

The sub-CHANNEL command data formats consist of a four-byte header followed by a sub-channel data block. The header contains the audio status byte and the sub-channel data length field. If the sub Q bit is zero, the target shall not return the sub-channel data block; in this case, the sub-channel data length is 0.

Table 253 defines the sub-Q channel data format.

Table 253 - Sub-Q channel data format

Bit Byte	7	6	5	4	3	2	1	0
	Sub-channel data header							
0	Reserved							
1	Audio status							
2	(MSB)	Sub-channel data length						(LSB)
3								
	Sub-Q channel data block							
4	Sub channel data format code (00h)							
5	ADR				Control			
6	Track number							
7	Index number							
8	(MSB)	Absolute CD-ROM address						(LSB)
11								
12	(MSB)	Track relative CD-ROM address						(LSB)
15								
16	MCVal	Reserved						
17	(MSB)	Media catalogue number (UPC/Bar code)						(LSB)
31								
32	TCVal	Reserved						
33	(MSB)	Track international standard recording code (ISRC)						(LSB)
47								

The audio status field indicates the status of audio play operations. The audio status values are defined in table 254. Audio status values greater than zero are returned only to the initiator that requested the last audio play operation. Audio status values 13h and 14h return information on previous audio operations; they are returned only once after the condition has occurred. If another audio play operation is not requested, the audio status returned for subsequent READ SUB-CHANNEL commands is 15h.

Table 254 - Audio status codes

Status	Description
00h	Audio status byte not supported or not valid
11h	Audio play operation in progress
12h	Audio play operation paused
13h	Audio play operation successfully completed
14h	Audio play operation stopped due to error
15h	No current audio status to return

The sub-channel data length specifies the length in bytes of the following sub-channel data block. A sub-channel data length of zero indicates that no sub-channel data block is included in the returned data.

ANSI X3.131-1994

NOTE 180 Usual values for sub-channel data length are 0, 12, 20, 28 and 44 bytes. Sub-channel data length does not include the sub channel header.

The sub-Q channel data block consists of control data (bytes 4-5), current position data (bytes 6 - 15) and identification data (bytes 16 - 47). The control data and current position data is obtained from the Q sub-channel information of the current block. Identification data may be reported that was obtained from a previous block. If identification data is reported, the data shall be valid for the sector addressed by the current position data.

- a) If an audio play operation is proceeding in the background, position data for the last sector played shall be reported.
- b) In other cases, for instance after a READ command, the target may either report position data for the last sector processed for that operation or may report position data from the sector at the current read head position.

NOTE 181 When the type of information encoded in the Q sub-channel of the current sector is the media catalog number or ISRC; the track, index, and address fields should be extrapolated from the previous sector.

The ADR field gives the type of information encoded in the Q sub-channel of this block, as shown in table 255.

Table 255 - ADR sub-channel Q field

ADR code	Description
0h	Sub-channel Q mode information not supplied
1h	Sub-channel Q encodes current position data (i.e. track, index, absolute address, relative address)
2h	Sub-channel Q encodes media catalogue number
3h	Sub-channel Q encodes ISRC
4h - Fh	Reserved

The control bits are defined in table 256.

Table 256 - Sub-channel Q control bits

Bit	Equals zero	Equals one
0	Audio without pre-emphasis	Audio with pre-emphasis
1	Digital copy prohibited	Digital copy permitted
2	Audio track	Data track
3	Two-channel audio	Four-channel audio

The track number specifies the current track number.

The index number specifies the index number in the current track.

The absolute CD-ROM address field gives the current location relative to the logical beginning of the media. If the MSF bit is zero, this field is a logical block address. If the MSF bit is one, this field is an absolute MSF address. (See 14.1.5.)

The track relative CD-ROM address field gives the current location relative to the logical beginning of the current track. If the MSF bit is zero, this field is a track relative logical block address. (If the current block is in the pre-gap area of a track, this will be a negative value, expressed as a twos-complement number. See 14.1.5). If the MSF bit is one, this field is the relative MSF address from the Q sub-channel.

A media catalogue valid (MCVal) bit of one indicates that the media catalogue number field is valid. A MCVal bit of zero indicates that the media catalogue number field is not valid.

The media catalogue number field contains the identifying number of this media according to the uniform product code values (UPC/EAN bar coding) expressed in ASCII. Non-zero values in this field are controlled by the Uniform Product Code Council 1) and the European Article Number Council 2). A value in this field of all ASCII zeros indicates that the media catalog number is not supplied.

The track code valid (TCVal) bit of one indicates that the track ISRC field is valid. A TCVal bit of zero indicates that the track international standard recording code (ISRC) field is not valid.

The track ISRC field contains the identifying number of this media according to the ISRC standards (DIN-31-621) expressed in ASCII.

-
- 1) The Uniform Product Code Council is located at 8163 Old Yankee Road, Suite J, Dayton, Ohio 45459.
 - 2) The European Article Number Council is located at Rue des Colonies, 54-BTE8, 1000 Brussels, Belgium.

ANSI X3.131-1994

14.2.10.2 CD-ROM current position data format

Table 257 defines the CD-ROM current position data format.

Table 257 - CD-ROM current position data format

Bit Byte	7	6	5	4	3	2	1	0	
	Sub-channel data header								
0	Reserved								
1	Audio status								
2	(MSB)	Sub-channel data length							
3								(LSB)	
	CD-ROM current position data block								
4	Sub channel data format code (01h)								
5	ADR				Control				
6	Track number								
7	Index number								
8	(MSB)	Absolute CD-ROM address							
11								(LSB)	
12	(MSB)	Track relative CD-ROM address							
15								(LSB)	

14.2.10.3 Media catalogue number data format

Table 258 defines the media catalogue number data format.

Table 258 - Media catalogue number data format

Bit Byte	7	6	5	4	3	2	1	0	
	Sub-channel data header								
0	Reserved								
1	Audio status								
2	(MSB)	Sub-channel data length							
3								(LSB)	
	Media catalogue number data block								
4	Sub channel data format code (02h)								
5	Reserved								
6	Reserved								
7	Reserved								
8	MCVal	Reserved							
9	(MSB)	Media catalogue number (UPC/Bar code)							
23								(LSB)	

If media catalogue number data is found, the MCVal bit is set to one. If MCN data is not detected, the MCVal bit is set to zero to indicate the media catalogue number field is invalid.

NOTE 182 Media catalogue number data returned by this command with sub-channel data format field code 02h may be from any block that has UPC bar code Q sub-channel data. (This code is constant anywhere in every applicable disc.)

14.2.10.4 Track International standard recording code data format

Table 259 defines the track international standard recording code data format.

Table 259 - Track international standard recording code data format

Bit Byte	7	6	5	4	3	2	1	0
	Sub-channel data header							
0	Reserved							
1	Audio status							
2	(MSB) Sub-channel data length							
3	(LSB)							
	Track ISRC data block							
4	Sub channel data format code (03h)							
5	ADR				Control			
6	Track number							
7	Reserved							
8	TCVal	Reserved						
9	(MSB) Track international standard recording code (ISRC)							
23	(LSB)							

If ISRC data is detected, the TCVal bit is set to one. If ISRC data is not detected, the TCVal bit is set to zero to indicate the ISRC field is invalid.

NOTE 183 Track ISRC data returned by this command with sub-channel data format field 03h may be from any block in the specified track that has ISRC data.

14.2.11 READ TOC command

The READ TOC command (see table 260) requests that the target transfers data from the table of contents to the initiator.

Table 260 - READ TOC command

Bit Byte	7	6	5	4	3	2	1	0	
0	Operation code (43h)								
1	Logical unit number			Reserved			MSF	Reserved	
2	Reserved								
3	Reserved								
4	Reserved								
5	Reserved								
6	Starting track								
7	(MSB)			Allocation length					
8								(LSB)	
9	Control								

See 14.1.5. for a description of the MSF bit.

The starting track field specifies the starting track number for which the data shall be returned. If this value is zero, the table of contents data shall begin with the first track on the medium. The data are returned in contiguous ascending track number order.

If the starting track field is not valid for the currently installed medium, the command shall be terminated with CHECK CONDITION status. The sense key shall be set to ILLEGAL REQUEST and the additional sense code set to INVALID FIELD IN CDB.

NOTE 184 The maximum TOC data length possible on currently available CD-ROM media is 804 bytes, or 100 TOC track descriptors.

The format of the data returned is specified in table 261.

Table 261 - READ TOC data format

Bit Byte	7	6	5	4	3	2	1	0
0	(MSB) TOC data length							
1	(LSB)							
2	First track number							
3	Last track number							
	TOC track descriptor(s)							
0	Reserved							
1	ADR				Control			
2	Track number							
3	Reserved							
4	(MSB) Absolute CD-ROM address							
7	(LSB)							

The TOC data block contains a four-byte header followed by zero or more TOC track descriptors.

The TOC data length specifies the length in bytes of the following TOC data that is available to be transferred during the DATA IN phase. The TOC data length value does not include the TOC data length field itself.

The first track number field indicates the first track number in the table of contents.

The last track number field indicates the last track number in the table of contents before the lead-out track number.

NOTE 185 The first track number is not required to be one. A disc may start at any valid track number. The track numbers between the first track number and the last track number are required to be in contiguous ascending order, except for the lead-out track.

The ADR field gives the type of information encoded in the Q sub-channel of the block where this TOC entry was found. The possible ADR values are defined in 14.2.10.1.

The control field indicates the attributes of the track. The possible control field values are defined in 14.2.10.1.

The track number field indicates the track number for which the data in the TOC track descriptor is valid. A track number of 0AAh indicates that the track descriptor is for the start of the lead-out area.

The absolute CD-ROM address contains the address of the first block with user information for that track number as read from the table of contents. An MSF bit of zero indicates that the absolute CD-ROM address field contains a logical block address. An MSF bit of one indicates the absolute CD-ROM address field contains an MSF address (see 14.1.5).

NOTE 186 The starting logical block address value recovered from the TOC has a tolerance of zero for data tracks and plus or minus 75 CD sectors for audio tracks. This tolerance is multiplied by a factor dependent on the logical block length.

14.3 Parameters for CD-ROM devices

14.3.1 Diagnostic parameters

This subclause defines the descriptors and pages for diagnostic parameters used with CD-ROM devices.

The diagnostic page codes for CD-ROM devices are defined in table 262.

Table 262 - Diagnostic page codes

Page code	Description	Subclause
00h	Supported diagnostic pages	8.3.1.1
01h - 3Fh	Reserved (for all device type pages)	
40h - 7Fh	Reserved	
80h - FFh	Vendor-specific pages	

14.3.2 Log parameters

This subclause defines the descriptors and pages for log parameters used with CD-ROM devices.

The log page codes for CD-ROM devices are defined in table 263.

Table 263 - Log page codes

Page code	Description	Subclause
01h	Buffer over-run/under-run page	8.3.2.1
03h	Error counter page (read) page	8.3.2.2
07h	Last n error events page	8.3.2.3
06h	Non-medium error page	8.3.2.4
02h	Reserved	
04h - 05h	Reserved	
08h - 2Fh	Reserved	
3Fh	Reserved	
00h	Supported log pages	8.3.2.5
30h - 3Eh	Vendor-specific pages	

14.3.3 Mode parameters

This subclause defines the descriptors and pages for mode parameters used with CD-ROM devices.

The mode parameter list, including the mode parameter header and mode block descriptor are defined in 8.3.3.

The medium-type code field is contained in the mode parameter header (see 8.3.3). Table 264 defines the medium type values for CD-ROM devices.

Table 264 - CD-ROM medium type codes

Code	Medium type description
00h	Default (only one type supported)
01h	120 mm CD-ROM data only
02h	120 mm CD-DA audio only
03h	120 mm CD-ROM data and audio combined
04h	Reserved
05h	80 mm CD-ROM data only
06h	80 mm CD-DA audio only
07h	80 mm CD-ROM data and audio combined
08h - 7Fh	Reserved
80h - FFh	Vendor-specific

The device-specific parameter field is contained in the mode parameter header (see 8.3.3). Table 265 defines the device-specific parameter field for CD-ROM devices.

Table 265 - CD-ROM device-specific parameter

Bit	7	6	5	4	3	2	1	0
	Reserved			DPOFUA	Reserved			EBC

When used with the MODE SELECT command, the DPOFUA bit is not used and the field is reserved.

When used with the MODE SENSE command, a DPOFUA bit of one indicates that the target supports the DPO and FUA bits (see 9.2.6).

The enable blank check (EBC) bit is reserved.

The density code field is contained in the mode parameter block descriptor (see 8.3.3). Table 266 defines the density code values for CD-ROM devices.

Table 266 - CD-ROM density codes

Code	Data types to be transferred
00h	Default density code
01h	User data only (2 048 bytes per physical sector)
02h	User data plus auxiliary data field (2 336 bytes per sector)
03h	4-byte tag field, user data plus auxiliary data (2 340 bytes per sector)
04h	Audio information only (1/75th of a second per logical block)
05h - 7Fh	Reserved
80h - FFh	Vendor-specific

NOTE 187 The number of bytes per sector specified by this parameter is used with the block length to map CD-ROM sectors to logical block addresses.

The mode page codes for CD-ROM devices are defined in table 267.

Table 267 - Mode page codes

Page code	Description	Subclause
08h	Caching page	9.3.3.1
0Eh	CD-ROM audio control page	14.3.3.1
0Dh	CD-ROM page	14.3.3.2
0Ah	Control mode page	8.3.3.1
02h	Disconnect-reconnect page	8.3.3.2
0Bh	Medium types supported page	9.3.3.4
09h	Peripheral device page	8.3.3.3
01h	Read error recovery page	14.3.3.3
03h - 06h	Reserved	
0Ch	Reserved	
0Fh - 1Fh	Reserved	
07h	Verify error recovery page	14.3.3.4
00h	Vendor-specific (does not require page format)	
20h - 3Eh	Vendor-specific (page format required)	
3Fh	Return all pages (valid only for the MODE SENSE command)	

14.3.3.1 CD-ROM audio control parameters

The CD-ROM audio control parameters page (see table 268) sets the playback modes and output controls for subsequent PLAY AUDIO commands and any current audio playback operation.

Table 268 - CD-ROM audio control parameters page

Bit Byte	7	6	5	4	3	2	1	0
0	PS	Reserved	Page code (0Eh)					
1	Parameter length (0Eh)							
2	Reserved				Immed	SOTC	Reserved	
3	Reserved							
4	Reserved							
5	APRVa1	Reserved			Format of LBAs / Sec.			
6	(MSB)	Logical blocks per second of audio playback						
7								(LSB)
8	Reserved				Output port 0 channel selection			
9	Output port 0 volume							
10	Reserved				Output port 1 channel selection			
11	Output port 1 volume							
12	Reserved				Output port 2 channel selection			
13	Output port 2 volume							
14	Reserved				Output port 3 channel selection			
15	Output port 3 volume							

The parameters savable (PS) bit is only used with the MODE SENSE command. This bit is reserved with the MODE SELECT command. A PS bit of one indicates that the target is capable of saving the page in a non-volatile vendor-specific location.

ANSI X3.131-1994

An immediate (Immed) bit of zero indicates the target shall not send completion status until the audio playback operation is terminated.

An Immed bit of one indicates the target shall send completion status as soon as the playback operation has been started.

NOTE 188 It is recommended that a Logical Unit type RESERVE be issued prior to starting audio play operations with an Immed bit of one in any multiple initiator environment.

A stop on track crossing (SOTC) bit of zero indicates the target shall terminate the audio playback operation when the transfer length is satisfied. Multiple tracks shall be played as necessary. Periods of time encoded as audio pause/silence at the beginning of tracks, (index 0) shall also be played.

A stop on track crossing (SOTC) bit of one indicates the target shall terminate the audio playback operation when the beginning of a following track is encountered.

The audio playback rate valid (APRVa) bit value of one indicates that the format of logical blocks per second field and the logical blocks per second of audio playback field are valid.

The format of logical blocks addresses per second field gives the multiplier to be used with the logical blocks per second of audio playback. This is defined in table 269.

Table 269 - Multiplier for LBAs

Format of LBAs / Sec value	Multiplier for LBAs / Sec field
0h	1
1h - 7h	Reserved
8h	1/256
9h - Fh	Reserved

NOTE 189 This field is provided as a means to return fractional (i.e. non-integral) values in the logical block addresses per second of audio playback. This shall occur when logical block sizes that are not even multiples or divisions of the physical block size are used.

The logical blocks per second of audio playback field gives the relationship between time and the duration of play per logical block address. The value in this field is to be multiplied by the value in format of LBAs per second field.

NOTE 190 The logical blocks per second of audio playback field and its companion format of LBAs per second field may not be supported by most current CD-ROM devices as a modifiable mode select parameter.

The output port channel selection specifies the audio channels from the disc to which this output port should be connected (see table 270). More than one output port may be connected to an audio channel. More than one audio channel may be connected to an output port.

Table 270 - Output port channel selection

Code	Description
0000b	output port muted
0001b	connect audio channel 0 to this output port
0010b	connect audio channel 1 to this output port
0100b	connect audio channel 2 to this output port
1000b	connect audio channel 3 to this output port

The channel volume control indicates the relative volume level for this audio output port. A value of zero indicates the output is muted, and a value of FFh indicates maximum volume level.

NOTE 191 If volume controls are implemented, the default volume level should be no more than 25 % of the maximum level as a personal safety consideration.

14.3.3.2 CD-ROM device parameters

The CD-ROM parameters page (see table 271) specifies parameters that affect all CD-ROM data types.

Table 271 - CD-ROM parameters page

Bit Byte	7	6	5	4	3	2	1	0
0	PS	Reserved	Page code (0Dh)					
1	Parameter length (06h)							
2	Reserved							
3	Reserved				Inactivity timer multiplier			
4	Number of MSF - S units per MSF - M unit							
5	---							
6	Number of MSF - F units per MSF - S unit							
7	---							

The parameters savable (PS) bit is only used with the MODE SENSE command. This bit is reserved with the MODE SELECT command. A PS bit of one indicates that the target is capable of saving the page in a non-volatile vendor-specific location.

The inactivity timer multiplier specifies the length of time that the drive shall remain in the hold track state after completion of a seek or read operation (see table 272).

NOTE 192 Higher values in this parameter may have an adverse effect on the drive MTBF, in some implementations.

Table 272 - Inactivity timer multiplier values

Inactivity timer multiplier	Minimum time in hold track state	Inactivity timer multiplier	Minimum time in hold track state
0h	Vendor-specific	8h	16s
1h	125 ms	9h	32s
2h	250 ms	Ah	1 min
3h	500 ms	Bh	2 min
4h	1 s	Ch	4 min
5h	2 s	Dh	8 min
6h	4 s	Eh	16 min
7h	8 s	Fh	32 min

The number of S units per M unit field gives the ratio of these MSF address values. For media conforming to the CD-ROM and CD-DA standard, this value is 60.

The number of F units per S unit field gives the ratio of these MSF address values. For media conforming to the CD-ROM and CD-DA standard, this value is 75.

ANSI X3.131-1994

14.3.3.3 Read error recovery parameters

The read error recovery parameters page (see table 273) specifies the error recovery parameters the target shall use during any command that performs a data read operation to the media (e.g. READ, READ TOC, etc.).

Table 273 - Read error recovery parameters page

Bit Byte	7	6	5	4	3	2	1	0
0	PS	Reserved	Page code (01h)					
1	Parameter length (06h)							
2	Error recovery parameter							
3	Read retry count							
4	Reserved							
5	Reserved							
6	Reserved							
7	Reserved							

The parameters savable (PS) bit is only used with the MODE SENSE command. This bit is reserved with the MODE SELECT command. A PS bit of one indicates that the target is capable of saving the page in a non-volatile vendor-specific location.

The error recovery parameter bits are defined in 9.3.3.6.

NOTE 193 The implementation of error recovery procedures for CD-ROM devices is markedly different from those used for magnetic medium disk drives. At least one level of error correction (i.e. CIRC) is required to transfer the data stream. Therefore, the performance of the drive may differ substantially from what would be expected by sending the same error recovery parameters to a magnetic medium device.

The correlation of the error recovery parameter and the bit settings defined for CD-ROM devices is given in table 274. The interpretation of these bit settings for CD-ROM devices is given in table 275. If the error recovery parameter is set to any other value, the command shall be terminated with CHECK CONDITION status. The sense key shall be set to ILLEGAL REQUEST and the additional sense code set to INVALID FIELD IN PARAMETER LIST.

Table 274 - Error recovery bit settings

Error recovery parameter	Bit settings							
	7	6	5	4	3	2	1	0
00h	R	R	0	0	R	0	0	0
01h	R	R	0	0	R	0	0	1
04h	R	R	0	0	R	1	0	0
05h	R	R	0	0	R	1	0	1
06h	R	R	0	0	R	1	1	0
07h	R	R	0	0	R	1	1	1
10h	R	R	0	1	R	0	0	0
11h	R	R	0	1	R	0	0	1
14h	R	R	0	1	R	1	0	0
15h	R	R	0	1	R	1	0	1
20h	R	R	1	0	R	0	0	0
21h	R	R	1	0	R	0	0	1
24h	R	R	1	0	R	1	0	0
25h	R	R	1	0	R	1	0	1
26h	R	R	1	0	R	1	1	0
27h	R	R	1	0	R	1	1	1
30h	R	R	1	1	R	0	0	0
31h	R	R	1	1	R	0	0	1
34h	R	R	1	1	R	1	0	0
35h	R	R	1	1	R	1	0	1

NOTE Reserved bits shall be set to zero.

Table 275 - CD-ROM error recovery descriptions

Error recovery description	
00h	The maximum error recovery procedures available are used. If an error occurs which is uncorrectable with the error correction codes (ECC) on the media, data transfer is terminated with CHECK CONDITION status. The block with the error is not transferred. The sense key is set to MEDIUM ERROR. The information bytes give the address of the block where the unrecovered error was detected. Recovered errors are not reported.
01h	Only retries of the read operation and CIRC are used (layered error correction is not used). Only CIRC unrecovered data errors are reported. If a CIRC unrecovered data error occurs, data transfer is terminated with CHECK CONDITION status. The block with the error is not transferred. The sense key is set to MEDIUM ERROR. The information bytes give the address of the block where the unrecovered error was detected. Recovered errors are not reported.
04h	The maximum error recovery procedures available are used. Recovered data errors are reported. If a recovered data error occurs, data transfer is not terminated. However, when the data transfer has completed CHECK CONDITION status is reported. The sense key is set to RECOVERED ERROR. The information bytes give the address of the last block where a recovered data error was detected. If a data error occurs that is uncorrectable with the ECC information available on the media, data transfer is terminated and CHECK CONDITION status is reported. The block with the error is not transferred. The sense key is set to MEDIUM ERROR. The information bytes give the address of the block where the uncorrectable error was detected.
05h	Only retries of the read operation and CIRC are used (layered error correction is not used). Recovered data errors are reported. If a recovered data error occurs, data transfer is not terminated. However, when the data transfer has completed CHECK CONDITION status is reported. The sense key is set to RECOVERED ERROR. The information bytes give the address of the last block where a CIRC recovered data error was detected. If an unrecovered data error occurs, data transfer is terminated and CHECK CONDITION status is reported. The block with the error is not transferred. The sense key is set to MEDIUM ERROR. The information bytes give the address of the block where the unrecovered error was detected.
06h	The maximum error recovery procedures are used. Recovered data errors are reported. If a recovered data error occurs data transfer is terminated and CHECK CONDITION status is reported. The block with the recovered error is not transferred. The sense key is set to RECOVERED ERROR. The information bytes give the address of the block where the recovered data error was detected. If a data error occurs that is uncorrectable with the ECC information on the medium, data transfer is terminated with CHECK CONDITION status. The block with the error is not transferred. The sense key is set to MEDIUM ERROR. The information bytes give the address of the block where the uncorrectable error was detected.

Table 275 (continued)

Error recovery description

07h Only retries of the read operation are used (layer error correction is not used). CIRC recovered data errors are reported. If a CIRC recovered data error occurs, data transfer is terminated with CHECK CONDITION status. The block with the recovered error is not transferred. The sense key is set to RECOVERED ERROR. The information bytes give the address of the block where the recovered data error was detected.

If a CIRC unrecovered data error occurs, data transfer is terminated with CHECK CONDITION status. The block with the error is not transferred. The sense key is set to MEDIUM ERROR. The information bytes give the address of the block where the unrecovered error was detected.

10h If data transfer can be maintained, the maximum error recovery procedures available are used. (RC = 1.) If an error occurs which is uncorrectable with the error correction codes (ECC) on the media, or is uncorrectable in time to maintain data transfer, the data transfer is not terminated. However, when the data transfer has completed, CHECK CONDITION status is reported. The sense key is set to MEDIUM ERROR. The information bytes give the address of the block where the first unrecovered error was detected. Recovered errors are not reported.

11h If data transfer can be maintained, retries of the read operation and CIRC are used (layered error correction is not used). (RC = 1.) Only CIRC unrecovered data errors are reported. If a CIRC unrecovered data error occurs, data transfer is not terminated. However, when the data transfer has completed, CHECK CONDITION status is reported. The sense key is set to MEDIUM ERROR. The information bytes give the address of the block where the first unrecovered error was detected. Recovered errors are not reported.

14h If data transfer can be maintained, the maximum error recovery procedures available are used. (RC = 1.) Recovered data errors are reported. If a recovered data error occurs, data transfer is not terminated. However, when the data transfer has completed, CHECK CONDITION status is reported. The sense key is set to RECOVERED ERROR. The information bytes give the address of the block where a recovered data error was detected.

If an data error occurs that is uncorrectable with the ECC information available on the media, or is uncorrectable in time to maintain data transfer, the data transfer is not terminated. However, when the data transfer has completed CHECK CONDITION, status is reported. The sense key is set to MEDIUM ERROR. The information bytes give the address of the block where the first uncorrectable error was detected. Reporting unrecovered errors takes precedence over reporting recovered errors.

Table 275 (continued)

Error recovery description
<p>15h If data transfer can be maintained, retries of the read operation and CIRC are used (layered error correction is not used). (RC = 1.) Recovered data errors are reported. If a recovered data error occurs, data transfer is not terminated. However, when the data transfer has completed CHECK CONDITION status is reported. The sense key is set to RECOVERED ERROR. The information bytes give the address of the block where a CIRC recovered data error was detected.</p> <p>If an unrecovered data error occurs, data transfer is not terminated. However, when the data transfer has completed CHECK CONDITION status is reported. The sense key is set to MEDIUM ERROR. The information bytes give the address of the block where the first unrecovered error was detected. Reporting unrecovered errors takes precedence over reporting recovered errors.</p>
<p>20h The maximum error recovery procedures available are used. If an error occurs which is uncorrectable with the error correction codes (ECC) on the media, data transfer is terminated with CHECK CONDITION status. The block with the error is transferred. The sense key is set to MEDIUM ERROR. The information bytes give the address of the block where the unrecovered error was detected. Recovered errors are not reported.</p>
<p>21h Only retries of the read operation and CIRC are used (layered error correction is not used). Only CIRC unrecovered data errors are reported. If a CIRC unrecovered data error occurs data transfer is terminated with CHECK CONDITION status. The block with the error is transferred. The sense key is set to MEDIUM ERROR. The information bytes give the address of the block where the unrecovered error was detected. Recovered errors are not reported.</p>
<p>24h The maximum error recovery procedures available are used. Recovered data errors are reported. If a recovered data error occurs data transfer is not terminated. However, when the data transfer has completed, CHECK CONDITION status is reported. The sense key is set to RECOVERED ERROR. The information bytes give the address of the last block where a recovered data error was detected.</p> <p>If a data error occurs that is uncorrectable with the ECC information available on the media data transfer is terminated and CHECK CONDITION status is reported. The block with the error is transferred. The sense key is set to MEDIUM ERROR. The information bytes give the address of the block where the uncorrectable error was detected.</p>

Table 275 (concluded)

Error recovery description	
25h	<p>Only retries of the read operation and CIRC are used (layered error correction is not used). Recovered data errors are reported. If a recovered data error occurs, data transfer is not terminated. However, when the data transfer has completed, CHECK CONDITION status is reported. The sense key is set to RECOVERED ERROR. The information bytes give the address of the last block where a CIRC recovered data error was detected.</p> <p>If an unrecovered data error occurs, data transfer is terminated and CHECK CONDITION status is reported. The block with the error is transferred. The sense key is set to MEDIUM ERROR. The information bytes give the address of the block where the unrecovered error was detected.</p>
26h	<p>The maximum error recovery procedures are used. Recovered data errors are reported. If a recovered data error occurs, data transfer is terminated and CHECK CONDITION status is reported. The block with the recovered error is transferred. The sense key is set to RECOVERED ERROR. The information bytes give the address of the block where the recovered data error was detected.</p> <p>If a data error occurs that is uncorrectable with the ECC information on the media, data transfer is terminated with CHECK CONDITION status. The block with the error is transferred. The sense key is set to MEDIUM ERROR. The information bytes give the address of the block where the uncorrectable error was detected.</p>
27h	<p>Only retries of the read operation are used (layer error correction is not used). CIRC recovered data errors are reported. If a CIRC recovered data error occurs, data transfer is terminated with CHECK CONDITION status. The block with the recovered error is transferred. The sense key is set to RECOVERED ERROR. The information bytes give the address of the block where the recovered data error was detected.</p> <p>If a CIRC unrecovered data error occurs, data transfer is terminated with CHECK CONDITION status. The block with the error is transferred. The sense key is set to MEDIUM ERROR. The information bytes give the address of the block where the unrecovered error was detected.</p>
30h	Same as code 10H.
31h	Same as code 11H.
34h	Same as code 14H.
35h	Same as code 15H.

The read retry count field specifies the number of times that the controller shall attempt its read recovery algorithm.

A CIRC recovered data error is defined as a block for which the CIRC based error correction algorithm was unsuccessful for a read attempt, but on a subsequent read operation no error was reported. The number of subsequent read operations is limited to the read retry count. Layered error correction was not used.

A CIRC unrecovered data error is defined as a block for which the CIRC based error correction algorithm was unsuccessful on all read attempts up to the read retry count. Layered error correction was not used.

An L-EC recovered data error is defined as a block for which the CIRC based error correction algorithm was unsuccessful, but the layered error correction was able to correct the block within the read retry count.

An L-EC uncorrectable data error is defined as a block which could not be corrected by layered error correction within the read retry count.

ANSI X3.131-1994

14.3.3.4 Verify error recovery parameters

The verify error recovery parameters page (see table 276) specifies the error recovery parameter the target shall use during verify operations.

Table 276 - Verify error recovery parameters page

Bit Byte	7	6	5	4	3	2	1	0
0	PS	Reserved	Page code (07h)					
1	Parameter length (06h)							
2	Error recovery parameter							
3	Verify retry count							
4	Reserved							
5	Reserved							
6	Reserved							
7	Reserved							

The parameters savable (PS) bit is only used with the MODE SENSE command. This bit is reserved with the MODE SELECT command. A PS bit of one indicates that the target is capable of saving the page in a non-volatile vendor-specific location.

The error recovery parameters for verify operations are as defined by the read error recovery parameters (see 14.3.3.3).

14.4 Definitions specific to CD-ROM devices

14.4.1 absolute F field: The sub-division of the S Field part of the absolute physical address from the beginning of the media. One physical sector. Written on CD-ROM media in binary coded decimal notation. The value is from 00bcd to 74bcd. (See 14.4.12 and 14.4.18.)

14.4.2 absolute M field: The most significant part of the absolute physical address from the beginning of the media. Written on CD-ROM media in binary coded decimal notation. The value is from 00bcd to 74bcd. (See 14.4.18.)

14.4.3 absolute S field: The intermediate significant part of the absolute physical address from the beginning of the media. Written on CD-ROM media in binary coded decimal notation. The value is from 00bcd to 59bcd. (See 14.4.18.)

14.4.4 bcd; binary coded decimal: The number system used on the physical CD-ROM and CD-DA media. Numbers that use this notation have the 'bcd' suffix attached. A byte has two four-bit values each of which can have a value from 0 to 9. The maximum value is 99bcd (99 decimal). Hence the maximum number of tracks is 99bcd.

Example: 00 01 02 03 ... 08 09 10 11 ... 19 20 21 ... 98 99.

14.4.5 block: The term block refers to the data in one logical block - the number of bytes defined by the logical block length in the mode block descriptor.

14.4.6 blocks per sector: The number of logical blocks read from each CD-ROM physical sector. The value depends on the logical block Length as defined in the mode block descriptor. The value for blocks per sector is:

- 1 if the logical block length is 2 048,
- 2 if the logical block length is 1 024,
- 4 if the logical block length is 512, and
- 8 if the logical block length is 256 bytes.

(Assuming a density code of 1 - 2 048 bytes of data per sector.)

14.4.7 CD-DA; compact disc - digital audio: The standardized media for recording digital audio information. The 'Red Book' defines CD-DA media.

14.4.8 CD-ROM; compact disc - read only memory: A standardized medium for recording digitized audio and digital data. CD-ROM is used to describe media with digital data rather than discs that encode audio only. The ISO/IEC 10149 standard defines CD-ROM media.

14.4.9 CD-ROM control field: A four bit field in the Q sub-channel data indicating the type of information encoded on the current track. Indicates audio versus data and the type of audio encoding, etc. The control field is also found in the table of contents entries.

14.4.10 CD-ROM data mode: A byte in the header of CD-ROM data sectors. This indicates if data is present and if layered error correction information is present.

14.4.11 CIRC; cross interleaved reed-solomon code: The error detection and correction technique used within small frames of audio or data. The CIRC bytes are present in all CD-ROM data modes. The error correction procedure which uses the CIRC bytes is referred to as the CIRC based algorithm. In most CD-ROM drives, this function is implemented in hardware.

14.4.12 frame: A physical sector on CD-ROM media. Also the F field unit of a MSF CD-ROM address. The term frame is also used in the CD-ROM model to describe the amount of data received between synchronization patterns. 98 of these frames make a sector. This sort of frame is referred to as 'small frames' where the meaning is not clear from context.

14.4.13 hold track state: When a CD-ROM device enters the hold track state the optical pick-up is maintained at an approximately constant position on the media. This allows a paused operation to be resumed without latency due to seeking. Rotational latency may be incurred, however.

14.4.14 index: An index is a subdivision of a CD-ROM track. A track can have from 1 to 99 index numbers. Index numbers within a track are sequential starting with 1.

14.4.15 lead-in area: The area on a CD-ROM disc prior to track one. The main channel in the lead-in area contains audio or data null information. This area is coded as track zero but is not addressable via the SCSI command set. The Q sub-channel in this area is coded with the table of contents information.

14.4.16 lead-out area: The area on a CD-ROM disc beyond the last information track. The main channel in the lead-out area contains audio or data null information. This area is coded as track AAbcd but is not addressable via the SCSI command set. The READ CD-ROM CAPACITY data is the first logical block address of this area minus one.

14.4.17 L-EC; layered error correction: The error correction technique used with CD-ROM data mode one sectors. In such sectors, 276 bytes of the auxiliary data field contain L-EC bytes. The algorithm that uses these bytes to perform error correction is often implemented in the drive firmware.

14.4.18 MSF address: The physical address written on CD-ROM discs. Expressed as a sector count relative to either the beginning of the medium (absolute) or to the beginning of the current track (relative). As defined by the CD-DA and CD-ROM standards, each F field unit is one physical sector; each S field unit is 75 F field units; each

ANSI X3.131-1994

M field unit is 60 S field units. Valid contents of F fields are binary values from 0 through 74. Valid contents of S fields are binary values from 0 through 59. Valid contents of M fields are binary values from 0 through 74.

14.4.19 output port: A means for connecting the audio signal being played to equipment outside the CD-ROM device.

14.4.20 pause area: A transition area at the beginning or end of an audio track encoded with audio silence. This transition area is required where the audio track immediately precedes a data track.

14.4.21 post-gap area: A transition area at the end of a data track encoded with null information. This transition area is required where the data track immediately precedes an audio track.

14.4.22 pre-gap area: A transition area at the beginning of a data track encoded with null information. This transition area is required where the data track immediately follows an audio track.

14.4.23 relative F field: The sub-division of the S field part of the relative physical address from the beginning of the current track. One physical sector. Written on CD-ROM medium in binary coded decimal notation. The value is from 00bcd to 74bcd. (See 14.4.12 and 14.4.18.)

14.4.24 relative M field: The most significant part of the relative physical address from the beginning of the current track. Written on CD-ROM media in binary coded decimal notation. The value is from 00bcd to 74bcd. (See 14.4.18.)

14.4.25 relative S field: The intermediate significant part of the relative physical address from the beginning of the current track. Written on CD-ROM medium in binary coded decimal notation. The value is from 00bcd to 59bcd. (See 14.4.18.)

14.4.26 sector: Refers to the data contained during one frame time. (On CD-DA medium with two channels of audio this is 1/75th of a second). In the CD-ROM standard document the term block is used for this unit. There may be more than one logical block per sector. Similarly, a single logical block may map to multiple sectors.

14.4.27 sub-channel: CD-ROM and CD-DA media have a main channel and a sub-channel. The sub-channel area has eight parts called P, Q, R, S, T, U, V, and W. The Q-sub-channel contains information useful to the controller and drive, such as the control field and MSF addresses. The data rate of each sub-channel (P, Q, etc.) is 1/192nd of that of the main channel.

14.4.28 TOC: The table of contents has information on the type of disc and the starting address of the tracks. This information is encoded in the Q sub-channel.

14.4.29 track: A sub-division of the CD-ROM media. A disc has from one to ninety-nine tracks. The data within a track is always of the same type. A track can be either CD-ROM or CD-Audio. A disc can start at any track number.

14.4.30 track relative logical address: An offset from the beginning of the recorded information on a track expressed in units of the logical block length. The value is used to address logical blocks relative to the beginning of a track using the relative MSF address encoded in the CD-ROM Q sub-channel.

14.4.31 transition area: Sectors at the beginning or end of tracks coded with null information. Where required by the media standards, these areas have minimum lengths of 1 s or 2 s. The maximum lengths are not specified. Transition areas at the beginning of a track are encoded with index zero. Addresses within transition areas may not be read.

15 Scanner devices

15.1 Model for scanner devices

Scanner devices generate a digital representation of two- or three-dimensional objects (e.g. a page of text, a photograph, or a piece of art). This is accomplished by sensing the amount of light reflected from the object and generating the digital data. The digital data can then be sent across the SCSI bus to an initiator for further processing.

There are two types of scanners in use; in one type, the operations and functions of the scanner are fixed; in the other type, the operations and functions are programmable and need to be set up prior to being used for scanning objects.

The scanner device generates the data and transfers it in accordance with the commands received from the initiator. The contents of the data is vendor-specific; therefore, the initiator and the scanner must know how to use the contents of the data.

Scanners generate a digital image of an object in a two dimensional plane. The x -axis dimension is along the cross-scan direction that is perpendicular to the direction in which a scan occurs. The y -axis dimension is along the scan direction, and is parallel to the direction in which a scan occurs. The coordinates are measured from the upper left hand corner of the two dimensional plane. The x -axis measurement increases in a positive manner going from left to right. The left side of the two dimensional plane (i.e. where x equals zero) is called the base element line. The y -axis measurement increases in a positive manner going from top to bottom. The top side of the two dimensional plane (i.e. where y equals zero) is called the base line. The scanning range encompasses the area in which the scanner can operate, from the scan line and base line to the maximum x and y position. These conventions are adopted to aid in understanding the fields within the command descriptor blocks and parameters used for scanner devices. As such this is a conceptual model and may not accurately reflect the physical device.

The displacements used for positioning windows is independent of the resolution with which a window is scanned. The measurement of displacements is controlled by the scan measurement mode parameters.

In the event of a scanner automatic creation of sub-windows within a defined window (i.e. the auto bit in the DEFINE WINDOW parameters is one), one of the following responses is appropriate:

- a) the initiator may issue a GET WINDOW PARAMETERS command prior to any READ commands;
- b) if the initiator issues a READ command before issuing a GET WINDOW PARAMETERS command, the target shall return CHECK CONDITION status. The ILL and valid bits in the sense data shall be set to one. The initiator should then issue a GET WINDOW PARAMETERS command. This feature is useful when the scanner has the ability to distinguish between image and text data and to define windows accordingly.

It may occur that a scanner device temporarily does not have resources available to manage a data transfer from the initiator or does not have data available to transfer to the initiator. One of the following responses is appropriate in such a case:

- a) A CHECK CONDITION status is returned and the sense key is set to NOT READY with the appropriate additional sense code. This response is applicable to a TEST UNIT READY command.
- b) The target disconnects until the resource or data are available, and then reconnects to resume the operation.
- c) A BUSY status is returned.

If the scanner device determines that an error or exception condition has occurred while executing the SCSI command from the initiator, a CHECK CONDITION status is returned. A REQUEST SENSE command can then be used to determine additional information regarding the error or exception condition.

ANSI X3.131-1994

15.2 Commands for scanner devices

The commands for scanner devices shall be as shown in table 277.

Table 277 - Commands for scanner devices

Command name	Operation code	Type	Subclause
CHANGE DEFINITION	40h	O	8.2.1
COMPARE	39h	O	8.2.2
COPY	18h	O	8.2.3
COPY AND VERIFY	3Ah	O	8.2.4
GET DATA BUFFER STATUS	34h	O	15.2.1
GET WINDOW	25h	O	15.2.2
INQUIRY	12h	M	8.2.5
LOG SELECT	4Ch	O	8.2.6
LOG SENSE	4Dh	O	8.2.7
MODE SELECT(6)	15h	O	8.2.8
MODE SELECT(10)	55h	O	8.2.9
MODE SENSE(6)	1Ah	O	8.2.10
MODE SENSE(10)	5Ah	O	8.2.11
OBJECT POSITION	31h	O	15.2.3
READ	28h	M	15.2.4
READ BUFFER	3Ch	O	8.2.12
RECEIVE DIAGNOSTIC RESULTS	1Ch	O	8.2.13
RELEASE UNIT	17h	M	10.2.9
REQUEST SENSE	03h	M	8.2.14
RESERVE UNIT	16h	M	10.2.10
SCAN	1Bh	O	15.2.5
SET WINDOW	24h	M	15.2.7
SEND	2Ah	O	15.2.6
SEND DIAGNOSTIC	1Dh	M	8.2.15
TEST UNIT READY	00h	M	8.2.16
WRITE BUFFER	3Bh	O	8.2.17

Key: M = command implementation is mandatory.
O = command implementation is optional.

All other operation codes for scanner devices are reserved for future standardization.

15.2.1 GET DATA BUFFER STATUS command

The GET DATA BUFFER STATUS command (see table 278) provides a means for the initiator to get information about the data buffer. Information is returned only for window identifiers for which a SCAN command has been received (see 15.2.5).

Table 278 - GET DATA BUFFER STATUS command

Bit Byte	7	6	5	4	3	2	1	0
0	Operation code (34h)							
1	Logical unit number			Reserved				Wait
2	Reserved							
3	Reserved							
4	Reserved							
5	Reserved							
6	Reserved							
7	(MSB)	Allocation length						
8								(LSB)
9	Control							

A wait bit of zero indicates that the target shall respond immediately. A wait bit of one indicates that the target shall wait for image data to be available before returning scan status data.

The data buffer status data format is defined in table 279.

Table 279 - Data buffer status format

Bit Byte	7	6	5	4	3	2	1	0
0	(MSB)							
1	Data buffer status length							
2	(LSB)							
3	Reserved							Block
Data buffer status descriptor(s)								
0	Window identifier							
1	Reserved							
2	(MSB)							
3	Available data buffer							
4	(LSB)							
5	(MSB)							
6	Filled data buffer							
7	(LSB)							

The data buffer status length indicates the length, in bytes, of the following scan status data that is available to be transferred during the DATA IN phase. The data buffer status length does not include itself. The data buffer status data transferred to the initiator includes zero or more data buffer status descriptors. Each descriptor returns information for the window specified by the window identifier.

The block bit specifies the buffering capabilities of the scanner. A block bit of one indicates that the data buffer is full and all image data must be transferred to the initiator before the scan operation resumes. A block bit of zero indicates that the data buffer is not full and scan operations can continue with the available data buffer space.

The available data buffer field indicates, in bytes, the amount of buffer available for transfers from the initiator. This field is valid only in scanners with the ability to accept data from an initiator for processing.

The filled data buffer field indicates the amount of image data in bytes available for transfer to the initiator.

15.2.2 GET WINDOW command

The GET WINDOW command (see table 280) provides a means for the initiator to get information about previously defined windows.

Table 280 - GET WINDOW command

Bit Byte	7	6	5	4	3	2	1	0	
0	Operation code (25h)								
1	Logical unit number			Reserved				Single	
2	Reserved								
3	Reserved								
4	Reserved								
5	Window identifier								
6	(MSB)								
7	Transfer length								
8								(LSB)	
9	Control								

A single bit of one specifies that a single window descriptor shall be returned for the specified window identifier. A single bit of zero specifies that window descriptors be returned for all window identifiers that were defined by a SET WINDOWS command or by the target, if the automatic bit was set to one.

The GET WINDOW data shall consist of a header (see table 281) followed by one or more window descriptors. Each window descriptor specifies the location, size, and scanning method used for a window.

Table 281 - Get window data header

Bit Byte	7	6	5	4	3	2	1	0	
0	(MSB)	Window data length							
1								(LSB)	
2	Reserved								
3	Reserved								
4	Reserved								
5	Reserved								
6	(MSB)	Window descriptor length							
7								(LSB)	

The window data length specifies the length in bytes of the following data that is available to be transferred. The window data length does not include itself. If the allocation length is not sufficient to return all the get window data, the window data length shall not be adjusted to reflect the truncation data.

ANSI X3.131-1994

The window descriptor length specifies the length in bytes of a single window descriptor. Each descriptor shall be of equal length. The first forty-eight bytes are defined in this standard and the remaining bytes in each descriptor are vendor-specific.

The window descriptors are defined in table 282.

Table 282 - Window descriptor bytes

Bit Byte	7	6	5	4	3	2	1	0
0	Window identifier							
1	Reserved							Auto
2	(MSB)	X-Axis resolution						(LSB)
3								
4	(MSB)	Y-Axis resolution						(LSB)
5								
6	(MSB)	X-Axis upper left						(LSB)
9								
10	(MSB)	Y-Axis upper left						(LSB)
13								
14	(MSB)	Window width						(LSB)
17								
18	(MSB)	Window length						(LSB)
21								
22	Brightness							
23	Threshold							
24	Contrast							
25	Image composition							
26	Bits per pixel							
27	(MSB)	Halftone pattern						(LSB)
28								
29	RIF	Reserved			Padding type			
30	(MSB)	Bit ordering						(LSB)
31								
32	Compression type							
33	Compression argument							
34								
39	Reserved							
40								
n	Vendor-specific parameter byte(s)							

The window identifier specifies the window defined by the window descriptor. A window is referenced by the window identifier during data transfers and parameter updates.

When used with the SET WINDOW command, an automatic (auto) bit of one indicates that the target is allowed to create sub-windows within the window specified. An auto bit of zero indicates that the target is not allowed to create sub-windows.

When used with the GET WINDOW command, an auto bit of zero indicates that the window was defined directly by the SET WINDOW command. A value of one indicates that the window was defined by the target. This is a sub-window within a window defined by a SET WINDOW command.

The window identifiers assigned by the target shall be unique and shall not be currently in use. The parameters for the sub-windows may be retrieved using the GET WINDOW command.

The x-axis resolution field specifies the resolution in the scan line direction. The unit of measure is picture elements (pixels) per inch. A value of zero specifies the default resolution.

The y-axis resolution field specifies the resolution in the base line direction. The unit of measure is scan lines per inch. A value of zero specifies the default resolution.

The x-axis upper left field specifies the x-axis coordinate of the upper left corner of the window. This coordinate is measured from the scan line using the target's current measurement unit divisor (see 15.3.3.1).

The y-axis upper left field specifies the y-axis coordinate of the upper left corner of the window. This coordinate is measured from the base line using target's current measurement unit divisor (see 15.3.3.1).

The window width field specifies the width of window in the scan line direction. The window width is measured using the target's current measurement unit divisor (see 15.3.3.1).

The window length field specifies the length of the window in the base line direction. The window length is measured using the target's current measurement unit divisor (see 15.3.3.1).

The brightness field specifies the level of brightness used to scan the object. A value of zero specifies the default brightness or automatic brightness control, if it is supported. Any other value indicates a relative brightness setting, with 255 being the highest setting, one being the lowest setting, and 128 being the nominal setting.

The threshold field specifies the threshold at which scan data is converted to binary data. A value of zero specifies the default threshold or automatic threshold control if it is supported. Any other value indicates relative threshold setting, with 255 being the highest setting, one being the lowest setting, and 128 being the nominal setting.

The contrast field specifies the level of contrast used to scan the object. A value of zero specifies the default contrast or automatic contrast control, if it is supported. Any other value indicates a relative contrast setting, with 255 being the highest setting, one being the lowest setting, and 128 being the nominal setting.

The halftone field specifies the level of halftone at which the scan data is converted to binary data. The values in this field are vendor-specific. The halftone field is used in conjunction with the image composition field.

The image composition field specifies the type of scan operation requested. The image composition is defined as shown in table 283.

Table 283 - Image composition codes

Code	Description
00h	Bi-level black & white
01h	Dithered/halftone black & white
02h	Multi-level black & white (gray scale)
03h	Bi-level RGB colour
04h	Dithered/halftone RGB colour
05h	Multi-level RGB colour
06h - FFh	Reserved

The bits per pixel field specifies the number of bits used to represent the intensity of a single colour.

A reverse image format (RIF) bit of zero indicates that white pixels are indicated by zeros and black pixels are indicated by ones. A RIF bit of one indicates that white pixels are to be indicated by ones and black pixels are to be indicated by zeros. The RIF bit is applicable only for images represented by one bit per pixel.

The padding type field specifies how the target shall pad the image data transmitted to the initiator if it is not an integral number of bytes. The padding type is defined in table 284.

Table 284 - Padding types

Code	Description
00h	No padding
01h	Pad with 0's to byte boundary
02h	Pad with 1's to byte boundary
03h	Truncate to byte boundary
04h - FFh	Reserved

The bit ordering field specifies the order in which data is transferred to the host from the window. The bit ordering specifies the direction of pixels in a scan line, the direction of scan lines within a window and the image data packing within a byte. The values in this field are vendor-specific.

The compression type and compression argument fields specify the compression technique to be applied to the image data (see table 285).

Table 285 - Compression types and arguments

Compression code	Description	Compression argument
00h	No compression	Reserved
01h	CCITT group III, 1 dimensional	Reserved
02h	CCITT group III, 2 dimensional	K factor
03h	CCITT group IV, 2 dimensional	Reserved
04h - 0Fh	Reserved	Reserved
10h	Optical character recognition (OCR)	Vendor-specific
11h - 7Fh	Reserved	Reserved
80h - FFh	Vendor-specific	Vendor-specific

15.2.3 OBJECT POSITION command

The OBJECT POSITION command (see table 286) provides positioning functions. Absolute as well as relative positioning is provided. A target shall return CHECK CONDITION status and set the sense key to ILLEGAL REQUEST if a positioning function is requested that is not supported.

Table 286 - OBJECT POSITION command

Bit Byte	7	6	5	4	3	2	1	0
0	Operation code (31h)							
1	Logical unit number			Reserved		Position function		
2	(MSB)							
3	Count							
4	(LSB)							
5	Reserved							
6	Reserved							
7	Reserved							
8	Reserved							
9	Control							

The position function field specifies the requested function (see table 287).

Table 287 - Position function

Position function	Description
000b	Unload object
001b	Load object
010b	Absolute positioning
011b	Relative positioning
100b	Rotate object
101b	Reserved
110b	Reserved
111b	Reserved

- a) **Unload Object.** This position function specifies that the object shall be positioned for removal. If upon receipt of this command there is no object loaded, the target shall return a GOOD status. This condition shall not be considered as an error. If the target is unable to unload the object (i.e. paper jam or mis-feed condition), the target shall return CHECK CONDITION status and set the sense key sense to MEDIUM ERROR.
- b) **Load object.** This position function specifies that the object is to be loaded and positioned to the base line. If upon receipt of this command there is a object already loaded, the target shall returns GOOD status. This condition shall not be considered as an error. If an object is not loaded and the target is unable to load an object, the target shall return CHECK CONDITION status and set the EOM bit to one and the sense key to MEDIUM ERROR.
- c) **Absolute positioning.** This position function specifies that the object is to be positioned at a y-axis displacement from the base line. The y-axis displacement is determined using the count field and the

ANSI X3.131-1994

target's current measurement unit divisor (see 15.3.3.1). A count field of zero positions the object at the base line.

Any other value in the count field shall cause the target to position the object that number of units in the scan line direction. If there is no object loaded or if the specified *y*-axis displacement is not achieved, the target shall return CHECK CONDITION status and set the EOM bit to one and the sense key to MEDIUM ERROR.

- d) Relative positioning. This position function specifies that the object is to be positioned at a *y*-axis displacement relative to the current position. The *y*-axis displacement is determined using the count field and the target's current measurement unit divisor (see 15.3.3.1). A count field of zero causes no change in position of the object.

A positive value in the count field shall cause the target to position the object that number of units in the scan line direction. If the scan range is exceeded, the target shall return CHECK CONDITION status. The EOM bit is set to one, the ILI bit is set to one, and the sense key is set to MEDIUM ERROR. The valid bit is set to one and the information bytes are set to the difference (residue) between the requested count and the actual number of units moved.

A negative value (e.g. twos complement notation) in the count field shall cause the target to position the object that number of units toward the base line. If there is no object loaded or if the specified *y*-axis displacement is not achieved, the target shall return CHECK CONDITION status and set the EOM bit to one and the sense key to MEDIUM ERROR. If the base line is encountered, the target shall position the object at the base line and return CHECK CONDITION status. The ILI bit is set to one and the sense key is set to MEDIUM ERROR. The valid bit is set to one and the information bytes are set to the difference (residue) between the requested count and the actual number of units moved.

- e) Rotate object. This position function specifies that the object is rotated in an anti-clockwise direction expressed in thousandths of a degree. The count field specifies the number of units that the object is to be moved.

The count field is used with the position function to specify the displacement of the object.

15.2.4 READ command

The READ command (see table 288) requests that the target transfer data to the initiator.

Table 288 - READ command

Bit Byte	7	6	5	4	3	2	1	0
0	Operation code (28h)							
1	Logical unit number			Reserved				
2	Data type code							
3	Reserved							
4	(MSB) Data type qualifier							
5	(LSB)							
6	(MSB) Transfer length							
7	(LSB)							
8	(LSB)							
9	Control							

The transfer data type distinguishes between the different types of data that may be transferred between the initiator and the target. The types of transfers are specified in table 289.

Table 289 - Data type codes

Code	Description
00h	Image
01h	Vendor-specific
02h	Halftone mask
03h	Gamma function
04h - 7Fh	Reserved
80h - FFh	Vendor-specific

The data type qualifier field provides a means to differentiate data transfers of the same data type code. The values used in this field are vendor-specific.

The transfer length specifies the number of blocks the target shall transfer to the initiator during the DATA IN phase. The block size is the current block size in the mode parameters block descriptor (see 8.3.3). A transfer length of zero is not considered an error and no data shall be transferred.

If the target transfers less than transfer length blocks, a CHECK CONDITION status shall be returned. The ILI bit is set to one, the valid bit is set to one, and the information bytes are set to the difference (residue) between the requested transfer length and the actual number of blocks transferred.

This command shall be terminated with a status of RESERVATION CONFLICT if any reservation access conflict (see 10.2.10) exists, and no data shall be transferred.

ANSI X3.131-1994

15.2.5 SCAN command

The SCAN command (see table 290) requests the target begin a scan operation.

Table 290 - SCAN command

Bit Byte	7	6	5	4	3	2	1	0
0	Operation code (1Bh)							
1	Logical unit number			Reserved				
2	Reserved							
3	Reserved							
4	Transfer length							
5	Control							

The transfer length specifies the length in bytes of the window identifier list that shall be sent during the DATA OUT phase. A transfer length of zero indicates that no data shall be transferred. This condition shall not be considered an error.

The window identifier list consists of zero or more window identifiers, each of which specifies a window to be scanned.

15.2.6 SEND command

The SEND command (see table 291) transfers data from the initiator to the target.

Table 291 - SEND command

Bit Byte	7	6	5	4	3	2	1	0	
0	Operation code (2Ah)								
1	Logical unit number			Reserved					
2	Data type code								
3	Reserved								
4	(MSB)	Data type qualifier							
5								(LSB)	
6	(MSB)	Transfer length							
7									
8								(LSB)	
9	Control								

The data type code and data type qualifier are defined in the READ command (see 15.2.4).

The transfer length specifies the number of blocks the target shall transfer from the initiator during the DATA OUT phase. The block size is the current block size in the mode parameters block descriptor (see 8.3.3). A transfer length of zero is not considered an error and no data shall be transferred.

This command shall be terminated with a status of RESERVATION CONFLICT if any reservation access conflict (see 10.2.10) exists, and no data shall be transferred.

15.2.7 SET WINDOW command

The SET WINDOW command (see table 292) provides a means for the initiator to specify one or more windows within the scanning range of the device.

Table 292 - SET WINDOW command

Bit Byte	7	6	5	4	3	2	1	0
0	Operation code (24H)							
1	Logical unit number			Reserved				
2	Reserved							
3	Reserved							
4	Reserved							
5	Reserved							
6	(MSB)							
7	Transfer length							
8	(LSB)							
9	Control							

The transfer length specifies the length, in bytes, of the data that shall be sent during the DATA OUT phase. A transfer length of zero indicates that no window parameters data shall be transferred. This condition shall not be considered an error.

The window parameters data shall consist of a header followed by one or more window descriptors. Each window descriptor specifies the location, size, and scanning method used for a window.

The set window data header is defined in table 293.

Table 293 - Set window data header

Bit Byte	7	6	5	4	3	2	1	0	
0	Reserved								
1	Reserved								
2	Reserved								
3	Reserved								
4	Reserved								
5	Reserved								
6	(MSB)	Window descriptor length							
7								(LSB)	

The window descriptor length specifies the length, in bytes, of a single window descriptor. Each descriptor shall be of equal length. The first 48 bytes are defined in this standard and the remaining bytes in each descriptor are vendor-specific.

See table 282 for the definition of a window descriptor.

15.3 Parameters for scanner devices

15.3.1 Diagnostic parameters

This subclause defines the descriptors and pages for diagnostic parameters used with scanner devices.

The diagnostic page codes for scanner devices are defined in table 294.

Table 294 - Diagnostic page codes

Page code	Description	Subclause
00h	Supported diagnostic pages	8.3.1.1
01h - 7Fh	Reserved	
80h - FFh	Vendor-specific pages	

15.3.2 Log parameters

This subclause defines the descriptors and pages for log parameters used with scanner devices.

The log page codes for scanner devices are defined in table 295.

Table 295 - Log page codes

Page code	Description	Subclause
01h	Buffer over-run/under-run page	8.3.2.1
03h	Error counter page (read) page	8.3.2.2
07h	Last n error events page	8.3.2.3
06h	Non-medium error page	8.3.2.4
00h	Supported log pages	8.3.2.5
08h - 2Fh	Reserved	
3Fh	Reserved	
30h - 3Eh	Vendor-specific pages	

15.3.3 Mode parameters

This subclause defines the descriptors and pages for mode parameters used with scanner devices.

The mode parameter list, including the mode parameter header and mode block descriptor, is defined in 8.3.3.

The medium-type code field is contained in the mode parameter header (see 8.3.3). This field is reserved for scanners devices.

The device specific parameter field is contained in the mode parameter header (see 8.3.3). This field is reserved for scanner devices.

The density code field is contained in the mode parameter block descriptor (see table 8.3.3). This field is reserved for scanner devices.

The mode page codes for scanner devices are defined in table 296.

Table 296 - Mode page codes

Page code	Description	Subclause
0Ah	Control mode page	8.3.3.1
02h	Disconnect-reconnect page	8.3.3.2
03h	Measurement units page	15.3.3.1
09h	Peripheral device page	8.3.3.3
01h	Reserved	
03h - 08h	Reserved	
0Bh - 1Fh	Reserved	
00h	Vendor-specific (does not require page format)	
20h - 3Eh	Vendor-specific (page format required)	
3Fh	Return all pages (valid only for the MODE SENSE command)	

15.3.3.1 Measurement units page

The measurement units page (see table 297) specifies the units of measurement used for calculating the displacement of window and for positioning an object.

The measurement units are independent of the horizontal and vertical scan resolutions.

Table 297 - Measurement units page

Bit Byte	7	6	5	4	3	2	1	0
0	PS	Reserved	Page code (03h)					
1	Parameter length (06h)							
2	Basic measurement unit							
3	Reserved							
4	(MSB)	Measurement unit divisor						
5								(LSB)
6	Reserved							
7	Reserved							

The parameters savable (PS) bit is only used with the MODE SENSE command. This bit is reserved for the MODE SELECT command. A PS bit of one indicates that the target is capable of saving the page in a non-volatile vendor-specific location.

The basic measurement unit field is defined in table 298. Targets shall use inches as the default basic measurement unit.

Table 298 - Basic measurement units

Code	Description
00h	Inch
01h	Millimetre
02h	Point
03h - FFh	Reserved

The measurement unit divisor specifies the number of units needed to equal one basic measurement unit. Targets shall use 1 200 as the default measurement unit divisor. If a value of zero is specified the target shall return CHECK CONDITION status and set the sense key to ILLEGAL REQUEST.

NOTE 194 A target that does not implement this page or only supports default values uses twelve hundredths (1/1200) of an inch as the unit of measure.

15.4 Definitions specific to scanner devices

15.4.1 base element line: An x -axis displacement equal to zero.

15.4.2 base line: An y -axis displacement equal to zero.

15.4.3 beginning-of-medium: A x -axis and y -axis of zero displacement. Alternatively this is being positioned at the intersection of the base and scan lines.

15.4.4 end-of-medium: The maximum x -axis and y -axis displacement.

15.4.5 image: The digital result of a scan.

15.4.6 object: The original or item being scanned.

15.4.7 pixel: Picture-element, which is the smallest photo sight in the array.

15.4.8 platen: The surface on which the target is positioned.

15.4.9 scan: An operation that generates a digital image from the reflected light of an object.

15.4.10 scan line: A y -axis displacement from the base line.

15.4.11 scanning range: The total area that a scanner can generate an image from. For two dimensional objects this may correspond to the largest object that can be scanned.

15.4.12 window: All or part of the scanning range of a scanner. A window defines the part of the object scanned.

16 Optical memory devices

16.1 Model for optical memory devices

An optical memory device is a device that can potentially support a variety of optical media, (e.g. read-only, write-once, erasable, or reversible). In several respects, an optical memory device is similar to a direct-access device. However, optical memory devices typically offer features that are not available with other devices, including very large capacity removable media.

These devices often require the functions that are not found in direct-access devices such as logical block update, pre-erasure before writing, or scanning for blank medium and twelve-byte command descriptor blocks. This standard has specific device types for write-once and CD-ROM devices that also use optical media, but are not capable of supporting several types of optical media. A device that uses write-once media can be an optical memory device. Devices that use read-only media can be optical memory devices; however, devices using CD-ROM media have certain unique characteristics and should not be implemented as optical memory devices.

A model of optical memory devices is complicated by the nature of one of its potential advantages, that it can support media which has different characteristics. There are three types of optical media in general use, read-only, write-once and reversible. Read-only media are typically used for publishing applications requiring dissemination of large amounts of data, since the data can be replicated on a disk at low cost. Write-once media are used in applications that have large backup or archiving requirements. It is also used in applications that need large amounts of on-line reference information. Reversible media is typically used in applications that need large amounts of temporary storage (e.g. a graphics workstation), and can take advantage of removable media. In some applications, reversible media drives are used in place of direct-access devices.

Reversible media usually need to be reversed (erased, blanked) before new data can be written. In such cases an erase operation is required before data can be written. Some optical memory devices perform this erase operation implicit with each write operation that typically impacts the data throughput. Some devices can perform the erase separately. The ERASE command may be used to erase areas of the medium with a corresponding increase in data throughput on subsequent write operations. Products using optical media should not be implemented as direct-access devices, due to the overhead penalty on performance from the emulation and the lack of support in direct-access devices to take advantage of the sophisticated features available with optical memory devices.

The type of medium supported by the device and the type of medium currently loaded can be determined by examining the MODE SENSE data. One unique feature of optical memory devices is support of media with mixed types (e.g. media with read-only and write-once areas). The INQUIRY command informs the initiator that the target is an optical memory device; the initiator should then determine the medium type from the MODE SENSE data. The initiator needs to be cognizant of medium type since the device's characteristics can change when the media are changed.

Write-once media can have valid data written to a logical block once. This is an important feature where audit trails and permanent archives are needed. Many optical memory devices supporting write-once media have the ability to update a logical block, preserving the previous generation of data. These devices usually provide a means to recover the previous data through use of commands that allow read access to the different generations of data that are stored at the same logical block address.

An important requirement in dealing with optical media is determining which logical blocks contain written data and which are blank. A blank logical block is one that is properly initialized so that data written to it can be recovered. The logical blocks usually have a flag associated with each that indicates whether they have been written or not.

Many of the strategies used to manage write once and erasable media depend on being able to determine the boundary between written and blank areas of the medium. The MEDIUM SCAN command is useful in finding blank areas for subsequent write operations.

16.1.1 Defect management

Defect management can be performed on logical blocks by updating in a manner similar to that used by direct-access devices with the REASSIGN BLOCKS command. The advantage of using the updating (which is not supported by direct-access devices) is access to the previous data.

The update operation assigns an alternate physical block to the logical block while simultaneously writing the data to the block. Commands are provided to allow the recovery of previous generations of updated blocks.

Defect management on optical-memory devices is usually vendor-specific. However there are standards for some types of optical-memory media that specify defect management techniques. These standards, where they exist, may supersede the implementation requirements pertaining to error and defect reporting in this standard.

16.1.2 Error reporting

If any of the following conditions occur during the execution of a command the target shall return CHECK CONDITION status. The appropriate sense key and additional sense code should be set. The following list illustrates some error conditions and the applicable sense keys. The list does not provide an exhaustive enumeration of all conditions that may cause the CHECK CONDITION status.

<u>Condition</u>	<u>Sense Key</u>
Invalid logical block address	ILLEGAL REQUEST
Unsupported option requested	ILLEGAL REQUEST
Target reset or medium change since last command from this initiator	UNIT ATTENTION
Self diagnostic failed	HARDWARE ERROR
Unrecovered read error	MEDIUM ERROR HARDWARE ERROR
Recovered read error	RECOVERED ERROR
Overrun or other error that might be resolved by repeating the command	ABORTED command
Attempt to write on write protected medium	DATA PROTECT
Attempt to read a blank or previously unwritten block	BLANK CHECK
Attempt to write a previously written block and blank checking is enabled	BLANK CHECK
Attempt to write on read-only medium	DATA PROTECT

In the case of an invalid logical block address, the sense data information field shall be set to the logical block address of the first invalid address.

In the case of an attempt to read a blank or previously unwritten block, the sense data information field shall be set to the logical block address of the first blank block encountered. The data read up to that block shall be transferred.

ANSI X3.131-1994

In the case of an attempt to write a previously written block when blank checking is enabled, the sense information field shall be set to the logical block address of the first non-blank block encountered.

16.2 Commands for optical memory devices

The commands for optical memory devices shall be as shown in table 299.

Table 299 - Commands for optical memory devices

Command name	Operation code	Type	Subclause
CHANGE DEFINITION	40h	0	8.2.1
COMPARE	39h	0	8.2.2
COPY	18h	0	8.2.3
COPY AND VERIFY	3Ah	0	8.2.4
ERASE(10)	2Ch	0	16.2.1
ERASE(12)	ACh	0	16.2.2
FORMAT UNIT	04h	0	9.2.1
INQUIRY	12h	M	8.2.5
LOCK UNLOCK CACHE	36h	0	9.2.2
LOG SELECT	4Ch	0	8.2.6
LOG SENSE	4Dh	0	8.2.7
MEDIUM SCAN	38h	0	16.2.3
MODE SELECT(6)	15h	0	8.2.8
MODE SELECT(10)	55h	0	8.2.9
MODE SENSE(6)	1Ah	0	8.2.10
MODE SENSE(10)	5Ah	0	8.2.11
PRE-FETCH	34h	0	9.2.3
PREVENT ALLOW MEDIUM REMOVAL	1Eh	0	9.2.4
READ(6)	08h	0	9.2.5
READ(10)	28h	M	9.2.6
READ(12)	A8h	0	16.2.4
READ BUFFER	3Ch	0	8.2.12
READ CAPACITY	25h	M	9.2.7
READ DEFECT DATA(10)	37h	0	9.2.8
READ DEFECT DATA(12)	B7h	0	16.2.5
READ GENERATION	29h	0	16.2.6
READ LONG	3Eh	0	9.2.9
READ UPDATED BLOCK	2Dh	0	16.2.7
REASSIGN BLOCKS	07h	0	9.2.10
RECEIVE DIAGNOSTIC RESULTS	1Ch	0	8.2.13
RELEASE	17h	M	9.2.11
REQUEST SENSE	03h	M	8.2.14
RESERVE	16h	M	9.2.12
REZERO UNIT	01h	0	9.2.13
SEARCH DATA EQUAL(10)	31h	0	9.2.14.1
SEARCH DATA EQUAL(12)	B1h	0	16.2.8
SEARCH DATA HIGH(10)	30h	0	9.2.14.2
SEARCH DATA HIGH(12)	B0h	0	16.2.8
SEARCH DATA LOW(12)	B2h	0	16.2.8
SEEK(6)	0Bh	0	9.2.15
SEEK(10)	2Bh	0	9.2.15
SEND DIAGNOSTIC	1Dh	M	8.2.15
SET LIMITS(10)	33h	0	9.2.16
SET LIMITS(12)	B3h	0	16.2.9
START STOP UNIT	1Bh	0	9.2.17
SYNCHRONIZE CACHE	35h	0	9.2.18
TEST UNIT READY	00h	M	8.2.16
UPDATE BLOCK	3Dh	0	16.2.10
VERIFY(10)	2Fh	0	16.2.11
VERIFY(12)	AFh	0	16.2.12
WRITE(6)	0Ah	0	9.2.20
WRITE(10)	2Ah	M	16.2.13
WRITE(12)	AAh	0	16.2.14
WRITE AND VERIFY(10)	2Eh	0	16.2.15
WRITE AND VERIFY(12)	AEh	0	16.2.16
WRITE BUFFER	3Bh	0	8.2.17
WRITE LONG	3Fh	0	9.2.23

Key: M = command implementation is mandatory.
0 = command implementation is optional.

The following codes are vendor-specific: 20h, 21h, 22h, 23h, and C0h through FFh. All remaining codes for optical memory devices are reserved for future standardization.

16.2.1 ERASE(10) command

The ERASE(10) command (see table 300) requests that the target erase the specified number of blocks starting at the specified logical block address on the medium. As used here, erased means either the medium shall be erased, or a pattern shall be written on the medium that appears to the target as no data present. The blocks erased shall be considered blank for purposes of blank checking (see 16.1). The previous data recorded on the medium, if any, shall not be recoverable.

Table 300 - ERASE(10) command

Bit Byte	7	6	5	4	3	2	1	0
0	Operation code (2Ch)							
1	Logical unit number			Reserved		ERA	Reserved	RelAdr
2	(MSB) _____							
3	_____							
4	Logical block address							
5	_____ (LSB)							
6	Reserved							
7	(MSB) _____							
8	Transfer length							
9	_____ (LSB)							
9	Control							

The erase all (ERA) bit set to one indicates that all remaining blocks on the medium shall be erased. If the ERA bit is set to one and if the number of blocks is not zero, the target shall return CHECK CONDITION, and the sense key shall be set to ILLEGAL REQUEST, with an additional sense code of INVALID FIELD IN CDB.

See 9.2.2 for a description of the RelAdr bit and logical block address field.

The transfer length specifies the number of contiguous logical blocks that shall be erased when the ERA bit is zero. If the ERA bit is zero a transfer length of zero indicates that no blocks shall be erased. This condition shall not be considered an error and no data shall be erased. Any other value indicates the number of logical blocks that shall be erased.

This command shall be terminated with a status of RESERVATION CONFLICT if any reservation access conflict (see 9.2.12) exists and no data shall be erased.

NOTE 195 This command allows the user to separate the erase and write operations. This may increase system performance in certain applications.

ANSI X3.131-1994

16.2.2 ERASE(12) command

The ERASE(12) command (see table 301) requests that the target erase the specified number of blocks starting at the specified logical block address on the medium.

Table 301 - ERASE(12) command

Bit Byte	7	6	5	4	3	2	1	0
0	Operation code (ACh)							
1	Logical unit number			Reserved		ERA	Reserved	RelAdr
2	(MSB)							
3	Logical block address							
4								
5								
5								
6	(MSB)							
7	Transfer length							
8								
9								
10	Reserved							
11	Control							

See the ERASE(10) command (16.2.1) for a description of the fields in this command.

16.2.3 MEDIUM SCAN command

The MEDIUM SCAN command (see table 302) requests that the target scan the medium for a contiguous set of written or blank logical blocks.

Table 302 - MEDIUM SCAN command

Bit Byte	7	6	5	4	3	2	1	0
0	Operation code (38h)							
1	Logical unit number			WBS	ASA	RSD	PRA	RelAdr
2	(MSB)							
3	Logical block address							
4								
5								
5								
6	Reserved							
7	Reserved							
8	Parameter list length							
9	Control							

A written block search (WBS) bit of zero indicates that the scan is for blank blocks. A WBS bit of one indicates that the scan is for written blocks.

An advanced scan algorithm (ASA) bit of zero indicates that the scan area is scanned in sequential order (as selected by the RSD bit). An ASA bit of one indicates to the target that the written and blank areas within the scan area form contiguous extents (as opposed to scattered blocks). This indication is advisory to the target.

NOTE 196 The purpose of this bit is to allow the target to use a more advanced algorithm (such as a binary search) to locate the requested blocks.

A reverse scan direction (RSD) bit of zero indicates the scan shall begin with the first logical block of the scan area. A RSD bit of one indicates the scan shall begin with the last logical block of the scan area.

A partial results acceptable (PRA) bit of zero indicates that the scan shall not be considered satisfied until a contiguous set of blocks is found within the scan area that is at least equal in size to the number of blocks requested, and meets the other criteria specified in the command descriptor block. A PRA bit of one indicates that the scan may be satisfied by a contiguous set of blocks within the scan area that is less than the number of blocks requested, and meets the other criteria specified in the command descriptor block.

See 9.2.2 for a description of the RelAdr bit and logical block address field.

The parameter list length specifies the length in bytes of the parameter list that shall be transferred during the DATA OUT phase. A parameter list length of zero indicates that the number of blocks requested field has a value of one, and the number of blocks to scan field has a value of zero. This condition shall not be considered an error. The contents of the parameter list are specified in table 303.

Table 303 - MEDIUM SCAN parameter list

Bit Byte	7	6	5	4	3	2	1	0
0	(MSB)							
1	Number of blocks requested							
2								
3								
4	(MSB)							
5	Number of blocks to scan							
6								
7								

A link bit of zero indicates a non-linked command; if the scan is satisfied, the command shall be terminated with a CONDITION MET status. A REQUEST SENSE command can then be issued to determine the starting logical block address of the area that meets the request. If the scan is not satisfied and no error occurs, the command shall be terminated with GOOD status.

A link bit of one indicates that a command is linked to the MEDIUM SCAN command; if the search is satisfied, CONDITION MET status is returned and the next command is executed. If the RelAdr bit in the next command is one, the logical block address of the next command is used as a displacement from the logical block address at which the search was satisfied. If a linked scan is not satisfied, the command is terminated with a CHECK CONDITION status. A REQUEST SENSE command may then be issued.

A REQUEST SENSE command following a satisfied MEDIUM SCAN command shall:

ANSI X3.131-1994

- a) return a sense key of EQUAL if the scan was satisfied by a contiguous set of blocks equal in size to the number of blocks requested. If the PRA bis is one and the scan was satisfied by a contiguous set of blocks less than the number of blocks requested, then a sense key of NO SENSE shall be returned;
- b) return the valid bit set to one;
- c) return the logical block address of the first logical block of the contiguous set of blocks that satisfied the scan criteria in the information bytes;
- d) return the number of contiguous logical blocks meeting the scan criteria in the command specific information bytes.

A REQUEST SENSE command following an unsatisfied MEDIUM SCAN command shall:

- a) return a sense key of NO SENSE if no errors occurred during the command execution;
- b) return the valid bit set to zero.

The number of blocks requested field specifies the number of blocks that meet the specified requirements. The number of blocks requested field, if set to zero, indicates that the scan shall not take place. This shall not be considered an error condition.

The number of blocks to scan field specifies the length in blocks of the area to be scanned on the medium. The number of blocks to scan field, if set to zero, indicates that the scan shall continue for all remaining blocks on the medium or until the scan is satisfied. See 16.1.2 for a description of error reporting.

16.2.4 READ(12) command

The READ(12) command (see table 304) requests that the target transfer data to the initiator from the medium. See the READ(10) command (9.2.6) for a complete description of the fields in this command.

Table 304 - READ(12) command

Bit Byte	7	6	5	4	3	2	1	0
0	Operation code (A8h)							
1	Logical unit number			DPO	FUA	Reserved		RelAdr
2	(MSB)							
3	Logical block address							
4								
5								
6	(MSB)							
7	Transfer length							
8								
9								
10	Reserved							
11	Control							

16.2.5 READ DEFECT DATA(12) command

The READ DEFECT DATA(12) command (see table 305) requests that the target transfer the medium defect data to the initiator. See the READ DEFECT DATA(10) command (9.2.8) for a description of the fields in this command.

Table 305 - READ DEFECT DATA(12) command

Bit Byte	7	6	5	4	3	2	1	0	
0	Operation code (B7h)								
1	Logical unit number			Plist	Glist	Defect list format			
2	Reserved								
3	Reserved								
4	Reserved								
5	Reserved								
6	(MSB)								
7									
8	Allocation length								
9							(LSB)		
10	Reserved								
11	Control								

The READ DEFECT DATA(12) list header (see table 306) contains an eight byte header, followed by zero or more defect descriptors.

Table 306 - READ DEFECT DATA(12) list header

Bit Byte	7	6	5	4	3	2	1	0	
0	Reserved								
1	Reserved			Plist	Glist	Defect list format			
2	Reserved								
3	Reserved								
4	(MSB)								
5									
6	Defect list length								
7							(LSB)		
Defect descriptors									
0									
n									

ANSI X3.131-1994

See the description of the READ DEFECT DATA defect list (see 9.2.1.1) for a description of the fields in this header.

16.2.6 READ GENERATION command

The READ GENERATION command (see table 307) requests that the target transfer to the initiator the maximum generation address for the logical block specified.

Table 307 - READ GENERATION command

Bit Byte	7	6	5	4	3	2	1	0
0	Operation code (29h)							
1	Logical unit number			Reserved				RelAdr
2	(MSB)							
3	Logical block address							
4								
5								
6	Reserved							
7	Reserved							
8	Allocation length							
9	Control							

See 9.2.2 for a description of the RelAdr bit and logical block address field.

The READ GENERATION data is defined in table 308.

Table 308 - Maximum generation data block

Bit Byte	7	6	5	4	3	2	1	0
0	(MSB)							
1	Maximum generation address							(LSB)
2	Reserved							
3	Reserved							

The maximum generation address field defines the maximum generation address available for the logical block address specified.

16.2.7 READ UPDATED BLOCK(10) command

The READ UPDATED BLOCK(10) command (see table 309) requests that the target transfer data to the initiator from the specified generation and logical block.

Table 309 - READ UPDATED BLOCK(10) command

Bit Byte	7	6	5	4	3	2	1	0
0	Operation code (2Dh)							
1	Logical unit number			DPO	FUA	Reserved		RelAdr
2	(MSB)							
3	Logical block address							
4								
5								
6	Latest	(MSB)						
7	Generation address							(LSB)
8	Reserved							
9	Control							

See 9.2.6 for a description of the cache control bits (DPO and FUA). See 9.2.2 for a description of the RelAdr bit and logical block address field.

One block of data is transferred during the DATA IN phase.

The latest bit determines the meaning of the generation address field. A latest bit of zero indicates that the generation address is specified relative to the first generation of the block; generation address zero specifies the first generation. Increasing generation addresses specify later generations.

A latest bit of one indicates that the generation address is specified relative to the latest generation of the block; generation address zero specifies the most recent generation. Increasing generation addresses specify earlier generations.

If the requested generation does not exist, the command shall be terminated with CHECK CONDITION status. The sense key shall be set to BLANK CHECK, and the additional sense code shall be set to GENERATION DOES NOT EXIST.

This command shall be terminated with a status of RESERVATION CONFLICT if any reservation access conflict (see 9.2.12) exists and no data shall be transferred.

ANSI X3.131-1994

16.2.8 SEARCH DATA(12) commands

The SEARCH DATA(12) commands (see table 310) search one or more logical blocks for equality or inequality to a data pattern. See the SEARCH DATA(10) commands (9.2.14) for a description of the fields in this command.

Table 310 - SEARCH DATA(12) commands

Bit Byte	7	6	5	4	3	2	1	0
0	Operation code (B0h, B1h, B2h)							
1	Logical unit number			Invert	Reserved		SpnDat	RelAdr
2	(MSB)							
3	Logical block address							
4								
5								
6	(MSB)							
7	Transfer length							
8								
9								
10	Reserved							
11	Control							

16.2.9 SET LIMITS(12) command

The SET LIMITS(12) command (see table 311) defines the range within which subsequent linked commands may operate. See the SET LIMITS(10) command (9.2.16) for a description of the fields in this command.

Table 311 - SET LIMITS(12) command

Bit Byte	7	6	5	4	3	2	1	0
0	Operation code (B3h)							
1	Logical unit number			Reserved			RdInh	WrInh
2	(MSB)							
3	Logical block address							
4								
5								
5								
6	(MSB)							
7	Number of blocks							
8								
9								
10	Reserved							
11	Control							

16.2.10 UPDATE BLOCK command

The UPDATE BLOCK command (see table 312) requests that the target logically replace data on the medium with the data sent during the DATA OUT phase.

Table 312 - UPDATE BLOCK command

Bit Byte	7	6	5	4	3	2	1	0
0	Operation code (3Dh)							
1	Logical unit number			Reserved			RelAdr	
2	(MSB)							
3	Logical block address							
4								
5								
5								
6	Reserved							
7	Reserved							
8	Reserved							
9	Control							

See 9.2.2 for a description of the RelAdr bit and logical block address field.

One block of data is transferred during the DATA OUT phase.

ANSI X3.131-1994

NOTE 197 See the MODE Parameters (16.3) for a description of the behaviour of the UPDATE BLOCK command relative to the enable blank check (EBC) bit.

This standard does not define the result of a WRITE command issued to a block previously updated by an UPDATE BLOCK command when blank checking is disabled.

NOTE 198 It is recommended that the target inhibit this behaviour.

A logical block may be updated until the alternate block area is exhausted. The alternate blocks used for the update operation shall not be reported in the READ CAPACITY data. If the alternate block area is exhausted, the command shall be terminated with CHECK CONDITION and the sense key shall be set to MEDIUM ERROR, and the additional sense code set to NO DEFECT SPARE LOCATION AVAILABLE.

If the report updated block read parameter specifies posting of recovered errors for a read operation of a logical block that has had a successful update operation performed, occurs the command shall terminate with a CHECK CONDITION status. The sense key shall be set to RECOVERED ERROR and the additional sense code set to UPDATED BLOCK READ.

16.2.11 VERIFY(10) command

The VERIFY command (see table 313) requests that the target verify the data on the medium.

Table 313 - VERIFY command

Bit Byte	7	6	5	4	3	2	1	0
0	Operation code (2Fh)							
1	Logical unit number			DPO	Reserved	BlkVfy	BytChk	RelAdr
2	(MSB)							
3	Logical block address							
4								
5								
6	Reserved							
7	(MSB)							
8	Verification length							
9	(LSB)							
9	Control							

If the MODE SELECT command is implemented, and the Verify Error Recovery Parameters page is also implemented, then the current settings in that page define the verification criteria. If the Verify Error Recovery Parameters page is not implemented, then the verification criteria is vendor unique.

A byte check (BytChk) bit of zero causes a medium verification to be performed with no data comparison. A BytChk bit of one causes a byte-by-byte compare of the data written on the medium and the data transferred from the initiator. The data shall be transferred as it would be for a WRITE command. If the compare is unsuccessful, for any reason, the target shall return CHECK CONDITION status and the sense key shall be set to MISCOMPARE.

A blank verify (BlkVfy) bit of one causes a verification that the blocks are blank.

If the BytChk is one when the BlkVfy bit is one, this shall be considered an error. The target shall return CHECK CONDITION status and the sense key shall be set to ILLEGAL REQUEST, and the additional sense code set to INVALID FIELD IN CDB.

See 9.2.6 for a description of the cache control bits (DPO). See 9.2.2 for a description of the RelAdr bit and logical block address field.

The verification length specifies the number of contiguous logical blocks of data or blanks that shall be verified. A verification length of zero indicates that no logical blocks shall be verified. This condition shall not be considered as an error. Any other value indicates the number of logical blocks that shall be verified.

16.2.12 VERIFY(12) command

The VERIFY(12) command (see table 314) requests that the target verify the data on the medium. See the VERIFY(10) command (16.2.11) for a description of the fields in this command.

Table 314 - VERIFY(12) command

Bit Byte	7	6	5	4	3	2	1	0
0	Operation code (AFh)							
1	Logical unit number			DPO	Reserved	BlkVfy	BytChk	RelAdr
2	(MSB)							
3	Logical block address							
4								
5								
6	(MSB)							
7	Verification length							
8								
9								
10	Reserved							
11	Control							

ANSI X3.131-1994

16.2.13 WRITE(10) command

The WRITE(10) command (see table 315) requests that the target write the data transferred from the initiator to the medium.

Table 315 - WRITE(10) command

Bit Byte	7	6	5	4	3	2	1	0
0	Operation code (2Ah)							
1	Logical unit number			DPO	FUA	EBP	Reserved	RelAdr
2	(MSB)							
3	Logical block address							
4								
5								
6	Reserved							
7	(MSB)							
8	Transfer length							
	(LSB)							
9	Control							

An erase by-pass (EBP) bit of zero indicates that the device will default to the normal write operation. An EBP bit of one indicates that the target is allowed to by-pass the erase operation prior to writing the data. When accessing write-once media, the EBP bit shall be considered reserved.

See 9.2.6 for a description of the cache control bits (DPO and FUA). See 9.2.2 for a description of the RelAdr bit and logical block address field.

The transfer length specifies the number of contiguous logical blocks of data that shall be transferred. A transfer length of zero indicates that no data shall be transferred. This condition shall not be considered an error and no data shall be written. Any other value indicates the number of logical blocks that shall be transferred.

This command shall be terminated with a status of RESERVATION CONFLICT if any reservation access conflict (see 9.2.12) exists, and no data shall be written.

16.2.14 WRITE(12) command

The WRITE(12) command (see table 316) requests that the target write the data transferred from the initiator to the medium. See the WRITE(10) command (16.2.13) for a description of the fields in this command.

Table 316 - WRITE(12) command

Bit Byte	7	6	5	4	3	2	1	0
0	Operation code (AAh)							
1	Logical unit number			DPO	FUA	EBP	Reserved	RelAdr
2	(MSB)							
3	Logical block address							
4								
5								
6	(MSB)							
7	Transfer length							
8								
9								
10	Reserved							
11	Control							

16.2.15 WRITE AND VERIFY(10) command

The WRITE AND VERIFY(10) command (see table 317) requests that the target write the data transferred from the initiator to the medium and then verify that the data is correctly written.

Table 317 - WRITE AND VERIFY(10) command

Bit Byte	7	6	5	4	3	2	1	0
0	Operation code (2Eh)							
1	Logical unit number			DPO	Reserved	EBP	BytChk	RelAdr
2	(MSB)							
3	Logical block address							
4								
5								
6	Reserved							
7	(MSB)							
8	Transfer length							
9								
9	Control							

ANSI X3.131-1994

If the MODE SELECT command is implemented, and the Verify Error Recovery Parameters page is also implemented, then the current settings in that page define the verification criteria. If the Verify Error Recovery Parameters page is not implemented, then the verification criteria is vendor unique.

A byte check (BytChk) bit of zero causes a medium verification to be performed with no data comparison. A BytChk bit of one causes a byte-by-byte compare of the data written on the medium and the data transferred from the initiator. The data shall be transferred as it would be for a WRITE command. If the compare is unsuccessful, for any reason, the target shall return CHECK CONDITION status and the sense key shall be set to MISCOMPARE.

An erase by-pass (EBP) bit of zero indicates that the device will default to the normal write operation. An EBP bit of one indicates that the target is allowed to by-pass the erase operation prior to writing the data. When accessing write-once media, the EBP bit shall be considered reserved.

See 9.2.6 for a description of the cache control bits (DPO). See 9.2.2 for a description of the RelAdr bit and logical block address field.

The transfer length specifies the number of contiguous logical blocks of data that shall be transferred. A transfer length of zero indicates that no logical blocks shall be transferred. This condition shall not be considered as an error and no data shall be written. Any other value indicates the number of logical blocks that shall be transferred.

16.2.16 WRITE AND VERIFY(12) command

The WRITE AND VERIFY(12) command (see table 318) requests that the target write the data transferred from the initiator to the medium and then verify that the data is correctly written. See the WRITE AND VERIFY(10) command (16.2.15) for a description of the bits in this command.

Table 318 - WRITE AND VERIFY(12) command

Bit Byte	7	6	5	4	3	2	1	0
0	Operation code (AEh)							
1	Logical unit number			DPO	Reserved	EBP	BytChk	RelAdr
2	(MSB)							
3	Logical block address							
4								
5								
6	(MSB)							
7	Transfer length							
8								
9								
10	Reserved							
11	Control							

16.3 Parameters for optical memory devices

16.3.1 Diagnostic parameters

This subclause defines the descriptors and pages for diagnostic parameters used with optical memory devices.

The diagnostic page codes for optical memory devices are defined in table 319.

Table 319 - Diagnostic page codes

Page code	Description	Subclause
00h	List of supported parameters page	8.3.1.1
01h - 3Fh	Reserved (for all device type pages)	
40h	Translate address page	9.3.1
41h - 7Fh	Reserved	
80h - FFh	Vendor-specific pages	

16.3.2 Log parameters

This subclause defines the descriptors and pages for log parameters used with optical memory devices.

The log page codes for optical memory devices are defined in table 320.

Table 320 - Log page codes

Page code	Description	Subclause
01h	Buffer over-run/under-run page	8.3.2.1
03h	Error counter page (read) page	8.3.2.2
05h	Error counter page (verify) page	8.3.2.2
02h	Error counter page (write) page	8.3.2.2
07h	Last n error events page	8.3.2.3
00h	List of supported parameters page	8.3.2.5
06h	Non-media error page	8.3.2.4
04h	Reserved	
08h - 2Fh	Reserved	
30h - 3Eh	Vendor-specific	
3Fh	Reserved	

16.3.3 Mode parameters

This subclause defines the descriptors and pages for mode parameters used with optical memory devices.

The mode parameter list, including the mode parameter header and mode block descriptor, are defined in 8.3.3.

The medium-type code field is contained in the mode parameter header (see 8.3.3). Table 321 defines the medium-type code values used for optical memory devices.

Table 321 - Optical memory medium-type codes

Code	Description
00h	Default (only one medium type supported)
01h	Optical read-only medium
02h	Optical write-once medium
03h	Optical reversible or erasable medium
04h	Combination of read-only and write-once medium
05h	Combination of read-only and reversible or erasable medium
06h	Combination of write-once and reversible or erasable medium
07h - 7Fh	RESERVED
80h - FFh	Vendor-specific

The device specific parameter field is contained in the mode parameter header (see 8.3.3). Table 322 defines the device specific parameter values used for optical memory devices.

Table 322 - Optical memory device specific parameter

Bit	7	6	5	4	3	2	1	0
	WP	Reserved		DPOFUA	Reserved			EBC

When used with the MODE SELECT command the WP bit is not defined.

When used with the MODE SENSE command, a write protected (WP) bit of zero indicates that the medium is write enabled. A WP bit of one indicates that the medium is write protected. For read-only media the WP bit is reserved.

When used with the MODE SELECT command the DPOFUA bit is reserved.

When used with the MODE SENSE command, a DPOFUA bit of one indicates that the target supports the DPO and FUA bits (see 9.2.6).

For the MODE SELECT command, an enable blank check (EBC) bit of zero advises the target to disable the blank checking operation of the medium during write operations or during an UPDATE BLOCK command. An EBC bit of one enables blank checking. If a non-blank block is found during a write operation, the command shall be terminated with a CHECK CONDITION status and the sense key shall be set to BLANK CHECK. If a blank block is found during an UPDATE BLOCK command, the command shall be terminated with a CHECK CONDITION status, and the sense key shall be set to BLANK CHECK. For read-only media, the EBC bit is reserved.

For the MODE SENSE command, an enable blank check (EBC) bit of zero indicates that blank checking of the medium during write operations is disabled. An EBC bit of one indicates that blank checking during write and update operations is enabled. For read-only media, the EBC bit is reserved.

The density code field is contained in the mode parameter block descriptor (see 8.3.3). Table 323 defines the density code values used for optical memory devices.

Table 323 - Optical memory density codes

Density code	Optical media							
00h	Default density (currently mounted density)							
	Diameter mm (in)	Type	Sector size	Tracks	Sides	Servo	Reference standard	Notes
01h	86 (3,5)	R/W	512/1 024	12 500	1		660-D	1
02h	89 (3,5)	R/W	512/1 024	12 500	2		581-D	1
03h	130 (5,25)	R/W	512/1 024	18 750	2	CS	607-I	1
04h	130 (5,25)	W-0	512/1 024	30 000	2	SS	655-D	1,2
05h	130 (5,25)	W-0	512/1 024	20 000	2	SS	659-D	1,3
06h	130 (5,25)	W-0	512/1 024	18 750	2	CS	457-D	1
07h	200 (8,0)						407-D	1,4
08h	300 (12,0)		1 024		2		408-D	1,4
09h	356 (14,0)		1 024	56 350	2		456-D	1
Codes 80h - FFh are vendor-specific, all other codes are reserved								
Key:	<u>Type</u>	<u>Description</u>		<u>Servo</u>	<u>Description</u>			
	R/W	Erasable		CS	Continuous servo			
	W-0	Write once		SS	Sampled servo			
	R/O	Read only						
NOTES								
1 The reference standard refers to an ANSI X3B11 project under development. The project may have several documents describing different aspects of the media. Please contact the Secretariat for current information on status and availability.								
2 RZ modulation.								
3 4/15 modulation.								
4 This project is not presently active.								

The mode page codes for optical memory devices are shown in table 324.

Table 324 - Mode page codes

Page code	Description	Subclause
08h	Caching page	9.3.3.1
0Ah	Control mode page	8.5.3.1
02h	Disconnect-reconnect page	8.3.3.2
0Bh	Medium types supported page	9.3.3.4
06h	Optical memory page	16.3.3.1
09h	Peripheral device page	8.3.3.3
01h	Read-write error recovery page	9.3.3.6
07h	Verify error recovery page	9.3.3.8
03h - 05h	Reserved	
0Ch - 1Fh	Reserved	
00h	Vendor-specific (does not require page format)	
20h - 3Eh	Vendor-specific (page format required)	
3Fh	Return all pages (valid only for the MODE SENSE command)	

16.3.3.1 Optical memory page

The optical memory page (see table 325) defines parameters for control of optical memory devices.

Table 325 - Optical memory page

Bit Byte	7	6	5	4	3	2	1	0
0	PS	Reserved	Page code (06h)					
1	Parameter length (02h)							
2	Reserved							RUBR
3	Reserved							

The parameter savable (PS) bit is only used with the MODE SENSE command. This bit is reserved with the MODE SELECT command. A PS bit of one indicates that the target is capable of saving the page in a non-volatile, vendor-specific location.

A report updated block read (RUBR) bit of zero indicates the target shall not report an error when a command performs a successful read of a block that has been updated. A RUBR bit of one indicates the target shall terminate a command that performs a read of a block that has been updated with CHECK CONDITION status, the sense key set to RECOVERED ERROR, the additional sense code set to UPDATED BLOCK READ, and the data shall be transferred to the initiator. The default state of the RUBR bit for write-once devices (as reported in the INQUIRY command) shall be one.

16.4 Definitions specific to write-once and optical memory devices

16.4.1 blank: The logical block contains no information detectable by the target, or is written with a pattern that appears to the target as no data present. The logical block is considered ready for a write operation.

16.4.2 generation: Indicates a relative revision level of a logical block that has been updated via the UPDATE BLOCK command. A logical block that has never been updated has only one generation associated with it.

16.4.3 read-only medium: This is medium that may not be written by the initiator. The media contains data prepared in a manner not defined by this standard.

16.4.4 update: To write new data to a logical block without destroying the previous data. After a block has been updated, a normal read returns the most recent generation of the data. Earlier generations are still available after the update.

16.4.5 write-once medium: This is medium that may be written only once by the initiator. Logical blocks on write-once media that have not been written are considered blank. Logical blocks on write-once media that have been written may not be written again.

17 Medium-changer devices

17.1 Medium-changer device model

Medium changer devices mechanize the movement of media to and from primary devices (such as disk or tape drives) and other locations within the range of the medium changer. The medium changer command set is based on a physical model of this functionality.

This command set supports varied physical implementations of the medium changer function. Most of these variations are hidden from the initiator by the high level of function provided by the MOVE MEDIUM and EXCHANGE MEDIUM commands and by the generalized nature of the element addressing scheme. However, initiators may need to be aware of the capabilities of the particular medium changer device. These characteristics and capabilities are conveyed via MODE SENSE pages.

17.1.1 Medium-changer elements

The medium-changer command set uses as its address space the set of physical locations and mechanisms within the scope of a medium changer device. The term element is used throughout this clause to refer to one member of the medium changer address space. Each element is a discrete physical entity that may hold zero or one physical unit of media - one disk cartridge, one spool of tape, etc. Element addresses do not extend across multiple physical units of media. Likewise, element addresses are independent of any logical partitioning that the primary device may support within a physical unit of media.

A medium changer is viewed as a set of addressable elements, each of which may contain a unit of media or be used to move a unit of media. Each medium changer element has a unique 16 bit element address. Each element is an instance of one of four classes or element types.

- a) MEDIUM TRANSPORT ELEMENT
- b) STORAGE ELEMENT
- c) IMPORT EXPORT ELEMENT
- d) DATA TRANSFER ELEMENT

Units of media (cartridges, cassettes, caddies, etc.) are referred to only indirectly by this device model. Units of media can be moved to or from any of the elements of the medium changer device. The presence of media at the various elements in a medium changer can be sensed. In order to ensure exclusive access to a unit of media, the element where the unit of media is located (the element address) must be reserved.

Elements of the medium transport, import export and (rarely) data transport types may not provide independent storage for medium. The capabilities of a particular medium changer in this respect can be sensed via the device capabilities page of the mode sense data. The following hypothetical medium changer implementation illustrates one case of an element not providing independent storage for medium. Consider a medium changer which has a carousel style storage for medium. The import export function could be provided by a port which allows operator access to one of the storage elements. In such a device, the MOVE ELEMENT command from storage element to import export element would rotate the carousel to align the addressed storage element to the import export position. In this case the import export element does not provide independent storage but rather access to one of the storage elements.

17.1.1.1 Medium transport elements

Medium transport elements address the functions of the medium changer device that perform the movement of units of media. Where a medium transport element can serve (even temporarily) as a storage location for medium, the location of each unit of media must have a separate element address.

ANSI X3.131-1994

In larger medium changer devices, the medium movement functions may be performed by multiple independent robotics subsystems. Each of these may have a number of medium transport element addresses. The element addresses within each subsystem shall be contiguous. Any of the element addresses within a subsystem may be used interchangeably in the medium transport element address field of MOVE MEDIUM and EXCHANGE MEDIUM commands. An initiator may determine the capabilities of the medium movement facilities of a medium changer device via the transport geometry MODE SENSE page, see 17.3.3.3.

Element address zero is reserved for use in the medium transport element address field of MOVE MEDIUM and EXCHANGE MEDIUM commands to direct the medium changer to use a default or medium changer selected medium transport element.

In some implementations, medium transport elements may be source and/or destination addresses in MOVE MEDIUM and EXCHANGE MEDIUM commands. They may or may not provide independent storage of a unit of media. See the device capabilities MODE SENSE page, see 17.3.3.1.

17.1.1.2 Storage elements

Storage elements are locations of units of media while not in some other element type. Medium in storage elements is available for access by medium transport elements.

Storage elements may be source and/or destination addresses in MOVE MEDIUM and EXCHANGE MEDIUM commands.

17.1.1.3 Import export elements

Import export elements are locations of units of media which are being inserted into or withdrawn from the medium changer device. Medium in these elements is accessible by both medium transport elements, by the operator, or by another independent medium changer device.

Import export elements may be source and/or destination addresses in MOVE MEDIUM and EXCHANGE MEDIUM commands. They may or may not provide independent storage of a unit of media, see the device capabilities MODE SENSE page, see 17.3.3.

Particular import export elements may be capable of either import actions, export actions, both or neither (if an element is not present).

17.1.1.4 Data transfer element

Data transfer elements are locations of the primary devices which are capable of reading or writing the medium. Data transfer elements may also be viewed as medium changer element addresses of units of media loaded in or available for loading in or removal from primary devices such as disk or tape drives. Note that the medium changer function specified in this clause does not control the primary device. That is the responsibility of the system.

Data transfer elements may be source and/or destination addresses in MOVE MEDIUM and EXCHANGE MEDIUM commands. They may or may not provide independent storage of a unit of media, see the device capabilities MODE SENSE page, see 17.3.3.

17.1.2 SCSI addressing of medium changer devices

Medium changer devices respond to a SCSI ID / LUN address different from those used by the data transfer element devices. If the data transfer elements served by the medium changer device are SCSI devices, they may be addressed though the same SCSI ID as the changer device but with a different logical unit number or through a different SCSI ID. There is no requirement that communication with the data transfer elements be done with the same SCSI bus as the medium changer device or by an SCSI interface at all. This command set does not

support addressing both the changer and the data transfer elements with the same SCSI ID / LUN because the device at a particular SCSI ID / LUN address must have a single peripheral device type.

The READ ELEMENT STATUS response page for data transfer elements provides the SCSI ID / LUN address of the primary devices serviced by a medium changer device if known to the medium changer device.

17.1.3 Data access operations using a medium changer device

The medium changer device moves units of media among the several elements accessible to it. It is able to report the full/empty status of any of these elements. Data transfer elements represent the interface between the medium changer device and some primary device such as a removable media optical disk drive or tape drive.

In order to access data on a unit of media currently located in a medium changer storage element, a system will have to issue commands to both the medium changer device and to the primary device. The commands to the medium changer may include MOVE MEDIUM or EXCHANGE MEDIUM plus READ ELEMENT STATUS commands. The commands to the primary device may include TEST UNIT READY, INQUIRY, START STOP and LOAD UNLOAD commands in addition to READ and WRITE commands.

17.1.4 Element status maintenance requirements

If the medium changer device chooses to implement the READ ELEMENT STATUS command, the medium changer device must be capable of reporting the various data (i.e. full, error, etc.) required by each page type. The medium changer may maintain this information at all times or regenerate it in response to the READ ELEMENT STATUS command. The INITIALIZE ELEMENT STATUS command can be used to force regeneration of this information.

17.1.5 Volume tags

The read element status descriptor format for all element types includes two sets of fields that contain volume tag information. These optional fields are used to report media identification information that the medium changer has acquired either by reading an external label (e.g. bar code labels), by a SEND VOLUME TAG command or by other means which may be vendor unique. The same volume tag information shall be available to all initiators whether assigned by that initiator, by some other initiator or by the media changer itself.

Volume tag information provides a means to confirm the identity of a unit of media that resides in a medium changer element. This command set does not define any direct addressing of units of media based on these fields. However, commands are defined that provide translation between volume tag information and the element address where that unit of media currently resides.

The medium changer command set definition does not impose the requirement that volume tag information be unique over the units of media within the scope of the changer device.

The following commands support the optional volume tag functionality:

- a) SEND VOLUME TAG - either as a translation request or to associate a volume tag with the unit of media currently residing at an element address.
- b) REQUEST VOLUME ELEMENT ADDRESS - return the element address currently associated with the volume tag information transferred with the last send volume tag command.
- c) READ ELEMENT STATUS - optionally reports volume tag information for all element types.
- d) MOVE MEDIUM and EXCHANGE MEDIUM commands - if volume tags are implemented, these commands must retain the association between volume tag information and units of media as they are moved from element to element.

ANSI X3.131-1994

17.1.5.1 Volume tag format

Volume tag information consists of a volume identifier field of 32 bytes plus a volume sequence number field of 2 bytes. The volume identifier shall consist of a left justified sequence of ASCII characters. Unused positions shall be blank (20h) filled. In order for the SEND VOLUME TAG translate with template to work the characters '*' and '?' (2Ah and 3Fh) must not appear in volume identification data and there must be no blanks (20h) within the significant part of the volume identifier. If volume tag information for a particular element is undefined, the volume identifier field shall be zero.

The volume sequence number is a 2 byte integer field. If the volume sequence number is not used this field shall be zero. The volume tag contents are independent of the volume identification information recorded on the media.

NOTE 199 For compatibility with the volume identifier defined by volume and file structure standards, it is recommended that the characters in the significant non-blank portion of the volume identifier field be restricted to the set: '0'..'9', 'A'..'Z', and '_' (30h .. 39h, 41h .. 5Ah, 5Fh). Specific systems may have differing requirements that may take precedence over this recommendation.

Table 326 defines the fields within the 36 byte primary and alternate volume tag information fields found in READ ELEMENT STATUS descriptors and in the data format for the SEND VOLUME TAG command.

Table 326 - Volume tag information format

Bit Byte	7	6	5	4	3	2	1	0
0	Volume identification field							
31								
32	Reserved							
33								
34	(MSB)	Volume sequence number						
35								(LSB)

17.1.5.2 Primary and alternate volume tag information

Element status descriptors as reported by the READ ELEMENT STATUS command define a primary volume tag and an alternate volume tag. Alternate volume tag information provides a means for a system to use different volume identification information for each side of double sided media. In such a system, the primary volume tag information refers to the logical medium accessible via a MOVE MEDIUM command without the invert bit set. The alternate volume tag information refers to the other side of the media, i.e. the side that would be accessed via a MOVE MEDIUM command with the invert bit set.

17.2 Commands for medium changer devices

The commands for medium changer devices shall be as shown in table 327.

Table 327 - Commands for medium changer devices

Command name	Operation code	Type	Subclause
CHANGE DEFINITION	40h	O	8.2.1
EXCHANGE MEDIUM	A6h	O	17.2.1
INITIALIZE ELEMENT STATUS	07h	O	17.2.2
INQUIRY	12h	M	8.2.5
LOG SELECT	4Ch	O	8.2.6
LOG SENSE	4Dh	O	8.2.7
MODE SELECT(6)	15h	O	8.2.8
MODE SELECT(10)	55h	O	8.2.9
MODE SENSE(6)	1Ah	O	8.2.10
MODE SENSE(10)	5Ah	O	8.2.11
MOVE MEDIUM	A5h	M	17.2.3
POSITION TO ELEMENT	2Bh	O	17.2.4
PREVENT ALLOW MEDIUM REMOVAL	1Eh	O	9.2.4
READ BUFFER	3Ch	O	8.2.12
READ ELEMENT STATUS	B8h	O	17.2.5
RECEIVE DIAGNOSTIC RESULTS	1Ch	O	8.2.13
RELEASE	17h	O	17.2.6
REQUEST VOLUME ELEMENT ADDRESS	B5h	O	17.2.7
REQUEST SENSE	03h	M	8.2.14
RESERVE	16h	O	17.2.8
REZERO UNIT	01h	O	9.2.13
SEND DIAGNOSTIC	1Dh	M	8.2.15
SEND VOLUME TAG	B6h	O	17.2.9
TEST UNIT READY	00h	M	8.2.16
WRITE BUFFER	3Bh	O	8.2.17

Key: M = command implementation is mandatory.
O = command implementation is optional.

Operation codes 0Ch, and C0h through FFh are vendor-specific. All other operation codes are reserved.

ANSI X3.131-1994

17.2.1 EXCHANGE MEDIUM command

The EXCHANGE MEDIUM command (see table 328) provides a means to exchange the medium in the source element, with the medium located at a destination element.

Table 328 - EXCHANGE MEDIUM command

Bit Byte	7	6	5	4	3	2	1	0
0	Operation code (A6h)							
1	Logical unit number			Reserved				
2	(MSB) Transport element address							
3	(LSB)							
4	(MSB) Source address							
5	(LSB)							
6	(MSB) First destination address							
7	(LSB)							
8	(MSB) Second destination address							
9	(LSB)							
10	Reserved					Inv2		Inv1
11	Control							

NOTE 200 Support of this command requires that the device have the capability of handling two units of media at the same time or that it emulate this capability.

The medium in the source element is moved to the first destination element and the medium that previously occupied the first destination element is moved to the second destination element. The second destination element may or may not be the same element as the source element. In the case of a simple exchange, the source element and the second destination element are the same.

If this command is received and the source element is empty or the first destination element is empty, or the second destination element (if different from the source element) is full, or the second destination element (if the same as the source element) is empty, the target shall return CHECK CONDITION status and set the sense key to ILLEGAL REQUEST.

The transport element address specifies the medium transport element that is to be used in executing this command. The default transport element address of zero may be used if this functionality is supported by the medium changer device. If the transport element address specified has not been assigned or has been assigned to an element other than a medium transport element, the target shall return CHECK CONDITION status and the set the sense key to ILLEGAL REQUEST.

The source address, the first destination address, and the second destination address may represent a storage element, an import export element, a data transfer element, or a medium transport element. If the address specified has not been assigned to a specific element of the medium changer, the target shall return CHECK CONDITION status and set the sense key to ILLEGAL REQUEST.

The device capabilities page (see 17.3.3.) provides a matrix which defines the supported source element type and first destination element type combinations for EXCHANGE MEDIUM commands when the source element type is the same as second destination element type.

An Inv1 bit of one specifies that the medium shall be inverted prior to depositing the medium into the first destination element.

An Inv2 bit of one specifies that the medium shall be inverted prior to depositing the medium into the second destination element.

If the medium changer does not support medium rotation for handling double sided media, the Inv1 and Inv2 bits should be set to zero. If either of these bits is non-zero, a target which is not capable of medium rotation shall return CHECK CONDITION status and set the sense key to ILLEGAL REQUEST.

17.2.2 INITIALIZE ELEMENT STATUS command

The INITIALIZE ELEMENT STATUS command (see table 329) will cause the medium changer to check all elements for medium and any other status relevant to that element. The intent of this command is to enable the initiator to get a quick response from a following READ ELEMENT STATUS command. It may be useful to issue this command after a power failure, or if medium has been changed by an operator, or if configurations have been changed.

Table 329 - INITIALIZE ELEMENT STATUS command

Bit Byte	7	6	5	4	3	2	1	0
0	Operation code (07h)							
1	Logical unit number			Reserved				
2	Reserved							
3	Reserved							
4	Reserved							
5	Control							

ANSI X3.131-1994

17.2.3 MOVE MEDIUM command

The MOVE MEDIUM command (see table 330) requests that the target move a unit of media from a source element to a destination element.

Table 330 - MOVE MEDIUM command

Bit Byte	7	6	5	4	3	2	1	0
0	Operation code (A5h)							
1	Logical unit number			Reserved				
2	(MSB) Transport element address							
3	(LSB)							
4	(MSB) Source address							
5	(LSB)							
6	(MSB) Destination address							
7	(LSB)							
8	Reserved							
9	Reserved							
10	Reserved							Invert
11	Control							

The source address specifies the location that the medium is taken from, and the destination address specifies the location that the medium is moved to.

If this command is received and the source element is empty or the destination element (if different from the source element) is full, the target shall return CHECK CONDITION status and set the sense key to ILLEGAL REQUEST.

The transport element address specifies the medium transport element that is to be used in executing this command. The default medium transport element address of zero may be used if this functionality is supported by the medium changer device. If the address specified has not been assigned or has been assigned to an element other than a medium transport element, the target shall return CHECK CONDITION status and the set the sense key to ILLEGAL REQUEST.

The source address and the destination address may represent a storage element, an import export element, a data transfer element, or a medium transport element. If the address specified has not been assigned to a specific element of the medium changer, the target shall return CHECK CONDITION status and set the sense key to ILLEGAL REQUEST.

The device capabilities MODE SENSE page provides a matrix with the supported source element or destination element combinations for the MOVE MEDIUM command. See 17.3.3.1

An invert bit of one specifies that the medium shall be inverted or rotated prior to depositing the medium into the destination element. If the medium changer does not support medium rotation for handling double sided media, the invert bit should be set to zero. If this bit is non-zero, a target that is not capable of medium rotation shall return CHECK CONDITION status and set the sense key to ILLEGAL REQUEST.

17.2.4 POSITION TO ELEMENT command

The POSITION TO ELEMENT command (see table 331) will position the transport element specified in front of the destination element specified.

Table 331 - POSITION TO ELEMENT command

Bit Byte	7	6	5	4	3	2	1	0
0	Operation code (2Bh)							
1	Logical unit number			Reserved				
2	(MSB) Transport element address							
3	(LSB)							
4	(MSB) Destination element address							
5	(LSB)							
6	Reserved							
7	Reserved							
8	Reserved							Invert
9	Control							

NOTE 201 In this context, in front of is defined to mean positioned so that no further motion of the medium transport element is necessary to execute an appropriate MOVE MEDIUM command between the two elements.

An invert bit value of one requests that the transport element be inverted or rotated before positioning in front of the destination element. A value of zero requests that the orientation be unchanged before positioning in front of the destination element.

ANSI X3.131-1994

17.2.5 READ ELEMENT STATUS command

The READ ELEMENT STATUS command (see table 332) requests that the target report the status of its internal elements to the initiator.

Table 332 - READ ELEMENT STATUS command

Bit Byte	7	6	5	4	3	2	1	0
0	Operation code (B8h)							
1	Logical unit number			VolTag	Element type code			
2	(MSB) Starting element address							
3	(LSB)							
4	(MSB) Number of elements							
5	(LSB)							
6	Reserved							
7	(MSB) Allocation length							
8	(LSB)							
9	Reserved							
10	Control							
11								

A volume tag (VolTag) bit of one indicates that the target shall report volume tag information if this feature is supported. A value of zero indicates that volume tag information shall not be reported. If the volume tag feature is not supported this field shall be treated as reserved.

The element type code field specifies the particular element type(s) selected for reporting by this command. A value of zero specifies that status for all element types shall be reported. The element type codes are defined in table 333.

Table 333 - Element type code

Code	Description
0h	All element types reported, (valid in CDB only)
1h	Medium transport element
2h	Storage element
3h	Import export element
4h	Data transfer element
5h - Fh	Reserved

The starting element address specifies the minimum element address to report. Only elements with an element type code permitted by the element type code specification, and an element address greater than or equal to the starting element address shall be reported. Element descriptor blocks are not generated for undefined element addresses.

The number of elements specifies the maximum number of element descriptors to be created by the target for this command. The value specified by this field is not the range of element addresses to be considered for reporting but rather the number of defined elements to report. If the allocation length is not sufficient to transfer all

the element descriptors, the target shall transfer all those descriptors that can be completely transferred and this shall not be considered an error.

17.2.5.1 Element status data

The data returned by the READ ELEMENT STATUS command is defined in table 334 and 17.2.5.3 through 17.2.5.6. Element status data consists of an eight-byte header, (see table 334) followed by one or more element status pages.

Table 334 - Element status data

Bit Byte	7	6	5	4	3	2	1	0
0	(MSB) First element address reported							
1	(LSB)							
2	(MSB) Number of elements available							
3	(LSB)							
4	Reserved							
5	(MSB) Byte count of report available							
6	(all pages, n - 7)							
7	(LSB)							
8	Element status page(s)							
n								

The first element address reported field indicates the element address of the element with the smallest element address found to meet the CDB request.

The number of elements available field indicates the number of elements meeting the request in the command descriptor block. The status for these elements is returned if sufficient allocation length was specified.

The byte count of report available field indicates the number of bytes of element status page data available for all elements meeting the request in the command descriptor block. This value shall not be adjusted to match the allocation length available.

NOTE 202 - The READ ELEMENT STATUS command can be issued with an allocation length of eight bytes in order to determine the allocation length required to transfer all the element status data specified by the command.

Figure 28 provides an illustration of the element status data structure.

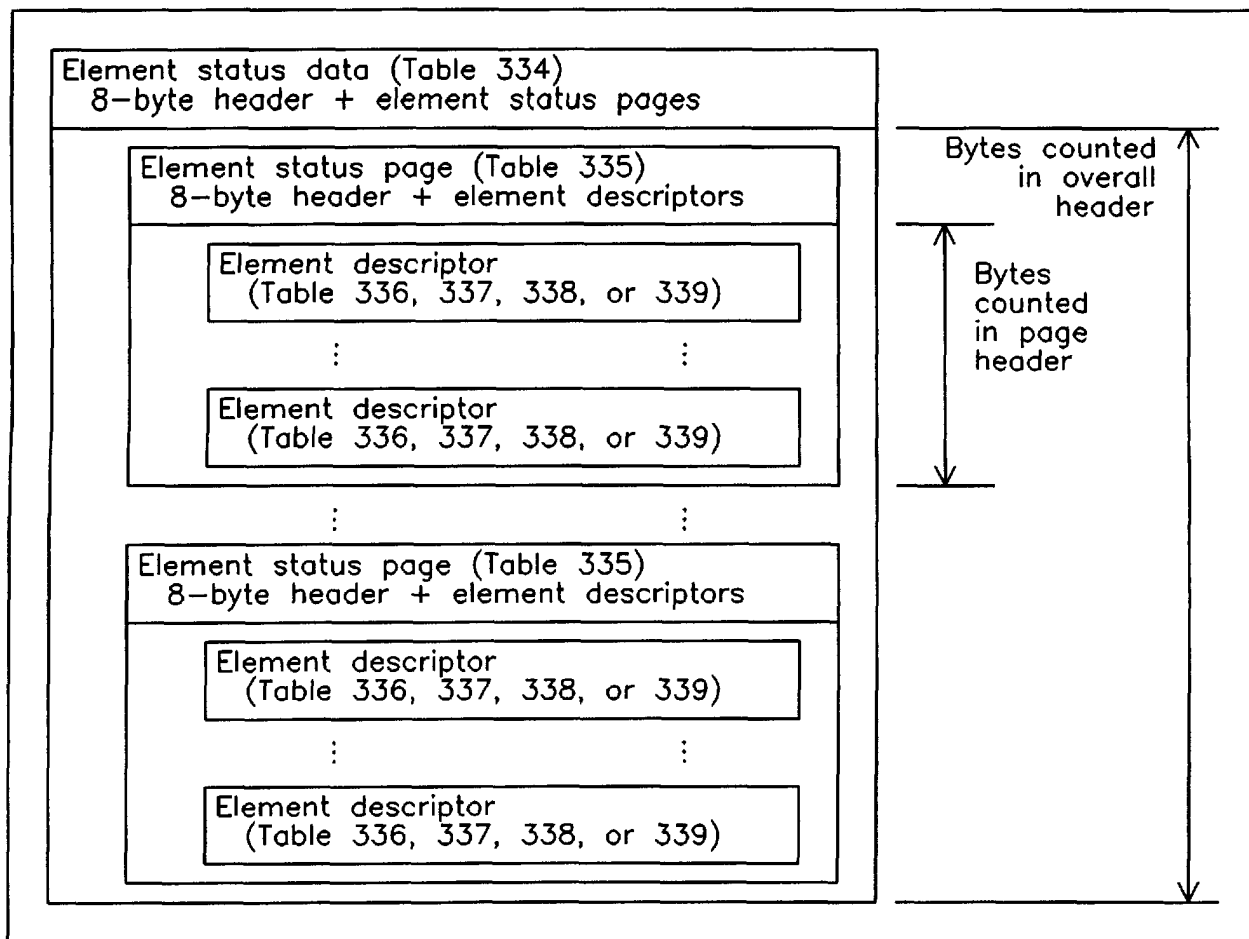

Figure 28 - Illustration of element status data structure

17.2.5.2 Element status page

The element status page is defined in table 335. Each element status page includes an eight-byte header followed by one or more element descriptor blocks. The header includes the element type code, the length of each descriptor block and the number of bytes of element descriptor information that follow the header for this element type.

Table 335 - Element status page

Bit Byte	7	6	5	4	3	2	1	0
0	Element type code							
1	PVolTag	AVolTag	Reserved					
2	(MSB)	Element descriptor length						(LSB)
3								
4	Reserved							
5	(MSB)	Byte count of descriptor data available (this page, n - 7)						(LSB)
6								
7								
8	Element descriptor(s)							
n								

The element type code field indicates the element type reported by this page.

A primary volume tag (PVolTag) bit of one indicates that the primary volume tag information field is present in each of the following element descriptor blocks. A value of zero indicates that these bytes are omitted from the element descriptors that follow.

An alternate volume tag (AVolTag) bit of one indicates that the alternate volume tag information field is present in each of the following element descriptor blocks. A value of zero indicates that these bytes are omitted from the element descriptors that follow.

The element descriptor length field indicates the number of bytes in each element descriptor.

The byte count of descriptor data available field indicates the number of bytes of element descriptor data available for elements of this element type meeting the request in the CDB. This value shall not be adjusted to match the allocation length available.

Each element descriptor includes the element address and status flags; it may also contain sense code information as well as other information depending on the element type (see 17.2.5.3 through 17.2.5.6).

ANSI X3.131-1994

17.2.5.3 Medium transport element descriptor

Table 336 defines the medium transport element descriptor.

Table 336 - Medium transport element descriptor

Bit Byte	7	6	5	4	3	2	1	0
0	(MSB) Element address							
1	(LSB)							
2	Reserved				Except	Reserved	Full	
3	Reserved							
4	Additional sense code							
5	Additional sense code qualifier							
6	Reserved							
8	Reserved							
9	SValid	Invert	Reserved					
10	(MSB) Source storage element address							
11	(LSB)							
12	Primary volume tag information							
47	(Field omitted if PVolTag = 0)							
48	Alternate volume tag information							
83	(Field omitted if AVolTag = 0)							
84	Reserved							
87	(Field moved up if volume tag information field(s) are omitted.)							
88	Vendor-specific							
z-1	(Field moved up if volume tag information field(s) are omitted.)							

The element address field gives the address of the medium changer element whose status is reported by this element descriptor block.

An exception (Except) bit of one indicates the element is in an abnormal state. An exception bit of zero indicates the element is in a normal state. If this bit is one, information on the abnormal state may be available in the additional sense code and additional sense code qualifier bytes.

A full bit value of one indicates that the element contains a unit of media. A value of zero indicates that the element does not contain a unit of media.

The additional sense code field may provide specific information on an abnormal element state. The values in this field are as defined for the additional sense code of the REQUEST SENSE data (see 8.2.14.3).

The additional sense code qualifier field may provide more detailed information on an abnormal element state. The values in this field are as defined for the additional sense code qualifier of the REQUEST SENSE data (see 8.2.14.4).

A source valid (SValid) bit value of one indicates that the source storage element address field and the invert bit information are valid. A value of zero indicates that the values in these fields are not valid.

An invert bit value of one indicates that the unit of media now in this element was inverted by MOVE MEDIUM or EXCHANGE MEDIUM operations since it was last in the source storage element. A value of zero indicates that no inversion occurred during the operation.

The source storage element address field provides the address of the last storage element this unit of media was moved. This field is valid only if the SValid bit is one.

The primary and alternate volume tag information fields provide for identifying the unit of media residing in this element (see 17.1.5.). Either or both of these fields may be omitted for all the element descriptor blocks that comprise an element status page as indicated by the PVolTag and AVolTag bits in the element status page header.

17.2.5.4 Storage element descriptor

Table 337 defines the storage element descriptor.

Table 337 - Storage element descriptor

Bit Byte	7	6	5	4	3	2	1	0
0	(MSB) Element address							
1	(LSB)							
2	Reserved			Access	Except	Reserved	Full	
3	Reserved							
4	Additional sense code							
5	Additional sense code qualifier							
6	Reserved							
8	Reserved							
9	SValid	Invert	Reserved					
10	(MSB) Source element address							
11	(LSB)							
12	Primary volume tag information							
47	(Field omitted if PVolTag = 0)							
48	Alternate volume tag information							
83	(Field omitted if PVolTag = 0)							
84	Reserved							
87	(Field moved up if volume tag information field(s) are omitted.)							
88	Vendor unique							
z-1	(Field moved up if volume tag information field(s) are omitted.)							

An access bit value of one indicates that access to the element by a medium transport element is allowed. An access bit of zero indicates that access to the element by the medium transport element is denied.

ANSI X3.131-1994

The source storage element address field provides the address of the last storage element this unit of media was moved from. This element address value may or may not be the same as this element. This field is valid only if the SValid bit is one.

For fields not defined in this subclause, see 17.2.5.3.

17.2.5.5 Import export element descriptor

Table 338 defines the import export element descriptor.

Table 338 - Import export element descriptor

Bit Byte	7	6	5	4	3	2	1	0
0	(MSB) Element address							
1	(LSB)							
2	Reserved	InEnab	ExEnab	Access	Except	ImpExp	Full	
3	Reserved							
4	Additional sense code							
5	Additional sense code qualifier							
6	Reserved							
8	Reserved							
9	SValid	Invert	Reserved					
10	(MSB) Source storage element address							
11	(LSB)							
12	Primary volume tag information							
47	(Field omitted if PVolTag = 0)							
48	Alternate volume tag information							
83	(Field omitted if PVolTag = 0)							
84	Reserved							
87	(Field moved up if volume tag information field(s) are omitted.)							
88	Vendor unique							
z-1	(Field moved up if volume tag information field(s) are omitted.)							

An import enable (InEnab) bit of one indicates that the import export element supports movement of media into the scope of the medium changer device. An InEnab bit of zero indicates that this element does not support import actions.

An export enable (ExEnab) bit of one indicates that the import export element supports movement of media out of the scope of the medium changer device. An ExEnab bit of zero indicates that this element does not support export actions.

An access bit of one indicates that access to the import export element by a medium transport element is allowed. An access bit of zero indicates access to the import export element by medium transport elements is denied.

NOTE 203 An example of when access would be denied is when the operator has exclusive access to the import export element.

An import export (ImpExp) bit of one indicates the unit of media in the import export element was placed there by an operator. An ImpExp bit of zero indicates the unit of media in the import export element was placed there by the medium transport element.

For fields not defined in this clause, see 17.2.5.3.

17.2.5.6 Data transfer element descriptor

Table 339 defines the data transfer element descriptor.

Table 339 - Data transfer element descriptor

Bit Byte	7	6	5	4	3	2	1	0
0	(MSB) Element address							
1	(LSB)							
2	Reserved			Access	Except	Reserved	Full	
3	Reserved							
4	Additional sense code							
5	Additional sense code qualifier							
6	Not bus	Reserved	ID valid	LU valid	Reserved	Logical unit number		
7	SCSI bus address							
8	Reserved							
9	SValid	Invert	Reserved					
10	(MSB) Source storage element address							
11	(LSB)							
12	Primary volume tag information							
47	(Field omitted if PVolTag = 0)							
48	Alternate volume tag information							
83	(Field omitted if PVolTag = 0)							
84	Reserved							
87	(Field moved up if volume tag information field(s) are omitted.)							
88	Vendor unique							
z-1	(Field moved up if volume tag information field(s) are omitted.)							

An access bit value of one indicates access to the data transfer element by the medium transport element is allowed. A value of zero indicates access to the data transfer element by a medium transport element is denied.

NOTE 204 Access to the data transfer element by medium transport elements might be denied if a data transfer operation was under way. Note that a one value in this bit may not be sufficient to ensure a successful operation. This bit can only reflect the best information available to the medium changer device, which may not accurately reflect the state of the primary (data transfer) device.

ANSI X3.131-1994

A not this bus (not bus) bit value of one indicates that the SCSI bus address and logical unit number values are not valid for the SCSI bus used to select the medium changer device. A not bus bit value of zero indicates that the SCSI address and logical unit values, if valid, are on the same bus as the medium changer device.

An ID Valid bit value of one indicates that the SCSI bus address field contains valid information. An LU Valid bit value of one indicates that the logical unit number field contains valid information.

The SCSI bus address field, if valid, provides the SCSI address (binary representation) of the primary device served by the medium changer at this element address.

The logical unit number field, if valid, provides the logical unit number within the SCSI bus device of the primary device served by the medium changer at this element address.

For fields not defined in this clause, see 17.2.5.3.

17.2.6 REQUEST VOLUME ELEMENT ADDRESS command

The REQUEST VOLUME ELEMENT ADDRESS command (see table 340) is used to transfer the results of a SEND VOLUME TAG command. Multiple REQUEST VOLUME ELEMENT ADDRESS commands may be used to recover the results of a single SEND VOLUME TAG command with the translate option.

Table 340 - REQUEST VOLUME ELEMENT ADDRESS command

Bit Byte	7	6	5	4	3	2	1	0
0	Operation code (B5h)							
1	Logical unit number			VolTag	Element type code			
2	(MSB) Element address							
3	(LSB)							
4	(MSB) Number of elements							
5	(LSB)							
6	Reserved							
7	(MSB) Allocation length							
8	(LSB)							
9	Reserved							
10	Control							
11								

For each SEND VOLUME TAG command, the target shall be able to report multiple elements that match a volume tag template in element address order. Once information for a given element address has been reported, only higher element addresses will be reported by subsequent REQUEST VOLUME ELEMENT ADDRESS commands.

NOTE 205 In order to ensure the successful completion of a SEND VOLUME TAG, REQUEST VOLUME ELEMENT ADDRESS sequence in a multi-initiator environment, it may be necessary to reserve the medium changer device. To do this, issue a unit RESERVE command prior to the SEND VOLUME TAG command and delay issuing the RELEASE until after the last REQUEST VOLUME ELEMENT ADDRESS.

A volume tag (VolTag) bit of one indicates that the target shall report volume tag information. A value of zero indicates that volume tag information shall not be reported. This is provided for compatibility with the READ ELEMENT STATUS command.

The element type code field specifies the particular element type(s) selected for reporting by this command. A value of zero specifies that status for all element types shall be reported. The codes for this field are defined in 17.2.5. This acts as a qualification of the element(s) determined by SEND VOLUME TAG to match the template specified.

The element address field gives a medium changer element address whose interpretation depends on the send action code received with the last SEND VOLUME TAG command. This code is echoed in the volume element address return format transferred by this command. When the last send action code was a translate, (code values 0h .. 7h), the element address field gives the minimum element address to be reported by this command. When the send action code is other than translate, (i.e. assert, replace, and undefined, code values 8h .. Dh), the element address field gives the particular element whose volume tag information was modified.

The number of elements specifies the maximum number of elements and volume tags to be reported by the target for this command. The value specified by this field is not the range of element addresses to be considered for reporting but rather the number of elements to report of those that match the last send volume tag translate template. If the allocation length is not sufficient to transfer all the element descriptors, the target shall transfer all those descriptors that can be completely transferred and this shall not be considered an error.

The data returned by this command consists of a header as defined by table 341, plus one or more element type specific pages in the same format as defined by the READ ELEMENT STATUS command.

Table 341 - Volume element address header format

Bit Byte	7	6	5	4	3	2	1	0
0	(MSB) First element address reported							_____
1								(LSB)
2	(MSB) Number of elements reported							_____
3								(LSB)
4	Reserved			Send action code				
5	(MSB) Byte count of report available							_____
6	(all pages, x - 7)							_____
7								(LSB)
8 to - x	Element status page(s)							_____

The send action code field gives the function performed by the last SEND VOLUME TAG command as defined in 17.2.9. This command reports the results of this send action code operation.

For fields not defined in this subclause, see 17.2.5.1.

ANSI X3.131-1994

17.2.7 RELEASE command

The RELEASE command (see table 342) is used to release previously reserved units, or, if the element release option is implemented, previously reserved elements within units. It is not an error for an initiator to attempt to release a reservation that is not currently active. In this case, the target shall return GOOD status without altering any other reservation.

Table 342 - RELEASE command

Bit Byte	7	6	5	4	3	2	1	0
0	Operation code (17h)							
1	Logical unit number			3rdPty	Third party device ID			Element
2	Reservation identification							
3	Reserved							
4	Reserved							
5	Control							

17.2.7.1 Logical unit release

If the element bit is zero, this command shall cause the target to terminate all non-third party unit and element reservations that are active from the initiator to the specified logical unit.

17.2.7.2 Element release (optional)

If the element bit is one and the element release option is not implemented, the RELEASE command shall be terminated with CHECK CONDITION status and the sense key shall be set to ILLEGAL REQUEST. This option shall be implemented if the element reservation option (see 17.2.8.1) is implemented.

If the element bit is one and the element release option is implemented, this command shall cause any reservation from the requesting initiator with a matching reservation identification to be terminated. Other reservations from the requesting initiator shall remain in effect.

17.2.7.3 Third party release

The third-party release option of the RELEASE command allows an initiator to release a unit or elements within a unit that were previously reserved using third-party reservation (see 17.2.8.3). Third-party release shall be implemented if third-party reserve is implemented.

If the third-party (3rdPty) bit is zero, the third-party release option is not requested. If the 3rdPty bit is one and the target implements the third-party release option, the target shall release the specified unit or elements, but only if the reservation was made using the third-party reservation option by the initiator that is requesting the release for the same SCSI device as specified in the third-party device ID field.

If the 3rdPty bit is one and the target does not implement the third-party release option, the target shall terminate the command with CHECK CONDITION status and the sense key shall be set to ILLEGAL REQUEST.

17.2.8 RESERVE command

The RESERVE command (see table 343) is used to reserve units or, if the element reservation option is implemented, elements within units for the use of the initiator. The third-party reservation allows units or elements to be reserved for another specified SCSI device. The RESERVE and RELEASE commands provide the basic mechanism for contention resolution in multiple-initiator systems.

Table 343 - RESERVE command

Bit Byte	7	6	5	4	3	2	1	0
0	Operation code (16h)							
1	Logical unit number			3rdPty	Third party device ID			Element
2	Reservation identification							
3	(MSB)	Element list length						(LSB)
4								
5	Control							

17.2.8.1 Logical unit reservation

If the element bit is zero, this command shall request that the entire unit be reserved for the exclusive use of the initiator until the reservation is superseded by another valid RESERVE command from the initiator that made the reservation or until released by a RELEASE command from the same initiator that made the reservation, by a BUS DEVICE RESET message from any initiator, by a hard RESET condition, or by a power off/on cycle. A unit reservation shall not be granted if the unit or any element is reserved by another initiator. It shall be permissible for an initiator to reserve a unit that is currently reserved by that initiator. If the element bit is zero, the reservation identification and the element list length shall be ignored.

If the unit, or any element within the unit, is reserved for another initiator, the target shall respond by returning RESERVATION CONFLICT status.

If, after honouring the reservation, any other initiator attempts to perform any command on the reserved unit other than an INQUIRY, REQUEST SENSE, ALLOW MEDIUM REMOVAL, RESERVE, or a RELEASE command, the command shall be rejected with RESERVATION CONFLICT status.

17.2.8.2 Element reservation (optional)

The reservation identification provides a means for an initiator to identify each element reservation. This allows an initiator in a multiple-tasking environment, to have multiple reservations outstanding. The reservation identification is used in the RELEASE command to specify which reservation is to be released. It is also used in superseding RESERVE commands to specify which reservation is to be superseded.

If the element reservation option is implemented, the element release option (see 17.2.7.2) shall also be implemented. These options permit multiple elements within the unit to be reserved, each with a separate reservation identification.

If the element bit is one, and the element reservation option is implemented, the target shall process the reservation request as follows:

- a) The element list shall be checked for valid element addresses. If any element address is invalid for this unit, the command shall be terminated with CHECK CONDITION status and the sense key shall be set to ILLEGAL REQUEST. The element list shall be checked for invalid element overlaps with other element

ANSI X3.131-1994

descriptors in the element list and if invalid overlaps are found, the command shall be terminated with CHECK CONDITION status and the sense key shall be set to ILLEGAL REQUEST.

- b) If the requested reservation does not conflict with any active or previously requested reservation, the elements specified shall be reserved until superseded by another valid RESERVE command from the initiator that made the reservation, or until released by a RELEASE command from the same initiator, by a BUS DEVICE RESET message from any initiator, or by a hard RESET condition. If either of the last two conditions occur, the next command from each initiator shall be terminated with CHECK CONDITION status and the sense key shall be set to UNIT ATTENTION.
- c) If the reservation request conflicts with a reservation already active the target shall return RESERVATION CONFLICT status.

If the element bit is one, and the element reservation option is not implemented, the RESERVE command shall be terminated with CHECK CONDITION status. The sense key shall be set to ILLEGAL REQUEST.

The size of the element list shall be defined by the element list length parameter. The element list shall consist of zero or more descriptors as shown in table 344. Each element list descriptor defines a series of elements beginning at the specified element address for the specified number of elements. If the number of elements is zero, the element list shall begin at the specified element address and continue through the last element address on the unit.

Table 344 - Data format of element list descriptors

Bit Byte	7	6	5	4	3	2	1	0	
0	Reserved								
1									
2	(MSB)	Number of elements							
3								(LSB)	
4	(MSB)	Element address							
5								(LSB)	

If an initiator issues a command to an element that has been reserved by a different initiator, the command shall not be performed and the command shall be terminated with a RESERVATION CONFLICT status. If a reservation conflict precludes any part of the command, none of the command shall be performed.

17.2.8.3 Third party reservation

The third-party reservation option of the RESERVE command allows an initiator to reserve a unit or elements within a unit for another SCSI device.

If the third-party (3rdPty) bit is zero, the third-party reservation option is not requested. If the 3rdPty bit is one and the third-party reservation option is implemented, the RESERVE command shall reserve the specified unit or elements for the SCSI device specified in the third-party device ID field. The target shall preserve the reservation until it is superseded by another valid RESERVE command from the initiator that made the reservation or until it is released by the same initiator, by a BUS DEVICE RESET message from any initiator, or a hard RESET condition. The target shall ignore any attempt to release the reservation made by any other initiator.

If the 3rdPty bit is one and the third-party reservation option is not implemented, the target shall reject the RESERVE command with CHECK CONDITION status and the sense key shall be set to ILLEGAL REQUEST.

17.2.8.4 Superseding reservations

An initiator that holds a current reservation may modify that reservation by issuing another RESERVE command to the same unit and, if the element bit is one, using the same reservation identification. The superseding RESERVE command shall release the previous reservation in place when the new reservation request is granted. The current reservation shall not be modified if the new reservation request cannot be granted. If the superseding reservation cannot be granted because of conflicts with a previous active reservation (other than the reservation being superseded), the target shall return RESERVATION CONFLICT status.

NOTE 206 Superseding reservations are principally intended to allow the SCSI device ID to be changed on a reservation using the third-party reservation option.

17.2.9 SEND VOLUME TAG command

The SEND VOLUME TAG command (see table 345) transfers a volume tag template to be searched for or new volume tag information for one or more media changer elements. The function of the command is conveyed by the send action code field. The REQUEST VOLUME ELEMENT ADDRESS command is used to transfer the results of a translate search operation.

Table 345 - SEND VOLUME TAG command

Bit Byte	7	6	5	4	3	2	1	0
0	Operation code (B6h)							
1	Logical unit number			Reserved	Element type code			
2	(MSB) Element address							
3	(LSB)							
4	Reserved							
5	Reserved			Send action code				
6	Reserved							
7	Reserved							
8	(MSB) Parameter list length							
9	(LSB)							
10	Reserved							
11	Control							

The element type code field specifies an element type specification as defined in 17.2.5. If the send action code indicates a translate operation, this field indicates the element types to be searched. If this is a zero, all element types are candidates for a translate operation. If the send action code does not indicate a translate, this field shall be treated as reserved.

The send action code field gives the function to be performed by this command as listed in table 346.

Table 346 - Send volume tag action codes

Code	Description
0h	Translate - search all defined volume tags
1h	Translate - search only primary volume tags
2h	Translate - search only alternate volume tags
3h	Reserved
4h	Translate - search all defined tags - ignore sequence numbers
5h	Translate - search primary tags - ignore sequence numbers
6h	Translate - search alternate tags - ignore sequence numbers
7h	Reserved
8h	Assert - as the primary volume tag - if tag now undefined
9h	Assert - as the alternate volume tag - if tag now undefined
Ah	Replace - the primary volume tag - current tag ignored
Bh	Replace - the alternate volume tag - current tag ignored
Ch	Undefined - the primary volume tag - current tag ignored
Dh	Undefined - the alternate volume tag - current tag ignored
Eh - 1Bh	Reserved
1Ch - 1Fh	Vendor-specific

Translate operations request that the target search the volume tag information available to it for elements whose volume tag information matches the template given by the command parameters. The resulting information is reported via the REQUEST VOLUME ELEMENT ADDRESS command.

Assert operations define volume tag information for a single element. A CHECK CONDITION with ILLEGAL REQUEST is reported if the subject element already has defined volume tag information; in this case, the original volume tag information shall remain unaltered.

Replace operations define volume tag information for a single element. Any previously defined volume tag information is overwritten.

Undefined operations cause previously defined volume tag information for the specified element to be cleared. It shall not be considered an error to undefined volume tag information that was not previously defined.

A medium changer device that implements volume tag information may choose to not implement the facilities that modify the volume tag information. With such an implementation a request for the assert, replace or undefined functions would cause the SEND VOLUME TAG command to be terminated with CHECK CONDITION and a sense key of ILLEGAL REQUEST.

The element address field gives a medium changer element address whose interpretation depends on the send action code received with this command. When the send action code is a translate, (code values 0h .. 7h), the element address field gives the starting element to be examined for satisfaction of the search criteria. When the send action code is other than translate, (i.e. assert, replace, and undefined, code values 8h .. Dh), the element address field gives the particular element whose volume tag information is to be modified.

The volume tag information used for translate, assert and replace functions is defined in table 347. No parameters are necessary for undefined operations.

Table 347 - Send volume tag parameters format

Bit Byte	7	6	5	4	3	2	1	0
0	Volume identification template field							
31								
32	Reserved							
33								
34	(MSB)	Minimum volume sequence number						(LSB)
35								
36	Reserved							
37								
38	(MSB)	Maximum volume sequence number						(LSB)
39								

The volume identification template field specifies a search template for translate functions and the exact value of the new volume identification information for other SEND VOLUME TAG command functions.

As a search template, this field may contain the wildcard characters '*' and '?' (2Ah and 3Fh). '*' will match any string of characters, when it appears in a template the remainder of the template is not used. '?' will match any single character.

For a function other than translate, this field may not contain the '*' or '?' wildcard characters.

The minimum volume sequence number field specifies the new sequence number for the assert and replace functions. For a translate, this specifies the least value that will meet the search specification.

The maximum volume sequence number field specifies the greatest value that will meet the search specification. This field is ignored on functions other than translate.

17.3 Parameters for medium changer devices

17.3.1 Diagnostic parameters

This subclause defines the descriptors and pages for diagnostic parameters used with medium changer devices.

The diagnostic page codes for medium changer devices are defined in table 348.

Table 348 - Diagnostic page codes

Page code	Description	Subclause
00h	Supported diagnostic pages	8.3.1.1
01h - 3Fh	Reserved (for all device type pages)	
40h - 7Fh	Reserved	
80h - FFh	Vendor-specific pages	

ANSI X3.131-1994

17.3.2 Log parameters

This subclause defines the descriptors and pages for log parameters used with medium changer devices.

The log page codes for medium changer devices are defined in table 349.

Table 349 - Log page codes

Page code	Description	Subclause
00h	Supported log pages	8.3.2.5
06h	Non-medium error page	8.3.2.4
07h	Last n error events page	8.3.2.3
01h - 05h	Reserved	
08h - 2Fh	Reserved	
3Fh	Reserved	
30h - 3Eh	Vendor-specific pages	

17.3.3 Mode parameters

This subclause defines the descriptors and pages for mode parameters used with medium changer devices.

The mode parameter list, including the mode parameter header and mode block descriptor, are defined in 8.3.3.

The medium-type code field is contained in the mode parameter header (see 8.3.3). This field is reserved for medium changer devices.

The device specific parameter field is contained in the mode parameter header (see 8.3.3). This field is reserved for medium changer devices.

The density code field is contained in the mode parameter block descriptor (see 8.3.3). This field is reserved for medium changer devices.

The mode page codes for medium changer devices are shown in table 350.

Table 350 - Mode page codes

Page code	Description	Subclause
1Fh	Device capabilities	17.3.3.1
1Dh	Element address assignment	17.3.3.2
1Eh	Transport geometry parameters	17.3.3.3
01h - 1Ch	Reserved	
00h	Vendor-specific (does not require page format)	
20h - 3Eh	Vendor-specific (page format required)	
3Fh	Return all pages (valid only for the MODE SENSE command)	

17.3.3.1 Device capabilities page

The device capabilities page (see table 351) defines characteristics of the element types on this medium changer implementation. This information may be employed by the initiator to determine functions permitted by the MOVE MEDIUM and EXCHANGE MEDIUM commands.

Table 351 - Device capabilities page

Bit Byte	7	6	5	4	3	2	1	0
0	PS	Reserved	Page code (1Fh)					
1	Parameter length (12h)							
2	Reserved			StorDT	StorI/E	StorST	StorMT	
3	Reserved							
4	Reserved			MT->DT	MT->I/E	MT->ST	MT->MT	
5	Reserved			ST->DT	ST->I/E	ST->ST	ST->MT	
6	Reserved			I/E->DT	I/E->I/E	I/E->ST	I/E->MT	
7	Reserved			DT->DT	DT->I/E	DT->ST	DT->MT	
8	Reserved							
11	Reserved							
12	Reserved			MT<>DT	MT<>I/E	MT<>ST	MT<>MT	
13	Reserved			ST<>DT	ST<>I/E	ST<>ST	ST<>MT	
14	Reserved			I/E<>DT	I/E<>I/E	I/E<>ST	I/E<>MT	
15	Reserved			DT<>DT	DT<>I/E	DT<>ST	DT<>MT	

The parameters savable (PS) bit is only used with the MODE SENSE command. This bit is reserved with the MODE SELECT command. A PS bit of one indicates that the target is capable of saving the page in a non-volatile, vendor-specific location.

In the field names on this page, the following element type abbreviations are used:

- MT a medium transport element,
- ST a storage element,
- I/E an import export element, and
- DT a data transfer element.

In the descriptions, XX and YY are any of the element type abbreviations.

A StorXX bit value of one indicated that the defined elements of type XX may provide independent storage for a unit of media. A value of zero indicates that elements of type XX provide virtual sources or destinations, that the location of the unit of media is provided by an element of some other type. The value of StorST is one by the definition of that type. See 17.1.1.

An XX->YY bit value of one indicates that the medium changer device supports all MOVE MEDIUM commands where the source is element type XX, the destination is element type YY and these element addresses are otherwise valid. An XX->YY bit value of zero indicates that these MOVE MEDIUM commands may or may not be valid depending on the particular elements requested. Those which are not valid will be rejected with ILLEGAL REQUEST.

ANSI X3.131-1994

An XX<>YY bit value of one indicates that the medium changer device supports all EXCHANGE MEDIUM commands where the source is element type XX, destination 1 is element type YY, destination 2 is the same type as the source element type and these element addresses are otherwise valid. An XX<>YY bit value of zero indicates that these EXCHANGE MEDIUM commands may or may not be valid depending on the particular elements requested. Those which are not valid will be rejected with ILLEGAL REQUEST.

17.3.3.2 Element address assignment page

The element address assignment page (see table 352) is used to assign addresses to the elements of the medium changer (MODE SELECT) and to report those assignments (MODE SENSE). This page also defines the number of each type of element present.

Table 352 - Element address assignment page

Bit Byte	7	6	5	4	3	2	1	0
0	PS	Reserved	Page code (1Dh)					
1	Parameter length (12h)							
2	(MSB)	Medium transport element address						_____
3								(LSB)
4	(MSB)	Number of medium transport elements						_____
5								(LSB)
6	(MSB)	First storage element address						_____
7								(LSB)
8	(MSB)	Number of storage elements						_____
9								(LSB)
10	(MSB)	First import export element address						_____
11								(LSB)
12	(MSB)	Number of import export elements						_____
13								(LSB)
14	(MSB)	First data transfer element address						_____
15								(LSB)
16	(MSB)	Number of data transfer elements						_____
17								(LSB)
18	Reserved							
19								

The parameters savable (PS) bit is only used with the MODE SENSE command. This bit is reserved with the MODE SELECT command. A PS bit of one indicates that the target is capable of saving the page in a non-volatile vendor-specific location.

The first medium transport element address field identifies the first medium transport element contained in the medium changer (other than the default medium transport address of zero). The number of medium transport elements field defines the total number of medium transport elements contained in the medium changer. If the number of medium transport elements field in a MODE SELECT command is greater than the default value

returned in the MODE SENSE parameter data, the target shall return CHECK CONDITION status and set the sense key to ILLEGAL REQUEST.

The first storage element address field identifies the first medium storage element contained in the medium changer. The number of storage elements field defines the total number of medium storage elements contained in the medium changer. If the number of medium storage elements field in a MODE SELECT command is greater than the default value returned in the MODE SENSE parameter data, the target shall return CHECK CONDITION status and set the sense key to ILLEGAL REQUEST.

The first import export element address field identifies the first medium portal that is accessible both by the medium transport devices and also by an operator from outside the medium changer. The number of import export elements field defines the total number of import export elements contained in the medium changer and accessible to the medium transport elements. If the number of import export elements field in a MODE SELECT command is greater than the default value returned in the MODE SENSE parameter data, the target shall return CHECK CONDITION status and set the sense key to ILLEGAL REQUEST .

NOTE 207 The number of import export elements may be zero.

The first data transfer element address field identifies the first data transfer element contained in the medium changer. The data transfer elements may be either read/write or read-only devices. The number of data transfer field defines the total number of data transfer elements contained within the medium changer and accessible to the medium transport elements. If the number of data transfer elements field in a MODE SELECT command is greater than the default value returned in the MODE SENSE parameter data, the target shall return CHECK CONDITION status and set the sense key to ILLEGAL REQUEST .

Each element in the medium changer must have a unique address. If the address ranges defined for any of the element types overlap, the target shall return CHECK CONDITION status and set the sense key to ILLEGAL REQUEST.

ANSI X3.131-1994

17.3.3.3 Transport geometry parameters page

The transport geometry parameters page (see table 353) defines whether each medium transport element is a member of a set of elements that share a common robotics subsystem and whether the element is capable of media rotation. One transport geometry descriptor is transferred for each medium transport element, beginning with the first medium transport element. (Other than the default transport element address of zero.)

Table 353 - Transport geometry parameters page

Bit Byte	7	6	5	4	3	2	1	0
0	PS	Reserved	Page code (1Eh)					
1	Parameter length							
	Transport geometry descriptor(s)							
0	Reserved							Rotate
1	Member number in transport element set							

The parameters savable (PS) bit is only used with the MODE SENSE command. This bit is reserved with the MODE SELECT command. A PS bit of one indicates that the target is capable of saving the page in a non-volatile vendor-specific location.

The parameter length specifies the number of bytes of transport geometry descriptors that follow. The geometry of each medium transport element is defined using a two-byte field as defined below.

A rotate bit of one indicates that the medium transport element supports media rotation for handling double-sided media. A rotate bit of zero indicates that the medium transport element does not support media rotation.

The member number in set indicates the position of this element in a set of medium transport elements that share a common robotics subsystem. The first element in a set has a member number of zero.

NOTE 208 This page reports information about the way transport elements are physically clustered in a system. The model for this is a medium changer device with more than one independent robotics subsystem, where each of these supports multiple transport elements. The elements that are supported by a particular robotics subsystem form a set. This sort of information is helpful for optimization and error recovery in such a large system. (Recall that in the model for this device type, see 17.1, the individual transport element is addressed not the robotics subsystem. An element is defined to be a place where a unit of media may be at any point in time.)

17.4 Definitions specific to medium changer devices

17.4.1 data transfer element: A component of a medium changer used to access the data stored on a unit of media. The address in medium changer element space of a primary device.

17.4.2 element: An addressable physical component of a medium changer device that can serve as the location of a unit of media.

17.4.3 import export element: A location within a medium changer device that can be accessed by both the medium transport elements and by the operator.

17.4.4 medium transport element: A component of a medium changer device that is used to move units of media.

17.4.5 media rotation: The process of changing the orientation of a unit of media. In particular this refers to inverting a two sided media cartridge so that a data transport element that can access only one side at a time can access data on the other side.

17.4.6 primary device: A device for reading or writing data on medium. These devices would typically implement the direct access, sequential access, optical memory device or CD-ROM command sets in this standard. Examples are magnetic disk drives, cartridge tape drives, optical disk drives and CD-ROM drives. Use in a medium changer environment implies that the device supports removable media.

17.4.7 storage element: A component of a medium changer device used for inactive storage of a unit of media.

18 Communications devices

18.1 Communications device model

A communications device provides a facility to send and receive information over some medium (usually an electrical or fiber-optic cable) using a defined protocol to one or more other systems that support the same protocol. The media and protocols are often specified in national or international standards, although some are proprietary. Within this subclause, the protocol used on the external medium is called the external protocol.

The SCSI communications device model assumes that information to control the external protocol is embedded within the data transferred by the SEND and GET MESSAGE commands. The structure of the data transferred by these commands is not defined by this standard. Vendor-unique MODE pages may be defined to provide additional control over the external protocol.

The SCSI communications device is a target with the characteristics of a network access device, typically attached to a local area network (LAN), public telecommunications network, private telecommunications network, or packet switching network, etc., with no theoretical limits. Such a communications device is often called a network node. The communications device transmits or receives packets of data as requested by the initiator. The contents and meaning of the data packets is not defined by this standard. The bytes in the data packets may or may not contain addressing, path selection, or path control information identifying separate data streams. Additional information may be provided by the stream selection identifier found in the ten and twelve byte SEND MESSAGE and GET MESSAGE commands.

In the SCSI communications device, the target accepts and provides the data packets transferred in accordance with commands received from the initiator. There is an assumption that the initiator and the communications device know the rules by which information is exchanged between them, how the information is to be interpreted by the communications device, and when it is allowable to exchange the information. These rules are not specified by this standard.

The initiator requests that the communications device accept a packet of data by transmitting a SEND MESSAGE command. The initiator requests that the communications device return a packet of data by transmitting a GET MESSAGE command. The communications device also supports commands related to configuration of the network access device and network management of the particular environment. MODE SENSE and MODE SELECT are examples of these configuration commands.

If a communications device temporarily has no resource available to handle a data packet from the initiator, or has no data packet to provide to the initiator, or has no resources assigned to perform the operation, the device may then choose one of the following responses:

- a) Terminate the command with CHECK CONDITION status. The sense key shall be set to NOT READY and the appropriate additional sense code for the condition.
- b) Disconnect until the necessary resource or data packet becomes available, and then reconnect to the initiator and resume the operation.
- c) Terminate the command with BUSY status.

More than one logical unit can be implemented by a communications device. Logical units can serve as multiple paths to a single network access device, and/or each logical unit can serve as a discrete path to different resources within the device. A single logical unit may also serve as a path to multiple resources if the communications device can interpret information within the data packet and route the packet to the appropriate resource. If the logical unit addressed by the initiator does not have an available resource or data packet associated with it, the communications device may choose to treat the logical unit as an invalid logical unit (see 7.5.3) or respond as described in the previous paragraph.

If the communications device determines that an error or unusual condition has occurred while performing an operation specified by the contents of a data packet, the information describing the condition is normally returned

as a part of a data packet from another network device. If the communications device determines that an error or unusual condition has occurred while either executing the SCSI command from the initiator, or during a network medium access transaction, the command is terminated with a CHECK CONDITION. The failures are identified through a REQUEST SENSE command.

The SCSI communications device is distinguished from an SCSI processor device by the fact that the primary destination of the data packets transferred to the communications device is not the target device itself, but another network node. A SCSI communications device passes the data on to an ultimate destination outside the target through a network. In contrast, the SCSI processor device is itself the primary destination of the data packets. Devices requiring protocols and command sets that are totally incompatible with the communications device protocols should be examined carefully to be sure that the incompatibilities are based on functional requirements.

18.1.1 Implementation examples

Several examples of communications device implementations are provided to clarify the range of utility of this device type.

18.1.1.1 Host-to-host communications

In this example of host to host communications, only the SEND MESSAGE command is used.

A communications device (comm A) is attached to a network (net A), and another communications device (comm B) is attached to a network (net B). Comm A takes the initiator role and selects a communications device (comm B), transmitting a packet to comm B using the SEND MESSAGE command. After transmitting the packet on the attached network medium (net B), the action required by the SEND MESSAGE command, comm B assumes the initiator mode and selects comm A as a communications device, and uses a SEND MESSAGE command to transmit a packet on the network (net A) attached to comm A.

Note 209 The SEND MESSAGE command is sufficient to perform complete transactions between communications devices if comm A and comm B act as initiators. This provides the function of a network bridge or gateway for high bandwidth intercommunication among nearby host processors.

18.1.1.2 Host-to-device communications

In this example of host to device communications, the SEND MESSAGE and GET MESSAGE commands are used.

A host system, host A, takes the initiator role and selects a communications device (comm A) attached to a network (net A), transmitting a packet on network net A to some other network node(s) using the SEND MESSAGE command to comm A. Host A then assumes that a result will be obtained by the other network node(s) consistent with rules understood by all involved network devices. Host A generates a GET MESSAGE command to obtain packets from other network nodes. If there are no packets that need handling pending at comm A, comm A may disconnect until a packet arrives. Comm A can then complete the transaction, reconnect to host A and the requested data packet can be returned to host A. Note that Host A need not support target mode and Comm A need not support initiator mode to successfully complete an exchange between the two devices. The host system (host A) can be replaced by a communications device that is capable of acting as an initiator.

18.1.1.3 Multiple role communications

In this example of multiple role communications, the SEND MESSAGE and GET MESSAGE commands are used. The device acts as both a host and a communications device, depending on its needs and the requests made in the network.

ANSI X3.131-1994

A communications device (comm A) is attached to a network (net A), and another communications device (comm B) is attached to a network (net B). Comm A takes the initiator role and selects a communications device (comm B). Comm A transmits a packet for network net B using the SEND MESSAGE command to comm B. Comm A then requests data packets from net B by issuing a GET MESSAGE command to the comm B device. Following these actions, comm B assumes the initiator role and transmits a packet using the SEND MESSAGE command to comm A for transmission to network node(s) located on net A. Comm B then requests data packets from net A by issuing a GET MESSAGE command to comm A.

18.2 Command descriptions for communications devices

The commands for communications devices shall be as shown in table 354.

Table 354 - Commands for communications devices

Command name	Operation code	Type	Subclause
CHANGE DEFINITION	40h	O	8.2.1
GET MESSAGE(6)	08h	O	8.2.17
GET MESSAGE(10)	28h	O	18.2.2
GET MESSAGE(12)	A8h	O	18.2.3
INQUIRY	12h	M	8.2.5
LOG SELECT	4Ch	O	8.2.6
LOG SENSE	4Dh	O	8.2.7
MODE SELECT(6)	15h	O	8.2.8
MODE SELECT(10)	55h	O	8.2.9
MODE SENSE(6)	1Ah	O	8.2.10
MODE SENSE(10)	5Ah	O	8.2.11
READ BUFFER	3Ch	O	8.2.12
RECEIVE DIAGNOSTIC RESULTS	1Ch	O	8.2.13
REQUEST SENSE	03h	M	8.2.14
SEND DIAGNOSTIC	1Dh	M	8.2.15
SEND MESSAGE(6)	0Ah	M	18.2.4
SEND MESSAGE(10)	2Ah	O	18.2.5
SEND MESSAGE(12)	AAh	O	18.2.6
TEST UNIT READY	00h	M	8.2.16
WRITE BUFFER	3Bh	O	8.2.17

Key: M = command implementation is mandatory.
O = command implementation is optional.

All other operation codes for communications devices are reserved for future standardization.

18.2.1 GET MESSAGE(6) command

The GET MESSAGE(6) command (see table 355) transfers data from the target to the initiator.

Table 355 - GET MESSAGE(6) command

Bit Byte	7	6	5	4	3	2	1	0
0	Operation code (08h)							
1	Logical unit number			Reserved				
2	(MSB)							
3	Allocation length							
4	(LSB)							
5	Control							

18.2.2 GET MESSAGE(10) command

The GET MESSAGE(10) command (see table 356) transfers data from the target to the initiator.

Table 356 - GET MESSAGE(10) command

Bit Byte	7	6	5	4	3	2	1	0
0	Operation code (28h)							
1	Logical unit number			Reserved				
2	Reserved							
3	Reserved							
4	(MSB)							
5	Stream selection							
6	(LSB)							
7	Reserved							
8	(MSB)							
9	Allocation length							
	(LSB)							
9	Control							

The stream selection field specifies a further level of addressing for the data, so that it can be accessed by the target from the appropriate data stream.

ANSI X3.131-1994

18.2.3 GET MESSAGE(12) command

The GET MESSAGE(12) command (see table 357) transfers data from the target to the initiator.

Table 357 - GET MESSAGE(12) command

Bit Byte	7	6	5	4	3	2	1	0
0	Operation code (A8h)							
1	Logical unit number			Reserved				
2	Reserved							
3	Reserved							
4	(MSB)		Stream selection				(LSB)	
5								
6	(MSB)		Allocation length				(LSB)	
7								
8								
9								
10	Reserved							
11	Control							

The stream selection field specifies a further level of addressing for the data, so that it can be accessed by the target from the appropriate data stream.

18.2.4 SEND MESSAGE(6) command

The SEND MESSAGE(6) command (see table 358) transfers data from the initiator to the target.

Table 358 - SEND MESSAGE(6) command

Bit Byte	7	6	5	4	3	2	1	0
0	Operation code (0Ah)							
1	Logical unit number			Reserved				
2	(MSB)		Transfer length				(LSB)	
3								
4								
5	Control							

The transfer length specifies the length in bytes of data that shall be sent during the DATA OUT phase. A transfer length of zero indicates that no data shall be sent. This condition shall not be considered an error.

18.2.5 SEND MESSAGE(10) command

The SEND MESSAGE(10) command (see table 359) transfers data from the initiator to the target.

Table 359 - SEND MESSAGE(10) command

Bit Byte	7	6	5	4	3	2	1	0
0	Operation code (2Ah)							
1	Logical unit number			Reserved				
2	Reserved							
3	Reserved							
4	(MSB)		Stream selection				(LSB)	
5	Reserved							
6	Reserved							
7	(MSB)		Transfer length				(LSB)	
8	Reserved							
9	Control							

The stream selection field specifies a further level of addressing for the data, so that it can be directed by the target to the appropriate data stream.

Please refer to the SEND MESSAGE(6) command for a description of the fields in this command.

18.2.6 SEND MESSAGE(12) command

The SEND MESSAGE(12) command (see table 360) transfers data from the initiator to the target.

Table 360 - SEND MESSAGE(12) command

Bit Byte	7	6	5	4	3	2	1	0
0	Operation code (AAh)							
1	Logical unit number			Reserved				
2	Reserved							
3	Reserved							
4	(MSB)	Stream selection					(LSB)	
5								
6	(MSB)						(LSB)	
7								
8	Transfer length							
9								
10	Reserved							
11	Control							

The stream selection field specifies a further level of addressing for the data, so that it can be directed by the target to the appropriate data stream.

Please refer to the SEND MESSAGE(6) command for a description of the fields in this command.

18.3 Parameters for communication devices

18.3.1 Diagnostic parameters

This subclause defines the descriptors and pages for diagnostic parameters used with communication devices.

The diagnostic page codes for communication devices are defined in table 361.

Table 361 - Diagnostic page codes

Page Code	Description	Subclause
00h	Supported log pages	8.3.1.1
01h - 3Fh	Reserved (for all device type pages)	
40h - 7Fh	Reserved	
80h - FFh	Vendor-specific pages	

18.3.2 Log parameters

This subclause defines the descriptors and pages for log parameters used with communication devices.

The log page codes for communication devices are defined in table 362.

Table 362 - Log page codes

Page code	Description	Subclause
01h	Buffer over-run/under-run page	8.3.2.1
02h	Error counter page (write) page	8.3.2.2
03h	Error counter page (read) page	8.3.2.2
04h	Error counter page (read reverse) page	8.3.2.2
05h	Error counter page (verify) page	8.3.2.2
07h	Last n error events page	8.3.2.3
06h	Non-medium error page	8.3.2.4
00h	Supported log pages	8.3.2.5
08h - 2Fh	Reserved	
30h - 3Eh	Vendor-specific pages	
3Fh	Reserved	

18.3.3 Mode parameters

This subclause defines the descriptors and pages for mode parameters used with communication devices.

The mode parameter list, including the mode parameter header and mode block descriptor, are defined in 8.3.3.

The medium-type code field is contained in the mode parameter header (see 8.3.3). This field is reserved for communications devices.

The device specific parameter field is contained in the mode parameter header (see 8.3.3). This field is reserved for communications devices.

The density code field is contained in the mode parameter block descriptor (see 8.3.3). This field is reserved for communications devices.

The mode page codes for communications devices are shown in table 363.

Table 363 - Mode page codes

Page code	Description	Subclause
0Ah	Control mode page	8.3.3.1
02h	Disconnect-reconnect page	8.3.3.2
09h	Peripheral device page	8.3.3.3
01h	Reserved	
03h - 08h	Reserved	
0Bh - 1Fh	Reserved	
00h	Vendor-specific (does not require page format)	
20h - 3Eh	Vendor-specific (page format required)	
3Fh	Return all pages (valid only for the MODE SENSE command)	

ANSI X3.131-1994

18.4 Definitions specific to communications devices

18.4.1 communications device: An SCSI device whose principal function is to communicate with one or more other systems, usually over distances that exceed the maximum cable length defined for SCSI.

18.4.2 external medium: The medium used by the communications device to send or receive information to or from one or more communications devices. The other communications devices may or may not use an SCSI interface.

18.4.3 external protocol: The protocol(s) used by the communications device to transfer information over the external medium. The external protocol(s) are not defined by this standard.

Annex A (informative)

SCSI signal sequence example

This annex is included to provide an example of the signal sequencing of an I/O process that includes most of the SCSI bus phases (see figure 29). In this example, the target does not disconnect from the SCSI bus prior to completing the I/O process.

In a typical system, the computer's host adapter acts as the initiator and the peripheral device's controller acts as the target. In general, this standard does not attempt to distinguish between a computer and its host adapter. These functions may be separate or merged. The term initiator encompasses both. The term target refers to the controller portion of the peripheral device, which may be separate (bridge controller) from the peripheral device or merged with it (embedded controller). The term SCSI device refers to a device that may be connected to the SCSI bus. An SCSI device may act in the initiator role, the target role, or both roles.

The following notes apply to figure A.1.

DATA BUS NOTES

- 1) DB(7) is the most significant bit.
- 2) DB(7) is the highest priority arbitration bit.
- 3) DB(P) is the data parity bit (odd). Parity is not valid during the ARBITRATION phase.

BUS PHASE NOTES

- 1) **BUS FREE phase.** BUS FREE phase begins when the SEL and BSY signals are both continuously false for a bus settle delay. It ends when the BSY signal becomes true. (In the SCSI-1 single-initiator option, BUS FREE phase could also end when the SEL signal became true.)
- 2) **ARBITRATION phase.** This phase is documented as mandatory in SCSI-2. In SCSI-1, this phase was optional.

At least one bus free delay after first detecting BUS FREE phase, but no more than a bus set delay after the bus was last free, the initiator asserts the BSY signal and its assigned SCSI device ID bit on the DATA BUS. The initiator waits an arbitration delay, then examines the DATA BUS. If a higher priority SCSI device ID bit is true, the initiator loses arbitration and may release the BSY signal and its SCSI ID bit. Otherwise, the initiator wins arbitration and asserts the SEL signal. All SCSI devices must release the BSY signal and their SCSI ID bit within a bus clear delay after the SEL signal becomes true (even if they have not yet examined the DATA BUS). The winning SCSI device waits at least a bus clear delay plus a bus settle delay after asserting the SEL signal before changing any signals on the bus.

- 3) **SELECTION phase.** The I/O signal is false during this phase to distinguish it from the RESELECTION phase.

NON-ARBITRATING SYSTEMS (only permitted in SCSI-1): In such systems, the initiator waits at least a bus clear delay after detecting BUS FREE phase, then it asserts the target's SCSI ID bit and, optionally, the initiator's SCSI ID bit on the DATA BUS. After at least two deskew delays, the initiator asserts the SEL signal.

ARBITRATING SYSTEMS: In such systems, the SCSI device that won arbitration has both the BSY and SEL signals asserted. After at least a bus clear delay plus a bus settle delay, it places both the target's and the initiator's SCSI ID bits on the DATA BUS. At least two deskew delays later, it releases the BSY signal.

ALL SYSTEMS: The target determines that it is selected when the SEL signal and its SCSI ID bit are true and the BSY and I/O signals are false for at least a bus settle delay. The target then asserts the BSY signal within a selection abort time after it last determined that it was still being selected. (The target is not required to respond to a selection within a selection abort time; but it must ensure that it will not assert the BSY signal more than a selection abort time after the initiator aborts a selection attempt.)

At least two deskew delays after the initiator detects the BSY signal is true, it releases the SEL signal.

- 4) **MESSAGE OUT phase.** During this phase the initiator sends an IDENTIFY message to the target. The target asserts the C/D and MSG signals and negates the I/O signal for the message transfer. After detecting the assertion of the REQ signal, the initiator negates the ATN signal before asserting the ACK signal. (Refer to the handshake procedure for the command phase.)
- 5) **COMMAND phase.** The target asserts the C/D signal and negates the I/O and MSG signals for all of the bytes transferred during this phase. The direction of transfer is from the initiator to the target.

HANDSHAKE PROCEDURE: The target asserts the REQ signal. Upon detecting the REQ signal is true, the initiator drives the DATA BUS to the desired value, waits at least one deskew delay plus a cable skew delay and then asserts the ACK signal. The initiator continues to drive the DATA BUS until the REQ signal is false.

When the ACK signal is true at the target, the target reads the DATA BUS and then negates the REQ signal.

When the REQ signal becomes false at the initiator, the initiator may change or release the DATA BUS and negate the ACK signal.

The target may continue to request command bytes by asserting the REQ signal again. The number of command bytes is determined by the group code (most significant 3 bits) that is contained in the first command byte.

- 6) **DATA IN phase.** The target asserts the I/O signal and negates the C/D and MSG signal for all of the bytes transferred during this phase. The direction of transfer is from the target to the initiator.

HANDSHAKE PROCEDURE: The target first drives the DATA BUS to their desired values, waits at least one deskew delay plus a cable skew delay, and then asserts the REQ signal. The target continues to drive the DATA BUS until the ACK signal is true.

When the REQ signal is true at the initiator, the initiator reads the DATA BUS and then asserts the ACK signal.

When the ACK signal is true at the target, the target may change or release the DATA BUS and negate the REQ signal.

When the REQ signal is false at the initiator, the initiator negates the ACK signal. After the ACK signal is false, the target may continue the transfer by driving the DATA BUS and asserting the REQ signal as described above.

- 7) **DATA OUT phase (not shown in the figure).** The target negates the C/D, I/O, and MSG signals for all of the bytes transferred during this phase. The direction of transfer is from the initiator to the target. (Refer to the handshake procedure for the command phase.)
- 8) **STATUS phase.** The target asserts the C/D and I/O signals and negates the MSG signal for the byte transferred during this phase. The direction of transfer is from the target to the initiator. (Refer to the handshake procedure for the DATA IN phase.)

- 9) **MESSAGE IN phase.** The target asserts the C/D, I/O, and MSG signals during the byte transferred during this phase. Typically, a command COMPLETE message would be sent at this point. The direction of transfer is from the target to the initiator. (Refer to the handshake procedure for the DATA IN phase.)
- 10) **BUS FREE phase.** The target returns to BUS FREE phase by releasing the BSY signal. Both the target and the initiator release all bus signals within a bus clear delay after the BSY signal is continuously false for a bus settle delay.

NOTE - Please refer to the notes contained in the text of annex A.

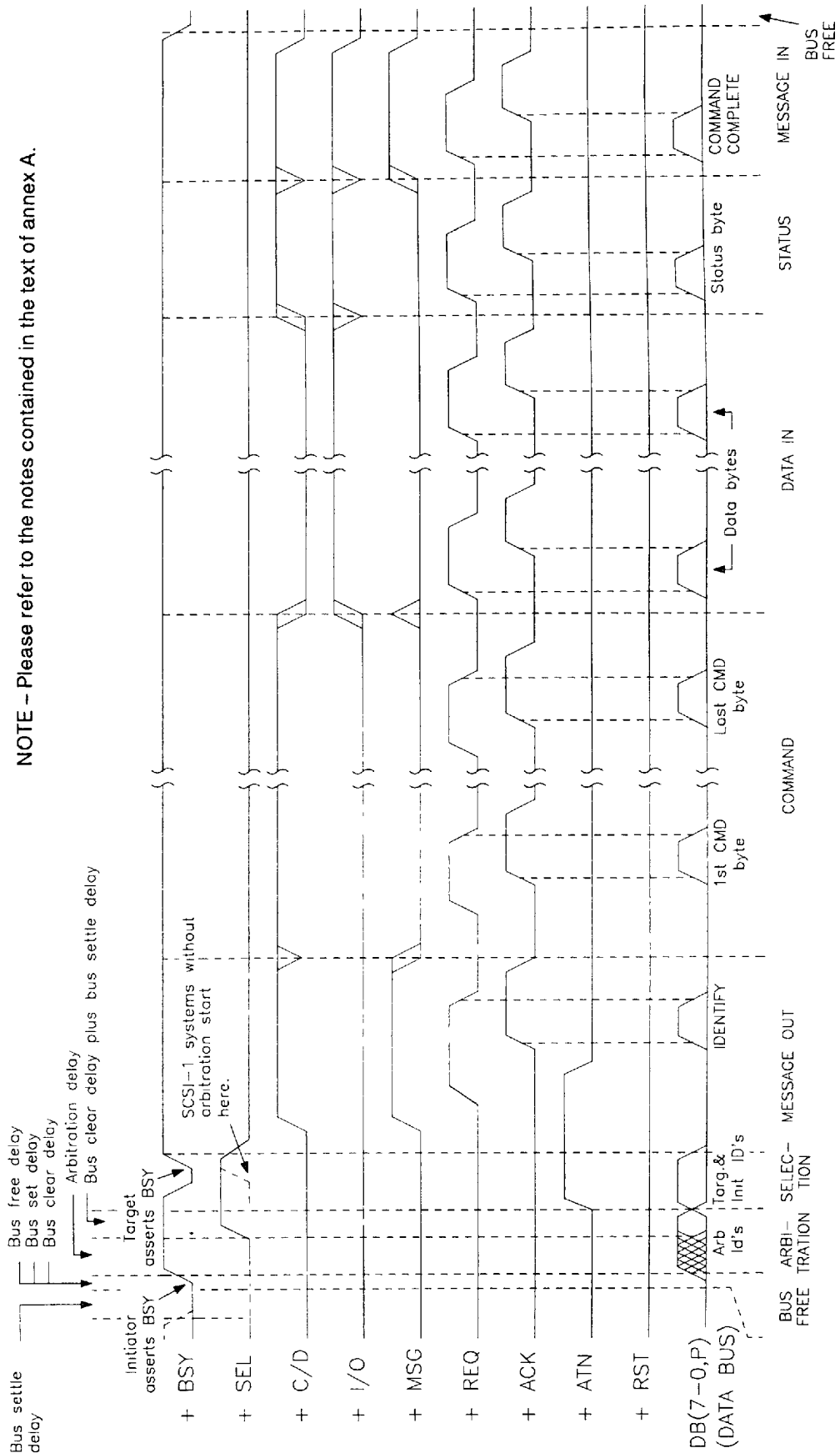

Figure A.1 - SCSI signal sequence example

Annex B (informative)

Fast SCSI skew time

This annex is included to explain the skew budget for the fast SCSI option which is defined in Clause 4.

Synchronous transfer rates using a transfer period between 100 ns and 200 ns are known as the fast SCSI option. Fast data transfer times have been tested using the following skew budget (see table B.1) with the differential alternative using transceivers with 25 m of 0,080 42 mm² (28 AWG) twisted pair cable as specified in 5.2.3. The transceivers were subjected to a maximum temperature difference of 25° C and a maximum of 200 mV of V_{CC} difference.

Table B.1 - Fast SCSI jitter budget

Parameter label	Description	Jitter budget +/- ns	
Transmitting Device	a	clock offset	5
	b	transmitting logic skew	3
	c	foil delay	1
	d	transmitter propagation delay skew	6
	e	foil delay	1
	f	drop cable propagation delay	1
-- Connector	-----		
Cable	g	external cable - skew between pairs	5
	h	distortion due to cable impedance	1
	i	distortion due to intersymbol interference	2
	j	bias distortion	2
-- Connector	-----		
Receiving Device	k	drop cable propagation delay	1
	l	foil delay	1
	m	receiver propagation delay skew	9
	n	foil delay	1
	o	logic setup/hold	5
total jitter budget		44	

Mapping the above jitter or skew budget to the SCSI format in 5.7 and 5.8 is done in Table B.2.

Table B.2 - Mapping of jitter to SCSI

SCSI timing parameter	Calculation	Value (ns)
Fast cable skew delay	g	5
Fast deskew delay	SUM(h..n)	20 (note 1)
Fast hold time	o	10 (note 1)
Fast assertion period	(note 2)	30
Fast negation period	(note 2)	30
Notes		
1) Value is rounded up from the jitter budget.		
2) The fast assertion period and fast negation period are derived from isolated pulse measurements and represent a minimum pulse width with a satisfactory margin.		

ANSI X3.131-1994

The maximum driver skew allowed was 6 ns (t_{PLH} min. - t_{PHL} max.) and the maximum receiver skew tested was 9 ns (t_{PLH} min. - t_{PHL} max.). Values greater than these could be used if other numbers could be reduced -- the sum is what is important.

Fast data transfer timing parameters were not tested for the single-ended transceiver option prior to publication of this standard.

Annex C (informative)

Other SCSI standardization activities

This annex provides information on other formal standardization activities related to SCSI.

C.1 SCSI-3 standards projects

Accredited Standards Committee X3 has approved several SCSI-3 projects to enhance and restructure the SCSI-2 standard as shown in figure C.1. These projects (except fibre channel) are assigned to the X3T10 Technical Committee which developed this standard and the SCSI-1 standard. Please contact the Chairman of X3T10 for further information concerning these projects.

C.2 Digital data exchange for color electronic prepress systems

Accredited Standards Committee IT8 has developed several standards pertaining to the exchange of digital data between color electronic prepress systems. These devices are used for high quality color printing. At least one of the IT8 projects involves transferring such data over SCSI. Please contact the Secretariat of IT8 for further information concerning their projects.

C.3 Fibre channel

Accredited Standards Committee X3 has approved a project to develop a fibre optic channel physical layer for the Intelligent Peripheral Interface (IPI), SCSI, and the High Performance Parallel Interface (HIPPI). This project is assigned to the X3T11 Technical Committee. Please contact the Chairman of X3T11 for further information concerning this project.

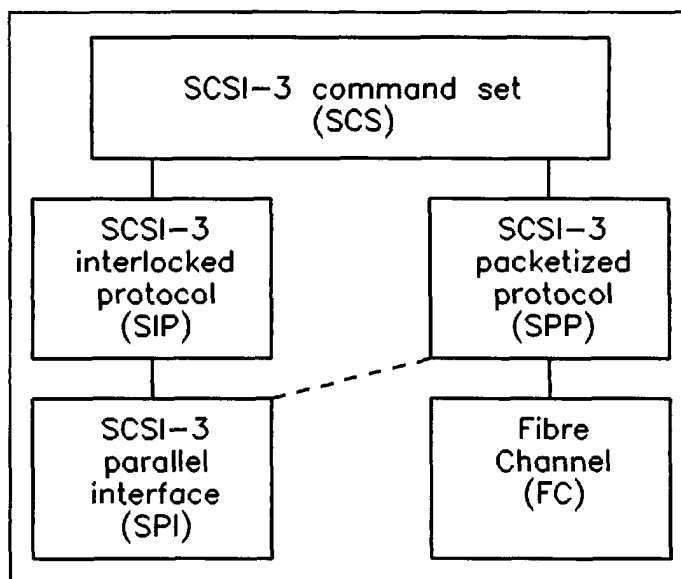

Figure C.1 - SCSI-3 standards structure

Annex D (informative)

Numeric order codes

This annex contains SCSI-2 additional sense codes and operation codes in numeric order as a reference. In the event of a conflict with between the codes in this annex and the body of this standard, the codes in the body should be regarded as correct.

Table D.1 is a numerical order listing of the additional sense codes and the additional sense code qualifiers.

Table D.1 - ASC and ASCQ assignments

ASC	ASCQ	DTLPWRSOMC	DESCRIPTION
			D - DIRECT ACCESS DEVICE
			.T - SEQUENTIAL ACCESS DEVICE
			.L - PRINTER DEVICE
			.P - PROCESSOR DEVICE
			.W - WRITE ONCE READ MULTIPLE DEVICE
			.R - READ ONLY (CD-ROM) DEVICE
			.S - SCANNER DEVICE
			.O - OPTICAL MEMORY DEVICE
			.M - MEDIA CHANGER DEVICE
			.C - COMMUNICATION DEVICE
00	00	DTLPWRSOMC	NO ADDITIONAL SENSE INFORMATION
00	01	T	FILEMARK DETECTED
00	02	T S	END-OF-PARTITION/MEDIUM DETECTED
00	03	T	SETMARK DETECTED
00	04	T S	BEGINNING-OF-PARTITION/MEDIUM DETECTED
00	05	T S	END-OF-DATA DETECTED
00	06	DTLPWRSOMC	I/O PROCESS TERMINATED
00	11	R	AUDIO PLAY OPERATION IN PROGRESS
00	12	R	AUDIO PLAY OPERATION PAUSED
00	13	R	AUDIO PLAY OPERATION SUCCESSFULLY COMPLETED
00	14	R	AUDIO PLAY OPERATION STOPPED DUE TO ERROR
00	15	R	NO CURRENT AUDIO STATUS TO RETURN
01	00	DW O	NO INDEX/SECTOR SIGNAL
02	00	DWR OM	NO SEEK COMPLETE
03	00	DTL W SO	PERIPHERAL DEVICE WRITE FAULT
03	01	T	NO WRITE CURRENT
03	02	T	EXCESSIVE WRITE ERRORS
04	00	DTLPWRSOMC	LOGICAL UNIT NOT READY, CAUSE NOT REPORTABLE
04	01	DTLPWRSOMC	LOGICAL UNIT IS IN PROCESS OF BECOMING READY
04	02	DTLPWRSOMC	LOGICAL UNIT NOT READY, INITIALIZING COMMAND REQUIRED
04	03	DTLPWRSOMC	LOGICAL UNIT NOT READY, MANUAL INTERVENTION REQUIRED
04	04	DTL O	LOGICAL UNIT NOT READY, FORMAT IN PROGRESS
05	00	DTL WRSOMC	LOGICAL UNIT DOES NOT RESPOND TO SELECTION
06	00	DWR OM NO	REFERENCE POSITION FOUND
07	00	DTL WRSOMC	MULTIPLE PERIPHERAL DEVICES SELECTED
08	00	DTL WRSOMC	LOGICAL UNIT COMMUNICATION FAILURE
08	01	DTL WRSOMC	LOGICAL UNIT COMMUNICATION TIME-OUT
08	02	DTL WRSOMC	LOGICAL UNIT COMMUNICATION PARITY ERROR
09	00	DT WR O	TRACK FOLLOWING ERROR
09	01	WR O	TRACKING SERVO FAILURE
09	02	WR O	FOCUS SERVO FAILURE
09	03	WR O	SPINDLE SERVO FAILURE

Table D.1 (continued)

ASC	ASCQ	DTLPWRSOMC	DESCRIPTION
			D - DIRECT ACCESS DEVICE
			.T - SEQUENTIAL ACCESS DEVICE
			. L - PRINTER DEVICE
			. P - PROCESSOR DEVICE
			. .W - WRITE ONCE READ MULTIPLE DEVICE
			. . R - READ ONLY (CD-ROM) DEVICE
			. . S - SCANNER DEVICE
			. . .O - OPTICAL MEMORY DEVICE
			. . . M - MEDIA CHANGER DEVICE
			. . . C - COMMUNICATION DEVICE
ASC	ASCQ	DTLPWRSOMC	DESCRIPTION
0A	00	DTLPWRSOMC	ERROR LOG OVERFLOW
0B	00		
0C	00	T S	WRITE ERROR
0C	01	D W O	WRITE ERROR RECOVERED WITH AUTO REALLOCATION
0C	02	D W O	WRITE ERROR - AUTO REALLOCATION FAILED
0D	00		
0E	00		
0F	00		
10	00	D W O	ID CRC OR ECC ERROR
11	00	DT WRSO	UNRECOVERED READ ERROR
11	01	DT W SO	READ RETRIES EXHAUSTED
11	02	DT W SO	ERROR TOO LONG TO CORRECT
11	03	DT W SO	MULTIPLE READ ERRORS
11	04	D W O	UNRECOVERED READ ERROR - AUTO REALLOCATE FAILED
11	05	WR O	L-EC UNCORRECTABLE ERROR
11	06	WR O	CIRC UNRECOVERED ERROR
11	07	W O	DATA RESYNCHRONIZATION ERROR
11	08	T	INCOMPLETE BLOCK READ
11	09	T	NO GAP FOUND
11	0A	DT O	MISCORRECTED ERROR
11	0B	D W O	UNRECOVERED READ ERROR - RECOMMEND REASSIGNMENT
11	0C	D W O	UNRECOVERED READ ERROR - RECOMMEND REWRITE THE DATA
12	00	D W O	ADDRESS MARK NOT FOUND FOR ID FIELD
13	00	D W O	ADDRESS MARK NOT FOUND FOR DATA FIELD
14	00	DTL WRSO	RECORDED ENTITY NOT FOUND
14	01	DT WR O	RECORD NOT FOUND
14	02	T	FILEMARK OR SETMARK NOT FOUND
14	03	T	END-OF-DATA NOT FOUND
14	04	T	BLOCK SEQUENCE ERROR
15	00	DTL WRSOM	RANDOM POSITIONING ERROR
15	01	DTL WRSOM	MECHANICAL POSITIONING ERROR
15	02	DT WR O	POSITIONING ERROR DETECTED BY READ OF MEDIUM
16	00	DW O	DATA SYNCHRONIZATION MARK ERROR
17	00	DT WRSO	RECOVERED DATA WITH NO ERROR CORRECTION APPLIED
17	01	DT WRSO	RECOVERED DATA WITH RETRIES
17	02	DT WR O	RECOVERED DATA WITH POSITIVE HEAD OFFSET
17	03	DT WR O	RECOVERED DATA WITH NEGATIVE HEAD OFFSET
17	04	WR O	RECOVERED DATA WITH RETRIES AND/OR CIRC APPLIED
17	05	D WR O	RECOVERED DATA USING PREVIOUS SECTOR ID
17	06	D W O	RECOVERED DATA WITHOUT ECC - DATA AUTO-REALLOCATED
17	07	D W O	RECOVERED DATA WITHOUT ECC - RECOMMEND REASSIGNMENT
17	08	D W O	RECOVERED DATA WITHOUT ECC - RECOMMEND REWRITE
18	00	DT WR O	RECOVERED DATA WITH ERROR CORRECTION APPLIED
18	01	D WR O	RECOVERED DATA WITH ERROR CORRECTION & RETRIES APPLIED
18	02	D WR O	RECOVERED DATA - DATA AUTO-REALLOCATED
18	03	R	RECOVERED DATA WITH CIRC
18	04	R	RECOVERED DATA WITH LEC
18	05	D WR O	RECOVERED DATA - RECOMMEND REASSIGNMENT
18	06	D WR O	RECOVERED DATA - RECOMMEND REWRITE

ANSI X3.131-1994

Table D.1 (continued)

ASC	ASCQ	DTLPWRSOMC	DESCRIPTION
			D - DIRECT ACCESS DEVICE
			.T - SEQUENTIAL ACCESS DEVICE
			.L - PRINTER DEVICE
			.P - PROCESSOR DEVICE
			.W - WRITE ONCE READ MULTIPLE DEVICE
			.R - READ ONLY (CD-ROM) DEVICE
			.S - SCANNER DEVICE
			.O - OPTICAL MEMORY DEVICE
			.M - MEDIA CHANGER DEVICE
			.C - COMMUNICATION DEVICE
ASC	ASCQ	DTLPWRSOMC	DESCRIPTION
19	00	D 0	DEFECT LIST ERROR
19	01	D 0	DEFECT LIST NOT AVAILABLE
19	02	D 0	DEFECT LIST ERROR IN PRIMARY LIST
19	03	D 0	DEFECT LIST ERROR IN GROWN LIST
1A	00	DTLPWRSOMC	PARAMETER LIST LENGTH ERROR
1B	00	DTLPWRSOMC	SYNCHRONOUS DATA TRANSFER ERROR
1C	00	D 0	DEFECT LIST NOT FOUND
1C	01	D 0	PRIMARY DEFECT LIST NOT FOUND
1C	02	D 0	GROWN DEFECT LIST NOT FOUND
1D	00	D W 0	MISCOMPARE DURING VERIFY OPERATION
1E	00	D W 0	RECOVERED ID WITH ECC
1F	00		
20	00	DTLPWRSOMC	INVALID COMMAND OPERATION CODE
21	00	DT WR OM	LOGICAL BLOCK ADDRESS OUT OF RANGE
21	01	M	INVALID ELEMENT ADDRESS
22	00	D	ILLEGAL FUNCTION (SHOULD USE 20 00, 24 00, OR 26 00)
23	00		
24	00	DTLPWRSOMC	INVALID FIELD IN CDB
25	00	DTLPWRSOMC	LOGICAL UNIT NOT SUPPORTED
26	00	DTLPWRSOMC	INVALID FIELD IN PARAMETER LIST
26	01	DTLPWRSOMC	PARAMETER NOT SUPPORTED
26	02	DTLPWRSOMC	PARAMETER VALUE INVALID
26	03	DTLPWRSOMC	THRESHOLD PARAMETERS NOT SUPPORTED
27	00	DT W 0	WRITE PROTECTED
28	00	DTLPWRSOMC	NOT READY TO READY TRANSITION(MEDIUM MAY HAVE CHANGED)
28	01	M	IMPORT OR EXPORT ELEMENT ACCESSED
29	00	DTLPWRSOMC	POWER ON, RESET, OR BUS DEVICE RESET OCCURRED
2A	00	DTL WRSOMC	PARAMETERS CHANGED
2A	01	DTL WRSOMC	MODE PARAMETERS CHANGED
2A	02	DTL WRSOMC	LOG PARAMETERS CHANGED
2B	00	DTLPWRSO C	COPY CANNOT EXECUTE SINCE HOST CANNOT DISCONNECT
2C	00	DTLPWRSOMC	COMMAND SEQUENCE ERROR
2C	01	S	TOO MANY WINDOWS SPECIFIED
2C	02	S	INVALID COMBINATION OF WINDOWS SPECIFIED
2D	00	T	OVERWRITE ERROR ON UPDATE IN PLACE
2E	00		
2F	00	DTLPWRSOMC	COMMANDS CLEARED BY ANOTHER INITIATOR
30	00	DT WR OM	INCOMPATIBLE MEDIUM INSTALLED
30	01	DT WR 0	CANNOT READ MEDIUM - UNKNOWN FORMAT
30	02	DT WR 0	CANNOT READ MEDIUM - INCOMPATIBLE FORMAT
30	03	DT	CLEANING CARTRIDGE INSTALLED
31	00	DT W 0	MEDIUM FORMAT CORRUPTED
31	01	D L 0	FORMAT COMMAND FAILED
32	00	D W 0	NO DEFECT SPARE LOCATION AVAILABLE
32	01	D W 0	DEFECT LIST UPDATE FAILURE
33	00	T	TAPE LENGTH ERROR
34	00		
35	00		
36	00	L	RIBBON, INK, OR TONER FAILURE

Table D.1 (continued)

ASC	ASCQ	DTLPWRSOMC	DESCRIPTION
			D - DIRECT ACCESS DEVICE
			.T - SEQUENTIAL ACCESS DEVICE
			.L - PRINTER DEVICE
			.P - PROCESSOR DEVICE
			.W - WRITE ONCE READ MULTIPLE DEVICE
			.R - READ ONLY (CD-ROM) DEVICE
			.S - SCANNER DEVICE
			.O - OPTICAL MEMORY DEVICE
			.M - MEDIA CHANGER DEVICE
			.C - COMMUNICATION DEVICE
ASC	ASCQ	DTLPWRSOMC	DESCRIPTION
37	00	DTL WRSOMC	ROUNDED PARAMETER
38	00		
39	00	DTL WRSOMC	SAVING PARAMETERS NOT SUPPORTED
3A	00	DTL WRSOM	MEDIUM NOT PRESENT
3B	00	TL	SEQUENTIAL POSITIONING ERROR
3B	01	T	TAPE POSITION ERROR AT BEGINNING-OF-MEDIUM
3B	02	T	TAPE POSITION ERROR AT END-OF-MEDIUM
3B	03	L	TAPE OR ELECTRONIC VERTICAL FORMS UNIT NOT READY
3B	04	L	SLEW FAILURE
3B	05	L	PAPER JAM
3B	06	L	FAILED TO SENSE TOP-OF-FORM
3B	07	L	FAILED TO SENSE BOTTOM-OF-FORM
3B	08	T	REPOSITION ERROR
3B	09	S	READ PAST END OF MEDIUM
3B	0A	S	READ PAST BEGINNING OF MEDIUM
3B	0B	S	POSITION PAST END OF MEDIUM
3B	0C	S	POSITION PAST BEGINNING OF MEDIUM
3B	0D	M	MEDIUM DESTINATION ELEMENT FULL
3B	0E	M	MEDIUM SOURCE ELEMENT EMPTY
3C	00		
3D	00	DTLPWRSOMC	INVALID BITS IN IDENTIFY MESSAGE
3E	00	DTLPWRSOMC	LOGICAL UNIT HAS NOT SELF-CONFIGURED YET
3F	00	DTLPWRSOMC	TARGET OPERATING CONDITIONS HAVE CHANGED
3F	01	DTLPWRSOMC	MICROCODE HAS BEEN CHANGED
3F	02	DTLPWRSOMC	CHANGED OPERATING DEFINITION
3F	03	DTLPWRSOMC	INQUIRY DATA HAS CHANGED
40	00	D	RAM FAILURE (SHOULD USE 40 NN)
40	NN	DTLPWRSOMC	DIAGNOSTIC FAILURE ON COMPONENT NN (80H-FFH)
41	00	D	DATA PATH FAILURE (SHOULD USE 40 NN)
42	00	D	POWER-ON OR SELF-TEST FAILURE (SHOULD USE 40 NN)
43	00	DTLPWRSOMC	MESSAGE ERROR
44	00	DTLPWRSOMC	INTERNAL TARGET FAILURE
45	00	DTLPWRSOMC	SELECT OR RESELECT FAILURE
46	00	DTLPWRSOMC	UNSUCCESSFUL SOFT RESET
47	00	DTLPWRSOMC	SCSI PARITY ERROR
48	00	DTLPWRSOMC	INITIATOR DETECTED ERROR MESSAGE RECEIVED
49	00	DTLPWRSOMC	INVALID MESSAGE ERROR
4A	00	DTLPWRSOMC	COMMAND PHASE ERROR
4B	00	DTLPWRSOMC	DATA PHASE ERROR
4C	00	DTLPWRSOMC	LOGICAL UNIT FAILED SELF-CONFIGURATION
4D	00		
4E	00	DTLPWRSOMC	OVERLAPPED COMMANDS ATTEMPTED
4F	00		
50	00	T	WRITE APPEND ERROR
50	01	T	WRITE APPEND POSITION ERROR
50	02	T	POSITION ERROR RELATED TO TIMING
51	00	T	ERASE FAILURE
52	00	T	CARTRIDGE FAULT

ANSI X3.131-1994

Table D.1 (continued)

ASC	ASCQ	DTLPWRSOMC	DESCRIPTION
			D - DIRECT ACCESS DEVICE
			.T - SEQUENTIAL ACCESS DEVICE
			.L - PRINTER DEVICE
			.P - PROCESSOR DEVICE
			.W - WRITE ONCE READ MULTIPLE DEVICE
			.R - READ ONLY (CD-ROM) DEVICE
			.S - SCANNER DEVICE
			.O - OPTICAL MEMORY DEVICE
			.M - MEDIA CHANGER DEVICE
			.C - COMMUNICATION DEVICE
53	00	DTL WRSOM	MEDIA LOAD OR EJECT FAILED
53	01	T	UNLOAD TAPE FAILURE
53	02	DT WR OM	MEDIUM REMOVAL PREVENTED
54	00	P	SCSI TO HOST SYSTEM INTERFACE FAILURE
55	00	P	SYSTEM RESOURCE FAILURE
56	00		
57	00	R	UNABLE TO RECOVER TABLE-OF-CONTENTS
58	00	O	GENERATION DOES NOT EXIST
59	00	O	UPDATED BLOCK READ
5A	00	DTLPWRSOM	OPERATOR REQUEST OR STATE CHANGE INPUT (UNSPECIFIED)
5A	01	DT WR OM	OPERATOR MEDIUM REMOVAL REQUEST
5A	02	DT W O	OPERATOR SELECTED WRITE PROTECT
5A	03	DT W O	OPERATOR SELECTED WRITE PERMIT
5B	00	DTLPWRSOM	LOG EXCEPTION
5B	01	DTLPWRSOM	THRESHOLD CONDITION MET
5B	02	DTLPWRSOM	LOG COUNTER AT MAXIMUM
5B	03	DTLPWRSOM	LOG LIST CODES EXHAUSTED
5C	00	D O	RPL STATUS CHANGE
5C	01	D O	SPINDLES SYNCHRONIZED
5C	02	D O	SPINDLES NOT SYNCHRONIZED
5D	00		
5E	00		
5F	00		
60	00	S	LAMP FAILURE
61	00	S	VIDEO ACQUISITION ERROR
61	01	S	UNABLE TO ACQUIRE VIDEO
61	02	S	OUT OF FOCUS
62	00	S	SCAN HEAD POSITIONING ERROR
63	00	R	END OF USER AREA ENCOUNTERED ON THIS TRACK
64	00	R	ILLEGAL MODE FOR THIS TRACK
65	00		
66	00		
67	00		
68	00		
69	00		
6A	00		
6B	00		
6C	00		
6D	00		
6E	00		
6F	00		

Table D.1 (concluded)

ASC	ASCQ	DTLPWRSOMC	DESCRIPTION
			D - DIRECT ACCESS DEVICE
			.T - SEQUENTIAL ACCESS DEVICE
			.L - PRINTER DEVICE
			.P - PROCESSOR DEVICE
			.W - WRITE ONCE READ MULTIPLE DEVICE
			.R - READ ONLY (CD-ROM) DEVICE
			.S - SCANNER DEVICE
			.O - OPTICAL MEMORY DEVICE
			.M - MEDIA CHANGER DEVICE
			.C - COMMUNICATION DEVICE
70	00		
71	00		
72	00		
73	00		
74	00		
75	00		
76	00		
77	00		
78	00		
79	00		
7A	00		
7B	00		
7C	00		
7D	00		
7E	00		
7F	00		
80	xxh \		
	THROUGH >		Vendor-specific.
FF	xxh /		
xxh	80 \		
	THROUGH >		Vendor-specific QUALIFICATION OF STANDARD ASC.
xxh	FF /		
			ALL CODES NOT SHOWN OR BLANK ARE RESERVED.

Table D.2 is a numerical order listing of the command operation codes.

Table D.2 - SCSI-2 Operation Codes

OP	DTLPWRSOMC	Description	Device column key
		D - DIRECT ACCESS DEVICE	M = Mandatory
		.T - SEQUENTIAL ACCESS DEVICE	O = Optional
		. L - PRINTER DEVICE	V = Vendor-specific
		. P - PROCESSOR DEVICE	R = Reserved
		. .W - WRITE ONCE READ MULTIPLE DEVICE	
		. . R - READ ONLY (CD-ROM) DEVICE	
		. . S - SCANNER DEVICE	
		. . .O - OPTICAL MEMORY DEVICE	
		. . . M - MEDIA CHANGER DEVICE	
		. . . C - COMMUNICATION DEVICE	
00	MMMMMMMMMM	TEST UNIT READY	
01	M	REWIND	
01	O V OO OO	REZERO UNIT	
02	VVVVVV V		
03	MMMMMMMMMM	REQUEST SENSE	
04	O	FORMAT	
04	M O	FORMAT UNIT	
05	VMVVVV V	READ BLOCK LIMITS	
06	VVVVVV V		
07	O	INITIALIZE ELEMENT STATUS	
07	OVV O OV	REASSIGN BLOCKS	
08		GET MESSAGE(06)	
08	OMV OO OV	READ(06)	
08	O	RECEIVE	
09	VVVVVV V		
0A	M	PRINT	
0A		SEND MESSAGE(06)	
0A	M	SEND(06)	
0A	OM O OV	WRITE(06)	
0B	O OO OV	SEEK(06)	
0B	O	SLEW AND PRINT	
0C	VVVVVV V		
0D	VVVVVV V		
0E	VVVVVV V		
0F	VOVVVV V	READ REVERSE	
10	O O	SYNCHRONIZE BUFFER	
10	VM VVV	WRITE FILEMARKS	
11	VMVVVV	SPACE	
12	MMMMMMMMMM	INQUIRY	
13	VOVVVV	VERIFY(06)	
14	VOOVVV	RECOVER BUFFERED DATA	
15	OMO 000000	MODE SELECT(06)	
16	M MM MO	RESERVE	
16	MM M	RESERVE UNIT	
17	M MM MO	RELEASE	
17	MM M	RELEASE UNIT	
18	00000000	COPY	
19	VMVVVV	ERASE	
1A	OMO 000000	MODE SENSE(06)	
1B	O	LOAD UNLOAD	
1B	O	SCAN	
1B	O	STOP PRINT	
1B	O OO O	STOP START UNIT	

Table D.2 (continued)

OP	DTLPWRSOMC	Description	Device column key
		D - DIRECT ACCESS DEVICE	M = Mandatory
		.T - SEQUENTIAL ACCESS DEVICE	O = Optional
		.L - PRINTER DEVICE	V = Vendor-specific
		.P - PROCESSOR DEVICE	R = Reserved
		.W - WRITE ONCE READ MULTIPLE DEVICE	
		.R - READ ONLY (CD-ROM) DEVICE	
		.S - SCANNER DEVICE	
		.O - OPTICAL MEMORY DEVICE	
		.M - MEDIA CHANGER DEVICE	
		.C - COMMUNICATION DEVICE	
1C	000000000	RECEIVE DIAGNOSTIC RESULTS	
1D	MMMMMMMMMM	SEND DIAGNOSTIC	
1E	00 00 00	PREVENT ALLOW MEDIUM REMOVAL	
1F			
20	V V V		
21	V V V		
22	V V V		
23	V V V		
24	V V M	SET WINDOW	
25	O	GET WINDOW	
25	M M M	READ CAPACITY	
25	M	READ CD-ROM CAPACITY	
26	V V		
27	V V		
28		O GET MESSAGE(10)	
28	M MMM	READ(10)	
29	V V V O	READ GENERATION	
2A		O SEND MESSAGE(10)	
2A	O	SEND(10)	
2A	O M M	WRITE(10)	
2B	O	LOCATE	
2B		O POSITION TO ELEMENT	
2B	O O O	SEEK(10)	
2C	V O	ERASE(10)	
2D	V O O	READ UPDATED BLOCK	
2E	O O O	WRITE AND VERIFY(10)	
2F	O O O	VERIFY(10)	
30	O O O	SEARCH DATA HIGH(10)	
31	O	OBJECT POSITION	
31	O O O	SEARCH DATA EQUAL(10)	
32	O O O	SEARCH DATA LOW(10)	
33	O O O	SET LIMITS(10)	
34	O	GET DATA BUFFER STATUS	
34	O O O	PRE-FETCH	
34	O	READ POSITION	
35	O O O	SYNCHRONIZE CACHE	
36	O O O	LOCK UNLOCK CACHE	
37	O O	READ DEFECT DATA(10)	
38	O O	MEDIUM SCAN	
39	000000000	COMPARE	
3A	000000000	COPY AND VERIFY	
3B	0000000000	WRITE BUFFER	
3C	0000000000	READ BUFFER	
3D	O O	UPDATE BLOCK	
3E	O O O	READ LONG	
3F	O O O	WRITE LONG	

ANSI X3.131-1994

Table D.2 (continued)

OP	DTLPWRSOMC	Description	Device column key
		D - DIRECT ACCESS DEVICE	M = Mandatory
		.T - SEQUENTIAL ACCESS DEVICE	O = Optional
		.L - PRINTER DEVICE	V = Vendor-specific
		.P - PROCESSOR DEVICE	R = Reserved
		.W - WRITE ONCE READ MULTIPLE DEVICE	
		.R - READ ONLY (CD-ROM) DEVICE	
		.S - SCANNER DEVICE	
		.O - OPTICAL MEMORY DEVICE	
		.M - MEDIA CHANGER DEVICE	
		.C - COMMUNICATION DEVICE	
40	0000000000	CHANGE DEFINITION	
41	0	WRITE SAME	
42	0	READ SUB-CHANNEL	
43	0	READ TOC	
44	0	READ HEADER	
45	0	PLAY AUDIO(10)	
46			
47	0	PLAY AUDIO MSF	
48	0	PLAY AUDIO TRACK INDEX	
49	0	PLAY TRACK RELATIVE(10)	
4A			
4B	0	PAUSE RESUME	
4C	0000000000	LOG SELECT	
4D	0000000000	LOG SENSE	
4E			
4F			
50			
51			
52			
53			
54			
55	000 000000	MODE SELECT(10)	
56			
57			
58			
59			
5A	000 000000	MODE SENSE(10)	
5B			
5C			
5D			
5E			
5F			

Table D.2 (concluded)

OP	DTLPWRSOMC	Description
D - DIRECT ACCESS DEVICE .T - SEQUENTIAL ACCESS DEVICE . L - PRINTER DEVICE . P - PROCESSOR DEVICE . .W - WRITE ONCE READ MULTIPLE DEVICE . . R - READ ONLY (CD-ROM) DEVICE . . S - SCANNER DEVICE . . .O - OPTICAL MEMORY DEVICE . . . M - MEDIA CHANGER DEVICE . . . C - COMMUNICATION DEVICE		
Device column key M = Mandatory O = Optional V = Vendor-specific R = Reserved		
A0		
A1		
A2		
A3		
A4		
A5	M	MOVE MEDIUM
A5	O	PLAY AUDIO(12)
A6	O	EXCHANGE MEDIUM
A7		
A8	O	GET MESSAGE(12)
A8	OO O	READ(12)
A9	O	PLAY TRACK RELATIVE(12)
AA	O	SEND MESSAGE(12)
AA	O O	WRITE(12)
AB		
AC	O	ERASE(12)
AD		
AE	O O	WRITE AND VERIFY(12)
AF	OO O	VERIFY(12)
B0	OO O	SEARCH DATA HIGH(12)
B1	OO O	SEARCH DATA EQUAL(12)
B2	OO O	SEARCH DATA LOW(12)
B3	OO O	SET LIMITS(12)
B4		
B5		
B5	O	REQUEST VOLUME ELEMENT ADDRESS
B6		
B6	O	SEND VOLUME TAG
B7	O	READ DEFECT DATA(12)
B8		
B8	O	READ ELEMENT STATUS
B9		
BA		
BB		
BC		
BD		
BE		
BF		

Annex E
(informative)

Vendor identification

This annex contains the list of SCSI-2 vendor identifications (see table E.1) as of the date of this document. The purpose of this list is to help avoid redundant usage of vendor identifications. Technical Committee X3T10 of Accredited Standards Committee X3 maintains an informal list of vendor identifications currently in use. Please contact the chairman of X3T10 prior to using a new vendor identification to avoid conflicts.

Table E.1 - Vendor identification list

ID	Organization
3M	3M Company
ACL	Automated Cartridge Librarys, Inc.
ADAPTEC	Adaptec
ADSI	Adaptive Data Systems, Inc. (a Western Digital subsidiary)
AMCODYNE	Amcodyne
ANAMATIC	Anamartic Limited (England)
ANCOT	ANCOT Corp.
ANRITSU	Anritsu Corporation
APPLE	Apple Computer, Inc.
ARCHIVE	Archive
ASACA	ASACA Corporation
ASPEN	Aspen Peripherals
AST	AST Research
ASTK	Alcatel STK A/S
AT&T	AT&T
ATARI	Atari Corporation
ATTO	ATTO Technology Inc.
ATX	Alphatronix
AVR	Advanced Vision Research
BALLARD	Ballard Synergy Corp.
BERGSWD	Berg Software Design
BEZIER	Bezier Systems, Inc.
BULL	Bull Peripherals Corp.
CalComp	CalComp, A Lockheed Company
CALIPER	Caliper (California Peripheral Corp.)
CAST	Advanced Storage Tech
CDC	Control Data or MPI
CDP	Columbia Data Products
CHEROKEE	Cherokee Data Systems
CHINON	Chinon
CIE&YED	YE Data, C.Itoh Electric Corp.
CIPHER	Cipher Data Products

Table E.1 - (continued)

ID	Organization
Ciprico	Ciprico, Inc.
CMD	CMD Technology
CNGR SFW	Congruent Software, Inc.
COGITO	Cogito
COMPORT	Comport Corp.
COMPSIG	Computer Signal Corporation
CONNER	Conner Peripherals
CPU TECH	CPU Technology, Inc
CREO	CREO Products Inc.
CROSFLD	Crosfield Electronics
CSM, INC	Computer SM, Inc.
CYGNET	Cygnets Systems, Inc.
DATABOOK	Databook, Inc.
DATACOPY	Datcopy Corp.
DATAPT	Datapoint Corp.
DEC	Digital Equipment
DELPHI	Delphi Data Div. of Sparks Industries, Inc.
DENON	Denon/Nippon Columbia
DEST	DEST Corp.
DGC	Data General Corp.
DIGIDATA	Digi-Data Corporation
DILOG	Distributed Logic Corp.
DISC	Document Imaging Systems Corp.
DPT	Distributed Processing Technology
DSM	Deterner Steuerungs- und Maschinenbau GmbH & Co.
DTC QUME	Data Technology Qume
DXIMAGIN	DX Imaging
EMULEX	Emulex
EPSON	Epson
EXABYTE	Exabyte Corp.
FILENET	FileNet Corp.
FUJI	Fuji Electric Co., Ltd. (Japan)
FUJITSU	Fujitsu
FUTURED	Future Domain Corp.
Gen_Dyn	General Dynamics
GIGATAPE	GIGATAPE GmbH
GIGATRND	GigaTrend Incorporated
Goidelic	Goidelic Precision, Inc.
GOULD	Gould
HITACHI	Hitachi America Ltd or Nissei Sangyo America Ltd
HONEYWEL	Honeywell Inc.
HP	Hewlett Packard
IBM	International Business Machines
ICL	ICL
IDE	International Data Engineering, Inc.
IGR	Intergraph Corp.
IMPLTD	Integrated Micro Products Ltd.
IMPRIMIS	Imprimis Technology Inc.
INSITE	Insite Peripherals
IOC	I/O Concepts, Inc.
IOMEGA	Iomega

ANSI X3.131-1994

Table E.1 - (continued)

ID	Organization
ISi	Information Storage inc.
ITC	International Tapetronics Corporation
JVC	JVC Information Products Co.
KENNEDY	Kennedy Company
KODAK	Eastman Kodak
KONAN	Konan
KONICA	Konica Japan
LAPINE	Lapine Technology
LASERDRV	LaserDrive Limited
LASERGR	Lasergraphics, Inc.
LMS	Laser Magnetic Storage International Company
MATSHITA	Matsushita
MAXTOR	Maxtor Corp.
MaxOptix	Maxoptix Corp.
MDI	Micro Design International, Inc.
MELA	Mitsubishi Electronics America
MELCO	Mitsubishi Electric (Japan)
MEMREL	Memrel Corporation
MEMTECH	MemTech Technology
MICROBTX	Microbotics Inc.
MICROP	Micropolis
MICROTEK	Microtek Storage Corp
MINSCRIB	Miniscribe
MITSUMI	MITSUMI Electric Co., Ltd.
MOTOROLA	Motorola
MST	Morning Star Technologies, Inc.
NAI	North Atlantic Industries
NatInst	National Instruments
NatSemi	National Semiconductor Corp.
NCL	NCL America
NCR	NCR Corporation
NEC	NEC
NISCA	NISCA Inc.
NKK	NKK Corp.
NT	Northern Telecom
OCE	Oce Graphics
OMI	Optical Media International
OMNIS	OMNIS Company (FRANCE)
OPTIMEM	Cipher/Optimem
OPTOTECH	Optotech
ORCA	Orca Technology
OSI	Optical Storage International
OTL	OTL Engineering
PASCOsci	Pasco Scientific
PERTEC	Pertec Peripherals Corporation
PFTI	Performance Technology Inc.
PIONEER	Pioneer Electronic Corp.
PRAIRIE	PrairieTek
PRESOFT	PreSoft Architects
PRESTON	Preston Scientific
PRIAM	Priam
PRIMAGFX	Primagraphics Ltd

Table E.1 - (concluded)

ID	Organization
PTI	Peripheral Technology Inc.
QUALSTAR	Qualstar
QUANTEL	Quantel Ltd.
QUANTUM	Quantum Corp.
R-BYTE	R-Byte Inc.
RACALREC	Racal Recorders
RADSTONE	Radstone Technology
RGI	Raster Graphics, Inc.
RICOH	Ricoh
RODIME	Rodime
RTI	Reference Technology
SANKYO	Sankyo Seiki
SANYO	SANYO Electric Co., Ltd.
SCREEN	Dainippon Screen Mfg. Co., Ltd.
SEAGATE	Seagate
SEQUOIA	Sequoia Advanced Technologies, Inc.
Shinko	Shinko Electric Co., Ltd.
SIEMENS	Siemens
SII	Seiko Instruments Inc.
SMS	Scientific Micro Systems/OMTI
SNYSIDE	Sunnyside Computing Inc.
SONIC	Sonic Solutions
SONY	Sony Corporation Japan
SPECTRA	Spectra Logic, a Division of Western Automation Labs, Inc.
SPERRY	Sperry (now Unisys Corp.)
STK	Storage Technology Corporation
SUMITOMO	Sumitomo Electric Industries, Ltd.
SUN	Sun Microsystems, Inc.
SyQuest	SyQuest Technology, Inc.
SYSGEN	Sysgen
T-MITTON	Transmitton England
TALARIS	Talaris Systems, Inc.
TALLGRAS	Tallgrass Technologies
TANDBERG	Tandberg Data A/S
TANDON	Tandon
TEAC	TEAC Japan
TECOLOTE	Techolote Designs
TEGRA	Tegra Varsityper
Tek	Tektronix
TI-DSG	Texas Instruments
TOSHIBA	Toshiba Japan
ULTRA	UltraStor Corporation
UNISYS	Unisys
USDC	US Design Corp.
VERBATIM	Verbatim Corporation
VRC	Vermont Research Corp.
WangDAT	WangDAT
WANGTEK	Wangtek
WDIGTL	Western Digital
WEARNES	Wearnes Technology Corporation
XEBEC	Xebec Corporation

ANSI X3.131-1994

Index

3rdPty bit	176, 179, 237, 238, 378, 380
ABORT	3, 35, 37, 39, 41, 42, 47, 49, 50, 52-56, 61, 71, 75, 77, 78, 80, 400
ABORT TAG	3, 39, 49, 52, 53, 55, 61, 71, 75, 80
absolute CD-ROM address field	300, 306
access bit	373-375
active format field	251
active I/O process	3, 49, 51
active notch field	196, 204, 207
active partition field	250, 251
actual retry count field	116
additional length field	99
additional partitions defined field	253
additional sense code field	114, 115, 372
additional sense code qualifier	114, 115, 285, 372-375
ADDRESS MARK NOT FOUND FOR DATA FIELD	121, 407
ADDRESS MARK NOT FOUND FOR ID FIELD	121, 407
address to translate field	192-194
ADR field	284, 300, 306
advanced scan algorithm	343
AEN	xx, 5, 76-78, 83, 87, 117, 118, 140-142, 274
AENC bit	77, 99
AFC	266, 267
allocation length	64, 68-70, 87, 96, 99, 103, 104, 106, 109-113, 115, 145-149, 171, 172, 273, 296, 297, 305, 323, 325, 345, 346, 368, 369, 371, 376, 377, 393, 394
allocation length field	70, 103
alternate sector	193
alternate sectors per zone field	204
alternate track	194
alternate tracks per logical unit field	204
alternate tracks per zone	202-204
alternate volume tag	362, 371-375, 382
alternate volume tag information field	371
ALTSEC bit	193
ALTTRK bit	194
ANSI-approved version field	87, 98
APRVal	309, 310
arbitration delay	xxx, 34, 35, 40, 399
ARBITRATION phase	32, 33, 35, 36, 39-41, 56, 81, 399
ARRE bit	208
ASA	342, 343
ASC	xvii, xxiii, 98, 115, 121-124, 126, 406-411
ASCII forms control	267
ASCII Implemented Operating Definition Page	144, 145
ASCII information field	146
ASCII operating definition description data field	145
ASCQ	xvii, xxiii, 115, 121-124, 126, 406-411
assertion period	34, 35, 37, 43, 44, 403
asynchronous event notification	xxx, 5, 26, 53, 58, 76-78, 99, 117, 136, 140-142, 223, 226, 274
attention condition	32, 46-49, 53, 56, 60, 75, 77, 80, 83, 87, 96, 102, 104, 119, 129, 133, 139, 141, 176, 215, 237, 248
AUDIO PLAY OPERATION IN PROGRESS	121, 299, 406
AUDIO PLAY OPERATION PAUSED	121, 299, 406
AUDIO PLAY OPERATION STOPPED DUE TO ERROR	121, 299, 406
AUDIO PLAY OPERATION SUCCESSFULLY COMPLETED	121, 299, 406

audio playback rate valid	310
audio status field	299
auto bit	321, 327
autofd	264, 265
automatic line feed	265
automatic read reallocation	208
automatic velocity control	251
automatic write reallocation	208
available data buffer field	324
AVC	250, 251
AVolTag	371-373
AWG	5, 8, 403
AWRE bit	189, 208, 216
basic measurement unit field	336
baud rate field	270
beginning of partition	234
BEGINNING-OF-PARTITION/MEDIUM DETECTED	121, 406
BIS	233, 250, 251, 344
bit ordering field	328
bit pointer field	116
bit pointer valid	116
bits per character field	270
bits per pixel field	328
BLANK CHECK	94, 120, 231, 241, 277, 286, 287, 289, 308, 339, 347, 350, 356
blank verify	282, 350
BlkVfy	282, 350, 351
block address type	229, 233
block descriptor	xviii, 104, 105, 107, 115, 137-139, 150, 194, 195, 230, 243, 246, 247, 263, 264, 281, 307, 308, 318, 319, 331, 333, 335, 355, 356, 384, 397
block descriptor length	137, 138
block device logical block address field	92
block device number of blocks field	92
block identifiers supported	251
block length field	93, 115, 139, 230
block length in bytes	170, 230, 243
block position unknown	234
BLOCK SEQUENCE ERROR	121, 407
BOP	221-225, 233, 234
BPU	233, 234
BPV bit	116
brightness field	327
BT	229, 233
buffer capacity field	110, 111, 128
buffer empty ratio field	142
buffer full ratio field	142
buffer ID field	110, 128
buffer offset field	110, 111
Buffer Over-Run/Under-Run Page	134, 194, 246, 263, 275, 307, 334, 355, 397
buffered mode field	243, 247, 264
bus clear delay	34, 35, 39-41, 48, 399, 401
BUS DEVICE RESET	3, 39, 47, 48, 52, 54-56, 62-64, 66, 71, 75, 78, 80, 83, 103, 104, 107, 123, 167, 177-179, 238, 379, 380, 408
bus free delay	34, 35, 40, 399
BUS FREE phase	3, 4, 35, 36, 39-42, 47, 48, 50, 54-57, 61, 63, 65, 66, 73, 79, 81, 399, 401
bus set delay	34, 36, 40, 399
bus settle delay	34-36, 39-42, 47, 399-401

ANSI X3.131-1994

BUSY status	78-80, 117, 271, 321, 390
BytChk bit	95, 187, 189, 350, 354
byte check	95, 187, 189, 350, 354
byte count of descriptor data available field	371
byte count of report available field	369
byte transfer length field	173, 190
C/D bit	116
cable skew delay	34-37, 43, 44, 400, 403
Caching Page	196, 309, 357
CAF	250, 251
CANNOT READ MEDIUM - INCOMPATIBLE FORMAT	121, 408
CANNOT READ MEDIUM - UNKNOWN FORMAT	121, 408
CAP	250
CARTRIDGE FAULT	121, 409
cat bit	xvii, 89, 92, 94
catenate	92
cause field	xviii, 134, 135
CD-ROM Audio Control Page	309
CD-ROM devices	xxix, 115, 280, 282, 286-288, 295, 307, 308, 310, 312, 318, 338
CD-ROM Page	309
change active format	251
change active partition	250
CHANGE DEFINITION command	xvii, 74, 86, 87, 96, 146, 153
change partition	229
CHANGED OPERATING DEFINITION	75, 121, 409
channel bit	261, 266, 267
channel volume control	311
CHECK CONDITION status	3, 45, 47, 49, 57, 67, 71, 75-77, 83, 85, 88, 90-93, 95, 96, 100-105, 107, 108, 110, 111, 113, 116-118, 125, 126, 128, 130, 131, 133, 134, 136, 139, 143, 151, 154, 158, 159, 161, 162, 164, 170-173, 175, 176, 178, 179, 181, 182, 185, 186, 187, 189-192, 204, 208-211, 213, 215, 218, 225, 227-231, 235, 236, 239-245, 251, 255, 260-262, 271, 276, 285-289, 291-293, 305, 312-317, 321, 329-331, 336, 339, 343, 347, 350, 351, 354, 356, 358, 364-366, 378, 379, 380, 387, 390
CIRC UNRECOVERED ERROR	121, 407
CLEANING CARTRIDGE INSTALLED	121, 408
CLEAR QUEUE	3, 39, 52, 53, 55, 56, 71, 75, 80
clear to send	270
CmpLst bit	159-161
code field	xviii, xx, 69, 90, 96, 104, 107, 108, 112, 114, 115, 130-132, 134, 139, 146, 148, 194, 195, 240, 246, 247, 263, 264, 281, 307, 308, 335, 355, 356, 368, 371, 372, 377, 381, 384, 397
command code	69, 70
COMMAND COMPLETE	3, 39, 49, 50, 52, 56, 59, 71, 73, 74, 78, 81, 87, 401
command data	116, 298
command descriptor block	xvii, 3, 48, 51, 64, 68-71, 73, 75, 81, 91-94, 99, 109, 113, 115, 116, 119, 128, 131, 132, 137-139, 146-148, 162, 166, 170, 176, 183, 185, 186, 205, 227-229, 239, 242, 244, 256, 295, 343, 369
COMMAND phase	39, 46, 48, 58, 71, 73, 78, 118, 121, 400, 409
COMMAND PHASE ERROR	121, 409
command queue	3, 4, 61, 64, 72, 78-81
COMMAND SEQUENCE ERROR	121, 408
COMMAND TERMINATED status	58, 64, 72, 78, 113, 117, 119
command-specific information field	91, 115, 175, 181
COMMANDS CLEARED BY ANOTHER INITIATOR	56, 80, 121, 141, 408
communications devices	1, xxii, xxv, xxix, 390-392, 397, 398
COMPARE command	xvii, 88, 90
complete list	160, 172
CONDITION MET status	71, 72, 166, 181, 343
connect time limit field	143
connection	3, 4, 6, 8, 26, 34, 39, 54-57, 60, 61, 75, 80, 143, 280

PANASONIC CORP., et al.
Ex 1305, p. 449 of 465

contingent allegiance	xxx, 3, 55, 56, 58, 61, 64, 72, 75, 76, 78-80, 83, 85, 87, 112, 140, 141, 223
contrast field	327
control . . . xvii, xviii, xx, xxi, xxxi, 3, 6, 32, 36, 40, 42, 43, 64, 68, 69, 71, 73, 76, 79-81, 86, 88, 89, 95, 96, 101-104, 106, 107, 109, 112, 125-127, 129, 132-134, 136, 140, 143, 151, 152, 158, 159, 161, 165-169, 171, 173-175, 177, 180, 181, 183, 184-191, 196, 199, 208, 215, 227-230, 232, 233, 235-240, 242-244, 249, 251, 257, 259-262, 264-267, 271, 272, 273-276, 282, 284, 285, 288-294, 296-298, 300, 302, 303, 305, 306, 309, 311, 319, 320, 323, 325, 327, 329, 331, 332, 333, 335, 341, 342, 344-354, 357, 360, 364-368, 376, 378, 379, 381, 390, 393-397, 416	
control field	xvii, 71, 101, 103, 106, 107, 284, 306, 319, 320
Control Mode Page	xviii, 64, 76, 79, 80, 133, 134, 136, 140, 196, 249, 264, 309, 335, 357, 397
COPY ABORTED	90-93, 120
COPY AND VERIFY command	xvii, 95, 114, 115, 215
COPY CANNOT EXECUTE SINCE HOST CANNOT DISCONNECT	121, 408
COPY command	xvii, xxxi, 5, 26, 88-92, 94-96, 176, 179, 238, 271
COPY function code field	90
CORRECT bit	173
correct	41, 73, 78, 81, 116, 119, 121, 155, 228, 317, 406, 407
count basis field	134, 135
count field	94, 116, 209-213, 216, 240, 241, 317, 329, 330
CP	229
CTS	269, 270
current I/O process	3, 39, 55, 56, 62, 64, 72, 79
current operating definition field	147
cylinder skew factor field	204
data buffer recovery	251
data buffer status descriptor	323
data bytes per physical sector field	204
data bytes per sector field	200
data defect list	xviii, 159, 171, 172, 346
DATA IN phase	46, 58, 70, 73, 110, 170, 261, 275, 295, 306, 324, 331, 347, 400, 401
DATA OUT phase . . . 46, 68, 70, 77, 89, 101, 102, 105, 116, 128, 159, 160, 259-261, 274, 275, 332, 333, 343, 349, 394, 400	
DATA PATH FAILURE (SHOULD USE 40 NN)	121, 409
DATA PHASE ERROR	121, 409
DATA PROTECT	119, 155, 179, 185, 225, 277, 339
data release delay	34, 36, 47
DATA SYNCHRONIZATION MARK ERROR	121, 407
data transfer disconnect control	xviii, 143
data transfer element	xxii, 359, 360, 364, 366, 368, 375, 385-387, 389
data type qualifier field	331
DBD bit	106
DBR	250, 251
DC bit	92-94
DCR bit	209, 255
DCRT bit	161
default operating definition field	147
defect descriptor	xviii, 159, 160, 162, 163, 172, 174, 175
DEFECT LIST ERROR	121, 161, 408
DEFECT LIST ERROR IN GROWN LIST	121, 408
DEFECT LIST ERROR IN PRIMARY LIST	121, 408
defect list format field	160, 171, 172
defect list length field	162, 172, 175
DEFECT LIST NOT AVAILABLE	121, 408
DEFECT LIST NOT FOUND	121-123, 161, 171, 408
DEFECT LIST UPDATE FAILURE	121, 408
defect logical block address	174, 175

ANSI X3.131-1994

definition parameter field	xvii, 86
demand read retention priority field	197
deskeew delay	34-37, 43, 44, 47, 400, 403
destination count	92, 93
destination logical block address field	93
device off-line	125
device-specific parameter	xx, xxi, 137, 246, 256, 263, 308
DevOfL bit	126
DIAGNOSTIC FAILURE ON COMPONENT NN (80H-FFH)	121, 409
diagnostic parameters	7, 70, 125, 129, 130, 192, 246, 263, 275, 307, 334, 355, 383, 396
direct-access devices	xviii, xxix, 6, 90, 115, 135, 139, 150-152, 154, 157, 192, 194-196, 206, 214, 217, 218, 280, 338, 339
disable block descriptors	106
disable certification	161
disable correction	209, 255
disable page out	152, 169
disable pre-fetch transfer length field	198
disable primary	161
disable queuing	141
disable save	132
disable saving parameters	161
disable transfer on error	209, 255
disable update	132
DISCONNECT	xviii, 3, 5, 36, 39, 45, 47, 48, 50, 52, 54, 56, 57, 59, 71, 73, 74, 79, 81, 112, 117, 121, 140, 142, 143, 196, 249, 264, 271, 272, 309, 335, 357, 390, 391, 397, 399, 408
disconnect time limit field	143
Disconnect-Reconnect Page	xviii, 57, 140, 142, 196, 249, 264, 309, 335, 357, 397
disconnection delay	35, 36, 56
displacement field	182, 183
download microcode	128, 129
DPO bit	152, 169
DPOFUA bit	195, 308, 356
DPRY bit	161
DQue bit	80, 141
drive step pulse width field	200
drive step rate field	200, 215
DS bit	101, 103, 132
DSP bit	161
dt	121-124, 385, 406-408, 410
DTE bit	209, 255
DU bit	132, 133
EAENP bit	141
EBC	308, 350, 356
EBP	352-354
EECA bit	141
EEG	250, 252
EER bit	208, 209, 216, 255
electronic vertical forms unit	124, 266, 267, 409
Element Address Assignment Page	xxii, 386
element address field	360, 372-374, 377, 382, 386, 387
element bit	378-381
element descriptor length field	371
element descriptors	368, 369, 371, 377, 380
element status	xxii, 361-363, 365, 368-371, 373, 377, 412, 415
element type code field	368, 371, 377, 381
enable blank check	308, 350, 356
enable early recovery	208, 255

enable EOD generation	252
enable extended contingent allegiance	141
enable threshold comparison	132
enable vital product data	96
end of partition	234
END OF USER AREA ENCOUNTERED ON THIS TRACK	121, 286, 289, 410
END-OF-DATA DETECTED	121, 406
END-OF-DATA NOT FOUND	121, 407
end-of-medium	114, 124, 218, 219, 221, 224, 228, 256, 262, 337, 409
END-OF-PARTITION/MEDIUM DETECTED	121, 406
end-of-tape	228
ending boundary field	207
ending F field	290, 291
ending index field	292
ending M field	290, 291
ending S field	290, 291
ending track field	292
EOD defined field	252, 256
EOM bit	114, 231, 241, 242, 251, 329, 330
EOP	221, 222, 224, 233, 234
EOT	228, 256
EQUAL	37, 43, 45, 54, 63, 65, 74, 105, 120, 133, 138, 157, 162, 163, 170, 172, 175, 181, 183, 198, 200, 207, 213-215, 232, 234, 278, 283, 287, 289, 291-293, 295, 326, 334, 336, 337, 340, 343, 344, 368, 413, 415
ERA	341, 342
erase all	341
erase by-pass	352, 354
ERASE command	xix, 222, 227, 338
ERASE FAILURE	121, 409
ERASE(10) command	xxi, 341, 342
ERASE(12) command	xxi, 342
error AEN permission	141
Error Counter Pages	xviii, 135
ERROR LOG OVERFLOW	121, 407
ERROR TOO LONG TO CORRECT	121, 407
ETC bit	132, 133
EVFU	266, 267
EVFU format start character field	267
EVFU format stop character field	267
EVPD bit	96, 100
except	27, 34, 39, 46-48, 56, 61, 72, 74, 75, 79, 88, 95, 102, 104, 107, 113, 115, 125, 129, 132, 133, 141, 144, 158, 160, 235, 236, 283, 285, 286, 306, 372-375, 405
EXCESSIVE WRITE ERRORS	121, 406
EXCHANGE MEDIUM command	xxii, 364
exclusive access	178, 179, 359, 375
ExEnab	374
export enable	374
extended contingent allegiance	xxx, 3, 55, 56, 58, 61, 75, 76, 78-80, 87, 140, 141, 223
extent	xix, 72, 151, 153, 158, 175-180
extent bit	176-178
extent list length field	178
FAILED TO SENSE BOTTOM-OF-FORM	121, 409
FAILED TO SENSE TOP-OF-FORM	121, 409
fast assertion period	35, 37, 403
fast cable skew delay	35, 37, 403
fast deskew delay	35, 37, 403
fast hold time	35, 37, 403

ANSI X3.131-1994

fast negation period	35, 38, 403
fast synchronous transfer option	37
FDP	253
field pointer field	116
filemark	113, 114, 119, 121, 222, 224, 225, 231, 235, 236, 240-242, 256, 406, 407
filemark bit	114, 241
FILEMARK DETECTED	121, 406
FILEMARK OR SETMARK NOT FOUND	121, 407
filled data buffer field	324
first block location field	234
first data transfer element address field	387
first element address reported field	369
first import export element address field	387
first record offset field	182
first storage element address field	387
fixed bit	115, 225, 226, 230-232, 235-237, 242-244
fixed data partitions	253
flag bit	59, 71, 284
Flexible Disk Page	xix, 196, 199
FmtData bit	160, 161
FOCUS SERVO FAILURE	121, 406
font identification field	266
forced unit access	152
form slew options field	268
FORMAT command	xx, 121, 259, 267, 408
FORMAT COMMAND FAILED	121, 408
format data	158, 159
Format Device Page	xix, 154, 196, 202
format of logical blocks addresses per second field	310
format options valid	161
format type field	259
FORMAT UNIT command	xviii, 108, 117, 151, 154, 158-161, 171, 172, 174, 179, 192, 203-205, 276
FOV bit	161
FUA bit	169
full bit	372
gap size field	227
generation address field	346, 347
GENERATION DOES NOT EXIST	121, 347, 410
GET DATA BUFFER STATUS command	xxi, 323
GET MESSAGE(10) command	xxii, 393
GET MESSAGE(12) command	xxii, 394
GET WINDOW command	xxi, 325, 327
GList bit	171, 172
GOOD status	73, 77, 81, 83, 85, 108, 113, 117, 118, 125, 126, 154, 166, 169, 175, 181, 197, 223, 237, 243, 247, 262, 264, 329, 343, 378
group code	69, 70, 249, 400
grown defect list	122, 159, 161, 171, 172, 174, 408
GROWN DEFECT LIST NOT FOUND	122, 408
hard sector	204, 205
HARDWARE ERROR	116, 119, 125, 155, 175, 215, 225, 277, 286, 339
head load delay field	201
HEAD OF QUEUE TAG	xvii, 52, 60, 61, 72, 80, 82
head settle delay field	200
head unload delay	199, 201
hold time	35-37, 44, 48, 403
host adapter	3, 5, 399
HSEC bit	204

PANASONIC CORP., et al.
Ex 1305, p. 453 of 465

i/e	385
I/O process	3-5, 39, 40, 45, 49, 51, 52, 55-58, 60-62, 64, 71-75, 77, 79-82, 99, 113, 117, 122, 141, 215, 399, 406
I/O PROCESS TERMINATED	64, 122, 406
I_T	4, 54, 55, 57, 58, 60, 61, 70, 73, 75, 76, 78, 79, 81, 104, 112, 113, 141, 237
I_T_L	4, 54, 55, 57, 58, 60, 61, 70, 73, 75, 76, 78, 79, 81, 104, 237
I_T_L_Q	4, 55, 58, 60, 61, 75, 79, 81
I_T_R	4, 54, 57
I_T_x	4, 55, 61, 78, 79, 112, 113, 141
I_T_x_y	4
ID CRC OR ECC ERROR	122, 407
ID Valid bit	376
IDENTIFY	xvi, 4, 6, 48, 49, 52-55, 57, 58, 61, 70, 73, 75, 78, 79, 81, 84, 88, 95, 97, 118, 119, 122, 150, 155, 161, 177, 253, 254, 379, 400, 409
IDP	253
IGNORE WIDE RESIDUE	xvi, 52, 58
ILI bit	330, 331
ILLEGAL FUNCTION (SHOULD USE 20 00, 24 00, OR 26 00)	122, 408
ILLEGAL MODE FOR THIS TRACK	122, 287, 289, 410
ILLEGAL REQUEST	57, 67, 71, 75, 76, 92, 93, 95, 96, 100-105, 107, 108, 110, 111, 116, 119, 126, 128, 130, 131, 133, 134, 139, 143, 154, 159, 161, 164, 170, 173, 176, 178, 179, 182, 186, 190-192, 212, 213, 225, 228, 230, 240, 242, 261, 267, 268, 277, 286, 289, 291-293, 305, 312, 329, 336, 339, 341, 351, 364-366, 378-380, 382, 385-387
image composition field	327
Immed bit	117, 162, 166, 185, 186, 227-229, 239, 242-245, 310
immediate	76, 77, 117, 162, 166, 185, 186, 223, 227-229, 239, 242, 244, 285, 288, 310
ImpExp	374, 375
Implemented Operating Definition Page	xviii, 86, 87, 144-146
import enable	374
import export	xxii, 359, 360, 364, 366, 368, 374, 375, 385-387, 389
import export element	xxii, 359, 364, 366, 368, 374, 375, 385-387, 389
IMPORT OR EXPORT ELEMENT ACCESSED	122, 408
inactivity timer multiplier	xxi, 311
INCOMPATIBLE MEDIUM INSTALLED	122, 408
INCOMPLETE BLOCK READ	122, 407
incorrect length indicator	114, 230
InEnab	374
information field	64, 90, 91, 94, 114, 115, 119, 146, 155, 173, 175, 181, 190, 210-213, 225-227, 230, 231, 235-237, 240-245, 277, 286, 339, 340, 371-375
Information Page	xviii, 115, 145, 146
initial connection	3, 4, 57, 60, 75, 80
initialization pattern	xviii, 159, 161-164
initialization pattern descriptor	xviii, 159, 161-163
initialization pattern length field	164
INITIALIZE ELEMENT STATUS command	xxii, 361, 365
INITIATE RECOVERY	3, 52, 53, 58, 61, 78, 87
INITIATOR DETECTED ERROR	45, 52, 59, 122, 409
INITIATOR DETECTED ERROR MESSAGE RECEIVED	122, 409
initiator-defined partitions	253
INQUIRY command	xvii, 62, 74-77, 83-85, 87, 96, 100, 144, 146, 148, 158, 205, 338, 358
INQUIRY DATA HAS CHANGED	122, 409
interleave field	161, 204
INTERMEDIATE status	166
INTERMEDIATE-CONDITION MET status	71, 72, 166, 181
INTERNAL TARGET FAILURE	122, 409
Inv1 bit	365
Inv2 bit	365

ANSI X3.131-1994

INVALID BITS IN IDENTIFY MESSAGE	57, 122, 409
INVALID COMBINATION OF WINDOWS SPECIFIED	122, 408
INVALID COMMAND OPERATION CODE	122, 408
INVALID ELEMENT ADDRESS	122, 408
INVALID FIELD IN CDB	96, 100-105, 107, 122, 126, 128, 173, 186, 190, 230, 305, 341, 351, 408
INVALID FIELD IN PARAMETER LIST	92, 93, 102, 103, 105, 122, 130, 131, 133, 134, 139, 159, 161, 164, 192, 212, 312, 408
INVALID MESSAGE ERROR	122, 409
invert	181, 183, 348, 362, 366, 367, 372-375
Invert bit	181, 183, 362, 366, 367, 373
IP bit	161
IP modifier field	164
L-EC UNCORRECTABLE ERROR	122, 407
LAMP FAILURE	122, 410
landing zone cylinder field	215
last block location field	234
Last n Error Events Page	134, 136, 194, 246, 263, 275, 307, 334, 355, 384, 397
latest bit	347
line slew options field	267
link bit	71, 166, 181, 189, 343
LINKED COMMAND COMPLETE	52, 59, 71, 74
LINKED COMMAND COMPLETE (WITH FLAG)	52, 59, 71, 74
list parameter	133, 136
load bit	228
load eject	185
LOAD UNLOAD command	xix, 228, 256
LOCATE command	xix, 224, 229, 234
lock	xviii, 152, 153, 157, 165, 277, 283, 287, 340, 413
lock bit	165
LOCK UNLOCK CACHE command	xviii, 165
LoEj bit	185
LOG COUNTER AT MAXIMUM	122, 133, 410
LOG EXCEPTION	122, 140, 410
LOG LIST CODES EXHAUSTED	122, 133, 136, 410
Log Parameters	7, 70, 101-104, 122, 126, 131, 132, 135, 194, 246, 263, 275, 307, 334, 355, 384, 396, 408
LOG PARAMETERS CHANGED	102, 122, 408
LOG SELECT command	xvii, 101-103, 131, 132, 134, 137
LOG SENSE command	xvii, 101, 103, 131-133, 136
logical block	4, 7, 48, 68-70, 74, 81, 91-93, 114, 115, 122, 139, 150-152, 154-156, 158, 162-166, 168-170, 172-175, 178, 179, 181, 182-184, 186-194, 198, 204, 207, 210-213, 216, 222-225, 229, 231, 233, 234, 236, 276, 277, 280, 282, 283, 285, 286, 287, 289, 290, 293-297, 300, 306, 308, 310, 318-320, 338-344, 346-354, 358, 408
logical block address	7, 68-70, 91-93, 115, 122, 150, 151, 154, 155, 164-166, 168-170, 172-175, 178, 179, 181, 183, 184, 186-193, 207, 210, 211, 212, 225, 229, 233, 276, 277, 282, 283, 285-287, 289, 290, 293-297, 300, 306, 310, 319, 338-344, 346, 347, 348-354, 408
LOGICAL BLOCK ADDRESS OUT OF RANGE	122, 408
logical block data	191
logical blocks per second of audio playback field	310
logical or physical notch	206
logical record length field	182
logical unit	xxx, 4-6, 49, 54-57, 60, 61, 68, 70, 72-79, 81, 83-89, 91-93, 95-99, 101-104, 106, 109, 112, 113, 117-119, 122, 125, 126, 127, 134, 137, 139, 144, 145, 148, 149, 153, 158, 165-171, 173-181, 183-191, 196, 202-207, 215, 227-240, 242-245, 251-254, 257, 259-262, 271, 273, 274, 288-290, 292-297, 305, 310, 323, 325, 329, 331-333, 341, 342, 344-354, 360, 364-368, 375, 376, 378, 379, 381, 390, 393-395, 406, 408, 409
LOGICAL UNIT COMMUNICATION FAILURE	122, 406
LOGICAL UNIT COMMUNICATION PARITY ERROR	122, 406
LOGICAL UNIT COMMUNICATION TIME-OUT	122, 406

LOGICAL UNIT DOES NOT RESPOND TO SELECTION	122, 406
LOGICAL UNIT FAILED SELF-CONFIGURATION	122, 409
LOGICAL UNIT HAS NOT SELF-CONFIGURED YET	122, 409
LOGICAL UNIT IS IN PROCESS OF BECOMING READY	122, 406
LOGICAL UNIT NOT READY, CAUSE NOT REPORTABLE	122, 406
LOGICAL UNIT NOT READY, FORMAT IN PROGRESS	122, 406
LOGICAL UNIT NOT READY, INITIALIZING COMMAND REQUIRED	122, 406
LOGICAL UNIT NOT READY, MANUAL INTERVENTION REQUIRED	122, 406
LOGICAL UNIT NOT SUPPORTED	75, 122, 126, 408
logical unit number	4, 5, 54, 57, 68, 70, 84, 86, 88, 89, 95, 96, 101, 103, 104, 106, 109, 112, 125-127, 158, 165-169, 171, 173-175, 177, 180, 181, 183-191, 227-230, 232, 233, 235-240, 242-244, 257, 259-262, 273, 274, 288-290, 292-294, 296, 297, 305, 323, 325, 329, 331-333, 341, 342, 344-354, 360, 364-368, 375, 376, 378, 379, 381, 393, 394, 395
long bit	227
LP bit	132, 133
LPN bit	206, 207
LU Valid bit	376
mandatory	xxix, 4, 6, 52, 54, 60, 67, 70, 85, 114, 115, 125, 157, 158, 160, 176, 177, 179, 180, 221, 226, 240, 258, 273, 278, 287, 322, 340, 363, 392, 399, 412-415
maximum additional partitions field	253
maximum burst size field	143
maximum generation address field	346
maximum line length field	267
maximum number of notches field	206
maximum pre-fetch ceiling field	198
maximum pre-fetch field	198
maximum volume sequence number	383
MCVal	298, 301, 303
Measurement Units Page	xxi, 335
MECHANICAL POSITIONING ERROR	122, 407
MEDIA LOAD OR EJECT FAILED	122, 410
MEDIUM DESTINATION ELEMENT FULL	122, 409
MEDIUM ERROR	xviii, 116, 119, 134, 136, 155, 161, 171, 175, 194, 223, 225, 231, 241, 242, 244, 263, 275, 277, 286, 307, 313-317, 329, 330, 334, 339, 350, 384, 397
MEDIUM FORMAT CORRUPTED	122, 408
medium format recognition field	253, 254
MEDIUM NOT PRESENT	122, 126, 409
Medium Partition Page	xx, 249, 250, 253, 254
MEDIUM REMOVAL PREVENTED	122, 167, 410
medium rotation rate field	202
MEDIUM SCAN command	xxi, 276, 339, 342-344
MEDIUM SOURCE ELEMENT EMPTY	122, 409
medium transport element	xxii, 359, 360, 364, 366-368, 372-375, 385, 386, 388, 389
medium transport element address field	360, 386
medium type	xxi, 137, 156, 195, 205, 206, 307, 338, 355
medium types supported	xix, 196, 205, 309, 357
Medium Types Supported Page	xix, 196, 205, 309, 357
medium-changer devices	359
MESSAGE ERROR	47, 122, 409
MESSAGE IN phase	46, 48, 50, 56-59, 61, 63, 66, 73, 401
MESSAGE OUT phase	40, 42, 46-49, 52, 57, 59-61, 63, 65, 66, 73, 75, 81, 400
MESSAGE PARITY ERROR	48, 52, 59, 63, 65
MESSAGE REJECT	52, 56-60, 62-66, 80, 141
MF bit	197, 198
MICROCODE HAS BEEN CHANGED	83, 122, 129, 409
minimum pre-fetch field	198

ANSI X3.131-1994

minimum volume sequence number	383
MISCOMPARE	88, 96, 120, 122, 187, 189, 242, 243, 350, 354, 408
MISCOMPARE DURING VERIFY OPERATION	122, 408
MISCORRECTED ERROR	122, 407
MO bit	201
mode field	xvii, xviii, 109, 110, 128, 243, 247, 264, 266, 284, 296
mode parameter header	xviii, 105, 107, 137, 194, 195, 243-246, 256, 263, 307, 308, 335, 355, 356, 384, 397
Mode Parameters	7, 70, 83, 104, 105, 107, 108, 117, 122, 137-140, 151, 176, 179, 194, 196, 216, 230, 237-239, 246, 263, 286, 289, 290, 292-294, 307, 321, 331, 333, 335, 350, 355, 384, 397, 408
MODE PARAMETERS CHANGED	104, 122, 408
MODE SELECT(10) command	xvii, 106, 109
MODE SENSE(10) command	xvii, 106, 107, 109
MODIFY DATA POINTER	xvii, 52, 54, 60
motor off delay field	200
motor on	199-201
motor on delay field	200
MOVE MEDIUM command	xxii, 362, 366, 367
MSF	xx, 280-287, 289-291, 293, 295-297, 300, 305, 306, 311, 319, 320, 414
mt	385
MULTIPLE PERIPHERAL DEVICES SELECTED	122, 406
MULTIPLE READ ERRORS	122, 407
multiplication factor	197
ND bit	204, 206
negation period	35, 36, 38, 43, 44, 403
nexus	3, 4, 39, 48, 54, 55, 57, 58, 60, 61, 70, 73-79, 81, 104, 112, 113, 141, 237
NO ADDITIONAL SENSE INFORMATION	113, 115, 122, 126, 406
NO CURRENT AUDIO STATUS TO RETURN	122, 299, 406
NO DEFECT SPARE LOCATION AVAILABLE	122, 175, 350, 408
NO GAP FOUND	122, 407
NO INDEX/SECTOR SIGNAL	122, 406
NO OPERATION	52, 60
NO SEEK COMPLETE	123, 406
NO SENSE	64, 76, 113, 119, 126, 171, 181, 182, 231, 235, 236, 240, 241, 243, 245, 260, 285, 344
NO WRITE CURRENT	123, 406
Non-Medium Error Page	134, 136, 194, 263, 275, 307, 334, 384, 397
Not Bus	375, 376
NOT READY	76, 108, 117, 119, 122-124, 126, 127, 151, 158, 218, 228, 248, 271, 285, 289, 291-293, 321, 390, 406, 408, 409
NOT READY TO READY TRANSITION(MEDIUM MAY HAVE CHANGED)	408
not this bus	376
Notch and Partition Page	196, 206
notched drive	206
number of blocks field	90-94, 139, 165, 184, 186, 191
number of blocks in buffer field	234
number of blocks requested field	343, 344
number of blocks to scan field	343, 344
number of bytes in buffer field	235
number of cylinders field	200, 214, 215
number of data transfer elements field	387
number of elements available field	369
number of F units per S unit field	311
number of heads field	200, 214
number of import export elements field	387
number of medium transport elements field	386
number of records field	182
number of S units per M unit field	311
number of storage elements field	387

PANASONIC CORP., et al.
Ex 1305, p. 457 of 465

OBJECT POSITION command	xxi, 329
offset boundary field	111
operation code	xvii, 67-70, 86, 88, 89, 95, 96, 101, 103, 104, 106, 109, 112, 122, 125-127, 158, 165-169, 171, 173-175, 177, 180, 181, 183-191, 227-230, 232, 233, 235-239, 242-244, 259-262, 273, 274, 288-290, 292-297, 305, 323, 325, 329, 331, 332, 333, 341, 342, 344-354, 364-368, 376, 378, 379, 381, 393-395, 408
OPERATOR MEDIUM REMOVAL REQUEST	123, 410
OPERATOR REQUEST OR STATE CHANGE INPUT (UNSPECIFIED)	123, 410
OPERATOR SELECTED WRITE PERMIT	123, 410
OPERATOR SELECTED WRITE PROTECT	123, 410
optical memory devices	xxi, xxix, 115, 276, 279, 338, 340, 355-358
Optical Memory Page	xxii, 357, 358
ORDERED QUEUE TAG	52, 60, 61, 72, 79, 80
OUT OF FOCUS	123, 410
output port channel selection	xxi, 310
OVERLAPPED COMMANDS ATTEMPTED	75, 123, 409
OVERWRITE ERROR ON UPDATE IN PLACE	123, 408
pacing protocol field	270
pad bit	89, 92, 94
padding type field	328
page code field	96, 104, 107, 108, 112, 130, 131, 139, 146, 148
page control	xvii, 101, 103, 106, 107
page format	xviii, 104, 107, 112, 125, 129-131, 135, 139, 140, 196, 250, 264, 309, 335, 357, 384, 397
page length field	130, 131, 137, 139, 140, 145-149, 193
pages notched field	207
paper instruction parity check	265
PAPER JAM	123, 329, 409
Parallel Printer Interface Page	264
parameter code field	xviii, 132, 134
parameter code reset	101
parameter data length field	86
parameter list length	64, 68-70, 88, 89, 91-95, 101, 102, 104-106, 123, 125-129, 342, 343, 381, 408
PARAMETER LIST LENGTH ERROR	105, 123, 408
parameter list length field	89, 102, 105, 126, 128
PARAMETER NOT SUPPORTED	123, 408
parameter pointer control	103
parameter rounding	76
parameter value field	136
PARAMETER VALUE INVALID	123, 408
PARAMETERS CHANGED	102, 104, 122, 123, 408
parameters savable	139, 196, 199, 203, 206, 208, 214, 216, 264, 266, 269, 309, 311, 312, 318, 336, 358, 385, 386, 388
parity select field	264
parity selection field	270
partial medium indicator	170, 295
partial results acceptable	343
partition field	229, 250, 251
partition size descriptor	253, 254
partition size field	254
partition size unit of measure	253
pattern field	182, 183
pattern length field	164, 182, 183
pattern type field	164
PAUSE RESUME command	xx, 288
PCR bit	101
PER bit	209, 255
Peripheral Device Page	xviii, 140, 144, 196, 250, 264, 309, 335, 357, 397

ANSI X3.131-1994

peripheral device type field	145-149
PERIPHERAL DEVICE WRITE FAULT	123, 406
peripheral qualifier field	145-149
PF bit	104, 125, 126, 129
physical block data	191
pin 1 field	201
pin 34 field	xix, 201, 202
pin 4 field	xix, 201
PIPC	264, 265
PLAY AUDIO MSF command	xx, 290
PLAY AUDIO TRACK INDEX command	xx, 292
PLAY AUDIO(10) command	xx, 289, 290
PLAY AUDIO(12) command	xx, 290
PList bit	171, 172
PMI bit	151, 170, 295
POSITION ERROR RELATED TO TIMING	123, 409
position function field	329
POSITION PAST BEGINNING OF MEDIUM	123, 409
POSITION PAST END OF MEDIUM	123, 409
POSITION TO ELEMENT command	xxii, 367
POSITIONING ERROR DETECTED BY READ OF MEDIUM	123, 407
post error	208, 255
POWER ON, RESET, OR BUS DEVICE RESET OCCURRED	123, 408
POWER-ON OR SELF-TEST FAILURE (SHOULD USE 40 NN)	123, 409
power-on to selection time	35, 36, 47
PPC bit	103
PRA	342-344
PRE-FETCH command	xviii, 166
prevent	xviii, 26, 49, 62, 100, 150, 152-154, 157, 167, 177, 226, 238, 252, 277, 287, 340, 363, 413
PREVENT ALLOW MEDIUM REMOVAL command	xviii, 150, 167
prevent bit	153, 167, 177, 238
primary defect list	123, 158, 161, 171, 172, 408
PRIMARY DEFECT LIST NOT FOUND	123, 408
primary volume tag	362, 371-375, 382
primary volume tag information field	371
PRINT command	xx, 260-262, 266-268
printer devices	xx, xxix, 114, 115, 257, 258, 261, 263, 264, 269
Printer Options Page	261, 262, 264, 266
priority field	90, 197
product identification field	100
product serial number field	149
progress indication field	117
PS bit	105, 107, 139, 161, 196, 199, 203, 206, 208, 214, 216, 264, 266, 269, 309, 311, 312, 318, 336, 358, 385, 386, 388
PSUM	253, 254
PVolTag	371-375
QErr bit	141
queue algorithm modifier field	140
queue error management	80, 141
QUEUE FULL status	78-80
queue tag	xvii, 4, 49, 52, 54, 57, 58, 60, 61, 72, 78-82, 140, 141
queued I/O process	4, 55, 80
RAENP bit	141
RAM FAILURE (SHOULD USE 40 NN)	123, 409
RANDOM POSITIONING ERROR	123, 407
RAREA bit	193
RBO	236, 250, 251

RC bit	208
RCD bit	197
READ BLOCK LIMITS command	xix, 230, 232, 243
READ BUFFER command	xvii, 109, 110, 127, 128
read cache disable	197
READ CAPACITY command	xviii, 150, 169, 172, 295
READ CD-ROM CAPACITY command	xx, 282, 283, 294
read continuous	208
READ DEFECT DATA(10) command	345
READ DEFECT DATA(12) command	xxii, 345
READ ELEMENT STATUS command	xxii, 361, 362, 365, 368, 369, 377
read exclusive	178, 179
READ GENERATION command	xxii, 346
READ HEADER command	xxi, 296
read inhibit	184
READ LONG command	xviii, 173, 190
READ PAST BEGINNING OF MEDIUM	123, 409
READ PAST END OF MEDIUM	123, 409
READ POSITION command	xix, 223, 224, 233
READ RETRIES EXHAUSTED	123, 407
READ REVERSE command	xix, 235
read shared	178, 179
READ SUB-CHANNEL command	xxi, 283, 297
READ TOC command	xxi, 281, 305
READ(10) command	xviii, 168, 189, 344
READ(12) command	xxi, 344
Read-Write Error Recovery Page	xix, xx, 189, 196, 207, 216, 225, 250, 254, 357
ready AEN permission	141
REASSIGN BLOCKS command	xviii, 151, 153, 159, 174, 175, 208, 339
RECEIVE command	xx, 271-273, 275
RECEIVE DIAGNOSTIC RESULTS command	xvii, 85, 112, 125, 126, 129, 130, 192, 193
reconnect	xviii, 4, 41, 56-59, 61, 75, 77, 79, 135, 140, 142, 196, 249, 264, 271, 309, 335, 357, 390, 391, 397
RECORD NOT FOUND	123, 407
RECORDED ENTITY NOT FOUND	123, 407
recover buffer order	251
RECOVER BUFFERED DATA command	xix, xx, 236, 251, 260, 262
RECOVERED DATA - DATA AUTO-REALLOCATED	123, 407
RECOVERED DATA - RECOMMEND REASSIGNMENT	123, 407
RECOVERED DATA - RECOMMEND REWRITE	123, 407
RECOVERED DATA USING PREVIOUS SECTOR ID	123, 407
RECOVERED DATA WITH CIRC	123, 407
RECOVERED DATA WITH ERROR CORRECTION & RETRIES APPLIED	123, 407
RECOVERED DATA WITH ERROR CORRECTION APPLIED	123, 407
RECOVERED DATA WITH L-EC	123
RECOVERED DATA WITH NEGATIVE HEAD OFFSET	123, 407
RECOVERED DATA WITH NO ERROR CORRECTION APPLIED	123, 407
RECOVERED DATA WITH POSITIVE HEAD OFFSET	123, 407
RECOVERED DATA WITH RETRIES	123, 407
RECOVERED DATA WITH RETRIES AND/OR CIRC APPLIED	123, 407
RECOVERED DATA WITHOUT ECC - DATA AUTO-REALLOCATED	123, 407
RECOVERED DATA WITHOUT ECC - RECOMMEND REASSIGNMENT	123, 407
RECOVERED DATA WITHOUT ECC - RECOMMEND REWRITE	123, 407
RECOVERED ERROR	76, 113, 116, 119, 133, 136, 155, 161, 171, 209-212, 215, 225, 231, 235, 243, 245, 277, 286, 313-317, 339, 350, 358
RECOVERED ID WITH ECC	123, 408
REFERENCE POSITION FOUND	122, 406

ANSI X3.131-1994

RelAdr bit	99, 165, 166, 169, 170, 173, 181, 186, 187, 189-191, 341, 343, 346, 347, 349, 351, 352, 354
RELEASE command	xix, xxii, 175-178, 378-380
RELEASE RECOVERY	3, 39, 52, 61, 78
RELEASE UNIT command	xix, 237, 238
removable	76, 83, 85, 98, 119, 150, 151, 155, 205, 338, 361, 389
report early-warning	251
report log exception condition	140
report setmarks	251
report updated block read	350, 358
REPOSITION ERROR	123, 409
REQUEST SENSE command	xvii, 39, 64, 75-77, 83, 85, 87, 112-114, 117, 146, 158, 181, 182, 271, 285, 321, 343, 344, 391
request to send	270
REQUEST VOLUME ELEMENT ADDRESS command	xxii, 376, 381, 382
RESELECTION phase	4, 33, 37, 39-42, 48, 54, 58, 81, 399
RESERVATION CONFLICT status	153, 158, 177-180, 238, 239, 379-381
reservation identification field	177
reservation type field	178
RESERVE command	xix, xxii, 104, 153, 154, 176-180, 238, 376, 379-381
RESERVE UNIT command	xix, 237-239
reserved area	193
reset condition	3, 32, 36, 39, 45, 47-50, 56, 62-64, 66, 71, 75, 78, 83, 87, 99, 103, 104, 107, 108, 167, 177-179, 238, 248, 379, 380
reset hold time	35, 37, 48
reset to selection time	35, 36, 49
response data format field	87
RESTORE POINTERS	51, 52, 54, 57, 59, 61, 73
resume bit	288
retain bit	262
reverse scan direction	343
REW	231, 241-243, 245, 250-252, 256
REWIND command	xix, 76, 221, 239
REZERO UNIT command	xix, 154, 180
RIBBON, INK, OR TONER FAILURE	123, 408
RIF	326, 328
Rigid Disk Drive Geometry Page	xix, 214
RLEC bit	133, 134, 136, 140
RMB bit	98, 205
rotate bit	388
ROUNDED PARAMETER	76, 123, 409
RPL	123, 214, 215, 410
RPL STATUS CHANGE	123, 215, 410
RSD	342, 343
RSmk	94, 114, 231, 236, 240-242, 250, 251
RTS	269, 270
RUBR	358
save bit	86
SAVE DATA POINTER	49, 51, 52, 56, 61, 62, 73
save implemented	147
save parameters	101, 103, 205
SaveImp bit	147
SAVING PARAMETERS NOT SUPPORTED	108, 123, 409
SCAN command	xxi, 276, 323, 332, 339, 342-344
SCAN HEAD POSITIONING ERROR	123, 410
scanner devices	xxi, xxix, 320-322, 334, 335, 337
SCSI ID	5, 30, 33, 36, 40, 41, 77, 360, 361, 399, 400
SCSI PARITY ERROR	123, 409

SCSI Pointers	51
SCSI TO HOST SYSTEM INTERFACE FAILURE	123, 410
SCSI-2	1, xxiii, xxix, xxx, 1, 5, 6, 8, 32, 41, 70, 74, 79, 84, 86, 87, 140, 175, 177, 399, 405, 406, 412, 416
SCTE	266, 267
SDP	253
search argument descriptor	182, 183
search argument length field	182
sectors per track field	200, 204
SEEK(10) command	xix, 183
segment descriptor	xvii, 89-94, 114, 115
segment number field	114
select data compression algorithm field	252
select data partitions	253
SELECT OR RESELECT FAILURE	123, 409
selection abort time	35, 37, 41, 42, 400
SELECTION phase	3, 33, 39, 40, 48, 54, 57, 73, 81, 399
selection time-out delay	35, 37, 41, 42
self test	85, 119
send action code field	377, 381
SEND DIAGNOSTIC command	xvii, 85, 112, 125, 129, 130, 192-194
SEND MESSAGE(10) command	xxii, 395
SEND MESSAGE(12) command	xxii, 395
SEND VOLUME TAG command	xxii, 361, 362, 376, 377, 381-383
sense key field	115, 116
sense-key specific field	116, 117
sense-key specific valid	116
SEQUENTIAL POSITIONING ERROR	124, 409
sequential-access devices	xix, xxix, 75, 90, 94, 95, 114, 115, 139, 218, 224, 226, 227, 246, 249
Serial Printer Interface Page	264, 269
SET LIMITS(10) command	348
SET LIMITS(12) command	xxii, 348
SET WINDOW command	xxi, 327, 333
SETMARK DETECTED	124, 231, 236, 240, 241, 406
SEW	243, 245, 250-252
StfRe bit	48, 99
SIL	230, 235, 236
SIMPLE QUEUE TAG	52, 58, 60, 61, 72, 79, 81, 140, 141
single bit	40, 325
SKSV bit	116, 117
SLEW AND PRINT command	xx, 260-262, 266-268
SLEW FAILURE	124, 409
slew mode field	266
slew value field	261
SOCF	250-252
soft sector	204, 205
SOTC	289, 290, 292-294, 309, 310
source block length field	93
source logical block address field	93
source storage element address field	373, 374
source valid	373
SP bit	101, 103, 105, 108, 132
SPACE command	xix, 240
spanned data	181
speed field	xx, 247
SPINDLE SERVO FAILURE	124, 406
SPINDLES NOT SYNCHRONIZED	124, 410

ANSI X3.131-1994

SPINDLES SYNCHRONIZED	124, 410
SpnDat bit	181
SSEC bit	204
SSN bit	200
st	385
start . xix, 3, 51, 76, 100, 126, 150, 151, 153, 155, 157, 181, 183, 185, 200, 266, 267, 278, 287-289, 292, 293, 306, 320, 340, 361, 412	
start bit	185
start sector number	200
starting boundary field	207
starting F field	290, 291
starting index field	292
starting M field	290, 291
starting S field	290, 291
starting track field	292, 293, 305
status xvii, xxi, xxii, xxix, 3, 5, 30, 32, 33, 36, 39, 42, 43, 45-51, 55-59, 61, 64, 67, 71-73, 75-83, 85, 88, 90-93, 95, 96, 100, 101-105, 107, 108, 110, 111, 113, 116-119, 122, 123, 125, 126, 128, 130, 131, 133, 134, 136, 139, 143, 151, 153, 154, 158, 159, 161, 162, 164, 166, 169-173, 175-182, 185-187, 189-192, 197, 200, 204, 205, 208-213, 215, 218, 223, 225, 227-231, 235-245, 247, 251, 255, 260-262, 264, 267, 268, 271, 275, 276, 285-289, 291-293, 298, 299, 302, 303, 305, 310, 312-317, 321-324, 329-331, 333, 336, 339, 341, 343, 347, 350-352, 354, 356-358, 361, 362, 363-366, 368-373, 377-381, 387, 390, 400, 406, 410, 412, 413, 415	
STATUS phase	39, 46, 48, 71, 73, 400
step count truncate enable	267
step pulse per cylinder	201
stop bit length field	269
stop format	161
stop on consecutive filemarks	251
stop on track crossing	292, 293, 310
STOP PRINT command	xx, 262
storage element	xxii, 359, 361, 364, 366, 368, 372-375, 385-387, 389
STPF bit	161
stream selection field	393-396
sub Q bit	297, 298
sub-channel data format field	297, 298, 303, 304
sub-channel data header	298, 302, 303
sub-channel data length field	298
SubQ	297
supplied format field	192, 193
Supported Diagnostic Pages	xviii, 130, 192, 246, 263, 307, 334, 383
Supported Log Pages	xviii, 134, 136, 137, 194, 246, 263, 307, 335, 384, 396, 397
supported page list field	130, 137, 148
Supported Vital Product Data Pages	xviii, 145, 148
suppress incorrect length indicator	230
SURF bit	205
surface	205, 337
SValid	372-375
SYNCHRONIZE BUFFER command	xx, 262, 268
SYNCHRONIZE CACHE command	xix, 154, 185, 186
SYNCHRONOUS DATA TRANSFER ERROR	124, 408
SYNCHRONOUS DATA TRANSFER REQUEST	xvii, 52, 54, 62, 77
SYSTEM RESOURCE FAILURE	124, 410
TAPE LENGTH ERROR	124, 408
TAPE OR ELECTRONIC VERTICAL FORMS UNIT NOT READY	124, 409
TAPE POSITION ERROR AT BEGINNING-OF-MEDIUM	124, 409
TAPE POSITION ERROR AT END-OF-MEDIUM	124, 409
target certification list	159
TARGET OPERATING CONDITIONS HAVE CHANGED	124, 409

target routine	4, 5, 54-57, 60, 75, 78, 79, 84, 274
target save disable	132
TB bit	208, 255
TCVal	298, 301, 304
TERMINATE I/O PROCESS	52, 64, 72, 75, 99
TEST UNIT READY command	xviii, 77, 85, 126, 150, 271, 321
third party	89, 104, 175, 177, 179, 237, 238, 378-380
third party reservation	104, 179, 238, 380
THRESHOLD CONDITION MET	124, 133, 410
threshold field	327
threshold met criteria	xviii, 132, 133
THRESHOLD PARAMETERS NOT SUPPORTED	124, 408
TOO MANY WINDOWS SPECIFIED	124, 408
track code valid	301
TRACK FOLLOWING ERROR	124, 406
track number field	298, 306
track relative CD-ROM address field	300
track skew factor field	204
TRACKING SERVO FAILURE	124, 406
tracks per zone field	203, 204
transfer block	208-212, 255
transfer length	51, 64, 68-70, 128, 139, 166, 168, 169, 173, 187-190, 196, 198, 225, 226, 230, 231, 235-237, 243-245, 256, 259, 260, 261, 267, 274, 286, 289, 290, 293, 294, 310, 325, 331-333, 341, 342, 344, 348, 352-354, 394, 395
transfer period	35, 37, 43, 45, 62, 63, 403
Translate Address Page - RECEIVE DIAGNOSTIC	xix, 192, 193
Translate Address Page - SEND DIAGNOSTIC	xix, 192
translate format field	192, 194
translated address field	194
transport element address field	360, 386
transport geometry descriptor	388
true ready	200
TSD bit	101, 132
UAAENP bit	141
UNABLE TO ACQUIRE VIDEO	124, 410
UNABLE TO RECOVER TABLE-OF-CONTENTS	124, 410
unexpected disconnect	3, 5, 45, 47, 48, 54, 57, 71, 112, 117
unexpected reselection	77
UNIT ATTENTION	49, 56, 75-77, 80, 83, 87, 96, 102, 104, 119, 129, 133, 139, 141, 154, 176, 178, 215, 225, 237, 248, 277, 286, 339, 380
unit attention AEN permission	141
unit off-line	125
Unit Serial Number Page	xviii, 145, 149
UnitOfL bit	125
UNLOAD TAPE FAILURE	124, 410
UNRECOVERED READ ERROR	124, 155, 223, 225, 277, 286, 339, 407
UNRECOVERED READ ERROR - AUTO REALLOCATE FAILED	124, 407
UNRECOVERED READ ERROR - RECOMMEND REASSIGNMENT	124, 407
UNRECOVERED READ ERROR - RECOMMEND REWRITE THE DATA	124, 407
UNSUCCESSFUL SOFT RESET	124, 409
UPDATE BLOCK command	xxii, 349, 350, 356, 358
UPDATED BLOCK READ	124, 350, 358, 410
VCBP	264, 265
VCBS	264, 265
vendor identification field	100
verification length field	187

ANSI X3.131-1994

verify correction span field	216
Verify Error Recovery Page	xix, 189, 196, 215, 216, 309, 357
verify recovery time limit field	216
verify retry count field	209-211, 216
VERIFY(10) command	xxii, 350, 351, 353, 354
VERIFY(12) command	xxii, 351, 354
vertical forms unit	124, 265-267, 409
VES	264, 265
VFU	xx, 265
VFU control bit polarity	265
VFU control bit select	265
VFU extended skip	265
VIDEO ACQUISITION ERROR	124, 410
Vital Product Data Parameters	7, 144
VolTag	368, 376, 377
volume identification field	362
volume identification template field	382, 383
VOLUME OVERFLOW	120, 225, 243-245, 251
volume sequence number field	362, 383
volume tag	xxii, 361-363, 368, 371-377, 381-383, 415
wait bit	323
WBS	342, 343
WCE bit	197
WIDE DATA TRANSFER REQUEST	44, 52, 54, 64
window length field	327
window width field	327
WP bit	195, 247, 356
WRITE AND VERIFY(10) command	xxii, 353, 354
WRITE AND VERIFY(12) command	xxii, 354
WRITE APPEND ERROR	124, 409
WRITE APPEND POSITION ERROR	124, 409
WRITE BUFFER command	xviii, 109, 110, 127, 129
write cache enable	197
WRITE ERROR	xix, xx, 115, 124, 189, 196, 207, 216, 223, 225, 226, 250, 254, 255, 357, 407
WRITE ERROR - AUTO REALLOCATION FAILED	124, 407
WRITE ERROR RECOVERED WITH AUTO REALLOCATION	124, 407
write exclusive	178, 179
WRITE FILEMARKS command	xx, 223, 228, 239, 243-245, 252
write inhibit	184
WRITE LONG command	xix, 190
write precompensation field	200, 201, 214
write protect	76, 123, 195, 247, 410
WRITE PROTECTED	124, 155, 195, 218, 225, 247, 277, 339, 356, 408
write retention priority field	197
WRITE SAME command	xix, 191
write setmark	244
WRITE(10) command	xix, xxii, 188, 189, 352, 353
WRITE(12) command	xxii, 353
written block search	343
WSmk	244
X-axis resolution field	327
X-axis upper left field	327
Y-axis resolution field	327
Y-axis upper left field	327