



UNITED STATES PATENT AND TRADEMARK OFFICE

UNITED STATES DEPARTMENT OF COMMERCE
United States Patent and Trademark Office
Address: COMMISSIONER FOR PATENTS
P.O. Box 1450
Alexandria, Virginia 22313-1450
www.uspto.gov

APPLICATION NO.	ISSUE DATE	PATENT NO.	ATTORNEY DOCKET NO.	CONFIRMATION NO.
12/891,443	08/06/2013	8504746	0757-113189	1408

24628 7590 07/17/2013
Husch Blackwell LLP
Husch Blackwell Sanders LLP Welsh & Katz
120 S RIVERSIDE PLAZA
22ND FLOOR
CHICAGO, IL 60606

ISSUE NOTIFICATION

The projected patent number and issue date are specified above.

Determination of Patent Term Adjustment under 35 U.S.C. 154 (b) (application filed on or after May 29, 2000)

The Patent Term Adjustment is 0 day(s). Any patent to issue from the above-identified application will include an indication of the adjustment on the front page.

If a Continued Prosecution Application (CPA) was filed in the above-identified application, the filing date that determines Patent Term Adjustment is the filing date of the most recent CPA.

Applicant will be able to obtain more detailed information by accessing the Patent Application Information Retrieval (PAIR) WEB site (<http://pair.uspto.gov>).

Any questions regarding the Patent Term Extension or Adjustment determination should be directed to the Office of Patent Legal Administration at (571)-272-7702. Questions relating to issue and publication fee payments should be directed to the Application Assistance Unit (AAU) of the Office of Data Management (ODM) at (571)-272-4200.

APPLICANT(s) (Please see PAIR WEB site <http://pair.uspto.gov> for additional applicants):

Michael Tasler, Wurzburg, GERMANY;

The United States represents the largest, most dynamic marketplace in the world and is an unparalleled location for business investment, innovation, and commercialization of new technologies. The USA offers tremendous resources and advantages for those who invest and manufacture goods here. Through SelectUSA, our nation works to encourage and facilitate business investment. To learn more about why the USA is the best country in the world to develop technology, manufacture products, and grow your business, visit SelectUSA.gov.

JVC KENWOOD CORP., et al.
Ex 1402, p. 1 of 340

Under the Paperwork Reduction Act of 1995, no persons are required to respond to a collection of information unless it contains a valid OMB control number.

10/24/2001 W&K Substitute for Form PTO-SB/08A, which is a US PTO Substitute for form 1449A/PTO and 1449B/PTO SUPPLEMENTAL INFORMATION DISCLOSURE STATEMENT BY APPLICANT (use as many sheets as necessary)		Complete if Known	
		Application Number	12/891,443
		Filing Date	09/27/2010
		First Named Inventor	Michael Tasler
		Art Unit	2111
		Examiner Name	na
Sheet	8	of	24
		Attorney Docket Number	0757-113189

	JP Hei 4-309156	10/30/1992	Kashiwaki Laboratory Co. Ltd.	
	JP Hei7-177406	07/14/1995	Olympus Optical Co., Ltd.	
	JP 02-051727	02/21/1990	Kiyotaka Ouchi et al.	
	JP 04-309156	10/30/1992	Yasutada Kashiwagi	
	JP 06-83917	03/25/1994	Koji Kajita	
	JP 07-177406	07/14/1995	Hirokazu Hisayoshi	
	JP 08-130702	05/21/1996	Satomi Tanaka et al.	
	JP 08-223341	08/30/1996	Izumi Miyake	
	JP 08-328990	12/13/1996	Tadashi Uewaki, et al.	
	JP 01303554A	07/12/89		X
	JP 01293404A	11/27/89		X
	JP 02114351A	04/26/90		X
	JP 09016506A	01/17/97		X
	JP 6-301607	10/28/1994		X
	JP 8-191410	1996 / 7	Japan	X
	JP 53145535A	12/18/78		X
	JP 61034652A	2/18/86		X
	JP 61060164A	03/27/86		X
	WO 94/19746	09/01/1994	PCT	X

Change(s) applied to document, /M.C.E./ 6/21/2013

OTHER ART - NON PATENT LITERATURE DOCUMENTS			
Examiner Initials*	Cite No. ¹	Include name of the author (in CAPITAL LETTERS), title of the article (when appropriate), title of the item (book, magazine, journal, serial, symposium, catalog, etc.), date, page(s), volume-issue number(s), publisher, city and/or country where published.	T ⁶
		Tasler, Michael, <i>Design and Construction of a Universal Data Acquisition and Control System for Scanning Probe Microscopy</i> , The University of Texas At Austin, May 1996, (94 pgs).	
		Universal Serial Bus (USB), <i>Devise Class Definition for Human Interface Devices (HID)</i> , 1997, USB Implementers' Forum.	
		<i>About the SCSI Manager</i> , http://developer.apple.com/documentation/mac/Devices/Devices-121.html , (6 pgs)	

Examiner Signature	/Chun Kuan Lee/	Date Considered	07/18/2011
--------------------	-----------------	-----------------	------------

EXAMINER: Initial if reference considered, whether or not citation is in conformance with MPEP 609. Draw line through citation if not in conformance and not considered. Include copy of this form with next communication to applicant.

¹Applicant's unique citation designation number (optional). ²See Kind Codes of USPTO Patent Documents at www.uspto.gov or MPEP 901.04. ³Enter Office that issued the document, by the two-letter code (WIPO Standard ST. 3). ⁴For Japanese patent documents, the indication of the year of the reign of the Emperor must precede the serial number of the patent document. ⁵Kind of document by the appropriate symbols as indicated on the document under WIPO Standard ST. 16 if possible. ⁶Applicant is to place a check mark here if English language Translation is attached.

Burden Hour Statement: This form is estimated to take 2.0 hours to complete. Time will vary depending upon the needs of the individual case. Any comments on the amount of time you are required to complete this form should be sent to the Chief Information Officer, U.S. Patent and Trademark Office, Washington, DC 20231. DO NOT SEND FEES OR COMPLETED FORMS TO THIS ADDRESS. SEND TO: Assistant Commissioner for Patents, Washington, DC 20231. CHI-12038-3

Under the Paperwork Reduction Act of 1995, no persons are required to respond to a collection of information unless it contains a valid OMB control number.

10/24/2001 W&K Substitute for Form PTO-SB/08A, which is a US PTO Substitute for form 1449A/PTO and 1449B/PTO SUPPLEMENTAL INFORMATION DISCLOSURE STATEMENT BY APPLICANT <i>(use as many sheets as necessary)</i>		Complete if Known	
		Application Number	12/891,443
		Filing Date	09/27/2010
		First Named Inventor	Michael Tasler
		Art Unit	2111
		Examiner Name	na
Sheet: 7	of 24	Attorney Docket Number	0757-113189

Change(s) applied
to document,
/M.C.E./
6/21/2013

	06-301607	JP	10/28/1994	Hitachi Ltd.		
	07-044290	JP	02/14/1995	Canon Inc.		
	07-202982	JP	08/04/1995	Olympus Optical Co. Ltd.		
	08-110883	JP	04/30/1996	NEC Corp.		
	08-191375	JP	07/23/1996	Asahi Optical Co. Ltd.		
	08-191412	JP	07/23/1996	Asahi Optical Co. Ltd.		
	09-091237	JP	04/04/1997	NEC Software Ltd.		
	10-177535	JP	06/30/1998	Fuji Xerox Co. Ltd.		
	63-133204	JP	06/06/1988	Matsushita Electronic Works Ltd.		
	DE 41 37 928 A1		05/27/1992	Sundstrand Data Control, Inc.		
	DE 88 G 3559		03/30/1989	Siemens Aktiengesellschaft		
	DE 195 28 889 A1		02/06/1997	Noventa Konzept und Kommunikation GmbH		
	DE 296 07 724 U 1		4/29/96	Germany	X	
	DE 3624373 A1		01/29/1987	Diesel Kiki Co. Ltd.		
	DE 390 332 B		04/25/1990	Leitner Helmut Inc.		
	EP 0 03 044 (see United States Patent no. 4,466,573)		04/25/1984	Societe Nationale D'Etude Et De Construction Moteurs D' Aviation		
	EP 0 259 786 A1		09/03/1987	XMIT AG		
	EP 0 391 157 A2		03/22/1990	Siemens Aktiengesellschaft		
	EP 0 685 799 A1		05/31/1995			X
	JP H2-51727 (1990-51727)		02/21/1990	K.K. CSK		
	JP H6-83917 (1994-83917)		03/25/1994	Canon, Inc.		
	JP H8-130702		05/21/1996	SONY Corporation		
	JP H08-223341		08/30/1996	Fuji Photo Film Co., Ltd.		
	JP H8-328990 (1996-328990)		12/13/1996	Hitachi Ltd.		

Examiner Signature	/Chun Kuan Lee/	Date Considered	07/18/2011
--------------------	-----------------	-----------------	------------

EXAMINER: Initial if reference considered, whether or not citation is in conformance with MPEP 609. Draw line through citation if not in conformance and not considered. Include copy of this form with next communication to applicant.

¹Applicant's unique citation designation number (optional). ²See Kind Codes of USPTO Patent Documents at www.uspto.gov or MPEP 901.04. ³Enter Office that issued the document, by the two-letter code (WIPO Standard ST.3). ⁴For Japanese patent documents, the indication of the year of the reign of the Emperor must precede the serial number of the patent document. ⁵Kind of document by the appropriate symbols as indicated on the document under WIPO Standard ST. 16 if possible. ⁶Applicant is to place a check mark here if English language Translation is attached.

Burden Hour Statement: This form is estimated to take 2.0 hours to complete. Time will vary depending upon the needs of the individual case. Any comments on the amount of time you are required to complete this form should be sent to the Chief Information Officer, U.S. Patent and Trademark Office, Washington, DC 20231. DO NOT SEND FEES OR COMPLETED FORMS TO THIS ADDRESS. SEND TO: Assistant Commissioner for Patents, Washington, DC 20231.
CHI-12038-3

ALL REFERENCES CONSIDERED EXCEPT **JVC KENWOOD CORP., et al.** /C.L./
Ex 1402, p. 3 of 340

Under the Paperwork Reduction Act of 1995, no persons are required to respond to a collection of information unless it contains a valid OMB control number.

10/24/2001 W&K Substitute for Form PTO-SB/08A, which is a US PTO Substitute for form 1449A/PTO and 1449B/PTO SUPPLEMENTAL INFORMATION DISCLOSURE STATEMENT BY APPLICANT (use as many sheets as necessary)				Complete if Known		
				Application Number	12/891,443	
Sheet		6	of	24	Examiner Name	na
					Attorney Docket Number	0757-113189

		6,119,180	09/12/2000	Terho et al	
		6,131,125	10/20/2000	Rostoker et al	
		6,147,703	12/19/1996	Miller et al	11/14/2000
		6,149,316	11/21/2000	Harari et al.	
		6,163,344	12/19/2000	Kawamura et al	
		6,182,145	01/30/2001	Schuman et al	
		6,188,675	02/13/2001	Casper et al	
		6,256,319	07/03/2001	Apgar et al	
		6,256,452	07/03/2001	Yamamoto	
		6,260,102	07/10/2001	Robinson	
		6,286,073	09/04/2001	Vegter	
		6,292,589	9/18/2001	Chow et al	
		6,298,388	10/02/2001	Taguchi	
		6,344,875	02/05/2002	Hashimoto et al	
		6,424,809	07/23/2002	Yamamoto et al	
		6,441,854	08/27/2002	Fellagara et al	
		6,470,399	10/22/2002	Tasler	
		6,654,050	11/25/2003	Karube et al	
		6,895,449	05/17/1999 2005	Tasler	
		7,046,276	05/16/2006	Hashimoto et al	

Change(s) applied to document, /A.T.L./ 7/2/2013

FOREIGN PATENT DOCUMENTS							
Examiner Initials*	Cite No. ¹	Foreign Patent Document		Publication Date MM-DD-YYYY	Name of Patentee or Applicant of Cited Document	Pages, Columns, Lines, Where Relevant Passages or Relevant Figures Appear	T ⁶
		Country Code ²	Number ³ -Kind Code ⁴ (if known)				
		03-246654	JP	11/05/1997	OKI Electric IND CO LTD		
		04-133152	JP	05/07/1992	Ricoh Co. Ltd.		
		04-213715	JP	08/04/1992	1992 Canon Inc.		
		06-052087	JP	02/25/1994	Hitachi Ltd.		
		06-067815	JP	03/11/1994	NEC Corp		
		06-090423	JP	03/29/1994	Canon Inc.		

Change(s) applied to document, /M.C.E./ 6/21/2013

Examiner Signature	/Chun Kuan Lee/	Date Considered	07/18/2011
--------------------	-----------------	-----------------	------------

EXAMINER: Initial if reference considered, whether or not citation is in conformance with MPEP 609. Draw line through citation if not in conformance and not considered. Include copy of this form with next communication to applicant.

¹Applicant's unique citation designation number (optional). ²See Kind Codes of USPTO Patent Documents at www.uspto.gov or MPEP 901.04. ³Enter Office that issued the document, by the two-letter code (WIPO Standard ST. 3). ⁴For Japanese patent documents, the indication of the year of the reign of the Emperor must precede the serial number of the patent document. ⁵Kind of document by the appropriate symbols as indicated on the document under WIPO Standard ST. 16 if possible. ⁶Applicant is to place a check mark here if English language Translation is attached.

Burden Hour Statement: This form is estimated to take 2.0 hours to complete. Time will vary depending upon the needs of the individual case. Any comments on the amount of time you are required to complete this form should be sent to the Chief Information Officer, U.S. Patent and Trademark Office, Washington, DC 20231. DO NOT SEND FEES OR COMPLETED FORMS TO THIS ADDRESS. SEND TO: Assistant Commissioner for Patents, Washington, DC 20231. CHI-12038-3

Under the Paperwork Reduction Act of 1995, no persons are required to respond to a collection of information unless it contains a valid OMB control number.

10/24/2001 W&K Substitute for Form PTO-SB/08A, which is a US PTO Substitute for form 1449A/PTO and 1449B/PTO SUPPLEMENTAL INFORMATION DISCLOSURE STATEMENT BY APPLICANT (use as many sheets as necessary)	Complete if Known	
	Application Number	12/891,443
	Filing Date	09/27/2010
	First Named Inventor	Michael Tasler
	Art Unit	2111
	Examiner Name	na
	Attorney Docket Number	0757-113189

Change(s) added to document

Sheet 3 of 24

/A.T.L./
7/2/2013

	5,539,535	07/04/1996	Aizawa et al	
	5,548,782	08/20/1996	Michael et al	
	5,548,783	08/20/1996	Jones et al	
	5,570,146	10/29/1996	Collette	
	5,574,859	11/12/1996	Yeh	
	5,579,529	11/26/1996	Terrell et al.	
	5,581,741	12/03/1996	Clark et al	
	5,596,628	01/21/1997	Klein	
	5,614,344	03/25/1997	Kawakami et al.	
	5,614,670	3/25/1997	Nazarian et al	
	5,614,948	3/25/1997	Hannah	
	5,619,659	04/08/1997	Kikinis et al.	
	5,625,800	04/29/1997	Brayton et al.	
	5,625,840	04/29/1997	Numata et al.	
	5,628,030	05/06/1997	Tuckner	
	5,630,164	5/13/1997	Williams et al	
	5,634,075	5/27/1997	Smith et al	
	5,638,299	06/10/1997	Miller	
	5,639,606	06/17/1997	Willey	
	5,640,204	06/17/1997	Tsutsui	
	5,663,901	09/02/1997	Wallace et al	
	5,668,976	09/16/1997	Zook	
	5,689,710	11/18/1997	Stanley et al.	
	5,692,159	11/25/1997	Shand	
	5,696,970	12/09/1997	Sandage et al.	
	5,703,584	12/30/1997	Hill	
	5,712,682	01/27/1998	Hannah	
	5,724,155	03/03/1998	Saito	
	5,724,574	03/03/1998	Stratigos et al	
	5,748,924	05/05/1998	Llorens et al	

Examiner Signature	/Chun Kuan Lee/	Date Considered	07/18/2011
---------------------------	-----------------	------------------------	------------

EXAMINER: Initial if reference considered, whether or not citation is in conformance with MPEP 609. Draw line through citation if not in conformance and not considered. Include copy of this form with next communication to applicant.

¹Applicant's unique citation designation number (optional). ²See Kind Codes of USPTO Patent Documents at www.uspto.gov or MPEP 901.04. ³Enter Office that issued the document, by the two-letter code (WIPO Standard ST. 3). ⁴For Japanese patent documents, the indication of the year of the reign of the Emperor must precede the serial number of the patent document. ⁵Kind of document by the appropriate symbols as indicated on the document under WIPO Standard ST. 16 if possible. ⁶Applicant is to place a check mark here if English language Translation is attached.

Burden Hour Statement: This form is estimated to take 2.0 hours to complete. Time will vary depending upon the needs of the individual case. Any comments on the amount of time you are required to complete this form should be sent to the Chief Information Officer, U.S. Patent and Trademark Office, Washington, DC 20231. DO NOT SEND FEES OR COMPLETED FORMS TO THIS ADDRESS. SEND TO: Assistant Commissioner for Patents, Washington, DC 20231.

CHI-12038-3

Change(s) applied
to document,

/A.T.L./
7/2/2013

1PTO/SB/08A & PTO/SB/08B (10-01)

Approved for use through 10/31/2002. OMB 0651-0031
U.S. Patent and Trademark Office: U.S. DEPARTMENT OF COMMERCE

Under the Paperwork Reduction Act of 1995, no persons are required to respond to a collection of information unless it contains a valid OMB control number.

10/24/2001 W&K Substitute for Form PTO-SB/08A, which is a US PTO Substitute for form 1449A/PTO and 1449B/PTO				Complete if Known	
				Application Number	12/891,443
SUPPLEMENTAL INFORMATION DISCLOSURE STATEMENT BY APPLICANT <i>(use as many sheets as necessary)</i>				Filing Date	09/27/2010
				First Named Inventor	Michael Tasler
				Art Unit	2111
				Examiner Name	na
				Attorney Docket Number	0757-113189
Sheet	2	of	24		

		5,296,611	03/22/1994	Solladie et al	
		5,297,124	03/22/1994	Plotkin et al	
		5,303,326	04/12/1994	Dean et al.	
		5,369,484	11/29/1994	Haugen	
		5,379,382	01/03/1995	Work et al	
		5,386,518	01/31/1995	Reagle et al.	
		5,402,170	03/28/1995	Parulski et al	
		5,428,357	6/27/1995	Haab et al	
		5,430,855	07/04/1995	Walsh et al	
		5,440,699	08/08/1995	Farrand et al	
		5,444,644	08/22/1995	Divjak	
		5,457,784	10/10/1995	Wells et al.	
		5,457,785	10/10/1995	Kikinis et al.	
		5,463,772	10/31/1995	Thompson et al	
		5,465,106	11/07/1995	Keech et al.	
		5,475,441	12/12/1995	Parulski et al	
		5,479,206	12/26/1995	Ueno et al	
		5,487,154	01/23/1996	Gunji	
		5,493,335	02/20/1996	Parulski et al	
		5,499,378	03/12/1/996	McNeill, Jr. et al	
		5,506,617	04/09/1996	Parulski et al	
		5,506,692	04/09/1996	Murata	
		5,508,821	04/16/1996	Murata	
		5,510,774	04/23/1996	Phillips	
		5,515,474	05/07/1996	Deacon et al.	
		5,524,047	06/04/1996	Brown et al	
		5,528,765	06/18/1996	Milligan	
		5,530,858	06/25/1996	Stanley et al.	
		5,532,825	07/04/1996	Lim et al	
		5,537,597	07/16/1996	Sandage	

Examiner Signature	/Chun Kuan Lee/	Date Considered	07/18/2011
--------------------	-----------------	-----------------	------------

EXAMINER: Initial if reference considered, whether or not citation is in conformance with MPEP 609. Draw line through citation if not in conformance and not considered. Include copy of this form with next communication to applicant.

¹Applicant's unique citation designation number (optional). ²See Kind Codes of USPTO Patent Documents at www.uspto.gov or MPEP 901.04. ³Enter Office that issued the document, by the two-letter code (WIPO Standard ST. 3). ⁴For Japanese patent documents, the indication of the year of the reign of the Emperor must precede the serial number of the patent document. ⁵Kind of document by the appropriate symbols as indicated on the document under WIPO Standard ST. 16 if possible. ⁶Applicant is to place a check mark here if English language Translation is attached.

Burden Hour Statement: This form is estimated to take 2.0 hours to complete. Time will vary depending upon the needs of the individual case. Any comments on the amount of time you are required to complete this form should be sent to the Chief Information Officer, U.S. Patent and Trademark Office, Washington, DC 20231. DO NOT SEND FEES OR COMPLETED FORMS TO THIS ADDRESS. SEND TO: Assistant Commissioner for Patents, Washington, DC 20231.

CHI-12038-3

ALL REFERENCES CONSIDERED EXCEPT **JVC KENWOOD CORP., et al.** /C.L./
Ex 1402, p. 6 of 340

PART B - FEE(S) TRANSMITTAL

**Complete and send this form, together with applicable fee(s), to: Mail Mail Stop ISSUE FEE
 Commissioner for Patents
 P.O. Box 1450
 Alexandria, Virginia 22313-1450
 or Fax (571)-273-2885**

INSTRUCTIONS: This form should be used for transmitting the ISSUE FEE and PUBLICATION FEE (if required). Blocks 1 through 5 should be completed where appropriate. All further correspondence including the Patent, advance orders and notification of maintenance fees will be mailed to the current correspondence address as indicated unless corrected below or directed otherwise in Block 1, by (a) specifying a new correspondence address; and/or (b) indicating a separate "FEE ADDRESS" for maintenance fee notifications.

Note: A certificate of mailing can only be used for domestic mailings of the Fee(s) Transmittal. This certificate cannot be used for any other accompanying papers. Each additional paper, such as an assignment or formal drawing, must have its own certificate of mailing or transmission.

CURRENT CORRESPONDENCE ADDRESS (Note: Use Block 1 for any change of address)

24628 7590 06/07/2013
Husch Blackwell LLP
 Husch Blackwell Sanders LLP Welsh & Katz
 120 S RIVERSIDE PLAZA
 22ND FLOOR
 CHICAGO, IL 60606

Certificate of Mailing or Transmission

I hereby certify that this Fee(s) Transmittal is being deposited with the United States Postal Service with sufficient postage for first class mail in an envelope addressed to the Mail Stop ISSUE FEE address above, or being facsimile transmitted to the USPTO (571) 273-2885, on the date indicated below.

_____ (Depositor's name)
_____ (Signature)
_____ (Date)

APPLICATION NO.	FILING DATE	FIRST NAMED INVENTOR	ATTORNEY DOCKET NO.	CONFIRMATION NO.
12/891,443	09/27/2010	Michael Tasler	0757-113189	1408

TITLE OF INVENTION: ANALOG DATA GENERATING AND PROCESSING DEVICE FOR USE WITH A PERSONAL COMPUTER

APPLN. TYPE	ENTITY STATUS	ISSUE FEE DUE	PUBLICATION FEE DUE	PREV. PAID ISSUE FEE	TOTAL FEE(S) DUE	DATE DUE
nonprovisional	UNDISCOUNTED	\$1780	\$300	\$0	\$2080	09/09/2013

EXAMINER	ART UNIT	CLASS-SUBCLASS
LEE, CHUN KUAN	2181	710-069000

1. Change of correspondence address or indication of "Fee Address" (37 CFR 1.363). <input type="checkbox"/> Change of correspondence address (or Change of Correspondence Address form PTO/SB/122) attached. <input type="checkbox"/> "Fee Address" indication (or "Fee Address" Indication form PTO/SB/47; Rev 03-02 or more recent) attached. Use of a Customer Number is required.	2. For printing on the patent front page, list (1) the names of up to 3 registered patent attorneys or agents OR, alternatively, (2) the name of a single firm (having as a member a registered attorney or agent) and the names of up to 2 registered patent attorneys or agents. If no name is listed, no name will be printed.	1. <u>Husch Blackwell LLP</u> 2. _____ 3. _____
---------------------------------------------------------------------------------------------------------------------------------------------------------------------------------------------------------------------------------------------------------------------------------------------------------------------------------------------------------------------------------------------	-----------------------------------------------------------------------------------------------------------------------------------------------------------------------------------------------------------------------------------------------------------------------------------------------------------------------------------------	-------------------------------------------------------

3. ASSIGNEE NAME AND RESIDENCE DATA TO BE PRINTED ON THE PATENT (print or type)
 PLEASE NOTE: Unless an assignee is identified below, no assignee data will appear on the patent. If an assignee is identified below, the document has been filed for recordation as set forth in 37 CFR 3.11. Completion of this form is NOT a substitute for filing an assignment.
 (A) NAME OF ASSIGNEE Papst Licensing GmbH & Co. KG (B) RESIDENCE: (CITY and STATE OR COUNTRY) St. Georgen, Germany

Please check the appropriate assignee category or categories (will not be printed on the patent) : Individual Corporation or other private group entity Government

4a. The following fee(s) are submitted: <input checked="" type="checkbox"/> Issue Fee <input checked="" type="checkbox"/> Publication Fee (No small entity discount permitted) <input type="checkbox"/> Advance Order - # of Copies _____	4b. Payment of Fee(s): (Please first reapply any previously paid issue fee shown above) <input type="checkbox"/> A check is enclosed. <input type="checkbox"/> Payment by credit card. Form PTO-2038 is attached. <input checked="" type="checkbox"/> The Director is hereby authorized to charge the required fee(s), any deficiency, or credit any overpayment, to Deposit Account Number <u>230920</u> (enclose an extra copy of this form).
----------------------------------------------------------------------------------------------------------------------------------------------------------------------------------------------------------------------------------------------------	----------------------------------------------------------------------------------------------------------------------------------------------------------------------------------------------------------------------------------------------------------------------------------------------------------------------------------------------------------------------------------------------------------------------------------------------------------

5. Change in Entity Status (from status indicated above)

- Applicant certifying micro entity status. See 37 CFR 1.29
- Applicant asserting small entity status. See 37 CFR 1.27
- Applicant changing to regular undiscounted fee status.

NOTE: Absent a valid certification of Micro Entity Status (see form PTO/SB/15A and 15B), issue fee payment in the micro entity amount will not be accepted at the risk of application abandonment.

NOTE: If the application was previously under micro entity status, checking this box will be taken to be a notification of loss of entitlement to micro entity status.

NOTE: Checking this box will be taken to be a notification of loss of entitlement to small or micro entity status, as applicable.

NOTE: The Issue Fee and Publication Fee (if required) will not be accepted from anyone other than the applicant; a registered attorney or agent; or the assignee or other party in interest as shown by the records of the United States Patent and Trademark Office.

Authorized Signature James A. Scheer
Typed or printed name James A. Scheer

Date June 13, 2013

Registration No. 29,434

This collection of information is required by 37 CFR 1.311. The information is required to obtain or retain a benefit by the public which is to file (and by the USPTO to process) an application. Confidentiality is governed by 35 U.S.C. 122 and 37 CFR 1.14. This collection is estimated to take 12 minutes to complete, including gathering, preparing, and submitting the completed application form to the USPTO. Time will vary depending upon the individual case. Any comments on the amount of time you require to complete this form and/or suggestions for reducing this burden, should be sent to the Chief Information Officer, U.S. Patent and Trademark Office, U.S. Department of Commerce, P.O. Box 1450, Alexandria, Virginia 22313-1450. DO NOT SEND FEES OR COMPLETED FORMS TO THIS ADDRESS. SEND TO: Commissioner for Patents, P.O. Box 1450, Alexandria, Virginia 22313-1450.

Under the Paperwork Reduction Act of 1995, no persons are required to respond to a collection of information unless it displays a valid OMB control number.

Electronic Patent Application Fee Transmittal

Application Number:	12891443
Filing Date:	27-Sep-2010
Title of Invention:	ANALOG DATA GENERATING AND PROCESSING DEVICE FOR USE WITH A PERSONAL COMPUTER
First Named Inventor/Applicant Name:	Michael Tasler
Filer:	James A. Scheer/mawish elahi
Attorney Docket Number:	0757-113189

Filed as Large Entity

Utility under 35 USC 111(a) Filing Fees

Description	Fee Code	Quantity	Amount	Sub-Total in USD(\$)
Basic Filing:				
Pages:				
Claims:				
Miscellaneous-Filing:				
Petition:				
Patent-Appeals-and-Interference:				
Post-Allowance-and-Post-Issuance:				
Utility Appl Issue Fee	1501	1	1780	1780
Publ. Fee- Early, Voluntary, or Normal	1504	1	000	000

JVC KENWOOD CORP., et al.

Description	Fee Code	Quantity	Amount	Sub-Total in USD(\$)
Extension-of-Time:				
Miscellaneous:				
Total in USD (\$)				2080

Electronic Acknowledgement Receipt

EFS ID:	16034473
Application Number:	12891443
International Application Number:	
Confirmation Number:	1408
Title of Invention:	ANALOG DATA GENERATING AND PROCESSING DEVICE FOR USE WITH A PERSONAL COMPUTER
First Named Inventor/Applicant Name:	Michael Tasler
Customer Number:	24628
Filer:	James A. Scheer/mawish elahi
Filer Authorized By:	James A. Scheer
Attorney Docket Number:	0757-113189
Receipt Date:	13-JUN-2013
Filing Date:	27-SEP-2010
Time Stamp:	16:35:31
Application Type:	Utility under 35 USC 111(a)

Payment information:

Submitted with Payment	yes
Payment Type	Deposit Account
Payment was successfully received in RAM	\$2080
RAM confirmation Number	3709
Deposit Account	230920
Authorized User	

The Director of the USPTO is hereby authorized to charge indicated fees and credit any overpayment as follows:

Charge any Additional Fees required under 37 C.F.R. Section 1.19 (Document supply fees)

Charge any Additional Fees required under 37 C.F.R. Section 1.20 (Post Issuance fees)

JVC KENWOOD CORP., et al.
Ex 1402, p. 11 of 340

File Listing:

Document Number	Document Description	File Name	File Size(Bytes)/ Message Digest	Multi Part /.zip	Pages (if appl.)
1	Issue Fee Payment (PTO-85B)	113189issuefee.PDF	48181 <small>74a1e25e288492ff5cef16429bc98adc9adc7e5</small>	no	2

Warnings:

Information:

2	Fee Worksheet (SB06)	fee-info.pdf	32101 <small>d6948a6d5a99ded3e24cf2c4757fc46c492b15f8</small>	no	2
---	----------------------	--------------	------------------------------------------------------------------	----	---

Warnings:

Information:

Total Files Size (in bytes):			80282		
-------------------------------------	--	--	-------	--	--

This Acknowledgement Receipt evidences receipt on the noted date by the USPTO of the indicated documents, characterized by the applicant, and including page counts, where applicable. It serves as evidence of receipt similar to a Post Card, as described in MPEP 503.

New Applications Under 35 U.S.C. 111

If a new application is being filed and the application includes the necessary components for a filing date (see 37 CFR 1.53(b)-(d) and MPEP 506), a Filing Receipt (37 CFR 1.54) will be issued in due course and the date shown on this Acknowledgement Receipt will establish the filing date of the application.

National Stage of an International Application under 35 U.S.C. 371

If a timely submission to enter the national stage of an international application is compliant with the conditions of 35 U.S.C. 371 and other applicable requirements a Form PCT/DO/EO/903 indicating acceptance of the application as a national stage submission under 35 U.S.C. 371 will be issued in addition to the Filing Receipt, in due course.

New International Application Filed with the USPTO as a Receiving Office

If a new international application is being filed and the international application includes the necessary components for an international filing date (see PCT Article 11 and MPEP 1810), a Notification of the International Application Number and of the International Filing Date (Form PCT/RO/105) will be issued in due course, subject to prescriptions concerning national security, and the date shown on this Acknowledgement Receipt will establish the international filing date of the application.



NOTICE OF ALLOWANCE AND FEE(S) DUE

24628 7590 06/07/2013
Husch Blackwell LLP
Husch Blackwell Sanders LLP Welsh & Katz
120 S RIVERSIDE PLAZA
22ND FLOOR
CHICAGO, IL 60606

Table with 2 columns: EXAMINER (LEE, CHUN KUAN), ART UNIT (2181), PAPER NUMBER (1408)

DATE MAILED: 06/07/2013

Table with 5 columns: APPLICATION NO., FILING DATE, FIRST NAMED INVENTOR, ATTORNEY DOCKET NO., CONFIRMATION NO.

TITLE OF INVENTION: ANALOG DATA GENERATING AND PROCESSING DEVICE FOR USE WITH A PERSONAL COMPUTER

Table with 7 columns: APPLN. TYPE, ENTITY STATUS, ISSUE FEE DUE, PUBLICATION FEE DUE, PREV. PAID ISSUE FEE, TOTAL FEE(S) DUE, DATE DUE

THE APPLICATION IDENTIFIED ABOVE HAS BEEN EXAMINED AND IS ALLOWED FOR ISSUANCE AS A PATENT. PROSECUTION ON THE MERITS IS CLOSED. THIS NOTICE OF ALLOWANCE IS NOT A GRANT OF PATENT RIGHTS. THIS APPLICATION IS SUBJECT TO WITHDRAWAL FROM ISSUE AT THE INITIATIVE OF THE OFFICE OR UPON PETITION BY THE APPLICANT. SEE 37 CFR 1.313 AND MPEP 1308.

THE ISSUE FEE AND PUBLICATION FEE (IF REQUIRED) MUST BE PAID WITHIN THREE MONTHS FROM THE MAILING DATE OF THIS NOTICE OR THIS APPLICATION SHALL BE REGARDED AS ABANDONED. THIS STATUTORY PERIOD CANNOT BE EXTENDED. SEE 35 U.S.C. 151. THE ISSUE FEE DUE INDICATED ABOVE DOES NOT REFLECT A CREDIT FOR ANY PREVIOUSLY PAID ISSUE FEE IN THIS APPLICATION. IF AN ISSUE FEE HAS PREVIOUSLY BEEN PAID IN THIS APPLICATION (AS SHOWN ABOVE), THE RETURN OF PART B OF THIS FORM WILL BE CONSIDERED A REQUEST TO REAPPLY THE PREVIOUSLY PAID ISSUE FEE TOWARD THE ISSUE FEE NOW DUE.

HOW TO REPLY TO THIS NOTICE:

I. Review the ENTITY STATUS shown above. If the ENTITY STATUS is shown as SMALL or MICRO, verify whether entitlement to that entity status still applies.

If the ENTITY STATUS is the same as shown above, pay the TOTAL FEE(S) DUE shown above.

If the ENTITY STATUS is changed from that shown above, on PART B - FEE(S) TRANSMITTAL, complete section number 5 titled "Change in Entity Status (from status indicated above)".

For purposes of this notice, small entity fees are 1/2 the amount of undiscounted fees, and micro entity fees are 1/2 the amount of small entity fees.

II. PART B - FEE(S) TRANSMITTAL, or its equivalent, must be completed and returned to the United States Patent and Trademark Office (USPTO) with your ISSUE FEE and PUBLICATION FEE (if required). If you are charging the fee(s) to your deposit account, section "4b" of Part B - Fee(s) Transmittal should be completed and an extra copy of the form should be submitted. If an equivalent of Part B is filed, a request to reapply a previously paid issue fee must be clearly made, and delays in processing may occur due to the difficulty in recognizing the paper as an equivalent of Part B.

III. All communications regarding this application must give the application number. Please direct all communications prior to issuance to Mail Stop ISSUE FEE unless advised to the contrary.

IMPORTANT REMINDER: Utility patents issuing on applications filed on or after Dec. 12, 1980 may require payment of maintenance fees. It is patentee's responsibility to ensure timely payment of maintenance fees when due.

PART B - FEE(S) TRANSMITTAL

**Complete and send this form, together with applicable fee(s), to: Mail Mail Stop ISSUE FEE
 Commissioner for Patents
 P.O. Box 1450
 Alexandria, Virginia 22313-1450
 or Fax (571)-273-2885**

INSTRUCTIONS: This form should be used for transmitting the ISSUE FEE and PUBLICATION FEE (if required). Blocks 1 through 5 should be completed where appropriate. All further correspondence including the Patent, advance orders and notification of maintenance fees will be mailed to the current correspondence address as indicated unless corrected below or directed otherwise in Block 1, by (a) specifying a new correspondence address; and/or (b) indicating a separate "FEE ADDRESS" for maintenance fee notifications.

Note: A certificate of mailing can only be used for domestic mailings of the Fee(s) Transmittal. This certificate cannot be used for any other accompanying papers. Each additional paper, such as an assignment or formal drawing, must have its own certificate of mailing or transmission.

CURRENT CORRESPONDENCE ADDRESS (Note: Use Block 1 for any change of address)

24628 7590 06/07/2013
Husch Blackwell LLP
 Husch Blackwell Sanders LLP Welsh & Katz
 120 S RIVERSIDE PLAZA
 22ND FLOOR
 CHICAGO, IL 60606

Certificate of Mailing or Transmission

I hereby certify that this Fee(s) Transmittal is being deposited with the United States Postal Service with sufficient postage for first class mail in an envelope addressed to the Mail Stop ISSUE FEE address above, or being facsimile transmitted to the USPTO (571) 273-2885, on the date indicated below.

(Depositor's name)
(Signature)
(Date)

APPLICATION NO.	FILING DATE	FIRST NAMED INVENTOR	ATTORNEY DOCKET NO.	CONFIRMATION NO.
12/891,443	09/27/2010	Michael Tasler	0757-113189	1408

TITLE OF INVENTION: ANALOG DATA GENERATING AND PROCESSING DEVICE FOR USE WITH A PERSONAL COMPUTER

APPLN. TYPE	ENTITY STATUS	ISSUE FEE DUE	PUBLICATION FEE DUE	PREV. PAID ISSUE FEE	TOTAL FEE(S) DUE	DATE DUE
nonprovisional	UNDISCOUNTED	\$1780	\$300	\$0	\$2080	09/09/2013

EXAMINER	ART UNIT	CLASS-SUBCLASS
LEE, CHUN KUAN	2181	710-069000

<p>1. Change of correspondence address or indication of "Fee Address" (37 CFR 1.363).</p> <p><input type="checkbox"/> Change of correspondence address (or Change of Correspondence Address form PTO/SB/122) attached.</p> <p><input type="checkbox"/> "Fee Address" indication (or "Fee Address" Indication form PTO/SB/47; Rev 03-02 or more recent) attached. Use of a Customer Number is required.</p>	<p>2. For printing on the patent front page, list</p> <p>(1) the names of up to 3 registered patent attorneys or agents OR, alternatively, _____ 1</p> <p>(2) the name of a single firm (having as a member a registered attorney or agent) and the names of up to 2 registered patent attorneys or agents. If no name is listed, no name will be printed. _____ 2</p> <p>_____ 3</p>
-------------------------------------------------------------------------------------------------------------------------------------------------------------------------------------------------------------------------------------------------------------------------------------------------------------------------------------------------------------------------------------------------------------------	---------------------------------------------------------------------------------------------------------------------------------------------------------------------------------------------------------------------------------------------------------------------------------------------------------------------------------------------------------------------------------------

3. ASSIGNEE NAME AND RESIDENCE DATA TO BE PRINTED ON THE PATENT (print or type)

PLEASE NOTE: Unless an assignee is identified below, no assignee data will appear on the patent. If an assignee is identified below, the document has been filed for recordation as set forth in 37 CFR 3.11. Completion of this form is NOT a substitute for filing an assignment.

(A) NAME OF ASSIGNEE _____ (B) RESIDENCE: (CITY and STATE OR COUNTRY) _____

Please check the appropriate assignee category or categories (will not be printed on the patent) : Individual Corporation or other private group entity Government

<p>4a. The following fee(s) are submitted:</p> <p><input type="checkbox"/> Issue Fee</p> <p><input type="checkbox"/> Publication Fee (No small entity discount permitted)</p> <p><input type="checkbox"/> Advance Order - # of Copies _____</p>	<p>4b. Payment of Fee(s): (Please first reapply any previously paid issue fee shown above)</p> <p><input type="checkbox"/> A check is enclosed.</p> <p><input type="checkbox"/> Payment by credit card. Form PTO-2038 is attached.</p> <p><input type="checkbox"/> The Director is hereby authorized to charge the required fee(s), any deficiency, or credit any overpayment, to Deposit Account Number _____ (enclose an extra copy of this form).</p>
-------------------------------------------------------------------------------------------------------------------------------------------------------------------------------------------------------------------------------------------------	-----------------------------------------------------------------------------------------------------------------------------------------------------------------------------------------------------------------------------------------------------------------------------------------------------------------------------------------------------------------------------------------------------------------------------------------------------------------

5. **Change in Entity Status** (from status indicated above)

- Applicant certifying micro entity status. See 37 CFR 1.29
- Applicant asserting small entity status. See 37 CFR 1.27
- Applicant changing to regular undiscounted fee status.

NOTE: Absent a valid certification of Micro Entity Status (see form PTO/SB/15A and 15B), issue fee payment in the micro entity amount will not be accepted at the risk of application abandonment.

NOTE: If the application was previously under micro entity status, checking this box will be taken to be a notification of loss of entitlement to micro entity status.

NOTE: Checking this box will be taken to be a notification of loss of entitlement to small or micro entity status, as applicable.

NOTE: The Issue Fee and Publication Fee (if required) will not be accepted from anyone other than the applicant; a registered attorney or agent; or the assignee or other party in interest as shown by the records of the United States Patent and Trademark Office.

Authorized Signature _____

Date _____

Typed or printed name _____

Registration No. _____

This collection of information is required by 37 CFR 1.311. The information is required to obtain or retain a benefit by the public which is to file (and by the USPTO to process) an application. Confidentiality is governed by 35 U.S.C. 122 and 37 CFR 1.14. This collection is estimated to take 12 minutes to complete, including gathering, preparing, and submitting the completed application form to the USPTO. Time will vary depending upon the individual case. Any comments on the amount of time you require to complete this form and/or suggestions for reducing this burden, should be sent to the Chief Information Officer, U.S. Patent and Trademark Office, U.S. Department of Commerce, P.O. Box 1450, Alexandria, Virginia 22313-1450. DO NOT SEND FEES OR COMPLETED FORMS TO THIS ADDRESS. SEND TO: Commissioner for Patents, P.O. Box 1450, Alexandria, Virginia 22313-1450.

Under the Paperwork Reduction Act of 1995, no persons are required to respond to a collection of information unless it displays a valid OMB control number.



UNITED STATES PATENT AND TRADEMARK OFFICE

UNITED STATES DEPARTMENT OF COMMERCE
United States Patent and Trademark Office
Address: COMMISSIONER FOR PATENTS
P.O. Box 1450
Alexandria, Virginia 22313-1450
www.uspto.gov

Table with 5 columns: APPLICATION NO., FILING DATE, FIRST NAMED INVENTOR, ATTORNEY DOCKET NO., CONFIRMATION NO.

24628 7590 06/07/2013
Husch Blackwell LLP
Husch Blackwell Sanders LLP Welsh & Katz
120 S RIVERSIDE PLAZA
22ND FLOOR
CHICAGO, IL 60606

EXAMINER

LEE, CHUN KUAN

ART UNIT PAPER NUMBER

2181

DATE MAILED: 06/07/2013

Determination of Patent Term Adjustment under 35 U.S.C. 154 (b)
(application filed on or after May 29, 2000)

The Patent Term Adjustment to date is 0 day(s). If the issue fee is paid on the date that is three months after the mailing date of this notice and the patent issues on the Tuesday before the date that is 28 weeks (six and a half months) after the mailing date of this notice, the Patent Term Adjustment will be 0 day(s).

If a Continued Prosecution Application (CPA) was filed in the above-identified application, the filing date that determines Patent Term Adjustment is the filing date of the most recent CPA.

Applicant will be able to obtain more detailed information by accessing the Patent Application Information Retrieval (PAIR) WEB site (http://pair.uspto.gov).

Any questions regarding the Patent Term Extension or Adjustment determination should be directed to the Office of Patent Legal Administration at (571)-272-7702. Questions relating to issue and publication fee payments should be directed to the Customer Service Center of the Office of Patent Publication at 1-(888)-786-0101 or (571)-272-4200.

Privacy Act Statement

The Privacy Act of 1974 (P.L. 93-579) requires that you be given certain information in connection with your submission of the attached form related to a patent application or patent. Accordingly, pursuant to the requirements of the Act, please be advised that: (1) the general authority for the collection of this information is 35 U.S.C. 2(b)(2); (2) furnishing of the information solicited is voluntary; and (3) the principal purpose for which the information is used by the U.S. Patent and Trademark Office is to process and/or examine your submission related to a patent application or patent. If you do not furnish the requested information, the U.S. Patent and Trademark Office may not be able to process and/or examine your submission, which may result in termination of proceedings or abandonment of the application or expiration of the patent.

The information provided by you in this form will be subject to the following routine uses:

1. The information on this form will be treated confidentially to the extent allowed under the Freedom of Information Act (5 U.S.C. 552) and the Privacy Act (5 U.S.C. 552a). Records from this system of records may be disclosed to the Department of Justice to determine whether disclosure of these records is required by the Freedom of Information Act.
2. A record from this system of records may be disclosed, as a routine use, in the course of presenting evidence to a court, magistrate, or administrative tribunal, including disclosures to opposing counsel in the course of settlement negotiations.
3. A record in this system of records may be disclosed, as a routine use, to a Member of Congress submitting a request involving an individual, to whom the record pertains, when the individual has requested assistance from the Member with respect to the subject matter of the record.
4. A record in this system of records may be disclosed, as a routine use, to a contractor of the Agency having need for the information in order to perform a contract. Recipients of information shall be required to comply with the requirements of the Privacy Act of 1974, as amended, pursuant to 5 U.S.C. 552a(m).
5. A record related to an International Application filed under the Patent Cooperation Treaty in this system of records may be disclosed, as a routine use, to the International Bureau of the World Intellectual Property Organization, pursuant to the Patent Cooperation Treaty.
6. A record in this system of records may be disclosed, as a routine use, to another federal agency for purposes of National Security review (35 U.S.C. 181) and for review pursuant to the Atomic Energy Act (42 U.S.C. 218(c)).
7. A record from this system of records may be disclosed, as a routine use, to the Administrator, General Services, or his/her designee, during an inspection of records conducted by GSA as part of that agency's responsibility to recommend improvements in records management practices and programs, under authority of 44 U.S.C. 2904 and 2906. Such disclosure shall be made in accordance with the GSA regulations governing inspection of records for this purpose, and any other relevant (i.e., GSA or Commerce) directive. Such disclosure shall not be used to make determinations about individuals.
8. A record from this system of records may be disclosed, as a routine use, to the public after either publication of the application pursuant to 35 U.S.C. 122(b) or issuance of a patent pursuant to 35 U.S.C. 151. Further, a record may be disclosed, subject to the limitations of 37 CFR 1.14, as a routine use, to the public if the record was filed in an application which became abandoned or in which the proceedings were terminated and which application is referenced by either a published application, an application open to public inspection or an issued patent.
9. A record from this system of records may be disclosed, as a routine use, to a Federal, State, or local law enforcement agency, if the USPTO becomes aware of a violation or potential violation of law or regulation.

Notice of Allowability	Application No. 12/891,443	Applicant(s) TASLER, MICHAEL	
	Examiner Chun-Kuan Lee	Art Unit 2181	AIA (First Inventor to File) Status No

-- The MAILING DATE of this communication appears on the cover sheet with the correspondence address--

All claims being allowable, PROSECUTION ON THE MERITS IS (OR REMAINS) CLOSED in this application. If not included herewith (or previously mailed), a Notice of Allowance (PTOL-85) or other appropriate communication will be mailed in due course. **THIS NOTICE OF ALLOWABILITY IS NOT A GRANT OF PATENT RIGHTS.** This application is subject to withdrawal from issue at the initiative of the Office or upon petition by the applicant. See 37 CFR 1.313 and MPEP 1308.

1. This communication is responsive to 05/28/2013.
 A declaration(s)/affidavit(s) under **37 CFR 1.130(b)** was/were filed on _____.
2. An election was made by the applicant in response to a restriction requirement set forth during the interview on _____; the restriction requirement and election have been incorporated into this action.
3. The allowed claim(s) is/are 2-36 (renumbered as claims 1-35). As a result of the allowed claim(s), you may be eligible to benefit from the **Patent Prosecution Highway** program at a participating intellectual property office for the corresponding application. For more information, please see http://www.uspto.gov/patents/init_events/pph/index.jsp or send an inquiry to PPHfeedback@uspto.gov.
4. Acknowledgment is made of a claim for foreign priority under 35 U.S.C. § 119(a)-(d) or (f).

Certified copies:

- a) All b) Some *c) None of the:
 1. Certified copies of the priority documents have been received.
 2. Certified copies of the priority documents have been received in Application No. _____.
 3. Copies of the certified copies of the priority documents have been received in this national stage application from the International Bureau (PCT Rule 17.2(a)).

* Certified copies not received: _____.

Interim copies:

- a) All b) Some c) None of the: Interim copies of the priority documents have been received.

Applicant has THREE MONTHS FROM THE "MAILING DATE" of this communication to file a reply complying with the requirements noted below. Failure to timely comply will result in ABANDONMENT of this application.

THIS THREE-MONTH PERIOD IS NOT EXTENDABLE.

5. CORRECTED DRAWINGS (as "replacement sheets") must be submitted.
 including changes required by the attached Examiner's Amendment / Comment or in the Office action of Paper No./Mail Date _____.
Identifying indicia such as the application number (see 37 CFR 1.84(c)) should be written on the drawings in the front (not the back) of each sheet. Replacement sheet(s) should be labeled as such in the header according to 37 CFR 1.121(d).
6. DEPOSIT OF and/or INFORMATION about the deposit of BIOLOGICAL MATERIAL must be submitted. Note the attached Examiner's comment regarding REQUIREMENT FOR THE DEPOSIT OF BIOLOGICAL MATERIAL.

Attachment(s)

- | | |
|------------------------------------------------------------------------------------------------------------|--------------------------------------------------------------------------------------|
| 1. <input type="checkbox"/> Notice of References Cited (PTO-892) | 5. <input type="checkbox"/> Examiner's Amendment/Comment |
| 2. <input type="checkbox"/> Information Disclosure Statements (PTO/SB/08),
Paper No./Mail Date _____ | 6. <input checked="" type="checkbox"/> Examiner's Statement of Reasons for Allowance |
| 3. <input type="checkbox"/> Examiner's Comment Regarding Requirement for Deposit
of Biological Material | 7. <input type="checkbox"/> Other _____. |
| 4. <input type="checkbox"/> Interview Summary (PTO-413),
Paper No./Mail Date _____. | |

/Chun-Kuan Lee/
Primary Examiner, Art Unit 2181

DETAILED ACTION

I. ELECTION / RESTRICTION

Claim 2 is directed to an allowable product. Pursuant to the procedures set forth in MPEP § 821.04(B), claims 14, 17, 23, 25-26, 28-29 and 33-34, including similar allowable subject matter recited by the allowable product, previously withdrawn from consideration as a result of a restriction requirement, are hereby rejoined and fully examined for patentability under 37 CFR 1.104.

Because all claims previously withdrawn from consideration under 37 CFR 1.142 have been rejoined, **the restriction requirement as set forth in the Office action mailed on 04/19/2011 is hereby withdrawn.** In view of the withdrawal of the restriction requirement as to the rejoined inventions, applicant(s) are advised that if any claim presented in a continuation or divisional application is anticipated by, or includes all the limitations of, a claim that is allowable in the present application, such claim may be subject to provisional statutory and/or nonstatutory double patenting rejections over the claims of the instant application. Once the restriction requirement is withdrawn, the provisions of 35 U.S.C. 121 are no longer applicable. See *In re Ziegler*, 443 F.2d 1211, 1215, 170 USPQ 129, 131-32 (CCPA 1971). See also MPEP § 804.01.

II. DISTINGUISHING FEATURES RECITED IN THE CLAIMS

ALLOWABLE SUBJECT MATTER

Claims 2-36 (renumbered as claims 1-35) are allowed.

The following is an **Examiner's Statement of Reasons for Allowance**, See **MPEP 1302.14**:

The reasons for allowance of claims 2, 32, 33 and 35 (renumbered as claims 1, 31, 32, and 34) in the instant application is that the examiner finds applicant's arguments filed on 05/28/2013 are persuasive and that the combination of ***all*** the claimed limitations is neither anticipates nor renders obvious by the prior art of record. Because claims 3-31, 34 and 36 (renumbered as claims 2-30, 33 and 35) depend directly or indirectly on claims 2, 32, 33 and 35 (renumbered as claims 1, 31, 32, and 34), these claims are considered allowable for at least the same reasons noted above.

Any comments considered necessary by applicant must be submitted no later than the payment of the issue fee and, to avoid processing delays, should preferably accompany the issue fee. Such submissions should be clearly labeled "Comments on Statement of Reasons for Allowance."

Art Unit: 2181

CONCLUSION

Any inquiry concerning this communication or earlier communications from the examiner should be directed to Chun-Kuan (Mike) Lee whose telephone number is (571) 272-0671. The examiner can normally be reached on 8AM to 5PM.

If attempts to reach the examiner by telephone are unsuccessful, the examiner's supervisor, Idriss Alrobaye can be reached on (571) 270-1023. The fax phone number for the organization where this application or proceeding is assigned is 571-273-8300.

Information regarding the status of an application may be obtained from the Patent Application Information Retrieval (PAIR) system. Status information for published applications may be obtained from either Private PAIR or Public PAIR. Status information for unpublished applications is available through Private PAIR only. For more information about the PAIR system, see <http://pair-direct.uspto.gov>. Should you have questions on access to the Private PAIR system, contact the Electronic Business Center (EBC) at 866-217-9197 (toll-free). If you would like assistance from a USPTO Customer Service Representative or access to the automated information system, call 800-786-9199 (IN USA OR CANADA) or 571-272-1000.

/Chun-Kuan Lee/
Primary Examiner
Art Unit 2181
May 31, 2013

Issue Classification 	Application/Control No. 12891443	Applicant(s)/Patent Under Reexamination TASLER, MICHAEL
	Examiner CHUN-KUAN LEE	Art Unit 2181

<input type="checkbox"/> Claims renumbered in the same order as presented by applicant		<input type="checkbox"/> CPA		<input checked="" type="checkbox"/> T.D.		<input type="checkbox"/> R.1.47									
Final	Original	Final	Original	Final	Original	Final	Original	Final	Original	Final	Original	Final	Original	Final	Original
1	2	17	18	33	34										
2	3	18	19	34	35										
3	4	19	20	35	36										
4	5	20	21												
5	6	21	22												
6	7	22	23												
7	8	23	24												
8	9	24	25												
9	10	25	26												
10	11	26	27												
11	12	27	28												
12	13	28	29												
13	14	29	30												
14	15	30	31												
15	16	31	32												
16	17	32	33												

NONE		Total Claims Allowed:	
(Assistant Examiner)	(Date)	35	
/CHUN-KUAN LEE/ Primary Examiner.Art Unit 2181	05/31/2013	O.G. Print Claim(s)	O.G. Print Figure
(Primary Examiner)	(Date)	1	2

Search Notes 	Application/Control No. 12891443	Applicant(s)/Patent Under Reexamination TASLER, MICHAEL
	Examiner Chun-Kuan Lee	Art Unit 2181

CPC- SEARCHED		
Symbol	Date	Examiner

CPC COMBINATION SETS - SEARCHED		
Symbol	Date	Examiner

US CLASSIFICATION SEARCHED			
Class	Subclass	Date	Examiner
710	15,63,69	5/31/2013	CKL

SEARCH NOTES		
Search Notes	Date	Examiner
Updated EAST search:US-PGPUB; USPAT; USOCR; EPO; JPO; DERWENT	5/31/2013	CKL
Updated inventor search utilizing eDan and EAST	5/31/2013	CKL

INTERFERENCE SEARCH			
US Class/ CPC Symbol	US Subclass / CPC Group	Date	Examiner
710	15,63,69	5/31/2013	CKL

--	--

EAST Search History**EAST Search History (Prior Art)**

Ref #	Hits	Search Query	DBs	Default Operator	Plurals	Time Stamp
S1	2782	(710/15,63,69).ccls.	US-PGPUB; USPAT; USOCR; EPO; JPO; DERWENT	SAME	OFF	2013/05/31 00:31
S2	9	(TASLER near MICHAEL).in.	US-PGPUB; USPAT; USOCR; EPO; JPO; DERWENT	SAME	OFF	2013/05/31 08:29
S3	15332	plug near play	US-PGPUB; USPAT; USOCR; EPO; JPO; DERWENT	SAME	OFF	2013/05/31 08:33
S4	143	multimeter\$2 and (plug with play)	US-PGPUB; USPAT; USOCR; EPO; JPO; DERWENT	SAME	OFF	2013/05/31 12:22
S5	4492	((disk near drive\$2) or (hard near drive\$2) or HD or HDD or (hard near disk near drive\$2)) with(emulat\$4 or simulat\$4))	US-PGPUB; USPAT; USOCR; EPO; JPO; DERWENT	SAME	OFF	2013/05/31 14:08

UNITED STATES PATENT AND TRADEMARK OFFICE

 UNITED STATES DEPARTMENT OF COMMERCE
 United States Patent and Trademark Office
 Address: COMMISSIONER FOR PATENTS
 P.O. Box 1450
 Alexandria, Virginia 22313-1450
 www.uspto.gov

BIB DATA SHEET
CONFIRMATION NO. 1408

SERIAL NUMBER	FILING or 371(c) DATE RULE	CLASS	GROUP ART UNIT	ATTORNEY DOCKET NO.		
12/891,443	09/27/2010	710	2181	0757-113189		
APPLICANTS Michael Tasler, Wurzburg, GERMANY;						
** CONTINUING DATA ***** This application is a CON of 11/928,283 10/30/2007 ABN which is a CON of 11/467,073 08/24/2006 and is a CON of 11/078,778 03/11/2005 ABN and is a CON of 10/219,105 08/15/2002 PAT 6895449 and is a CON of 09/331,002 06/14/1999 PAT 6470399						
** FOREIGN APPLICATIONS ***** GERMANY 19708755.8 03/04/1997 EUROPEAN PATENT OFFICE (EPO) PCT/EP98/01187 03/03/1998						
** IF REQUIRED, FOREIGN FILING LICENSE GRANTED ** 10/08/2010						
Foreign Priority claimed	<input checked="" type="checkbox"/> Yes <input type="checkbox"/> No	<input type="checkbox"/> Met after Allowance	STATE OR COUNTRY	SHEETS DRAWINGS	TOTAL CLAIMS	INDEPENDENT CLAIMS
35 USC 119(a-d) conditions met	<input checked="" type="checkbox"/> Yes <input type="checkbox"/> No	Initials	GERMANY	2	35	4
Verified and Acknowledged	/CHUN-KUAN LEE/ Examiner's Signature					
ADDRESS						
Husch Blackwell LLP Husch Blackwell Sanders LLP Welsh & Katz 120 S RIVERSIDE PLAZA 22ND FLOOR CHICAGO, IL 60606 UNITED STATES						
TITLE						
ANALOG DATA GENERATING AND PROCESSING DEVICE FOR USE WITH A PERSONAL COMPUTER						
FILING FEE RECEIVED	FEES: Authority has been given in Paper			<input type="checkbox"/> All Fees		
1220	No. _____ to charge/credit DEPOSIT ACCOUNT			<input type="checkbox"/> 1.16 Fees (Filing)		
	No. _____ for following:			<input type="checkbox"/> 1.17 Fees (Processing Ext. of time)		
				<input type="checkbox"/> 1.18 Fees (Issue)		
				<input type="checkbox"/> Other _____		
				<input type="checkbox"/> Credit		

Index of Claims 	Application/Control No. 12891443	Applicant(s)/Patent Under Reexamination TASLER, MICHAEL
	Examiner CHUN-KUAN LEE	Art Unit 2181

✓	Rejected
=	Allowed

-	Cancelled
÷	Restricted

N	Non-Elected
I	Interference

A	Appeal
O	Objected

Claims renumbered in the same order as presented by applicant
 CPA
 T.D.
 R.1.47

CLAIM		DATE							
Final	Original	04/18/2011	11/27/2012	05/31/2013					
	1	-	-	-					
1	2	÷	✓	=					
2	3	÷	✓	=					
3	4	÷	✓	=					
4	5	÷	✓	=					
5	6	÷	✓	=					
6	7	÷	✓	=					
7	8	÷	✓	=					
8	9	÷	✓	=					
9	10	÷	✓	=					
10	11	÷	✓	=					
11	12	÷	✓	=					
12	13	÷	✓	=					
13	14	÷	N	=					
14	15	÷	✓	=					
15	16	÷	✓	=					
16	17	÷	N	=					
17	18	÷	✓	=					
18	19	÷	✓	=					
19	20	÷	✓	=					
20	21	÷	✓	=					
21	22	÷	✓	=					
22	23	÷	N	=					
23	24	÷	✓	=					
24	25	÷	N	=					
25	26	÷	N	=					
26	27	÷	✓	=					
27	28	÷	N	=					
28	29	÷	N	=					
29	30	÷	✓	=					
30	31	÷	✓	=					
31	32	÷	✓	=					
32	33	÷	N	=					
33	34	÷	N	=					
34	35	÷	✓	=					
35	36	÷	✓	=					

Docket No.: 0757-113189
(PATENT)

IN THE UNITED STATES PATENT AND TRADEMARK OFFICE

In re Patent Application of:
Michael Tasler

Application No.: 12/891,443

Confirmation No.: 1408

Filed: September 27, 2010

Art Unit: 2181

For: ANALOG DATA GENERATING AND
PROCESSING DEVICE FOR USE WITH A
PERSONAL COMPUTER

Examiner: Lee, Chun Kuan

AMENDMENT

Mail Stop Amendment
Commissioner for Patents
P.O. Box 1450
Alexandria, VA 22313-1450

Dear Sir:

In response to the Office Action mailed November 28, 2012, please amend the above-identified application as follows:

Amendments To The Claims:

Please cancel claim 1 and add new claims 2-36:

1. (cancelled).

2. (currently amended) An analog data acquisition device operatively connectable to a computer through a multipurpose interface of the computer, the computer having an operating system being programmed so that, when the computer receives a signal from the device through said multipurpose interface of the computer indicative of a class of devices, the computer automatically activates a device driver corresponding to the class of devices for allowing the transfer of data between the device and the operating system of the computer, the analog data acquisition device comprising:
 - a) a program memory;
 - b) an analog signal acquisition channel for receiving a signal from an analog source;
 - c) a processor operatively interfaced with the multipurpose interface of the computer, the program memory, and a data storage memory when the analog data acquisition device is operational;
 - d) wherein the processor is configured and programmed to implement a data generation process by which analog data is acquired from the analog signal acquisition channel, the analog data is processed, and digitized, and the processed and digitized analog data is stored in a file system of the data storage memory as at least one file of digitized analog data;
 - e) wherein when the analog acquisition device is operatively interfaced with the multipurpose interface of the computer, the processor executes at least one instruction set stored in the program memory and thereby automatically causes at least one parameter indicative of the class of devices to be sent to the computer through the multipurpose interface of the computer,

independent of the analog source, wherein the analog data acquisition device is not within the class of devices; and

f) wherein the processor is further configured and programmed to execute at least one other instruction set stored in the program memory to thereby allow the at least one file of digitized analog data acquired from the analog signal acquisition channel to be transferred to the computer using the device driver corresponding to said class of devices so that the analog data acquisition device appears to the computer as if it were a device of the class of devices;

whereby there is no requirement for any user-loaded file transfer enabling software to be loaded on or installed in the computer in addition to the operating system.

3. (previously presented) The analog data acquisition device of claim 2, wherein the analog data acquisition device is a stand alone device.

4. (previously presented) The analog data acquisition device of claim 2, wherein the analog data acquisition device includes a SCSI interface circuit.

5. (previously presented) The analog data acquisition device of claim 2, wherein the analog data acquisition device is designed so that the analog source is detachable.

6. (previously presented) The analog data acquisition device of claim 2 configured to allow for a plurality of different data transmit devices to be attached thereto and detached therefrom.

7. (previously presented) The analog data acquisition device of claim 2, wherein the processor is adapted to be interfaced with the multi-purpose interface of an external computing device by means of a cable.

8. (previously presented) The analog data acquisition device of claim 2, wherein the analog source comprises a data transmit/receive device.

9. (previously presented) The analog data acquisition device of claim 8, wherein the analog source is designed for one of one-way and two-way communication with the host device.

10. (previously presented) The analog data acquisition device of claim 2, wherein the processor converts the digitized analog data acquired from the analog signal acquisition channel to a form that simulates data from a hard disk and transfers that converted data to the computer through the multipurpose interface such that the converted data appears to the computer as data from a hard disk.

11. (previously presented) The analog data acquisition device of Claim 2 further comprising a plurality of independent analog signal acquisition channels, each of the plurality of channels operatively coupled to the processor for operatively coupling to one of a plurality of analog sources such that analog data is simultaneously acquired from at least two of the plurality of channels, is digitized and is coupled into the processor and is processed by the processor.

12. (previously presented) The analog data acquisition device of claim 2, wherein the processor allows for a plurality of different data transmit devices to be attached thereto and detached therefrom.

13. (previously presented) The analog data acquisition device of claim 2, wherein the processor is designed so that a user can attach the analog source thereto or detach the analog source therefrom.

14. (withdrawn) The analog data acquisition device of claim 2, wherein the analog source comprises a multimeter.

15. (previously presented) The analog data acquisition device of claim 2, wherein the analog source includes at least first and second transducers both of which are designed to transmit data.

16. (previously presented) The analog data acquisition device of claim 2, wherein the at least one parameter is consistent with the analog data acquisition device being responsive to a SCSI inquiry command.

17. (withdrawn) The analog data acquisition device of claim 2, wherein the analog

source is a medical device.

18. (previously presented) The analog data acquisition device of claim 2, wherein the processor is configured to cause acquired analog data file system information to be automatically sent to the multi-purpose interface after the at least one parameter has been sent to the multi-purpose interface of the computer, (a) without requiring any end user to load any software onto the computer at any time, and (b) without requiring any end user to interact with the computer to set up a file system in the analog data acquisition device at any time.

19. (previously presented) The analog data acquisition and interface device of claim 18, wherein the analog data acquisition device file system information comprises at least an indication of a file system type that is used to store the digitized analog data.

20. (previously presented) The analog data acquisition device of claim 2,
wherein the processor is configured to cause file allocation table information to be sent to the multipurpose interface,
wherein the processor is configured to cause a virtual boot sequence to be sent to the multipurpose interface which includes at least information that is representative of a number of sectors of a storage disk, and
wherein the file allocation table information includes at least a start location of a file allocation table.

21. (previously presented) The analog data acquisition device of claim 2, wherein the processor is configured to initiate a process by which the at least one file of digitized analog data is directly transferred to an input/output device.

22. (previously presented) The analog data acquisition device of claim 21, wherein the processor is configured to allow a mode of operation of the analog data acquisition device other than the transfer of at least some of the at least one file of digitized analog data to the multipurpose interface to be controlled by means of an external personal computer.

23. (withdrawn) The analog data acquisition device of claim 2, wherein the analog data acquisition device comprises at least a portion of a medical device.

24. (previously presented) The analog data acquisition device of claim 2, wherein the analog data is processed by being subject to a fast Fourier transform.

25. (withdrawn) The analog data acquisition device of claim 2 wherein the analog data acquisition device is designed so that both the data generation process and automatic file transfer, when they occur, take place only after the at least one parameter has been automatically sent.

26. (withdrawn) The analog data acquisition device of claim 2 wherein the data generation process and automatic data transfer of digitized analog data, when they occur, at least partially overlap in time.

27. (previously presented) The analog data acquisition device of claim 2, wherein the analog source is designed to receive signals from the computer.

28. (withdrawn) The analog data acquisition device of claim 2, wherein the analog data acquisition and interface device is designed so that at least one aspect of how the analog data acquisition device creates at least one file of digitized analog data can be controlled by means of commands that are issuable from a source external to the analog data acquisition device.

29. (withdrawn) The analog data acquisition device of claim 28, wherein the analog data acquisition device is designed so that the at least one aspect is controlled by means of a configuration file.

30. (previously presented) The analog data acquisition device of claim 2, wherein the analog data acquisition device is designed to be responsive to a test unit ready command.

31. (currently amended) The analog data acquisition device of claim 2 wherein the device driver is installed with the operating system such that communication between the computer and the analog data acquisition device takes place by means of a device driver program which is matched to the multi-purpose interface of the computer rendering the analog data

acquisition device host device independent.

32. (previously presented) An analog data acquisition and interface device for interfacing to a host device which includes a mass storage device and associated device driver, comprising:

a processor configured to operatively interface with a memory, an analog source, and a multi-purpose interface of the host device;

wherein the processor is configured to control a data generation process by which analog data is acquired from the analog source, the analog data is processed and digitized, and the processed and digitized analog data is stored in the memory as digitized analog data;

wherein the processor is configured such that, when operatively interfaced with the multi-purpose interface, the processor causes at least one parameter identifying the analog data acquisition device as a digital mass storage device, instead of as an analog data acquisition device and regardless of the analog source, to be automatically sent to the multi-purpose interface of the host device; and

wherein the processor is configured to automatically transfer the digitized analog data acquired from the analog source to the host device in response to a digital mass storage device data read signal from the host device, in a manner that causes the analog data acquisition and interface device to appear to be the mass storage device, while using the device driver associated with the mass storage device to perform the automatic transfer without requiring any user-loaded file transfer enabling software to be loaded on or installed in the computer.

33. (withdrawn) An analog data acquisition and interface device for interfacing to a host device which includes a mass storage device and associated device driver, comprising:

a program memory;

a processor coupled to the program memory and configured to operatively interface with a storage memory, an analog source, and a multi-purpose interface of the host device;

wherein the processor is configured to control a data generation process by which analog data is acquired from the analog source, the analog data is processed and digitized, and the processed and digitized analog data is stored in the memory as digitized analog data;

wherein the processor is configured such that, when operatively interfaced with the multi-purpose interface, the processor causes at least one parameter identifying the analog data acquisition device as a digital mass storage device instead of an analog data acquisition device and regardless of the analog source, to be automatically sent to the multi-purpose interface of the host device;

wherein the processor is configured to automatically transfer to the host device the digitized analog data acquired from the analog source, in a manner that causes the analog data acquisition and interface device to appear to be the mass storage device while using the device driver associated with the mass storage device to perform the automatic transfer; and

wherein the processor is configured to transmit to the host device commands to access a system bus of the host device to enable direct communications with other data devices of the host device while bypassing any host device processor.

34. (withdrawn) The analog data acquisition and interface device of claim 33, wherein the processor further comprises a plurality of independent analog data acquisition channels for simultaneously acquiring analog data in parallel from a plurality of analog sources.

35. (currently amended) A method for analog data acquisition and interfacing to a host

device wherein the host device includes a device driver, comprising:

operatively interfacing a data acquisition device, including a processor and a memory, with a multi-purpose interface of the host device;

acquiring analog data from an analog source, processing and digitizing the analog data, and storing the processed and digitized analog data in the memory as digitized analog data under control of the processor;

automatically sending under control of the processor at least one parameter to the multi-purpose interface of the host device, the at least one parameter identifying the analog data acquisition device as a digital device instead of as an analog data acquisition device, regardless of the analog source: and

automatically transferring data from the analog source to the host device in response to a digital data read command from the host device, in a manner that causes the analog data acquisition device to appear to be a digital device instead of as an analog data acquisition device, while using the device driver to perform the automatic transfer of the acquired digitized analog data to the host device without requiring any user-loaded file transfer enabling software to be loaded on or installed in the host device.

36. (previously presented) The method of claim 35, further comprising simultaneously acquiring the analog data from each respective analog channel of a plurality of respective independent acquisition channels under control of the processor and acquiring analog data from the analog source time independent of transferring the acquired analog data to the host device.

REMARKS

Reconsideration and further examination of the subject patent application in view of the present Amendment and the following Remarks is respectfully requested. Claim 1 was previously cancelled, and claims 2-36 are pending, with claims 14, 17, 23, 25, 26, 28, 29, 33 and 34 are withdrawn from examination. Claims 2-4, 6-10, 12, 15-16, 18-22, 27, 30-32 and 35 have been rejected under 35 U.S.C. §103(a) as being unpatentable over Hashimoto (U.S. Pat. No. 6,111,604), in view of Smith (U.S. Pat. No. 5,634,075), Ristelhueber (“Plug and Play is almost here”), and Shinohara (U.S. Pat. No. 5,742,934). Claims 5 and 13 have been rejected under 35 U.S.C. §103(a) as being unpatentable over Hashimoto, Smith, Ristelhueber and Shinohara, and further in view of Endo (U.S. Pat. No. 4,652,928), and Claim 24 has been rejected under 35 U.S.C. §103(a) as being unpatentable over Hashimoto, Smith, Ristelhueber, and Shinohara and further in view of Roberts (U.S. Pat. No. 5,576,757). Claims 11 and 36 have been rejected under 35 U.S.C. §103(a) as being unpatentable over Hashimoto, Smith, Ristelhueber, and Shinohara further in view of Nakamura (U.S. Pat. No. 6,278,492). Claims 2, 31, and 35 have been amended. After careful review of the claims and references, it is believed that the claims are in allowable form and a Notice of Allowance is respectfully requested.

Independent claim 2, and 35 have been amended for clarification. Claim 31 has been amended to call for a device driver program matched to the multi-purpose interface of the computer so that the data acquisition device is host device independent (see, e.g. ‘399 patent, Col. 5, lines 22-32).

Applicant respectfully continues disagreement with the summary of the interview set out in the remarks in the previous amendments. Applicant did not and does not agree with recharacterizing the claims to an inventive concept of the summary's indications of invention concepts. It is Applicant's position that the claims as they are set out define the invention, and that it is these claims which should be examined. Thus, Applicant respectfully continues to request that each claim of this application be examined as written and as a whole.

It is respectfully submitted that, the claims as amended are distinguishable over any combination of the cited references Hashimoto, Smith, Ristelhueber, Shinohara, Endo and Roberts. As such, it is respectfully submitted that the claims 2-36 are patentably distinguishable over all prior art of record.

The Office Action rejected claims 2-4, 6-10, 12, 15-16, 18-22, 27, 30-32, and 35 (which includes all the independent claims 2, 32, and 35) as obvious based on the combination of Hashimoto, Smith, Ristelhueber, and Shinohara. The Office Action asserts (Office Action, p. 23) that Hashimoto teaches a processor that executes at least one instruction set to establish communications with the computer in several passages in Cols. 1-14. However, Hashimoto in Cols 1-14 does not describe such a recognition process in which the processor executes an instruction set to establish communication with the host computer by sending an identifying parameter as claimed. Rather, Hashimoto describes a circuit in which a processor 23 detects proper connection to a host circuit interface by monitoring the data terminal ready (DTR) signal of the RS-232 connection or another signal of similar function of another user selected communications protocol (Hashimoto, Col. 10, lines 44-65; Fig. 4). When the signal from the communication interface is detected, a communication algorithm is set up in the camera to prepare the camera to transmit or receive information. Then the camera system detects whether

a switch on the camera has been manually set to transmit or to receive to determine whether to transmit image data or receive data (Hashimoto, Col. 15, lines 3-16). Thus, Hashimoto merely describes a process for detection by the camera of an active connection by monitoring the interface. This detection process is not the recognition process claimed which is a process in which the analog device processor executes instructions to cause a class identifying parameter (mis-indicative of the class of the device) to be sent to the host computer (i.e. automatically sends a identifying parameter to the host computer). Hashimoto merely describes a process performed by the peripheral which detects the peripheral's proper connection to a host interface, not a recognition process performed by the host to identify a peripheral. Hashimoto's process (peripheral detecting its connection to host) is the opposite of the claimed process (host detects a class parameter sent from the peripheral). Thus, there is no description anywhere in Hashimoto of the claimed process of executing a set of instructions that sends an identifying parameter to the host computer . Further, at the time of the Hashimoto disclosure, the user would load software and input information into the host computer to identify the camera. There was no requirement for or need for the camera CPU of Hashimoto to be involved in a process to identify itself to the host computer.

Similarly, neither Hashimoto nor any of the other cited references disclose a processor in the peripheral device involved in automatically sending a mis-identifying class parameter to the host computer. The Office Action concedes that Hashimoto does not teach automatically causing a class identifying parameter different than the class of the analog device to be sent as claimed (Office Action; p. 24), but asserts that Smith teaches automatically sending the computer at least one parameter through the multipurpose port in figs. 2-5, and Col. 1-4, and Col. 6; and further asserts that by combining Hashimoto's analog data acquisition device

architecture with Smith's Plug and Play functionality (Plug and Play refers to ISA PnP system bus technology referred to in both the Smith and Ristelhueber references) the combination further teaches this feature.

However, not only does Hashimoto not disclose a process with automatic transmission of an identification parameter to a host as discussed above, but Smith also fails to disclose this feature of automatically sending such identification information. Smith describes Plug and Play systems as requiring the Plug and Play host computer to assign a "handle" (I.D. number) to each peripheral card and then the host computer reads resource data from the peripheral (see, e.g. Col. 4, lines 26-34; Col. 3, lines 41-59). Thus, the host computer in Smith assigns an identifying number rather than the peripheral processor automatically sending identification information. Then the host computer reads resource data from the peripheral (Smith, Col. 4, lines 26-28: "the operating system will isolate each PnP device assign a "handle" (number) to each card, and read the resource data from that card"). There is no description of automatic sending of class of device identification data. The Plug and Play process described in Smith or any other of the references is not concerned with recognizing the class of the device. It is not a device recognition process, rather it is a host computer resource allocation process concerned with allocation of the resources of the host computer to avoid conflicts between resources within the host. The host computer after supplying an I.D. merely performs a process of reading resource data and then allocating its resources to accommodate all the peripherals attached to it. There is no mention of identification information being read or sent. The cited passages of Smith do not mention a peripheral processor automatically providing identification information to the host computer. Instead, the host computer initiates a "read" function to obtain resource data from the peripheral. Thus, the plug and play functionality of Smith does

not teach or suggest the processor of the peripheral device automatically sending a class parameter to the host. Further, sending a mis-identifying class parameter would be contrary to the concept of plug and play, then teaching away from the claimed feature.

Smith also does not describe a peripheral having a processor involved in the Plug and Play process. The only Plug and Play peripheral device circuitry in Smith is shown in Figs. 6, 7, and 9 which show a circuit made up of registers, flips flops, etc. to allow the peripheral to configure upon power up to operate in legacy mode or plug or play mode. There is no peripheral processor described involved in automatic recognition of the peripheral by the host.

Further, the Plug and Play functionality of Smith is functionality which is primarily located in the host computer not the peripheral. The Plug and Play compatibility as implemented in the peripheral in Smith is merely a set of logic gates and registers (not a processor) to give the peripheral compatibility with the Plug and Play functionality of the host computer. Plug and Play functionality calls for the host computer to configure its resources according to the needs of all the peripherals attached to it and thus primarily concerns software or firmware supplied functions located in the host computer. Thus, it would not make sense to one skilled in the art to put these Plug and Play functions into the peripheral device which would have no use for them. The peripheral device is only going to connect to a host computer and thus does not need to allocate its resources to handle multiple Plug and Play devices. In addition, as discussed above, neither Hashimoto nor Smith teach automatically sending identification information.

The Office Action also suggests that the combination of Smith's Plug and Play functionality into Hashimoto's analog data acquisition device architecture would be obvious to one of ordinary skill in the art because it would simplify the installation for the user without the

need to install software or configure the peripheral devices. However, Smith expressly teaches the contrary, that a device driver must be loaded once the peripherals have been set up and host computer resources assigned (see e.g., Smith, Fig. 2, ref. 126 and Col. 4 lines 32-33).

The Office Action asserts that Ristelhueber at pages 1-3 teaches a peripheral device whereby there is no requirement for any user-loaded file transfer software to be loaded on the computer in addition to the operating system (Office Action, p. 25). Ristelhueber, however, is a non-technical buyer magazine article which generically describes a future Plug and Play standard with an enthusiastic description of the future (“In about a year the key standard and specifications will be in place to make PnP a reality”, p. 1, paragraph 3). Thus, Ristelhueber is not enabling prior art. Ristelhueber is relied upon for disclosure of Plug and Play functionality. The Office Action appears to rely on vague predictions in Ristelhueber regarding recognition of new hardware, and configuring of hardware to relieve the user of the need to fumble with floppy disks and user manuals to get the device up and running. However, when read in context these phrases are predicting PnP will recognize that a new device is connected. The author is not describing recognizing what peripheral is attached, only whether there is a peripheral attached to the port. Further, there is no enabling disclosure of how such recognition would one day be implemented. The description in Ristelhueber is just an over enthusiastic prediction of the hoped for goals for PnP, which is to detect when a new device is attached (i.e. identifying presence not what it is), configure the host computer resources to accommodate it, and then activate the device. However, Ristelhueber nowhere discusses or even mentions device drivers, or what will happen after a device is configured and activated. As discussed herein, the Smith reference and the PnP Standards Specification make clear that a device driver is still needed after the peripheral has been detected, assigned resources, and activated in

accordance with Plug and Play.

In addition, there is no teaching in Ristelhueber of the processor of the peripheral automatically sending identification information to the computer, or of anything done or not done by a processor of a Plug and Play peripheral device. Ristelhueber merely describes the host computer determining the presence of a peripheral device, identifying the resources needed by the peripheral device and configuring its hardware thereby relieving the user from having to do so. There is no teaching in Ristelhueber to relieve the user from having to load a device driver. There is no mention of a processor on the peripheral, and no mention of the need or lack of need for user loaded software on the host computer. Thus, Ristelhueber does not disclose this claimed feature. Rather, Ristelhueber merely broadly describes future Plug and Play hopes without discussing device driver software for proper functioning of the peripheral after it is activated. As discussed above, the Plug and Play still requires loading a device driver after the peripheral device has been activated using a Plug and Play process. Thus, Ristelhueber does not teach a peripheral device which doesn't require an end user to load software onto the computer at anytime and none of the other cited references teach this feature. Therefore, all pending claims are distinguishable over the cited references on this ground as well.

The Office Action also asserts that Shinohara teaches sending a class of devices parameter wherein the analog data acquisition device is not within the class, and teaches transferring acquired analog data to the computer using the device driver of the class so that the analog device appears as if it is a device of the class at Col 1, lines 48-60, and Col 3, lines 3 to Col 4, line 49. Shinohara describes a flash disk drive which couples only to a host computer to allow the host computer to send data for storage and retrieve the data stored by the host computer. This is entirely different from the claimed analog data acquisition device which

acquires analog data from analog sources through a first port, and provides for transfer of the digitized analog data to a separate host computer through a second port. Therefore, the environment and functionality, and the problems to be resolved are completely different, and it would thus not be obvious to combine the Shinohara flash disk drive features with Hashimoto, and because of these fundamental differences, Shinohara is not compatible with Hashimoto.

Moreover, the combination (even if considered somehow together) still would not end up meeting the terms of the claims. Shinohara merely describes how the host computer sends data and sets up the data structure in the flash disk drive but does not teach or even mention that there is no need for user interaction to set up a file system, or that the device is not identified as an analog data acquisition device and is identified instead as a digital mass storage device. Shinohara is merely a mass storage device acting as a mass storage device. Further, the data structure set up would require software on the host computer to perform these set-up functions. Thus, additional software must be added to the host computer to set up the data structure for the flash drive. Further, since Shinohara is merely a hard disk emulator connected to a computer, it cannot cause and not teach or suggest analog data acquired from a analog source to be transferred to a computer (i.e., there is only digital data stored by the host computer). Since Hashimoto, Smith, Kerigan, and Ristelhueber do not teach the automatic process of identifying an analog data acquisition device as some other device and Shinohara also does not teach this feature, all pending claims are distinguishable over the cited references.

Further, none of the references disclose an analog device which acquires and processes analog data but operates and identifies itself as a digital storage device. Shinohara discloses a mass storage device (i.e. a flash memory) which operates as a mass storage device. This teaching of Shinohara does not suggest to one of ordinary skill in the art the operation and

identification of an analog data acquisition device as an entirely different type of device, i.e. a mass storage device, and does not suggest a device which sends an identifying parameter to the host computer identifying the device as a device of dramatically different type than what it actually is. Thus the claims are further distinguishable over the cited references for this reason in addition to the reasons discussed herein above.

The Office Action further asserts that Shinohara teaches a system and a method comprising data transferring using a device driver for the identified class of device while causing the analog data acquisition device to appear to the computer as if it were a device of the identified class without requiring any user-loaded file transfer enabling software to be loaded on or installed in the computer at anytime at Col. 1 lines 48-60 and Col. 3, line 33 to Col. 4, line 49 (Office Action, p. 18). The Office Action alleges that by combining the emulation of a mass storage device of Shinohara with the data transferring Plug and Play functionality of the combined other references, the resulting combination would teach this feature.

However, this is not the case because Shinohara merely describes an approach to extending the life of the flash memory in a flash disk drive. Shinohara at the cited Col. 1, line 48-60 merely describes a flash disk memory which can erase and write data in a unit sector of a flash memory to emulate a hard disk, where the host computer erases and writes a sector designated by the host computer so an address conversion table is not needed and also describes a disk operating system. There is no mention of device drivers, no mention of not needing to load file transfer enabling software. Similarly Col. 3, line 33 to Col. 4, line 49 of Shinohara merely describes details of the flash disk which can cause the flash memory to last for a longer time using an address conversion table. However, nowhere in Shinohara is there any mention of transferring a file of digitized analog data (Shinohara is a disk drive, as such, it cannot

acquire and digitize analog data and therefore cannot transfer it), or any data, without requiring any user loaded file transfer enabling software. Rather, the detailed description cited calls for the host computer to perform unique file management functions (Col. 4, lines 34-49) which would require data transfer software in the host computer to set up the disk emulation. Further, there is no teaching or mention of the disclosed disk emulator being able to transfer data without data-transfer software loaded on the host computer. The Shinohara reference is devoid of any such teaching. Thus, Shinohara does not teach the feature of transferring digitized analog data without requiring any user loaded file transfer enabling software.

The Office Action also asserts that combining the flash memory device of Shinohara with the Plug and Play functionality of the other references such as Smith, teaches this feature. However, as discussed above, Plug and Play is concerned with allocation of the resources of the host computer to avoid conflicts between resources within the host computer. In Plug and Play, the host computer reads the resource requirements from each attached peripheral, such resources as i/o addresses, interrupts levels, and DMA channels, (see, Smith, Col. 3, lines 1-4; also see Plug and Play ISA Specification, Version 1.0a, May 5, 1994 (“Plug and Play Specification”) p.1, abstract, line 5, and lines 9-11). The computer then assigns to each peripheral device the necessary resources so as to avoid resource conflicts (see Smith, Col. 4, lines 25-32; and Plug and Play Spec. p.1, lines 11-12). Once the host computer has assigned its resources and activated the device, an appropriate device driver must then be loaded to permit operation. As described in Smith, Col. 4, lines 26-33 in a PnP (Plug and Play) system:

“...the operating system will isolate each PNP device, assign a ‘handle’ (number) to each card, and read the resource data from that card. Once each card had been isolated, assigned a handle and read, the operating system software will arbitrate system resources for all PNP devices. Conflict-free resources may then be assigned and the devices activated. Finally, appropriate device drivers may be loaded and the system thus

configured.”

Also see Plug and Play Spec. p.1, Abstract, and Smith, Col. 3, lines 52-59. The Plug and Play process thus does not eliminate the need to supply a driver but rather calls for loading the driver after the system resources are allocated and the devices activated. The Plug and Play standard does not address device drivers other than the fact that one is needed. (Plug and Play Specification p. 1 Abstract: “However, user interface issues for installation of device drivers are not addressed”.) Thus, even with Plug and Play, a device specific driver is still needed for each peripheral installed in the Plug and Play computer system in order for the peripheral’s processor to execute an instruction to automatically transfer a file of digitized analog data to the computer from the peripheral device. This is clearly demonstrated by the Smith reference and the Plug and Play Specification document. Thus, neither Shinohara nor the Plug and Play functionality disclosed in the other cited references teach data transfer without a user loaded driver.

Moreover, the device described in Shinohara is merely a memory for storage of digital data by a host computer and for retrieval of that data by the host computer, and thus is not suitable for receiving analog data from a source independent of the host computer nor for transferring acquired digitized analog data to a host computer. Further, Shinohara does not teach transferring the acquired analog data while causing the analog data acquisition device to appear to the computer as a digital storage device, as claimed. The Shinohara device has one port that merely receives and stores digital data from the computer and allows that same computer to retrieve that stored data through the same port. The claimed invention has two separate ports providing input of analog data on one port and subsequent transfer of digitized analog data to a computer on another port. Thus, the disk memory emulation of Shinohara is dramatically different from the claimed invention and not compatible with or combinable with

Hashimoto to obtain the claimed invention. Further, neither Shinohara nor Hashimoto teach or suggest transfer of data from an analog source to the host in response to a digital data read signal from the host as now claimed in claim 32 and 35. Shinohara merely transfer digital data previously stored as digital data by the host. Nothing in Shinohara and Hashimoto suggest converting Hashimoto's analog transfer to an analog transfer controlled by Shinohara's digital data read signal.

Stated another way, at most Shinohara merely teaches that a digital memory device having a single read/write port such as a flash memory, may be configured to emulate another digital memory device. This does not suggest, and is not related to, an analog data acquisition device having both an analog input and a host computer interface port which can emulate a hard disk. Thus, the combination of Shinohara with the other references does not teach or suggest the claimed automatic file transfer of acquired digitized analog data without requiring user loaded file transfer enabling software. Indeed, there is nothing to suggest the advantage of not requiring user loaded file transfer enabling software in any device, let alone in an analog data acquisition device.

Accordingly, it is respectfully submitted that all the pending claims are distinguishable over the cited references because none of the references teaches the claimed transfer of a file of acquired digitized analog data by an analog data acquisition device while appearing to be another class of device without loading file transfer enabling software. That is, even if all the references could somehow be combined (which they cannot, as explained hereinafter), the result would still not meet the combined limitations of the claims.

In addition to the lack of disclosure of the claimed feature discussed hereinabove, Hashimoto and Smith are incompatible and cannot be properly combined. As previously

discussed, Hashimoto detects that it is properly connected to a host computer interface by monitoring for a DTR signal. Until the DTR signal is detected, the power to the communication circuitry is turned off or in standby mode (Hashimoto, Col. 12, lines 62 to Col. 13, lines 8). After detecting the proper connection and activating the communication circuitry, Hashimoto checks a switch 110 which is manually set by the camera user, to determine whether it is in the transmit mode or is in a receive mode. (Hashimoto, Fig. 14, Ref. No. 308; Col. 10, lines 51-54 and Col. 11, lines 7-13). Thus, at any point in time, the Hashimoto camera is enabled to only transmit, or only receive; it is not enabled to do both. The user must manually switch between modes. Smith, however, describes a Plug and Play process which requires the host computer to read resource data from the PnP peripheral device (see e.g. Smith, Col. 3, lines 41-43; Col. 4, lines 25-28). This read function requires the peripheral to receive a read request, which would include an address, and then requires the peripheral to transmit the resource data to the host computer. Thus, Smith's Plug and Play (and PnP in general) cannot be added to Hashimoto because the Hashimoto camera cannot both transmit and receive data at any one moment. If the mode switch in the Hashimoto camera is in the transmit position, then the camera would not be able to receive the read request and address, and if the mode switch is in the receive position, the camera would not be able to transmit the resource data. Thus, Hashimoto and Smith, are incompatible and cannot properly be combined. This is also true of Plug and Play in general.

In a further inconsistency, the rejection assumes that Plug and Play calls for the peripheral device to identify itself (although, as discussed above, this is not disclosed in the references). This assumption would inherently call for the device to correctly identify itself which is contrary to the claim requirement that the class parameter sent to the host computer

identify a different class of device. Thus, the references cannot be properly combined to render the claim obvious.

The combination of Hashimoto and Shinohara is also improper. Hashimoto describes an electronic camera while Shinohara describes a flash disk drive. The Office Action combines Shinohara with Hashimoto by converting the Hashimoto camera to a disk drive emulator, thereby dramatically changing the fundamental structure, operation, and purpose of Hashimoto. Shinohara is merely a digital memory device having a single port to receive digital data from a computer for storage and to allow the same computer to retrieve that data through the same port. In other words, Shinohara merely teaches that a single port digital memory device can be configured to emulate a hard disk. This does not teach or suggest an analog data acquisition device having both an analog input and a separate host computer interface port emulating a hard disk. It is a huge inventive step to go from a digital mass storage device emulating a digital mass storage device to an analog device emulating a digital mass storage device. Thus, the combination requires improper hindsight based on the teachings of the instant application and therefore, Hashimoto and Shinohara cannot be properly combined.

In addition, as discussed above, Hashimoto operates in a transmit only mode or a receive only mode selected by the user with a mode selection switch. However, to function properly the Shinohara flash disk requires the host computer to read data from it. This is incompatible with Hashimoto one way communication, because the read function requires that the flash memory receive a read request with the address or sectors of the data requested, followed by an immediate transmission of the data. Hashimoto's one way communication would prevent this two way exchange. Thus, Shinohara is incompatible and not properly combinable with Hashimoto for this reason as well.

In view of the foregoing, applicant submits that claims 2-13, 15, 16, 18-22, 24, 27, 30-32, 35 and 36 are patentable over Hashimoto in view of the combined teachings of Smith, Ristelhueber, Roberts, Endo, Nakamura, and Shinohara. Accordingly, applicant respectfully submits that the instant application is in condition for allowance, and a Notice of Allowance is respectfully requested. Should the Examiner be of the opinion that a telephone conference would expedite prosecution of the subject application, the Primary Examiner is respectfully requested to call the undersigned at the below-listed number.

The Commissioner is hereby authorized to charge any additional fee which may be required for this application under 37 C.F.R. §§ 1.16-1.18, including but not limited to the extension of time fee, RCE fee, petition fee, extra claims fee, the issue fee, or credit any overpayment, to Deposit Account No. 23-0920. Should no proper amount be enclosed herewith, as by a check being in the wrong amount, unsigned, post-dated, otherwise improper or informal, or even entirely missing, the Commissioner is authorized to charge the unpaid amount to Deposit Account No. 23-0920.

Respectfully submitted,

HUSCH BLACKWELL LLP

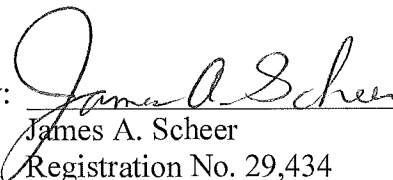
By:  _____
James A. Scheer
Registration No. 29,434

Dated: May 28, 2013

HUSCH BLACKWELL LLP
120 South Riverside Plaza, 22nd Floor
Chicago, Illinois 60606
(312) 655-1500

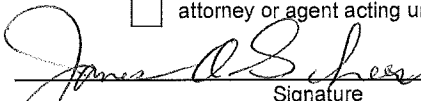
PETITION FOR EXTENSION OF TIME UNDER 37 CFR 1.136(a)		Docket Number (Optional) 0757-113189																														
Application Number 12/891,443	Filed September 27, 2010																															
For ANALOG DATA GENERATING AND PROCESSING DEVICE FOR USE WITH A PERSONAL COMPUTER																																
Art Unit 2181	Examiner Lee, Chun Kuan																															
<p>This is a request under the provisions of 37 CFR 1.136(a) to extend the period for filing a reply in the above-identified application.</p> <p>The requested extension and fee are as follows (check time period desired and enter the appropriate fee below):</p> <table style="width: 100%; border-collapse: collapse;"> <thead> <tr> <th style="width: 40%;"></th> <th style="text-align: center; border-bottom: 1px solid black;">Fee</th> <th style="text-align: center; border-bottom: 1px solid black;">Small Entity Fee</th> <th style="text-align: center; border-bottom: 1px solid black;">Micro Entity Fee</th> <th style="width: 10%;"></th> </tr> </thead> <tbody> <tr> <td><input type="checkbox"/> One month (37 CFR 1.17(a)(1))</td> <td style="text-align: center;">\$200</td> <td style="text-align: center;">\$100</td> <td style="text-align: center;">\$50</td> <td style="text-align: center;">\$ _____</td> </tr> <tr> <td><input type="checkbox"/> Two months (37 CFR 1.17(a)(2))</td> <td style="text-align: center;">\$600</td> <td style="text-align: center;">\$300</td> <td style="text-align: center;">\$150</td> <td style="text-align: center;">\$ _____</td> </tr> <tr> <td><input checked="" type="checkbox"/> Three months (37 CFR 1.17(a)(3))</td> <td style="text-align: center;">\$1,400</td> <td style="text-align: center;">\$700</td> <td style="text-align: center;">\$350</td> <td style="text-align: center;">\$ <u>1,400.00</u></td> </tr> <tr> <td><input type="checkbox"/> Four months (37 CFR 1.17(a)(4))</td> <td style="text-align: center;">\$2,200</td> <td style="text-align: center;">\$1,100</td> <td style="text-align: center;">\$550</td> <td style="text-align: center;">\$ _____</td> </tr> <tr> <td><input type="checkbox"/> Five months (37 CFR 1.17(a)(5))</td> <td style="text-align: center;">\$3,000</td> <td style="text-align: center;">\$1,500</td> <td style="text-align: center;">\$750</td> <td style="text-align: center;">\$ _____</td> </tr> </tbody> </table> <p><input type="checkbox"/> Applicant asserts small entity status. See 37 CFR 1.27.</p> <p><input type="checkbox"/> Applicant certifies micro entity status. See 37 CFR 1.29. Form PTO/SB/15A or B or equivalent must either be enclosed or have been submitted previously.</p> <p><input type="checkbox"/> A check in the amount of the fee is enclosed.</p> <p><input type="checkbox"/> Payment by credit card. Form PTO-2038 is attached.</p> <p><input type="checkbox"/> The Director has already been authorized to charge fees in this application to a Deposit Account.</p> <p><input checked="" type="checkbox"/> The Director is hereby authorized to charge any fees which may be required, or credit any overpayment, to Deposit Account Number <u>23-0920</u>.</p> <p><input checked="" type="checkbox"/> Payment made via EFS-Web.</p> <p>WARNING: Information on this form may become public. Credit card information should not be included on this form. Provide credit card information and authorization on PTO-2038.</p> <p>I am the</p> <p><input type="checkbox"/> applicant.</p> <p><input checked="" type="checkbox"/> attorney or agent of record. Registration number <u>29,434</u></p> <p><input type="checkbox"/> attorney or agent acting under 37 CFR 1.34. Registration number _____</p> <p style="margin-left: 40px;">  _____ Signature </p> <p style="margin-left: 40px;"> <u>May 28, 2013</u> _____ Date </p> <p style="margin-left: 40px;"> <u>James A. Scheer</u> _____ Typed or printed name </p> <p style="margin-left: 40px;"> <u>312-655-1500</u> _____ Telephone Number </p> <p>NOTE: This form must be signed in accordance with 37 CFR 1.33. See 37 CFR 1.4 for signature requirements and certifications. Submit multiple forms if more than one signature is required, see below*.</p>				Fee	Small Entity Fee	Micro Entity Fee		<input type="checkbox"/> One month (37 CFR 1.17(a)(1))	\$200	\$100	\$50	\$ _____	<input type="checkbox"/> Two months (37 CFR 1.17(a)(2))	\$600	\$300	\$150	\$ _____	<input checked="" type="checkbox"/> Three months (37 CFR 1.17(a)(3))	\$1,400	\$700	\$350	\$ <u>1,400.00</u>	<input type="checkbox"/> Four months (37 CFR 1.17(a)(4))	\$2,200	\$1,100	\$550	\$ _____	<input type="checkbox"/> Five months (37 CFR 1.17(a)(5))	\$3,000	\$1,500	\$750	\$ _____
	Fee	Small Entity Fee	Micro Entity Fee																													
<input type="checkbox"/> One month (37 CFR 1.17(a)(1))	\$200	\$100	\$50	\$ _____																												
<input type="checkbox"/> Two months (37 CFR 1.17(a)(2))	\$600	\$300	\$150	\$ _____																												
<input checked="" type="checkbox"/> Three months (37 CFR 1.17(a)(3))	\$1,400	\$700	\$350	\$ <u>1,400.00</u>																												
<input type="checkbox"/> Four months (37 CFR 1.17(a)(4))	\$2,200	\$1,100	\$550	\$ _____																												
<input type="checkbox"/> Five months (37 CFR 1.17(a)(5))	\$3,000	\$1,500	\$750	\$ _____																												
<input checked="" type="checkbox"/> * Total of <u>1</u> forms are submitted.																																

This collection of information is required by 37 CFR 1.136(a). The information is required to obtain or retain a benefit by the public, which is to file (and by the USPTO to process) an application. Confidentiality is governed by 35 U.S.C. 122 and 37 CFR 1.11 and 1.14. This collection is estimated to take 6 minutes to complete, including gathering, preparing, and submitting the completed application form to the USPTO. Time will vary depending upon the individual case. Any comments on the amount of time you require to complete this form and/or suggestions for reducing this burden should be sent to the Chief Information Officer, U.S. Patent and Trademark Office, U.S. Department of Commerce, P.O. Box 1450, Alexandria, VA 22313-1450. DO NOT SEND FEES OR COMPLETED FORMS TO THIS ADDRESS. SEND TO: Mail Stop PCT, Commissioner for Patents, P.O. Box 1450, Alexandria, VA 22313-1450.

Electronic Patent Application Fee Transmittal

Application Number:	12891443
Filing Date:	27-Sep-2010
Title of Invention:	ANALOG DATA GENERATING AND PROCESSING DEVICE FOR USE WITH A PERSONAL COMPUTER
First Named Inventor/Applicant Name:	Michael Tasler
Filer:	James A. Scheer/mawish elahi
Attorney Docket Number:	0757-113189

Filed as Large Entity

Utility under 35 USC 111(a) Filing Fees

Description	Fee Code	Quantity	Amount	Sub-Total in USD(\$)
Basic Filing:				
Pages:				
Claims:				
Miscellaneous-Filing:				
Petition:				
Patent-Appeals-and-Interference:				
Post-Allowance-and-Post-Issuance:				
Extension-of-Time:				
Extension - 3 months with \$0 paid	125	JVC	KENWOOD CORP., et al.	

Description	Fee Code	Quantity	Amount	Sub-Total in USD(\$)
Miscellaneous:				
Total in USD (\$)				1400

Electronic Acknowledgement Receipt

EFS ID:	15879547
Application Number:	12891443
International Application Number:	
Confirmation Number:	1408
Title of Invention:	ANALOG DATA GENERATING AND PROCESSING DEVICE FOR USE WITH A PERSONAL COMPUTER
First Named Inventor/Applicant Name:	Michael Tasler
Customer Number:	24628
Filer:	James A. Scheer/mawish elahi
Filer Authorized By:	James A. Scheer
Attorney Docket Number:	0757-113189
Receipt Date:	28-MAY-2013
Filing Date:	27-SEP-2010
Time Stamp:	14:21:09
Application Type:	Utility under 35 USC 111(a)

Payment information:

Submitted with Payment	yes
Payment Type	Deposit Account
Payment was successfully received in RAM	\$1400
RAM confirmation Number	489
Deposit Account	230920
Authorized User	

The Director of the USPTO is hereby authorized to charge indicated fees and credit any overpayment as follows:

Charge any Additional Fees required under 37 C.F.R. Section 1.19 (Document supply fees)

Charge any Additional Fees required under 37 C.F.R. Section 1.20 (Post Issuance fees)

JVC KENWOOD CORP., et al.
Ex 1402, p. 56 of 340

File Listing:

Document Number	Document Description	File Name	File Size(Bytes)/ Message Digest	Multi Part /.zip	Pages (if appl.)
1	Applicant Arguments/Remarks Made in an Amendment	113189amendment.PDF	223587 fbd9bf71892209672433b6fbb221f7d7c047d4c4	no	24
Warnings:					
Information:					
2	Extension of Time	113189eot.PDF	26723 d70dbf3adafbeb9e9ea542b13aebac95aab c2b8c	no	1
Warnings:					
Information:					
3	Fee Worksheet (SB06)	fee-info.pdf	30482 5e55d28d0e6ba63ef4bb62c267486d94cd9e525	no	2
Warnings:					
Information:					
Total Files Size (in bytes):			280792		

This Acknowledgement Receipt evidences receipt on the noted date by the USPTO of the indicated documents, characterized by the applicant, and including page counts, where applicable. It serves as evidence of receipt similar to a Post Card, as described in MPEP 503.

New Applications Under 35 U.S.C. 111

If a new application is being filed and the application includes the necessary components for a filing date (see 37 CFR 1.53(b)-(d) and MPEP 506), a Filing Receipt (37 CFR 1.54) will be issued in due course and the date shown on this Acknowledgement Receipt will establish the filing date of the application.

National Stage of an International Application under 35 U.S.C. 371

If a timely submission to enter the national stage of an international application is compliant with the conditions of 35 U.S.C. 371 and other applicable requirements a Form PCT/DO/EO/903 indicating acceptance of the application as a national stage submission under 35 U.S.C. 371 will be issued in addition to the Filing Receipt, in due course.

New International Application Filed with the USPTO as a Receiving Office

If a new international application is being filed and the international application includes the necessary components for an international filing date (see PCT Article 11 and MPEP 1810), a Notification of the International Application Number and of the International Filing Date (Form PCT/RO/105) will be issued in due course, subject to prescriptions concerning national security, and the date shown on this Acknowledgement Receipt will establish the international filing date of the application.

Under the Paperwork Reduction Act of 1995, no persons are required to respond to a collection of information unless it displays a valid OMB control number.

PATENT APPLICATION FEE DETERMINATION RECORD Substitute for Form PTO-875	Application or Docket Number 12/891,443	Filing Date 09/27/2010	<input type="checkbox"/> To be Mailed
-----------------------------------------------------------------------------------	---------------------------------------------------	----------------------------------	---------------------------------------

ENTITY: LARGE SMALL MICRO

APPLICATION AS FILED – PART I

FOR	NUMBER FILED	NUMBER EXTRA	RATE (\$)	FEE (\$)
<input type="checkbox"/> BASIC FEE (37 CFR 1.16(a), (b), or (c))	N/A	N/A	N/A	
<input type="checkbox"/> SEARCH FEE (37 CFR 1.16(k), (l), or (m))	N/A	N/A	N/A	
<input type="checkbox"/> EXAMINATION FEE (37 CFR 1.16(o), (p), or (q))	N/A	N/A	N/A	
TOTAL CLAIMS (37 CFR 1.16(i))	minus 20 =	*	X \$ =	
INDEPENDENT CLAIMS (37 CFR 1.16(h))	minus 3 =	*	X \$ =	
<input type="checkbox"/> APPLICATION SIZE FEE (37 CFR 1.16(s))	If the specification and drawings exceed 100 sheets of paper, the application size fee due is \$310 (\$155 for small entity) for each additional 50 sheets or fraction thereof. See 35 U.S.C. 41(a)(1)(G) and 37 CFR 1.16(s).			
<input type="checkbox"/> MULTIPLE DEPENDENT CLAIM PRESENT (37 CFR 1.16(j))				
* If the difference in column 1 is less than zero, enter "0" in column 2.			TOTAL	

APPLICATION AS AMENDED – PART II

	(Column 1)	(Column 2)	(Column 3)	PRESENT EXTRA	RATE (\$)	ADDITIONAL FEE (\$)
AMENDMENT	05/28/2013	CLAIMS REMAINING AFTER AMENDMENT		HIGHEST NUMBER PREVIOUSLY PAID FOR		
	Total (37 CFR 1.16(i))	* 35	Minus	** 35	= 0	X \$80 = 0
	Independent (37 CFR 1.16(h))	* 4	Minus	***4	= 0	X \$420 = 0
	<input type="checkbox"/> Application Size Fee (37 CFR 1.16(s))					
<input type="checkbox"/> FIRST PRESENTATION OF MULTIPLE DEPENDENT CLAIM (37 CFR 1.16(j))						
					TOTAL ADD'L FEE	0

	(Column 1)	(Column 2)	(Column 3)	PRESENT EXTRA	RATE (\$)	ADDITIONAL FEE (\$)
AMENDMENT		CLAIMS REMAINING AFTER AMENDMENT		HIGHEST NUMBER PREVIOUSLY PAID FOR		
	Total (37 CFR 1.16(i))	*	Minus	**	=	X \$ =
	Independent (37 CFR 1.16(h))	*	Minus	***	=	X \$ =
	<input type="checkbox"/> Application Size Fee (37 CFR 1.16(s))					
<input type="checkbox"/> FIRST PRESENTATION OF MULTIPLE DEPENDENT CLAIM (37 CFR 1.16(j))						
					TOTAL ADD'L FEE	

* If the entry in column 1 is less than the entry in column 2, write "0" in column 3.
 ** If the "Highest Number Previously Paid For" IN THIS SPACE is less than 20, enter "20".
 *** If the "Highest Number Previously Paid For" IN THIS SPACE is less than 3, enter "3".
 The "Highest Number Previously Paid For" (Total or Independent) is the highest number found in the appropriate box in column 1.

LIE
/SUSAN FORD/

This collection of information is required by 37 CFR 1.16. The information is required to obtain or retain a benefit by the public which is to file (and by the USPTO to process) an application. Confidentiality is governed by 35 U.S.C. 122 and 37 CFR 1.14. This collection is estimated to take 12 minutes to complete, including gathering, preparing, and submitting the completed application form to the USPTO. Time will vary depending upon the individual case. Any comments on the amount of time you require to complete this form and/or suggestions for reducing this burden, should be sent to the Chief Information Officer, U.S. Patent and Trademark Office, U.S. Department of Commerce, P.O. Box 1450, Alexandria, VA 22313-1450. DO NOT SEND FEES OR COMPLETED FORMS TO THIS ADDRESS. **SEND TO: Commissioner for Patents, P.O. Box 1450, Alexandria, VA 22313-1450.**

If you need assistance in completing the form, call 1-800-PTO-9199 and select option 2.



UNITED STATES PATENT AND TRADEMARK OFFICE

UNITED STATES DEPARTMENT OF COMMERCE
United States Patent and Trademark Office
Address: COMMISSIONER FOR PATENTS
P.O. Box 1450
Alexandria, Virginia 22313-1450
www.uspto.gov

APPLICATION NO.	FILING DATE	FIRST NAMED INVENTOR	ATTORNEY DOCKET NO.	CONFIRMATION NO.
12/891,443	09/27/2010	Michael Tasler	0757-113189	1408
24628	7590	11/28/2012	EXAMINER	
Husch Blackwell LLP Husch Blackwell Sanders LLP Welsh & Katz 120 S RIVERSIDE PLAZA 22ND FLOOR CHICAGO, IL 60606			LEE, CHUN KUAN	
			ART UNIT	PAPER NUMBER
			2181	
			MAIL DATE	DELIVERY MODE
			11/28/2012	PAPER

Please find below and/or attached an Office communication concerning this application or proceeding.

The time period for reply, if any, is set in the attached communication.

Office Action Summary	Application No. 12/891,443	Applicant(s) TASLER, MICHAEL	
	Examiner Chun-Kuan Lee	Art Unit 2181	

-- The MAILING DATE of this communication appears on the cover sheet with the correspondence address --

Period for Reply

A SHORTENED STATUTORY PERIOD FOR REPLY IS SET TO EXPIRE 3 MONTH(S) OR THIRTY (30) DAYS, WHICHEVER IS LONGER, FROM THE MAILING DATE OF THIS COMMUNICATION.

- Extensions of time may be available under the provisions of 37 CFR 1.136(a). In no event, however, may a reply be timely filed after SIX (6) MONTHS from the mailing date of this communication.
- If NO period for reply is specified above, the maximum statutory period will apply and will expire SIX (6) MONTHS from the mailing date of this communication.
- Failure to reply within the set or extended period for reply will, by statute, cause the application to become ABANDONED (35 U.S.C. § 133). Any reply received by the Office later than three months after the mailing date of this communication, even if timely filed, may reduce any earned patent term adjustment. See 37 CFR 1.704(b).

Status

- 1) Responsive to communication(s) filed on 29 October 2012.
- 2a) This action is **FINAL**.
- 2b) This action is non-final.
- 3) An election was made by the applicant in response to a restriction requirement set forth during the interview on _____; the restriction requirement and election have been incorporated into this action.
- 4) Since this application is in condition for allowance except for formal matters, prosecution as to the merits is closed in accordance with the practice under *Ex parte Quayle*, 1935 C.D. 11, 453 O.G. 213.

Disposition of Claims

- 5) Claim(s) 2-36 is/are pending in the application.
- 5a) Of the above claim(s) 14, 17, 23-26, 28, 29 and 33 is/are withdrawn from consideration.
- 6) Claim(s) _____ is/are allowed.
- 7) Claim(s) 2-13, 15, 16, 18-22, 24, 27, 30-32, 35 and 36 is/are rejected.
- 8) Claim(s) _____ is/are objected to.
- 9) Claim(s) _____ are subject to restriction and/or election requirement.

* If any claims have been determined allowable, you may be eligible to benefit from the **Patent Prosecution Highway** program at a participating intellectual property office for the corresponding application. For more information, please see http://www.uspto.gov/patents/init_events/pph/index.jsp or send an inquiry to PPHfeedback@uspto.gov.

Application Papers

- 10) The specification is objected to by the Examiner.
- 11) The drawing(s) filed on 27 September 2010 is/are: a) accepted or b) objected to by the Examiner.
Applicant may not request that any objection to the drawing(s) be held in abeyance. See 37 CFR 1.85(a).
Replacement drawing sheet(s) including the correction is required if the drawing(s) is objected to. See 37 CFR 1.121(d).

Priority under 35 U.S.C. § 119

- 12) Acknowledgment is made of a claim for foreign priority under 35 U.S.C. § 119(a)-(d) or (f).
 - a) All b) Some * c) None of:
 - 1. Certified copies of the priority documents have been received.
 - 2. Certified copies of the priority documents have been received in Application No. _____.
 - 3. Copies of the certified copies of the priority documents have been received in this National Stage application from the International Bureau (PCT Rule 17.2(a)).

* See the attached detailed Office action for a list of the certified copies not received.

Attachment(s)

- 1) Notice of References Cited (PTO-892)
- 2) Information Disclosure Statement(s) (PTO/SB/08)
Paper No(s)/Mail Date _____.
- 3) Interview Summary (PTO-413)
Paper No(s)/Mail Date. _____.
- 4) Other: _____.

DETAILED ACTION

CONTINUED EXAMINATION UNDER 37 CFR 1.114

1. A request for continued examination under 37 CFR 1.114, including the fee set forth in 37 CFR 1.17(e), was filed in this application after final rejection. Since this application is eligible for continued examination under 37 CFR 1.114, and the fee set forth in 37 CFR 1.17(e) has been timely paid, the finality of the previous Office action has been withdrawn pursuant to 37 CFR 1.114. Applicant's submission filed on 10/29/2012 has been entered.

RESPONSE TO ARGUMENTS

2. Applicant's arguments filed 10/29/2012 have been fully considered but they are not persuasive.

3. In response to applicant's reiteration with regard to the telephone interview conducted such that Applicant respectfully disagrees with the summary of the interview particularly the attempt to reduce the claims to the "inventive concept". Applicant did not and does not agree with recharacterizing the claims to an inventive concept of the summary's indications of invention concepts. It is Applicant's position that the claims as they are set out define the invention, and that it is these claims which should be examined. Thus, Applicant respectfully requests that each claim of this application be examined as written and as a whole.

Art Unit: 2181

As indicated in the interview summary, "... the inventive concept for the instant application is the claims ..." and the explanation with regard to the function of the inventive concept in the interview summary is a clear exemplary interpretation regarding on how the claims can be envisioned; therefore, the examiner is examining each claims as written and as a whole based on the examiner's best understanding on how the claims can be interpreted. If the interpretation is erroneous in any way, the examiner welcomes the applicant's clarification in the subsequent response, as the applicant currently do not offer how the examiner's interpretation of the claims are inaccurate and what is the correct interpretation of the claims.

Additionally, the examiner clearly understood that the summary for the inventive concept regarding to claims of another application (11/467,092) is relevant to the instant application as the examiner did inquire as to how this application differ from the copending application 11/467,092, wherein the applicant indicted that the claims for the instant application are broader as the independent claims for the instant do not require the multiple parallel channels and that the instant application is basically the same concept as the copending application 11/467,092. Furthermore, this was part of the examiner's rational for the double patenting rejection between the instant application and the copending application 11/467,092.

4. In response to applicant's plurality of arguments with regard to the independent claims 2, 32 and 35 rejected under 35 U.S.C. 103(a) that the resulting combination of

Art Unit: 2181

the references does not teach/suggest applicant's inventive concept because of the following:

- Hashimoto does not describe execution of an instruction set to establish communication with the host computer as claimed because Hashimoto merely describes a process for detection by the camera of an active connection by monitoring for a signal from the interface, and not the process claimed which is a process in which the analog device processor executes instructions to cause a class identifying parameter (mis-indicative of the class of the device) to be sent to the host computer (i.e. automatically sends mis-identifying information to the host computer);
- there is no description anywhere in Hashimoto of the claimed process of executing a set of instructions that sends a class identifying parameter to the host computer;
- at the time of the Hashimoto disclosure, the user would load software and input information into the host computer to identify the camera and there was no requirement for the camera CPU to be involved in a process to identify itself to the host computer;
- neither Hashimoto nor any of the other cited references disclose a processor in the peripheral device involved in automatically sending a mis-identifying class parameter/information to the host computer because host computer in Smith's Plug and Play functionality assigns an identifying number rather than the peripheral processor automatically sending identification information; therefore

Art Unit: 2181

Smith do not disclose automatic sending of identification (i.e. a host computer resource allocation process concerned with allocation of the resources of the host computer to avoid conflicts between resources within the host and not device recognition process), Smith does not mention of identification information being read or sent and Smith does not even mention a peripheral processor automatically providing identification information to the host computer

- Smith also does not describe a peripheral having a processor involved in the Plug and Play process;
- the Plug and Play functionality of Smith is functionality which is primarily located in the host computer not the peripheral. The Plug and Play compatibility as implemented in the peripheral in Smith is merely a set of logic gates and registers (not a processor) to give the peripheral compatibility with the Plug and Play functionality of the host computer. Plug and Play functionality calls for the host computer to configure its resources according to the needs of all the peripherals attached to it and thus primarily concerns software or firmware supplied functions located in the host computer. Thus, it would not make sense to one skilled in the art to put these Plug and Play functions into the peripheral device which would have no use for them. The peripheral device is only going to connect to a host computer and thus does not need to allocate its resources to handle multiple Plug and Play devices;

Art Unit: 2181

- Smith expressly teaches the contrary, that a device driver must be loaded once the peripherals have been set up and host computer resources assigned (see e.g., Smith, Fig. 2, ref. 126 and Col. 4 lines 32-33);
- Ristelhueber do not describes a peripheral device whereby there is no requirement for any user-loaded file transfer software to be loaded on the computer in addition to the operating system because Ristelhueber is a non-technical buyer magazine article which generically describes a future Plug and Play standard with an enthusiastic description of the future ("In about a year the key standard and specifications will be in place to make PnP a reality", p. 1, paragraph 3); thus, Ristelhueber is not enabling prior art; Ristelhueber is not describing recognizing what peripheral is attached, only whether there is a peripheral attached to the port; further, there is no enabling disclosure of how such recognition would one day be implemented; the description in Ristelhueber is just an over enthusiastic prediction of the hoped for goals for PnP, which is to detect when a new device is attached (i.e. identifying presence not what it is), configure the host computer resources to accommodate it, and then activate the device; however, Ristelhueber nowhere discusses or even mentions device drivers, or what will happen after a device is configured and activated. The Smith reference and the PnP Standards Specification make clear that a device driver is still needed after the peripheral has been detected, assigned resources and activated in accordance with Plug and Play; furthermore, there is no teaching in Ristelhueber to relieve the user from having

Art Unit: 2181

to load a device driver, there is no mention of a processor on the peripheral, and there is no mention of the need or lack of need for user loaded software on the host computer;

- the environment and functionality, and the problems to be resolved in Shinohara are completely different to Hashimoto; therefore, it would not be obvious to combine the Shinohara's flash disk drive features with Hashimoto because of these fundamental differences; Shinohara does not teach or even mention that there is no need for user interaction to set up a file system, or that the device is not identified as an analog data generating and processing device and is identified instead as a digital mass storage device; Shinohara is merely a mass storage device acting as a mass storage device; further, the data structure set up would require software on the host computer to perform these set-up functions; thus, additional software must be added to the host computer to set up the data structure for the flash drive; further, since Shinohara is merely a hard disk emulator connected to a computer, it cannot cause an acquired file of digitized analog data acquired from a analog source to be transferred (i.e., there is only digital data stored by the host computer); and the teaching of Shinohara does not suggest to one of ordinary skill in the art the operation and identification of an analog data acquisition device as an entirely different type of device, i.e. a mass storage device, and does not suggest a device which sends an identifying parameter to the host computer identifying the device as a device of dramatically different type than what it actually is;

Art Unit: 2181

- Shinohara merely describes an approach to extending the life of the flash memory in a flash disk drive, and there is no mention of device drivers or no mention of not needing to load file transfer enabling software by Shinohara; nowhere in Shinohara is there any mention of transferring a file of digitized analog data (Shinohara is a disk driver, as such, it cannot acquire and digitize analog data and therefore cannot transfer it), or any data, without requiring any user loaded file transfer enabling software; rather, the detailed description cited calls for the host computer to perform unique file management functions (Col. 4, lines 34-49) which would require data transfer software in the host computer to set up the disk emulation; further, there is no teaching or mention of the disclosed disk emulator being able to transfer data without data-transfer software loaded on the host computer; thus, Shinohara does not teach the feature of transferring digitized analog data without requiring any user loaded file transfer enabling software; the Office Action also asserts that combining the flash memory device of Shinohara with the Plug and Play functionality of the other references such as Smith, teaches this feature; however, as discussed above, Plug and Play is concerned with allocation of the resources of the host computer to avoid conflicts between resources within the host computer; the Plug and Play process thus does not eliminate the need to supply a driver but rather calls for loading the driver after the system resources are allocated and the devices activated; the Plug and Play standard does not address device drivers other than the fact that one is needed. (Plug and Play Specification p. 1

Art Unit: 2181

Abstract: "However, user interface issues for installation of device drivers are not addressed";) thus, even with Plug and Play, a device specific driver is still needed for each peripheral installed in the Plug and Play computer system in order for the peripheral's processor to execute an instruction to automatically transfer a file of digitized analog data to the computer from the peripheral device; this is clearly demonstrated by the Smith reference and the Plug and Play Specification document; thus, neither Shinohara nor the Plug and Play functionality disclosed in the other cited references teach data transfer without a user loaded driver;

- the device described in Shinohara is merely a memory for storage of digital data by a host computer and for retrieval of that data by the host computer, and thus is not suitable for receiving analog data from a source independent of the host computer nor for transferring acquiring digitized analog data to a host computer; further, Shinohara does not teach transferring the acquired analog data while causing the analog data generating and processing device to appear to the computer as a digital storage device, as claimed; the Shinohara device has one port that merely receives and stores digital data from the computer and allows that same computer to retrieve that stored data through the same port; the claimed invention has two separate ports providing input of analog data on one port and subsequent transfer of digitized analog data to a computer on another port; thus, the disk memory emulation of Shinohara is dramatically different from the claimed invention and not compatible with or combinable with

Art Unit: 2181

Hashimoto to obtain the claimed invention; stated another way, at most Shinohara merely teaches that a digital memory device having a single read/write port such as a flash memory, may be configured to emulate another digital memory device; this does not teach and is not related to an analog data acquisition device having both an analog input and a host computer interface port which can emulate a hard disk; thus, the combination of Shinohara with the other references does not teach or suggest the claimed automatic file transfer of acquired digitized analog data without requiring user loaded file transfer enabling software; indeed, there is nothing to suggest the advantage of not requiring user loaded file transfer enabling software in any device, let alone in an analog data acquisition device;

- Hashimoto and Smith are incompatible and cannot be properly combined, because Hashimoto describes checking a switch 110 which is manually set by the camera user, to determine whether it is in the transmit mode or is in a receive mode and Smith describes a Plug and Play process which requires the host computer to read and write data between the PnP peripheral device and the host computer;
- the rejection assumes that Plug and Play calls for the peripheral device to identify itself (although, as discussed above, this is not disclosed in the references). This assumption would inherently call for the device to correctly identify itself which is contrary to the claim requirement that the class parameter

Art Unit: 2181

sent to the host computer identify a different class of device. Thus, the references cannot be properly combined to render the claim obvious; and - combination of Hashimoto and Shinohara is also improper because Hashimoto describes an electronic camera while Shinohara describes a flash disk drive; and Hashimoto operates in a transmit only mode or a receive only mode selected by the user with a mode selection switch and Shinohara's flash disk requires the host computer to read and write (i.e. Hashimoto's one way communication would prevent two way exchange); applicant's arguments have fully been considered, but are not found to be persuasive.

The examiner respectfully disagrees; and please note that applicant's arguments against the references individually, one cannot show nonobviousness by attacking references individually where the rejections are based on combinations of references. See *In re Keller*, 642 F.2d 413, 208 USPQ 871 (CCPA 1981); *In re Merck & Co.*, 800 F.2d 1091, 231 USPQ 375 (Fed. Cir. 1986).

To further clarify the examiner's position, first of all, based on the interview dated 07/12/2011, applicant's inventive concept corresponds to the functionality of

"... single analog sensing device with multiple parallel channels for acquiring analog data through the multiple parallel channels, wherein the single analog sensing device is connected to a digital device, such as a host, and the digital device (host) recognizing the connected single analog sensing device as a digital device, such as a hard drive (e.g. digital storage device) or printer; and when the single analog sensing device is connected to the digital device (host) for transferring the acquired analog data to the digital device (host), the digital device (host) use a corresponding digital device driver, such as hard drive driver, for communicating with the single analog sensing

Art Unit: 2181

device, as the digital device (host) thinks that the connected single analog sensing device is the hard drive (digital device) ...,”

and the applicant further clarify during the interview that:

“... The examiner then inquired how is the instant application differ from application 11/467,092; and applicant indicated that the claims for the instant application are broader as the independent claims for the instant application do not require the multiple parallel channels.

The examiner then inquired how is the functionality for the instant application differs from the application 11/467,092; and applicant indicated that the instant application is basically the same concept as the application 11/467,092.

The examiner then inquired whether the claimed feature regarding one parameter indicative of the class of devices of the analog data acquisition device to be send to the computer corresponds to the functionality for the host to recognize the connected analog device as a hard drive; and applicant responded that the claimed feature is part of the recognition process of the analog device as the hard drive.

The informing of such file transfer characteristics would not necessarily be required for the analog sensing device to do the functioning of what the applicant has been describing. Applicant also indicated that the analog sensing device would not require to do that and that this is an extra limitation that is not necessarily needed; and if the applicant took this claimed limitation out of the independent claim, the applicant would still have a perfectly good independent claim.

Applicant also indicated that the analog data acquisition device communicates with the host in “real time” and provided the following citations in applicant’s Specification for support:

Paragraph [0025] on page 10;

Paragraph [0027] on page 11; and

Paragraph [0038] on page 15 (e.g. real time FFT),

wherein applicant indicated that the real time application is optional and not a requirement for implementing the inventive concept for the instant application ...”

wherein the examiner relied on the references as following for the teaching of applicant's invention:

Hashimoto teaches single analog sensing device (e.g. digital camera peripheral device) with multiple parallel channels (e.g. channel for audio and channel for image) for acquiring analog data (e.g. audio and image) through the multiple parallel channels, wherein the single analog sensing device is connected to a digital device, such as a

Art Unit: 2181

host, and the digital device (host) recognizing the connected single analog sensing device (e.g. host need to recognize the connected peripheral device in order to know how to communicate with the connected peripheral device); and the single analog sensing device is connected to the digital device (host) for transferring the acquired analog data (e.g. audio data and image data) to the digital device (host), and for communicating with the single analog sensing device (Fig. 1A-1B; Fig. 8; Fig. 11-12; Fig. 14-15; col. 1, ll. 35-57; col. 3, l. 43 to col. 4, l. 57; col. 5, ll. 43-57; col. 6, l. 16 to col. 9, l. 17; col. 9, l. 46 to col. 11, l. 42 and col. 12, l. 16 to col. 14, l. 14), wherein the digital camera acquire analog image data and analog audio data and store them into the flash memory card, and when the digital camera is connect to the host computer, the digitized image and audio data is then transferred from the flash memory card to the host computer.

Smith teaches plug and play functionality for a peripheral device connected to a host computer, wherein the host would recognize the connected peripheral device (Fig. 2-5; col. 1, ll. 9-22; col. 2, l. 40 to col. 3, l. 59; col. 4, ll. 5-34 and col. 6, ll. 63-62).

Ristelhueber teaches plug and play functionality without user loading software (e.g. plug and play of a peripheral device by having a user to simply insert a peripheral into a desktop system and have it start running immediately, as the PnP computer will automatically identify any new hardware installed and configure the new hardware, and relieving the end user of any need to fumble with floppy disks and user manuals to get the device up and running; therefore, the peripheral device is connected and operational

Art Unit: 2181

without requiring any end user to load any software/device driver on the computer at anytime) (pages 1-3).

Shinohara teaches a host recognizing the connected single analog sensing device as a digital device, such as a hard drive (e.g. hard disk drive emulation) and using a corresponding digital device driver, such as hard drive driver, as the digital device (host) thinks that the connected single analog sensing device is the hard drive (digital device) (col. 1, ll. 48-60 and col. 3, l. 33 to col. 4, l. 49), by combining the hard disk drive emulation of the flash memory card into Hashimoto's digital camera peripheral device's flash memory card having the image data and audio data that is to be transferred to the host, the resulting combination of the references further teaches the above feature as the digital camera transfers the flash memory card's image data and audio data to the host via hard disk drive emulation by the flash memory card.

Therefore, the resulting combination of the references does teach the core of applicant's invention as following: the digital camera peripheral device having the flash memory card that receives and maintains the analog image data and the analog audio data; the digital camera peripheral device is then connected to the host, wherein the host views the connected digital camera peripheral device to be the hard disk drive as the flash memory card is emulating as the hard disk drive for transferring the image data and the audio data from the flash memory card to the host computer (e.g. the digital camera peripheral device acquires the analog image and audio data while causing the digital camera peripheral device appear/be identified to the computer as an emulating hard disk drive/digital storage device).

The claimed features associated with sending "...a class identifying parameter to the host computer ..." and "a process in which the analog device processor executes instructions to cause a class identifying parameter (mis-indicative of the class of the device) to be sent to the host computer (i.e. automatically sends mis-identifying information to the host computer)" is not taught by Hashimoto along, as argued by the applicant; instead, it is taught by the combined teaching of Hashimoto, Smith, Ristelhueber : "Plug and play is almost here" and Shinohara.

As Hashimoto does disclose the digital camera communicating with the PC; therefore, it would be required for the PC to recognize the connected device in order for the PC to know how to properly communicate with the connected device. The examiner is not certain where Hashimoto discloses that the user would load software and input information into the host computer to identify the camera and there was no requirement for the camera CPU to be involved in a recognition process; therefore, is unable to properly respond to applicant's remark/argument.

Base on applicant's clarification during the interviews dated 03/31/2011 and 07/12/2011, it is the examiner's best understanding that the claimed feature of "automatic sending of identification," "identification information being read or sent," and "a peripheral processor automatically providing identification information to the host computer," are process that corresponds to the functionality of recognizing the connected analog device as the hard drive (digital device), and as explained in detail above, the resulting combination of the references does teach/suggest recognizing the connected analog device as the hard drive (digital device); therefore, in order to load the

Art Unit: 2181

appropriate device driver (or identify the resources needed), the plug and play process need to recognize the connected peripheral device to be able to pick/select the appropriate device driver, because if the device driver is inappropriate, then operation would not permitted.

The examiner is relying on the combined teaching of Hashimoto, Smith, Ristelhueber : “Plug and play is almost here” and Shinohara, not Smith along, for the teaching of a peripheral having a processor involved in the Plug and Play process.

To further clarify the examiner’s position with regard to combining Smith’s plug-and-play functionality into Hashimoto’s analog data acquisition device architecture, it make sense to one skilled in the art to combine the plug-and-play functionality into the analog data acquisition device architecture, because the resulting combination teaches/suggests that the analog data acquisition device conforming to the plug-and-play standard such that analog data acquisition device is a plug-and-play device; therefore, the installation of the analog data acquisition device is simplified for the user as the analog data acquisition device may be installed without the need for the user to install software or configure the analog data acquisition device.

Smith’s loading of the device driver is not contrary to “automatic recognition,” because Smith’s loading of the device driver is similar to applicant’s loading of the corresponding device driver, such as the digital device driver, as explained by the applicant during the interviews dated 03/31/2011 and 07/12/2011.

Plug and Play functionality is not functionality which is primarily located in the host computer instead of the peripheral, Plug and Play functionality is a protocol that

Art Unit: 2181

both the host and the peripheral device must conform to so that the peripheral device can be plug into the host and directly start playing/utilizing the connected peripheral device; and to further clarify, it is Smith's invention, not Plug and Play functionality/protocol/standard, that is primarily located in the host computer instead of the peripheral device (Fig. 2-5; col. 1, ll. 9-22; col. 2, l. 40 to col. 3, l. 8; col. 3, ll. 22-27; col. 3, ll. 53-59; col. 4, ll. 5-34; col. 6, ll. 63-62).

Ristelhueber is clearly technically related the Plug and Play protocol and as the applicant indicated, it is prior art; wherein the Plug and Play functionality/protocol is clearly enabled by Smith and Plug and Play Standard, and the examiner relied on Ristelhueber because Ristelhueber provided a clear description that is easily understood regarding how Plug and Play functions; and Ristelhueber does describe recognizing of what peripheral is attached because after the peripheral device is connected to the host, the host need to recognize what peripheral device is attached in order for the host to know what device driver is to be loaded for the connected peripheral device; additionally, applicant's arguments also suggest that the host device recognize the connected peripheral device because in order for the host to identify "the resources needed by the peripheral device" the host would need to know what that connected peripheral device is (on page 17 of applicant's arguments); therefore, Plug and Play functionality will recognize the new hardware and configure hardware to relieve the user of the need to fumble with floppy disks (e.g. looking for the device driver on the floppy disks) and user manuals to get the device up and running; therefore, by combining Ristelhueber with the other references, the resulting combination of the

Art Unit: 2181

references does teach/suggest the automatic recognition process corresponds to Plug and Play by the user simply inserting a peripheral into the desktop and having it start running immediately, as the PnP computer will automatically identify any new hardware installed and configure the new hardware, and relieving the end user of any need to fumble with floppy disks and user manuals to get the device up and running. To further clarify, Ristelhueber does teach/suggest that the plug and play functionality relieve the user from having to load a device driver and lack of need for user loaded software on the host computer, because the installation of a peripheral device without Plug and Play functionality would need the end user of to fumble with floppy disks (e.g. looking for the device driver on the floppy disks) and user manuals to get the device up and running; and the examiner is relying on the other references, and not on Ristelhueber, for the teaching/suggesting regarding the claimed feature of “a processor on the peripheral”; and as discussed above, Plug and Play functionality for loading of a device driver is similar to applicant’s loading of the corresponding device driver, such as the digital device driver, as explained by the applicant during the interviews dated 03/31/2011 and 07/12/2011 (Ristelhueber, pages 1-3).

Shinohara’s hard disk drive emulation is compatible with Hashimoto, as the examiner is combining Shinohara’s hard disk drive emulation by the flash memory card into Hashimoto’s flash memory card; with regard to the claimed features for “no need for user interaction to set up a file system” and “device is not identified as an analog data generating and processing device and is identified instead as a digital mass storage device,” the examiner is not relying on Shinohara along, as the examiner is relying on

Art Unit: 2181

the combination of Shinohara with the other prior art references; therefore, by combining the hard drive emulation into Hashimoto's flash memory card, the resulting combination of the references does teach/suggest when the analog data acquisition device is connected to the host for transferring data from the analog data acquisition device's flash memory card, the host will recognize the connected analog data acquisition device as a hard disk drive via the flash memory card's hard disk drive emulation as data is transferred from the flash memory card to the host; and by combining the Plug and Play functionality with the hard disk drive emulation, additional software would not need to be added to the host computer to set up the data structure for the flash drive; to further clarify, the examiner is relying on the combination of the references, not on Shinohara alone, for the teaching of claimed features associated with operation and identification of an analog data acquisition device as an entirely different type of device and device which sends an identifying parameter to the host computer identifying the device as a device of dramatically different type than what it actually is (e.g. the analog data acquisition device's flash memory card implementing hard disk emulation for data transferring to the host; therefore, the host recognizes the connected analog data acquisition device as the hard disk) (Shinohara, col. 1, ll. 48-60; and col. 3, l. 56 to col. 4, l. 49).

The examiner is relying on the combination of the references, not on Shinohara alone, for the teaching of the claimed features associated with "device drivers," "not needing to load file transfer enabling software," "transferring a file of digitized analog data without requiring any user loaded file transfer enabling software," and "disk

Art Unit: 2181

emulator being able to transfer data without data-transfer software loaded on the host computer;" and as discussed above, the combination of the references does teach/suggest Plug and Play functionality eliminates the need to supply a driver by the end user as the loading the driver after the system resources are allocated and the devices activated is done by the host; and also discussed in detail above, the Plug and Play functionality for loading of a device driver is similar to applicant's loading of the corresponding device driver, such as the digital device driver, as explained by the applicant during the interviews dated 03/31/2011 and 07/12/2011; therefore, the combination of the references does teach/suggest "data transfer without a user loaded driver" via the Plug and Play functionality.

Shinohara's memory is suitable for receiving analog data from a source independent of the host computer and for transferring acquiring digitized analog data to a host computer because Shinohara's memory is a flash memory card and Hashimoto does teach/suggest that flash memory card is suitable for receiving analog data from a source independent of the host computer and for transferring acquiring digitized analog data to a host computer; as discussed above, the examiner is relying on the combination of the references, not on Shinohara along, for the teaching of the claimed features associated with "transferring the acquired analog data while causing the analog data generating and processing device to appear to the computer as a digital storage device," "has two separate ports providing input of analog data on one port and subsequent transfer of digitized analog data to a computer on another port," "an analog data acquisition device having both an analog input and a host computer interface port

Art Unit: 2181

which can emulate a hard disk,” and “automatic file transfer of acquired digitized analog data without requiring user loaded file transfer enabling software”; as also previously discussed, Shinohara’s hard disk drive emulation by the flash memory card is not dramatically different because the examiner is combining Shinohara’s hard disk drive emulation by the flash memory card into Hashimoto’s flash memory card (i.e. both Shinohara and Hashimoto include the same flash memory card).

Hashimoto is compatible with other references because, based on the assumption that applicant’s analysis of Hashimoto is correct, Hashimoto is not limited to one way communication, as Hashimoto does have two way exchange via a switch; to further clarify, the combination of the references would teach/suggest two way exchange via switch (e.g. electrical switch control by host) for implementing Plug and Play functionality or the combination of the references is not limited to DTR signaling and two way exchange take place without the need of the switch for implementing the Plug and Play functionality; additionally, as discussed above, Hashimoto and Shinohara are compatible as both have the corresponding flash memory card.

Additionally, as discussed in detail above, the resulting combination of the references teaches/suggests the analog data acquisition device to be the plug and play hard disk emulating device; therefore, when the analog data acquisition device is connected to the host computer, the analog data acquisition device is identified as the hard disk emulating device (e.g. the class parameter sent is a different class of device).

Art Unit: 2181

5. In response to applicant's arguments with regard to the independent claims 32 and 35 rejected under 35 U.S.C. 103(a) that the combination of the references does not teach/suggest the claimed feature "... transfer of data from the analog source to the host in response to a data read signal from the host ..."; applicant's arguments have fully been considered, but are not found to be persuasive.

The examiner respectfully disagrees, and in combination of the examiner's above explanations/clarification, by combining Hashimoto's transferring of data from the analog source to the host with Shinohara's transferring of data to the host in response to a data read signal from the host (Shinohara, col. 1, ll. 48-60; col. 3, l. 34 to col. 4, l. 49), the resulting combination of the references further teaches the above claimed features.

6. In response to applicant's arguments with regard to the dependent claim 36 rejected under 35 U.S.C. 103(a) that the combination of the references does not teach/suggest the claimed feature "... acquiring analog data time independent of transferring the acquired data ..."; applicant's arguments have fully been considered, but are not found to be persuasive.

The examiner respectfully disagrees, and in combination of the examiner's above explanations/clarification, Hashimoto's does teach/suggest acquiring analog data time independent of transferring the acquired data, as the analog data acquired by the digital camera occurs at one point in time before the digital camera is connected to the host (e.g. Fig. 11) and the transferring of the acquired analog data to the host occurs at

Art Unit: 2181

another point in time when the digital camera is connected to the host (e.g. Fig. 14) (Hashimoto, Fig. 1A-1B; Fig. 8; Fig. 11-12; Fig. 14-15; col. 1, ll. 27-57; col. 3, l. 43 to col. 4, l. 67; col. 5, ll. 43-57; col. 6, l. 16 to col. 9, l. 17; col. 9, l. 46 to col. 11, l. 42; and col. 12, l. 16 to col. 14, l. 14).

I. REJECTIONS BASED ON PRIOR ART

Claim Rejections - 35 USC § 103

The following is a quotation of 35 U.S.C. 103(a) which forms the basis for all obviousness rejections set forth in this Office action:

(a) A patent may not be obtained though the invention is not identically disclosed or described as set forth in section 102 of this title, if the differences between the subject matter sought to be patented and the prior art are such that the subject matter as a whole would have been obvious at the time the invention was made to a person having ordinary skill in the art to which said subject matter pertains. Patentability shall not be negated by the manner in which the invention was made.

7. Claims 2-4, 6-10, 12, 15-16, 18-22, 27, 30-32 and 35 are rejected under 35 U.S.C. 103(a) as being unpatentable over Hashimoto et al. (US Patent 6,111,604) in view of Smith et al. (US Patent 5,634,075), Ristelhueber : "Plug and play is almost here" and Shinohara (US Patent 5,742,934).

8. As per claim 2, Hashimoto teaches an analog data acquisition device operatively connectable to a computer through a multipurpose interface of the computer, wherein the computer having an operating system, the analog data acquisition device comprising:

a) a program memory (Fig. 9, ref. 52, 54-55 and col. 8, l. 48 to col. 9, l. 17);

b) an analog signal acquisition channel for receiving a signal from an analog source (Fig. 8, ref. 1, 6, 9; col. 6, l. 16 to col. 9, l. 17 and col. 10, l. 41 to col. 11, l. 42);

c) a processor operatively interfaced with the multipurpose interface of the computer, the program memory (Fig. 9, ref. 52, 54-55), and a data storage memory (Fig. 8, ref. 16) when the analog data acquisition device is operational (Fig. 8; Fig. 9; col. 6, l. 16 to col. 9, l. 17 and col. 10, l. 41 to col. 11, l. 42);

d) wherein the processor is configured and programmed to implement a data generation process by which analog data (e.g. audio and visual analog data) is acquired from the analog signal acquisition channel, the analog data is processed, and digitized, and the processed and digitized analog data is stored in a file system of the data storage memory (Fig. 8, ref. 16 and Fig. 10) as at least one file of digitized analog data (Fig. 1A-1B; Fig. 11-12; Fig. 14-15; col. 1, ll. 27-57; col. 3, l. 43 to col. 4, l. 67; col. 5, ll. 43-57; col. 6, l. 16 to col. 9, l. 17; col. 9, l. 46 to col. 11, l. 42 and col. 12, l. 16 to col. 14, l. 14);

e) wherein when the analog data acquisition device is operatively interfaced with the multipurpose interface of the computer, the processor executes at least one instruction set stored in the program memory to establish communication with the computer (Fig. 1A-1B; Fig. 11-12; Fig. 14-15; col. 1, ll. 27-57; col. 3, l. 43 to col. 4, l. 67; col. 5, ll. 43-57; col. 6, l. 16 to col. 9, l. 17; col. 9, l. 46 to col. 11, l. 42 and col. 12, l. 16 to col. 14, l. 14); and

f) wherein the processor is further configured and programmed to execute at least one other instruction set stored in the program memory to thereby allow the at

Art Unit: 2181

least one file of digitized analog data acquired from the analog signal acquisition channel to be transferred to the computer (Fig. 1A-1B; Fig. 11-12; Fig. 14-15; col. 1, ll. 27-57; col. 3, l. 43 to col. 4, l. 67; col. 5, ll. 43-57; col. 6, l. 16 to col. 9, l. 17; col. 9, l. 46 to col. 11, l. 42 and col. 12, l. 16 to col. 14, l. 14).

Hashimoto does not teach the analog data acquisition device operatively connectable to a computer through a multipurpose interface of the computer, the computer having an operating system and being programmed so that when the computer receives a signal from the device through said multipurpose interface of the computer indicative of a class of devices, the computer automatically activates a device driver corresponding to the class of devices for allowing the transfer of data between the device and the operating system of the computer, the analog data acquisition device comprising:

wherein after interfacing with the computer, to thereby automatically causes at least one parameter indicative of the class of devices to be sent to the computer through the multipurpose interface of the computer, independent of the analog source, wherein the analog data acquisition device is not within the class of devices; and

data transferring to the computer using the device driver corresponding to said class of devices so that the analog data acquisition device appears to the computer as if it were a device of the class of devices;

whereby there is no requirement for any user-loaded file transfer enabling software to be loaded on or installed in the computer in addition to the operating system.

Art Unit: 2181

Smith teaches a system and a method comprising: wherein after interfacing with the computer, to thereby automatically causes at least one parameter to be sent to the computer through the multipurpose interface of the computer, independent of the analog source (e.g. plug and play functionality) (Fig. 2-5; col. 1, ll. 9-22; col. 2, l. 40 to col. 3, l. 59; col. 4, ll. 5-34 and col. 6, ll. 63-62), by combining the plug-and-play functionality into Hashimoto's analog data acquisition device architecture, the resulting combination further teaches the above claimed features.

Ristelhueber teaches a system and a method comprising whereby there is no requirement for any user-loaded software to be loaded on or installed in the computer in addition to the operating system (pages 1-3).

Shinohara teaches a system and a method comprising: sending a class of devices (e.g. class of device associated with hard disk drive), wherein the analog data acquisition device is not within the class of devices (e.g. hard disk drive emulation by the device); data transferring to the computer using the device driver (e.g. hard disk drive device driver) corresponding to said class of devices so that the analog data acquisition device appears to the computer as if it were a device of the class of devices (e.g. device appear as hard disk drive); no requirement for any user-loaded file transfer enabling software (e.g. the plug and play of the device for hard disk drive emulation as taught by the combination of the references) (col. 1, ll. 48-60 and col. 3, l. 33 to col. 4, l. 49), by combining the emulation of the hard disk drive with Hashimoto, Smith and Ristelhueber's analog data acquisition device architecture having the plug-and-play

Art Unit: 2181

functionality, the resulting combination of the references further teaches the above claimed features.

It would have been obvious for one of ordinary skill in this art, at the time of invention was made to include Smith's plug and play functionality, Ristelhueber's installation without user intervention and Shinohara's hard disk drive emulation into Hashimoto's analog data acquisition device architecture for the benefit of simplifying the installation of the peripheral device for the user as the peripheral device may be installed without the need for the user to install software or configure the peripheral device (Smith, col. 2, ll. 40-67 and col. 5, ll. 41-51 and col. 6, ll. 63-65), simplifying the end user's PC upgrading and reducing cost for the computing industry (Ristelhueber, page 2, 3rd paragraph), and expanding the lifetime usage of the memory card (Shinohara, col. 2, ll. 7-8) to obtain the invention as specified in claim 2.

9. As per claim 3, Hashimoto, Smith, Ristelhueber and Shinohara teach all the claimed limitation of claim 2 above, where Hashimoto, Smith, Ristelhueber and Shinohara further teach the analog data acquisition device comprising wherein the analog data acquisition device is a stand alone device (Hashimoto, Fig. 1A-1B; Fig. 11-12; Fig. 14-15; col. 1, ll. 27-57; col. 3, l. 43 to col. 4, l. 67; col. 5, ll. 43-57; col. 6, l. 16 to col. 9, l. 17; col. 9, l. 46 to col. 11, l. 42; col. 12, l. 16 to col. 14, l. 14; Smith, Fig. 2-5; col. 1, ll. 9-22; col. 2, l. 40 to col. 3, l. 59; col. 4, ll. 5-34; col. 6, ll. 63-62; Ristelhueber, pages 1-3; and Shinohara, col. 1, ll. 48-60; col. 3, l. 33 to col. 4, l. 49).

Art Unit: 2181

10. As per claim 4, Hashimoto, Smith, Ristelhueber and Shinohara teach all the claimed limitation of claim 2 above, where Hashimoto, Smith, Ristelhueber and Shinohara further teach the analog data acquisition device comprising wherein the analog data acquisition device includes a SCSI interface circuit (Hashimoto, Fig. 1A-1B; Fig. 11-12; Fig. 14-15; col. 1, ll. 27-57; col. 3, l. 43 to col. 4, l. 67; col. 5, ll. 43-57; col. 6, l. 16 to col. 9, l. 17; col. 9, l. 46 to col. 11, l. 42; col. 12, l. 16 to col. 14, l. 14; Smith, Fig. 2-5; col. 1, ll. 9-22; col. 2, l. 40 to col. 3, l. 59; col. 4, ll. 5-34; col. 6, ll. 63-62; Ristelhueber, pages 1-3; and Shinohara, col. 1, ll. 48-60; col. 3, l. 33 to col. 4, l. 49).

11. As per claim 6, Hashimoto, Smith, Ristelhueber and Shinohara teach all the claimed limitation of claim 2 above, where Hashimoto, Smith, Ristelhueber and Shinohara further teach the analog data acquisition device configured to allow for a plurality of different data transmit devices to be attached thereto and detached therefrom (Hashimoto, Fig. 1A-1B; Fig. 8; Fig. 11-12; Fig. 14-15; col. 1, ll. 27-57; col. 3, l. 43 to col. 4, l. 67; col. 5, ll. 43-57; col. 6, l. 16 to col. 9, l. 17; col. 9, l. 46 to col. 11, l. 42; col. 12, l. 16 to col. 14, l. 14; Smith, Fig. 2-5; col. 1, ll. 9-22; col. 2, l. 40 to col. 3, l. 8; col. 3, ll. 22-27; col. 3, ll. 53-59; col. 4, ll. 5-34; col. 6, ll. 63-62; Ristelhueber, pages 1-3; and Shinohara, col. 1, ll. 48-60; col. 3, l. 56 to col. 4, l. 49).

12. As per claim 7, Hashimoto, Smith, Ristelhueber and Shinohara teach all the claimed limitation of claim 2 above, where Hashimoto and Smith further teach the analog data acquisition device comprising wherein the processor is adapted to be

Art Unit: 2181

interfaced with the multipurpose interface of an external computing device by means of a cable (Hashimoto, Fig. 1A-1B; Fig. 8; Fig. 11-12; Fig. 14-15; col. 1, ll. 27-57; col. 3, l. 43 to col. 4, l. 67; col. 5, ll. 43-57; col. 6, l. 16 to col. 9, l. 17; col. 9, l. 46 to col. 11, l. 42; col. 12, l. 16 to col. 14, l. 14; Smith, Fig. 2-5; col. 1, ll. 9-22; col. 2, l. 40 to col. 3, l. 8; col. 3, ll. 22-27; col. 3, ll. 53-59; col. 4, ll. 5-34; col. 6, ll. 63-62; Ristelhueber, pages 1-3; and Shinohara, col. 1, ll. 48-60; col. 3, l. 56 to col. 4, l. 49).

13. As per claim 8, Hashimoto, Smith, Ristelhueber and Shinohara teach all the claimed limitation of claim 2 above, where Hashimoto further teaches the analog data acquisition device comprising wherein the analog source comprises a data transmit/receive device (e.g. for transferring the audiovisual information to the computer and receiving control instruction from the computer) (Hashimoto, Fig. 1A-1B; Fig. 8; Fig. 11-12; Fig. 14-15; col. 1, ll. 27-57; col. 3, l. 43 to col. 4, l. 67; col. 5, ll. 43-57; col. 6, l. 16 to col. 9, l. 17; col. 9, l. 46 to col. 11, l. 42; and col. 12, l. 16 to col. 14, l. 14).

14. As per claim 9, Hashimoto, Smith, Ristelhueber and Shinohara teach all the claimed limitation of claim 8 above, where Hashimoto further teaches the analog data acquisition device comprising wherein the analog source is designed for one of one-way and two-way communication with the host device (Hashimoto, Fig. 1A-1B; Fig. 8; Fig. 11-12; Fig. 14-15; col. 1, ll. 27-57; col. 3, l. 43 to col. 4, l. 67; col. 5, ll. 43-57; col. 6, l. 16 to col. 9, l. 17; col. 9, l. 46 to col. 11, l. 42; and col. 12, l. 16 to col. 14, l. 14).

Art Unit: 2181

15. As per claim 10, Hashimoto, Smith, Ristelhueber and Shinohara teach all the claimed limitation of claim 2 above, where Hashimoto, Smith, Ristelhueber and Shinohara further teaches the analog data acquisition device comprising wherein processor converts the digitized analog data acquired from the analog signal acquisition channel to a form that simulates data from a hard disk and transfers that converted data to the computer through the multipurpose interface such that the converted data appears to the computer as data from a hard disk. (Hashimoto, Fig. 1A-1B; Fig. 8; Fig. 11-12; Fig. 14-15; col. 1, ll. 27-57; col. 3, l. 43 to col. 4, l. 67; col. 5, ll. 43-57; col. 6, l. 16 to col. 9, l. 17; col. 9, l. 46 to col. 11, l. 42; col. 12, l. 16 to col. 14, l. 14 Smith, Fig. 2-5; col. 1, ll. 9-22; col. 2, l. 40 to col. 3, l. 8; col. 3, ll. 22-27; col. 3, ll. 53-59; col. 4, ll. 5-34; col. 6, ll. 63-62; Ristelhueber, pages 1-3; and Shinohara, col. 1, ll. 48-60; col. 3, l. 56 to col. 4, l. 49), as the analog data acquisition device is being recognized as the hard disk when connected to the host, the digitized analog data would need to conform to the hard disk standard/protocol via conversion such that the digitized analog data can properly be transferred to the host.

16. As per claim 12, Hashimoto, Smith, Ristelhueber and Shinohara teach all the claimed limitation of claim 2 above, where Hashimoto, Smith, Ristelhueber and Shinohara further teach the analog data acquisition device comprising wherein the processor allows for a plurality of different data transmit devices to be attached thereto and detached therefrom (Hashimoto, Fig. 1A-1B; Fig. 8; Fig. 11-12; Fig. 14-15; col. 1, ll. 27-57; col. 3, l. 43 to col. 4, l. 67; col. 5, ll. 43-57; col. 6, l. 16 to col. 9, l. 17; col. 9, l. 46

Art Unit: 2181

to col. 11, l. 42; col. 12, l. 16 to col. 14, l. 14; Smith, Fig. 2-5; col. 1, ll. 9-22; col. 2, l. 40 to col. 3, l. 8; col. 3, ll. 22-27; col. 3, ll. 53-59; col. 4, ll. 5-34; col. 6, ll. 63-62; Ristelhueber, pages 1-3; and Shinohara, col. 1, ll. 48-60; col. 3, l. 56 to col. 4, l. 49).

17. As per claim 15, Hashimoto, Smith, Ristelhueber and Shinohara teach all the claimed limitation of claim 2 above, where Hashimoto, Smith, Ristelhueber and Shinohara further teach the analog data acquisition device comprising wherein the analog source includes at least first and second transducers both of which are designed to transmit data (Hashimoto, Fig. 1A-1B; Fig. 8; Fig. 11-12; Fig. 14-15; col. 1, ll. 27-57; col. 3, l. 43 to col. 4, l. 67; col. 5, ll. 43-57; col. 6, l. 16 to col. 9, l. 17; col. 9, l. 46 to col. 11, l. 42; col. 12, l. 16 to col. 14, l. 14; Smith, Fig. 2-5; col. 1, ll. 9-22; col. 2, l. 40 to col. 3, l. 8; col. 3, ll. 22-27; col. 3, ll. 53-59; col. 4, ll. 5-34; col. 6, ll. 63-62; Ristelhueber, pages 1-3; and Shinohara, col. 1, ll. 48-60; col. 3, l. 56 to col. 4, l. 49).

18. As per claim 16, Hashimoto, Smith, Ristelhueber and Shinohara teach all the claimed limitation of claim 2 above, where Hashimoto, Smith, Ristelhueber and Shinohara further teach the analog data acquisition device comprising wherein the at least one parameter is consistent with the analog data acquisition device being responsive to a SCSI inquiry command (Hashimoto, Fig. 1A-1B; Fig. 8; Fig. 11-12; Fig. 14-15; col. 1, ll. 27-57; col. 3, l. 43 to col. 4, l. 67; col. 5, ll. 43-57; col. 6, l. 16 to col. 9, l. 17; col. 9, l. 46 to col. 11, l. 42; col. 12, l. 16 to col. 14, l. 14; Smith, Fig. 2-5; col. 1, ll. 9-

Art Unit: 2181

22; col. 2, l. 40 to col. 3, l. 8; col. 3, ll. 22-27; col. 3, ll. 53-59; col. 4, ll. 5-34; col. 6, ll. 63-62; Ristelhueber, pages 1-3; and Shinohara, col. 1, ll. 48-60; col. 3, l. 56 to col. 4, l. 49).

19. As per claim 18, Hashimoto, Smith, Ristelhueber and Shinohara teach all the claimed limitation of claim 2 above, where Hashimoto, Smith, Ristelhueber and Shinohara further teach the analog data acquisition device comprising wherein the processor is configured to cause acquired analog data file system information to be automatically sent to the multipurpose interface after the at least one parameter has been sent to the multipurpose interface of the computer, (a) without requiring any end user to load any software onto the computer at any time, and b) without requiring any end user to interact with the computer to set up a file system in the analog data acquisition device at any time (Hashimoto, Fig. 1A-1B; Fig. 8; Fig. 11-12; Fig. 14-15; col. 1, ll. 27-57; col. 3, l. 43 to col. 4, l. 67; col. 5, ll. 43-57; col. 6, l. 16 to col. 9, l. 17; col. 9, l. 46 to col. 11, l. 42; col. 12, l. 16 to col. 14, l. 14; Smith, Fig. 2-5; col. 1, ll. 9-22; col. 2, l. 40 to col. 3, l. 8; col. 3, ll. 22-27; col. 3, ll. 53-59; col. 4, ll. 5-34; col. 6, ll. 63-62; Ristelhueber, pages 1-3; and Shinohara, col. 1, ll. 48-60; col. 3, l. 56 to col. 4, l. 49).

20. As per claim 19, Hashimoto, Smith, Ristelhueber and Shinohara teach all the claimed limitation of claim 18 above, where Hashimoto, Smith, Ristelhueber and Shinohara further teach the analog data acquisition device comprising wherein the analog data acquisition device file system information comprises at least an indication of a file system type that is used to store the digitized analog data (Hashimoto, Fig. 1A-1B;

Art Unit: 2181

Fig. 8; Fig. 11-12; Fig. 14-15; col. 1, ll. 27-57; col. 3, l. 43 to col. 4, l. 67; col. 5, ll. 43-57; col. 6, l. 16 to col. 9, l. 17; col. 9, l. 46 to col. 11, l. 42; col. 12, l. 16 to col. 14, l. 14; Smith, Fig. 2-5; col. 1, ll. 9-22; col. 2, l. 40 to col. 3, l. 8; col. 3, ll. 22-27; col. 3, ll. 53-59; col. 4, ll. 5-34; col. 6, ll. 63-62; Ristelhueber, pages 1-3; and Shinohara, col. 1, ll. 48-60; col. 3, l. 56 to col. 4, l. 49), as the type of file system corresponds to the plug-and-play analog data acquisition device having the memory card emulating as the hard disk drive for data transferring after the plug-and-play analog data acquisition device is connected to the PC.

21. As per claim 20, Hashimoto, Smith, Ristelhueber and Shinohara teach all the claimed limitation of claim 2 above, where Hashimoto, Smith, Ristelhueber and Shinohara further teach the analog data acquisition device comprising wherein the processor is configured to cause file allocation table information to be sent to the multipurpose interface, wherein the processor is configured to cause a virtual boot sequence to be sent to the multipurpose interface which includes at least information that is representative of a number of sectors of a storage disk, and wherein the file allocation table information includes at least a start location of a file allocation table (Hashimoto, Fig. 1A-1B; Fig. 8; Fig. 11-12; Fig. 14-15; col. 1, ll. 27-57; col. 3, l. 43 to col. 4, l. 67; col. 5, ll. 43-57; col. 6, l. 16 to col. 9, l. 17; col. 9, l. 46 to col. 11, l. 42; col. 12, l. 16 to col. 14, l. 14; Smith, Fig. 2-5; col. 1, ll. 9-22; col. 2, l. 40 to col. 3, l. 8; col. 3, ll. 22-27; col. 3, ll. 53-59; col. 4, ll. 5-34; col. 6, ll. 63-62; Ristelhueber, pages 1-3; and Shinohara, col. 1, ll. 48-60; col. 3, l. 56 to col. 4, l. 49), as the analog data acquisition

Art Unit: 2181

device being a mass storage device corresponds to the plug-and-play analog data acquisition device having the memory card emulating as the hard disk drive.

22. As per claim 21, Hashimoto, Smith, Ristelhueber and Shinohara teach all the claimed limitation of claim 2 above, where Hashimoto further teaches the analog data acquisition device comprising wherein the processor is configured to initiate a process by which the at least one file of digitized analog data is directly transferred to an input/output device (Hashimoto, Fig. 1A-1B; Fig. 8; Fig. 11-12; Fig. 14-15; col. 1, ll. 27-57; col. 3, l. 43 to col. 4, l. 67; col. 5, ll. 43-57; col. 6, l. 16 to col. 9, l. 17; col. 9, l. 46 to col. 11, l. 42; and col. 12, l. 16 to col. 14, l. 14).

23. As per claim 22, Hashimoto, Smith, Ristelhueber and Shinohara teach all the claimed limitation of claim 21 above, where Hashimoto further teaches the analog data acquisition device comprising wherein the processor is configured to allow a mode of operation (e.g. update mode) of the analog data acquisition device other than the transfer of at least some of the at least one file of digitized analog data to the multipurpose interface to be controlled by means of an external personal computer (Hashimoto, Fig. 1A-1B; Fig. 8; Fig. 11-12; Fig. 14-15; col. 1, ll. 27-57; col. 3, l. 43 to col. 4, l. 67; col. 5, ll. 43-57; col. 6, l. 16 to col. 9, l. 17; col. 9, l. 46 to col. 11, l. 42; and col. 12, l. 16 to col. 14, l. 14), as the PC directly update the control program.

Art Unit: 2181

24. As per claim 27, Hashimoto, Smith, Ristelhueber and Shinohara teach all the claimed limitation of claim 2 above, where Hashimoto further teaches the analog data acquisition device comprising wherein the analog source is designed to receive signals from the computer (Hashimoto, Fig. 1A-1B; Fig. 8; Fig. 11-12; Fig. 14-15; col. 1, ll. 27-57; col. 3, l. 43 to col. 4, l. 67; col. 5, ll. 43-57; col. 6, l. 16 to col. 9, l. 17; col. 9, l. 46 to col. 11, l. 42; and col. 12, l. 16 to col. 14, l. 14), such as the computer communicating to the camera by updating control program to control the sensor.

25. As per claim 30, Hashimoto, Smith, Ristelhueber and Shinohara teach all the claimed limitation of claim 2 above, where Hashimoto, Smith, Ristelhueber and Shinohara further teach the analog data acquisition device comprising wherein the analog data acquisition device is designed to be responsive to a test unit ready command (Hashimoto, Fig. 1A-1B; Fig. 8; Fig. 11-12; Fig. 14-15; col. 1, ll. 27-57; col. 3, l. 43 to col. 4, l. 67; col. 5, ll. 43-57; col. 6, l. 16 to col. 9, l. 17; col. 9, l. 46 to col. 11, l. 42; col. 12, l. 16 to col. 14, l. 14; Smith, Fig. 2-5; col. 1, ll. 9-22; col. 2, l. 40 to col. 3, l. 8; col. 3, ll. 22-27; col. 3, ll. 53-59; col. 4, ll. 5-34; col. 6, ll. 63-62; Ristelhueber, pages 1-3; and Shinohara, col. 1, ll. 48-60; col. 3, l. 56 to col. 4, l. 49).

26. As per claim 31, Hashimoto, Smith, Ristelhueber and Shinohara teach all the claimed limitation of claim 2 above, where Hashimoto, Smith, Ristelhueber and Shinohara further teach the analog data acquisition device comprising wherein the device driver is installed with the operating system (Hashimoto, Fig. 1A-1B; Fig. 8; Fig.

Art Unit: 2181

11-12; Fig. 14-15; col. 1, ll. 27-57; col. 3, l. 43 to col. 4, l. 67; col. 5, ll. 43-57; col. 6, l. 16 to col. 9, l. 17; col. 9, l. 46 to col. 11, l. 42; col. 12, l. 16 to col. 14, l. 14; Smith, Fig. 2-5; col. 1, ll. 9-22; col. 2, l. 40 to col. 3, l. 8; col. 3, ll. 22-27; col. 3, ll. 53-59; col. 4, ll. 5-34; col. 6, ll. 63-62; Ristelhueber, pages 1-3; and Shinohara, col. 1, ll. 48-60; col. 3, l. 56 to col. 4, l. 49).

27. As per claim 32, independent claim 32 is rejected in accordance to the same rational and reasoning as the above rejection of independent claim 2, wherein the class of devices corresponds to the digital mass storage device (e.g. hard disk drive emulation); furthermore, Shinohara teaches transferring data in response to a digital mass storage device data read request from the host device (Shinohara, col. 1, ll. 48-60; col. 3, l. 34 to col. 4, l. 49).

28. As per claim 35, independent claim 35 is rejected in accordance to the same rational and reasoning as the above rejection of independent claims 2 and 32, as independent claim 35 is the method claim for the analog data acquisition and interface device of independent claim 32, wherein the class of devices corresponds to the digital mass storage device (e.g. hard disk drive emulation).

29. Claims 5 and 13 are rejected under 35 U.S.C. 103(a) as being unpatentable over Hashimoto et al. (US Patent 6,111,604) in view of Smith et al. (US Patent 5,634,075),

Art Unit: 2181

Ristelhueber : “Plug and play is almost here” and Shinohara (US Patent 5,742,934) as applied to claim 2 above, and further in view of Endo et al. (US Patent 4,652,928).

Hashimoto, Smith, Ristelhueber and Shinohara teach all the limitations of claim 2 as discussed above, wherein Hashimoto further teaches the analog data acquisition device comprising wherein the processor is designed so that the sensor can be attached to the processor (Hashimoto, Fig. 1A-1B; Fig. 8; Fig. 11-12; Fig. 14-15; col. 1, ll. 27-57; col. 3, l. 43 to col. 4, l. 67; col. 5, ll. 43-57; col. 6, l. 16 to col. 9, l. 17; col. 9, l. 46 to col. 11, l. 42; and col. 12, l. 16 to col. 14, l. 14).

Hashimoto, Smith, Ristelhueber and Shinohara do not expressly teach the analog data acquisition device comprising:

wherein the analog data acquisition device is designed so that the analog source is detachable; and

wherein the processor is designed so that a user can attach the analog source thereto or detach the analog source therefrom.

Endo teaches a system comprising: wherein the analog data acquisition device is designed so that the analog source is detachable (e.g. de-coupling); and wherein the processor is designed so that a user can attach the analog source thereto or detach the analog source therefrom (col. 1, ll. 18-25 and col. 13, ll. 57-58), by combining the de-couplable of the sensor architecture with Hashimoto, Smith, Kerigan and Shinohara's analog data acquisition device having the sensor architecture, the resulting combination of the references further teaches the above claimed features.

Art Unit: 2181

It would have been obvious for one of ordinary skill in this art, at the time of invention was made to include Endo's interchangeable sensor into Hashimoto, Smith, Ristelhueber and Shinohara's sensor coupled to the processor for the benefit of adaptively increase the resolution of the camera to obtaining a better quality image (Endo, col. 1, ll. 18-20) to obtain the invention as specified in claims 5 and 13.

30. Claims 11 and 36 are rejected under 35 U.S.C. 103(a) as being unpatentable over Hashimoto et al. (US Patent 6,111,604) in view of Smith et al. (US Patent 5,634,075), Ristelhueber : "Plug and play is almost here" and Shinohara (US Patent 5,742,934) as applied to claims 2 and 35 above, and further in view of Nakamura et al. (US Patent 6,278,492).

Hashimoto, Smith, Ristelhueber and Shinohara teach all the limitations of claims 2 and 35 as discussed above, where Hashimoto further teaches/suggests acquiring analog data from the analog source time independent of transferring the acquired analog data to the host device (e.g. the analog data acquired by the digital camera occurs at one point in time before the digital camera is connected to the host (e.g. Fig. 11) and the transferring of the acquired analog data to the host occurs at another point in time when the digital camera is connected to the host (e.g. Fig. 14)) (Hashimoto, Fig. 1A-1B; Fig. 8; Fig. 11-12; Fig. 14-15; col. 1, ll. 27-57; col. 3, l. 43 to col. 4, l. 67; col. 5, ll. 43-57; col. 6, l. 16 to col. 9, l. 17; col. 9, l. 46 to col. 11, l. 42; and col. 12, l. 16 to col. 14, l. 14); but Hashimoto, Smith, Ristelhueber and Shinohara do not expressly teach the analog data acquisition device comprising:

a plurality of independent analog signal acquisition channels, each of the plurality of channels operatively coupled to the processor for operatively coupling to one of a

Art Unit: 2181

plurality of analog sources analog sources such that analog data is simultaneously acquired from at least two of the plurality of channels, is digitized and is coupled into the processor mid is processed by the processor; and

simultaneously acquiring the analog data from each respective analog channel of a plurality of respective independent acquisition channels under control of the processor.

Nakamura teaches a system comprising: a plurality of independent analog signal acquisition channels, each of the plurality of channels operatively coupled to the processor for operatively coupling to one of a plurality of analog sources such that analog data is simultaneously acquired from at least two of the plurality of channels, is digitized and is coupled into the processor mid is processed by the processor; and simultaneously acquiring the analog data from each respective analog channel of a plurality of respective independent acquisition channels under control of the processor (Fig. 1 and col. 1, ll. 12-40), by combining the multiple sensor architecture into Hashimoto, Smith, Ristelhueber and Shinohara analog data acquisition device having the sensor architecture, the resulting combination of the references further teaches the above claimed features.

It would have been obvious for one of ordinary skill in this art, at the time of invention was made to include Nakamura's multiple sensors into Hashimoto, Smith, Ristelhueber and Shinohara's analog data acquisition device architecture for the benefit of improving the resolution (Nakamura, col. 1, ll. 12-40) to obtain the invention as specified in claims 11 and 36.

31. Claim 24 is rejected under 35 U.S.C. 103(a) as being unpatentable over Hashimoto et al. (US Patent 6,111,604) in view of Smith et al. (US Patent 5,634,075), Ristelhueber : "Plug and play is almost here" and Shinohara (US Patent 5,742,934) as applied to claim 2 above, and further in view of Roberts et al. (US Patent 5,576,757).

Hashimoto, Smith, Ristelhueber and Shinohara teach all the limitations of claim 2 as discussed above, wherein Hashimoto further teaches the analog data acquisition device comprising generating and processing of the analog data (Hashimoto, Fig. 1A-1B; Fig. 11-12; Fig. 14-15; col. 1, ll. 35-57; col. 3, l. 43 to col. 4, l. 57; col. 5, ll. 43-57; col. 6, l. 16 to col. 9, l. 17 and col. 9, l. 46 to col. 10, l. 16).

Hashimoto, Smith, Ristelhueber and Shinohara do not expressly teach the analog data acquisition device comprising a fast Fourier transform.

Roberts teaches a system and a method comprising an electronic still camera processing data by being subject to a fast Fourier transform (Abstract and col. 9, l. 60 to col. 10, l. 7).

It would have been obvious for one of ordinary skill in this art, at the time of invention was made to include Roberts's fast Fourier transform into Hashimoto, Smith, Ristelhueber and Shinohara's analog data acquisition device architecture for the benefit of having an easier computation for image processing while providing a reasonable visual fidelity (Roberts, col. 10, ll. 1-3) to obtain the invention as specified in claim 24.

Art Unit: 2181

II. CLOSING COMMENTS

Conclusion

a. STATUS OF CLAIMS IN THE APPLICATION

The following is a summary of the treatment and status of all claims in the application as recommended by **M.P.E.P. 707.07(i)**:

a(1) CLAIMS REJECTED IN THE APPLICATION

Per the instant office action, claims 1-13, 15-16, 18-22, 24, 27, 30-32 and 35-36 have received a first action on the merits and are subject of a first action non-final.

b. DIRECTION OF FUTURE CORRESPONDENCES

Any inquiry concerning this communication or earlier communications from the examiner should be directed to Chun-Kuan (Mike) Lee whose telephone number is (571) 272-0671. The examiner can normally be reached on 8AM to 5PM.

IMPORTANT NOTE

If attempts to reach the examiner by telephone are unsuccessful, the examiner's supervisor, Idriss Alrobaye can be reached on (571) 270-1023. The fax phone number for the organization where this application or proceeding is assigned is 571-273-8300.

Art Unit: 2181

Information regarding the status of an application may be obtained from the Patent Application Information Retrieval (PAIR) system. Status information for published applications may be obtained from either Private PAIR or Public PAIR. Status information for unpublished applications is available through Private PAIR only. For more information about the PAIR system, see <http://pair-direct.uspto.gov>. Should you have questions on access to the Private PAIR system, contact the Electronic Business Center (EBC) at 866-217-9197 (toll-free). If you would like assistance from a USPTO Customer Service Representative or access to the automated information system, call 800-786-9199 (IN USA OR CANADA) or 571-272-1000.

/Chun-Kuan Lee/
Primary Examiner
Art Unit 2181
November 27, 2012

EAST Search History**EAST Search History (Prior Art)**

Ref #	Hits	Search Query	DBs	Default Operator	Plurals	Time Stamp
S1	2655	(710/15,63,69).ccls.	US-PGPUB; USPAT; USOCR; EPO; JPO; DERWENT	SAME	OFF	2012/11/27 09:36
S2	9	(TASLER near MICHAEL).in.	US-PGPUB; USPAT; USOCR; EPO; JPO; DERWENT	SAME	OFF	2012/11/27 10:34
S3	14415	plug near play	US-PGPUB; USPAT; USOCR; EPO; JPO; DERWENT	SAME	OFF	2012/11/27 10:50
S4	141	multimeter\$2 and (plug with play)	US-PGPUB; USPAT; USOCR; EPO; JPO; DERWENT	SAME	OFF	2012/11/27 11:24
S5	4274	((disk near drive\$2) or (hard near drive\$2) or HD or HDD or (hard near disk near drive\$2)) with(emulat\$4 or simulat\$4))	US-PGPUB; USPAT; USOCR; EPO; JPO; DERWENT	SAME	OFF	2012/11/27 11:48

Index of Claims 	Application/Control No. 12891443	Applicant(s)/Patent Under Reexamination TASLER, MICHAEL
	Examiner Chun-Kuan Lee	Art Unit 2181

✓	Rejected
=	Allowed

-	Cancelled
÷	Restricted

N	Non-Elected
I	Interference

A	Appeal
O	Objected

Claims renumbered in the same order as presented by applicant
 CPA
 T.D.
 R.1.47

CLAIM		DATE							
Final	Original	04/18/2011	11/27/2012						
	1	-	-						
	2	÷	✓						
	3	÷	✓						
	4	÷	✓						
	5	÷	✓						
	6	÷	✓						
	7	÷	✓						
	8	÷	✓						
	9	÷	✓						
	10	÷	✓						
	11	÷	✓						
	12	÷	✓						
	13	÷	✓						
	14	÷	N						
	15	÷	✓						
	16	÷	✓						
	17	÷	N						
	18	÷	✓						
	19	÷	✓						
	20	÷	✓						
	21	÷	✓						
	22	÷	✓						
	23	÷	N						
	24	÷	✓						
	25	÷	N						
	26	÷	N						
	27	÷	✓						
	28	÷	N						
	29	÷	N						
	30	÷	✓						
	31	÷	✓						
	32	÷	✓						
	33	÷	N						
	34	÷	N						
	35	÷	✓						
	36	÷	✓						

Search Notes 	Application/Control No. 12891443	Applicant(s)/Patent Under Reexamination TASLER, MICHAEL
	Examiner Chun-Kuan Lee	Art Unit 2181

SEARCHED			
Class	Subclass	Date	Examiner
710	15,63,69	11/27/2012	CKL

SEARCH NOTES		
Search Notes	Date	Examiner
Updated EAST search:US-PGPUB; USPAT; USOCR; EPO; JPO; DERWENT	11/27/2012	CKL
Updated inventor search utilizing eDan and EAST	11/27/2012	CKL

INTERFERENCE SEARCH			
Class	Subclass	Date	Examiner

--	--

Under the Paperwork Reduction Act of 1995, no persons are required to respond to a collection of information unless it contains a valid OMB control number.

Request For Continued Examination (RCE) Transmittal

Address to:
Mail Stop RCE
Commissioner for Patents
P.O. Box 1450
Alexandria, VA 22313-1450

Application Number	12/891,443
Filing Date	September 27, 2010
First Named Inventor	TASLER, Micheal L.
Art Unit	2181
Examiner Name	Lee, Chun K.
Attorney Docket Number	113189

This is a Request for Continued Examination (RCE) under 37 C.F.R. § 1.114 of the above-identified application.

Request for Continued Examination (RCE) practice under 37 CFR 1.114 does not apply to any utility or plant application filed prior to June 8, 1995, or to any design application. See Instruction Sheet for RCEs (not to be submitted to the USPTO) on page 2.

1. **Submission required under 37 C.F.R. 1.114** Note: If the RCE is proper, any previously filed unentered amendments and amendments enclosed with the RCE will be entered in the order in which they were filed unless applicant instructs otherwise. If applicant does not wish to have any previously filed unentered amendment(s) entered, applicant must request non-entry of such amendment(s).
- a. Previously submitted. If a final Office action is outstanding, any amendments filed after the final Office action may be considered as a submission even if this box is not checked.
- i. Consider the arguments in the Appeal Brief or Reply Brief previously filed on _____
- ii. Other _____
- b. Enclosed
- i. Amendment/Reply
- ii. Affidavit(s)/Declaration(s)
- iii. Information Disclosure Statement (IDS)
- iv. Other _____

2. Miscellaneous

- a. Suspension of action on the above-identified application is requested under 37 C.F.R. 1.103(c) for a period of _____ months. (Period of suspension shall not exceed 3 months; Fee under 37 C.F.R. 1.17(i) required)
- b. Other _____

3. Fees

The RCE fee under 37 C.F.R. 1.17 (e) is required by 37 C.F.R. 1.114 when RCE is filed.

- a. The Director is hereby authorized to charge the following fees, any underpayment of fees, or credit any overpayments, to Deposit Account No. **11-0160**.
- i. RCE fee required under 37 C.F.R. 1.17 (e)
- ii. Extension of time fee (37 C.F.R. 1.136 and 1.17)
- iii. Other _____
- b. Check in the amount of \$ _____ enclosed
- c. Payment by credit card (Form PTO-2038 enclosed)

WARNING: Information on this form may become public. Credit card information should not be included on this form. Provide credit card information and authorization on PTO-2038.

SIGNATURE OF APPLICANT, ATTORNEY, OR AGENT REQUIRED

Signature		Date	October 29, 2012
Name (Print/Type)	James A. Scheer	Registration No.	29,434

CERTIFICATE OF MAILING OR TRANSMISSION

I hereby certify that this correspondence is being deposited with the United States Postal Service with sufficient postage as first class mail in an envelope addressed to: Mail Stop RCE, Commissioner for Patents, P. O. Box 1450, Alexandria, VA 22313-1450 or facsimile transmitted to the U.S. Patent and Trademark Office on the date shown below.

Signature		Date	October 29, 2012
Name (Print/Type)		Date	October 29, 2012

This collection of information is required by 37 CFR 1.114. The information is required to obtain or retain a benefit by the public which is to file (and by the USPTO to process) an application. Confidentiality is governed by 35 U.S.C. 122 and 37 CFR 1.11 and 1.14. This collection is estimated to take 12 minutes to complete, including gathering, preparing, and submitting the completed application form to the USPTO. Time will vary depending upon the individual case. Any comments on the amount of time you require to complete this form and/or suggestions for reducing this burden, should be sent to the Chief Information Officer, U.S. Patent and Trademark Office, U.S. Department of Commerce, P.O. Box 1450, Alexandria, VA 22313-1450. DO NOT SEND FEES OR COMPLETED FORMS TO THIS ADDRESS. SEND TO: Mail Stop RCE, Commissioner for Patents, P.O. Box 1450, Alexandria, VA 22313-1450.

If you need assistance in completing the form, call 1-800-PTO-9199 and select option 2.

Electronic Patent Application Fee Transmittal

Application Number:	12891443
Filing Date:	27-Sep-2010
Title of Invention:	ANALOG DATA GENERATING AND PROCESSING DEVICE FOR USE WITH A PERSONAL COMPUTER
First Named Inventor/Applicant Name:	Michael Tasler
Filer:	James A. Scheer/mawish elahi
Attorney Docket Number:	0757-113189

Filed as Large Entity

Utility under 35 USC 111(a) Filing Fees

Description	Fee Code	Quantity	Amount	Sub-Total in USD(\$)
Basic Filing:				
Pages:				
Claims:				
Miscellaneous-Filing:				
Petition:				
Patent-Appeals-and-Interference:				
Post-Allowance-and-Post-Issuance:				
Extension-of-Time:				
Extension - 3 months with \$0 paid	125	JVC	KENWOOD CORP., et al.	
Ex 1402, p. 106 of 340				

Description	Fee Code	Quantity	Amount	Sub-Total in USD(\$)
Miscellaneous:				
Request for continued examination	1801	1	930	930
Total in USD (\$)				2220

Electronic Acknowledgement Receipt

EFS ID:	14098445
Application Number:	12891443
International Application Number:	
Confirmation Number:	1408
Title of Invention:	ANALOG DATA GENERATING AND PROCESSING DEVICE FOR USE WITH A PERSONAL COMPUTER
First Named Inventor/Applicant Name:	Michael Tasler
Customer Number:	24628
Filer:	James A. Scheer/mawish elahi
Filer Authorized By:	James A. Scheer
Attorney Docket Number:	0757-113189
Receipt Date:	29-OCT-2012
Filing Date:	27-SEP-2010
Time Stamp:	16:57:31
Application Type:	Utility under 35 USC 111(a)

Payment information:

Submitted with Payment	yes
Payment Type	Deposit Account
Payment was successfully received in RAM	\$2220
RAM confirmation Number	2576
Deposit Account	230920
Authorized User	

The Director of the USPTO is hereby authorized to charge indicated fees and credit any overpayment as follows:

Charge any Additional Fees required under 37 C.F.R. Section 1.16 (National application filing, search, and examination fees)

Charge any Additional Fees required under 37 C.F.R. Section 1.17 (Patent application)

JVC KENWOOD CORP., et al.

Ex 1402, p. 108 of 340

Charge any Additional Fees required under 37 C.F.R. Section 1.19 (Document supply fees)

Charge any Additional Fees required under 37 C.F.R. Section 1.20 (Post Issuance fees)

Charge any Additional Fees required under 37 C.F.R. Section 1.21 (Miscellaneous fees and charges)

File Listing:

Document Number	Document Description	File Name	File Size(Bytes)/ Message Digest	Multi Part /.zip	Pages (if appl.)
1	Amendment After Final	113189amendment.PDF	251796 2f2bd4c6586b43ba8aa186a183999e94c836871	no	24

Warnings:

Information:

2	Extension of Time	113189eot.PDF	25881 c800a2f83b30c42d5fb09d8611d6fbd1cf2e860d	no	1
---	-------------------	---------------	---------------------------------------------------	----	---

Warnings:

Information:

3	Request for Continued Examination (RCE)	113189rce.PDF	33938 6965f645630347eceb4a7cf51eebb9153f81c20a	no	1
---	-----------------------------------------	---------------	---------------------------------------------------	----	---

Warnings:

This is not a USPTO supplied RCE SB30 form.

Information:

4	Fee Worksheet (SB06)	fee-info.pdf	32315 df2908672f493178fa8b0e5dcb56c0588d17b92	no	2
---	----------------------	--------------	--------------------------------------------------	----	---

Warnings:

Information:

Total Files Size (in bytes): 343930

This Acknowledgement Receipt evidences receipt on the noted date by the USPTO of the indicated documents, characterized by the applicant, and including page counts, where applicable. It serves as evidence of receipt similar to a Post Card, as described in MPEP 503.

New Applications Under 35 U.S.C. 111

If a new application is being filed and the application includes the necessary components for a filing date (see 37 CFR 1.53(b)-(d) and MPEP 506), a Filing Receipt (37 CFR 1.54) will be issued in due course and the date shown on this Acknowledgement Receipt will establish the filing date of the application.

National Stage of an International Application under 35 U.S.C. 371

If a timely submission to enter the national stage of an international application is compliant with the conditions of 35 U.S.C. 371 and other applicable requirements a Form PCT/DO/EO/903 indicating acceptance of the application as a national stage submission under 35 U.S.C. 371 will be issued in addition to the Filing Receipt, in due course.

New International Application Filed with the USPTO as a Receiving Office

If a new international application is being filed and the international application includes the necessary components for an international filing date (see PCT Article 11 and MPEP 1810), a Notification of the International Application Number and of the International Filing Date (Form PCT/RO/105) will be issued in due course, subject to prescriptions concerning national security, and the date shown on this Acknowledgement Receipt will establish the international filing date of the application.

Docket No.: 0757-113189
(PATENT)

IN THE UNITED STATES PATENT AND TRADEMARK OFFICE

In re Patent Application of:

Michael Tasler

Application No.: 12/891,443

Confirmation No.: 1408

Filed: September 27, 2010

Art Unit: 2181

For: ANALOG DATA GENERATING AND
PROCESSING DEVICE FOR USE WITH A
PERSONAL COMPUTER

Examiner: Lee, Chun Kuan

AMENDMENT

Mail Stop Amendment
Commissioner for Patents
P.O. Box 1450
Alexandria, VA 22313-1450

Dear Sir:

In conjunction with the Request for Continued Examination submitted herewith and in response to the Office Action mailed April 27, 2012, please amend the above identified application as follows:

Amendments To The Claims:

Please cancel claim 1 and add new claims 2-36:

1. (cancelled).

2. (currently amended) An analog data acquisition device operatively connectable to a computer through a multipurpose interface of the computer, the computer having an operating system and being programmed so that when ~~it~~the computer receives a signal from the device through said multipurpose interface of the computer indicative of a class of devices, the computer automatically activates a device driver corresponding to the class of devices for allowing the transfer of data between the device and the operating system of the computer, the analog data acquisition device comprising:
 - a) a program memory;
 - b) an analog signal acquisition channel for receiving a signal from an analog source;
 - c) a processor operatively interfaced with the multipurpose interface of the computer, the program memory, and a data storage memory when the analog data acquisition device is operational;
 - d) wherein the processor is configured and programmed to implement a data generation process by which analog data is acquired from the analog signal acquisition channel, the analog data is processed, and digitized, and the processed and digitized analog data is stored in a file system of the data storage memory as at least one file of digitized analog data;
 - e) wherein when the analog acquisition device is operatively interfaced with the multipurpose interface of the computer, the processor executes at least one instruction set stored in the program memory and thereby automatically causes at least one parameter indicative of the class of devices to be sent to the computer through the multipurpose interface of the computer,

independent of the analog source, wherein the analog data acquisition device is not within the class of devices; and

f) wherein the processor is further configured and programmed to execute at least one other instruction set stored in the program memory to thereby allow the at least one file of digitized analog data acquired from the analog signal acquisition channel to be transferred to the computer using the device driver corresponding to said class of devices so that the analog data acquisition device appears to the computer as if it were a device of the class of devices;

whereby there is no requirement for any user-loaded file transfer enabling software to be loaded on or installed in the computer in addition to the operating system.

3. (previously presented) The analog data acquisition device of claim 2, wherein the analog data acquisition device is a stand alone device.

4. (previously presented) The analog data acquisition device of claim 2, wherein the analog data acquisition device includes a SCSI interface circuit.

5. (previously presented) The analog data acquisition device of claim 2, wherein the analog data acquisition device is designed so that the analog source is detachable.

6. (previously presented) The analog data acquisition device of claim 2 configured to allow for a plurality of different data transmit devices to be attached thereto and detached therefrom.

7. (previously presented) The analog data acquisition device of claim 2, wherein the processor is adapted to be interfaced with the multi-purpose interface of an external computing device by means of a cable.

8. (previously presented) The analog data acquisition device of claim 2, wherein the analog source comprises a data transmit/receive device.

9. (previously presented) The analog data acquisition device of claim 8, wherein the analog source is designed for one of one-way and two-way communication with the host device.

10. (previously presented) The analog data acquisition device of claim 2, wherein the processor converts the digitized analog data acquired from the analog signal acquisition channel to a form that simulates data from a hard disk and transfers that converted data to the computer through the multipurpose interface such that the converted data appears to the computer as data from a hard disk.

11. (previously presented) The analog data acquisition device of Claim 2 further comprising a plurality of independent analog signal acquisition channels, each of the plurality of channels operatively coupled to the processor for operatively coupling to one of a plurality of analog sources such that analog data is simultaneously acquired from at least two of the plurality of channels, is digitized and is coupled into the processor and is processed by the processor.

12. (previously presented) The analog data acquisition device of claim 2, wherein the processor allows for a plurality of different data transmit devices to be attached thereto and detached therefrom.

13. (previously presented) The analog data acquisition device of claim 2, wherein the processor is designed so that a user can attach the analog source thereto or detach the analog source therefrom.

14. (withdrawn) The analog data acquisition device of claim 2, wherein the analog source comprises a multimeter.

15. (previously presented) The analog data acquisition device of claim 2, wherein the analog source includes at least first and second transducers both of which are designed to transmit data.

16. (previously presented) The analog data acquisition device of claim 2, wherein the at least one parameter is consistent with the analog data acquisition device being responsive to a SCSI inquiry command.

17. (withdrawn) The analog data acquisition device of claim 2, wherein the analog

source is a medical device.

18. (previously presented) The analog data acquisition device of claim 2, wherein the processor is configured to cause acquired analog data file system information to be automatically sent to the multi-purpose interface after the at least one parameter has been sent to the multi-purpose interface of the computer, (a) without requiring any end user to load any software onto the computer at any time, and (b) without requiring any end user to interact with the computer to set up a file system in the analog data acquisition device at any time.

19. (previously presented) The analog data acquisition and interface device of claim 18, wherein the analog data acquisition device file system information comprises at least an indication of a file system type that is used to store the digitized analog data.

20. (previously presented) The analog data acquisition device of claim 2,
wherein the processor is configured to cause file allocation table information to be sent to the multipurpose interface,
wherein the processor is configured to cause a virtual boot sequence to be sent to the multipurpose interface which includes at least information that is representative of a number of sectors of a storage disk, and
wherein the file allocation table information includes at least a start location of a file allocation table.

21. (previously presented) The analog data acquisition device of claim 2, wherein the processor is configured to initiate a process by which the at least one file of digitized analog data is directly transferred to an input/output device.

22. (previously presented) The analog data acquisition device of claim 21, wherein the processor is configured to allow a mode of operation of the analog data acquisition device other than the transfer of at least some of the at least one file of digitized analog data to the multipurpose interface to be controlled by means of an external personal computer.

23. (withdrawn) The analog data acquisition device of claim 2, wherein the analog data acquisition device comprises at least a portion of a medical device.

24. (previously presented) The analog data acquisition device of claim 2, wherein the analog data is processed by being subject to a fast Fourier transform.

25. (withdrawn) The analog data acquisition device of claim 2 wherein the analog data acquisition device is designed so that both the data generation process and automatic file transfer, when they occur, take place only after the at least one parameter has been automatically sent.

26. (withdrawn) The analog data acquisition device of claim 2 wherein the data generation process and automatic data transfer of digitized analog data, when they occur, at least partially overlap in time.

27. (previously presented) The analog data acquisition device of claim 2, wherein the analog source is designed to receive signals from the computer.

28. (withdrawn) The analog data acquisition device of claim 2, wherein the analog data acquisition and interface device is designed so that at least one aspect of how the analog data acquisition device creates at least one file of digitized analog data can be controlled by means of commands that are issuable from a source external to the analog data acquisition device.

29. (withdrawn) The analog data acquisition device of claim 28, wherein the analog data acquisition device is designed so that the at least one aspect is controlled by means of a configuration file.

30. (previously presented) The analog data acquisition device of claim 2, wherein the analog data acquisition device is designed to be responsive to a test unit ready command.

31. (previously presented) The analog data acquisition device of claim 2 wherein the device driver is installed with the operating system.

32. (currently amended) An analog data acquisition and interface device for

interfacing to a host device which includes a mass storage device and associated device driver, comprising:

a processor configured to operatively interface with a memory, an analog source, and a multi-purpose interface of the host device;

wherein the processor is configured to control a data generation process by which analog data is acquired from the analog source, the analog data is processed and digitized, and the processed and digitized analog data is stored in the memory as digitized analog data;

wherein the processor is configured such that, when operatively interfaced with the multi-purpose interface, the processor causes at least one parameter identifying the analog data acquisition device as a digital mass storage device, instead of as an analog data acquisition device and regardless of the analog source, to be automatically sent to the multi-purpose interface of the host device; and

wherein the processor is configured to automatically transfer the digitized analog data acquired from the analog source to the host device in response to a digital mass storage device data read signal from the host device, in a manner that causes the analog data acquisition and interface device to appear to be the mass storage device, while using the device driver associated with the mass storage device to perform the automatic transfer without requiring any user-loaded file transfer enabling software to be loaded on or installed in the computer.

33. (withdrawn) An analog data acquisition and interface device for interfacing to a host device which includes a mass storage device and associated device driver, comprising:

a program memory;

a processor coupled to the program memory and configured to operatively

interface with a storage memory, an analog source, and a multi-purpose interface of the host device;

wherein the processor is configured to control a data generation process by which analog data is acquired from the analog source, the analog data is processed and digitized, and the processed and digitized analog data is stored in the memory as digitized analog data;

wherein the processor is configured such that, when operatively interfaced with the multi-purpose interface, the processor causes at least one parameter identifying the analog data acquisition device as a digital mass storage device instead of an analog data acquisition device and regardless of the analog source, to be automatically sent to the multi-purpose interface of the host device;

wherein the processor is configured to automatically transfer to the host device the digitized analog data acquired from the analog source, in a manner that causes the analog data acquisition and interface device to appear to be the mass storage device while using the device driver associated with the mass storage device to perform the automatic transfer; and

wherein the processor is configured to transmit to the host device commands to access a system bus of the host device to enable direct communications with other data devices of the host device while bypassing any host device processor.

34. (withdrawn) The analog data acquisition and interface device of claim 33, wherein the processor further comprises a plurality of independent analog data acquisition channels for simultaneously acquiring analog data in parallel from a plurality of analog sources.

35. (currently amended) A method for analog data acquisition and interfacing to a host device wherein the host device includes a device driver, comprising:

operatively interfacing a data acquisition device, including a processor and a memory, with a multi-purpose interface of the host device;

acquiring analog data from an analog source, processing and digitizing the analog data, and storing the processed and digitized analog data in the memory as digitized analog data under control of the processor;

automatically sending under control of the processor at least one parameter to the multi-purpose interface of the host device, the at least one parameter identifying the analog data acquisition device as a digital storage-device instead of as an analog data acquisition device, regardless of the analog source: and

automatically transferring data from the analog source to the host device at least some of the digitized analog data acquired from the analog source to the host device in response to a data request read command from the host device, in a manner that causes the analog data acquisition device to appear to be a digital storage-device instead of as an analog data acquisition device, while using the device driver to perform the automatic transfer of the acquired digitized analog data to the host device without requiring any user-loaded file transfer enabling software to be loaded on or installed in the host device.

36. (currently amended) The method of claim 35, further comprising simultaneously acquiring the analog data from each respective analog channel of a plurality of respective independent acquisition channels under control of the processor and acquiring analog data from the analog source time independent of transferring the acquired analog data to the host device.

REMARKS

Reconsideration and further examination of the subject patent application in view of the RCE submitted herewith and in view of the present Amendment and the following Remarks is respectfully requested. Claim 1 was previously cancelled, and claims 2-36 are pending, with claims 14, 17, 23, 25, 26, 28, 29, 33 and 34 are withdrawn from examination. Claims 2, 7, 14, 17, 18, 20, 23, 25, 26, 28, 29, 33 and 34 have been objected to for informalities. Claims 2-4, 6-10, 12, 15-16, 18-22, 27, 30-32 and 35 have been rejected under 35 U.S.C. §103(a) as being unpatentable over Hashimoto (U.S. Pat. No. 6,111,604), in view of Smith (U.S. Pat. No. 5,634,075), Ristelhueber (“Plug and Play is almost here”), and Shinohara (U.S. Pat. No. 5,742,934). Claims 5 and 13 have been rejected under 35 U.S.C. §103(a) as being unpatentable over Hashimoto, Smith, Ristelhueber and Shinohara, and further in view of Endo (U.S. Pat. No. 4,652,928), and Claim 24 has been rejected under 35 U.S.C. §103(a) as being unpatentable over Hashimoto, Smith, Ristelhueber, and Shinohara and further in view of Roberts (U.S. Pat. No. 5,576,757). Claims 11 and 36 have been rejected under 35 U.S.C. §103(a) as being unpatentable over Hashimoto, Smith, Ristelhueber, and Shinohara further in view of Nakamura (U.S. Pat. No. 6,278,492). Claims 2, 32, 35 and 36 have been amended. After careful review of the claims and references, it is believed that the claims are in allowable form and a Notice of Allowance if respectfully requested.

Independent claims 2, 32, 35 and 36 have been amended for clarification. Claim 32 has been amended to call for transfer of acquired analog data in response to a digital mass storage request signal from the host and claim 35 has been amended to call for transferring data from the

analog source to the host in response to a data read command (see, e.g. '399 patent, Col. 6, lines 60-67). Claim 36 has been amended to call for acquiring analog data time independent of transferring data to the host (see, e.g. '399 patent, Col. 10, lines 17-32)

Applicant respectfully reiterates his disagreement with the summary of the interview in the prior Office Action set out in the remarks in the last amendment particularly the attempt to reduce the claims to the "inventive concept". Applicant did not and does not agree with recharacterizing the claims to an inventive concept of the summary's indications of invention concepts. It is Applicant's position that the claims as they are set out define the invention, and that it is these claims which should be examined. Thus, Applicant respectfully requests that each claim of this application be examined as written and as a whole.

It is respectfully submitted that, the claims as amended are distinguishable over any combination of the cited references Hashimoto, Smith, Ristelhueber, Shinohara, Endo and Roberts. As such, it is respectfully submitted that the claims 2-36 are patentably distinguishable over all prior art of record.

The Office Action rejected claims 2-4, 6-10, 12, 15-16, 18-22, 27, 30-32, and 35 (which includes all the independent claims 2, 32, and 35) as obvious based on the combination of Hashimoto, Smith, Ristelhueber, and Shinohara. The Office Action asserts (Office Action, p. 23) that Hashimoto teaches a processor that executes at least one instruction set to establish communications with the computer in several passages in Cols. 1-14. However, Hashimoto in Cols 1-14 does not describe such execution of an instruction set to establish communication with the host computer as claimed. Rather, Hashimoto describes a circuit in which a processor 23 detects proper connection to a host circuit interface by monitoring the data terminal ready (DTR) signal of the RS-232 connection or another signal of similar function of another user

selected communications protocol (Hashimoto, Col. 10, lines 44-65; Fig. 4). When the signal from the communication interface is detected, a communication algorithm is set up in the camera to prepare the camera to transmit or receive information. Then the camera system detects whether a switch on the camera has been manually set to transmit or to receive to determine whether to transmit image data or receive data (Hashimoto, Col. 15, lines 3-16). Thus, Hashimoto merely describes a process for detection by the camera of an active connection by monitoring the interface. This detection process is not the process claimed which is a process in which the analog device processor executes instructions to cause a class identifying parameter (mis-indicative of the class of the device) to be sent to the host computer (i.e. automatically sends mis-identifying information to the host computer). Hashimoto merely describes a process performed by the peripheral which detects the peripheral's proper connection to a host interface, not a process performed by the host to identify a peripheral. Hashimoto's process (peripheral detecting its connection to host) is the opposite of the claimed process (host detects a class parameter sent from the peripheral). Thus, there is no description anywhere in Hashimoto of the claimed process of executing a set of instructions that sends a class identifying parameter to the host computer. Further, at the time of the Hashimoto disclosure, the user would load software and input information into the host computer to identify the camera. There was no requirement for or need for the camera CPU of Hashimoto to be involved in a process to identify itself to the host computer.

Similarly, neither Hashimoto nor any of the other cited references disclose a processor in the peripheral device involved in automatically sending a mis-identifying class parameter to the host computer. The Office Action concedes that Hashimoto does not teach automatically causing a class identifying parameter different than the class of the analog device to be sent as

claimed (Office Action; p. 24), but asserts that Smith teaches automatically sending the computer at least one parameter through the multipurpose port in figs. 2-5, and Col. 1-4, and Col. 6; and further asserts that by combining Hashimoto's analog data acquisition device architecture with Smith's Plug and Play functionality (Plug and Play refers to ISA PnP system bus technology referred to in both the Smith and Ristelhueber references) the combination further teaches this feature.

However, not only does Hashimoto not disclose automatic transmission of a class indicating parameter as discussed above, but Smith also fails to disclose this feature of automatically sending such class identification information. Smith describes Plug and Play systems as requiring the Plug and Play host computer to assign a "handle" (I.D. number) to each peripheral card and then the host computer reads resource data from the peripheral (see, e.g. Col. 4, lines 26-34; Col. 3, lines 41-59). Thus, the host computer in Smith assigns an identifying number rather than the peripheral processor automatically sending identification information. Then the host computer reads resource data from the peripheral (Smith, Col. 4, lines 26-28: "the operating system will isolate each PnP device assign a "handle" (number) to each card, and read the resource data from that card"). There is no description of automatic sending of class of device identification data. The Plug and Play process described in Smith or any other of the references is not concerned with recognizing the class of the device. It is not a device recognition process, rather it is a host computer resource allocation process concerned with allocation of the resources of the host computer to avoid conflicts between resources within the host. The host computer after supplying an I.D. merely performs a process of reading resource data and then allocating its resources to accommodate all the peripherals attached to it. There is no mention of identification information being read or sent. The cited

passages of Smith do not mention a peripheral processor automatically providing identification information to the host computer. Instead, the host computer initiates a “read” function to obtain resource data from the peripheral. Thus, the plug and play functionality of Smith does not teach or suggest the processor of the peripheral device automatically sending a class parameter to the host. Further, sending a mis-identifying class parameter would be contrary to the concept of plug and play, then teaching away from the claimed feature.

Smith also does not describe a peripheral having a processor involved in the Plug and Play process. The only Plug and Play peripheral device circuitry in Smith is shown in Figs. 6, 7, and 9 which show a circuit made up of registers, flips flops, etc. to allow the peripheral to configure upon power up to operate in legacy mode or plug or play mode. There is no peripheral processor described involved in automatic recognition of the peripheral by the host.

Further, the Plug and Play functionality of Smith is functionality which is primarily located in the host computer not the peripheral. The Plug and Play compatibility as implemented in the peripheral in Smith is merely a set of logic gates and registers (not a processor) to give the peripheral compatibility with the Plug and Play functionality of the host computer. Plug and Play functionality calls for the host computer to configure its resources according to the needs of all the peripherals attached to it and thus primarily concerns software or firmware supplied functions located in the host computer. Thus, it would not make sense to one skilled in the art to put these Plug and Play functions into the peripheral device which would have no use for them. The peripheral device is only going to connect to a host computer and thus does not need to allocate its resources to handle multiple Plug and Play devices. In addition, as discussed above, neither Hashimoto nor Smith teach automatically sending identification information.

The Office Action also suggests that the combination of Smith's Plug and Play functionality into Hashimoto's analog data acquisition device architecture would be obvious to one of ordinary skill in the art because it would simplify the installation for the user without the need to install software or configure the peripheral devices. However, Smith expressly teaches the contrary, that a device driver must be loaded once the peripherals have been set up and host computer resources assigned (see e.g., Smith, Fig. 2, ref. 126 and Col. 4 lines 32-33).

The Office Action asserts that Ristelhueber at pages 1-3 teaches a peripheral device whereby there is no requirement for any user-loaded file transfer software to be loaded on the computer in addition to the operating system (Office Action, p. 25). Ristelhueber, however, is a non-technical buyer magazine article which generically describes a future Plug and Play standard with an enthusiastic description of the future ("In about a year the key standard and specifications will be in place to make PnP a reality", p. 1, paragraph 3). Thus, Ristelhueber is not enabling prior art. Ristelhueber is relied upon for disclosure of Plug and Play functionality. The Office Action appears to rely on vague predictions in Ristelhueber regarding recognition of new hardware, and configuring of hardware to relieve the user of the need to fumble with floppy disks and user manuals to get the device up and running. However, when read in context these phrases are predicting PnP will recognize that a new device is connected. The author is not describing recognizing what peripheral is attached, only whether there is a peripheral attached to the port. Further, there is no enabling disclosure of how such recognition would one day be implemented. The description in Ristelhueber is just an over enthusiastic prediction of the hoped for goals for PnP, which is to detect when a new device is attached (i.e. identifying presence not what it is), configure the host computer resources to accommodate it, and then activate the device. However, Ristelhueber nowhere discusses or even mentions

device drivers, or what will happen after a device is configured and activated. As discussed herein, the Smith reference and the PnP Standards Specification make clear that a device driver is still needed after the peripheral has been detected, assigned resources, and activated in accordance with Plug and Play.

In addition, there is no teaching in Ristelhueber of the processor of the peripheral automatically sending identification information to the computer, or of anything done or not done by a processor of a Plug and Play peripheral device. Ristelhueber merely describes the host computer determining the presence of a peripheral device, identifying the resources needed by the peripheral device and configuring its hardware thereby relieving the user from having to do so. There is no teaching in Ristelhueber to relieve the user from having to load a device driver. There is no mention of a processor on the peripheral, and no mention of the need or lack of need for user loaded software on the host computer. Thus, Ristelhueber does not disclose this claimed feature. Rather, Ristelhueber merely broadly describes future Plug and Play hopes without discussing device driver software for proper functioning of the peripheral after it is activated. As discussed above, the Plug and Play still requires loading a device driver after the peripheral device has been activated using a Plug and Play process. Thus, Ristelhueber does not teach a peripheral device which doesn't require an end user to load software onto the computer at anytime and none of the other cited references teach this feature. Therefore, all pending claims are distinguishable over the cited references on this ground as well.

The Office Action also asserts that Shinohara teaches sending a class of devices parameter wherein the analog data acquisition device is not within the class, and teaches transferring acquired analog data to the computer using the device driver of the class so that the analog device appears as if it is a device of the class at Col 1, lines 48-60, and Col 3, lines 3 to

Col 4, line 49. Shinohara describes a flash disk drive which couples only to a host computer to allow the host computer to send data for storage and retrieve the data stored by the host computer. This is entirely different from the claimed analog data acquisition device which acquires analog data from analog sources through a first port, and provides for transfer of the digitized analog data to a separate host computer through a second port. Therefore, the environment and functionality, and the problems to be resolved are completely different, and it would thus not be obvious to combine the Shinohara flash disk drive features with Hashimoto, and because of these fundamental differences, Shinohara is not compatible with Hashimoto.

Moreover, the combination (even if considered somehow together) still would not end up meeting the terms of the claims. Shinohara merely describes how the host computer sends data and sets up the data structure in the flash disk drive but does not teach or even mention that there is no need for user interaction to set up a file system, or that the device is not identified as an analog data acquisition device and is identified instead as a digital mass storage device. Shinohara is merely a mass storage device acting as a mass storage device. Further, the data structure set up would require software on the host computer to perform these set-up functions. Thus, additional software must be added to the host computer to set up the data structure for the flash drive. Further, since Shinohara is merely a hard disk emulator connected to a computer, it cannot cause and not teach or suggest analog data acquired from an analog source to be transferred to a computer (i.e., there is only digital data stored by the host computer). Since Hashimoto, Smith, Kerigan, and Ristelhueber do not teach the automatic process of identifying an analog data acquisition device as some other device and Shinohara also does not teach this feature, all pending claims are distinguishable over the cited references.

Further, none of the references disclose an analog device which acquires and processes

analog data but operates and identifies itself as a digital storage device. Shinohara discloses a mass storage device (i.e. a flash memory) which operates as a mass storage device. This teaching of Shinohara does not suggest to one of ordinary skill in the art the operation and identification of an analog data acquisition device as an entirely different type of device, i.e. a mass storage device, and does not suggest a device which sends an identifying parameter to the host computer identifying the device as a device of dramatically different type than what it actually is. Thus the claims are further distinguishable over the cited references for this reason in addition to the reasons discussed herein above.

The Office Action further asserts that Shinohara teaches a system and a method comprising data transferring using a device driver for the identified class of device while causing the analog data acquisition device to appear to the computer as if it were a device of the identified class without requiring any user-loaded file transfer enabling software to be loaded on or installed in the computer at anytime at Col. 1 lines 48-60 and Col. 3, line 33 to Col. 4, line 49 (Office Action, p. 18). The Office Action alleges that by combining the emulation of a mass storage device of Shinohara with the data transferring Plug and Play functionality of the combined other references, the resulting combination would teach this feature.

However, this is not the case because Shinohara merely describes an approach to extending the life of the flash memory in a flash disk drive. Shinohara at the cited Col. 1, line 48-60 merely describes a flash disk memory which can erase and write data in a unit sector of a flash memory to emulate a hard disk, where the host computer erases and writes a sector designated by the host computer so an address conversion table is not needed and also describes a disk operating system. There is no mention of device drivers, no mention of not needing to load file transfer enabling software. Similarly Col. 3, line 33 to Col. 4, line 49 of Shinohara

merely describes details of the flash disk which can cause the flash memory to last for a longer time using an address conversion table. However, nowhere in Shinohara is there any mention of transferring a file of digitized analog data (Shinohara is a disk drive, as such, it cannot acquire and digitize analog data and therefore cannot transfer it), or any data, without requiring any user loaded file transfer enabling software. Rather, the detailed description cited calls for the host computer to perform unique file management functions (Col. 4, lines 34-49) which would require data transfer software in the host computer to set up the disk emulation. Further, there is no teaching or mention of the disclosed disk emulator being able to transfer data without data-transfer software loaded on the host computer. The Shinohara reference is devoid of any such teaching. Thus, Shinohara does not teach the feature of transferring digitized analog data without requiring any user loaded file transfer enabling software.

The Office Action also asserts that combining the flash memory device of Shinohara with the Plug and Play functionality of the other references such as Smith, teaches this feature. However, as discussed above, Plug and Play is concerned with allocation of the resources of the host computer to avoid conflicts between resources within the host computer. In Plug and Play, the host computer reads the resource requirements from each attached peripheral, such resources as i/o addresses, interrupts levels, and DMA channels, (see, Smith, Col. 3, lines 1-4; also see Plug and Play ISA Specification, Version 1.0a, May 5, 1994 (“Plug and Play Specification”) p.1, abstract, line 5, and lines 9-11). The computer then assigns to each peripheral device the necessary resources so as to avoid resource conflicts (see Smith, Col. 4, lines 25-32; and Plug and Play Spec. p.1, lines 11-12). Once the host computer has assigned its resources and activated the device, an appropriate device driver must then be loaded to permit operation. As described in Smith, Col. 4, lines 26-33 in a PnP (Plug and Play) system:

“...the operating system will isolate each PNP device, assign a ‘handle’ (number) to each card, and read the resource data from that card. Once each card had been isolated, assigned a handle and read, the operating system software will arbitrate system resources for all PNP devices. Conflict-free resources may then be assigned and the devices activated. Finally, appropriate device drivers may be loaded and the system thus configured.”

Also see Plug and Play Spec. p.1, Abstract, and Smith, Col. 3, lines 52-59. The Plug and Play process thus does not eliminate the need to supply a driver but rather calls for loading the driver after the system resources are allocated and the devices activated. The Plug and Play standard does not address device drivers other than the fact that one is needed. (Plug and Play Specification p. 1 Abstract: “However, user interface issues for installation of device drivers are not addressed”.) Thus, even with Plug and Play, a device specific driver is still needed for each peripheral installed in the Plug and Play computer system in order for the peripheral’s processor to execute an instruction to automatically transfer a file of digitized analog data to the computer from the peripheral device. This is clearly demonstrated by the Smith reference and the Plug and Play Specification document. Thus, neither Shinohara nor the Plug and Play functionality disclosed in the other cited references teach data transfer without a user loaded driver.

Moreover, the device described in Shinohara is merely a memory for storage of digital data by a host computer and for retrieval of that data by the host computer, and thus is not suitable for receiving analog data from a source independent of the host computer nor for transferring acquired digitized analog data to a host computer. Further, Shinohara does not teach transferring the acquired analog data while causing the analog data acquisition device to appear to the computer as a digital storage device, as claimed. The Shinohara device has one port that merely receives and stores digital data from the computer and allows that same computer to retrieve that stored data through the same port. The claimed invention has two

separate ports providing input of analog data on one port and subsequent transfer of digitized analog data to a computer on another port. Thus, the disk memory emulation of Shinohara is dramatically different from the claimed invention and not compatible with or combinable with Hashimoto to obtain the claimed invention. Further, Shinohara and the other references do not teach or suggest transfer of data from the analog source to the host in response to a data read signal from the host as now claimed in claim 32 and 35, and acquiring analog data time independent of transferring the acquired data as now claimed in claim 36.

Stated another way, at most Shinohara merely teaches that a digital memory device having a single read/write port such as a flash memory, may be configured to emulate another digital memory device. This does not suggest, and is not related to, an analog data acquisition device having both an analog input and a host computer interface port which can emulate a hard disk. Thus, the combination of Shinohara with the other references does not teach or suggest the claimed automatic file transfer of acquired digitized analog data without requiring user loaded file transfer enabling software. Indeed, there is nothing to suggest the advantage of not requiring user loaded file transfer enabling software in any device, let alone in an analog data acquisition device.

Accordingly, it is respectfully submitted that all the pending claims are distinguishable over the cited references because none of the references teaches the claimed transfer of a file of acquired digitized analog data by an analog data acquisition device while appearing to be another class of device without loading file transfer enabling software. That is, even if all the references could somehow be combined (which they cannot, as explained hereinafter), the result would still not meet the combined limitations of the claims.

In addition to the lack of disclosure of the claimed feature discussed hereinabove,

Hashimoto and Smith are incompatible and cannot be properly combined. As previously discussed, Hashimoto detects that it is properly connected to a host computer interface by monitoring for a DTR signal. Until the DTR signal is detected, the power to the communication circuitry is turned off or in standby mode (Hashimoto, Col. 12, lines 62 to Col. 13, lines 8). After detecting the proper connection and activating the communication circuitry, Hashimoto checks a switch 110 which is manually set by the camera user, to determine whether it is in the transmit mode or is in a receive mode. (Hashimoto, Fig. 14, Ref. No. 308; Col. 10, lines 51-54 and Col. 11, lines 7-13). Thus, at any point in time, the Hashimoto camera is enabled to only transmit, or only receive; it is not enabled to do both. The user must manually switch between modes. Smith, however, describes a Plug and Play process which requires the host computer to read resource data from the PnP peripheral device (see e.g. Smith, Col. 3, lines 41-43; Col. 4, lines 25-28). This read function requires the peripheral to receive a read request, which would include an address, and then requires the peripheral to transmit the resource data to the host computer. Thus, Smith's Plug and Play (and PnP in general) cannot be added to Hashimoto because the Hashimoto camera cannot both transmit and receive data at any one moment. If the mode switch in the Hashimoto camera is in the transmit position, then the camera would not be able to receive the read request and address, and if the mode switch is in the receive position, the camera would not be able to transmit the resource data. Thus, Hashimoto and Smith, are incompatible and cannot properly be combined. This is also true of Plug and Play in general.

In a further inconsistency, the rejection assumes that Plug and Play calls for the peripheral device to identify itself (although, as discussed above, this is not disclosed in the references). This assumption would inherently call for the device to correctly identify itself

which is contrary to the claim requirement that the class parameter sent to the host computer identify a different class of device. Thus, the references cannot be properly combined to render the claim obvious.

The combination of Hashimoto and Shinohara is also improper. Hashimoto describes an electronic camera while Shinohara describes a flash disk drive. The Office Action combines Shinohara with Hashimoto by converting the Hashimoto camera to a disk drive emulator, thereby dramatically changing the fundamental structure, operation, and purpose of Hashimoto. Shinohara is merely a digital memory device having a single port to receive digital data from a computer for storage and to allow the same computer to retrieve that data through the same port. In other words, Shinohara merely teaches that a single port digital memory device can be configured to emulate a hard disk. This does not teach or suggest an analog data acquisition device having both an analog input and a separate host computer interface port emulating a hard disk. It is a huge inventive step to go from a digital mass storage device emulating a digital mass storage device to an analog device emulating a digital mass storage device. Thus, the combination requires improper hindsight based on the teachings of the instant application and therefore, Hashimoto and Shinohara cannot be properly combined.

In addition, as discussed above, Hashimoto operates in a transmit only mode or a receive only mode selected by the user with a mode selection switch. However, to function properly the Shinohara flash disk requires the host computer to read data from it. This is incompatible with Hashimoto one way communication, because the read function requires that the flash memory receive a read request with the address or sectors of the data requested, followed by an immediate transmission of the data. Hashimoto's one way communication would prevent this two way exchange. Thus, Shinohara is incompatible and not properly

combinable with Hashimoto for this reason as well.

In view of the foregoing, applicant submits that claims 2-13, 15, 16, 18-22, 24, 27, 30-32, 35 and 36 are patentable over Hashimoto in view of the combined teachings of Smith, Ristelhueber, Roberts, Endo, Nakamura, and Shinohara. Accordingly, applicant respectfully submits that the instant application is in condition for allowance, and a Notice of Allowance is respectfully requested. Should the Examiner be of the opinion that a telephone conference would expedite prosecution of the subject application, the Primary Examiner is respectfully requested to call the undersigned at the below-listed number.

The Commissioner is hereby authorized to charge any additional fee which may be required for this application under 37 C.F.R. §§ 1.16-1.18, including but not limited to the extension of time fee, RCE fee, petition fee, extra claims fee, the issue fee, or credit any overpayment, to Deposit Account No. 23-0920. Should no proper amount be enclosed herewith, as by a check being in the wrong amount, unsigned, post-dated, otherwise improper or informal, or even entirely missing, the Commissioner is authorized to charge the unpaid amount to Deposit Account No. 23-0920.

Respectfully submitted,

HUSCH BLACKWELL LLP

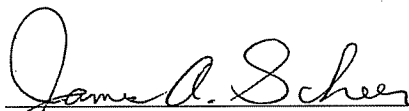
By: 
James A. Scheer
Registration No. 29,434

Dated: October 29, 2012

HUSCH BLACKWELL LLP
120 South Riverside Plaza, 22nd Floor
Chicago, Illinois 60606
(312) 655-1500

Under the Paperwork Reduction Act of 1995, no persons are required to respond to a collection of information unless it displays a valid OMB control number.

PETITION FOR EXTENSION OF TIME UNDER 37 CFR 1.136(a)	Docket Number (Optional) 113189
Application Number 12/891,443	Filed September 27, 2010
For AN ANALOG DATA GENERATING AND PROCESSING DEVICE FOR USE WITH A PERSONAL COMPUTER	
Art Unit 2181	Examiner Lee, Chun K.

This is a request under the provisions of 37 CFR 1.136(a) to extend the period for filing a reply in the above identified application.

The requested extension and fee are as follows (check time period desired and enter the appropriate fee below):

	<u>Fee</u>	<u>Small Entity Fee</u>	
<input type="checkbox"/> One month (37 CFR 1.17(a)(1))	\$150	\$75	\$ _____
<input type="checkbox"/> Two month (37 CFR 1.17(a)(2))	\$560	\$280	\$ _____
<input checked="" type="checkbox"/> Three month (37 CFR 1.17(a)(3))	\$1270	\$635	\$ <u>1270.00</u>
<input type="checkbox"/> Four month (37 CFR 1.17(a)(4))	\$1980	\$990	\$ _____
<input type="checkbox"/> Five month (37 CFR 1.17(a)(5))	\$2690	\$1345	\$ _____

- Applicant claims small entity status. See 37 CFR 1.27.
- A check in the amount of the fee is enclosed.
- Payment by credit card. Form PTO-2038 is attached.
- The Director has already been authorized to charge fees in this application to a Deposit Account.
- The Director is hereby authorized to charge any fees which may be required, or credit any overpayment, to Deposit Account Number - **23-0920**.

WARNING: Information on this form may become public. Credit card information should not be included on this form. Provide credit card information and authorization on PTO-2038.

- I am the
- applicant/inventor.
 - assignee of record of the entire interest. See 37 CFR 3.71.
Statement under 37 CFR 3.73(b) is enclosed (Form PTO/SB/96).
 - attorney or agent of record. Registration number **29434**.
 - attorney or agent acting under 37 CFR 1.34.
Registration number if acting under 37 CFR 1.34. _____

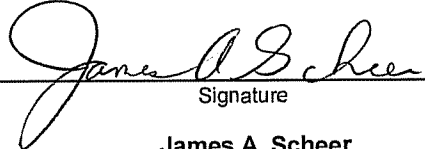

 Signature
James A. Scheer
 Type or printed name

October 29, 2012

 Date
312-655-1500

 Telephone Number

NOTE: Signatures of all the inventors or assignees of record of the entire interest or their representative(s) are required. Submit multiple forms if more than one signature is required, see below.

Total of **1** forms are submitted.

This collection of information is required by 37 CFR 1.136(a). The information is required to obtain or retain a benefit by the public which is to file (and by the USPTO to process) an application. Confidentiality is governed by 35 U.S.C. 122 and 37 CFR 1.11 and 1.14. This collection is estimated to take 6 minutes to complete, including gathering, preparing, and submitting the completed application form to the USPTO. Time will vary depending upon the individual case. Any comments on the amount of time you require to complete this form and/or suggestions for reducing this burden, should be sent to the Chief Information Officer, U.S. Patent and Trademark Office, U.S. Department of Commerce, P.O. Box 1450, Alexandria, VA 22313-1450. DO NOT SEND FEES OR COMPLETED FORMS TO THIS ADDRESS. SEND TO: Commissioner for Patents, P.O. Box 1450, Alexandria, VA 22313-1450.
 If you need assistance in completing the form, call 1-800-PTO-9199 and select option 2.

Under the Paperwork Reduction Act of 1995, no persons are required to respond to a collection of information unless it displays a valid OMB control number.

PATENT APPLICATION FEE DETERMINATION RECORD Substitute for Form PTO-875	Application or Docket Number 12/891,443	Filing Date 09/27/2010	<input type="checkbox"/> To be Mailed
-----------------------------------------------------------------------------------	---------------------------------------------------	----------------------------------	---------------------------------------

APPLICATION AS FILED – PART I			OTHER THAN SMALL ENTITY			
	(Column 1)	(Column 2)	SMALL ENTITY <input type="checkbox"/>	OR		
FOR	NUMBER FILED	NUMBER EXTRA	RATE (\$)	FEE (\$)	RATE (\$)	FEE (\$)
<input type="checkbox"/> BASIC FEE <small>(37 CFR 1.16(a), (b), or (c))</small>	N/A	N/A	N/A		N/A	
<input type="checkbox"/> SEARCH FEE <small>(37 CFR 1.16(k), (j), or (m))</small>	N/A	N/A	N/A		N/A	
<input type="checkbox"/> EXAMINATION FEE <small>(37 CFR 1.16(o), (p), or (q))</small>	N/A	N/A	N/A		N/A	
TOTAL CLAIMS <small>(37 CFR 1.16(j))</small>	minus 20 =	*	X \$ =	OR	X \$ =	
INDEPENDENT CLAIMS <small>(37 CFR 1.16(h))</small>	minus 3 =	*	X \$ =		X \$ =	
<input type="checkbox"/> APPLICATION SIZE FEE <small>(37 CFR 1.16(s))</small>	If the specification and drawings exceed 100 sheets of paper, the application size fee due is \$250 (\$125 for small entity) for each additional 50 sheets or fraction thereof. See 35 U.S.C. 41(a)(1)(G) and 37 CFR 1.16(s).					
<input type="checkbox"/> MULTIPLE DEPENDENT CLAIM PRESENT <small>(37 CFR 1.16(j))</small>						
			TOTAL		TOTAL	

* If the difference in column 1 is less than zero, enter "0" in column 2.

APPLICATION AS AMENDED – PART II					OTHER THAN SMALL ENTITY			
	(Column 1)	(Column 2)	(Column 3)					
AMENDMENT	10/29/2012	CLAIMS REMAINING AFTER AMENDMENT	HIGHEST NUMBER PREVIOUSLY PAID FOR	PRESENT EXTRA	RATE (\$)	ADDITIONAL FEE (\$)	RATE (\$)	ADDITIONAL FEE (\$)
	Total <small>(37 CFR 1.16(i))</small>	* 35	Minus ** 35	= 0	X \$ =		OR	X \$62= 0
	Independent <small>(37 CFR 1.16(h))</small>	* 4	Minus ***4	= 0	X \$ =		OR	X \$250= 0
	<input type="checkbox"/> Application Size Fee <small>(37 CFR 1.16(s))</small>						OR	
	<input type="checkbox"/> FIRST PRESENTATION OF MULTIPLE DEPENDENT CLAIM <small>(37 CFR 1.16(j))</small>						OR	
					TOTAL ADD'L FEE		OR	TOTAL ADD'L FEE
							OR	0

	(Column 1)	(Column 2)	(Column 3)					
AMENDMENT		CLAIMS REMAINING AFTER AMENDMENT	HIGHEST NUMBER PREVIOUSLY PAID FOR	PRESENT EXTRA	RATE (\$)	ADDITIONAL FEE (\$)	RATE (\$)	ADDITIONAL FEE (\$)
	Total <small>(37 CFR 1.16(i))</small>	*	Minus **	=	X \$ =		OR	X \$ =
	Independent <small>(37 CFR 1.16(h))</small>	*	Minus ***	=	X \$ =		OR	X \$ =
	<input type="checkbox"/> Application Size Fee <small>(37 CFR 1.16(s))</small>						OR	
	<input type="checkbox"/> FIRST PRESENTATION OF MULTIPLE DEPENDENT CLAIM <small>(37 CFR 1.16(j))</small>						OR	
					TOTAL ADD'L FEE		OR	TOTAL ADD'L FEE
							OR	

* If the entry in column 1 is less than the entry in column 2, write "0" in column 3.
 ** If the "Highest Number Previously Paid For" IN THIS SPACE is less than 20, enter "20".
 *** If the "Highest Number Previously Paid For" IN THIS SPACE is less than 3, enter "3".

Legal Instrument Examiner:
 /FREDERICK BRISCOE/

The "Highest Number Previously Paid For" (Total or Independent) is the highest number found in the appropriate box in column 1.

This collection of information is required by 37 CFR 1.16. The information is required to obtain or retain a benefit by the public which is to file (and by the USPTO to process) an application. Confidentiality is governed by 35 U.S.C. 122 and 37 CFR 1.14. This collection is estimated to take 12 minutes to complete, including gathering, preparing, and submitting the completed application form to the USPTO. Time will vary depending upon the individual case. Any comments on the amount of time you require to complete this form and/or suggestions for reducing this burden, should be sent to the Chief Information Officer, U.S. Patent and Trademark Office, U.S. Department of Commerce, P.O. Box 1450, Alexandria, VA 22313-1450. DO NOT SEND FEES OR COMPLETED FORMS TO THIS ADDRESS. **SEND TO: Commissioner for Patents, P.O. Box 1450, Alexandria, VA 22313-1450.**

If you need assistance in completing the form, call 1-800-PTO-9199 and select option 2.



UNITED STATES PATENT AND TRADEMARK OFFICE

UNITED STATES DEPARTMENT OF COMMERCE
United States Patent and Trademark Office
Address: COMMISSIONER FOR PATENTS
P.O. Box 1450
Alexandria, Virginia 22313-1450
www.uspto.gov

APPLICATION NO.	FILING DATE	FIRST NAMED INVENTOR	ATTORNEY DOCKET NO.	CONFIRMATION NO.
12/891,443	09/27/2010	Michael Tasler	0757-113189	1408
24628	7590	04/27/2012	EXAMINER	
Husch Blackwell LLP Husch Blackwell Sanders LLP Welsh & Katz 120 S RIVERSIDE PLAZA 22ND FLOOR CHICAGO, IL 60606			LEE, CHUN KUAN	
			ART UNIT	PAPER NUMBER
			2181	
			MAIL DATE	DELIVERY MODE
			04/27/2012	PAPER

Please find below and/or attached an Office communication concerning this application or proceeding.

The time period for reply, if any, is set in the attached communication.

DETAILED ACTION

RESPONSE TO ARGUMENTS

1. Applicant's arguments filed 12/28/2011 have been fully considered but they are not persuasive. Currently, claims 14, 17, 23, 25, 26, 28-29 and 33-34 are withdrawn and claims 2-13, 15-16, 18-22, 24, 27, 30-32 and 35-36 are pending for examination.
2. In response to applicant's comment with regard to the telephone interview conducted on July 12, 2011 that Applicant respectfully disagrees with the summary of the interview particularly the attempt to reduce the claims to the "inventive concept". The summary states that Applicant indicated an inventive concept with regard to claims of another application. However, these claims are not believed to be relevant as they concern another application and invention. Applicant would like to clarify that much of the interview was merely a discussion to help the understanding of the examiner, but that applicant still relies on the claims as written and as a whole, and does not agree with reducing the claim to an inventive concept. The summary also refers to "the informing for such file transfer characteristics...". Applicant does not understand this statement and therefore disagrees. In addition, the summary states that agreement was reached with regard to "the inventive concept for the instant application." Applicant respectfully disagrees. Applicant did not and does not agree with recharaterizing the claims to an inventive concept of the summary's indications of invention concepts. It is Applicant's position that the claims as they are set out define the invention, and that it is

Art Unit: 2181

these claims which should be examined. Thus, Applicant respectfully requests that each claim of this application be examined as written and as a whole.

As indicated in the interview summary, "... the inventive concept for the instant application is the claims ..." and the explanation with regard to the function of the inventive concept in the interview summary is a clear exemplary interpretation regarding on how the claims can be envisioned; therefore, the examiner is examining each claims as written and as a whole based on the examiner's best understanding on how the claims can be interpreted. If the interpretation is erroneous in any way, the examiner welcomes the applicant's clarification in the subsequent response, as the applicant currently do not offer how the examiner's interpretation of the claims are inaccurate and what is the correct interpretation of the claims.

Additionally, the examiner clearly understood that the summary for the inventive concept regarding to claims of another application (11/467,092) is relevant to the instant application as the examiner did inquire as to how this application differ from the copending application 11/467,092, wherein the applicant indicted that the claims for the instant application are broader as the independent claims for the instant do not require the multiple parallel channels and that the instant application is basically the same concept as the copending application 11/467,092. Furthermore, this was part of the examiner's rational for the double patenting rejection between the instant application and the copending application 11/467,092.

Additionally, with regard to the "... file transfer characteristic ...," applicant's was trying to explain the difference in limitation between the co-pending application

Art Unit: 2181

11/467,092 and the instant application, wherein the "... file transfer characteristic ..." is a claimed limitation of the co-pending application 11/467,092 and not in the instant application. Furthermore, to further clarify, based on the applicant's clarification during the interview conducted on July 12, 2011, "... the information for such file transfer characteristic ..." is part of the process for the host to recognize the connected as a hard drive but it is not necessary/require step, wherein this is one of the embodiments described in the specification.

3. In response to applicant's plurality of arguments with regard to the independent claims 2, 32 and 35 rejected under 35 U.S.C. 103(a) that the resulting combination of the references does not teach/suggest applicant's inventive concept because of the following:

- Hashimoto does not describe execution of an instruction set to establish communication with the host computer as claimed because Hashimoto merely describes a process for detection by the camera of an active connection by monitoring for a signal from the interface, and not the process claimed which is a process in which the analog device processor executes instructions to cause a class identifying parameter (mis-indicative of the class of the device) to be sent to the host computer (i.e. automatically sends mis-identifying information to the host computer);

Art Unit: 2181

- there is no description anywhere in Hashimoto of the claimed process of executing a set of instructions that sends a class identifying parameter to the host computer;
- at the time of the Hashimoto disclosure, the user would load software and input information into the host computer to identify the camera and there was no requirement for the camera CPU to be involved in a process to identify itself to the host computer;
- neither Hashimoto nor any of the other cited references disclose a processor in the peripheral device involved in automatically sending a mis-identifying class parameter/information to the host computer because host computer in Smith's Plug and Play functionality assigns an identifying number rather than the peripheral processor automatically sending identification information; therefore Smith do not disclose automatic sending of identification (i.e. a host computer resource allocation process concerned with allocation of the resources of the host computer to avoid conflicts between resources within the host and not device recognition process), Smith does not mention of identification information being read or sent and Smith does not even mention a peripheral processor automatically providing identification information to the host computer
- Smith also does not describe a peripheral having a processor involved in the Plug and Play process;

Art Unit: 2181

- the Plug and Play functionality of Smith is functionality which is primarily located in the host computer not the peripheral. The Plug and Play compatibility as implemented in the peripheral in Smith is merely a set of logic gates and registers (not a processor) to give the peripheral compatibility with the Plug and Play functionality of the host computer. Plug and Play functionality calls for the host computer to configure its resources according to the needs of all the peripherals attached to it and thus primarily concerns software or firmware supplied functions located in the host computer. Thus, it would not make sense to one skilled in the art to put these Plug and Play functions into the peripheral device which would have no use for them. The peripheral device is only going to connect to a host computer and thus does not need to allocate its resources to handle multiple Plug and Play devices;
- Smith expressly teaches the contrary, that a device driver must be loaded once the peripherals have been set up and host computer resources assigned (see e.g., Smith, Fig. 2, ref. 126 and Col. 4 lines 32-33);
- Ristelhueber do not describes a peripheral device whereby there is no requirement for any user-loaded file transfer software to be loaded on the computer in addition to the operating system because Ristelhueber is a non-technical buyer magazine article which generically describes a future Plug and Play standard with an enthusiastic description of the future ("In about a year the key standard and specifications will be in place to make PnP a reality", p. 1, paragraph 3); thus, Ristelhueber is not enabling prior art; Ristelhueber is not

Art Unit: 2181

describing recognizing what peripheral is attached, only whether there is a peripheral attached to the port; further, there is no enabling disclosure of how such recognition would one day be implemented; the description in Ristelhueber is just an over enthusiastic prediction of the hoped for goals for PnP, which is to detect when a new device is attached (i.e. identifying presence not what it is), configure the host computer resources to accommodate it, and then activate the device; however, Ristelhueber nowhere discusses or even mentions device drivers, or what will happen after a device is configured and activated. The Smith reference and the PnP Standards Specification make clear that a device driver is still needed after the peripheral has been detected, assigned resources and activated in accordance with Plug and Play; furthermore, there is no teaching in Ristelhueber to relieve the user from having to load a device driver, there is no mention of a processor on the peripheral, and there is no mention of the need or lack of need for user loaded software on the host computer;

- the environment and functionality, and the problems to be resolved in

Shinohara are completely different to Hashimoto; therefore, it would not be obvious to combine the Shinohara's flash disk drive features with Hashimoto because of these fundamental differences; Shinohara does not teach or even mention that there is no need for user interaction to set up a file system, or that the device is not identified as an analog data generating and processing device and is identified instead as a digital mass storage device; Shinohara is merely a

Art Unit: 2181

mass storage device acting as a mass storage device; further, the data structure set up would require software on the host computer to perform these set-up functions; thus, additional software must be added to the host computer to set up the data structure for the flash drive; further, since Shinohara is merely a hard disk emulator connected to a computer, it cannot cause an acquired file of digitized analog data acquired from a analog source to be transferred (i.e., there is only digital data stored by the host computer); and the teaching of Shinohara does not suggest to one of ordinary skill in the art the operation and identification of an analog data acquisition device as an entirely different type of device, i.e. a mass storage device, and does not suggest a device which sends an identifying parameter to the host computer identifying the device as a device of dramatically different type than what it actually is;

- Shinohara merely describes an approach to extending the life of the flash memory in a flash disk drive, and there is no mention of device drivers or no mention of not needing to load file transfer enabling software by Shinohara; nowhere in Shinohara is there any mention of transferring a file of digitized analog data (Shinohara is a disk driver, as such, it cannot acquire and digitize analog data and therefore cannot transfer it), or any data, without requiring any user loaded file transfer enabling software; rather, the detailed description cited calls for the host computer to perform unique file management functions (Col. 4, lines 34-49) which would require data transfer software in the host computer to set up the disk emulation; further, there is no teaching or mention of the

Art Unit: 2181

disclosed disk emulator being able to transfer data without data-transfer software loaded on the host computer; thus, Shinohara does not teach the feature of transferring digitized analog data without requiring any user loaded file transfer enabling software; the Office Action also asserts that combining the flash memory device of Shinohara with the Plug and Play functionality of the other references such as Smith, teaches this feature; however, as discussed above, Plug and Play is concerned with allocation of the resources of the host computer to avoid conflicts between resources within the host computer; the Plug and Play process thus does not eliminate the need to supply a driver but rather calls for loading the driver after the system resources are allocated and the devices activated; the Plug and Play standard does not address device drivers other than the fact that one is needed. (Plug and Play Specification p. 1 Abstract: "However, user interface issues for installation of device drivers are not addressed";) thus, even with Plug and Play, a device specific driver is still needed for each peripheral installed in the Plug and Play computer system in order for the peripheral's processor to execute an instruction to automatically transfer a file of digitized analog data to the computer from the peripheral device; this is clearly demonstrated by the Smith reference and the Plug and Play Specification document; thus, neither Shinohara nor the Plug and Play functionality disclosed in the other cited references teach data transfer without a user loaded driver;

Art Unit: 2181

- the device described in Shinohara is merely a memory for storage of digital data by a host computer and for retrieval of that data by the host computer, and thus is not suitable for receiving analog data from a source independent of the host computer nor for transferring acquiring digitized analog data to a host computer; further, Shinohara does not teach transferring the acquired analog data while causing the analog data generating and processing device to appear to the computer as a digital storage device, as claimed; the Shinohara device has one port that merely receives and stores digital data from the computer and allows that same computer to retrieve that stored data through the same port; the claimed invention has two separate ports providing input of analog data on one port and subsequent transfer of digitized analog data to a computer on another port; thus, the disk memory emulation of Shinohara is dramatically different from the claimed invention and not compatible with or combinable with Hashimoto to obtain the claimed invention; stated another way, at most Shinohara merely teaches that a digital memory device having a single read/write port such as a flash memory, may be configured to emulate another digital memory device; this does not teach and is not related to an analog data acquisition device having both an analog input and a host computer interface port which can emulate a hard disk; thus, the combination of Shinohara with the other references does not teach or suggest the claimed automatic file transfer of acquired digitized analog data without requiring user loaded file transfer enabling software; indeed, there is nothing to suggest the advantage of not

Art Unit: 2181

requiring user loaded file transfer enabling software in any device, let alone in an analog data acquisition device;

- Hashimoto and Smith are incompatible and cannot be properly combined, because Hashimoto describes checking a switch 110 which is manually set by the camera user, to determine whether it is in the transmit mode or is in a receive mode and Smith describes a Plug and Play process which requires the host computer to read and write data between the PnP peripheral device and the host computer;
- the rejection assumes that Plug and Play calls for the peripheral device to identify itself (although, as discussed above, this is not disclosed in the references). This assumption would inherently call for the device to correctly identify itself which is contrary to the claim requirement that the class parameter sent to the host computer identify a different class of device. Thus, the references cannot be properly combined to render the claim obvious; and
- combination of Hashimoto and Shinohara is also improper because Hashimoto describes an electronic camera while Shinohara describes a flash disk drive; and Hashimoto operates in a transmit only mode or a receive only mode selected by the user with a mode selection switch and Shinohara's flash disk requires the host computer to read and write (i.e. Hashimoto's one way communication would prevent two way exchange);

applicant's arguments have fully been considered, but are not found to be persuasive.

The examiner respectfully disagrees; and please note that applicant's arguments against the references individually, one cannot show nonobviousness by attacking references individually where the rejections are based on combinations of references. See *In re Keller*, 642 F.2d 413, 208 USPQ 871 (CCPA 1981); *In re Merck & Co.*, 800 F.2d 1091, 231 USPQ 375 (Fed. Cir. 1986).

To further clarify the examiner's position, first of all, based on the interview dated 07/12/2011, applicant's inventive concept corresponds to the functionality of

"... single analog sensing device with multiple parallel channels for acquiring analog data through the multiple parallel channels, wherein the single analog sensing device is connected to a digital device, such as a host, and the digital device (host) recognizing the connected single analog sensing device as a digital device, such as a hard drive (e.g. digital storage device) or printer; and when the single analog sensing device is connected to the digital device (host) for transferring the acquired analog data to the digital device (host), the digital device (host) use a corresponding digital device driver, such as hard drive driver, for communicating with the single analog sensing device, as the digital device (host) thinks that the connected single analog sensing device is the hard drive (digital device) ...,"

and the applicant further clarify during the interview that:

"... The examiner then inquired how is the instant application differ from application 11/467,092; and applicant indicated that the claims for the instant application are broader as the independent claims for the instant application do not require the multiple parallel channels.

The examiner then inquired how is the functionality for the instant application differs from the application 11/467,092; and applicant indicated that the instant application is basically the same concept as the application 11/467,092.

The examiner then inquired whether the claimed feature regarding one parameter indicative of the class of devices of the analog data acquisition device to be send to the computer corresponds to the functionality for the host to recognize the connected analog device as a hard drive; and applicant responded that the claimed feature is part of the recognition process of the analog device as the hard drive.

The informing of such file transfer characteristics would not necessarily be required for the analog sensing device to do the functioning of what the applicant has been describing. Applicant also indicated that the analog sensing device would not

Art Unit: 2181

require to do that and that this is an extra limitation that is not necessarily needed; and if the applicant took this claimed limitation out of the independent claim, the applicant would still have a perfectly good independent claim.

Applicant also indicated that the analog data acquisition device communicates with the host in "real time" and provided the following citations in applicant's Specification for support:

Paragraph [0025] on page 10;

Paragraph [0027] on page 11; and

Paragraph [0038] on page 15 (e.g. real time FFT),

wherein applicant indicated that the real time application is optional and not a requirement for implementing the inventive concept for the instant application ..."

wherein the examiner relied on the references as following for the teaching of applicant's invention:

Hashimoto teaches single analog sensing device (e.g. digital camera peripheral device) with multiple parallel channels (e.g. channel for audio and channel for image) for acquiring analog data (e.g. audio and image) through the multiple parallel channels, wherein the single analog sensing device is connected to a digital device, such as a host, and the digital device (host) recognizing the connected single analog sensing device (e.g. host need to recognize the connected peripheral device in order to know how to communicate with the connected peripheral device); and the single analog sensing device is connected to the digital device (host) for transferring the acquired analog data (e.g. audio data and image data) to the digital device (host), and for communicating with the single analog sensing device (Fig. 1A-1B; Fig. 8; Fig. 11-12; Fig. 14-15; col. 1, ll. 35-57; col. 3, l. 43 to col. 4, l. 57; col. 5, ll. 43-57; col. 6, l. 16 to col. 9, l. 17; col. 9, l. 46 to col. 11, l. 42 and col. 12, l. 16 to col. 14, l. 14), wherein the digital camera acquire analog image data and analog audio data and store them into the flash memory card, and when the digital camera is connect to the host computer, the digitized

Art Unit: 2181

image and audio data is then transferred from the flash memory card to the host computer.

Smith teaches plug and play functionality for a peripheral device connected to a host computer, wherein the host would recognize the connected peripheral device (Fig. 2-5; col. 1, ll. 9-22; col. 2, l. 40 to col. 3, l. 59; col. 4, ll. 5-34 and col. 6, ll. 63-62).

Ristelhueber teaches plug and play functionality without user loading software (e.g. plug and play of a peripheral device by having a user to simply insert a peripheral into a desktop system and have it start running immediately, as the PnP computer will automatically identify any new hardware installed and configure the new hardware, and relieving the end user of any need to fumble with floppy disks and user manuals to get the device up and running; therefore, the peripheral device is connected and operational without requiring any end user to load any software/device driver on the computer at anytime) (pages 1-3).

Shinohara teaches a host recognizing the connected single analog sensing device as a digital device, such as a hard drive (e.g. hard disk drive emulation) and using a corresponding digital device driver, such as hard drive driver, as the digital device (host) thinks that the connected single analog sensing device is the hard drive (digital device) (col. 1, ll. 48-60 and col. 3, l. 33 to col. 4, l. 49), by combining the hard disk drive emulation of the flash memory card into Hashimoto's digital camera peripheral device's flash memory card having the image data and audio data that is to be transferred to the host, the resulting combination of the references further teaches

Art Unit: 2181

the above feature as the digital camera transfers the flash memory card's image data and audio data to the host via hard disk drive emulation by the flash memory card.

Therefore, the resulting combination of the references does teach the core of applicant's invention as following: the digital camera peripheral device having the flash memory card that receives and maintains the analog image data and the analog audio data; the digital camera peripheral device is then connected to the host, wherein the host views the connected digital camera peripheral device to be the hard disk drive as the flash memory card is emulating as the hard disk drive for transferring the image data and the audio data from the flash memory card to the host computer (e.g. the digital camera peripheral device acquires the analog image and audio data while causing the digital camera peripheral device appear/be identified to the computer as an emulating hard disk drive/digital storage device).

The claimed features associated with sending "...a class identifying parameter to the host computer ..." and "a process in which the analog device processor executes instructions to cause a class identifying parameter (mis-indicative of the class of the device) to be sent to the host computer (i.e. automatically sends mis-identifying information to the host computer)" is not taught by Hashimoto along, as argued by the applicant; instead, it is taught by the combined teaching of Hashimoto, Smith, Ristelhueber : "Plug and play is almost here" and Shinohara.

As Hashimoto does disclose the digital camera communicating with the PC; therefore, it would be required for the PC to recognize the connected device in order for the PC to know how to properly communicate with the connected device. The examiner

Art Unit: 2181

is not certain where Hashimoto discloses that the user would load software and input information into the host computer to identify the camera and there was no requirement for the camera CPU to be involved in a recognition process; therefore, is unable to properly respond to applicant's remark/argument.

Base on applicant's clarification during the interviews dated 03/31/2011 and 07/12/2011, it is the examiner's best understanding that the claimed feature of "automatic sending of identification," "identification information being read or sent," and "a peripheral processor automatically providing identification information to the host computer," are process that corresponds to the functionality of recognizing the connected analog device as the hard drive (digital device), and as explained in detail above, the resulting combination of the references does teach/suggest recognizing the connected analog device as the hard drive (digital device); therefore, in order to load the appropriate device driver (or identify the resources needed), the plug and play process need to recognize the connected peripheral device to be able to pick/select the appropriate device driver, because if the device driver is inappropriate, then operation would not permitted.

The examiner is relying on the combined teaching of Hashimoto, Smith, Ristelhueber : "Plug and play is almost here" and Shinohara, not Smith along, for the teaching of a peripheral having a processor involved in the Plug and Play process.

To further clarify the examiner's position with regard to combining Smith's plug-and-play functionality into Hashimoto's analog data acquisition device architecture, it make sense to one skilled in the art to combine the plug-and-play functionality into the

Art Unit: 2181

analog data acquisition device architecture, because the resulting combination teaches/suggests that the analog data acquisition device conforming to the plug-and-play standard such that analog data acquisition device is a plug-and-play device; therefore, the installation of the analog data acquisition device is simplified for the user as the analog data acquisition device may be installed without the need for the user to install software or configure the analog data acquisition device.

Smith's loading of the device driver is not contrary to "automatic recognition," because Smith's loading of the device driver is similar to applicant's loading of the corresponding device driver, such as the digital device driver, as explained by the applicant during the interviews dated 03/31/2011 and 07/12/2011.

Plug and Play functionality is not functionality which is primarily located in the host computer instead of the peripheral, Plug and Play functionality is a protocol that both the host and the peripheral device must conform to so that the peripheral device can be plug into the host and directly start playing/utilizing the connected peripheral device; and to further clarify, it is Smith's invention, not Plug and Play functionality/protocol/standard, that is primarily located in the host computer instead of the peripheral device (Fig. 2-5; col. 1, ll. 9-22; col. 2, l. 40 to col. 3, l. 8; col. 3, ll. 22-27; col. 3, ll. 53-59; col. 4, ll. 5-34; col. 6, ll. 63-62).

Ristelhueber is clearly technically related the Plug and Play protocol and as the applicant indicated, it is prior art; wherein the Plug and Play functionality/protocol is clearly enabled by Smith and Plug and Play Standard, and the examiner relied on Ristelhueber because Ristelhueber provided a clear description that is easily

Art Unit: 2181

understood regarding how Plug and Play functions; and Ristelhueber does describe recognizing of what peripheral is attached because after the peripheral device is connected to the host, the host need to recognize what peripheral device is attached in order for the host to know what device driver is to be loaded for the connected peripheral device; additionally, applicant's arguments also suggest that the host device recognize the connected peripheral device because in order for the host to identify "the resources needed by the peripheral device" the host would need to know what that connected peripheral device is (on page 17 of applicant's arguments); therefore, Plug and Play functionality will recognize the new hardware and configure hardware to relieve the user of the need to fumble with floppy disks (e.g. looking for the device driver on the floppy disks) and user manuals to get the device up and running; therefore, by combining Ristelhueber with the other references, the resulting combination of the references does teach/suggest the automatic recognition process corresponds to Plug and Play by the user simply inserting a peripheral into the desktop and having it start running immediately, as the PnP computer will automatically identify any new hardware installed and configure the new hardware, and relieving the end user of any need to fumble with floppy disks and user manuals to get the device up and running. To further clarify, Ristelhueber does teach/suggest that the plug and play functionality relieve the user from having to load a device driver and lack of need for user loaded software on the host computer, because the installation of a peripheral device without Plug and Play functionality would need the end user of to fumble with floppy disks (e.g. looking for the device driver on the floppy disks) and user manuals to get the device up and running;

Art Unit: 2181

and the examiner is relying on the other references, and not on Ristelhueber, for the teaching/suggesting regarding the claimed feature of “a processor on the peripheral”; and as discussed above, Plug and Play functionality for loading of a device driver is similar to applicant’s loading of the corresponding device driver, such as the digital device driver, as explained by the applicant during the interviews dated 03/31/2011 and 07/12/2011 (Ristelhueber, pages 1-3).

Shinohara’s hard disk drive emulation is compatible with Hashimoto, as the examiner is combining Shinohara’s hard disk drive emulation by the flash memory card into Hashimoto’s flash memory card; with regard to the claimed features for “no need for user interaction to set up a file system” and “device is not identified as an analog data generating and processing device and is identified instead as a digital mass storage device,” the examiner is not relying on Shinohara along, as the examiner is relying on the combination of Shinohara with the other prior art references; therefore, by combining the hard drive emulation into Hashimoto’s flash memory card, the resulting combination of the references does teach/suggest when the analog data acquisition device is connected to the host for transferring data from the analog data acquisition device’s flash memory card, the host will recognize the connected analog data acquisition device as a hard disk drive via the flash memory card’s hard disk drive emulation as data is transferred from the flash memory card to the host; and by combining the Plug and Play functionality with the hard disk drive emulation, additional software would not need to be added to the host computer to set up the data structure for the flash drive; to further clarify, the examiner is relying on the combination of the

Art Unit: 2181

references, not on Shinohara along, for the teaching of claimed features associated with operation and identification of an analog data acquisition device as an entirely different type of device and device which sends an identifying parameter to the host computer identifying the device as a device of dramatically different type than what it actually is (e.g. the analog data acquisition device's flash memory card implementing hard disk emulation for data transferring to the host; therefore, the host recognizes the connected analog data acquisition device as the hard disk) (Shinohara, col. 1, ll. 48-60; and col. 3, l. 56 to col. 4, l. 49).

The examiner is relying on the combination of the references, not on Shinohara along, for the teaching of the claimed features associated with "device drivers," "not needing to load file transfer enabling software," "transferring a file of digitized analog data without requiring any user loaded file transfer enabling software," and "disk emulator being able to transfer data without data-transfer software loaded on the host computer;" and as discussed above, the combination of the references does teach/suggest Plug and Play functionality eliminates the need to supply a driver by the end user as the loading the driver after the system resources are allocated and the devices activated is done by the host; and also discussed in detail above, the Plug and Play functionality for loading of a device driver is similar to applicant's loading of the corresponding device driver, such as the digital device driver, as explained by the applicant during the interviews dated 03/31/2011 and 07/12/2011; therefore, the combination of the references does teach/suggest "data transfer without a user loaded driver" via the Plug and Play functionality.

Art Unit: 2181

Shinohara's memory is suitable for receiving analog data from a source independent of the host computer and for transferring acquiring digitized analog data to a host computer because Shinohara's memory is a flash memory card and Hashimoto does teach/suggest that flash memory card is suitable for receiving analog data from a source independent of the host computer and for transferring acquiring digitized analog data to a host computer; as discussed above, the examiner is relying on the combination of the references, not on Shinohara along, for the teaching of the claimed features associated with "transferring the acquired analog data while causing the analog data generating and processing device to appear to the computer as a digital storage device," "has two separate ports providing input of analog data on one port and subsequent transfer of digitized analog data to a computer on another port," "an analog data acquisition device having both an analog input and a host computer interface port which can emulate a hard disk," and "automatic file transfer of acquired digitized analog data without requiring user loaded file transfer enabling software"; as also previously discussed, Shinohara's hard disk drive emulation by the flash memory card is not dramatically different because the examiner is combining Shinohara's hard disk drive emulation by the flash memory card into Hashimoto's flash memory card (i.e. both Shinohara and Hashimoto include the same flash memory card).

Hashimoto is compatible with other references because, based on the assumption that applicant's analysis of Hashimoto is correct, Hashimoto is not limited to one way communication, as Hashimoto does have two way exchange via a switch; to further clarify, the combination of the references would teach/suggest two way

Art Unit: 2181

exchange via switch (e.g. electrical switch control by host) for implementing Plug and Play functionality or the combination of the references is not limited to DTR signaling and two way exchange take place without the need of the switch for implementing the Plug and Play functionality; additionally, as discussed above, Hashimoto and Shinohara are compatible as both have the corresponding flash memory card.

Additionally, as discussed in detail above, the resulting combination of the references teaches/suggests the analog data acquisition device to be the plug and play hard disk emulating device; therefore, when the analog data acquisition device is connected to the host computer, the analog data acquisition device is identified as the hard disk emulating device (e.g. the class parameter sent is a different class of device).

I. REJECTIONS BASED ON PRIOR ART

Claim Rejections - 35 USC § 103

The following is a quotation of 35 U.S.C. 103(a) which forms the basis for all obviousness rejections set forth in this Office action:

(a) A patent may not be obtained though the invention is not identically disclosed or described as set forth in section 102 of this title, if the differences between the subject matter sought to be patented and the prior art are such that the subject matter as a whole would have been obvious at the time the invention was made to a person having ordinary skill in the art to which said subject matter pertains. Patentability shall not be negated by the manner in which the invention was made.

4. Claims 2-4, 6-10, 12, 15-16, 18-22, 27, 30-32 and 35 are rejected under 35 U.S.C. 103(a) as being unpatentable over Hashimoto et al. (US Patent 6,111,604) in view of Smith et al. (US Patent 5,634,075), Ristelhueber : “Plug and play is almost here” and Shinohara (US Patent 5,742,934).

Art Unit: 2181

5. As per claim 2, Hashimoto teaches an analog data acquisition device operatively connectable to a computer through a multipurpose interface of the computer, wherein the computer having an operating system, the analog data acquisition device comprising:

- a) a program memory (Fig. 9, ref. 52, 54-55 and col. 8, l. 48 to col. 9, l. 17);
- b) an analog signal acquisition channel for receiving a signal from an analog source (Fig. 8, ref. 1, 6, 9; col. 6, l. 16 to col. 9, l. 17 and col. 10, l. 41 to col. 11, l. 42);
- c) a processor operatively interfaced with the multipurpose interface of the computer, the program memory (Fig. 9, ref. 52, 54-55), and a data storage memory (Fig. 8, ref. 16) when the analog data acquisition device is operational (Fig. 8; Fig. 9; col. 6, l. 16 to col. 9, l. 17 and col. 10, l. 41 to col. 11, l. 42);
- d) wherein the processor is configured and programmed to implement a data generation process by which analog data (e.g. audio and visual analog data) is acquired from the analog signal acquisition channel, the analog data is processed, and digitized, and the processed and digitized analog data is stored in a file system of the data storage memory (Fig. 8, ref. 16 and Fig. 10) as at least one file of digitized analog data (Fig. 1A-1B; Fig. 11-12; Fig. 14-15; col. 1, ll. 27-57; col. 3, l. 43 to col. 4, l. 67; col. 5, ll. 43-57; col. 6, l. 16 to col. 9, l. 17; col. 9, l. 46 to col. 11, l. 42 and col. 12, l. 16 to col. 14, l. 14);
- e) wherein when the analog data acquisition device is operatively interfaced with the multipurpose interface of the computer, the processor executes at least one instruction set stored in the program memory to establish communication with the

Art Unit: 2181

computer (Fig. 1A-1B; Fig. 11-12; Fig. 14-15; col. 1, ll. 27-57; col. 3, l. 43 to col. 4, l. 67; col. 5, ll. 43-57; col. 6, l. 16 to col. 9, l. 17; col. 9, l. 46 to col. 11, l. 42 and col. 12, l. 16 to col. 14, l. 14); and

f) wherein the processor is further configured and programmed to execute at least one other instruction set stored in the program memory to thereby allow the at least one file of digitized analog data acquired from the analog signal acquisition channel to be transferred to the computer (Fig. 1A-1B; Fig. 11-12; Fig. 14-15; col. 1, ll. 27-57; col. 3, l. 43 to col. 4, l. 67; col. 5, ll. 43-57; col. 6, l. 16 to col. 9, l. 17; col. 9, l. 46 to col. 11, l. 42 and col. 12, l. 16 to col. 14, l. 14).

Hashimoto does not teach the analog data acquisition device operatively connectable to a computer through a multipurpose interface of the computer, the computer having an operating system and being programmed so that when it receives a signal from the device through said multipurpose interface of the computer indicative of a class of devices, the computer automatically activates a device driver corresponding to the class of devices for allowing the transfer of data between the device and the operating system of the computer, the analog data acquisition device comprising:

wherein after interfacing with the computer, to thereby automatically causes at least one parameter indicative of the class of devices to be sent to the computer through the multipurpose interface of the computer, independent of the analog source, wherein the analog data acquisition device is not within the class of devices; and

data transferring to the computer using the device driver corresponding to said class of devices so that the analog data acquisition device appears to the computer as if it were a device of the class of devices;

whereby there is no requirement for any user-loaded file transfer enabling software to be loaded on or installed in the computer in addition to the operating system.

Smith teaches a system and a method comprising: wherein after interfacing with the computer, to thereby automatically causes at least one parameter to be sent to the computer through the multipurpose interface of the computer, independent of the analog source (e.g. plug and play functionality) (Fig. 2-5; col. 1, ll. 9-22; col. 2, l. 40 to col. 3, l. 59; col. 4, ll. 5-34 and col. 6, ll. 63-62), by combining the plug-and-play functionality into Hashimoto's analog data acquisition device architecture, the resulting combination further teaches the above claimed features.

Ristelhueber teaches a system and a method comprising whereby there is no requirement for any user-loaded software to be loaded on or installed in the computer in addition to the operating system (pages 1-3).

Shinohara teaches a system and a method comprising: sending a class of devices (e.g. class of device associated with hard disk drive), wherein the analog data acquisition device is not within the class of devices (e.g. hard disk drive emulation by the device); data transferring to the computer using the device driver (e.g. hard disk drive device driver) corresponding to said class of devices so that the analog data acquisition device appears to the computer as if it were a device of the class of devices

Art Unit: 2181

(e.g. device appear as hard disk drive); no requirement for any user-loaded file transfer enabling software (e.g. the plug and play of the device for hard disk drive emulation as taught by the combination of the references) (col. 1, ll. 48-60 and col. 3, l. 33 to col. 4, l. 49), by combining the emulation of the hard disk drive with Hashimoto, Smith and Ristelhueber's analog data acquisition device architecture having the plug-and-play functionality, the resulting combination of the references further teaches the above claimed features.

It would have been obvious for one of ordinary skill in this art, at the time of invention was made to include Smith's plug and play functionality, Ristelhueber's installation without user intervention and Shinohara's hard disk drive emulation into Hashimoto's analog data acquisition device architecture for the benefit of simplifying the installation of the peripheral device for the user as the peripheral device may be installed without the need for the user to install software or configure the peripheral device (Smith, col. 2, ll. 40-67 and col. 5, ll. 41-51 and col. 6, ll. 63-65), simplifying the end user's PC upgrading and reducing cost for the computing industry (Ristelhueber, page 2, 3rd paragraph), and expanding the lifetime usage of the memory card (Shinohara, col. 2, ll. 7-8) to obtain the invention as specified in claim 2.

6. As per claim 3, Hashimoto, Smith, Ristelhueber and Shinohara teach all the claimed limitation of claim 2 above, where Hashimoto, Smith, Ristelhueber and Shinohara further teach the analog data acquisition device comprising wherein the analog data acquisition device is a stand alone device (Hashimoto, Fig. 1A-1B; Fig. 11-

Art Unit: 2181

12; Fig. 14-15; col. 1, ll. 27-57; col. 3, l. 43 to col. 4, l. 67; col. 5, ll. 43-57; col. 6, l. 16 to col. 9, l. 17; col. 9, l. 46 to col. 11, l. 42; col. 12, l. 16 to col. 14, l. 14; Smith, Fig. 2-5; col. 1, ll. 9-22; col. 2, l. 40 to col. 3, l. 59; col. 4, ll. 5-34; col. 6, ll. 63-62; Ristelhueber, pages 1-3; and Shinohara, col. 1, ll. 48-60; col. 3, l. 33 to col. 4, l. 49).

7. As per claim 4, Hashimoto, Smith, Ristelhueber and Shinohara teach all the claimed limitation of claim 2 above, where Hashimoto, Smith, Ristelhueber and Shinohara further teach the analog data acquisition device comprising wherein the analog data acquisition device includes a SCSI interface circuit (Hashimoto, Fig. 1A-1B; Fig. 11-12; Fig. 14-15; col. 1, ll. 27-57; col. 3, l. 43 to col. 4, l. 67; col. 5, ll. 43-57; col. 6, l. 16 to col. 9, l. 17; col. 9, l. 46 to col. 11, l. 42; col. 12, l. 16 to col. 14, l. 14; Smith, Fig. 2-5; col. 1, ll. 9-22; col. 2, l. 40 to col. 3, l. 59; col. 4, ll. 5-34; col. 6, ll. 63-62; Ristelhueber, pages 1-3; and Shinohara, col. 1, ll. 48-60; col. 3, l. 33 to col. 4, l. 49).

8. As per claim 6, Hashimoto, Smith, Ristelhueber and Shinohara teach all the claimed limitation of claim 2 above, where Hashimoto, Smith, Ristelhueber and Shinohara further teach the analog data acquisition device configured to allow for a plurality of different data transmit devices to be attached thereto and detached therefrom (Hashimoto, Fig. 1A-1B; Fig. 8; Fig. 11-12; Fig. 14-15; col. 1, ll. 27-57; col. 3, l. 43 to col. 4, l. 67; col. 5, ll. 43-57; col. 6, l. 16 to col. 9, l. 17; col. 9, l. 46 to col. 11, l. 42; col. 12, l. 16 to col. 14, l. 14; Smith, Fig. 2-5; col. 1, ll. 9-22; col. 2, l. 40 to col. 3, l. 8;

Art Unit: 2181

col. 3, ll. 22-27; col. 3, ll. 53-59; col. 4, ll. 5-34; col. 6, ll. 63-62; Ristelhueber, pages 1-3; and Shinohara, col. 1, ll. 48-60; col. 3, l. 56 to col. 4, l. 49).

9. As per claim 7, Hashimoto, Smith, Ristelhueber and Shinohara teach all the claimed limitation of claim 2 above, where Hashimoto and Smith further teach the analog data acquisition device comprising wherein the processor is adapted to be interfaced with the multipurpose interface of an external computing device by means of a cable (Hashimoto, Fig. 1A-1B; Fig. 8; Fig. 11-12; Fig. 14-15; col. 1, ll. 27-57; col. 3, l. 43 to col. 4, l. 67; col. 5, ll. 43-57; col. 6, l. 16 to col. 9, l. 17; col. 9, l. 46 to col. 11, l. 42; col. 12, l. 16 to col. 14, l. 14; Smith, Fig. 2-5; col. 1, ll. 9-22; col. 2, l. 40 to col. 3, l. 8; col. 3, ll. 22-27; col. 3, ll. 53-59; col. 4, ll. 5-34; col. 6, ll. 63-62; Ristelhueber, pages 1-3; and Shinohara, col. 1, ll. 48-60; col. 3, l. 56 to col. 4, l. 49).

10. As per claim 8, Hashimoto, Smith, Ristelhueber and Shinohara teach all the claimed limitation of claim 2 above, where Hashimoto further teaches the analog data acquisition device comprising wherein the analog source comprises a data transmit/receive device (e.g. for transferring the audiovisual information to the computer and receiving control instruction from the computer) (Hashimoto, Fig. 1A-1B; Fig. 8; Fig. 11-12; Fig. 14-15; col. 1, ll. 27-57; col. 3, l. 43 to col. 4, l. 67; col. 5, ll. 43-57; col. 6, l. 16 to col. 9, l. 17; col. 9, l. 46 to col. 11, l. 42; and col. 12, l. 16 to col. 14, l. 14).

Art Unit: 2181

11. As per claim 9, Hashimoto, Smith, Ristelhueber and Shinohara teach all the claimed limitation of claim 8 above, where Hashimoto further teaches the analog data acquisition device comprising wherein the analog source is designed for one of one-way and two-way communication with the host device (Hashimoto, Fig. 1A-1B; Fig. 8; Fig. 11-12; Fig. 14-15; col. 1, ll. 27-57; col. 3, l. 43 to col. 4, l. 67; col. 5, ll. 43-57; col. 6, l. 16 to col. 9, l. 17; col. 9, l. 46 to col. 11, l. 42; and col. 12, l. 16 to col. 14, l. 14).

12. As per claim 10, Hashimoto, Smith, Ristelhueber and Shinohara teach all the claimed limitation of claim 2 above, where Hashimoto, Smith, Ristelhueber and Shinohara further teaches the analog data acquisition device comprising wherein processor converts the digitized analog data acquired from the analog signal acquisition channel to a form that simulates data from a hard disk and transfers that converted data to the computer through the multipurpose interface such that the converted data appears to the computer as data from a hard disk. (Hashimoto, Fig. 1A-1B; Fig. 8; Fig. 11-12; Fig. 14-15; col. 1, ll. 27-57; col. 3, l. 43 to col. 4, l. 67; col. 5, ll. 43-57; col. 6, l. 16 to col. 9, l. 17; col. 9, l. 46 to col. 11, l. 42; col. 12, l. 16 to col. 14, l. 14 Smith, Fig. 2-5; col. 1, ll. 9-22; col. 2, l. 40 to col. 3, l. 8; col. 3, ll. 22-27; col. 3, ll. 53-59; col. 4, ll. 5-34; col. 6, ll. 63-62; Ristelhueber, pages 1-3; and Shinohara, col. 1, ll. 48-60; col. 3, l. 56 to col. 4, l. 49), as the analog data acquisition device is being recognized as the hard disk when connected to the host, the digitized analog data would need to conform to the hard disk standard/protocol via conversion such that the digitized analog data can properly be transferred to the host.

Art Unit: 2181

13. As per claim 12, Hashimoto, Smith, Ristelhueber and Shinohara teach all the claimed limitation of claim 2 above, where Hashimoto, Smith, Ristelhueber and Shinohara further teach the analog data acquisition device comprising wherein the processor allows for a plurality of different data transmit devices to be attached thereto and detached therefrom (Hashimoto, Fig. 1A-1B; Fig. 8; Fig. 11-12; Fig. 14-15; col. 1, ll. 27-57; col. 3, l. 43 to col. 4, l. 67; col. 5, ll. 43-57; col. 6, l. 16 to col. 9, l. 17; col. 9, l. 46 to col. 11, l. 42; col. 12, l. 16 to col. 14, l. 14; Smith, Fig. 2-5; col. 1, ll. 9-22; col. 2, l. 40 to col. 3, l. 8; col. 3, ll. 22-27; col. 3, ll. 53-59; col. 4, ll. 5-34; col. 6, ll. 63-62; Ristelhueber, pages 1-3; and Shinohara, col. 1, ll. 48-60; col. 3, l. 56 to col. 4, l. 49).

14. As per claim 15, Hashimoto, Smith, Ristelhueber and Shinohara teach all the claimed limitation of claim 2 above, where Hashimoto, Smith, Ristelhueber and Shinohara further teach the analog data acquisition device comprising wherein the analog source includes at least first and second transducers both of which are designed to transmit data (Hashimoto, Fig. 1A-1B; Fig. 8; Fig. 11-12; Fig. 14-15; col. 1, ll. 27-57; col. 3, l. 43 to col. 4, l. 67; col. 5, ll. 43-57; col. 6, l. 16 to col. 9, l. 17; col. 9, l. 46 to col. 11, l. 42; col. 12, l. 16 to col. 14, l. 14; Smith, Fig. 2-5; col. 1, ll. 9-22; col. 2, l. 40 to col. 3, l. 8; col. 3, ll. 22-27; col. 3, ll. 53-59; col. 4, ll. 5-34; col. 6, ll. 63-62; Ristelhueber, pages 1-3; and Shinohara, col. 1, ll. 48-60; col. 3, l. 56 to col. 4, l. 49).

Art Unit: 2181

15. As per claim 16, Hashimoto, Smith, Ristelhueber and Shinohara teach all the claimed limitation of claim 2 above, where Hashimoto, Smith, Ristelhueber and Shinohara further teach the analog data acquisition device comprising wherein the at least one parameter is consistent with the analog data acquisition device being responsive to a SCSI inquiry command (Hashimoto, Fig. 1A-1B; Fig. 8; Fig. 11-12; Fig. 14-15; col. 1, ll. 27-57; col. 3, l. 43 to col. 4, l. 67; col. 5, ll. 43-57; col. 6, l. 16 to col. 9, l. 17; col. 9, l. 46 to col. 11, l. 42; col. 12, l. 16 to col. 14, l. 14; Smith, Fig. 2-5; col. 1, ll. 9-22; col. 2, l. 40 to col. 3, l. 8; col. 3, ll. 22-27; col. 3, ll. 53-59; col. 4, ll. 5-34; col. 6, ll. 63-62; Ristelhueber, pages 1-3; and Shinohara, col. 1, ll. 48-60; col. 3, l. 56 to col. 4, l. 49).

16. As per claim 18, Hashimoto, Smith, Ristelhueber and Shinohara teach all the claimed limitation of claim 2 above, where Hashimoto, Smith, Ristelhueber and Shinohara further teach the analog data acquisition device comprising wherein the processor is configured to cause acquired analog data file system information to be automatically sent to the multipurpose interface after the at least one parameter has been sent to the multipurpose interface of the computer, (a) without requiring any end user to load any software onto the computer at any time, and b) without requiring any end user to interact with the computer to set up a file system in the analog data acquisition device at any time (Hashimoto, Fig. 1A-1B; Fig. 8; Fig. 11-12; Fig. 14-15; col. 1, ll. 27-57; col. 3, l. 43 to col. 4, l. 67; col. 5, ll. 43-57; col. 6, l. 16 to col. 9, l. 17; col. 9, l. 46 to col. 11, l. 42; col. 12, l. 16 to col. 14, l. 14; Smith, Fig. 2-5; col. 1, ll. 9-22; col.

Art Unit: 2181

2, l. 40 to col. 3, l. 8; col. 3, ll. 22-27; col. 3, ll. 53-59; col. 4, ll. 5-34; col. 6, ll. 63-62; Ristelhueber, pages 1-3; and Shinohara, col. 1, ll. 48-60; col. 3, l. 56 to col. 4, l. 49).

17. As per claim 19, Hashimoto, Smith, Ristelhueber and Shinohara teach all the claimed limitation of claim 18 above, where Hashimoto, Smith, Ristelhueber and Shinohara further teach the analog data acquisition device comprising wherein the analog data acquisition device file system information comprises at least an indication of a file system type that is used to store the digitized analog data (Hashimoto, Fig. 1A-1B; Fig. 8; Fig. 11-12; Fig. 14-15; col. 1, ll. 27-57; col. 3, l. 43 to col. 4, l. 67; col. 5, ll. 43-57; col. 6, l. 16 to col. 9, l. 17; col. 9, l. 46 to col. 11, l. 42; col. 12, l. 16 to col. 14, l. 14; Smith, Fig. 2-5; col. 1, ll. 9-22; col. 2, l. 40 to col. 3, l. 8; col. 3, ll. 22-27; col. 3, ll. 53-59; col. 4, ll. 5-34; col. 6, ll. 63-62; Ristelhueber, pages 1-3; and Shinohara, col. 1, ll. 48-60; col. 3, l. 56 to col. 4, l. 49), as the type of file system corresponds to the plug-and-play analog data acquisition device having the memory card emulating as the hard disk drive for data transferring after the plug-and-play analog data acquisition device is connected to the PC.

18. As per claim 20, Hashimoto, Smith, Ristelhueber and Shinohara teach all the claimed limitation of claim 2 above, where Hashimoto, Smith, Ristelhueber and Shinohara further teach the analog data acquisition device comprising wherein the processor is configured to cause file allocation table information to be sent to the multipurpose interface, wherein the processor is configured to cause a virtual boot

Art Unit: 2181

sequence to be sent to the multipurpose interface which includes at least information that is representative of a number of sectors of a storage disk, and wherein the file allocation table information includes at least a start location of a file allocation table (Hashimoto, Fig. 1A-1B; Fig. 8; Fig. 11-12; Fig. 14-15; col. 1, ll. 27-57; col. 3, l. 43 to col. 4, l. 67; col. 5, ll. 43-57; col. 6, l. 16 to col. 9, l. 17; col. 9, l. 46 to col. 11, l. 42; col. 12, l. 16 to col. 14, l. 14; Smith, Fig. 2-5; col. 1, ll. 9-22; col. 2, l. 40 to col. 3, l. 8; col. 3, ll. 22-27; col. 3, ll. 53-59; col. 4, ll. 5-34; col. 6, ll. 63-62; Ristelhueber, pages 1-3; and Shinohara, col. 1, ll. 48-60; col. 3, l. 56 to col. 4, l. 49), as the analog data acquisition device being a mass storage device corresponds to the plug-and-play analog data acquisition device having the memory card emulating as the hard disk drive.

19. As per claim 21, Hashimoto, Smith, Ristelhueber and Shinohara teach all the claimed limitation of claim 2 above, where Hashimoto further teaches the analog data acquisition device comprising wherein the processor is configured to initiate a process by which the at least one file of digitized analog data is directly transferred to an input/output device (Hashimoto, Fig. 1A-1B; Fig. 8; Fig. 11-12; Fig. 14-15; col. 1, ll. 27-57; col. 3, l. 43 to col. 4, l. 67; col. 5, ll. 43-57; col. 6, l. 16 to col. 9, l. 17; col. 9, l. 46 to col. 11, l. 42; and col. 12, l. 16 to col. 14, l. 14).

20. As per claim 22, Hashimoto, Smith, Ristelhueber and Shinohara teach all the claimed limitation of claim 21 above, where Hashimoto further teaches the analog data acquisition device comprising wherein the processor is configured to allow a mode of

Art Unit: 2181

operation (e.g. update mode) of the analog data acquisition device other than the transfer of at least some of the at least one file of digitized analog data to the multipurpose interface to be controlled by means of an external personal computer (Hashimoto, Fig. 1A-1B; Fig. 8; Fig. 11-12; Fig. 14-15; col. 1, ll. 27-57; col. 3, l. 43 to col. 4, l. 67; col. 5, ll. 43-57; col. 6, l. 16 to col. 9, l. 17; col. 9, l. 46 to col. 11, l. 42; and col. 12, l. 16 to col. 14, l. 14), as the PC directly update the control program.

21. As per claim 27, Hashimoto, Smith, Ristelhueber and Shinohara teach all the claimed limitation of claim 2 above, where Hashimoto further teaches the analog data acquisition device comprising wherein the analog source is designed to receive signals from the computer (Hashimoto, Fig. 1A-1B; Fig. 8; Fig. 11-12; Fig. 14-15; col. 1, ll. 27-57; col. 3, l. 43 to col. 4, l. 67; col. 5, ll. 43-57; col. 6, l. 16 to col. 9, l. 17; col. 9, l. 46 to col. 11, l. 42; and col. 12, l. 16 to col. 14, l. 14), such as the computer communicating to the camera by updating control program to control the sensor.

22. As per claim 30, Hashimoto, Smith, Ristelhueber and Shinohara teach all the claimed limitation of claim 2 above, where Hashimoto, Smith, Ristelhueber and Shinohara further teach the analog data acquisition device comprising wherein the analog data acquisition device is designed to be responsive to a test unit ready command (Hashimoto, Fig. 1A-1B; Fig. 8; Fig. 11-12; Fig. 14-15; col. 1, ll. 27-57; col. 3, l. 43 to col. 4, l. 67; col. 5, ll. 43-57; col. 6, l. 16 to col. 9, l. 17; col. 9, l. 46 to col. 11, l. 42; col. 12, l. 16 to col. 14, l. 14; Smith, Fig. 2-5; col. 1, ll. 9-22; col. 2, l. 40 to col. 3, l. 8;

Art Unit: 2181

col. 3, ll. 22-27; col. 3, ll. 53-59; col. 4, ll. 5-34; col. 6, ll. 63-62; Ristelhueber, pages 1-3; and Shinohara, col. 1, ll. 48-60; col. 3, l. 56 to col. 4, l. 49).

23. As per claim 31, Hashimoto, Smith, Ristelhueber and Shinohara teach all the claimed limitation of claim 2 above, where Hashimoto, Smith, Ristelhueber and Shinohara further teach the analog data acquisition device comprising wherein the device driver is installed with the operating system (Hashimoto, Fig. 1A-1B; Fig. 8; Fig. 11-12; Fig. 14-15; col. 1, ll. 27-57; col. 3, l. 43 to col. 4, l. 67; col. 5, ll. 43-57; col. 6, l. 16 to col. 9, l. 17; col. 9, l. 46 to col. 11, l. 42; col. 12, l. 16 to col. 14, l. 14; Smith, Fig. 2-5; col. 1, ll. 9-22; col. 2, l. 40 to col. 3, l. 8; col. 3, ll. 22-27; col. 3, ll. 53-59; col. 4, ll. 5-34; col. 6, ll. 63-62; Ristelhueber, pages 1-3; and Shinohara, col. 1, ll. 48-60; col. 3, l. 56 to col. 4, l. 49).

24. As per claim 32, independent claim 32 is rejected in accordance to the same rational and reasoning as the above rejection of independent claim 2, wherein the class of devices corresponds to the digital mass storage device (e.g. hard disk drive emulation).

25. As per claim 35, independent claim 35 is rejected in accordance to the same rational and reasoning as the above rejection of independent claims 2 and 32, as independent claim 35 is the method claim for the analog data acquisition and interface

Art Unit: 2181

device of independent claim 32, wherein the class of devices corresponds to the digital mass storage device (e.g. hard disk drive emulation).

26. Claims 5 and 13 are rejected under 35 U.S.C. 103(a) as being unpatentable over Hashimoto et al. (US Patent 6,111,604) in view of Smith et al. (US Patent 5,634,075), Ristelhueber : "Plug and play is almost here" and Shinohara (US Patent 5,742,934) as applied to claim 2 above, and further in view of Endo et al. (US Patent 4,652,928).

Hashimoto, Smith, Ristelhueber and Shinohara teach all the limitations of claim 2 as discussed above, wherein Hashimoto further teaches the analog data acquisition device comprising wherein the processor is designed so that the sensor can be attached to the processor (Hashimoto, Fig. 1A-1B; Fig. 8; Fig. 11-12; Fig. 14-15; col. 1, ll. 27-57; col. 3, l. 43 to col. 4, l. 67; col. 5, ll. 43-57; col. 6, l. 16 to col. 9, l. 17; col. 9, l. 46 to col. 11, l. 42; and col. 12, l. 16 to col. 14, l. 14).

Hashimoto, Smith, Ristelhueber and Shinohara do not expressly teach the analog data acquisition device comprising:

wherein the analog data acquisition device is designed so that the analog source is detachable; and

wherein the processor is designed so that a user can attach the analog source thereto or detach the analog source therefrom.

Endo teaches a system comprising: wherein the analog data acquisition device is designed so that the analog source is detachable (e.g. de-coupling); and wherein the processor is designed so that a user can attach the analog source thereto or detach the analog

Art Unit: 2181

source therefrom (col. 1, ll. 18-25 and col. 13, ll. 57-58), by combining the de-couplable of the sensor architecture with Hashimoto, Smith, Kerigan and Shinohara's analog data acquisition device having the sensor architecture, the resulting combination of the references further teaches the above claimed features.

It would have been obvious for one of ordinary skill in this art, at the time of invention was made to include Endo's interchangeable sensor into Hashimoto, Smith, Ristelhueber and Shinohara's sensor coupled to the processor for the benefit of adaptively increase the resolution of the camera to obtaining a better quality image (Endo, col. 1, ll. 18-20) to obtain the invention as specified in claims 5 and 13.

27. Claims 11 and 36 are rejected under 35 U.S.C. 103(a) as being unpatentable over Hashimoto et al. (US Patent 6,111,604) in view of Smith et al. (US Patent 5,634,075), Ristelhueber : "Plug and play is almost here" and Shinohara (US Patent 5,742,934) as applied to claims 2 and 35 above, and further in view of Nakamura et al. (US Patent 6,278,492).

Hashimoto, Smith, Ristelhueber and Shinohara teach all the limitations of claims 2 and 35 as discussed above, but Hashimoto, Smith, Ristelhueber and Shinohara do not expressly teach the analog data acquisition device comprising:

a plurality of independent analog signal acquisition channels, each of the plurality of channels operatively coupled to the processor for operatively coupling to one of a plurality of analog sources analog sources such that analog data is simultaneously acquired from at least two of the plurality of channels, is digitized and is coupled into the processor mid is processed by the processor; and

simultaneously acquiring the analog data from each respective analog channel of a plurality of respective independent acquisition channels under control of the processor.

Nakamura teaches a system comprising: a plurality of independent analog signal acquisition channels, each of the plurality of channels operatively coupled to the processor for operatively coupling to one of a plurality of analog sources such that analog data is simultaneously acquired from at least two of the plurality of channels, is digitized and is coupled into the processor and is processed by the processor; and simultaneously acquiring the analog data from each respective analog channel of a plurality of respective independent acquisition channels under control of the processor (Fig. 1 and col. 1, ll. 12-40), by combining the multiple sensor architecture into Hashimoto, Smith, Ristelhueber and Shinohara analog data acquisition device having the sensor architecture, the resulting combination of the references further teaches the above claimed features.

It would have been obvious for one of ordinary skill in this art, at the time of invention was made to include Nakamura's multiple sensors into Hashimoto, Smith, Ristelhueber and Shinohara's analog data acquisition device architecture for the benefit of improving the resolution (Nakamura, col. 1, ll. 12-40) to obtain the invention as specified in claims 11 and 36.

28. Claim 24 is rejected under 35 U.S.C. 103(a) as being unpatentable over Hashimoto et al. (US Patent 6,111,604) in view of Smith et al. (US Patent 5,634,075), Ristelhueber : "Plug

Art Unit: 2181

and play is almost here" and Shinohara (US Patent 5,742,934) as applied to claim 2 above, and further in view of Roberts et al. (US Patent 5,576,757).

Hashimoto, Smith, Ristelhueber and Shinohara teach all the limitations of claim 2 as discussed above, wherein Hashimoto further teaches the analog data acquisition device comprising generating and processing of the analog data (Hashimoto, Fig. 1A-1B; Fig. 11-12; Fig. 14-15; col. 1, ll. 35-57; col. 3, l. 43 to col. 4, l. 57; col. 5, ll. 43-57; col. 6, l. 16 to col. 9, l. 17 and col. 9, l. 46 to col. 10, l. 16).

Hashimoto, Smith, Ristelhueber and Shinohara do not expressly teach the analog data acquisition device comprising a fast Fourier transform.

Roberts teaches a system and a method comprising an electronic still camera processing data by being subject to a fast Fourier transform (Abstract and col. 9, l. 60 to col. 10, l. 7).

It would have been obvious for one of ordinary skill in this art, at the time of invention was made to include Roberts's fast Fourier transform into Hashimoto, Smith, Ristelhueber and Shinohara's analog data acquisition device architecture for the benefit of having an easier computation for image processing while providing a reasonable visual fidelity (Roberts, col. 10, ll. 1-3) to obtain the invention as specified in claim 24.

II. CLOSING COMMENTS

Conclusion

a. STATUS OF CLAIMS IN THE APPLICATION

The following is a summary of the treatment and status of all claims in the application as recommended by **M.P.E.P. 707.07(i)**:

a(1) CLAIMS REJECTED IN THE APPLICATION

THIS ACTION IS MADE FINAL. Applicant is reminded of the extension of time policy as set forth in 37 CFR 1.136(a).

A shortened statutory period for reply to this final action is set to expire THREE MONTHS from the mailing date of this action. In the event a first reply is filed within TWO MONTHS of the mailing date of this final action and the advisory action is not mailed until after the end of the THREE-MONTH shortened statutory period, then the shortened statutory period will expire on the date the advisory action is mailed, and any extension fee pursuant to 37 CFR 1.136(a) will be calculated from the mailing date of the advisory action. In no event, however, will the statutory period for reply expire later than SIX MONTHS from the mailing date of this final action.

b. DIRECTION OF FUTURE CORRESPONDENCES

Any inquiry concerning this communication or earlier communications from the examiner should be directed to Chun-Kuan (Mike) Lee whose telephone number is (571) 272-0671. The examiner can normally be reached on 8AM to 5PM.

Art Unit: 2181

IMPORTANT NOTE

If attempts to reach the examiner by telephone are unsuccessful, the examiner's supervisor, Alford Kindred can be reached on (571) 272-4037. The fax phone number for the organization where this application or proceeding is assigned is 571-273-8300.

Information regarding the status of an application may be obtained from the Patent Application Information Retrieval (PAIR) system. Status information for published applications may be obtained from either Private PAIR or Public PAIR. Status information for unpublished applications is available through Private PAIR only. For more information about the PAIR system, see <http://pair-direct.uspto.gov>. Should you have questions on access to the Private PAIR system, contact the Electronic Business Center (EBC) at 866-217-9197 (toll-free). If you would like assistance from a USPTO Customer Service Representative or access to the automated information system, call 800-786-9199 (IN USA OR CANADA) or 571-272-1000.

/Chun-Kuan Lee/
Primary Examiner
Art Unit 2181
April 23, 2012

Search Notes 	Application/Control No. 12891443	Applicant(s)/Patent Under Reexamination TASLER, MICHAEL
	Examiner Chun-Kuan Lee	Art Unit 2181

SEARCHED			
Class	Subclass	Date	Examiner
710	15,63,69	4/10/2012	CKL

SEARCH NOTES		
Search Notes	Date	Examiner
Updated EAST search:US-PGPUB; USPAT; USOCR; EPO; JPO; DERWENT	4/10/2012	CKL
Updated inventor search utilizing eDan and EAST	4/10/2012	CKL

INTERFERENCE SEARCH			
Class	Subclass	Date	Examiner

--	--

EAST Search History**EAST Search History (Prior Art)**

Ref #	Hits	Search Query	DBs	Default Operator	Plurals	Time Stamp
S1	2466	(710/15,63,69).ccls.	US-PGPUB; USPAT; USOCR; EPO; JPO; DERWENT	SAME	OFF	2012/04/10 13:00
S2	9	(TASLER near MICHAEL).in.	US-PGPUB; USPAT; USOCR; EPO; JPO; DERWENT	SAME	OFF	2012/04/10 14:20
S3	13288	plug near play	US-PGPUB; USPAT; USOCR; EPO; JPO; DERWENT	SAME	OFF	2012/04/10 15:32
S4	138	multimeter\$2 and (plug with play)	US-PGPUB; USPAT; USOCR; EPO; JPO; DERWENT	SAME	OFF	2012/04/11 10:33
S5	4034	((((disk near drive\$2) or (hard near drive\$2) or HD or HDD or (hard near disk near drive\$2)) with(emulat\$4 or simulat\$4))	US-PGPUB; USPAT; USOCR; EPO; JPO; DERWENT	SAME	OFF	2012/04/11 11:07

<i>Index of Claims</i> 	Application/Control No. 12891443	Applicant(s)/Patent Under Reexamination TASLER, MICHAEL
	Examiner Chun-Kuan Lee	Art Unit 2181

✓	Rejected
=	Allowed

-	Cancelled
÷	Restricted

N	Non-Elected
I	Interference

A	Appeal
O	Objected

Claims renumbered in the same order as presented by applicant
 CPA
 T.D.
 R.1.47

CLAIM		DATE							
Final	Original	04/18/2011	04/23/2012						
	1	-	-						
	2	÷	✓						
	3	÷	✓						
	4	÷	✓						
	5	÷	✓						
	6	÷	✓						
	7	÷	✓						
	8	÷	✓						
	9	÷	✓						
	10	÷	✓						
	11	÷	✓						
	12	÷	✓						
	13	÷	✓						
	14	÷	N						
	15	÷	✓						
	16	÷	✓						
	17	÷	N						
	18	÷	✓						
	19	÷	✓						
	20	÷	✓						
	21	÷	✓						
	22	÷	✓						
	23	÷	N						
	24	÷	✓						
	25	÷	N						
	26	÷	N						
	27	÷	✓						
	28	÷	N						
	29	÷	N						
	30	÷	✓						
	31	÷	✓						
	32	÷	✓						
	33	÷	N						
	34	÷	N						
	35	÷	✓						
	36	÷	✓						

Application Number 	Application/Control No. 12/891,443	Applicant(s)/Patent under Reexamination TASLER, MICHAEL

Document Code - DISQ	Internal Document – DO NOT MAIL
-----------------------------	----------------------------------------

TERMINAL DISCLAIMER	<input checked="" type="checkbox"/> APPROVED	<input type="checkbox"/> DISAPPROVED
Date Filed : 12/28/11	This patent is subject to a Terminal Disclaimer	

Approved/Disapproved by:

jean proctor

Under the Paperwork Reduction Act of 1995, no persons are required to respond to a collection of information unless it displays a valid OMB control number.

**TERMINAL DISCLAIMER TO OBIVATE A PROVISIONAL DOUBLE PATENTING
REJECTION OVER A PENDING "REFERENCE" APPLICATION**

Docket Number (Optional)

113189

In re Application of: Michael Tasler

Application No.: 12/891,443

Filed: 09/27/2010

For: ANALOG DATA GENERATING AND PROCESSING DEVICE FOR USE WITH A PERSONAL COMPUTER

The owner*, Papst Licensing GmbH & Co. KG, of 100 percent interest in the instant application hereby disclaims, except as provided below, the terminal part of the statutory term of any patent granted on the instant application which would extend beyond the expiration date of the full statutory term of any patent granted on pending reference Application Number 11/467,092, filed 08-24-2006, as the term of any patent granted on said reference application may be shortened by any terminal disclaimer filed prior to the grant of any patent on the pending reference application. The owner hereby agrees that any patent so granted on the instant application shall be enforceable only for and during such period that it and any patent granted on the reference application are commonly owned. This agreement runs with any patent granted on the instant application and is binding upon the grantee, its successors or assigns.

In making the above disclaimer, the owner does not disclaim the terminal part of any patent granted on the instant application that would extend to the expiration date of the full statutory term of any patent granted on said reference application, "as the term of any patent granted on said reference application may be shortened by any terminal disclaimer filed prior to the grant of any patent on the pending reference application," in the event that: any such patent: granted on the pending reference application: expires for failure to pay a maintenance fee, is held unenforceable, is found invalid by a court of competent jurisdiction, is statutorily disclaimed in whole or terminally disclaimed under 37 CFR 1.321, has all claims canceled by a reexamination certificate, is reissued, or is in any manner terminated prior to the expiration of its full statutory term as shortened by any terminal disclaimer filed prior to its grant.

Check either box 1 or 2 below, if appropriate.

1. For submissions on behalf of a business/organization (e.g., corporation, partnership, university, government agency, etc.), the undersigned is empowered to act on behalf of the business/organization.

I hereby declare that all statements made herein of my own knowledge are true and that all statements made on information and belief are believed to be true; and further that these statements were made with the knowledge that willful false statements and the like so made are punishable by fine or imprisonment, or both, under Section 1001 of Title 18 of the United States Code and that such willful false statements may jeopardize the validity of the application or any patent issued thereon.

2. The undersigned is an attorney or agent of record. Reg. No. 29,434

Signature

James A. Scheer

12/28/11
Date

Typed or printed name

312-655-1500

Telephone Number

- Terminal disclaimer fee under 37 CFR 1.20(d) is included.

WARNING: Information on this form may become public. Credit card information should not be included on this form. Provide credit card information and authorization on PTO-2038.

*Statement under 37 CFR 3.73(b) is required if terminal disclaimer is signed by the assignee (owner).
Form PTO/SB/96 may be used for making this statement. See MPEP § 324.

This collection of information is required by 37 CFR 1.321. The information is required to obtain or retain a benefit by the public which is to file (and by the USPTO to process) an application. Confidentiality is governed by 35 U.S.C. 122 and 37 CFR 1.11 and 1.14. This collection is estimated to take 12 minutes to complete, including gathering, preparing, and submitting the completed application form to the USPTO. Time will vary depending upon the individual case. Any comments on the amount of time you require to complete this form and/or suggestions for reducing this burden, should be sent to the Chief Information Officer, U.S. Patent and Trademark Office, U.S. Department of Commerce, P.O. Box 1450, Alexandria, VA 22313-1450. DO NOT SEND FEES OR COMPLETED FORMS TO THIS ADDRESS. SEND TO: Commissioner for Patents, P.O. Box 1450, Alexandria, VA 22313-1450.

If you need assistance in completing the form, call 1-800-PTO-9199 and select option 2.

Electronic Patent Application Fee Transmittal

Application Number:	12891443
Filing Date:	27-Sep-2010
Title of Invention:	ANALOG DATA GENERATING AND PROCESSING DEVICE FOR USE WITH A PERSONAL COMPUTER
First Named Inventor/Applicant Name:	Michael Tasler
Filer:	James A. Scheer/mawish elahi
Attorney Docket Number:	0757-113189

Filed as Large Entity

Utility under 35 USC 111(a) Filing Fees

Description	Fee Code	Quantity	Amount	Sub-Total in USD(\$)
Basic Filing:				
Pages:				
Claims:				
Miscellaneous-Filing:				
Petition:				
Patent-Appeals-and-Interference:				
Post-Allowance-and-Post-Issuance:				
Extension-of-Time:				
Extension - 3 months with \$0 paid	125	JVC	KENWOOD CORP., et al.	

Description	Fee Code	Quantity	Amount	Sub-Total in USD(\$)
Miscellaneous:				
Statutory or terminal disclaimer	1814	1	160	160
Total in USD (\$)				1430

Electronic Acknowledgement Receipt

EFS ID:	11716403
Application Number:	12891443
International Application Number:	
Confirmation Number:	1408
Title of Invention:	ANALOG DATA GENERATING AND PROCESSING DEVICE FOR USE WITH A PERSONAL COMPUTER
First Named Inventor/Applicant Name:	Michael Tasler
Customer Number:	24628
Filer:	James A. Scheer/mawish elahi
Filer Authorized By:	James A. Scheer
Attorney Docket Number:	0757-113189
Receipt Date:	28-DEC-2011
Filing Date:	27-SEP-2010
Time Stamp:	11:13:44
Application Type:	Utility under 35 USC 111(a)

Payment information:

Submitted with Payment	yes
Payment Type	Deposit Account
Payment was successfully received in RAM	\$1430
RAM confirmation Number	7065
Deposit Account	230920
Authorized User	

The Director of the USPTO is hereby authorized to charge indicated fees and credit any overpayment as follows:

Charge any Additional Fees required under 37 C.F.R. Section 1.21 (Miscellaneous fees and charges)

File Listing:					
Document Number	Document Description	File Name	File Size(Bytes)/ Message Digest	Multi Part /.zip	Pages (if appl.)
1	Extension of Time	113189eot.PDF	29147 b020f0b46fc86ab8b1054c597ec8f4b4d5f948fc	no	1
Warnings:					
Information:					
2	Applicant Arguments/Remarks Made in an Amendment	113189amendment.PDF	272592 28e5e5ad56539b6940cb6dbc1eae8609c481ba42	no	25
Warnings:					
Information:					
3	Terminal Disclaimer Filed	113189terminaldisclaimeersigned.pdf	28767 ca370e254150c54ab7d9f3c22f1f43abff202e15	no	1
Warnings:					
Information:					
4	Fee Worksheet (SB06)	fee-info.pdf	32266 34f549638258e7729041010ad557d9552fc9e1c5	no	2
Warnings:					
Information:					
Total Files Size (in bytes):			362772		
<p>This Acknowledgement Receipt evidences receipt on the noted date by the USPTO of the indicated documents, characterized by the applicant, and including page counts, where applicable. It serves as evidence of receipt similar to a Post Card, as described in MPEP 503.</p> <p><u>New Applications Under 35 U.S.C. 111</u> If a new application is being filed and the application includes the necessary components for a filing date (see 37 CFR 1.53(b)-(d) and MPEP 506), a Filing Receipt (37 CFR 1.54) will be issued in due course and the date shown on this Acknowledgement Receipt will establish the filing date of the application.</p> <p><u>National Stage of an International Application under 35 U.S.C. 371</u> If a timely submission to enter the national stage of an international application is compliant with the conditions of 35 U.S.C. 371 and other applicable requirements a Form PCT/DO/EO/903 indicating acceptance of the application as a national stage submission under 35 U.S.C. 371 will be issued in addition to the Filing Receipt, in due course.</p> <p><u>New International Application Filed with the USPTO as a Receiving Office</u> If a new international application is being filed and the international application includes the necessary components for an international filing date (see PCT Article 11 and MPEP 1810), a Notification of the International Application Number and of the International Filing Date (Form PCT/RO/105) will be issued in due course, subject to prescriptions concerning national security, and the date shown on this Acknowledgement Receipt will establish the international filing date of the application.</p>					

Under the paperwork Reduction Act of 1995, no persons are required to respond to a collection of information unless it displays a valid OMB control number.

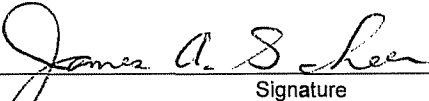
PETITION FOR EXTENSION OF TIME UNDER 37 CFR 1.136(a) FY 2009 <i>(Fees pursuant to the Consolidated Appropriations Act, 2005 (H.R. 4818).)</i>		Docket Number (Optional) 113189	
Application Number 12/891,443		Filed September 27, 2010	
For AN ANALOG DATA GENERATING AND PROCESSING DEVICE FOR USE WITH A PERSONAL COMPUTER			
Art Unit 2111		Examiner Lee, Chun Kuan	
This is a request under the provisions of 37 CFR 1.136(a) to extend the period for filing a reply in the above identified application.			
The requested extension and fee are as follows (check time period desired and enter the appropriate fee below):			
		<u>Fee</u>	<u>Small Entity Fee</u>
<input type="checkbox"/>	One month (37 CFR 1.17(a)(1))	\$130	\$65
<input type="checkbox"/>	Two months (37 CFR 1.17(a)(2))	\$490	\$245
<input checked="" type="checkbox"/>	Three months (37 CFR 1.17(a)(3))	\$1110	\$555
<input type="checkbox"/>	Four months (37 CFR 1.17(a)(4))	\$1730	\$865
<input type="checkbox"/>	Five months (37 CFR 1.17(a)(5))	\$2350	\$1175
<input type="checkbox"/>	Applicant claims small entity status. See 37 CFR 1.27.		
<input type="checkbox"/>	A check in the amount of the fee is enclosed.		
<input type="checkbox"/>	Payment by credit card. Form PTO-2038 is attached.		
<input checked="" type="checkbox"/>	The Director has already been authorized to charge fees in this application to a Deposit Account.		
<input checked="" type="checkbox"/>	The Director is hereby authorized to charge any fees which may be required, or credit any overpayment, to Deposit Account Number <u>23-0920</u> .		
WARNING: Information on this form may become public. Credit card information should not be included on this form. Provide credit card information and authorization on PTO-2038.			
I am the	<input type="checkbox"/>	applicant/inventor.	
	<input type="checkbox"/>	assignee of record of the entire interest. See 37 CFR 3.71. Statement under 37 CFR 3.73(b) is enclosed (Form PTO/SB/96).	
	<input checked="" type="checkbox"/>	attorney or agent of record. Registration Number <u>29,434</u>	
	<input type="checkbox"/>	attorney or agent under 37 CFR 1.34. Registration number if acting under 37 CFR 1.34 _____.	
		December 27, 2011	
James A. Scheer		Date	
Typed or printed name		(312) 655-1500	
		Telephone Number	
NOTE: Signatures of all the inventors or assignees of record of the entire interest or their representative(s) are required. Submit multiple forms if more than one signature is required, see below.			
<input type="checkbox"/>	Total of <u>1</u> forms are submitted.		

This collection of information is required by 37 CFR 1.136(a). The information is required to obtain or retain a benefit by the public which is to file (and by the USPTO to process) an application. Confidentiality is governed by 35 U.S.C. 122 and 37 CFR 1.11 and 1.14. This collection is estimated to take 6 minutes to complete, including gathering, preparing, and submitting the completed application form to the USPTO. Time will vary depending upon the individual case. Any comments on the amount of time you require to complete this form and/or suggestions for reducing this burden, should be sent to the Chief Information Officer, U.S. Patent and Trademark Office, U.S. Department of Commerce, P.O. Box 1450, Alexandria, VA 22313-1450. DO NOT SEND FEES OR COMPLETED FORMS TO THIS ADDRESS. SEND TO: Commissioner for Patents, P.O. Box 1450, Alexandria, VA 22313-1450.

Docket No.: 0757-113189
(PATENT)

IN THE UNITED STATES PATENT AND TRADEMARK OFFICE

In re Patent Application of:
Michael Tasler

Application No.: 12/891,443

Confirmation No.: 1408

Filed: September 27, 2010

Art Unit: 2181

For: ANALOG DATA GENERATING AND
PROCESSING DEVICE FOR USE WITH A
PERSONAL COMPUTER

Examiner: Lee, Chun Kuan

AMENDMENT

Mail Stop Amendment
Commissioner for Patents
P.O. Box 1450
Alexandria, VA 22313-1450

Dear Sir:

In response to the Office Action mailed July 22, 2011, please amend the above identified application as follows:

Amendments To The Claims:

Please cancel claim 1 and add new claims 2-36:

1. (cancelled).

2. (currently amended) An analog data acquisition device operatively connectable to a computer through a multipurpose interface of the computer, the computer having an operating system and being programmed so that when it receives a signal from the device through said multipurpose interface of the computer indicative of a class of devices, the computer automatically activates a device driver corresponding to ~~that~~the class of devices for allowing the transfer of data between the device and the operating system of the computer, the analog data acquisition device comprising:

a) a program memory;

b) an analog signal acquisition channel for receiving a signal from an analog source;

c) a processor operatively interfaced with the multipurpose interface of the computer, the program memory, and a data storage memory when the analog data acquisition device is operational;

d) wherein the processor is configured and programmed to implement a data generation process by which analog data is acquired from the analog signal acquisition channel, the analog data is processed, and digitized, and the processed and digitized analog data is stored in a file system of the data storage memory as at least one file of digitized analog data;

e) wherein when the analog acquisition device is operatively interfaced with the multipurpose interface of the computer, the processor executes at least one instruction set stored in the program memory and thereby automatically causes at least one parameter indicative of the class of devices to be sent to the computer through the multipurpose interface of the computer,

independent of the analog source, wherein the analog data acquisition device is not within the class of devices; and

f) wherein the processor is further configured and programmed to execute at least one other instruction set stored in the program memory to thereby allow the at least one file of digitized analog data acquired from the analog signal acquisition channel to be transferred to the computer using the device driver corresponding to said class of devices so that the analog data acquisition device appears to the computer as if it were a device of ~~that~~the class of devices;

whereby there is no requirement for any user-loaded file transfer enabling software to be loaded on or installed in the computer in addition to ~~it~~the operating system.

3. (previously presented) The analog data acquisition device of claim 2, wherein the analog data acquisition device is a stand alone device.

4. (previously presented) The analog data acquisition device of claim 2, wherein the analog data acquisition device includes a SCSI interface circuit.

5. (previously presented) The analog data acquisition device of claim 2, wherein the analog data acquisition device is designed so that the analog source is detachable.

6. (previously presented) The analog data acquisition device of claim 2 configured to allow for a plurality of different data transmit devices to be attached thereto and detached therefrom.

7. (currently amended) The analog data acquisition device of claim 2, wherein the processor is adapted to be interfaced with ~~a~~the multi-purpose interface of an external computing device by means of a cable.

8. (previously presented) The analog data acquisition device of claim 2, wherein the analog source comprises a data transmit/receive device.

9. (previously presented) The analog data acquisition device of claim 8, wherein the analog source is designed for one of one-way and two-way communication with the host device.

10. (currently amended) The analog data acquisition device of claim 2, wherein the ~~analog source is designed to receive data from the host device~~processor converts the digitized analog data acquired from the analog signal acquisition channel to a form that simulates data from a hard disk and transfers that converted data to the computer through the multipurpose interface such that the converted data appears to the computer as data from a hard disk.

11. (currently amended) The analog data acquisition device of Claim 2 further comprising a plurality of independent analog signal acquisition channels, each of the plurality of channels operatively coupled to the processor for operatively coupling to one of a plurality of analog sources such that analog data is simultaneously acquired from at least two of the plurality of channels, is digitized and is coupled into the processor and is processed by the processor.

12. (previously presented) The analog data acquisition device of claim 2, wherein the processor allows for a plurality of different data transmit devices to be attached thereto and detached therefrom.

13. (previously presented) The analog data acquisition device of claim 2, wherein the processor is designed so that a user can attach the analog source thereto or detach the analog source therefrom.

14. (withdrawn) The analog data acquisition device of claim 2, wherein the analog source comprises a multimeter.

15. (previously presented) The analog data acquisition device of claim 2, wherein the analog source includes at least first and second transducers both of which are designed to transmit data.

16. (previously presented) The analog data acquisition device of claim 2, wherein the at least one parameter is consistent with the analog data acquisition device being responsive to a SCSI inquiry command.

17. (withdrawn) The analog data acquisition device of claim 2, wherein the analog

source is a medical device.

18. (currently amended) The analog data acquisition device of claim 2, wherein the processor is configured to cause acquired analog data file system information to be automatically sent to the multi-purpose interface after the at least one parameter has been sent to ~~the~~ multi-purpose interface of the computer, (a) without requiring any end user to load any software onto the computer at any time, and (b) without requiring any end user to interact with the computer to set up a file system in the analog data acquisition device at any time.

19. (previously presented) The analog data acquisition and interface device of claim 18, wherein the analog data acquisition device file system information comprises at least an indication of a file system type that is used to store the digitized analog data.

20. (currently amended) The analog data acquisition device of claim 2, wherein the processor is configured to cause file allocation table information to be sent to the ~~multi-purpose~~multipurpose interface, wherein the processor is configured to cause a virtual boot sequence to be sent to the ~~multi-purpose~~multipurpose interface which includes at least information that is representative of a number of sectors of a storage disk, and wherein the file allocation table information includes at least a start location of a file allocation table.

21. (previously presented) The analog data acquisition device of claim 2, wherein the processor is configured to initiate a process by which the at least one file of digitized analog data is directly transferred to an input/output device.

22. (currently amended) The analog data acquisition device of claim 21, wherein the processor is configured to allow a mode of operation of the analog data acquisition device other than the transfer of at least some of the at least one file of digitized analog data to the ~~multi-purpose~~multipurpose interface to be controlled by means of an external personal computer.

23. (withdrawn) The analog data acquisition device of claim 2, wherein the analog data acquisition device comprises at least a portion of a medical device.

24. (previously presented) The analog data acquisition device of claim 2, wherein the analog data is processed by being subject to a fast Fourier transform.

25. (withdrawn) The analog data acquisition device of claim 2 wherein the analog data acquisition device is designed so that both the data generation process and automatic file transfer, when they occur, take place only after the at least one parameter has been automatically sent.

26. (withdrawn) The analog data acquisition device of claim 2 wherein the data generation process and automatic data transfer of digitized analog data, when they occur, at least partially overlap in time.

27. (previously presented) The analog data acquisition device of claim 2, wherein the analog source is designed to receive signals from the computer.

28. (withdrawn) The analog data acquisition device of claim 2, wherein the analog data acquisition and interface device is designed so that at least one aspect of how the analog data acquisition device creates at least one file of digitized analog data can be controlled by means of commands that are issuable from a source external to the analog data acquisition device.

29. (withdrawn) The analog data acquisition device of claim 28, wherein the analog data acquisition device is designed so that the at least one aspect is controlled by means of a configuration file.

30. (previously presented) The analog data acquisition device of claim 2, wherein the analog data acquisition device is designed to be responsive to a test unit ready command.

31. (previously presented) The analog data acquisition device of claim 2 wherein the device driver is installed with the operating system.

32. (previously presented) An analog data acquisition and interface device for

interfacing to a host device which includes a mass storage device and associated device driver, comprising:

a processor configured to operatively interface with a memory, an analog source, and a multi-purpose interface of the host device;

wherein the processor is configured to control a data generation process by which analog data is acquired from the analog source, the analog data is processed and digitized, and the processed and digitized analog data is stored in the memory as digitized analog data;

wherein the processor is configured such that, when operatively interfaced with the multi-purpose interface, the processor causes at least one parameter identifying the analog data acquisition device as a digital mass storage device, instead of as an analog data acquisition device and regardless of the analog source, to be automatically sent to the multi-purpose interface of the host device; and

wherein the processor is configured to automatically transfer the digitized analog data acquired from the analog source to the host device, in a manner that causes the analog data acquisition and interface device to appear to be the mass storage device, while using the device driver associated with the mass storage device to perform the automatic transfer without requiring any user-loaded file transfer enabling software to be loaded on or installed in the computer.

33. (withdrawn) An analog data acquisition and interface device for interfacing to a host device which includes a mass storage device and associated device driver, comprising:

a program memory;

a processor coupled to the program memory and configured to operatively interface with a storage memory, an analog source, and a multi-purpose interface of the host

device;

wherein the processor is configured to control a data generation process by which analog data is acquired from the analog source, the analog data is processed and digitized, and the processed and digitized analog data is stored in the memory as digitized analog data;

wherein the processor is configured such that, when operatively interfaced with the multi-purpose interface, the processor causes at least one parameter identifying the analog data acquisition device as a digital mass storage device instead of an analog data acquisition device and regardless of the analog source, to be automatically sent to the multi-purpose interface of the host device;

wherein the processor is configured to automatically transfer to the host device the digitized analog data acquired from the analog source, in a manner that causes the analog data acquisition and interface device to appear to be the mass storage device while using the device driver associated with the mass storage device to perform the automatic transfer;
and

wherein the processor is configured to transmit to the host device commands to access a system bus of the host device to enable direct communications with other data devices of the host device while bypassing any host device processor.

34. (withdrawn) The analog data acquisition and interface device of claim 33, wherein the processor further comprises a plurality of independent analog data acquisition channels for simultaneously acquiring analog data in parallel from a plurality of analog sources.

35. (previously presented) A method for analog data acquisition and interfacing to a host device wherein the host device includes a device driver, comprising:

operatively interfacing a data acquisition device, including a processor and a memory, with a multi-purpose interface of the host device;

acquiring analog data from an analog source, processing and digitizing the analog

data, and storing the processed and digitized analog data in the memory as digitized analog data under control of the processor;

automatically sending under control of the processor at least one parameter to the multi-purpose interface of the host device, the at least one parameter identifying the analog data acquisition device as a digital storage device instead of as an analog data acquisition device, regardless of the analog source: and

automatically transferring to the host device at least some of the digitized analog data acquired from the analog source to the host device in response to a data request command, in a manner that causes the analog data acquisition device to appear to be a digital storage device instead of as an analog data acquisition device, while using the device driver to perform the automatic transfer of the acquired digitized analog data to the host device without requiring any user-loaded file transfer enabling software to be loaded on or installed in the host device.

36. (previously presented) The method of claim 35, further comprising simultaneously acquiring the analog data from each respective analog channel of a plurality of respective independent acquisition channels under control of the processor.

REMARKS

Reconsideration and further examination of the subject patent application in view of the present Amendment and the following Remarks is respectfully requested. Claim 1 was previously cancelled, and claims 2-36 are pending, with claims 14, 17, 23, 25, 26, 28, 29, 33 and 34 withdrawn from examination. Claims 2, 7, 14, 17, 18, 20, 23, 25, 26, 28, 29, 33 and 34 have been objected to for informalities. Claims 2-4, 6-10, 12, 15-16, 18-22, 27, 30-32 and 35 have been rejected under 35 U.S.C. §103(a) as being unpatentable over Hashimoto (U.S. Pat. No. 6,111,604), in view of Smith (U.S. Pat. No. 5,634,075), Ristelhueber (“Plug and Play is almost here”), and Shinohara (U.S. Pat. No. 5,742,934). Claims 5 and 13 have been rejected under 35 U.S.C. §103(a) as being unpatentable over Hashimoto, Smith, Ristelhueber and Shinohara, and further in view of Endo (U.S. Pat. No. 4,652,928), and Claim 24 has been rejected under 35 U.S.C. §103(a) as being unpatentable over Hashimoto, Smith, Ristelhueber, and Shinohara and further in view of Roberts (U.S. Pat. No. 5,576,757). Claims 11 and 36 have been rejected under 35 U.S.C. §103(a) as being unpatentable over Hashimoto, Smith, Ristelhueber, and Shinohara further in view of Nakamura (U.S. Pat. No. 6,278,492). Claim 2 has been provisionally rejected on the grounds of non-statutory obviousness type double patenting over claim 239 of co-pending application no, 11/467,092. Claims 2, 7, 10, 11, 18, 20 and 22 have been amended and a terminal disclaimer has been submitted herewith. After careful review of the claims and references, it is believed that the claims are in allowable form and a Notice of Allowance if respectfully requested.

Claims 14, 17, 23, 25-26, 28-29, and 33-34 have been objected to as being withdrawn

and have been labeled as “withdrawn” as suggested by the Examiner. Claims 2, 7, 18, 20 and 22 have been objected to for typographical errors regarding the phrases “a multipurpose interface” and “class of devices”. These claims have been amended as suggested by the Examiner. Applicant submits that all the claims are now in allowable form.

Claim 2 has been provisionally rejected on the grounds of non-statutory obviousness – type double patenting as being unpatentable over claim 239 of co-pending application no. 11/467,092. The Office Action indicated that this rejection would be overcome by a terminal disclaimer. A terminal disclaimer has been submitted herewith thereby overcoming the rejection.

Independent claim 10 has been amended to recite that the processor converts the acquired, digitized analog data to a form that simulates data from a hard disk (see e.g. specification p. 9-10, paragraphs 0024-25). Claim 11 has been amended to recite that data from a plurality of analog acquisition channels is simultaneously acquired, and is coupled into the processor (see, e.g. Fig.2 and specification p.16, paragraph 0040) and processed by the processor. Neither of these features is disclosed by any of the cited references.

At the Examiner’s request, a telephone interview was conducted on July 12, 2011 in which the claims in general were discussed and the Examiner asked questions regarding characterizing the invention. An interview summary by the Examiner has been submitted with the Office Action. Applicant respectfully disagrees with the summary of the interview particularly the attempt to reduce the claims to the “inventive concept”. The summary states that Applicant indicated an inventive concept with regard to claims of another application. However, these claims are not believed to be relevant as they concern another application and invention. Applicant would like to clarify that much of the interview was merely a discussion

to help the understanding of the examiner, but that applicant still relies on the claims as written and as a whole, and does not agree with reducing the claim to an inventive concept. The summary also refers to “the informing for such file transfer characteristics...”. Applicant does not understand this statement and therefore disagrees. In addition, the summary states that agreement was reached with regard to “the inventive concept for the instant application.” Applicant respectfully disagrees. Applicant did not and does not agree with recharacterizing the claims to an inventive concept of the summary’s indications of invention concepts. It is Applicant’s position that the claims as they are set out define the invention, and that it is these claims which should be examined. Thus, Applicant respectfully requests that each claim of this application be examined as written and as a whole.

It is respectfully submitted that, the claims as presented are distinguishable over any combination of the cited references Hashimoto, Smith, Ristelhueber, Shinohara, Endo and Roberts. As such, it is respectfully submitted that the claims 2-36 are patentably distinguishable over all prior art of record.

The Office Action rejected claims 2-4, 6-10, 12, 15-16, 18-22, 27, 30-32, and 35 (which includes all the independent claims 2, 32, and 35) as obvious based on the combination of Hashimoto, Smith, Ristelhueber, and Shinohara. The Office Action asserts (Office Action, p. 16) that Hashimoto teaches a processor that executes at least one instruction set to establish communications with the computer. However, Hashimoto does not describe such execution of an instruction set to establish communication with the host computer as claimed. Rather, Hashimoto describes a circuit in which a processor 23 detects proper connection to a host circuit interface by monitoring the data terminal ready (DTR) signal of the RS-232 connection or another signal of similar function of another user selected communications protocol

(Hashimoto, Col. 10, lines 44-65; Fig. 4). When the signal from the communication interface is detected, a communication algorithm is set up in the camera to prepare the camera to transmit or receive information. Then the camera system detects whether a switch on the camera has been manually set to transmit or to receive to determine whether to transmit image data or receive data (Hashimoto, Col. 15, lines 3-16). Thus, Hashimoto merely describes a process for detection by the camera of an active connection by monitoring the interface. This detection process is not the process claimed which is a process in which the analog device processor executes instructions to cause a class identifying parameter (mis-indicative of the class of the device) to be sent to the host computer (i.e. automatically sends mis-identifying information to the host computer). Hashimoto merely describes a process performed by the peripheral which detects the peripheral's proper connection to a host interface, not a process performed by the host to identify a peripheral. Hashimoto's process (peripheral detecting its connection to host) is the opposite of the claimed process (host detects a class parameter sent from the peripheral). Thus, there is no description anywhere in Hashimoto of the claimed process of executing a set of instructions that sends a class identifying parameter to the host computer. Further, at the time of the Hashimoto disclosure, the user would load software and input information into the host computer to identify the camera. There was no requirement for or need for the camera CPU of Hashimoto to be involved in a process to identify itself to the host computer.

Similarly, neither Hashimoto nor any of the other cited references disclose a processor in the peripheral device involved in automatically sending a mis-identifying class parameter to the host computer. The Office Action concedes that Hashimoto does not teach automatically causing a class identifying parameter different than the class of the analog device to be sent as claimed (Office Action; p. 16-17), but asserts that Smith teaches automatically sending the

computer at least one parameter through the multipurpose port in figs. 2-5, and Col. 1-4, and Col. 6; and further asserts that by combining Hashimoto's analog data acquisition device architecture with Smith's Plug and Play functionality (Plug and Play refers to ISA PnP system bus technology referred to in both the Smith and Ristelhueber references) the combination further teaches this feature.

However, not only does Hashimoto not disclose automatic transmission of a class indicating parameter as discussed above, but Smith also fails to disclose this feature of automatically sending such class identification information. Smith describes Plug and Play systems as requiring the Plug and Play host computer to assign a "handle" (I.D. number) to each peripheral card and then the host computer reads resource data from the peripheral (see, e.g. Col. 4, lines 26-34; Col. 3, lines 41-59). Thus, the host computer in Smith assigns an identifying number rather than the peripheral processor automatically sending identification information. Then the host computer reads resource data from the peripheral (Smith, Col. 4, lines 26-28: "the operating system will isolate each PnP device assign a "handle" (number) to each card, and read the resource data from that card"). There is no description of automatic sending of class of device identification data. The Plug and Play process described in Smith or any other of the references is not concerned with recognizing the class of the device. It is not a device recognition process, rather it is a host computer resource allocation process concerned with allocation of the resources of the host computer to avoid conflicts between resources within the host. The host computer after supplying an I.D. merely performs a process of reading resource data and then allocating its resources to accommodate all the peripherals attached to it. There is no mention of identification information being read or sent. The cited passages of Smith do not mention a peripheral processor automatically providing identification

information to the host computer. Instead, the host computer initiates a “read” function to obtain resource data from the peripheral. Thus, the plug and play functionality of Smith does not teach or suggest the processor of the peripheral device automatically sending a class parameter to the host. Further, sending a mis-identifying class parameter would be contrary to the concept of plug and play, then teaching away from the claimed feature.

Smith also does not describe a peripheral having a processor involved in the Plug and Play process. The only Plug and Play peripheral device circuitry in Smith is shown in Figs. 6, 7, and 9 which show a circuit made up of registers, flips flops, etc. to allow the peripheral to configure upon power up to operate in legacy mode or plug or play mode. There is no peripheral processor described involved in automatic recognition of the peripheral by the host.

Further, the Plug and Play functionality of Smith is functionality which is primarily located in the host computer not the peripheral. The Plug and Play compatibility as implemented in the peripheral in Smith is merely a set of logic gates and registers (not a processor) to give the peripheral compatibility with the Plug and Play functionality of the host computer. Plug and Play functionality calls for the host computer to configure its resources according to the needs of all the peripherals attached to it and thus primarily concerns software or firmware supplied functions located in the host computer. Thus, it would not make sense to one skilled in the art to put these Plug and Play functions into the peripheral device which would have no use for them. The peripheral device is only going to connect to a host computer and thus does not need to allocate its resources to handle multiple Plug and Play devices. In addition, as discussed above, neither Hashimoto nor Smith teach automatically sending identification information.

The Office Action also suggests that the combination of Smith’s Plug and Play

functionality into Hashimoto's analog data acquisition device architecture would be obvious to one of ordinary skill in the art because it would simplify the installation for the user without the need to install software or configure the peripheral devices. However, Smith expressly teaches the contrary, that a device driver must be loaded once the peripherals have been set up and host computer resources assigned (see e.g., Smith, Fig. 2, ref. 126 and Col. 4 lines 32-33).

The Office Action asserts that Ristelhueber at pages 1-3 teaches a peripheral device whereby there is no requirement for any user-loaded file transfer software to be loaded on the computer in addition to the operating system (Office Action, p. 17). Ristelhueber, however, is a non-technical buyer magazine article which generically describes a future Plug and Play standard with an enthusiastic description of the future ("In about a year the key standard and specifications will be in place to make PnP a reality", p. 1, paragraph 3). Thus, Ristelhueber is not enabling prior art. Ristelhueber is relied upon for disclosure of Plug and Play functionality. The Office Action appears to rely on vague predictions in Ristelhueber regarding recognition of new hardware, and configuring of hardware to relieve the user of the need to fumble with floppy disks and user manuals to get the device up and running. However, when read in context these phrases are predicting PnP will recognize that a new device is connected. The author is not describing recognizing what peripheral is attached, only whether there is a peripheral attached to the port. Further, there is no enabling disclosure of how such recognition would one day be implemented. The description in Ristelhueber is just an over enthusiastic prediction of the hoped for goals for PnP, which is to detect when a new device is attached (i.e. identifying presence not what it is), configure the host computer resources to accommodate it, and then activate the device. However, Ristelhueber nowhere discusses or even mentions device drivers, or what will happen after a device is configured and activated. As discussed

herein, the Smith reference and the PnP Standards Specification make clear that a device driver is still needed after the peripheral has been detected, assigned resources, and activated in accordance with Plug and Play.

In addition, there is no teaching in Ristelhueber of the processor of the peripheral automatically sending identification information to the computer, or of anything done or not done by a processor of a Plug and Play peripheral device. Ristelhueber merely describes the host computer determining the presence of a peripheral device, identifying the resources needed by the peripheral device and configuring its hardware thereby relieving the user from having to do so. There is no teaching in Ristelhueber to relieve the user from having to load a device driver. There is no mention of a processor on the peripheral, and no mention of the need or lack of need for user loaded software on the host computer. Thus, Ristelhueber does not disclose this claimed feature. Rather, Ristelhueber merely broadly describes future Plug and Play hopes without discussing device driver software for proper functioning of the peripheral after it is activated. As discussed above, the Plug and Play still requires loading a device driver after the peripheral device has been activated using a Plug and Play process. Thus, Ristelhueber does not teach a peripheral device which doesn't require an end user to load software onto the computer at anytime and none of the other cited references teach this feature. Therefore, all pending claims are distinguishable over the cited references on this ground as well.

The Office Action also asserts that Shinohara teaches sending a class of devices parameter wherein the analog data acquisition device is not within the class, and teaches transferring acquired analog data to the computer using the device driver of the class so that the analog device appears as if it is a device of the class at Col 1, lines 48-60, and Col 3, lines 3 to Col 4, line 49. Shinohara describes a flash disk drive which couples only to a host computer to

allow the host computer to send data for storage and retrieve the data stored by the host computer. This is entirely different from the claimed analog data acquisition device which acquires analog data from analog sources through a first port, and provides for transfer of the digitized analog data to a separate host computer through a second port. Therefore, the environment and functionality, and the problems to be resolved are completely different, and it would thus not be obvious to combine the Shinohara flash disk drive features with Hashimoto, and because of these fundamental differences, Shinohara is not compatible with Hashimoto.

Moreover, the combination (even if considered somehow together) still would not end up meeting the terms of the claims. Shinohara merely describes how the host computer sends data and sets up the data structure in the flash disk drive but does not teach or even mention that there is no need for user interaction to set up a file system, or that the device is not identified as an analog data acquisition device and is identified instead as a digital mass storage device. Shinohara is merely a mass storage device acting as a mass storage device. Further, the data structure set up would require software on the host computer to perform these set-up functions. Thus, additional software must be added to the host computer to set up the data structure for the flash drive. Further, since Shinohara is merely a hard disk emulator connected to a computer, it cannot cause an acquired file of digitized analog data acquired from a analog source to be transferred (i.e., there is only digital data stored by the host computer). Since Hashimoto, Smith, Kerigan, and Ristelhueber do not teach the automatic process of identifying an analog data acquisition device as some other device and Shinohara also does not teach this feature, all pending claims are distinguishable over the cited references.

Further, none of the references disclose an analog device which acquires and processes analog data but operates and identifies itself as a digital storage device. Shinohara discloses a

mass storage device (i.e. a flash memory) which operates as a mass storage device. This teaching of Shinohara does not suggest to one of ordinary skill in the art the operation and identification of an analog data acquisition device as an entirely different type of device, i.e. a mass storage device, and does not suggest a device which sends an identifying parameter to the host computer identifying the device as a device of dramatically different type than what it actually is. Thus the claims are further distinguishable over the cited references for this reason in addition to the reasons discussed herein above.

The Office Action further asserts that Shinohara teaches a system and a method comprising data transferring using a device driver for the identified class of device while causing the analog data acquisition device to appear to the computer as if it were a device of the identified class without requiring any user-loaded file transfer enabling software to be loaded on or installed in the computer at anytime at Col. 1 lines 48-60 and Col. 3, line 33 to Col. 4, line 49 (Office Action, p. 21). The Office Action alleges that by combining the emulation of a mass storage device of Shinohara with the data transferring Plug and Play functionality of the combined other references, the resulting combination would teach this feature.

However, this is not the case because Shinohara merely describes an approach to extending the life of the flash memory in a flash disk drive. Shinohara at the cited Col. 1, line 48-60 merely describes a flash disk memory which can erase and write data in a unit sector of a flash memory to emulate a hard disk, where the host computer erases and writes a sector designated by the host computer so an address conversion table is not needed and also describes a disk operating system. There is no mention of device drivers, no mention of not needing to load file transfer enabling software. Similarly Col. 3, line 33 to Col. 4, line 49 of Shinohara merely describes details of the flash disk which can cause the flash memory to last for a longer

time using an address conversion table. However, nowhere in Shinohara is there any mention of transferring a file of digitized analog data (Shinohara is a disk drive, as such, it cannot acquire and digitize analog data and therefore cannot transfer it), or any data, without requiring any user loaded file transfer enabling software. Rather, the detailed description cited calls for the host computer to perform unique file management functions (Col. 4, lines 34-49) which would require data transfer software in the host computer to set up the disk emulation. Further, there is no teaching or mention of the disclosed disk emulator being able to transfer data without data-transfer software loaded on the host computer. The Shinohara reference is devoid of any such teaching. Thus, Shinohara does not teach the feature of transferring digitized analog data without requiring any user loaded file transfer enabling software.

The Office Action also asserts that combining the flash memory device of Shinohara with the Plug and Play functionality of the other references such as Smith, teaches this feature. However, as discussed above, Plug and Play is concerned with allocation of the resources of the host computer to avoid conflicts between resources within the host computer. In Plug and Play, the host computer reads the resource requirements from each attached peripheral, such resources as i/o addresses, interrupts levels, and DMA channels, (see, Smith, Col. 3, lines 1-4; also see Plug and Play ISA Specification, Version 1.0a, May 5, 1994 (“Plug and Play Specification”) p.1, abstract, line 5, and lines 9-11). The computer then assigns to each peripheral device the necessary resources so as to avoid resource conflicts (see Smith, Col. 4, lines 25-32; and Plug and Play Spec. p.1, lines 11-12). Once the host computer has assigned its resources and activated the device, an appropriate device driver must then be loaded to permit operation. As described in Smith, Col. 4, lines 26-33 in a PnP (Plug and Play) system:

“...the operating system will isolate each PNP device, assign a ‘handle’ (number) to each card, and read the resource data from that card. Once

each card had been isolated, assigned a handle and read, the operating system software will arbitrate system resources for all PNP devices. Conflict-free resources may then be assigned and the devices activated. Finally, appropriate device drivers may be loaded and the system thus configured.”

Also see Plug and Play Spec. p.1, Abstract, and Smith, Col. 3, lines 52-59. The Plug and Play process thus does not eliminate the need to supply a driver but rather calls for loading the driver after the system resources are allocated and the devices activated. The Plug and Play standard does not address device drivers other than the fact that one is needed. (Plug and Play Specification p. 1 Abstract: “However, user interface issues for installation of device drivers are not addressed”.) Thus, even with Plug and Play, a device specific driver is still needed for each peripheral installed in the Plug and Play computer system in order for the peripheral’s processor to execute an instruction to automatically transfer a file of digitized analog data to the computer from the peripheral device. This is clearly demonstrated by the Smith reference and the Plug and Play Specification document. Thus, neither Shinohara nor the Plug and Play functionality disclosed in the other cited references teach data transfer without a user loaded driver.

Moreover, the device described in Shinohara is merely a memory for storage of digital data by a host computer and for retrieval of that data by the host computer, and thus is not suitable for receiving analog data from a source independent of the host computer nor for transferring acquired digitized analog data to a host computer. Further, Shinohara does not teach transferring the acquired analog data while causing the analog data acquisition device to appear to the computer as a digital storage device, as claimed. The Shinohara device has one port that merely receives and stores digital data from the computer and allows that same computer to retrieve that stored data through the same port. The claimed invention has two separate ports providing input of analog data on one port and subsequent transfer of digitized

analog data to a computer on another port. Thus, the disk memory emulation of Shinohara is dramatically different from the claimed invention and not compatible with or combinable with Hashimoto to obtain the claimed invention.

Stated another way, at most Shinohara merely teaches that a digital memory device having a single read/write port such as a flash memory, may be configured to emulate another digital memory device. This does not suggest, and is not related to, an analog data acquisition device having both an analog input and a host computer interface port which can emulate a hard disk. Thus, the combination of Shinohara with the other references does not teach or suggest the claimed automatic file transfer of acquired digitized analog data without requiring user loaded file transfer enabling software. Indeed, there is nothing to suggest the advantage of not requiring user loaded file transfer enabling software in any device, let alone in an analog data acquisition device.

Accordingly, it is respectfully submitted that all the pending claims are distinguishable over the cited references because none of the references teaches the claimed transfer of a file of acquired digitized analog data by an analog data acquisition device while appearing to be another class of device without loading file transfer enabling software. That is, even if all the references could somehow be combined (which they cannot, as explained hereinafter), the result would still not meet the combined limitations of the claims.

In addition to the lack of disclosure of the claimed feature discussed hereinabove, Hashimoto and Smith are incompatible and cannot be properly combined. As previously discussed, Hashimoto detects that it is properly connected to a host computer interface by monitoring for a DTR signal. Until the DTR signal is detected, the power to the communication circuitry is turned off or in standby mode (Hashimoto, Col. 12, lines 62 to Col.

13, lines 8). After detecting the proper connection and activating the communication circuitry, Hashimoto checks a switch 110 which is manually set by the camera user, to determine whether it is in the transmit mode or is in a receive mode. (Hashimoto, Fig. 14, Ref. No. 308; Col. 10, lines 51-54 and Col. 11, lines 7-13). Thus, at any point in time, the Hashimoto camera is enabled to only transmit, or only receive; it is not enabled to do both. The user must manually switch between modes. Smith, however, describes a Plug and Play process which requires the host computer to read resource data from the PnP peripheral device (see e.g. Smith, Col. 3, lines 41-43; Col. 4, lines 25-28). This read function requires the peripheral to receive a read request, which would include an address, and then requires the peripheral to transmit the resource data to the host computer. Thus, Smith's Plug and Play (and PnP in general) cannot be added to Hashimoto because the Hashimoto camera cannot both transmit and receive data at any one moment. If the mode switch in the Hashimoto camera is in the transmit position, then the camera would not be able to receive the read request and address, and if the mode switch is in the receive position, the camera would not be able to transmit the resource data. Thus, Hashimoto and Smith, are incompatible and cannot properly be combined. This is also true of Plug and Play in general.

In a further inconsistency, the rejection assumes that Plug and Play calls for the peripheral device to identify itself (although, as discussed above, this is not disclosed in the references). This assumption would inherently call for the device to correctly identify itself which is contrary to the claim requirement that the class parameter sent to the host computer identify a different class of device. Thus, the references cannot be properly combined to render the claim obvious.

The combination of Hashimoto and Shinohara is also improper. Hashimoto describes

an electronic camera while Shinohara describes a flash disk drive. The Office Action combines Shinohara with Hashimoto by converting the Hashimoto camera to a disk drive emulator, thereby dramatically changing the fundamental structure, operation, and purpose of Hashimoto. Shinohara is merely a digital memory device having a single port to receive digital data from a computer for storage and to allow the same computer to retrieve that data through the same port. In other words, Shinohara merely teaches that a single port digital memory device can be configured to emulate a hard disk. This does not teach or suggest an analog data acquisition device having both an analog input and a separate host computer interface port emulating a hard disk. It is a huge inventive step to go from a digital mass storage device emulating a digital mass storage device to an analog device emulating a digital mass storage device. Thus, the combination requires improper hindsight based on the teachings of the instant application and therefore, Hashimoto and Shinohara cannot be properly combined.

In addition, as discussed above, Hashimoto operates in a transmit only mode or a receive only mode selected by the user with a mode selection switch. However, to function properly the Shinohara flash disk requires the host computer to read data from it. This is incompatible with Hashimoto one way communication, because the read function requires that the flash memory receive a read request with the address or sectors of the data requested, followed by an immediate transmission of the data. Hashimoto's one way communication would prevent this two way exchange. Thus, Shinohara is incompatible and not properly combinable with Hashimoto for this reason as well.

In view of the foregoing, applicant submits that claims 2-13, 15, 16, 18-22, 24, 27, 30-32, 35 and 36 are patentable over Hashimoto in view of the combined teachings of Smith, Ristelhueber, Roberts, Endo, and Shinohara. Accordingly, applicant respectfully submits that

the instant application is in condition for allowance, and a Notice of Allowance is respectfully requested. Should the Examiner be of the opinion that a telephone conference would expedite prosecution of the subject application, the Primary Examiner is respectfully requested to call the undersigned at the below-listed number.

The Commissioner is hereby authorized to charge any additional fee which may be required for this application under 37 C.F.R. §§ 1.16-1.18, including but not limited to the extension of time fee, RCE fee, petition fee, extra claims fee, the issue fee, or credit any overpayment, to Deposit Account No. 23-0920. Should no proper amount be enclosed herewith, as by a check being in the wrong amount, unsigned, post-dated, otherwise improper or informal, or even entirely missing, the Commissioner is authorized to charge the unpaid amount to Deposit Account No. 23-0920.

Respectfully submitted,

HUSCH BLACKWELL LLP

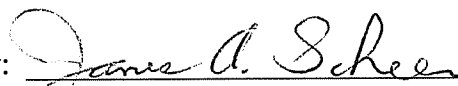
By: 
James A. Scheer
Registration No. 29,434

Dated: December 27, 2011

HUSCH BLACKWELL LLP
120 South Riverside Plaza, 22nd Floor
Chicago, Illinois 60606
(312) 655-1500



UNITED STATES PATENT AND TRADEMARK OFFICE

UNITED STATES DEPARTMENT OF COMMERCE
United States Patent and Trademark Office
Address: COMMISSIONER FOR PATENTS
P.O. Box 1450
Alexandria, Virginia 22313-1450
www.uspto.gov

APPLICATION NO.	FILING DATE	FIRST NAMED INVENTOR	ATTORNEY DOCKET NO.	CONFIRMATION NO.
12/891,443	09/27/2010	Michael Tasler	0757-113189	1408
24628	7590	07/22/2011	EXAMINER	
Husch Blackwell LLP Husch Blackwell Sanders LLP Welsh & Katz 120 S RIVERSIDE PLAZA 22ND FLOOR CHICAGO, IL 60606			LEE, CHUN KUAN	
			ART UNIT	PAPER NUMBER
			2181	
			MAIL DATE	DELIVERY MODE
			07/22/2011	PAPER

Please find below and/or attached an Office communication concerning this application or proceeding.

The time period for reply, if any, is set in the attached communication.

Office Action Summary	Application No. 12/891,443	Applicant(s) TASLER, MICHAEL
	Examiner Chun-Kuan Lee	Art Unit 2181

-- The MAILING DATE of this communication appears on the cover sheet with the correspondence address --

Period for Reply

A SHORTENED STATUTORY PERIOD FOR REPLY IS SET TO EXPIRE 3 MONTH(S) OR THIRTY (30) DAYS, WHICHEVER IS LONGER, FROM THE MAILING DATE OF THIS COMMUNICATION.

- Extensions of time may be available under the provisions of 37 CFR 1.136(a). In no event, however, may a reply be timely filed after SIX (6) MONTHS from the mailing date of this communication.
- If NO period for reply is specified above, the maximum statutory period will apply and will expire SIX (6) MONTHS from the mailing date of this communication.
- Failure to reply within the set or extended period for reply will, by statute, cause the application to become ABANDONED (35 U.S.C. § 133). Any reply received by the Office later than three months after the mailing date of this communication, even if timely filed, may reduce any earned patent term adjustment. See 37 CFR 1.704(b).

Status

- 1) Responsive to communication(s) filed on 07 June 2011.
- 2a) This action is **FINAL**.
- 2b) This action is non-final.
- 3) Since this application is in condition for allowance except for formal matters, prosecution as to the merits is closed in accordance with the practice under *Ex parte Quayle*, 1935 C.D. 11, 453 O.G. 213.

Disposition of Claims

- 4) Claim(s) 2-36 is/are pending in the application.
 - 4a) Of the above claim(s) 14, 17, 23, 25, 26, 28, 29, 33 and 34 is/are withdrawn from consideration.
- 5) Claim(s) _____ is/are allowed.
- 6) Claim(s) 2-13, 15, 16, 18-22, 24, 27, 30-32, 35 and 36 is/are rejected.
- 7) Claim(s) 2, 7, 14, 17, 18, 20, 22, 23, 25, 26, 28, 29, 33 and 34 is/are objected to.
- 8) Claim(s) _____ are subject to restriction and/or election requirement.

Application Papers

- 9) The specification is objected to by the Examiner.
- 10) The drawing(s) filed on 27 September 2010 is/are: a) accepted or b) objected to by the Examiner.
 - Applicant may not request that any objection to the drawing(s) be held in abeyance. See 37 CFR 1.85(a).
 - Replacement drawing sheet(s) including the correction is required if the drawing(s) is objected to. See 37 CFR 1.121(d).
- 11) The oath or declaration is objected to by the Examiner. Note the attached Office Action or form PTO-152.

Priority under 35 U.S.C. § 119

- 12) Acknowledgment is made of a claim for foreign priority under 35 U.S.C. § 119(a)-(d) or (f).
 - a) All b) Some * c) None of:
 - 1. Certified copies of the priority documents have been received.
 - 2. Certified copies of the priority documents have been received in Application No. _____.
 - 3. Copies of the certified copies of the priority documents have been received in this National Stage application from the International Bureau (PCT Rule 17.2(a)).

* See the attached detailed Office action for a list of the certified copies not received.

Attachment(s)

- | | |
|-------------------------------------------------------------------------------------------------------------------------------------------------------------------------------------------------------------------------------------------------------------------------------------------------------------------------------------------------------------------------------------------|------------------------------------------------------------------------------------------------------------------------------------------------------------------------------------------------------------------------------------------------------------------------------------------------|
| <ul style="list-style-type: none"> 1) <input checked="" type="checkbox"/> Notice of References Cited (PTO-892) 2) <input type="checkbox"/> Notice of Draftsperson's Patent Drawing Review (PTO-948) 3) <input checked="" type="checkbox"/> Information Disclosure Statement(s) (PTO/SB/08)
Paper No(s)/Mail Date <u>03/17/2011 & 04/12/2011</u>. | <ul style="list-style-type: none"> 4) <input checked="" type="checkbox"/> Interview Summary (PTO-413)
Paper No(s)/Mail Date. <u>20110718</u>. 5) <input type="checkbox"/> Notice of Informal Patent Application 6) <input type="checkbox"/> Other: _____. |
|-------------------------------------------------------------------------------------------------------------------------------------------------------------------------------------------------------------------------------------------------------------------------------------------------------------------------------------------------------------------------------------------|------------------------------------------------------------------------------------------------------------------------------------------------------------------------------------------------------------------------------------------------------------------------------------------------|

Examiner-Initiated Interview Summary	Application No. 12/891,443	Applicant(s) TASLER, MICHAEL
	Examiner Chun-Kuan Lee	Art Unit 2181
All Participants:	Status of Application: _____	
(1) <u>Alford Kindred (SPE)</u> . (2) <u>Chun-Kuan Lee (Examiner)</u> .	(3) <u>James Sheer (Reg. # 29,434)</u> . (4) <u>Sidney Katz</u> .	
Date of Interview: <u>12 July 2011</u>	Time: _____	

Type of Interview:

- Telephonic
 Video Conference
 Personal (Copy given to: Applicant Applicant's representative)

Exhibit Shown or Demonstrated: Yes No
If Yes, provide a brief description: .

Part I.

Rejection(s) discussed:
N/A

Claims discussed:
N/A

Prior art documents discussed:
N/A

Part II.

SUBSTANCE OF INTERVIEW DESCRIBING THE GENERAL NATURE OF WHAT WAS DISCUSSED:
Please see Continuation Sheet below.

Part III.

- It is not necessary for applicant to provide a separate record of the substance of the interview, since the interview directly resulted in the allowance of the application. The examiner will provide a written summary of the substance of the interview in the Notice of Allowability.
 It is not necessary for applicant to provide a separate record of the substance of the interview, since the interview did not result in resolution of all issues. A brief summary by the examiner appears in Part II above.

(Applicant/Applicant's Representative Signature – if appropriate)

The interview mainly focused on getting a clear understand of applicant's claimed invention, wherein the examiner requested the applicant to clarify how applicant's inventive concept should be characterized, as applicant's indicated in applicant's response, dated 06/07/2011, that the applicant's disagree with the examiner's re-characterization of applicant's claimed invention, and this interview was conducted at the same time as application 11/467,092, wherein during the interview for application 11/467,092, applicant indicated the following:

Applicant indicated that the inventive concept for the instant application is the claims, and concede that the following is how the invention concept is functioning:

Single analog sensing device with multiple parallel channels for acquiring analog data through the multiple parallel channels, wherein the single analog sensing device is connected to a digital device, such as a host, and the digital device (host) recognizing the connected single analog sensing device as a digital device, such as a hard drive (e.g. digital storage device) or printer; and when the single analog sensing device is connected to the digital device (host) for transferring the acquired analog data to the digital device (host), the digital device (host) use a corresponding digital device driver, such as hard drive driver, for communicating with the single analog sensing device, as the digital device (host) thinks that the connected single analog sensing device is the hard drive (digital device).

Additionally, because the utilization of digital device driver (hard drive driver) by the host (digital device), end user loading of any software onto the computer at any time and end user interaction with the computer to set up a file system is not required, as the host (digital device) thinks that the connected single analog sensing device is the hard drive (digital device), and the hard drive driver (digital device driver) is part of the host, that is the host already have the needed digital device driver (hard disk driver).

The examiner then inquired the applicant, base on the applicant's best knowledge, if there is anything out there that has an analog device with multiple parallel channels conventionally? And applicant responded that, at the time when this application was filed, applicant thinks multi-channel analog device exists.

The examiner then inquired how is the instant application differ from application 11/467,092; and applicant indicated that the claims for the instant application are broader as the independent claims for the instant application do not require the multiple parallel channels.

The examiner then inquired how is the functionality for the instant application differs from the application 11/467,092; and applicant indicated that the instant application is basically the same concept as the application 11/467,092.

The examiner then inquired whether the claimed feature regarding one parameter indicative of the class of devices of the analog data acquisition device to be send to the computer corresponds to the functionality for the host to recognize the connected analog device as a hard drive; and applicant responded that the claimed feature is part of the recognition process of the analog device as the hard drive.

The informing of such file transfer characteristics would not necessarily be required for the analog sensing device to do the functioning of what the applicant has been describing. Applicant also indicated that the analog sensing device would not require to do that and that this is an extra limitation that is not necessarily needed; and if the applicant took this claimed limitation out of the independent claim, the applicant would still have a perfectly good independent claim.

Applicant also indicated that the analog data acquisition device communicates with the host in "real time" and provided the following citations in applicant's Specification for support:

Paragraph [0025] on page 10;

Paragraph [0027] on page 11; and

Paragraph [0038] on page 15 (e.g. real time FFT),

wherein applicant indicated that the real time application is optional and not a requirement for implementing the inventive concept for the instant application

Agreement was reached with regard to the inventive concept for the instant application, and no agreement was reached with regard to the allowability of the claims.

DETAILED ACTION

CONTINUED EXAMINATION UNDER 37 CFR 1.114

I. INTERVIEW SUMMARY

1. The interview mainly focused on getting a clear understand of applicant's claimed invention, wherein the examiner requested the applicant to clarify how applicant's inventive concept should be characterized, as applicant's indicated in applicant's response, dated 06/07/2011, that the applicant's disagree with the examiner's re-characterization of applicant's claimed invention, and this interview was conducted at the same time as application 11/467,092, wherein during the interview for application 11/467,092, applicant indicated the following:

Applicant indicated that the inventive concept for the instant application is the claims, and concede that the following is how the invention concept is functioning:

Single analog sensing device with multiple parallel channels for acquiring analog data through the multiple parallel channels, wherein the single analog sensing device is connected to a digital device, such as a host, and the digital device (host) recognizing the connected single analog sensing device as a digital device, such as a hard drive (e.g. digital storage device) or printer; and when the single analog sensing device is connected to the digital device (host) for transferring the acquired analog data to the digital device (host), the digital device (host) use a corresponding digital device driver, such as hard drive driver,

Art Unit: 2181

for communicating with the single analog sensing device, as the digital device (host) thinks that the connected single analog sensing device is the hard drive (digital device).

Additionally, because the utilization of digital device driver (hard drive driver) by the host (digital device), end user loading of any software onto the computer at any time and end user interaction with the computer to set up a file system is not required, as the host (digital device) thinks that the connected single analog sensing device is the hard drive (digital device), and the hard drive driver (digital device driver) is part of the host, that is the host already have the needed digital device driver (hard disk driver).

The examiner then inquired the applicant, base on the applicant's best knowledge, if there is anything out there that has an analog device with multiple parallel channels conventionally? And applicant responded that, at the time when this application was filed, applicant thinks multi-channel analog device exists.

The examiner then inquired how is the instant application differ from application 11/467,092; and applicant indicated that the claims for the instant application are broader as the independent claims for the instant application do not require the multiple parallel channels.

The examiner then inquired how is the functionality for the instant application differs from the application 11/467,092; and applicant indicated that the instant application is basically the same concept as the application 11/467,092.

The examiner then inquired whether the claimed feature regarding one parameter indicative of the class of devices of the analog data acquisition device to be send to the computer corresponds to the functionality for the host to recognize the connected analog device as a hard drive; and applicant responded that the claimed feature is part of the recognition process of the analog device as the hard drive.

The informing of such file transfer characteristics would not necessarily be required for the analog sensing device to do the functioning of what the applicant has been describing. Applicant also indicated that the analog sensing device would not require to do that and that this is an extra limitation that is not necessarily needed; and if the applicant took this claimed limitation out of the independent claim, the applicant would still have a perfectly good independent claim.

Applicant also indicated that the analog data acquisition device communicates with the host in “real time” and provided the following citations in applicant’s Specification for support:

Paragraph [0025] on page 10;

Paragraph [0027] on page 11; and

Paragraph [0038] on page 15 (e.g. real time FFT),

wherein applicant indicated that the real time application is optional and not a requirement for implementing the inventive concept for the instant application

Art Unit: 2181

I. ELECTION / RESTRICTION

2. Applicant's election with traverse of Specie I: claims 2-13, 15-16, 18-22, 24, 27, 30-32, and 35-36 in the reply filed on 06/07/2011 is acknowledged. The traversal is on the ground(s) that Species II-IV are all similarly drawn to the analog data acquisition interface device, wherein claim 14 (Specie II), which is dependent on claim 2, is directed to the analog data acquisition device of claim 2 and merely adds the requirement that the analog source from which data is acquired comprises a multimeter; thus, claim 14 is not directed to a multimeter, but to the analog data acquisition interface device where the analog source comprises a multimeter; similarly, claims 17 and 23 (Species III) are directed to the data acquisition device of claim 2 where the analog source is further limited to require that the analog source is a medical device; claims 25-26 (Specie IV) are also dependent on claim 2 and are directed to the analog data acquisition device of claim 2 with additional timing limitations; claims 28-29 (Specie V) are also dependent on claim 2 and are addressed to the analog data acquisition device of claim 2 with the added limitation of control from an external source and a configuration file; and claims 33 and 34 (Specie VI) are also directed to an analog data acquisition and interface device including direct communication with data devices of the host computer, not to an ASPI driver as asserted by the Office Action; in summary, Species II-VI are directed to the analog data acquisition device of independent claim 2 and are merely dependent claims which further limit an existing element of claim 2; thus, the Examiner can examine all claims together without need for substantial further searching or

Art Unit: 2181

additional fields of search; furthermore, the Office Action characterized the Specie I claims as directed to a "stand along" device, which Applicant interprets to mean "stand alone;" applicant disagrees with this characterization, as there is nothing in the independent claims which limit the claims to a stand alone device; further, dependent claim 3 is expressly further limited to a stand-alone device; thus, in accordance with the well known doctrine of claim differentiation, only claim 3 is directed to a stand alone analog data acquisition interface device; all other claims are not limited to a stand-alone device; the Office Action further characterized the Specie I claims as directed to a device that communicates via a customary I/O driver; however, none of the claims have any limitation to a customary I/O driver; thus, it is Applicant's position that this characterization of the claims is incorrect, and that none of the claims is limited to requiring a customary I/O driver.

This is not found persuasive because the restriction requirement is Species restriction, basing on the different implementation/embodiments on how applicant's inventive concept can be realized, and as indicated in applicant's arguments, each of the Species II-VI is distinguished by the additional requirement on how the analog data acquisition device can be implemented/embodied and a different field of search is needed for each of the additional requirements. Additionally, with regard to Specie VI, paragraph [0053] of applicant's Specification discloses the embodiment/implementation for having the ASPI architecture for direct communication. Furthermore, the examiner is grouping the claims into the different implementation/embodiments, wherein

Art Unit: 2181

Specie I is to implement/embody the analog data acquisition device as a stand-alone device, and as indicated by the examiner in the restriction requirement, claim 2 is the generic claim associated with the analog data acquisition device, wherein applicant's arguments also indicated that Species II-VI each implement/embody the generic analog data acquisition device with different additional requirement. Additionally, paragraph [0015] of applicant's Specification discloses the implement/embodyment for the analog data acquisition to communicate via customary I/O driver.

The requirement is still deemed proper and is therefore made FINAL.

II. REJECTIONS BASED ON DOUBLE PATENTING

The nonstatutory double patenting rejection is based on a judicially created doctrine grounded in public policy (a policy reflected in the statute) so as to prevent the unjustified or improper timewise extension of the "right to exclude" granted by a patent and to prevent possible harassment by multiple assignees. A nonstatutory obviousness-type double patenting rejection is appropriate where the conflicting claims are not identical, but at least one examined application claim is not patentably distinct from the reference claim(s) because the examined application claim is either anticipated by, or would have been obvious over, the reference claim(s). See, e.g., *In re Berg*, 140 F.3d 1428, 46 USPQ2d 1226 (Fed. Cir. 1998); *In re Goodman*, 11 F.3d 1046, 29 USPQ2d 2010 (Fed. Cir. 1993); *In re Longi*, 759 F.2d 887, 225 USPQ 645 (Fed. Cir. 1985); *In re Van Ornum*, 686 F.2d 937, 214 USPQ 761 (CCPA 1982); *In re Vogel*, 422 F.2d 438, 164 USPQ

Art Unit: 2181

619 (CCPA 1970); and *In re Thorington*, 418 F.2d 528, 163 USPQ 644 (CCPA 1969).

A timely filed terminal disclaimer in compliance with 37 CFR 1.321(c) or 1.321(d) may be used to overcome an actual or provisional rejection based on a nonstatutory double patenting ground provided the conflicting application or patent either is shown to be commonly owned with this application, or claims an invention made as a result of activities undertaken within the scope of a joint research agreement.

Effective January 1, 1994, a registered attorney or agent of record may sign a terminal disclaimer. A terminal disclaimer signed by the assignee must fully comply with 37 CFR 3.73(b).

3. Claim 2 provisionally rejected on the ground of nonstatutory obviousness-type double patenting as being unpatentable over claim 239 of copending Application No. 11/467,092. (Please note that as both the instant and copending applications claimed similar subject matters, and in the interest of time and clarity, the examiner is selecting one of the independent claims from the instant and copending applications for the instant double patenting rejection) Although the conflicting claims are not identical, they are not patentably distinct from each other because of the following:

copending Application No. 11/467,092 teaches An analog data acquisition device operatively connectable to a computer through a multipurpose interface of the computer, the computer having an operating system and being programmed so that when it receives a signal from the device through said multipurpose

Art Unit: 2181

interface of the computer indicative of a class of devices, the computer automatically activates a device driver corresponding to the class of devices for allowing the transfer of data between the device and the operating system of the computer, the analog data acquisition device comprising: a) a program memory; b) an analog signal acquisition channel for receiving a signal from an analog source; c) a processor operatively interfaced with the multipurpose interface of the computer, the program memory, and a data storage memory when the analog data acquisition device is operational; d) wherein the processor is configured and programmed to implement a data generation process by which analog data is acquired from the analog signal acquisition channel, the analog data is processed, and digitized, and the processed and digitized analog data is stored in a file system of the data storage memory as at least one file of digitized analog data; e) wherein when the analog acquisition device is operatively interfaced with the multipurpose interface of the computer, the processor executes at least one instruction set stored in the program memory and thereby automatically causes at least one parameter indicative of the class of devices to be sent to the computer through the multipurpose interface of the computer, independent of the analog source, wherein the analog data acquisition device is not within the class of devices; and f) wherein the processor is further configured and programmed to execute at least one other instruction set stored in the program memory to thereby allow the at least one file of digitized analog data acquired from the analog signal acquisition channel to be transferred to the computer using the device driver corresponding to said class of devices so that

Art Unit: 2181

the analog data acquisition device appears to the computer as if it were a device of the class of devices; whereby there is no requirement for any user-loaded file transfer enabling software to be loaded on or installed in the computer in addition to the operating system (claim 239).

This is a provisional obviousness-type double patenting rejection because the conflicting claims have not in fact been patented.

III. OBJECTIONS TO THE CLAIMS

4. Claim 2, 7, 14, 17-18, 20, 22-23, 25-26, 28-29, and 33-34 are objected to because of the following informalities:

in claims 14, 17, 23, 25-26, 28-29, and 33-34, please correct the claim status for claims 14, 17, 23, 25-26, 28-29, and 33-34 to reflect that the claims are now (Withdrawn);

in claim 2, "...An analog data acquisition device operatively connectable to a computer through a multipurpose interface of the computer, the computer having an operating system and being programmed so that when it receives a signal from the device through said multipurpose interface of the computer indicative of a class of devices, the computer automatically activates a device driver corresponding to that class of devices for allowing the transfer of data between the device and the operating system of the computer, the analog data acquisition device comprising:

a) a program memory;

b) an analog signal acquisition channel for receiving a signal from an analog source;

c) a processor operatively interfaced with the multipurpose interface of the computer, the program memory, and a data storage memory when the analog data acquisition device is operational;

d) wherein the processor is configured and programmed to implement a data generation process by which analog data is acquired from the analog signal acquisition channel, the analog data is processed, and digitized, and the processed and digitized analog data is stored in a file system of the data storage memory as at least one file of digitized analog data;

e) wherein when the analog acquisition device is operatively interfaced with multipurpose interface of the computer, the processor executes at least one instruction set stored in the program memory and thereby automatically causes at least one parameter indicative of the class of devices to be sent to the computer through the multipurpose interface of the computer, independent of the analog source, wherein the analog data acquisition device is not within the class; and

f) wherein the processor is further configured and programmed to execute at least one other instruction set stored in the program memory to thereby allow the at least one file of digitized analog data acquired from the analog signal acquisition channel to be transferred to the computer using the device driver corresponding to said class of devices so that the analog data acquisition device appears to the computer as if it were a device of that class;

whereby there is no requirement for any user-loaded file transfer enabling software to be loaded on or installed in the computer in addition to its operating system ...”

should be replaced with

-... An analog data acquisition device operatively connectable to a computer through a multipurpose interface of the computer, the computer having an operating system and being programmed so that when it receives a signal from the device through said multipurpose interface of the computer indicative of a class of devices, the computer automatically activates a device driver corresponding to the class of devices for allowing the transfer of data between the device and the operating system of the computer, the analog data acquisition device comprising:

- a) a program memory;
- b) an analog signal acquisition channel for receiving a signal from an analog source;
- c) a processor operatively interfaced with the multipurpose interface of the computer, the program memory, and a data storage memory when the analog data acquisition device is operational;
- d) wherein the processor is configured and programmed to implement a data generation process by which analog data is acquired from the analog signal acquisition channel, the analog data is processed, and digitized, and the processed and digitized analog data is stored in a file system of the data storage memory as at least one file of digitized analog data;

Art Unit: 2181

e) wherein when the analog acquisition device is operatively interfaced with the multipurpose interface of the computer, the processor executes at least one instruction set stored in the program memory and thereby automatically causes at least one parameter indicative of the class of devices to be sent to the computer through the multipurpose interface of the computer, independent of the analog source, wherein the analog data acquisition device is not within the class of devices; and

f) wherein the processor is further configured and programmed to execute at least one other instruction set stored in the program memory to thereby allow the at least one file of digitized analog data acquired from the analog signal acquisition channel to be transferred to the computer using the device driver corresponding to said class of devices so that the analog data acquisition device appears to the computer as if it were a device of the class of devices;

whereby there is no requirement for any user-loaded file transfer enabling software to be loaded on or installed in the computer in addition to the operating system ...-;

in claim 7, line 2, "... a multi-purpose interface ..." should be replaced with -... the multipurpose interface ...-;

in claim 18, line 3, "... multi-purpose interface ... a multi-purpose interface ..."" should be replaced with -... multipurpose interface ... the multipurpose interface ..." -;

in claim 20, lines 3 and 5, "... the multi-purpose interface ... the multi-purpose interface ..." should be replaced with "... the multipurpose interface ... the multipurpose interface ...-; and

in claim 22, lines 3-4, "... the multi-purpose interface ..." should be replaced with "... the multipurpose interface ... -.

Please note that the request for the replacements as stated above is for the purpose to improve the clarity of the claim language. Appropriate correction is required.

IV. REJECTIONS BASED ON PRIOR ART

Claim Rejections - 35 USC § 103

The following is a quotation of 35 U.S.C. 103(a) which forms the basis for all obviousness rejections set forth in this Office action:

(a) A patent may not be obtained though the invention is not identically disclosed or described as set forth in section 102 of this title, if the differences between the subject matter sought to be patented and the prior art are such that the subject matter as a whole would have been obvious at the time the invention was made to a person having ordinary skill in the art to which said subject matter pertains. Patentability shall not be negated by the manner in which the invention was made.

5. Claims 2-4, 6-10, 12, 15-16, 18-22, 27, 30-32 and 35 are rejected under 35 U.S.C. 103(a) as being unpatentable over Hashimoto et al. (US Patent 6,111,604) in view of Smith et al. (US Patent 5,634,075), Ristelhueber : "Plug and play is almost here" and Shinohara (US Patent 5,742,934).

6. As per claim 2, Hashimoto teaches an analog data acquisition device operatively connectable to a computer through a multipurpose interface of the computer, wherein the computer having an operating system, the analog data acquisition device comprising:

a) a program memory (Fig. 9, ref. 52, 54-55 and col. 8, l. 48 to col. 9, l. 17);

b) an analog signal acquisition channel for receiving a signal from an analog source (Fig. 8, ref. 1, 6, 9; col. 6, l. 16 to col. 9, l. 17 and col. 10, l. 41 to col. 11, l. 42);

c) a processor operatively interfaced with the multipurpose interface of the computer, the program memory (Fig. 9, ref. 52, 54-55), and a data storage memory (Fig. 8, ref. 16) when the analog data acquisition device is operational (Fig. 8; Fig. 9; col. 6, l. 16 to col. 9, l. 17 and col. 10, l. 41 to col. 11, l. 42);

d) wherein the processor is configured and programmed to implement a data generation process by which analog data (e.g. audio and visual analog data) is acquired from the analog signal acquisition channel, the analog data is processed, and digitized, and the processed and digitized analog data is stored in a file system of the data storage memory (Fig. 8, ref. 16 and Fig. 10) as at least one file of digitized analog data (Fig. 1A-1B; Fig. 11-12; Fig. 14-15; col. 1, ll. 27-57; col. 3, l. 43 to col. 4, l. 67; col. 5, ll. 43-57; col. 6, l. 16 to col. 9, l. 17; col. 9, l. 46 to col. 11, l. 42 and col. 12, l. 16 to col. 14, l. 14);

e) wherein when the analog data acquisition device is operatively interfaced with the multipurpose interface of the computer, the processor executes at least one instruction set stored in the program memory to establish communication with the computer (Fig. 1A-1B; Fig. 11-12; Fig. 14-15; col. 1, ll. 27-57; col. 3, l. 43 to col. 4, l. 67; col. 5, ll. 43-57; col. 6, l. 16 to col. 9, l. 17; col. 9, l. 46 to col. 11, l. 42 and col. 12, l. 16 to col. 14, l. 14); and

f) wherein the processor is further configured and programmed to execute at least one other instruction set stored in the program memory to thereby allow the at least one file of digitized analog data acquired from the analog signal acquisition channel to be transferred to the computer (Fig. 1A-1B; Fig. 11-12; Fig. 14-15; col. 1, ll. 27-57; col. 3, l. 43 to col. 4, l. 67; col. 5, ll. 43-57; col. 6, l. 16 to col. 9, l. 17; col. 9, l. 46 to col. 11, l. 42 and col. 12, l. 16 to col. 14, l. 14).

Hashimoto does not teach the analog data acquisition device operatively connectable to a computer through a multipurpose interface of the computer, the computer having an operating system and being programmed so that when it receives a signal from the device through said multipurpose interface of the computer indicative of a class of devices, the computer automatically activates a device driver corresponding to the class of devices for allowing the transfer of data between the device and the operating system of the computer, the analog data acquisition device comprising:

wherein after interfacing with the computer, to thereby automatically causes at least one parameter indicative of the class of devices to be sent to the computer through the multipurpose interface of the computer, independent of the

Art Unit: 2181

analog source, wherein the analog data acquisition device is not within the class of devices; and

data transferring to the computer using the device driver corresponding to said class of devices so that the analog data acquisition device appears to the computer as if it were a device of the class of devices;

whereby there is no requirement for any user-loaded file transfer enabling software to be loaded on or installed in the computer in addition to the operating system.

Smith teaches a system and a method comprising: wherein after interfacing with the computer, to thereby automatically causes at least one parameter to be sent to the computer through the multipurpose interface of the computer, independent of the analog source (e.g. plug and play functionality) (Fig. 2-5; col. 1, ll. 9-22; col. 2, l. 40 to col. 3, l. 59; col. 4, ll. 5-34 and col. 6, ll. 63-62), by combining the plug-and-play functionality into Hashimoto's analog data acquisition device architecture, the resulting combination further teaches the above claimed features.

Ristelhueber teaches a system and a method comprising whereby there is no requirement for any user-loaded software to be loaded on or installed in the computer in addition to the operating system (pages 1-3).

Shinohara teaches a system and a method comprising: sending a class of devices (e.g. class of device associated with hard disk drive), wherein the analog data acquisition device is not within the class of devices (e.g. hard disk drive emulation by the device); data transferring to the computer using the device

Art Unit: 2181

driver (e.g. hard disk drive device driver) corresponding to said class of devices so that the analog data acquisition device appears to the computer as if it were a device of the class of devices (e.g. device appear as hard disk drive); no requirement for any user-loaded file transfer enabling software (e.g. the plug and play of the device for hard disk drive emulation as taught by the combination of the references) (col. 1, ll. 48-60 and col. 3, l. 33 to col. 4, l. 49), by combining the emulation of the hard disk drive with Hashimoto, Smith and Ristelhueber's analog data acquisition device architecture having the plug-and-play functionality, the resulting combination of the references further teaches the above claimed features.

It would have been obvious for one of ordinary skill in this art, at the time of invention was made to include Smith's plug and play functionality, Ristelhueber's installation without user intervention and Shinohara's hard disk drive emulation into Hashimoto's analog data acquisition device architecture for the benefit of simplifying the installation of the peripheral device for the user as the peripheral device may be installed without the need for the user to install software or configure the peripheral device (Smith, col. 2, ll. 40-67 and col. 5, ll. 41-51 and col. 6, ll. 63-65), simplifying the end user's PC upgrading and reducing cost for the computing industry (Ristelhueber, page 2, 3rd paragraph), and expanding the lifetime usage of the memory card (Shinohara, col. 2, ll. 7-8) to obtain the invention as specified in claim 2.

Art Unit: 2181

7. As per claim 3, Hashimoto, Smith, Ristelhueber and Shinohara teach all the claimed limitation of claim 2 above, where Hashimoto, Smith, Ristelhueber and Shinohara further teach the analog data acquisition device comprising wherein the analog data acquisition device is a stand alone device (Hashimoto, Fig. 1A-1B; Fig. 11-12; Fig. 14-15; col. 1, ll. 27-57; col. 3, l. 43 to col. 4, l. 67; col. 5, ll. 43-57; col. 6, l. 16 to col. 9, l. 17; col. 9, l. 46 to col. 11, l. 42; col. 12, l. 16 to col. 14, l. 14; Smith, Fig. 2-5; col. 1, ll. 9-22; col. 2, l. 40 to col. 3, l. 59; col. 4, ll. 5-34; col. 6, ll. 63-62; Ristelhueber, pages 1-3; and Shinohara, col. 1, ll. 48-60; col. 3, l. 33 to col. 4, l. 49).

8. As per claim 4, Hashimoto, Smith, Ristelhueber and Shinohara teach all the claimed limitation of claim 2 above, where Hashimoto, Smith, Ristelhueber and Shinohara further teach the analog data acquisition device comprising wherein the analog data acquisition device includes a SCSI interface circuit (Hashimoto, Fig. 1A-1B; Fig. 11-12; Fig. 14-15; col. 1, ll. 27-57; col. 3, l. 43 to col. 4, l. 67; col. 5, ll. 43-57; col. 6, l. 16 to col. 9, l. 17; col. 9, l. 46 to col. 11, l. 42; col. 12, l. 16 to col. 14, l. 14; Smith, Fig. 2-5; col. 1, ll. 9-22; col. 2, l. 40 to col. 3, l. 59; col. 4, ll. 5-34; col. 6, ll. 63-62; Ristelhueber, pages 1-3; and Shinohara, col. 1, ll. 48-60; col. 3, l. 33 to col. 4, l. 49).

9. As per claim 6, Hashimoto, Smith, Ristelhueber and Shinohara teach all the claimed limitation of claim 2 above, where Hashimoto, Smith, Ristelhueber and Shinohara further teach the analog data acquisition device configured to

Art Unit: 2181

allow for a plurality of different data transmit devices to be attached thereto and detached therefrom (Hashimoto, Fig. 1A-1B; Fig. 8; Fig. 11-12; Fig. 14-15; col. 1, ll. 27-57; col. 3, l. 43 to col. 4, l. 67; col. 5, ll. 43-57; col. 6, l. 16 to col. 9, l. 17; col. 9, l. 46 to col. 11, l. 42; col. 12, l. 16 to col. 14, l. 14; Smith, Fig. 2-5; col. 1, ll. 9-22; col. 2, l. 40 to col. 3, l. 8; col. 3, ll. 22-27; col. 3, ll. 53-59; col. 4, ll. 5-34; col. 6, ll. 63-62; Ristelhueber, pages 1-3; and Shinohara, col. 1, ll. 48-60; col. 3, l. 56 to col. 4, l. 49).

10. As per claim 7, Hashimoto, Smith, Ristelhueber and Shinohara teach all the claimed limitation of claim 2 above, where Hashimoto and Smith further teach the analog data acquisition device comprising wherein the processor is adapted to be interfaced with the multipurpose interface of an external computing device by means of a cable (Hashimoto, Fig. 1A-1B; Fig. 8; Fig. 11-12; Fig. 14-15; col. 1, ll. 27-57; col. 3, l. 43 to col. 4, l. 67; col. 5, ll. 43-57; col. 6, l. 16 to col. 9, l. 17; col. 9, l. 46 to col. 11, l. 42; col. 12, l. 16 to col. 14, l. 14; Smith, Fig. 2-5; col. 1, ll. 9-22; col. 2, l. 40 to col. 3, l. 8; col. 3, ll. 22-27; col. 3, ll. 53-59; col. 4, ll. 5-34; col. 6, ll. 63-62; Ristelhueber, pages 1-3; and Shinohara, col. 1, ll. 48-60; col. 3, l. 56 to col. 4, l. 49).

11. As per claim 8, Hashimoto, Smith, Ristelhueber and Shinohara teach all the claimed limitation of claim 2 above, where Hashimoto further teaches the analog data acquisition device comprising wherein the analog source comprises a data transmit/receive device (e.g. for transferring the audiovisual information to

Art Unit: 2181

the computer and receiving control instruction from the computer) (Hashimoto, Fig. 1A-1B; Fig. 8; Fig. 11-12; Fig. 14-15; col. 1, ll. 27-57; col. 3, l. 43 to col. 4, l. 67; col. 5, ll. 43-57; col. 6, l. 16 to col. 9, l. 17; col. 9, l. 46 to col. 11, l. 42; and col. 12, l. 16 to col. 14, l. 14).

12. As per claim 9, Hashimoto, Smith, Ristelhueber and Shinohara teach all the claimed limitation of claim 8 above, where Hashimoto further teaches the analog data acquisition device comprising wherein the analog source is designed for one of one-way and two-way communication with the host device (Hashimoto, Fig. 1A-1B; Fig. 8; Fig. 11-12; Fig. 14-15; col. 1, ll. 27-57; col. 3, l. 43 to col. 4, l. 67; col. 5, ll. 43-57; col. 6, l. 16 to col. 9, l. 17; col. 9, l. 46 to col. 11, l. 42; and col. 12, l. 16 to col. 14, l. 14).

13. As per claim 10, Hashimoto, Smith, Ristelhueber and Shinohara teach all the claimed limitation of claim 2 above, where Hashimoto further teaches the analog data acquisition device comprising wherein the analog source is designed to receive data from the host device (Hashimoto, Fig. 1A-1B; Fig. 8; Fig. 11-12; Fig. 14-15; col. 1, ll. 27-57; col. 3, l. 43 to col. 4, l. 67; col. 5, ll. 43-57; col. 6, l. 16 to col. 9, l. 17; col. 9, l. 46 to col. 11, l. 42; and col. 12, l. 16 to col. 14, l. 14).

14. As per claim 12, Hashimoto, Smith, Ristelhueber and Shinohara teach all the claimed limitation of claim 2 above, where Hashimoto, Smith, Ristelhueber and Shinohara further teach the analog data acquisition device comprising

Art Unit: 2181

wherein the processor allows for a plurality of different data transmit devices to be attached thereto and detached therefrom (Hashimoto, Fig. 1A-1B; Fig. 8; Fig. 11-12; Fig. 14-15; col. 1, ll. 27-57; col. 3, l. 43 to col. 4, l. 67; col. 5, ll. 43-57; col. 6, l. 16 to col. 9, l. 17; col. 9, l. 46 to col. 11, l. 42; col. 12, l. 16 to col. 14, l. 14; Smith, Fig. 2-5; col. 1, ll. 9-22; col. 2, l. 40 to col. 3, l. 8; col. 3, ll. 22-27; col. 3, ll. 53-59; col. 4, ll. 5-34; col. 6, ll. 63-62; Ristelhueber, pages 1-3; and Shinohara, col. 1, ll. 48-60; col. 3, l. 56 to col. 4, l. 49).

15. As per claim 15, Hashimoto, Smith, Ristelhueber and Shinohara teach all the claimed limitation of claim 2 above, where Hashimoto, Smith, Ristelhueber and Shinohara further teach the analog data acquisition device comprising wherein the analog source includes at least first and second transducers both of which are designed to transmit data (Hashimoto, Fig. 1A-1B; Fig. 8; Fig. 11-12; Fig. 14-15; col. 1, ll. 27-57; col. 3, l. 43 to col. 4, l. 67; col. 5, ll. 43-57; col. 6, l. 16 to col. 9, l. 17; col. 9, l. 46 to col. 11, l. 42; col. 12, l. 16 to col. 14, l. 14; Smith, Fig. 2-5; col. 1, ll. 9-22; col. 2, l. 40 to col. 3, l. 8; col. 3, ll. 22-27; col. 3, ll. 53-59; col. 4, ll. 5-34; col. 6, ll. 63-62; Ristelhueber, pages 1-3; and Shinohara, col. 1, ll. 48-60; col. 3, l. 56 to col. 4, l. 49).

16. As per claim 16, Hashimoto, Smith, Ristelhueber and Shinohara teach all the claimed limitation of claim 2 above, where Hashimoto, Smith, Ristelhueber and Shinohara further teach the analog data acquisition device comprising wherein the at least one parameter is consistent with the analog data acquisition

Art Unit: 2181

device being responsive to a SCSI inquiry command (Hashimoto, Fig. 1A-1B; Fig. 8; Fig. 11-12; Fig. 14-15; col. 1, ll. 27-57; col. 3, l. 43 to col. 4, l. 67; col. 5, ll. 43-57; col. 6, l. 16 to col. 9, l. 17; col. 9, l. 46 to col. 11, l. 42; col. 12, l. 16 to col. 14, l. 14; Smith, Fig. 2-5; col. 1, ll. 9-22; col. 2, l. 40 to col. 3, l. 8; col. 3, ll. 22-27; col. 3, ll. 53-59; col. 4, ll. 5-34; col. 6, ll. 63-62; Ristelhueber, pages 1-3; and Shinohara, col. 1, ll. 48-60; col. 3, l. 56 to col. 4, l. 49).

17. As per claim 18, Hashimoto, Smith, Ristelhueber and Shinohara teach all the claimed limitation of claim 2 above, where Hashimoto, Smith, Ristelhueber and Shinohara further teach the analog data acquisition device comprising wherein the processor is configured to cause acquired analog data file system information to be automatically sent to the multipurpose interface after the at least one parameter has been sent to the multipurpose interface of the computer, (a) without requiring any end user to load any software onto the computer at any time, and b) without requiring any end user to interact with the computer to set up a file system in the analog data acquisition device at any time (Hashimoto, Fig. 1A-1B; Fig. 8; Fig. 11-12; Fig. 14-15; col. 1, ll. 27-57; col. 3, l. 43 to col. 4, l. 67; col. 5, ll. 43-57; col. 6, l. 16 to col. 9, l. 17; col. 9, l. 46 to col. 11, l. 42; col. 12, l. 16 to col. 14, l. 14; Smith, Fig. 2-5; col. 1, ll. 9-22; col. 2, l. 40 to col. 3, l. 8; col. 3, ll. 22-27; col. 3, ll. 53-59; col. 4, ll. 5-34; col. 6, ll. 63-62; Ristelhueber, pages 1-3; and Shinohara, col. 1, ll. 48-60; col. 3, l. 56 to col. 4, l. 49).

Art Unit: 2181

18. As per claim 19, Hashimoto, Smith, Ristelhueber and Shinohara teach all the claimed limitation of claim 18 above, where Hashimoto, Smith, Ristelhueber and Shinohara further teach the analog data acquisition device comprising wherein the analog data acquisition device file system information comprises at least an indication of a file system type that is used to store the digitized analog data (Hashimoto, Fig. 1A-1B; Fig. 8; Fig. 11-12; Fig. 14-15; col. 1, ll. 27-57; col. 3, l. 43 to col. 4, l. 67; col. 5, ll. 43-57; col. 6, l. 16 to col. 9, l. 17; col. 9, l. 46 to col. 11, l. 42; col. 12, l. 16 to col. 14, l. 14; Smith, Fig. 2-5; col. 1, ll. 9-22; col. 2, l. 40 to col. 3, l. 8; col. 3, ll. 22-27; col. 3, ll. 53-59; col. 4, ll. 5-34; col. 6, ll. 63-62; Ristelhueber, pages 1-3; and Shinohara, col. 1, ll. 48-60; col. 3, l. 56 to col. 4, l. 49), as the type of file system corresponds to the plug-and-play analog data acquisition device having the memory card emulating as the hard disk drive for data transferring after the plug-and-play analog data acquisition device is connected to the PC.

19. As per claim 20, Hashimoto, Smith, Ristelhueber and Shinohara teach all the claimed limitation of claim 2 above, where Hashimoto, Smith, Ristelhueber and Shinohara further teach the analog data acquisition device comprising wherein the processor is configured to cause file allocation table information to be sent to the multipurpose interface, wherein the processor is configured to cause a virtual boot sequence to be sent to the multipurpose interface which includes at least information that is representative of a number of sectors of a storage disk, and wherein the file allocation table information includes at least a

Art Unit: 2181

start location of a file allocation table (Hashimoto, Fig. 1A-1B; Fig. 8; Fig. 11-12; Fig. 14-15; col. 1, ll. 27-57; col. 3, l. 43 to col. 4, l. 67; col. 5, ll. 43-57; col. 6, l. 16 to col. 9, l. 17; col. 9, l. 46 to col. 11, l. 42; col. 12, l. 16 to col. 14, l. 14; Smith, Fig. 2-5; col. 1, ll. 9-22; col. 2, l. 40 to col. 3, l. 8; col. 3, ll. 22-27; col. 3, ll. 53-59; col. 4, ll. 5-34; col. 6, ll. 63-62; Ristelhueber, pages 1-3; and Shinohara, col. 1, ll. 48-60; col. 3, l. 56 to col. 4, l. 49), as the analog data acquisition device being a mass storage device corresponds to the plug-and-play analog data acquisition device having the memory card emulating as the hard disk drive.

20. As per claim 21, Hashimoto, Smith, Ristelhueber and Shinohara teach all the claimed limitation of claim 2 above, where Hashimoto further teaches the analog data acquisition device comprising wherein the processor is configured to initiate a process by which the at least one file of digitized analog data is directly transferred to an input/output device (Hashimoto, Fig. 1A-1B; Fig. 8; Fig. 11-12; Fig. 14-15; col. 1, ll. 27-57; col. 3, l. 43 to col. 4, l. 67; col. 5, ll. 43-57; col. 6, l. 16 to col. 9, l. 17; col. 9, l. 46 to col. 11, l. 42; and col. 12, l. 16 to col. 14, l. 14).

21. As per claim 22, Hashimoto, Smith, Ristelhueber and Shinohara teach all the claimed limitation of claim 21 above, where Hashimoto further teaches the analog data acquisition device comprising wherein the processor is configured to allow a mode of operation (e.g. update mode) of the analog data acquisition device other than the transfer of at least some of the at least one file of digitized analog data to the multipurpose interface to be controlled by means of an

Art Unit: 2181

external personal computer (Hashimoto, Fig. 1A-1B; Fig. 8; Fig. 11-12; Fig. 14-15; col. 1, ll. 27-57; col. 3, l. 43 to col. 4, l. 67; col. 5, ll. 43-57; col. 6, l. 16 to col. 9, l. 17; col. 9, l. 46 to col. 11, l. 42; and col. 12, l. 16 to col. 14, l. 14), as the PC directly update the control program.

22. As per claim 27, Hashimoto, Smith, Ristelhueber and Shinohara teach all the claimed limitation of claim 2 above, where Hashimoto further teaches the analog data acquisition device comprising wherein the analog source is designed to receive signals from the computer (Hashimoto, Fig. 1A-1B; Fig. 8; Fig. 11-12; Fig. 14-15; col. 1, ll. 27-57; col. 3, l. 43 to col. 4, l. 67; col. 5, ll. 43-57; col. 6, l. 16 to col. 9, l. 17; col. 9, l. 46 to col. 11, l. 42; and col. 12, l. 16 to col. 14, l. 14), such as the computer communicating to the camera by updating control program to control the sensor.

23. As per claim 30, Hashimoto, Smith, Ristelhueber and Shinohara teach all the claimed limitation of claim 2 above, where Hashimoto, Smith, Ristelhueber and Shinohara further teach the analog data acquisition device comprising wherein the analog data acquisition device is designed to be responsive to a test unit ready command (Hashimoto, Fig. 1A-1B; Fig. 8; Fig. 11-12; Fig. 14-15; col. 1, ll. 27-57; col. 3, l. 43 to col. 4, l. 67; col. 5, ll. 43-57; col. 6, l. 16 to col. 9, l. 17; col. 9, l. 46 to col. 11, l. 42; col. 12, l. 16 to col. 14, l. 14; Smith, Fig. 2-5; col. 1, ll. 9-22; col. 2, l. 40 to col. 3, l. 8; col. 3, ll. 22-27; col. 3, ll. 53-59; col. 4, ll. 5-34; col.

Art Unit: 2181

6, ll. 63-62; Ristelhueber, pages 1-3; and Shinohara, col. 1, ll. 48-60; col. 3, l. 56 to col. 4, l. 49).

24. As per claim 31, Hashimoto, Smith, Ristelhueber and Shinohara teach all the claimed limitation of claim 2 above, where Hashimoto, Smith, Ristelhueber and Shinohara further teach the analog data acquisition device comprising wherein the device driver is installed with the operating system (Hashimoto, Fig. 1A-1B; Fig. 8; Fig. 11-12; Fig. 14-15; col. 1, ll. 27-57; col. 3, l. 43 to col. 4, l. 67; col. 5, ll. 43-57; col. 6, l. 16 to col. 9, l. 17; col. 9, l. 46 to col. 11, l. 42; col. 12, l. 16 to col. 14, l. 14; Smith, Fig. 2-5; col. 1, ll. 9-22; col. 2, l. 40 to col. 3, l. 8; col. 3, ll. 22-27; col. 3, ll. 53-59; col. 4, ll. 5-34; col. 6, ll. 63-62; Ristelhueber, pages 1-3; and Shinohara, col. 1, ll. 48-60; col. 3, l. 56 to col. 4, l. 49).

25. As per claim 32, independent claim 32 is rejected in accordance to the same rational and reasoning as the above rejection of independent claim 2, wherein the class of devices corresponds to the digital mass storage device (e.g. hard disk drive emulation).

26. As per claim 35, independent claim 35 is rejected in accordance to the same rational and reasoning as the above rejection of independent claims 2 and 32, as independent claim 35 is the method claim for the analog data acquisition and interface device of independent claim 32, wherein the class of devices corresponds to the digital mass storage device (e.g. hard disk drive emulation).

27. Claims 5 and 13 are rejected under 35 U.S.C. 103(a) as being unpatentable over Hashimoto et al. (US Patent 6,111,604) in view of Smith et al. (US Patent 5,634,075), Ristelhueber : “Plug and play is almost here” and Shinohara (US Patent 5,742,934) as applied to claim 2 above, and further in view of Endo et al. (US Patent 4,652,928).

Hashimoto, Smith, Ristelhueber and Shinohara teach all the limitations of claim 2 as discussed above, wherein Hashimoto further teaches the analog data acquisition device comprising wherein the processor is designed so that the sensor can be attached to the processor (Hashimoto, Fig. 1A-1B; Fig. 8; Fig. 11-12; Fig. 14-15; col. 1, ll. 27-57; col. 3, l. 43 to col. 4, l. 67; col. 5, ll. 43-57; col. 6, l. 16 to col. 9, l. 17; col. 9, l. 46 to col. 11, l. 42; and col. 12, l. 16 to col. 14, l. 14).

Hashimoto, Smith, Ristelhueber and Shinohara do not expressly teach the analog data acquisition device comprising:

wherein the analog data acquisition device is designed so that the analog source is detachable; and

wherein the processor is designed so that a user can attach the analog source thereto or detach the analog source therefrom.

Endo teaches a system comprising: wherein the analog data acquisition device is designed so that the analog source is detachable (e.g. de-coupling); and wherein the processor is designed so that a user can attach the analog source thereto or detach the analog source therefrom (col. 1, ll. 18-25 and col. 13, ll. 57-58), by combining the de-couplable of the sensor architecture with Hashimoto, Smith, Kerigan and Shinohara's

Art Unit: 2181

analog data acquisition device having the sensor architecture, the resulting combination of the references further teaches the above claimed features.

It would have been obvious for one of ordinary skill in this art, at the time of invention was made to include Endo's interchangeable sensor into Hashimoto, Smith, Ristelhueber and Shinohara's sensor coupled to the processor for the benefit of adaptively increase the resolution of the camera to obtaining a better quality image (Endo, col. 1, ll. 18-20) to obtain the invention as specified in claims 5 and 13.

28. Claims 11 and 36 are rejected under 35 U.S.C. 103(a) as being unpatentable over Hashimoto et al. (US Patent 6,111,604) in view of Smith et al. (US Patent 5,634,075), Ristelhueber : "Plug and play is almost here" and Shinohara (US Patent 5,742,934) as applied to claims 2 and 35 above, and further in view of Nakamura et al. (US Patent 6,278,492).

Hashimoto, Smith, Ristelhueber and Shinohara teach all the limitations of claims 2 and 35 as discussed above, but Hashimoto, Smith, Ristelhueber and Shinohara do not expressly teach the analog data acquisition device comprising:

a plurality of independent analog signal acquisition channels, each of the plurality of channels operatively coupled to the processor for operatively coupling to one of a plurality of analog sources; and

simultaneously acquiring the analog data from each respective analog channel of a plurality of respective independent acquisition channels under control of the processor.

Art Unit: 2181

Nakamura teaches a system comprising: a plurality of independent analog signal acquisition channels, each of the plurality of channels operatively coupled to the processor for operatively coupling to one of a plurality of analog sources; and simultaneously acquiring the analog data from each respective analog channel of a plurality of respective independent acquisition channels under control of the processor (Fig. 1 and col. 1, ll. 12-40), by combining the multiple sensor architecture into Hashimoto, Smith, Ristelhueber and Shinohara analog data acquisition device having the sensor architecture, the resulting combination of the references further teaches the above claimed features.

It would have been obvious for one of ordinary skill in this art, at the time of invention was made to include Nakamura's multiple sensors into Hashimoto, Smith, Ristelhueber and Shinohara's analog data acquisition device architecture for the benefit of improving the resolution (Nakamura, col. 1, ll. 12-40) to obtain the invention as specified in claims 11 and 36.

29. Claim 24 is rejected under 35 U.S.C. 103(a) as being unpatentable over Hashimoto et al. (US Patent 6,111,604) in view of Smith et al. (US Patent 5,634,075), Ristelhueber : "Plug and play is almost here" and Shinohara (US Patent 5,742,934) as applied to claim 2 above, and further in view of Roberts et al. (US Patent 5,576,757).

Hashimoto, Smith, Ristelhueber and Shinohara teach all the limitations of claim 2 as discussed above, wherein Hashimoto further teaches the analog data acquisition device comprising generating and processing of the analog data (Hashimoto, Fig. 1A-

Art Unit: 2181

1B; Fig. 11-12; Fig. 14-15; col. 1, ll. 35-57; col. 3, l. 43 to col. 4, l. 57; col. 5, ll. 43-57; col. 6, l. 16 to col. 9, l. 17 and col. 9, l. 46 to col. 10, l. 16).

Hashimoto, Smith, Ristelhueber and Shinohara do not expressly teach the analog data acquisition device comprising a fast Fourier transform.

Roberts teaches a system and a method comprising an electronic still camera processing data by being subject to a fast Fourier transform (Abstract and col. 9, l. 60 to col. 10, l. 7).

It would have been obvious for one of ordinary skill in this art, at the time of invention was made to include Roberts's fast Fourier transform into Hashimoto, Smith, Ristelhueber and Shinohara's analog data acquisition device architecture for the benefit of having an easier computation for image processing while providing a reasonable visual fidelity (Roberts, col. 10, ll. 1-3) to obtain the invention as specified in claim 24.

V. CLOSING COMMENTSIV

Conclusion

a. STATUS OF CLAIMS IN THE APPLICATION

The following is a summary of the treatment and status of all claims in the application as recommended by **M.P.E.P. 707.07(i)**:

a(1) CLAIMS REJECTED IN THE APPLICATION

Per the instant office action, claims 2-13, 15-16, 18-22, 24, 27, 30-32, and 35-36 have received a first action on the merits and are subject of a first action non-final.

b. DIRECTION OF FUTURE CORRESPONDENCES

Any inquiry concerning this communication or earlier communications from the examiner should be directed to Chun-Kuan (Mike) Lee whose telephone number is (571) 272-0671. The examiner can normally be reached on 8AM to 5PM.

IMPORTANT NOTE

If attempts to reach the examiner by telephone are unsuccessful, the examiner's supervisor, Alford Kindred can be reached on (571) 272-4037. The fax phone number for the organization where this application or proceeding is assigned is 571-273-8300.

Art Unit: 2181

Information regarding the status of an application may be obtained from the Patent Application Information Retrieval (PAIR) system. Status information for published applications may be obtained from either Private PAIR or Public PAIR. Status information for unpublished applications is available through Private PAIR only. For more information about the PAIR system, see <http://pair-direct.uspto.gov>. Should you have questions on access to the Private PAIR system, contact the Electronic Business Center (EBC) at 866-217-9197 (toll-free). If you would like assistance from a USPTO Customer Service Representative or access to the automated information system, call 800-786-9199 (IN USA OR CANADA) or 571-272-1000.

/Chun-Kuan Lee/
Primary Examiner
Art Unit 2181
July 18, 2011

Notice of References Cited	Application/Control No. 12/891,443	Applicant(s)/Patent Under Reexamination TASLER, MICHAEL	
	Examiner Chun-Kuan Lee	Art Unit 2181	Page 1 of 1

U.S. PATENT DOCUMENTS

*	Document Number Country Code-Number-Kind Code	Date MM-YYYY	Name	Classification
*	A US-4,652,928	03-1987	Endo et al.	348/219.1
*	B US-5,576,757	11-1996	Roberts et al.	348/220.1
*	C US-5,634,075	05-1997	Smith et al.	710/9
*	D US-5,742,934	04-1998	Shinohara, Takayuki	711/103
*	E US-6,111,604	08-2000	Hashimoto et al.	348/220.1
*	F US-6,278,492	08-2001	Nakamura, Hitoshi	348/441
	G US-			
	H US-			
	I US-			
	J US-			
	K US-			
	L US-			
	M US-			

FOREIGN PATENT DOCUMENTS

*	Document Number Country Code-Number-Kind Code	Date MM-YYYY	Country	Name	Classification
	N				
	O				
	P				
	Q				
	R				
	S				
	T				

NON-PATENT DOCUMENTS

*	Document Number Country Code-Number-Kind Code	Date MM-YYYY	Country	Name	Classification
	Include as applicable: Author, Title Date, Publisher, Edition or Volume, Pertinent Pages)				
	U	Ristelhueber : "Plug and play is almost here," May 1994, Electronic Business Buyer, v20, pages 1-3			
	V				
	W				
	X				

*A copy of this reference is not being furnished with this Office action. (See MPEP § 707.05(a).)
Dates in MM-YYYY format are publication dates. Classifications may be US or foreign.

Index of Claims 	Application/Control No. 12891443	Applicant(s)/Patent Under Reexamination TASLER, MICHAEL
	Examiner Chun-Kuan Lee	Art Unit 2181

✓	Rejected
=	Allowed

-	Cancelled
÷	Restricted

N	Non-Elected
I	Interference

A	Appeal
O	Objected

Claims renumbered in the same order as presented by applicant
 CPA
 T.D.
 R.1.47

CLAIM		DATE							
Final	Original	04/18/2011	07/18/2011						
	1	-	-						
	2	÷	✓						
	3	÷	✓						
	4	÷	✓						
	5	÷	✓						
	6	÷	✓						
	7	÷	✓						
	8	÷	✓						
	9	÷	✓						
	10	÷	✓						
	11	÷	✓						
	12	÷	✓						
	13	÷	✓						
	14	÷	N						
	15	÷	✓						
	16	÷	✓						
	17	÷	N						
	18	÷	✓						
	19	÷	✓						
	20	÷	✓						
	21	÷	✓						
	22	÷	✓						
	23	÷	N						
	24	÷	✓						
	25	÷	N						
	26	÷	N						
	27	÷	✓						
	28	÷	N						
	29	÷	N						
	30	÷	✓						
	31	÷	✓						
	32	÷	✓						
	33	÷	N						
	34	÷	N						
	35	÷	✓						
	36	÷	✓						

113189

PATENT

IN THE UNITED STATES PATENT AND TRADEMARK OFFICE

Applicant:	Michael Tasler)	
)	
Filed:	September 27, 2010)	
)	Art Group: 2181
For:	ANALOG DATA GENERATING AND)	
	PROCESSING DEVICE FOR USE WITH A)	
	PERSONAL COMPUTER)	
)	
Application No.:	12/891,443)	
)	Confirmation No.:
Examiner:	Lee, Chun Kuan)	1408

RESPONSE

Commissioner for Patents
P.O. Box 1450
Alexandria, Virginia 22313-1450

In reply to the Office Action mailed on April 19, 2011, requiring election, election is made with traverse as set out in the following Remarks:

REMARKS

Reconsideration and further examination of the subject patent application is respectfully requested in view of the following Remarks. Claims 2-36 are currently pending in the application. The Office Action requires restriction of Claims 2-36 to one of six species: Specie I, Claims 2-13, 15-16, 18-22, 24, 27, 30-32 and 35-36 drawn to a data acquisition device; Specie II, Claim 14; Specie III, Claims 17 and 23; Specie IV, Claims 25-26; Specie V, Claims 28-29; and Specie VI, Claims 33-34. Applicant respectfully traverses the restriction requirement.

The Office Action has required restriction to one of six Species, and requires Applicant to elect one. Applicant provisionally elects, with traverse, the Specie I, Claims 2-13, 15-16, 18-22, 24, 27, 30-32, 35 and 36.

Applicant traverses the restriction requirement because all the claims relate to substantially similar subject matter. For example, Specie I claims are drawn to an analog data acquisition interface device of independent Claims 2 and 32, and the method of independent Claim 35, which acquires analog data from an analog source and couples it to a host computer via a multipurpose interface using a host computer device driver. Species II-VI are all similarly drawn to the analog data acquisition interface device. The Office Action asserts that Claim 14 (Specie II) is directed to a multimeter. However Claim 14, which is dependent on Claim 2, is directed to the analog data acquisition device of Claim 2 and merely adds the requirement that the analog source from which data is acquired comprises a multimeter. Thus, Claim 14 is not directed to a multimeter as asserted in the Office Action, but to the analog data acquisition interface device where the analog source comprises a multimeter. Similarly, Claims 17 and 23, Species III, are directed to the data acquisition

device of Claim 2 where the analog source is further limited to require that the analog source is a medical device. Claims 25-26, Specie IV, are also dependent on Claim 2 and are directed to the analog data acquisition device of Claim 2 with additional timing limitations; and Claims 28-29, Specie V, are also dependent on Claim 2 and are addressed to the analog data acquisition device of Claim 2 with the added limitation of control from an external source and a configuration file. Claims 33 and 34, Specie VI, are also directed to an analog data acquisition and interface device including direct communication with data devices of the host computer, not to an ASPI driver as asserted by the Office Action. All the sets of claims of Species II-V are directed to the analog data acquisition device of independent Claim 2 and are merely dependent claims which further limit an existing element of Claim 2. Thus, the Examiner can examine all claims together without need for substantial further searching or additional fields of search. For the foregoing reasons, Applicant submits that the restriction requirement should be withdrawn, and that the subject application is in condition for allowance and earnestly solicits a Notice of Allowance.

The Office Action characterized the Specie I claims as directed to a “stand along” device, which Applicant interprets to mean “stand alone”. Applicant disagrees with this characterization. There is nothing in the independent claims which limit the claims to a stand alone device. Further, dependent Claim 3 is expressly further limited to a stand-alone device. Thus, in accordance with the well known doctrine of claim differentiation, only Claim 3 is directed to a stand alone analog data acquisition interface device; all other claims are not limited to a stand-alone device.

The Office Action further characterized the Specie I claims as directed to a device that communicates via a customary I/O driver. However, none of the claims have any limitation to a customary I/O driver. Thus, it is Applicant’s position that this characterization of the claims is

incorrect, and that none of the claims is limited to requiring a customary I/O driver.

The Office Action also included an interview summary of an interview between the Examiner and Applicant's attorney, James A. Scheer, conducted on March 31, 2011 at the Examiner's request.

Applicant disagrees with the re-characterization of the claimed invention set out in the interview summary. As expressed by Applicant's attorney during the interview, Applicant submits that it is the claims as written that define the invention.

Should the Examiner be of the opinion that a telephone conference would expedite prosecution of the subject application, the Examiner is respectfully requested to call the undersigned at the below-listed number.

The Commissioner is hereby authorized to charge any additional fee which may be required for this application under 37 C.F.R. §§ 1.16-1.18, including but not limited to the extension of time fee, petition fee, RCE fee, petition fee, extra claim fee, extra claim fee, issue fee, or credit any overpayment, to Deposit Account No. 23-0920. Should no proper amount be enclosed herewith, as by a check being in the wrong amount, unsigned, post-dated, otherwise improper or informal, or even entirely missing, the Commissioner is authorized to charge the unpaid amount to Deposit Account No. 23-0920.

Respectfully submitted,

HUSCH BLACKWELL LLP

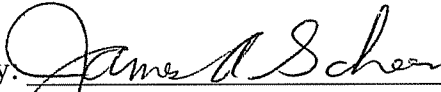
By: 
James A. Scheer
Registration No. 29,434

Dated: June 7, 2011

HUSCH BLACKWELL LLP
120 South Riverside Plaza, 22nd Floor
Chicago, Illinois 60606
(312) 655-1500

Electronic Patent Application Fee Transmittal

Application Number:	12891443
Filing Date:	27-Sep-2010
Title of Invention:	ANALOG DATA GENERATING AND PROCESSING DEVICE FOR USE WITH A PERSONAL COMPUTER
First Named Inventor/Applicant Name:	Michael Tasler
Filer:	James A. Scheer/mawish elahi
Attorney Docket Number:	0757-113189

Filed as Large Entity

Utility under 35 USC 111(a) Filing Fees

Description	Fee Code	Quantity	Amount	Sub-Total in USD(\$)
Basic Filing:				
Pages:				
Claims:				
Miscellaneous-Filing:				
Petition:				
Patent-Appeals-and-Interference:				
Post-Allowance-and-Post-Issuance:				
Extension-of-Time:				
Extension - 1 month with \$0 paid	125	JVC	KENWOOD CORP., et al.	

Description	Fee Code	Quantity	Amount	Sub-Total in USD(\$)
Miscellaneous:				
Total in USD (\$)				130

Electronic Acknowledgement Receipt

EFS ID:	10250585
Application Number:	12891443
International Application Number:	
Confirmation Number:	1408
Title of Invention:	ANALOG DATA GENERATING AND PROCESSING DEVICE FOR USE WITH A PERSONAL COMPUTER
First Named Inventor/Applicant Name:	Michael Tasler
Customer Number:	24628
Filer:	James A. Scheer/mawish elahi
Filer Authorized By:	James A. Scheer
Attorney Docket Number:	0757-113189
Receipt Date:	07-JUN-2011
Filing Date:	27-SEP-2010
Time Stamp:	15:21:29
Application Type:	Utility under 35 USC 111(a)

Payment information:

Submitted with Payment	yes
Payment Type	Deposit Account
Payment was successfully received in RAM	\$130
RAM confirmation Number	1866
Deposit Account	230920
Authorized User	

The Director of the USPTO is hereby authorized to charge indicated fees and credit any overpayment as follows:

Charge any Additional Fees required under 37 C.F.R. Section 1.21 (Miscellaneous fees and charges)

File Listing:					
Document Number	Document Description	File Name	File Size(Bytes)/ Message Digest	Multi Part /.zip	Pages (if appl.)
1	Extension of Time	113189eot.PDF	28859 0d4e55f7b54ab5b3a85f496886ee1d6e65756f08	no	1
Warnings:					
Information:					
2	Response to Election / Restriction Filed	113189response.PDF	47473 e997dcd5cb074b949c9753f1a2b296d922ed992	no	5
Warnings:					
Information:					
3	Fee Worksheet (SB06)	fee-info.pdf	30414 c78979b347b665893fc02efccb20c8e8eb362393	no	2
Warnings:					
Information:					
Total Files Size (in bytes):			106746		

This Acknowledgement Receipt evidences receipt on the noted date by the USPTO of the indicated documents, characterized by the applicant, and including page counts, where applicable. It serves as evidence of receipt similar to a Post Card, as described in MPEP 503.

New Applications Under 35 U.S.C. 111

If a new application is being filed and the application includes the necessary components for a filing date (see 37 CFR 1.53(b)-(d) and MPEP 506), a Filing Receipt (37 CFR 1.54) will be issued in due course and the date shown on this Acknowledgement Receipt will establish the filing date of the application.

National Stage of an International Application under 35 U.S.C. 371

If a timely submission to enter the national stage of an international application is compliant with the conditions of 35 U.S.C. 371 and other applicable requirements a Form PCT/DO/EO/903 indicating acceptance of the application as a national stage submission under 35 U.S.C. 371 will be issued in addition to the Filing Receipt, in due course.

New International Application Filed with the USPTO as a Receiving Office

If a new international application is being filed and the international application includes the necessary components for an international filing date (see PCT Article 11 and MPEP 1810), a Notification of the International Application Number and of the International Filing Date (Form PCT/RO/105) will be issued in due course, subject to prescriptions concerning national security, and the date shown on this Acknowledgement Receipt will establish the international filing date of the application.

Under the paperwork Reduction Act of 1995, no persons are required to respond to a collection of information unless it displays a valid OMB control number.

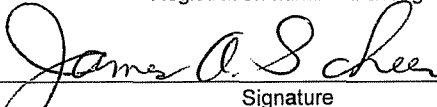
PETITION FOR EXTENSION OF TIME UNDER 37 CFR 1.136(a) FY 2009 <i>(Fees pursuant to the Consolidated Appropriations Act, 2005 (H.R. 4818).)</i>		Docket Number (Optional) 113189	
Application Number 12/891,443		Filed September 27, 2010	
For AN ANALOG DATA GENERATING AND PROCESSING DEVICE FOR USE WITH A PERSONAL COMPUTER			
Art Unit 2111		Examiner Lee, Chun Kuan	
This is a request under the provisions of 37 CFR 1.136(a) to extend the period for filing a reply in the above identified application.			
The requested extension and fee are as follows (check time period desired and enter the appropriate fee below):			
		<u>Fee</u>	<u>Small Entity Fee</u>
<input checked="" type="checkbox"/>	One month (37 CFR 1.17(a)(1))	\$130	\$65 \$ <u>130.00</u>
<input type="checkbox"/>	Two months (37 CFR 1.17(a)(2))	\$490	\$245 \$ _____
<input type="checkbox"/>	Three months (37 CFR 1.17(a)(3))	\$1110	\$555 \$ _____
<input type="checkbox"/>	Four months (37 CFR 1.17(a)(4))	\$1730	\$865 \$ _____
<input type="checkbox"/>	Five months (37 CFR 1.17(a)(5))	\$2350	\$1175 \$ _____
<input type="checkbox"/>	Applicant claims small entity status. See 37 CFR 1.27.		
<input type="checkbox"/>	A check in the amount of the fee is enclosed.		
<input type="checkbox"/>	Payment by credit card. Form PTO-2038 is attached.		
<input checked="" type="checkbox"/>	The Director has already been authorized to charge fees in this application to a Deposit Account.		
<input checked="" type="checkbox"/>	The Director is hereby authorized to charge any fees which may be required, or credit any overpayment, to Deposit Account Number <u>23-0920</u> .		
WARNING: Information on this form may become public. Credit card information should not be included on this form. Provide credit card information and authorization on PTO-2038.			
I am the	<input type="checkbox"/>	applicant/inventor.	
	<input type="checkbox"/>	assignee of record of the entire interest. See 37 CFR 3.71. Statement under 37 CFR 3.73(b) is enclosed (Form PTO/SB/96).	
	<input checked="" type="checkbox"/>	attorney or agent of record. Registration Number <u>29,434</u>	
	<input type="checkbox"/>	attorney or agent under 37 CFR 1.34. Registration number if acting under 37 CFR 1.34 _____.	
		June 7, 2011	
James A. Scheer		Date	
Typed or printed name		(312) 655-1500	
		Telephone Number	
NOTE: Signatures of all the inventors or assignees of record of the entire interest or their representative(s) are required. Submit multiple forms if more than one signature is required, see below.			
<input type="checkbox"/>	Total of <u>1</u> forms are submitted.		

This collection of information is required by 37 CFR 1.136(a). The information is required to obtain or retain a benefit by the public which is to file (and by the USPTO to process) an application. Confidentiality is governed by 35 U.S.C. 122 and 37 CFR 1.11 and 1.14. This collection is estimated to take 6 minutes to complete, including gathering, preparing, and submitting the completed application form to the USPTO. Time will vary depending upon the individual case. Any comments on the amount of time you require to complete this form and/or suggestions for reducing this burden, should be sent to the Chief Information Officer, U.S. Patent and Trademark Office, U.S. Department of Commerce, P.O. Box 1450, Alexandria, VA 22313-1450. DO NOT SEND FEES OR COMPLETED FORMS TO THIS ADDRESS. SEND TO: Commissioner for Patents, P.O. Box 1450, Alexandria, VA 22313-1450.

Under the Paperwork Reduction Act of 1995, no persons are required to respond to a collection of information unless it displays a valid OMB control number.

PATENT APPLICATION FEE DETERMINATION RECORD Substitute for Form PTO-875	Application or Docket Number 12/891,443	Filing Date 09/27/2010	<input type="checkbox"/> To be Mailed
-----------------------------------------------------------------------------------	---------------------------------------------------	----------------------------------	---------------------------------------

APPLICATION AS FILED – PART I			OTHER THAN SMALL ENTITY				
	(Column 1)	(Column 2)	SMALL ENTITY <input type="checkbox"/>	OR			
FOR	NUMBER FILED	NUMBER EXTRA	RATE (\$)	FEE (\$)	OR	RATE (\$)	FEE (\$)
<input type="checkbox"/> BASIC FEE <small>(37 CFR 1.16(a), (b), or (c))</small>	N/A	N/A	N/A			N/A	
<input type="checkbox"/> SEARCH FEE <small>(37 CFR 1.16(k), (j), or (m))</small>	N/A	N/A	N/A			N/A	
<input type="checkbox"/> EXAMINATION FEE <small>(37 CFR 1.16(o), (p), or (q))</small>	N/A	N/A	N/A			N/A	
TOTAL CLAIMS <small>(37 CFR 1.16(j))</small>	minus 20 =	*	X \$ =		OR	X \$ =	
INDEPENDENT CLAIMS <small>(37 CFR 1.16(h))</small>	minus 3 =	*	X \$ =			X \$ =	
<input type="checkbox"/> APPLICATION SIZE FEE <small>(37 CFR 1.16(s))</small>	If the specification and drawings exceed 100 sheets of paper, the application size fee due is \$250 (\$125 for small entity) for each additional 50 sheets or fraction thereof. See 35 U.S.C. 41(a)(1)(G) and 37 CFR 1.16(s).						
<input type="checkbox"/> MULTIPLE DEPENDENT CLAIM PRESENT <small>(37 CFR 1.16(j))</small>							
			TOTAL			TOTAL	

* If the difference in column 1 is less than zero, enter "0" in column 2.

APPLICATION AS AMENDED – PART II					OTHER THAN SMALL ENTITY				
	(Column 1)	(Column 2)	(Column 3)						
AMENDMENT	06/07/2011	CLAIMS REMAINING AFTER AMENDMENT	HIGHEST NUMBER PREVIOUSLY PAID FOR	PRESENT EXTRA	RATE (\$)	ADDITIONAL FEE (\$)	OR	RATE (\$)	ADDITIONAL FEE (\$)
	Total <small>(37 CFR 1.16(i))</small>	* 1	Minus ** 20	= 0	X \$ =		OR	X \$52=	0
	Independent <small>(37 CFR 1.16(h))</small>	* 1	Minus ***3	= 0	X \$ =		OR	X \$220=	0
	<input type="checkbox"/> Application Size Fee <small>(37 CFR 1.16(s))</small>								
	<input type="checkbox"/> FIRST PRESENTATION OF MULTIPLE DEPENDENT CLAIM <small>(37 CFR 1.16(j))</small>						OR		
					TOTAL ADD'L FEE		OR	TOTAL ADD'L FEE	0

APPLICATION AS AMENDED – PART II					OTHER THAN SMALL ENTITY				
	(Column 1)	(Column 2)	(Column 3)						
AMENDMENT		CLAIMS REMAINING AFTER AMENDMENT	HIGHEST NUMBER PREVIOUSLY PAID FOR	PRESENT EXTRA	RATE (\$)	ADDITIONAL FEE (\$)	OR	RATE (\$)	ADDITIONAL FEE (\$)
	Total <small>(37 CFR 1.16(i))</small>	*	Minus **	=	X \$ =		OR	X \$ =	
	Independent <small>(37 CFR 1.16(h))</small>	*	Minus ***	=	X \$ =		OR	X \$ =	
	<input type="checkbox"/> Application Size Fee <small>(37 CFR 1.16(s))</small>								
	<input type="checkbox"/> FIRST PRESENTATION OF MULTIPLE DEPENDENT CLAIM <small>(37 CFR 1.16(j))</small>						OR		
					TOTAL ADD'L FEE		OR	TOTAL ADD'L FEE	

* If the entry in column 1 is less than the entry in column 2, write "0" in column 3.
 ** If the "Highest Number Previously Paid For" IN THIS SPACE is less than 20, enter "20".
 *** If the "Highest Number Previously Paid For" IN THIS SPACE is less than 3, enter "3".

The "Highest Number Previously Paid For" (Total or Independent) is the highest number found in the appropriate box in column 1.

Legal Instrument Examiner:
 /VANESSA BARBER/

This collection of information is required by 37 CFR 1.16. The information is required to obtain or retain a benefit by the public which is to file (and by the USPTO to process) an application. Confidentiality is governed by 35 U.S.C. 122 and 37 CFR 1.14. This collection is estimated to take 12 minutes to complete, including gathering, preparing, and submitting the completed application form to the USPTO. Time will vary depending upon the individual case. Any comments on the amount of time you require to complete this form and/or suggestions for reducing this burden, should be sent to the Chief Information Officer, U.S. Patent and Trademark Office, U.S. Department of Commerce, P.O. Box 1450, Alexandria, VA 22313-1450. DO NOT SEND FEES OR COMPLETED FORMS TO THIS ADDRESS. **SEND TO: Commissioner for Patents, P.O. Box 1450, Alexandria, VA 22313-1450.**

If you need assistance in completing the form, call 1-800-PTO-9199 and select option 2.



UNITED STATES PATENT AND TRADEMARK OFFICE

UNITED STATES DEPARTMENT OF COMMERCE
United States Patent and Trademark Office
Address: COMMISSIONER FOR PATENTS
P.O. Box 1450
Alexandria, Virginia 22313-1450
www.uspto.gov

Table with 4 columns: APPLICATION NUMBER (12/891,443), FILING OR 371(C) DATE (09/27/2010), FIRST NAMED APPLICANT (Michael Tasler), ATTY. DOCKET NO./TITLE (0757-113189)

CONFIRMATION NO. 1408

PUBLICATION NOTICE



24628
Husch Blackwell LLP
Husch Blackwell Sanders LLP Welsh & Katz
120 S RIVERSIDE PLAZA
22ND FLOOR
CHICAGO, IL 60606

Title:ANALOG DATA GENERATING AND PROCESSING DEVICE FOR USE WITH A PERSONAL COMPUTER

Publication No.US-2011-0131353-A1
Publication Date:06/02/2011

NOTICE OF PUBLICATION OF APPLICATION

The above-identified application will be electronically published as a patent application publication pursuant to 37 CFR 1.211, et seq. The patent application publication number and publication date are set forth above.

The publication may be accessed through the USPTO's publically available Searchable Databases via the Internet at www.uspto.gov. The direct link to access the publication is currently http://www.uspto.gov/patft/.

The publication process established by the Office does not provide for mailing a copy of the publication to applicant. A copy of the publication may be obtained from the Office upon payment of the appropriate fee set forth in 37 CFR 1.19(a)(1). Orders for copies of patent application publications are handled by the USPTO's Office of Public Records. The Office of Public Records can be reached by telephone at (703) 308-9726 or (800) 972-6382, by facsimile at (703) 305-8759, by mail addressed to the United States Patent and Trademark Office, Office of Public Records, Alexandria, VA 22313-1450 or via the Internet.

In addition, information on the status of the application, including the mailing date of Office actions and the dates of receipt of correspondence filed in the Office, may also be accessed via the Internet through the Patent Electronic Business Center at www.uspto.gov using the public side of the Patent Application Information and Retrieval (PAIR) system. The direct link to access this status information is currently http://pair.uspto.gov/. Prior to publication, such status information is confidential and may only be obtained by applicant using the private side of PAIR.

Further assistance in electronically accessing the publication, or about PAIR, is available by calling the Patent Electronic Business Center at 1-866-217-9197.

Office of Data Management, Application Assistance Unit (571) 272-4000, or (571) 272-4200, or 1-888-786-0101



UNITED STATES PATENT AND TRADEMARK OFFICE

UNITED STATES DEPARTMENT OF COMMERCE
United States Patent and Trademark Office
Address: COMMISSIONER FOR PATENTS
P.O. Box 1450
Alexandria, Virginia 22313-1450
www.uspto.gov

APPLICATION NO.	FILING DATE	FIRST NAMED INVENTOR	ATTORNEY DOCKET NO.	CONFIRMATION NO.
12/891,443	09/27/2010	Michael Tasler	0757-113189	1408
24628	7590	04/19/2011	EXAMINER	
Husch Blackwell LLP Husch Blackwell Sanders LLP Welsh & Katz 120 S RIVERSIDE PLAZA 22ND FLOOR CHICAGO, IL 60606			LEE, CHUN KUAN	
			ART UNIT	PAPER NUMBER
			2181	
			MAIL DATE	DELIVERY MODE
			04/19/2011	PAPER

Please find below and/or attached an Office communication concerning this application or proceeding.

The time period for reply, if any, is set in the attached communication.

Examiner-Initiated Interview Summary	Application No. 12/891,443	Applicant(s) TASLER, MICHAEL	
	Examiner Chun-Kuan Lee	Art Unit 2181	

All Participants:

- (1) Alford Kindred.
- (2) Chun-Kuan Lee.

Status of Application: _____

- (3) James A. Sheer (Reg. # 29,434).
- (4) _____.

Date of Interview: 31 March 2011

Time: _____

Type of Interview:

- Telephonic
- Video Conference
- Personal (Copy given to: Applicant Applicant's representative)

Exhibit Shown or Demonstrated: Yes No
If Yes, provide a brief description: .

Part I.

Rejection(s) discussed:
N/A

Claims discussed:
2

Prior art documents discussed:
N/A

Part II.

SUBSTANCE OF INTERVIEW DESCRIBING THE GENERAL NATURE OF WHAT WAS DISCUSSED:
Please see Continuation Sheet below

Part III.

- It is not necessary for applicant to provide a separate record of the substance of the interview, since the interview directly resulted in the allowance of the application. The examiner will provide a written summary of the substance of the interview in the Notice of Allowability.
- It is not necessary for applicant to provide a separate record of the substance of the interview, since the interview did not result in resolution of all issues. A brief summary by the examiner appears in Part II above.

(Applicant/Applicant's Representative Signature – if appropriate)

The interview mainly focused on getting a clear understand of applicant's claimed invention, wherein the examiner requested the applicant to provide a real world example reflecting the heart/core of applicant's invention, and the applicant in response, provided the following explanation:

An analog sensing device that misrepresent itself to the computer by telling the computer that it is a digital device and the computer then uses an existing digital device driver to communicate with the analog sensing device, despite the fact that the analog sensing device is not a digital device.

Applicant's further clarified that the analog sensing device can be a medial instrument with analog sensor sensing analog data or a multimeter having analog sensor sensing analog data, wherein the medical instrument or the multimeter interfaces with the computer to download the sensed analog data into the computer, and the transferring of the sensed analog data between the medial instrument or the multimeter and the computer do not require a specific driver associated with the medial instrument or the multimeter as the medial instrument or the multimeter is recognized as a hard disk drive, wherein hard disk drive driver is part of the computer's operating system when the computer was manufactured.

Applicant further clarified that applicant's invention is for an analog sensing device, such as the medical instrument or the multimeter, to be connected to a host computer, and transferring the data from the analog sensing device to the host computer; furthermore, when the analog sensing device is connected to the host, the analog sensing device tells the host that the analog sensing device is a digital device, instead of an analog device, so that the host is recognizing the analog sensing device as the digital device, and the host will then utilize a digital device driver that is already part of the host's operating system when the host was manufactured to communication with the analog sensing device, wherein the digital device driver that is already part of the host's operating system can be a hard disk drive driver or a printer driver. Therefore, the user can just connected the analog peripheral device to the host computer and start using the connected analog peripheral device directly.

The examiner also inquired, with regard to the current independent claim 2, if the functionality/purpose of the claimed "class of device" is to let the host see the connected analog device as the digital device; and applicant conceded the examiner's interpretation, and further clarified that one of the "class of device" would be a hard disk drive or a printer.

Applicant also indicated that it is conceivable that the instant invention could be used in conjunction with a digital camera and that the core inventive concept is the claims, the claim as a whole is what applicant is claiming as applicant's invention.

The examiner also inquired how the inventive concept of the instant application differ from the other applications, such as applications 11/928,283, 11/467,073 and 11/467,092 which were also reviewed by the examiner; and the applicant responded that the claims in the instant application is broader that the other applications.

Agreement with regard to applicant's inventive concept was reached, as the examiner agrees with applicant's clarification of applicant's inventive concept, but no agreement was reached with regard to the allowability of the claims.

DETAILED ACTION

Election/Restrictions

1. This application contains claims directed to the following patentably distinct species of the claimed invention:

Specie I: Claims 2-13, 15-16, 18-22, 24, 27, 30-32 and 35-36 are directed to an stand along analog data acquisition device that communicate via customary I/O driver.

Specie II: Claim 14 is directed to a multimeter.

Specie III: Claims 17 and 23 are directed to a medical device.

Specie IV: Claims 25-26 are directed to various timing associated with data generation and data transferring.

Specie V: Claims 28-29 are directed to control via a configuration file.

Specie VI: Claims 33-34 is directed to communication via an ASPI driver.

Applicant is required under 35 U.S.C. 121 to elect a single disclosed species, or a single grouping of patentably indistinct species, for prosecution on the merits to which the claims shall be restricted if no generic claim is finally held to be allowable. Currently, claims 2, 32 and 35 are generic.

There is a search and/or examination burden for the patentably distinct species as set forth above because at least the following reason(s) apply: the species or groupings of patentably indistinct species require a different field of search (e.g.,

Art Unit: 2181

searching different classes /subclasses or electronic resources, or employing different search strategies or search queries).

Applicant is advised that the reply to this requirement to be complete must include (i) an election of a species or a grouping of patentably indistinct species to be examined even though the requirement may be traversed (37 CFR 1.143) and (ii) identification of the claims encompassing the elected species or grouping of patentably indistinct species, including any claims subsequently added. An argument that a claim is allowable or that all claims are generic is considered nonresponsive unless accompanied by an election.

The election may be made with or without traverse. To preserve a right to petition, the election must be made with traverse. If the reply does not distinctly and specifically point out supposed errors in the election of species requirement, the election shall be treated as an election without traverse. Traversal must be presented at the time of election in order to be considered timely. Failure to timely traverse the requirement will result in the loss of right to petition under 37 CFR 1.144. If claims are added after the election, applicant must indicate which of these claims are readable on the elected species or grouping of patentably indistinct species.

Should applicant traverse on the ground that the species, or groupings of patentably indistinct species from which election is required, are not patentably distinct, applicant should submit evidence or identify such evidence now of record showing them to be obvious variants or clearly admit on the record that this is the case. In either instance, if the examiner finds one of the species unpatentable over the prior art, the

Art Unit: 2181

evidence or admission may be used in a rejection under 35 U.S.C. 103(a) of the other species.

Upon the allowance of a generic claim, applicant will be entitled to consideration of claims to additional species which depend from or otherwise require all the limitations of an allowable generic claim as provided by 37 CFR 1.141.

A telephone call was made to Attorney James A. Scheer on 4/15/2011 to request an oral election to the above restriction requirement, but did not result in an election being made.

Art Unit: 2181

CONCLUSION

Any inquiry concerning this communication or earlier communications from the examiner should be directed to Chun-Kuan Lee whose telephone number is (571)272-0671. The examiner can normally be reached on 8AM to 4:30PM.

If attempts to reach the examiner by telephone are unsuccessful, the examiner's supervisor, Alford Kindred can be reached on (571) 272-4037. The fax phone number for the organization where this application or proceeding is assigned is 571-273-8300.

Information regarding the status of an application may be obtained from the Patent Application Information Retrieval (PAIR) system. Status information for published applications may be obtained from either Private PAIR or Public PAIR. Status information for unpublished applications is available through Private PAIR only. For more information about the PAIR system, see <http://pair-direct.uspto.gov>. Should you have questions on access to the Private PAIR system, contact the Electronic Business Center (EBC) at 866-217-9197 (toll-free). If you would like assistance from a USPTO Customer Service Representative or access to the automated information system, call 800-786-9199 (IN USA OR CANADA) or 571-272-1000.

/Chun-Kuan Lee/
Primary Examiner, Art Unit 2181

Index of Claims 	Application/Control No. 12891443	Applicant(s)/Patent Under Reexamination TASLER, MICHAEL
	Examiner Chun-Kuan Lee	Art Unit 2181

✓	Rejected
=	Allowed

-	Cancelled
÷	Restricted

N	Non-Elected
I	Interference

A	Appeal
O	Objected

Claims renumbered in the same order as presented by applicant
 CPA
 T.D.
 R.1.47

CLAIM		DATE							
Final	Original	04/18/2011							
	1	-							
	2	÷							
	3	÷							
	4	÷							
	5	÷							
	6	÷							
	7	÷							
	8	÷							
	9	÷							
	10	÷							
	11	÷							
	12	÷							
	13	÷							
	14	÷							
	15	÷							
	16	÷							
	17	÷							
	18	÷							
	19	÷							
	20	÷							
	21	÷							
	22	÷							
	23	÷							
	24	÷							
	25	÷							
	26	÷							
	27	÷							
	28	÷							
	29	÷							
	30	÷							
	31	÷							
	32	÷							
	33	÷							
	34	÷							
	35	÷							
	36	÷							

Docket No.: 0757-113189
(PATENT)

IN THE UNITED STATES PATENT AND TRADEMARK OFFICE

In re Patent Application of:
Michael Tasler

Application No.: 12/891,443

Confirmation No.: 1408

Filed: September 27, 2010

Art Unit: 2111

For: ANALOG DATA GENERATING AND
PROCESSING DEVICE HAVING A MULTI-
USE AUTOMATIC PROCESSOR (as amended)

Examiner: To be assigned

PRELIMINARY AMENDMENT

Mail Stop Amendment
Commissioner for Patents
P.O. Box 1450
Alexandria, VA 22313-1450

Dear Sir:

INTRODUCTORY COMMENTS

Please enter this preliminary amendment in the above-identified continuation application filed on September 27, 2010. A Notice to File Missing Parts in this application was mailed October 14, 2010 indicating missing fees. The required fees have been filed.

The Listing of the Claims begins on page 3 of this paper.

Remarks/Arguments begin on page 11 of this paper.

Amendments to Specification:

Please replace paragraph [0001] of the specification with the following paragraph:

[0001] This application is a continuation of application Ser. No. 11/928,283 filed October 30, 2007 which is a continuation of application Ser. No. 11/467,073, filed August 24, 2006, now currently pending, which is a continuation of application Ser. No. 11/078,778, filed March 11, 2005, expressly abandoned, which is a continuation of application Ser. No. 10/219,105, filed August 15, 2002, now Pat. No. 6,895,449, which is a divisional of application Ser. No. 09/331,002, filed Jun. 14, 1999, now Pat. No. 6,470,399.

Amendments To The Claims:

Please cancel claim 1 and add new claims 2-36:

1. (cancelled).
2. (new) An analog data acquisition device operatively connectable to a computer through a multipurpose interface of the computer, the computer having an operating system and being programmed so that when it receives a signal from the device through said multipurpose interface of the computer indicative of a class of devices, the computer automatically activates a device driver corresponding to that class of devices for allowing the transfer of data between the device and the operating system of the computer, the analog data acquisition device comprising:
 - a) a program memory;
 - b) an analog signal acquisition channel for receiving a signal from an analog source;
 - c) a processor operatively interfaced with the multipurpose interface of the computer, the program memory, and a data storage memory when the analog data acquisition device is operational;
 - d) wherein the processor is configured and programmed to implement a data generation process by which analog data is acquired from the analog signal acquisition channel, the analog data is processed, and digitized, and the processed and digitized analog data is stored in a file system of the data storage memory as at least one file of digitized analog data;
 - e) wherein when the analog acquisition device is operatively interfaced with multipurpose interface of the computer, the processor executes at least one instruction set stored in the program memory and thereby automatically causes at least one parameter indicative of the class of devices to be sent to the computer through the multipurpose interface of the computer, independent of the analog source, wherein the analog data acquisition device is not within the class; and
 - f) wherein the processor is further configured and programmed to execute at least one

other instruction set stored in the program memory to thereby allow the at least one file of digitized analog data acquired from the analog signal acquisition channel to be transferred to the computer using the device driver corresponding to said class of devices so that the analog data acquisition device appears to the computer as if it were a device of that class;

whereby there is no requirement for any user-loaded file transfer enabling software to be loaded on or installed in the computer in addition to its operating system.

3. (new) The analog data acquisition device of claim 2, wherein the analog data acquisition device is a stand alone device.

4. (new) The analog data acquisition device of claim 2, wherein the analog data acquisition device includes a SCSI interface circuit.

5. (new) The analog data acquisition device of claim 2, wherein the analog data acquisition device is designed so that the analog source is detachable.

6. (new) The analog data acquisition device of claim 2 configured to allow for a plurality of different data transmit devices to be attached thereto and detached therefrom.

7. (new) The analog data acquisition device of claim 2, wherein the processor is adapted to be interfaced with a multi-purpose interface of an external computing device by means of a cable.

8. (new) The analog data acquisition device of claim 2, wherein the analog source comprises a data transmit/receive device.

9. (new) The analog data acquisition device of claim 8, wherein the analog source is designed for one of one-way and two-way communication with the host device.

10. (new) The analog data acquisition device of claim 2, wherein the analog source is designed to receive data from the host device.

11. (new) The analog data acquisition device of Claim 2 further comprising a plurality of independent analog signal acquisition channels, each of the plurality of channels operatively

coupled to the processor for operatively coupling to one of a plurality of analog sources.

12. (new) The analog data acquisition device of claim 2, wherein the processor allows for a plurality of different data transmit devices to be attached thereto and detached therefrom.

13. (new) The analog data acquisition device of claim 2, wherein the processor is designed so that a user can attach the analog source thereto or detach the analog source therefrom.

14. (new) The analog data acquisition device of claim 2, wherein the analog source comprises a multimeter.

15. (new) The analog data acquisition device of claim 2, wherein the analog source includes at least first and second transducers both of which are designed to transmit data.

16. (new) The analog data acquisition device of claim 2, wherein the at least one parameter is consistent with the analog data acquisition device being responsive to a SCSI inquiry command.

17. (new) The analog data acquisition device of claim 2, wherein the analog source is a medical device.

18. (new) The analog data acquisition device of claim 2, wherein the processor is configured to cause acquired analog data file system information to be automatically sent to the multi-purpose interface after the at least one parameter has been sent to a multi-purpose interface of the computer, (a) without requiring any end user to load any software onto the computer at any time, and (b) without requiring any end user to interact with the computer to set up a file system in the analog data acquisition device at any time.

19. (new) The analog data acquisition and interface device of claim 18, wherein the analog data acquisition device file system information comprises at least an indication of a file system type that is used to store the digitized analog data.

20. (new) The analog data acquisition device of claim 2,
wherein the processor is configured to cause file allocation table information to be

sent to the multi-purpose interface,

wherein the processor is configured to cause a virtual boot sequence to be sent to the multi-purpose interface which includes at least information that is representative of a number of sectors of a storage disk, and

wherein the file allocation table information includes at least a start location of a file allocation table.

21. (new) The analog data acquisition device of claim 2, wherein the processor is configured to initiate a process by which the at least one file of digitized analog data is directly transferred to an input/output device.

22. (new) The analog data acquisition device of claim 21, wherein the processor is configured to allow a mode of operation of the analog data acquisition device other than the transfer of at least some of the at least one file of digitized analog data to the multi-purpose interface to be controlled by means of an external personal computer.

23. (new) The analog data acquisition device of claim 2, wherein the analog data acquisition device comprises at least a portion of a medical device.

24. (new) The analog data acquisition device of claim 2, wherein the analog data is processed by being subject to a fast Fourier transform.

25. (new) The analog data acquisition device of claim 2 wherein the analog data acquisition device is designed so that both the data generation process and automatic file transfer, when they occur, take place only after the at least one parameter has been automatically sent.

26. (new) The analog data acquisition device of claim 2 wherein the data generation process and automatic data transfer of digitized analog data, when they occur, at least partially overlap in time.

27. (new) The analog data acquisition device of claim 2, wherein the analog source is designed to receive signals from the computer.

28. (new) The analog data acquisition device of claim 2, wherein the analog data acquisition and interface device is designed so that at least one aspect of how the analog data acquisition device creates at least one file of digitized analog data can be controlled by means of commands that are issuable from a source external to the analog data acquisition device.

29. (new) The analog data acquisition device of claim 28, wherein the analog data acquisition device is designed so that the at least one aspect is controlled by means of a configuration file.

30. (new) The analog data acquisition device of claim 2, wherein the analog data acquisition device is designed to be responsive to a test unit ready command.

31. (new) The analog data acquisition device of claim 2 wherein the device driver is installed with the operating system.

32. (new) An analog data acquisition and interface device for interfacing to a host device which includes a mass storage device and associated device driver, comprising:

a processor configured to operatively interface with a memory, an analog source, and a multi-purpose interface of the host device;

wherein the processor is configured to control a data generation process by which analog data is acquired from the analog source, the analog data is processed and digitized, and the processed and digitized analog data is stored in the memory as digitized analog data;

wherein the processor is configured such that, when operatively interfaced with the multi-purpose interface, the processor causes at least one parameter identifying the analog data acquisition device as a digital mass storage device, instead of as an analog data acquisition device and regardless of the analog source, to be automatically sent to the multi-purpose interface of the host device; and

wherein the processor is configured to automatically transfer the digitized analog

data acquired from the analog source to the host device, in a manner that causes the analog data acquisition and interface device to appear to be the mass storage device, while using the device driver associated with the mass storage device to perform the automatic transfer without requiring any user-loaded file transfer enabling software to be loaded on or installed in the computer.

33. (new) An analog data acquisition and interface device for interfacing to a host device which includes a mass storage device and associated device driver, comprising:

a program memory;

a processor coupled to the program memory and configured to operatively interface with a storage memory, an analog source, and a multi-purpose interface of the host device;

wherein the processor is configured to control a data generation process by which analog data is acquired from the analog source, the analog data is processed and digitized, and the processed and digitized analog data is stored in the memory as digitized analog data;

wherein the processor is configured such that, when operatively interfaced with the multi-purpose interface, the processor causes at least one parameter identifying the analog data acquisition device as a digital mass storage device instead of an analog data acquisition device and regardless of the analog source, to be automatically sent to the multi-purpose interface of the host device;

wherein the processor is configured to automatically transfer to the host device the digitized analog data acquired from the analog source, in a manner that causes the analog data acquisition and interface device to appear to be the mass storage device while using the device driver associated with the mass storage device to perform the automatic transfer; and

wherein the processor is configured to transmit to the host device commands to access a system bus of the host device to enable direct communications with other data devices of the host device while bypassing any host device processor.

34. (new) The analog data acquisition and interface device of claim 33, wherein the processor further comprises a plurality of independent analog data acquisition channels for simultaneously acquiring analog data in parallel from a plurality of analog sources.

35. (new) A method for analog data acquisition and interfacing to a host device wherein the host device includes a device driver, comprising:

operatively interfacing a data acquisition device, including a processor and a memory, with a multi-purpose interface of the host device;

acquiring analog data from an analog source, processing and digitizing the analog data, and storing the processed and digitized analog data in the memory as digitized analog data under control of the processor;

automatically sending under control of the processor at least one parameter to the multi-purpose interface of the host device, the at least one parameter identifying the analog data acquisition device as a digital storage device instead of as an analog data acquisition device, regardless of the analog source: and

automatically transferring to the host device at least some of the digitized analog data acquired from the analog source to the host device in response to a data request command, in a manner that causes the analog data acquisition device to appear to be a digital storage device instead of as an analog data acquisition device, while using the device driver to perform the automatic transfer of the acquired digitized analog data to the host device without requiring any user-loaded file transfer enabling software to be loaded on or installed in the host device.

36. (new) The method of claim 35, further comprising simultaneously acquiring the analog data from each respective analog channel of a plurality of respective independent

acquisition channels under control of the processor.

REMARKS

This is a preliminary amendment for the pending continuation application filed October 27, 2010 having serial number 12/891,443 which is a continuation of parent application serial number 11/928,283 filed October 30, 2007. New claims 2-36 have been added and original claim 1 has been cancelled. The Final Office Action mailed October 27, 2009 in the parent application rejected all pending claims under 35 U.S.C. §103(a). The new claims 2-36 are believed to be allowable over the references cited in the Final Office Action.

It is respectfully submitted that the instant application is in condition for allowance. A formal notice to that effect is respectfully solicited.

Respectfully submitted,

HUSCH BLACKWELL LLP

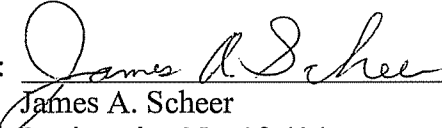
By: 
James A. Scheer
Registration No. 29,434

Dated: March 7, 2011

HUSCH BLACKWELL LLP
120 South Riverside Plaza, 22nd Floor
Chicago, Illinois 60606
(312) 655-1500

Electronic Acknowledgement Receipt

EFS ID:	9600715
Application Number:	12891443
International Application Number:	
Confirmation Number:	1408
Title of Invention:	ANALOG DATA GENERATING AND PROCESSING DEVICE FOR USE WITH A PERSONAL COMPUTER
First Named Inventor/Applicant Name:	Michael Tasler
Customer Number:	24628
Filer:	James A. Scheer/mawish elahi
Filer Authorized By:	James A. Scheer
Attorney Docket Number:	0757-113189
Receipt Date:	07-MAR-2011
Filing Date:	27-SEP-2010
Time Stamp:	15:39:57
Application Type:	Utility under 35 USC 111(a)

Payment information:

Submitted with Payment	no
------------------------	----

File Listing:

Document Number	Document Description	File Name	File Size(Bytes)/ Message Digest	Multi Part /.zip	Pages (if appl.)
1	Preliminary Amendment	113189.PDF	111072 <small>d8089b5a6084147d6790e0ece2931904235f1dccc</small>	no	11

Warnings:

Information:

This Acknowledgement Receipt evidences receipt on the noted date by the USPTO of the indicated documents, characterized by the applicant, and including page counts, where applicable. It serves as evidence of receipt similar to a Post Card, as described in MPEP 503.

New Applications Under 35 U.S.C. 111

If a new application is being filed and the application includes the necessary components for a filing date (see 37 CFR 1.53(b)-(d) and MPEP 506), a Filing Receipt (37 CFR 1.54) will be issued in due course and the date shown on this Acknowledgement Receipt will establish the filing date of the application.

National Stage of an International Application under 35 U.S.C. 371

If a timely submission to enter the national stage of an international application is compliant with the conditions of 35 U.S.C. 371 and other applicable requirements a Form PCT/DO/EO/903 indicating acceptance of the application as a national stage submission under 35 U.S.C. 371 will be issued in addition to the Filing Receipt, in due course.

New International Application Filed with the USPTO as a Receiving Office

If a new international application is being filed and the international application includes the necessary components for an international filing date (see PCT Article 11 and MPEP 1810), a Notification of the International Application Number and of the International Filing Date (Form PCT/RO/105) will be issued in due course, subject to prescriptions concerning national security, and the date shown on this Acknowledgement Receipt will establish the international filing date of the application.



UNITED STATES PATENT AND TRADEMARK OFFICE

UNITED STATES DEPARTMENT OF COMMERCE
United States Patent and Trademark Office
Address: COMMISSIONER FOR PATENTS
P.O. Box 1450
Alexandria, Virginia 22313-1450
www.uspto.gov

Table with 7 columns: APPLICATION NUMBER, FILING or 371(c) DATE, GRP ART UNIT, FIL FEE REC'D, ATTY. DOCKET NO, TOT CLAIMS, IND CLAIMS. Row 1: 12/891,443, 09/27/2010, 2111, 1220, 0757-113189, 1, 1

CONFIRMATION NO. 1408

UPDATED FILING RECEIPT



24628
Husch Blackwell Sanders, LLP
Husch Blackwell Sanders LLP Welsh & Katz
120 S RIVERSIDE PLAZA
22ND FLOOR
CHICAGO, IL 60606

Date Mailed: 02/18/2011

Receipt is acknowledged of this non-provisional patent application. The application will be taken up for examination in due course. Applicant will be notified as to the results of the examination. Any correspondence concerning the application must include the following identification information: the U.S. APPLICATION NUMBER, FILING DATE, NAME OF APPLICANT, and TITLE OF INVENTION. Fees transmitted by check or draft are subject to collection. Please verify the accuracy of the data presented on this receipt. If an error is noted on this Filing Receipt, please submit a written request for a Filing Receipt Correction. Please provide a copy of this Filing Receipt with the changes noted thereon. If you received a "Notice to File Missing Parts" for this application, please submit any corrections to this Filing Receipt with your reply to the Notice. When the USPTO processes the reply to the Notice, the USPTO will generate another Filing Receipt incorporating the requested corrections

Applicant(s)

Michael Tasler, Wurzburg, GERMANY;

Assignment For Published Patent Application

Papst Licensing GmbH & Co. KG, St. Georgen, GERMANY

Power of Attorney:

A Katz--24003

James Scheer--29434

Domestic Priority data as claimed by applicant

This application is a CON of 11/928,283 10/30/2007 ABN
which is a CON of 11/467,073 08/24/2006
and is a CON of 11/078,778 03/11/2005 ABN
and is a CON of 10/219,105 08/15/2002 PAT 6,895,449
and is a CON of 09/331,002 06/14/1999 PAT 6,470,399

Foreign Applications (You may be eligible to benefit from the Patent Prosecution Highway program at the USPTO. Please see http://www.uspto.gov for more information.)

GERMANY 19708755.8 03/04/1997

EUROPEAN PATENT OFFICE (EPO) PCT/EP98/01187 03/03/1998

If Required, Foreign Filing License Granted: 10/08/2010

The country code and number of your priority application, to be used for filing abroad under the Paris Convention, is US 12/891,443

Projected Publication Date: 06/02/2011

Non-Publication Request: No

**Early Publication Request: No
Title**

ANALOG DATA GENERATING AND PROCESSING DEVICE FOR USE WITH A PERSONAL
COMPUTER

Preliminary Class

710

PROTECTING YOUR INVENTION OUTSIDE THE UNITED STATES

Since the rights granted by a U.S. patent extend only throughout the territory of the United States and have no effect in a foreign country, an inventor who wishes patent protection in another country must apply for a patent in a specific country or in regional patent offices. Applicants may wish to consider the filing of an international application under the Patent Cooperation Treaty (PCT). An international (PCT) application generally has the same effect as a regular national patent application in each PCT-member country. The PCT process **simplifies** the filing of patent applications on the same invention in member countries, but **does not result** in a grant of "an international patent" and does not eliminate the need of applicants to file additional documents and fees in countries where patent protection is desired.

Almost every country has its own patent law, and a person desiring a patent in a particular country must make an application for patent in that country in accordance with its particular laws. Since the laws of many countries differ in various respects from the patent law of the United States, applicants are advised to seek guidance from specific foreign countries to ensure that patent rights are not lost prematurely.

Applicants also are advised that in the case of inventions made in the United States, the Director of the USPTO must issue a license before applicants can apply for a patent in a foreign country. The filing of a U.S. patent application serves as a request for a foreign filing license. The application's filing receipt contains further information and guidance as to the status of applicant's license for foreign filing.

Applicants may wish to consult the USPTO booklet, "General Information Concerning Patents" (specifically, the section entitled "Treaties and Foreign Patents") for more information on timeframes and deadlines for filing foreign patent applications. The guide is available either by contacting the USPTO Contact Center at 800-786-9199, or it can be viewed on the USPTO website at <http://www.uspto.gov/web/offices/pac/doc/general/index.html>.

For information on preventing theft of your intellectual property (patents, trademarks and copyrights), you may wish to consult the U.S. Government website, <http://www.stopfakes.gov>. Part of a Department of Commerce initiative, this website includes self-help "toolkits" giving innovators guidance on how to protect intellectual property in specific countries such as China, Korea and Mexico. For questions regarding patent enforcement issues, applicants may call the U.S. Government hotline at 1-866-999-HALT (1-866-999-4158).

LICENSE FOR FOREIGN FILING UNDER
Title 35, United States Code, Section 184
Title 37, Code of Federal Regulations, 5.11 & 5.15

GRANTED

The applicant has been granted a license under 35 U.S.C. 184, if the phrase "IF REQUIRED, FOREIGN FILING LICENSE GRANTED" followed by a date appears on this form. Such licenses are issued in all applications where the conditions for issuance of a license have been met, regardless of whether or not a license may be required as set forth in 37 CFR 5.15. The scope and limitations of this license are set forth in 37 CFR 5.15(a) unless an earlier license has been issued under 37 CFR 5.15(b). The license is subject to revocation upon written notification. The date indicated is the effective date of the license, unless an earlier license of similar scope has been granted under 37 CFR 5.13 or 5.14.

This license is to be retained by the licensee and may be used at any time on or after the effective date thereof unless it is revoked. This license is automatically transferred to any related applications(s) filed under 37 CFR 1.53(d). This license is not retroactive.

The grant of a license does not in any way lessen the responsibility of a licensee for the security of the subject matter as imposed by any Government contract or the provisions of existing laws relating to espionage and the national security or the export of technical data. Licensees should apprise themselves of current regulations especially with respect to certain countries, of other agencies, particularly the Office of Defense Trade Controls, Department of State (with respect to Arms, Munitions and Implements of War (22 CFR 121-128)); the Bureau of Industry and Security, Department of Commerce (15 CFR parts 730-774); the Office of Foreign Assets Control, Department of Treasury (31 CFR Parts 500+) and the Department of Energy.

NOT GRANTED

No license under 35 U.S.C. 184 has been granted at this time, if the phrase "IF REQUIRED, FOREIGN FILING LICENSE GRANTED" DOES NOT appear on this form. Applicant may still petition for a license under 37 CFR 5.12, if a license is desired before the expiration of 6 months from the filing date of the application. If 6 months has lapsed from the filing date of this application and the licensee has not received any indication of a secrecy order under 35 U.S.C. 181, the licensee may foreign file the application pursuant to 37 CFR 5.15(b).

PATENT APPLICATION FEE DETERMINATION RECORD

Substitute for Form PTO-875

Application or Docket Number
12/891,443

APPLICATION AS FILED - PART I

(Column 1) (Column 2)

FOR	NUMBER FILED	NUMBER EXTRA
BASIC FEE (37 CFR 1.16(a), (b), or (c))	N/A	N/A
SEARCH FEE (37 CFR 1.16(k), (l), or (m))	N/A	N/A
EXAMINATION FEE (37 CFR 1.16(o), (p), or (q))	N/A	N/A
TOTAL CLAIMS (37 CFR 1.16(j))	1 minus 20 = *	
INDEPENDENT CLAIMS (37 CFR 1.16(h))	1 minus 3 = *	
APPLICATION SIZE FEE (37 CFR 1.16(s))	If the specification and drawings exceed 100 sheets of paper, the application size fee due is \$270 (\$135 for small entity) for each additional 50 sheets or fraction thereof. See 35 U.S.C. 41(a)(1)(G) and 37 CFR 1.16(s).	
MULTIPLE DEPENDENT CLAIM PRESENT (37 CFR 1.16(j))		

SMALL ENTITY

RATE(\$)	FEE(\$)
N/A	
N/A	
N/A	
TOTAL	

OTHER THAN SMALL ENTITY

RATE(\$)	FEE(\$)
N/A	330
N/A	540
N/A	220
x 52 =	0.00
x 220 =	0.00
	0.00
	0.00
TOTAL	1090

* If the difference in column 1 is less than zero, enter "0" in column 2.

APPLICATION AS AMENDED - PART II

(Column 1) (Column 2) (Column 3)

AMENDMENT A		CLAIMS REMAINING AFTER AMENDMENT		HIGHEST NUMBER PREVIOUSLY PAID FOR	PRESENT EXTRA
	Total (37 CFR 1.16(i))	*	Minus	**	=
Independent (37 CFR 1.16(h))	*	Minus	***	=	
Application Size Fee (37 CFR 1.16(s))					
FIRST PRESENTATION OF MULTIPLE DEPENDENT CLAIM (37 CFR 1.16(j))					

SMALL ENTITY

RATE(\$)	ADDITIONAL FEE(\$)
x =	
x =	
TOTAL ADD'L FEE	

OTHER THAN SMALL ENTITY

RATE(\$)	ADDITIONAL FEE(\$)
x =	
x =	
TOTAL ADD'L FEE	

(Column 1) (Column 2) (Column 3)

AMENDMENT B		CLAIMS REMAINING AFTER AMENDMENT		HIGHEST NUMBER PREVIOUSLY PAID FOR	PRESENT EXTRA
	Total (37 CFR 1.16(i))	*	Minus	**	=
Independent (37 CFR 1.16(h))	*	Minus	***	=	
Application Size Fee (37 CFR 1.16(s))					
FIRST PRESENTATION OF MULTIPLE DEPENDENT CLAIM (37 CFR 1.16(j))					

RATE(\$)	ADDITIONAL FEE(\$)
x =	
x =	
TOTAL ADD'L FEE	

RATE(\$)	ADDITIONAL FEE(\$)
x =	
x =	
TOTAL ADD'L FEE	

* If the entry in column 1 is less than the entry in column 2, write "0" in column 3.

** If the "Highest Number Previously Paid For" IN THIS SPACE is less than 20, enter "20".

*** If the "Highest Number Previously Paid For" IN THIS SPACE is less than 3, enter "3".

The "Highest Number Previously Paid For" (Total or Independent) is the highest found in the appropriate box in column 1.

IN THE UNITED STATES PATENT AND TRADEMARK OFFICE

Appl. No.	:	12/891,443)	Confirmation No.:	1408
Applicant	:	Michael Tasler)		
Filed	:	9/27/2010)		
Art Unit	:	2111)		
Examiner	:	n/a)		
Docket No.	:	0757-113189)		
Customer No.:		24628)		
Title:		AN ANALOG DATA)		
		GENERATING AND PROCESSING DEVICE)		
		FOR USE WITH A PERSONAL COMPUTER)		

Response to Notification of Missing Parts

MAIL STOP MISSING PARTS
Commissioner for Patents
P.O. Box 1450
Alexandria, Virginia 22313-1450

Dear Sir:

Enclosed in response to the NOTICE TO FILE MISSING PARTS OF NON-PROVISIONAL APPLICATION, dated October 14, 2010 in connection with the above identified application please find:

- NOTICE TO FILE MISSING PARTS OF NON-PROVISIONAL APPLICATION (copy)
- Fees in the amount of \$1220

Respectfully submitted,
Husch Blackwell

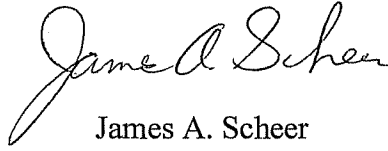

James A. Scheer
Reg. No. 29,434

February 14, 2011
Husch Blackwell
120 S. Riverside Plaza, 22nd Floor
Chicago, Illinois 60606
Telephone: 312 655 1500

Electronic Patent Application Fee Transmittal

Application Number:	12891443
Filing Date:	27-Sep-2010
Title of Invention:	ANALOG DATA GENERATING AND PROCESSING DEVICE FOR USE WITH A PERSONAL COMPUTER
First Named Inventor/Applicant Name:	Michael Tasler
Filer:	James A. Scheer/mawish elahi
Attorney Docket Number:	113189

Filed as Large Entity

Utility under 35 USC 111(a) Filing Fees

Description	Fee Code	Quantity	Amount	Sub-Total in USD(\$)
Basic Filing:				
Utility application filing	1011	1	330	330
Utility Search Fee	1111	1	540	540
Utility Examination Fee	1311	1	220	220

Pages:

Claims:

Miscellaneous-Filing:

Late filing fee for oath or declaration	1051	1	130	130
-----------------------------------------	------	---	-----	-----

Petition:

Description	Fee Code	Quantity	Amount	Sub-Total in USD(\$)
Patent-Appeals-and-Interference:				
Post-Allowance-and-Post-Issuance:				
Extension-of-Time:				
Extension - 2 months with \$0 paid	1252	1	490	490
Miscellaneous:				
Total in USD (\$)				1710

Electronic Acknowledgement Receipt

EFS ID:	9440255
Application Number:	12891443
International Application Number:	
Confirmation Number:	1408
Title of Invention:	ANALOG DATA GENERATING AND PROCESSING DEVICE FOR USE WITH A PERSONAL COMPUTER
First Named Inventor/Applicant Name:	Michael Tasler
Customer Number:	24628
Filer:	James A. Scheer/mawish elahi
Filer Authorized By:	James A. Scheer
Attorney Docket Number:	113189
Receipt Date:	14-FEB-2011
Filing Date:	27-SEP-2010
Time Stamp:	16:34:35
Application Type:	Utility under 35 USC 111(a)

Payment information:

Submitted with Payment	yes
Payment Type	Deposit Account
Payment was successfully received in RAM	\$1710
RAM confirmation Number	3388
Deposit Account	230920
Authorized User	

The Director of the USPTO is hereby authorized to charge indicated fees and credit any overpayment as follows:

Charge any Additional Fees required under 37 C.F.R. Section 1.21 (Miscellaneous fees and charges)

File Listing:					
Document Number	Document Description	File Name	File Size(Bytes)/ Message Digest	Multi Part /.zip	Pages (if appl.)
1	Extension of Time	113189eot.PDF	29361 d646bbb8b1e4fb87dd310a125b48895f9e463b69	no	1
Warnings:					
Information:					
2	Miscellaneous Incoming Letter	113189responsetonotificationofmissingparts.PDF	16463 547e1a087d816f51674cf9e28030ac6d6e50f21e	no	2
Warnings:					
Information:					
3	Fee Worksheet (PTO-875)	fee-info.pdf	38512 a81953002ad7ec771d248729408aebf34e3d624	no	2
Warnings:					
Information:					
Total Files Size (in bytes):			84336		

This Acknowledgement Receipt evidences receipt on the noted date by the USPTO of the indicated documents, characterized by the applicant, and including page counts, where applicable. It serves as evidence of receipt similar to a Post Card, as described in MPEP 503.

New Applications Under 35 U.S.C. 111

If a new application is being filed and the application includes the necessary components for a filing date (see 37 CFR 1.53(b)-(d) and MPEP 506), a Filing Receipt (37 CFR 1.54) will be issued in due course and the date shown on this Acknowledgement Receipt will establish the filing date of the application.

National Stage of an International Application under 35 U.S.C. 371

If a timely submission to enter the national stage of an international application is compliant with the conditions of 35 U.S.C. 371 and other applicable requirements a Form PCT/DO/EO/903 indicating acceptance of the application as a national stage submission under 35 U.S.C. 371 will be issued in addition to the Filing Receipt, in due course.

New International Application Filed with the USPTO as a Receiving Office

If a new international application is being filed and the international application includes the necessary components for an international filing date (see PCT Article 11 and MPEP 1810), a Notification of the International Application Number and of the International Filing Date (Form PCT/RO/105) will be issued in due course, subject to prescriptions concerning national security, and the date shown on this Acknowledgement Receipt will establish the international filing date of the application.

Under the paperwork Reduction Act of 1995, no persons are required to respond to a collection of information unless it displays a valid OMB control number.

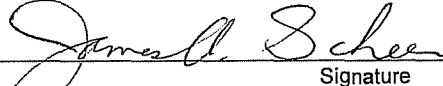
PETITION FOR EXTENSION OF TIME UNDER 37 CFR 1.136(a) FY 2009 <i>(Fees pursuant to the Consolidated Appropriations Act, 2005 (H.R. 4818).)</i>		Docket Number (Optional) 113189	
Application Number 12/891,443		Filed September 27, 2010	
For AN ANALOG DATA GENERATING AND PROCESSING DEVICE FOR USE WITH A PERSONAL COMPUTER			
Art Unit 2111		Examiner na	
This is a request under the provisions of 37 CFR 1.136(a) to extend the period for filing a reply in the above identified application.			
The requested extension and fee are as follows (check time period desired and enter the appropriate fee below):			
		<u>Fee</u>	<u>Small Entity Fee</u>
<input type="checkbox"/>	One month (37 CFR 1.17(a)(1))	\$130	\$65
<input checked="" type="checkbox"/>	Two months (37 CFR 1.17(a)(2))	\$490	\$245
<input type="checkbox"/>	Three months (37 CFR 1.17(a)(3))	\$1110	\$555
<input type="checkbox"/>	Four months (37 CFR 1.17(a)(4))	\$1730	\$865
<input type="checkbox"/>	Five months (37 CFR 1.17(a)(5))	\$2350	\$1175
<input type="checkbox"/>	Applicant claims small entity status. See 37 CFR 1.27.		
<input type="checkbox"/>	A check in the amount of the fee is enclosed.		
<input type="checkbox"/>	Payment by credit card. Form PTO-2038 is attached.		
<input checked="" type="checkbox"/>	The Director has already been authorized to charge fees in this application to a Deposit Account.		
<input checked="" type="checkbox"/>	The Director is hereby authorized to charge any fees which may be required, or credit any overpayment, to Deposit Account Number <u>23-0920</u> .		
WARNING: Information on this form may become public. Credit card information should not be included on this form. Provide credit card information and authorization on PTO-2038.			
I am the	<input type="checkbox"/>	applicant/inventor.	
	<input type="checkbox"/>	assignee of record of the entire interest. See 37 CFR 3.71. Statement under 37 CFR 3.73(b) is enclosed (Form PTO/SB/96).	
	<input checked="" type="checkbox"/>	attorney or agent of record. Registration Number <u>29,434</u>	
	<input type="checkbox"/>	attorney or agent under 37 CFR 1.34. Registration number if acting under 37 CFR 1.34 _____.	
		February 14, 2011	
James A. Scheer		Date	
Typed or printed name		(312) 655-1500	
		Telephone Number	
NOTE: Signatures of all the inventors or assignees of record of the entire interest or their representative(s) are required. Submit multiple forms if more than one signature is required, see below.			
<input type="checkbox"/>	Total of <u>1</u> forms are submitted.		

This collection of information is required by 37 CFR 1.136(a). The information is required to obtain or retain a benefit by the public which is to file (and by the USPTO to process) an application. Confidentiality is governed by 35 U.S.C. 122 and 37 CFR 1.11 and 1.14. This collection is estimated to take 6 minutes to complete, including gathering, preparing, and submitting the completed application form to the USPTO. Time will vary depending upon the individual case. Any comments on the amount of time you require to complete this form and/or suggestions for reducing this burden, should be sent to the Chief Information Officer, U.S. Patent and Trademark Office, U.S. Department of Commerce, P.O. Box 1450, Alexandria, VA 22313-1450. DO NOT SEND FEES OR COMPLETED FORMS TO THIS ADDRESS. SEND TO: Commissioner for Patents, P.O. Box 1450, Alexandria, VA 22313-1450.

Under the paperwork Reduction Act of 1995, no persons are required to respond to a collection of information unless it displays a valid OMB control number.

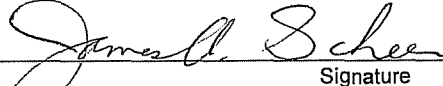
PETITION FOR EXTENSION OF TIME UNDER 37 CFR 1.136(a) FY 2009 <i>(Fees pursuant to the Consolidated Appropriations Act, 2005 (H.R. 4818).)</i>		Docket Number (Optional) 113189	
Application Number 12/891,443		Filed September 27, 2010	
For AN ANALOG DATA GENERATING AND PROCESSING DEVICE FOR USE WITH A PERSONAL COMPUTER			
Art Unit 2111		Examiner na	
This is a request under the provisions of 37 CFR 1.136(a) to extend the period for filing a reply in the above identified application.			
The requested extension and fee are as follows (check time period desired and enter the appropriate fee below):			
		<u>Fee</u>	<u>Small Entity Fee</u>
<input type="checkbox"/>	One month (37 CFR 1.17(a)(1))	\$130	\$65
<input checked="" type="checkbox"/>	Two months (37 CFR 1.17(a)(2))	\$490	\$245
<input type="checkbox"/>	Three months (37 CFR 1.17(a)(3))	\$1110	\$555
<input type="checkbox"/>	Four months (37 CFR 1.17(a)(4))	\$1730	\$865
<input type="checkbox"/>	Five months (37 CFR 1.17(a)(5))	\$2350	\$1175
<input type="checkbox"/>	Applicant claims small entity status. See 37 CFR 1.27.		
<input type="checkbox"/>	A check in the amount of the fee is enclosed.		
<input type="checkbox"/>	Payment by credit card. Form PTO-2038 is attached.		
<input checked="" type="checkbox"/>	The Director has already been authorized to charge fees in this application to a Deposit Account.		
<input checked="" type="checkbox"/>	The Director is hereby authorized to charge any fees which may be required, or credit any overpayment, to Deposit Account Number <u>23-0920</u> .		
WARNING: Information on this form may become public. Credit card information should not be included on this form. Provide credit card information and authorization on PTO-2038.			
I am the	<input type="checkbox"/>	applicant/inventor.	
	<input type="checkbox"/>	assignee of record of the entire interest. See 37 CFR 3.71. Statement under 37 CFR 3.73(b) is enclosed (Form PTO/SB/96).	
	<input checked="" type="checkbox"/>	attorney or agent of record. Registration Number <u>29,434</u>	
	<input type="checkbox"/>	attorney or agent under 37 CFR 1.34. Registration number if acting under 37 CFR 1.34 _____.	
		February 14, 2011	
James A. Scheer		Date	
Typed or printed name		(312) 655-1500	
		Telephone Number	
NOTE: Signatures of all the inventors or assignees of record of the entire interest or their representative(s) are required. Submit multiple forms if more than one signature is required, see below.			
<input type="checkbox"/>	Total of <u>1</u> forms are submitted.		

This collection of information is required by 37 CFR 1.136(a). The information is required to obtain or retain a benefit by the public which is to file (and by the USPTO to process) an application. Confidentiality is governed by 35 U.S.C. 122 and 37 CFR 1.11 and 1.14. This collection is estimated to take 6 minutes to complete, including gathering, preparing, and submitting the completed application form to the USPTO. Time will vary depending upon the individual case. Any comments on the amount of time you require to complete this form and/or suggestions for reducing this burden, should be sent to the Chief Information Officer, U.S. Patent and Trademark Office, U.S. Department of Commerce, P.O. Box 1450, Alexandria, VA 22313-1450. DO NOT SEND FEES OR COMPLETED FORMS TO THIS ADDRESS. SEND TO: Commissioner for Patents, P.O. Box 1450, Alexandria, VA 22313-1450.



UNITED STATES PATENT AND TRADEMARK OFFICE

UNITED STATES DEPARTMENT OF COMMERCE
United States Patent and Trademark Office
Address: COMMISSIONER FOR PATENTS
P.O. Box 1450
Alexandria, Virginia 22313-1450
www.uspto.gov

Table with 7 columns: APPLICATION NUMBER, FILING or 371(c) DATE, GRP ART UNIT, FIL FEE REC'D, ATTY. DOCKET NO, TOT CLAIMS, IND CLAIMS. Row 1: 12/891,443, 09/27/2010, 2111, 0.00, 113189, 1, 1

CONFIRMATION NO. 1408

24628
Husch Blackwell Sanders, LLP
Husch Blackwell Sanders LLP Welsh & Katz
120 S RIVERSIDE PLAZA
22ND FLOOR
CHICAGO, IL 60606

FILING RECEIPT



Date Mailed: 10/14/2010

Receipt is acknowledged of this non-provisional patent application. The application will be taken up for examination in due course. Applicant will be notified as to the results of the examination. Any correspondence concerning the application must include the following identification information: the U.S. APPLICATION NUMBER, FILING DATE, NAME OF APPLICANT, and TITLE OF INVENTION. Fees transmitted by check or draft are subject to collection. Please verify the accuracy of the data presented on this receipt. If an error is noted on this Filing Receipt, please submit a written request for a Filing Receipt Correction. Please provide a copy of this Filing Receipt with the changes noted thereon. If you received a "Notice to File Missing Parts" for this application, please submit any corrections to this Filing Receipt with your reply to the Notice. When the USPTO processes the reply to the Notice, the USPTO will generate another Filing Receipt incorporating the requested corrections

Applicant(s)

Michael Tasler, Wurzburg, GERMANY;

Assignment For Published Patent Application

Papst Licensing GmbH & Co. KG, St. Georgen, GERMANY

Power of Attorney:

A Katz--24003
James Scheer--29434

Domestic Priority data as claimed by applicant

This application is a CON of 11/928,283 10/30/2007
which is a CON of 11/467,073 08/24/2006
and is a CON of 11/078,778 03/11/2005 ABN
and is a CON of 10/219,105 08/15/2002 PAT 6,895,449
and is a CON of 09/331,002 06/14/1999 PAT 6,470,399

Foreign Applications

GERMANY 19708755.8 03/04/1997
EUROPEAN PATENT OFFICE (EPO) PCT/EP98/01187 03/03/1998

If Required, Foreign Filing License Granted: 10/08/2010

The country code and number of your priority application, to be used for filing abroad under the Paris Convention, is US 12/891,443

Projected Publication Date: To Be Determined - pending completion of Missing Parts

Non-Publication Request: No

Early Publication Request: No

Title

ANALOG DATA GENERATING AND PROCESSING DEVICE FOR USE WITH A PERSONAL COMPUTER

Preliminary Class

710

PROTECTING YOUR INVENTION OUTSIDE THE UNITED STATES

Since the rights granted by a U.S. patent extend only throughout the territory of the United States and have no effect in a foreign country, an inventor who wishes patent protection in another country must apply for a patent in a specific country or in regional patent offices. Applicants may wish to consider the filing of an international application under the Patent Cooperation Treaty (PCT). An international (PCT) application generally has the same effect as a regular national patent application in each PCT-member country. The PCT process **simplifies** the filing of patent applications on the same invention in member countries, but **does not result** in a grant of "an international patent" and does not eliminate the need of applicants to file additional documents and fees in countries where patent protection is desired.

Almost every country has its own patent law, and a person desiring a patent in a particular country must make an application for patent in that country in accordance with its particular laws. Since the laws of many countries differ in various respects from the patent law of the United States, applicants are advised to seek guidance from specific foreign countries to ensure that patent rights are not lost prematurely.

Applicants also are advised that in the case of inventions made in the United States, the Director of the USPTO must issue a license before applicants can apply for a patent in a foreign country. The filing of a U.S. patent application serves as a request for a foreign filing license. The application's filing receipt contains further information and guidance as to the status of applicant's license for foreign filing.

Applicants may wish to consult the USPTO booklet, "General Information Concerning Patents" (specifically, the section entitled "Treaties and Foreign Patents") for more information on timeframes and deadlines for filing foreign patent applications. The guide is available either by contacting the USPTO Contact Center at 800-786-9199, or it can be viewed on the USPTO website at <http://www.uspto.gov/web/offices/pac/doc/general/index.html>.

For information on preventing theft of your intellectual property (patents, trademarks and copyrights), you may wish to consult the U.S. Government website, <http://www.stopfakes.gov>. Part of a Department of Commerce initiative, this website includes self-help "toolkits" giving innovators guidance on how to protect intellectual property in specific countries such as China, Korea and Mexico. For questions regarding patent enforcement issues, applicants may call the U.S. Government hotline at 1-866-999-HALT (1-866-999-4158).

LICENSE FOR FOREIGN FILING UNDER

Title 35, United States Code, Section 184

Title 37, Code of Federal Regulations, 5.11 & 5.15

GRANTED

The applicant has been granted a license under 35 U.S.C. 184, if the phrase "IF REQUIRED, FOREIGN FILING LICENSE GRANTED" followed by a date appears on this form. Such licenses are issued in all applications where

the conditions for issuance of a license have been met, regardless of whether or not a license may be required as set forth in 37 CFR 5.15. The scope and limitations of this license are set forth in 37 CFR 5.15(a) unless an earlier license has been issued under 37 CFR 5.15(b). The license is subject to revocation upon written notification. The date indicated is the effective date of the license, unless an earlier license of similar scope has been granted under 37 CFR 5.13 or 5.14.

This license is to be retained by the licensee and may be used at any time on or after the effective date thereof unless it is revoked. This license is automatically transferred to any related applications(s) filed under 37 CFR 1.53(d). This license is not retroactive.

The grant of a license does not in any way lessen the responsibility of a licensee for the security of the subject matter as imposed by any Government contract or the provisions of existing laws relating to espionage and the national security or the export of technical data. Licensees should apprise themselves of current regulations especially with respect to certain countries, of other agencies, particularly the Office of Defense Trade Controls, Department of State (with respect to Arms, Munitions and Implements of War (22 CFR 121-128)); the Bureau of Industry and Security, Department of Commerce (15 CFR parts 730-774); the Office of Foreign Assets Control, Department of Treasury (31 CFR Parts 500+) and the Department of Energy.

NOT GRANTED

No license under 35 U.S.C. 184 has been granted at this time, if the phrase "IF REQUIRED, FOREIGN FILING LICENSE GRANTED" DOES NOT appear on this form. Applicant may still petition for a license under 37 CFR 5.12, if a license is desired before the expiration of 6 months from the filing date of the application. If 6 months has lapsed from the filing date of this application and the licensee has not received any indication of a secrecy order under 35 U.S.C. 181, the licensee may foreign file the application pursuant to 37 CFR 5.15(b).



UNITED STATES PATENT AND TRADEMARK OFFICE

UNITED STATES DEPARTMENT OF COMMERCE
United States Patent and Trademark Office
Address: COMMISSIONER FOR PATENTS
P.O. Box 1450
Alexandria, Virginia 22313-1450
www.uspto.gov

Table with 4 columns: APPLICATION NUMBER (12/891,443), FILING OR 371(C) DATE (09/27/2010), FIRST NAMED APPLICANT (Michael Tasler), ATTY. DOCKET NO./TITLE (113189)

CONFIRMATION NO. 1408

FORMALITIES LETTER

24628
Husch Blackwell Sanders, LLP
Husch Blackwell Sanders LLP Welsh & Katz
120 S RIVERSIDE PLAZA
22ND FLOOR
CHICAGO, IL 60606



Date Mailed: 10/14/2010

NOTICE TO FILE MISSING PARTS OF NONPROVISIONAL APPLICATION

FILED UNDER 37 CFR 1.53(b)

Filing Date Granted

Items Required To Avoid Abandonment:

An application number and filing date have been accorded to this application. The item(s) indicated below, however, are missing. Applicant is given TWO MONTHS from the date of this Notice within which to file all required items and pay any fees required below to avoid abandonment.

- The statutory basic filing fee is missing. Applicant must submit \$330 to complete the basic filing fee for a non-small entity. If appropriate, applicant may make a written assertion of entitlement to small entity status and pay the small entity filing fee (37 CFR 1.27).

The applicant needs to satisfy supplemental fees problems indicated below.

The required item(s) identified below must be timely submitted to avoid abandonment:

- To avoid abandonment, a surcharge (for late submission of filing fee, search fee, examination fee or oath or declaration) as set forth in 37 CFR 1.16(f) of \$130 for a non-small entity, must be submitted with the missing items identified in this notice.

SUMMARY OF FEES DUE:

Total additional fee(s) required for this application is \$1220 for a non-small entity

- \$330 Statutory basic filing fee.
\$130 Surcharge.
The application search fee has not been paid. Applicant must submit \$540 to complete the search fee.
The application examination fee has not been paid. Applicant must submit \$220 to complete the examination fee for a non-small entity.

Replies should be mailed to:

Mail Stop Missing Parts
Commissioner for Patents
P.O. Box 1450
Alexandria VA 22313-1450

Registered users of EFS-Web may alternatively submit their reply to this notice via EFS-Web.
<https://sportal.uspto.gov/authenticate/AuthenticateUserLocalEPF.html>

For more information about EFS-Web please call the USPTO Electronic Business Center at **1-866-217-9197** or visit our website at <http://www.uspto.gov/ebc>.

If you are not using EFS-Web to submit your reply, you must include a copy of this notice.

/tnguyen/

Office of Data Management, Application Assistance Unit (571) 272-4000, or (571) 272-4200, or 1-888-786-0101



UNITED STATES PATENT AND TRADEMARK OFFICE

UNITED STATES DEPARTMENT OF COMMERCE
United States Patent and Trademark Office
Address: COMMISSIONER FOR PATENTS
P.O. Box 1450
Alexandria, Virginia 22313-1450
www.uspto.gov

APPLICATION NUMBER	FILING OR 371(C) DATE	FIRST NAMED APPLICANT	ATTY. DOCKET NO./TITLE
12/891,443	09/27/2010	Michael Tasler	113189

CONFIRMATION NO. 1408

POA ACCEPTANCE LETTER

24628
Husch Blackwell Sanders, LLP
Husch Blackwell Sanders LLP Welsh & Katz
120 S RIVERSIDE PLAZA
22ND FLOOR
CHICAGO, IL 60606



Date Mailed: 10/14/2010

NOTICE OF ACCEPTANCE OF POWER OF ATTORNEY

This is in response to the Power of Attorney filed 09/27/2010.

The Power of Attorney in this application is accepted. Correspondence in this application will be mailed to the above address as provided by 37 CFR 1.33.

/tran/

Office of Data Management, Application Assistance Unit (571) 272-4000, or (571) 272-4200, or 1-888-786-0101

Under the Paperwork Reduction Act of 1995, no persons are required to respond to a collection of information unless it displays a valid OMB control number.

UTILITY PATENT APPLICATION TRANSMITTAL

(Only for new nonprovisional applications under 37 CFR 1.53(b))

Attorney Docket No.	113189
First Inventor	Michael L. Tasler
Title	An Analog Data Generating and ...
Express Mail Label No.	

APPLICATION ELEMENTS

See MPEP chapter 600 concerning utility patent application contents.

1. Fee Transmittal Form (e.g., PTO/SB/17)
2. Applicant claims small entity status.
See 37 CFR 1.27.
3. Specification [Total Pages 24]
Both the claims and abstract must start on a new page
(For information on the preferred arrangement, see MPEP 608.01(a))
4. Drawing(s) (35 U.S.C. 113) [Total Sheets 2]
5. Oath or Declaration [Total Sheets _____]
 - a. Newly executed (original or copy)
 - b. A copy from a prior application (37 CFR 1.63(d))
(for continuation/divisional with Box 18 completed)
 - i. DELETION OF INVENTOR(S)
Signed statement attached deleting inventor(s)
name in the prior application, see 37 CFR 1.63(d)(2) and 1.33(b).
6. Application Data Sheet. See 37 CFR 1.76
7. CD-ROM or CD-R in duplicate, large table or Computer Program (Appendix)
 - Landscape Table on CD
8. Nucleotide and/or Amino Acid Sequence Submission
(if applicable, items a. - c. are required)
 - a. Computer Readable Form (CRF)
 - b. Specification Sequence Listing on:
 - i. CD-ROM or CD-R (2 copies); or
 - ii. Paper
 - c. Statements verifying identity of above copies

ADDRESS TO:

Commissioner for Patents
P.O. Box 1450
Alexandria VA 22313-1450

ACCOMPANYING APPLICATION PARTS

9. Assignment Papers (cover sheet & document(s))
Name of Assignee _____
10. 37 CFR 3.73(b) Statement (when there is an assignee) Power of Attorney
11. English Translation Document (if applicable)
12. Information Disclosure Statement (PTO/SB/08 or PTO-1449)
 Copies of citations attached
13. Preliminary Amendment
14. Return Receipt Postcard (MPEP 503)
(Should be specifically itemized)
15. Certified Copy of Priority Document(s)
(if foreign priority is claimed)
16. Nonpublication Request under 35 U.S.C. 122(b)(2)(B)(i).
Applicant must attach form PTO/SB/35 or equivalent.
17. Other: _____

18. If a CONTINUING APPLICATION, check appropriate box, and supply the requisite information below and in the first sentence of the specification following the title, or in an Application Data Sheet under 37 CFR 1.76:

Continuation Divisional Continuation-in-part (CIP) of prior application No.: 11/928,283.....

Prior application information: Examiner C.K. Lee Art Unit 2181

19. CORRESPONDENCE ADDRESS

The address associated with Customer Number: 24628 OR Correspondence address below

Name			
Address			
City	State	Zip Code	
Country	Telephone	Email	

Signature		Date	September 27, 2010
Name (Print/Type)	James A. Scheer	Registration No. (Attorney/Agent)	29,434

This collection of information is required by 37 CFR 1.53(b). The information is required to obtain or retain a benefit by the public which is to file (and by the USPTO to process) an application. Confidentiality is governed by 35 U.S.C. 122 and 37 CFR 1.11 and 1.14. This collection is estimated to take 12 minutes to complete, including gathering, preparing, and submitting the completed application form to the USPTO. Time will vary depending upon the individual case. Any comments on the amount of time you require to complete this form and/or suggestions for reducing this burden, should be sent to the Chief Information Officer, U.S. Patent and Trademark Office, U.S. Department of Commerce, P.O. Box 1450, Alexandria, VA 22313-1450. DO NOT SEND FEES OR COMPLETED FORMS TO THIS ADDRESS. SEND TO: Commissioner for Patents, P.O. Box 1450, Alexandria, VA 22313-1450.

If you need assistance in completing the form, call 1-800-PTO-9199 and select option 2.

APPLICATION DATA SHEET

APPLICATION INFORMATION

Application Type:	Utility
Title:	AN ANALOG DATA GENERATING AND PROCESSING DEVICE FOR USE WITH A PERSONAL COMPUTER
Attorney Docket Number:	
Request for Early Publication?:	No
Request for Non-Publication?:	No
Suggested Drawing Figure:	None
Total Drawing Sheets:	2
Small Entity?:	No
Preliminary Amendment	No

APPLICANT INFORMATION

Applicant Authority Type:	Inventor
Primary Citizenship:	GERMANY
Inventor One Given Name:	Michael
Family Name:	L.
City of Residence:	Tasler
State or Province of Residence:	
Street of Mailing Address:	Cronthalstraß 6c
City of Mail Address:	Würzburg
Country of Mailing Address:	GERMANY
Postal or Zip Code of Mailing Address:	D-97074

CORRESPONDENCE INFORMATION

U.S.P.T.O. Customer Number: 24628
 Phone Number: 312-655-1500
 Facsimile Number: 312-655-1501
 E-Mail Address: jasdocket@welshkatz.com

REPRESENTATIVE INFORMATION

Those attorneys under Customer No. 24628

DOMESTIC PRIORITY INFORMATION

Application:	Continuity Type:	Parent Application:	Parent Filing Date:
This Application	Continuation	11/928,283	October 30, 2007
	Continuation	11/467,073	August 24, 2006
	Continuation	11/078,778	March 11, 2005
	Continuation	10/219,105	August 15, 2002
	Continuation	09/331,002	June 14, 1999

FOREIGN PRIORITY INFORMATION

Foreign Application No.: 19708755.8
 Filing Date: March 4, 1997
 Country: GERMANY
 Priority Claimed: Yes

PCT Application No.: PCT/EP/98/01187
 International Filing Date: March 3, 1998
 Receiving Office:
 Priority Claimed: Yes

ASSIGNMENT INFORMATION

Assignee Name: Papst Licensing GmbH & Co. KG

Assignee Address:	Bahnhofstrasse 33
Assignee City:	St. Georgen
Assignee Postal Code:	78112
Assignee Country:	GERMANY

AN ANALOG DATA GENERATING AND PROCESSING DEVICE
FOR USE WITH A PERSONAL COMPUTER

CROSS-REFERENCE TO RELATED APPLICATIONS

[0001] This application is a continuation of application Ser. No. 11/467,073, filed August 24, 2006, which is a continuation of application Ser. No. 11/078,778, filed March 11, 2005, now expressly abandoned, which is a continuation of application Ser. No. 10/219,105, filed August 15, 2002, now Pat. No. 6,895,449, which is a divisional of application Ser. No. 09/331,002, filed Jun. 14, 1999, now Pat. No. 6,470,399.

FIELD OF THE INVENTION

[0002] The present invention relates to the transfer of data and in particular to interface devices for communication between a computer or host device and a data transmit/receive device from which data is to be acquired or with which two-way communication is to take place.

BACKGROUND OF THE INVENTION

[0003] Existing data acquisition systems for computers are very limited in their areas of application. Generally such systems can be classified into two groups.

[0004] In the first group host devices or computer systems are attached by means of an interface to a device whose data is to be acquired. The interfaces of this group are normally standard interfaces which, with specific driver software, can be used with a variety of host systems. An advantage of such interfaces is that they are largely independent of the host device. However, a disadvantage is that they generally require very sophisticated drivers which are prone

to malfunction and which limit data transfer rates between the device connected to the interface and the host device and vice versa. Further, it is often very difficult to implement such interfaces for portable systems and they offer few possibilities for adaptation with the result that such systems offer little flexibility.

[0005] The devices from which data is to be acquired cover the entire electrical engineering spectrum. In a typical case, it is assumed that a customer who operates, for example, a diagnostic radiology system in a medical engineering environment reports a fault. A field service technician of the system manufacturer visits the customer and reads system log files generated by the diagnostic radiology system by means a portable computer or laptop for example. If the fault cannot be localized or if the fault is intermittent, it will be necessary for the service technician to read not only an error log file but also data from current operation. It is apparent that in this case fast data transfer and rapid data analysis are necessary.

[0006] Another case requiring the use of an interface could be, for example, when an electronic measuring device, e.g. a multimeter, is attached to a computer system to transfer the data measured by the multimeter to the computer. Particularly when long-term measurements or large volumes of data are involved is it necessary for the interface to support a high data transfer rate.

[0007] From these randomly chosen examples it can be seen that an interface may be put to totally different uses. It is therefore desirable that an interface be sufficiently flexible to permit attachment of very different electrical or electronic systems to a host device by means of the interface. To prevent operator error, it is also desirable that a service technician is not required to operate different interfaces in different ways for different applications but that, if

possible, a universal method of operating the interface be provided for a large number of applications.

[0008] To increase the data transfer rates across an interface, the route chosen in the second group of data acquisition systems for the interface devices was to specifically match the interface very closely to individual host systems or computer systems. The advantage of this solution is that high data transfer rates are possible. However, a disadvantage is that the drivers for the interfaces of the second group are very closely matched to a single host system with the result that they generally cannot be used with other host systems or their use is very ineffective. Further, such types of interface have the disadvantage that they must be installed inside the computer casing to achieve maximum data transfer rates as they access the internal host bus system. They are therefore generally not suitable for portable host systems in the form of laptops whose minimum possible size leaves little internal space to plug in an interface card.

[0009] A solution to this problem is offered by the interface devices of IOtech (business address: 25971 Cannon Road, Cleveland, Ohio 44146, USA) which are suitable for laptops such as the WaveBook/512 (registered trademark). The interface devices are connected by means of a plug-in card, approximately the size of a credit card, to the PCMCIA interface which is now a standard feature in laptops. The plug-in card converts the PCMCIA interface into an interface known in the art as IEEE 1284. The said plug-in card provides a special printer interface which is enhanced as regards the data transfer rate and delivers a data transfer rate of approximately 2 MBps as compared with a rate of approx. 1 MBps for known printer interfaces. The known interface device generally consists of a driver component, a digital signal processor, a buffer and a hardware module which terminates in a connector to which the device whose data is to be acquired is attached. The driver component is attached directly to the enhanced printer interface

thus permitting the known interface device to establish a connection between a computer and the device whose data is to be acquired.

[0010] In order to work with the said interface, an interface-specific driver must be installed on the host device so that the host device can communicate with the digital signal processor of the interface card. As described above, the driver must be installed on the host device. If the driver is a driver developed specifically for the host device, a high data transfer rate is achieved but the driver cannot be easily installed on a different host system. However, if the driver is a general driver which is as flexible as possible and which can be used on many host devices, compromises must be accepted with regard to the data transfer rate.

[0011] Particularly in an application for multi-tasking systems in which several different tasks such as data acquisition, data display and editing are to be performed quasi-simultaneously, each task is normally assigned a certain priority by the host system. A driver supporting a special task requests the central processing system of the host device for processor resources in order to perform its task. Depending on the particular priority assignment method and on the driver implementation, a particular share of processor resources is assigned to a special task in particular time slots. Conflicts arise if one or more drivers are implemented in such a way that they have the highest priority by default, i.e. they are incompatible, as happens in practice in many applications. It may occur that both drivers are set to highest priority which, in the worst case, can result in a system crash.

[0012] EP 0685799 A1 discloses an interface by means of which several peripheral devices can be attached to a bus. An interface is connected between the bus of a host device and various peripheral devices. The interface comprises a finite state machine and several branches each of which is assigned to a peripheral device. Each branch comprises a data manager, cycle

control, user logic and a buffer. This known interface device provides optimal matching between a host device and a specific peripheral device.

[0013] The specialist publication IBM Technical Disclosure Bulletin, Vol. 38, No. 05, page 245; "Communication Method between Devices through FDD Interface" discloses an interface which connects a host device to a peripheral device via a floppy disk drive interface. The interface consists in particular of an address generator, an MFM encoder/decoder, a serial/parallel adapter and a format signal generator. The interface makes it possible to attach not only a floppy disk drive but also a further peripheral device to the FDD host controller of a host device. The host device assumes that a floppy disk drive is always attached to its floppy disk drive controller and communication is initiated if the address is correct. However, this document contains no information as to how communication should be possible if the interface is connected to a multi-purpose interface instead of to a floppy disk drive controller.

SUMMARY OF THE INVENTION

[0014] It is the object of the present invention to provide an interface device for communication between a host device and a data transmit/receive device whose use is host device-independent and which delivers a high data transfer rate.

[0015] The present invention is based on the finding that both a high data transfer rate and host device-independent use can be achieved if a driver for an input/output device customary in a host device, normally present in most commercially available host devices, is utilized. Drivers for input/output devices customary in a host device which are found in practically all host devices are, for example, drivers for hard disks, for graphics devices or for printer devices. As however the hard disk interfaces in common host devices which can be, for example, IBM

PCs, IBM-compatible PCs, Commodore PCs, Apple computers or even workstations, are the interfaces with the highest data transfer rate, the hard disk driver is utilized in the preferred embodiment of the interface device of the present invention. Drivers for other storage devices such as floppy disk drives, CD-ROM drives or tape drives could also be utilized in order to implement the interface device according to the present invention.

[0016] As described in the following, the interface device according to the present invention is to be attached to a host device by means of a multi-purpose interface of the host device which can be implemented, for example, as an SCSI interface or as an enhanced printer interface. Multi-purpose interfaces comprise both an interface card and specific driver software for the interface card. The driver software can be designed so that it can replace the BIOS driver routines. Communication between the host device and the devices attached to the multi-purpose interface then essentially takes place by means of the specific driver software for the multi-purpose interface and no longer primarily by means of BIOS routines of the host device. Recently however drivers for multi-purpose interfaces can also already be integrated in the BIOS system of the host device as, alongside classical input/output interfaces, multi-purpose interfaces are becoming increasingly common in host devices. It is of course also possible to use BIOS routines in parallel with the specific driver software for the multi-purpose interface, if this is desired.

[0017] The interface device according to the present invention comprises a processor means, a memory means, a first connecting device for interfacing the host device with the interface device, and a second connecting device for interfacing the interface device with the data transmit/receive device. The interface device is configured by the processor means and the memory means in such a way that the interface device, when receiving an inquiry from the host

device via the first connecting device as to the type of a device attached to the host device, sends a signal, regardless of the type of the data transmit/receive device, to the host device via the first connecting device which signals to the host device that it is communicating with an input/output device. The interface device according to the present invention therefore simulates, both in terms of hardware and software, the way in which a conventional input/output device functions, preferably that of a hard disk drive. As support for hard disks is implemented as standard in all commercially available host systems, the simulation of a hard disk, for example, can provide host device-independent use. The interface device according to the present invention therefore no longer communicates with the host device or computer by means of a specially designed driver but by means of a program which is present in the BIOS system (Basic Input/Output System) and is normally precisely matched to the specific computer system on which it is installed, or by means of a specific program for the multi-purpose interface. Consequently, the interface device according to the present invention combines the advantages of both groups. On the one hand, communication between the computer and the interface takes place by means of a host device-specific BIOS program or by means of a driver program which is matched to the multi-purpose interface and which could be regarded as a "device-specific driver". On the other hand, the BIOS program or a corresponding multi-purpose interface program which operates one of the common input/output interfaces in host systems is therefore present in all host systems so that the interface device according to the present invention is host device-independent.

BRIEF DESCRIPTION OF THE DRAWINGS

[0018] In the following, preferred embodiments of the present invention will be explained in more detail with reference to the drawings enclosed, in which:

[0019] FIG. 1 shows a general block diagram of the interface device according to the present invention; and

[0020] FIG. 2 shows a detailed block diagram of an interface device according to a preferred embodiment of the present invention.

DETAILED DESCRIPTION OF THE PREFERRED EMBODIMENTS

[0021] It should be understood that the title of this section of this specification, namely, "Detailed Description Of The Invention", relates to a requirement of the United States Patent Office, and does not imply, nor should be inferred to limit the subject matter disclosed herein.

[0022] FIG. 1 shows a general block diagram of an interface device 10 according to the present invention. A first connecting device 12 of the interface device 10 can be attached to a host device (not shown) via a host line 11. The first connecting device is attached both to a digital signal processor 13 and to a memory means 14. The digital signal processor 13 and the memory means 14 are also attached to a second connecting device 15 by means of bi-directional communication lines (shown for all lines by means of two directional arrows). The second connecting device can be attached by means of an output line 16 to a data transmit/receive device which is to receive data from the host device or from which data is to be read, i.e. acquired, and transferred to the host device. The data transmit/receive device itself can also communicate actively with the host device via the first and second connecting device, as described in more detail in the following.

[0023] Communication between the host system or host device and the interface device is based on known standard access commands as supported by all known operating systems (e.g. DOS, Windows, Unix). Preferably, the interface device according to the present invention

simulates a hard disk with a root directory whose entries are "virtual" files which can be created for the most varied functions. When the host device system with which the interface device according to the present invention is connected is booted and a data transmit/receive device is also attached to the interface device 10, usual BIOS routines or multi-purpose interface programs issue an instruction, known by those skilled in the art as the INQUIRY instruction, to the input/output interfaces in the host device. The digital signal processor 13 receives this inquiry instruction via the first connecting device and generates a signal which is sent to the host device (not shown) again via the first connecting device 12 and the host line 11. This signal indicates to the host device that, for example, a hard disk drive is attached at the interface to which the INQUIRY instruction was sent. Optionally, the host device can send an instruction, known by those skilled in the art as "Test Unit Ready", to the interface device to request more precise details regarding the queried device.

[0024] Regardless of which data transmit/receive device at the output line 16 is attached to the second connecting device, the digital signal processor 13 informs the host device that it is communicating with a hard disk drive. If the host device receives the response that a drive is present, it then sends a request to the interface device 10 to read the boot sequence which, on actual hard disks, normally resides on the first sectors of the disk. The digital signal processor 13, whose operating system is stored in the memory means 14, responds to this instruction by sending to the host device a virtual boot sequence which, in the case of actual drives, includes the drive type, the starting position and the length of the file allocation table (FAT), the number of sectors, etc., known to those skilled in the art. Once the host device has received this data, it assumes that the interface device 10 according to a preferred embodiment of the present invention is a hard disk drive. In reply to an instruction from the host device to display the

directory of the "virtual" hard disk drive simulated by the interface device 10 with respect to the host device, the digital signal processor can respond to the host device in exactly the same way as a conventional hard disk would, namely by reading on request the file allocation table or FAT on a sector specified in the boot sequence, normally the first writable sector, and transferring it to the host device, and subsequently by transferring the directory structure of the virtual hard disk. Further, it is possible that the FAT is not read until immediately prior to reading or storing the data of the "virtual" hard disk and not already at initialization.

[0025] In a preferred embodiment of the present invention, the digital signal processor 13, which need not necessarily be implemented as a digital signal processor but may be any other kind of microprocessor, comprises a first and a second command interpreter. The first command interpreter carries out the steps described above whilst the second command interpreter carries out the read/write assignment to specific functions. If the user now wishes to read data from the data transmit/receive device via the line 16, the host device sends a command, for example "read file xy", to the interface device. As described above, the interface device appears to the host device as a hard disk. The second command interpreter of the digital signal processor now interprets the read command of the host processor as a data transfer command, by decoding whether "xy" denotes, for example, a "real-time input" file, a "configuration" file or an executable file, whereby the same begins to transfer data from the data transmit/receive device via the second connecting device to the first connecting device and via the line 11 to the host device.

[0026] Preferably, the volume of data to be acquired by a data transmit/receive device is specified in a configuration file described in the following by the user specifying in the said configuration file that a measurement is to last, for example, five minutes. To the host device the

"real-time input" file then appears as a file whose length corresponds to the anticipated volume of data in those five minutes. Those skilled in the art know that communication between a processor and a hard disk consists of the processor transferring to the hard disk the numbers of the blocks or clusters or sectors whose contents it wishes to read. By reference to the FAT the processor knows which information is contained in which block. In this case, communication between the host device and the interface device according to the present invention therefore consists of the very fast transfer of block numbers and preferably of block number ranges because a virtual "real-time input" file will not be fragmented. If the host device now wants to read the "real-time input" file, it transfers a range of block numbers to the interface device, whereupon data commences to be received via the second connecting device and data commences to be sent to the host device via the first connecting device.

[0027] In addition to the digital signal processor instruction memory, which comprises the operating system of the digital signal processor and can be implemented as an EPROM or EEPROM, the memory means 14 can have an additional buffer for purposes of synchronizing data transfer from the data transmit/receive device to the interface device 10 and data transfer from the interface device 10 to the host device.

[0028] Preferably, the buffer is implemented as a fast random access memory or RAM buffer.

[0029] Further, from the host device the user can also create a configuration file, whose entries automatically set and control various functions of the interface device 10, on the interface device 10 which appears to the host device as a hard disk. These settings can be, for example, gain, multiplex or sampling rate settings. By creating and editing a configuration file, normally a text file which is simple to understand with little prior knowledge, users of the interface device

10 are able to perform essentially identical operator actions for almost any data transmit/receive devices which can be attached to the second connecting device via the line 16, thus eliminating a source of error arising from users having to know many different command codes for different applications. In the case of the interface device 10 according to the present invention it is necessary for users to note the conventions of the configuration file once only in order to be able to use the interface device 10 as an interface between a host device and almost any data transmit/receive device.

[0030] As a result of the option of storing any files in agreed formats in the memory means 14 of the interface device 10, taking into account the maximum capacity of the memory means, any enhancements or even completely new functions of the interface device 10 can be quickly implemented. Even files executable by the host device, such as batch files or executable files (BAT or EXE files), and also help files can be implemented in the interface device, thus achieving independence of the interface device 10 from any additional software (with the exception of the BIOS routines) of the host device. On the one hand, this avoids licensing and/or registration problems and, on the other hand, installation of certain routines which can be frequently used, for example an FFT routine to examine acquired time-domain data in the frequency domain, is rendered unnecessary as the EXE files are already installed on the interface device 10 and appear in the virtual root directory, by means of which the host device can access all programs stored on the interface device 10.

[0031] In a preferred embodiment of the present invention in which the interface device 10 simulates a hard disk to the host device, the interface device is automatically detected and readied for operation when the host system is powered up or booted. This corresponds to the plug-and-play standard which is currently finding increasingly widespread use. The user is no

longer responsible for installing the interface device 10 on the host device by means of specific drivers which must also be loaded; instead the interface device 10 is automatically readied for operation when the host system is booted.

[0032] For persons skilled in the art it is however obvious that the interface device 10 is not necessarily signed on when the computer system is powered up but that a special BIOS routine or a driver for a multi-purpose interface can also be started on the host device during current operation of the computer system in order to sign on or mount the interface device 10 as an additional hard disk. This embodiment is suitable for larger workstation systems which are essentially never powered down as they perform, e.g. mail functions or monitor processes which run continuously, for example, in multi-tasking environments.

[0033] In the interface device according to the present invention an enormous advantage is to be gained, as apparent in the embodiment described in the following, in separating the actual hardware required to attach the interface device 10 to the data transmit/receive device from the communication unit, which is implemented by the digital signal processor 13, the memory means 14 and the first connecting device 12, as this allows a plurality of dissimilar device types to be operated in parallel in identical manner. Accordingly, many interface devices 10 can be connected to a host device which then sees many different "virtual" hard disks. In addition, any modification of the specific hardware symbolized by the second connecting device 15 can be implemented essentially without changing the operation of the interface device according to the present invention. Further, an experienced user can intervene at any time on any level of the existing second connecting device by making use of the above mentioned option of creating a configuration file or adding or storing new program sections for the second connecting device.

[0034] An important advantage of the interface device 10 of the present invention is that it also permits extremely high data transfer rates by using, for data interchange, the host device-own BIOS routines which are optimized for each host device by the host device manufacturer or BIOS system manufacturer, or by using driver programs which are normally optimized and included by the manufacturers of multi-purpose interfaces. Furthermore, due to the simulation of a virtual mass storage device, the data is managed and made available in such a way that it can be transferred directly to other storage media, e.g. to an actual hard disk of the host device without, as it were, intervention of the host device processor. The only limitation to long-term data transfer at high speed is therefore imposed exclusively by the speed and the size of the mass storage device of the host device. This is the case as the digital signal processor 13 already formats the data read by the data transmit/receive device via the second connecting device 15 into block sizes suitable for a hard disk of the host device, whereby the data transfer speed is limited only by the mechanical latency of the hard disk system of the host device. At this point, it should be noted that normally data flow from a host device must be formatted in blocks to permit writing to a hard disk and subsequent reading from a hard disk, as known by those skilled in the art.

[0035] The said data transfer rate can be increased further by setting up a direct memory access (DMA) or RAM drive in the host system. As those skilled in the art know, the setting up of a RAM drive requires processor resources of the host device, with the result that the advantage of writing the data to a hard disk drive of the host device essentially without the need for processor resources is lost.

[0036] As described above, a data buffer can be implemented in the memory means 14 to permit independence in terms of time of the data transmit/receive device attached to the second

connecting device from the host device attached to the first connecting device. This guarantees error-free operation of the interface device 10 even for time-critical applications in multi-tasking host systems.

[0037] FIG. 2 shows a detailed block diagram of an interface device 10 according to the present invention.

[0038] A digital signal processor (DSP) 1300 is, in a manner of speaking, the heart of the interface device 10. The DSP can be any DSP but preferably has a 20-MB on-chip random access memory (RAM). Certain instruction sets, for example, can be stored in the RAM already integrated in the DSP. An 80-MHz clock generator is attached to the DSP 1300 in order to synchronize the DSP. The DSP implements a fast Fourier transformation (FFT) in real time and also optional data compression of the data to be transferred from the data transmit/receive device to the host device in order to achieve greater efficiency and to permit interoperability with host devices which have a smaller memory.

[0039] In the preferred embodiment of the interface device 10 shown in FIG. 2, the first connecting device 12 of FIG. 1 contains the following components: an SCSI interface 1220 and a 50-pin SCSI connector 1240 for attachment to an SCSI interface present on most host devices or laptops. The SCSI (small computer system interface) interface 1220 translates the data received via the SCSI connector 1240 into data understood by the DSP 1300, as known by those skilled in the art. Further, the first connecting device 12 comprises an EPP (enhanced parallel port) with a data transfer rate of approx. 1 MBps which delivers a more moderate data transfer rate of 1 MBps by comparison to the data transfer rate of 10 MBps of the SCSI interface. The EPP 1260 is connected to a 25-pin D-shell connector 1280 to permit attachment to a printer interface of a host device for example. Optionally, the first connecting device 12 also comprises a 25-pin

connector 1282 which permits the attachment of 8 digital outputs and 8 digital inputs 1284 at a host device.

[0040] Preferably, the second connecting device comprises 8 BNC inputs with the calibration relay 1505, a block 1510 with 8 device amplifiers with an overvoltage protection of ± 0.75 V, this block being connected in turn to 8 sample/hold (S&H) circuits 1515. The calibration relays are relays which permit controlled changeover between a test voltage and a calibration reference voltage. Each sample/hold circuit is connected to a corresponding input of an 8-channel multiplexer 1520 which feeds its output signals via a programmable amplifier 1525 into an analog/digital converter (ADC) with 12 bit and 1.25 MHz 1530 and to the DSP 1300. The ADC 1530 is controlled by means of a 20-bit timer 1535, as known by persons skilled in the art. The programmable amplifier 1525 and the 8-channel multiplexer 1520 are controlled via an amplifier channel selection circuit 1540 which is in turn controlled by the DSP 1300.

[0041] The complete interface device 10 is supplied with power by an external AC/DC converter 1800 which delivers a digital supply voltage of ± 5 V and is attached to a DC/DC converter 1810 which can deliver analog supply voltages of ± 5 V and ± 15 V as required for the interface device 10. Further, the DC/DC converter controls a precision voltage reference 1820 which controls the 8 BNC inputs 1505 and the ADC 1530 as well as a digital/analog converter (DAC) 1830 which permits, via an output amplifier block with 4 output amplifiers 1840 and a 9-pin connector 1850, analog output direct from the DSP 1300 to an output device, e.g. printer device or monitor device, which can be attached via the 9-pin connector 1850, thus providing the option of monitoring the data transferred to the host device or also, for example, of viewing an FFT to obtain rapid and comprehensive data analysis without using processor time of the host device.

[0042] In FIG. 2 the memory means 14 of FIG. 1 is implemented by an EPROM 1400 which, in a preferred embodiment of the present invention, contains the operating system of the digital signal processor 1300. A random access memory with an access time of 15 ns and a size of 512 KB or optionally 1024 KB 1420 serves as a data buffer to achieve independence in terms of time of the output line 16 from the output lines 11a, 11b and 11c to the data transmit/receive device and to the host device respectively. As described above, in a preferred embodiment of the present invention the digital signal processor 1300 already contains a 20-KB on-chip RAM 1440 which can store certain instruction sets, functions and also smaller application software units.

[0043] The connection, symbolized by the line 16, of the interface device 10 to any data transmit/receive device implements, by means of the blocks 1505-1535, an analog input with a sampling rate of 1.25 MHz and quantization of 12 bits. There are 8 channels with an overvoltage protection of ± 0.75 V. By means of the programmable amplifier 1525 the channels can be programmed independently of each other in voltage ranges up to a maximum of ± 0.10 V. Unused channels can be grounded internally to reduce channel intermodulation. The block 1515 is implemented as a monolithic high-precision, high-speed sample/hold amplifier for simultaneous sampling of all channels. The precision voltage reference 1820 provides a high-precision, temperature-compensated monolithic energy gap voltage reference for auto-calibration of each channel and each gain. Further, offset fine adjustment for each channel is implemented by the same.

[0044] The blocks 1830, 1840 and 1850 implement a direct analog output for the digital signal processor 1300, and the DAC 1830 provides a data transfer rate of 625 kHz and a quantization of 12 bits. The block 1840 comprises 4 channels with a common output latch.

[0045] Further, the interface device 10 comprises a digital input/output device

implemented by the blocks 1284 and 1282. Here there are 8 digital inputs, 8 digital outputs with a common latch, and the digital port can be attached preferably to a side panel of the interface device 10 so that the port itself can easily be accessed.

[0046] The digital signal processor 1300 provides on-board digital data processing. In particular, it is a high-performance DSP with a clock speed of 80 MHz and a 20-bit timer 1535.

[0047] As described above, the first connecting device 12 comprises the SCSI interface 1220 with a peak transfer rate of 10 MBps. An optional PCMCIA-to-SCSI adapter permits high-speed communication with laptop computers which are desirable and in widespread use, particularly by mobile service technicians. The EPP 1260 with its associated connector 1280 permits data transfer at a more moderate rate.

[0048] As described above, the interface device 10 is supplied with power by means of an external AC/DC adapter which has a universal power input (85-264 VAC, 47-63 Hz). Interference suppression complies with the standards EN 55022, curve B and FFC, Class B). Further, it is also in accordance with international safety regulations (TUV, UL, CSA). The interface device 10 is externally shielded and achieves a value of 55 dB at 30-60 MHz and a value of approximately 40 dB at 1 GHz, and therefore complies with the MILSTD 285-1 standard.

[0049] As described above, communication between the host device and the multi-purpose interface can take place not only via drivers for input/output device customary in a host device which reside in the BIOS system of the host device but also via specific interface drivers which, in the case of SCSI interfaces, are known as multi-purpose interface ASPI (advanced SCSI programming interface) drivers. This ASPI driver, which can also be referred to as an ASPI manager, is specific to a special SCSI host adapter, i.e. to a special multi-purpose interface,

and is normally included by the manufacturer of the multi-purpose interface. Generally speaking, this multi-purpose interface driver has the task of moving precisely specified SCSI commands from the host system program to the host system SCSI adapter. For this reason, the command set is almost identical to that of the SCSI interface itself. Essentially, only status and reset commands for the host adapter have been added.

[0050] The ASPI driver can be used if the hard disk was not already addressable at boot time or if the SCSI-related BIOS routines of the host computer were still disabled. Here too, the steps needed to initialize the interface device, preferably as a virtual hard disk, are similar to the steps taken when initializing at boot time.

[0051] In general terms, the ASPI manager comprises two sides. One side is the proprietary, hardware-oriented side. It is responsible for converting all commands into a form required by the corresponding multi-purpose interface. The hardware-oriented side of the ASPI driver is therefore matched to a very specific type of multi-purpose interface or SCSI interface. The other side is known as the user software side. This side is totally independent of the proprietary operating characteristics of the SCSI adapter and is therefore identical for all SCSI interfaces. This permits SCSI programming which is however independent of the individual SCSI adapter types.

[0052] In contrast to communication between the host device and the interface device according to the present invention on the basis of a BIOS driver, the use of such an ASPI driver for communication between the host device and the interface device according to the present invention allows various further possibilities of the SCSI multi-purpose interface to be exploited. In the case described above, the interface device which preferably signs on and behaves as a virtual hard disk is detected by the BIOS driver of the host computer at boot time and is

configured as a hard disk. This step does not however support active requests sent by the interface device to the host computer. If however the virtual hard disk wishes to write data actively to, for example, a hard disk of the host computer or wishes to initiate communication with the processor of the host computer, the host computer must recognize the request of the virtual hard disk and tolerate a further issuer of instructions on its bus. If the interface device behaves solely like a virtual hard disk, it would always receive and never issue commands. The BIOS has no objections to an additional issuer of commands that actively wishes to place data on the bus of the host device but the BIOS does not support the host device in recognizing corresponding requests of the interface device or in granting the interface device permission to access the bus.

[0053] Using the ASPI manager the interface device according to the present invention can now obtain active access to an SCSI hard disk of the host device connected to the same SCSI bus which, in contrast to the interface device, cannot be a virtual but a real SCSI mass storage device or also a further interface device according to the present invention. Thereupon, the interface device according to the present invention can write the desired data to the SCSI hard disk of the host computer totally independently of the host computer or can communicate with the same in some other manner. The interface device according to the present invention therefore initially behaves passively as a virtual hard disk and then, as required and using the driver software for the multi-purpose interface, actively on the same SCSI bus. This means however that the interface device according to the present invention, using a driver software for the multi-purpose interface which comprises the BIOS routines customary in host devices and simultaneously provides the option of active participation, can, regardless of the type of the data transmit/receive device attached to the second connecting device, behave initially as a virtual and

at the same time passive hard disk but can, as required, participate actively on the bus so as to be able to initiate communication directly with other SCSI hard disks of the host device by bypassing the processor of the host device.

[0054] Using a standard interface of a host device, the interface device according to the present invention permits communication with any host device. By simulating an input/output device to the host device and, in a preferred embodiment, by simulating a virtual mass storage device, the interface device 10 is automatically supported by all known host systems without any additional sophisticated driver software. The simulation of a freely definable file structure on the "virtual" hard disk provides simple operation and expansion options and, through the implementation of any programs, independence from special software implemented on the host device. Help files included on the interface device 10 and plug-and-play support ensure ease of use even in portable, flexible host devices. Despite the very simple user interface, experienced users are free at any time to intervene in the functions of the interface device 10 on system level. The interface device 10 thus provides a universal solution which can cover the entire spectrum of possible data transmit/receive devices.

What is claimed is:

1. An analog data generating and processing device for use with a personal computer having at least one multi-purpose interface to which inquiry signals are periodically sent as to what type of device is operatively connected thereto, comprising:

a connecting device that is to be operatively connected to the multi-purpose interface of the personal computer and that is able to receive therefrom the periodic inquiry signals;

a circuit that includes a sensor and an analog to digital converter, the circuit being adapted (i) to be exposed to analog wave signals that originate from a source that is external to the analog data generating and processing device and that is not located in substantial proximity to the sensor, (ii) to generate one or more sets of analog data therefrom, and (iii) to generate a set of digitized analog data that are representative of each one of the sets of analog data;

a processor and a first memory both of which are operatively connected to the circuit, the processor being adapted to cause one or more of the sets of digitized analog data to be stored in the first memory irrespective of whether or not the analog data generating and processing device has been recognized by the personal computer;

the processor being further adapted to cause one or more of the sets of digitized analog data to be stored in the first memory before the connecting device is connected to a multi-purpose interface of the personal computer;

the processor and first memory being adapted to automatically and without user intervention send a response signal to the multi-purpose interface of the personal computer after the connecting device is operatively connected to the multi-purpose interface and after the connecting device receives at least one periodic inquiry signal therefrom, the response signal

informing the personal computer that it can automatically and without user intervention recognize the analog data generating and processing device as being a device having digital data that is stored therein;

the processor and first memory being adapted to, after the analog data generating and processing device has been automatically recognized by the personal computer, and after the connecting device has been coupled to the multi-purpose interface of the personal computer, cause one or more of the sets of digitized analog data, including any digitized analog data sets that are generated before the input/output port is connected to the multi-purpose interface of the personal computer, to be transferred to the personal computer;

the analog data generating and processing device being adapted to affect the transfer of one or more of the sets of digitized analog data by means of a software driver that is stored in a second memory of the personal computer without user intervention;

a conductive path having a first portion physically connected to the processor and a second portion physically connected to the first memory, the first and second portions of the conductive path being contiguous and not electrically disconnected from each other while one or more of the digitized analog data sets are being transferred to the personal computer; and

the processor being further adapted to store one or more of the sets of digitized analog data in a file system defined within the first memory so that each set of digitized analog data can be selectively retrieved therefrom.

ABSTRACT

An interface device (10) provides fast data communication between a host device with input/output interfaces and a data transmit/receive device, wherein the interface device (10) comprises a processor means (13), a memory means (14), a first connecting device (12) for interfacing the host device with the interface device, and a second connecting device (15) for interfacing the interface device (10) with the data transmit/receive device. The interface device (10) is configured by the processor means (13) and the memory means (14) in such a way that, when receiving an inquiry from the host device via the first connecting device (12) as to the type of a device attached to the host device, regardless of the type of the data transmit/receive device, the interface device sends a signal to the host device via the first connecting device (12) which signals to the host device that it is communicating with an input/output device.

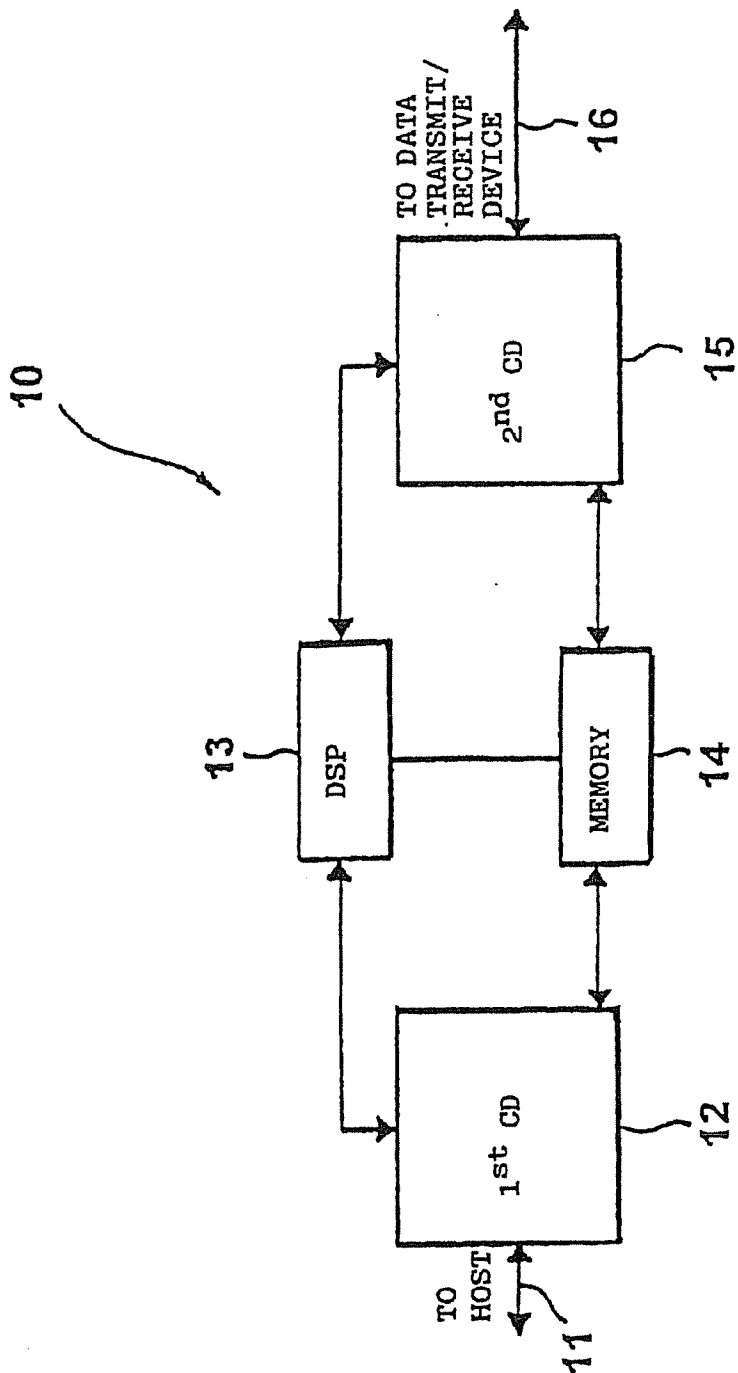

FIG. 1

TO DATA TRANSMIT/RECEIVE DEVICE

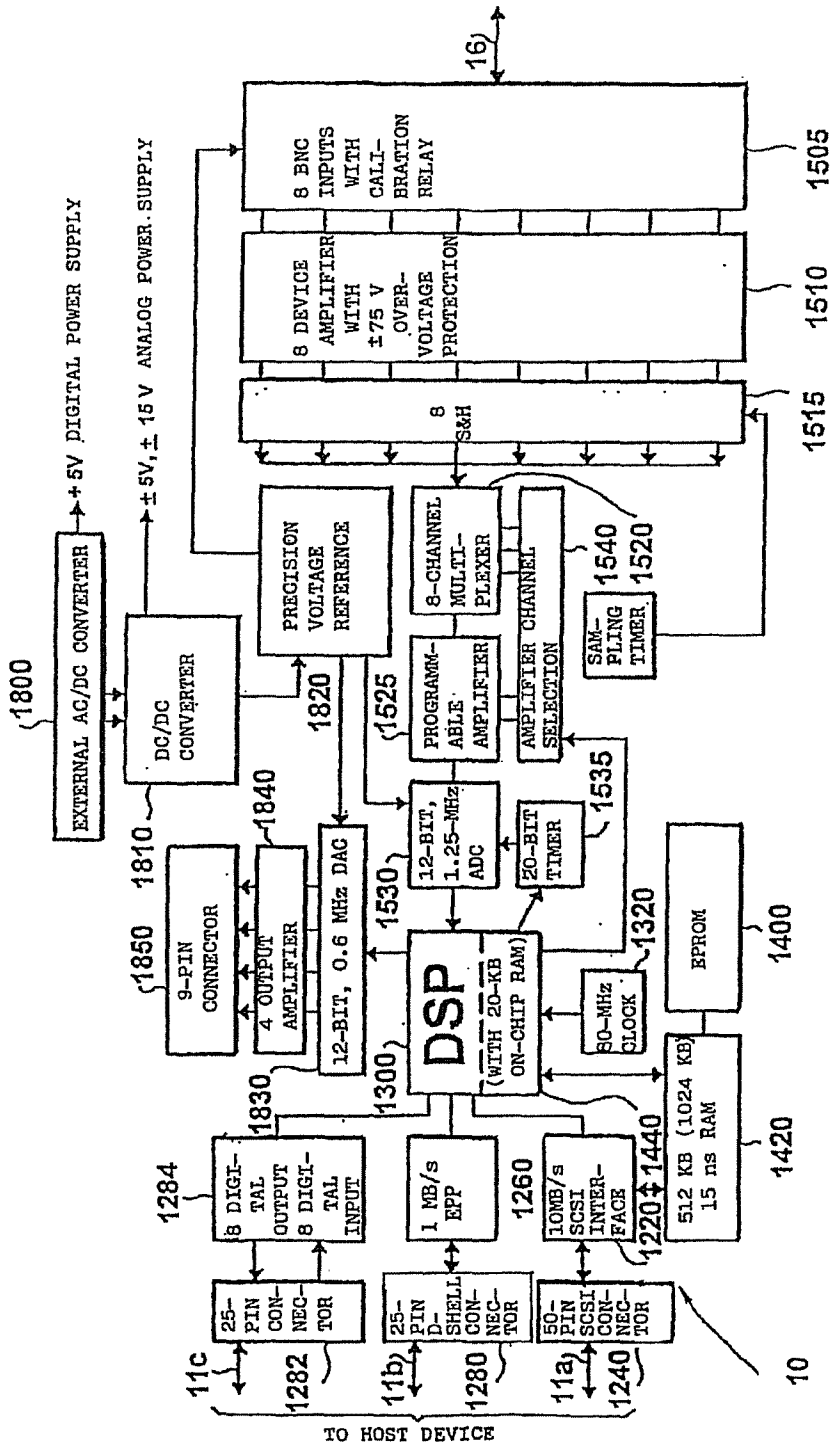

FIG. 2

Declaration and Power of Attorney For Patent **COPY**

Erklärung Für Patentanmeldungen Mit Vollmacht

German Language Declaration

Als nachstehend benannter Erfinder erkläre ich hiermit an Eides Statt:

dass mein Wohnsitz, meine Postanschrift, und meine Staatsangehörigkeit den im Nachstehenden nach meinem Namen aufgeführten Angaben entsprechen.

dass ich, nach bestem Wissen der ursprüngliche, erste und alleinige Erfinder (falls nachstehend nur ein Name angegeben ist) oder ein ursprünglicher, erster und Miterfinder (falls nachstehend mehrere Namen aufgeführt sind) des Gegenstandes bin, für den dieser Antrag gestellt wird und für den ein Patent beantragt wird, die Erfindung mit dem Titel:

deren Beschreibung

(zutreffendes ankreuzen)

hier beigefügt ist.

am _____ unter der

Anmeldungsseriennummer _____

eingereicht wurde und am _____

abgeändert wurde (falls tatsächlich abgeändert).

Ich bestätige hiermit, dass ich den Inhalt der obigen Patentanmeldung einschliesslich der Ansprüche durchgesehen und verstanden habe, die eventuell durch einen Zusatzantrag wie oben erwähnt abgeändert wurde.

Ich erkenne meine Pflicht zur Offenbarung irgendwelcher Informationen, die für die Prüfung der vorliegenden Anmeldung in Einklang mit Absatz 37, Bundesgesetzbuch, Paragraph 1.56(a) von Wichtigkeit sind, an.

Ich beanspruche hiermit ausländische Prioritätsvorteile gemäss Abschnitt 35 der Zivilprozessordnung der Vereinigten Staaten, Paragraph 119 aller unten angegebenen Auslandsanmeldungen für ein Patent oder eine Erfindersurkunde, und habe auch alle Auslandsanmeldungen für ein Patent oder eine Erfindersurkunde nachstehend gekennzeichnet, die ein Anmeldedatum haben, das vor dem Anmeldedatum der Anmeldung liegt, für die Priorität beansprucht wird.

As a below named inventor, I hereby declare that:

My residence, post office address and citizenship are as stated below next to my name.

I believe I am the original, first and sole inventor (if only one name is listed below) or an original, first and joint inventor (if plural names are listed below) of the subject matter which is claimed and for which a patent is sought on the invention entitled

Flexible Interface

the specification of which

(check one)

is attached hereto.

was filed on _____ as

Application Serial No. _____

and was amended on _____

(if applicable)

I hereby state that I have reviewed and understand the contents of the above identified specification, including the claims, as amended by any amendment referred to above.

I acknowledge the duty to disclose information which is material to the examination of this application in accordance with Title 37, Code of Federal Regulations, §1.56(a).

I hereby claim foreign priority benefits under Title 35, United States Code, §119 of any foreign application(s) for patent or inventor's certificate listed below and have also identified below any foreign application for patent or inventor's certificate having a filing date before that of the application on which priority is claimed:

Priorität beansprucht

Priority Claimed

19708755.8 Germany 04/3/97 (March 4, 1997)
 (Number) (Country) (Day/Month/Year Filed)
 (Nummer) (Land) (Tag/Monat/Jahr eingereicht)

Yes No
 Ja Nein

PCT/EP98/01187 Germany 03/03/98 (March 3, 1998)
 (Number) (Country) (Day/Month/Year Filed)
 (Nummer) (Land) (Tag/Monat/Jahr eingereicht)

Yes No
 Ja Nein

 (Number) (Country) (Day/Month/Year Filed)
 (Nummer) (Land) (Tag/Monat/Jahr eingereicht)

Yes No
 Ja Nein

Ich beanspreche hiermit gemäss Absatz 35 der Zivilprozessordnung der Vereinigten Staaten, Paragraph 120, den Vorzug aller unten aufgeführten Anmeldungen und falls der Gegenstand aus jedem Anspruch dieser Anmeldung nicht in einer früheren amerikanischen Patentanmeldung laut dem ersten Paragraphen des Absatzes 35 der Zivilprozessordnung der Vereinigten Staaten, Paragraph 112 offenbart ist, erkenne ich gemäss Absatz 37, Bundesgesetzbuch, Paragraph 1.56(a) meine Pflicht zur Offenbarung von Informationen an, die zwischen dem Anmeldedatum der früheren Anmeldung und dem nationalen oder PCT internationalen Anmeldedatum dieser Anmeldung bekannt geworden sind.

I hereby claim the benefit under Title 35, United States Code, §120 of any United States application(s) listed below and, insofar as the subject matter of each of the claims of this application is not disclosed in the prior United States application in the manner provided by the first paragraph of Title 35, United States Code, §112, I acknowledge the duty to disclose material information as defined in Title 37, Code of Federal Regulations, §1.56(a) which occurred between the filing date of the prior application and the national or PCT international filing date of this application:

 (Application Serial No.)
 (Anmeldeseriennummer)

 (Filing Date)
 (Anmeldedatum)

 (Status)
 (patentiert, anhängig,
 aufgegeben)

 (Status)
 (patented, pending,
 abandoned)

 (Application Serial No.)
 (Anmeldeseriennummer)

 (Filing Date)
 (Anmeldedatum)

 (Status)
 (patentiert, anhängig,
 aufgegeben)

 (Status)
 (patented, pending,
 abandoned)

Ich erkläre hiermit, dass alle von mir in der vorliegenden Erklärung gemachten Angaben nach meinem besten Wissen und Gewissen der vollen Wahrheit entsprechen, und dass ich diese eidesstattliche Erklärung in Kenntnis dessen abgebe, dass wissentlich und vorsätzlich falsche Angaben gemäss Paragraph 1001, Absatz 18 der Zivilprozessordnung der Vereinigten Staaten von Amerika mit Geldstrafe belegt und/oder Gefängnis bestraft werden koennen, und dass derartig wissentlich und vorsätzlich falsche Angaben die Gültigkeit der vorliegenden Patentanmeldung oder eines darauf erteilten Patentes gefährden können.

I hereby declare that all statements made herein of my own knowledge are true and that all statements made on information and belief are believed to be true; and further that these statements were made with the knowledge that willful false statements and the like so made are punishable by fine or imprisonment, or both, under Section 1001 of Title 18 of the United States Code and that such willful false statements may jeopardize the validity of the application or any patent issued thereon.

VERTRETUNGSVOLLMACHT: Als benannter Erfinder beauftrage ich hiermit den nachstehend benannten Patentanwalt (oder die nachstehend benannten Patentanwälte) und/oder Patent-Agenten mit der Verfolgung der vorliegenden Patentanmeldung sowie mit der Abwicklung aller damit verbundenen Geschäfte vor dem Patent- und Warenzeichenamt: *(Name und Registrationsnummer anführen)*

POWER OF ATTORNEY: As a named inventor, I hereby appoint the following attorney(s) and/or agent(s) to prosecute this application and transact all business in the Patent and Trademark Office connected therewith. *(list name and registration number)*

Donald M. Duft	17,484	William P. Wilbar	43,265
James M. Graziano	28,300	Thomas Swenson	36,696
Carl A. Forest	28,494	Curtis A. Vock	38,356
Dan Cleveland, Jr.	36,106	Kirk D. Williams	42,229
Michael J. Setter	37,936	Steven W. Weinrieb	26,520

Telefongespräche bitte richten an:
(Name und Telefonnummer)

Direct Telephone Calls to: *(name and telephone number)*

Postanschrift:

Send Correspondence to:
Carl A. Forest, Ph.D.
c/o DUFT, GRAZIANO & FOREST, P.C.
1790-30th Street
- Suite 140 -
Boulder, Colorado 80301-1018, U.S.A.

Voller Name des einzigen oder ursprünglichen Erfinders:		Full name of sole or first inventor	
Unterschrift des Erfinders		Inventor's signature	
Datum		Date	
Wohnsitz		Residence	
Staatsangehörigkeit		Citizenship	
Postanschrift		Post Office Address	
		D-97074 Würzburg, Germany	
Voller Name des zweiten Miterfinders (falls zutreffend)		Full name of second joint inventor, if any	
Unterschrift des Erfinders		Second inventor's signature	
Datum		Date	
Wohnsitz		Residence	
Staatsangehörigkeit		Citizenship	
Postanschrift		Post Office Address	

(Bitte entsprechende Informationen und Unterschriften im Falle von dritten und weiteren Miterfindern angeben.)

(Supply similar information and signature for third and subsequent joint inventors.)

Under the Paperwork Reduction Act of 1995, no persons are required to respond to a collection of information unless it displays a valid OMB control number.

POWER OF ATTORNEY OR REVOCAION OF POWER OF ATTORNEY WITH A NEW POWER OF ATTORNEY AND CHANGE OF CORRESPONDENCE ADDRESS	Application Number	11/928,283
	Filing Date	October 30, 2007
	First Named Inventor	Michael Tasler
	Title	ANALOG DATA GENERATING AND PROCESSING...
	Art Unit	2181
	Examiner Name	C.K. Lee
	Attorney Docket Number	

I hereby revoke all previous powers of attorney given in the above-identified application.

A Power of Attorney is submitted herewith.

OR

I hereby appoint Practitioner(s) associated with the following Customer Number as my/our attorney(s) or agent(s) to prosecute the application identified above, and to transact all business in the United States Patent and Trademark Office connected therewith:

OR

I hereby appoint Practitioner(s) named below as my/our attorney(s) or agent(s) to prosecute the application identified above, and to transact all business in the United States Patent and Trademark Office connected therewith:

Practitioner(s) Name	Registration Number
James A. Scheer	29,434
A. Sidney Katz	24,003

Please recognize or change the correspondence address for the above-identified application to:

The address associated with the above-mentioned Customer Number.

OR

The address associated with Customer Number: 24628

OR

<input type="checkbox"/> Firm or Individual Name	
Address	
City	State Zip
Country	
Telephone	Email

I am the:

Applicant/Inventor.

OR

Assignee of record of the entire interest. See 37 CFR 3.71.
Statement under 37 CFR 3.73(b) (Form PTO/SB/96) submitted herewith or filed on _____.

SIGNATURE of Applicant or Assignee of Record

Signature	<i>Daniel Papst</i>	Date	05/20/2010
Name	Daniel Papst	Telephone	
Title and Company	DIRECTOR PATENT LICENSING CMBH & CO. KG		

NOTE: Signatures of all the inventors or assignees of record of the entire interest or their representative(s) are required. Submit multiple forms if more than one signature is required, see below.

Total of 1 forms are submitted.

This collection of information is required by 37 CFR 1.31, 1.32 and 1.33. The information is required to obtain or retain a benefit by the public which is to file (and by the USPTO to process) an application. Confidentially is governed by 35 U.S.C. 122 and 37 CFR 1.11 and 1.14. This collection is estimated to take 3 minutes to complete, including gathering, preparing, and submitting the completed application form to the USPTO. Time will vary depending upon the individual case. Any comments on the amount of time you require to complete this form and/or suggestions for reducing this burden, should be sent to the Chief Information Officer, U.S. Patent and Trademark Office, U.S. Department of Commerce, P.O. Box 1450, Alexandria, VA 22313-1450. DO NOT SEND FEES OR COMPLETED FORMS TO THIS ADDRESS. SEND TO: Commissioner for Patents, P.O. Box 1450, Alexandria, VA 22313-1450.

If you need assistance in completing the form, call 1-800-PTO-9199 and select option 2.

STATEMENT UNDER 37 CFR 3.73(b)

Applicant/Patent Owner: Papst Licensing GmbH & Co. KG
 Application No./Patent No.: 11/928,283 Filed/Issue Date: October 30, 2007
 Titled: ANALOG DATA GENERATING AND PROCESSING DEVICE FOR USE WITH A PERSONAL COMPUTER

Papst Licensing GmbH & Co. KG, a German Corporation
(Name of Assignee) (Type of Assignee, e.g., corporation, partnership, university, government agency, etc.)

states that it is:

1. the assignee of the entire right, title, and interest in;
2. an assignee of less than the entire right, title, and interest in
(The extent (by percentage) of its ownership interest is _____ %); or
3. the assignee of an undivided interest in the entirety of (a complete assignment from one of the joint inventors was made)

the patent application/patent identified above, by virtue of either:

A. An assignment from the inventor(s) of the patent application/patent identified above. The assignment was recorded in the United States Patent and Trademark Office at Reel _____, Frame _____, or for which a copy therefore is attached.

OR

B. A chain of title from the inventor(s), of the patent application/patent identified above, to the current assignee as follows:

1. From: Michael Tasler To: Labortechnik Tasler GmbH

The document was recorded in the United States Patent and Trademark Office at
 Reel 012023, Frame 0515, or for which a copy thereof is attached.

2. From: Labortechnik Tasler GmbH To: Papst Licensing GmbH & Co. KG

The document was recorded in the United States Patent and Trademark Office at
 Reel 017314, Frame 0114, or for which a copy thereof is attached.

3. From: _____ To: _____

The document was recorded in the United States Patent and Trademark Office at
 Reel _____, Frame _____, or for which a copy thereof is attached.

Additional documents in the chain of title are listed on a supplemental sheet(s).

As required by 37 CFR 3.73(b)(1)(i), the documentary evidence of the chain of title from the original owner to the assignee was, or concurrently is being, submitted for recordation pursuant to 37 CFR 3.11.

[NOTE: A separate copy (i.e., a true copy of the original assignment document(s)) must be submitted to Assignment Division in accordance with 37 CFR Part 3, to record the assignment in the records of the USPTO. See MPEP 302.08]

The undersigned (whose title is supplied below) is authorized to act on behalf of the assignee.

Daniel Papst
 Signature

05/20/2010
 Date

Daniel Papst
 Printed or Typed Name

LITIGATING DIRECTOR
 Title

This collection of information is required by 37 CFR 3.73(b). The information is required to obtain or retain a benefit by the public which is to file (and by the USPTO to process) an application. Confidentiality is governed by 35 U.S.C. 122 and 37 CFR 1.11 and 1.14. This collection is estimated to take 12 minutes to complete, including gathering, preparing, and submitting the completed application form to the USPTO. Time will vary depending upon the individual case. Any comments on the amount of time you require to complete this form and/or suggestions for reducing this burden, should be sent to the Chief Information Officer, U.S. Patent and Trademark Office, U.S. Department of Commerce, P.O. Box 1450, Alexandria, VA 22313-1450. DO NOT SEND FEES OR COMPLETED FORMS TO THIS ADDRESS. SEND TO: Commissioner for Patents, P.O. Box 1450, Alexandria, VA 22313-1450.

If you need assistance in completing the form, call 1-800-PTO-9199 and select option 2.

Electronic Acknowledgement Receipt

EFS ID:	8507845
Application Number:	12891443
International Application Number:	
Confirmation Number:	1408
Title of Invention:	AN ANALOG DATA GENERATING AND PROCESSING DEVICE FOR USE WITH A PERSONAL COMPUTER
First Named Inventor/Applicant Name:	Michael L. Tasler
Customer Number:	24628
Filer:	James A. Scheer
Filer Authorized By:	
Attorney Docket Number:	0757-113189 (0300757-70)
Receipt Date:	27-SEP-2010
Filing Date:	
Time Stamp:	17:35:48
Application Type:	Utility under 35 USC 111(a)

Payment information:

Submitted with Payment	no
------------------------	----

File Listing:

Document Number	Document Description	File Name	File Size(Bytes)/ Message Digest	Multi Part /.zip	Pages (if appl.)
1		113189.PDF	4707699 <small>d5d87211b63edfb548adb50f70dcac71018d6d394</small>	yes	35

Multipart Description/PDF files in .zip description		
Document Description	Start	End
Transmittal of New Application	1	1
Application Data Sheet	2	4
Specification	5	25
Claims	26	27
Abstract	28	28
Drawings-only black and white line drawings	29	30
Oath or Declaration filed	31	33
Power of Attorney	34	34
Assignee showing of ownership per 37 CFR 3.73(b).	35	35

Warnings:

Information:

Total Files Size (in bytes):

4707699

This Acknowledgement Receipt evidences receipt on the noted date by the USPTO of the indicated documents, characterized by the applicant, and including page counts, where applicable. It serves as evidence of receipt similar to a Post Card, as described in MPEP 503.

New Applications Under 35 U.S.C. 111

If a new application is being filed and the application includes the necessary components for a filing date (see 37 CFR 1.53(b)-(d) and MPEP 506), a Filing Receipt (37 CFR 1.54) will be issued in due course and the date shown on this Acknowledgement Receipt will establish the filing date of the application.

National Stage of an International Application under 35 U.S.C. 371

If a timely submission to enter the national stage of an international application is compliant with the conditions of 35 U.S.C. 371 and other applicable requirements a Form PCT/DO/EO/903 indicating acceptance of the application as a national stage submission under 35 U.S.C. 371 will be issued in addition to the Filing Receipt, in due course.

New International Application Filed with the USPTO as a Receiving Office

If a new international application is being filed and the international application includes the necessary components for an international filing date (see PCT Article 11 and MPEP 1810), a Notification of the International Application Number and of the International Filing Date (Form PCT/RO/105) will be issued in due course, subject to prescriptions concerning national security, and the date shown on this Acknowledgement Receipt will establish the international filing date of the application.

Date: 09/27/10

Approved for use through 7/31/2006. OMB 0651-0032

U.S. Patent and Trademark Office; U.S. DEPARTMENT OF COMMERCE

Under the Paperwork Reduction Act of 1995, no persons are required to respond to a collection of information unless it displays a valid OMB control number.

PATENT APPLICATION FEE DETERMINATION RECORD					Application or Docket Number	
Substitute for Form PTO-875					12/891,443	
APPLICATION AS FILED – PART I						
(Column 1)			(Column 2)		(Column 3)	
FOR	NUMBER FILED	NUMBER EXTRA	SMALL ENTITY		OTHER THAN SMALL ENTITY	
BASIC FEE (37 CFR 1.16(a), (b), or (c))	N/A	N/A	RATE (\$)	FEE (\$)	RATE (\$)	FEE (\$)
SEARCH FEE (37 CFR 1.16(k), (l), or (m))	N/A	N/A	N/A	N/A	N/A	330
EXAMINATION FEE (37 CFR 1.16(o), (p), or (q))	N/A	N/A	N/A	N/A	N/A	540
TOTAL CLAIMS (37 CFR 1.16(i))	1	minus 20 =	x\$26	N/A	x\$52	220
INDEPENDENT CLAIMS (37 CFR 1.16(h))	1	minus 3 = *	x\$110	N/A	x\$220	N/A
APPLICATION SIZE FEE (37 CFR 1.16(s))	If the specification and drawings exceed 100 sheets of paper, the application size fee due is \$270 (\$135 for small entity) for each additional 50 sheets or fraction thereof. See 35 U.S.C. 41(a)(1)(G) and 37 CFR		195	N/A	390	N/A
MULTIPLE DEPENDENT CLAIM PRESENT (37 CFR 1.16(j))			TOTAL	TOTAL	TOTAL	1090
* If the difference in column 1 is less than zero, enter "0" in column 2.						
APPLICATION AS AMENDED – PART II						
(Column 1)			(Column 2)		(Column 3)	
AMENDMENT A	CLAIMS REMAINING AFTER AMENDMENT	HIGHEST NUMBER PREVIOUSLY PAID FOR	SMALL ENTITY		OTHER THAN SMALL ENTITY	
	PRESENT EXTRA	PRESENT EXTRA	RATE (\$)	ADDITIONAL FEE (\$)	RATE (\$)	ADDITIONAL FEE (\$)
	Total (37 CFR 1.16(i))	Minus **	X =	X =	X =	X =
	Independent (37 CFR 1.16(h))	Minus ***	X =	X =	X =	X =
	Application Size Fee (37 CFR 1.16(s))			N/A	N/A	N/A
FIRST PRESENTATION OF MULTIPLE DEPENDENT CLAIM (37 CFR 1.16(j))			TOTAL	TOTAL	TOTAL	TOTAL
ADD'T FEE			ADD'T FEE	ADD'T FEE	ADD'T FEE	ADD'T FEE
* If the entry in column 1 is less than the entry in column 2, write "0" in column 3.						
** If the "Highest Number Previously Paid For" IN THIS SPACE is less than 20, enter "20".						
*** If the "Highest Number Previously Paid For" IN THIS SPACE is less than 3, enter "3".						
The "Highest Number Previously Paid For" (total or independent) is the highest number found in the appropriate box in column 1.						

This collection of information is required by 37 CFR 1.16. The information is required to obtain or retain a benefit by the public which is to file (and by the USPTO to process) an application. Confidentiality is governed by 35 U.S.C. 122 and 37 CFR 1.14. This collection is estimated to take 12 minutes to complete, including gathering, preparing, and submitting the completed application form to the USPTO. Time will vary depending upon the individual case. Any comments on the amount of time you require to complete this form and/or suggestions for reducing this burden, should be sent to the Chief Information Officer, U.S. Patent and Trademark Office, U.S. Department of Commerce, P.O. Box 1450, Alexandria, VA 22313-1450. DO NOT SEND FEES OR COMPLETED FORMS TO THIS ADDRESS. SEND TO: Commissioner for Patents, P.O. Box 1450, Alexandria, VA 22313-1450.

If you need assistance in completing the form, call 1-800-PTO-9199 and select option 2.