

US005742797A

United States Patent [19]
Celi, Jr. et al.

[11] Patent Number: 5,742,797
[45] Date of Patent: Apr. 21, 1998

[54] DYNAMIC OFF-SCREEN DISPLAY MEMORY MANAGER

5,592,670 1/1997 Pletcher 395/670
5,606,657 2/1997 Dennison et al. 395/501

[75] Inventors: Joseph Celi, Jr., Boynton Beach;
Roger Louie, Deerfield Beach;
Jonathan Mark Wagner, Coral Springs, all of Fla.

OTHER PUBLICATIONS

IBM Technical Disclosure Bulletin "Linked List Search Table Array for Free Storage Blocks" vol. 33 No. 8 pp. 474-479, Jan. 1991.

[73] Assignee: International Business Machines Corporation, Armonk, N.Y.

S.L. Goncharsky et al. "Use of Binary Trees for Storage Allocation" IBM Technical Disclosure Bulletin vol. 24 No. 6 pp. 2710-2711, Nov. 1981.

[21] Appl. No.: 513,710

S.L. Goncharsky et al. Use of Binary Trees for Storage De-allocation IBM Technical Disclosure Bulletin vol. 24 No. 6 p. 2713, Nov. 1981.

[22] Filed: Aug. 11, 1995

[51] Int. Cl.⁶ G06T 1/60

Primary Examiner—Kee M. Tung

[52] U.S. Cl. 395/507; 395/497.01

Attorney, Agent, or Firm—Mark S. Walker; Andrew J. Dillon

[58] Field of Search 345/185, 189, 345/200, 201, 203; 395/507, 497.01, 497.02, 509, 520, 492, 497.04, 497.03

[57] ABSTRACT

[56] References Cited

U.S. PATENT DOCUMENTS

4,742,474	5/1988	Knierim	345/187
4,906,985	3/1990	Furlong	345/189
4,983,958	1/1991	Carrick	345/190
5,083,121	1/1992	Nomura et al.	345/200
5,132,992	7/1992	Yurt et al.	375/240
5,206,859	4/1993	Anzai	370/522
5,291,188	3/1994	McIntyre et al.	345/189
5,309,173	5/1994	Izzi et al.	345/190
5,319,395	6/1994	Larky et al.	345/190
5,335,322	8/1994	Mattialo	395/511
5,361,387	11/1994	Miller et al.	395/511
5,392,415	2/1995	Badovinatz et al.	395/406
5,408,650	4/1995	Arsenault	395/704
5,414,826	5/1995	Garcia	395/428
5,561,786	10/1996	Morse	395/497.01

A display memory manager allocates and deallocates off-screen video memory by dividing the memory space into a plurality of lapping and non-overlapping regions each capable of storing a different amount of digitized display data, and creating a linked list data structure indicative of the allocated and unallocated regions and various combinations of the unallocated regions. Upon receiving a request for off-screen display memory the display memory manager traverses the linked list data structure searching for a region, or combination of regions, large enough to store the requested amount of digitized display data. Once a region or combination of regions has been found and allocated, the linked list data structure is updated to indicate that the new regions are now allocated and hence unavailable to a subsequent requested allocation unless deallocated.

21 Claims, 7 Drawing Sheets

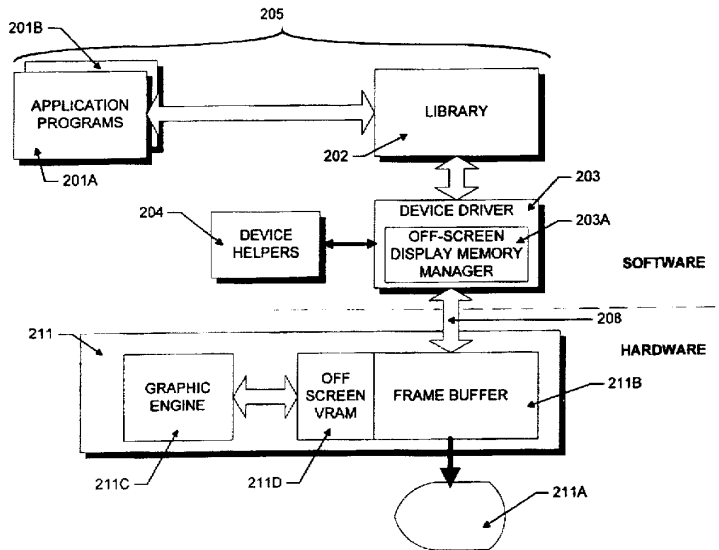

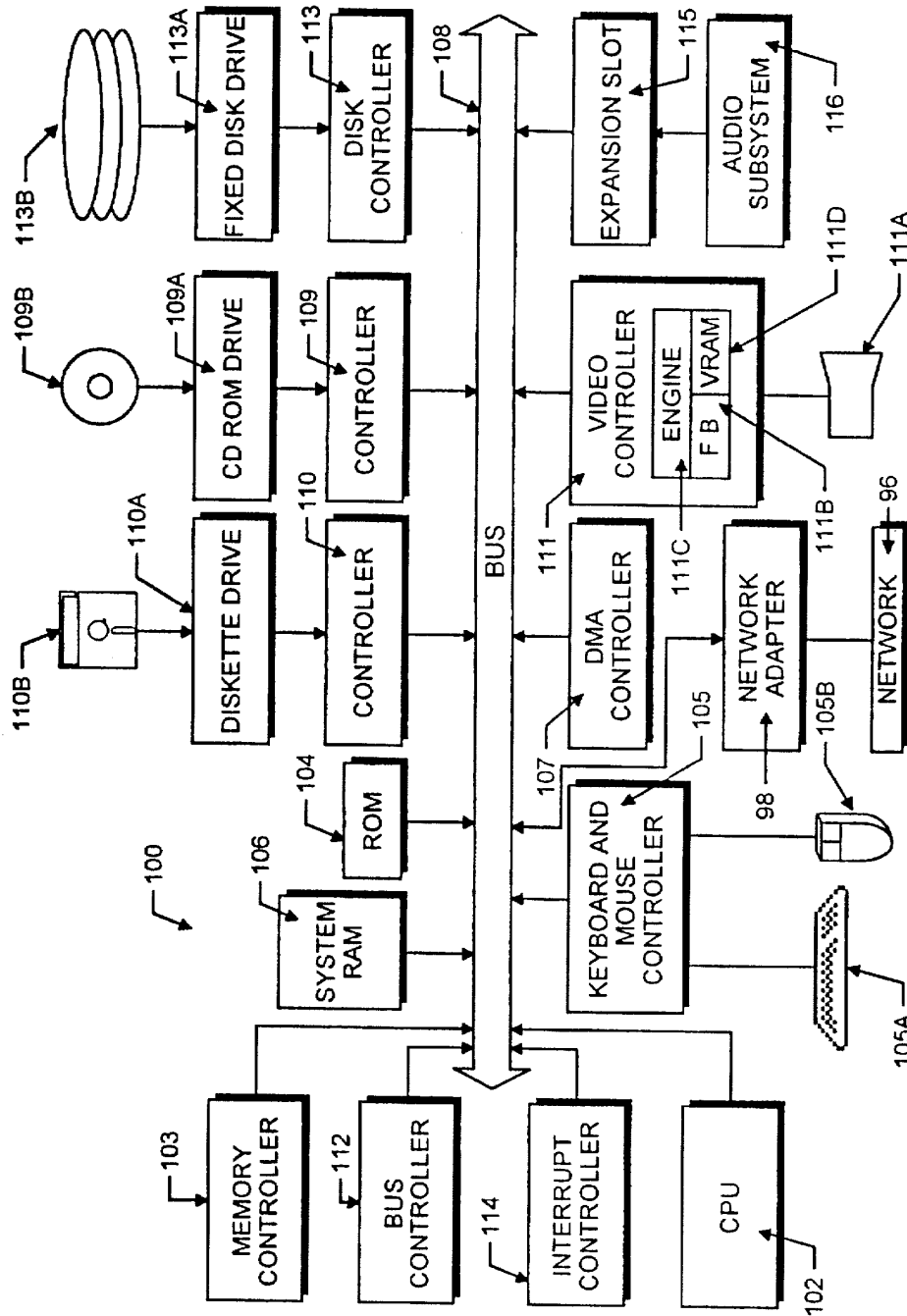

FIG. 1 (PRIOR ART)

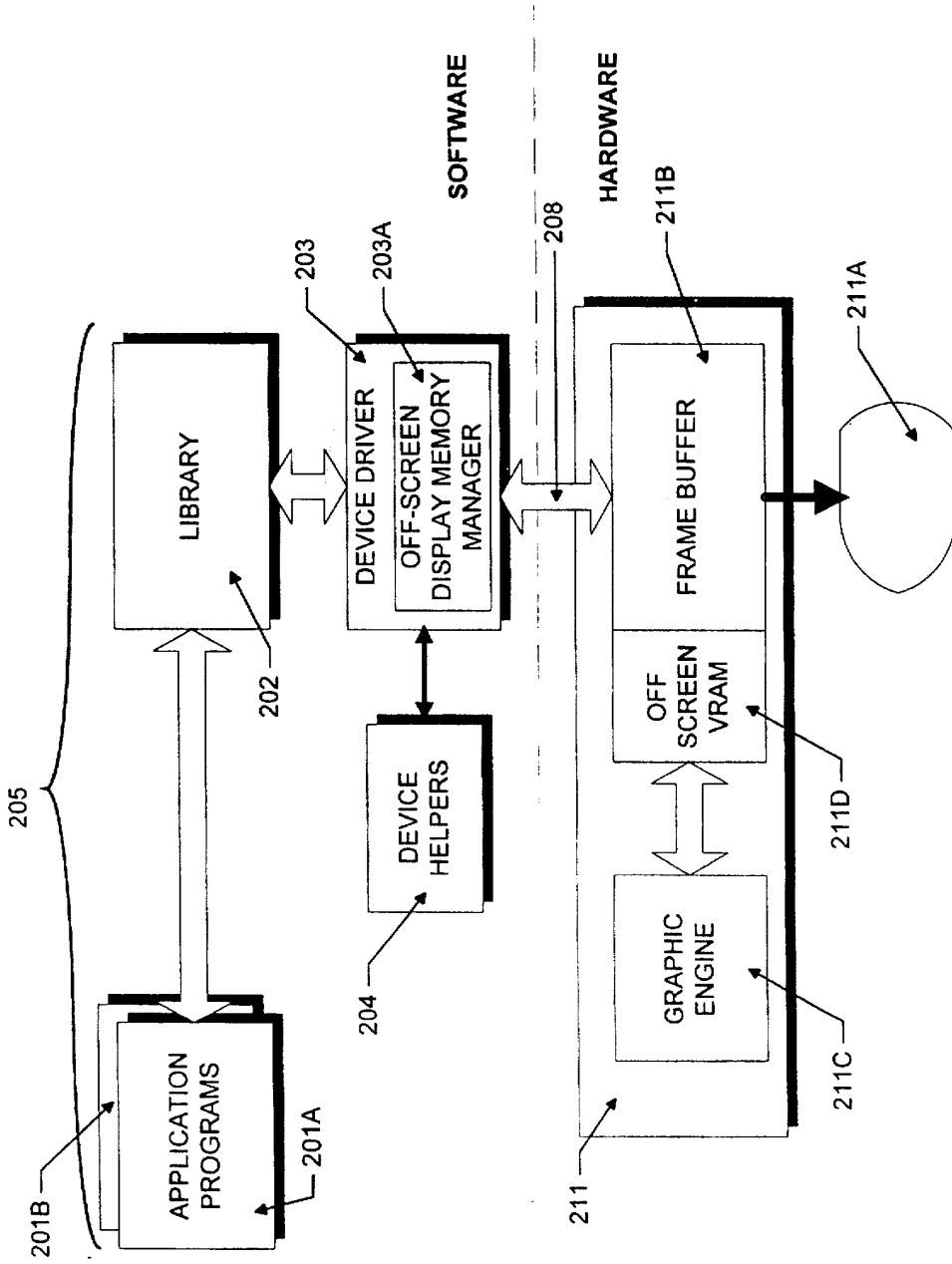

FIG. 2

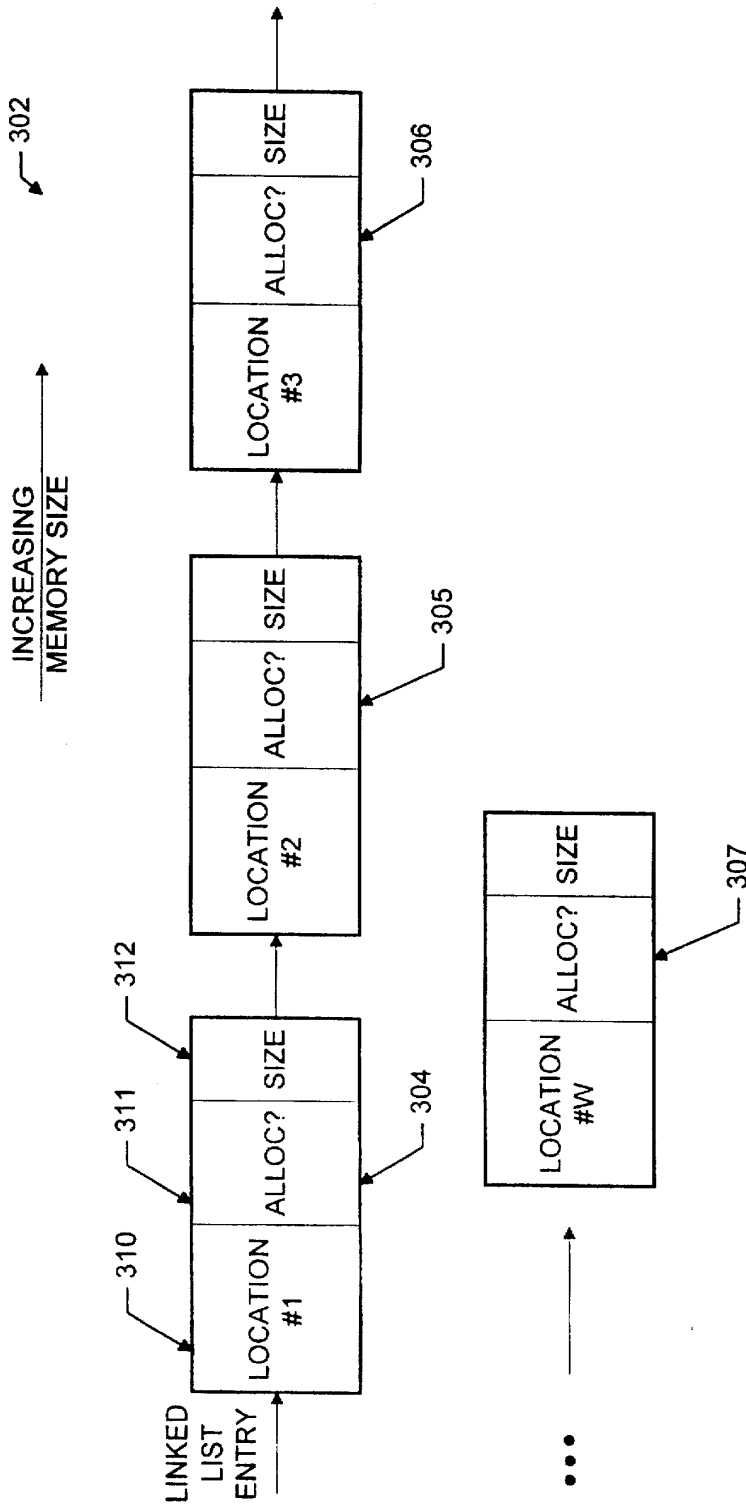

FIG. 3

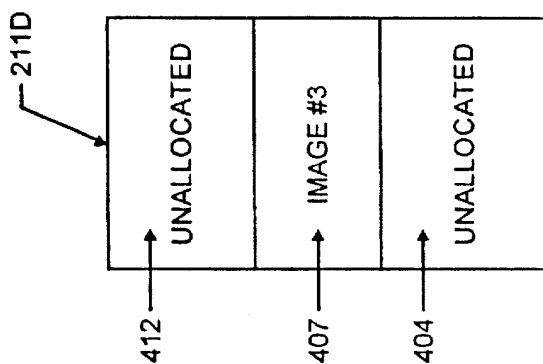

FIG. 4D

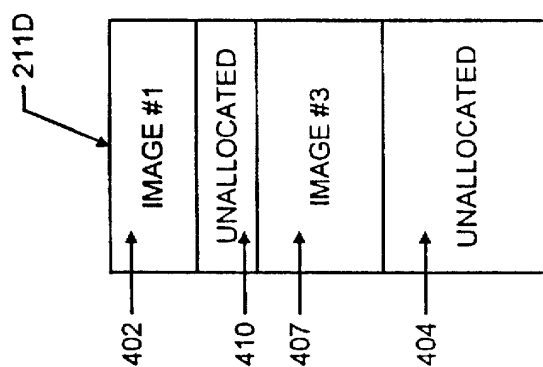

FIG. 4C

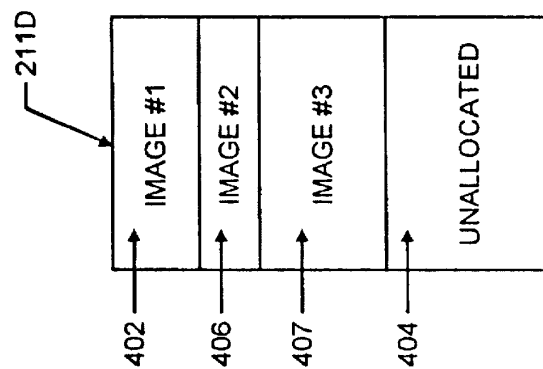

FIG. 4B

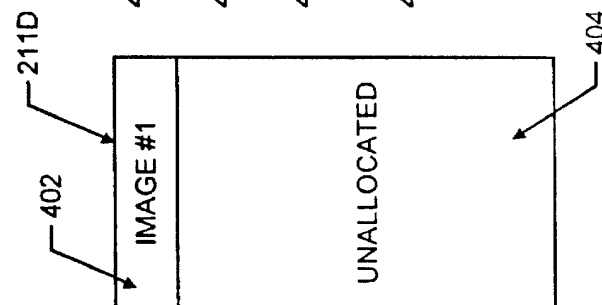

FIG. 4A

Explore Litigation Insights

Docket Alarm provides insights to develop a more informed litigation strategy and the peace of mind of knowing you're on top of things.

Real-Time Litigation Alerts



Keep your litigation team up-to-date with **real-time alerts** and advanced team management tools built for the enterprise, all while greatly reducing PACER spend.

Our comprehensive service means we can handle Federal, State, and Administrative courts across the country.

Advanced Docket Research



With over 230 million records, Docket Alarm's cloud-native docket research platform finds what other services can't. Coverage includes Federal, State, plus PTAB, TTAB, ITC and NLRB decisions, all in one place.

Identify arguments that have been successful in the past with full text, pinpoint searching. Link to case law cited within any court document via Fastcase.

Analytics At Your Fingertips



Learn what happened the last time a particular judge, opposing counsel or company faced cases similar to yours.

Advanced out-of-the-box PTAB and TTAB analytics are always at your fingertips.

API

Docket Alarm offers a powerful API (application programming interface) to developers that want to integrate case filings into their apps.

LAW FIRMS

Build custom dashboards for your attorneys and clients with live data direct from the court.

Automate many repetitive legal tasks like conflict checks, document management, and marketing.

FINANCIAL INSTITUTIONS

Litigation and bankruptcy checks for companies and debtors.

E-DISCOVERY AND LEGAL VENDORS

Sync your system to PACER to automate legal marketing.