



US 20050036509A1

(19) **United States**

(12) **Patent Application Publication**
Acharya et al.

(10) **Pub. No.: US 2005/0036509 A1**

(43) **Pub. Date: Feb. 17, 2005**

(54) **WIRELESS PRESENTATION SYSTEM**

Publication Classification

(76) Inventors: **Shrikant Acharya**, Fremont, CA (US);
Shrinath Acharya, Fremont, CA (US);
John E. Crosbie, Fremont, CA (US);
Shiro Ninomiya, Fremont, CA (US)

(51) **Int. Cl.⁷** H04J 3/22; H04L 5/22; H04Q 11/00;
H04L 12/28; H04Q 7/20;
H04B 7/14
(52) **U.S. Cl.** 370/466; 370/467; 370/300;
370/385; 370/401; 455/414.4;
455/432.2; 455/450; 455/20

Correspondence Address:
BRINKS HOFER GILSON & LIONE
P.O. BOX 10395
CHICAGO, IL 60610 (US)

(21) Appl. No.: **10/859,653**

(57) **ABSTRACT**

(22) Filed: **Jun. 2, 2004**

A system and method for interactive management of multiple wireless devices (such as PDA's or desktop or laptop computers) making graphical or video presentations while connected wirelessly to a display device whose wireless module converts the transmitted data from the wireless devices to the required format for display.

Related U.S. Application Data

(60) Provisional application No. 60/475,751, filed on Jun. 3, 2003.

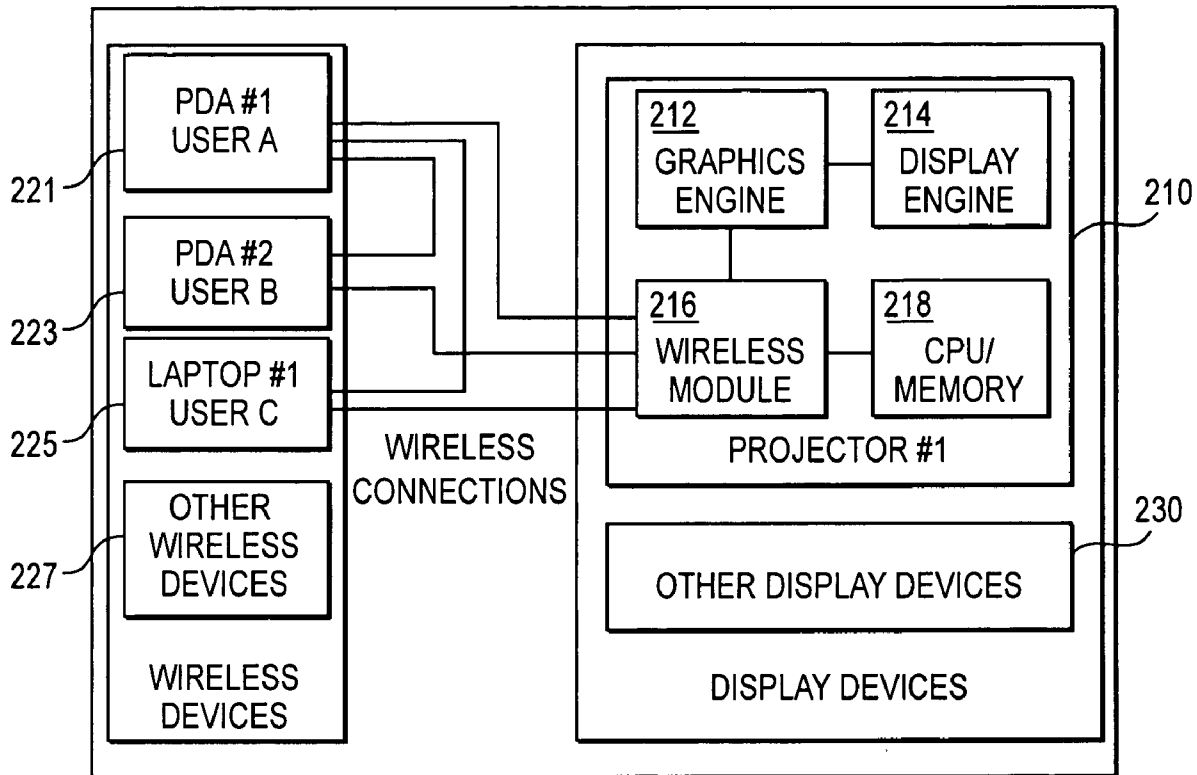

200

RPX Corp.
Exhibit 1203

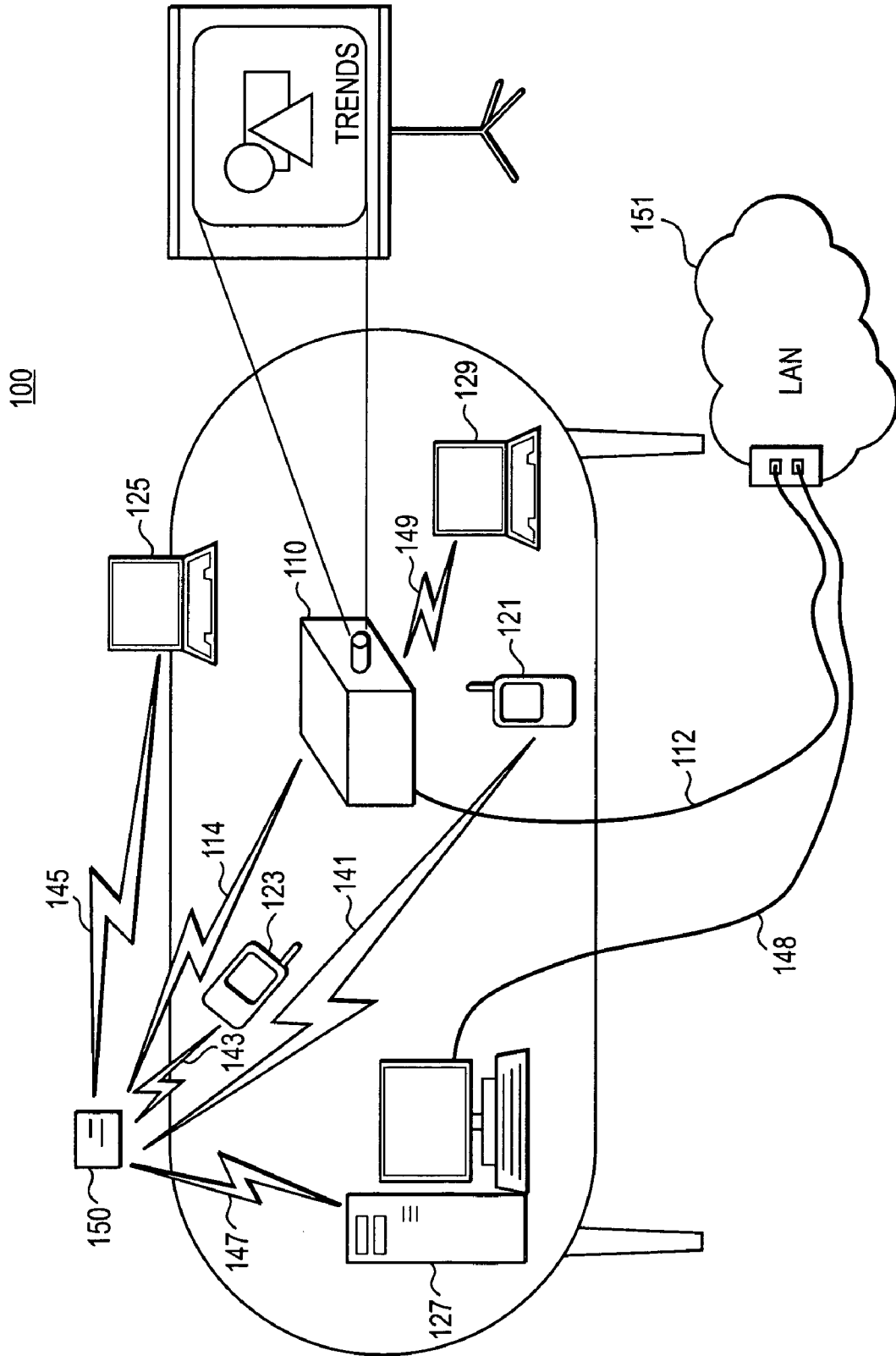

FIG. 1

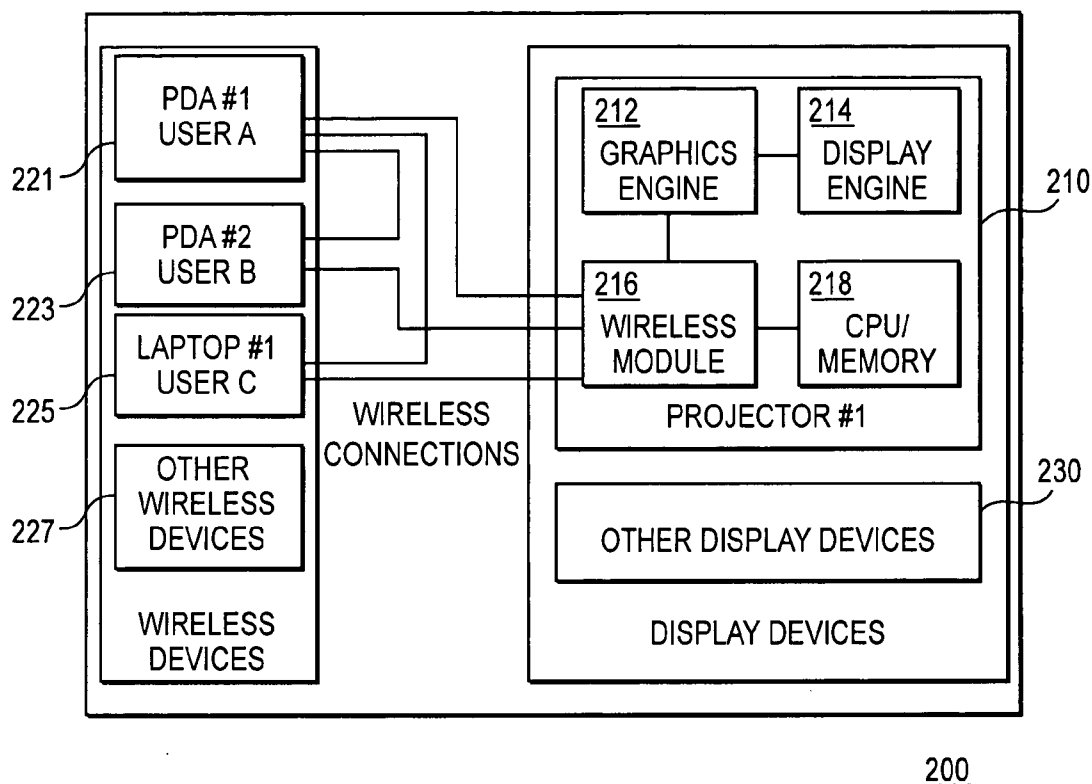

FIG. 2

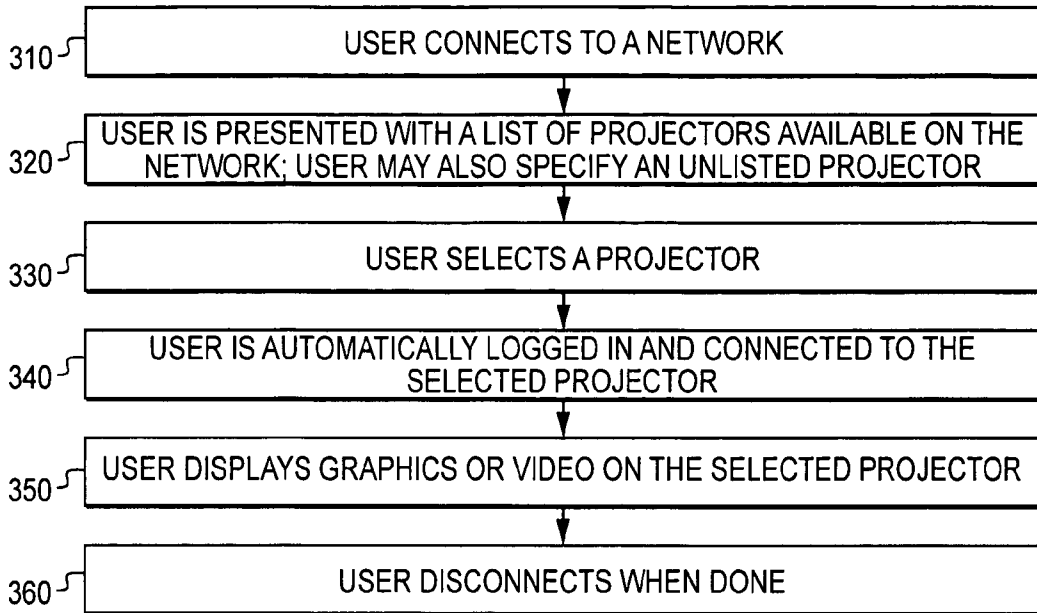

FIG. 3

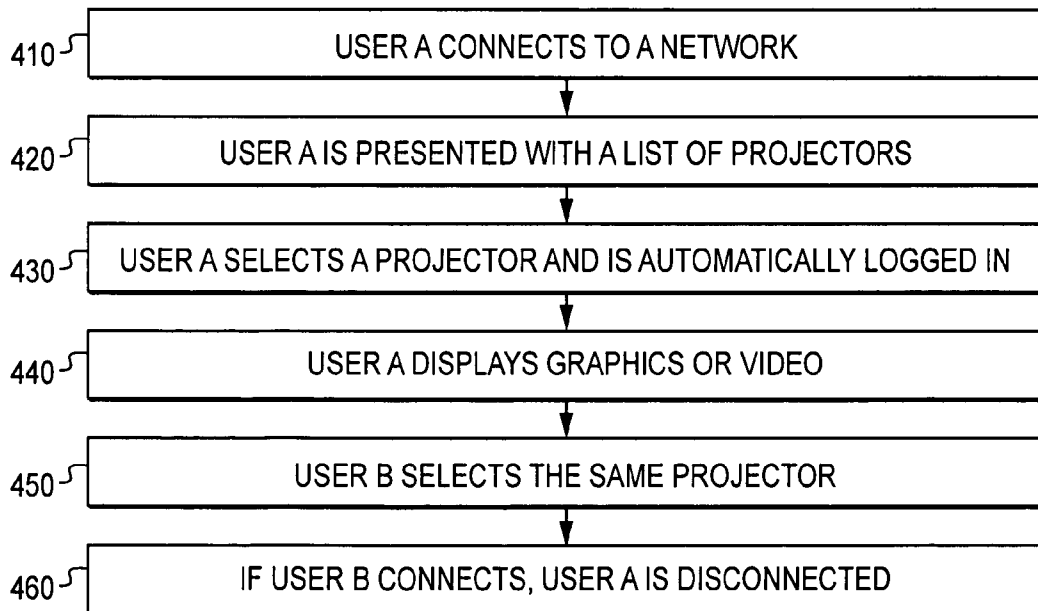

FIG. 4

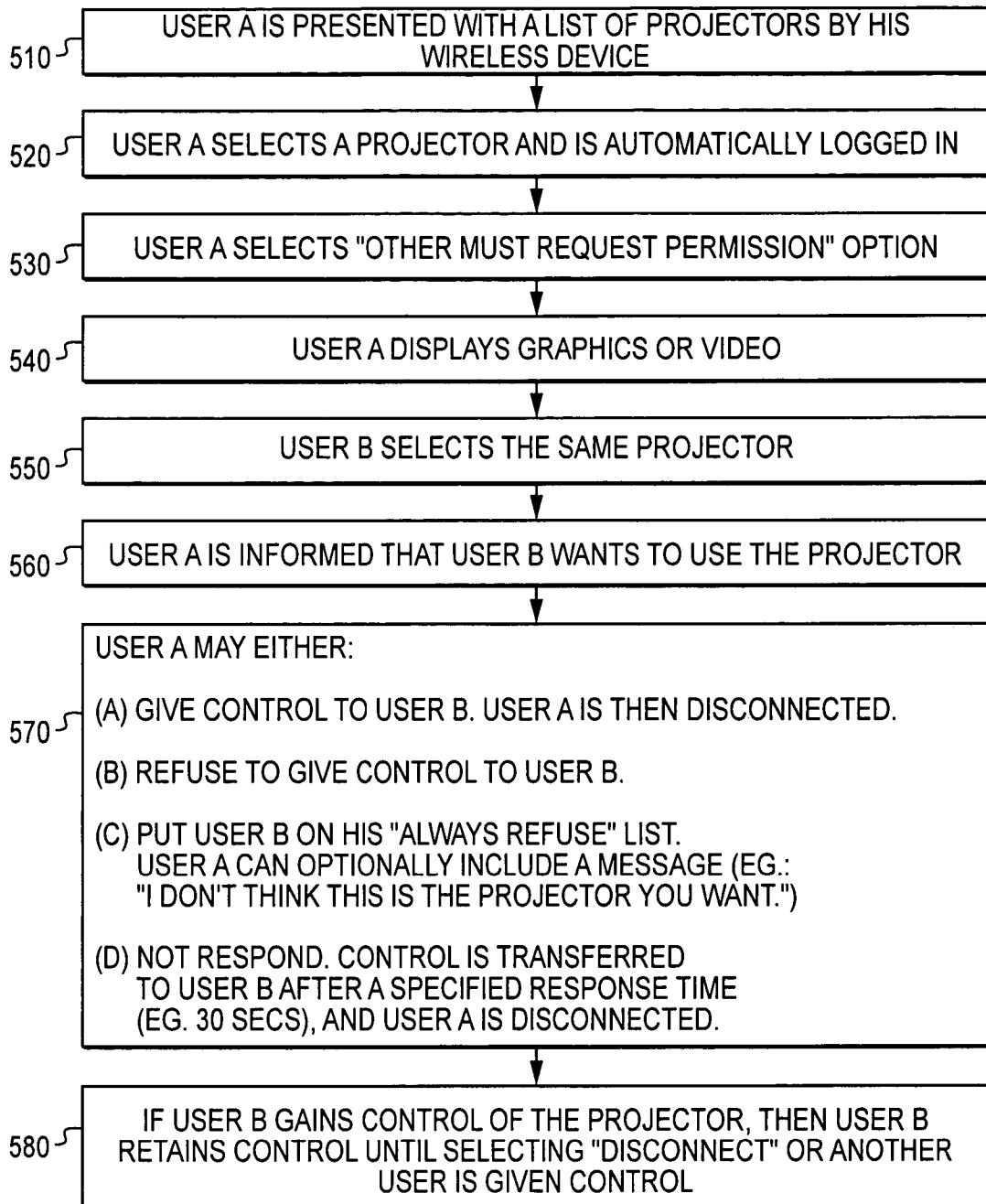

FIG. 5

Explore Litigation Insights

Docket Alarm provides insights to develop a more informed litigation strategy and the peace of mind of knowing you're on top of things.

Real-Time Litigation Alerts



Keep your litigation team up-to-date with **real-time alerts** and advanced team management tools built for the enterprise, all while greatly reducing PACER spend.

Our comprehensive service means we can handle Federal, State, and Administrative courts across the country.

Advanced Docket Research



With over 230 million records, Docket Alarm's cloud-native docket research platform finds what other services can't. Coverage includes Federal, State, plus PTAB, TTAB, ITC and NLRB decisions, all in one place.

Identify arguments that have been successful in the past with full text, pinpoint searching. Link to case law cited within any court document via Fastcase.

Analytics At Your Fingertips



Learn what happened the last time a particular judge, opposing counsel or company faced cases similar to yours.

Advanced out-of-the-box PTAB and TTAB analytics are always at your fingertips.

API

Docket Alarm offers a powerful API (application programming interface) to developers that want to integrate case filings into their apps.

LAW FIRMS

Build custom dashboards for your attorneys and clients with live data direct from the court.

Automate many repetitive legal tasks like conflict checks, document management, and marketing.

FINANCIAL INSTITUTIONS

Litigation and bankruptcy checks for companies and debtors.

E-DISCOVERY AND LEGAL VENDORS

Sync your system to PACER to automate legal marketing.