

(b)

NOTE: See Figs 8.2 and 8.3 for simple and isolate type MAUs.

**Fig 7-9
Interface Function for MAU with Conditioning**

of the data sequence. A phase-locked loop or equivalent mechanism maintains continuous tracking of the phase of the information on the Data circuit.

7.3.1.2 Control Encoding. A simpler encoding mechanism is used for control signaling than for data signaling. The encoded symbols used in this signaling mechanism are CS0, CS1, and IDL. The CS0 signal is a signal stream of frequency equal to the bit rate (BR). The CS1 signal is a signal stream of frequency equal to half of the bit rate (BR/2). If the interface supports more than one bit rate (see 4.2), the bit rate in use on the data circuits is the one to which the control signals are referenced. The IDL signal used on the control circuits is the same as the IDL signal defined for the data circuits (see 7.3.1.1). The Control Out circuit is optional (O) as is one message on Control In.

The frequency tolerance of the CS1 and CS0 signals on the CO circuit shall be ±5% and that of the CS1 signal on the CI circuit shall be ±15%. The duty cycle of the above signals is nominally 50%/50% and shall

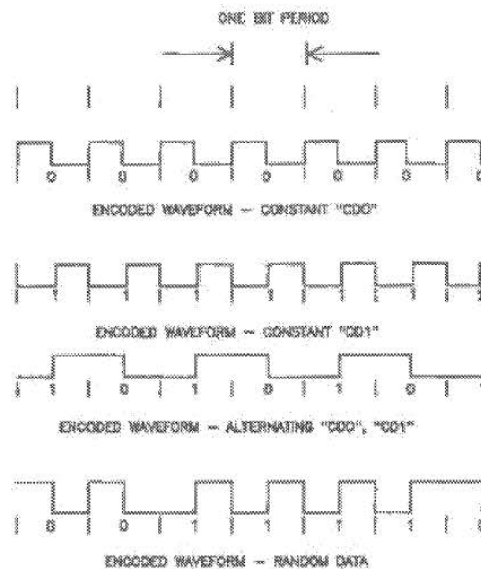

Fig 7-10
Examples of Manchester Waveforms

be no worse than 60%/40%. The CS0 signal on the CI circuit shall have a frequency tolerance of BR +25%, -15% with the pulse widths no less than 35 ns and no greater than 70 ns at the zero crossing points.

The meaning of the signals on the Control Out circuit (DTE to MAU) are:

Signal	Message	Description
IDL	<i>normal</i>	Instructs the MAU to enter (remain in) normal mode
CS1	<i>mau_request</i> (0)	Requests that the MAU should be made available
CS0	<i>isolate</i> (0)	Instructs the MAU to enter (remain in) monitor mode

The meaning of the signals on the Control In circuit (MAU to DTE) are:

Signal	Message	Description
IDL	<i>mau_available</i>	Indicates that the MAU is ready to output data
CS1	<i>mau_not_available</i>	Indicates that the MAU is not ready to output data
CS0	<i>signal_quality_error</i>	Indicates that the MAU has detected an error output data

7.3.2 Signaling Rate. Signaling rates of from 1 to 20 Mb/s are encompassed by this standard. This edition of the standard specifies a signaling rate of 10 million bits per second $\pm 0.01\%$.

It is intended that a given MDI operate at a single data rate. It is not precluded that specific DTE and MAU designs be manually switched or set to alternate rates. A given local network shall operate at a single signaling rate. To facilitate the configuration of operational systems, DTE and MAU devices shall be labeled with the actual signaling rate used with that device.

7.3.3 Signaling Levels. Exact voltage and current specifications are listed in 7.4.

7.4 Electrical Characteristics. Terms BR and BR/2 have very specific meaning as used in this subsection. The term BR is used to mean the bit rate of the highest signaling rate supported by any one implementation of this interface, BR/2 is used to mean half the bit rate of the lowest signaling rate supported by any one implementation of this interface (see 7.3.2). An interface may support one or more signaling rates.

NOTE: The characteristics of the driver and receiver can be achieved with standard ECL logic with the addition of an appropriate coupling network; however, this implementation is not mandatory.

7.4.1 Driver Characteristics. The driver is a differential driver capable of driving the specified 78 Ω interface cable. Only the parameters necessary to ensure compatibility with the specified receiver and to assure personnel safety at the interface connector are specified in the following sections.

7.4.1.1 Differential Output Voltage, Loaded. Drivers shall meet all requirements of this section under *two* basic sets of test conditions (that is, each of two resistive values). For drivers located within a DTE, a combined inductive load of 27 $\mu\text{H} \pm 1\%$ and either a 73 or 83 $\Omega \pm 1\%$ resistive load shall be used. For a driver located within a MAU, a combined inductive load of 50 $\mu\text{H} \pm 1\%$ and either 73 or 83 $\Omega \pm 1\%$ resistive load shall be used.

The differential output voltage, V_{dm} , is alternately positive and negative in magnitude with respect to zero voltage. The value of V_{dm} into either of the two test loads identified above ($R = 73 \Omega$ or $83 \Omega \pm 1\%$) at the interface connector of the driving unit shall satisfy the conditions defined by values V_1 , V_2 , and V_3 shown in Fig 7-11 for signals in between BR and BR/2 meeting the frequency and duty cycle tolerances specified for the signal being driven. The procedure for measuring and applying the test condition is as follows:

- (1) Measure the output voltage V_{dm} for the driver being tested at the waveform point after overshoot, before droop, under test load conditions of 7.4.1.1. This voltage is V_2 .
- (2) Calculate V_1 and V_3 .
- (3) V_1 shall be $< 1315 \text{ mV}$, V_3 shall be $> 450 \text{ mV}$.
- (4) The waveform shall remain within shaded area limits.

The differential output voltage magnitude, V_{dm} , into either of the two test loads identified above, at the interface connector of the driving unit during the idle state shall be within 40 mV of 0 V. The current into either of the two test loads shall be limited to 4 mA.

When a driver, connected to the appropriate two test loads identified above, enters the idle state, it shall maintain a minimum differential output voltage of at least $0.7 \times V_2$ mV for at least 2 bit times after the last low to high transition. The driver differential output voltage shall then approach within 40 mV of 0 V within 80 bit times. In addition, the current into the appropriate test load shall be limited in magnitude to 4 mA within 80 bit times. Undershoot, if any, upon reaching 0 V shall be limited to -100 mV . See Fig 7-12.

For drivers on either the CO or CI circuits, the first transition or the last positive going transition may occur asynchronously with respect to the timing of the following transitions or the preceding transition(s), respectively.

7.4.1.2 Requirements After Idle. When the driver becomes nonidle after a period of idle on the interface circuit, the differential output voltage at the interface connector shall meet the requirements of 7.4.1.1 beginning with the first bit transmitted. The first transition may occur asynchronously with respect to the timing of the following transitions.

7.4.1.3 AC Common-Mode Output Voltage. The magnitude of the ac component of the common-mode output voltage of the driver, measured between the midpoint of a test load consisting of a pair of matched 39 $\Omega \pm 1\%$ resistors and circuit VC, as shown in Fig 7-13, shall not exceed 40 mV peak.

7.4.1.4 Differential Output Voltage, Open Circuit. The differential output voltage into an open circuit, measured at the interface connector of the driving unit, shall not exceed 13 V peak.

7.4.1.5 DC Common-Mode Output Voltage. The magnitude of the dc component of the common-mode output voltage of the driver, measured between the midpoint of a test load consisting of a pair of matched 39 $\Omega \pm 1\%$ resistors and circuit VC, as shown in Fig 7-13, shall not exceed 5.5 V.

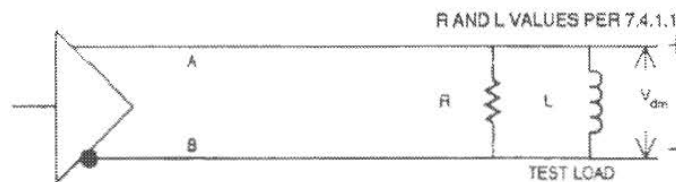
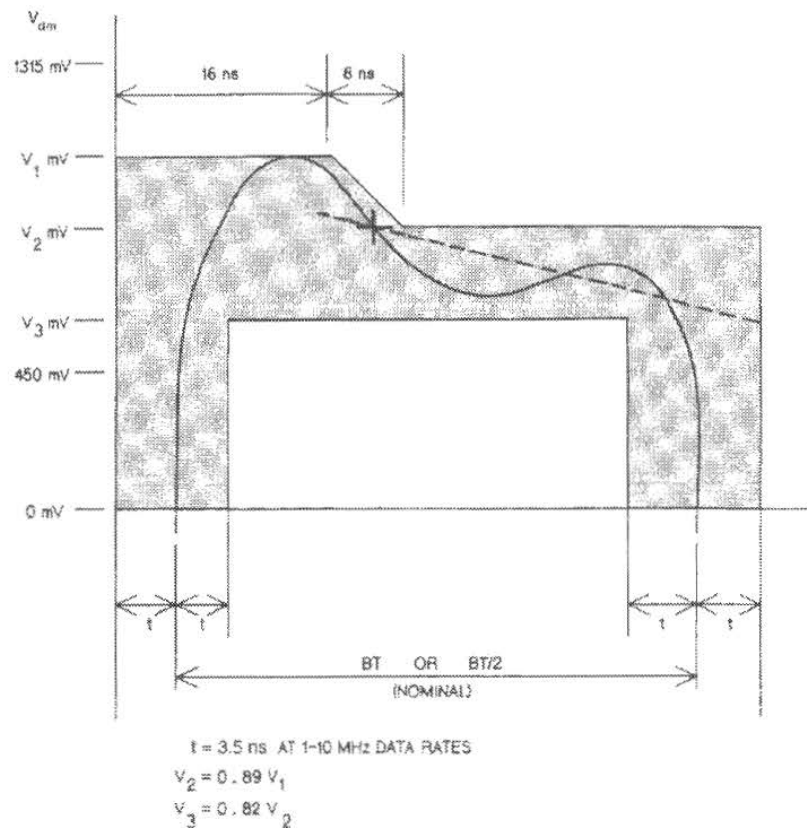

NOTE: The time t in this figure refers to the rise time envelope. Jitter and duty cycle are specified elsewhere.

Fig 7-11
Differential Output Voltage, Loaded

7.4.1.6 Fault Tolerance. Any single driver in the interface, when idle or driving any permissible signal, shall tolerate the application of each of the faults specified by the switch settings in Fig 7-14 indefinitely; and after the fault condition is removed, the operation of the driver, according to the specifications of 7.4.1.1 through 7.4.1.5, shall not be impaired.

In addition, the magnitude of the output current from either output of the driver under any of the fault conditions specified shall not exceed 150 mA.

7.4.2 Receiver Characteristics. The receiver specified terminates the interface cable in its characteristic impedance. The receiver shall function normally over the specified dc and ac common-mode ranges.

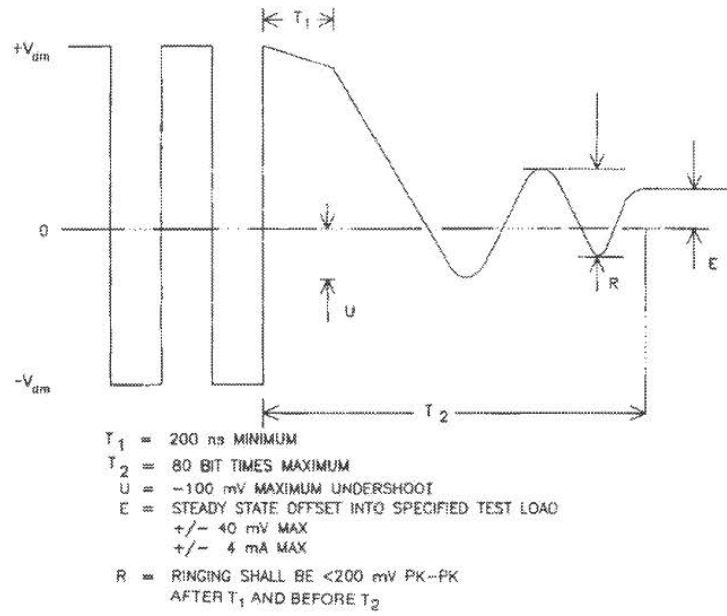

Fig 7-12
Generalized Driver Waveform

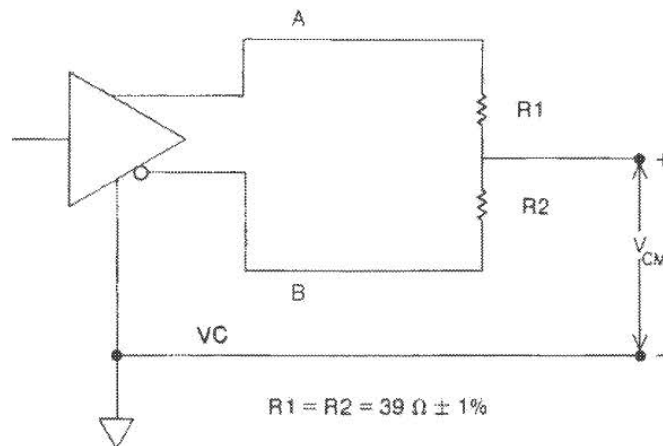

Fig 7-13
Common-Mode Output Voltage

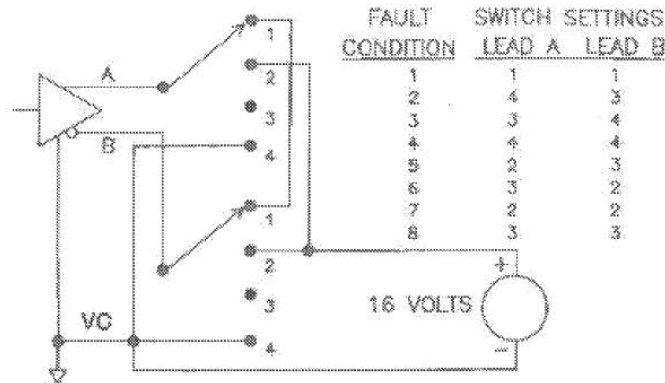

Fig 7-14
Driver Fault Conditions

7.4.2.1 Receiver Threshold Levels. When the receiving interface circuit at the interface connector of the receiving equipment is driven by a differential input signal at either BR or BR/2 meeting the frequency and duty cycle tolerances specified for the receiving circuit, when the A lead is 160 mV positive with respect to the B lead, the interface circuit is in the HI state, and when the A lead is 160 mV negative with respect to the B lead, the interface circuit is in the LO state. The receiver output shall assume the intended HI and LO states for the corresponding input conditions.

If the receiver has a squelch feature, the specified receive threshold levels apply only when the squelch is allowing the signal to pass through the receiver.

NOTE: The specified threshold levels do not take precedence over the duty cycle and jitter tolerance specified elsewhere. Both sets of specifications must be met.

7.4.2.2 AC Differential Input Impedance. The ac differential input impedance for AUI receivers located in MAUs shall have a real part of $77.83 \Omega \pm 6\%$, with the sign of the imaginary part positive, and the phase angle of the impedance in degrees less than or equal to 0.0338 times the real part of the impedance, when measured with a 10 MHz sine wave.

The ac differential input impedance for AUI receivers located in the DTE shall have a real part of $77.95 \Omega \pm 6\%$, with the sign of the imaginary part positive, and the phase angle of the impedance in degrees less than or equal to 0.0183 times the real part of the impedance, when measured with a 10 MHz sine wave.

A $78 \Omega \pm 6\%$ resistor in parallel with an inductance of greater than $27 \mu\text{H}$ or $50 \mu\text{H}$ for receivers in the MAU and DTE respectively, satisfies this requirement.

7.4.2.3 AC Common-Mode Range. When the receiving interface circuit at the receiving equipment is driven by a differential input signal at either BR or BR/2 meeting the frequency and duty cycle tolerances specified for the circuit being driven, the receiver output shall assume the proper output state as specified in 7.4.2.1, in the presence of a peak common-mode ac sine wave voltage either of from 30 Hz to 40 kHz referenced to circuit VC in magnitude from 0 to 3 V, or in magnitude 0 to 100 mV for ac voltages of from 40 kHz to BR as shown in Fig 7-15.

NOTE: The receiver shall also be able to reject small ac common-mode signals in frequencies outside of this range.

7.4.2.4 Total Common-Mode Range. When the receiving interface circuit at the receiving equipment is driven by a differential input signal at either BR or BR/2 meeting the frequency and duty cycle tolerances specified for the circuit being driven, the receiver output shall assume the intended output state as specified in 7.4.2.1 in the presence of a total common-mode voltage, dc plus ac, referenced to circuit VC in magnitude from 0 to 5.5 V, as shown in the test setup of Fig 7-15. The ac component shall not exceed the requirements of 7.4.2.3.

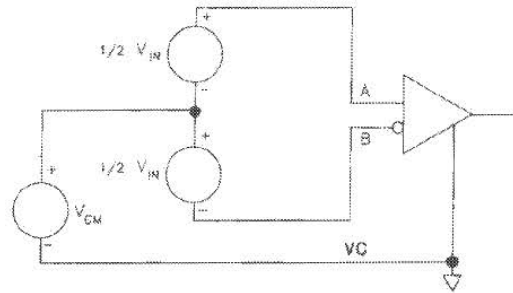

Fig 7-15
Common-Mode Input Test

The receiver shall be so designed that the magnitude of the current from the common-mode voltage source used in the test shall not exceed 1 mA.

7.4.2.5 Idle Input Behavior. When the receiver becomes nonidle after a period of idle on the interface circuit, the characteristics of the signal at the output of the receiver shall stabilize within the startup delay allowed for the device incorporating the receiver so that it is not prevented from meeting the jitter specifications established for that device.

The receiving unit shall take precautions to ensure that a HI to idle transition is not falsely interpreted as an idle to nonidle transition, even in the presence of signal droop due to ac coupling in the interface driver or receiver circuits.

7.4.2.6 Fault Tolerance. Any single receiver in the interface shall tolerate the application of each of the faults specified by the switch settings in Fig 7-16 indefinitely, and after the fault condition is removed, the operation of the receiver according to the specifications of 7.4.2.1 through 7.4.2.6 shall not be impaired.

In addition, the magnitude of the current into either input of the receiver under any of the fault conditions specified shall not exceed 3 mA.

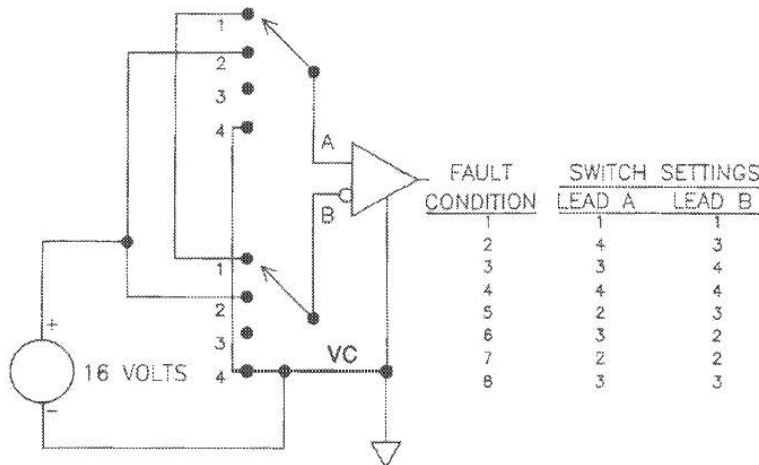

Fig 7-16
Receiver Fault Conditions

7.4.3 AUI Cable Characteristics. The interface cable consists of individually shielded twisted pairs of wires with an overall shield covering those individual shielded wire pairs. These shields must provide sufficient shielding to meet the requirements of protection against rf interference and the following cable parameters. Individual shields for each signal pair are electrically isolated from the outer shield but not necessarily from each other.

The overall shield shall be returned to the MAU and DTE Units via the AUI connector shell as defined in 7.6.2 and 7.6.3. If a common drain wire is used for all the signal pair shields, then it shall be connected to pin 4. Individual drain wire returns for each signal pair may be used (see 7.6.3). It is recommended that individual drain wires be used on all control and data circuit shields to meet satisfactory crosstalk levels. If individual drain wires are used, they shall be interconnected within the AUI cable at each end and shall be connected at least to pin 4 at each end of the cable.

The presence of the Control Out signal pair is optional. If driver or receiver circuit components for CO are not provided, consideration should be given to properly terminating the CO signal pair within the DTE and MAU to preclude erroneous operation.

7.4.3.1 Conductor Size. The dc power pair in the interconnecting cable, voltage common and voltage minus, shall be composed of a twisted pair of sufficient gauge stranded wires to result in a nominal dc resistance not to exceed 1.75 Ω per conductor.

Conductor size for the signal pairs shall be determined according to the ac related parameters in 7.4.3.2–7.4.3.6.

7.4.3.2 Pair-to-Pair Balanced Crosstalk. The balanced crosstalk from one pair of wires to any other pair in the same cable sheath (when each pair is driven per 7.4.1.1–7.4.1.5) shall have a minimum value of 40 dB of attenuation measured over the range of BR/2 to BR.

7.4.3.3 Differential Characteristic Impedance. The differential characteristic impedance for all signal pairs shall be equal within 3 Ω and shall be $78 \pm 5 \Omega$ measured at a frequency of BR.

7.4.3.4 Transfer Impedance

- (1) The common-mode transfer impedance shall not exceed the values shown in Fig 7-17 over the indicated frequency range.
- (2) The differential mode transfer impedance for all pairs shall be at least 20 dB below the common-mode transfer impedance.

7.4.3.5 Attenuation. Total cable attenuation levels between driver and receiver (at separate stations) for each signal pair shall not exceed 3 dB over the frequency range of BR/2 to BR (Hz) for sine wave measurements.

7.4.3.6 Timing Jitter. Cable meeting this specification shall exhibit edge jitter of no more than 1.5 ns at the receiving end when the longest legal length of the cable as specified in 7.4.3.1 through 7.4.3.7 is terminated in a $78 \Omega \pm 1\%$ resistor at the receiving end and is driven with pseudorandom Manchester encoded binary data from a data generator which exhibits no more than 0.5 ns of edge jitter on half bit cells of exactly 1/2 BT and whose output meets the specifications of 7.4.1.1 through 7.4.1.5. This test shall be conducted in a noise-free environment. The above specified component is not to introduce more than 1 ns of edge jitter into the system.

NOTE: Special attention will have to be applied to the cable characteristics and length at 20 Mba.

7.4.3.7 Delay. Total signal delay between driver and receiver (at separate stations) for each signal pair shall not exceed 257 ns.

7.5 Functional Description of Interchange Circuits

7.5.1 General. The AUI consists of either three or four differential signal circuits, power, and ground. Two of the circuits carry encoded data and two carry encoded control information. Circuits DO (Data Out) and CO (Control Out) are sourced by the DTE, and circuits DI (Data In) and CI (Control In) are sourced by

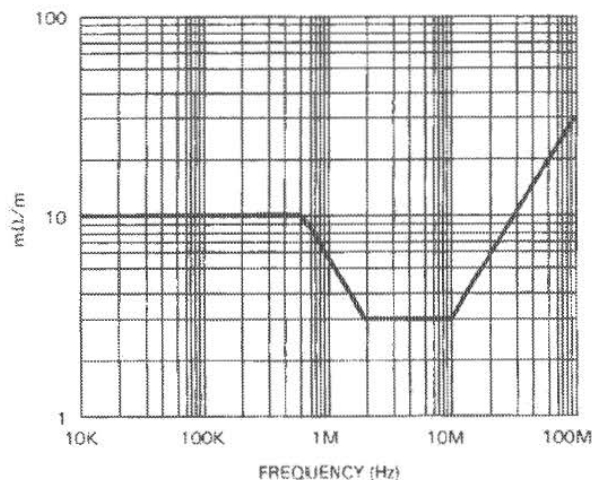

Fig 7-17
Common-Mode Transfer Impedance

the MAU. The interface also provides for power transfer from the DTE to the MAU. The CO circuit is optional.

7.5.2 Definition of Interchange Circuits. The following circuits are defined by this specification:

Circuit	Name	Signal Direction		Remarks
		to MAU	from MAU	
DO	Data Out	X		Encoded Data
DI	Data In		X	Encoded Data
CO	Control Out	X		Encoded Control
CI	Control In		X	Encoded Control
VP	Voltage Plus	X		12 Volts
VC	Voltage Common	X		Return for VP
PG	Protective Ground	X		Shield

7.5.2.1 Circuit DO-Data Out. The Data Out (DO) circuit is sourced by the DTE. It is a differential pair consisting of DO-A (Data Out circuit A) and DO-B (Data Out circuit B).

The signal transferred over this circuit is Manchester encoded. An *output* message containing a one bit is encoded as CD1. An *output_idle* message is encoded as an IDL.

The following symmetry requirements shall be met when the DTE transfers pseudo-random Manchester encoded binary data over a DO circuit loaded by the test load specified in 7.4.1.1.

Bit cells generated internal to the DTE are required to be 1 BT within the permitted tolerance on data rate specified in 7.3.2. Half bit cells in each data bit are to be exactly 1/2 BT (that is, the reference point for edge jitter measurements) within the permitted tolerance on the data rate specified in 7.3.2. Each transition on the DO circuit is permitted to exhibit edge jitter not to exceed 0.5 ns in each direction. This means that any transition may occur up to 0.5 ns earlier or later than this transition would have occurred had no edge jitter occurred on this signal.

7.5.2.2 Circuit DI-Data In. The Data In (DI) circuit is sourced by the MAU. It is a differential pair consisting of DI-A (Data In circuit A) and DI-B (Data In circuit B).

The signal transferred over this circuit is Manchester encoded. An *input* message containing a zero bit is encoded as CD0. An *input* message containing a one bit is encoded as CD1. An *input_idle* message is encoded as an IDL.

A DTE meeting this specification shall be able to receive, on the DI circuit without a detectable FCS error, normal preamble data arranged in legal length packets as sent by another station to the DTE. The test generator for the data on the DI circuit shall meet the requirements for drivers in MAUs specified in 7.4.1.1 through 7.4.1.5 and shall drive the DI circuit through a zero length AUI cable. Random amounts of edge jitter from 0 to 12 ns on either side of each transition shall be added by the test generator to transitions in bits in the preamble, and random amounts of edge jitter of from 0 to 18 ns on either side of each transition shall be added to the transitions in all bits in the frame. Preamble length from the test generator shall be 47 bits of preamble, followed by the 8 bit SFD.

NOTE: A significant portion of the system jitter may be nonrandom in nature and consists of a steady-state shift of the midbit transitions in either direction from their nominal placement. A 16.5 ns edge jitter is expected on the transmitted signal at the receiving DTE, worst case. The difference between 16.5 ns and 19 ns jitter represents receiver design margin.

7.5.2.3 Circuit CO-Control Out (Optional). The Control Out (CO) circuit is sourced by the DTE. It is a differential pair consisting of CO-A (Control Out circuit A) and CO-B (Control Out circuit B).

The signal transferred over this circuit is encoded as described in 7.3.1.2. A *max_request* message is encoded as CS1. A *normal* message is encoded as IDL. An *isolate* message is encoded as CS0.

7.5.2.4 Circuit CI-Control In. The Control In (CI) circuit is sourced by the MAU. It is a differential pair consisting of CI-A (Control In circuit A) and CI-B (Control In circuit B).

The signal transferred over this circuit is encoded as described in 7.3.1.2. A *max_available* message is encoded as IDL. A *max_not_available* message is encoded as CS1. A *signal_quality_error* message is encoded as a CS0.

7.5.2.5 Circuit VP-Voltage Plus. The Voltage Plus (VP) circuit is an optional circuit that may be sourced from the DTE. If this circuit is sourced from the DTE it shall be capable of operating at one fixed level between + 12 V dc \pm 5% and + 15 V dc \pm 5% with respect to circuit VC for all currents from 0 to 500 mA. The source shall provide protection for this circuit against an overload condition. The method of overload protection is not specified; however, under no conditions of operation, either normal or overload, shall the source apply a voltage to circuit VP of less than 0 or greater than + 15.75 V dc as specified above. MAU designers are cautioned that protection means employed by power sources may cause the voltage at signal VP to drop below the minimum operational voltage specified without going completely to zero volts when loads drawing in excess of the current supplied are applied between VP and VC. Adequate provisions shall be made to ensure that such a condition does not cause the MAU to disrupt the medium.

If the DTE does not support circuit VP, it shall have no connection to this circuit.

7.5.2.6 Circuit VC-Voltage Common. Circuit VC is the ground return to the power source for circuit VP, capable of sinking 2.0 A. Also, all common-mode terminators for AUI circuits shall be made to circuit VC.

7.5.2.7 Circuit PG-Protective Ground. Circuit PG shall be connected to chassis ground through a maximum dc resistance of 20 m Ω at the DTE end.

7.5.2.8 Circuit Shield Terminations. Individual pin terminations shall meet the following requirements:

- (1) Pins 1, 4, 8, 11, 14 connected to logic ground in the DTE
- (2) Pins 1, 4, 8, 11, 14 capacitively coupled to VC in MAU
- (3) Impedance to ground $<$ 5 Ω at the lowest operational BR/2 in the MAU and at the highest BR in the DTE

7.6 Mechanical Characteristics

7.6.1 Definition of Mechanical Interface. All connectors used shall be as specified in 7.6.2. The DTE shall have a female connector and the MAU shall have a male connector. The MAU may be plugged directly into the DTE or may be connected by one or more cable segments whose total length is less than or equal to 50 m. All cable segments shall have a male connector on one end and a female connector on the other end. All female connectors shall have the slide latch, and all male connectors shall have the locking posts (as defined in Figs 7-18, 7-19, and 7-20) as the retention system.

7.6.2 Line Interface Connector. A 15-pole connector having the mechanical mateability dimensions as specified in IEC 807-2 [7] with gold-plated contacts shall be used for the line interface connector. The shells of these connectors shall be tin plated to ensure the integrity of the cable shield to chassis current path. The resistance of the cable shield to equipment chassis shall not exceed 5 mΩ, after a minimum of 500 cycles of mating and unmating.

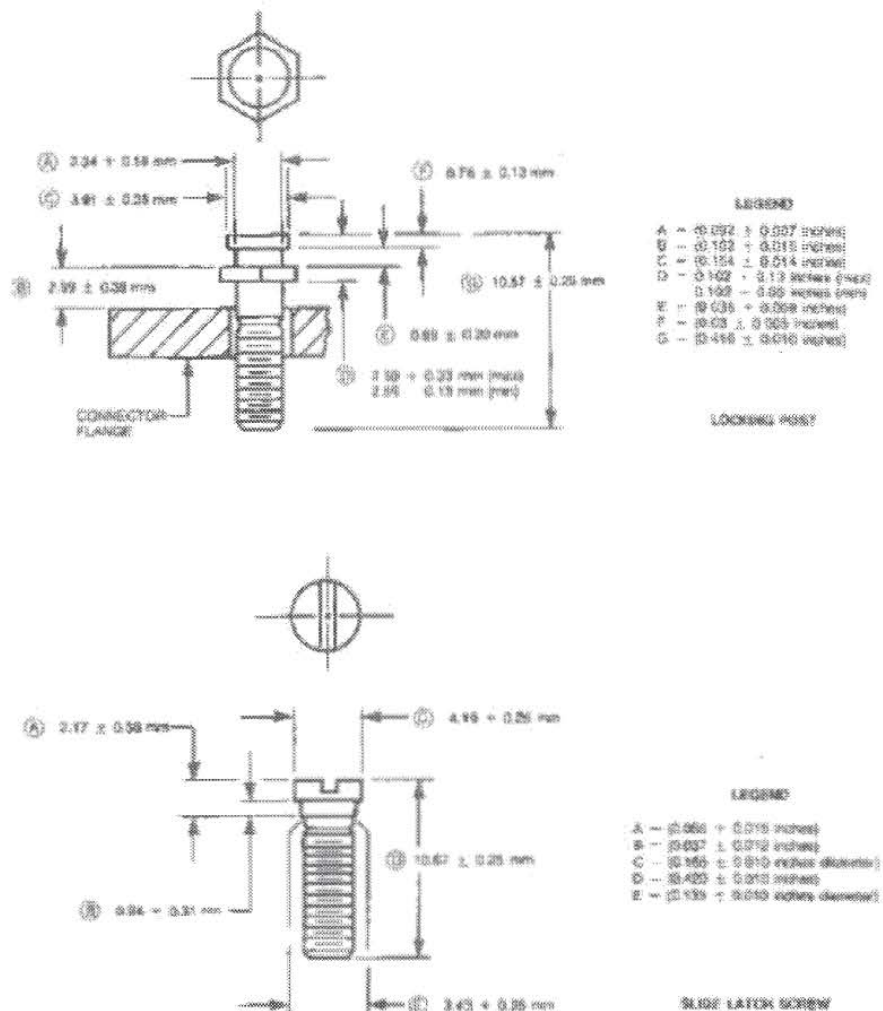

Fig 7-18
Connector Locking Posts

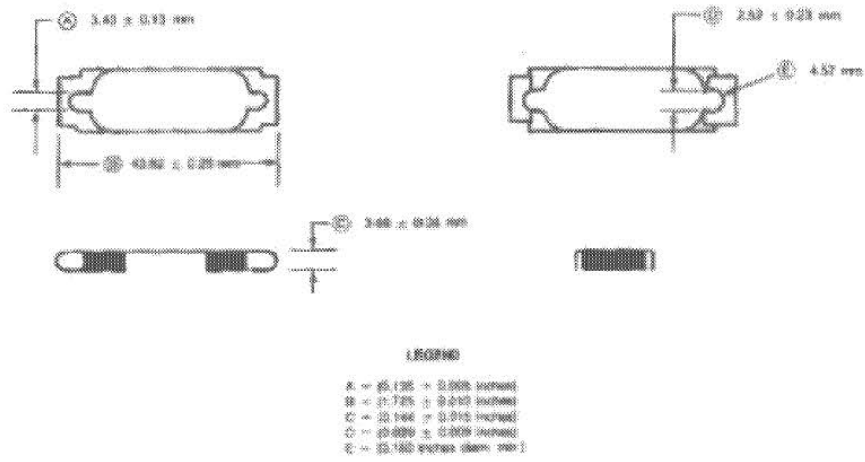

Fig 7-19
Connector Slide Latch

(material 24 gauge maximum)

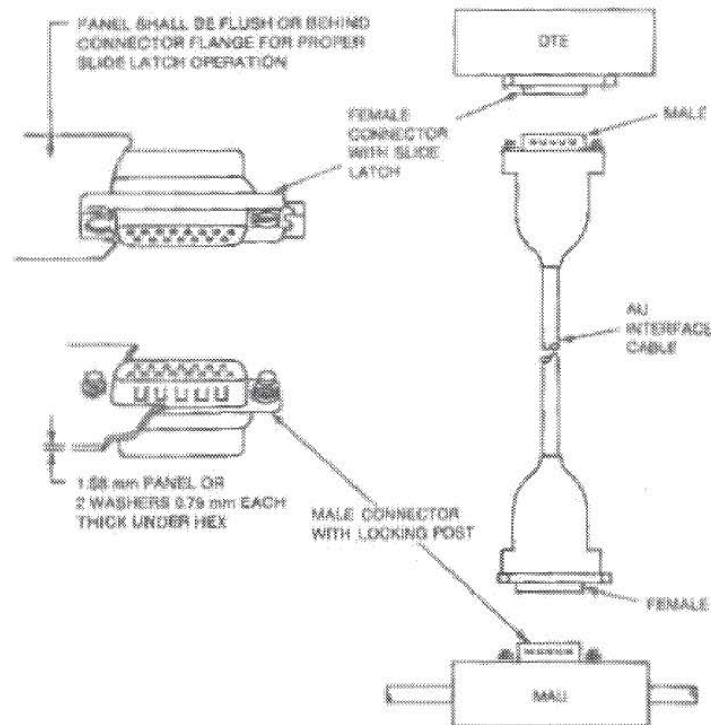

Fig 7-20
Connector Hardware and AUI Cable Configuration

In order to ensure intermateability of connectors obtained from different manufacturers, the connector with female contacts shall conform to IEC 807-2 [7] and have gold-plated contacts and tin-plated shells. All additions to provide for female shell to male shell conductivity shall be on the shell of the connector with male contacts. There should be multiple contact points around the sides of this shell to provide for shield continuity.

NOTE: Use of similar metallic surfaces on connector conductors and similar metallic surfaces on the connector shells minimizes galvanic action and reduced performance.

The connector is not specified to prevent operator contact with the shield, and precautions shall be taken at installation time to ensure that the installer is warned that the shield is not to be brought into contact with any hazardous voltage while being handled by operating personnel.

See reference [A13].

7.6.3 Contact Assignments. The following table shows the assignment of circuits to connector contacts:

Contact	Circuit	Use
9	DO-A	Data Out circuit A
10	DO-B	Data Out circuit B
11	DO-S	Data Out circuit Shield
5	DI-A	Data In circuit A
12	DI-B	Data In circuit B
4	DI-S	Data In circuit Shield
7	CO-A	Control Out circuit A
15	CO-B	Control Out circuit B
8	CO-S	Control Out circuit Shield
2	CI-A	Control In circuit A
9	CI-B	Control In circuit B
1	CI-S	Control In circuit Shield
6	VC	Voltage Common
13	VP	Voltage Plus
14	VS	Voltage Shield
Shell	PG	Protection Ground (Conductive Shell)

NOTES: (1) Voltage Plus and Voltage Common use a single twisted pair in the AUI cable.

(2) As indicated in 7.4.2.1, the A lead of a circuit is positive relative to the B lead for a HI signal and negative for a LO signal.

8. Medium Attachment Unit and Baseband Medium Specifications, Type 10BASE5

8.1 Scope

8.1.1 Overview. This standard defines the functional, electrical, and mechanical characteristics of the MAU and one specific medium for use with local networks. The relationship of this specification to the entire ISO [IEEE] Local Network specification is shown in Fig 8-1. The purpose of the MAU is to provide a simple, inexpensive, and flexible means of attaching devices to the local network medium.

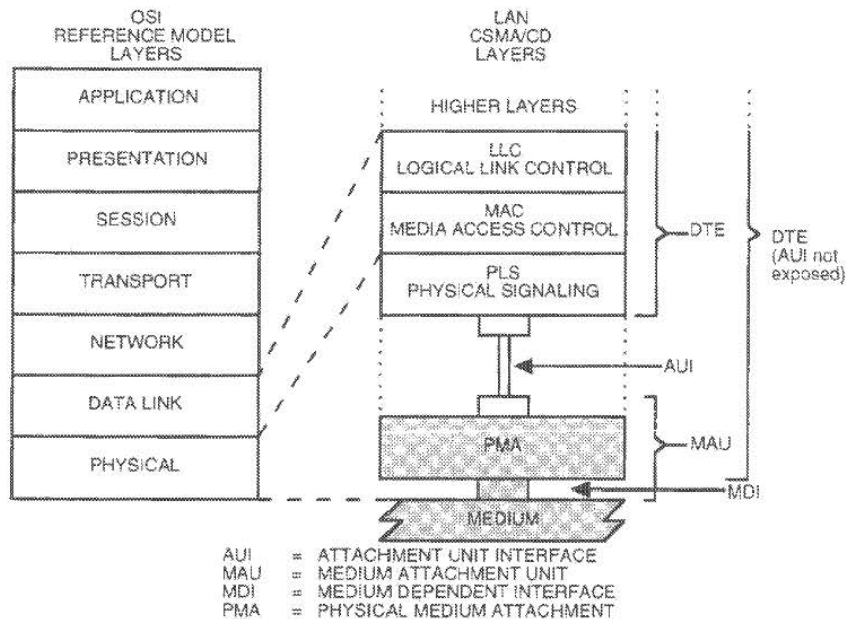

Fig 8-1
Physical Layer Partitioning, Relationship to the ISO Open Systems Interconnection (OSI) Reference Model

8.1.1.1 Medium Attachment Unit. The MAU has the following general characteristics:

- (1) Enables coupling the PLS by way of the AUI to the explicit baseband coaxial transmission system defined in this section of the standard.
- (2) Supports message traffic at a data rate of 10 Mb/s (alternative data rates may be considered in future additions to the standard).
- (3) Provides for driving up to 500 m (1640 ft) of coaxial trunk cable without the use of a repeater.
- (4) Permits the DTE to test the MAU and the medium itself.
- (5) Supports system configurations using the CSMA/CD access mechanism defined with baseband signaling.
- (6) Supports a bus topology interconnection means.

8.1.1.2 Repeater Unit. The repeater unit is used to extend the physical system topology, has the same general characteristics as defined in 8.1.1.1, and provides for coupling together two or more 500 m (1640 ft) coaxial trunk cable segments. Multiple repeater units are permitted within a single system to provide a maximum trunk cable connection path of 2.5 km (8200 ft) between any two MAUs.

8.1.2 Definitions

baseband coaxial system. A system whereby information is directly encoded and impressed on the coaxial transmission medium. At any point on the medium, only one information signal at a time can be present without disruption (see collision).

BR. The rate of data throughput (bit rate) on the medium in bits per second.

BR/2. One half of the BR in Hertz.

branch cable. The AUI cable interconnecting the DTE and MAU system components.

carrier sense. In a local area network, an ongoing activity of a data station to detect whether another station is transmitting.

NOTE: A collision presence signal is provided by the PLS to the PMA sublayer to indicate that one or more stations are currently transmitting on the trunk coaxial cable.

coaxial cable. A two-conductor (center conductor, shield system), concentric, constant impedance transmission line used as the trunk medium in the baseband system.

coaxial cable interface. The electrical and mechanical interface to the shared coaxial cable medium either contained within or connected to the MAU. Also known as MDI (Medium Dependent Interface).

coaxial cable segment. A length of coaxial cable made up from one or more coaxial cable sections and coaxial connectors, and terminated at each end in its characteristic impedance.

collision. An unwanted condition that results from concurrent transmissions on the physical medium.

collision presence. A signal provided by the PLS to the PMA sublayer (within the data link layer) to indicate that multiple stations are contending for access to the transmission medium.

compatibility interfaces. The MDI coaxial cable interface and the AUI branch cable interface, the two points at which hardware compatibility is defined to allow connection of independently designed and manufactured components to the baseband transmission system.

Medium Attachment Unit (MAU). In a local area network, a device used in a data station to couple the data terminal equipment to the transmission medium.

Medium Dependent Interface (MDI). The mechanical and electrical interface between the trunk cable medium and the MAU.

Physical Medium Attachment (PMA). The portion of the MAU that contains the functional circuitry.

Physical Signaling (PLS). That portion of the Physical Layer, contained within the DTE that provides the logical and functional coupling between MAU and Data Link Layers.

repeater. A device used to extend the length, topology, or interconnectivity of the physical medium beyond that imposed by a single segment, up to the maximum allowable end-to-end trunk transmission line length. Repeaters perform the basic actions of restoring signal amplitude, waveform, and timing applied to normal data and collision signals.

trunk cable. The trunk coaxial cable system.

8.1.3 Application Perspective: MAU and MEDIUM Objectives. This section states the broad objectives and assumptions underlying the specifications defined throughout this section of the standard.

8.1.3.1 Object

- (1) Provide the physical means for communication between local network data link entities.

NOTE: This standard covers a portion of the physical layer as defined in the OSI Reference Model and, in addition, the physical medium itself, which is beyond the scope of the OSI Reference Model.

- (2) Define a physical interface that can be implemented independently among different manufacturers of hardware and achieve the intended level of compatibility when interconnected in a common local network.
- (3) Provide a communication channel capable of high bandwidth and low bit error rate performance. The resultant mean bit error rate, at the physical layer service interface should be less than one part in 10^8 (on the order of one part in 10^9 at the link level).
- (4) Provide for ease of installation and service.
- (5) Provide for high network availability (ability of a station to gain access to the medium and enable the data link connection in a timely fashion).
- (6) Enable relatively low-cost implementations.

8.1.3.2 Compatibility Considerations. All implementations of this baseband coaxial system shall be compatible at the MDI.

This standard provides no explicit trunk cable medium specification for the interconnection of all MAU devices. The medium itself, the functional capability of the MAU, and the AUI are defined to provide the highest possible level of compatibility among devices designed by different manufacturers. Designers are free to implement circuitry within the MAU in an application-dependent manner provided the MD Interface and AUI specifications are satisfied.

Subsystems based on this specification may be implemented in several different ways provided compatibility at the medium is maintained. It is possible, for example, to design an integrated station where the MAU is contained within a physical DTE system component, thereby eliminating the AUI cable. The device designer (and system user) shall then consider such factors as topological flexibility, system availability, and configurability.

8.1.3.3 Relationship to PLS and AUI Interface. This section defines the primary physical layer for the local area network, a layer comprised of both the physical medium and the rudimentary circuitry necessary to couple a station's message path directly to/from the medium. The complete logical physical layer of the local area network may reside physically in two distinct locations, the MAU and the DTE. Therefore, a close relationship exists between this section and Section 7. This section specifies all of the physical medium parameters, all of the PMA logical functions residing in the physical MAU, and references the AUI associated with and defined throughout Section 7.

NOTE: The design of a physical MAU component requires the use of both this section and Section 7 for the PLS and AUI specifications.

8.1.3.4 Modes of Operation. The MAU is capable of operating in either a "Normal" mode or an optional "Monitor" mode.

- (1) *Normal Mode.* The MAU functions as a direct connection between the baseband medium and the DTE. Data output from the DTE is output to the coaxial trunk medium and all data on the coaxial trunk medium is input to the DTE. This mode is the "normal" mode of operation for the intended message traffic between stations.
- (2) *Monitor Mode.* The MAU Transmit Function is disabled to prevent data from being output on the trunk coaxial medium while the receive function and collision presence function remain active for purposes of monitoring medium message traffic. This mode also serves as a limited test mode at the same time it isolates the MAU transmitter from the medium. Under most local (that is, intrastation) fault conditions the monitor mode enables continued use of the network while the local station is being serviced.

8.2 MAU Functional Specifications. The MAU component provides the means by which signals on the four physically separate AUI signal circuits to/from the DTE and their associated interlayer messages are coupled to the single coaxial cable baseband signal line. To achieve this basic objective, the MAU compo-

ment contains the following functional capabilities to handle message flow between the DTE and the baseband medium:

- (1) *Transmit Function*. The ability to transmit serial data bit streams on the baseband medium from the local DTE entity and to one or more remote DTE entities on the same network.
- (2) *Receive Function*. The ability to receive serial data bit streams over the baseband medium.
- (3) *Collision Presence Function*. The ability to detect the presence of two or more stations' concurrent transmissions.
- (4) *Monitor Function (Optional)*. The ability to inhibit the normal transmit data stream to the medium at the same time the normal receive function and collision presence function remain operational.
- (5) *Jabber Function*. The ability to automatically interrupt the transmit function and inhibit an abnormally long output data stream.

8.2.1 MAU Physical Layer Functions

8.2.1.1 Transmit Function Requirements. At the start of a frame transmission on the coaxial cable, no more than 2 bits (2 full bit cells) of information may be received from the DO circuit and not transmitted onto the coaxial medium. In addition, it is permissible for the first bit sent to contain encoded phase violations or invalid data; however, all successive bits of the frame shall be reproduced with no more than the specified amount of jitter. The second bit cell transmitted onto the coaxial cable shall be carried from the DO signal line and transmitted onto the coaxial trunk cable medium with the correct timing and signal levels. The steady-state propagation delay between the DO circuit receiver input and the coaxial cable output shall not exceed one-half bit cell. There shall be no logical signal inversions between the branch cable DO circuit and the coaxial trunk cable (for example, a "high" logic level input to the MAU shall result in the less negative current flow value on the trunk coaxial medium). A positive signal on the A signal lead of the DO circuit shall result in a more positive voltage level on the trunk coaxial medium. It is assumed that the AUI shall provide adequate protection against noise. It is recommended that the designer provide an implementation in which a minimum threshold signal is required to establish a transmit bit stream.

The Transmit Function shall output a signal on the trunk coaxial medium whose levels and waveform comply with 8.3.1.3.

In addition, when the DO circuit has gone idle after a frame is output, the MAU shall then activate the collision presence function as close to the trunk coaxial cable as possible without introducing an extraneous signal on the trunk coaxial medium. The MAU shall initiate the collision presence state within 0.6 μ s to 1.6 μ s after the start of the output idle signal and shall maintain an active collision presence state for a time equivalent to 10 ± 5 bit cells.

8.2.1.2 Receive Function Requirements. The signal from the coaxial trunk cable shall be directly coupled to the receiver and subsequently ac coupled before reaching the receive circuit connected to the DTE. The receive function shall output a signal onto the DI circuit of the AUI cable that complies with the AUI specification for drivers in MAUs.

At the start of a frame reception from the coaxial cable, no more than 5 bits (five full bit cells) of information may be received from the coaxial cable and not transmitted onto the receive (DI) circuit. In addition, it is permissible for the first bit sent over the receive circuit to contain encoded phase violations or invalid data; however, all successive bits of the frame shall reproduce the incoming signal with no more than the above specified amount of jitter. This implies that the second bit cell sent onto the DI circuit presents valid data to the branch cable. The steady-state propagation delay between the coaxial cable and the receive (DI) circuit output shall not exceed one-half bit cell. There are no logical signal inversions between the coaxial (trunk) cable and the MAU (branch) cable receive circuit. The circuit bandwidth of the receiver function shall be limited to 50 MHz.

A MAU meeting this specification shall exhibit edge jitter into the DI pair when terminated in the appropriate test load specified in 7.4.3.6, of no more than 8.0 ns in either direction when it is installed on the distant end of all lengths between 2.5 m and 500 m of the cable specified in 8.4.1.1 through 8.4.2.1.5 terminated at both ends with terminators meeting the impedance requirements of 8.5.2.1 and driven at one end with pseudo-random Manchester encoded binary data from a data generator that exhibits no more than 1.0 ns of edge jitter in either direction on half-bit cells of exactly $1/2$ BT and whose output meets the specifications of 8.3.1.3 except that the risetime of the signal must be $30 \text{ ns} + 0, - 2 \text{ ns}$. This test shall be

conducted in a noise-free environment. The combination of coaxial cable and MAU receiver introduce no more than 6 ns of edge jitter into the system.

The local transmit and receive functions shall operate simultaneously while connected to the medium operating in the half duplex operating mode.

8.2.1.3 Collision Presence Function Requirements. The signal presented to the CI circuit in the absence of a collision shall be the IDL signal except when the MAU is required to signal the CS1 signal.

The signal presented to the CI circuit during the presence of a collision shall be the CS0 signals encoded as specified in 7.3.1.2. This signal shall be presented to the CI circuit no more than 9 bit times after the signal (for example, dc average) on the coaxial cable at the MAU equals or exceeds that produced by two (or more) MAU outputs transmitting concurrently under the condition that the MAU detecting collision presence is transmitting. Under no conditions shall the collision presence function generate an output when only one MAU is transmitting. A MAU, while not transmitting, may detect the presence of two other MAUs transmitting and shall detect the presence of more than two other MAUs transmitting. Table 8-1 summarizes the allowable conditions under which collisions shall be detected.

The collision presence function may, in some implementations, be able to sense an abnormal (for example, open) medium. The use of MAUs in repeaters requires added considerations; see 8.3.1.5.

Table 8-1
Generation of Collision Presence Signal

MAU	Numbers of Transmitters		
	<2	=2	>2
Transmitting	N	Y	Y
Not transmitting	N	May	Y
	Y	= will generate SQE message	
	N	= will not generate SQE message	
	May	= may generate SQE message	

8.2.1.4 Monitor Function Requirements (Optional). Upon receipt of the *isolate* message the MAU shall, within 20 ms (implementations: solid-state preferred, relay switched permitted), disable the transmit function in such a way as to prevent both the transmission of signals on the trunk coaxial medium and any abnormal loading by the disabled transmitter on the trunk coaxial medium itself. The monitor function is intended to prevent a malfunctioning active component (for example, transmit driver) from bringing down the network. The *isolate* message shall not interact with the receive or collision presence functions, thus permitting the normal operational mode wherein all data appearing on the trunk coaxial medium are carried to the DTE on the DI signal circuit.

NOTE: Verification for successful execution of the *isolate* message requires use of the trunk coaxial medium itself. This level of guaranteed performance requires use of system layers above the physical layer and implies some interruption of normal trunk coaxial medium message traffic.

8.2.1.5 Jabber Function Requirements. The MAU shall contain a self-interrupt capability to inhibit transmit data from reaching the medium. Hardware within the MAU (with no external message other than the detection of output data, bits, or leakage, by way of the transmit function) shall provide a nominal window of at least 20 ms to at most 150 ms during which time a normal data link frame may be transmitted. If the frame length exceeds this duration, the jabber function shall inhibit further output data from reaching the medium.

When the transmit function has been positively disabled, the MAU shall then activate the collision presence function as close to the trunk coaxial medium as possible without introducing an extraneous signal on the trunk coaxial medium. A MAU without the monitor function and powered by the DTE may reset the jabber and collision presence functions on power reset once the error condition has been cleared. Alternatively, a self-powered MAU may reset these functions after a period of $0.5 \text{ s} \pm 50\%$ if the monitor function has not been implemented. If the monitor function has been implemented then it shall be used to reset the collision presence and jabber functions.

8.2.2 MAU Interface Messages

8.2.2.1 DTE Physical Layer to MAU Physical Layer Messages. The following messages can be sent by the DTE physical layer entities to the MAU physical layer entities:

Message	Circuit	Signal	Meaning
<i>output</i>	DO	CD1, CD0	Output information
<i>output_idle</i>	DO	IDL	No data to be output
<i>normal</i>	CO	IDL	Assume the nonintrusive state on the trunk coaxial medium
	(Optional Circuit)		
<i>isolate</i>	CO	CS0(BR)	Positively disable the trunk coaxial medium transmitter

8.2.2.2 MAU Physical Layer to DTE Physical Layer. The following messages can be sent by the MAU physical layer entities to the DTE physical layer entities:

Message	Circuit	Signal	Meaning
<i>input</i>	DI	CD1, CD0	Input information
<i>input_idle</i>	DI	IDL	No information to be input
<i>mau_available</i>	CI	IDL	MAU is available for output
<i>signal_quality_error</i>	CI	CS0	Error detected by MAU

8.2.2.2.1 *input* Message. The MAU physical layer sends an *input* message to the DTE physical layer when the MAU has a bit of data to send to the DTE. The physical realization of the *input* message is a CD0 or CD1 sent by the MAU to the DTE on the data in circuit. The MAU sends CD0 if the *input* bit is a zero or CD1 if the *input* bit is a one. No retiming of the CD1 or CD0 signals takes place within the MAU.

8.2.2.2.2 *input_idle* Message. The MAU physical layer sends an *input_idle* message to the DTE physical layer when the MAU does not have data to send to the DTE. The physical realization of the *input_idle* message is the IDL signal sent by the MAU to the DTE on the data in circuit.

8.2.2.2.3 *mau_available* Message. The MAU physical layer sends the *mau_available* message to the DTE physical layer when the MAU is available for output. The *mau_available* message is always sent by a MAU that is always prepared to output data unless the *signal_quality_error* message shall be sent instead. Such a MAU does not require *mau_request* to prepare itself for data output. The physical realization of the *mau_available* message is an IDL signal sent by the MAU to the DTE on the control in circuit.

8.2.2.2.4 *signal_quality_error* Message. The *signal_quality_error* message shall be implemented in the following fashion:

- (1) The *signal_quality_error* message shall not be sent by the MAU if no MAU or only one MAU is transmitting on the trunk coaxial medium in the normal mode.
- (2) If two or more remote MAUs are transmitting on the trunk coaxial medium, but the MAU connected to the local node is not transmitting, then the local MAU shall send the *signal_quality_error* message in every instance when it is possible for it to ascertain that more than one MAU is transmitting on the trunk coaxial medium. The MAU shall make the best determination possible. It is acceptable for the MAU to fail to send the *signal_quality_error* message when it is unable to conclusively determine that more than one MAU is transmitting.

- (3) When the local MAU is transmitting on the trunk coaxial medium, all occurrences of one or more additional MAUs transmitting shall cause the *signal_quality_error* message to be sent by the local MAU to its DTE.
- (4) When the MAU has completed each output frame it shall perform an SQE test sequence, as defined in Figs 8-2 and 8-3.
- (5) When the MAU has inhibited the transmit function it shall send the *signal_quality_error* message in accordance with the jabber function requirements of 8.2.1.5.

The *signal_quality_error* message shall be asserted less than 9 bit cells after the occurrence of the multiple-transmission condition is present at the MDI and shall no longer be asserted within 20 bit cells after the indication of multiple transmissions ceases to be present at the MDI. It is to be noted that an extended delay in the removal of the *signal_quality_error* message may affect adversely the access method performance.

The physical realization of the *signal_quality_error* message is the CS0 signal sent by the MAU to the DTE on the control in circuit.

Note that the MAU is required to assert the *signal_quality_error* message at the appropriate times whenever the MAU is powered and not just when the DTE is providing output data.

8.2.3 MAU State Diagrams. The state diagrams Figs 8-2, 8-3, and 8-4 depict the full set of allowed MAU state functions relative to the control circuits of the DTE-MAU interface for MAUs without conditioning requirements. Messages used in these state diagrams are explained below:

- (1) *positive_disable*. Activates the positive means provided in the MAU transmitter to prevent interference with the trunk coaxial medium.
- (2) *enable_driver*. Activates the path employed during normal operation to cause the MAU transmitter to impress data onto the trunk coaxial medium.
- (3) *disable_driver*. Deactivates the path employed during normal operation to cause the MAU transmitter to impress data onto the trunk coaxial medium.
- (4) *no_collision*. Signifies that the condition of multiple transmitters simultaneously active on the trunk coaxial medium does not exist.
- (5) *collision*. Signifies that the condition of multiple transmitters simultaneously active on the trunk coaxial medium does exist.
- (6) *not_positive_disable*. Deactivates the positive means provided in the MAU transmitter to prevent interference with the trunk coaxial medium.

8.3 MAU-Medium Electrical Characteristics

8.3.1 MAU-to-Coaxial Cable Interface. The following sections describe the interface between the MAU and the coaxial cable. Negative current is defined as current into the MAU (out of the center conductor of the cable).

8.3.1.1 Input Impedance. The shunt capacitance presented to the coaxial cable by the MAU circuitry (not including the means of attachment to the coaxial cable) is recommended to be no greater than 2 pF. The resistance to the coaxial cable shall be greater than 100 k Ω .

The total capacitive load due to MAU circuitry and the mechanical connector as specified in 8.5.3.2 shall be no greater than 4 pF.

These conditions shall be met in the power-off and power-on, not transmitting states (over the frequencies BR/2 to BR).

The magnitude of the reflection from a MAU shall not be more than that produced by a 4 pF capacitance when measured by both a 25 ns rise time and 25 ns fall time waveform. This shall be met in both the power on and power off, not transmitting states.

8.3.1.2 Bias Current. The MAU shall draw (from the cable) between + 2 μ A and - 25 μ A in the power-off and the power-on, not transmitting states.

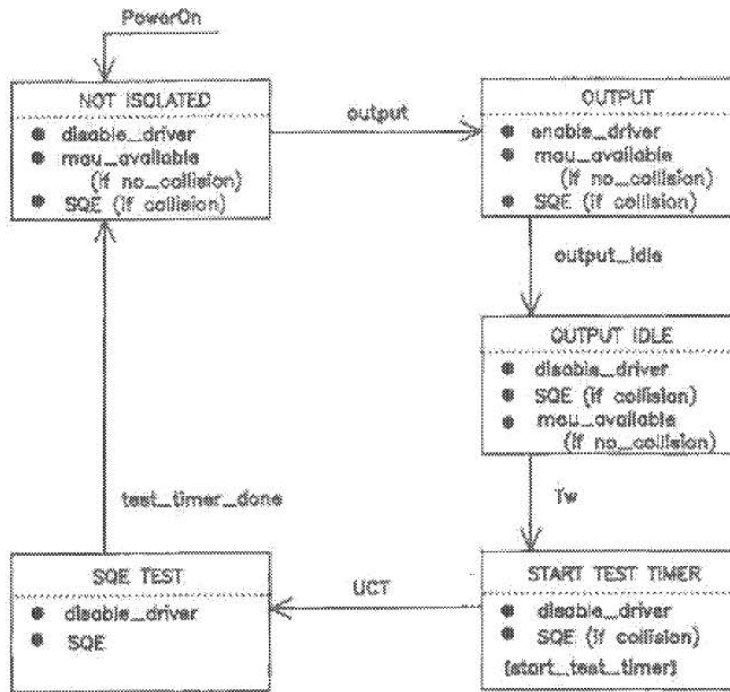

NOTE: UCT = unconditional transition
Tw = wait time, see 8.2.1.1

Fig 8-2
Interface Function: Simple MAU Without Isolate Capability

8.3.1.3 Coaxial Cable Signaling Levels. The signal on the coaxial cable due to a single MAU as measured at the MAU transmitter output is composed of an ac component and an offset component. Expressed in terms of current immediately adjacent to the MAU connection (just prior to splitting the current flow in each direction) the signal has an offset component (direct current including the effects of timing distortion) of from -87 mA minimum to -45 mA maximum and an ac component from +28 mA up to the offset value.

The current drive limit shall be met even in the presence of one other MAU transmitter. A MAU shall be capable of maintaining at least 2.2 V of average dc level on the coaxial cable in the presence of two or more other MAUs transmitting concurrently. The MAU shall, in addition, sink no more than ±250 µA when the voltage on the center conductor of the cable drops to -10 V when the MAU is transmitting.

The MAU shall sink no more than -25 µA when the voltage on the center conductor of the cable drops to -7 V when the MAU is transmitting.

The actual current measured at a given point on the cable is a function of the transmitted current and the cable loss to the point of measurement. Negative current is defined as current out of the center conductor of the cable (into the MAU). The 10-90% rise/fall times shall be 25 ± 5 ns at 10 Mb/s. The rise and fall times shall match within 2 ns. Figures 8-5 and 8-6 shows typical waveforms present on the cable. Harmonic content generated from the BR fundamental periodic input shall meet the following requirements:

- 2nd and 3rd Harmonics: at least 20 dB below fundamental
- 4th and 5th Harmonics: at least 30 dB below fundamental
- 6th and 7th Harmonics: at least 40 dB below fundamental
- All Higher Harmonics: at least 50 dB below fundamental

NOTE: Even harmonics are typically much lower.

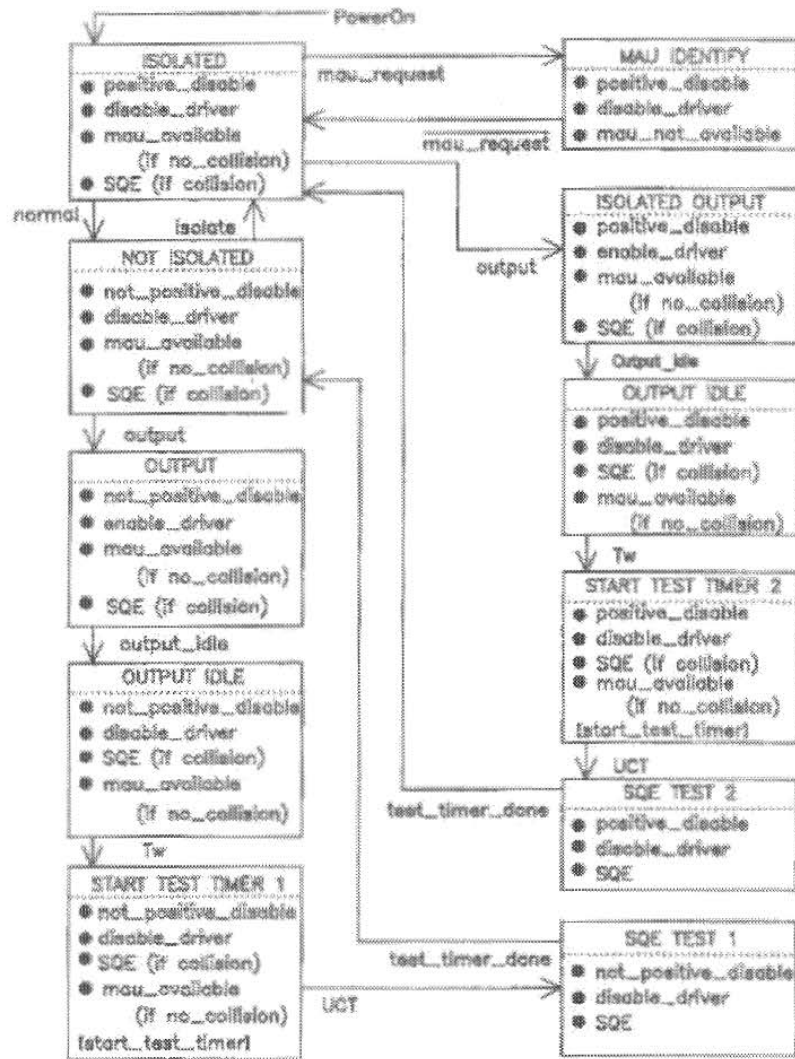

NOTE: UCT = unconditional transition
Tw = wait time, see 8.2.1.1

Fig 8-3
Interface Function: Simple MAU with Isolate Capability

The above specifications concerning harmonics cannot be satisfied by a square-wave with a single-pole filter, nor can they be satisfied by an output waveform generator employing linear ramps without additional waveshaping. The signals as generated from the encoder within PLS shall appear on the coaxial cable without any inversions (see Fig 8-6).

8.3.1.4 Transmit Output Levels Symmetry. Signals received from the AUI DO circuit shall be transmitted onto the coaxial cable with the characteristics specified in 8.3.1.3. Since the coaxial cable proceeds in two directions from the MAU, the current into the MAU is nominally twice the current measured on the coaxial cable.

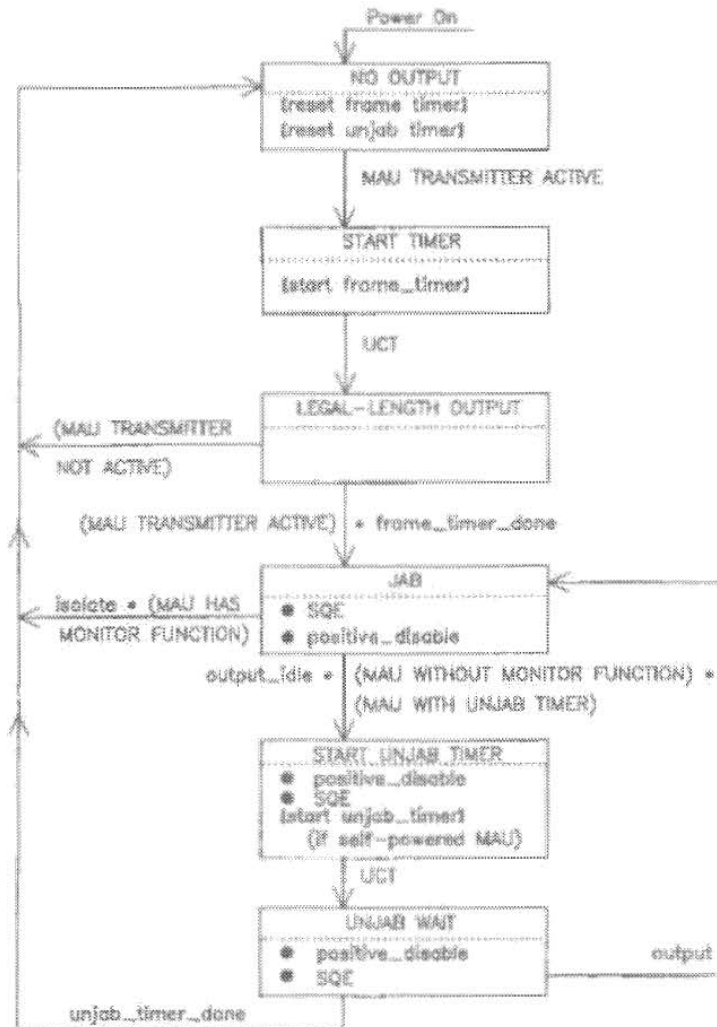

Fig 8-4
Jabber Function

The output signal of a MAU meeting this specification shall exhibit edge jitter of no more than 2.5 ns into a $35 \Omega \pm 1\%$ resistor substituted for the connection to the coaxial cable when the DO circuit into the MAU is driven through a zero length AUI cable with pseudorandom Manchester encoded binary data from a data generator that exhibits no more than 0.5 ns of edge jitter on half bit cells of exactly 1/2 BT whose output meets the specifications of 7.4.1.1 through 7.4.1.5. The above specified component is not to introduce more than 2 ns of edge jitter into the system.

The MAU shall not transmit a negative going edge after cessation of the CD output data stream on DO or before the first edge of the next frame on the DO circuit.

8.3.1.5 Receive Collision Detect Threshold. It is recommended that the MAU implement the collision detect function with a -1.492 V to -1.629 V threshold range corresponding to the recommended tolerances for coax drive currents specified in 8.3.1.3. The threshold voltage is measured on the coax at the MAU connector.

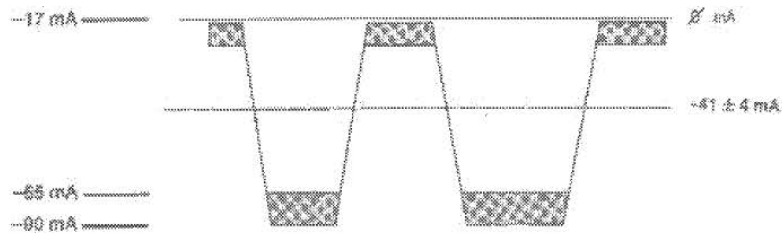
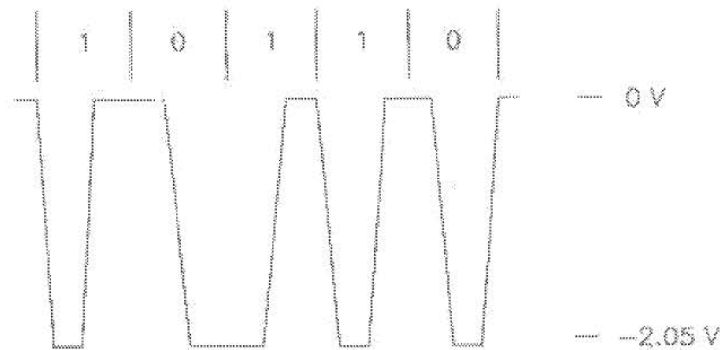

Fig 8-5
Recommended Driver Current Signal Levels



NOTES: (1) Voltages given are nominal, for a single transmitter
(2) Rise and fall time is 25 ns nominal at 10 Mb/s rate
(3) Voltages are measured on terminated coaxial cable adjacent to transmitting MAU
(4) Manchester coding

Fig 8-6
Typical Coaxial Trunk Cable Signal Waveform

Collision detection threshold voltages tighter than those recommended above may be used to improve collision detection performance in the presence of noise on the coax, poor system component tolerances, and coaxial transmit levels outside of the recommended range.

A MAU that implements the recommended receive threshold shall be considered to have implemented receive mode collision detect. Receive mode collision detect indicates that a nontransmitting MAU has the capability to detect collisions when two or more MAUs are transmitting simultaneously. Repeater units require both MAUs directly connected to it to implement receive mode collision detection.³

8.3.2 MAU Electrical Characteristics

8.3.2.1 Electrical Isolation. The MAU must provide isolation between the AUI cable and the coaxial trunk cable. The isolation impedance measured between each conductor (including shield) of the AUI cable and either the center conductor or shield of the coaxial cable shall be greater than 250 k Ω at 60 Hz and not greater than 15 Ω between 3 MHz and 30 MHz. The breakdown of the isolation means provided shall be at least 250 V ac, rms. See references [A7], [A8], and [A9].

³Repeater networks may require all MAU components to use the recommended coaxial drive compact levels. This matter is under reconsideration.

8.3.2.2 Power Consumption. The current drawn by the MAU shall not exceed 0.5 A as powered by the AUI source. The MAU shall be capable of operating from all possible voltage sources as supplied by the DTE through the resistance of all permissible AUI cables. The MAU shall not disrupt the trunk coaxial medium should the DTE power source fall below the minimum operational level under abnormal MAU load conditions.

The MAU shall be labeled externally to identify the maximum value of current required by the device at any specified input voltage.

8.3.2.3 Reliability. The MAU shall be designed to provide an MTBF of at least 1 million hours of continuous operation without causing communication failure among other stations attached to the local network medium. Component failures within the MAU electronics should not prevent communication among other MAUs on the coaxial cable. Connectors and other passive components comprising the means of connecting the MAU to the coaxial cable shall be designed to minimize the probability of total network failure.

It should be noted that a fault condition that causes a MAU to draw in excess of 2 mA may cause communication failure among other stations.

8.3.3 MAU-DTE Electrical Characteristics. The electrical characteristics for the driver and receiver components connected to the branch cable within the MAU shall be identical to those as specified in Section 7 of this standard.

8.3.4 MAU-DTE Mechanical Connection. The MAU shall be provided with a 15-pin male connector as specified in detail in the AUI specification, Section 7.

8.4 Characteristics of the Coaxial Cable. The trunk cable is of constant impedance, coaxial construction. It is terminated at each end by a terminator (see 8.5.2), and provides the transmission path for MAU device connection. Coaxial cable connectors are used to make the connection from the cable to the terminators, and between cable sections (if needed). The cable has various electrical and mechanical requirements that shall be met to ensure proper operation.

8.4.1 Coaxial Cable Electrical Parameters

8.4.1.1 Characteristic Impedance. The average characteristic cable impedance shall be $50 \pm 2 \Omega$, measured according to IEC Publications 96-1 [2] and 96-1A [3]. Periodic variations in impedance along a single piece of cable may be up to $\pm 3 \Omega$ sinusoidal centered around the average value, with a period of less than 2 m.

NOTE: If the requirements of 8.4.2.1.1 (2), 8.4.2.1.2, 8.4.2.1.3, 8.4.2.1.4 (2) are met, then it is expected that the characteristic impedance periodicity requirement shall be considered met.

8.4.1.2 Attenuation. The attenuation of a 500 m (1640 ft) cable segment shall not exceed 8.5 dB (17 dB/km) measured with a 10 MHz sine wave, nor 6.0 dB (12 dB/km) measured with a 5 MHz sine wave.

8.4.1.3 Velocity of Propagation. The minimum required velocity of propagation is 0.77 c.

8.4.1.4 Edge Jitter, Untapped Cable. Untapped coaxial cable meeting this specification shall exhibit edge jitter of no more than 8.0 ns in either direction at the receiving end when 500 m of the cable is terminated at both ends with terminators meeting the impedance requirements of 8.5.2.1 and is driven at one end with pseudorandom Manchester encoded binary data from a data generator that exhibits no more than 1.0 ns of edge jitter in either direction on half bit cells of exactly 1/2 BT and whose output meets the specifications of 8.3.1.3 except that the rise time of the signal must be $30 \text{ ns} + 0, - 2 \text{ ns}$, and no offset component in the output current is required. This test shall be conducted in a noise-free environment. The above specified component is not to introduce more than 7 ns of edge jitter into the system.

8.4.1.5 Transfer Impedance. The coaxial cable medium shall provide sufficient shielding capability to minimize its susceptibility to external noise and also to minimize the generation of interference by the medium and related signals. While the cable construction is not mandated, it is necessary to indicate a measure of performance expected from the cable component. A cable's EMC performance is determined, to a large extent, by the transfer impedance value of the cable. See reference [A12].

The transfer impedance of the cable shall not exceed the values shown in Fig 8-7 as a function of frequency.

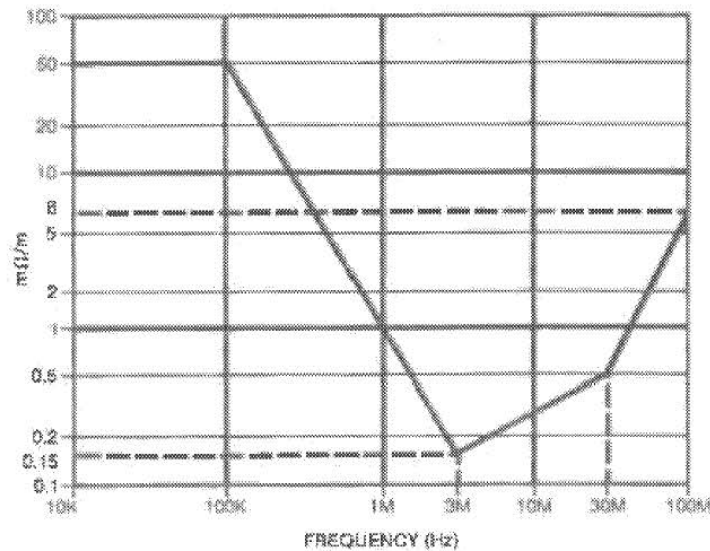

Fig 8-7
Maximum Coaxial Cable Transfer Impedance

8.4.1.6 Cable DC Loop Resistance. The sum of the center conductor resistance plus the shield resistance, measured at 20 °C, shall not exceed 10 mΩ/m.

8.4.2 Coaxial Cable Properties

8.4.2.1 Mechanical Requirements. The cable used should be suitable for routing in various environments, including but not limited to, dropped ceilings, raised floors, cable troughs, and throughout open floor space. The jacket shall provide insulation between the cable sheath and any building structural metal. Also, the cable shall be capable of accepting coaxial cable connectors, described in 8.5. The cable shall conform to the following requirements.

8.4.2.1.1 General Construction

- (1) The coaxial cable shall consist of a center conductor, dielectric, shield system, and overall insulating jacket.
- (2) The concentricity (for example, positional relationship between center conductor to shield system and outer jacket) of the coaxial cable elements shall be greater than 92% as measured in accordance with the following general configuration:

$$\frac{(\text{jacket radius}) - (\text{center offset})}{\text{jacket radius}} \times 100 \geq 92\%$$

It is assumed that the offset and radius values are worst case at any point within the measured system.

- (3) The coaxial cable jacket, shield system, and dielectric material shall be pierceable either by means of the connector type specified in 8.5.3.2 or by an external core tool. Overall cable system pierceability (the ability of a tap probe to pierce the jacket, shields, and dielectric cable system without

substantial dielectric deformation and without causing a short circuit between center conductor and shield system) is a vital parameter affecting tap connection reliability.

Pierceability of the cable system can be measured in terms of the probe's load versus displacement signature. A pierceable cable exists where the displacement is ≥ 1.52 mm (0.06 in) between rupture (piercing) of the shield system and contact with the center conductor.

- (4) The coaxial cable shall be sufficiently flexible to support a bend radius of 254 mm (10 in).

8.4.2.1.2 Center Conductor. The center conductor shall be 2.17 mm \pm 0.013 mm (0.0855 ± 0.0005 in) diameter solid copper.

8.4.2.1.3 Dielectric Material. The dielectric may be of any type provided the conditions of 8.4.1.2, 8.4.1.3, and 8.4.2.1.1(3) are met.

8.4.2.1.4 Shielding System

- (1) The shielding system may contain both braid and foil elements sufficient to meet the transfer impedance of 8.4.1.5 and the EMC specifications of 8.7.2.
- (2) The inside diameter of the innermost shield shall be 6.15 mm (0.242 in) minimum.
- (3) The outside diameter of the outermost shield shall be 8.28 mm \pm 0.178 mm (0.326 ± 0.007 in).
- (4) The outermost shield shall be greater than 90% coverage. The use of tinned copper braid is advised to meet the contact resistance requirements.

8.4.2.1.5 Overall Jacket

- (1) Any one of several jacket materials shall be used provided the specifications of 8.4.1 and 8.4.2 are met.
- (2) Either of two jacket dimensions may be used for the two broad classes of materials, provided the specification of 8.4.2.1.1 are met:
 - (a) Polyvinyl Chloride (for example, PVC) or equivalent having an OD of 10.287 mm \pm 0.178 mm (0.405 nominal \pm 0.007 in).
 - (b) Fluoropolymer (for example, FEP, E-CTFE) or equivalent having an OD of 9.525 mm \pm 0.254 mm (0.375 nominal \pm 0.010 in).

The cable shall meet applicable flammability and smoke criteria and local and national codes for the installed environment. See 8.7.4. Different types of cable sections (for example, polyvinyl chloride and fluoropolymer dielectric) may be interconnected, while meeting the sectioning requirements of 8.6. See references [A6] and [A14].

8.4.2.2 Jacket Marking. The cable jacket shall be marked with annular rings in a color contrasting with the background color of the jacket. The rings shall be spaced at 2.5 m \pm 5 cm regularly along the entire length of the cable. It is permissible for the 2.5 m spacing to be interrupted at discontinuities between cable sections joined by connectors. (See 8.6.2.2 for MAU placement rules that mandate cable markings.) It is recommended that the base color of the cable jacket itself be a bright color (for example, yellow) other than that normally used for power mains.

8.4.3 Total Segment DC Loop Resistance. The sum of the center conductor, connectors, and shield resistance shall not exceed 5Ω total per segment.

Each in-line connector pair or MAU shall be no more than 10 m Ω . Use of these components reduces the overall allowable segment length accordingly. Values given above are at 20°C . For temperature variations, cable length shall be adjusted accordingly such that the 5Ω total is not exceeded.

If a trunk coaxial cable segment consists of several cable sections, then all connectors and internal resistance of the shield and center conductor shall be included in the loop resistance measurement.

8.5 Coaxial Trunk Cable Connectors. The trunk coaxial medium requires termination and may be extended or partitioned into sections. Devices to be attached to the medium as MAUs require a means of connection to the medium. Two basic connector types provide the necessary connection means:

- (1) Standard Type N connectors (IEC Publication 169-16 [4])
- (2) A coaxial "tap" connector

All Type N connectors shall be of the 50 Ω constant impedance type. Since the frequencies present in the transmitted data are well below UHF range (being band-limited to approximately 20 MHz), high-quality versions of the connectors are not required (but are recommended).

All of the coaxial tap connectors shall follow the requirements as defined in 8.5.3.

8.5.1 Inline Coaxial Extension Connector. All coaxial cables shall be terminated with the Type N plug connectors. A means shall be provided to ensure that the connector shell (which connects to the cable sheath) does not make contact with any building metal or other unintended conductor. An insulating sleeve or boot slipped over the connector at installation time is suitable.

Inline coaxial extensions between two sections of coaxial cable shall be made with a pair of Type N receptacle connectors joined together to form one "barrel." An insulating sleeve or boot shall also be provided with each barrel assembly.

8.5.2 Coaxial Cable Terminator

8.5.2.1 Termination. Coaxial cable terminators are used to provide a termination impedance for the cable equal in value to its characteristic impedance, thereby minimizing reflection from the ends of the cables. Terminators shall be packaged within an inline female receptacle connector. The termination impedance shall be 50 $\Omega \pm 1\%$ measured from 0 – 20 MHz, with the magnitude of the phase angle of the impedance not to exceed 5°. The terminator power rating shall be 1 W or greater.

8.5.2.2 Earthing. Either the coaxial cable terminator or inline extension connector provides a convenient location for meeting the earth grounding requirement of 8.6.2.3. It is recommended that a ground lug with current rating of at least 1500 ampacity be provided on one of the two terminators or on one extension connector used within a cable segment.

NOTES: (1) A single ground return lug on an inline connector located in the center of the cable transmission system may be used to satisfy this requirement.

(2) Alternatively, termination might be supplied in pairs, one with and one without the ground lug connection point.

8.5.3 MAU-to-Coaxial Cable Connection. A means shall be provided to allow for attaching a MAU to the coaxial cable. The connection shall not disturb the transmission line characteristics of the cable significantly; it shall present a predictably low shunt capacitance, and therefore a negligibly short stub length. This is facilitated by the MAU being located as close to its cable connection as possible; the MAU and connector are normally considered to be one assembly. Long (greater than 30 mm) connections between the coaxial cable and the input of the MAU jeopardize this objective.

Overall system performance is dependent largely on the MAU-to-coaxial cable connection being of low shunt capacitance.

If the design of the connection is such that the coaxial cable is to be severed to install the MAU, the coaxial cable segment shall still meet the sectioning requirements of 8.6.2.1. Coaxial connectors used on a severed cable shall be type N, as specified in 8.5.1.

The type N connectors selected should be of high quality (that is, low contact resistance) to minimize the impact on system performance.

If the design of the connection is such that the piercing tap connector is to be used without severing the cable, then the tap connector and cable assembly shall conform to the mechanical and electrical requirements as defined throughout 8.5.3.1 and 8.5.3.2.

8.5.3.1 Electrical Requirements. Requirements for the coaxial tap connector are as follows:

- (1) Capacitance: 2 pF nominal connector loading measured at 10 MHz.

NOTE: Total capacitance of tap and active circuitry connected directly shall be no greater than 4 pF. Specific implementations may allocate capacitance between tap and circuitry as deemed appropriate.

- (2) Contact resistance (applies to center conductor and shield contacts): 50 m Ω maximum for both shield and center conductor over useful connector lifetime.

- (3) Contact material: surface material on signal probe or shield sufficient to meet contact resistance requirements in environment and over time.
- (4) Voltage rating: 600 V dc or ac rms maximum.
- (5) Insulation: dc leakage resistance of tap housing shall be higher than 1 GΩ between braid and external conductors in the normal operating environment.
- (6) Probe current rating: 0.1 A per contact (probe and shield)
- (7) Shield current rating: 1 A surge for 1 s

8.5.3.2 Mechanical Requirements

8.5.3.2.1 Connector Housing. Shielding characteristics: > 40 dB at 50 MHz.

8.5.3.2.2 Contact Reliability. Overall performance of the LAN system depends to a large extent on the reliability of the coaxial cable medium and the connection to that medium. Tap connection systems should consider the relevant electrical and mechanical parameters at the point of electrical connection between tap probe and cable center conductor to ensure that a reliable electrical contact is made and retained throughout the useful life of these components. It is recommended that some means be provided to ensure relatively constant contact loading over time, with creep, in temperature, and typical environment. Typical coaxial tap connector configurations are shown in Figs 8-8 and 8-9. See references [A1], [A15], and [A16].

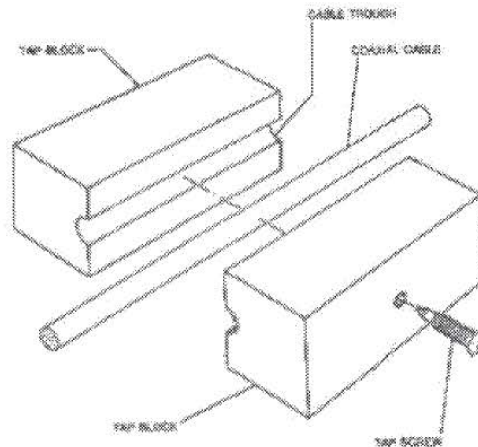

NOTE: Tutorial only and not part of specification.

Fig 8-8
Coaxial Tap Connector Configuration Concepts

8.5.3.2.3 Shield Probe Characteristics. The shield probe shall penetrate the cable jacket and outer layer(s) of the shield system to make effective capture of the outer braid (pick 2 or more typical strands).

8.6 System Considerations

8.6.1 Transmission System Model. Certain physical limits have been placed on the physical transmission system. These revolve around maximum cable lengths (or maximum propagation times), as these affect critical time values for the CSMA/CD access method. These maxima, in terms of propagation times, were derived from the physical configuration model described here. The maximum configuration is as follows:

- (1) A trunk coaxial cable, terminated in its characteristic impedance at each end, constitutes a coaxial segment. A coaxial segment may contain a maximum of 500 m of coaxial cable and a maximum of

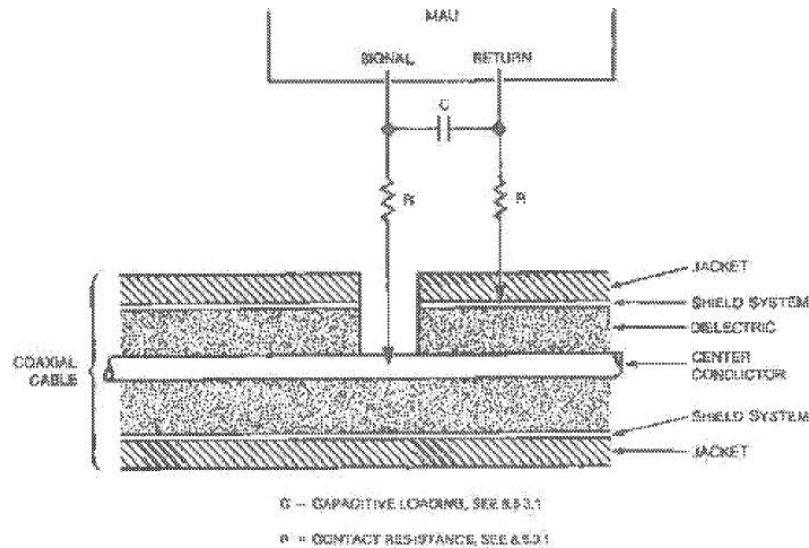

Fig 8-9
Typical Coaxial Tap Connection Circuit.

- 100 MAUs. The propagation velocity of the coaxial cable is assumed to be 0.77 c minimum ($c = 300\,000$ km/s). The maximum end-to-end propagation delay for a coaxial segment is 2185 ns.
- (2) A point-to-point link constitutes a link segment. A link segment may contain a maximum end-to-end propagation delay of 2570 ns.
 - (3) Repeater sets are required for segment interconnection. Repeater sets occupy MAU positions on coaxial segments and count toward the maximum number of MAUs on a coaxial segment. Repeater sets may be located in any MAU position on a coaxial segment but shall only be located at the ends of a link segment.
 - (4) The maximum length, between driver and receivers, of an AUI cable is 50 m. The propagation velocity of the AUI cable is assumed to be 0.65 c minimum. The maximum allowable end-to-end delay for the AUI cable is 257 ns.
 - (5) The maximum transmission path permitted between any two stations is five segments, four repeater sets (including optional AUIs), two MAUs, and two AUIs. Of the five segments a maximum of three may be coaxial segments; the remainder are link segments.

NOTE: If only two link segments are used in the entire network and they are adjacent, the repeater set joining them is not required (see Fig 8-10). End-to-end jitter, propagation delay, and attenuation requirements shall still be met.

The maximum transmission path consists of 6 segments, 4 repeater sets (with AUIs), 2 MAUs, and 2 AUIs (see Fig 8-10). The total number of segments equals the number of link segments plus the number of coaxial segments. If there are two link segments on the transmission path, there may be a maximum of three coaxial segments on that path. If there are no link segments on a transmission path, there may be a maximum of three coaxial segments on that path given current repeater technology.

Figures 8-11, 8-12, 8-13, and 8-14 show transmission systems of various sizes to illustrate the boundary conditions on topologies generated according to the specifications in this section.

8.6.2 Transmission System Requirements

8.6.2.1 Cable Sectioning. The 500 m (1640 ft) maximum length coaxial cable segment need not be made from a single, homogeneous length of cable. The boundary between two cable sections (joined by coaxial connectors: two male plugs and a barrel) represents a signal reflection point due to the impedance discontinuity caused by the batch-to-batch impedance tolerance of the cable. Since the worst-case variation from 50 Ω is 2 Ω , a possible worst-case reflection of 4% may result from the joining of two cable sections.

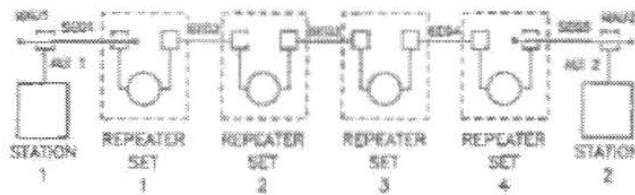

Fig 8-10
Maximum Transmission Path

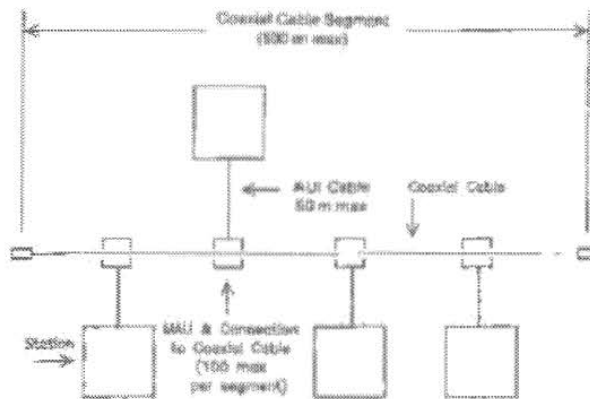

Fig 8-11
Minimal System Configuration

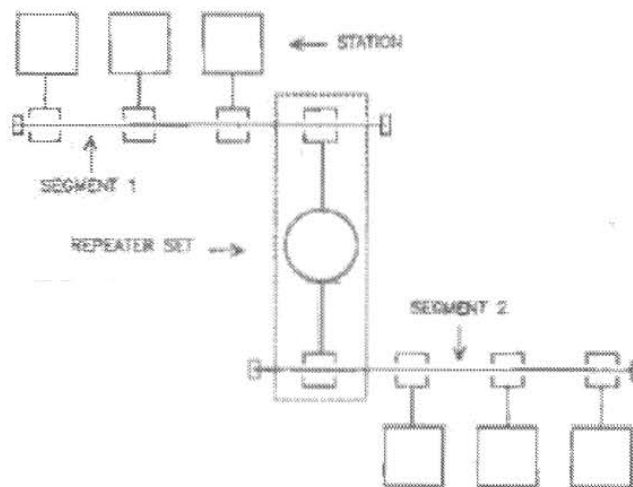

Fig 8-12
Minimal System Configuration Requiring a Repeater Set

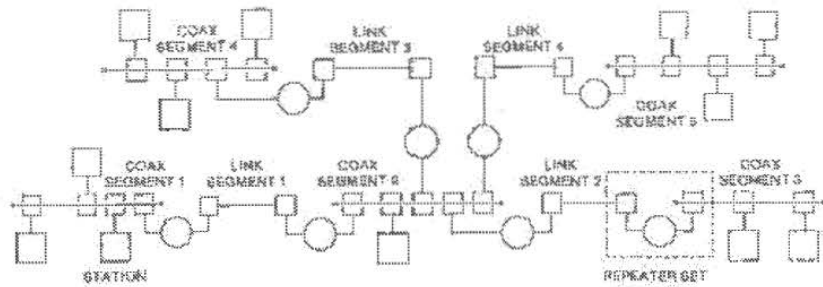

Fig 8-13
An Example of a Large System with Maximum Transmission Paths

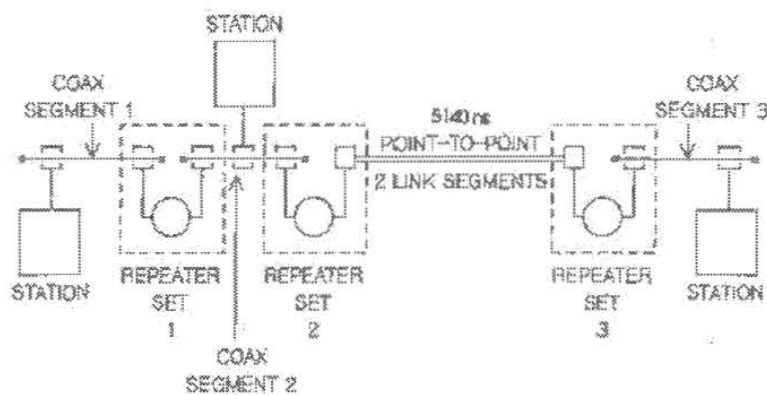

Fig 8-14
An Example of a Large Point-to-Point Link System (5140 ns)

The configuration of long cable segments (up to 500 m) from smaller sections must be made with care. The following *recommendations* apply, and are given *in order of preference*:

- (1) If possible, the total segment should be made from one homogeneous (no breaks) cable. This is feasible for short segments, and results in minimal reflections from cable impedance discontinuities.
- (2) If cable segments are built up from smaller sections, it is recommended that all sections come from the same manufacturer and lot. This is equivalent to using a single cable, since the cable discontinuities are due to extruder limitations, and not extruder-to-extruder tolerances. There are no restrictions in cable sectioning if this method is used. However, if a cable section in such a system is later replaced, it shall be replaced either with another cable from the same manufacturer and lot, or with one of the standard lengths described below.
- (3) If uncontrolled cable sections must be used in building up a longer segment, the lengths should be chosen so that reflections, when they occur, do not have a high probability of adding in phase. This can be accomplished by using lengths that are odd integral multiples of a half wavelength in the cable at 5 MHz; this corresponds to using lengths of 23.4 m, 70.2 m, and 117 m (± 0.5 m) for all sections. These are considered to be the standard lengths for all cable sections. Using these lengths exclusively, any mix or match of cable sections may be used to build up a 500 m segment without incurring excessive reflections.

NOTE: If cable segments are to be added to existing installations, then care shall be taken (explicit physical or TDR measurements) to ensure that no more than a 500 m cable segment results.

- (4) As a last resort, an arbitrary configuration of cable sections may be employed, if it has been confirmed by analysis or measurement that the worst-case signal reflection due to the impedance discontinuities at any point on the cable does not exceed 7% of the incident wave when driven by a MAU meeting these specifications.

8.6.2.2 MAU Placement. MAU components and their associated connections to the cable cause signal reflections due to their noninfinite bridging impedance. While this impedance shall be implemented as specified in Section 7, placement of MAUs along the coaxial cable must also be controlled to ensure that reflections from the MAU do not add in phase to a significant degree.

Coaxial cables marked as specified in 8.4.2.2 have marks at regular 2.5 m spacing; a MAU shall only be placed at a mark on the cable. This guarantees both a minimum spacing between MAUs of 2.5 m, and controlling the relative spacing of MAUs to ensure nonalignment on fractional wavelength boundaries.

The total number of MAUs on a cable segment shall not exceed 100.

8.6.2.3 Trunk Cable System Grounding. The *shield conductor* of each coaxial cable segment shall make electrical contact with an effective earth reference (see Annex) at one point and shall not make electrical contact with earth elsewhere on such objects as building structural metal, ducting, plumbing fixture, or other unintended conductor. Insulators may be used to cover any coaxial connectors used to join cable sections and terminators, to ensure that this requirement is met. A sleeve or boot attached at installation time is acceptable.

This specification is intended for use within (intraplant) buildings. Applications requiring interplant connections by way of external (outdoors) means may require special consideration beyond the scope of the standard.

The sheath conductor of the AUI cable shall be connected to the earth reference or chassis of the DTE.

8.6.3 Labeling. It is recommended that each MAU (and supporting documentation) be labeled in a manner visible to the user with at least these parameters:

- (1) Data rate capability in Mb/s
- (2) Power level in terms of maximum current drain
- (3) Safety warning (for example, shock hazard)

8.7 Environmental Specifications

8.7.1 General Safety Requirements. All stations meeting this standard shall conform to one of the following IEC Publications: 380 [5], 435 [6], or 950 [8].

NOTE: For ISO/IEC 8802-3:1993, conformance shall be to IEC 950 [8].

8.7.2 Network Safety Requirements. This section sets forth a number of recommendations and guidelines related to safety concerns, the list is neither complete nor does it address all possible safety issues. The designer is urged to consult the relevant local, national, and international safety regulations to ensure compliance with the appropriate standards. References [A5] and [A9] provide additional guidance.

Local area network trunk cable systems as described in this standard are subject to at least four direct electrical safety hazards during their use. These hazards are

- (1) Direct contact between local network components and power or lighting circuits.
- (2) Static charge buildup on local network cables and components.
- (3) High-energy transients coupled onto the local network cabling system.
- (4) Potential differences between safety grounds to which various network components are connected.

These electrical safety hazards, to which all similar cabling systems are subject, should be alleviated properly for a local network to perform properly. In addition to provisions for properly handling these faults in an operational system, special measures must be taken to ensure that the intended safety features are not negated during installation of a new network or during modification of an existing network.

Proper implementation of the following provisions will greatly decrease the likelihood of shock hazards to persons installing and operating the local area network.

8.7.2.1 Installations. Sound installation practice, as defined by applicable local codes and regulations, shall be followed in every instance in which such practice is applicable.

8.7.2.2 Grounding. The shield of the trunk coaxial cable shall be effectively grounded at only one point along the length of the cable. Effectively grounded means permanently connected to earth through a ground connection of sufficiently low impedance and having sufficient ampacity to prevent the building up of voltages that may result in undue hazard to connected equipment or to persons.

8.7.2.3 Safety. All portions of the trunk cabling system that are at the same potential as the trunk cable shall be insulated by adequate means to prevent their contact by either persons or by unintended conductors or grounds. The insulation employed shall provide the same or greater dielectric resistance to current flow as the insulation required between the outermost shield of the trunk cable and the above-mentioned unintended conductors. The use of insulating boots is permitted, provided that such boots (or sleeves) are mechanically and electrically equivalent to the trunk cable outer insulation characteristics and are not removed easily (that is, they shall prevent inadvertent removal by a system operator).

The MAU shall be so designed that the provisions of 8.7.2.3 and 8.7.2.4 are not defeated if the connector affixing the AUI cable to the MAU is removed.

Portions of the trunk cabling system that may become live during the dissipation of a high-energy transient by the cabling system shall also be insulated as described in 8.7.2.3.

8.7.2.4 Breakdown Path. MAUs meeting this standard should provide a controlled breakdown path that will shunt high-energy transients to an effective ground either through a separate safety ground connection or through the overall shield of the branch cable. The breakdown voltage of this controlled breakdown path must meet the isolation requirements for the MAU specified in 8.3.2.1.

8.7.2.5 Isolation Boundary. The isolation boundary between the branch cable and trunk cable specified in 8.3.2.1 shall be maintained to properly meet the safety requirements of this standard.

WARNING: It is assumed that the DTE equipment is properly earthed and not left floating or serviced by "doubly insulated ac power distribution system." The use of floating or insulated DTEs is beyond the scope of this standard.

8.7.2.6 Installation and Maintenance Guidelines

- (1) When exposing the shield of the trunk coaxial cable for any reason, care shall be exercised to ensure that the shield does not make electrical contact with any unintended conductors or grounds. Personnel performing the operation should not do so if dissipation of a high energy transient by the cabling system is likely during the time the shield is to be exposed. Personnel should not contact both the shield and any grounded conductor at any time.
- (2) Before breaking the trunk coaxial cable for any reason, a strap with ampacity equal to that of the shield of the coaxial cable shall be affixed to the cable shield in such a manner as to join the two pieces and to maintain continuity when the shield of the trunk cable is severed. This strap shall not be removed until after normal shield continuity has been restored.
- (3) At no time should the shield of any portion of the coaxial trunk cable to which an MAU or MAUs are attached be permitted to float without an effective ground connection. If a section of floating cable is to be added to an existing cable system, the installer shall take care not to complete the circuit between the shield of the floating cable section and the grounded cable section through body contact.
- (4) The installation instructions for network components shall contain language which familiarizes the installer with the cautions mentioned in the above paragraphs.
- (5) Network components shall contain prominent warning labels that refer installers and service personnel to the safety notes in the installation instructions.

8.7.3 Electromagnetic Environment

8.7.3.1 Susceptibility Levels. Sources of interference from the environment include electromagnetic fields, electrostatic discharge, transient voltages between earth connections, and similar interference. Mul-

multiple sources of interference may contribute to voltage buildup between the coaxial cable and the earth connection of a DTE.

The physical channel hardware shall meet its specifications when operating in either of the following conditions:

- (1) Ambient plane wave field of 2 V/m from 10 kHz through 30 MHz, 5 V/m from 30 MHz through 1 GHz.

NOTE: Levels typically 1 km from broadcast stations.

- (2) Interference voltage of 1 V/ns peak slope, between coaxial cable shield and DTE earth connection; for example, 15.8 V peak for a 10 MHz sine wave with a 50 Ω source resistance.

MAUs meeting this standard should provide adequate rf ground return to satisfy the referenced EMC specifications.

8.7.3.2 Emission Levels. The physical MAU and trunk cable system shall comply with applicable local and national codes such as FCC Docket 20780-1980 [A11] in the USA. Equipment shall comply with local and national requirements for limitation of electromagnetic interference. Where no local or national requirements exist, equipment shall comply with CISPR Publication 22 [1].

8.7.4 Temperature and Humidity. The MAU and associated connector/cable systems are expected to operate over a reasonable range of environmental conditions related to temperature, humidity, and physical handling such as shock and vibration. Specific requirements and values for these parameters are considered to be beyond the scope of this standard. Manufacturers are requested to indicate in the literature associated with the MAU (and on the MAU if possible) the operating environment specifications to facilitate selection, installation, and maintenance of these components. See reference [A10] for specification terminology.

8.7.5 Regulatory Requirements. The design of MAU and medium components should take into consideration applicable local or national requirements. See references [A5], [A6], [A7], [A8], [A9], and [A11] and Appendix A for helpful resource material.¹⁰

¹⁰Appendix A provides useful system guidelines on delays and bit budgets.

9. Repeater Unit for 10 Mb/s Baseband Networks

9.1 Overview. This section specifies a repeater for use with type 10BASE5, 10BASE2, and 10BASE-T networks and fiber optic inter-repeater links (FOIRLs). A repeater for any other ISO 8802-3 network type is beyond the scope of this section.

A repeater set connects segments of network medium together, thus allowing larger topologies and a larger MAU base than are allowed by rules governing individual segments (that is, for 10BASE5, 500 m and 100 stations; for 10BASE2, 185 m and 30 stations; for 10BASE-T, nominal 100 m link segment).

Repeater sets are used to extend the network length and topology beyond what could be achieved by a single coaxial segment, as defined in 8.6 or 10.7. Segments may be connected directly by a repeater set (Fig 9-1) or by pairs of repeater units which are, in turn, connected by inter-repeater links (IRLs). Allowable topologies shall contain only one operative signal path between any two points on the network. A maximum of four repeater sets may be in the signal path between any two stations on the network (this assumes two link segments).

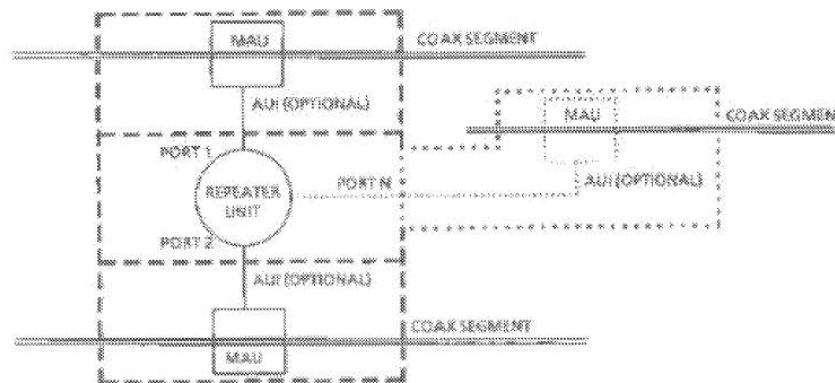

NOTE: The AUI is not necessarily exposed when the MAU is, optionally, part of the physical repeater.

Fig 9-1
Repeater Set, Coax-to-Coax Configuration

If the repeater set uses MAUs connected via AUIs to a repeater unit, the external MAUs shall be basic MAUs with the exception of the *signal_quality_error* test function. A manufacturer may, optionally, integrate one or all MAUs into a single package with the repeater unit (internal MAUs). In all cases, the MAU portion of the repeater set must be counted toward the maximum number of MAUs on each segment, as specified in 8.6 and 10.7. A repeater set is not a station and does not count toward the overall limit of 1024 stations on a network.

A repeater set can receive and decode data from any segment under worst-case noise, timing, and signal amplitude conditions. It retransmits the data to all other segments attached to it with timing and amplitude restored. The retransmission of data occurs simultaneously with reception. If a collision occurs, the repeater set propagates the collision event throughout the network by transmitting a Jam signal.

9.2 Definitions

data frame. Consists of the Destination Address, Source Address, Length Field, LLC Data, Pwd, and Frame Check Sequence.

Fiber Optic Medium Attachment Unit (FOMAU). The portion of the physical layer between the FOMDI and AUI (or repeater unit physical layer signaling [PLS] when the AUI is not implemented) which contains the electronics that transmit, receive, and manage the encoded signals impressed on, and recovered from, the optical fiber cable link segment.

Fiber Optic Medium-Dependent Interface (FOMDI). The mechanical and optical interface between the optical fiber cable link segment and the FOMAU.

Fiber Optic Physical Medium Attachment (FOPMA). The portion of the FOMAU that contains the functional circuitry.

FOIRL BER. Mean bit error rate of the FOIRL.

FOIRL Collision. Simultaneous transmission and reception of data in a FOMAU.

FOIRL Compatibility Interfaces. The FOMDI and the AUI (optional); the two points at which hardware compatibility is defined to allow connection of independently designed and manufactured components to the baseband optical fiber cable link segment.

FOMAU's Transmit Optical Fiber. The optical fiber into which the local FOMAU transmits signals.

FOMAU's Receive Optical Fiber. The optical fiber from which the local FOMAU receives signals.

IRL (Inter-Repeater Link). A mechanism for interconnecting two and only two repeater units.

link segment. The point-to-point full duplex medium connection between two and only two Medium-Dependent Interfaces (MDIs).

optical fiber. A filament-shaped optical waveguide made of dielectric materials.

Optical Fiber Cable Interface. See FOMDI.

Optical Fiber Cable Link Segment. A length of optical fiber cable that contains two optical fibers, as specified in 9.9.5.1, and is comprised of one or more optical fiber cable sections and their means of interconnection, with each optical fiber terminated at each end in the optical connector plug specified in 9.9.5.2.

Optical Idle Signal. The signal transmitted by the FOMAU into its transmit optical fiber during the idle state of the DO circuit.

Packet. Consists of a data frame as defined previously, preceded by the Preamble and the Start Frame Delimiter.

port. A segment or IRL interface of a repeater unit.

repeater unit. The portion of a repeater set that is inboard of its PMA/PLS interfaces.

repeater set. A repeater unit plus its associated MAUs and, if present, AU Interfaces (AUIs).

9.9 References. See 1.3.

9.4 Compatibility Interface. The repeater shall attach to its network segments by any of the means specified below.

9.4.1 AUI Compatibility. The repeater unit shall be compatible at its AUI connector (if so equipped) as specified in Section 7 with the exception of the *signal_quality_error* message Test, 7.2.1.2.3, which shall not be implemented.

The MAUs associated with the repeater shall be as specified in Section 8 for type 10BASE5 or Section 10 for type 10BASE2 with the following restrictions:

- (1) The MAU shall implement receive mode collision detect as defined in 8.3.1.5 or 10.4.1.5.
- (2) The MAU shall not implement the *signal_quality_error* message Test function as defined in 8.2.1.1 and 10.3.1.1.
- (3) The MAU shall not activate its Jabber function when operated under the worst-case Jabber Lockup Protection condition as specified in 9.6.5.

MAUs associated with the repeater unit shall be as specified in Section 14 for type 10BASE-T with the restriction that the MAU shall not perform the *signal_quality_error* message Test function as defined in 14.2.1.5.

9.4.2 Direct Coaxial Cable Compatibility. The repeater set, which includes MAUs integrated with the repeater package (internal MAUs), may have any of the interfaces specified in the following subsections.

9.4.2.1 Direct Cable Attachment Compatibility. The repeater shall be compatible at its coaxial tap connector (if so equipped) as specified in 8.5.3 of the 10BASE5 standard. The MAUs associated with the repeater that are connected in this manner shall be subject to the restrictions of MAUs as specified in 9.4.1.

9.4.2.2 "N" Connector Compatibility. The repeater shall be compatible at its Type N connector (if so equipped) as specified in 8.5. The MAUs associated with the repeater that are connected in this manner shall be subject to the restrictions of MAUs as specified in 9.4.1.

9.4.2.3 BNC Compatibility. The repeater shall be compatible at its BNC connector (if so equipped) as specified in 10.6. The MAUs associated with the repeater that are connected in this manner shall be subject to the restrictions of MAUs as specified in 9.4.1.

9.4.3 Link Segment Compatibility. The compatibility interfaces for link segments including IRL segments are either vendor-dependent, as specified in 9.4.3.1, or are vendor-independent MDI, as defined in the remainder of this section.

9.4.3.1 Vendor-Dependent IRL. The budget allowances for the topology supported by the IRL shall ensure that the total network round-trip delay requirement is met and the maximum collision frame size of 511 bits is not exceeded. (See 8.6.1 and 10.7.1.)

9.4.3.2 Vendor-Independent FOIRL. A vendor-independent FOIRL provides a standard means of connecting two repeater units. It comprises a fiber optic medium link segment, a FOMAU at each end of the link segment, and if present, AU Interfaces. A vendor-independent FOIRL is suitable for interconnecting coaxial segments, especially segments located in different buildings.

The vendor-independent FOMAU should be compatible at its FOMDI, as specified in 9.9. If a FOMAU contains an AU Interface, it shall be electrically and mechanically compatible at its AUI connector as specified in Section 7, with the exception of the *signal_quality_error* message Test, 7.2.1.2.3, which shall not be implemented.

9.4.3.3 Twisted-Pair Jack Compatibility. The repeater set shall be compatible at its 8-pin modular jack (if so equipped), as specified in 14.5. The MAUs associated with the repeater set that are connected in this manner shall be subject to the restrictions of MAUs, as specified in 9.4.1.

9.5 Basic Functions

9.5.1 Repeater Set Network Properties. The repeater set shall be transparent to all network acquisition activity and to all DTEs. The repeater set shall not alter the basic fairness criterion for all DTEs to

access the network or weigh it toward any DTE or group of DTEs regardless of network location. A repeater set shall not attempt to be a packet store and forward device.

Repeaters are not addressable. An addressable station on the network that controls a repeater is outside the scope of this standard.

9.5.2 Signal Amplification. The repeater set (including its associated or integral MAUs) shall ensure that the amplitude characteristics of the signals at the MDI outputs of the repeater set are within the tolerance of the specification for the appropriate MAU type. Therefore, any loss of signal-to-noise ratio due to cable loss and noise pickup is regained at the output of the repeater set as long as the incoming data is within the system specification.

9.5.3 Signal Symmetry. The repeater set shall ensure that the symmetry characteristics of the signals at the MDI outputs of a repeater set are within the tolerance of the specification for the appropriate MAU type. Therefore, any loss of symmetry due to MAUs and media distortion is regained at the output of the repeater set.

9.5.4 Signal Retiming. The repeater unit shall ensure that the encoded data output from the repeater unit is within the jitter tolerance of a transmitting DTE as specified in 7.3. Therefore jitter cannot accumulate over multiple segments.

9.5.5 Data Handling. The repeater unit, when presented a packet at any of its ports, shall pass the data frame of said packet intact and without modification, subtraction, or addition to all other ports connected with the repeater unit. The only exceptions to this rule are when contention exists among any of the ports or when the receive port is partitioned as defined in 9.6.6. Between unpartitioned ports, the rules for collision handling (9.5.6) take precedence.

9.5.5.1 Start of Packet Propagation Delays. The start of packet propagation delay for a repeater set is the time delay between the first edge transition of the packet on its repeated from (input) port to the first edge transition of the packet on its repeated to (output) port (or ports).

For a repeater unit with AUI connectors at input and output ports, this time shall be less than or equal to 8 bit times.

For a repeater set with internal FOMAUs, 10BASE2, or 10BASE5 MAUs on both input and output ports, an additional 6.5 bit times delay for an input port MAU and 3.5 bit times delay for an output port MAU shall be allowed. This added delay does not include any dc rise time for the coaxial cable.

For a repeater set with internal 10BASE-T MAUs on input and output ports, an additional 8 BT delay for an input port MAU and 5 BT delay for an output port MAU shall be allowed.

9.5.6 Collision Handling

9.5.6.1 Collision Presence. The repeater set shall implement the Collision Presence Function using receive-mode collision detection as specified for the media with which it is connected.

9.5.6.2 Jam Generation. If a collision is detected on any of the ports to which the repeater set is transmitting, the repeater set shall transmit a Jam to all of the ports to which it is connected. The Jam shall be transmitted in accordance with the Repeater Unit State Diagram in Fig 9-2 and shall be as specified in 4.2.3.2.4 with the further constraint that the first 62 bits transmitted to any port shall be a pattern of alternate 1's and 0's starting with the first bit transmitted as a 1.

9.5.6.3 Collision-Jam Propagation Delays. The start of collision propagation delay for a repeater set is the time delay between the first edge transition of the *signal_quality_error* signal on any of its ports to the first edge transition of the Jam on its (output) port (or ports).

For a repeater unit with AUI connectors at input and output ports, this time shall be less than or equal to 6.5 bit times.

For a repeater set with internal FOMAUs, 10BASE2, or 10BASE5 MAUs on both input and output ports, an additional allowance of 9 bit times delay for an input port MAU and 3.5 bit times delay for an output port MAU shall be made. This added delay does not include any dc rise time for the coaxial cable.

For a repeater set with internal 10BASE-T MAUs on input and output ports, an additional 9 BT delay for an input port MAU and 5 BT delay for an output port MAU shall be allowed.

The cessation of Jam propagation delay for a repeater unit is the time delay between the input signals at its ports reaching a state such that Jam should end at a port and the last transition of Jam at that port. The states of the input signals that should cause Jam to end are covered in detail in the repeater state diagrams.

For a repeater unit with AUI connectors at input and output ports, this time shall be less than or equal to 5 bit times when not extending fragments. When extending fragments, this delay may be longer as required by the fragment extension algorithm. See 9.6.4.

For a repeater set with internal FOMAU, 10 BASE2, and 10BASE5 MAUs on its input ports, an additional allowance of 0.5 bit time delay for DI and 20 bit times for *signal_quality_error* deassertion shall be made. For a repeater set with internal FOMAU, 10BASE2, and 10BASE5 MAUs on its output ports, an additional allowance of 0.5 bit time delay shall be made. This added delay does not include any dc fall time for the coaxial cable.

For a repeater set with internal 10BASE-T MAUs on its input ports, an additional 2 BT delay for DI and 9 BT for *signal_quality_error* deassertion shall be allowed. For a repeater set with internal MAUs on its output ports, an additional 2 BT delay shall be allowed.

9.5.6.4 Transmit Recovery Time. It is essential that the repeater unit not monitor a port for input for a short time after the repeater stops transmitting to that port. This recovery time prevents the repeater from receiving its own transmission as a new receive activity. The minimum recovery time allowable for a repeater is implementation-dependent, but must be greater than the sum of the delays in the transmit and receive paths for the port. In all cases the recovery time must be less than 10 bit times from the last transition on the transmitting AU Interface.

9.5.6.5 Carrier Recovery Time. During a collision, the *input_idle* signal is unreliable for short periods of time (bits) because of the possibility of signal cancellation on the collision segment. In order to prevent premature detection of the true end of the collision, the repeater unit must wait for data to become sensed from a port for a short time after *signal_quality_error* has gone inactive from that port. This recovery time prevents the repeater from prematurely ending a Jam on an active network. The minimum carrier recovery time allowable for a repeater is implementation-dependent, but shall be greater than the CARRIER ON time after *signal_quality_error* is deasserted. In all cases, the carrier recovery time shall be less than 4 bit times from the last transition on the AU Interface.

9.5.7 Electrical Isolation. Network segments that have different isolation and grounding requirements shall have those requirements provided by the port-to-port isolation of the repeater set.

9.6 Detailed Repeater Functions and State Diagrams. A precise algorithmic definition is given in this section, providing a complete procedural model for the operation of a repeater, in the form of state diagrams. Note that whenever there is any apparent ambiguity concerning the definition of repeater operation, the state diagrams should be consulted for the definitive statement.

The model presented in this section is intended as a primary specification of the functions to be provided by any repeater unit. It is important to distinguish, however, between the model and a real implementation. The model is optimized for simplicity and clarity of presentation, while any realistic implementation should place heavier emphasis on such constraints as efficiency and suitability to a particular implementation technology.

It is the functional behavior of any repeater unit implementation that shall match the standard, not the internal structure. The internal details of the procedural model are useful only to the extent that they help specify the external behavior clearly and precisely. For example, the model uses a separate Transmit Timer state machine for each port. However, in an actual implementation, the hardware may be shared.

9.6.1 State Diagram Notation. The notation used in the state diagrams (Figs 9-2 through 9-5) follows the conventions in 1.2.1.

Description of State Diagram Variables

Input/Output Variables

DataIn (X)

Status of DataIn input at port X.

Values: II = *input_idle*; indicates no activity

-II; indicates activity

Note that DataIn (X) may be undefined during collision but that it is a don't care in all instances when this is true.

CollIn (X)

Status of ControlIn input at port X.

Values: SQE = *signal_quality_error*; indicates collision

-SQE; indicates no collision

Out (X)

Type of output repeater is sourcing at port X.

Values: Idle; Repeater is not transmitting

-Idle; Repeater is transmitting Preamble Pattern

or Data or Jam or TwoOnes.

Preamble Pattern; Repeater is sourcing alternating 1's and 0's on port X.

Data; Repeater is repeating data frame on port X.

Jam; Repeater is sourcing Jam on port X.

TwoOnes; Repeater is sourcing two consecutive Manchester encoded ones on port X.

DisableOut (X)

Override of Out (X)

Values: ON; Disable repeater transmission regardless of value of Out (X).

-ON; Repeater transmission depends on the value of Out (X).

Port Variables

TT (X)

Transmit Timer indicates number of bits transmitted on port X.

Values: Positive integers

Inter-Process Flags

AllDataSent

All received data frame bits have been sent.

Bit Transmitted

Indicates a bit has been transmitted by the repeater unit.

DataRdy

Indicates the repeater has detected the SFD and is ready to send the received data. The search for SFD shall not begin before 15 bits have been received. Note, transmit and receive clock differences shall also be accommodated.

Tw1

Wait Timer for the end of transmit recovery time (see 9.5.6.4). It is started by StartTw1. Tw1Done is satisfied when the end of transmit recovery time is completed.

Tw2

Wait Timer for the end of carrier recovery time (see 9.5.6.5). It is started by StartTw2. Tw2Done is satisfied when the timer has expired.

Tw3

Wait Timer for length of continuous output (see 9.6.5). It is started by StartTw3. Tw3Done is satisfied when the timer has expired.

Tw4

Wait Timer for time to disable output for Jabber Lockup Protection (see 9.6.5). It is started by StartTw4. Tw4Done is satisfied when the timer has expired.

Port Functions**Port (Test)**

A function that returns the designation of a port passing the test condition. For example, Port (CollIn=SQE) returns the designation: X for a port that has SQE true. If multiple ports meet the test condition, the Port function will be assigned one and only one of the acceptable values.

Port Designation

Ports are referred to by number. Port information is obtained by replacing the X in the desired function with the number of the port of interest. Ports are referred to in general as follows:

ALL	Indicates all repeater ports are to be considered. All ports shall meet test conditions in order for the test to pass.
ANY	Indicates all ports are to be considered. One or more ports shall meet the test conditions in order for the test to pass.
ONLY1	Indicates all ports are to be considered. One, but not more than one, port shall meet the test condition in order for the test to pass.
X	Generic port designator. When X is used in a state diagram, its value is local to that diagram and not global to the set of state diagrams.
N	Is defined by the Port function on exiting the IDLE state of Fig 9-2. It indicates a port that caused the exit from the IDLE state.
M	Is defined by the Port function on exiting the TRANSMIT COLLISION state of Fig 9-2. It indicates the only port where CollIn=SQE.
ALLXN	Indicates all ports except N should be considered. All ports considered shall meet the test conditions in order for the test to pass.
ALLXM	Indicates all ports except M should be considered. All ports considered shall meet the test conditions in order for the test to pass.
ANYXN	Indicates any port other than N meeting the test conditions shall cause the test to pass.
ANYXM	Indicates any port other than M meeting the test conditions shall cause the test to pass.

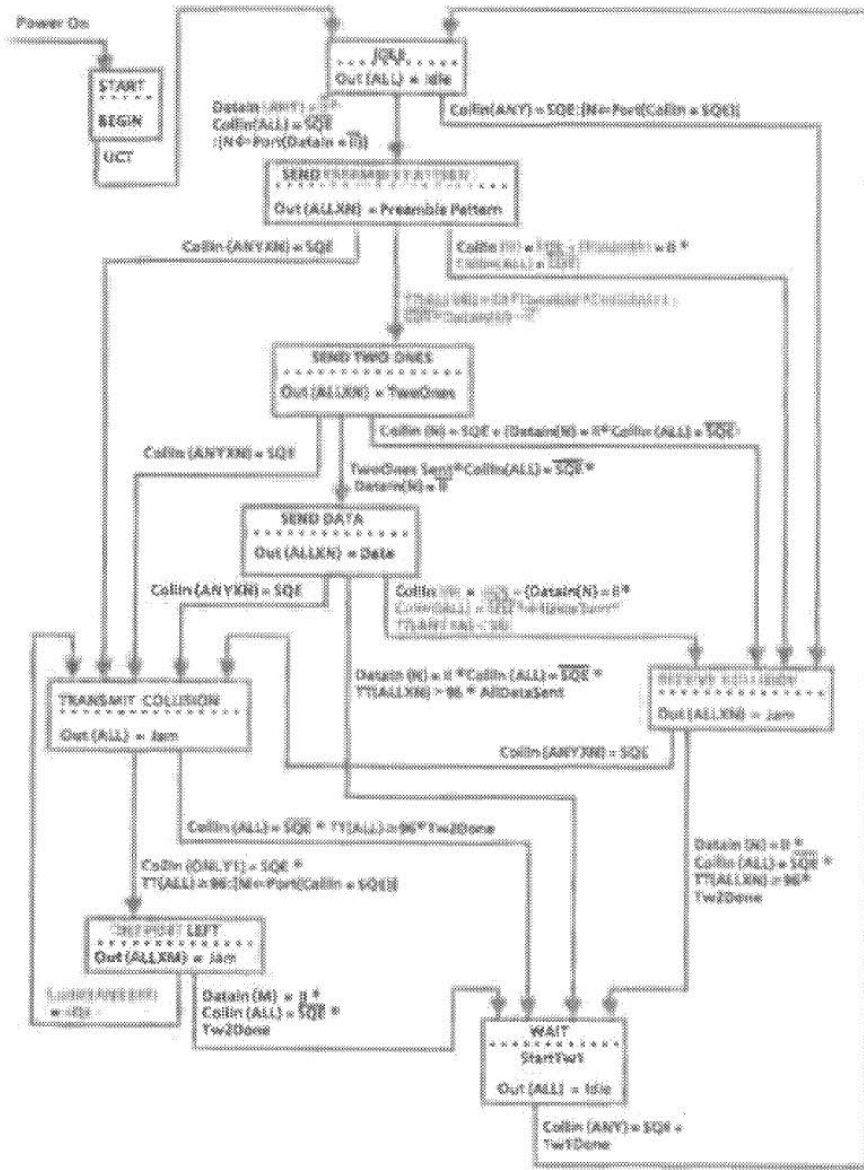

NOTE: Out (X) = Idle in all instances unless specified otherwise.

Fig 9-2
Repeater Unit State Diagram

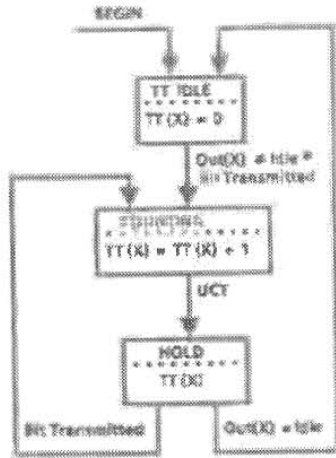

Fig 9-3
Transmit Timer State Diagram
for Part X

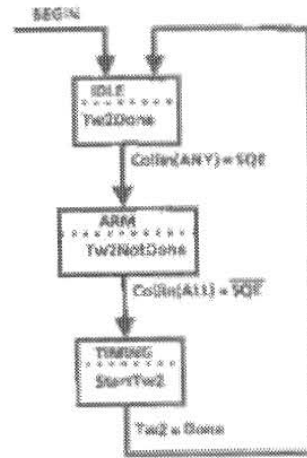

Fig 9-4
Tw2 State Diagram

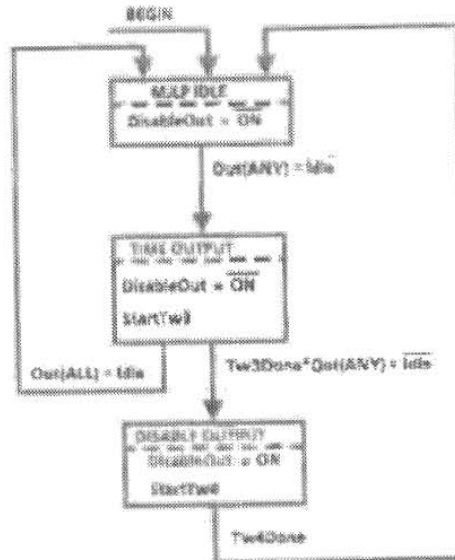

Fig 9-5
MAU Jabber Lockup Protection State Diagram

9.6.2 Data and Collision Handling. The repeater unit shall implement the CARRIER_ON function for all its ports. Upon detection of carrier from one port, the repeater unit shall repeat all received signals in the Data Frame from that port to the other port (or ports).

The repeater unit data and collision-handling algorithm shall be as defined in Fig 9-2.

9.6.3 Preamble Regeneration. The repeater unit shall output at least 56 bits of preamble followed by the SFD. When the repeater unit must send more than 56 bits, the maximum length preamble pattern it shall send is the number received plus 6.

9.6.4 Fragment Extension. If the received bit sequence from CARRIER_ON to CARRIER_OFF is fewer than 96 bits in length, including preamble, the repeater unit shall extend the output bit sequence with Jam such that the total number of bits output from the repeater unit shall equal 96.

9.6.5 MAU Jabber Lockup Protection. MAU Jabber Lockup Protection must operate as shown in the MAU Jabber Lockup Protection state diagram. The repeater unit shall interrupt its output if it has transmitted continuously for longer than 5 ms or 50 000 bit times $-20\% + 50\%$. The repeater unit shall then, after 96 to 116 bit times (9.6 to 11.6 μ s), re-enable transmissions.

9.6.6 Auto-Partitioning/Reconnection (Optional)

9.6.6.1 Overview. In large multisegment networks it may be desirable that the repeater unit protect the network from some fault conditions that would halt all network communication. A potentially likely cause of this condition could be due to a cable break, a faulty connector, or a faulty or missing termination.

In order to isolate a faulty segment's collision activity from propagating through the network, the repeater unit may optionally implement an auto-partition algorithm and, on detection of the malfunction being cleared, an auto-reconnection algorithm.

9.6.6.2 Detailed Auto-Partition/Reconnection Algorithm State Diagram. Repeater sets with 10BASE-T MAUs shall implement an auto-partition/reconnection algorithm on those ports. The repeater unit may optionally implement an auto-partition/reconnection algorithm that protects the rest of the network from an open-circuited segment. If the repeater unit provides this function, it shall conform to the state diagram of Fig 9-6.

The algorithm defined in Fig 9-6 shall isolate a segment from the network when one of the following two conditions has occurred on the segment:

- (1) When a consecutive collision count has been reached; or
- (2) When a single collision duration has exceeded a specific amount of time.

When a segment is partitioned, DataIn (X) and CollIn (X) from that segment are forced to II (input idle) and -SQE (no collision), respectively, so that activity on the port will not affect the repeater unit. Output from the repeater to the segment is not blocked.

The segment will be reinstated when the repeater has detected activity on the segment for more than the number of bits specified for Tw5 without incurring a collision.

Description of State Diagram Variables and Constants

Port Constants

CCLimit

The number of consecutive collisions that must occur before a segment is partitioned. The value shall be greater than 30.

Input/Output Variables

DIPresent(X)

Data in from the MAU on port X. (This input is gated by the partition state machine to produce DataIn (X) to the main state machine.)

Values: II = *input_idle* ; no activity
-II = Input not idle ; activity

CIPresent(X)

Control input from the MAU on port X. (This input is gated by the partition state machine to produce CollIn (X) to the main state machine.)

Values: SQE = *signal_quality_error* ; indicates collision
-SQE ; indicates no collision

Port Variables

CC(X)

Consecutive port collision count on a particular port X. Partitioning occurs on a terminal count of CCLimit being reached.

Values: Positive integers up to a terminal count of CCLimit.

Inter-Process Flags

Tw5

Wait Timer for length of packet without collision. Its value shall be between 450 and 500 bit times. It is started by StartTw5. Tw5Done is satisfied when the timer has expired.

Tw6

Wait Timer for excessive length of collision. Its value shall be between 1000 and 30 000 bit times. It is started by StartTw6. Tw6Done is satisfied when the timer has expired.

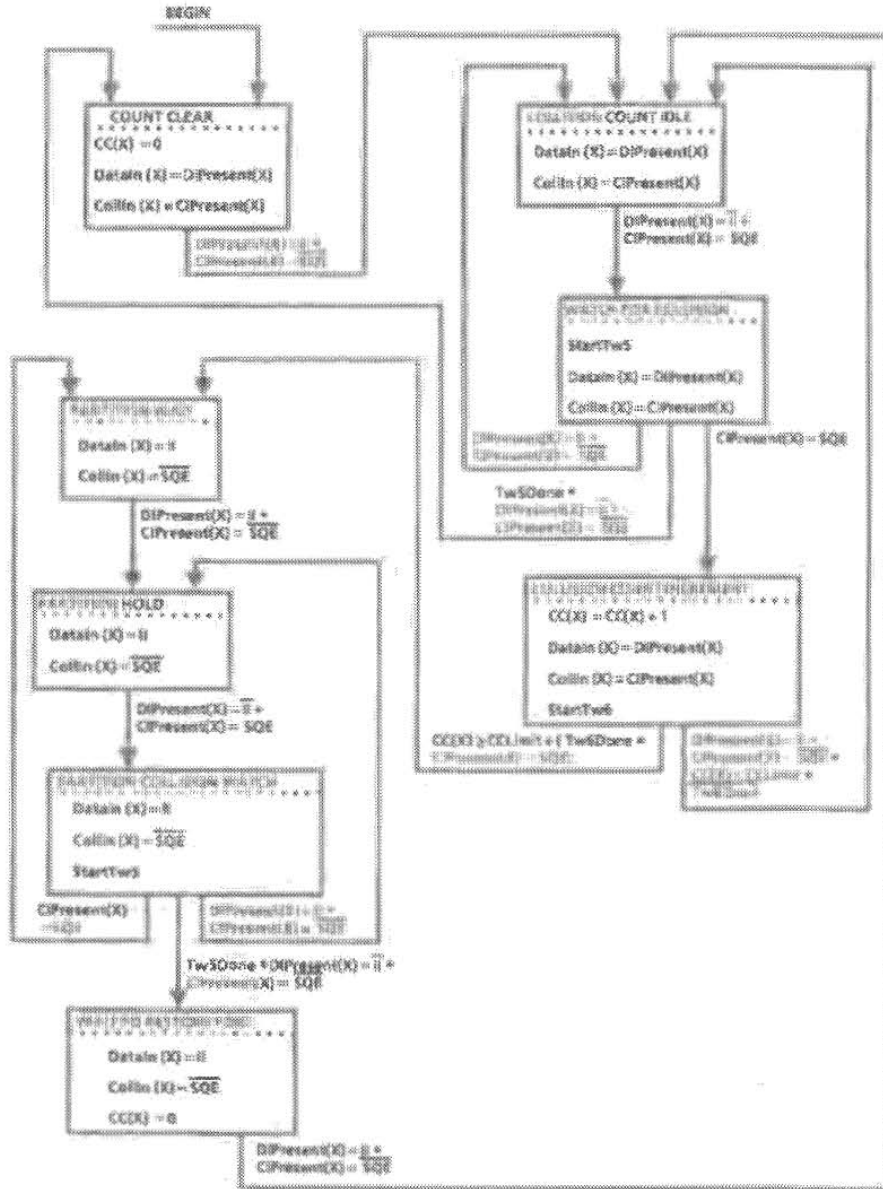

Fig 9-6
Partitioning State Diagram for Part X

9.7 Electrical Isolation. There are two electrical power distribution environments to be considered that require different electrical isolation properties.

- Environment A — When a LAN or LAN segment, with all its associated interconnected equipment, is entirely contained within a single low-voltage power distribution system and within a single building.
- Environment B — When a LAN crosses the boundary between separate power distribution systems or the boundaries of a single building.

The repeater unit shall comply with applicable local and national codes related to safety. See ECMA-97 [A9].

9.7.1 Environment A Requirements. Attachment of network segments via repeaters (sets) possessing internal MAUs requires electrical isolation of 500 Vrms, 1 minute withstand, between the segment and the protective ground of the repeater unit.

For repeater ports that connect to external MAUs via an AU Interface, the requirement for isolation is encompassed within the isolation requirements of the basic MAU standard. (See 8.3.2.1, 10.4.2.1, and 14.3.11.) The repeater unit shall not require any electrical isolation between exposed AU Interfaces or between exposed AU Interfaces and chassis ground of the repeater unit. No isolation boundary need therefore exist at any AUI compatible interface (that is "D" connector) provided by a repeater unit.

9.7.2 Environment B Requirements. The attachment of network segments, which cross environment A boundaries, requires electrical isolation of 1500 Vrms, 1 minute withstand, between each segment and all other attached segments and also the protective ground of the repeater unit.

It is recommended that this isolation be provided by the use of external MAUs connected by AU Interfaces. If internal MAUs are used the segments shall be installed such that it is not possible for an equipment user to touch the trunk cable screen or signal conductor. A repeater of this variety requires professional installation.

The requirements for interconnected coaxial cable/electrically conducting LAN segments that are partially or fully external to a single building environment may require additional protection against lightning strike hazards. Such requirements are beyond the scope of this standard. It is recommended that the above situation be handled by the use of a nonelectrically conducting IRL (for example, fiber optic).

It is assumed that any nonelectrically conducting segments will provide sufficient isolation within that media to satisfy the isolation requirements of environment B.

9.8 Reliability. A 2-port repeater set shall be designed to provide a mean time between failure (MTBF) of at least 50 000 hours of continuous operation without causing a communication failure among stations attached to the network medium. Repeater sets with more than two ports shall add no more than 3.46×10^{-5} failures per hour for each additional port.

The repeater set electronics shall be designed to minimize the probability of component failures within the repeater electronics that prevent communication among the other MAUs on the individual coaxial cable segments. Connectors and other passive components comprising the means of connecting the repeater to the coaxial cable shall be designed to minimize the probability of total network failure.

9.9 Medium Attachment Unit and Baseband Medium Specification for a Vendor-Independent FOIRL

9.9.1 Scope

9.9.1.1 Overview. A vendor-independent FOIRL provides a standard means for connecting only two repeater units. It thus extends the network length and topology beyond that which could be achieved by interconnecting coaxial segments via repeater sets only, as defined in 8.6 or 10.7. A vendor-independent FOIRL is particularly suited for interconnecting coaxial segments located in different buildings. The FOIRL described in this document is not intended for use in connecting DTEs.

In particular, this section defines the following:

- (1) The functional, optical, electrical, and mechanical characteristics of a fiber optic MAU (FOMAU) suitable for interfacing to a repeater unit, either directly (FOMAU and repeater unit integrated into a single package) or via an AUI mechanical connection.
- (2) Various optical fiber sizes suitable for connecting only two FOMAU's.

A schematic of the vendor-independent FOIRL and its relationship to the repeater unit is shown in Fig 9-7. The vendor-independent FOIRL comprises an optical fiber cable link segment, a vendor-independent FOMAU at each end of the link segment and, if present, AUI cables.

The purpose of this specification is to enable interoperability of FOMAU's that originate from different manufacturers, thereby facilitating the development of simple and inexpensive inter-repeater links (IRLs). To satisfy this objective, the FOMAU has the following general characteristics:

- (a) Enables coupling the repeater unit PLS directly, or by way of the AUI mechanical connection, to the explicit baseband optical fiber cable link segment defined in this section of the standard.
- (b) Supports signaling at a data rate of 10 Mb/s.
- (c) Provides for driving up to 1000 m of an optical fiber cable link segment.
- (d) Operates indistinguishably from a repeater set MAU, as defined in Section 9, 10, or 14 when viewed from the AU Interface.
- (e) Supports 10BASE2, 10BASE5, and 10BASE-T system configurations as defined in Sections 8, 10, and 13 of this standard.
- (f) Allows integration of the FOMAU into a single package with the repeater unit, thereby eliminating the need for an AUI mechanical connection.

The implementation may incorporate additional features, for example those that allow compatibility with vendor-dependent FOMAU's, as in 9.4.3.1. The means to support these features are beyond the scope of this subsection.

9.9.1.2 Application Perspective: FOMAU and Medium Objectives. This section states the broad objectives underlying the vendor-independent FOIRL specification defined throughout this section of the standard. These are as follows:

- (1) Provide the physical means for connecting only two repeater units.
- (2) Define a physical interface for the vendor-independent FOMAU component of the vendor-independent FOIRL that can be implemented independently among different manufacturers of hardware and achieve the intended level of compatibility when interconnected in a common IRL.
- (3) Provide a communication channel capable of high bandwidth and low bit error rate performance. The resultant BER of the FOIRL should be less than one part in 10^{10} .
- (4) Provide a means to prevent packet transmission through an FOIRL when transmission capability in one or both directions is disrupted.

9.9.1.3 Compatibility Considerations. All implementations of the vendor-independent FOMAU shall be compatible at the FOMDI and at the AUI (when physically and mechanically implemented).

This standard provides an optical fiber cable link segment specification for the interconnection of only two FOMAU devices. The medium itself, the functional capability of the FOMAU, and the AUI are defined to provide the highest possible level of compatibility among devices designed by different manufacturers. Designers are free to implement circuitry within the FOMAU in an application-dependent manner provided the FOMDI and AUI are satisfied. (The provision of the physical and mechanical implementation of the AUI is optional.)

9.9.1.4 Relationship to AUI. A close relationship exists between this section and Section 7. This section specifies all of the physical medium parameters, all of the FOPMA logical functions residing in the FOMAU, and references the AUI defined in Section 7 with the exception of the *signal_quality_error* message Test of 7.2.1.2.3(3), which shall not be implemented, that is, shall not be enabled when connected to a repeater unit.

NOTE: The specification of a FOMAU component requires the use of both this section and Section 7 for the AUI specifications.

9.9.1.5 Mode of Operation. The FOMAU functions as a direct connection between the optical fiber cable link segment and the repeater unit. During collision-free operation, data from the repeater unit is

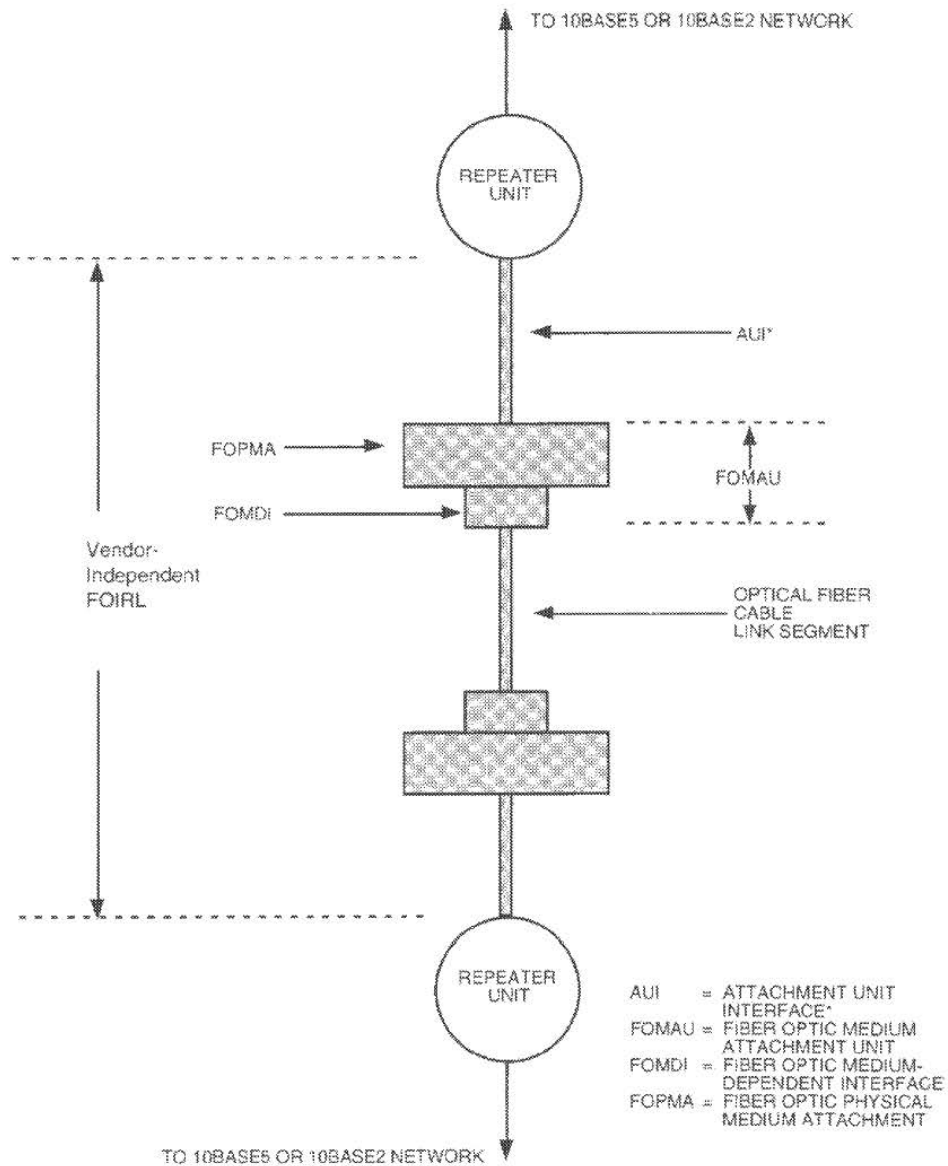

* See 9.9.1.3 for implementation requirements.

Fig 9-7
Schematic of the Vendor-Independent FOIRL and Its Relationship to the Repeater Unit

transmitted into the FOMAU's transmit optical fiber, and all data in the FOMAU's receive optical fiber is transmitted to the repeater unit.

9.9.2 FOMAU Functional Specifications. The FOMAU component provides the means by which signals on the three AUI signal circuits are coupled:

- (1) From the repeater unit into the FOMAU's transmit optical fiber, and
- (2) From the FOMAU's receive optical fiber to the repeater unit.

To achieve this basic objective, the FOMAU component contains the following functional capabilities to handle message flow between the repeater unit and the optical fiber cable link segment:

- | | |
|---|---|
| (a) <i>Transmit Function</i> | : The ability to receive serial bit streams from the attached repeater unit and transmit them into the FOMAU's optical fiber. |
| (b) <i>Receive Function</i> | : The ability to receive serial data bit streams from the FOMAU's receive optical fiber and transmit them to the attached repeater unit. |
| (c) <i>Collision Presence Function</i> | : The ability to detect, and report to the attached repeater unit, an FOIRL collision. |
| (d) <i>Jabber Function</i> | : The ability to automatically interrupt the Transmit Function and inhibit an abnormally long output data stream. |
| (e) <i>Low Light Level Detection Function</i> | : The ability to automatically interrupt the Receive Function and inhibit the reception of signals from the FOMAU's receive optical fiber which could result in abnormally high BERs. |

9.9.2.1 Transmit Function Requirements. At the start of a packet transmission into the FOMAU's transmit optical fiber, no more than two bits (two full bit cells) of information may be received from the DO circuit and not transmitted into the FOMAU's transmit optical fiber. In addition, it is permissible for the first bit sent to contain encoded phase violations or invalid data. All successive bits of the packet shall be transmitted into the FOMAU's transmit optical fiber and shall exhibit the following:

- (1) No more edge jitter than that given by the sum of the worst-case edge jitter components specified in 7.4.3.6, 7.5.2.1, and 9.9.4.1.7, and
- (2) The levels and waveforms specified in 9.9.4.1.

The FOMAU DO circuit shall comply with the AUI specification for receivers given in 7.4.2. The FOMAU's DI circuit driver shall comply with the AUI specification for drivers given in 7.4.1.

The steady-state propagation delay between the DO circuit receiver input and the FOMAU's transmit optical fiber input shall not exceed one-half a bit cell. It is recommended that the designer provide an implementation in which a minimum threshold level is required on the DO circuit to establish a transmit bit stream.

The higher optical power level transmitted into the FOMAU's transmit optical fiber shall be defined as the low (LO) logic state on the optical fiber link segment. There shall be no logical signal inversions between the DO circuit and the FOMAU's transmit optical fiber, as specified in 9.9.4.1.5.

The difference in the start-up delay (bit loss plus invalid bits plus steady-state propagation delay), as distinct from the absolute start-up delays, between any two packets that are separated by 9.6 μ s or less shall not exceed 2 bit cells.

The FOMAU shall loop back a packet received from the DO circuit into the DI circuit. At the start of a packet transmission, no more than five bits of information may be received from the DO circuit and not transmitted into the DI circuit. It is permissible for the first bit sent to contain encoded phase violations or invalid data. All successive bits of the packet shall be transmitted into the DI circuit and shall exhibit no more edge jitter than that specified for signals transmitted into the DI circuit by the Receive Function, as specified in 9.9.2.2. The steady-state propagation delay between the DO circuit receiver input and the DI circuit driver output for such signals shall not exceed one bit cell. There shall be no logical signal inversions between the DO circuit and the DI circuit during collision-free transmission.

When the DO circuit has gone idle after a packet has been transmitted into the FOMAU's transmit optical fiber, the FOMAU shall not activate the Collision Presence Function so as not to send the *signal_quality_error* message Test of 7.2.1.2.3(3) to the repeater unit.

During the idle state of the DO circuit, the Transmit Function shall output into the transmit optical fiber an optical idle signal as specified in 9.9.4.1.4. The transmitted optical signals shall exhibit the optical power levels specified in 9.9.4.1.8. At the end of a packet transmission, the first optical idle signal pulse

transition to the higher optical power level must occur no sooner than 400 ns and no later than 2100 ns after the packet's last transition to the lower optical power level. This first optical pulse must meet the timing requirements of 9.9.4.1.4.

The FOMAU shall not introduce extraneous optical signals into the transmit optical fiber under normal operating conditions, including powering-up or powering-down of the FOMAU.

9.9.2.2 Receive Function Requirements. At the start of a packet reception from the FOMAU's receive optical fiber, no more than two bits (two full bit cells) of information may be received from the FOMAU's receive optical fiber and not transmitted into the DI circuit. It is permissible for the first bit transmitted into the DI circuit to contain encoded phase violations or invalid data. All successive bits of the packet shall be transmitted into the DI circuit and shall exhibit the following:

- (1) The levels and waveforms specified in 7.4.1, and
- (2) No more edge jitter than that given by the sum of the worst-case edge jitter components specified in 7.4.3.6, 7.5.2.1, 9.9.4.1.7, 9.9.4.2.2, and 9.9.5.1.

The steady-state propagation delay between the output of the FOMAU's receive optical fiber and the output of the DI circuit driver shall not exceed one-half a bit cell. There shall be no logical signal inversions between the FOMAU's receive optical fiber and the DI circuit during collision-free operation, as specified in 9.9.4.2.3.

The difference in the start-up delay (bit loss plus invalid bits plus steady-state propagation delay), as distinct from the absolute start-up delays, between any two packets that are separated by 9.6 μ s or less shall not exceed 2 bit cells.

The FOMAU shall not introduce extraneous signals into the DI circuit under normal operating conditions, including powering-up or powering-down of the FOMAU.

9.9.2.3 Collision Presence Function Requirements. The signal presented to the CI circuit in the absence of an SQE signal shall be the IDL signal.

The signal presented to the CI circuit during the presence of a collision shall be the CS0 signal, a periodic pulse waveform of frequency 10 MHz $\pm 25\%$ -15% with pulse transitions that are no less than 35 ns and no greater than 70 ns apart at the zero crossing points. This signal shall be presented to the CI circuit no more than 3.5 bit times after the simultaneous appearance of signals at both the input of the FOMAU's transmit optical fiber and the output of the FOMAU's receive optical fiber. This signal shall be deasserted no earlier than 4.5 bit times and no later than 7 bit times after the above defined collision condition ceases to exist.

During a collision, if a packet is received at the DO circuit before a packet is received at the FOMAU's receive optical fiber, then only the packet received at the DO circuit shall be transmitted into the DI circuit, as specified in 9.9.2.1. Conversely, if during a collision a packet is received at the FOMAU's receive optical fiber before a packet is received at the DO circuit, then only the packet received at the FOMAU's receive optical fiber shall be transmitted into the DI circuit, as specified in 9.9.2.2. In the event of both packets being received at their respective ports within 3.5 bit times of each other, then either one, but only one, of the packets shall be selected to be transmitted into the DI circuit.

The Collision Function shall not introduce extraneous signals into the CI circuit under normal operating conditions, including powering-up or powering-down of the FOMAU.

9.9.2.4 Jabber Function Requirements. The FOMAU shall have the capability, as defined in Fig 9-9, to interrupt a transmission from the repeater unit that exceeds a time duration determined by the FOMAU. This time duration shall not be less than 20 ms nor more than 150 ms. If the packet being transmitted is still being transmitted after the specified time duration, the FOMAU shall activate the Jabber Function by the following:

- (1) First inhibiting the transmission of bits from its DO circuit into its transmit optical fiber,
- (2) Then transmitting into its transmit optical fiber the optical idle signal specified in 9.9.4.1.4, and
- (3) Presenting the CS0 signal to the CI circuit.

Once the error condition has been cleared, the FOMAU shall reset the Jabber Function and present the IDL signal to the CI circuit:

- (a) On power reset, and
- (b) Optionally, automatically after a continuous period of 0.5 s \pm 50% of inactivity on the DO circuit.

The FOMAU shall not activate its Jabber Function when operated under the worst-case Jabber Lockup Protection condition specified in 9.6.5.

When both the Jabber Function and the Low Light Level Detection Function (see 9.9.2.5) have been activated, the Jabber Function shall override the Low Light Level Detection Function.

9.9.2.5 Low Light Level Detection Function Requirements. The FOMAU shall have a low light level detection capability, as defined in Fig 9-10, whereby it shall interrupt the reception of both the optical idle signal and packets from the FOMAU's receive optical fiber when reliable reception can no longer be assured. This error condition shall not be activated if the peak optical power level at the output of the FOMAU's receive optical fiber exceeds -27 dBm. It shall be activated before the peak optical power level at the output of the FOMAU's receive optical fiber has fallen to a level that is lower than the peak optical power level that corresponds to a BER = 10^{-10} for the FOMAU under consideration. Once this error condition has been activated, the FOMAU shall, no earlier than 30 bit times and no later than 200 bit times

- (1) Disable its Receive Function so that the transmission of bits from its receive optical fiber to the DI circuit is inhibited.
- (2) Assure that only the optical idle signal is transmitted into its transmit optical fiber, irrespective of the state of the DO circuit.
- (3) Disable its Transmit Function during the period of time that the FOMAU recognizes the presence of a packet on the DO circuit such that the transmission of the packet from the DO circuit into the DI circuit is inhibited.

Once this error condition has been cleared, the FOMAU shall return automatically to its normal mode of operation within 40 bit times once the DO circuit is in the idle state.

When both the Jabber Function (see 9.9.2.4) and the Low Light Level Detection Function have been activated, the Jabber Function shall override the Low Light Level Detection Function.

NOTE: It is recommended that, for diagnostic purposes, the status of the Low Light Level Detection Function be indicated on the exterior of the FOMAU package.

9.9.2.6 Repeater Unit to FOMAU Physical Layer Messages. The following messages can be received by the FOMAU physical layer entities from the repeater unit:

Message	Circuit	Signal	Meaning
<i>output</i>	DO	CD1, CD0	Output information
<i>output_idle</i>	DO	IDL	No data to be output

9.9.2.7 FOMAU Physical Layer to Repeater Unit Messages. The following messages can be sent by the FOMAU physical layer entities to the repeater unit:

Message	Circuit	Signal	Meaning
<i>input</i>	DI	CD1, CD0	Input information
<i>input_idle</i>	DI	IDL	No information to be input
<i>fomau_available</i>	CI	IDL	FOMAU is available for output
<i>signal_quality_error</i>	CI	CS0	Collision or error detected by FOMAU

9.9.2.7.1 input Message. The FOMAU physical layer sends an *input* message to the repeater unit when the FOMAU has a bit of data to send to the repeater unit. The physical realization of the *input* message is a CD0 or CD1 sent by the FOMAU to the repeater unit on the DI circuit. The FOMAU sends CD0 if

the input bit is a zero, or CD1 if the input bit is a one. No retiming of the CD1 or CD0 signals takes place within the FOMAU.

9.9.2.7.2 *input_idle* Message. The FOMAU physical layer sends an *input_idle* message to the repeater unit when the FOMAU does not have data to send to the repeater unit. The physical realization of the *input_idle* message is the IDL signal sent by the FOMAU to the repeater unit on the DI circuit.

9.9.2.7.3 *fomau_available* Message. The FOMAU physical layer sends the *fomau_available* message to the repeater unit when the FOMAU is available for output, and when the FOMAU has activated the Low Light Level Detection Function in accordance with the Low Light Level Detection Function requirements of 9.9.2.5 and Fig 9-10. The *fomau_available* message shall be sent by a FOMAU that is prepared to output data. The physical realization of the *fomau_available* message is an IDL signal sent by the FOMAU to the repeater unit on the CI circuit.

9.9.2.7.4 *signal_quality_error* Message. The *signal_quality_error* message shall be implemented in the following fashion:

- (1) When the FOMAU has completed the transmission of a packet into its transmit optical fiber, it shall not send any *signal_quality_error* message Test sequence.
- (2) The simultaneous appearance of packets at both the input of a FOMAU's transmit optical fiber and the output of its receive optical fiber shall cause the *signal_quality_error* message to be sent by the FOMAU to the repeater unit.
- (3) When the FOMAU has activated the Jabber Function, it shall send the *signal_quality_error* message in accordance with the Jabber Function requirements of 9.9.2.4 and Fig 9-9.

The physical realization of the *signal_quality_error* message is the CS0 signal sent by the FOMAU to the repeater unit on the CI circuit.

The FOMAU is required to assert the *signal_quality_error* message at the appropriate times whenever the FOMAU is powered and not just when the repeater unit is providing output data.

9.9.2.8 FOMAU State Diagrams. The state diagrams, Figs 9-8, 9-9, and 9-10, depict the full set of allowed FOMAU state functions relative to the control circuits of the repeater unit/FOMAU interface for FOMAU's. Messages used in these state diagrams are explained as follows:

NOTE: Figures 9-8, 9-9, and 9-10 must all be considered together.

- (1) *enable_opt_driver* : Activates the path employed during normal operation to cause the FOMAU transmitter to impress the packet data received from the DO circuit into the FOMAU's transmit optical fiber.
- (2) *disable_opt_driver* : Deactivates the path employed during normal operation to cause the FOMAU transmitter to impress the packet data received from the DO circuit into the FOMAU's transmit optical fiber.
- (3) *enable_opt_idle_driver* : Causes the FOMAU transmitter to impress the optical idle signal into the FOMAU's transmit optical fiber.
- (4) *disable_opt_idle_driver* : Causes the FOMAU to stop transmitting the optical idle signal into the FOMAU's transmit optical fiber.
- (5) *enable_loop_back* : Activates the path employed during normal operation to cause the FOMAU Transmit Function to impress the packet data received from the DO circuit into the DI circuit.
- (6) *disable_loop_back* : Deactivates the path employed during normal operation to cause the FOMAU Transmit Function to impress the packet data received from the DO circuit into the DI circuit.
- (7) *enable_opt_receiver* : Activates the path employed during normal operation to cause the FOMAU to impress the packet data received from the FOMAU's receive optical fiber into the DI circuit.

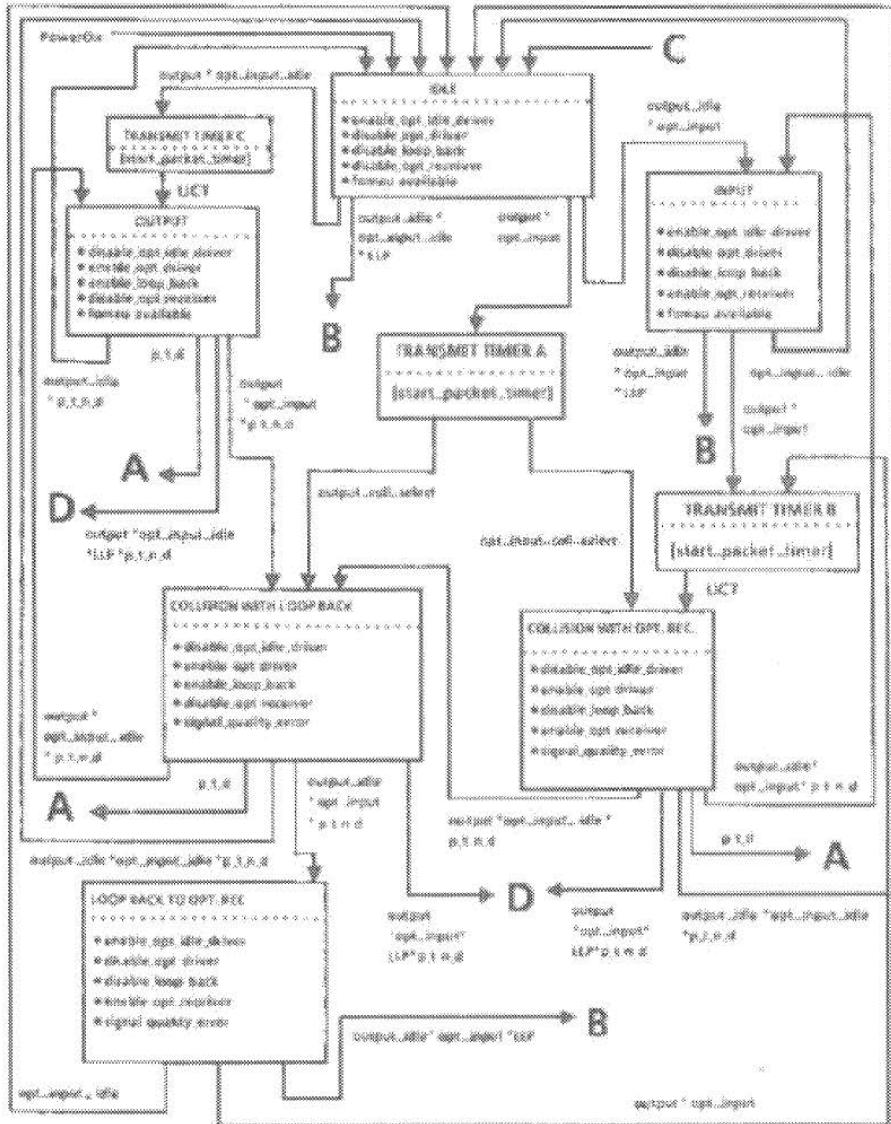

Fig 9-8
FOMAU Transmit, Receive, and Collision Functions State Diagram

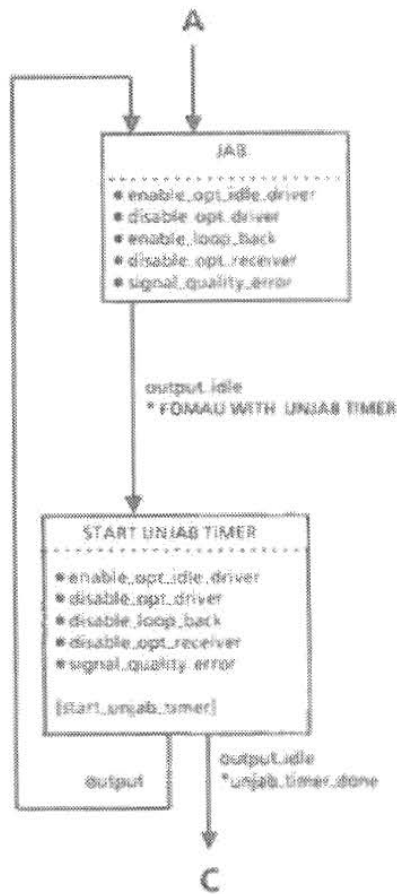

Fig 9-9
FOMAU Jabber Function
State Diagram

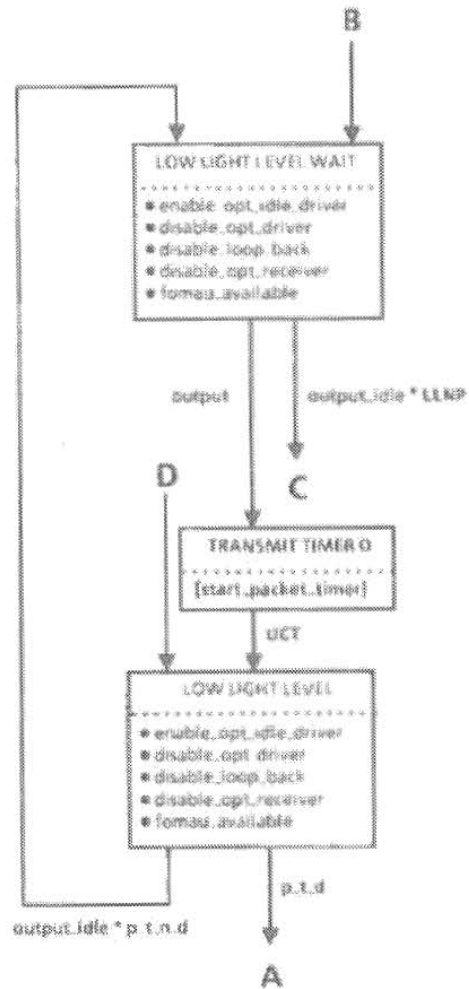

Fig 9-10
Low Light Level Detection
Function State Diagram

- (8) *disable_opt_receiver* : Deactivates the path employed during normal operation to cause the FOMAU to impress the packet data received from the FOMAU's receive optical fiber into the DI circuit.
- (9) *[start_packet_timer]* : Starts a timing function which is used to monitor the amount of time the FOMAU is transmitting a packet into the transmit optical fiber. The timing function is maintained as long as *output* is true and is stopped on the transition to *output_idle* true. The term *packet_timer_done* is satisfied when the timing function has run to expiration (see 9.9.2.4).
- (10) *[start_unjab_timer]* : Starts a timing function that is used to monitor the amount of time that the Jabber error condition has been clear. The timing function is maintained as long as *output_idle* is true and is stopped on the transition to *output* true. The term *unjab_timer_done* is satisfied when the timing function has run to expiration (see 9.9.2.4).
- (11) *opt_input* : Signifies that a packet is present at the FOMAU's receive optical fiber.
- (12) *opt_input_idle* : Signifies that a packet is no longer present at the FOMAU's receive optical fiber.
- (13) *opt_input_coll_select* : Signifies that, during a collision, a packet has been received at the DO circuit within 3.5 bit times of a packet being received at the FOMAU's receive optical fiber, and that only the packet received at the FOMAU's receive optical fiber is to be transmitted into the DI circuit.
- (14) *output_coll_select* : Signifies that, during a collision, a packet has been received at the DO circuit within 3.5 bit times of the packet being received at the FOMAU's receive optical fiber, and that only the packet received at the DO circuit is to be transmitted into the DI circuit.

The following abbreviations have been used in Figs 9-6, 9-9, and 9-10:

- (1) LLP = Low Light Level Condition Present
- (2) LLNP = Low Light Level Condition Not Present
- (3) p_t_d = *packet_timer_done*
- (4) p_t_n_d = *packet_timer_not_done*
- (5) * = logical AND operator

9.9.3 FOMAU Electrical Characteristics

9.9.3.1 Electrical Isolation. Electrical isolation shall be provided between FOMAUs attached to the FOIRL by the optical fiber cable link segment. There shall be no conducting path between the optical medium connector plug and any conducting element within the optical fiber cable link segment. This isolation shall withstand at least one of the following electrical strength tests:

- (1) 1500 V rms at 50–60 Hz for 60 s, applied as specified in 5.3.2 of IEC Publication 950 [8].
- (2) 2250 V dc for 60 s, applied as specified in 5.3.2 of IEC Publication 950 [8].
- (3) A sequence of ten 2400 V impulses of alternating polarity, applied at intervals of not less than 1 s. The shape of the impulses shall be 1.2/50 μ s (1.2 μ s virtual front time, 50 μ s virtual time of half value), as defined IEC Publication 60 [11].

There shall be no isolation breakdown, as defined in 5.3.2 of IEC Publication 950 [8], during the test. The resistance after the test shall be at least 2 M Ω , measured at 500 V dc.

NOTE: Although isolation is provided by the optical fiber cable link segment, it is recommended that the normal noise immunity provided by common-mode isolation on the AUI be retained.

9.9.3.2 Power Consumption. The current drawn by the FOMAU shall not exceed 0.5 A when powered by the AUI source. The FOMAU shall be capable of operating from all possible voltage sources as supplied by the repeater unit (7.5.2.5 and 7.5.2.6) through the resistance of all permissible AUI cables. The surge current drawn by the FOMAU on power-up shall not exceed 5 A peak for a period of 10 ms. In addition, the FOMAU shall be capable of powering-up from 0.5 A current limited sources.

It is permissible as an option to provide a separate power source for the FOMAU. If a separate power source is implemented, provision will be made to assure that power shall under no circumstances be sourced on pin 13 (Circuit VP) of the AUI.

The FOMAU shall be labeled externally to identify the maximum value of power supply current required by the device when the AUI mechanical connection is implemented.

The FOMAU shall not introduce into the FOMAU's transmit optical fiber or onto the DI or CI circuits of the AUI any extraneous signal on routine power-up or power-down under normal operating conditions.

The FOMAU shall be fully functional no later than 0.5 s after power is applied to it.

9.9.3.3 Reliability. The FOMAU shall be designed to provide a MTBF of at least 200 000 hours of operation without causing a communication failure amongst DTEs attached to the network. The FOMAU electronics shall be designed to minimize the probability of component failures within the FOMAU that prevent communication amongst other MAUs on the 10BASE5 and 10BASE2 segments. Connectors and other passive means of connection shall be designed to minimize the probability of total network failure.

9.9.3.4 FOMAU/Repeater Unit Electrical Characteristics. The electrical characteristics of the driver and receiver components connected to the AUI cable shall be identical to those specified in Section 7.

9.9.3.5 FOMAU/Repeater Unit Mechanical Connection. The FOMAU, if it implements the AUI mechanical connection, shall be provided with a 15-pin male connector, as specified in the AUI specification of Section 7.

9.9.4 FOMAU/Optical Medium Interface

9.9.4.1 Transmit Optical Parameters

9.9.4.1.1 Wavelength. The center wavelength of the optical source emission shall be between 790 and 860 nm. See Appendix D.

9.9.4.1.2 Spectral Width. The spectral width of the optical source shall be less than 75 nm full width half maximum (FWHM).

9.9.4.1.3 Optical Modulation. The optical modulation during packet transmission shall be on-off keying of the optical source power. The minimum extinction ratio shall be 13 dB.

9.9.4.1.4 Optical Idle Signal. During the idle state of the DO circuit, the Transmit Function shall input into the FOMAU's transmit optical fiber an optical idle signal. This signal shall consist of a periodic pulse waveform of frequency 1 MHz $\pm 25\%$ -15% with a duty cycle ratio between 45/55 and 55/45.

9.9.4.1.5 Transmit Optical Logic Polarity. The higher optical power level transmitted into the FOMAU's transmit optical fiber shall correspond to the low (LO) logic state (see 7.4.2.1) of the AUI DO circuit.

9.9.4.1.6 Optical Rise and Fall Times. The optical rise and fall times of the FOMAU shall be no more than 10 ns from the 10% to the 90% levels. There shall be no more than 3 ns difference between the rise and fall times.

9.9.4.1.7 Transmit Optical Pulse Edge Jitter. The additional edge jitter introduced by the FOMAU from the input of the DO circuit receiver to the output of the electro-optic source shall be no more than 2 ns. The jitter measured at the input of the DO circuit receiver shall be measured at the zero crossing points, as determined from the previous 16 or more transitions in any valid bit stream. The jitter measured at the output of the electro-optic source shall be measured at the power level median of the optical waveform's upper and lower power levels, as determined from the previous 16 or more transitions in any valid optical bit stream.

9.9.4.1.8 Peak Coupled Optical Power. At the beginning of the FOMAU's lifetime, the peak optical power coupled into the FOMAU's transmit optical fiber, when terminated with an optical connector as specified in 9.9.5.2, shall be -12 dBm ± 2 dB, when measured with a graded index optical fiber of nominal dimension of 62.5 μ m core diameter and 0.275 nominal numerical aperture. The actual optical power, which will be coupled into other fiber sizes listed in 9.9.5.1, may differ from the above value. The peak optical power shall be measured in the steady state, and the measurement shall be independent of optical pulse ringing effects. Peak optical overshoot shall not exceed 10%.

NOTE: The above value does not include an aging margin. The source is allocated an aging margin of 3 dB over its operating lifetime. The variation in the peak-coupled optical power due to tolerances allowed by IEC Publication 783-2 [14]¹⁾ for type A1b (62.5/125 μ m) fiber is ± 1 dB. Hence, the minimum power level at the start of life will be -15 dBm.

9.9.4.2 Receive Optical Parameters

9.9.4.2.1 Receive Peak Optical Power Range. The BER shall be $< 10^{-10}$ for peak optical powers at the output of the FOMAU's receive optical fiber between -27 dBm and -9 dBm.

9.9.4.2.2 Receive Optical Pulse Edge Jitter. The additional edge jitter introduced by the FOMAU from the input of the opto-electric detector to the output of the DI circuit driver shall be no more than 4 ns. The jitter measured at the input of the opto-electric receiver shall be measured at the power level median of the optical waveform's upper and lower power levels as determined from the previous 16 or more transitions in any valid optical bit stream. The jitter measured at the output of the DI circuit driver shall be measured at the zero crossing points as determined from the previous 16 or more transitions in any valid bit stream. This requirement shall apply when the optical receive peak power level is in the range -27 to -9 dBm.

9.9.4.2.3 Receive Optical Logic Polarity. The low (LO) logic state (see 7.4.2.1) on the DI circuit shall correspond to the presence of the higher optical power level at the output of the FOMAU's receive optical fiber.

9.9.5 Characteristics of the Optical Fiber Cable Link Segment. The optical fiber cable link segment is a length of optical fiber cable (IEC Publications 794-1 [15] and 794-2 [16]) containing two optical fibers, as specified in 9.9.5.1, and comprising one or more optical fiber cable sections and their means of

¹⁾This FOIRL specification is to be read with the understanding that the following changes to IEC Publications 783-2 [14] have been requested:

(1) Correction of the numerical aperture tolerance in Table III to ± 0.015 .

(2) Addition of another bandwidth category, of > 180 MHz referred to 1 km, for the type A1b fiber in Table III.

interconnection. Each optical fiber is terminated at each end in the optical connector plug specified in 9.9.5.2. The two optical fibers correspond to the FOMA's transmit and receive optical fibers.

9.9.5.1 Optical Fiber Medium. The FOMA can operate with a variety of optical fiber sizes, e.g., 50/125 μm , 62.5/125 μm , 85/125 μm , 100/140 μm .

Interoperability of FOMAs that originate from different manufacturers, using any of these fiber sizes, is assured provided that the received peak optical power is between -27 dBm and -9 dBm and the optical fiber cable link segment bandwidth is greater than or equal to 150 MHz.

In order to satisfy the above attenuation and bandwidth criteria for all allowable FOIRL lengths, and assuming up to 4 dB of connection losses within the optical fiber cable link segment, it is recommended that the cabled optical fiber have an attenuation ≤ 4 dB/km and a bandwidth of ≥ 150 MHz referred to 1 km at a wavelength of 850 nm.

The total incremental optical pulse edge jitter introduced by the optical fiber cable link segment shall be less than 1 ns when driven by an optical transmitter as specified in 9.9.4.1. The pulse delay introduced by the optical fiber cable shall not exceed 50 bit times for a 1 km length.

In the specific case of 62.5/125 μm fiber, to ensure interoperability of FOMAs that originate from different manufacturers:

- (1) The two cabled optical fibers contained in the optical fiber cable link segment shall satisfy the optical fiber parameters specified in IEC Publication 793-2 [14] type A1b (62.5/125 μm),¹² and
- (2) The optical fiber cable link segment shall have an attenuation less than or equal to 8 dB and a bandwidth greater than or equal to 150 MHz.

9.9.5.2 Optical Medium Connector Plug and Socket. The two optical fibers contained in the optical fiber cable link segment shall be terminated at each end in an optical connector plug as specified in IEC Publications 874-1 [18] and 874-2 [19].

The corresponding mating connector socket shall conform with the specifications given in IEC Publications 874-1 and 874-2. This document specifies the mechanical mating face dimensions to ensure mechanical intermateability without physical damage, of all F-SMA connectors covered by the document. In addition, the optical insertion loss when interconnecting two optical connector plugs shall not exceed 2.5 dB (measured using a socket adaptor conforming to the mechanical specifications given in IEC Publications 874-1 and 874-2 and also using two identical fibers, as specified in 9.9.5.1, assuming uniform mode distribution launch conditions).

9.9.6 System Requirements

9.9.6.1 Optical Transmission System Considerations. 9.9.4.2.1 specifies that the BER shall be $< 10^{-10}$ for peak optical powers at the output of the FOMA's receive optical fiber between -27 dBm and -9 dBm. The value of -9 dBm corresponds to the maximum allowable peak optical power that can be coupled into the worst-case optical fiber specified in 9.9.5.1 at the beginning of the FOMA's lifetime (see 9.9.4.1.8), and assumes zero optical loss between the optical source output and the optical detector input.

The value of -27 dBm is calculated by subtracting the FOIRL flux budget from the minimum allowable peak optical power that can be coupled into the FOMA's transmit optical fiber at the beginning of the FOMA's lifetime (see 9.9.4.1.8). The flux budget is the maximum loss allowed within the FOIRL to guarantee a BER $< 10^{-10}$ assuming worst-case link components. A portion of the flux budget has been allocated as a design margin to allow for degradation and tolerance effects in the optical source. This is noted in the table below as the optical source lifetime degradation. The remaining flux budget of 9 dB assumes a system margin allowance for the optical fiber cable link segment over its lifetime, and may be allocated to the optical fiber cable link segment loss at the discretion of the network planner/installer. The following summarizes the allocated optical flux budgets for the example graded index optical fiber of worst-case dimensions 62.5 μm - 3 μm (i.e., 59.5 μm) core diameter and 0.275 - 0.015 (i.e., 0.260) numerical aperture:

¹²This FOIRL specification is to be read with the understanding that the following changes to IEC Publication 793-2 [14] have been requested:

- (1) Correction of the numerical aperture tolerance in Table III to ± 0.015 .
- (2) Addition of another bandwidth category, of > 150 MHz to 1 km, for the type A1b fiber in Table III.

Start of life minimum peak coupled optical power (9.9.4.1.8)	: -15 dBm
Optical source lifetime degradation	: 3 dB
Maximum optical fiber cable link segment loss including system margin allowance	: 9 dB
Resultant required receive peak optical power	: -27 dBm

9.9.6.2 Timing Considerations. Table 9-1 summarizes the maximum allowable timing budget contributions to the system timing budget for the FOIRL. The last bit in to last bit out delay shall equal the Steady-State Propagation Delay.

Table 9-1
Maximum Allowable Timing Budget Contributions to the FOIRL System Timing Budget

Symbol	Function	Bit Loss (bit times)	Invalid Bits (bit times)	Steady-State Propagation Delay (bit times)	Start-Up Delay (bit times)
I1	OPTICAL DATA IN ASSERT-INPUT	2.0	3.0	0.5	3.5
I2	OUTPUT-OPTICAL DATA OUT ASSERT	2.0	1.0	0.5	3.5
LOOP BACK	DO CIRCUIT ASSERT ->DI CIRCUIT ASSERT	5.0	1.0	1.0	7.0
I3	OPTICAL COLLISION ->SQE ASSERT	---	---	---	3.5
I4	COLLISION DEASSERT ->SQE DEASSERT	---	---	---	7.0*
A1	AUI Propagation	---	---	2.57	2.57
F1	Optical Fiber Propagation per Kilometer	---	---	50	50

*Minimum Start-up Delay for I4 is 4.5 bit times.

9.9.7 Environmental Specifications

9.9.7.1 Safety Requirements

9.9.7.1.1 Electrical Safety. A major application for the vendor-independent FOIRL is for interconnecting 10BASE5 and/or 10BASE2 coaxial cable segments located within different buildings. The level of isolation provided by the optical fiber cable link segment shall be consistent with this application and provide adequate personnel and equipment safety from earth faults and lightning strike hazards.

9.9.7.1.2 Optical Source Safety. The recommendations of IEC 825 Publication [17], if applicable, shall be adhered to in determining the optical source safety and user warning requirements.

9.9.7.2 Electromagnetic Environment

9.9.7.2.1 Susceptibility Levels. Sources of interference from the environment include electromagnetic fields, electrostatic discharge, and transient voltages between earth connections. Several sources of interference contribute to voltage between the optical fiber cable link segment (either a metallic strength member in the cable, a metallic optical connector plug, or the outermost conducting element of the FOMAU for the case of no metallic strength member) and the earth connection of a DTE.

For information on limits and methods of measurements of radio interference characteristics of information technology equipment, see 1.3 in CISPR Publication 22 [1].

The physical channel hardware shall meet its specifications when operating in both of the following conditions:

- (1) Ambient plane wave field of 2 V/m from 10 kHz through 30 MHz and 5 V/m from 30 MHz through 1 GHz.

NOTE: These are the levels typically found 1 km from radio broadcast stations.

- (2) Interference source voltage of 15.8 V peak sine wave of frequency 10 MHz in series with a 50 Ω source resistance applied between the optical fiber cable link segment (either a metallic strength member in the cable, a metallic optical connector plug, or the outermost conducting element of the FOMAU for the case of no metallic strength member) and the earth connection of a DTE.

NOTE: The optical fiber link segment is capable of withstanding higher levels of electromagnetic interference. The above specifications are the minimum requirements for the environment in which the FOMAU is required to operate.

9.9.7.2.3 Emission Levels. The FOMAU and optical fiber cable link segment shall comply with CISPR Publication 22 [1].

9.9.7.3 Temperature and Humidity. The FOMAU and associated connector/cable systems are expected to operate over a reasonable range of environmental conditions related to temperature, humidity, and physical handling such as shock and vibration. Specific requirements and values for these parameters are beyond the scope of this standard. Manufacturers should indicate in the literature associated with the FOMAU (and on the FOMAU if possible) the operating environment specifications to facilitate selection, installation, and maintenance of these components. It is further recommended that such specifications be stated in standard terms, as specified in IEC Publications 68 [12], IEC 793-1 [13], IEC 794-1 [15], and IEC 874-1 [18].

10. Medium Attachment Unit and Baseband Medium Specifications, Type 10BASE2

10.1 Scope

10.1.1 Overview. This standard defines the functional, electrical, and mechanical characteristics of the Medium Attachment Unit (MAU) and one specific medium for use with local area networks. The relationship of this specification to the entire CSMA/CD Local Area Network Specification is shown in Fig 10-1.

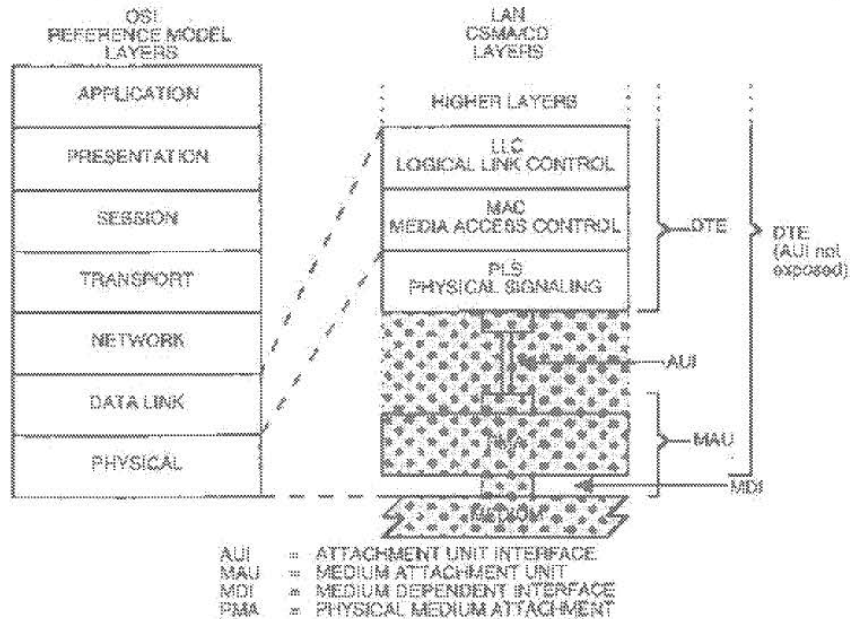

Fig 10-1

Physical Layer Partitioning, Relationship to the ISO Open Systems Interconnection (OSI) Reference Model

The purpose of the MAU is to provide a simple, inexpensive, and flexible means of attaching devices to the local area network medium. This standard defines a means of incorporating the MAU function within the DTE and bringing the trunk coaxial cable directly to the DTE. Interconnection of DTE units is easily achieved by the use of industry standard coaxial cables and BNC connectors.

This MAU and medium specification is aimed primarily at applications where there are a relatively small number of devices located in a work area. Installation and reconfiguration simplicity is achieved by the type of cable and connectors used. An inexpensive implementation is achieved by eliminating the MAU and Attachment Unit Interface (AU) as separate components and using widely available interconnection components.

10.1.1.1 Medium Attachment Unit (normally contained within the data terminal equipment (DTE)). The MAU has the following general characteristics:

- (1) Enables coupling the PLS to the explicit baseband coaxial transmission system defined in this section of the standard.
- (2) Supports message traffic at a data rate of 10 megabits per second (Mb/s).
- (3) Provides for driving up to 185 m (600 ft) coaxial trunk cable segment without a repeater.
- (4) Permits the DTE to treat the MAU and the medium itself.

- (5) Supports system configurations using the CSMA/CD access mechanism defined in the ISO (IEEE) Local Area Network Specification.
- (6) Supports a bus topology interconnection means.
- (7) Supports low-cost capability by incorporating the MAU function within the physical bounds of the DTE, thereby eliminating the need for a separate AU connector and cable but containing the remaining AU interface functionality.

10.1.1.2 Repeater Unit. The Repeater Unit is used to extend the physical system topology and provides for coupling two or more coaxial trunk cable segments. Multiple Repeater Units are permitted within a single system to provide the maximum trunk cable connection path specified in 10.7. The repeater is not a DTE and therefore has slightly different attachment requirements.

10.1.2 Definitions. This section defines the specialized terminology applicable to MAUs and Repeater Units.

Attachment Unit Interface (AUI). In a local area network, the interface between the Medium Attachment Unit (MAU) and the data terminal equipment within a data station.

baseband coaxial system. A system whereby information is directly encoded and impressed on the coaxial transmission medium. At any point on the medium only one information signal at a time can be present without disruption.

carrier sense. In a local area network, an ongoing activity of a data station to detect whether or not another station is transmitting.

NOTE: A collision presence signal is provided by the PLS to the PMA sublayer to indicate that one or more stations are currently transmitting on the trunk coaxial cable.

coaxial cable section. A single length of coaxial cable terminated at each end with a BNC male connector. Cable sections are joined to other cable sections via BNC plug/receptacle barrel or Type T adapters.

coaxial cable segment. A length of coaxial cable made up from one or more coaxial cable sections and coaxial connectors, terminated at each end in its characteristic impedance.

collision. An unwanted condition that results from concurrent transmission on the physical medium.

collision presence. A signal provided by the PLS to the PMA sublayer (within the Data Link Layer) to indicate that multiple stations are contending for access to the transmission medium.

Medium Attachment Unit (MAU). In a local area network, a device used in a data station to couple the data terminal equipment (DTE) to the transmission medium.

Medium Dependent Interface (MDI). The mechanical and electrical interface between the trunk cable medium and the MAU.

Physical Medium Attachment (PMA). The portion of the MAU that contains the functional circuitry.

Physical Signaling Sublayer (PLS). The portion of the Physical Layer, contained within the DTE, that provides the logical and functional coupling between MAU and Data Link Layers.

repeater. A device used to extend the length, topology, or interconnectivity of the physical medium beyond that imposed by a single segment, up to the maximum allowable end-to-end trunk transmission line length. Repeaters perform the basic actions of restoring signal amplitude, waveform, and timing applied to normal data and collision signals.

trunk cable. The trunk coaxial cable system.

NOTE: For additional definitions, see 8.1.2.

10.1.3 Application Perspective: MAU and Medium Objectives. This section states the broad objectives and assumptions underlying the specifications defined throughout Section 10 of the standard.

10.1.3.1 Object

- (1) Provide the physical means for communication between local network Data Link entities.

NOTE: This specification covers a portion of the Physical Layer as defined in the OSI Reference Model and, in addition, the physical medium itself, which is beyond the scope of the OSI Reference Model.

- (2) Define a physical interface that can be implemented independently among different manufacturers of hardware and achieves the intended level of compatibility when interconnected in a common local network.
- (3) Provide a communication channel capable of high bandwidth and low bit error rate performance. The resultant mean bit error rate, at the Physical Layer service interface, should be less than one part in 10^7 (on the order of one part in 10^8 at the link level).
- (4) Provide for ease of installation and service.
- (5) Provide for high network availability (ability of a station to gain access to the medium and enable the Data Link connection in a timely fashion).
- (6) Enable low-cost implementations.

NOTE: The figures and numerous textual references throughout the section refer to terminology associated with the AUI (that is, DO, DI, CI). Since the normal embodiment of the Type 10BASE2 configuration does not require an AUI, actual existence of the DO, DI, CI circuit may not be required. Use of this terminology, however, is retained throughout Section 10 for purposes of clarity and consistency.

10.1.3.2 Compatibility Considerations. All implementations of this baseband coaxial system shall be compatible at the Medium Dependent Interface (MDI).

This standard provides one explicit trunk cable medium specification for the interconnection of all MAU devices. The medium itself, and the functional capability of the MAU, are defined to provide the highest possible level of compatibility among devices designed by different manufacturers. Designers are free to implement circuitry within the MAU in an application-dependent manner provided the MDI specifications are satisfied.

10.1.3.3 Relationship to PLS and AUI. This section defines the Primary Physical Layer for the local area network, a layer comprised of both the physical medium and the rudimentary circuitry necessary to couple a station's message path directly to/from the medium. The complete Logical Physical Layer of the local area network resides within the DTE. Therefore, a close relationship exists between this section and Section 7. This section specifies the physical medium parameters, the PMA logical functions residing in the MAU, and references the signal circuits associated with the AUI as defined in Section 7.

The design of a MAU component requires the use of both this section and parts of the PLS and AUI specifications contained in Section 7.

10.1.3.4 Mode of Operation. The MAU functions as a direct connection between the baseband medium and the DTE. Data from the DTE is output to the coaxial trunk medium and all data on the coaxial trunk medium is input to the DTE.

10.2 References. References to such local or national standards that may be useful resource material for the reader are identified and located in the Annex at the end of this book.

10.3 MAU Functional Specifications. The MAU component provides the means by which signals on the three AUI signal circuits to/from the DTE and their associated interlayer messages are coupled to the single coaxial cable baseband signal line. To achieve this basic objective, the MAU component contains the following functional capabilities to handle message flow between the DTE and the baseband medium:

- (1) Transmit Function. The ability to transmit serial data bit streams on the baseband medium from the local DTE entity to one or more remote DTE entities on the same network.
- (2) Receive Function. The ability to receive serial data bit streams over the baseband medium.
- (3) Collision Presence Function. The ability to detect the presence of two or more stations' concurrent transmissions.

- (4) Jabber Function. The ability to automatically interrupt the Transmit Function and inhibit an abnormally long output data stream.

10.3.1 MAU Physical Layer Functional Requirements

10.3.1.1 Transmit Function Requirements. At the start of a frame transmission on the coaxial cable, no more than 2 bits (2 full bit cells) of information may be received from the DO circuit and not transmitted onto the coaxial medium. In addition, it is permissible for the first bit sent to contain invalid data or timing; however, all successive bits of the frame shall be reproduced with no more than the specified amount of jitter. The 4th bit cell shall be carried from the DO signal line and transmitted onto the coaxial trunk cable medium with the correct timing and signal levels. The steady-state propagation delay between the DO circuit receiver input and the coaxial cable output shall not exceed 1/2 bit cell. There shall be no logical signal inversions between the branch cable DO circuit and the coaxial trunk cable (for example, a "high" logic level input to the MAU shall result in the less negative current flow value on the trunk coaxial medium). A positive signal on the A signal lead of the DO circuit shall result in a more positive voltage level on the trunk coaxial medium. It is assumed that the AUI shall provide adequate protection against noise. It is recommended that the designer provide an implementation in which a minimum threshold signal is required to establish a transmit bit stream.

The Transmit Function shall output a signal on the trunk coaxial medium whose levels and waveform comply with 10.4.1.3.

In addition, when the DO circuit has gone idle after a frame is output, the MAU shall then activate the Collision Presence Function as close to the trunk coaxial cable as possible without introducing an extraneous signal on the trunk coaxial medium. The MAU shall initiate the Collision Presence state within 0.6 μ s to 1.6 μ s after the Output Idle signal (Wait_Timer_Done in Fig 10-2) and shall maintain an active Collision Presence state for a time equivalent to 10 ± 5 bit cells.

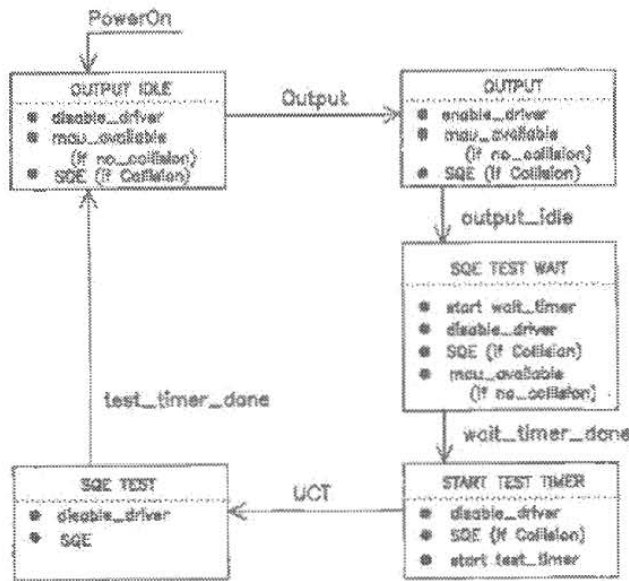

(UCT = unconditional transition)
(Wait_Timer_Done is specified in 10.3.1.1)

Fig 10-2
MAU Interface Function

10.3.1.2 Receive Function Requirements. The signal from the coaxial trunk cable shall be ac-coupled before reaching the receive DI circuit. The Receive Function shall output a signal onto the DI circuit that complies with the specification for drivers in MAUs (7.5).

At the start of a frame reception from the coaxial cable, no more than 5 bits (5 full bit cells) of information may be received from the coaxial cable and not transmitted onto the receive DI circuit. In addition, it is permissible for the first bit sent over the receive circuit to contain invalid data or timing; however, all successive bits of the frame shall reproduce the incoming signal with no more than the amount of jitter specified below. This implies that the 7th bit cell presents valid data to the PLS. The steady-state propagation delay between the coaxial cable and the receive DI circuit output shall not exceed 1/2 bit cell. There are no logical signal inversions between the coaxial (trunk) cable and the MAU receive circuit.

A MAU meeting this specification shall exhibit edge jitter into the DI pair when terminated in the appropriate test load specified in 7.4.1.1, of no more than 7.0 ns in either direction when it is installed on the distant end of all lengths up to 185 m (600 ft) of the cable specified in 10.5.1.1 through 10.5.2.1.5 terminated at both ends with terminators meeting the impedance requirements of 10.6.2.1 and driven at one end with pseudorandom Manchester encoded binary data from a data generator that exhibits no more than 1.0 ns of edge jitter in either direction on half bit cells of exactly 1/2 BT and whose output meets the specifications of 10.4.1.3 except that the rise time of the signal shall be $30 \text{ ns} + 0, - 2 \text{ ns}$. The combination of coaxial cable and MAU receiver introduce no more than 6 ns of edge jitter into the system.

The local Transmit and Receive Functions shall operate simultaneously while connected to the medium.

10.3.1.3 Collision Presence Function Requirements. The signal presented to the CI circuit in the absence of a collision shall be the IDL signal.

The signal presented to the CI circuit during the presence of a collision shall be the CS0 signals encoded as specified in 7.3.1.2. This signal shall be presented to the CI circuit no more than 9 bit times after the signal (that is, dc average) on the coaxial cable at the MAU equals or exceeds that produced by two (or more) MAU outputs transmitting concurrently under the condition that the MAU detecting collision presence is transmitting. Under no conditions shall the Collision Presence Function generate an output when only one MAU is transmitting. A MAU, while not transmitting, may detect the presence of two other MAUs transmitting and shall detect the presence of more than two other MAUs transmitting. Table 10-1 summarizes the allowable conditions under which collisions shall be detected.

The collision presence function may, in some implementations, be able to sense an abnormal (for example, open) medium.

The use of MAUs in repeaters requires additional considerations; see 10.4.1.5

Table 10-1
Generation of Collision Presence Signal

MAU	Numbers of Transmitters		
	<2	=2	>2
Transmitting	N	Y	Y
Not Transmitting	N	May	Y

Y = will generate SQE message
 N = will not generate SQE message
 May = may generate SQE message

10.3.1.4 Jabber Functional Requirements. The MAU shall contain the capability as defined in Fig 10-3 to interrupt a transmission from a DO circuit that exceeds a time duration determined by the MAU. This time duration shall not be less than 20 ms nor more than 150 ms. If the frame being transmitted continues longer than the specified time duration, the MAU shall inhibit transmission and assume its not-transmitting state on the coaxial cable.

When the Transmit Function has been positively disabled, the MAU shall then activate the Collision Presence Function without introducing an extraneous signal on the trunk coaxial medium. A MAU may reset the Jabber and Collision Presence Functions on power reset once the error condition has been cleared. Alternately, a MAU may reset these functions automatically after a period of $0.5 \text{ s} \pm 50\%$.

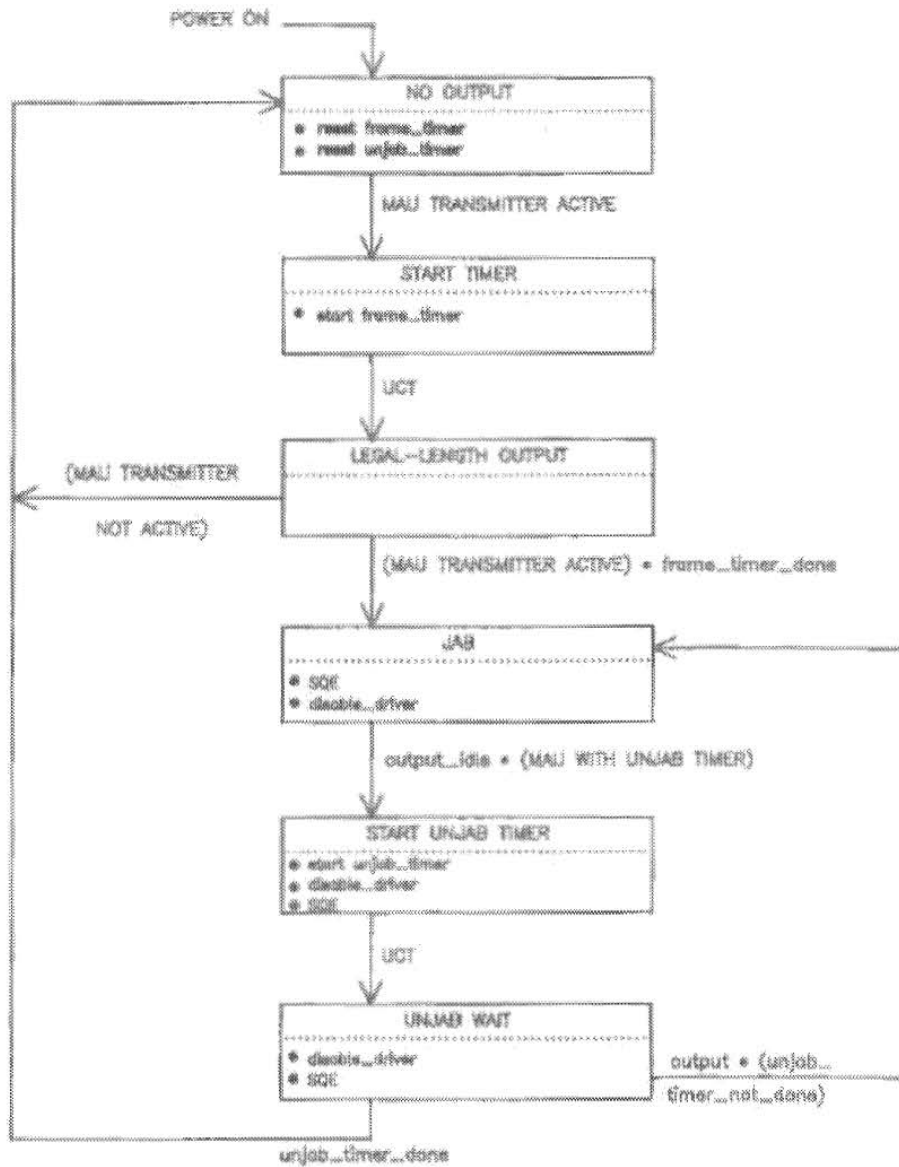

(Figure 10-3 outputs override those in Fig 10-2
Optional states: START UNJAB TIMER, UNJAB WAIT)

**Fig 10-3
Jabber Function State Diagram**

10.3.2 MAU Interface Messages

10.3.2.1 DTE to MAU Messages. The following messages can be sent by the DTE Physical Layer (PLS Sublayer) Entities to the MAU Entities:

Message	Circuit	Signal	Meaning
<i>output</i>	DO	CD1, CD0	Output information
<i>output_IDL</i>	DO	IDL	No data to be output

10.3.2.2 MAU to DTE Messages. The following messages can be sent by the MAU Physical Layer Entities to the DTE Physical Layer Entities:

Message	Circuit	Signal	Meaning
<i>input</i>	DI	CD1, CD0*	Input information
<i>input_idle</i>	DI	IDL	No information to be input
<i>mau_available</i>	CI	IDL	MAU is available for output
<i>SQE</i>	CI	CSQ	Error detected by MAU

*It is assumed that no retiming of these clocked data signals takes place within the MAU.

10.3.2.2.1 *input* Message. The MAU sends an input message to the DTE Physical Layer when the MAU has a bit of data to send to the DTE. The physical realization of the input message is a CD0 or CD1 sent by the MAU to the DTE on the Data In circuit. The MAU sends CD0 if the input bit is a zero or CD1 if the input bit is a one. No retiming of the CD1 or CD0 signals takes place within the MAU.

10.3.2.2.2 *input_idle* Message. The MAU sends an *input_idle* message to the DTE Physical Layer when the MAU does not have data to send to the DTE. The physical realization of the *input_idle* message is the IDL signal sent by the MAU to the DTE on the Data In circuit.

10.3.2.2.3 *mau_available* Message. The MAU sends the *mau_available* message to the DTE Physical Layer when the MAU is available for output. The *mau_available* message is always sent by a MAU that is always prepared to output data unless the *SQE* message should be sent instead. Such a MAU does not require *mau_request* to prepare itself for data output. The physical realization of the *mau_available* message is an IDL signal sent by the MAU to the DTE on the Control In circuit.

10.3.2.2.4 *signal_quality_error* (SQE) Message. The SQE message shall be implemented in the following fashion:

- (1) The SQE message shall not be sent by the MAU if no or only one MAU is transmitting on the trunk coaxial medium.
- (2) If more than two remote MAUs are transmitting on the trunk coaxial medium, but the MAU connected to the local DTE is not transmitting, then the local MAU shall send the SQE message. In every instance when more than one MAU is transmitting on the coaxial medium, the MAU shall make the best determination possible. It is acceptable for the MAU to fail to send the SQE message when it is unable to conclusively determine that more than one MAU is transmitting.
- (3) When the local MAU is transmitting on the trunk coaxial medium, all occurrences of one or more additional MAUs transmitting shall cause the SQE to be sent by the local MAU to its DTE.
- (4) When the MAU has completed each output frame it shall perform an SQE test sequence. Note that MAUs associated with repeaters shall not generate the SQE test sequence.
- (5) When the MAU has inhibited the Transmit Function, it shall send the SQE message in accordance with the Jabber Function requirements of 10.3.1.4 and Fig 10-3.

The SQE message shall be asserted less than 9 bit cells after the occurrence of the multiple-transmission condition is present at the Medium Dependent Interface (MDI) and shall no longer be asserted within 30 bit cells after the indication of multiple transmissions ceases to be present at the MDI. It is to be noted

that an extended delay in the removal of the SQE message may adversely affect the access method performance.

The physical realization of the SQE message is the CS0 signal sent by the MAU to the DTE physical layers on the Control In circuit.

NOTE: The MAU is required to assert the SQE at the appropriate times whenever the MAU is powered and not just when the DTE physical layer is providing data output.

10.3.3 MAU State Diagrams. The state diagrams, Figs 10-2 and 10-3, depict the full set of allowed MAU state functions relative to the control circuits of the DTE-MAU interface for MAUs without conditioning requirements. Messages used in these state diagrams are explained below:

enable_driver. Activates the path employed during normal operation to cause the MAU transmitter to impress data onto the trunk coaxial medium.

disable_driver. Deactivates the path employed during normal operation to cause the MAU transmitter to impress data onto the trunk coaxial medium.

no_collision. Signifies that the condition of multiple transmitters simultaneously active on the trunk coaxial medium does not exist.

collision. Signifies that the condition of multiple transmitters simultaneously active on the trunk coaxial medium does exist.

frame_timer. Measures the time the MAU transmits on the trunk coaxial cable.

test_timer. Measures the length of the SQE Test.

unjab_timer. Measures the amount of time the MAU has been in Jab mode.

wait_timer. Measures the time between output idle and the start of the SQE Test.

10.4 MAU-Medium Electrical Characteristics

10.4.1 MAU-to-Coaxial Cable Interface. The following subsections describe the interface between the MAU and the coaxial cable. Negative current is defined as current into the MAU (out of the center conductor of the cable).

10.4.1.1 Input Impedance. The shunt capacitance presented to the coaxial cable by the MAU circuitry (not including the means of attachment to the coaxial cable) is recommended to be not greater than 6 pF. The magnitude of the reflection from a MAU plus the cable connection specified in 10.6.3 shall not be more than that produced by an 8 pF capacitance when measured by both a 25 ns rise time and 25 ns fall time waveform. The resistance presented to the coaxial cable shall be greater than 100 k Ω .

These conditions shall be met in both the power-off and power-on, not-transmitting states.

10.4.1.2 Bias Current. The MAU must draw (from the cable) between +2 μ A and - 25 μ A in the power-off and the power-on, not-transmitting states.

10.4.1.3 Coaxial Cable Signaling Levels. The signal on the coaxial cable due to a single MAU as measured at the MAU's transmitter output is composed of an ac component and an offset component. Expressed in terms of current (immediately adjacent to the MAU connection (just prior to splitting the current flow in each direction), the signal has an offset component (average dc current, including the effects of timing distortion) of from - 37 mA min to - 45 mA max and an ac component from \pm 28 mA up to the offset value.

The current drive limit shall be met even in the presence of one other MAU transmitter. The MAU shall be capable of generating at least 2.2 V of average dc level on the coaxial cable in the presence of two or

more other MAUs transmitting concurrently. The MAU shall, in addition, sink no more than $\pm 280 \mu\text{A}$ when the voltage on the center conductor of the cable drops to -10 V when the MAU is transmitting.

The actual current measured at a given point on the cable is a function of the transmitted current and the cable loss to the point of measurement. Negative current is defined as current out of the center conductor of the cable (into the MAU). The 10–90% rise/fall times shall be $25 \pm 5 \text{ ns}$ at 10 Mb/s. The rise and fall times must match within 2 ns. Figure 10-4 shows typical waveforms present on the cable. Harmonic content generated from the 10 MHz fundamental periodic input shall meet the following requirements:

- Second and Third Harmonics: At least 20 dB below fundamental
- Fourth and Fifth Harmonics: At least 30 dB below fundamental
- Sixth and Seventh Harmonics: At least 40 dB below fundamental
- All Higher Harmonics: At least 50 dB below fundamental

NOTE: Even harmonics are typically much lower.

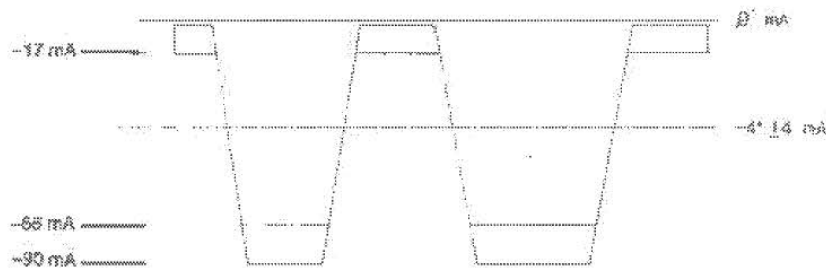
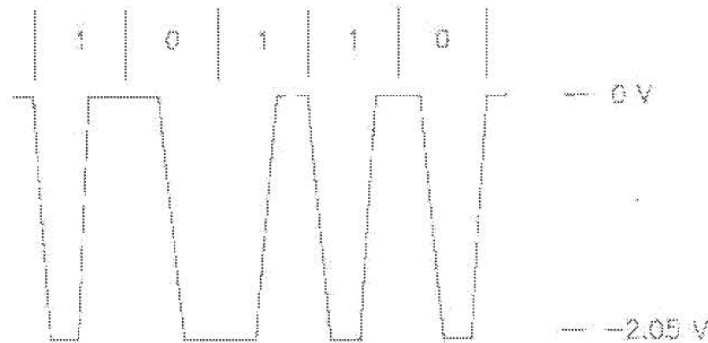

Fig 10-4
Driver Current Signal Levels

The above specifications concerning harmonics cannot be satisfied by a square wave with a single-pole filter, nor can they be satisfied by an output waveform generator employing linear ramps without additional waveshaping. The signals, as generated from the encoder within PLS, shall appear on the coaxial cable without any inversions (see Fig 10-5).



- NOTE: (1) Voltages given are nominal, for a single transmitter.
 (2) Rise time is 25 ns nominal at 10 Mb/s rate.
 (3) Voltages are measured on terminated coaxial cable adjacent to transmitting MAU.
 (4) Manchester coding.

Fig 10-5
Coaxial Trunk Cable Signal Waveform

10.4.1.4 Transmit Output Levels Symmetry. Signals received from the DO circuit must be transmitted onto the coaxial cable with the characteristics specified in 10.4.1.3. Since the coaxial cable proceeds in two directions from the MAU, the current into the MAU is nominally twice the current measured on the coaxial cable.

The output signal of a MAU meeting this specification shall exhibit edge jitter of no more than 2.5 ns into a $25 \Omega \pm 1\%$ resistor substituted for the connection to the coaxial cable when the DO circuit into the MAU is driven with pseudo-random Manchester encoded binary data from a data generator that exhibits no more than 0.5 ns of edge jitter on half bit cells of exactly 1/2 BT, whose output meets the specifications of 7.4.1.1 through 7.4.1.5. The above specified component shall not introduce more than 2 ns of edge jitter into the system.

The MAU shall not transmit a negative going edge after cessation of the CD output data stream or before the first valid edge of the next frame.

10.4.1.5 Collision Detect Thresholds. For receive mode collision detection the MAU shall have its collision detection threshold set in the range -1404 mV and -1581 mV. These limits take account of up to 8% collision detect filter impulse response. If a specific filter implementation has a higher value of impulse response, the lower threshold limit of -1404 mV is required to be replaced by 1300 mV \times $(1 + \text{impulse response})$.

Receive mode collision detection indicates that a nontransmitting MAU has the capability to detect collisions when two or more MAUs are transmitting simultaneously.

MAUs included with repeater sets are required to implement receive mode collision detection.

When receive mode collision detection is not implemented, the upper limit of -1581 mV may be relaxed to -1782 mV.

NOTE: The above threshold limits are measured at the coaxial cable center conductor with respect to the shield at the MAU connector. The MAU designer must take into account circuit offsets, low-frequency noise (for example, 50 Hz, 60 Hz), and 5 MHz ripple at the filter output in determining the actual internal threshold value and its tolerance.

10.4.2 MAU Electrical Characteristics

10.4.2.1 Electrical Isolation. The MAU must provide isolation between the DTE Physical Layer circuits and the coaxial trunk cable. The isolation impedance measured between any conductor in the DTE Physical Layer circuitry and either the center conductor or shield of the coaxial cable shall be greater than 250 k Ω at 50 Hz, 60 Hz. In addition, the isolation impedance between the DTE ground and the coaxial cable shield shall be less than 15Ω between 3 MHz and 30 MHz. The isolation means provided shall withstand 500 V ac, rms for one minute.

10.4.2.2 Power Consumption. The current drawn by the MAU shall not exceed 0.5 A if powered by the AUI source. The MAU shall be capable of operating from all permissible voltage sources as supplied by the DTE through the resistance of all permissible AUI cables. The MAU shall not disrupt the trunk coaxial medium should the DTE power source fall below the minimum operational level under abnormal MAU load conditions.

The MAU shall be labeled externally to identify the maximum value of current required by the device. This requirement only applies to MAUs that are external to DTEs.

10.4.2.3 Reliability. The MAU shall be designed to provide an MTBF of at least 100 000 hours of continuous operation without causing communication failure among other stations attached to the local network medium. Component failures within the MAU electronics should not impede the communication among other MAUs on the coaxial cable. Connectors and other passive components comprising the means of connecting the MAU to the coaxial cable shall be designed to minimize the probability of total network failure.

It should be noted that a fault condition that causes a MAU to draw in excess of 2 mA from the coaxial cable may cause communication failure among other stations.

10.4.3 MAU-DTE Electrical Characteristics. If the AUI is exposed, the electrical characteristics for the driver and receiver components connected between the DTE Physical Layer circuitry and the MAU shall be identical with those as specified in Section 7 of this standard.

10.5 Characteristics of Coaxial Cable System. The trunk cable is of constant impedance, coaxial construction. It is terminated at each of the two ends by a terminator (see 10.6.2), and provides the transmission path for connection of MAU devices. Coaxial cable connectors are used to make the connection from the cable to the terminators and between cable sections. The cable has various electrical and mechanical requirements that shall be met to ensure proper operation.

10.5.1 Coaxial Cable Electrical Parameters. The parameters specified in 10.5.1 are met by cable types RG 58 A/U or RG 58 C/U.

10.5.1.1 Characteristic Impedance. The average characteristic cable impedance shall be $50 \pm 2 \Omega$. Periodic variations in impedance along a single piece of cable may be up to $\pm 3 \Omega$ sinusoidal, centered around the average value, with a period of less than 2 m.

10.5.1.2 Attenuation. The attenuation of a 185 m (600 ft) cable segment shall not exceed 8.5 dB measured at 10 MHz, or 6.0 dB measured at 5 MHz.

10.5.1.3 Velocity of Propagation. The minimum required velocity of propagation is 0.65 c.

10.5.1.4 Edge Jitter; Entire Segment without DTEs Attached. A coaxial cable segment meeting this specification shall exhibit edge jitter of no more than 8.0 ns in either direction at the receiving end when 185 m (600 ft) of the cable is terminated at both ends with terminators meeting the impedance requirements of 10.6.2.1 and is driven at one end with pseudorandom Manchester encoded binary data from a data generator that exhibits no more than 1.0 ns of edge jitter in either direction on half bit cells of exactly $\frac{1}{2}$ BT and whose output meets the specifications of 10.4.1.3, except that the rise time of the signal must be $30 \text{ ns} + 0, - 2 \text{ ns}$, and no offset component in the output current is required. This test shall be conducted in a noise-free environment. The above specified component is not to introduce more than 7 ns of edge jitter into the system.

10.5.1.5 Transfer Impedance. The coaxial cable medium shall provide sufficient shielding capability to minimize its susceptibility to external noise and also to minimize the generation of interference by the medium and related signals. While the cable construction is not mandated, it is necessary to indicate a measure of performance expected from the cable component. A cable's EMC performance is determined, to a large extent, by the transfer impedance value of the cable.

The transfer impedance of the cable shall not exceed the values shown in Fig 10-6 as a function of frequency.

10.5.1.6 Cable DC Loop Resistance. The sum of the center conductor resistance plus the shield resistance measured at 20 °C shall not exceed 50 m Ω /m.

10.5.2 Coaxial Cable Physical Parameters

10.5.2.1 Mechanical Requirements. The cable used should be suitable for routing in various environments, including but not limited to, dropped ceilings, raised floors, and cable troughs as well as throughout open floor space. The jacket shall provide insulation between the cable sheath and any building structural metal. Also, the cable shall be capable of accepting coaxial cable connectors, described in 10.6. The cable shall conform to the following requirements.

10.5.2.1.1 General Construction

- (1) The coaxial cable shall consist of a center conductor, dielectric, shield system, and overall insulating jacket.
- (2) The coaxial cable shall be sufficiently flexible to support a bend radius of 5 cm.

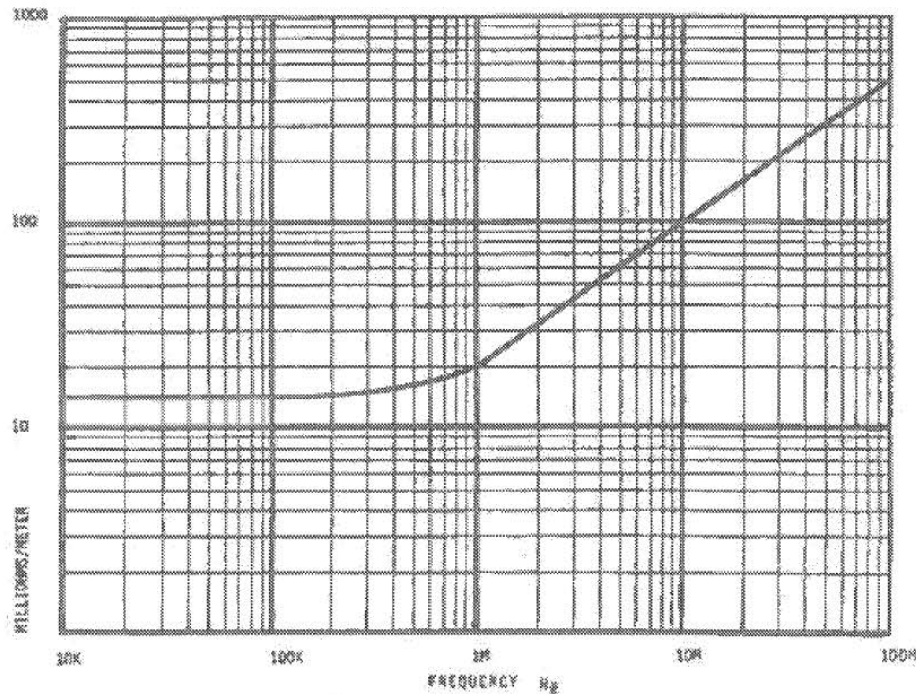

Fig 10-6
Maximum Coaxial Cable Transfer Impedance

10.5.2.1.2 Center Conductor. The center conductor shall be stranded, tinned copper with an overall diameter of $0.89 \text{ mm} \pm 0.05 \text{ mm}$.

10.5.2.1.3 Dielectric Material. The dielectric may be of any type, provided that the conditions of 10.5.1.2 and 10.5.1.3 are met; however, a solid dielectric is preferred.

10.5.2.1.4 Shielding System. The shielding system may contain both braid and foil elements sufficient to meet the transfer impedance of 10.5.1.5 and the EMC specifications of 10.8.2.

The inside diameter of the shielding system shall be $2.95 \text{ mm} \pm 0.15 \text{ mm}$.

The shielding system shall be greater than 95% coverage. The use of tinned copper braid is recommended to meet the contact resistance and shielding requirements.

10.5.2.1.5 Overall Jacket

- (1) Any one of several jacket materials shall be used provided the specifications of 10.5.1 and 10.5.2 are met.
- (2) Either of two jacket dimensions may be used for the two broad classes of materials provided the specification of 10.5.2.1.1 are met:
 - (a) Polyvinyl chloride (for example, PVC) or equivalent having an OD of $4.9 \text{ mm} \pm 0.3 \text{ mm}$.
 - (b) Fluoropolymer (for example, FEP, ECTFE) or equivalent having an OD of $4.8 \text{ mm} \pm 0.3 \text{ mm}$.

The cable shall meet applicable flammability and smoke criteria to meet the local and national codes for the installed environment (see 10.8.3).

Different types of cable sections (for example, polyvinyl chloride and fluoropolymer dielectric) may be interconnected, while meeting the sectioning requirements of 10.7.2.1.

10.5.2.2 Jacket Marking. It is recommended that the cable jacket be marked with manufacturer and type at a nominal frequency of at least once per meter along the cable.

10.5.3 Total Segment DC Loop Resistance. The sum of the center conductor, connectors, and shield resistance shall not exceed $10\ \Omega$ total per segment. Each in-line connector pair or MAU shall contribute no more than $10\ \text{m}\Omega$.

As a trunk coaxial cable segment consists of several cable sections, all connectors and internal resistance of the shield and center conductor shall be included in the loop resistance measurement.

10.6 Coaxial Trunk Cable Connectors. The trunk coaxial medium requires termination and is partitioned into sections. Devices to be attached to the medium require a means of connection to the medium. This means is provided by a BNC "T" adapter, as shown in Fig 10-7.

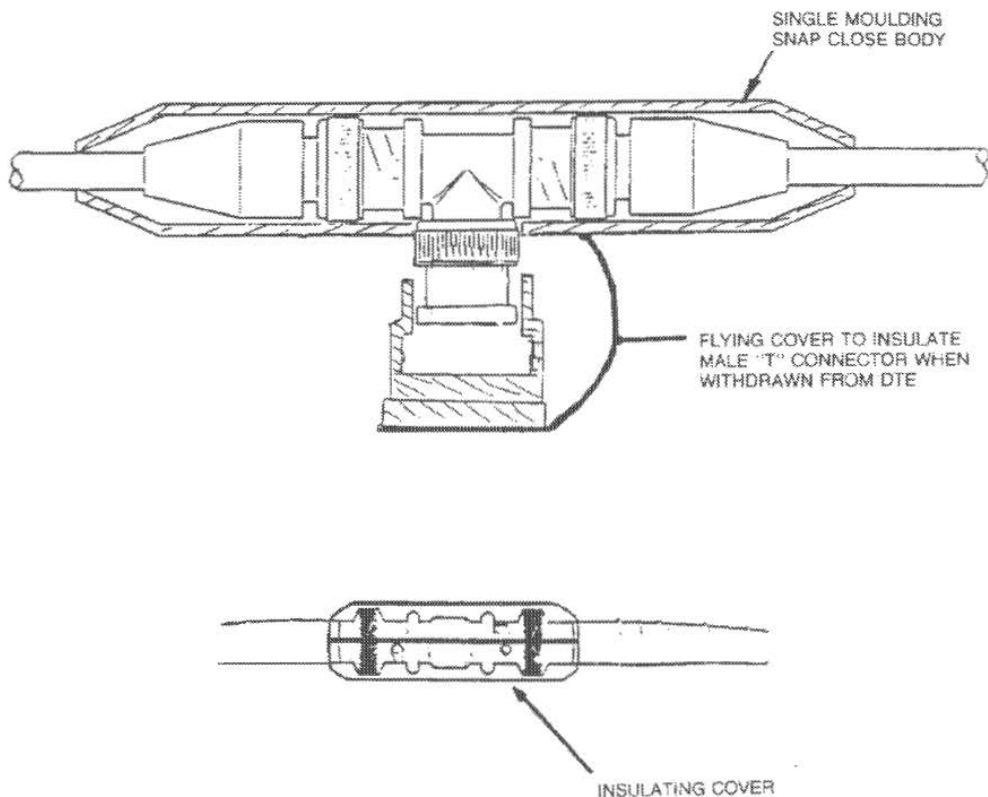

(Tutorial only and not part of the standard.)

Fig 10-7
Examples of Insulated Connector Cover

The BNC connectors shall be of the $50\ \Omega$ constant impedance type. High-quality versions of these connectors (per IEC 169-8 [4]) are recommended in order to meet dc loop resistance and reliability considerations. All of the coaxial connectors shall follow the requirements as defined in 10.6.3.

10.6.1 In-Line Coaxial Extension Connector. All coaxial cables shall be terminated with BNC plug connectors. A means shall be provided to ensure that the connector shell (which connects to the cable sheath) does not make contact with any building metal (at ground potential) or other unintended conductor.

An insulating sleeve or boot slipped over the connector at installation time is suitable.

In-line coaxial extensions shall be made with BNC receptacle-to-receptacle connectors joined together to form one "barrel." An insulating sleeve or boot shall also be provided with each barrel assembly.

10.6.2 Coaxial Cable Terminator

10.6.2.1 Coaxial cable terminators are used to provide a termination impedance for the cable equal in value to its characteristic impedance, thereby minimizing reflection from the ends of the cables. Terminators shall be packaged within a male or female connector. The termination impedance shall be $50 \Omega \pm 1\%$ measured from 0–20 MHz, with the magnitude of the phase angle of the impedance not to exceed 5° . The terminator power rating shall be 0.5 W or greater. A means of insulation shall be provided with each terminator.

10.6.3 MAU-to-Coaxial Cable Connection. A BNC "T" (plug, receptacle, plug) adaptor provides a means of attaching a MAU to the coaxial cable. The connection shall not disturb the transmission line characteristics of the cable significantly; it shall present a low shunt capacitance, and therefore a negligibly short stub length. This is facilitated by the MAU being located as close to its cable connection as possible; the MAU and connector are normally considered to be one assembly. Long (greater than 4 cm) connections between the coaxial cable and the input of the MAU jeopardize this objective.

Overall system performance is dependent largely on the MAU-to-coaxial cable connection being of low shunt capacitance.

The design of the connection shall meet the electrical requirements contained in 10.4.1.1 and the reliability specified in 10.4.2.3. The use of BNC "T" adaptors and connectors satisfies these requirements. Figure 10-7 shows a MAU-to-coaxial cable attachment.

A means shall be provided to ensure that the connector assembly (that is, BNC "T" plus male connectors) does not make contact with any building metalwork (at ground potential) or any other unintended conductors. An insulating cover should therefore be applied after connection. A possible design is depicted in Fig 10-7. The insulating cover should have these characteristics:

- (1) It should guard against accidental grounding of the connector assembly.
- (2) It should allow ease of attachment and detachment of an assembled "T" connector to the MAU without necessitating the removal of section cable connectors (that is, segment integrity is maintained).
- (3) It should be a simple moulding that attaches firmly to a connector assembly.

10.7 System Considerations

10.7.1 Transmission System Model. Certain physical limits have been placed on the physical transmission system. These revolve mostly around maximum cable lengths (or maximum propagation times), as these can affect critical time values for the CSMA/CD access method. These maxima, in terms of propagation times, were derived from the physical configuration model described here. The maximum configuration is as follows:

- (1) A trunk coaxial cable, terminated in its characteristic impedance at each end, constitutes a coaxial segment. A coaxial segment may contain a maximum of 185 m (600 ft) of coaxial cable and a maximum of 30 MAUs. The propagation velocity of the coaxial cable is assumed to be 0.65 c minimum ($c = 3 \times 10^8$ m/s). The maximum end-to-end propagation delay for a coaxial segment is 950 ns.
- (2) Repeater sets are required for segment interconnection. Repeater sets occupy MAU positions on coaxial segments and count toward the maximum number of MAUs on a coaxial segment. Repeater sets may be located anywhere on a coaxial segment.
- (3) The maximum transmission path permitted between any two MAUs is limited by the number of repeater sets that can be connected in series (that is, four). The maximum number of segments connected in series is therefore five (Fig 10-8), which shall consist of no more than three tapped coaxial segments; the remainder shall be link segments as defined in 8.6.1.

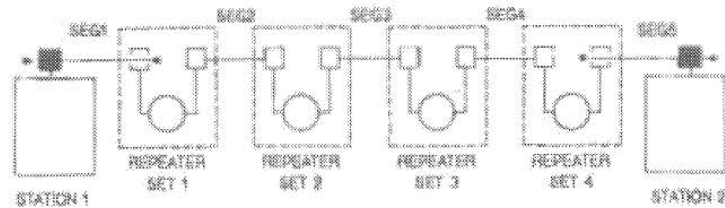

Fig 10-8
Maximum Transmission Path

NOTE: Care should be taken to ensure that the safety requirements are met when extending the trunk cable by the use of repeaters (see 10.7.2.5).

- (4) The transmission system may also contain segments comprising trunk coaxial cable specified in Section 8; however, these shall be attached by repeater sets. As such a combination of segments is capable of achieving longer lengths than (3) above, the maximum configuration then becomes limited by propagation delay. Type 10BASE2 segments should not be used to bridge two Type 10BASE5 segments.

Figures 10-9, 10-10, and 10-11 show transmission systems of various types and sizes to illustrate the boundary conditions on topologies generated according to the specifications in this section.

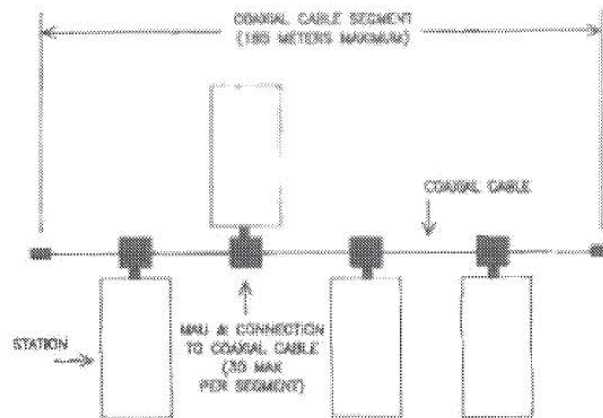

Fig 10-9
The Minimum System Configuration

10.7.2 Transmission System Requirements

10.7.2.1 Cable Sectioning. The 185 m (600 ft) maximum length coaxial cable segment will be made from a number of cable sections. As the variation on cable characteristic impedance is $\pm 2 \Omega$ on 50Ω , a possible worst-case reflection of 4% may result from the mismatch between two adjacent cable sections. The MAU will add to this reflection by the introduction of its noninfinite bridging impedance.

The accumulation of this reflection can be minimized by observing a minimum distance between MAUs (and between cable sections). In order to maintain reflections at an acceptable level, the minimum length cable section shall be 0.5 m.

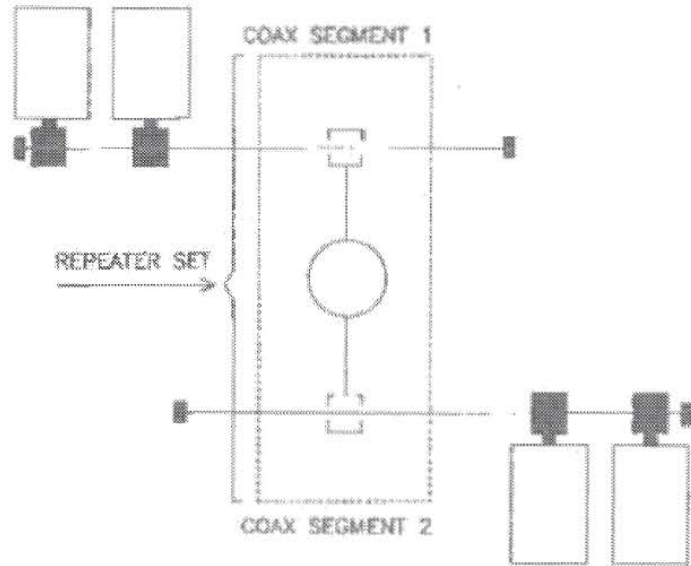

Fig 10-10
 The Minimum System Configuration Requiring a Repeater Set

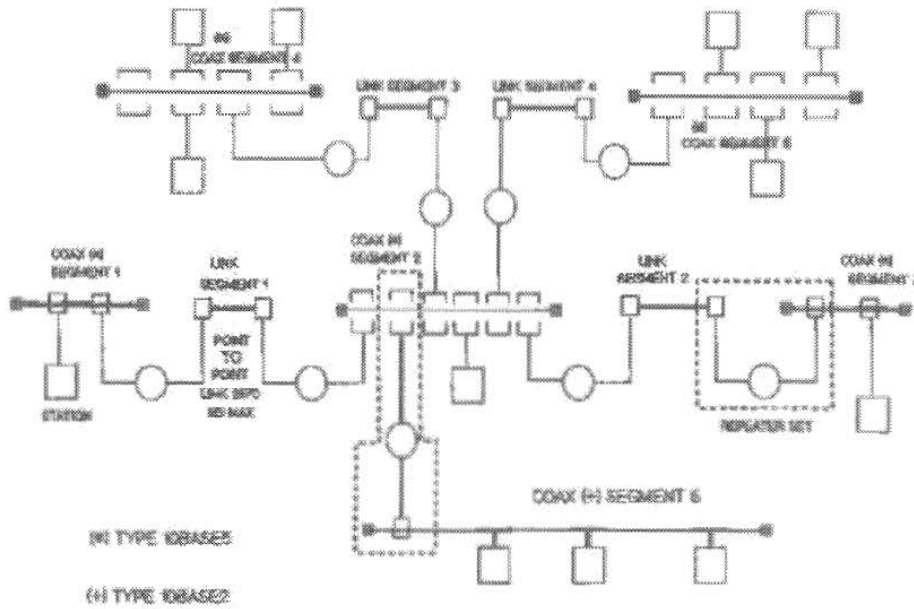

Fig 10-11
 An Example of a Large Hybrid System

10.7.2.2 MAU Placement. MAU components and their associated connections to the cable cause signal reflections due to their noninfinite bridging impedance. While this impedance must be implemented as specified in 10.6, the placement of MAUs along the coaxial cable must also be controlled to ensure that reflections from the MAU do not accumulate to a significant degree.

Coaxial cable sections as specified in 10.7.2.1 shall be used to connect MAUs. This guarantees a minimum spacing between MAUs of 0.5 m.

The total number of MAUs on a cable segment shall not exceed 30.

10.7.2.3 Trunk Cable System Earthing. The shield conductor of each coaxial cable segment may make electrical contact with an effective earth reference¹⁹ at one point and shall not make electrical contact with earth elsewhere on such objects as building structural metal, ducting, plumbing fixture, or other unintended conductor. Insulators should be used to cover any coaxial connectors used to join cable sections and terminators, to ensure that this requirement is met. A sleeve or boot attached at installation time is acceptable. (See 10.6.3.)

10.7.2.4 Static Discharge Path. A static discharge path shall be provided. The shield of the trunk coaxial cable is required to be connected to each DTE earth (within the DTE) via a 1 M Ω , 0.25 W resistor that has a voltage rating of at least 750 V dc.

10.7.2.5 Installation Environment. This specification is intended for networks in use within a single building and within an area served by a single low-voltage power distribution system. Applications requiring interplant connections via external (outdoors) means may require special considerations. Repeaters and nonconducting IRL components may provide the means to satisfy these isolation requirements.

NOTE: The reader is advised that devices should not be operated at significantly different frame potentials. The 10BASE2 connection system may not be capable of handling excessive earth currents.

10.8 Environmental Specifications

10.8.1 Safety Requirements. The designer should consult relevant local and national safety regulations to assure compliance with the appropriate standards (for example, see Appendix A for reference material).

10.8.1.1 Installations. If the trunk coaxial cable is to be installed in close proximity to electrical power cables, then installation practice according to local and national code shall be followed (see Annex for resource material).

10.8.1.2 Earthing. Where earthing is mandated by locally or nationally prescribed codes of practice, the shield of the trunk coaxial cable shall be effectively earthed at only one point along the length of the cable. Effectively earthed means permanently connected to earth through an earth connection of sufficiently low impedance and having sufficient ampacity to prevent the building up of voltages that may result in undue hazard to connected equipment or to persons.

10.8.2 Electromagnetic Environment

10.8.2.1 Susceptibility Levels. Sources of interference from the environment include electromagnetic fields, electrostatic discharge, transient voltages between earth connections, etc.

Several sources of interference will contribute to voltage buildup between the coaxial cable and the earth connection of a DTE.

The physical channel hardware shall meet its specifications when operating in either of the following conditions:

- (1) Ambient plane wave field of 1 V/m from 10 kHz through 1 GHz.

NOTE: Levels typically >1 km from broadcast stations.

¹⁹See local or national regulations for guidance on these matters and reference [A.12].

- (2) Interference source voltage of 15.10 V peak 10 MHz sine wave with a 50 Ω source resistance applied between the coaxial cable shield and the DTE ground connection.

MAUs meeting this standard should provide adequate RF ground return (coaxial cable shield to DTE ground) to satisfy the referenced EMC specifications.

10.8.3.3 Emission Levels. The physical MAU and trunk cable system shall comply with local and national regulations (see Annex for resource material).

10.8.3 Regulatory Requirements. The MAU and medium should consider IEC 435 in addition to local and national regulations. See references [6] and [A12].

11. Broadband Medium Attachment Unit and Broadband Medium Specifications, Type 10BROAD36

11.1 Scope

11.1.1 Overview. This section defines the functional, electrical, and mechanical characteristics of the Broadband Medium Attachment Unit (MAU) and the specific single- and dual-cable broadband media for use with local area networks. The headend frequency translator for single-cable broadband systems is also defined. The relationship of this specification to all of the IEEE Local Area Network standards (IEEE 802) is shown in Fig 11-1. Repeaters as defined in Section 9 are not relevant for 10BROAD36.

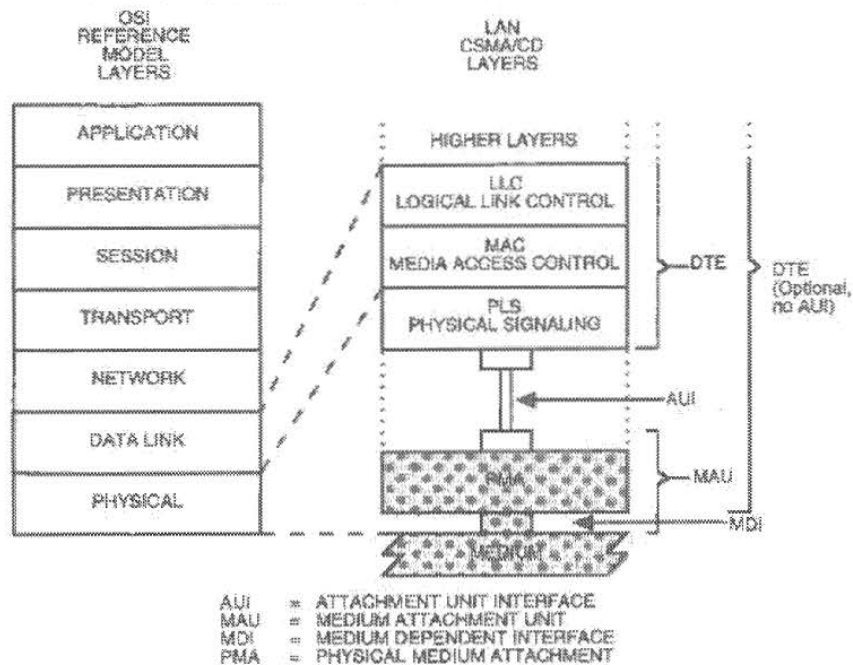

Fig 11-1
Physical Layer Partitioning, Relationship to the ISO Open Systems Interconnection
(OSI) Reference Model

The purpose of the MAU is to provide a means of attaching devices to a broadband local network medium. The medium comprises CATV-type cable, taps, connectors, and amplifiers. A coaxial broadband system permits the assignment of different frequency bands to multiple applications. For example, a band in the spectrum can be utilized by local area networks while other bands are used by point-to-point or multidrop links, television, or audio signals.

The physical tap is a passive directional device such that the MAU transmission is directed toward the headend location (reverse direction). On a single-cable system the transmission from the MAU is at a carrier frequency f_1 . A frequency translator (or remodulator) located at the headend up-converts to a carrier frequency f_2 , which is sent in the forward direction to the taps (receiver inputs). On a dual-cable system the transmit and receive carrier frequencies are identical (both f_1) and the MAU connects to the medium via two taps, one on the receive cable and the other on the transmit cable. The transmit and receive cables are connected to each other at the headend location. Figure 11-2 shows broadband single- and dual-cable systems.

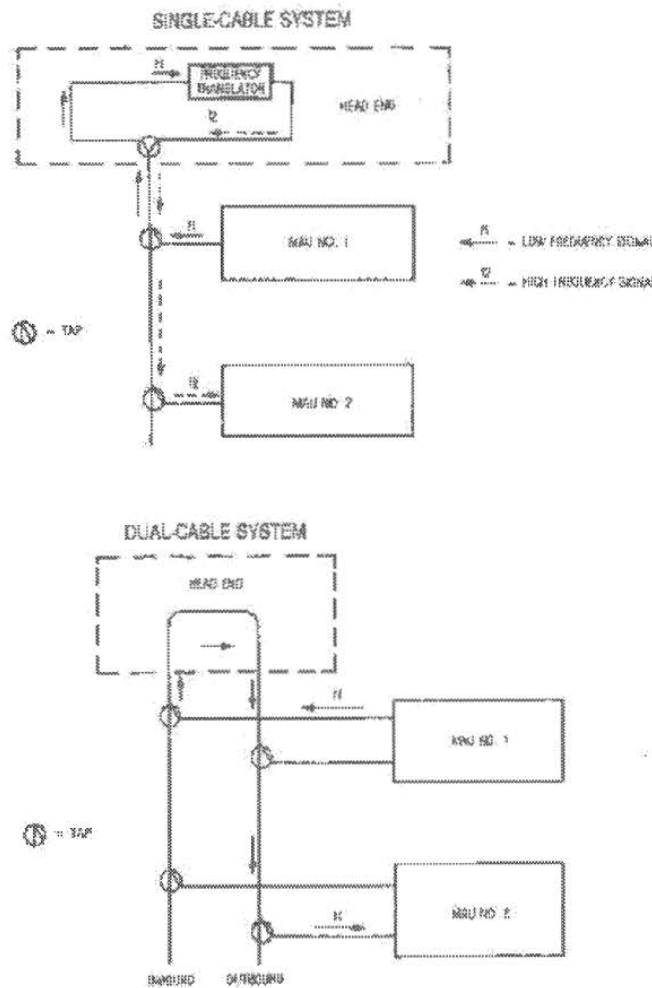

Fig 11-2
Broadband Cable Systems

The broadband MAU operates by accepting data from the attached Data Termination Equipment (DTE) and transmitting a modulated radio frequency (RF) data signal in a data band on the broadband coaxial cable system. All MAUs attached to the cable system receive and demodulate this RF signal and recover the DTE data. The broadband MAU emulates a baseband MAU except for delay between transmission and reception, which is inherent in the broadband cable system.

A transmitting MAU logically compares the beginning of the received data with the data transmitted. Any difference between them, which may be due to errors caused by colliding transmissions, or reception of an earlier transmission from another MAU, or a bit error on the channel, is interpreted as a collision.

When a collision is recognized, the MAU stops transmission in the data band and begins transmission of an RF collision enforcement (CE) signal in a separate CE band adjacent to the data band. The CE signal is detected by all MAUs and informs them that a collision has occurred. All MAUs signal to their attached Medium Access Controllers (MACs) the presence of the collision. The transmitting MACs then begin the collision handling process.

Collision enforcement is necessary because RF data signals from different MAUs on the broadband cable system may be received at different power levels. During a collision between RF data signals at different

levels, the MAU with the higher received power level may see no errors in the detected data stream. However, the MAU with the lower RF signal will see a difference between transmitted and received data; this MAU transmits the CE signal to force recognition of the collision by all transmitting MAUs.

11.1.2 Definitions

Attachment Unit Interface (AUI). In a local area network, the interface between the medium attachment unit and the DTE within a data station. Note that the AUI carries encoded signals and provides for duplex data transmission.

Binary Phase Shift Keying (Binary PSK or BPSK). A form of modulation in which binary data are transmitted by changing the carrier phase by 180 degrees.

Broadband LAN. A Local Area Network in which information is transmitted on modulated carriers, allowing coexistence of multiple simultaneous services on a single physical medium by frequency division multiplexing.

CATV-Type Broadband Medium. A broadband system comprising coaxial cables, taps, splitters, amplifiers, and connectors the same as those used in Community Antenna Television (CATV) or cable television installations.

Channel. A band of frequencies dedicated to a certain service transmitted on the broadband medium.

Coaxial Cable. A two conductor, concentric (center conductor and shield), constant impedance transmission line.

Continuous Wave (CW). A carrier that is not modulated or switched.

dBmV. Decibels referenced to 1.0 mV on 75 Ω , used to define signal levels in CATV-type broadband systems.

Drop Cable. The small diameter flexible coaxial cable of the broadband medium that connects to a Medium Access Unit (MAU). See **Trunk Cable**.

Group Delay. The rate of change of total phase shift, with respect to frequency, through a component or system. Group delay variation is the maximum difference in group delay over a band of frequencies.

Headend. The location in a broadband system that serves as the root for the branching tree comprising the physical medium; the point to which all inbound signals converge and the point from which all outbound signals emanate.

Jabber. A condition wherein a station transmits for a period of time longer than the maximum permissible packet length, usually due to a fault condition.

Postamble. In the broadband Medium Attachment Unit specified in this section, the bit pattern appended after the last bit of the Frame Check Sequence; the Broadband End-of-Frame Delimiter (BEOFD).

Return Loss. The ratio in decibels of the power reflected from a port to the power incident to the port. An indicator of impedance matching in a broadband system.

Seed. The twenty-three (23) bits residing in the scrambler shift register prior to the transmission of a packet.

Spectrum Mask. A graphic representation of the required power distribution as a function of frequency for a modulated transmission.

Translation. In a single-cable system, the process by which incoming transmissions at one frequency are converted to another frequency for outgoing transmission. The translation takes place at the headend.

Truncation Loss. In a modulated data waveform, the power difference before and after implementing the filtering necessary to constrain its spectrum to a specified frequency band.

Trunk Cable. The main (large-diameter) cable of a broadband coaxial cable system. See **Drop Cable**.

11.1.3 MAU and Medium Objectives. This subsection states the broad objectives and assumptions underlying the specifications defined throughout this section of the standard.

- (1) Provide the physical means for communication among local network Data Link Entities using a broadband coaxial medium.
- (2) Provide a broadband Medium Attachment Unit (MAU) that is compatible at the Attachment Unit Interface (AUI) with DTEs used on a baseband medium.
- (3) Provide a broadband MAU that emulates the baseband MAU except for the signal delay from Circuit DO to Circuit DI.
- (4) Provide a broadband MAU that detects collisions within the timing constraints specified in the baseband case.
- (5) Provide a broadband network diameter no less than 2600 m.
- (6) Provide a broadband Physical Layer that ensures that no MAU is allowed to capture the medium during a collision due to signal level advantage (that is, ensures fairness of the physical layer).
- (7) Provide a broadband MAU that detects collisions in both receive and transmit modes.
- (8) Provide a broadband MAU that requires a transmission bandwidth no wider than 18 MHz.
- (9) Define a physical interface that can be implemented independently among different manufacturers of hardware and achieve the intended level of compatibility when interconnected in a common broadband local area network.
- (10) Provide a communication channel capable of high bandwidth and low bit error rate performance. The resultant mean bit error rate at the physical layer service interface should be less than one part in 10^9 (on the order of one part in 10^9 at the link level) in a worst-case signal-to-noise ratio of 26 dB.
- (11) Provide a broadband medium physical layer that allows for implementation in both dual- and single-cable systems.
- (12) Provide for ease of installation and service.
- (13) Provide a communication channel that coexists with other channels on the same physical medium.

It is not an objective of this broadband MAU to allow its use with the baseband repeater defined in Section 9 of this standard.

11.1.4 Compatibility Considerations. All implementations of the broadband coaxial system shall be compatible at the Medium Dependent Interface (MDI). This standard provides medium specifications for the interconnection of all MAU devices. The medium itself, the functional capability of the MAU and the AU Interface are defined to provide the highest possible level of compatibility among devices designed by different manufacturers. Designers are free to implement circuitry within the MAU in an application-dependent manner provided the MDI and AUI specifications are satisfied. Subsystems based on this specification may be implemented in several different ways provided compatibility at the medium is maintained. It is possible, for example, to design an integrated station where the MAU is contained within a physical DTE system component, thereby eliminating the AUI cable.

11.1.5 Relationship to PLS and AUI. The broadband MAU and cable system specifications are closely related to Section 7 (Physical Signaling and Attachment Unit Interface Specifications). The design of a physical MAU component requires the use of both this section and the PLS and AUI specifications in Section 7.

11.1.6 Mode of Operation. In its normal mode of operation, the MAU functions as a direct connection between the DTE and the broadband medium. Data from the DTE are transmitted onto the broadband coaxial system and all inband data on the coaxial cable system is received by the DTE. This mode is the

mode of operation for the intended message traffic between stations. Other operating modes, such as a loopback mode or a monitor mode, may be provided but are not defined by this standard.

11.2 MAU Functional Specifications

11.2.1 MAU Functional Requirements. The MAU component provides the means by which signals on the physically separate AUI signal circuits to and from the DTE and their associated interlayer messages are coupled to the broadband coaxial medium. To achieve this basic objective, the MAU component contains the following capabilities to handle message flow between the DTE and the broadband medium:

- (1) **Transmit Function.** The ability to transmit serial data bit streams originating at the local DTE in a band-limited modulated RF carrier form, to one or more remote DTEs on the same network.
- (2) **Receive Function.** The ability to receive a modulated RF data signal in the band of interest from the broadband coaxial medium and demodulate it into a serial bit stream.
- (3) **Collision Presence Function.** The ability to detect the presence of two or more stations' concurrent transmissions.
- (4) **Jabber Function.** The ability of the MAU itself to interrupt the transmit function and inhibit an abnormally long output data stream.

11.2.1.1 Transmit Function Requirements. The transmit function shall include the following capabilities:

- (1) Receive Manchester encoded data sent by the local DTE to the attached MAU on Circuit DO (transmit data pair).
- (2) Decode the Manchester encoded data received on Circuit DO to produce NRZ (Non-Return to Zero) data and a recovered clock signal.
- (3) Scramble the NRZ data using a CCITT V.29-type scrambler with seed changed on each transmitted packet.
- (4) Transform the incoming bits (prior to modulation) to provide an unscrambled alternating zero-one pattern terminated by an Unscrambled Mode Delimiter (UMD); scramble the remainder of the incoming preamble, Start Frame Delimiter (SFD), and data frame; and append an unscrambled postamble (Broadband End of Frame Delimiter [BEOFD]).
- (5) Differentially encode the packet generated above.
- (6) Produce a bandlimited, double sideband suppressed carrier, binary FSK modulated RF signal representing the above generated differentially encoded packet.
- (7) Drive the coaxial cable with the modulated RF signal.

Figure 11-3 functionally represents these capabilities. The order of the functional blocks may be altered provided that the result is the same.

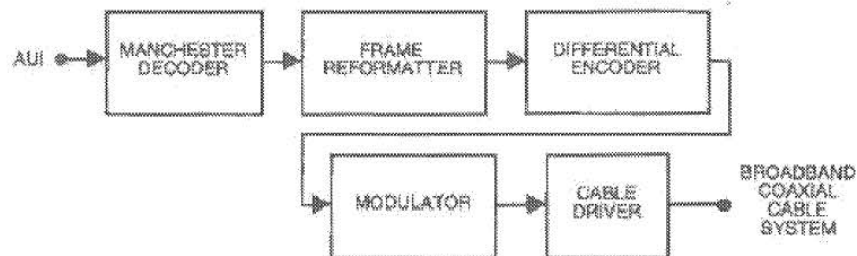

Fig 11-3
Transmit Function Requirements

11.2.1.2 Receive Function Requirements. The receive function shall include the following:

- (1) Receive the differentially encoded binary PSK modulated RF signal from the broadband coaxial medium.
- (2) Receive the data band RF signals and reject signals in bands other than the data band (rejection of signals in the adjacent collision enforcement band is optional).
- (3) Demodulate and differentially decode the incoming RF data signal from the coaxial medium to provide a receive bit stream that represents the scrambled bit stream at the transmitter.
- (4) Descramble the receive bit stream using a self-synchronizing descrambler.
- (5) Manchester encode the descrambled bit stream.
- (6) Send to the DTE, using Circuit DI (receive data pair), an additional, locally-generated, Manchester encoded preamble equal to the number of preamble bits lost in the receive data path (plus or minus one bit), followed by the Manchester encoded bit stream. No more than 8 preamble bits may be lost from the preamble presented to Circuit DO at the transmitting MAU.
- (7) Detect end of frame, using the postamble (BEOFDF), and ensure that no extraneous bits are sent to the DTE on Circuit DI.
- (8) Receive signals in the collision enforcement band and reject signals in the data band and all other bands on the broadband medium.

11.2.1.3 Collision Detection Function Requirements. The MAU shall perform the following functions to meet the collision detection requirements:

- (1) Store the scrambled bits (not differentially encoded) in the transmit section through to the last bit in the source address.
- (2) Detect the UMD in the transmit and receive paths.
- (3) Compare received scrambled bits after the received UMD with transmitted scrambled bits after the transmit UMD through to the last bit in the source address.
- (4) A Receive UMD Timer function shall be performed by the MAU. The timer shall be as long as the time required from initial detection of RF data signal presence to detection of a UMD in a normally received (no collision) packet.
- (5) Enter a LOCAL COLLISION DETECTION state if one of the following occurs:
 - (a) A bit error is found in the bit compare process through the last bit in the source address.
 - (b) The Receive UMD Timer expires before a UMD is detected in the received bit stream.
 - (c) The MAU receives the *output* (that is, transmit) signal from the AUI AFTER having received an RF signal from the coaxial cable.
- (6) Upon entering the LOCAL COLLISION DET state, cease transmission in the data band and commence transmission in the collision enforcement band for as long as the DTE continues to send data to the MAU.
- (7) Upon entering the LOCAL COLLISION DET state send the *signal_quality_error* (SQE) message on Circuit CI (collision presence pair) using the CS0 signal for as long as RF signals are detected on the broadband coaxial medium in either the data or collision enforcement bands.
- (8) Detect power in the collision enforcement band and send the SQE message on Circuit CI using the CS0 signal. Send the SQE message for as long as energy is detected in the collision enforcement band.
- (9) Ensure that during collisions, due to phase cancellations of the colliding carriers, Circuit DI does not become inactive before Circuit CI becomes active.
- (10) Test the collision detection circuitry following every transmission that does not encounter a collision. This test consists of transmitting a burst of collision enforcement RF signal after the end of the postamble transmission and detecting this burst on the receive side. If the burst is detected, the CS0 (BR) signal is sent on Circuit CI of the transmitting MAU.

11.2.1.3.1 Collision Enforcement Transmitter Requirements. The MAU shall provide a collision enforcement (CE) transmitter that generates a constant amplitude RF signal in the CE band at the same power level as the data signal postamble.

11.2.1.3.2 Collision Enforcement Detection Requirements. The MAU shall detect energy in the CE band that is within the specified range of receive levels, irrespective of the signal power level in the data band.

11.2.1.4 Jabber Function Requirements. The MAU shall have a jabber function that inhibits transmission onto the coaxial cable interface if the MAU attempts to transmit an RF signal longer than 150 ms. The MAU shall provide an MTBF of at least 1 million hours of continuous operation without rendering the transmission medium unusable by other transceivers. Transmissions of less than 20 ms shall not be affected. When the jabber circuit is activated, *signal_quality_error* shall be sent on Circuit CI.

Circuit DO shall also be monitored for transmissions in excess of the maximum packet length. If the packet is longer than 20 ms, an attempt shall be made to deactivate the transmitter before the jabber circuit is activated, to avoid locking up the unit due to a non-MAU failure.

State diagrams defining the jabber function may be found in 11.2.3.

11.2.2 DTE PLS to MAU and MAU to DTE PLS Messages

11.2.2.1 DTE Physical Layer to MAU Physical Layer Messages. The following messages can be sent by the DTE Physical Layer Entities to the MAU Physical Layer Entities (refer to 7.3 of this standard for the definitions of the signals):

Message	Circuit	Signal	Meaning
<i>output</i>	DO	CD1, CD0	Output information
<i>output_idle</i>	DO	IDL	No data to be output

11.2.2.2 MAU Physical Layer to DTE Physical Layer Messages. The following messages can be sent by the MAU Physical Layer Entities to the DTE Physical Layer Entities:

Message	Circuit	Signal	Meaning
<i>input</i>	DI	CD1, CD0	Input information
<i>input_idle</i>	DI	IDL	No input information
<i>mau_available</i>	CI	IDL	MAU is available for output
<i>signal_quality_error</i>	CI	CS0 (BR)	Error detected by MAU

11.2.2.2.1 *input* Message. The MAU Physical Layer sends an *input* message to the DTE Physical Layer when the MAU has a bit of data to send to the DTE. The physical realization of the *input* message is a CD0 or CD1 sent by the MAU to the DTE on Circuit DI. The MAU sends CD0 if the input bit is a zero or CD1 if the input bit is a one. The jitter and asymmetry on CD0 and CD1 shall be no more than that specified in 7.5.2.1.

11.2.2.2.2 *input_idle* Message. The MAU Physical Layer sends an *input_idle* message to the DTE Physical Layer when the MAU does not have data to send to the DTE. The physical realization of the *input_idle* message is the IDL signal sent by the MAU to the DTE on Circuit DI.

11.2.2.2.3 *mau_available* Message. The MAU Physical Layer sends a *mau_available* message to the DTE Physical Layer when the MAU is available for output. The *mau_available* message is always sent by an MAU that is prepared to output data. The physical realization of the *mau_available* message is an IDL signal sent by the MAU to the DTE on Circuit CI.

11.2.2.2.4 *signal_quality_error* Message. The *signal_quality_error* message shall be implemented in the following fashion:

- (1) The *signal_quality_error* (SQE) message shall not be sent by the MAU if no or only one MAU is transmitting a legal length packet (as specified in this standard) on the coaxial medium, except as a part of the SQE self test.
- (2) If the MAU connected to the local node is not transmitting, then the local MAU shall send the *signal_quality_error* message in every instance when it detects power in the collision enforcement band earlier than the time equivalent for reception of a 512 bit data frame plus preamble and SFD.
- (3) When the local MAU is transmitting on the coaxial medium, all occurrences of one or more additional MAUs transmitting shall cause the *signal_quality_error* message to be sent by the local MAU to the attached DTE.
- (4) When the MAU has completed a successful transmission of a packet it shall perform an SQE Test sequence. In this instance, the collision enforcement RF signal is interpreted as an SQE Test signal.

11.2.3 MAU State Diagrams. The operation of the MAU during normal transmission and reception can be described by a state diagram that relates the functions of transmission, reception, collision detection, and collision detection testing. Figure 11-4, at the end of this subsection, shows the state transitions for normal operation. Abnormal conditions are implementation-specific.

The state diagram in Fig 11-4 does not describe the operation of the MAU in detail. This is found in 11.2 and 11.3.

The operation of the jabber function is described by the state diagram of Fig 11-5. When the MAU Jabber state machine is in the INTERRUPT or JAB state, outputs of the MAU Jabber state machine shall override those of the MAU state machine.

11.2.3.1 MAU State Diagram Messages. The following messages are used in the state diagram:

- (1) *disable_data_driver*. Deactivates the mechanism by which the RF data signal is impressed onto the coaxial cable.
- (2) *enable_data_driver*. Activates the mechanism by which the RF data signal is impressed onto the coaxial cable.
- (3) *disable_CE_driver*. Deactivates the mechanism by which collision enforcement RF signals are impressed onto the coaxial cable.
- (4) *enable_CE_driver*. Activates the mechanism by which collision enforcement RF signals are impressed onto the coaxial cable.
- (5) *mau_available*. Signifies that the MAU is available for transmission (that is, there is no SQE active).
- (6) *signal_quality_error* (SQE). Signifies that the MAU has detected a collision, it has successfully completed the SQE Test sequence, or the jabber circuit is active.
- (7) *start_SQE_test_timer*. Causes a timer to begin counting so that the SQE Test signal may be sent to the coaxial cable interface.
- (8) *positive_disable*. Prevents any RF signal from being sent onto the coaxial cable.

11.2.3.2 MAU State Diagram Signal Names. The signal names used in the state diagram are as follows:

- (1) *PowerOn*. This signal signifies that power has been applied to the unit.
- (2) *rx_energy*. When this signal is active, an RF signal on the coaxial cable has been detected either in the data band or in the collision enforcement band or in both. The delay in asserting or deasserting this signal is sufficiently short that the delays specified in 11.3.4.5 are met.
- (3) *output*. Signifies that data from the DTE is being presented for transmission at the AUI.
- (4) *tx_umd* (Transmit Unscrambled Mode Delimiter). When the Unscrambled Mode Delimiter has been detected in the transmit data sequence, this signal is asserted.
- (5) *rx_umd* (Receive Unscrambled Mode Delimiter). When the Unscrambled Mode Delimiter has been detected in the receive data sequence as it is conveyed from the coaxial cable interface, this signal is asserted.
- (6) *SQE_test_timer*. This signal is on during the time that the SQE Test Timer is engaged. At the end of the time, this signal is deasserted.
- (7) *rx* (Receive). As long as data is being presented by the MAU to Circuit DI of the AUI, this signal is active. When the last bit of the receive data has been presented to the AUI, this signal is deasserted.

- (8) **ced** (Collision Enforcement Detection). RF signal power in the collision enforcement band causes this signal to be asserted.
- (9) **ced_window** (Collision Enforcement Detection Window). This signal defines a period of time (a "window") during which collisions may occur. Its purpose is to distinguish collision enforcements from SQE Test sequences on the coaxial cable. The window opens when **rx_energy** goes active and closes a minimum of 365 bit times later. The maximum time the window may be open is the minimum frame length, plus preamble and SFD: 576 bits.
- (10) **rx_umd_timeout** (Receive Unscrambled Mode Delimiter Timeout). It is possible that the Receive Unscrambled Mode Delimiter may be corrupted by a collision such that the bit-by-bit comparison may not begin. This signal forces detection of a collision due to failure to detect the **rx_umd** within a maximum time. The timeout begins upon receipt of RF signal in the data band and expires 32 bit times later.
- (11) **tx_#_rx** (Transmit Not Equal to Receive). Assertion of this signal occurs when a difference is detected between the received data stream and the transmitted data stream.
- (12) **bbbw** (Bit-by-Bit Window). Bit-by-bit comparison shall be performed only for a time long enough to guarantee that the last bit of the source address has been examined. This signal is asserted after the UMD is received and throughout the bit-by-bit comparison process. To place a bound on the location of the source address relative to the UMD, the maximum preamble length permitted for operation with the broadband MAU is 62 bits. This places the last bit of the source address no later than 143 bits after the UMD.
- (13) **ced_gate**. This signal is a gating function that serves to shape the timing of **ced** during an SQE Test. It becomes true a minimum of 8 and a maximum of 16 bit times after the last bit has been presented to Circuit DI and stays active 10 ± 5 bit times.
- (14) **tx_energy**. This signal signifies that the MAU is attempting to transmit an RF signal onto the coaxial cable.
- (15) **frame_timer**. This signal is on from the beginning of output until it is reset or until it has been on continuously for **timeout1** s. The value of **timeout1** shall be greater than 20 ms and less than **timeout2**.
- (16) **jab_timer**. This signal turns on when **tx_energy** turns on and lasts until it is reset or until it has been on continuously for **timeout2** s. The value of **timeout2** shall be greater than **timeout1** and less than 160 ms.

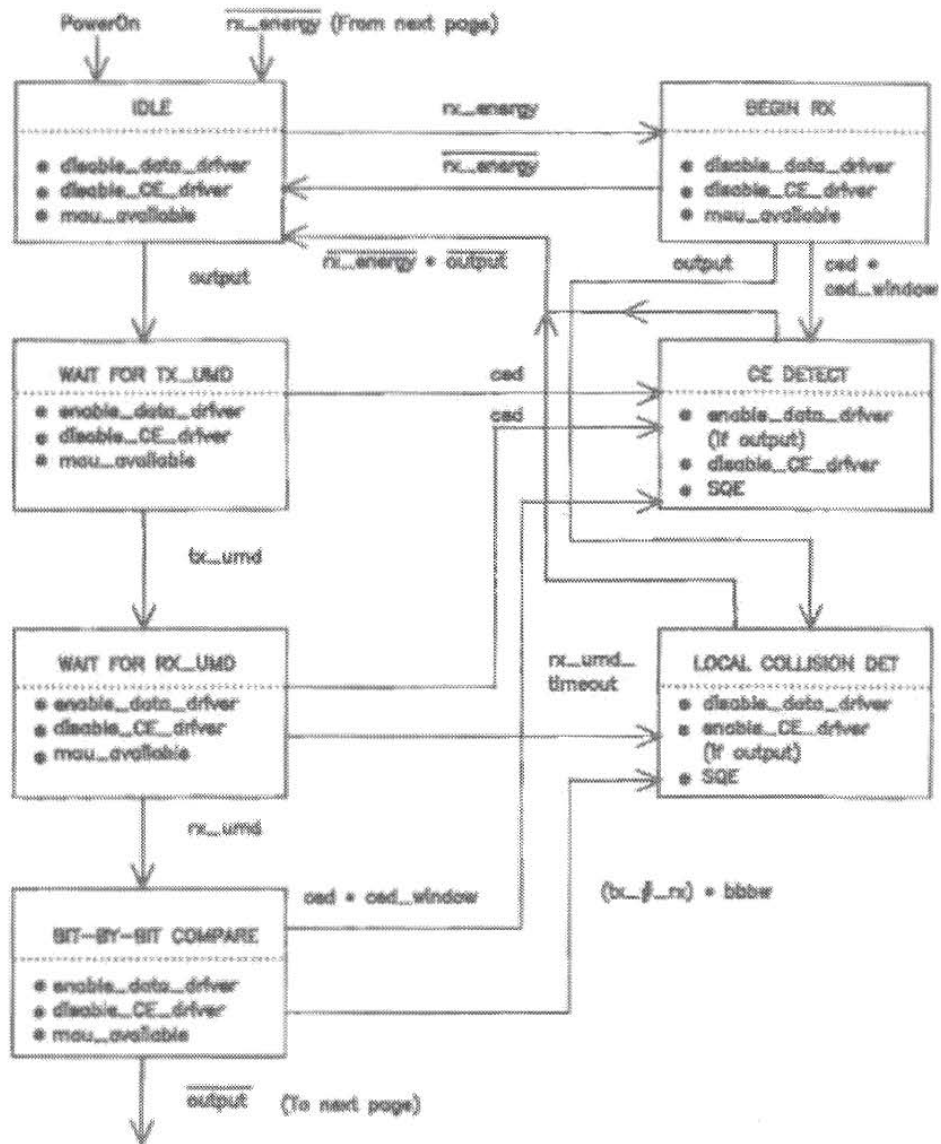

Fig 11-4
MAU State Diagram

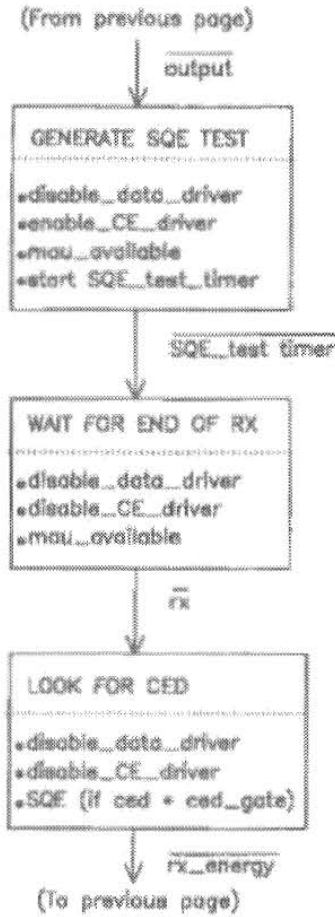

Fig 11-4
MAU State Diagram (continued)

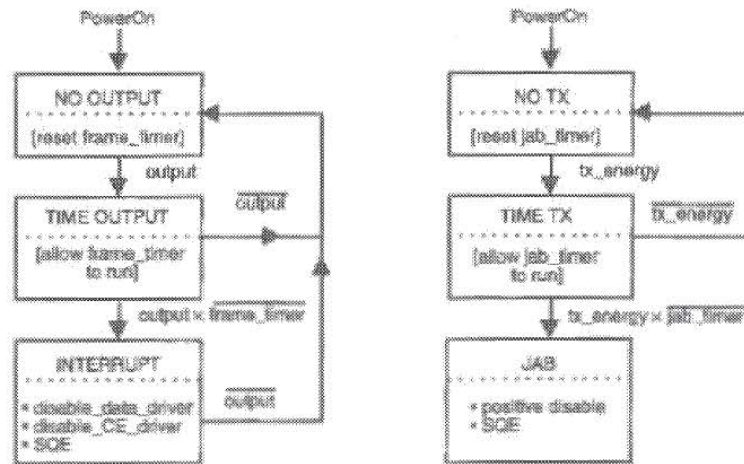

Fig 11-5
MAU Jabber State Diagram

11.3 MAU Characteristics

11.3.1 MAU-to-Coaxial Cable Interface. The following subsections describe the interface between the MAU and the broadband coaxial medium. The medium is a 75 Ω CATV-type broadband cable installation employing a single bidirectional cable with band-split amplifiers and filters, or dual unidirectional cables with line amplifiers.

11.3.1.1 Receive Interface

11.3.1.1.1 Receive Input Impedance. The nominal input impedance at the receive port shall be 75 Ω . The return loss within the data and collision enforcement frequency bands shall be at least 14 dB with power applied to the MAU.

11.3.1.1.2 Receiver Squelch Requirements. There shall be a receiver squelch that inhibits reception of RF signals that are too low in level. This squelch shall permit reception of RF data or collision enforcement signals that are greater than or equal to -7 dBmV rms as measured by the method of 11.3.1.2.5. RF signals (data, collision enforcement, noise, or other signals) of levels lower than -15 dBmV rms shall be ignored.

The receive squelch for CE signals shall be derived from a power detector with noise bandwidth greater than or equal to 1.5 MHz centered at the CE center frequency.

11.3.1.1.3 Receive Level Requirements. The receiver shall operate with RF data and CE signals having levels from -4 dBmV to $+16$ dBmV rms. The nominal receive level shall be $+6$ dBmV rms.

11.3.1.1.4 Receiver Selectivity and Linearity Requirements. The MAU shall operate in the presence of single frequency (CW) signals adjacent to the receive band of the MAU and offset from the band edges, received at the following levels:

- (1) 0 dBmV rms at 0.25 MHz below and above the band
- (2) 10 dBmV rms at 1.25 MHz below and above the band

The receiver shall be capable of operating in a cable environment loaded with TV signals (for example, every 6 MHz in the USA). The TV signals shall be no higher than +10 dBmV peak video at the receiver coaxial cable interface.

11.3.1.1.5 Receive Input Mechanical Requirements. The receiver mechanical interface shall be a 75 Ω female F-series coaxial connector. The connection to the broadband medium shall be through a coaxial drop cable with a mating male F-series connector. For single-cable configurations, the same connector may be used for receive and transmit.

11.3.1.2 Transmit Interface

11.3.1.2.1 Transmit Output Impedance. The nominal output impedance at the transmit port shall be 75 Ω . The return loss within the data and collision enforcement frequency bands shall be at least 14 dB with power applied.

11.3.1.2.2 Transmitted RF Packet Format. Figure 11-6 shows the transmitted RF packet format.

11.3.1.2.3 Transmit Spectrum and Group Delay Characteristics. The transmit RF data signal shall be binary phase-shift-keyed (PSK) modulated and shall have a frequency spectrum equivalent to baseband raised-cosine Nyquist filtering with a rolloff factor (α) of 0.4, and within the limits of Fig 11-7. For rectangular pulses, the filter characteristic is

$$H(j\omega) = \begin{cases} \frac{\omega T/2}{\sin(\omega T/2)} & \left[0 \leq \omega < \frac{\pi}{T}(1-\alpha) \right] \\ \frac{\omega T/2}{\sin(\omega T/2)} \cos^2 \left(\frac{T}{4\alpha} \left[\omega - \frac{\pi(1-\alpha)}{T} \right] \right) & \left[\frac{\pi}{T}(1-\alpha) \leq \omega < \frac{\pi}{T}(1+\alpha) \right] \\ 0 & \left[\omega \geq \frac{\pi}{T}(1+\alpha) \right] \end{cases}$$

where T = one symbol time (100 ns for 10 Mb/s) and $\alpha = 0.4$, and the first term accounts for the $\sin x/x$ spectrum of NRZ random data.

The total variation in group delay from Circuit DO to the RF coaxial medium interface shall not exceed 20 ns in the frequency band from the carrier frequency to ± 5 MHz, and 32 ns to ± 5.5 MHz.

The collision enforcement (CE) signal shall be a constant amplitude pulse with controlled turn-on and turn-off times. Random modulation may be added to reduce the probability of cancellation when more than one CE signal is received simultaneously. The modulated signal shall have an instantaneous frequency within 0.75 MHz of the CE band center frequency and shall conform to the spectrum mask specified in 11.3.1.2.4. The random modulation may be derived from the transmit NRZ data stream.

The CE signal rise and fall times shall approximate a Gaussian shape of the form:

$$f(t) = \exp\left(-\frac{1}{2} \left[\frac{t}{T} \right]^2\right)$$

where T = one symbol time and $t < 0$ for the rise time and $t > 0$ for the fall time.

The CE and data RF signals shall not be transmitted simultaneously.

11.3.1.2.4 Transmit Out-of-Band Spectrum. The transmitted power outside the specified band shall meet or exceed the relative attenuation (RA) specified below, under the following conditions:

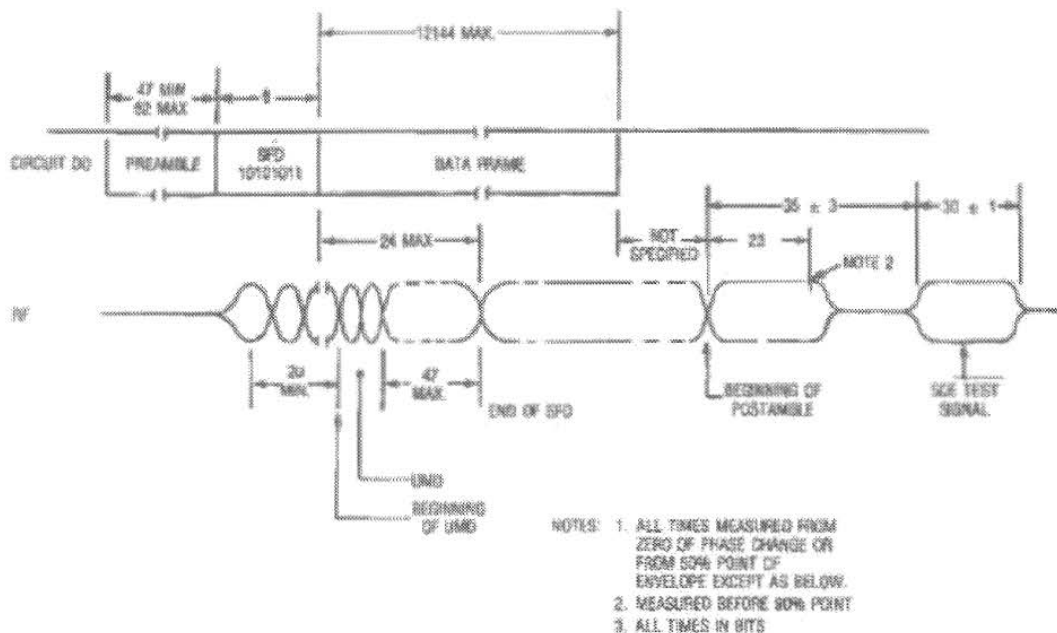

Fig 11-6
Packet Format and Timing Diagram (AUI to Coaxial Cable Interface)

- (1) Transmitted packet length is 256 bits with a 25.6 μ s interval between packets, for 50% duty cycle on the cable.
- (2) Reference level is an unmodulated carrier, equivalent to the postamble transmitted level.
- (3) RA is the attenuation in decibels relative to the reference level outside the specified band, measured in a 30 kHz noise bandwidth with a video filter of 300 Hz bandwidth or less.
- (4) B is 18 MHz, the width of data plus collision enforcement bands.
- (5) MF is the measurement frequency in MHz.
- (6) NCEF is the frequency of the nearest edge of the band, in MHz.

$$RA = \min \left(63,65 + 30 \times \left\lfloor \frac{MF - NCEF}{B} \right\rfloor \right)$$

Figure 11-8 graphically shows the attenuation requirement for out-of-band power.

11.3.1.2.5 Transmit Level Requirements. The transmitter output power during the postamble and during the SQE Test of the collision enforcement signal shall be 1000 mV peak-to-peak into a 75 Ω load (51 dBmV rms). Truncation loss due to the specified data filtering is 1 dB; transmitted RF data signal power is 50 dBmV rms. Transmit output power variations shall not exceed ± 2 dB.

11.3.1.2.6 Nontransmitting Signal Leakage Requirement. The RF data signal and collision enforcement signal leakage to the coaxial cable interface while the MAU is not in its transmission mode shall be less than -20 dBmV rms.

11.3.1.2.7 Transmit Spurious Output Requirement. All spurious signals from the transmitter (inband and out-of-band) while not transmitting shall be less than -20 dBmV rms. All spurious signals from the transmitter while transmitting data or collision enforcement shall be below the spectrum mask specified in 11.3.1.2.4.

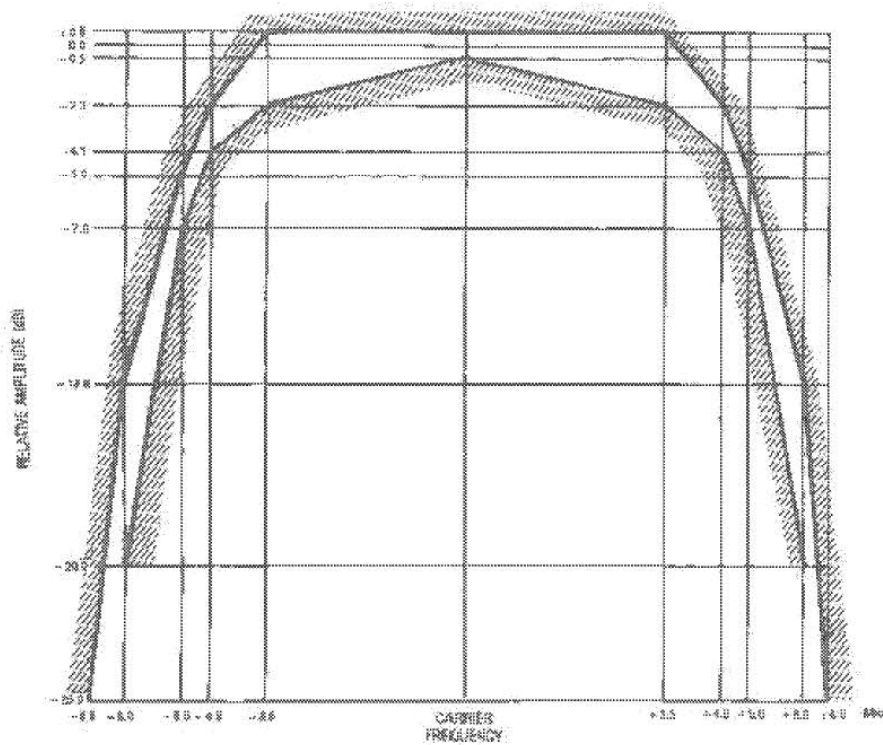

Fig 11-7
Spectrum Mask for RF Data Signal

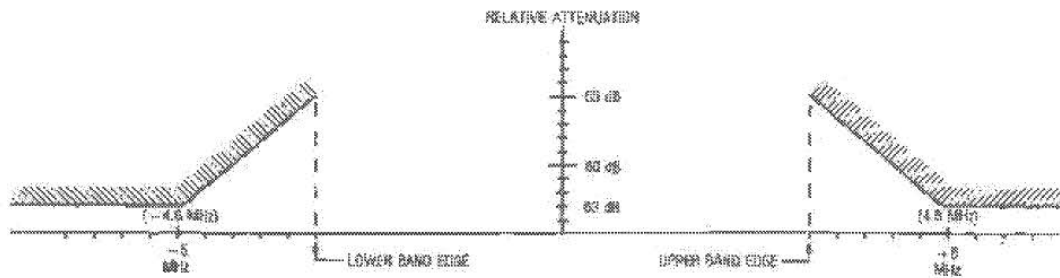

Fig 11-8
Transmit Out-of-Band Power Attenuation

11.3.1.2.8 Collision Enforcement Signal Leakage Requirement. The collision enforcement RF signal leakage to the coaxial cable during data transmission and while the MAU is not enforcing collisions shall be less than 5 dBmV rms. Leakage shall be less than -20 dBmV rms when the MAU is not in the transmission mode.

11.3.1.2.9 Transmit Output Mechanical Requirements. The transmit mechanical interface shall be a 75 Ω female F-series coaxial connector. The connection to the broadband medium shall be through a

coaxial drop cable with a mating male F-series connector. For single cable installations, the same connector may be used for transmit and receive.

11.3.2 MAU Frequency Allocations. The broadband MAU uses a data band 14 MHz wide and an adjacent collision enforcement band 4 MHz wide. A single cable midsplit configuration with a frequency offset of 156.25 MHz or 192.25 MHz between forward and reverse channels is recommended. Other configurations, including dual-cable, where forward and reverse channels are on separate unidirectional cables, also are permitted.* The preferred pairing for the usual North American 6 MHz channels is specified in Table 11.2-1 and Table 11.2-2. The tables also specify the data carrier or collision enforcement center frequency for each band, and for single-cable systems, the frequency translation and the headend local oscillator frequency.

11.3.2.1 Single-Cable Systems Frequency Allocations.* Table 11.2-1 lists the permissible frequency band allocations for single-cable systems. The 192.25 MHz translation is recommended for all new designs. The 156.25 MHz translation is allowed for compatibility with some existing systems. The 156.25 MHz translation results in a reversal of the data and collision enforcement bands, as the lower sideband is used.

11.3.2.2 Dual-Cable Systems Frequency Allocations.* In nontranslated dual-cable systems transmit and receive frequencies are identical. Table 11.2-2 lists the permissible frequency band allocations. In some instances translated dual-cable systems are installed. In such cases the single-cable frequency allocations may be used.

Table 11.2-1
Single-Cable Frequency Allocations (Frequencies in MHz)

TRANSMITTER			RECEIVER			
Data Carrier	Coll Enf Center Freq	Transmit Band	Translation 156.25 MHz		Translation 192.25 MHz	
			Headend Local Osc	Receive Band	Headend Local Osc	Receive Band
48	52	35.75-53.75	245.75	192-210	192.25	228-246
49	58	41.75-59.75	257.75	198-216	192.25	234-252
55	64	47.75-65.75	269.75	204-222	192.25	240-258
+61	70	53.75-71.75	281.75	210-228	192.25	246-264
67	76	59.75-77.75	293.75	216-234	192.25	252-270
73	82	65.75-83.75	305.75	222-240	192.25	258-276

NOTES: (1) Some of these optional bands are overlapping.
(2) Frequency tolerance of the data carrier and headend local oscillator shall each be ± 25 kHz.
(3) + denotes the preferred frequency allocation.

11.3.3 AUI Electrical Characteristics

11.3.3.1 Electrical Isolation Requirements. The MAU must provide isolation between the AUI cable and the broadband coaxial medium. The isolation impedance shall be greater than 250 k Ω at 60 Hz, measured between any conductor (including shield) of the AUI interface cable and either the center conductor or shield of the coaxial cable. The isolation means provided shall be able to withstand 500 Vac rms for one minute.

The MAU power supply, if provided, shall meet the appropriate national requirements. See Reference [8] for guidance.

*The remainder of 11.3.2 and all of 11.3.2.1 and 11.3.2.2 are not part of the ISO standard. Frequency allocations are a subject for national standardization.

Table 11.2-2
Dual-Cable Frequency Allocations (Frequencies in MHz)

Data Carrier	Coll. Enf. Center Freq.	Data Band	Coll. Enf. Band
43	53	36-50	50-54
49	58	42-56	56-60
55	64	48-62	62-66
+61	70	54-68	68-72
67	76	60-74	74-78
73	82	66-80	80-84
236.25	244.25	228-242	242-246
241.25	250.25	234-248	248-252
247.25	256.25	240-254	254-258
253.25	262.25	246-260	260-264
259.25	268.25	252-266	266-270
265.25	274.25	258-272	272-276

NOTES: (1) Some of these optional bands are overlapping.
(2) Frequency tolerance of the data carrier shall be ± 25 kHz.
(3) + denotes the preferred frequency allocations.

11.3.3.2 Current Consumption. The MAU may have its own power supply but is also allowed to use the power supplied by the DTE through the AUI cable. When drawing current from the AUI, the current shall not exceed 0.5 A as provided by the AUI source. The MAU shall be capable of operating from all possible voltage sources as supplied by the DTE through the resistance of all permissible AUI cables. The MAU shall not disrupt the broadband coaxial medium should the DTE power source fall below the minimum operational level under abnormal MAU load conditions. The MAU shall be labeled externally to identify the nominal value of current required by the device at the AUI.

11.3.3.3 Driver and Receiver Requirements. The requirements for AUI cable driver and receiver components within the MAU are identical with those specified in Section 7 of this standard. The drivers shall provide signals that meet the symmetry and jitter requirements of Circuit DI defined in Section 7 and the receivers shall accept signals that have traversed the worst-case lengths of AUI cable.

11.3.3.4 AUI Mechanical Connection. The MAU shall be provided with a 15-pin male connector as specified in detail in the PLS/AUI specifications, in 7.6 of this standard.

11.3.4 MAU Transfer Characteristics. Signals presented on Circuit DO are transformed into signals at the coaxial cable interface by delaying them and by reformatting them. Signals at the coaxial cable interface are transformed into signals on Circuit DI and Circuit CI by a different framing change and by additional delay.

11.3.4.1 AUI to Coaxial Cable Framing Characteristics. Data presented on Circuit DO shall first be received differentially, then Manchester decoded into an NRZ data stream. The framing of the data shall then be transformed into a new packet for presentation to the RF modulator in the following way (see Fig 11-6 and Fig 11-9):

- (1) Up to 5 bits of the incoming data stream may be dropped for detection and Manchester decoding purposes.
- (2) Beginning with the first zero, 20 bits of zero-one pattern shall be sent for receiver synchronization and clock recovery.

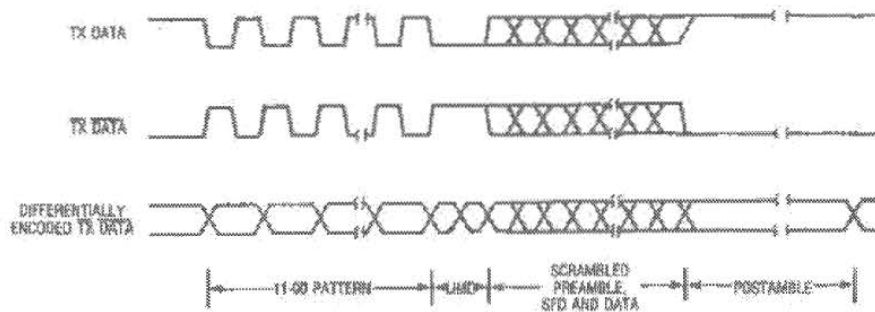

Fig 11-9
Packet Format at Modulator Input

- (3) The next two bits (zero-one in the incoming pattern) shall both be set to zero and form the Unscrambled Mode Delimiter (UMD). The UMD shall take the place of the zero-one in the incoming pattern; it shall not be inserted into the data stream.
- (4) All remaining bits in the preamble, SFD, and data fields shall be scrambled (using a CCITT V.29 scrambler plus a differential encoder per 11.3.4.1).
- (5) A postamble (BEOFD) consisting of a zero followed by 22 ones shall be added immediately after the last scrambled data bit (the postamble is not scrambled). The postamble may be extended to allow controlled turnoff of the transmitted signal, as shown in Fig 11-6.
- (6) All bits (unmodified preamble; UMD; scrambled preamble, SFD, and data; and postamble) are inverted.
- (7) All bits sent to the RF modulator are differentially encoded. Figure 11-9 shows the appearance of the data before and after the differential encoder.
- (8) The SQE Test sequence shall be generated after a successful data transmission by transmitting a collision enforcement RF signal with the timing shown in Fig 11-6.

Because the preamble of the incoming data on Circuit DO is modified, it is assumed that DTEs generate a minimum length preamble of 47 bits. The maximum preamble length is allowed to be 62 bits, as shown in Fig 11-6.

11.3.4.1.1 Scrambler and Differential Encoding Requirements. The NRZ data shall be scrambled (using a CCITT V.29-type scrambler). A new seed shall be used by the scrambler for every new packet presented by the DTE to the MAU. Figure 11-10 is a diagram of a typical scrambler implementation.

The scrambled NRZ data shall be differentially encoded (see Fig 11-11 for a typical implementation).

The entire encoding process comprising the scrambling and differential encoding is essentially equivalent to a division of the polynomial representing the data to be transmitted by the following polynomial:

$$G(x) = 1 + x^{-1} + x^{-18} + x^{-19} + x^{-23} + x^{-26}$$

11.3.4.2 Coaxial Cable to AUI Framing Characteristics. The MAU shall demodulate, differentially decode, and invert the received RF data signal to recover the scrambled and inverted data stream. Clock shall be recovered and a replica of the unfiltered and noninverted transmitted data stream shall be created. The restored data shall be forced to a logic "one" state whenever no RF data signal is detected. This prevents false UMD detection and forces postamble detection when no carrier is present.

The framing information contained in the RF data stream shall be used to reconstruct the received data so that no more than 6 bits are lost and no more than one bit added to the preamble field, and no bits are added to or lost from the end of the transmit data. Detection of the UMD in the receive data shall initiate, after a fixed delay, a locally generated preamble sequence of zero-one pattern. This pattern "fills in" the preamble bits altered due to the framing information at the beginning of the packet: the zero-one synchronization and clock recovery sequence, the UMD, and the descrambler synchronization sequence.

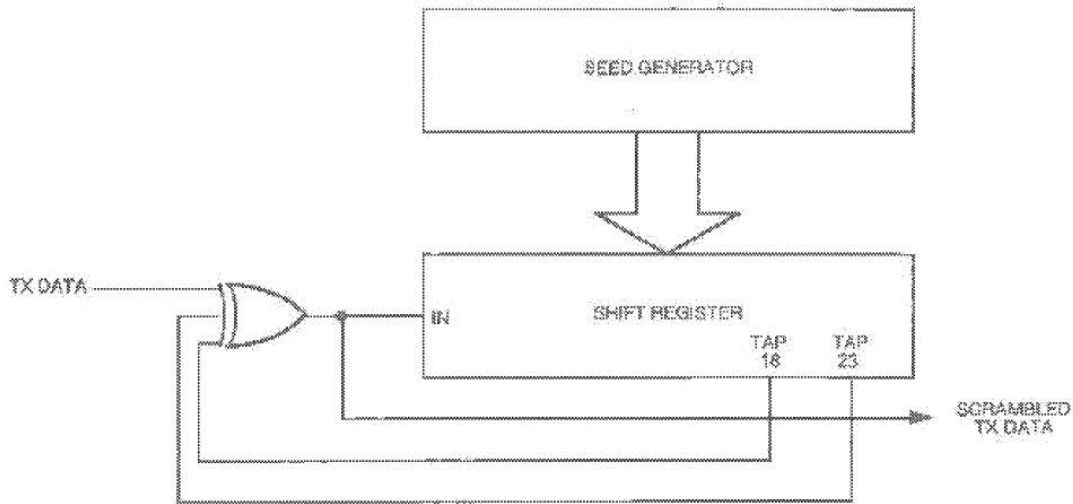

Fig 11-10
Scrambler

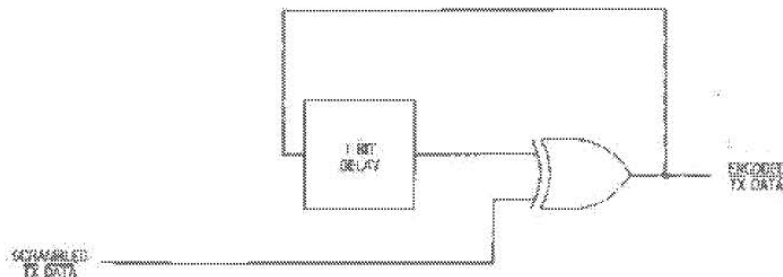

Fig 11-11
Differential Encoder

The MAU shall descramble the received data using a self-synchronizing (CCITT V.29-type) descrambler. No prior knowledge of the seed used by the scrambler shall be assumed by the descrambler circuit. The descrambler shall have valid output no later than 28 bit intervals after the UMD is detected by the receiver. An example of a descrambler is shown in Fig 11-12. The differential decoding performed by the demodulator and the descrambling function are essentially equivalent to multiplying the received polynomial by $G(x)$ as defined in the scrambling and differential encoding requirements subsection above.

After the descrambler is synchronized, 23 bits after the UMD, the correctly descrambled receive data, starting with the 24th bit after the UMD, shall be transferred to the Manchester encoder and therefrom to the AUI. The delay from the detection of the UMD to the beginning of the locally generated zero-one pattern shall be chosen so that no more than 6 bits of preamble are lost, and no more than one bit added, in transmission from Circuit DO to Circuit DI.

The MAU shall detect the "zero" followed by 22 "ones" (the postamble pattern) and, in conjunction with the loss of carrier detection in the data band or the presence of a collision enforcement detection signal, shall ensure that the packet presented to the local DTE has no extraneous bits added by the MAU to the end of the packet.

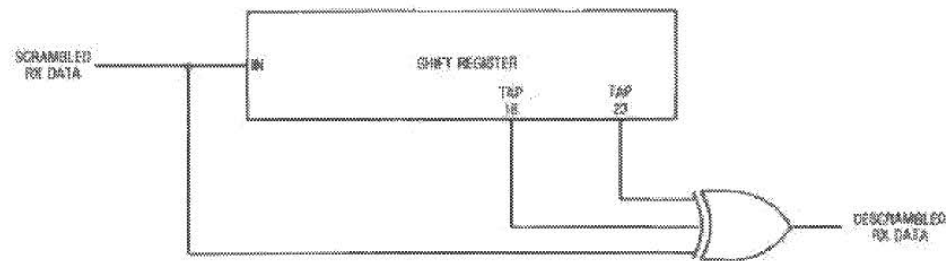

Fig 11-12
Descrambler

The SQE Test signal shall be detected on the RF interface and the SQE signal shall be presented to Circuit CI of the transmitting MAU, subject to the timing restrictions of 11.3.4.5.4. If the signal is not observed at the RF interface due to failure of any element in the transmitter or receiver, no SQE signal may be presented to the AUI. In the event of a collision enforcement, energy will appear in the collision enforcement band within the *ced_window* time after energy first appears in the data band. Circuit CI shall be asserted when collision enforcement is first detected and shall continue to be active until after the RF signal on the RF port has subsided. Note that an SQE Test signal appended to a packet whose length is less than the *ced_window* time (less than the minimum allowed packet length) will be indistinguishable from a collision enforcement, except by the MAU transmitting. The transmitting MAU shall take this into account and shall not interpret energy in the collision enforcement band to be a collision when the length of the transmitted packet is less than the *ced_window* time and the SQE Test sequence has been transmitted. See the discussion in 11.4.2 for more information on *ced_window*.

11.3.4.3 Circuit DO to Circuit DI Framing Characteristics. In the absence of a collision, the packet format of the receive data at the AUI is identical to that of the transmit data, except that there may be one more preamble bit than was sent at the transmit port and up to 6 bits of the preamble lost. In the presence of a collision, the receive data is undefined, but shall still be properly Manchester encoded.

11.3.4.4 AUI to Coaxial Cable Delay Characteristics. The timing and delays associated with the transmitter of the MAU are identified below. To ensure compatibility with all MAUs the delays identified below cannot be exceeded nor traded off with other delays in the system.

11.3.4.4.1 Circuit DO to RF Data Signal Delay. The delay from a transition on Circuit DO at the end of a bit to the corresponding phase change of the RF data signal (such bit chosen so that an RF burst phase change does exist) shall be no more than 24 bit times. The delay from the first transition on Circuit DO to the first appearance of RF energy, however, is not specified except as it is determined by other timing constraints.

11.3.4.4.2 Circuit DO to CE RF Output Delay. In the event that the MAU begins receiving energy on the coaxial medium just before the DTE presents data to the AUI, a collision shall be detected locally, as described in Fig 11-4. The delay from the first bit at Circuit DO of the AUI to the presentation of collision enforcement at the coaxial cable interface in this circumstance shall be 32 bit times maximum.

11.3.4.4.3 Transmit Postamble to SQE Test Signal Delay. The delay from the initial transition of the first bit of the postamble (Broadband End of Frame Delimiter) measured at the RF port to the 50% point of the rising edge of the SQE Test signal shall be 35 ± 3 bit times.

11.3.4.4.4 SQE Test Signal Length. The SQE Test signal length shall be 30 ± 1 bit times as measured at the 50% points of the RF signal.