



US005568525A

United States Patent [19] de Nijs et al.

[11] Patent Number: **5,568,525**
[45] Date of Patent: **Oct. 22, 1996**

[54] SYSTEM AND METHOD FOR CONNECTION OF MULTIPLE PROTOCOL TERMINALS

[75] Inventors: **Richard H. J. de Nijs; Charles L. Haymes; Dale T. Ulmer**, all of Raleigh, N.C.

[73] Assignee: **International Business Machines Corporation**, Armonk, N.Y.

[21] Appl. No.: **109,185**

[22] Filed: **Aug. 19, 1993**

[51] Int. Cl.⁶ **H04L 7/00**

[52] U.S. Cl. **375/356; 370/85.5; 370/85.14**

[58] Field of Search **375/106, 107, 375/108, 359; 370/100.1, 103, 105.2, 95.1, 95.3, 85.1, 85.5, 85.12, 85.14**

[56] References Cited

U.S. PATENT DOCUMENTS

4,696,001	9/1987	Gagliardi et al.	370/100.1 X
4,805,169	2/1989	Van Asselt	370/100.1 X
4,955,020	9/1990	Stone et al.	375/107 X
5,012,470	4/1991	Shobs et al.	370/110.1
5,228,030	7/1993	Dresher	375/108 X

OTHER PUBLICATIONS

IBM, TDB, vol. 29, No. 9, Feb. 1987, pp. 3776-3778.
IBM, TDB, Jul., 1986, pp. 892-900.

Primary Examiner—Stephen Chin
Assistant Examiner—Bryan E. Webster
Attorney, Agent, or Firm—Stephen T. Keohane

[57] ABSTRACT

A network port configurator device for automatically configuring a system having network workstations and corresponding network equipment of various physical protocols. The network port configurator comprises a plurality of input and output ports for receiving physical wiring to which the workstations and network equipment are attached. Detection circuitry attached to the input and output ports determine the physical protocol of the attached workstations and network equipment by determining a characteristic of the attached equipment. Examples of identifying characteristics include a characteristic impedance, a characteristic voltage, and a characteristic cable identification of the workstation. Logic circuitry uses this information to control a circuit switching mechanism that connects the input ports to the output ports.

20 Claims, 5 Drawing Sheets

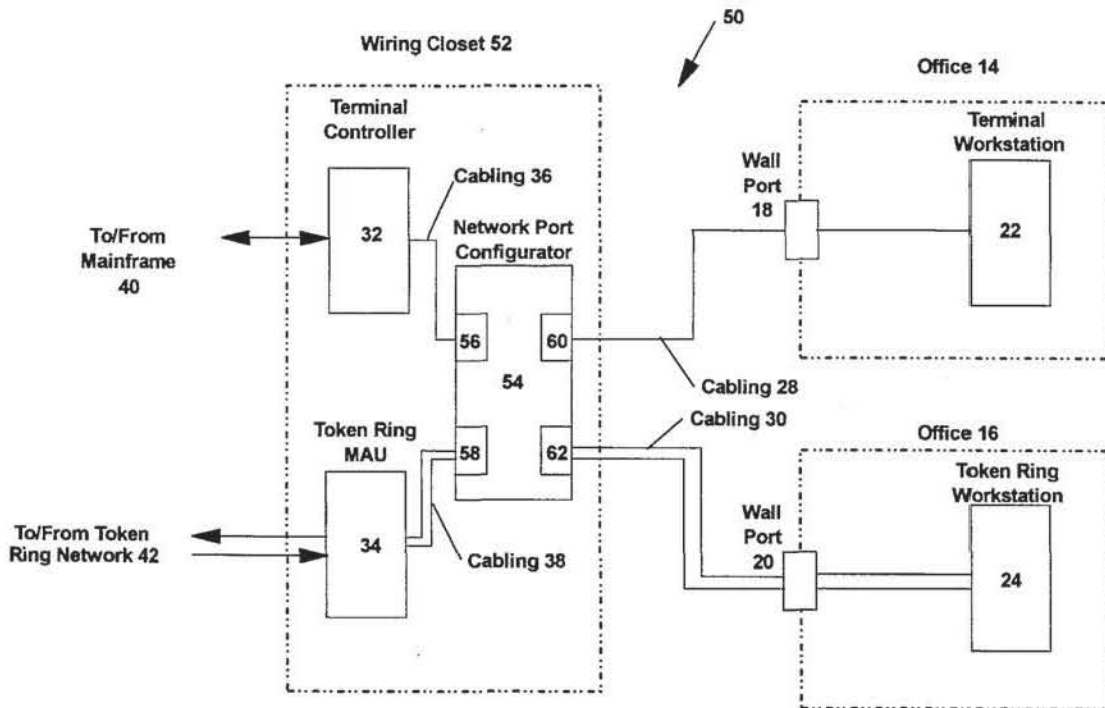

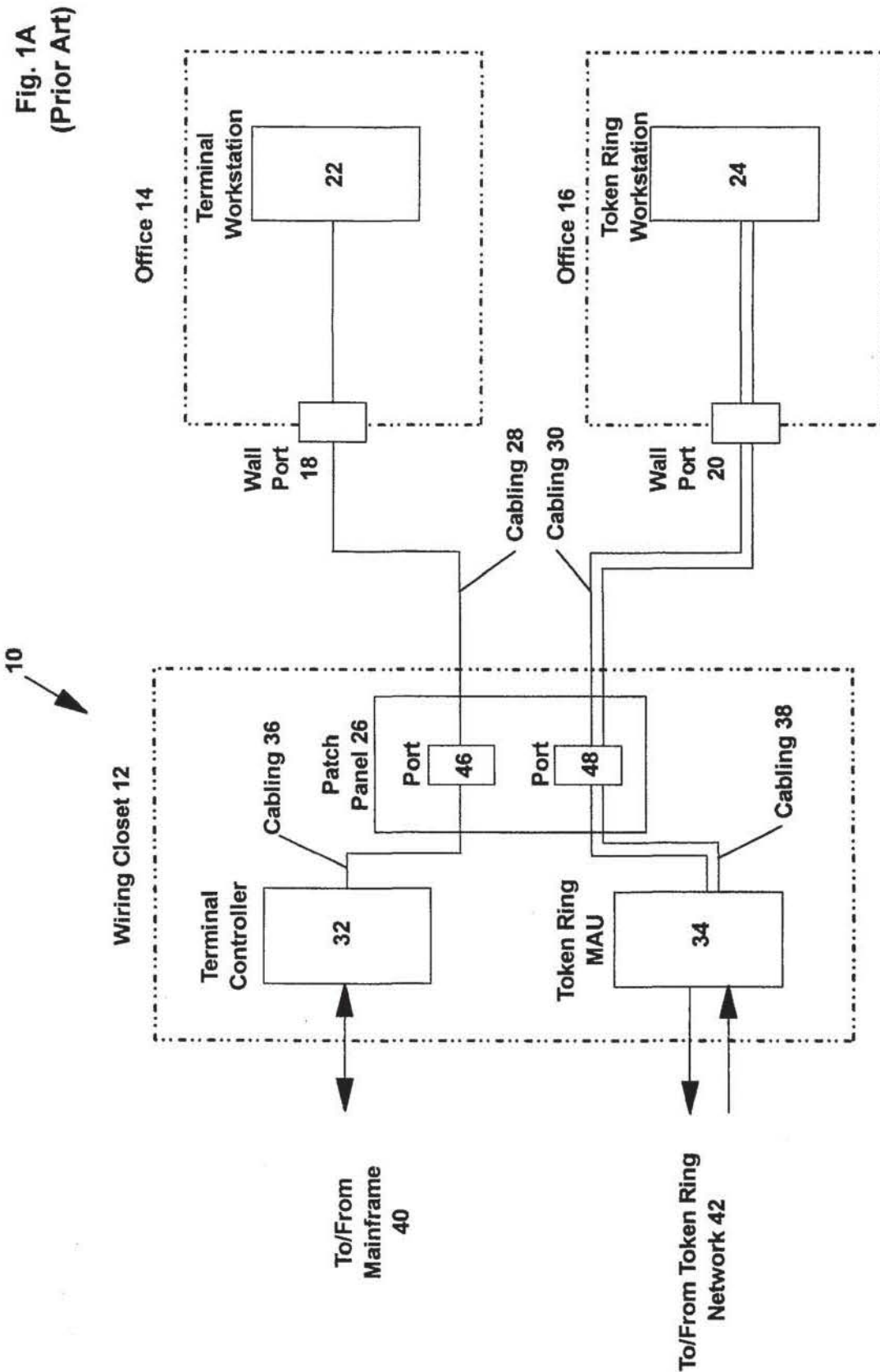

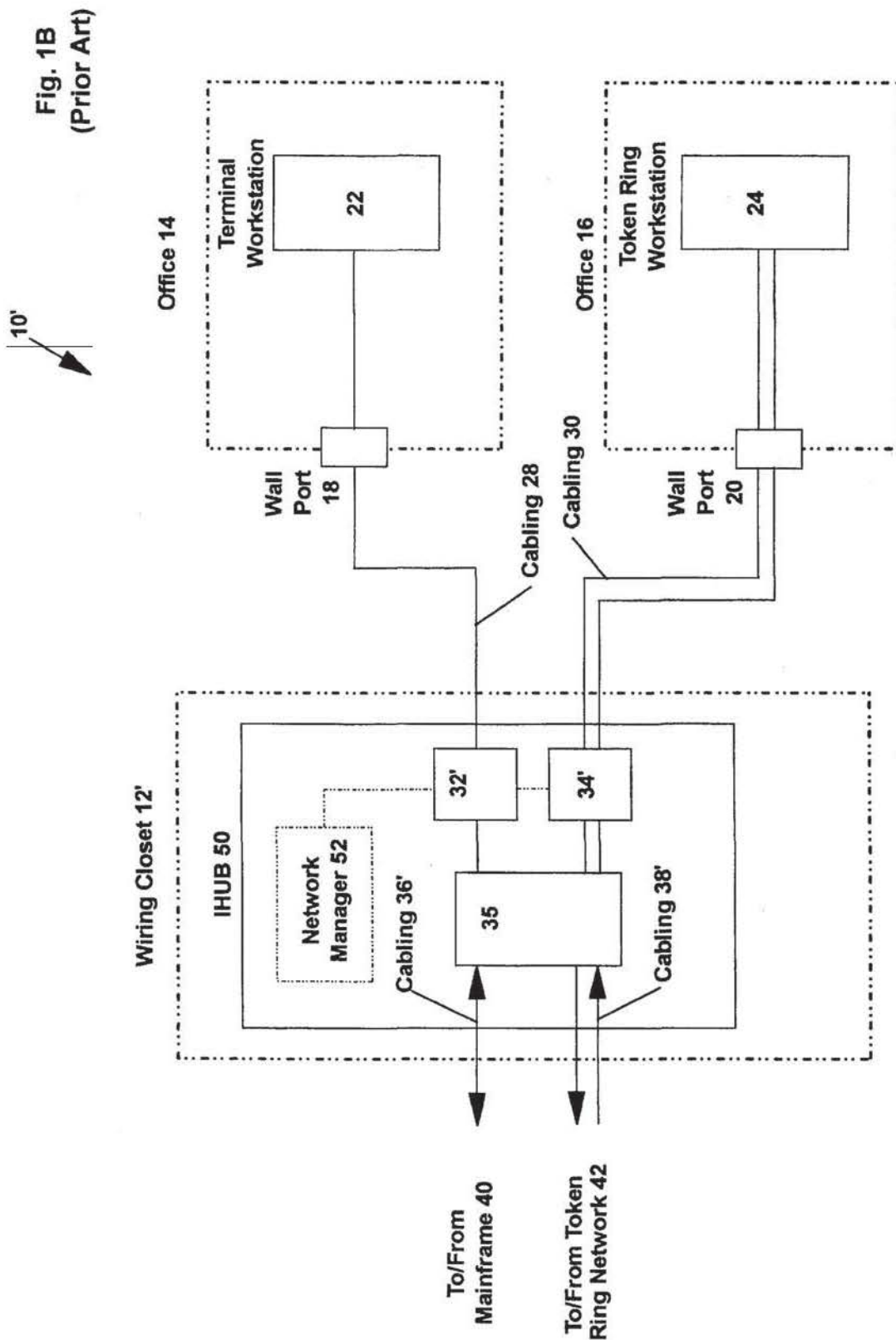

Fig. 2

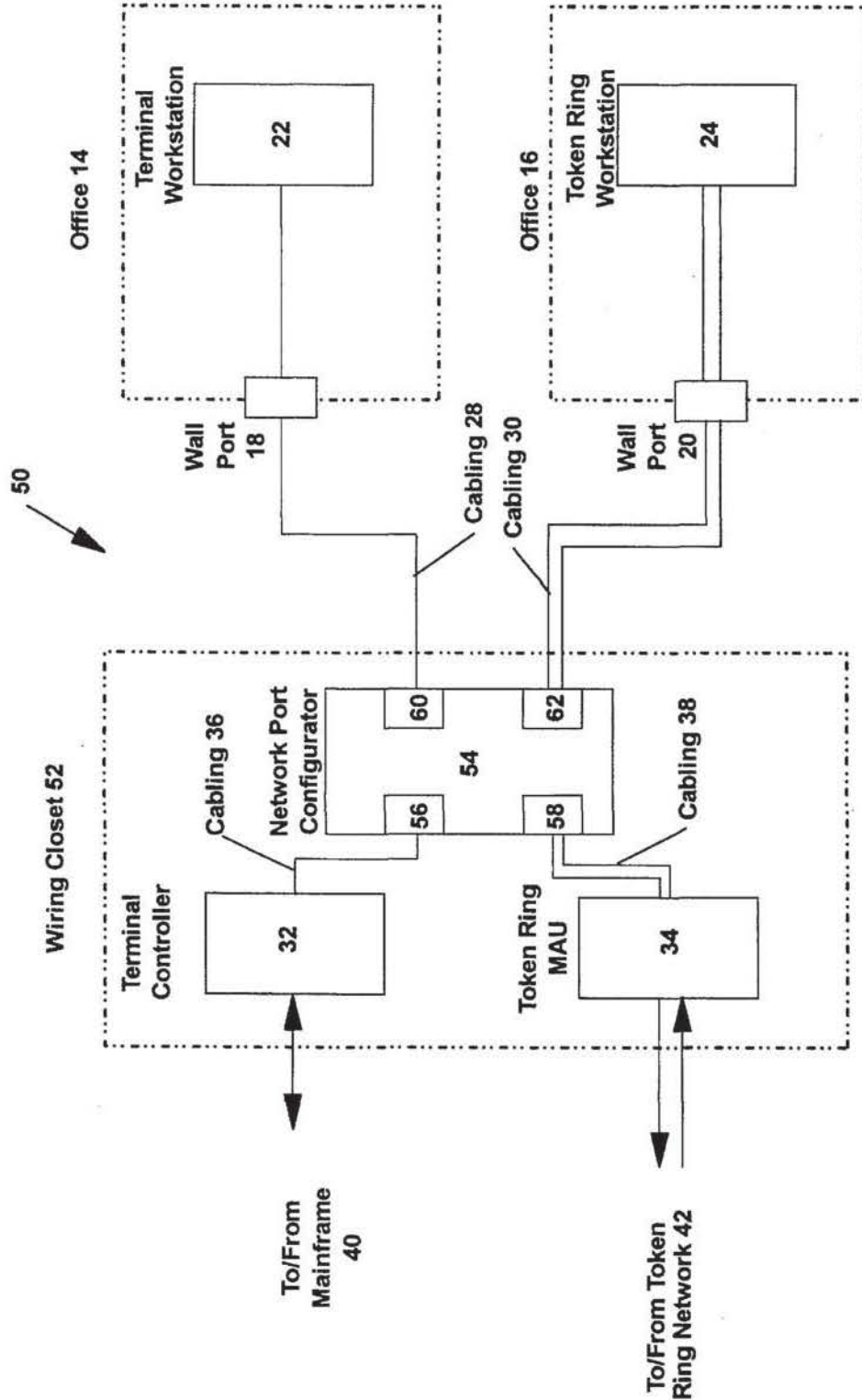

Fig. 3B

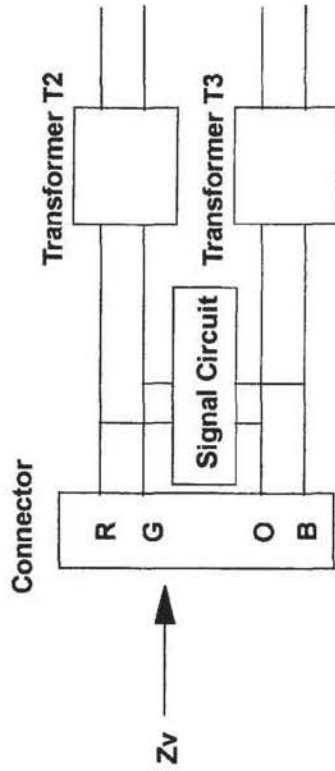

Fig. 3A

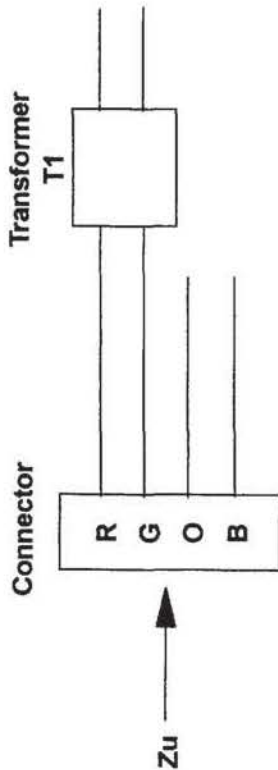
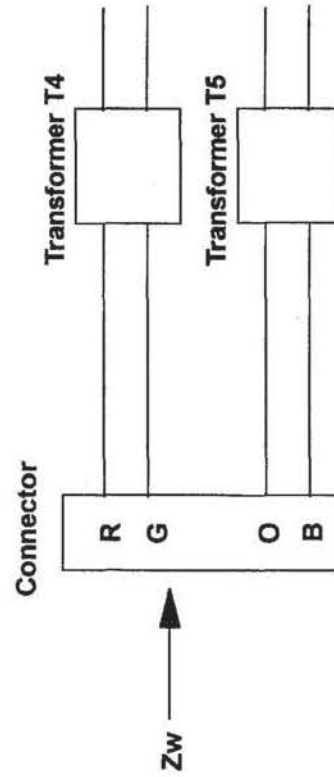

Fig. 3C



Explore Litigation Insights

Docket Alarm provides insights to develop a more informed litigation strategy and the peace of mind of knowing you're on top of things.

Real-Time Litigation Alerts



Keep your litigation team up-to-date with **real-time alerts** and advanced team management tools built for the enterprise, all while greatly reducing PACER spend.

Our comprehensive service means we can handle Federal, State, and Administrative courts across the country.

Advanced Docket Research



With over 230 million records, Docket Alarm's cloud-native docket research platform finds what other services can't. Coverage includes Federal, State, plus PTAB, TTAB, ITC and NLRB decisions, all in one place.

Identify arguments that have been successful in the past with full text, pinpoint searching. Link to case law cited within any court document via Fastcase.

Analytics At Your Fingertips



Learn what happened the last time a particular judge, opposing counsel or company faced cases similar to yours.

Advanced out-of-the-box PTAB and TTAB analytics are always at your fingertips.

API

Docket Alarm offers a powerful API (application programming interface) to developers that want to integrate case filings into their apps.

LAW FIRMS

Build custom dashboards for your attorneys and clients with live data direct from the court.

Automate many repetitive legal tasks like conflict checks, document management, and marketing.

FINANCIAL INSTITUTIONS

Litigation and bankruptcy checks for companies and debtors.

E-DISCOVERY AND LEGAL VENDORS

Sync your system to PACER to automate legal marketing.